

# RADIO NEWS

APRIL  
1948  
35c  
In Canada 40c

W9UIG



# N. U. BATTERIES

*by the Carload!*



## Get Immediate Deliveries of All Types for Standard Radio and Other Replacements

Now you can bring many thousands of good, serviceable battery-powered radio sets *back to life*. Portables—Farm Radios—"carry-about" sets! Here are the batteries you need to bring in this flood of profitable service and parts business. Order now and *tell* your customers to come on the run for the batteries they need.

In batteries as in other products, N. U. quality helps you build for the future. The patented construction of N. U. Batteries permits more active materials—more service hours per dollar. Every N. U. Battery is engineered to the highest initial equipment standards and is designed for universal replacement.

**PLACE YOUR BATTERY ORDER TODAY—with YOUR N. U. DISTRIBUTOR**

*Renew with N. U. . . .* the quality line that brings repeat sales at full profit to radio service men!

**NATIONAL UNION RADIO CORPORATION, Newark 2, New Jersey**

## NATIONAL UNION RADIO TUBES AND PARTS

Transmitting, Cathode Ray, Receiving, Special Purpose Tubes • Condensers • Volume Controls • Photo Electric Cells • Panel Lamps • Flashlight Bulbs



# I WILL TRAIN YOU TO START A SPARE TIME OR FULL TIME RADIO SERVICE BUSINESS WITHOUT CAPITAL

**J. E. SMITH**  
PRESIDENT  
National Radio  
Institute  
32nd Year of  
Training Men  
for Success  
in Radio



## You Build These and Many Other Radio Circuits with 6 Kits of Parts I Supply

By the time you've conducted 60 sets of Experiments with Radio Parts I supply, made hundreds of measurements and adjustments, you'll have valuable PRACTICAL Radio experience for a good full or part-time Radio job!

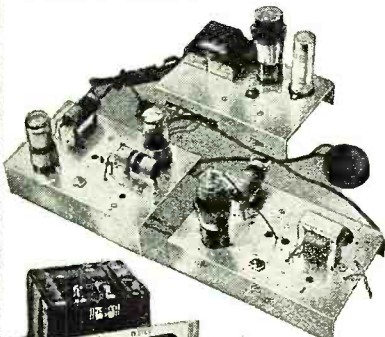

You build the **SUPERHETERODYNE CIRCUIT** above containing a preselector oscillator-mixer-first detector, I.F. stage, diode-detector-a.v.c. stage and audio stage. It will bring in local and distant stations. Get the thrill of learning at home evenings in spare time while you put the set through fascinating tests!

You build **MEASURING INSTRUMENT** above early in Course, useful for Radio work to pick up EXTRA spare time money. It is a vacuum tube multimeter, measures A.C., D.C., R.F. volts, D.C. currents, resistance, receiver output.

Building the **A. M. SIGNAL GENERATOR** at right will give you valuable experience. Provides amplitude-modulated signals for test and experimental purposes.



The men at the right are just a few of many I have trained, at home in their spare time, to be Radio Technicians. They are now operating their own successful spare time or full time Radio businesses. Hundreds of other men I trained are holding good jobs in practically every branch of Radio, as Radio Technicians or Operators. Doesn't this PROVE that my "50-50 Method" of training can give you, in your spare time at home, BOTH a thorough knowledge of Radio principles and the PRACTICAL experience you need to help you make more money in the fast-growing Radio industry?

Let me send you facts about rich opportunities in the busy Radio field. See how knowing Radio can give you security, a prosperous future... lead to jobs coming in Television and Electronics. Send the coupon NOW for FREE 64-page illustrated book, "Win Rich Rewards in Radio." Read how N.R.I. trains you at home in spare time. Read how you practice building, testing, repairing Radios with SIX BIG KITS of Radio parts I send as part of your Course.

### Future for Trained Men is Bright in Radio, Television, Electronics

The Radio Repair business is booming NOW. There is good money fixing Radios in your spare time or own full time business. And trained Radio Technicians also find wide-open opportunities in Police, Aviation and Marine Radio, in Broadcasting, Radio Manufacturing, Public Address work, etc. Send for free book which pictures your present and future opportunities.

Think of the boom coming now that new Radios can be made! Think of the backlog of business built up in all branches of Radio! And think of even greater opportunities when Television and Electronics are available to the public! Use only a few hours of your spare time each week to get into Radio NOW. You may never again see the time when it will be so easy and profitable to get started. Mail coupon for complete information.

### Many Beginners Soon Make \$5, \$10 a Week EXTRA in Spare Time

The day you enroll I start sending EXTRA MONEY JOB SHEETS to help you make EXTRA money fixing Radios in spare time while learning. You LEARN Radio principles from my easy-to-grasp Lessons -- PRACTICE what you learn by building real Radio Circuits with the six kits of Radio parts I send--USE your knowledge to make EXTRA money while getting ready for a good full time Radio job.

### Find Out What N.R.I. Can Do for YOU

MAIL THE COUPON for your FREE copy of my 64-page book. It's packed with facts about opportunities for you. Read the details about my Course. See the fascinating jobs Radio offers. See how you can train at home. Read letters from men I trained, telling what they are doing, earning. No obligation. Just MAIL COUPON in an envelope or paste it on a penny postal. **J. E. SMITH, President, Dept. 6DR, National Radio Institute, Pioneer Home Study Radio School, Washington 9, D. C.**

### I Trained These Men

### SPARE TIME RADIO BUSINESS



"I have a spare time Radio and very profitable, due to the efficient training I received from your Course. Last year I averaged over \$50 a month."  
—FRED H. GRIFFIE, Route 3, Newville, Pa.

"I am doing radio work in my spare time, and find it a profitable hobby. My extra earnings run about \$10 a week. I certainly am glad I took your N.R.I. Course." —FERDINAND ZIRBEL, Chaseley, North Dakota.



"About six months after I enrolled I started making extra money in radio. I am a farmer and just work on radios one evening and stormy days. That brought me a profit of \$600 in the last year."  
—BENNIE L. ARENDS, RFD 2, Alexander, Iowa.

### I Trained These Men

### FULL TIME RADIO BUSINESS



"Not long ago I was working 16 hours a day in a filling station at \$10 a week. Now I have my own radio business and average over \$60 a week. The N.R.I. course is fine."  
—ALBERT C. CHRISTENSEN, 1116-10th Avenue, Sidney, Neb.

"Previous to enrolling for your Radio training I made \$12 per week in a repair shop. Now I operate my own a week."  
—FREDERICK BELLA, 76 Golf Ave., St. Johns, Newfoundland.



"Am making over \$50 a week profit from my own shop. Have another N.R.I. graduate working for me. I like to hire N.R.I. men because they know radio."  
—NORMAN MILLER, Hebron, Neb.

## SAMPLE LESSON FREE

I will send you a FREE Lesson, "Getting Acquainted with Receiver Servicing," to show you how practical it is to train for Radio at home in spare time. It's a valuable lesson. Study it—keep it—use it—without obligation! Tells how Superheterodyne Circuits work, gives hints on Receiver Servicing, Locating Defects, Repair of Loudspeaker, I.F. Transformer, Gang Tuning, Condenser, etc. 31 illustrations.



**My Radio Course Includes  
TELEVISION • ELECTRONICS  
FREQUENCY MODULATION**

April, 1946

## GOOD FOR BOTH 64 PAGE BOOK SAMPLE LESSON FREE

**J. E. SMITH, President, Dept. 6DR  
National Radio Institute, Washington 9, D. C.**

Without obligating me, mail your Sample Lesson and 64-page book FREE. I am particularly interested in the branch of Radio checked below. (No salesman will call. Please write plainly.)

- |   |  |
|---|--|
| <input type="checkbox"/> Radio Service Business of My Own                   | <input type="checkbox"/> Aviation Radio                  |
| <input type="checkbox"/> Service Technicians for Radio Stores and Factories | <input type="checkbox"/> Operating Broadcasting Stations |
| <input type="checkbox"/> Spare Time Radio Servicing                         | <input type="checkbox"/> Army, Navy Radio Jobs           |
| <input type="checkbox"/> Government Civilian Radio                          | <input type="checkbox"/> Operating Police Radio Stations |
|   | <input type="checkbox"/> Operating Ship and Harbor Radio |

(If you have not decided which branch you prefer—mail coupon for facts to help you decide.)

Name..... Age.....

Address.....

City..... Zone..... State..... 4FR

If you are a war veteran, check here.



**AMATEUR**

A Precision Frequency Standard.....*Merl Saxon* 36  
 Microwave Pulse Modulation for Ham Communications....*R. Endall* 41  
 100 Watt-28 mc. Transmitter.....*Nicholas Lefor, W2BIQ* 50  
 Class "C" Grid Bias Modulation.....*W. W. Smith, W6BCX* 55

**SERVICE**

The Aircraft Radio Serviceman.....*Tony Wayne* 28  
 High-Fidelity All Purpose Amplifier....*R. T. Rogers and M. Putman* 32  
 Serviceman's Recording Studio.....*Russell Paige* 35  
 Practical Radio Course.....*Alfred A. Ghirardi* 46  
 Additional Notes on R.F.-I.F.-A.F. Signal Tracer....*Vincent Cavaleri* 66

**GENERAL**

For the Record.....*The Editor* 8  
 Spot Radio News.....*Fred Hamlin* 12  
 Radar Reaches the Moon.....*Tom Gootée* 25  
 Direct-Wire Television.....*Herbert E. Taylor, Jr.* 38  
 International Short-Wave.....*Kenneth R. Boord* 45  
 QTC.....*Carl Coleman* 49  
 Saga of the Vacuum Tube.....*Gerald F. J. Tyne* 52  
 What's New in Radio..... 62  
 Letters from our Readers..... 96  
 Technical Book and Bulletin Review..... 100  
 Within the Industry..... 122

**EDITORIAL**

- OLIVER READ, W9ETI**  
*Editor*
- WM. A. STOCKLIN**  
*Asst't to the Editor*
- H. S. RENNE, Ex. W8PTS**  
*Technical Editor*
- RAY FRANK, W9JU**  
*Amateur Radio*
- FRED HAMLIN**  
*Washington Editor*
- E. H. SEHNERT**  
*Chief Draftsman*
- R. S. KUPJACK**  
*Staff Artist*

**ADVERTISING**

- L. L. OSTEN**  
*Advertising Mgr.*
- JOHN A. RONAN, JR.**  
*Midwest Adv. Mgr.*
- WM. L. PINNEY**  
*Western Adv. Mgr.*



**Cover Photo**  
By **ARTHUR HAUG**

**Bill Shaw, W9UIG**, among the first hams back on the air, operates with 500 watts phone using a 3 element beam antenna. His receiver is a Hammarlund HQ120X. Other equipment includes a Meissner Signal Shifter and an RME DB20 pre-selector.

**COPYRIGHT, 1946 ZIFF-DAVIS PUBLISHING COMPANY**  
185 N. Wabash Ave., Chicago 1, Ill.

BRANCH OFFICES: NEW YORK, WASHINGTON, LOS ANGELES, TORONTO



- |  |   |   |
|--|---|---|
| <b>WILLIAM B. ZIFF</b><br><i>Publisher</i>     | <b>C. R. TIGHE</b><br><i>Ass't to the Publisher</i> | <b>GEORGE BERNER</b><br><i>Advertising Director</i>   |
| <b>B. G. DAVIS</b><br><i>General Manager</i>   | <b>H. G. STRONG</b><br><i>Circulation Director</i>  | <b>H. J. MORGANROTH</b><br><i>Production Director</i> |
| <b>HERMAN R. BOLLIN</b><br><i>Art Director</i> |   |   |

RADIO NEWS is published monthly by the Ziff-Davis Publishing Company, 185 N. Wabash Ave., Chicago 1, Ill. Subscription Rates: in U. S. \$3.00 (12 issues), single copies 35 cents; in Mexico, South and Central America, and U. S. Possessions, \$3.00 (12 issues); in Canada \$3.50 (12 issues), single copies 40 cents; in British Empire, \$4.00 (12 issues); all other foreign countries \$4.00 (12 issues). Subscribers should allow at least 2 weeks for change of address. All communications about subscriptions should be addressed to: Director of Circulation, 185 N. Wabash Ave., Chicago 1, Ill. Entered as second class matter March 9, 1938, at the Post Office, Chicago, Illinois, under the Act of March 3, 1879. Entered as second class matter at the Post Office Dept., Ottawa, Canada. Contributors should retain a copy of contributions and include return postage. Contributions will be handled with reasonable care but this magazine assumes no responsibility for their safety. Accepted material is subject to whatever revisions and by-line changes that are necessary. Payment, made at our current rates, covers all authors', contributors', or contestants' rights, title, and interest in and to accepted material, including photos and drawings.

Other Ziff-Davis Publications: Radio & Appliances, Radio-Electronic Engineering, Plastics, Flying, Popular Photography

# hallicrafters *new Model* S-40

New beauty and perfect ventilation in the perforated steel top

Separate electrical bandsread with inertia flywheel tuning.

Tuning range from 540 kc to 42 Mc continuous in four bands

Self-contained, shock mounted, permanent magnet dynamic speaker

All controls logically grouped for easiest operation. Normal position for broadcast reception marked in red, making possible general use by whole family.

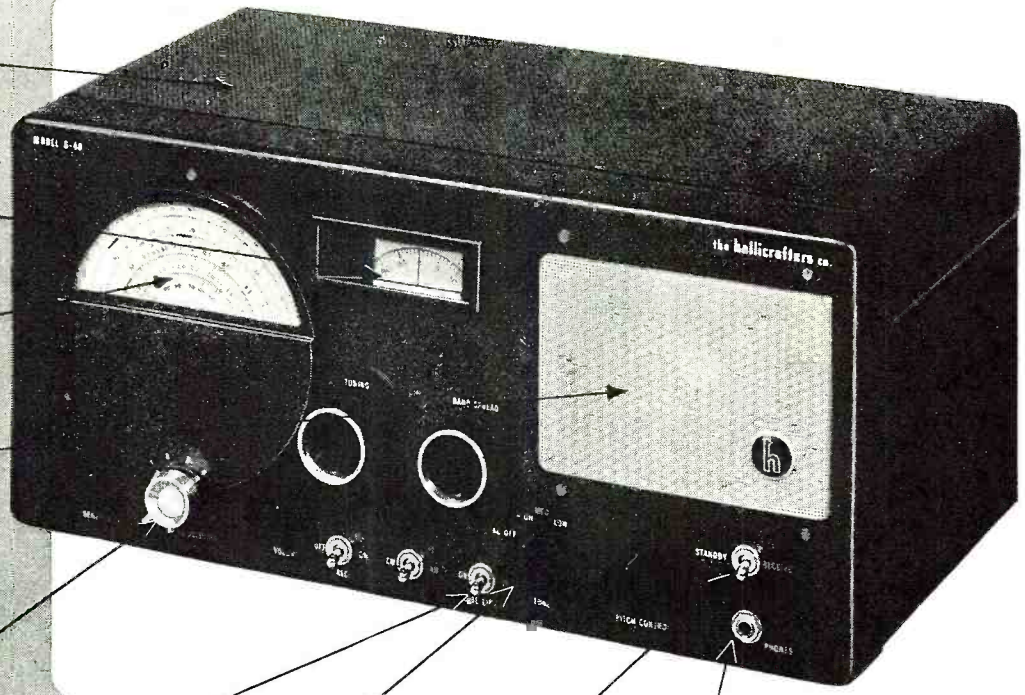

Automatic noise limiter

3-position tone control

Standby receive switch

Phone jack

(APPROXIMATELY)  
**New design, new utility in a great \$79<sup>50</sup>**  
**new communications receiver . . .**

Here is Hallicrafters new Model S-40. With this great communications receiver, handsomely designed, expertly engineered, Hallicrafters points the way to exciting new developments in amateur radio. Read those specifications . . . it's tailor-made for hams. Look at the sheer beauty of the S-40 . . . nothing like it to be seen in the communications field. Listen to the amazing performance . . . excels anything in its price class. See your local distributor about when you can get an S-40.

**INSIDE STUFF:** Beneath the sleek exterior of the S-40 is a beautifully engineered chassis. One stage of tuned radio frequency amplification, the S-40 uses a type 6SA7 tube as converter mixer for best signal to noise ratio. RF coils are of the permeability adjusted "micro-set" type identical with those used in the most expensive Hallicrafters receivers. The high frequency oscillator is temperature compensated for maximum stability.

*From every angle the S-40 is an ideal receiver for all high frequency applications.*

## hallicrafters RADIO

THE HALLICRAFTERS CO., MANUFACTURERS OF RADIO AND ELECTRONIC EQUIPMENT, CHICAGO 16, U. S. A.

Sole Hallicrafters Representatives in Canada: Rogers Majestic Limited, Toronto - Montreal

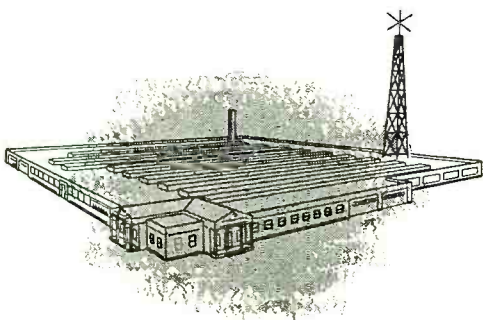

COPYRIGHT 1945 THE HALLICRAFTERS CO.

April, 1946

On the march with

**FADA**

The RADIO of Tomorrow — today

1946 MODELS NOW IN PRODUCTION



FADA 6 tube models are equipped with the new FADA "Sensitive-Tone" assuring greater sensitivity and clearer reception.

**MODEL 1001**

In Beautiful Walnut Wood Cabinet with Noise Reducing R.F. Stage.  
8 tubes with 8 tube performance. Features include Slide Rule Dial; FADA-SCOPE built-in LOOP ANTENNA; Automatic Volume Control; Beam Power Output System and New Wonder Speaker ALNICO V.

**1000 SERIES**

6 Tube A.C.-D.C. Superheterodynes . . . In Gemlike "FADA-LUCENT" Cabinets with the New Gemoid Illuminated Dial and Noise Reducing R.F. Stage.  
8 tube performance with 6 full working tubes; FADA-SCOPE built-in loop ANTENNA; Beam Power Output System; Automatic Volume Control; New Wonder Speaker ALNICO V. Housed in beautiful "FADA-LUCENT" Cabinets in Five Gorgeous COLOR COMBINATIONS resembling precious stones.

**652 SERIES**

6 Tube A.C.-D.C. Superheterodynes with the R.F. Noise Reducing Stage with Slide Rule Dial in Gemlike "FADA-LUCENT" Cabinets.  
6 tube radio with 8 tube performance. Features include the new Lock in type tubes; Beam Power Output System; New Wonder Speaker ALNICO V; Automatic Volume Control and FADA-SCOPE built-in LOOP ANTENNA. Housed in beautiful "FADA-LUCENT" Cabinets in Five Gorgeous COLOR COMBINATIONS resembling precious stones.

**MODEL 1002**

6 Tube Superheterodynes in Rich Walnut Wood Cabinet with R.F. Noise Reducing Stage.  
6 tubes with 8 tube performance. Uses standard preferred type tubes; Beam Power Output System; FADA-SCOPE built-in LOOP ANTENNA; Automatic Volume Control; Illuminated Golden Glo Dial; New Wonder Speaker ALNICO V.

**MODEL 605W**

In Handsome Walnut Plastic Cabinet.  
5 tube A.C.-D.C. Superheterodyne with 7 tube performance. Features include Horizontal type Slide Rule Dial; FADA-SCOPE built-in LOOP ANTENNA; Automatic Volume Control; New Wonder Speaker ALNICO V; Beam Power Output System.

**609 SERIES**

A.C.-D.C. Superheterodynes  
5 tubes with 7 tube performance. Uses standard preferred type tubes; Beam Power Output System; FADA-SCOPE built-in LOOP ANTENNA for noise-free reception. Just plug in and play! Automatic Volume Control; Illuminated Golden Glo Dial; New Wonder Speaker ALNICO V. Available in Walnut or Ivory Plastic Cabinets.

The name FADA has been synonymous with fine radio receivers since broadcasting began. Behind the name FADA lies 25 years of experience in building radios . . . PLUS 25 years of consistent advertising and sales promotion which have created unusual consumer acceptance.

The new FADA line is an achievement in tone quality and in beauty of design. FADA performance reaches peaks never before approached.

A part of the new 1946 line of FADA radio receivers is illustrated here.

YOU CAN ALWAYS DEPEND ON

**FADA**  
Radio

Famous Since Broadcasting Began!

FADA RADIO AND ELECTRIC COMPANY, INC., LONG ISLAND CITY, N. Y.

# I'LL SHOW YOU HOW TO SUCCEED IN RADIO

Here's the right training for Big Post-War Pay!

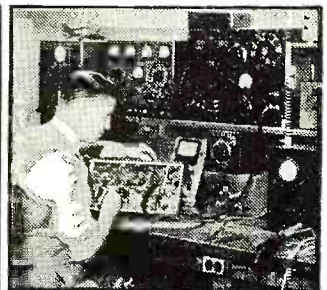
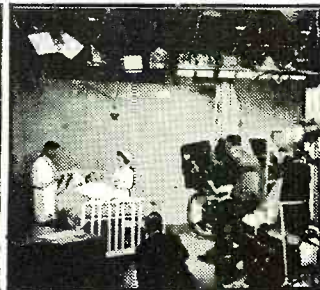

A RADIO SERVICE BUSINESS OF YOUR OWN

A GOOD JOB IN RADIO & TELEVISION BROADCASTING

RADIO-ELECTRONIC SERVICE ENGINEER



F. L. Sprayberry, one of the country's foremost Radio Teachers.

## BE A RADIO-ELECTRONICIAN

NOW YOU CAN PREPARE AT HOME IN SPARE TIME FOR AMAZING OPPORTUNITIES AHEAD IN RADIO — ELECTRONICS — TELEVISION



I SUPPLY A FULL RADIO SET for practical easy LEARNING

SPRAYBERRY TRAINING GIVES YOU BOTH TECHNICAL KNOWLEDGE—SKILLED HANDS

There's only one right way to learn Radio Electronics. You must get it through simplified lesson study combined with actual "shop" practice under the personal guidance of a qualified Radio Teacher. It's exactly this way that Sprayberry trains you... supplying real Radio parts for learn-by-doing experience right at home. Thus, you learn faster, your understanding is clear-cut, you acquire the practical "know how" essential to a good-paying Radio job or a Radio business of your own.

I'll Show You a New, Fast Way to Test Radio Sets Without Mfg. Equipment

The very same Radio Parts I supply with your Course for gaining Pre-experience in Radio Repair work may be adapted through an exclusive Sprayberry wiring procedure to serve for complete, fast, accurate Radio Receiver trouble-shooting. Thus, under Sprayberry methods, you do not have one cent of outlay for manufactured Test Equipment which is not only expensive but scarce.

Read What Graduate Says "One Job Nets About \$26.00"

"Since last week I fixed 7 radios, all good paying jobs and right now I am working on an amplifier system. This job alone will net me about \$26.00. As long as my work keeps coming in this way, I have only one word to say and that is, 'Thanks to my Sprayberry training,' and I am not afraid to boast about it."—ADRIEN BENJAMIN, North Grosvenordale, Conn.

DON'T PUT IT OFF!

Get the facts about my training—now! Take the first important step toward the money-making future of your dreams. All features are fully explained in my big, illustrated FREE Catalog which comes to you along with another valuable FREE book you'll be glad to own. Mail Coupon AT ONCE!

Prepares You for a Business of Your Own Or Good Radio Job

My training will give you the broad, fundamental principles so necessary as a background, no matter which branch of Radio you wish to specialize in. I make it easy for you to learn Radio Set Repair and Installation Work. I teach you how to install and repair Electronic Equipment. In fact, you'll be a fully qualified RADIO-ELECTRONICIAN, equipped with the skill and knowledge to perform efficiently and to make a wonderful success of yourself.

JUST OUT! FREE!

"How to Read Radio Diagrams and Symbols"

... a valuable new book which explains in simple English how to read and understand any Radio Set Diagram. Provides the quick key to analyzing any Radio circuit. Includes translations of all Radio symbols. Send for this FREE book now, and along with it I will send you another big FREE book describing my Radio-Electronic training.

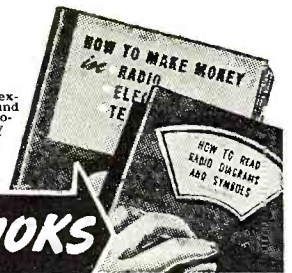

GET FREE BOOKS

SPRAYBERRY ACADEMY OF RADIO  
F. L. Sprayberry, Pres.  
Room 2546  
Pueblo, Colorado

Please rush my FREE copies of "HOW TO MAKE MONEY IN RADIO, ELECTRONICS and TELEVISION," and "HOW TO READ RADIO DIAGRAMS and SYMBOLS."

Name ..... Age.....  
Address .....  
City ..... State.....  
Tear off this coupon, mail in envelope or paste on penny postcard.

# AUDAX

RELAYED-FLUX  
Microdyne

## The Importance of SPECIALIZATION

Aside from outstanding and long-acknowledged technical skill—our “Specialization Formula” is probably as fully responsible for the world-renowned AUDAX quality as any other single factor.

We proudly concentrate all our energies and resources upon producing the BEST pick-ups and cutters. Because we are specialists in this field, much more is expected of us. Because the production of fine instruments like MICRODYNE is a full time job, it stands to reason that we could not afford to jeopardize our reputation—EVER—by making pick-ups a side-line.

Now that Victory is ours, you may expect AUDAX improvements, refinements . . . master-touches to heighten the marvelous facsimile realism of AUDAX reproduction.

**AUDAX COMPANY**  
500-N Fifth Ave., New York 18, N.Y.

Creators of Fine Electronic-Acoustical Apparatus Since 1915

Send for complimentary copy of our informative

“PICK-UP FACTS”



*“The Standard by Which Others Are Judged and Valued”*



## For the RECORD.

BY THE EDITOR

“METAMORPHOSIS” is defined by Webster as “a striking alteration in appearance, character, or circumstances.”

We gather from reading our daily mail, visits, and phone calls that the word is particularly applicable at this time to thousands of our readers. The alteration manifests itself in garb, outlook and environment. In those who have shed uniforms, the alteration in appearance is obvious, but there are also those who have shed overalls to don the guise of independent business men.

The change in outlook is sometimes clear, often elusive. There are those who, having been exposed to the virus of radio while in service, desire to continue a close association with this fascinating phenomenon; some as experimenters, others as “hams,” many as technicians and business men.

From the war plants come thousands who now look forward to establishing or re-establishing themselves as servicemen. More thousands who stuck to their service trade during the war have an eye to expansion as merchants selling the products they have so well sustained these long years.

Thus, as the cauldron of war is emptied, we find eager men everywhere spreading over the land in pursuit of a peaceful life involving some type of radio activity. The flood tide of these men is beating against industry, seeking an opening. We sympathize with their impatience and hope their persistence and courage will carry them through until our peacetime radio industry unfolds.

Mr. Laurence K. Marshall, president of *Raytheon Manufacturing Company* and *Belmont Radio Corporation*, well described the tempo of the industry when he said, “Tomorrow will never arrive in the electronics industry; new developments, ideas, inventions, models, are relentlessly pursued if for no other reason than scientific curiosity.”

This eternal greatness of radio, in all its forms, is naturally more obvious to us as we sit at the crossroads of the multitudes of radio interests represented by our readers.

We are fully aware of the metamorphosis of the men with radio engraved in their thought patterns. We, too, are undergoing the alteration in our editorial make up. In RADIO NEWS, as the months go past, every radio man will find much to stimulate, and add to his fund of knowledge, whether he is a service technician, ham, experimenter or builder.

We are as relentless in our search for vital information to publish for the benefit of peacetime radio men,

as we were in our efforts to satisfy the needs of wartime readers. We took a deep breath as the war terminated and consigned to oblivion thousands of dollars worth of manuscripts, photographs, and diagrams dealing with wartime radio and electronics.

We know that thousands of you who conversed on the radio communications of war, when lives were hanging in the balance, will be sitting in your own “shack” burning the midnight filaments to search for fellow “hams” who might have shared a similar martian experience. You’ll be buying rigs, building and rebuilding them, eternally striving for transmission and reception perfection. We’re going to publish material which should help you.

We’re aware of the fact that thousands of you who will earn your living as radio technicians will need every bit of information you can lay your eyes on to keep abreast of radio circuit developments, trends, and technical methods. We are on the alert for the best writers we can find to tell you the facts.

NOW we have proof that there are no limitations to radio! Radar has now taken us out of this world, plunged us into the infinite, challenged the universe with spears of radio impulses that have prodded the moon and returned to open new flood-gates of human mental activity. No longer can the defeatists tell us that mankind has passed its last frontier and that we must settle down to the uninspiring prospect of making the most of our little world, frustrated in the belief that the eternal stimulant of adventure into unknown, uncharted areas is a thing of the past.

Even as radio has been a vital factor in shrinking our own world, so does radio now break our fetters and carry us to worlds beyond. What space ship would dare venture into the outer regions without radio?

Now, as we alternately hope and shudder at the prospects of the use of atomic power for good or evil, we find our minds lifted by the hopes of explorations into space which will relieve the pressures of too close associations with men on our own planet.

It’s radio we can thank for the opening of these infinite vistas. It will be radio which will make possible the jaunts of twentieth century Vikings into outer space.

Small wonder that we who earn our living in radio, or know the thrill of radio as a hobby are proud of our association with this super-science. . . . . O. R.



# For Earliest Delivery... ORDER YOUR NEW COMMUNICATIONS RECEIVER

Now from **ALLIED**

AVAILABLE ON  
*Time Payments*  
TRADE-INS ACCEPTED

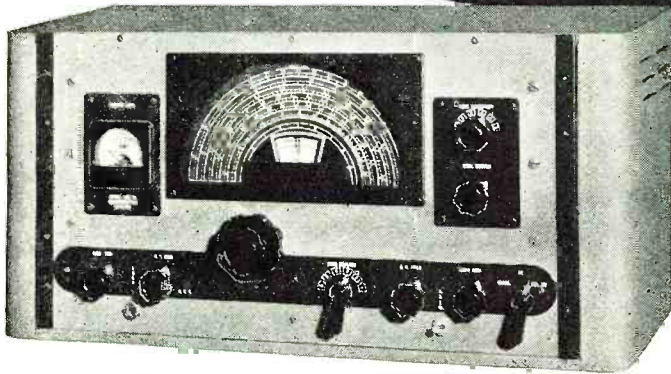

### RME 45

The new RME 45 Receiver delivers peak reception on all frequencies—500 to 33,000 Kc. Full vision calibrated dial using one control for two-speed tuning. Five Amateur bands with ample band spread. DB calibrated signal level meter. 5 step variable crystal filter. Automatic Noise Suppression. Stable, variable pitch beat oscillator. Streamline cabinet with matching speaker. Net, with Speaker... **\$186**



### HAMMARLUND HQ-129X

Designed to meet the most critical demands of professional operators. Full range 54 to 31 Mc., accurately calibrated. 4 calibrated Ham bands and one arbitrary scale. Variable selectivity crystal filter. Low drift beat oscillator for code and locating stations. Antenna compensator. Voltage regulation. Compensated oscillator to reduce drift during warm-up. Automatic noise limiter. Earphone jack. 3 i.f. amplifier stages. 2 audio stages. For phone or CW. Net..... **\$129**  
Speaker, net..... **\$10.50**

### Other Communications Receivers

Hallicrafters SX-25.....	\$94.50	Hallicrafters SX-28A.....	\$223.00
National HRO.....	197.70	Hallicrafters S-36A.....	415.00
RME DB-20 Preselector..	59.30	Hammarlund 400X.....	318.00
RME VHF-152 Converter	59.30	Hammarlund 400SX.....	318.00

Net, F.O.B. Chicago (All prices subject to change)

### HALLICRAFTERS S-40

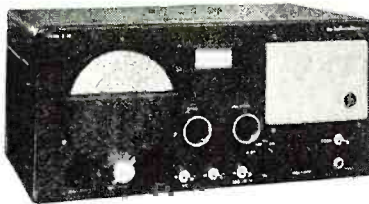

Sensational new Hallcrafters receiver! Offers many advanced design and performance features at a popular price. Simple to operate. Frequency range 550 Kc. to 44 Mc. in 4 bands. Wide vision main tuning dial accurately calibrated. Separate electrical bandspread dial, inertia flywheel tuning. Beat frequency oscillator. A.V.C. switch. CW/a.m. switch. Standby/receive switch. Automatic noise limiter. Separate RF and AF gain controls. Three position tone control. "Micro-set" permeability adjusted coils in RF section. Internal dynamic speaker. Net..... **\$79.50**

Model SM-40 External "S" Meter... **\$15.00**

### NATIONAL NC-2-40C

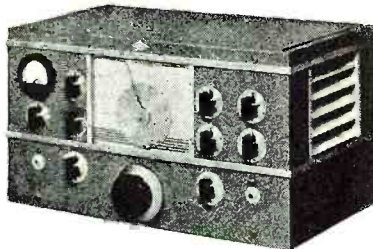

One of National's top receivers. 490 Kc. to 30 Mc. range in 6 tuning bands. Definite, accurate calibration for all bands. Actual single dial control. Stable high frequency circuits. Frequency drift reduction to a negligible value by temperature compensation. Automatic voltage stabilization. Wide range adjustable series-valve-noise limiter. Flexible crystal filter. Phonograph or high level microphone pick-up jack. Special r.f. coupling circuits maintain full sensitivity. Net..... **\$225**  
Speaker in matching cabinet, net..... **\$15.00**

## Free... SEND NOW FOR ALLIED'S NEW 1946 CATALOG

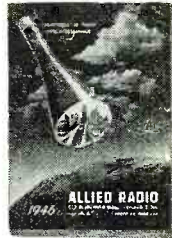

Here's your handiest, most complete 1946 Buying Guide for everything in radio! Includes latest communications receivers, Ham gear, code apparatus, parts, kits, tubes, tools, books, test instruments, public address and other equipment. 10,000 items at your finger tips... largest and most complete stocks under one roof. Nationally known makes. Fastest service—from one central source. Experienced staff of licensed radio amateurs to help you.

**ALLIED RADIO CORP., D. L. Warner W918C**  
833 West Jackson Blvd., Dept. DD-6  
Chicago 7, Illinois

- Date.....
- Please enter order for  
..... Model.....
- Enclosed \$.....  Full Payment  
 Part Payment (Balance C.O.D.)
- Please send full information on Communications Receivers and Time Payment Plan, without obligation.
- Send FREE new 1946 Allied Catalog.

Name.....  
Address.....  
City..... Zone..... State.....

# ALLIED RADIO

Everything in Radio and Electronics

833 West Jackson Blvd. • Chicago 7, Illinois

# THE RIGHT COMBINATION

## THORDARSON

TRANSFORMERS  
TRU-FIDELITY AMPLIFIERS

## MEISSNER

COMPONENTS • KITS  
SERVICE EQUIPMENT

## RADIART

VIBRATORS  
RUST-PROOF AERIALS

ONE  
SALES  
SOURCE

ONE  
RESPONSIBILITY

BETTER  
FASTER  
MORE  
COMPLETE  
SERVICE

ELECTRONIC DISTRIBUTOR AND  
INDUSTRIAL SALES DEPARTMENT

# FOR PRECISION-BUILT ELECTRONIC PRODUCTS!

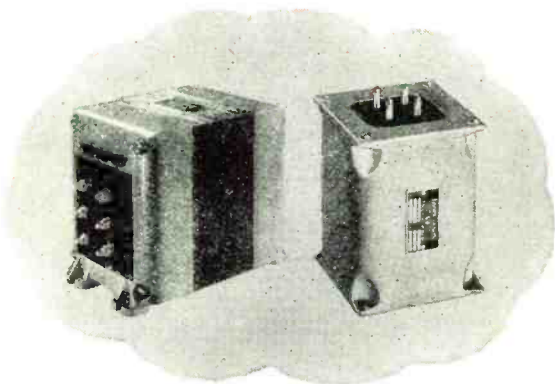

## THORDARSON TRANSFORMERS

Over fifty years experience in the manufacture of quality-built transformers for all applications—replacement, communications, sound amplifier, industrial, experimental and amateur. Thordarson also originated Tru-Fidelity Amplifiers.

## MEISSNER COMPONENTS

The Meissner reputation, gained and maintained by furnishing high quality components, including antenna, R.F. and oscillator coils; standard and Ferrocarr transformers; windings, chokes and accessories. Meissner also makes the finest in service equipments.

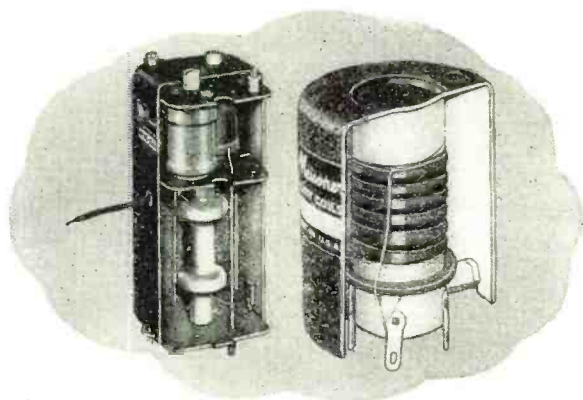

## RADIART VIBRATORS

Radiart Exact Duplicate Vibrators are individually engineered to meet the physical and electrical requirements of each application. This assures longer life, minimum R.F. interference, low hum level, etc. Radiart also makes rust-proof aerials to fit all cars.

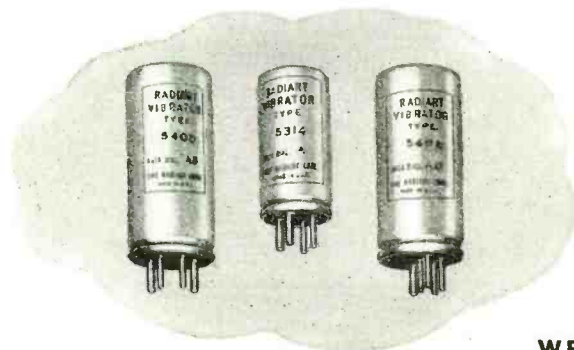

WRITE FOR COMPLETE INFORMATION TODAY

# MAGUIRE INDUSTRIES, INC.

936 NORTH MICHIGAN AVENUE, CHICAGO 11, ILLINOIS

Designed for

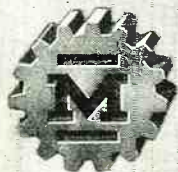

Application



90800.

### THE 90800 "50 WATT"

#### Transmitter-Exciter

Again in production is the No. 90800 transmitter-exciter unit. Based on an original Handbook design, this flexible unit is ideal for either low power amateur band transmitter use or as an exciter for higher power PA stages. Priced at only \$37.50; less tubes, but with coils for one band operation. Unless otherwise requested, coils furnished are for 10 meter output with 40 meter crystal. Tubes used are 807 and 6L6.

**JAMES MILLEN  
MFG. CO., INC.**

MAIN OFFICE AND FACTORY  
**MALDEN  
MASSACHUSETTS**



# Spot Radio News

★ Presenting latest information on the Radio Industry.

By **FRED HAMLIN**

Washington Editor, RADIO NEWS

**PAUL PORTER'S MOVE** from FCC to OPA is viewed unofficially by industrial observers in Washington as a beneficial one to radio. RMA and other Washington authorities are hopeful that some of their price problems will be ironed out under Porter's sympathetic eye and that at least they will be listened to with far more understanding than has been the case. The industry is unanimous that Porter learned quickly and a lot during his FCC chairmanship, and won a wide circle of friends. . . . On the other hand, within higher circles of the government, including the White House, Porter has lined up against the more conservative advisors, and leaders at the Federal level expect that he will go down the line on policies established by former OPA Administrator Chester Bowles who, as the new stabilization director, will, after all, be Porter's government boss.

**INDUSTRY FEELING** in Washington is otherwise not optimistic when it comes to considering the state of the nation so far as radio is concerned. The promise of big customer demands that led to high optimism on VJ-Day has since been dissipated by labor difficulties, price ceiling problems, and the general confusion prevalent in lining up supplies and production. . . . Skepticism is now being expressed toward the recent FCC forecasts before House appropriations committees concerning the bright future of the radio market. FCC witnesses testified, among other things, that they expected 200,000 walkie-talkie sets to be in operation by next year; that 11,000 stations may be in use by mid-'47 for bus, ambulance, and taxicab services; that railroad radio communications installations will have jumped to 2200 by the same time; ship radios will be up from a 1945 figure of some six thousand to nine thousand by the middle of next year; and radio-equipped aircraft will jump from some two thousand in mid-'45 to more than twenty-six thousand by mid-'47. . . . As for consumption by the general public, the industry is currently compromising the situation by concentrating on table models and other small sets, with the larger sets pushed to the back of the production line until current uncertainties clear up. But whether these will be eliminated in time to go full speed ahead in the last

two quarters of the year is now considered a grave question by many observers. . . . Even should full production be realized during the second half of the year, it is also doubted whether it will be sufficient to offset the present delays enough to register favorable profits on the final 1946 balance sheets.

**RADIO RECEIVER TRADE SHOWS** seem to be a casualty of the current situation. Eager though the industry may be to parade new models, it was decided to forego shows because there isn't sufficient production under way to back up the demonstrators. An optimistic note: Assuming that things do straighten out, manufacturers' representatives in Washington predict confidently that the 1947 show will be a honey. . . . And in spite of everything, the industry continues to expand. Significant is that so far this year, 35 new radio equipment and parts manufacturers have been admitted to membership in the Radio Manufacturers Association, one of the largest groups to become members at one time. This brings the RMA total to a new record of 307 members.

**ANOTHER OPTIMISTIC** note has been sounded on the outlook in the ham field. Belief is that the number of hams will grow by leaps and bounds as soon as sufficient equipment is available. Chief reason for the optimism is the widespread interest in radio among GI's, thousands of whom have indicated that they want to become hams as soon as they shuck off their uniforms. . . . Alert to the potential in this field, RMA has organized an amateur radio activities section among 35 radio equipment manufacturers. Chairman of the section is W. J. Halligan, president of *The Hallcrafters Co.*, Chicago. Frank Holmstrom, vice-president and treasurer of *Hugh H. Eby, Inc.*, Philadelphia, is vice-chairman, and other members include William A. Ready, president of the *National Company, Inc.*, Malden, Mass.; R. P. Almy, manager of distributor sales for *Sylvania Electric Products, Inc.*, Emporium, Pa.; George Grammer, technical director of the *American Radio Relay League*; Walter Jablon, sales manager of the *Hammarlund Manufacturing Company, Inc.*, New York, and Robert Adams, production manager of the *Aireon*



# BLUEPRINT

**YOUR MOVES  
WITH**

## **ALLIANCE MOTORS**

**THE MODEL RR** Intermittent duty is enclosed reversible control motor-split phase resistor type, 60 cycles, 24 or 117 volts, with or without gear reduction.

**THE MODEL MS** is shaded pole induction type for any A.C. voltage from 24 to 250 and frequency of 40, 50 or 60 cycles. Starting torques from one-half ounce inch at 10 watts input, to two ounce inches at 36 watt input.

**HERE ARE JUST A FEW PLACES:**

Radio, electronic and electric controls, time, temperature, pressure and humidity controls, coin operated phonographs, drink and merchandise dispensers, fans, valves and blowers, door openers, signals, motion displays, movie projectors and scores of industrial applications.

**MINIATURE MOTORS THAT  
MAKE 'EM MOVE!**



Besides the *millions* of Alliance phonomotors built for the radio industry, Alliance is making the POWR-PAKT line of miniature motors rated from less than 1-300th h.p. on up to 1-20th h.p.

Where your plans call for continuous or intermittent action, remote actuation, starting, stopping and reversing, there's probably an Alliance POWR-PAKT motor already engineered and available in quantities, at low unit cost, to do the job!

**WHEN YOU DESIGN—KEEP**

# **alliance**

**MOTORS IN MIND**

**ALLIANCE MANUFACTURING COMPANY • ALLIANCE, OHIO**  
Alliance Tool and Motor Ltd., Toronto 14, Canada



The  
**SPINTITE  
WRENCH**  
Works Like a  
Screw Driver

Speeds Production on  
the assembly line.

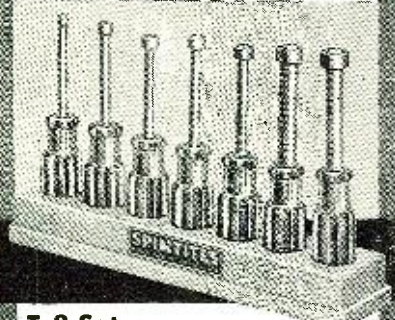

**T-8 Set**  
Seven Standard Hex  
sizes in a Convenient  
Holder.

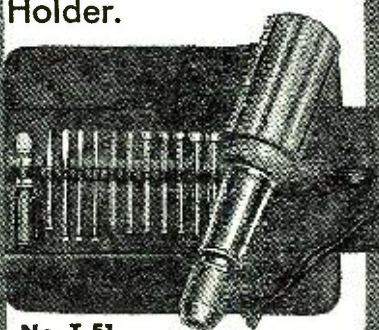

No. T-51  
**CHUCK TYPE  
SPINTITE**  
with Seven SPINTITES, three  
Screw Drivers and Ream-  
awl in Leatherette Roll

Send for Catalog No. 141 picturing a full line of Automobile, Aircraft and Radio Tools.

**WALDEN  
WORCESTER  
WRENCHES**

**STEVENS WALDEN, INC.**  
468 SHREWSBURY STREET  
WORCESTER, MASSACHUSETTS

*Manufacturing Corp.*, Kansas City, Kan. . . First targets of the RMA group will be to standardize equipment parts and to support legislation beneficial to radio amateurs.

**BOTH CBS AND ZENITH** have announced their intention of constructing color television transmitters in Chicago within the very near future.

According to reports from the company, the *Zenith Radio Corporation* will manufacture color television receivers exclusively, thus backing up the *CBS* contention that the future of television lies in the transmission of full color pictures.

Construction of the *Zenith* station is expected to be completed within 90 days.

**THE RADAR-TO-THE-MOON EXPERIMENT** conducted successfully by the Signal Corps early this year surprised the men working on it when it got such big headlines, because bouncing a beam off of another planet wasn't what they were primarily interested in. Main objective of the test, according to Maj. Gen. Harry C. Ingles, chief signal officer, was to demonstrate that radio waves in the very high frequency band could completely penetrate the ionosphere, or celestial void, as well as break through whatever jacket of atmosphere may shield the moon. . . . We're happy to report that the first radar wave sent out returned not at all travel-worn from its trip of nearly a half million miles, and others also sent on the trip came back equally fresh. . . . The radar set used in the experiment was a war baby, designed primarily for long-range detection of hostile aircraft. It's called the SCR-271. It was modified when it made its successful reach for the moon. A standard SCR-271 sends out a pulse with a peak power of 100 kilowatts. Each pulse lasts from 10 to 30 microseconds, and the pulses are transmitted at a rate of 344 or 621 per second, depending on how the set is adjusted. Because of the great distance to the moon, the set was modified to build up greater energy. The antenna was also altered to obtain the best possible beam projection for the long-distance shot and to employ a specially adjusted oscilloscope whose baseline would represent about 300,000 miles instead of 150 miles.

**SHOTS WERE TAKEN AT THE MOON** only just after it rose and just before it set. Reason for this was that the standard SCR-271 employs for its antenna an array consisting of 32 dipoles, 4 and 8 feet wide. The number of these was doubled for the moon experiment, but, because it was capable of being rotated only horizontally, the horizon shots had to be taken. Tests could be conducted for about 15 minutes at moonrise and moonset. . . . Tests are continuing with the present equipment, but with changes in the antenna which will per-

mit it to rotate vertically and thus shoot at the moon throughout its complete orbit above the earth. . . . The set was operated on its standard frequency of 111 megacycles—a wavelength of 300 centimeters. This lies in the very high frequency range. . . . Scientists are most interested, so far as future experiments are concerned, on the change in characteristics of the signals as the moon reaches its zenith, where the radio waves will strike the ionosphere almost at right angles.

**HAVING CLIMBED ON AND FALLEN OFF OF** the technical sled concerning moon radar half a dozen times at the Signal Corps, we paid a visit to another out-of-this-world set of experts, these in the Army's Ordnance Department. They have designed a machine—the first all-electronic general purpose computer ever developed—that can solve all the mathematical problems of a lifetime in a matter of hours. It's called the ENIAC—Electronic Numerical Integrator and Computer—and was invented by Dr. J. W. Mauchly and J. Presper Eckert, Jr., both of the Moore School of Electrical Engineering at the University of Pennsylvania. . . . Containing some 18,000 vacuum tubes in its mechanism, the new machine occupies a room 30 by 50 feet and weighs 30 tons and costs about \$400,000, but in the postwar world can be produced much more cheaply, since research is figured into this price. Thing that intrigued us most about it is that it can add a couple of figures in one-fifth-thousandths of a second and can do a number of distinct additions simultaneously. It can also multiply and divide. Matter of fact, the only thing that its inventors say it can't do in the mathematical field is think.

**GENERAL ACCEPTANCE** of a uniform vacation plan within the parts manufacturing branch of industry is anticipated following preliminary conferences in Washington and elsewhere. Parts manufacturers, of course, have been observing a plant shut-down plan for a number of years, but different plants have closed at different times, leading to delays and confusion. . . . Delays of two and three months have been suffered when the manufacturer of one part closed early in the summer, another in July, and a third in the early fall. The week of July 4th has been tentatively set as time for the shut-down, but no compulsory rules will be laid down.

**AN RMA COMMITTEE** headed by Ray F. Sparrow, of *P. R. Mallory & Co., Inc.*, Indianapolis, has been appointed to establish a policy on trade marking and customer's marking on radio components. Other members include Harry A. Ehle, of the *International Resistance Company*, Philadelphia, and A. Blumenkrantz, of the *General Instrument Corporation*.

SOON WE'LL PHONE HOME FROM AUTO

RADIO INDUSTRY POISED FOR BIG BOOM

Big Boom in FM Broadcasting

MARKET FOR 100 MILLION RADIOS REVEALED BY SYLVANIA SURVEY

COAST TO COAST NETWORK BEING PLANNED FOR FM

Let TODAY'S HEADLINES Guide You to TOMORROW'S OPPORTUNITIES

# Learn RADIO ELECTRONICS DeFOREST'S MODERN "A-B-C" WAY .. at Home



YOU CAN BUILD 133 FASCINATING EXPERIMENTS WITH THIS EQUIPMENT

Plan your future the way business men do: Watch the headlines! Pick a field that's "in the news"—one with many opportunities for interesting, PROFITABLE EMPLOYMENT or a good chance for establishing a BUSINESS OF YOUR OWN with little capital. Pick a field that offers a variety of interesting opportunities—a field with one of America's most promising futures... and see how you may MAKE YOUR START TOWARD A PLACE IN THIS FIELD BEFORE JOB COMPETITION BECOMES ACUTE. Write for DeForest's Big, Free, Illustrated Book—"VICTORY FOR YOU." Learn how DeForest's prepares you at home, in your leisure time—without interfering with the work you are now doing—then helps you make your start in the vast BILLION DOLLAR Radio-Electronics field.

### You Get EMPLOYMENT SERVICE

DeForest's Employment Service offers you the advantage of long and favorable contacts with some of America's foremost Radio-Electronics concerns. "VICTORY FOR YOU" tells you how this Service has helped many to their start in Radio-Electronics. You'll see how DeForest students and graduates are prepared to win and to hold good paying jobs—how DeForest students start businesses of their own with little, if any, capital.

## A You "LEARN-BY-DOING" at Home with Practical Equipment

Enjoy a "Home Laboratory." DeForest's provides 8 BIG KITS OF RADIO ASSEMBLIES AND PARTS to give you valuable practical experience at home. Build modern Radio Receivers and Circuits that operate. Build Electric Eye Devices, an Aviation Band Receiver, a Public Address System, a Wireless Microphone and numerous other fascinating experiments—in fact, 133 in all, in your spare time at home. NEW colorful Kit Supplement tells you about DeForest's "Home Laboratory," and how you use valuable Radio parts and sub-assemblies to get real practical experience as you learn.

DeForest's training includes instruction in motion picture sound equipment, FM radio and television...

## C WELL-ILLUSTRATED LOOSE-LEAF LESSONS

DeForest's provides 90 loose-leaf lessons prepared under the supervision of the man often referred to as the "Father of Radio"—Dr. Lee DeForest, inventor of the Audion Tube, and holder of over 300 important patents. . . . ACT PROMPTLY! See how you can learn Radio the

modern A-B-C DeForest's way—by Reading . . . by Doing . . . by Seeing at Home. Mail coupon Now!

## B Home MOVIES Help You Learn FASTER...EASIER

With DeForest's, you use a genuine DeVRY 16 mm. Motion Picture Projector and exciting training films to help you learn some of Radio's fundamentals FASTER . . . EASIER. SEE what happens inside of many circuits you are working on. SEE how electrons function. SEE how RADIO waves are changed into sound. Get DeForest's big, free book! Use it as a key to show you the way to Radio-Electronics job opportunities of today and tomorrow—the opportunities the headlines tell about.

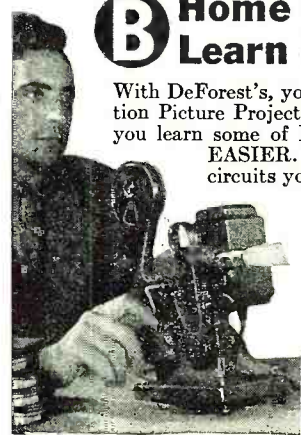

SEND FOR FREE BOOK & SUPPLEMENT TODAY!

# DeFOREST'S TRAINING INC., Chicago, Ill.

DeFOREST'S TRAINING, INC., 2533-41 N. Ashland Ave., Dept. RN-C4 Chicago 14, Illinois, U. S. A. Send me both your big book "VICTORY FOR YOU" and Kit Supplement, showing how I may make my start in Radio-Electronics with your modern A-B-C home training plan. No obligation.

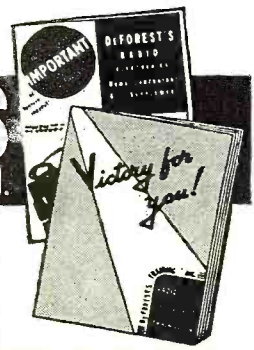

Name \_\_\_\_\_ Age \_\_\_\_\_  
 Address \_\_\_\_\_ Apt. \_\_\_\_\_  
 City \_\_\_\_\_ Zone \_\_\_\_\_ State \_\_\_\_\_  
 If under 16, check here for special information.  If a discharged veteran of World War II, check here.

# SYLVANIA NEWS

## RADIO SERVICE EDITION

APRIL Published by SYLVANIA ELECTRIC PRODUCTS INC., Emporium, Pa. 1946

**SYLVANIA  
SERVICEMAN  
SERVICE**

by  
**FRANK FAX**



### NEWS OF VALUABLE TECHNICAL AIDS FOR SERVICEMEN

Because of the many ways that Sylvania Electric is able to—and does—help the radio serviceman, you will find that handling Sylvania tubes means *extra* profits for you.

For instance, there is a long list of business and technical aids, compiled specially for you by experts in their fields. Included in this valuable material are two of the latest Sylvania technical helps, the SYLVANIA RADIO TUBES CHARACTERISTICS booklet and the SYLVANIA BASE CHART.

Make sure you have these up-to-the-minute aids to better servicing. They will give you accurate characteristics and base diagrams for all the Sylvania Electric radio receiving tubes. Give your customers the most satisfactory service. Feature the famous Sylvania line of radio tubes. That deal is the best deal for you.

Obtain your copies of the aids shown at the right from your Sylvania distributor, or write directly to me at Sylvania Electric, Emporium, Pa.

**LATEST REVISED TUBE  
CHARACTERISTICS BOOKLET**



**SYLVANIA  
RADIO TUBES  
Characteristics**

**SYLVANIA BASE CHART**

*Now!*  
get these valuable  
technical  
aids—

**HANDY "PIN-UP"  
SYLVANIA BASE CHART**

# SYLVANIA ELECTRIC

Emporium, Pa.

MAKERS OF RADIO TUBES; CATHODE RAY TUBES; ELECTRONIC DEVICES; FLUORESCENT LAMPS, FIXTURES, WIRING DEVICES; ELECTRIC LIGHT BULBS



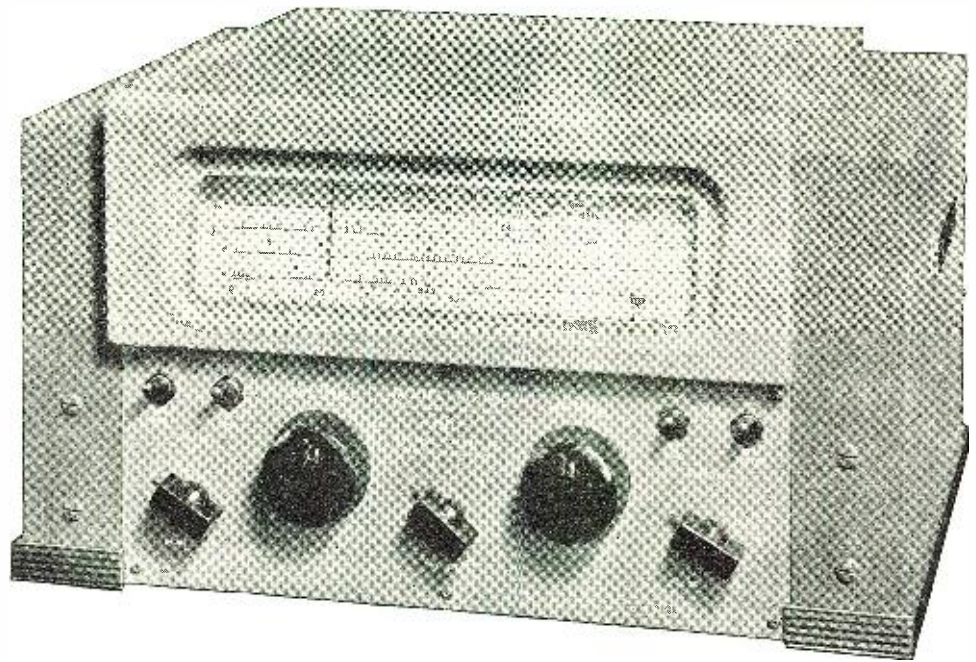

## THE NC-46

The new National NC-46 Receiver is a fine performer at a moderate price. Ten tubes in an advanced superheterodyne circuit provide excellent sensitivity throughout the receiver's range from 550 KC to 30 MC. Circuit features include an amplified and delayed AVC, series valve noise limiter with automatic threshold control, CW oscillator and separate RF and AF gain controls. The push-pull output provides 3 watts power, and the AC-DC power supply is self-contained.



**NATIONAL COMPANY, INC., MALDEN, MASSACHUSETTS**



**HERE'S THAT NEW  
TRIPLETT  
625-N**

## LONG SCALE, WIDE RANGE VOLT-OHM-MILLIAMMETER

### DOUBLE SENSITIVITY D. C. VOLT RANGES

0-1.25-5-25-125-500-2500 Volts,  
at 20,000 ohms per volt for greater accuracy on  
Television and other high resistance D.C. circuits.

0-2.5-10-50-250-1000-5000 Volts,  
at 10,000 ohms per volt.

### A. C. VOLT RANGES

0-2.5-10-50-250-1000-5000 Volts,  
at 10,000 ohms per volt.

### OHM-MEGOHMS

0-400 ohms (60 ohms center scale)  
0-50,000 ohms (300 ohms center scale)  
0-10 megohms (60,000 ohms center scale)

### DIRECT READING OUTPUT LEVEL DECIBEL RANGES

-30 to +3, +15, +29, +43, +55, +69 DB

TEMPERATURE COMPENSATED CIRCUIT FOR  
ALL CURRENT RANGES D.C. MICROAMPERES  
0-50 Microamperes, at 250 M.V.

### D. C. MILLIAMPERES

0-1-10-100-1000 Milliampères, at 250 M. V.

### D. C. AMPERES

0-10 Amperes, at 250 M. V.

### OUTPUT READINGS

Condenser in series with A.C. Volts for output  
readings.

### ATTRACTIVE COMPACT CASE

Size: 2½" x 5½" x 6". A readily portable, completely  
insulated, black, molded case, with strap handle.  
A suitable black, leather carrying case (No. 629)  
also available, with strap handle.

### LONG 5" SCALE ARC

For greater reading accuracy on the Triplet  
RED • DOT Lifetime Guaranteed meter.

### SIMPLIFIED SWITCHING CIRCUIT

Greater ease in changing ranges.

Write for descriptive folder giving full technical details



# Triplet

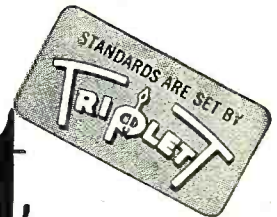

**ELECTRICAL INSTRUMENT CO. BLUFFTON, OHIO  
RADIO NEWS**

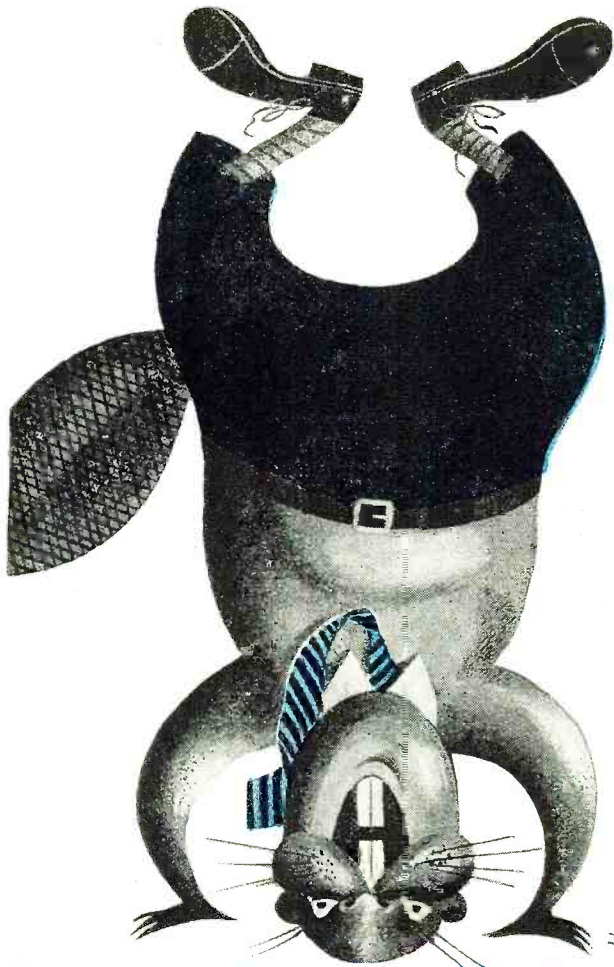

# I used to stand on my head...

... to do an under chassis mounting. That was, until a friend whipped out his C-D catalog. "Pull yourself together," says he, "and take a look at C-D's Blue Beavers."

"There's not a smart servicer in the business who's losing time on capacitor 'shopping' or 'installation.' They all stock these C-D electrolytics! And why not? Did you ever hear of a bigger name in capacitors than Cornell-Dubilier? 36 years of research and engineering is a long time and a lot of experience. Man, these Beavers have a pedigree... they're the stuff you want behind you in a service job."

Well, that fellow sure straightened me out. So I'm passing the good word along. Just to give you an idea of what these dandy Blue Beavers do...



## NO HEAT EXHAUSTION

Blue Beaver's don't droop even when the heat's on and the humidity's up. Strap two or more together for a variety of capacity combinations.



## EASY INSTALLATION

Pint-sized in physical dimensions; giants in quality. They're tailor-made for tight spot mounting. Polarity of units is clearly marked on tube casings.



## READ "THE CAPACITOR" ...

... for answers to everyday service problems and helpful hints from the experts. It's free; write: Cornell-Dubilier Electric Corporation, South Plainfield, New Jersey.



MICA • DYKANOL



PAPER • ELECTROLYTICS

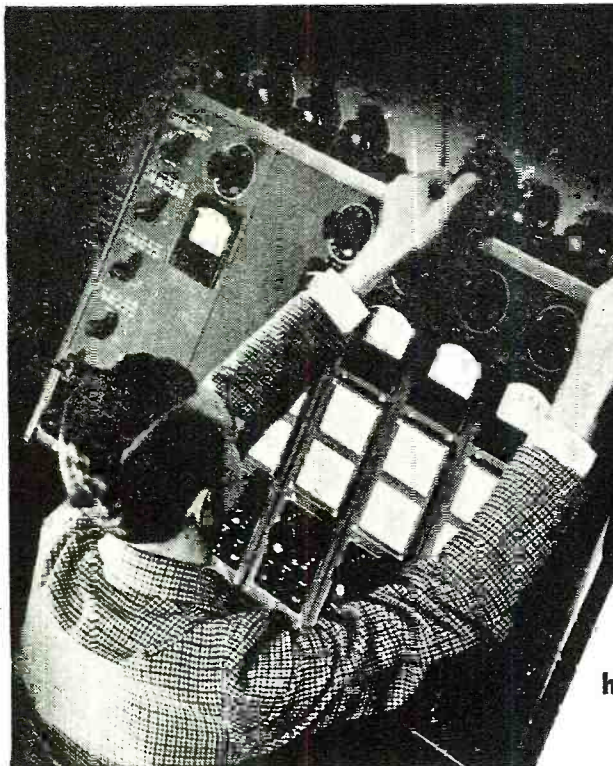

# Get Ready for POSTWAR RADIO ELECTRONICS AND TELEVISION NOW!

Great strides of progress have been made during the war. New equipment, methods, uses have been developed. Keep in the lead yourself with modern

## SHOP METHOD HOME TRAINING BY A GREAT ESTABLISHED RESIDENT SCHOOL

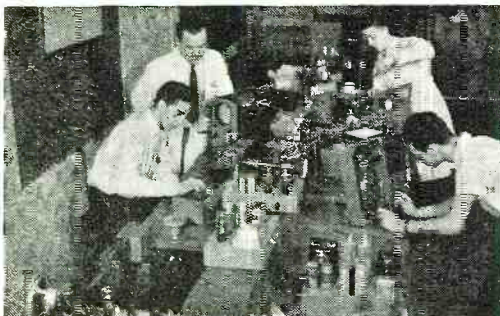

NATIONAL SCHOOLS HAS BEEN BRINGING OPPORTUNITY TO AMBITIOUS MEN FOR MORE THAN A THIRD OF A CENTURY. Above and to the right are two departments in this great school where modern developments are analyzed to provide National students with first-hand knowledge of shortcuts and trade secrets. For full details fill out the coupon.

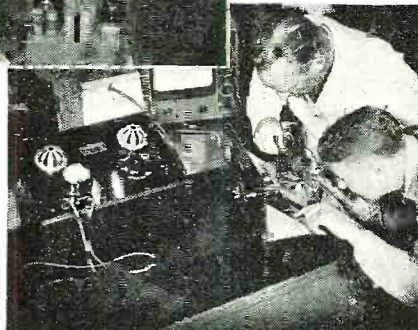

Take your place in the forefront of Radio, Television and Electronic progress. Get your share of the NEW business. War inventions and improvements—walkie-talkies, radar, aircraft control and communications—will quickly be adapted to civilian use. F.M. is winning almost universal acceptance and use.

Everywhere you turn new and important changes in the field of Radio are being put into operation every day. Television is rapidly being perfected. Electronics is being applied to industry and better living. **The successful technician MUST KEEP UP WITH PROGRESS** if he is going to be sure of his job—GET AHEAD IN BUSINESS.

National Schools presents a Radio and Electronic training system geared to the rapid advancement of the industry itself. Here is an exclusive home training system based on the shop methods as practiced in one of the World's foremost vocational education centers—the actual shops and experimental laboratories of this National institution. Send the coupon on the next page for complete details. Only National can bring you this type of training for only National has the shops, equipment and experimental laboratories for the development and extension of the system.

## Use This Modern Electronic Laboratory

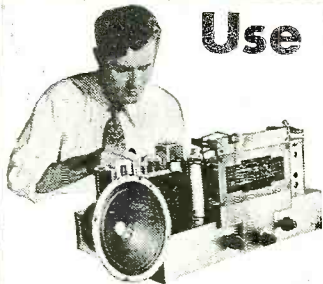

The very essence of National Shop Method Home Training is EXPERIENCE. You get to know Radio and Television circuits by building them yourself. You get

first-hand knowledge of how instruments work by a sound analysis and construction system.

You build a beautifully toned, high fidelity, long distance modern superheterodyne re-



ceiver from the parts furnished with your course. In this way you have a thorough understanding of the superheterodyne principle.

You learn modulation, beat frequency and

signal generation by building yourself a small, operating radio transmitter with National parts. You get to know and understand the process of creating

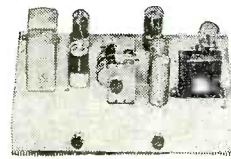

audible signals by electronic means by conducting experiments with a National Audio Oscillator.

You conduct cathode ray experiments to gain a first-hand knowledge of the operation, repair and maintenance of Television equipment. Hundreds of experiments may be performed to gain first-hand experience with your National laboratory equipment.

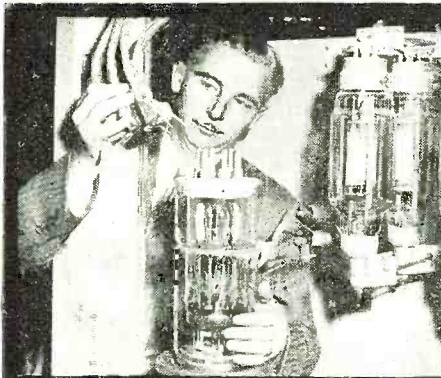

## New Fields

Electronics is already a most important factor in industry. Many manufacturing processes depend on electronic controls—employ electronic processes. In medicine and agriculture too, electronics is being used extensively. Are you ready to cash in on this development in a field that is so close to radio?

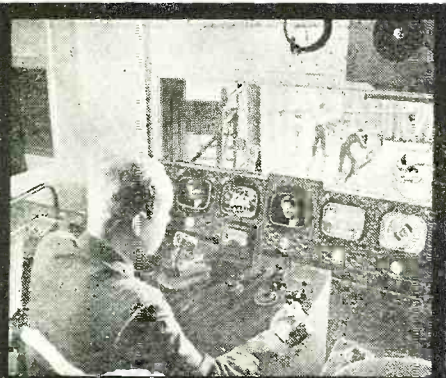

## New Equipment

Every day you learn of new types of radios and improved television—new electronic devices. Fac-simile, F.M., Radar, Sonar—all present new problems of manufacture, operation and maintenance that demand training and experience. Consider your advantages if you have the necessary preparation to tackle this work.

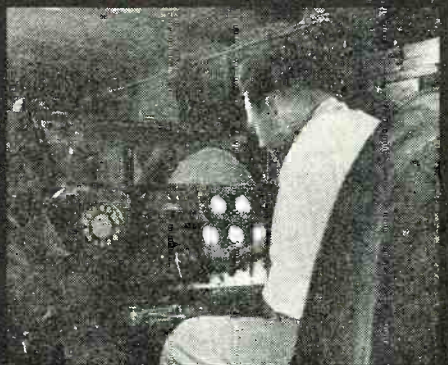

## New Hook-Ups

The relatively simple wiring of the radio receiver of a few years ago is as out-of-date today as one of the first automobiles. The new Radio and Television sets, and Electronic devices demand a thorough knowledge of new principles. National brings its students the results of continuous research and improved methods.

# NEW OPPORTUNITIES

Think what all this great progress in Radio, Electronic power and control and Television means to YOU PERSONALLY—you who are already in Radio or have a natural inclination toward it. The greatest opportunity of a lifetime is right within your grasp.

Compare the job you now have or expect to get when you are out of service or your present war job with the great future presented you by the broad field of Electronics.

Literally tens-of-thousands of technicians are needed in Radio and Television stations and communications companies all over the country—to operate, maintain and repair equipment. The man who **knows modern methods and equipment** is welcome almost at his own price.

Latest figures show that Radio represents a **5-billion dollar industry** and, in the opinion of experts, it is a **secure, well established, basic type of business offering steady employment**. Television, according to authorities, offers **half a million openings** right at the start. The man trained

in modern Electronics **CAN CHOOSE THE KIND OF INDUSTRY HE WANTS—THE PART OF THE COUNTRY HE PREFERS AND THE KIND OF POSITION MOST SUITABLE.**

### You Want Action

With this amazing speed-up training you can progress just as quickly as you wish—start taking advantage of your new found knowledge and experience in a very short time. Send the coupon below and learn the facts about this great educational development. Try out the **FREE SAMPLE LESSON** and see for yourself what you can accomplish so quickly and easily with the remarkable **SHOP METHOD HOME TRAINING.**

In a few months—perhaps only weeks—you may start making good money, maybe accept a **BIG PAY JOB** in industry—**GET INTO A PROFITABLE, LIFETIME BUSINESS OF YOUR OWN**, with little or no capital investment.

Take the first step now. Fill out and mail the coupon below.

# FREE LESSON

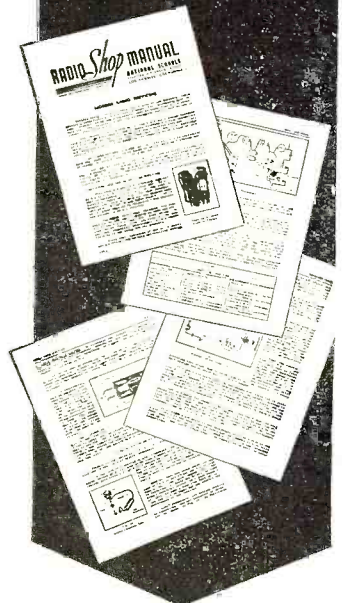

## Get this BOOK

Here is an interesting forecast of the future of Radio and the opportunities present for you in this, and allied fields right now. It is profusely illustrated and describes the jobs waiting for trained men everywhere. Send the coupon below for your copy.



## NATIONAL SCHOOLS

LOS ANGELES 37, CALIFORNIA. EST. 1905

### MAIL OPPORTUNITY COUPON FOR QUICK ACTION

**National Schools, Dept. RN-4** (Mail in envelope or paste on penny post card)  
**4000 South Figueroa Street, Los Angeles 37, California**  
 Mail me **FREE** the two books mentioned in your ad including a sample lesson of your course. I understand no salesman will call on me.

NAME ..... AGE .....

ADDRESS .....

CITY ..... STATE .....

Include your zone number

## Here Are Some Samples of Success in Radio by National Graduates

National Shop Method Home Training wins good jobs, independence and security quickly. Take the word of National men who have established records in their favorite Radio, Television, or other branches of Electronics:



**Joseph Gruntch**, Lake Hiawatha, New Jersey writes: "My latest offer was \$5,800.00 as Radio Photo Engineer but I'm doing well where I am now engaged. I am deeply indebted to National."



From **O. K. Ivey**, Washington, D. C. comes this endorsement: "I believe National offers the best course to be had. Keep up the good work."



**Robert Adamsen**, Kearney, Nebraska, National graduate, has two radio jobs—makes double pay as a radio instructor and as engineer at Station KGFW. He writes: "I am proud of my National training and appreciate the cooperative spirit."



Here's a statement from **R. R. Wright**, Blackfoot, Idaho: "Due to my training at National I was selected to instruct in the laboratory work of Navy and Marines."



Read what hundreds of other enthusiastic students have written about National Training. Send in your coupon today.

# The RAULAND

## 10" Flat Face, Direct-Viewing Tube . . .



## Now Available

This Rauland R-6025 is a 10 inch, flat face, direct-viewing electromagnetically focused and deflected tube. All necessity for Ion Trap has been eliminated. Now ready for the industry . . . operating features given at right:

### TYPICAL OPERATING CONDITIONS—R-6025

Overall length . . . . .	17.5" max.
Heater voltage . . . . .	6.3 volts
Grid No. 1 . . . . .	45 volts*
Grid No. 2 . . . . .	250 volts
Anode . . . . .	5000-11000 volts
P4 Screen—7 pin duodecal base	

\*cut-off voltage

RADIO • RADAR • SOUND

# Rauland

COMMUNICATIONS • TELEVISION

*Electroneering is our business*

THE RAULAND CORPORATION • CHICAGO 41, ILLINOIS

# A CONTINUING SERVICE

Rider Manuals are not just bound pages of radio schematics; they are more than static pieces of servicing equipment. Rider Manuals are living things! Working hand in hand with successful servicemen for the past sixteen years they have become an unchallenged institution in the servicing industry.

In spite of this leadership, Rider Manuals are constantly being improved with the sole aim of making still easier, the diagnosis and repair of faulty receivers. For example, in preparing the material for Volume XV we are doing things with the diagrams which will furnish information not normally appearing on, or in conjunction with, such diagrams. This additional information alone will save a serviceman hundreds of hours a year; time which will be worth ten times the cost of the Man-



ual. Rider Manual owners also enjoy continuing benefits from the findings of the staff of engineers employed in the Rider Laboratories of "Successful Servicing," the technical business paper published by John F. Rider. "Successful Servicing," sent free upon request, keeps you up to date on all developments in all phases of the servicing field.

So, your purchase of a Rider Manual, any volume, is not the end of a transaction; it is only the beginning of a chain of benefits that add up to an invaluable and continuing service.

Although your jobber may not have every volume number you want, please understand his position—and ours. We are doing everything possible to get them to you at the earliest possible date. Place your order to enjoy priority.

**JOHN F. RIDER PUBLISHER, INC. 404 FOURTH AVE., N. Y. 16, N. Y.**

Export Division: Rocke-International Electric Corp. 13 E. 40th Street, New York Cable: ARLAB

## YOU MUST STUDY TO KEEP UP TO DATE

Just Out "INSIDE THE VACUUM TUBE"...424 Pages, \$4.50

### RIDER MANUALS (14 VOLUMES)

- Volumes XIV to VII . . . \$12.50 each volume
- Volume VI . . . 9.50 each volume
- Abridged Manuals I to V  
(1 volume) . . . . . \$15.00
- Automatic Record Changers and  
Recorders . . . . . 7.50
- The Cathode Ray Tube at Work  
Accepted authority on subject . . . . 4.00

- Frequency Modulation  
Gives principles of FM radio . . . \$2.00
- Servicing by Signal Tracing  
Basic Method of radio servicing . . . 4.00
- The Meter at Work  
An elementary text on meters . . . 2.00
- The Oscillator at Work  
How to use, test and repair . . . . 2.50
- Vacuum Tube Voltmeters  
Both theory and practice . . . . . 2.50

- Automatic Frequency Control Systems  
—also automatic tuning systems . . \$1.75
- A-C Calculation Charts  
Two to five times as fast as slide rule . 7.50
- Hour-A-Day-with-Rider Series—  
On "Alternating Currents in Radio Receivers"  
On "Resonance & Alignment"  
On "Automatic Volume Control"  
On "D-C Voltage Distribution" . 1.25 each

✓✓  
**ONLY HAMMARLUND RECEIVERS  
 HAVE THIS FEATURE...**

**UNITED STATES PATENT OFFICE** 2,222,043

2,222,043  
**SELECTIVE WAVE TRANSMISSION**  
 Donald E. Oram, Forest Hills, N. Y., assignor to  
 The Hammarlund Manufacturing Company, In-  
 corporated, New York, N. Y., a corporation of  
 New York

Application June 28, 1939, Serial No. 281,612  
 8 Claims. (Cl. 178-44)

This invention pertains to electrical apparatus  
 and circuits of the type known as filters and  
 more especially to such apparatus and circuits  
 of the type referred to as band pass filter.  
 One object of my in-

corporated in such receiver to such a degree as  
 may be found necessary, and to make such re-  
 duction quickly and to a predetermined degree.  
 Another purpose is greatly to attenuate

Series 400  
 "Super-Pro"

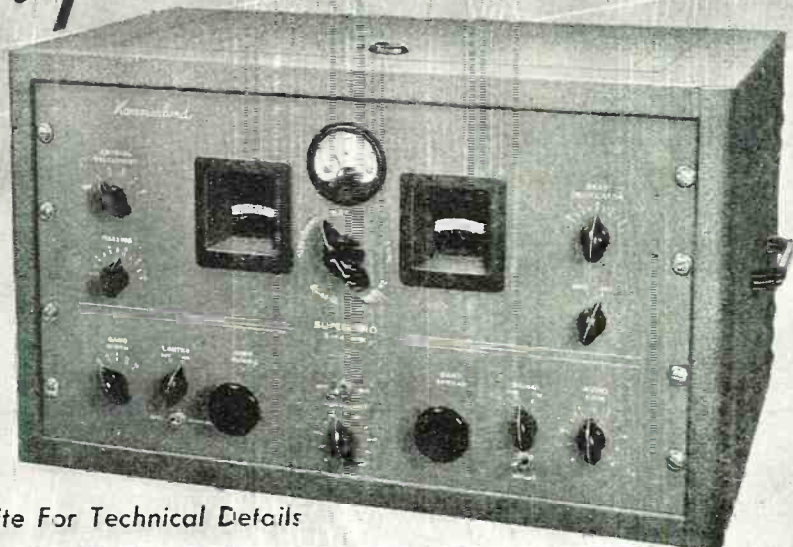

The variable crystal filter  
 used in the "HQ-129-X"  
 and the "Super-Pro" is an  
 exclusive Hammarlund  
 patent. It provides wide  
 band crystal selectivity for  
 use in crowded amateur  
 phone bands and single  
 signal code reception.

Write For Technical Details



**HAMMARLUND**

THE HAMMARLUND MFG. CO., INC., 460 W. 34TH ST., NEW YORK 1, N.Y.  
 MANUFACTURERS OF PRECISION COMMUNICATIONS EQUIPMENT



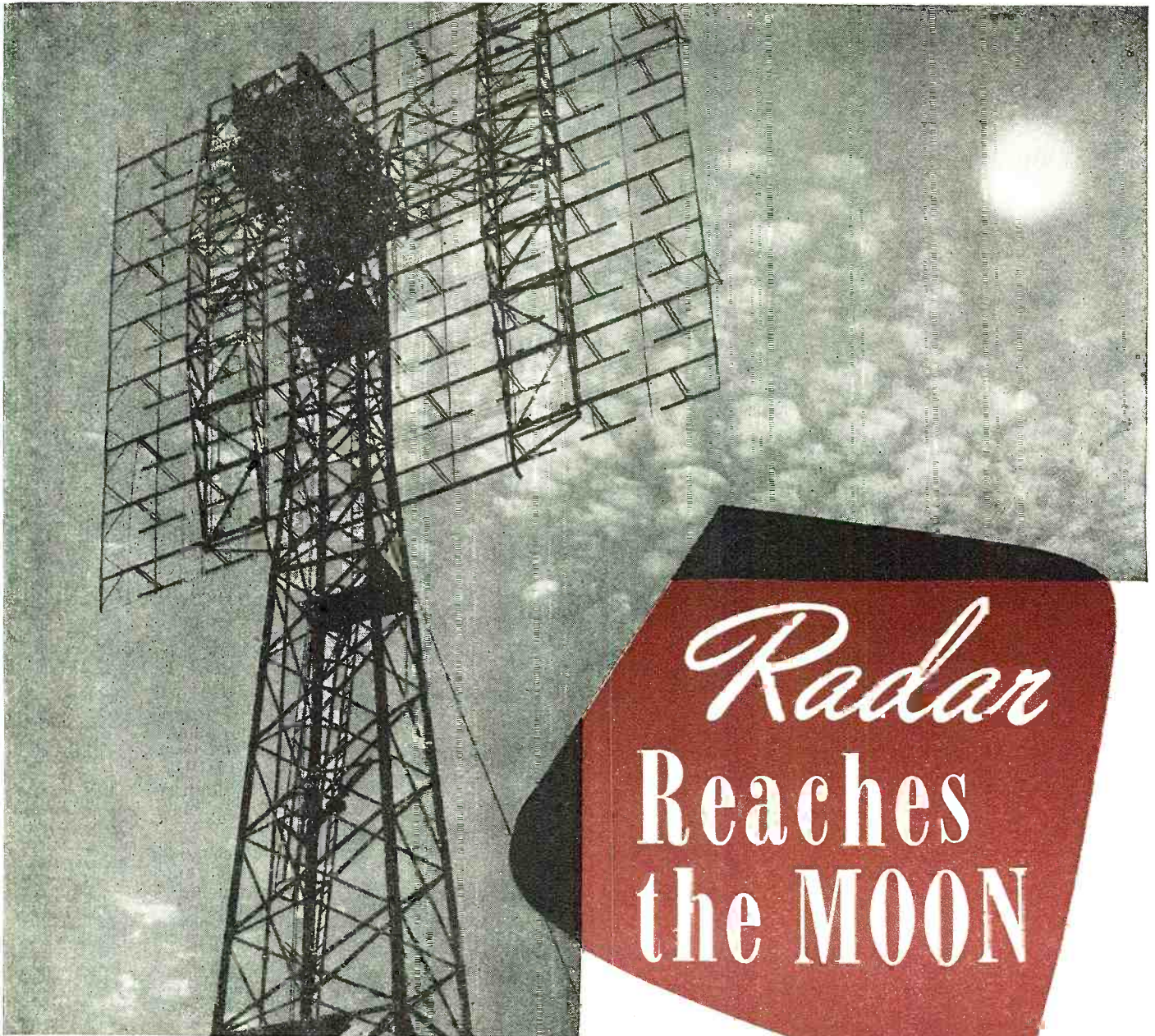

Special radar antenna array of 64 dipoles used for the transmission of pulses and the reception of radar echoes from the moon.

# Radar Reaches the MOON

By  
**TOM GOOTÉE**

*A new era of scientific exploration begins  
with development of the first lunar radar.*

**P**ULSES of r.f. energy shoot heavenward from the massive radar set—up and out into the darkness of unknown space. It might be like other nights during the five long years of war—when other radar sets swept other skies in search of enemy planes. But this is different. This is *lunar* radar.

The radar antenna—one of the largest ever constructed—points toward no military target. Its dipoles concentrate the r.f. pulses toward a great ball of whiteness, the moon, just rising above the New Jersey horizon.

In a tiny shack near the base of the antenna tower, components of the radar set generate the sharp pulses of r.f. energy. The pace is slow, compared to military radar sets. The transmitter functions only once every five sec-

onds. Like the heavy, labored pulsing of a giant heartbeat.

Then, concentrated into a narrow beam by the antenna array, these pulses speed toward the moon at the fantastic speed of light—more than 186,000 miles *per second*—through the ionosphere and on into the unknown void surrounding the earth's atmosphere. The pulses probe where man has never been before, where man has never even dared explore before—with radio waves.

But the men who guide these pulses across distant space have never left their prosaic, tiny shack near Belmar,

New Jersey. They wait quietly for results of their inter-planetary effort, they wait for echoes of the radar pulses to return to earth.

Seconds seem like eternities, as the base line crawls across the face of a single 9-inch oscilloscope. Even the scope is geared to cosmic thinking: its calibrated scale is not in miles, but in *hundreds of thousands of miles!*

Suddenly, through the "grass" of noise a wide pip appears along the base line of the scope. And simultaneously, a 180-cycle tone is heard from a speaker on the receiver console. Both last for almost half a sec-

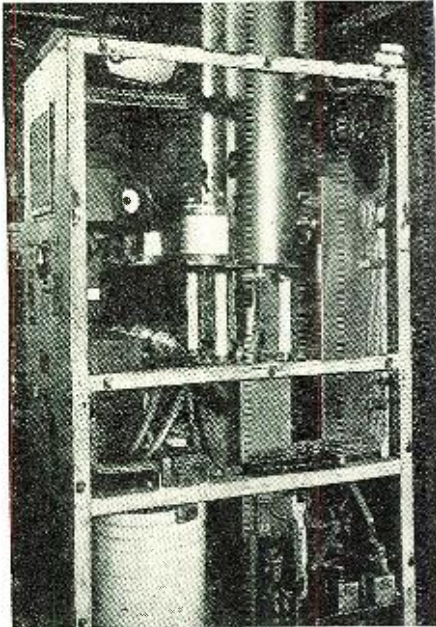

Output stage of the radar transmitter. Two W1-530 tubes (inside large copper shields) supply 50 kilowatts of pulsed power to the antenna. Blowers and filter equipment are in the lower compartment.

ond, then fade out. The time base finishes its sweep, there is a microsecond pause, and the entire procedure is repeated.

An echo pip lasts for almost half a second, and for every radar pulse transmitted: a received pip—appearing at the same place along the base line, indicating a reflecting surface about 238,000 miles distant! An almost stationary image appears on the base line that represents—the moon!

Radar echoes from the moon!

No scientific dream this, no wild tale of phantasy.

Almost every night and day for the past few months, radar engineers and scientists at the Evans Signal Corps Engineering Laboratory in New Jersey have repeated this astounding feat. And the results have been proven beyond a doubt, by leading scientists.

Radar echoes from the moon!

This is the outstanding scientific achievement since the revelation of

the atomic bomb. Radar, itself, was a miracle of science—bent to the defensive and offensive requirements of modern warfare: to detect and locate air and surface vessels.

But this *extension* of the use of radar—to measure vast distances that heretofore could only be computed in theory—becomes a singular and major step forward in the field of science.

### Planned Strategy

Contact with the moon was no mere accident.

Within a few hours after V-J Day, work was begun on the equipment—under the personal direction of Lt. Col. John H. DeWitt and his four chief associates. Some degree of secrecy was deemed necessary—at least until results were obtained, and proven certain and definite.

The new project was referred to only as the “Diana Project.” And the men went to work designing, building, rebuilding, and adapting suitable radar equipment to do the job.

All preparations were completed for a test on January 10th.

On that day the moon rose at 11:48 a.m. At about that time the first radar pulses were transmitted, and the first echoes appeared on the oscilloscope—indicating success.

Accurate timing of *each* pulse and its reflected echo indicated that it took 2.5 seconds for the echo to return.

Since radio waves travel at a fixed rate of speed—about 186,000 miles *per second*—it wasn't difficult to compute the distance from the radar set to the reflecting surface: about 238,000 miles. Col. DeWitt and his radar engineers were convinced they had contacted the moon, because there was nothing else in space at that distance from the earth.

But additional tests were made on following days and nights—each time the moon rose and set.

Said Col. DeWitt, “We knew our months of thinking, planning, calculations, and design were on the right track, but to make doubly positive and sure, as our Army Laboratories must be, we aimed our radar beam at the rising and setting satellite time

and time again, so that we knew without question of a doubt that our pulses were striking the moon and echoes were rebounding back to earth.”

Finally, a group of distinguished but unidentified scientists visited Belmar and verified all of the findings and conclusions of Col. DeWitt and his group.

Only then, weeks after the initial contact with the moon, did the War Department announce details of the Diana Project. The first earth-to-moon, inter-planetary circuit had been definitely established. All records of long-distance radio transmission had been broken.

And repercussions from the announcement were heard around the world—speculating on both the wartime and peacetime applications of the new long-range radar equipment.

For there are many possible, future applications of such radar equipment—some almost beyond the immediate comprehension of mankind.

A new and far more accurate study of the solar system will be entirely feasible, as soon as adequate and more powerful equipment can be built.

One war possibility is radar-beam control of long-range rockets and jet-propelled missiles. Man has gained *control* of outer space.

But the primary significance of the Signal Corps' achievement is that this is the first time scientists have known with certainty that a very high frequency radio wave sent out from the earth *can actually penetrate the electrically charged ionosphere* which encircles the earth and stratosphere.

And this proves to be a curious parallel with history.

### Link with the Past

More than two decades before contact with the moon was recorded in New Jersey, radio waves were first used for a very similar purpose: to determine the distance to the reflecting surface of the ionosphere.

In 1924, a particular portion of the upper atmosphere, called the Heaviside layer, was believed responsible for the transmission (by reflection) of low-frequency radio signals around the earth. In that year, experiments

Block diagram of the radar set that was used in the original detection of the moon echoes.

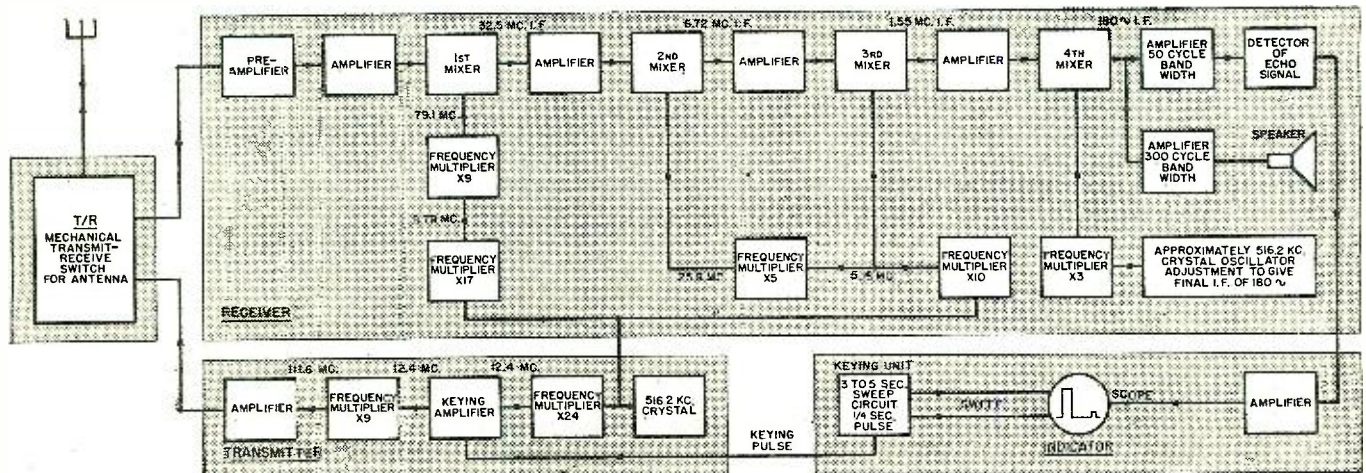

were begun in England by Dr. Edward Appleton and M. A. F. Barnett. Using frequency-modulated transmissions of a large broadcasting station, they were able to prove that the received signal varied in intensity with frequency—because it consisted of a direct wave and a reflected component. And a measure of signal intensity caused by a known change in wavelength resulted in a measure of the height of the reflecting layer.

In the same year in the United States, Dr. Gregory Breit and Dr. Merle A. Tuve, of the Carnegie Institute of Washington, used *pulses* of continuous waves for measuring the distance to the reflecting surface of the ionosphere. Their technique consisted of sending skyward a train of very short pulses—a small fraction of a second in length—and measuring the time it took the reflected pulse to return to earth. Fairly low-frequency radio waves were employed. And, after completion of the experiments, pulse ranging soon became the accepted method of ionospheric investigation.

The advent of short-wave radio transmission and the success of these early experiments led scientists in many countries to speculate on the possibility of using such energy to detect the presence of man-made reflectors, such as ships and airplanes. When powerful sources of high-frequency energy, highly sensitive receivers, and refinements in radio technique became available, these possibilities of detection were converted into working devices. Then, with the coming of war, pulse ranging—or radar—was developed under great impetus. And the story of radar's part in winning the war is now well known.

But even before the war, there were a few radio engineers and scientists who saw in the pulse ranging method a means for measuring phenomenal distances: to the moon, other planets, even, perhaps some day, the sun.

One of these men was John H. DeWitt—then chief engineer of station WSM in Nashville. He was also a "ham", and an amateur astronomer. Using his then meager knowledge of pulse ranging, in 1940 he built his own equipment and attempted to contact the moon. His efforts were wholly unsuccessful, but he was undaunted. He looked forward to the day when he might experiment on a really grandiose scale. A year later the country was plunged into war, and DeWitt entered the Armed Forces.

It was not until after the defeat of Japan that his thoughts returned to contacting the moon. Then a Lieutenant Colonel in the Army Signal Corps, he had participated directly in much of the radar development activity of the Army—particularly as Director of the Evans Signal Laboratory near Belmar, New Jersey, with its wartime personnel of over 6000.

Seizing the opportunity, Col. DeWitt immediately started work on equipment suitable for measuring great distances. Four key civilian radar en-

gineers joined his group: E. K. Stodola, Dr. Harold Webb, Herbert Kauffman, and Jacob Mofenson. They had all worked at Evans during the war developing military radar equipment.

First problem facing the group of men was a new philosophy of thought.

They no longer could think of radar ranges in terms of a few hundred miles. The distance to the moon is about 238,567 miles. But this figure varies from day to day, as the moon revolves and moves in an elliptical orbit around the earth. And both the earth and the moon move around the sun.

A staff of mathematicians and physicists spent weeks computing the trend in relationship between the earth and moon, before assembly of the equipment began. It was necessary to determine accurately the speed of the moon relative to the movement of the earth. And this speed varies—with respect to the earth's rotation—from 750 miles faster to 750 miles slower, at Belmar, New Jersey.

Variations in speed and positions of the earth and its satellite must be taken into consideration *each time* the moon is contacted. Because the net effect of two variables of movement causes a Doppler effect—a shift in the frequency of radio waves. Often this shift is greater than the receiver bandwidth. Thus the relative speeds of earth and moon must be calculated each day with the radar receiver tuned and adjusted to take advantage of the Doppler effect.

Only in this way can a positive check be made on the direct range measurements of the oscilloscope. These calculations are the most reliable verification that the moon is actually being contacted.

#### General Characteristics

Equipment used on the Diana Project comprised extensive adaptations to the standard wartime long-range radar known as the type SCR-271—originally designed in 1937 and used widely during the war.

Principal components are; trans-

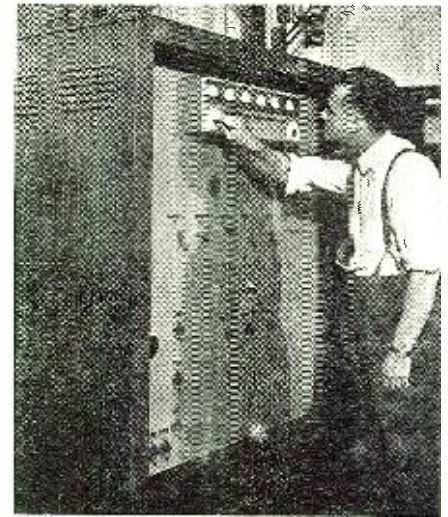

Herbert Kauffman, radio engineer who worked on the "Diana" project, adjusts one of the many stages of frequency multiplication.

mitter, receiver, antenna system, and indicator. The timer or keyer is part of the indicator unit.

The radar transmitter sends out bursts of radio energy, known as pulses. During intervals between pulses the transmitter is turned off, but the radar receiver functions—and picks up any echo reflections which may be received from distant objects or surfaces. These echoes are amplified and then displayed on the time base of a calibrated oscilloscope. The elapsed time between the transmission of a pulse and the reception of its echo is a measure of the distance from the radar set to the reflecting surface—because radio energy travels through space at the speed of light: about 186,000 miles per second.

Because of the distance and nature of the target, this radar set had to have a number of special features.

A very slow pulse rate was necessary—since the radio signal must travel a round trip distance of more than 477,714 miles. Time must be allowed for an echo to be received, be-

(Continued on page 84)

The five Signal Corps scientists responsible for contacting the moon by radar. (Left to right) Jacob Mofenson, Dr. Harold Webb, Lt. Col. J. H. DeWitt, E. King Stodola, and Herbert Kauffman.



# The Aircraft

# RADIO SERVICEMAN



By  
**TONY WAYNE\***

**I**RRRESPECTIVE of the modern trends of present day inventions, use of radio in light private planes doesn't seem to be popular. True, the war had a lot to do with it, but the war is over now. The principal reason for its unpopularity was, and is, installation and maintenance problems. Unlike the car radio, aircraft radio presents many problems, such as interference, bonding, electrolysis, and vibration.

While most everyone drives a car today, and is familiar with its mechanics, this is not true of the airplane. True, most pilots are familiar with their planes, and possess a certain amount of the mechanical aptitude necessary; yet, relatively few servicemen know enough about aircraft to install this equipment properly. The experienced aircraft radio mechanics

who were available prior to war, were absorbed by the airlines. Then too, the little aircraft radio business then existent was not sufficient to entice radio mechanics.

This condition has been rectified largely during the past four years, as thousands of men have been trained in Armed Forces' radio schools.

The radio serviceman has always been a resourceful individual. When home sets were not coming into the shop fast enough, and competition was not only keen but rough, with radio shops in every block, in attics, basements, and bedrooms, the serviceman was repairing toasters, irons, heaters, vacuum cleaners, and washing machines. With the advent of new radios, owners of old "blooper" or "orphan" sets, and recognized brands which have been holding out with a wire and

a prayer, will be reluctant to have them repaired now.

It scarcely seems the intelligent thing to do for servicemen to return to toasters and washing machines; rather, they should put their vast knowledge to work specializing in such fields as electronic equipment, television installation, small boat radio and aircraft radio maintenance and installation.

There are a number of public airports for light planes springing up all over the country, and all of them are taking into consideration the varieties of services the private flyer will demand; and are building with the idea in mind of allocating various concessions necessary. Aircraft radio servicemen—this should be your cue—get your bid in now. These airports will furnish you the necessary space, either on a reasonable percentage or rental basis.

All signs are definitely pointing toward an almost unbelievably rapid growth of the use of aircraft radio. Light plane purchasers can look forward to buying planes completely radio equipped. This is not mere crystal gazing, as many large light plane and radio manufacturers have made public this intention.

The subject, in general, should become of interest to the radio serviceman. To meet possible demands for information concerning general description, installation, and maintenance of aircraft radio equipment, and some new and unusual accompanying problems, this article is written. Its purpose is to make available such pertinent information as will provide a general outline of aircraft radio; its parallelisms to the radio serviceman's present activities, showing that the slight departure from those activities will not be too radical.

Fig. 1. Panel view of the Learadio receiver tuning unit. Model RCBB.

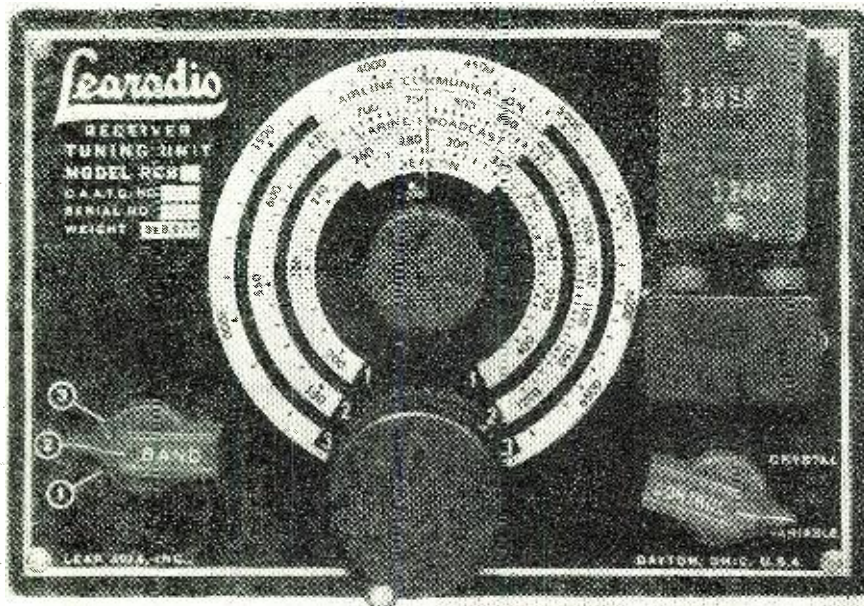

\*Formerly associated with the U. S. Navy Bureau of Aeronautics, and Aircraft Radio Laboratory, Wright Field, Dayton, Ohio.

**With the increasing demand for civilian operated planes, competent technicians will be needed for the installation and maintenance of aircraft radio equipment.**

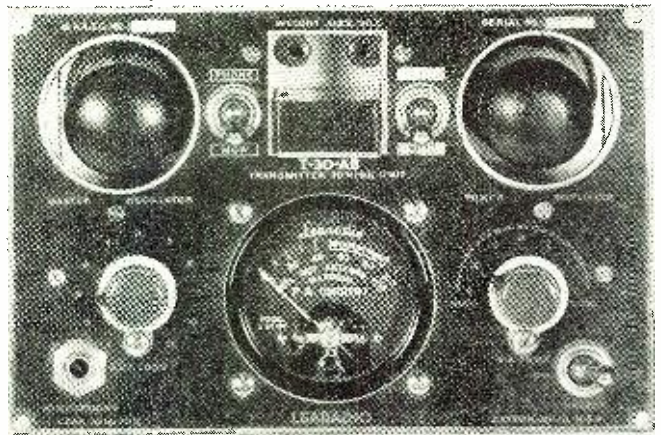

Fig. 2. Transmitter tuning unit, Learadio Model T-30-AB.

This article discusses the problems of aircraft radio, strictly from an elementary viewpoint, with sufficient detail given to enable the radio serviceman to answer questions intelligently. It is also intended that he will gain sufficient information from the detail herein so that he will be able to install and service aircraft radio.

There are a number of factors met in servicing aircraft radio not common to average radio servicing. Mounting and installation alone are of great importance; and when servicing is done on the more complicated units, such as the automatic direction finder, automatic pilot, etc., need of experience and knowledge is greatly enhanced. Need for radio mechanics qualified to service aircraft radio will undoubtedly become greater in the near future, and the importance of sound and dependable training cannot be minimized. Aircraft pilot's dependence upon his radio equipment is too important to leave to the wiles of an untrained serviceman.

Before actually installing radio equipment, it is imperative that you understand the construction of light planes.

For this purpose, we will use illustrations of one of the most popular light planes—the *Piper Cub*. These illustrations will give the necessary information concerning not only the *Piper Cub*, but many similar models as built by other manufacturers.

Fig. 5 shows a cutaway view, clearly indicating the various parts of the airplane, together with their correct names. Recognition of these parts will enable you to talk "pilot's language" about any light plane.

Fig. 3 shows the control system of the light plane.

As a model for our aircraft radio discussion, we will use the model T-30, RCBB two-way aircraft radio equipment as manufactured by *Lear, Incorporated*. Front view of the receiver is shown in Fig. 1.

To require a minimum of instrument panel control space, and to allow better weight distribution, this receiver has been divided electrically

and mechanically into two units. The tuning control unit incorporates r.f. amplifier, detector, and oscillator; while Model G-3-AB unit contains dynamotor power supply, i.f. amplifier, second detector, a.f. amplifier, and range filter. In the case of the transmitter-receiver power supply, Model G-30-AB, the modulator unit of the T-30 transmitter is also built on this chassis; and it is only necessary to add the i.f. section of the transmitter and the necessary cables to have the T-30, RCBB two-way combination.

A front view of the model T-30-AB transmitter tuning unit is shown in Fig. 2.

The RCBB is a three band receiver covering the 200 to 400 kc. beacon band; the 500 to 1200 kc. broadcast band; and the 2800 to 6700 kc. aircraft communications band.

Prior to the actual installation of any aircraft radio equipment, make a "bench" test of its operation. This will serve as a basis for trouble shooting the installation, should it not operate upon completion.

Actual placement of the tuning con-

trol unit and the power supply in an aircraft installation is dictated by several considerations.

Whether the receiver tuning and control section is mounted in the instrument panel, overhead or elsewhere within arm's reach, must be determined by the user of the equipment and may be limited by space available in the instrument panel, vision, movement of controls or other considerations. The wide variety of individual demands and limitations imposed by previously installed equipment makes it difficult to recommend standard installations in aircraft already in use.

### Center of Gravity

While an aircraft radio mechanic can scarcely be expected to be responsible for the weight and balance of the aircraft in which he is installing or servicing radio equipment, he should be concerned when his installation or the possible addition of radio equipment will affect the center-of-gravity consideration (Fig. 6A).

Every particular airplane is designed to do a certain job and fly

Fig. 3. Conventional control equipment employed in a Piper Cub Plane.

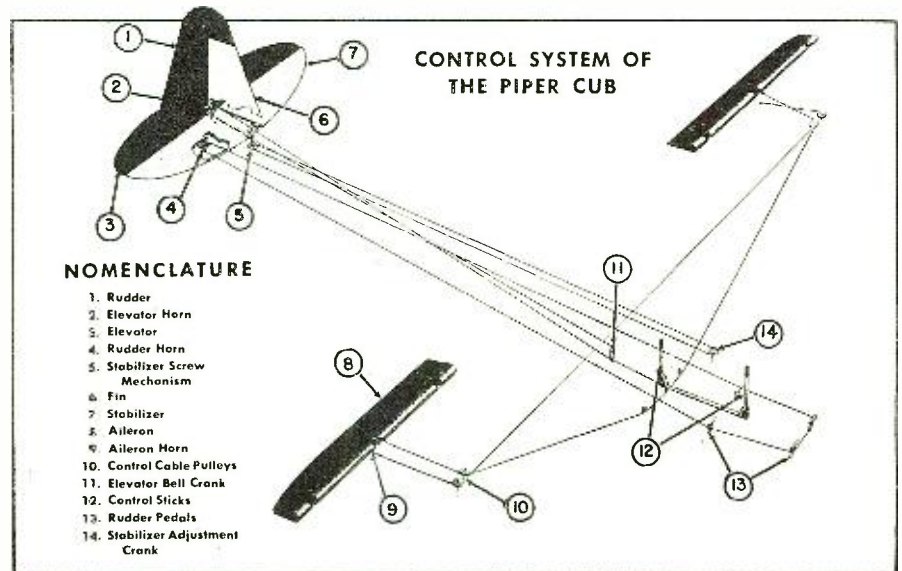

## EQUIPMENT TROUBLE SHOOTING CHART

EQUIPMENT SYMPTOM	POSSIBLE CAUSE
Entire Unit Dead	{ Power switch not on—No connection to power source—Supply voltage absent or low—Fuses blown—Broken wire—Defective rectifier—Short on voltage supply—Defective component.
Broad Tuning	{ Battery voltage low—Improper alignment—Weak tube—Open grid circuit.
Operation Below Normal	{ Remote control circuit open—Local or external interference—Poor connection to antenna (broken or shorted)—Transmitter defective—Receiver defective—Modulator defective.
Low Transmitter Power Output	{ Defective transmitter oscillator tube—Defective modulator tube—Low plate voltage—Low filament voltage—Loose or corroded connections which may result in high resistance joints.
Discrepancy of more than 15% in Meter Readings	{ Trouble in that circuit.
Contact Noise (Intermittent)	{ Poor bonding or parts not bonded—Loose light bulbs—Loose fuses—Loose fuse elements—Loose plugs.
Electrical Leakage Noise	{ Windshield wipers—Generator—Lights—Cigarette lighter, and other electrical accessories.
Dead Spots	{ Oscillator not working—Shorted tuning condenser—Switching arrangement defective—Bad oscillator tube.
Fuse Blows	{ Defective rectifier—High voltage grounded—Defective line switch.
Equipment Smokes	{ Resistor defective (incorrect size or wattage)—Shorted tube—Shorted condenser—Defective insulation—Circuit overloaded.
Distortion	{ Incorrect bias—Oscillator tube weak—Push-pull tubes not matched—Bias resistor filter condenser open—Defective microphone or headset—Excessive high voltage or filament voltage—Tube in wrong socket—Weak tubes—Receiver not tuned to resonance—Volume control advanced too much.
Inability to Tune	{ Defect purely mechanical and easily located by visual inspection.
High Input Current and Low Output Voltage	{ Shorted dynamotor armature—Defective dynamotor bearings.

within stipulated load limits. The top limit is figured with a factor of safety sufficient to allow for stresses and strains of all ordinary operations. Attempting to fly an overloaded airplane will definitely decrease its range, increase its stalling speed, and require a longer runway to take off and land. Should an overloaded airplane run into rough weather or experience any other unforeseen trouble, the margin of safety due to high gross weight will be reduced to such an extent that the pilot may not pull through.

Balance will affect an airplane's performance more than overload. An airplane slightly out of balance will not only change the spin and stall characteristics of the airplane, but will render it uncontrollable, and if a pilot encountered trouble in the air, he could not recover.—Fig. 6B.

The center-of-gravity (CG) for a loaded airplane should be that point at which it would balance itself were it suspended, as shown in Fig. 6A.

### Vibration

Shock and vibration are of relatively great amplitude and of three-dimensional character. The impact experienced when an airplane "bumps" in for a landing on rough terrain, is often of considerable magnitude and may cause serious damage to radio equipment if adequate cushioning of shocks is not afforded.

Also, it is important that radio equipment, in aircraft, be properly protected from the weather, as well as from such trouble makers as corrosion, commonly known as electrolysis. Two dissimilar metal bodies making contact with each other in salt air causes an electrolytic action to set in. This not only corrodes the parts, but results in a difference of potential, which causes noise in the radio.

When installed in an instrument panel and when using rubber mounted brackets, sufficient clearance must be allowed in the size of the hole cut in the panel to prevent the receiver from vibrating and rubbing the instrument panel. Mount the receiver from the front of the panel. Mount the power unit wherever space is available—baggage compartment, cabin floor, or on a special mounting in the rear of the fuselage. Because the power unit need not be accessible for operation, it may be installed forward or aft in the fuselage to bring the center-of-gravity to a desired point.

The various switches and controls may be installed wherever convenient and each cable to them should be securely taped and laced into place. *Danger!* Be certain that in lacing any electrical or mechanical cables they are not fastened to any of the aircraft controls. Double check all controls upon completion of the installation to be sure that they are free!

Don't fasten the unshielded antenna lead parallel to any metal parts of the aircraft, such as the fuselage tubing, for a greater distance than

necessary. The capacity between the antenna lead and such metal surfaces reduces signal strength. The antenna lead-in should not be shielded, except where transmission lines or coaxial cables are originally supplied.

*Don't* run the antenna lead near any of the ship's ignition, or electrical wiring. This includes the primary of the ignition system to the ignition switch even though these leads themselves are shielded.

*Don't* route the battery lead near the aircraft's magnetic compass. Check this by switching on the receiver and noting its effect on the magnetic compass.

### CAA and FCC Rules

A mechanic installing radio equipment in aircraft need not be a certified CAA mechanic. However, his work must be examined by one, to be sure it does not provide a hazard in plane operation. This is the only requirement in the Civil Air Regulations on this subject.

According to the CAA, "... Anyone using an aircraft radio transmitter, whether in checking frequencies or contacting the tower, according to FCC rules, must have at least a Class 3 operator's license."

The FCC has no specific requirements for radio mechanics performing work on aircraft radio equipment. However, personnel making adjustments to non-governmental radio transmitting equipment which involves the radiation of energy, should hold a radio operator's license of the second class or higher, either radio-telephone or telegraph.

Now, the \$64 question is—if it only takes a restricted phone ticket (3rd class phone), to operate the equipment in a plane, why make the poor mechanic take that "engineering course"—2nd class phone or telegraph exam?

### Precipitation Static

Aircraft radio servicemen should be cognizant of that type of static which is so common to aircraft radio—Precipitation Static—new pilots experiencing the brilliant fiery display on their prop tips, on the windshield, or along the wing and tail surfaces (as shown in Fig. 7), and have experienced the difficulties of the accompanying static, will expect the serviceman to do something about it. Actually, there is very little you can do, except give the customer an explanation of precipitation static, and then install a loop antenna, instructing the customer in its use.

It has been discovered that certain types of aircraft antennas are definite sources of precipitation static, since the antenna is directly exposed to extremely high electric fields.

These high fields cause corona discharge, which introduces electrical pulses directly into the radio receiver, shock exciting it, resulting in noisy precipitation static, Fig. 4.

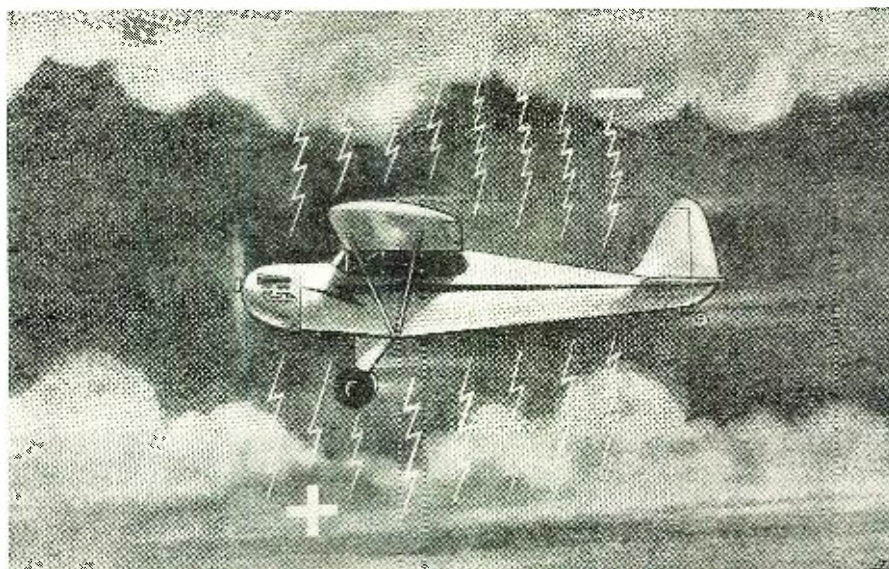

Fig. 4. Cloud layers that are electrically charged cause corona discharge. This charge introduces severe electrical pulses in the radio receiver.

Some of the present day static dischargers are not successful in eliminating this interference at the antenna. More desirable methods are to use an insulating plastic covering on the antenna wire or to use a bare wire of a very large diameter. All metallic connections to the antenna and lead-in should be covered with an insulating dielectric material, preferably plastic. However, even these methods are not effective, since it is possible on first encounter with an electrical field of sufficient intensity, the insulation will be punctured and you will be right back where you started.

It has been common practice for quite a few pilots to reel out their trailing antenna, grounding it to some metal part of their airplane, in an effort to provide a discharge path for the charge. This is a waste of energy since the discharge noise is worse than that which the pilot is endeavoring to eliminate, and is especially dangerous in storm areas, as the trailing

wire will function as a lightning rod, inviting lightning to strike and ruin the radio equipment.

### Bonding

One of the primary requisites for noise-free reception is proper grounding or so-called bonding of individual units of an installation. Each unit should have an individual grounding strap securely fastened to the nearest metal part of the aircraft structure. When this structure is steel tubing, the plated copper braiding can be soldered directly to the tubing after paint is cleaned away. This operation requires a heavy-duty soldering iron and the connection should be cleaned off and re-painted or shellacked to prevent corrosion or rust.

Non-metal fuselage aircraft present a special problem in this respect, and the aircraft manufacturer should be consulted for the right method of bonding, if the usual method of bond-

(Continued on page 111)

Fig. 5. Cutaway view indicating the various parts of a Piper Cub plane.

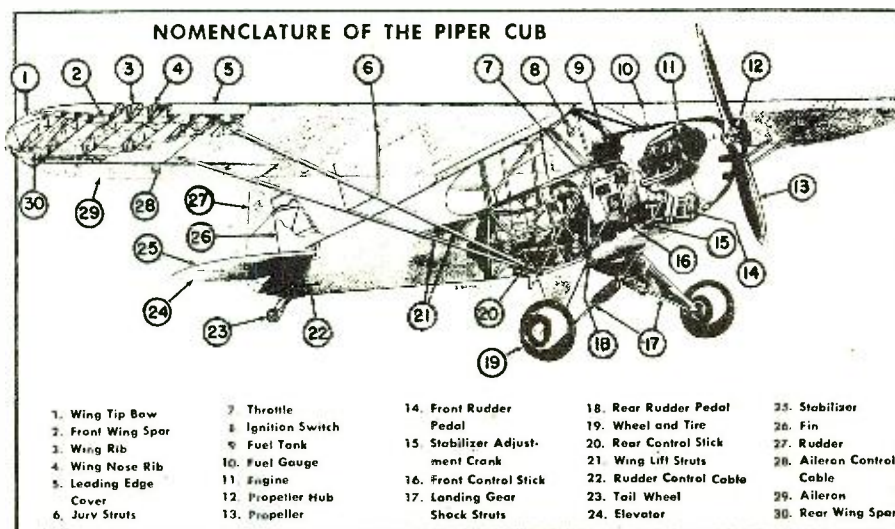

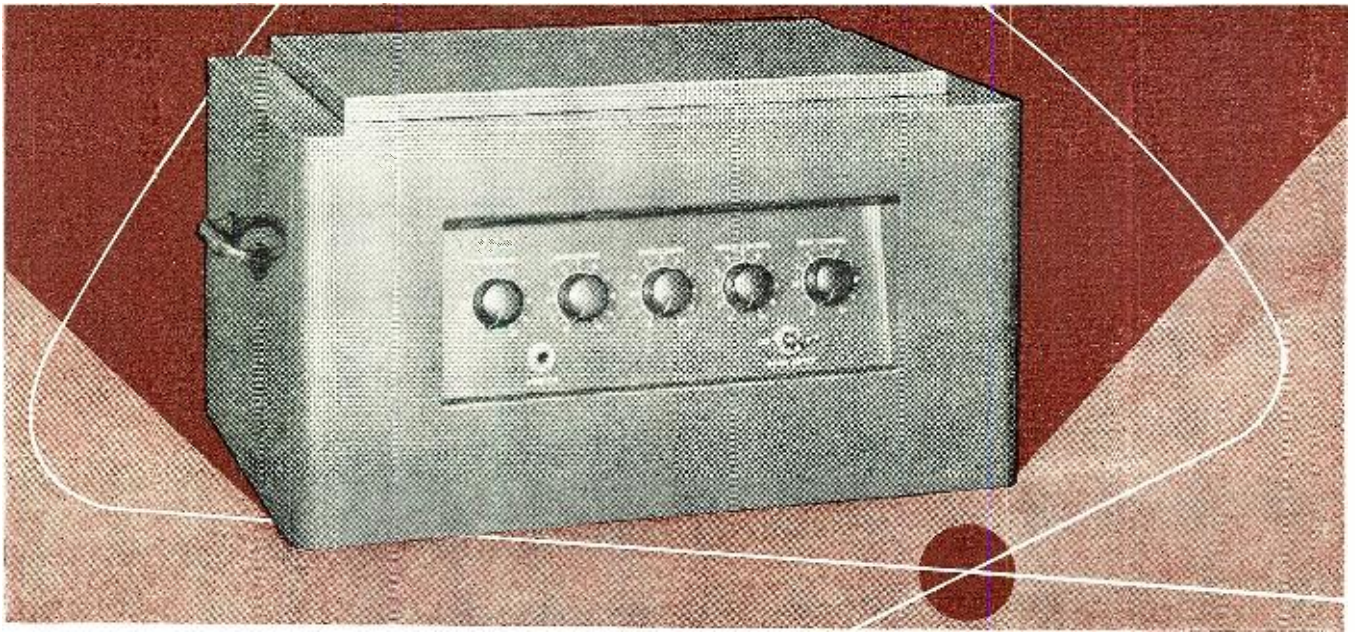

Front panel view shows simplicity of design. Controls from left to right are: microphone gain, microphone gain, phonograph gain, treble and bass controls.

# High-Fidelity ALL PURPOSE AMPLIFIER

By **ROY T. ROGERS**  
Chief Engineer  
and **MILTON PUTMAN**  
Clark Radio Equip. Corp.

*This 30 watt, commercially constructed amplifier is designed for public address work and high fidelity sound reproduction*

**T**HE amplifier to be described in this article was designed primarily to bridge the gap between equipment normally associated with public address work and that which is primarily designed for application in the broadcast field. With a view towards the ever increasing appreciation of the public in respect to sound reproduction, it is felt that certain improvements were warranted over the conventional equipment used for public address or sound reinforcement work.

Some of the more important considerations are; reduction of hum, improvement of linearity of frequency response, improvement of balance between upper and lower frequency limit, provision for greater flexibility and independent control of bass and treble frequencies in ranges which afford the most pleasing balance, and reduction of distortion and particularly improvement of the low frequency waveform within the useful range. No attempt was made to extend the frequency response beyond 10,000 cy-

cles in view of the specified field of application. However, consideration was given to the importance of choosing a low frequency limit which provided the most satisfactory balance. The amplifier, in the range between 50 and 10,000 cycles, was designed to give the least distorted output. The equalizer circuit which is incorporated provided a tremendous amount of variation at the lower and upper frequency limits of 50 and 10,000 cycles as described in more detail later on. Subjective tests were conducted to determine the characteristic slope of the pre-emphasis curve at the low and high frequency ends which gave the most pleasing results. This proved of considerable interest and it is concluded that a slope starting at approximately 500 cycles and increasing at the rate of 8 or 9 db. per octave down to 50 cycles provided the most satisfactory bass compensation when a very large amount of boost is used.

Various systems of equalization of audio amplifiers have been used. Among the most frequently used cir-

cuits are those which incorporate tuned circuits or at least inductances. These tuned circuits or conventional types of filters required, in some applications, rather large inductances which are frequently bulky or undesirable from the standpoint of hum pickup. A further disadvantage of employing the tuned circuit type of equalizer is that it introduces harmonic distortion particularly in highly selective circuits.

One of the objects of the design of this particular equalizer circuit was to provide a system which had none of the inherent limitations of any of the forenamed types, in order that a maximum flexibility of control over predetermined bands of frequencies be accomplished; that the amplification through the equalizer be sufficient that even at the frequencies passed at the least amplitude, the gain is still a useful amount; and that the system introduces a minimum of distortion throughout the wide variation in compensation.

The equalizer circuit consists essen-



tially of three separate channels; namely, low frequency, middle frequency and high frequency. The middle frequency network is a single "T" network in the input circuit of the high frequency section of the dual triode. A high pass circuit with a turn-over frequency of 500 cycles is in the plate circuit of this section of the tube. This is a fixed network designed to give linear response between 500 and 1500 cycles with the response falling off approximately 12 db. at 50 cycles and 15 db. at 10,000 cycles. The circuit was designed so that the equalizer tube provides a gain of approximately 6 db. between 500 and 1500 cycles. The middle frequency network is independent of the high and low frequency circuits; therefore, the gain through the middle network is not affected by the position of the bass or treble control. The high frequency circuit consists of a high pass network from the input source which also provides isolation. From the arm of the high frequency control an isolating resistance feeds the grid of the high frequency section of the triode. The relationship between the value of this isolating resistance and that in the middle frequency network is such as to prevent interaction between these two circuits. The feedback voltage is taken from the plate of the high frequency triode and fed back to the grid through the control in such a manner that as the amount of signal which passes through the high frequency channel is increased, the percentage of feedback is also increased, counteracting excessive phase shift and providing pre-emphasis of high frequencies as much as 20 db. at 10,000 cycles with very little increase in distortion. The low frequency circuit which consists of the other section of the dual triode is fed through an isolating resistance to the control. The feedback circuit for this section of the tube consists of a bridged "T" network which is very selective. As the amount of signal which reaches the grid of this section of the tube is increased, the feedback is also increased and the operation is the same as outlined above. The plate circuits of the high frequency and low frequency sections of the equalizer are coupled together through suitable isolating networks to prevent interaction and to give the desired response. The series resistance and capacitance in the plate circuit of the low frequency section is a network designed to reduce the response below fifty cycles. From the characteristic curves it can be seen that a variation of approximately 30 db. is possible at 50 and 10,000 cycles. The gain of the amplifier between 500 and 1500 cycles remains substantially constant with a variation of only  $\pm 1\frac{1}{2}$  db. throughout the complete variation of the high and low frequency controls. Without careful adjustment and from calibration curves given on production models, it is possible to set the amplifier in a flat position which will give response within  $\pm 1$  db., 50 to 10,000 cycles.

April, 1946

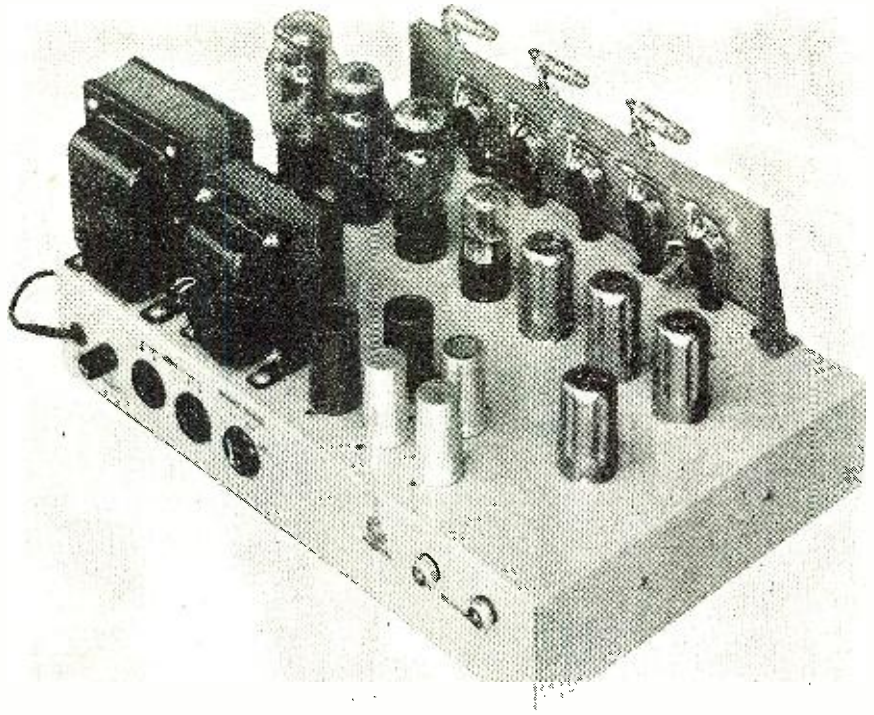

Top view of chassis shows most advantageous placement of component parts.

The advantages of this setting to any predetermined range are readily apparent to the reader. For many applications it is desirable to be able to have certain frequencies emphasized or attenuated and the use of the individual curves are ideal for this purpose.

Some of the applications where this feature is desirable are; sound effects, recording, band passing or rejection, or similar problems.

As mentioned previously, the characteristic slope was determined after consideration of all the factors involved, both from a technical standpoint and from the practical standpoint. In view of the characteristics which were chosen, it can readily be seen that the circuit lends itself par-

ticularly well to the type of work that involves wide ranges of equalization, such as recording. One problem which is encountered in the practical application of this type of circuit, however less serious than in the aforementioned equalizers which used iron core inductances, is the elimination of hum. This problem may be minimized by the proper choice of low frequency pre-emphasis slope and the frequency at which maximum pre-emphasis occurs.

The microphone and mixer stages of the amplifier use d.c. on the filaments supplied from the bias circuit of the output stage. This results in a hum reduction of 12 to 15 db. in the microphone stage and approximately

Frequency response curve. Selective boost or attenuation of both high and low ends of the audible spectrum can be obtained without affecting the middle frequencies.

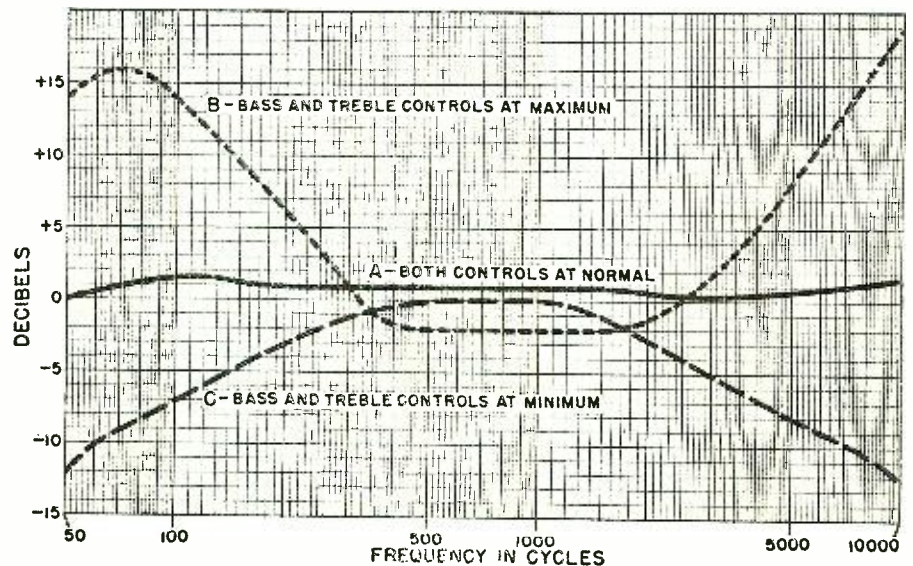

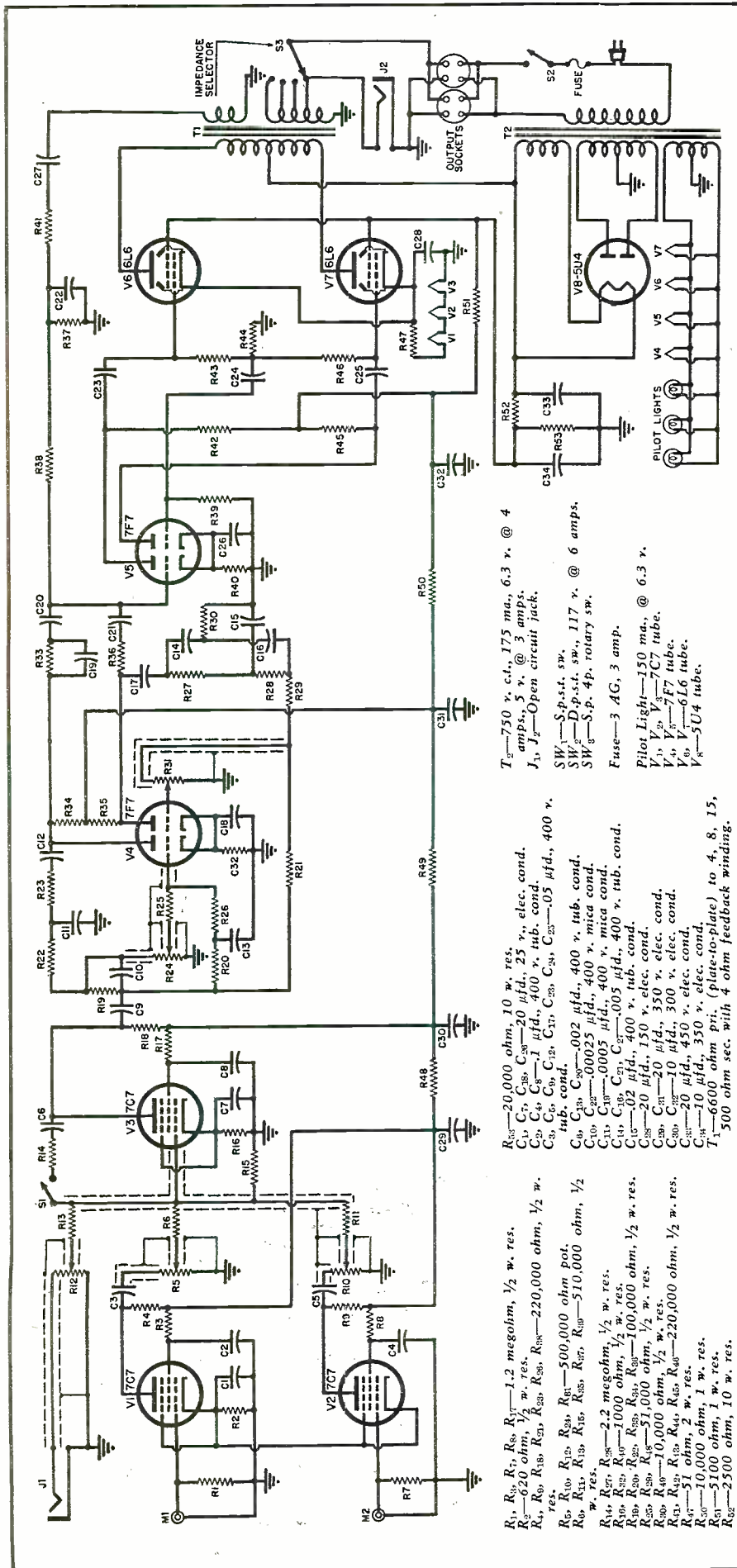

Schematic diagram of the eight-tube a.c. operated amplifier. Employing push-pull 6L6's, a maximum of 30 watts is obtained at less than four per-cent harmonic distortion.

4 db. in the mixer stage. The isolation resistors between the output of the microphone stage and the phonograph input prevent interaction from mixing and the total variation is less than 2 db. for any setting of the microphone or phonograph controls. The output from either the microphone stages or the mixer stage is flat going into the equalizer and variation shown in the characteristic curves is accomplished entirely in the equalizer stage. The feedback circuit in the plate of the mixer stage is switched in and out to provide a gain variation and a substantial reduction in tube noise when the amplifier is being used in applications which called for a still lower noise level. The output of the equalizer is connected to the phase inverter stage which is the self-balancing type. The over-all voltage feedback is taken from a separate feedback winding on the output transformer and fed back to the input grid of the phase inverter. Of many types of inverse feedback tried, this method proved by far the most satisfactory. By its inclusion, any distortion which is present immediately following the tone control circuits is effectively eliminated or considerably reduced. This is readily apparent in a listening test.

In making final test analysis of the amplifier's gain, measurements were made at an input impedance of 25,000 ohms and converted to gain based on 100,000 ohm input which is probably the most standard figure for high impedance input measurements in the field. However, the gain of many amplifiers is given in figures representing gain at an input impedance as high as two megohms. The noise level on production run amplifiers is normally around 55 db. below full output with the bass control full on. If a lower noise level is desired in a particular application, such as a monitor for phonograph playback, the feedback switch may be closed on the mixer stage and the noise level will be approximately 65 db. below full output. It is perhaps worthwhile to mention that to enjoy the full flexibility of the equalizer any device which is used as an input source should be equalized independently to a flat characteristic. It is not intended that the amplifier cannot be used to complement for the deficiencies of any other device, but rather that the increased flexibility for various compensation characteristics may be more greatly appreciated if the input source has a flat characteristic.

With an output power of 30 watts with less than four per-cent distortion, this amplifier will serve for a wide range of applications. Housed in an attractive metalized bronze gray cabinet, with the control panel indirectly illuminated, it will harmonize with almost any surroundings.

*Serviceman's*

# RECORDING STUDIO

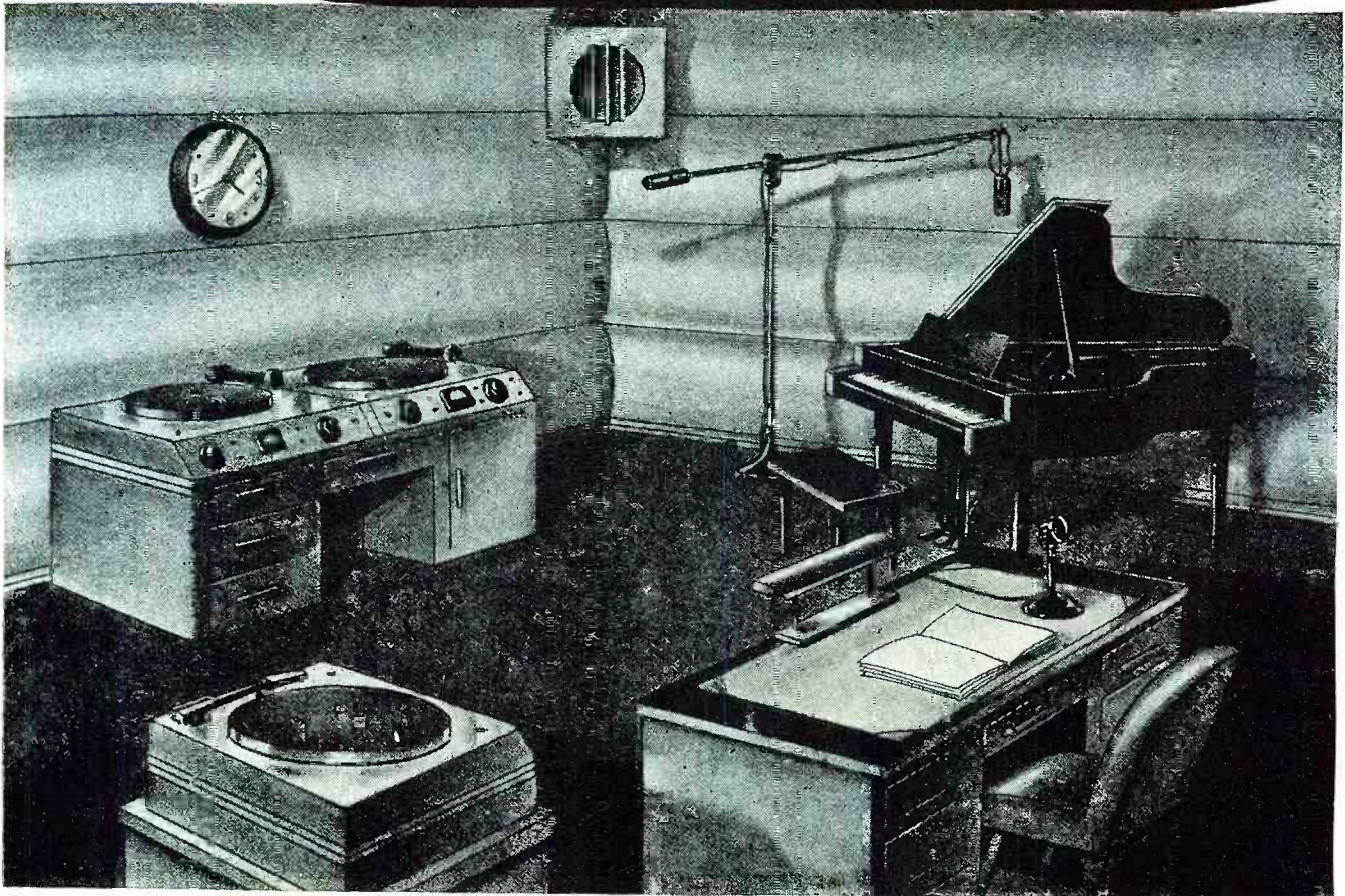

The recording studio incorporates all latest acoustical considerations. It features two separate microphone channels, dual recording units, and playback turntable and pickup.

By **RUSSELL PAIGE**

## **Radio serviceman Kenneth Doyle of Massena, New York, finds recording studio pays dividends.**

**K**ENNETH DOYLE returned from the wars determined to set up his own radio service establishment, but like many another returning warrior he discovered that he had, to put it mildly, a group of competitors—servicemen with an established clientele. Doyle, after a survey of existing radio service centers, decided that to be successful his service unit must offer a new service commodity to the community. With that thought in mind he has established a "Community Recording Center." As a companion service he has a portable recorder which journeys with him on all service calls.

Doyle's design of a recording studio in his own serviceshop is typically modern in all respects. The studio contains a dual recording turntable console equipped for 33 or 78 r.p.m. operation. A piano is, of course, standard equipment with a boom mike adjacent and overhead. A desk equipped with a desk mike is provided for solely speech recordings. A playback unit completes the equipment. The playback speaker is mounted in an upper corner of the recording studio. Wires connecting mike and turntables as well as all other wires are run underneath the floor to eliminate pickup.

When the record-making client ap-

pears on the Doyle premises, he or she is ushered into the studio by Doyle or an assistant. Two high school seniors have charge of the record studio—both trained musicians themselves. The client is shown the correct distance to stand or sit from the mike and the assistant is on the spot at all times while the record is being made. In the event that for reasons of privacy the customer prefers to "cut his own" he is instructed in the not-so-complex art of record-preparation. The customer is advised to start the record needle playing from the center of the disc outward rather than from the outside towards dead center. Provided with an accurate timepiece, wall mounted directly in front of them, the customers are able to time their musical or speech making activities to coincide with the playing limits of the disc.

*(Continued on page 127)*

# A Precision FREQUENCY STANDARD

By Merl Saxon

**Amateur version of the popular BC-211 frequency meter. Though surplus parts are used, high accuracy is obtained.**

**F**OR the past four years the construction of a piece of electronic gear in the home workshop was undertaken only by the most ambitious experimenter. At a time when 100% production of electronic parts went to military uses it became a huge task to assemble all necessary components to go into a project. But necessity can sire most any invention—thus this novel heterodyne frequency meter came into being.

Several months' association with the Army's BC-211 and BC-221 frequency meters left the author with a savory desire for one of them. These Army units were heterodyne type frequency meters employing a well designed variable frequency oscillator, a detec-

tor and an audio amplifier, feeding headphones. Of that oscillator much can be written, but a brief survey of its qualities will suffice. It has a superbly designed worm gear driven condenser with precious metal plated condenser plates to prevent corrosion from affecting its capacity. Even the metal used in the condenser was selected for minimum temperature coefficient of expansion. It is attached to a dial accurately readable to five places or digits and having 50,000 dial divisions, counting vernier scale. Fundamental range of the instrument is 125 to 250 kilocycles on the low range which figures slightly more than 25 cycles per main division or about 3 cycles for each vernier division. For such accuracy the dial was maintained in calibration by use of a 1000 kc. crystal oscillator and with initial adjustment to station WWV furnishes accurate check points throughout the dial range. A small corrector capacitor in multiple with the main tuning condenser provides calibration adjustment. Lastly, these BC-211's were powered by No. 6 dry cells and 22½ volt "C" batteries and required a 10 to 15-minute warmup period.

But where can one find the components to make a similar meter? Amateur radio operators are likely not to find even the time to build it in their mad scramble to get that old dust covered 40-meter transmitter to operate on 10 meters. Military aircraft radio has in recent months afforded a supply of parts rather unique in shape and design but quite adaptable to our use. The meter here described was built around a certain tuning condenser extracted from one unit of an SCR-274-N Command Transmitter. The condenser, driven by a well de-

signed worm gear, usually is removed from the command set when it is converted over to crystal control for civilian use. Most any airport that harbors a former military aircraft whose radio has been remodeled for private use will have a "heap" of removed radio parts lying around. The author found one firm selling the worm gear condensers used in his meter for fifty cents apiece. Several other aircraft parts are used and are identifiable in the photographs.

Self-contained battery operation with 50 milliampere miniature tubes were first of all settled upon for basic design so that long warm-up waiting periods might be avoided. This becomes feasible with a relatively small operating range of room temperature. Next, an oscillator tube had to be selected. A counterpart of the 1A7 could not be found in miniature so a second best was chosen in the 1R5. In isolating the oscillatory circuit from output plate, a 1A7 can offer two grounded grids (with respect to r.f.) while the 1R5 has one. Nevertheless to favor our selection is the fact that it is a stronger oscillator than the 1A7—a distinct advantage when using high order harmonics. The same type tube is used for a detector while the audio amplifier tube selection is a matter of preference.

First glance at the schematic diagram (Fig. 4) leaves one with the impression that the meter might be simple to construct. Behind the three battery powered tubes, one tuned circuit and a relative scarcity of parts lies more than the eye can see. In fact, making of the instrument boiled down to more mechanical than electrical problems. A constant vigil had to be maintained in the assembly and se-

Fig. 1. Chassis layout. Large dial drum is made from auto body wax can with top removed. A 2 inch tube mounts it to condenser shaft.

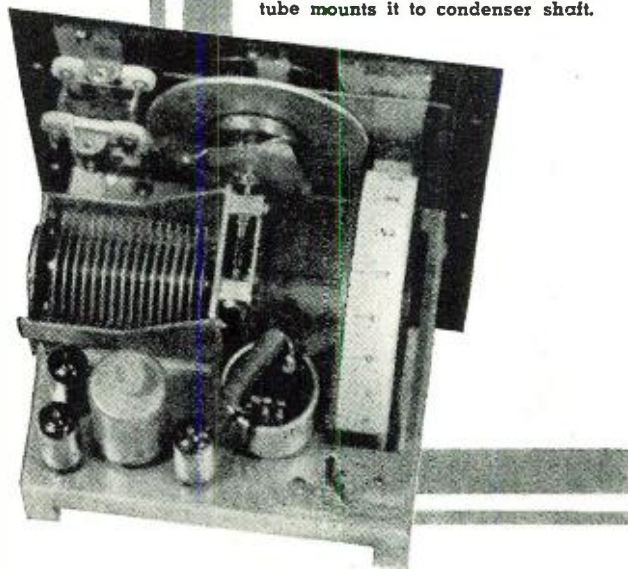
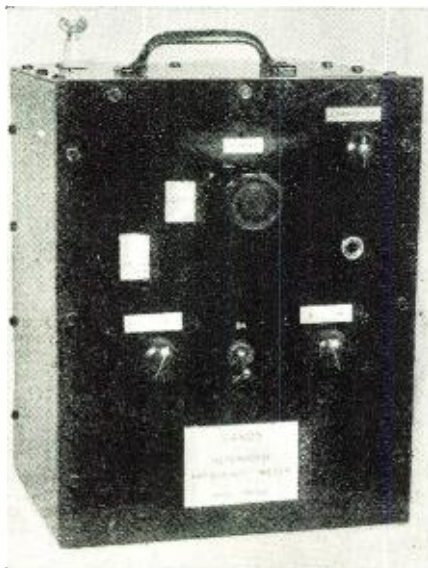

Fig. 2. Front panel view. The standoff insulator (left rear) is antenna post.



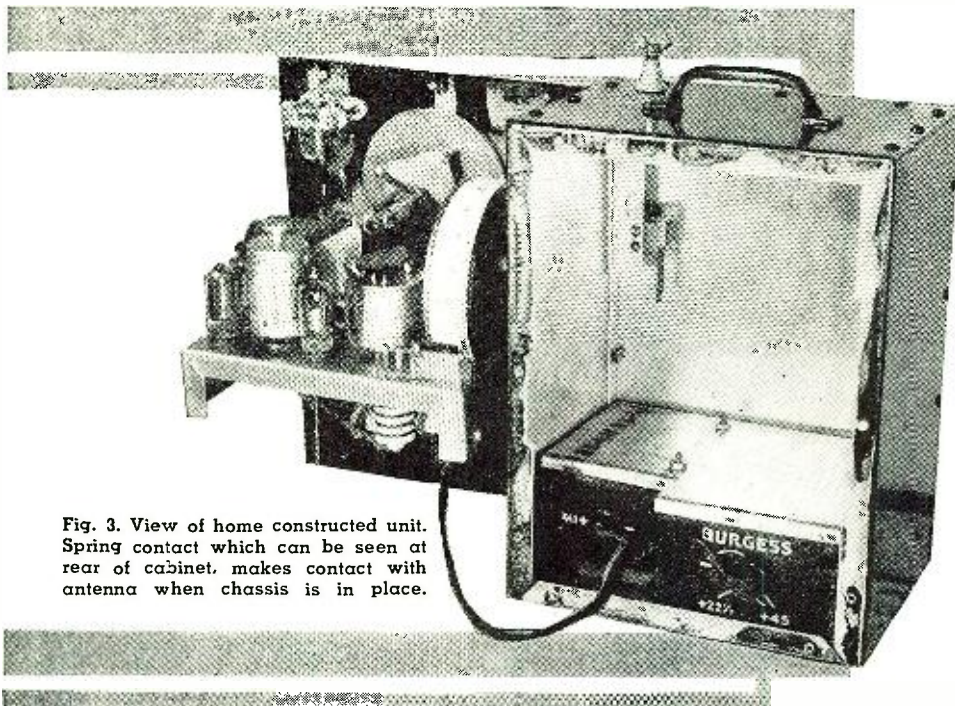

Fig. 3. View of home constructed unit. Spring contact which can be seen at rear of cabinet, makes contact with antenna when chassis is in place.

lection of parts so that no one weak point would jeopardize the accuracy of the very heart of the meter—the tuning condenser and its dial. Rigid wiring was used in the tuned circuit. All other circuits are served with a laced cable.

The cabinet was made of .064 inch aircraft aluminum sheet stock. Because small pieces were all that were available, each side had to be a separate piece. But with care taken to bend the stock evenly and accurately in a tin smithy's "brake" and to bolt or rivet the sides together firmly, a substantial metal box can be made. Rigid front panel construction is obtained with  $\frac{1}{8}$  inch panel aluminum supporting an inverted bathtub shelf. Gusset plates or angle supports from rear of shelf to top of the panel were unnecessary. Batteries shown in Fig. 3 are clamped firmly in bottom of the box with a top plate and two studs.

Our variable oscillator tuning condenser can never approach, in design, the one used in the BC-211, but it did have glass bead insulation and ball bearings, the latter a good point in preventing wear of bearings and, in turn, the disturbing of calibration. The worm also has ball bearings. Mounting this condenser firmly onto the shelf with four No. 6 screws gave sufficient rigidity, but the worm shaft then had to be connected directly to the front panel shaft. Since that arrangement could prove disastrous with any misalignment of the two shafts or any exertion of thrust upon the tuning knob, a large flexible coupling was made to fit just behind the 0—100 "tens" dial in Fig. 1. All this mass hung onto the tuning shaft proved to be an advantage in providing a flywheel effect.

To drive this condenser with a suitable dial presented by far the most important mechanical problem encountered. Initial planning gave consideration to several commercial dials, but a lengthy scrutiny of the tuner resulted in the 4800 division dial (worm gear ratio is 96 to 1). On the worm shaft a 360-degree dial with 100 numbered divisions was mounted. Then, on an extension from the main shaft of the condenser, a 5-inch diameter drum is placed to read 0 to 48 so that one complete revolution of the worm shaft moves the drum one division. The latter is the "hundreds" dial and the former is the "tens" dial. Through the two plexiglass windows (Fig. 2), not exactly aligned horizontally, the four place dial can be read directly in its

mathematical order from left to right. Dexterity will yield one-fourth or even one-tenth of a dial division on the 0—100 scale thus making the dial readable to five places.

Asking a broadcast band oscillator to deliver a usable 100th harmonic in the neighborhood of 75 megacycles is just about too much of a request, so two frequency ranges were provided. After initial tests were made with the condenser selected, it was found that a 2 to 1 range in frequency would be impossible. This came about by the inherent high minimum capacity of about 60  $\mu\mu\text{fd}$ . Maximum was 180  $\mu\mu\text{fd}$ . If we select a range for this meter of from 1500 kc. to well above 100 mc. and we do not have a 2 to 1 variable frequency tuning range, then it is necessary that the low range begin at slightly below one-half the above selected 1500 kc. in order that harmonics will overlap. The broadcast range has a coverage of 630 to 1040 kc., and its second harmonic is 1260 to 2080 kc. By this arrangement our dead spot is from 1040 to 1260 which is below our 1500 kc. minimum. Third and higher order harmonic ranges overlap and give no further dead spot. Short-wave range is 6750 to 11,000 kc.

After a five place dial is decided upon, there should be some method of reference check to give assurance that the dial will maintain its calibration. Incorporation of a crystal oscillator and a small shunt capacity corrector in the variable oscillator permits, by predetermined check points, an adjustment of the frequency and dial reading to exactly the point of original calibration. A 1000 kc. crystal would be about ideal, but again we compromised with what aircraft parts were available—a 4600 kc. BT-cut crystal. This combination produces nineteen broadcast band check points and eight on the short-wave band, all marked in red pencil in a spiral notebook used to record the calibration. It might be mentioned that a round figure like

(Continued on page 129)

Fig. 4. Schematic diagram of three tube, battery operated frequency standard.

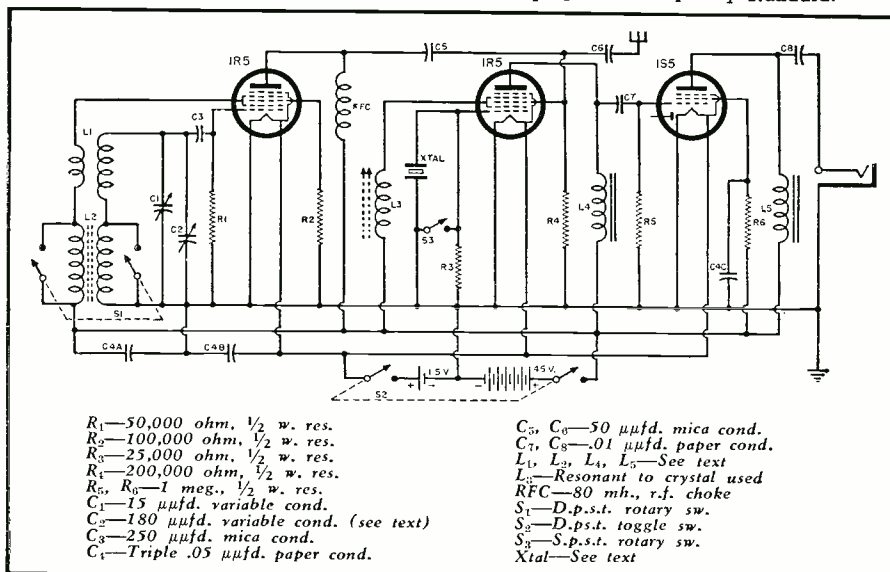

# DIRECT-WIRE TELEVISION

By **HERBERT E. TAYLOR, JR.**

Dir. of Transmitter Equip. Sales  
Allen B. DuMont Laboratories, Inc.

***Direct-wire television has an important future as a merchandising medium for department stores. Techniques for programming vary slightly from video broadcast.***

**P**ROSPECTS of broadcasting pictures in addition to sound have so captured the public's imagination that many of television's other very important applications have been shunted into the background. Yet these non-broadcast forms of television may well amount to hundreds of thousands, or even millions, of dollars worth of equipment purchased and a tremendous number of jobs for technical and semi-technical workers before many years have passed.

We will examine this phase of television, the types of outlets, equipment involved, nature of its installation, its personnel, operation, maintenance, and potential for expansion. But first, let's take a long, over-all view of the subject.

In an address before the National Retail Dry Goods Association's 1945 national convention, Leonard F. Cramer, Executive Vice President of *Allen B. DuMont Laboratories*, described the functions of direct-wire television as follows:

"For intra-store television, you don't require costly transmitters to send television through the ether to receivers in your trading area, nor do you need worry about a Federal license, elaborate studios, complicated antenna structures, large maintenance, and operational personnel or many of the other obstacles which might deter you from setting up your own complete television station.

"All you need for this simplified television is: (1) a camera or two before which merchandise is displayed and demonstrated, (2) enough studio space to house whatever settings and properties you consider necessary to

Glorianne Lehr demonstrates the Richard Hudnut course before the television cameras of DuMont television station WABD. The camera closed up on the miniatures of the exercising figures, then faded into live demonstration of the various exercises.

present your sales and institutional program material effectively, and (3) a number of vastly simplified receivers, located wherever you wish them throughout the building, linked to the cameras in your small tele-merchandising studio by cable. Your personnel problem will be partly solved by utilizing the sales and maintenance force already in the store."

To evidence the effectiveness of this type of installation in communicating information to crowds of people, Mr. Cramer cited the experience of a Jamaica, L. I., experimenter in television who "leaves a receiver on every night in his store window, so that every night, from approximately 8 to 10

o'clock, passersby can witness a television program there.

"Even in the worst weather, late at night, in this comparatively obscure location, there is always a crowd in front of that window. This crowd is gathered from a much thinner traffic than is found at almost any time of the day before department stores. Yet, night in and night out, for months, these groups have been forming and they are about as large now as they were when the television receiver was first installed."

In quick summary, Mr. Cramer pointed out that these systems help even out the flow of customers throughout the stores, put merchan-





sons and other information that must be distributed instantaneously by direct-wire television without danger of others intercepting the televised images. The full scope of direct-wire television will depend on the scope of the manufacturers' and users' imaginations.

Now, let's examine the equipment used in these operations.

Most conspicuous and basic of the studio equipment is the camera. Two of these are needed in most direct-wire coverages. The camera contains a pick-up tube on which the lens focuses the image to be telecast. This pick-up tube contains a mosaic consisting of thousands of individually insulated photoelectric cells. As the image is focused on the mosaic, each cell converts the light striking it into a tiny electrical charge.

Those cells on which bright light falls store comparatively powerful charges. Those struck by weaker light develop weaker charges.

A beam made up of billions of electrons scans the mosaic from left to right, top to bottom, of the mosaic. The electron beam sweeps over or scans 525 horizontal lines per frame, and at a speed of 30 frames per second. Thus, television exceeds the speed of 24 frames per second used in movie projection.

In addition to the lens and pick-up tube, the camera contains a pre-amplifier network. Tubes used in these circuits at this writing are those developed before the war, but all the equipment manufacturers in the country are working now to determine which of the tubes perfected during the war can be used in this work. These circuits are necessary because the impulses picked up from the mosaic are so weak that they would be lost

in the coaxial cable running from the camera to the camera controls unless a means is employed to raise the signal level. The five-stage, broad-band, pre-amplifier circuit mounted in the pick-up tube housing raises the value of the charges to approximately six milliwatts.

The horizontal sweep amplifier is also mounted on the camera housing. This permits the transmission of horizontal sweep signals from the synchronizing generator, which controls the scanning action of the beam in the pick-up tube, to be sent to the camera at a low signal level. The vertical sawtooth waveform, used in scanning, is fed directly to the camera and with no additional amplifier at the camera. We will touch on this operation further when the synchronizing generator comes under discussion.

Operating in conjunction with the camera is the electronic viewfinder, as distinguished from the camera-type optical viewfinder used on some television cameras. Through exploration it has been determined that the electronic viewfinder is the most practical, since it permits the operator to see the exact image being picked up by his camera on the five-inch tube of a miniature receiver. He has a picture he can examine at close range for critical focusing and composition. The image is free of extraneous detail, such as outside marginal material, and is viewed right side up. A stereoptic shield gives the operator a sharp view of the image despite studio lighting.

The electronic viewfinder needn't remain attached to the side of the television camera. It can be removed from the side of the camera and used in a comfortable position despite any camera movement that may be necessary, so that the operator doesn't need

**An effective application of the department store version of direct-wire television demonstrates "fashions in action." Skits are used to present fashions for various activities and occasions without resorting to the stylized type of fashion showing.**

dise on sale immediately, train sales personnel through their watching of the programs, afford facilities for demonstrating telesets even when no broadcasts are on the air, and serve as powerful sales implements.

While department stores represent one of the most important of the utilizers of direct-wire television, they are far from the only type of agency which will employ it. Schools may well use this system for teaching many classes throughout the city simultaneously and bringing to students all over town the finest visual instruction material, speakers, inspirational material and, occasionally, special entertainment programs available. Industry can use such a set-up for presenting information simultaneously to all departments, giving employees instruction in safety and new products in a quick, convenient manner or in countless other ways depending on the type of operation involved. In metropolitan areas, all police stations can present pictures of wanted per-

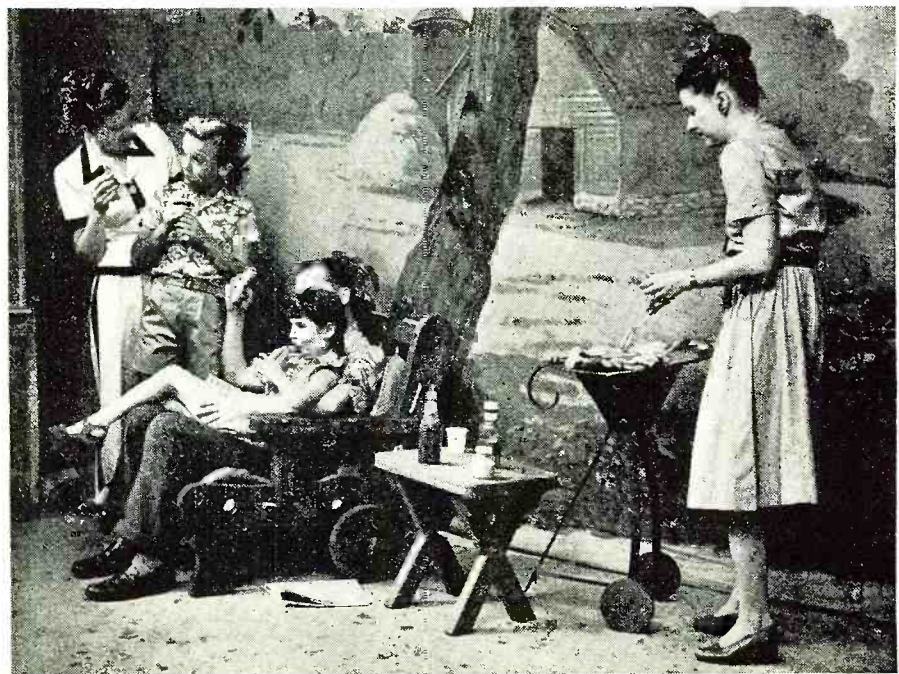



Nash-Kelvinator Corp. sponsored this televised program of the Society of Amateur Chefs. (Left to right) Otto Soglow, John Reed King, and Rube Goldberg demonstrate their cooking techniques before the all-seeing eye of the television camera.

to ride his camera to a variety of levels.

The cameraman has only two simple mechanical controls to handle in addition to his positioning of the camera. One is for camera angle or composition, the other is for bringing the lens into position for sharp focus.

The camera head is mounted on a gyroscopic neck which permits smooth, silent panning and tilting.

These are mounted on two different types of dollies. One is a free-rolling, lightweight push dolly, for standard floor shots. This is the basic, the less expensive, and the most practical of the two types. The other is a boom dolly which permits great elevation of the camera, swooping effects and low

dips by the camera for extreme angles.

The camera is electrically connected to the control operator's console by coaxial and other cables to permit the control engineer to hold the reins of the whole operation. The control engineer handles all electrical controls of the camera. The cameraman's operations are all mechanical.

The technical director of the program, or the control engineer, communicates with the camera operator, or operators, through a microphone which transmits the messages to earphones worn by the cameraman.

Some of the electrical controls handled at the control engineer's console are set before the program begins. Among controls adjusted prior to the

program period are the horizontal and vertical sweep controls and the key-stoning which gives uniform proportions to the frame; meter controls which let the operator switch different power units through a metering device to check the normalcy of their outputs; and beam intensity which determines the electron volume of the scanning beam. While all of this group of controls handled at the console are substantially fixed, they are often varied during the picking up of the program.

The other "active" controls handled by the operator need constant watching and frequent adjustment. One of these is the video gain to set the power level of the picture being fed to the control console. A second active control is of the light "pedestal." The pedestal control is a brightness control which electronically permits adjustment of the general or average brightness of the scene. It also can be used to raise or lower the key of the light for special effects, such as darkening the picture to denote a rising storm, lightening it suddenly to represent lightning, or permitting slow fades or lap dissolves.

The console also houses shading controls which compensate for uneven signal response from various portions of the mosaic. Shading is necessary due to the uneven rain and fall of secondary electrons upon the photosensitized surface of the mosaic, resulting in "dark spot signal" from the mosaic. Correction of these uneven tones is accomplished by inserting various types of d.c. signals to flatten the response at all parts of the signal ranges. Controls are four vertical and four horizontal shading knobs for inserting saw, sine, parabola, and sine phase signals to lop off peaks and valleys of the picked-up image as recorded on the cathode-ray oscillograph.

The output gain, or strengthening the power of the signal being fed to the line amplifier, is the next control handled by the operator. He also handles the vertical and horizontal sweep controls, for the 60 vertical and 15,750 horizontal sweeps a second.

The television system must arrange for the scanning of the picture being picked up to exactly parallel the recreation of that picture on the receiving set. This is accomplished by means of inserting a synchronizing or "trigger" signal which is more powerful than those translated to visual information. As each of these signals reaches the receiver or monitor, it causes the deflection plates to throw the electron beam back to the proper position for creating the next line. The synchronizing generator serves for both horizontal and vertical synchronization. This device has a separate panel on the control console and may even be separated from it.

As the engineer sits at the control console operating the many instruments described, he has before him,  
(Continued on page 134)

The correct use of various gardening tools is demonstrated graphically in this television program. R. H. Macy Company sponsored this showing over station WABD.

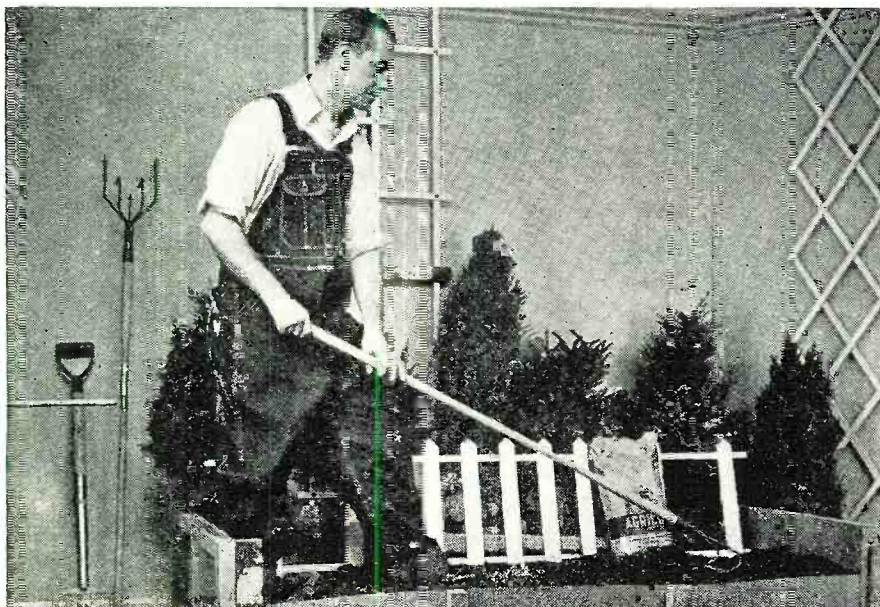



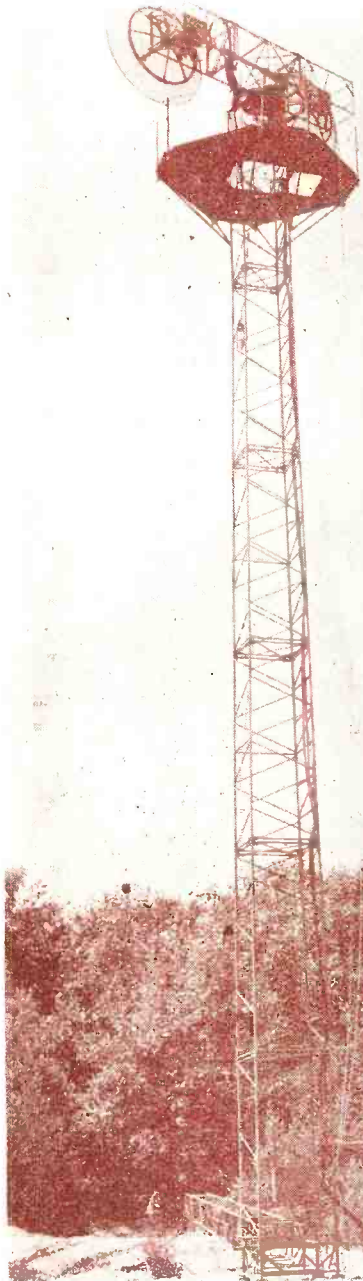

# MICROWAVE PULSE MODULATION

FOR HAM COMMUNICATIONS

By  
ROBERT ENDALL

*A simple analysis of a wartime  
development which will have  
widespread ham application in  
the u.h.f. and s.h.f. bands*

Fig. 1. Signal Corps 4500 mc. eight-channel pulse transmission equipment, showing all spare and operating components and antenna, set up for field operation.

**I**N THE past, radio amateurs have always been in the forefront of technical progress in experimental communication on the higher frequencies, and many of the advances in high-frequency communication are traceable directly to amateur activity. Before the war many hams were spending much of their time on the 56- and 112-mc. bands and experimenting with higher frequencies. War-time progress has so greatly extended the radio frequency spectrum that communication frequencies are now regularly assigned and may be expected to carry useful traffic up to 30,000 mc. Many radio amateurs, especially those who have for the past  
**April, 1946**

five years been active in wartime u.h.f. and microwave research, will now want to go on the air at carrier frequencies well up in the microwave region.

The cost of ultra-high frequency equipment, the expense of tubes for generating microwave power, and the difficulty of modulating at u.h.f., have up to now been a handicap to widespread amateur experimentation on these frequencies. The intensive military program of development and production of high frequency equipment has done much to eliminate these difficulties. The application of mass production techniques has greatly decreased the expense of equipment.

The development of disc-seal tubes, magnetrons and klystrons, has greatly simplified the problem of generating microwaves. Now the new technique of pulse-time modulation, which has recently been removed from the secret list by military authorities, introduces a considerable simplification in the problem of modulating microwave transmissions.

A pulse-time-modulated carrier consists of signals of the simplest type—short pulses of r.f. having constant shape and amplitude with variable timing. Because of bandwidth considerations, this type of modulation has its maximum usefulness at microwave frequencies. Although developed primarily for commercial multiplex telephone transmission, pulse-time modulation has distinct advantages which suit it particularly well to amateur communications:

1. Since the carrier is modulated

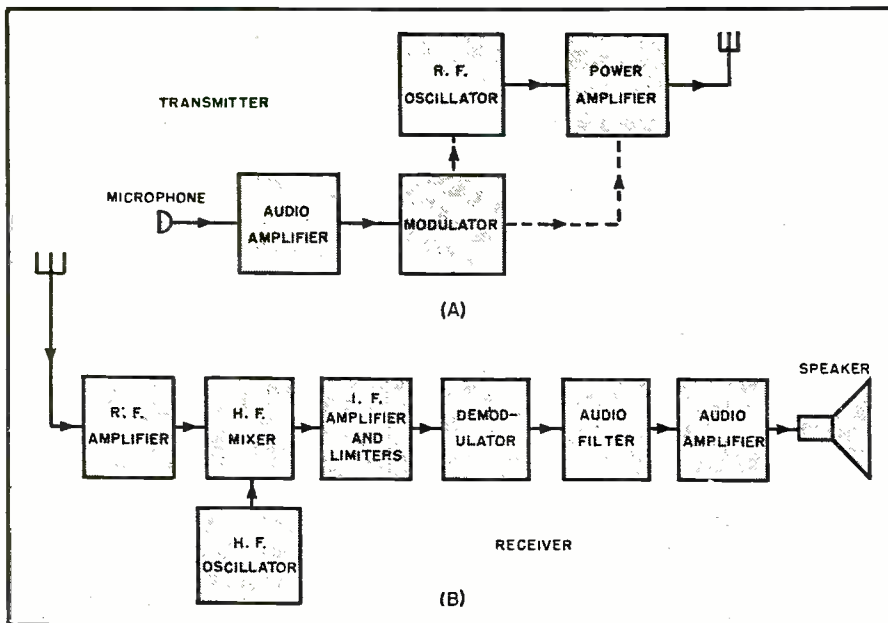

Fig. 2. Block diagrams of conventional type of transmitter and receiver that may be used for any type of modulation, (A) transmitter, (B) receiver.

only by being switched on or off to create the pulses, the circuit can be of an extreme simplicity of design not possible with other systems.

2. By making full use of the much wider bands per channel which are not only available, but definitely preferable, at the higher frequencies, this system makes it possible to reduce considerably the influence of parasites of artificial origin and to increase considerably signal-to-noise ratio.

3. Higher peak power and much

higher frequencies are attainable than would otherwise be possible because of limitations due to heating of the transmitter tubes.

Thus, at the same time that it effects economy in transmission and simplifies and improves the efficiency of reception, pulse-time modulation provides also a greater degree of static reduction in communication.

In addition, the multiplex properties of pulse-time modulation open up still another application for amateur com-

munication in helping to overcome line-of-sight difficulties to some extent. The transmitted pulses are of very short duration and separated by comparatively large spaces, therefore more than one telephone channel may be transmitted on the same carrier provided that the pulses are suitably displaced with respect to one another. It is quite conceivable that by making use of this factor, amateurs may cooperate in setting up long nets and relay systems by means of which each operator will be conducting his own conversation and acting as a relay point for as many as eight or ten other conversations taking place over distances far beyond the limitations of ordinary line-of-sight communication.

### Theory of Pulse-time Modulation

The basic theory of pulse-time modulation is extremely simple. It consists of transmitting intelligence by pulses of r.f. having constant amplitude and duration, the instantaneous amplitude of the voice being translated into variation of time intervals between successive pulses. The rate of this variation corresponds to the instantaneous frequency of the signal. The pulses themselves are of very short duration, separated by comparatively large spaces.

The spacing between the successive pulses can be varied in a number of different ways. Two of these possible methods of position-variation which have been used in practice are of interest to amateurs, and will be described.

The unmodulated carrier, consisting

Fig. 3. Methods of pulse-time modulation. Intelligence is transmitted by r.f. pulses having constant amplitude and duration.

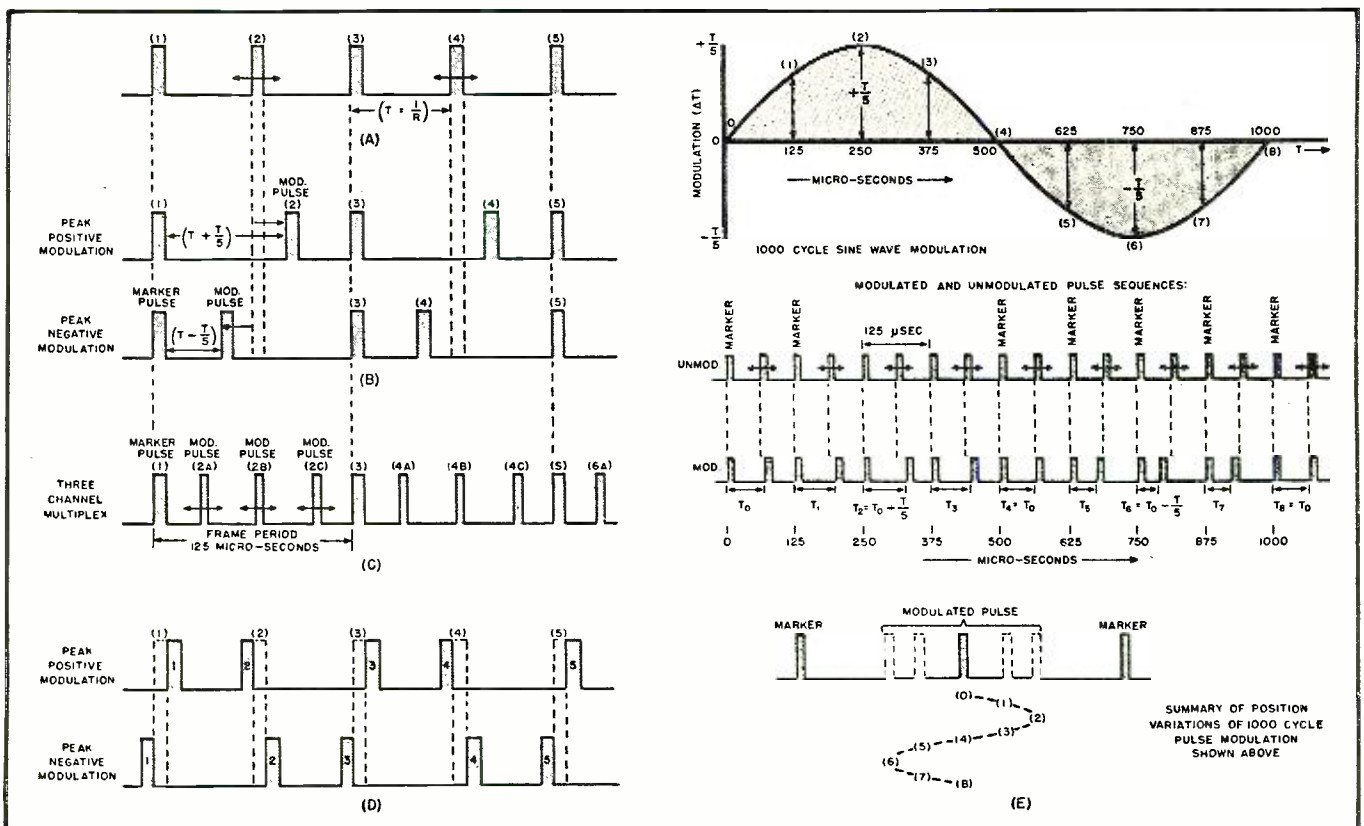

of a series of pulses having a constant repetition rate, is shown in (A) of Fig. 3. The individual pulses may be designated by numbers 1, 2, 3, 4, 5, etc., and the pulse repetition rate  $R$  per second. Then the time interval between successive pulses is  $T = 1/R$  seconds. When modulation is applied, the timing between the pulses is varied by an amount proportional to the modulating voltage, and at a rate corresponding to the frequency of the modulating signal.

In the first type of time modulation, one set of pulses is kept fixed in its time position and serves as a reference set for the time modulation of the other pulses. For instance, in Fig. 3A and 3B it can be seen that the odd-numbered pulses 1, 3, 5, etc., always remain in the same position under one another, while the position of the even-numbered pulses 2, 4, 6, etc., varies. The fixed pulses are the reference (or marker) pulses, and the others are modulated in position with reference to them. Fig. 3B illustrates the pulse position relationships for a single-channel system having a peak modulation of  $T/5$ . As shown in the upper part of the diagram, the distance between the modulated pulse and the marker is increased for positive modulation; the lower figure in diagram B shows the corresponding decrease in distance between modulated and marker pulse for peak negative modulation.

The process of modulation may be better understood by reference to Fig. 3E, which shows the pulse-position relationships when the single-channel system is modulated by one complete cycle of a 1000-cycle sine wave. During the positive half-cycle the pulse spacing is increased, as shown, by amounts varying from zero to  $T/5$  according to the modulating voltage; while during the negative half-cycle the spacing is decreased by amounts varying from zero to  $T/5$ . A comparison between pulse positions for the modulated and unmodulated condition can be seen in the middle diagram of Fig. 3E, which shows the pulse sequence through a complete position-modulated cycle. The position variations of the modulated pulse for the 1000-cycle modulation are shown in summarized form in the lower figure, which shows the various positions of the pulse at different times in the modulation cycle. A system of the type shown, having a frame period of 125 microseconds (i.e., repetition frequency of 8000 cycles), is capable of transmitting a telephone channel of 3000 cycles.

(This system may be used for multiplex transmission in the manner shown in Fig. 3C. In this case the same marker pulses and the same frame period are used as in the single-channel system just described, but for each marker pulse there are now three modulated pulses each capable of carrying its own independent modulation. Thus, when the  $B$  pulses are modu-

lated, the distance between the  $B$  pulses and the marker is varied within its limits regardless of the instantaneous position of the  $A$  and  $C$  pulses. Likewise the positions of the  $A$  and of the  $C$  pulses are varied regardless of the other channels. In the system illustrated, the  $A$  pulses constitute channel I, the  $B$  pulses channel II, and the  $C$  pulses channel III. When multiplex transmission is used, the marker pulse is made wider than the others, as illustrated, in order to distinguish it from the channel pulses.)

The second type of pulse-time modulation does not make use of a fixed series of pulses. Instead, the pulses are divided into pairs, and the timing between the two pulses of each set varied in accordance with the modulating voltage. Thus, pulses 1 and 2 would be one pair, 3 and 4 another, 5 and 6, etc. For the condition of peak positive modulation as shown in the upper part of Fig. 3D, these pairs are moved closer together while the pairs of pulses 2 and 3, 4 and 5, 6 and 7, etc., are moved farther apart by an equal amount. For the condition of peak negative modulation as shown in the lower part of the diagram, the situation is exactly reversed. Pulses 1 and 2, 3 and 4, etc., are moved farther apart while 2 and 3, 4 and 5, etc., are brought closer together. There is no change in the average pulse rate.

In pulse-time modulation systems the exact shape, duration or amplitude of the pulse has no fundamental importance, although it does affect the signal-to-noise ratio of the system. As in the case of a frequency-modulated system, the amplitudes are made uniform in the receiver by an amplitude-limiting circuit, thus making possible a considerable reduction in noise on the sole condition that the maximum potential due to noise is lower by a certain amount than the maximum amplitude of the received pulses. (In fact, even if the noise amplitude is greater than the signal pulse

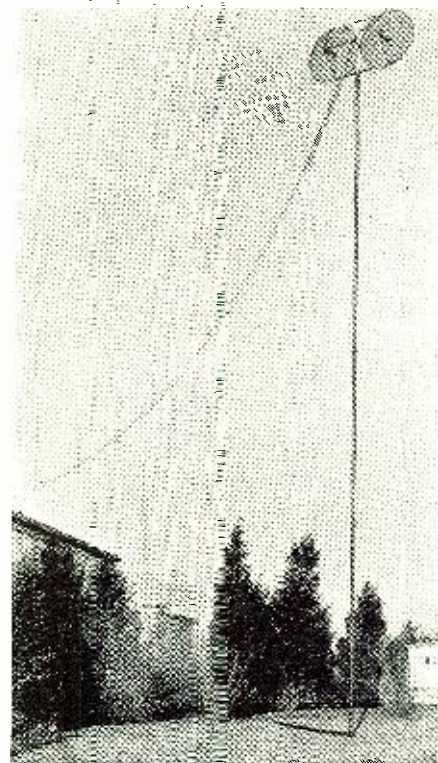
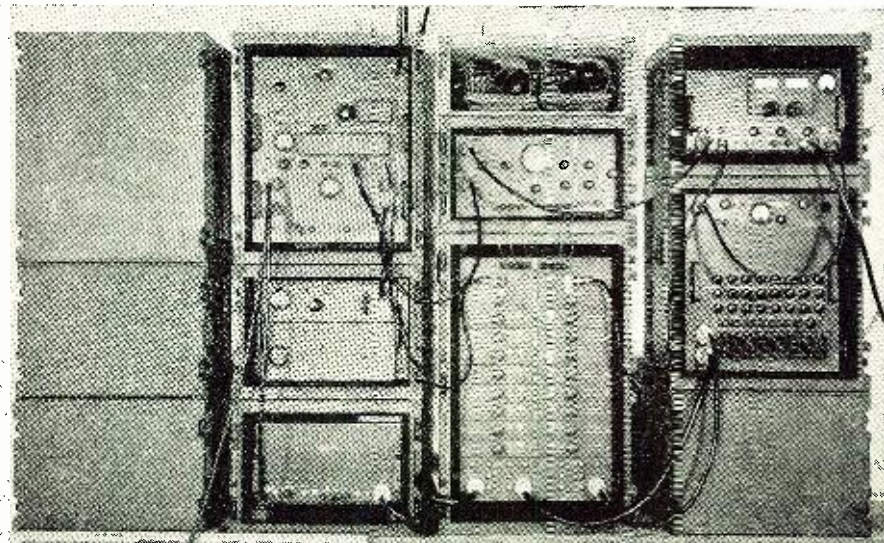

Fig. 4. Antenna system used in conjunction with equipment illustrated in Fig. 5.

amplitude, there is still the possibility of time modulating during part of the pulse interval only, and of eliminating the majority of the interference by blocking the receiver except during the extremely short interval when the pulses are actually transmitted.)

Any noise small enough in amplitude to be eliminated by the limiters will nevertheless generate an audible noise at the output of the demodulator, because it also has the effect of advancing or retarding the time position of the leading edge of the desired pulse. This effect is decreased as the steepness of the wave front of the transmitted pulse is increased.

Fig. 5. Signal Corps 1400 mc. pulse-time modulation equipment for transmitting and receiving eight independent telephone channels simultaneously. The photograph shows all operating and spare components in place.



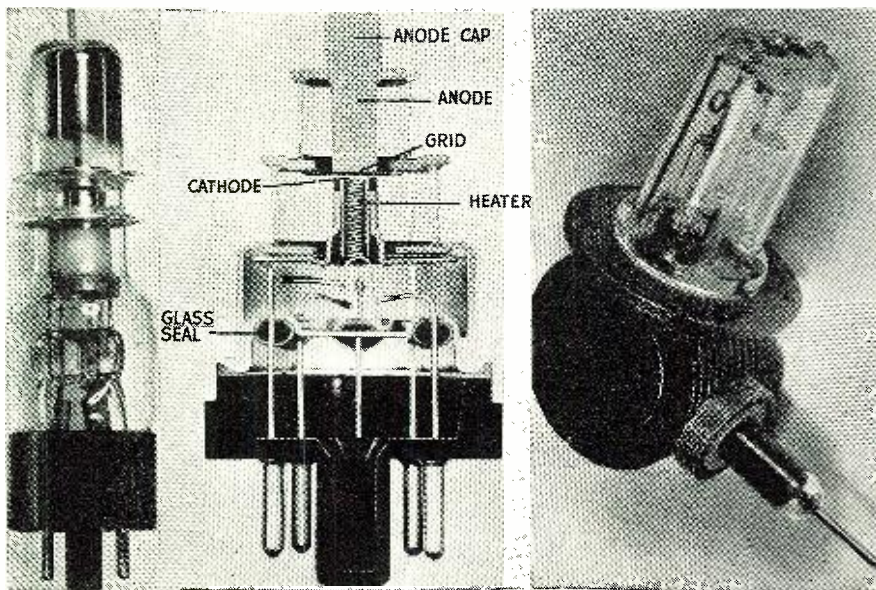

Fig. 6. Tubes for generating receiver beat oscillations and microwave power. (Left) Klystron. (Center) Disc-seal (lighthouse) tube. (Right) Magnetron.

Since both the required band-width and the signal-to-noise ratio are determined by the steepness of rise of the transmitted pulse, it is thus possible to strike the best compromise between band-width, noise, and receiver-oscillator stability to make most effective use of the high-frequency bands.

#### Pulse-time-modulation Circuits

A number of the circuits which have been developed for time-modulated pulse transmission and reception are of interest to radio amateurs from the viewpoint of experimental com-

munication on the microwave frequencies. Some of these circuits can be used with very little modification, while others can easily be adapted to make them reasonably inexpensive and suitable for ham use. A brief consideration of the existing circuits will serve to illustrate how amateurs can use them for experimental microwave communication, and how they may go about designing their own circuits for high-frequency pulse communication.

The principles of pulse-modulation transmitters and receivers can best be understood by considering them from

the viewpoint of the basic principles of radio transmitter and receiver design. Fig. 2 shows block diagrams giving the essential details of the most general types of transmitter and receiver. These block diagrams apply to all three types of modulation now in general use—amplitude modulation, frequency modulation, and pulse-time modulation.

For any type of modulation, the transmitter consists essentially of the following sections: (a) an audio amplifier, (b) the modulator, (c) a high-frequency oscillator for generating the carrier, (d) a radio-frequency power amplifier. The receiver can be divided into the following sections: (a) a radio-frequency amplifier, (b) a high-frequency local oscillator and converter, (c) an intermediate-frequency amplifier and a series of limiters, (d) a converter or demodulator to restore the audio characteristics of the original signal, (e) audio filters and an audio amplifier to bring the signal to the desired level. In u.h.f. receivers, the r.f. amplifier (a) is generally omitted and the signal from the antenna fed directly to the high-frequency mixer.

The circuits for the three types of modulation differ from one another primarily in the modulating and demodulating circuits, and in the manner in which the modulation is applied to the output stage of the transmitter. In an AM transmitter, the modulation is generally applied to the power amplifier or to an intermediate power amplifier. In an FM transmitter, the modulation is applied before the power amplifier to the r.f. oscillator, whose frequency is caused to vary by an amount proportional to the instantaneous audio amplitude. A pulse-time modulated transmitter uses no power amplifier, the oscillator supplying the carrier power directly to the antenna. The modulator in this system serves the function of converting the audio amplitude into time-modulated pulses, which are applied to either the grid or plate circuit of the power oscillator so that the carrier is generated in short position-modulated pulses.

The essential difference between AM receivers and receivers for FM and pulse-time modulation is in the use of limiters. The AM receiver is a linear system as regards both the audio signal and the noise input, whereas the use of limiters in FM and pulse-time modulation receivers makes possible a considerable reduction in the noise output. Pulse-time modulation possesses the further advantage that oscillator tuning and stability are much less critical than in FM reception.

Modulation and demodulation, which is where pulse-time communication differs basically from AM and FM, may be accomplished by many different methods:

(a) One pulse-time system of the first type—i.e., using a fixed series  
(Continued on page 88)

Fig. 7. Block diagram of a pulse-time modulation transmitter (A) and pulse time modulation receiver (B), using only conventional type tubes.

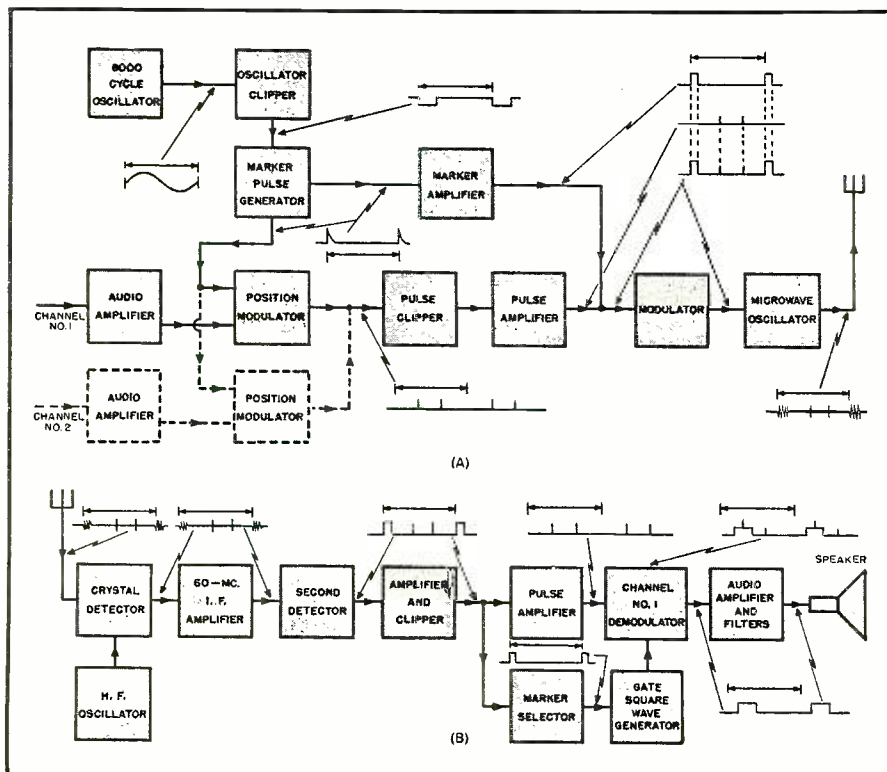

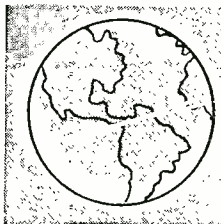

# International SHORT-WAVE

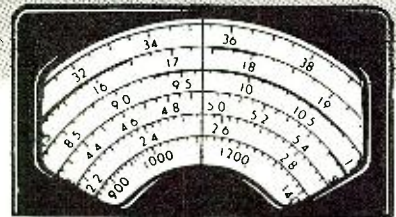

Compiled by **KENNETH R. BOORD**

**S**O many letters have been received from readers for information regarding active radio clubs that we have compiled the following data on those known to your Short-wave Editor:

Australia—Australian DX Radio Club, headquarters address is not known; South Australia Division can be addressed in care of Station 5KA, 43 Franklin Street, Adelaide, South Australia. There are several other active clubs in Australia about which I expect data soon.

Great Britain—British Short Wave League, address not known; gets out a monthly leaflet.

New Zealand—New Zealand DX Club, Harold J. Barr, Headquarters Secretary, 10 Koraha St., Remuera, Auckland, S.E. 2, New Zealand; house organ is "The N.A. DX-TRA," published monthly at 5 Dublin St., Invercargill, New Zealand; Merv Branks, Editor; Art Cushen, Short-wave Editor; Keith Robinson, Associate BCB Editor; Branch Notes Editor, Max Rattray; Competitions Editor, Des Lynn; Circulation Manager and Printer, Bill Milne.

N.Z. Radio Hobbies Club, 11 Manner St., Wellington, C.1., New Zealand; club formed in 1930 with sole object of fostering radio as a hobby. Started by the Electric Lamp House, Ltd., and has its mutual advantages to the club members and to the Company; "Radiogram" is the club's monthly paper. Membership fee is \$1.50 per year. Members are known as "Rahobs." Claims "over 6,000 members, the largest radio club in Australasia."

New Zealand DX Relay Association, Editor "Tune-In," 20 Marion St., Wellington, C. 2., New Zealand.

Sweden—Sveriges Radioklubb (Radio Club of Sweden), Stockholm 5, Sweden; house organ is "Kortvags-Lyssnaren," Stockholm 29, Sweden, H. G. Appelgren, Editor; DX Editor is Arne Skoog, Grundlaggarvagen 16, Abrahamsberg, Stockholm, Sweden.

United States—National Radio Club, 325 Shirley Avenue, Buffalo 15, New York; Ray Edge, Editor; strictly BCB.

Newark News Radio Club, Market St., Newark, New Jersey; Irving Potts, President; BCB and SW.

Universal Radio DX Club, Chas. Norton, Pres., 7507 Holly St., Oakland 3,

California; Bill Howe, Short-wave Editor, Apt. 301, 1614 Abingdon Drive, Alexandria, Virginia; Alexander F. Maley, BCB Editor, 46 Ft. Putnam St., Highland Falls, New York; Ralph Kastner, Amateur Editor, P.O. Box 134, New Braunfels, Texas; Dr. John William Kirk, BCB Contest Manager, 415½ Main St., Point Pleasant, West Virginia. Established 1933. Issues "Universalite" bulletin, semi-monthly during the DX season, 19 issues per year.

Victory Radio Club, Ligonier Ave., Latrobe, Pennsylvania; Art Hankins, Editor; BCB and SW.

*(If anyone can furnish information on additional active radio clubs anywhere in the world, I would be glad to have it.)*

\* \* \*

## EGYPTIAN DATA

Through the Royal Egyptian Embassy in Washington, D. C., I have received the following information from Cairo about short-wave service from Egypt:

"The Egyptian Government is hiring from the Marconi Company a radio transmitting apparatus, 10 kw., frequency 7.867 (38.13 m.), for two hours daily for broadcasting National Programs in Arabic language between 1:50-3:50 p.m. and to 7 p.m. on special occasions and holidays; also, once a week for broadcasting Friday's prayer and Koran recitation for one hour at

7 a.m. on 10 kw. apparatus with a frequency of 10.055 (29.83.).

"The Government will install a transmitting apparatus on short-wave of 25-50 kilowatts." (Proposed wavelength or date when this transmitter will be put in operation was not given.)

A copy of "Cairo Calling," the Journal of Egyptian State Broadcasting, was enclosed, giving program schedule of Radio Cairo on 7.190 (41.70 m.) for Middle East (except Cairo Area which is served by a BCB transmitter) as 1:30 a.m.-4 p.m. EST. "Cairo Calling" is the official organ of Egyptian State Broadcasting, Radio House, Cairo; Editor is E. Howitt.

\* \* \*

## RADIO CLUB DE PERNAMBUCO S/A

From Recife, Brazil, comes information about PRA-8, Recife, Pernambuco, Brazil, of the Radio Club de Pernambuco S/A:

PRA-8 operates on 6.015 (49.87 m.) on SW and on 720 kcs. (416 m.) on BCB, all days, 8 a.m. to 11 p.m. (6 a.m.-9 p.m. EST), in the Portuguese language. While there are no programs in English, the Director-Presidente of the Radio Club de Pernambuco S/A, who sent along this data, suggests that listeners in the United States and Canada might well listen to the studio programs between 6-9 p.m.

Location and address, Avenida Cruz  
*(Continued on page 70)*

This neat corner is the SWL Post of Jim Johnson, young Chicago DXer. With the recorder Jim was able to record programs from Berlin, Rome, and Tokyo during the war.



Unless otherwise indicated, all time referred to herein is Eastern Standard Time. (EST).

# Practical RADIO COURSE

By  
**ALFRED A. GHIRARDI**

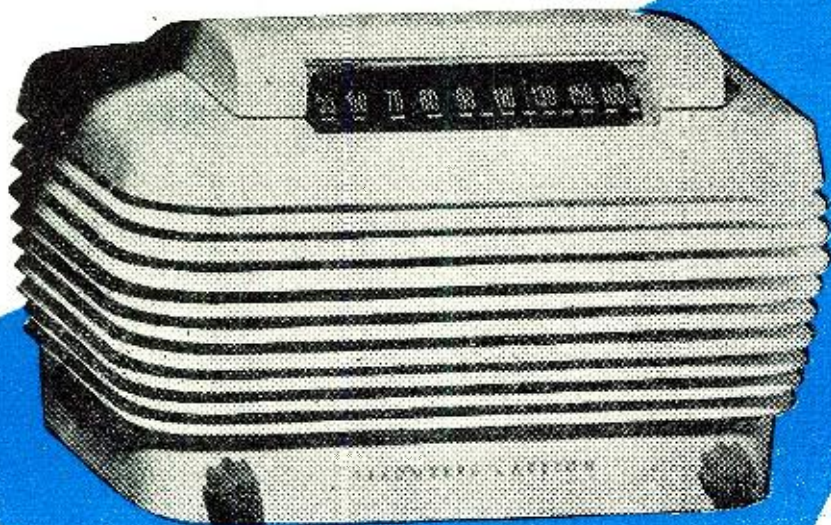

One of the many new 1946 table model receivers that will be off the production line shortly. This a.c.-d.c. operated superheterodyne set features a combined dial and hand-hold at top of cabinet.

## **Part 43. Analysis of automatic frequency control, as employed for adjusting oscillator frequency of superheterodyne receivers to its correct value.**

**A**N ENTIRELY different approach<sup>1</sup> to solution of the problem of providing correct oscillator frequency in the superheterodyne lies in the use of automatic frequency control (abbreviated AFC). A more correct name would be "automatic tuning correction control."

AFC provides a means by which the oscillator frequency is automatically adjusted or "pulled in" to the correct value required to make the i.f. carrier frequency exactly equal to that for which the i.f. amplifier is designed—all this, after the receiver tuning circuits have first been approximately tuned to the desired signal. Consequently, AFC operates in such a manner as to keep the oscillator frequency dead accurate at the required value for the signal being received. If the receiver ever happens to be so tuned (either manually, automatically, or due to oscillator frequency "drift") that the oscillator frequency is, say, 4 kc. too low or too high for proper reception of the signal being received,

then the AFC comes into operation and automatically increases or decreases (whichever is required) the oscillator frequency by the required 4 kc. so that the frequency of the intermediate carrier produced in the mixer or converter tube and passed on to the i.f. amplifier will lie exactly at the center of the pass-band of the sharply-tuned i.f. amplifier in which most of the amplification of the receiver is produced.

The control action that AFC exerts on the frequency of the oscillator makes it useful for correcting oscillator frequency drift caused by temperature change or anything else. It is particularly useful (when its cost is not prohibitive) in receivers employing any of the various types<sup>2</sup> of push-button systems. In these, the tuning may not remain quite accurate over extended time periods, and AFC may be used effectively to carry out the final adjustment of the oscillator frequency after the respective tuning capacitances and/or inductances have been selected by the automatic tuning system. Therefore, when AFC is used in such receivers, absolute accuracy of the mechanical and electrical parts and adjustments of the oscillator portion of the push-button controlled tun-

ing system is not required, because (within certain limits) the automatic correction corrects any possible oscillator tuning errors due to such imperfections.

### **Essential Parts of AFC Systems**

The adjustment of the oscillator frequency can be performed in several ways, by means of an *oscillator control stage*, usually employing a tube.

Obviously, however, this control stage must be supplied with some sort of signal which indicates to it whether the oscillator frequency is correct for the particular desired signal being received, and if not, what the amount of the error is and in what direction it lies. The part of the AFC system that performs this service is called the *frequency discriminator*, and usually contains a tube with accompanying circuit network.

The AFC system is composed then of two essential parts:

1. The frequency discriminator.
2. The oscillator frequency control.

The functional block diagram of Fig. 1 shows the various parts of a superhet equipped with AFC, and the relation of the discriminator and the oscillator frequency control to the other parts of the receiver. It will be noticed that the discriminator stage is fed by a branch circuit from the i.f. section of the receiver proper.

### **The Frequency Discriminator**

The function of the frequency discriminator is to develop a d.c. voltage that is proportional to the *extent* that the i.f. carrier (and the oscillator fre-

<sup>1</sup> See PRACTICAL RADIO COURSE, Part 42, March, 1946, issue of RADIO NEWS.

<sup>2</sup> For an explanation of the various push-button tuning systems, see Part 39, PRACTICAL RADIO COURSE in the December, 1945, issue of RADIO NEWS.

quency) differs from the required value, and whose polarity is dictated by the *direction* of this departure. When the oscillator frequency (and i.f. carrier frequency) is correct, the voltage output from the discriminator should be the same as that existing in the absence of signal. At frequencies above or below the correct frequency, the controlling voltage should be appropriately above or below the mean voltage. Normally, the discriminator is placed in the i.f. circuits of the receiver after the last i.f. amplifier tube, and comprises a specialized form of selective circuit combined with two differentially-connected diodes, the complete circuit giving the characteristic "S" type frequency-response curve illustrated in Fig. 2.

### The Detuned-Circuit Type of Frequency Discriminator

Two well-known frequency discriminator circuits (and slight modifications of them) have been developed for deriving the d.c. control voltage. That illustrated in Fig. 3 is called the Round-Travis circuit, after its inventors. It makes use of a primary circuit  $L_1C_1$ , tuned to the i.f. and coupled symmetrically to two *tuned* input circuits, one of which ( $L_2C_2$ ) is tuned to a frequency *above* (at least 1%) the i.f. peak of the receiver (to which  $L_1C_1$  is tuned), and the other of which ( $L_3C_3$ ) is tuned to a frequency *below* the i.f. peak by the same amount. In the illustration shown, the i.f. peak is 455 kc., and these two input circuits are tuned to 460 and 450 kc., respectively. Consequently they both are *detuned* an equal amount from the correct i.f. peak of the receiver. Each tuned input circuit is connected to a diode, forming a complete rectifying system by itself. Equal resistors  $R_1$  and  $R_2$  are connected across the diode outputs. The diode direct currents flowing through these resistors are in opposite directions, so the voltage drops across them are of such polarity as to buck each other.

Whenever the oscillator frequency is correct, the i.f. carrier will have the correct frequency value of 455 kc. Under this condition, tuned circuits  $L_1C_1$  and  $L_2C_2$  will be equally detuned from the i.f. carrier, so equal i.f. voltages will be set up in them and will be applied to the two diodes. The diode currents flowing through  $R_1$  and  $R_2$  will be equal, and, bucking each other, the net voltage across the complete diode output circuit will be zero. This means that point A will be at the same potential as ground. Consequently, no d.c. control voltage will be fed to the grid of the oscillator control tube which follows, so the oscillator frequency will not be influenced.

If the oscillator frequency drifts from the correct value for any reason whatsoever, the i.f. carrier frequency will change correspondingly, so one of the tuned input circuits will be less mistuned to the i.f. carrier and the i.f. voltage appearing across it will increase. The other will be corre-

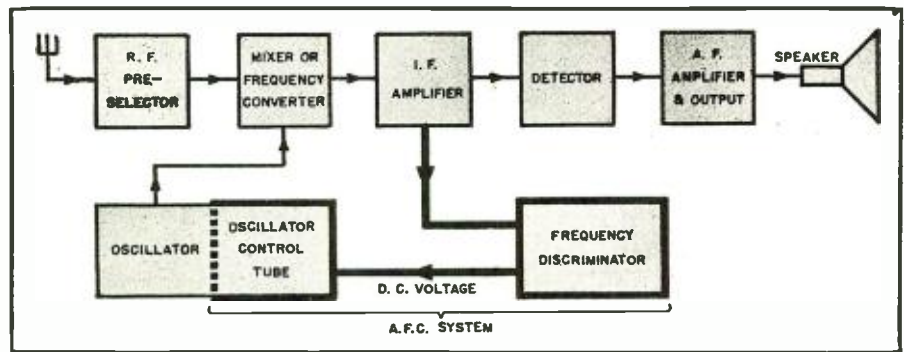

Fig. 1. Block diagram of a superheterodyne receiver provided with AFC. Notice that part of the i.f. is fed to the discriminator. This actuates the oscillator frequency control circuit, pulling the oscillator frequency to the value required for the frequency of the particular signal that the receiver has been tuned to receive.

spondingly more mistuned to the i.f. carrier, so the i.f. voltage appearing across it will *decrease*. As a result, the two diode currents become unequal, and the voltage across one output resistor becomes greater than that across the other. Accordingly, the potential of point A becomes either positive, or negative, with respect to ground by an amount equal to the difference between these two voltages. Since A is connected to the grid of the oscillator control tube this varies the control-grid bias potential of this tube. Just how this variation of its grid potential is translated into the required control of the oscillator frequency will be explained later when the various types of oscillator frequency control circuits are explained.

Variations and slight misadjustments, developing in the course of time, of the fixed resonant frequencies to which the two input circuits  $L_1C_1$  and  $L_2C_2$  are adjusted must be allowed for. The further apart the two circuits are tuned, the less will such changes affect the AFC. For this reason, these two resonant frequencies should be made *not less than*  $\pm 1\%$  off the intermediate frequency for which the receiver is designed.

The Round-Travis discriminator circuit has not found wide application in commercial receivers because other circuits which produce essentially the same results and possess certain distinctive advantages are available. However, the operation of this circuit

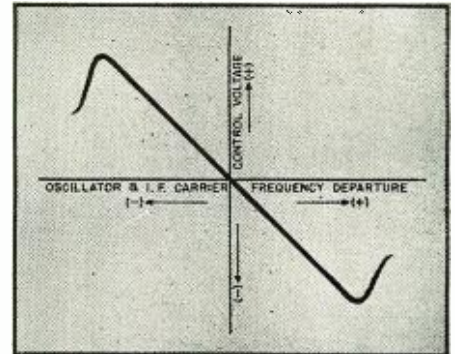

Fig. 2. Typical "S" shaped response curve of the discriminator. The curve represents the combined voltages across  $R_1$  and  $R_2$  (Figs. 3 and 4) for various values of oscillator and i.f. carrier frequency departure from correct values.

is of technical interest because the more complicated discriminator circuits embody the same fundamental principles.

### The Foster-Seeley Discriminator

The second discriminator circuit, one that has been used in the majority of AM receivers employing AFC, is illustrated in basic form in Fig. 4. It is called the Foster-Seeley circuit, after its inventors. It will be observed that the two diodes are fed by an input circuit containing an i.f. transformer consisting of a primary,  $L_3$ , loosely coupled to a center-tapped secondary, ( $L_1L_2$ ). Both the primary and second-

Fig. 3. Diagram of a detuned-circuit (Round-Travis) type of discriminator.

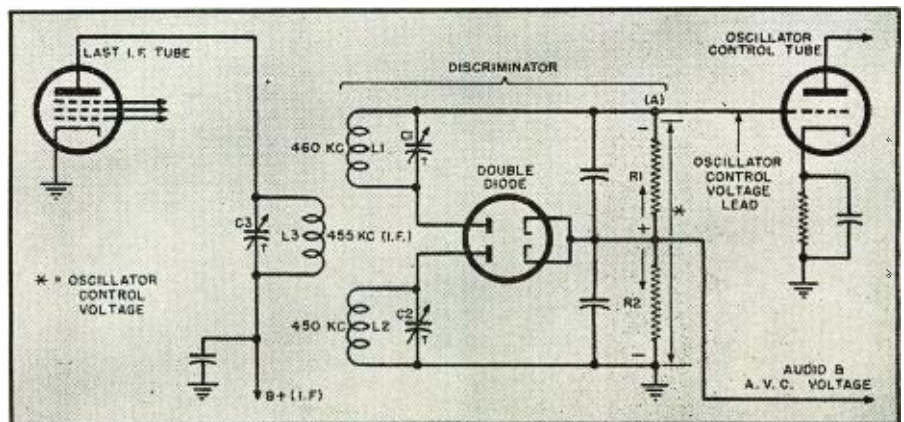

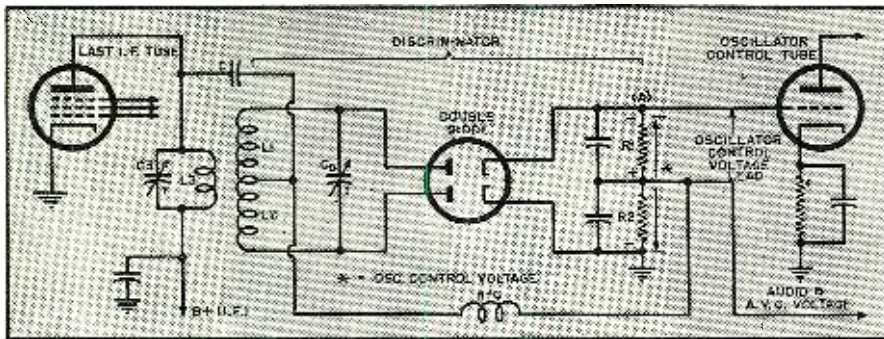

Fig. 4. Diagram of the often used Foster-Seeley discriminator circuit.

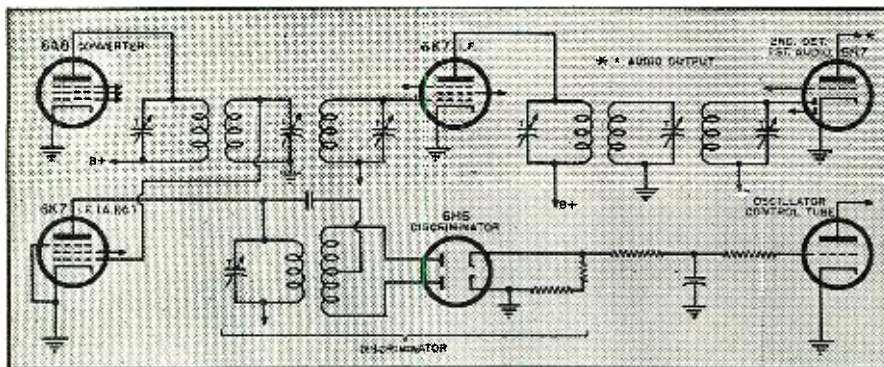

Fig. 5. AFC circuit employed in the Crosley Model 1316 receiver. Note that a separate i.f. channel is used which feeds directly to the 6H6 discriminator.

ary are accurately fixed-tuned to the i.f. employed in the receiver. The secondary feeds the double-diode discriminator tube. This is usually a special double diode having two separate cathodes—such as the 6H6 type. The resistance network in the output circuit of the diodes is very similar to that employed in the Round-Travis type of discriminator illustrated in Fig. 3, and the rectified output (osc.-control) voltage is the difference of the rectified outputs of the individual diodes.

The operation of the Foster-Seeley discriminator is based on the phase difference that exists between the primary and secondary in coupled tuned circuits. As the actions taking place in it are rather complex, space limita-

tions prevent a detailed discussion of them here. The brief explanation which follows will suffice for our purpose.

If an i.f. carrier of the resonant frequency flows through the primary of the two loosely-coupled circuits which are tuned to the same frequency, the voltage developed across the secondary,  $L_1L_2$ , differs  $90^\circ$  in phase from the voltage across the primary,  $L_3$ . The potentials acting on the plates of the diodes are then of equal magnitude. However, if the frequency of the i.f. carrier deviates slightly from the resonance frequency, the phase difference between the induced secondary voltage and the primary voltage becomes greater or less than  $90^\circ$ , with the re-

sult that the r.f. voltage applied to one diode plate becomes *larger* and the voltage to the other plate becomes *smaller*. The result is a rectified differential output voltage developed across the load resistance  $R_1R_2$  (as explained previously for the Round-Travis discriminator), making point A negative with respect to ground if the incoming intermediate carrier frequency is too high, and positive if it is too low (or vice versa). As before, point A is connected to the control-grid of the oscillator control tube, so whatever net voltage is developed across  $R_1R_2$  varies the control-grid bias potential of this tube. The control voltage developed varies almost linearly over a considerable range of intermediate carrier frequency deviation from the correct value. If the frequency of the intermediate carrier happens to be dead correct, no control voltage is produced across  $R_1R_2$ , and the oscillator frequency is not influenced.

The Foster-Seeley discriminator circuit is easier to align than is the Round-Travis discriminator since all the circuits are adjusted to resonate to the exact intermediate frequency. The discriminator secondary does not aid signal amplification, and is in a condition of absorptive resonance. Also, it does not contribute to the overall selectivity of the i.f. circuit of the receiver, so one extra tuned circuit is usually needed to regain the same order of selectivity as compared with a similar receiver not employing AFC.

When the AFC channel is to be made broad without causing corresponding reduction in the regular i.f. channel selectivity of the receiver, the arrangement shown in Fig. 5 may be used, splitting to two separate channels for i.f. amplification and discrimination. Here, the regular i.f. channel does not feed the AFC circuit directly. Instead, the grid of another 6K7 tube, arranged as an i.f. amplifier tube, is fed from an extra secondary winding on the first i.f. transformer of the regular i.f. channel, the output of this 6K7 stage feeding directly into a conventional Foster-Seeley type discriminator employing a 6H6 double-diode tube.

As indicated in the circuit diagrams, the discriminator circuits of Figs. 3 and 4 can be made to provide the audio and also AVC voltage, as well as the AFC control potential. However, the detector output represents a somewhat distorted reproduction of the modulated wave because of the asymmetric action of the discriminator with respect to the two side bands. Accordingly, when high fidelity is important, it is customary to employ a separate diode detector, as shown in the arrangement of Fig. 5, for developing the audio output. If the separate-channel arrangement of Fig. 5 is not employed, the detector tube may be fed by an extra secondary provided in the discriminator input transformer.

(Continued on page 102)

Fig. 6. Basic oscillator control tube circuit applied to a simple plate-tickler type oscillator.  $C_2$  and  $R_2$  form the phase-splitter circuit, and blocking capacitor,  $C_1$ , keeps the d.c. voltage from the grid of the control tube.

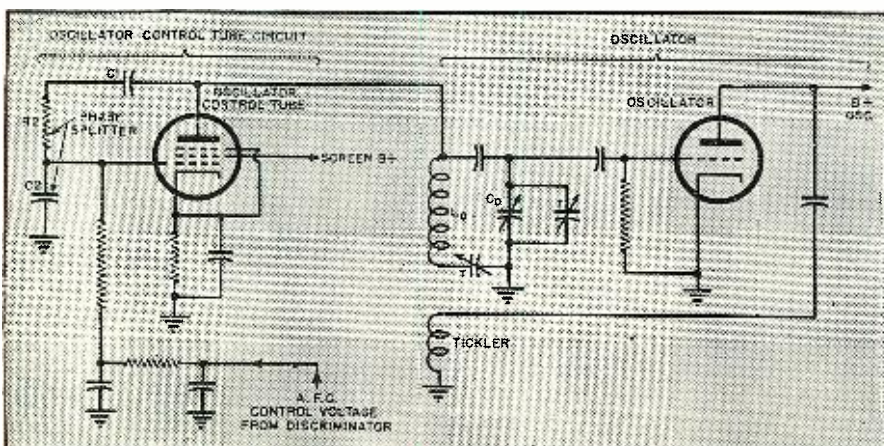



**T**HE U. S. Maritime Commission reported recently that 604 American merchant vessels of 1000 tons or more were lost through direct enemy action and that 139 more were sunk as a result of wartime marine hazards. . . . American President Lines reported that trans-Pacific service will be resumed within the next few months. Four large passenger liners will provide 2000 passenger accommodations and will operate on a sailing schedule of every fourteen days from San Francisco and Los Angeles. American South African Lines have recently launched their "African Star," first of a fleet of six new fast freighters of the modified C-3 type of 12,555 dwt. with accommodations for twelve passengers. The six new ships will provide passenger and cargo service between here and Cape Town, Port Elizabeth, East London, Durban and other points. The vessel now being fitted out will be placed in service early in April, it is expected. The Grace Line is also reported to have a total of nine, either built or building, of the modified C-2 class combination passenger-cargo vessels. Moore-McCormack Lines are reported to be under way with plans for two large passenger vessels and four smaller units of the cargo-passenger type for use in its Scandinavian services. With all this new construction is it any wonder that the Liberties are being tied up at the 'lay-up' points along all coasts having served their purpose and being too slow for post-war cargo carrying.

**S**ECRETARY of the Navy Forrestal, in his annual report to the President, said the active postwar fleet will include 3,627 aircraft, thirteen big carriers, the same number of escort carriers, but only four battleships, twenty-eight cruisers, one-hundred and thirty-five destroyers, thirty-six destroyer escorts and ninety submarines. Forrestal reported that the Atlantic Fleet under Admiral Jonas H. Ingram will be about one half the size of the Pacific Fleet under Admiral Raymond A. Spruance. Others of the Navy's warships will be divided between a "ready reserve" and a "laid up reserve." The peacetime personnel is to be composed of a force of 58,000 officers and 500,000 men.

**E**LTON JONES and Russel Werner are both recent additions to the shore staff of W. C. Simon's Tropical Radio Service Corp. in New York. . . . E. F. Dondajewski running regularly out of New York in the West Indies trade. . . . F. Bishop in recently aboard "Belle of the West." . . . The Santa Marta sailed with Pat O'Keefe, a real old timer as chief. . . . Maurice Reller is Pat's new 2nd. . . . Donald Gilmore making short runs to the islands and return during the past few trips. . . . James Sherman was in recently aboard his Liberty. . . . J. Victor Stout is now chief aboard the Freeport Seam, after having spent several months on a troop carrier and reports



**By CARL COLEMAN**

the new craft a big improvement over the older type vessels. . . . Alexander Pierce in recently aboard his Liberty for a short stay. . . . Nice letter from W. R. Gates down in the Gulf with the following: "The Mississippi Shipping Company have three new super-duper passenger ships to be delivered by the Ingalls Shipbuilding Co., for delivery early this spring and will be placed in the New Orleans-Houston-South American runs and are equipped with Radar, and Sparks will be called on to keep it in operation along with the D.F. Telephone and Telegraph Transmitters, Fathometer etc." . . . "Scotty" Gould again back at the old stand pounding brass for the Detroit Police after a year's assignment on the Geo. W. Woodward. . . . Ernie Baccarri on a 'Great White Fleet' banana run. . . . Rumor has it that the ever popular old timer, Madison Monroe has been elected prexy of Port Arthur College. Stanley 'Dusty' Rhoads expects to leave WNU to ship out soon. . . . We also understand that United Fruit Company is having two new ships designed for passenger service which will maintain that outfit's peacetime demands for some of the finest ships afloat. UFCO's new cargo ships of which some are already in service are really something to talk about with their yacht-like appearance and comfortable quarters. . . . Bill Lamson about to start out in marine or avia-

tion radio after three years in the AAF as a flight radio operator. . . . John McCurdy, five years in the Army, is out now looking for a job in civilian radio.

**F**RANCIS CULLEN in recently with his craft after another "ferry" run down among the islands. . . . Rufus Lea took out the Rolling Hitch. . . . John Scott was in New York for some time recently while his Liberty was overhauling. . . . John Largent assigned to a Victory in the Matson Line. . . . John Faiola, W. Connors and S. Allen aboard a Liberty. . . . Charles Morell expecting to get into marine radio operating shortly.

With all the talk and some action being taken in postwar cargo and passenger tonnage under construction for a modern U. S. merchant fleet it must be kept in mind that to make this a success it will be first of all necessary to get the customers, both passengers and those shipping freight, to 'Ship American'—commercial freight and passenger traffic from this country during peace times is usually high, the average American wants to travel and see how the other half lives, but in the past a large portion of this business of both types has gone to foreign shipping companies. . . . Both U. S. steamship and plane outfits must get this business if this country's shipping interests are to prosper, such will of

course also help American workers by employing American crew members. One big factor in this respect compared to the prewar set up is the fact that now the United States has the world's finest planes and ships, both for cargo and passenger traffic on a worldwide operating basis. After the last war the major portion of the American traveling public patronized foreign steamship lines, to the detriment of U. S. lines and ships; this was due in great part to the better ships (Cont. on page 107)

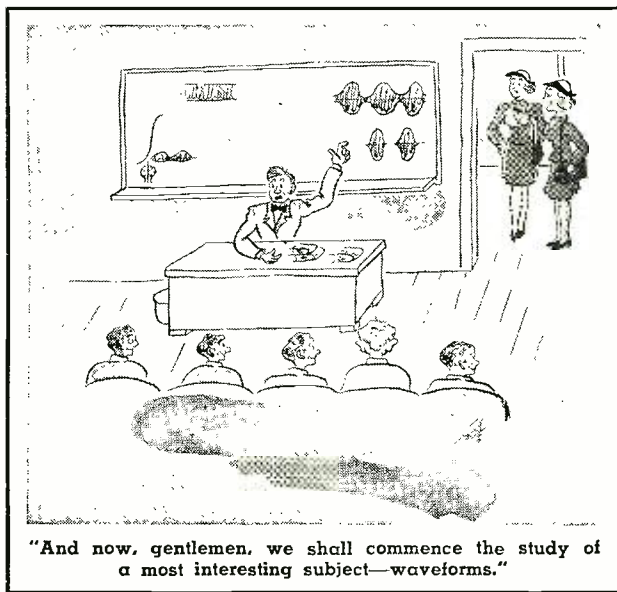

# 100 Watt - 28 MC. TRANSMITTER

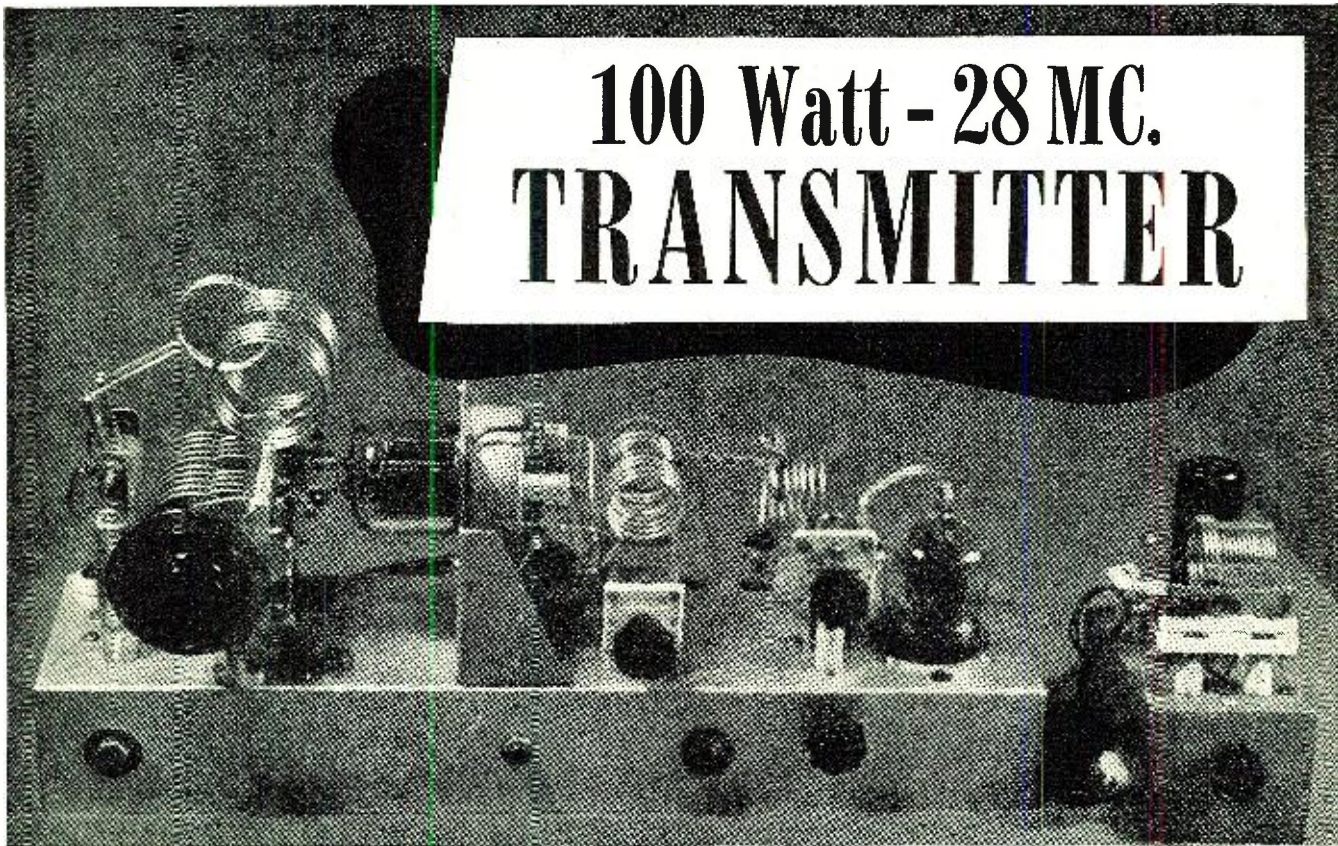

Fig. 1. Although home built and without a panel, mechanical rigidity and electrical efficiency compare favorably with commercial units.

By **NICHOLAS LEFOR, W2BIQ**

**Employing war-born 829B tubes, this rig is ideal for amateur use on recently reopened 28 mc. phone band.**

**P**RIOR to December 7, 1941, a date sooner to be forgotten than remembered, amateurs were content to utilize the common type of triodes, pentodes, and tetrodes, available at that time. The uncommon type of beam tubes, including the 829, were tubes designed more for laboratory use than general use.

The war effort has brought forth the 829, the 829A, and subsequently the 829B, which suits general amateur application more than at first is apparent. Examining the operating characteristics of the 829B, one finds that this tube will supply a fairly decent output with good efficiency at the amateur frequencies. This output is supplied at a minimum of expense since the drive requirements are extremely low, driving power being only 0.9 watts for maximum efficiency at 200 mc. Other considerations are freedom from neutralization, minimum power requirements, and its universal application as described herein, amplifying its use as doubler or quadrupler.

Since the 28 mc. phone band had just been returned to the amateur, it

was decided that a rig utilizing the 829B in its wider application would be used. Its application, as described, will undoubtedly suggest numerous applications of this tube. It was decided to put the 829B to work as push-push doubler driving an 829B amplifier.

The crystal oscillator unit is shown in Fig 1 at the right. The crystal unit is a plate grid oscillator, which functions equally well as a fundamental crystal oscillator utilizing a 20 meter crystal, or doubling in its plate circuit with a 40 meter crystal.

Operated in the manner as shown, the crystal oscillator will deliver approximately the same power with either a 20 meter or 40 meter crystal. Power output from this unit is more than sufficient to excite the 829B as a doubler or quadrupler. Consulting the schematic of the crystal oscillator will show that this circuit is quite common and requires no great detail, (Fig. 3).

The main r.f. unit containing the 829B push-push doubler or quadrupler and the 10 meter final is mounted on a 2½" x 4" x 18" aluminum chassis. The push-push doubler is mounted on

the right of the chassis with its input circuit beneath the chassis. The grid of this tube is resonated on the fundamental of the driver. In this case the grid is resonated on 20 meters. The plate circuit of this doubler is tuned to 10 meters. Power output on this frequency is more than sufficient to drive the 829B amplifier. The push-push doubler output, as shown, is sufficient to drive a ½ kw. c.w. final to full output. As will be noted, all stages utilize link coupling. The advantages of link coupling from stage to stage are readily apparent to all amateurs, in ease of adjustment of drive, minimum reaction on preceding stages, and servicing requirements being at a minimum.

The socket used for the 829B final is one of the type which has the bypass condensers built in as an integral part of the socket. While this is necessary in equipment built to operate above 60 mc., a standard socket may be used in this rig with no ill effects.

The 10 meter final occupies the greater portion of the left hand side of the chassis. A special bracket was constructed, as shown in the photograph, to support the 829B final. This construction lends itself admirably to short leads. While this tube normally requires no neutralization, various physical layouts of this final may find a slight amount of r.f. getting through to the final tank circuit. Such was the case in this layout. Neutralization is accomplished by the short leads

of No. 14 wire, shown alongside the plate elements of the 829B final. These leads are installed on the top of each plate element and cut  $\frac{1}{2}$ " at a time until all r.f. ceases to be present in the final r.f. tank circuit. Neutralization is, of course, effected with the plate voltage removed from the final stage.

The antenna is coupled to the final by the link, as shown, on the extreme left hand side of the chassis.

All circuit constants were designed to have optimum efficiencies on the recently opened 28 mc. phone band.

Examining Fig. 2 the 20 meter grid push-push coil is shown mounted directly on its grid tuning condenser. This coil may be a 40 meter coil with the plate circuit quadrupling to 10 meters. The filament transformer, as shown, operates all filaments. This is possible due to the complete isolation afforded by proper bypassing of filaments and cathode operation of the tubes in this r.f. lineup. Resistor values were carefully chosen as to optimum performance and should be strictly adhered to.

In Fig. 3, as shown, both crystal stage and push-push doubler are operated from the same power supply. Corresponding terminals, as indicated, are connected together. As will be noted, the number of resistors and condensers have been kept to a minimum. Metering is accomplished in the respective cathode circuits of the 829B tubes.

The 829B, being a tube of high power sensitivity, will, unless its plate and screen are operated at its correct values, give indication of double resonance and other effects. If operated at high values other than those recommended by the tube manufacturer the tube will indicate creeping plate, grid, and screen currents, and unless controlled, will

Fig. 2. Main r.f. assembly. This unit is built on a separate chassis from that of the crystal oscillator section.

eventually ruin the tube. An overexcited grid on the 829B will cause the grid to emit electrons and subsequently burn the grid of the tube and also ruin the tube. This all may be overcome by operating the tube well within its rating.

The dividends of operating this tube within its rating will be well worth the effort by continued performance of this remarkable tube.

If construction is carefully carried out, no difficulty should be experienced in obtaining optimum performance from this transmitter. No bugs should be encountered if reasonable precautions are observed, and all leads made as short as possible.

Correct operating conditions of these tubes are shown in the schematic diagram, Fig. 3. The 829B operating as a push-push doubler requires higher drive and subsequently greater wave distortion in its grid and plate circuits. This is of no consequence since it acts as a buffer and driver. About 25 grid mils is required for this tube. The same value is sufficient for the 829B final, operating as a modulated Class "C" stage. Screen voltage should hold to a maximum of 250 volts on both stages.

Any modulator capable of furnishing 50 watts of audio may be used as a modulator. An 815 operating in class "AB<sub>2</sub>" with 500 volts on the plate, and a plate-to-plate load of 8000 ohms, will be ideal for this purpose. Such a unit may be easily constructed.

While the physical design of this layout gives a compact 100 watt transmitter, it leaves a wide latitude for

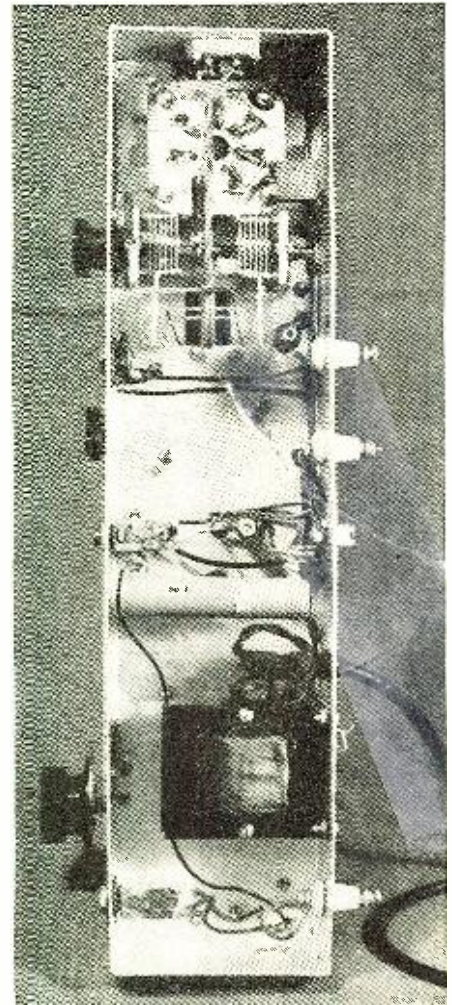

amateur design. However, the technical considerations are fundamental and should be considered in applying this tube to amateur applications.

-50-

Fig. 3. Schematic diagram of the crystal oscillator and r.f. section. An 829B is used as a push-push doubler driving an 829B amplifier.

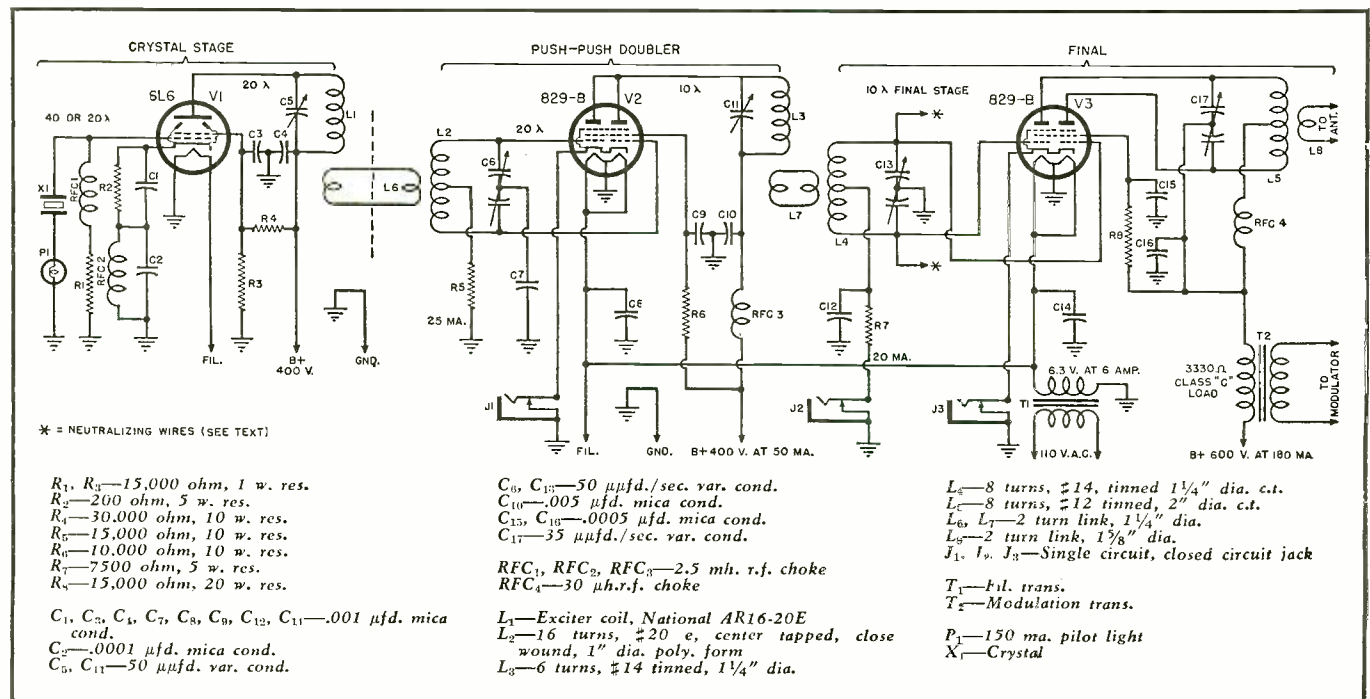
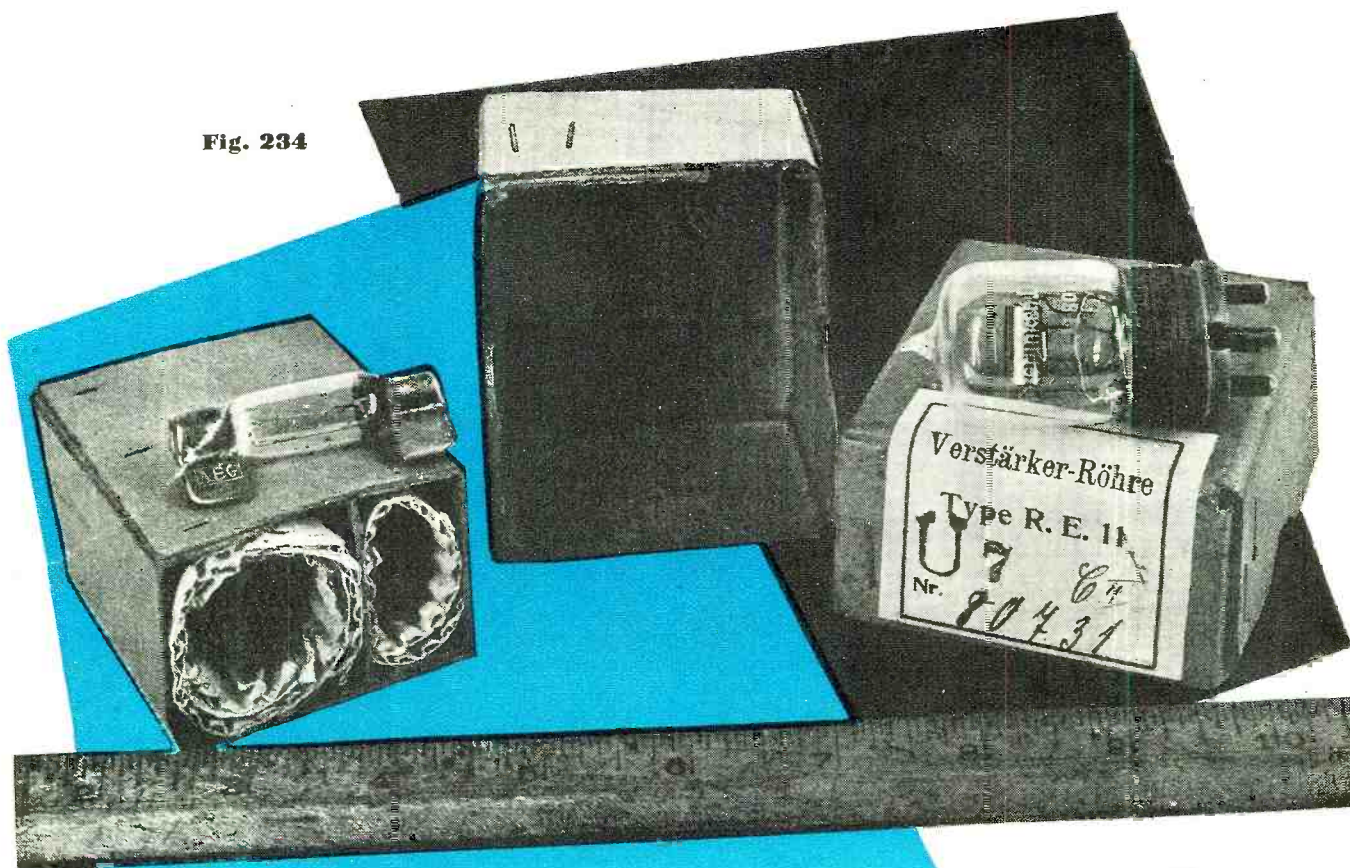

Fig. 234



# Saga of the

By  
**GERALD F. J. TYNE**  
Research Eng.

# VACUUM TUBE

**Part 22. Concluding article of a historical series which has covered the development of the vacuum tube from its conception to the end of World War I.**

**N**OT long after the EVE173 tube was put into production the system of nomenclature was changed and German receiving tubes were denoted by the prefix RE (= Rohre Empfänger), transmitting tubes by RS (= Rohre Sende), and two new prefixes came into being RG (= Rohre Gleichrichter) for rectifiers and RV (= Rohre Endverstärker) for output tubes.<sup>312</sup>

Probably the first of these tubes to be made in any quantity, 250 per day in 1918,<sup>313</sup> was the RE11, shown in Fig. 234. This tube like most of its predecessors was used with an iron wire ballast resistor in the filament circuit and one of these ballast resistors is also shown in the figure. This tube had a tungsten filament of about the same characteristics as the

EVE173 (.55 ampere at 2.8 volts), but operated at an anode voltage of 40 to 70 volts and had an amplification factor of 8 and mutual conductance of 120-150 micromhos, slightly higher than that of the EVE173.<sup>314</sup> It was a general purpose tube.

Another general purpose tube, bearing a closer resemblance to the EVE173, was the RE16 shown in Fig. 244. This was used chiefly as a detector for c.w. work.<sup>315</sup> The extent of its use may be gauged by the fact that in the summer of 1918 *Telefunken* was producing them at the rate of 1000 per day.<sup>313</sup> It had a filament which took 0.5-0.6 ampere at 4.0 volts. The usual anode voltage was 65 and the mutual conductance about 200 micromhos, the internal resistance being about 24,000 ohms. This tube had about the same

anode characteristics as the French tube described in the preceding installment although it required less filament power. The normal anode current was about 1 milliampere.

Triode tubes were also made during this period by other German manufacturers, among them *Huth*,<sup>316</sup> *Seddig*,<sup>317</sup> and *Auer*.<sup>318</sup> Some of these tubes are shown in Figs. 238 and 239. It will be observed that the *Huth* tube shown was of plane parallel electrode construction. Earlier *Huth* tubes used a cylindrical element assembly but *Huth* was compelled to change to the plane electrodes because of patent difficulties. The earlier *Huth* tubes bore RE numbers similar to those of *Telefunken*, but those with plane electrode systems were designated by LE numbers.<sup>319</sup>

It is during this period also that we find considerable research effort being expended in Germany on the multiple electrode tube. It was early realized by Dr. Walter Schottky<sup>320</sup> of the *Siemens & Halske Company* that there were limits to the amplification which could be attained by the use of a triode

**RADIO NEWS**

and he set out to devise a tube which would be capable of high amplification with the low anode potentials available in Army field equipment.

Accordingly he investigated the possibility of modifying the high vacuum triode by the insertion of additional electrodes. He patented the space charge principle in 1915<sup>321</sup> and the "protective network" type in 1916.<sup>322</sup> His first patent on a multiple electrode tube was German patent D.R.P. 300617, issued June 1, 1916, and covered a tube designated by Schottky as a "protective network" (Schutznetz) type. Another patent, D.R.P. 300192 issued June 21, 1916, covered another double grid arrangement. Patent D.R.P. 300191 for a tube having a space charge grid in which both grids were characterized by being composed of strips of sheet metal placed with edges toward the cathode was issued on January 24, 1917.

The first production of the multiple electrode Schottky tubes were tetrodes of the protective network type, known as the SSI, SSII, and SSIII. While the protective network was a grid inserted between the control grid and the anode these tubes differed from the modern "screen-grid" type in that no attempt was made to use the additional grid to minimize the electrostatic capacitance between the anode and the control grid. This difference is relatively unimportant for low-frequency work, but is of great importance in high-frequency applications. As Schottky himself pointed out, his tubes were not suitable for use at high frequencies.<sup>323</sup>

The early model and later quantity-production type of the SS tubes are shown in Fig. 241. Fig. 241 (left) shows the earliest construction of this type. The electrode assembly was cylindrical, the grids were of the "squirrel cage" type, and a double press was used. The electrodes were slotted so that it was possible to insert the filament assembly into the electrode assembly after fabricating the two separately. Fig. 241 (right) shows a single-ended production type tube with glass "star" as the support of the electrode system.

The SSI was first manufactured in 1917. It had a filament which operated with 0.4 ampere at 2.4 volts. The anode potential was 35 volts and the potential of the protective network was 15 volts. When so operated it gave an amplification of about 50 and had a mutual conductance of 250 micromhos.

The SSII, also known as the RE97,<sup>324</sup> was a lower powered, lower gain tube, operating with a filament current of 0.24 ampere at 1.9 to 2.2 volts, and with 10.5 volts on both the anode and the protective network. It had an amplification factor of 30 and mutual conductance of 30 micromhos.

The SSIII, also known as the RE114, drew a filament current of 0.55 ampere at 3.2 volts and operated with 120 volts on the anode and 45 volts on the protective network. It had an ampli-



Fig. 235



Fig. 236

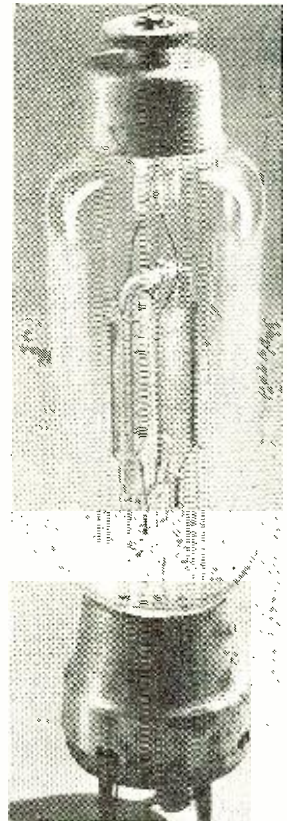

Fig. 237

fication factor of about 100 and a mutual conductance of 250 micromhos. The internal resistance was about 250,000 ohms.

Tubes of the space-charge grid type were also manufactured during this period. Typical examples of the smaller ones are the *Telefunken* RE20 and RE26, shown in Fig. 242. Both these tubes had tungsten filaments operating at 0.5 ampere at 2.8 and 4.0 volts respectively. They operated at 12 to 18 volts on the anode and space charge grid, had an amplification factor of about 8 and mutual conductance of about 350. Since they had 5 prong bases they required special sockets.

Larger tubes of the space-charge grid type were also developed and Fig. 243 shows the development series of one such tube. Figs. 243(A) and 243(B) show the early models. The grids are of wire netting. The space charge grid is small in diameter while

the control grid is very close to the anode. Fig. 243(C) shows a production type tube of the vintage of 1919, still with the double press, Fig. 243(D) illustrates the final construction which was put into production about 1920.

Combination space charge and protective network tubes with three grids were also developed and some of these are shown in Fig. 245. The tube at the left is an experimental type with three grids using a double press and slotted electrodes. That at the right is a production type similar to the SS series.

In parallel with the work on receiving tubes *Telefunken* and the other German concerns had also been carrying on the development of transmitting tubes. The first of these to be made in quantities was the RS1, shown

Fig. 239

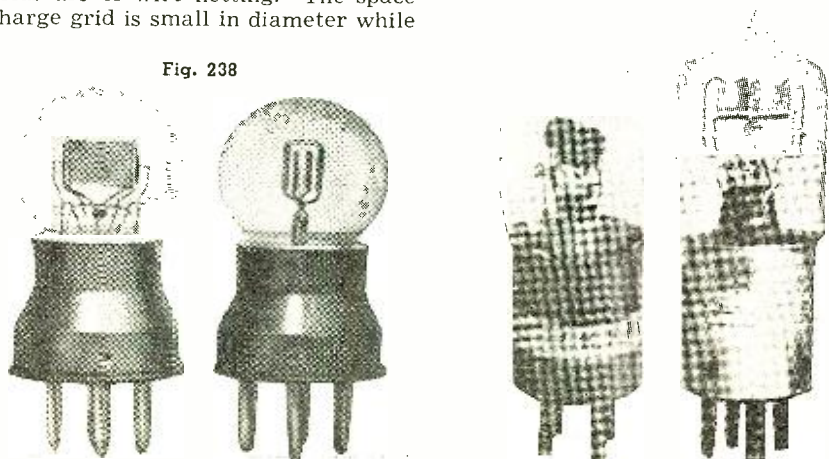

Fig. 238

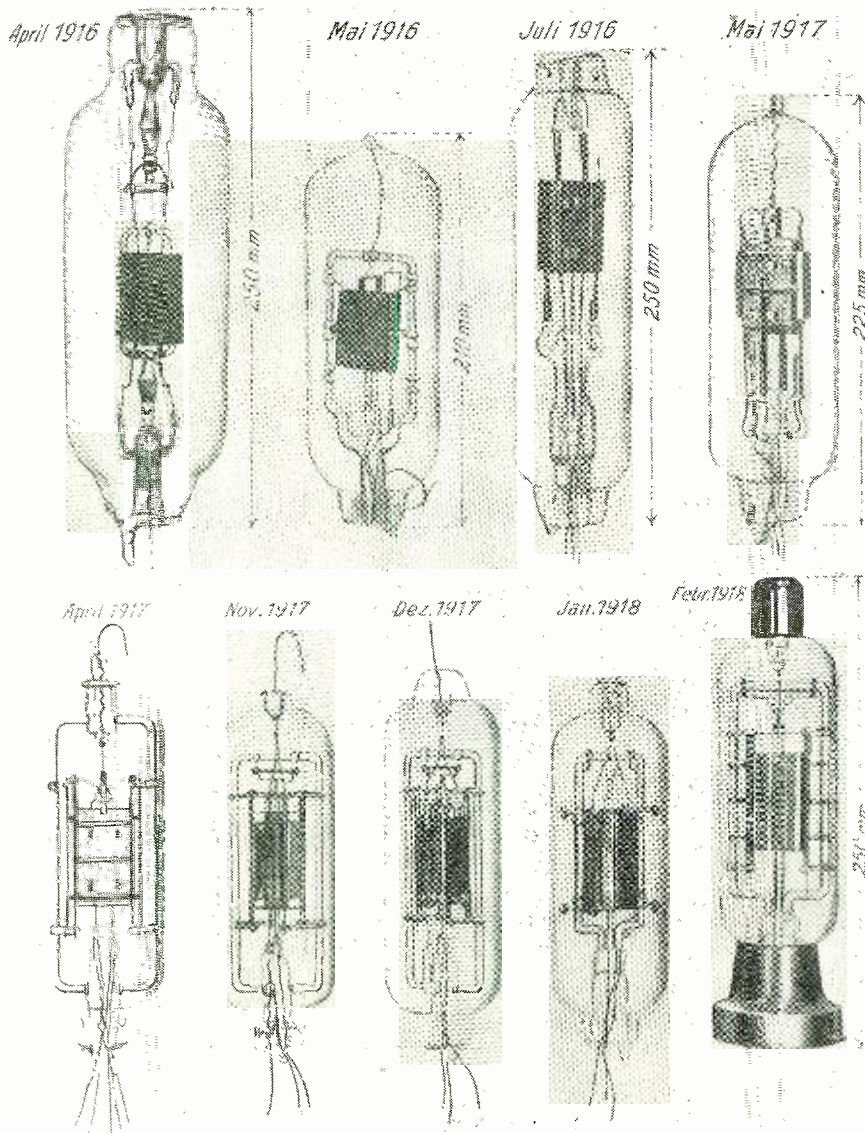

Fig. 240

in Fig. 235. It gave about three watts output when operated with 400 volts on the anode, in the apparatus in which it was first used, an Army trench transmitter. It was capable of operation at higher anode voltages, and at 600 to 800 volts would put out

10 to 20 watts.<sup>325</sup> The RS2 and RS3 were of no particular importance. The RS4 was a higher powered tube giving 50 to 75 watts output at 1000 to 2000 volts on the anode, and had a filament which took 3 amperes at 9 volts. The RS5, shown in Fig. 236, was an RS4

with improved characteristics. It took a filament current of 3 amperes at about 8 volts. The successor to the RS4 was the RS17, the evolution of which is shown graphically in Fig. 240.

All these transmitting tubes were characterized by the excellent glass work shown in their internal construction. This construction was common to all of the small transmitter tubes of early German manufacture, and is again exemplified in the TKD ST-12 shown in Fig. 237.<sup>326</sup> This tube again shows the effect of metal shortages. The interior portion of the base, in which the connecting pins are mounted, is of wood and the shell is of iron, with a poor nickel plate.

This series of articles has been presented to trace the development which took place up to the end of World War I along a particular branch of the network of roads which led to the modern radio tube. It has attempted to trace the evolution from studies of the interactions between heat and electricity as pursued by the early philosophers and by the physicists who followed them. These limitations have been adopted in an attempt to report the work done in the years where there is a dearth of readily available published material.

In any field of human activity, books and periodicals are published by and for those interested. Such was the case in the early days of radio, with which the vacuum tube is so inextricably bound up. Much of the widespread interest in radio in the United States may be traced to the band of eager enthusiasts who made up the amateur fraternity in the days before World War I. The ham of those days spent his spare, and often not-so-spare, cash, burned his midnight electricity, and experimented unceasingly to fathom the mysteries of transmission and reception. Much progress came from interchange of ideas and experiences with others of like inclination. But unlike the situation existing today the facilities for such interchange were very limited. Books and periodicals dealing with such matters were few

(Continued on page 132)

Fig. 241

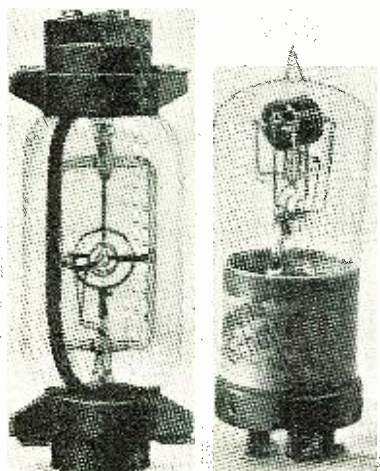

Fig. 242

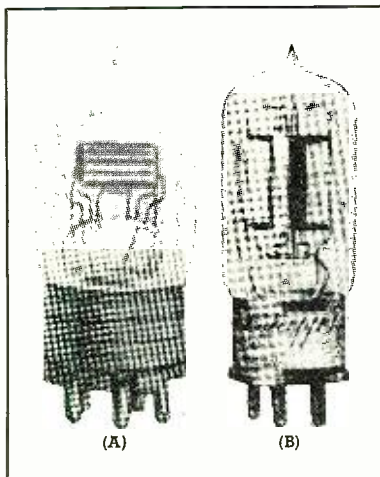
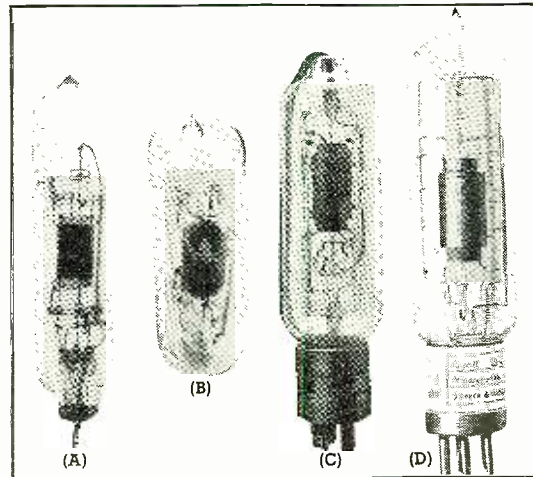

Fig. 243



# Class "C" GRID BIAS MODULATION

By W. W. SMITH, W6BCX

## Part I. The design and operation of some brand new circuit innovations of Class "C" grid bias modulation.

CLASS "C" grid modulation is one of the many significant developments in the communications field that can be credited to the traditional curiosity and "let's try it" spirit of the radio amateur. Back in the days when the literature described grid bias modulation as a highly inefficient method which required class "A" operation of the modulated stage and careful adjustment in order to keep distortion at an acceptable level, a number of amateurs independently decided to see for themselves. Perhaps in some cases they tried it because they hadn't read the literature and didn't know any better, but in most cases they tried it simply because they were not convinced.

Many a ham, with a hefty tube percolating on c.w. and a hankering to try phone, was reluctant to invest in the still bigger tube required for Heising (plate) modulation. Just who was the first amateur to try class "C" grid modulation, with some idea of what he was doing and why and how to go about it, has not been established. When the writer began wondering about its possibilities back in 1931 he discovered that Harwood, W6DJZ; McCullough, W6CHE; Sharp, W6DMY, and one or two other sixes whose identity has been forgotten were giving or already had given it a fling, and with considerable success. Undoubtedly there were others in other parts of the country.

At first, some of the considerations involved were not fully appreciated by many of those who were using the system, but results in most cases were nevertheless good. At first there was some argument as to whether or not the system was a true variable efficiency system of the same generic type as the class "B" linear amplifier. Some advanced the theory that it was a variable input system, and that with sine wave 100 per-cent modulation the plate current should kick up 50 per-cent to provide for the 50 per-cent increase in output power represented by the sidebands. However, before long

it was established that class "C" grid modulation is essentially a variable efficiency system, and that the plate current should remain substantially constant with modulation.

But even after the system had received widespread amateur acceptance, the commercial engineering profession was slow to acknowledge its highly gratifying performance characteristics. As late as 1934 a prominent engineer associated with one of the best known commercial laboratories made a statement to the effect that while the system might be made to give fair efficiency, the distortion would be intolerable. Shortly thereafter, however, the commercial

brethren conceded that with proper design and adjustment the distortion was sufficiently low for communications applications. Now, with rectified carrier inverse feedback to reduce the distortion, class "C" grid modulation is even used for broadcast work.

### General Theory

For amplitude modulation it is necessary that the r.f. output voltage of a modulated stage vary in accordance with the audio modulating voltage. For distortionless modulation the relationship must be linear.

It is readily apparent that if the bias to a normally operating class "C" stage is progressively increased, the

Fig. 1. Use of V.R. tubes as a source of fixed bias. Circuit (A) may be used where the resting current is at least 5 ma. and the current at 100 per-cent modulation does not exceed 60 ma. When the resting current of a push-pull stage is at least 10 ma. and the maximum not over 120 ma., circuit (B) may be used. Any combination of V.R. tubes in series may be employed to give 75, 105, 150, 180, 210, 255, 300 volts, etc. The condenser  $C_1$  may be an 8 microfarad electrolytic.

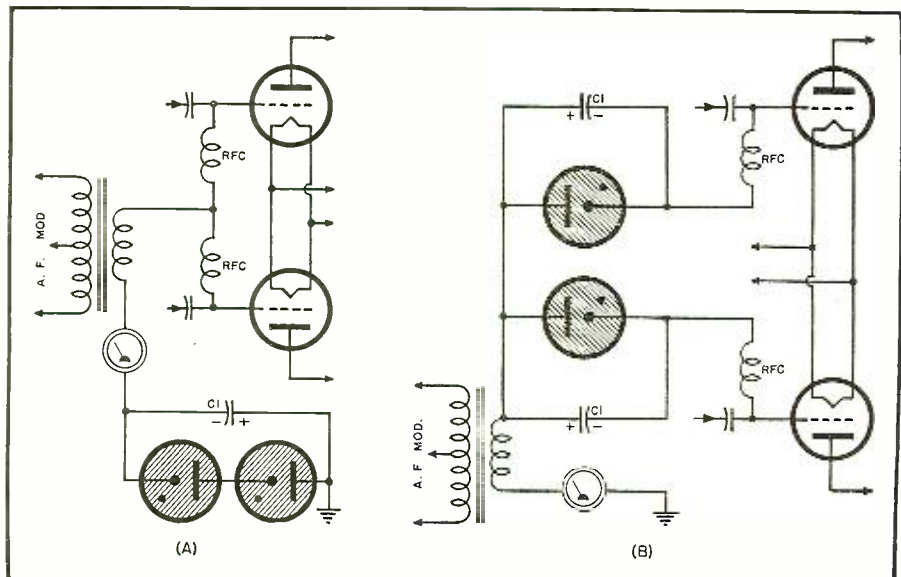

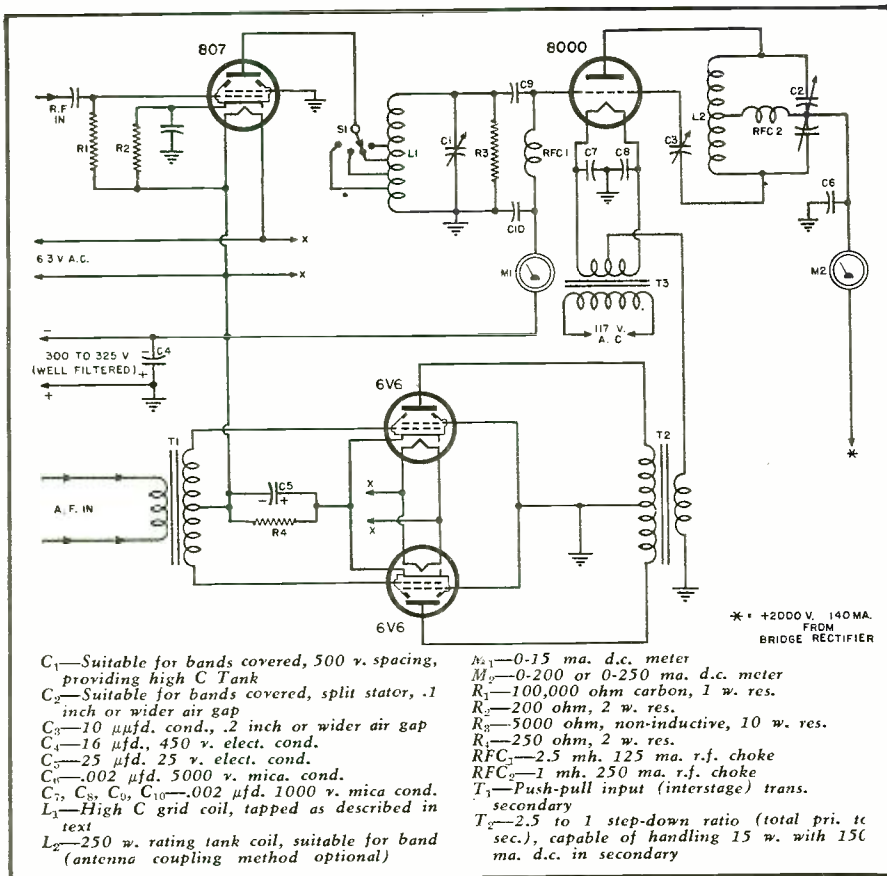

Fig. 2. Diagram and partial schematic of an inexpensive 125-watt grid modulated transmitter (low-power stages omitted), incorporating several novel features discussed in the text. The use of r.f. driver plate voltage for bias on the modulated stage not only is economical, but actually results in improved performance.

output will fall off, until finally a point is reached where the output is zero. This means that amplitude modulation can be accomplished by modulation of the bias. But if this is attempted in an ordinary grid-leak-biased c.w. amplifier, the distortion will be terrific, because the relationship between bias variation and r.f. output voltage variation is about as linear as a pretzel.

To get distortion-free modulation, something must be done to improve the linearity. The greatest single improvement can be effected by substituting fixed bias for the grid leak bias. If the bias source is such that it is not affected by the value of d.c. grid current, the linearity begins to show some promise.

The next step that must be taken in our quest for adequate linearity is to provide sufficiently good regulation of the r.f. driving voltage. If no precautions are taken, it will be found that the r.f. voltage applied between grid and cathode will vary considerably as the bias is changed, because changing the bias (and therefore the grid current) alters the effective load on the preceding driver stage. For the time being let's just assume that the r.f. driving voltage has been stabilized, so that it does not vary appreciably with bias, without worrying as to just how it is accomplished.

If the output r.f. voltage of the modulated stage is now checked

against bias voltage, it will be found that the variation in the former is substantially linear with respect to the latter, from zero or nearly zero output voltage to a saturation value having a peak voltage slightly less than the d.c. plate voltage.

We now have complied with the conditions necessary for modulation with low distortion, so far as the modulated amplifier is concerned. If the bias is adjusted to give a value of r.f. output voltage equal to half the saturation value, then modulation of the bias will provide high percentage modulation of the carrier with acceptable distortion. However, an important consideration is involved in the a.f. modulator: Little a.f. power is required for complete modulation of the carrier, but the modulator works under the same undesirable conditions as the driver for a class "B" audio stage, that is, the load impedance varies widely over the audio cycle, and a low driving impedance is required in order to avoid distortion.

#### Comparison with Class "B" Linear

Before going on to practical circuits and proper adjustment procedure, a comparison of the class "C" grid modulated stage with the classical class "B" linear r.f. amplifier is in order. Basically the two systems work on the same principle, and belong in the category of "variable efficiency" modulation systems.

In the case of the class "B" linear stage, the bias is held constant and the r.f. excitation voltage is varied. Usually the tube is run at "projected" cut off (plate voltage divided by  $\mu$ ), though sometimes the amplifier is run class "C" with an increase in efficiency and distortion. The latter case is not strictly class "B" linear operation, but it is interesting to note that such operation more nearly resembles class "C" grid bias modulation because the angle of plate current flow varies with modulation.

In the class "C" grid bias modulated stage, the excitation voltage between grid and cathode is held constant and the bias is varied, the net result being substantially the same as though the reverse were done, because as far as the grid of the tube is concerned it is the relationship between the two that counts, rather than absolute values.

It should be noted that when either the excitation or the bias is modulated with the mean bias value considerably beyond cut off, the angle of plate current flow is not constant over the modulation cycle. It is for this reason that there is some distortion inherent in class "C" grid modulation, making it unsuitable for high fidelity broadcast work except where rectified carrier inverse feedback is employed.

The chief advantage of class "C" grid modulation over the class "B" linear system, assuming that the latter is operated truly class "B," is the higher efficiency that can be obtained. The carrier or "resting" efficiency of a class "B" linear stage adjusted for 95 per-cent modulation capability is about 36 per-cent, assuming a triode and ignoring tank circuit losses. The efficiency of a class "C" grid modulated stage under the same conditions is about 44 per-cent. In both cases the efficiency is low enough so that the plate dissipation of the tube is the limiting factor with regards to maximum obtainable output, provided that the tube is run at or approaching maximum rated plate voltage.

The increase in output at the higher efficiency is greater than a first glance would indicate. Calculation will show that while the increase in efficiency is only 22 per-cent, the maximum output obtainable from a given tube is increased 41 per-cent.

#### Comparison with Plate Modulation

The over-all cost of a class "C" grid modulated transmitter is higher than that of a class "B" plate modulated transmitter of the same power, though the difference is very slight. Likewise, the average a.c. power drawn from the line is higher, but the difference again is very slight.

In a class "C" grid modulated transmitter considerable money is tied up in tubes, while in a class "B" plate modulated transmitter less is spent for tubes but a comparatively expensive modulation transformer is required. Tubes eventually wear out and have to be replaced, while a good quality



# NEW

... and Individually Marked

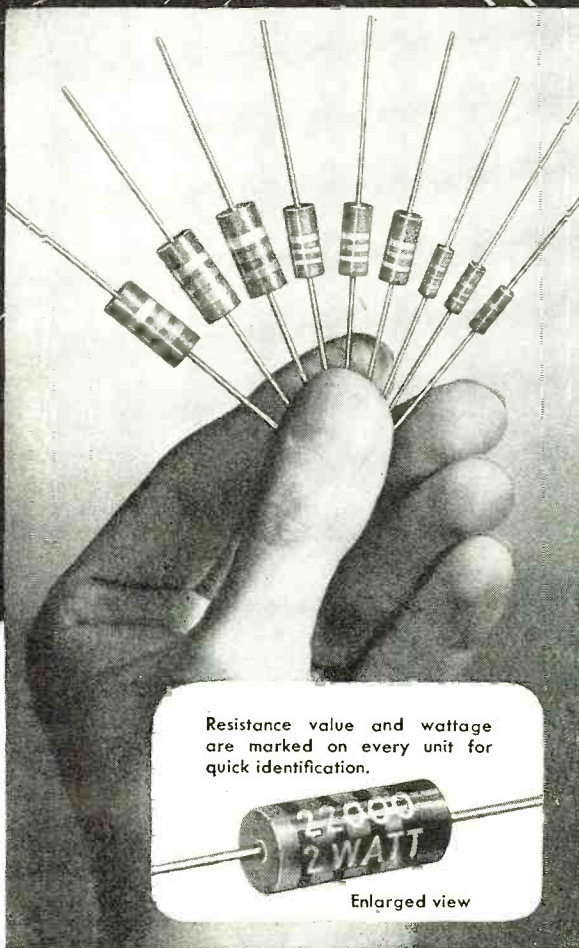

Resistance value and wattage are marked on every unit for quick identification.

Enlarged view

Meet Joint Army-Navy Specification JAN-R-11  
AVAILABLE FROM STOCK IN STANDARD  
RMA 10% TOLERANCE VALUES

TYPE	SIZE		RESISTANCE RANGE	MAXIMUM VOLTS	LIST PRICE
	LENGTH	DIAM.			
1/2 Watt	3/8"	3/64"	10 Ohms to 22 Meg.	500	13c
1 Watt	7/16"	7/32"	10 Ohms to 22 Meg.	1000	17c
2 Watt	1 1/16"	5/16"	10 Ohms to 22 Meg.	3500	25c



Send Now for  
BULLETIN No. 127

Gives complete data and list of RMA values. Includes dimensional drawings and handy color code. Write for it today!

# OHMITE

## Little Devil

### INSULATED COMPOSITION RESISTORS

1/2 Watt • 1 Watt • 2 Watt • ±10% Tolerance

NOW . . . OHMITE makes available to you three *Little Devils* of exceptional ruggedness and stability!

Millions of these tiny molded fixed composition resistors have been used in critical war equipment and in the nation's foremost laboratories. They meet Joint Army-Navy Specification JAN-R-11, including salt water immersion cycling and high humidity tests. They can be used at their full wattage ratings at 70°C (158°F) ambient temperature. They dissipate heat rapidly—have low noise level and low voltage coefficient.

Ratings for maximum continuous RMS voltage drop are high—500 volts for the 1/2 watt unit—1000 volts for the 1 watt unit—3500 volts for the 2 watt unit. Units have high insulation breakdown voltage.

*Little Devils* are completely sealed and insulated by their molded plastic construction. Leads are soft copper wire, hardened immediately adjacent to resistor body—strongly anchored—and hot solder coated.

Light, compact, easy to install. All units color coded. Resistance value and wattage are marked on every unit for quick identification. Available from stock in Standard RMA values from 10 ohms to 22 megohms.

*Little Devils* are ready for any job . . . anywhere. And they're low in cost. Order them now!

Authorized Distributors Everywhere

OHMITE MANUFACTURING COMPANY  
4883 FLOURNOY STREET, CHICAGO 44, U.S.A.

Be Right with

# OHMITE

RHEOSTATS • RESISTORS • TAP SWITCHES • CHOKES • ATTENUATORS

# Announcing **2 NEW** **CONCORD** **RADIO CATALOGS**

**Ready Soon!** The presses are roaring now, pouring out the thrill-packed pages of the first great, post-war COMPLETE CONCORD Catalog—featuring

**RADIO SETS**

**AMPLIFIERS**

**RADIO PARTS**

**Electronic Equipment**



Soon it will be in your hands, presenting the complete line of brand new postwar-designed CONCORD Radio Receiving Sets and Amplifiers—incorporating a host of new improvements, new developments, modern cabinets, and superb quality throughout—plus page after page of nationally-known standard, top-quality radio and electronic equipment, supplies and amateur equipment. Mail the coupon below NOW—to be sure your FREE copy will be mailed to you as soon as off the press.



## **Ready Now!** New CONCORD Bargain Book of **RADIO PARTS** **SUPPLIES • EQUIPMENT**

Just off the press! The newest, latest Concord Bargain Book listing hundreds and hundreds of money-saving bargains on hard-to-get, standard-make radio parts and electronic equipment. Select your needs from the remarkable values offered in Condensers, Resistors, Meters, Transformers, Volume Controls, Relays, Switches, Generators, Microphones, Speakers, Tools, and hundreds of other items. Mail the coupon for your copy now.

# CONCORD

RADIO CORPORATION  
LAFAYETTE RADIO CORP.

CHICAGO 7 ★ ATLANTA 3  
901 JACKSON BLVD 263 PEACHTREE ST.

Concord Radio Corporation, Dept. E-46  
901 W. Jackson Blvd.  
Chicago 7, Illinois  
Please mail immediately FREE copy of the New Radio Parts Bargain Supplement—and place my name on the list to be one of the first to receive the new CONCORD COMPLETE CATALOG.

Name.....  
Address.....  
City..... State.....

transformer *should* last indefinitely. Offsetting this is the fact that amateurs often come by large tubes “for free,” used tubes which have seen commercial service and have been replaced after a given number of hours regardless of the fact that they are still good.

One reason the difference in cost between a grid modulated transmitter and a plate modulated transmitter is not greater is that a power supply feeding a class “B” modulator must have very good regulation, while the power supply for a grid modulated stage does not require good regulation.

### Choice of Tubes

Tubes best suited to grid modulation are those having a high plate dissipation rating in proportion to their cost, because in a grid modulated stage the output is limited by the plate dissipation rather than filament emission (space current). If tubes are being purchased new at regular prices, the cost should not exceed 10 cents per watt of plate dissipation in order to compete with plate modulation on the basis of economy. Tubes such as the 250-TH, 805, 810, 812, 822, 8000, and HY-51 fall in this category.

With certain of the larger tubes it is possible to increase the allowable plate dissipation by 10 per-cent to 50 per-cent if a small dime store fan is used to maintain a flow of cool air on the envelope. Such operation is not harmful, because a tube running grid modulated is just loafing as regards peak voltage and peak current when the maximum safe plate dissipation is reached.

The d.c. plate voltage should preferably be the highest the tube(s) will stand safely, keeping in mind that the d.c. plate voltage remains constant with modulation. Ordinarily the plate voltage that may be applied with safety is the same as for c.w. service, and the rating for the latter may be used for grid modulation service if the tube does not carry a rating for low level modulation.

Either triodes, beam tetrodes, or pentodes may be control grid modulated, but because the ratio of plate dissipation to tube cost is much higher for triodes, their use will be assumed in this discussion except where otherwise noted.

Though the plate dissipation rating is the important one for grid modulation, it is, of course, necessary to choose a type of tube which operates efficiently at the highest desired operating frequency. Also, it is desirable that the transconductance be high, in order to minimize the size of r.f. driver, a.f. modulator, and bias pack required. Tubes having a medium or medium-high amplification factor are best suited for class “C” grid modulation service, assuming other considerations are satisfied. Triodes having a mu between 12 and 35 are recommended when a choice exists, but any-

# Your storefront is a newsfront of Electronics—with RCA Electron Tubes

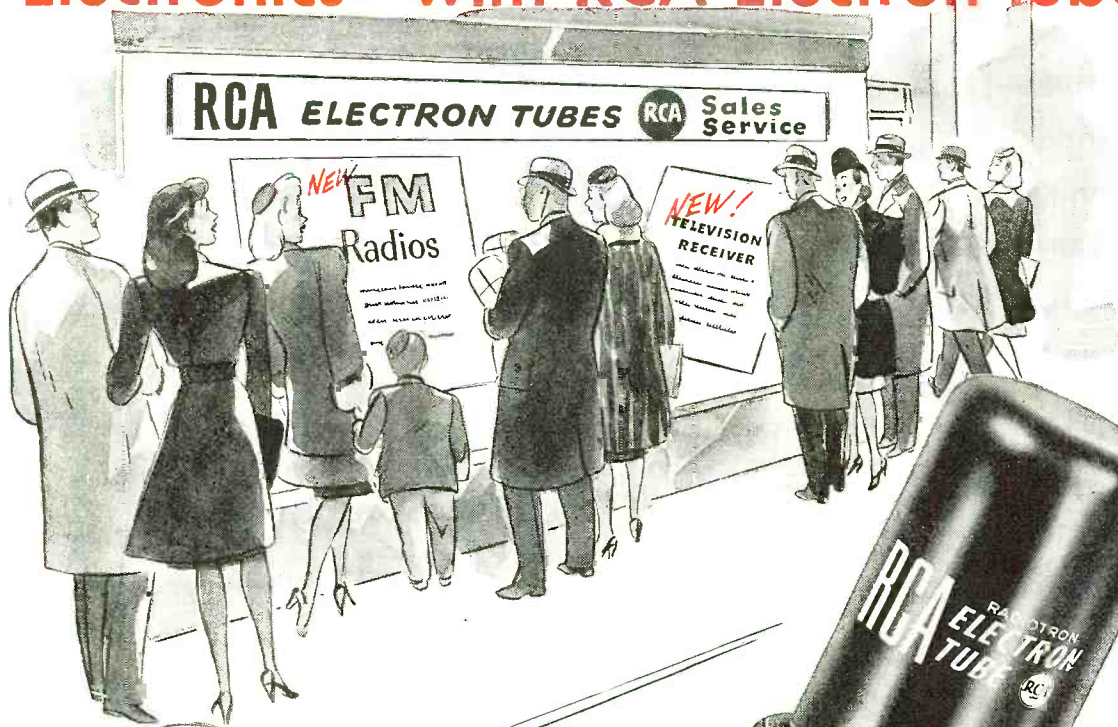

**SOON**  
**YOU'LL BE SEEING** **MORE**  
**RCA TELEVISION KINESCOPES**



The newsworthy developments in radio, television, and electronics, familiar through daily reading and hearing, are for the most part, new and revolutionary types of RCA Electron Tubes—such tubes are to be largely attributed to the great staff of RCA scientists and engineers.

The *Leadership in Engineering* of RCA brings about such highly newsworthy attainments. And, as it brings new vistas of science to the public, it also brings you new products to sell. Furthermore, it brings your store to the attention of your community.

The RCA Electron Tubes you'll soon be seeing and selling are miracles of Engineering . . . special metal, glass, and miniature types for Television and FM receivers, and for other instruments for home and afield. You'll sell more RCA Electron Tubes than ever before because far more will be in use.

So, push RCA Electron Tubes and watch your business grow.

Listen to "The RCA Show," Sundays, 4:30 PM, EST, NBC Network

**... and always see your  
RCA Tube Distributor for  
BATTERIES, TUBES,  
PARTS, TEST EQUIPMENT**

*The Fountainhead of Modern  
Tube Development is RCA*



**TUBE DIVISION**  
**RADIO CORPORATION of AMERICA**  
**HARRISON, N. J.**

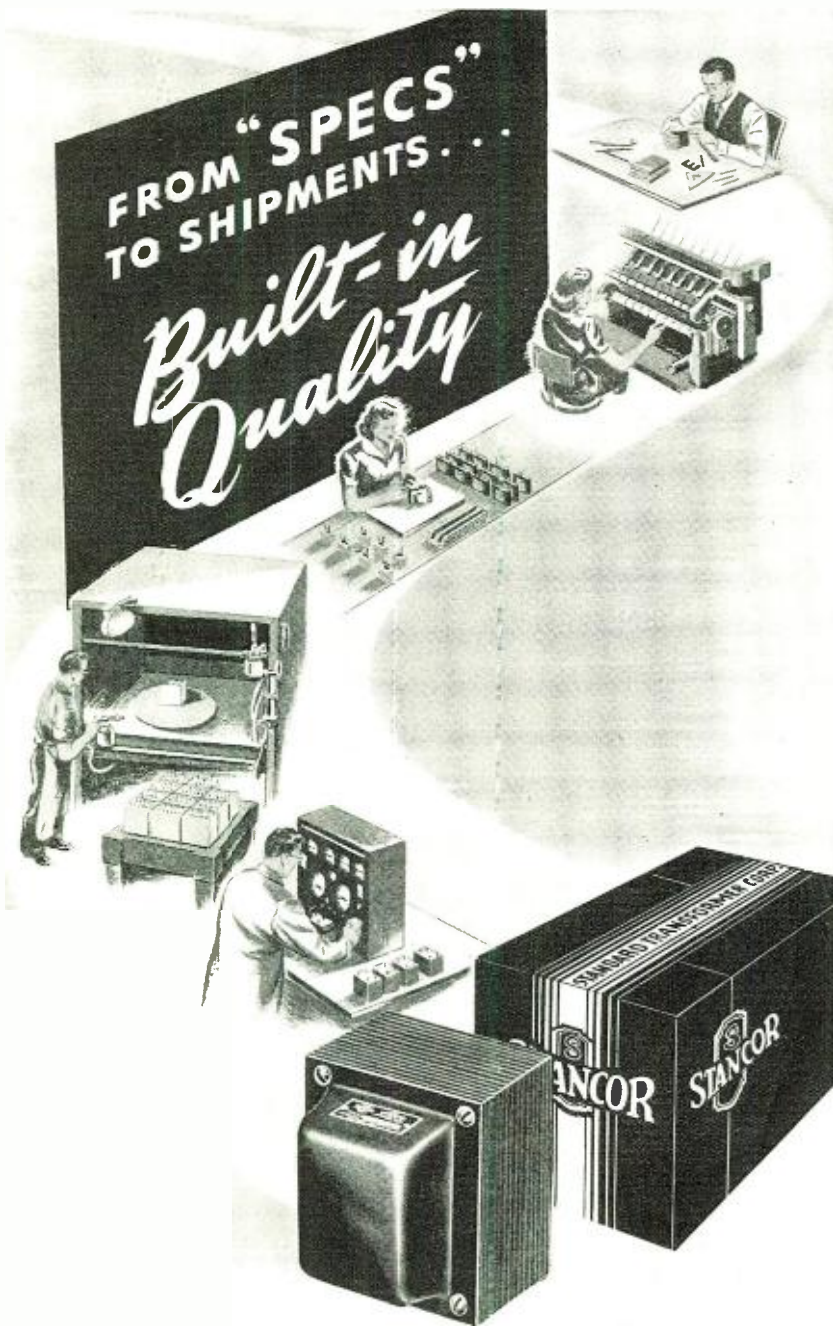

Radio servicemen, amateurs and electronic engineers have long demanded durable transformers with versatile adaptability. Stancor has consistently met these demands with manufacturing products with highest quality materials and workmanship in each separate production operation . . . engineering, coil-winding, laminating, assembling, finishing, testing and final packaging.

Today over 80% of all Universal Power Transformers now in use are replaceable with a Uni-dapt Stancor catalog item. For all transformer replacements, think first of Stancor.



**STANCOR**  
STANDARD TRANSFORMER CORPORATION  
1500 NORTH HALSTED STREET CHICAGO 22, ILLINOIS

thing between 8 and 50 is acceptable.

When a pentode or beam tetrode is grid modulated, the screen must be bypassed to ground for a.f., as well as r.f. A 1  $\mu$ fd. condenser shunted across the usual r.f. bypass ordinarily will suffice.

If two tubes are used in parallel or push-pull, it is important that they be well matched. Otherwise, special circuit expedients must be effected in order to obtain an output approaching twice that of a single tube. If both the plate resistance and amplification factor match within a few per-cent, then symmetrical circuit layout and a common value of bias will ensure that one tube does not do most of the work and thereby limit the output obtainable from the other tube.

The dynamic plate resistance of two tubes of the same type may be compared indirectly by returning the grid directly to cathode (zero bias), and applying a fixed plate voltage somewhere near the maximum that the plate *dissipation* rating will allow. Two tubes having the same plate resistance will draw the same amount of plate current under these conditions, and while this is not a direct measure of the dynamic plate resistance it serves as a useful method of comparing the dynamic plate resistance of two tubes of the same type which have the same mu.

To check the mu, determine how much bias is required to limit the plate current of one of the tubes to an arbitrary fixed value equal to about 5 per-cent of the plate current the tube draws at zero bias. If the bias required to bias the other tube to the same value of plate current is very nearly the same, say within 5 per-cent, then the tubes are sufficiently matched with regard to amplification factor.

#### Power Supply

Because the d.c. plate current drawn by a grid modulated stage is substantially constant, regulation is not an important consideration, and either a condenser input or a choke input power supply may be used satisfactorily. However, sufficient filtering may be obtained with a single section choke input filter consisting of a 20 henry choke and a condenser of 4  $\mu$ fd. This combination will give a ripple of approximately 2 per-cent, which is sufficiently low for communications work. Increasing the size of the choke or condenser will lower the ripple proportionately.

If the power supply is being designed from scratch, a choke input filter is recommended, because the low ratio of peak to average current permits use of smaller rectifier tubes and a smaller plate transformer for a given power. But if a husky plate transformer is on hand which will not deliver sufficient voltage with choke input, condenser input will permit 20 per-cent to 35 per-cent more plate voltage to be obtained. Care should be taken to see that the peak plate cur-  
(Continued on page 108)



**MR. RADIOMAN: CREI Training Can Equip You To Step Ahead of Competition and Gain the Confidence Born of Knowledge! . . .**

**Will You Be Ready?  
CREI Can Prepare You Now  
for a Better Job and a Secure  
Career in RADIO-ELECTRONICS**



CREI Technical Home Study Training Prepares You for the Secure radio jobs that pay good money for ability.

You can be ready to enjoy the security of an important engineering position and take advantage of new career opportunities . . . if you prepare yourself now.

Join the ambitious radiomen who are assuring themselves of secure good-paying jobs with a planned program of advancement made possible by CREI home study training in Practical Radio-Electronics Engineering.

You can study at home—in your spare time—develop your technical ability—increase your knowledge to keep pace with important developments now taking place in the industry.

CREI home study courses are constantly being revised and kept up-to-date with the rapid developments in the industry.

By adding CREI training to your present radio experience you can safeguard your

future and keep pace with such new developments as U.H.F. Circuits, Cavity Resonators, Pulse Generators, Wave Guides, Klystrons, Magnetrons and other tubes. Are you equipped to handle them? CREI is equipped to help you, by providing the know-how and ability that is required.

In our proved method of instruction, you learn not only how but why! Easy-to-read-and-understand lessons are provided well in advance, and each student has the benefit of personal guidance and supervision from a trained instructor. This is the basis of the CREI method of training for which many thousands of professional radiomen have enrolled since 1927.

Act Now. Get underway today!

It costs nothing but a moment's time to send for our booklet and complete details without obligation.

**• WRITE TODAY for FREE BOOKLET**



**"Your Opportunity in the New World of Electronics"**

If you have had professional or amateur experience—let us prove to you that we have something you need to qualify for a better radio job. To help us to intelligently answer your inquiry—PLEASE STATE BRIEFLY YOUR BACKGROUND OF EXPERIENCE, EDUCATION AND PRESENT POSITION.

**CAPITOL RADIO Engineering Institute**

HOME STUDY COURSES IN PRACTICAL RADIO-ELECTRONICS  
ENGINEERING FOR PROFESSIONAL SELF-IMPROVEMENT

**RN-4, 3224—16th Street, N. W., Washington 10, D. C.**

Contractors to U. S. Navy—U. S. Coast Guard—Canadian Broadcasting Corp.  
Producers of Well-trained Technical Radiomen for Industry.

Member: NATIONAL COUNCIL OF TECHNICAL SCHOOLS

# What's New in Radio

## NEW HAMMARLUND RECEIVER

The Hammarlund Manufacturing Company, Inc. of New York has announced a new communications receiver in their Series 400 "Super Pro" line.

This receiver has an expanded tuning range to include the broadcast band as well as the ten-meter ama-

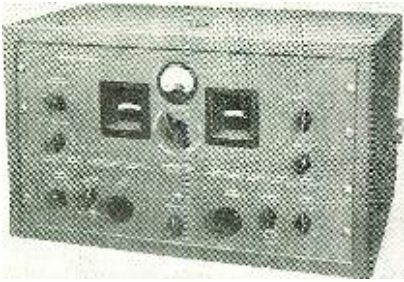

teur band. All commercial and amateur frequencies between 54 and 30 mc. are covered in five bands.

Automatic volume control operates on two r.f. stages and two i.f. stages, holding output at a steady level on voice and high speed code. A separate heavy duty power supply, designed to supply heater, plate and bias voltages, is available in both standard 115 volt, 50-60 cycle operation or in special models for other line voltages.

Details of this Model SP-400-X will be available to those requesting them from The Hammarlund Manufacturing Company, Inc., 460 West 34th Street, New York 1, New York.

## ANTENNA KITS

The Workshop Associates of Newton Highlands, Massachusetts have recently announced two FM antenna kits to meet specific localized reception problems.

Kit No. 1 is designed for the listener whose location is such that he will

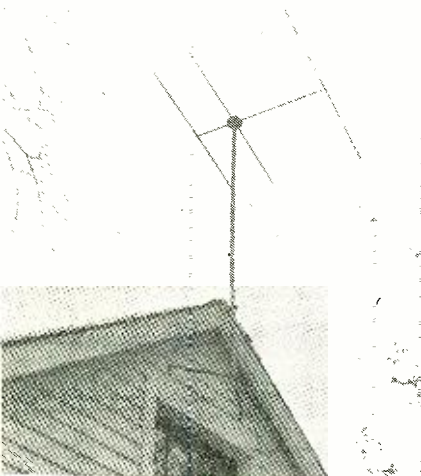

want to receive programs from many directions. Kit No. 2 is for the listener who lives outside a metropolitan area and will want reception from one general direction.

Kit No. 1 for non-directional use includes a mast for which no guys are necessary; a mounting fixture for the edge of any type of roof; 60 feet of low-loss transmission line, wired ready for assembly; four aluminum elements that are firmly supported in the plastic head.

The second kit, for high gain directional use, includes all of the components in Kit No. 1, plus a simple assembly which converts the non-directional antenna into a high gain directional array using the principle of a dipole with reflector and director.

Full information about both of these units will be furnished by The Workshop Associates, Newton Highlands, Massachusetts.

## RADIAL CONE SPEAKER

Two new model radial cone speakers, the Model RBP-12 and the Model RBP-8 have been announced by University Laboratories, of New York.

The infinite baffle design of these

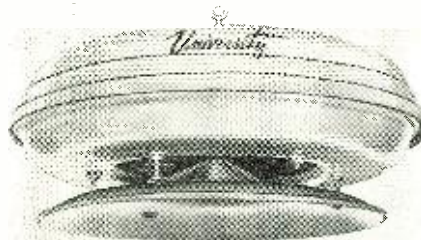

units gives improved low frequency response. Both speakers are rubber-rim damped to eliminate mechanical resonance. They are engineered for 360 degree sound dispersion and incorporate construction features which reduce undue sound concentration directly beneath the speaker.

The Model RBP-12 is 27" in diameter, 11" high and weighs 19 pounds. It is designed to be used with any standard 12" cone speaker. The Model RBP-8 is 18" in diameter, 9" high and weighs 9 pounds. It may be used with any 8" cone speaker.

Additional details will be furnished by writing University Laboratories. Address the company at 225 Varick Street, New York, 14, New York.

## NATIONAL RECEIVER

Production of a new receiver, known as the NC-46, has been announced by National Company of Malden, Massachusetts.

The NC-46 is a 10-tube superhetero-

dyne featuring a series valve noise limiter with automatic threshold con-

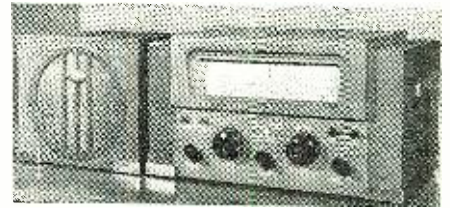

trol, c.w. oscillator, separate r.f. and a.f. gain controls and amplified and delayed AVC. Power supplies are self contained and operate on 105 to 130 volts, a.c. or d.c. An increased audio output of 4 watts is provided by 25L6's in push-pull.

A straight-line frequency condenser is used in conjunction with a separate spread condenser. This combination plus the full vision dial, calibrated in frequency for each range covered, with separate linear scale for the band spread condenser, makes accurate tuning easy.

A coil switch with silver plated contacts selects the four ranges from 550 kc. to 30 mc. Provision is made for either headphone or speaker. The cabinet is gray metal and styled along modernistic lines. Matching speaker is available.

Additional information will be forwarded upon request to National Company, Malden, Massachusetts.

## ELECTRONIC VOLT-OHMMETER

A new, laboratory-type electronic Volt-Ohmmeter, featuring extreme range and a new bridge type circuit, fully balanced through three stages, is now in production at Clippard Instrument Laboratory.

Known as Model 406, this unit is of special interest to the serviceman as it covers every a.c., d.c., a.f., i.f., r.f.

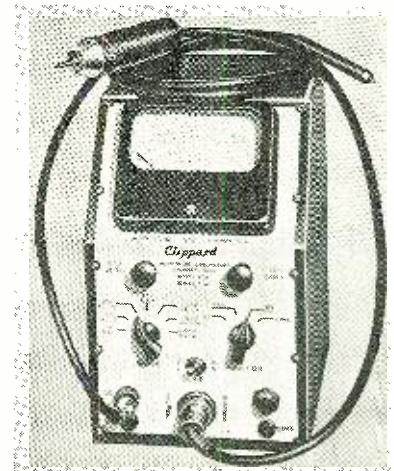

and u.h.f. potential and resistance range encountered in the testing or

PLEASE PLACE YOUR ORDER WITH YOUR REGULAR RADIO PARTS JOBBER. IF YOUR LOCAL JOBBER CANNOT SUPPLY YOU, KINDLY WRITE FOR A LIST OF JOBBERS IN YOUR STATE WHO DO DISTRIBUTE OUR INSTRUMENTS OR SEND YOUR ORDER DIRECTLY TO US.

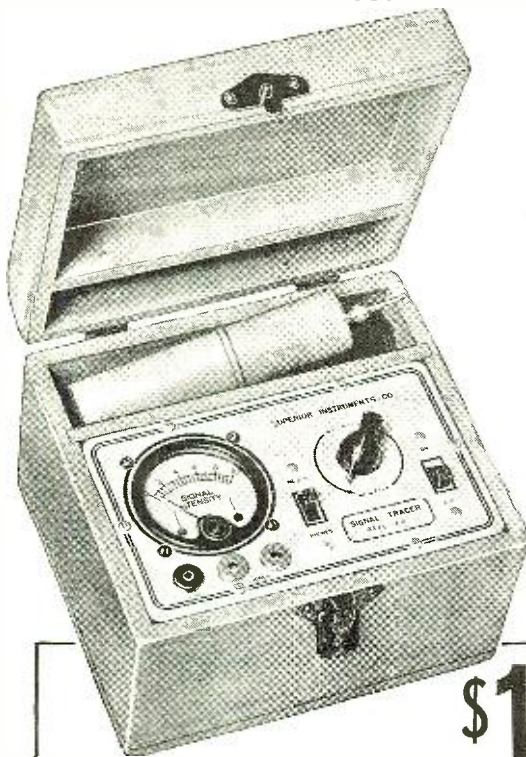

## The New Model CA-11 SIGNAL TRACER

Simple to operate . . . because signal intensity readings are indicated directly on the meter!

Essentially "Signal Tracing" means following the signal in a radio receiver and using the signal itself as a basis of measurement and as a means of locating the cause of trouble. In the CA-11 the Detector Probe is used to follow the signal from the antenna to the speaker — with relative signal intensity readings available on the scale of the meter which is calibrated to permit constant comparison of signal intensity as the probe is moved to follow the signal through the various stages.

### Features:

- ★ SIMPLE TO OPERATE — only 1 connecting cable — NO TUNING CONTROLS.
- ★ HIGHLY SENSITIVE — uses an improved Vacuum Tube Voltmeter circuit.
- ★ Tube and resistor-capacity network are built into the Detector Probe.
- ★ COMPLETELY PORTABLE — weighs 5 lbs. and measures 5" x 6" x 7".
- ★ Comparative Signal Intensity readings are indicated directly on the meter as the Detector Probe is moved to follow the Signal from Antenna to Speaker.
- ★ Provision is made for insertion of phones.

**\$18<sup>75</sup>**

The Model CA-11 comes housed in a beautiful hand-rubbed wooden cabinet. Complete with Probe, test leads and instructions.....Net price

## The New Model 450 TUBE TESTER

### Specifications:

- Tests all tubes up to 117 Volts including 4, 5, 6, 7, 7L, Octals, Loctals, Bantam Junior, Peanut, Television, Magic Eye, Hearing Aid, Thyratrons, Single Ended, Floating Filament, Mercury Vapor Rectifiers, etc. Also Pilot Lights.
- Tests by the well-established emission method for tube quality, directly read on the scale of the meter.
- Tests shorts and leakages up to 3 Megohms in all tubes.
- Tests individual sections such as diodes, triodes, pentodes, etc., in multi-purpose tubes.
- New type line voltage adjuster.
- NOISE TEST: Tip jacks on front panel for plugging in either phones or external amplifier will detect microphonic tubes or noise due to faulty elements and loose internal connections.
- Works on 90 to 125 Volts 60 Cycles A.C.



**SPEEDY OPERATION** assured by newly designed rotary selector switch which replaces the usual snap, toggle, or lever action switches.

The model 450 comes complete with all operating instructions. Size 13"x12"x6". Net weight 8 lbs. **\$39<sup>50</sup>** Our Net Price.....

## The Model PB-210 MULTI-METER

### Features:

- ★ SPEEDY!
- ★ PUSH-BUTTON OPERATION!

### Measures:

- ★ A.C. Volts
- ★ D.C. Volts
- ★ D.C. Current
- ★ Low Resistance
- ★ High Resistance
- ★ High Resistance
- ★ Low Capacity
- ★ High Capacity
- ★ Decibels

### Specifications:

5 A.C. VOLTAGE RANGES: 0 to 10/50/250/500/1000 Volts  
 5 D.C. VOLTAGE RANGES: 0 to 10/50/250/500/1000 Volts  
 5 OUTPUT METER RANGES: 0 to 10/50/250/500/1000 Volts  
 4 D.C. CURRENT RANGES: 0 to 1/10/100 Ma. 0 to 1 Amp.  
 2 CAPACITY RANGES: .0005 Mfd. to .3 Mfd. .25 Mfd. to 100 Mfd.  
 3 DECIBEL RANGES: —10 to +15; +10 to +35; +30 to +55  
 4 RESISTANCE RANGES:  
 0 to 2,000/20,000/200,000 Ohms. 0 to 20 Megohms

Model PB-210 comes housed in hand-rubbed oak portable cabinet, complete with cover, self-contained battery, test leads and instructions. Net Price.....

**\$35<sup>75</sup>**



# SUPERIOR INSTRUMENTS CO.

Dept. RN 227 FULTON ST., NEW YORK 7, N. Y.



# MONTHLY SPECIALS

- Brand New RCA UX-200 tubes in sealed cartons (Det. & Ampl.) 8 for \$1.00
- Following tubes in perfect condition, but not in sealed cartons. Guaranteed for 90 days: Nos. 26, 27, 46 and 56
- Nos. 6A3, 250, 866 . . . . . ea. .69
  - Nos. 77, 42 . . . . . ea. .49
- Western Electric Platinum-point key and buzzer \$1.75; Key only . . . . . ea. .49
- Trimm 2000~ earphones pair 1.75
- Crystal detector, isolantite base ea. .79
- CRYSTAL SET COIL; 140 turns on 2 7/8" bakelite tubing . . . . . ea. .69
- 1/4" brass sliding bar . . . . . per in. .03
- Sliders for 1/4" bar . . . . . ea. .10
- Astatic crystal pick-up; curved 8" arm . . . . . ea. 2.95
- Manual portable photo tone arm; chrome plated; 7 1/2" overall ea. 1.75
- CROSLY PICK-UP ARMS; CRYSTAL OR MAGNETIC . . . . . ea. .98
- 8" RIM-DRIVE TURNTABLES; 3/8" shaft hole . . . . . ea. .89
- 12" Turntable Felts . . . . . ea. .23
- 9 3/4" Philco Heavy Duty Recording Turntables; tapering shaft hole 5/8" to 1/2" shpg. wt. 3 lbs. 1.25
- Ohmite wire-wound power rheostats: 200~ 25 watt, O.D. 1 1/2" . . . . . ea. .89
- 50~ 100 watt O.D. 3 1/4" . . . . . ea. 1.25
- General Radio Wire-wound Rheostat; 200~ 10 watt; O.D. 1 3/4" . . . . . ea. .45

## RESISTOR SPECIALS:

- 5980 ohms (5680-300) 200 watt 1 1/8"x9" . . . . . ea. .49
  - 450 ohms 100 watt 3/4"x6" . . . . . ea. .49
  - 2500 ohms 75 watt 1"x4 1/2" . . . . . ea. .29
  - 800 ohms 50 watt 7/8"x4 1/2" . . . . . ea. .39
  - 12 ohms 20 watt 5/8"x2" . . . . . ea. .10
  - 12M ohms condohm . . . . . 12 for 1.50
  - 30 ohms wire-wound C.T. . . . . ea. .10
  - 1.5 ohms 5 watt 1/2"x1" . . . . . ea. .10
  - 110 ohms slider, enameled 25 watt 1/2"x4" . . . . . ea. .39
- Tinned resistor sliders 5/8" diam. . . . . 12 for .25
- Weston precision multipliers: 150M, 12.5M, 10.8M; on 1" bakelite bobbins . . . . . ea. .39
- WESTON 1% PRECISION RESISTORS: 200M, 500M, 600M, 800M, 3 Meg, 4 Meg, 5 Meg . . . . . 12 for 1.50
- 90~ meter shunts; wire-wound on bakelite bobbins 1"x1/2" . . . . . ea. .39
- MOD. 301 WESTON 5 M.A., DC Meters; O.D. 3" . . . . . ea. 4.95
- Mod. 301 Weston meter glass and housing . . . . . ea. .89
- 3 TUBE PHONO AMPLIFIER: Uses 7C7, 50A5, 35Y4. Vol. and tone controls. Chassis 6 3/4"x3 1/2"x2 1/2" with tubes . . . . . 8.95
- Moulded mica condensers. Kit of 15 asstd. . . . . 1.00
- 20 mfd. —200V. tubular electrolytics 2 1/2" . . . . . 6 for 1.00
- 1—1 mfd. —200V. in can 2 1/2"x1 1/2"x 5/8" . . . . . ea. .19

Write Dept. RN-4

MINIMUM ORDER \$2.00

20% DEPOSIT REQUIRED ON ALL ORDERS

PROMPT SERVICE ON ALL SPEAKER AND PHONO PICK-UP REPAIRS

- Midget Alnice magnets; 1 1/16" L ea. \$0.35
- Extractor fuse posts of black moulded bakelite; for type 3AG fuses. 2 3/4" L . . . . . .19
- 1/4" to 1/4" shaft extensions; 2" L. 7 for 1.00
- BROWN LINEN BAKELITE. 7"x10"x 3/16" . . . . . ea. .65
- 7"x14"x3/16" . . . . . ea. .85
- 7"x18"x3/16" . . . . . ea. 1.05
- 1/8" linen bakelite strips; 1 3/4"x13 1/2" . . . . . ea. .10
- Bakelite tubing, O.D. 3", 1/16" wall. . . . . per ft. .50
- Porcelain screw-eye insulator; 30" L., 3/8" thick . . . . . ea. .10
- GROOVED, RIBBED CERAMIC COIL FORMS: 3/16" Wall. . . . . .19
- 2" O.D. 5" L. . . . . .29
- 2 1/2" O.D. 6" L. . . . . .98
- 3 circuit Ceramic F.M. Tuning Coil Assembly; O.D. 1 3/4", 3" L. . . . . ea. .98
- 5 tube punched steel chassis and cover. 9 1/2"x11"x4 3/8" . . . . . set .95
- 25 ASSTD. DIAL SCALES: Airplane & Slide rule (acetate & glass incl.) . . . . . 2.98
- Fada Dial hub # 859 MP. 1/2" shaft hole, O.D. 2 3/8". Specify zero top or bot. of dial . . . . . .95
- 25 asstd. escutcheon plates; incl. air-plane, slide rule and full vision types . . . . . 2.95
- GENERAL ELECTRIC 110V. D.C. RELAYS; D.P.D.T., 2 Amp. contacts; 8000 coil . . . . . ea. .69
- Speaker rosette screws; 8/32 thread; 1 1/4" L. . . . . per 100 .75
- Kit of 16 speaker shims in durable leather case . . . . . ea. .29
- 14"x14" speaker baffles; 1/2" Celotex. Specify size of spkr. opening. . . . . ea. .35
- ASSORT. 12 POPULAR CONES, 4" to 12". Moulded and free edge 2.00
- Grille cloth; silver or gold. per sq. ft. .15
- Plastic louvre grilles for 5" speaker . . . . . ea. .15
- GOVT. F.M. MANUAL; 240pp. 86 illust. 49 diagrams . . . . . .39
- Majestic Service Manual for mods. 330, 340, 360, 370 and 390. . . . . ea. .39

## MULTI-CONDUCTOR SHIELDED CABLE:

- 2 cond. (#11) O.D. .458 . . . . . per ft. .10
- 6 cond. (2—#16, 4—#20) O.D. .490; Vinylite covered . . . . . per ft. .09
- 10 cond. (2—#16, 8—#20) O.D. .458, per ft. .10
- 18 cond. (2—#16, 16—#22) O.D. .590; Vinylite covered. . . . . per ft. .15
- 20 Asstd. experimental types; all guard. to light . . . . . 1.00
- Univex capacity control; 4"x4"x5 1/2" overall. 5.95
- Victor Power transformer for Mods. R-32, 45, 52, 75; unshielded. . . . . 5.95
- "SERVICEMAN'S HARDWARE TREASURE" Approx. 500 . . . . . .29
- 2 prong (round) foreign male plugs . . . . . ea. .19
- 4 WAY PLUG AND JACK in bakelite shells . . . . . per set .59
- "Vibro" contact microphone with vol. control . . . . . ea. 5.95
- Rubber shock mounts; 1 3/8" mtg. holes . . . . . ea. .10
- Battery clips; 2 1/2" heavy duty . . . . . ea. .10
- Screen grid tube shields; O.D. 1 7/8"x4 1/2" . . . . . 18 for 1.00
- 9"x13" sheet aluminum (.025) . . . . . ea. .19
- COPPER OXIDE RECTIFIERS; 110V. AC to 6V. DC; 3 1/2" L. . . . . .25
- Crosley knobs; 3/16" shaft hole; 1/2" extruding shank; black or brown. . . . . 18 for 1.00
- Whip antenna; 8 folding sections; 128 in. long . . . . . ea. 1.49

**LEOTONE RADIO CO.**

MAKERS OF CONES AND FIELD COILS

65-67 DEY STREET, NEW YORK 7, N. Y.

WORTH 2-0284-5

12,000 SQ. FT. OF RADIO PARTS

repairing of various types of electronic equipment.

A specially designed, small diameter, high impedance, pen-type dual-diode probe on a 36" detachable shielded cable is used to measure a.c. potentials. A convenient ground terminal near the end of the probe provides minimum lead length for maximum accuracy of a.c. measurements in all frequency ranges.

Full scale sensitivity of 0-1, 0-3, 0-10, 0-30, 0-100, 0-300 and 0-1000 volts a.c. and d.c.; 0-1000 megohms in seven ranges with ample overlap to eliminate guesswork and a d.b. scale of -20 to +51 is provided through use of a large square-faced D'Arsonval type meter of 200 microampere sensitivity, inclined for easy reading with a minimum of parallax.

Complete details of this instrument and copies of an informative bulletin may be secured by writing the *Clippard Instrument Laboratory*, 2440 Chase Avenue, Cincinnati 23, Ohio.

## TABLE RECEIVER

*Hoffman Radio Corporation* has announced production of a new table model receiver, Model A 301, "Laguna."

Styled with ultra modern lines, this receiver is available in grained ma-

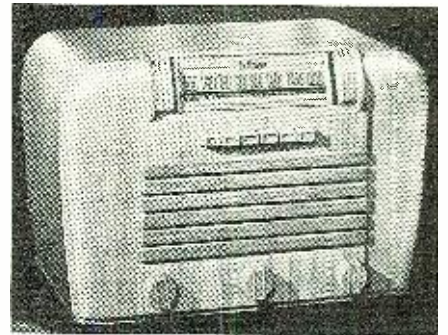

hogany, walnut or blonde wood. Push-button tuning is featured in addition to manual tuning on the fully illuminated slide rule dial.

A 6" oval electrodynamic dustproof speaker is concealed behind a wood grille. The receiver is a six tube, a.c. unit with tuned radio frequency amplifier, automatic volume control, variable tone control and built in loop antenna. The receiver is Underwriters listed.

*Hoffman Radio Corporation*, 3430 South Hill Street, Los Angeles 7, California, is the manufacturer.

## COMMUNICATIONS RECEIVER

A new communications receiver, the S-40, which will cover the frequency ranges from 550 kc. to 44 mc. has been announced by the *Hallcrafters Company* of Chicago.

This receiver which was designed by Raymond Loewy, incorporates several new features. The set contains all essential controls for communications work, in addition, a unique method of marking the controls for

(Continued on page 80)





# The Perfect Parallel Line Lead-in Wire



SPOOL SIZE 10 1/2" x 6"

Amphenol Twin-Lead is a new type of radio frequency transmission line which combines the low cost of an open line with the excellent dielectric qualities of Polyethylene as a continuous spacer and insulator for the line. It is light and flexible—it can be tacked to a wall and is easy to lead in under a window sash. Its resistance to moisture, cold and heat is far superior to the usual rubber insulated, woven-braid-covered twisted pair used for antennas prior to the war.

Twin-Lead is made in three impedances that serve numerous applications. Selection of type is a simple matter. The 300 ohm line is the most universal in use, particularly for FM and Television reception. Amateurs are using this line for both antenna and lead-in. The 150 ohm type is excellent for antennas used mostly for short-wave broadcast reception, and is useful as a link between stages of a transmitter. The 75 ohm line, originally designed for amateurs who operate in narrow bands of frequency, is also many times better for broadcast reception than the conventional rubber covered or cotton covered wire generally used.

It is to be emphasized that Amphenol Twin-Lead should not be thought of as exclusively for use at ultra-high frequencies. It is THE antenna lead-in for all frequencies.

**AMERICAN PHENOLIC CORPORATION**  
CHICAGO 50, ILLINOIS  
In Canada • Amphenol Limited • Toronto

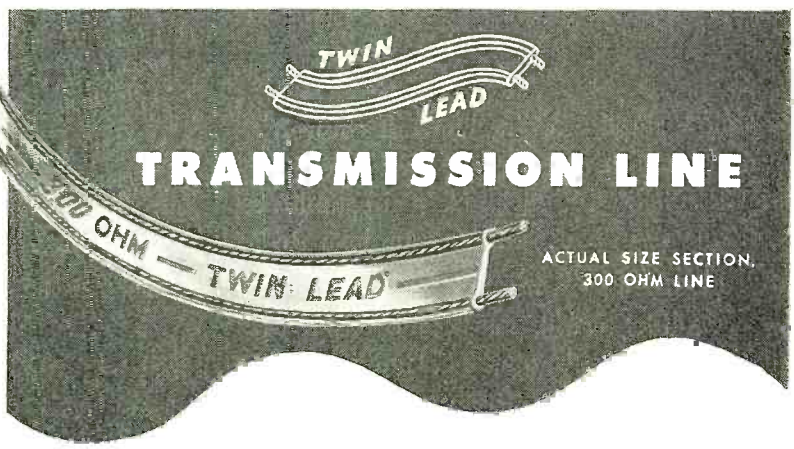

### ELECTRICAL DATA

**300-ohm** Amphenol "Twin-Lead" Transmission Line is available in 300-ohm impedance value. RMA standardized on 300-ohm lead-in line for Television as the most efficient over broadband operation.

**150-ohm** Amphenol also supplies 150-ohm twin-lead to those interested in particular applications and experimental work.

**75-ohm** Designed especially for amateurs who operate in very narrow bands of frequency or one particular frequency. Ideal for dipoles with a nominal impedance of 72 ohms at

the frequency for which they are cut. This line is also excellent for broadcast reception.

Dielectric constant of Polyethylene—2.29. Capacities (mmf per ft.): "300"—5.8; "150"—10; "75"—19.

Velocity of propagation (approximately): "300"—82%; "150"—77%; "75"—69%.

Power factor of Polyethylene—up to 1000 Mc—.0003 to .00045.

### ATTENUATION—FM AND TELEVISION BAND

Megacycles	300-ohm DB per 100 Ft.	150-ohm DB per 100 Ft.	75-ohm DB per 100 Ft.
25	0.77	0.9	1.7
30	0.88	1.03	2.0
40	1.1	1.3	2.5
60	1.45	1.8	3.4
80	1.8	2.25	4.3
100	2.1	2.7	5.0
200	3.6	4.7	8.3



COAXIAL CABLES AND CONNECTORS • INDUSTRIAL CONNECTORS, FITTINGS AND CONDUIT • ANTENNAS RADIO COMPONENTS • PLASTICS FOR ELECTRONICS

# Additional Notes on....

## R.F.-I.F.-A.F. SIGNAL TRACER

Original Article Published January 1946 Issue RADIO NEWS

By VINCENT CAVALERI

*As described herein, the placement of parts are an important factor in the construction of equipment.*

IN THE construction of any piece of equipment, from model airplanes to motor scooters, there are certain techniques which must be mastered and followed rigorously if the constructor wishes to have the completed project operate correctly and smoothly. The building of high frequency equipment is no exception to this rule, in fact, even greater care in "following the rules" must be taken if satisfactory results are to be secured.

The most persistent bug in any high gain amplifier is feedback. Another bug is hum pick-up. Feedback may occur at an audio rate and be audible; but it may also be above the audio range and not be heard. Bear in mind that the plate circuit of a high gain tube will radiate a signal very readily. If, in any way, that radiated field reaches its own grid again, it will be amplified over again which in turn increases the strength of the radiated field or signal. That in turn reaches the grid again stronger than before. This process increases in proportion, to the point where the signal now is self-sustaining and continues on indefinitely as a squeal, or perhaps cannot be heard by the human ear if it is of very high frequency. This phenomenon is called oscillation. Feedback may not necessarily occur in the same tube circuit. The output of one tube may feed into another tube where the plate leads will radiate a still

stronger signal and thus increase the possibility of feedback. When three tubes are used, the output of the third tube is tremendous and the amplifier becomes critical. You can readily see now that the plate circuit of the power

the center tap of the volume control. Lay the 50  $\mu$ fd. condenser  $C_2$  flat against the wall of the chassis just above the volume control. Make the condenser lead as short as possible to the volume control. Shield the other end. In one case, condenser  $C_2$ , .00025  $\mu$ fd. mica, caused feedback. It was placed near the grid of the 6SQ7 tube. Since it connects from the plate of the 6J5 tube it radiated a signal back to the grid of the 6SQ7. Altering its position stopped the squeal.  $C_2$  should be pointed away from the grid. The pictorial diagram illustrates how to place parts and leads. The keyways

EDITOR'S NOTE: Many readers who have constructed the r.f.-i.f.-a.f. signal tracer described in the January, 1946, issue of RADIO NEWS have written to us, and to the author, advising that they have experienced difficulty in obtaining proper performance from the final unit. The author, an instructor in testing and trouble shooting procedures, sensing that the difficulties could be attributed to an unfamiliarity on the part of the constructor with the oddities of high gain circuits, placement of parts, feedback, etc., instructed a group of his students to build this test unit from the instructions given in the original article. The results were similar to those indicated in many of the letters received from our readers. In general, the majority of these units built did not perform satisfactorily. Each unit presented a definite trouble shooting problem, and in the final analysis, it was found that if the constructor observed all of the techniques required for construction of equipment at r.f. frequencies, he would not experience difficulty in the operation of the final product. There are no errors in the diagrams or instructions which appeared in the original article. This article was prepared by the author in an attempt to point out possible errors which may have been committed by home constructors. He has included pictorial diagrams which some of the readers requested. By following these pictorials, the proper arrangements of parts can be visualized, thus resulting in shorter leads in critical circuits, which in turn will provide better performance.

tube can radiate an extremely strong field or signal that may reach the input leads of the 6SQ7 tube. Careful placement of parts and leads is therefore necessary. What has happened in many cases, is that the "magic eye" would close as the volume control was advanced, even though no signal was applied. This indicates that feedback or oscillation is occurring whether a squeal is heard or not. In some cases it was found that the plate lead of the 6V6 power tube was brought up in front of the chassis too near the input jack. Changing the lead to more remote position cured the trouble. On other tracers, unshielded or poorly shielded leads from the microphone jack to the volume control were found. Some of the students forget to shield the lead from the grid of the 6SQ7 to

on the sockets have been arranged to permit short leads. When using shielded wire, wind some bare wire around the ends of the shield and solder thoroughly. Then solder these ends to the chassis or convenient ground terminal.

In order to keep the hum level down, twist the filament leads and keep them away from all grids, especially the 6SQ7 grid and the input jacks. Hum is readily picked up by a high gain, high impedance grid circuit. When the volume control is advanced to maximum, the input resistance is rather high, therefore leads that have a.c. through them should be kept away.

In some cases the signal tracer would hum only when the cable was plugged in. A poor or defective cable or improper ground connection at the plug will cause hum. The construction of the cable and probe is illustrated. A good grade of microphone cable is used. The reason for the .00025  $\mu$ fd. condenser in the probe is to reduce the cable capacity and its shunting effect on a tuned circuit. The probe may be purchased or the builder may make one out of a half-inch dowel stick. Drill a hole through the probe large enough to admit the cable and the tiny tubular .00025  $\mu$ fd.

Detailed view of the construction of the probe assembly.

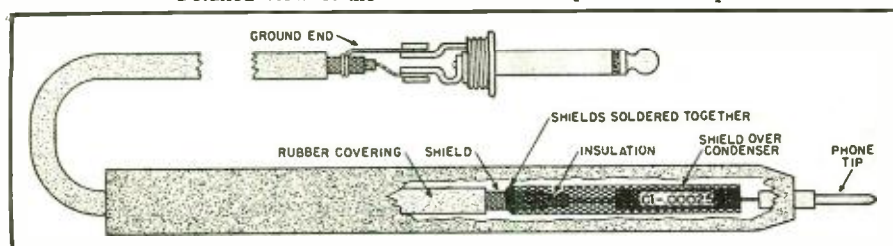

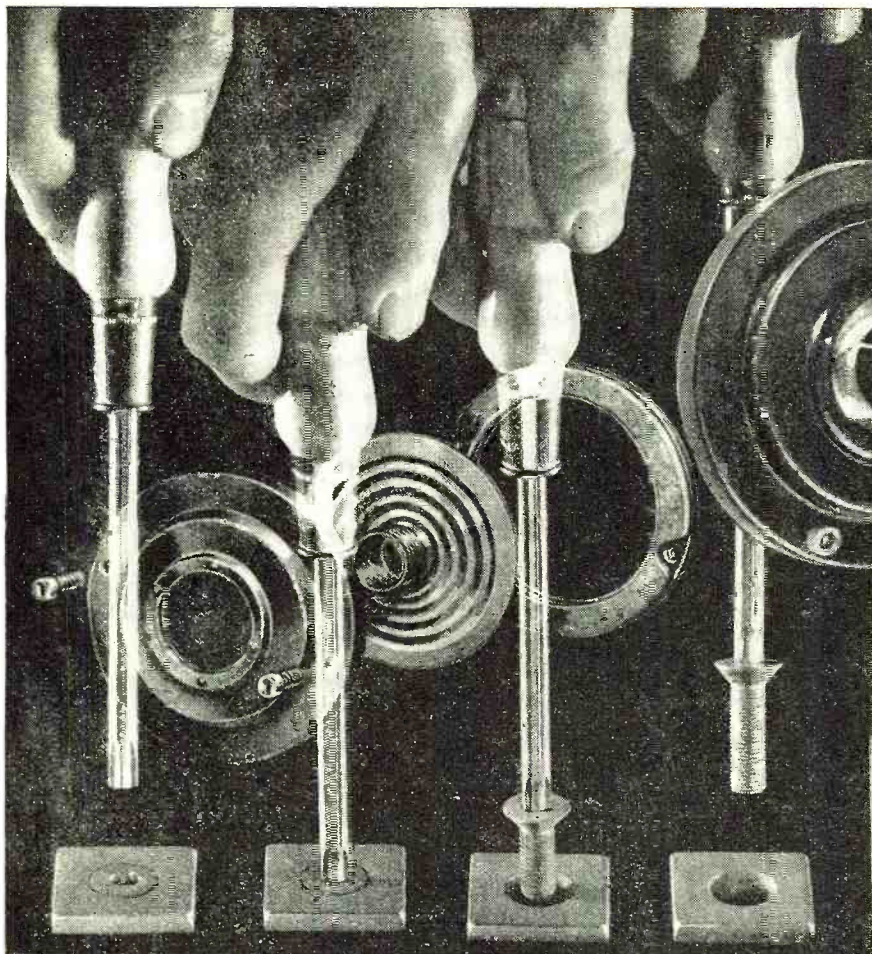

**Quam Reports:**  
**"20%  
 STEP-UP,  
 SLIPPAGE  
 ELIMINATED  
 AND  
 SERVICE  
 PROBLEMS  
 SIMPLIFIED"**

TYPE "A"  
ASSEMBLY BIT



## *The Clutch Head Pay-Off in Performance*

and lower cost is definite. Using this exclusive Lock-On feature for precision assembly of their "Adjust-A-Cone" Units, QUAM-NICHOLS CO., CHICAGO, record a 20% increase in assembly operation as well as the solution of two important problems. Damage from driver slippage went to zero and the simplicity of common screwdriver operation disposed of field service handicaps.

**THIS LOCK-ON**, available only with CLUTCH HEAD, is effected with a simple reverse turn of the Type "A" Bit in the head recess. This unites screw and bit as a unit for speedy, easy one-handed reaching to hard-to-get-at spots.

**IN "UN-BUTTONING" THE JOB TOO**, the reverse action automatically forms the Lock-On. Thus the Type "A" Hand Driver for field service withdraws the screw undamaged and safely held against dropping or loss for re-use. In many cases, this automatic Lock-On saves the dis-assembling of surrounding units.

*You may personally test this feature, and the many other exclusive CLUTCH HEAD advantages for faster, safer, smoother, and lower cost production. Ask us to mail you package assortment of CLUTCH HEAD Screws, sample Type "A" Bit, and illustrated Brochure.*

This rugged Type "A" Bit is important to tool economy. It delivers longer uninterrupted service and its original efficiency may be repeatedly restored by a 60-second application of the end surface to a grinding wheel.



Check the perfect operation of this screw with an ordinary type screwdriver or any flat blade, reasonably accurate in width. This is an exclusive feature that contributes importantly to emergency service in the field.

COMMON  
SCREWDRIVER



**UNITED SCREW AND BOLT CORPORATION**

CLEVELAND 2

CHICAGO 8

NEW YORK 7

# It's SOUND ADVICE to Consult MURDOCK



## Headphones Engineered to YOUR Requirements

Hearing efficiency is increased when MURDOCK Headphones are on the job. Their "hear-ability" has been demonstrated through two wars.

The widespread preference for them is a tribute to MURDOCK'S 42 years' insistence on highest quality standards . . . the same quality "yardstick" that William Murdock applied to his first radio phones which he patiently put together by hand 'way back in 1904.

On special or difficult assignments MURDOCK engineers can create Headphones to meet your particular needs. For finest listening performance, be sure to consult MURDOCK!

Write for Catalog

### JOBBERS!

MURDOCK Headphones are again available in greater quantities. Write us today for full details.

**WM. J. MURDOCK CO.**  
204 Carter St., Chelsea 50, Mass.

condenser. Drill this hole up to about a half-inch from the end. Drill a hole in the end for a phone tip. Solder the cable conductor to the condenser lead. Cut the shield back about a quarter-inch from the conductor so that the shield will not short to the conductor. Wrap a little tape around the conductor. Now slide a piece of shielding about an inch and a half long over the condenser till it reaches around the cable shield. Solder the shields together. This is done to prevent hum pick-up from your hand when you use the probe for testing. Slide the cable and condenser into the probe as far as they will go. Cut off the end of the condenser lead just long enough to solder into the phone tip sleeve. Put a little speaker cement in the end of the probe and force the phone tip into place. This completes the probe assembly. You can wedge a piece of rubber tape in the back end of the probe to help hold the cable tightly in place. If the probe is purchased, try to get one that is oversize. There is a type made that measures  $\frac{7}{16}$ " in diameter.

In answer to the queries about the various components; power trans-

formers with 350-0-350 v. secondaries are also suitable. The voltages will be somewhat higher. If the 6 volt heater windings do not have a center tap, ground one side of the filaments. If a six inch speaker cannot be obtained, a five inch speaker will do. The importance of using high quality parts cannot be overemphasized. No matter how perfectly the instrument is made, if there is one single defective part, it certainly won't work properly. Condensers and tubes are the greatest sources of trouble, even though they are brand new.

The voltages tested from chassis with a 1000 ohm-per-volt meter are approximately:

6SQ7 plate, 60 volts; 6J5 plate, 140 volts; 6J5 cathode, 4 volts; 6V6 plate, 240 volts; 6V6 screen, 250 volts; 6V6 cathode, 12½ volts. 5Y3 filament terminal #8, 300 volts (d.c.).

A gassy 6V6 will show a slight positive grid voltage and will cause hum and distortion, even though it may test "good" in a tube tester.

In testing radios with loop antennas, attach an aerial with a 60  $\mu\mu\text{fd}$ . condenser to the high side of the loop,

Pictorial diagram of the r.f.-i.f.-a.f. signal tracer, showing proper placement of parts.

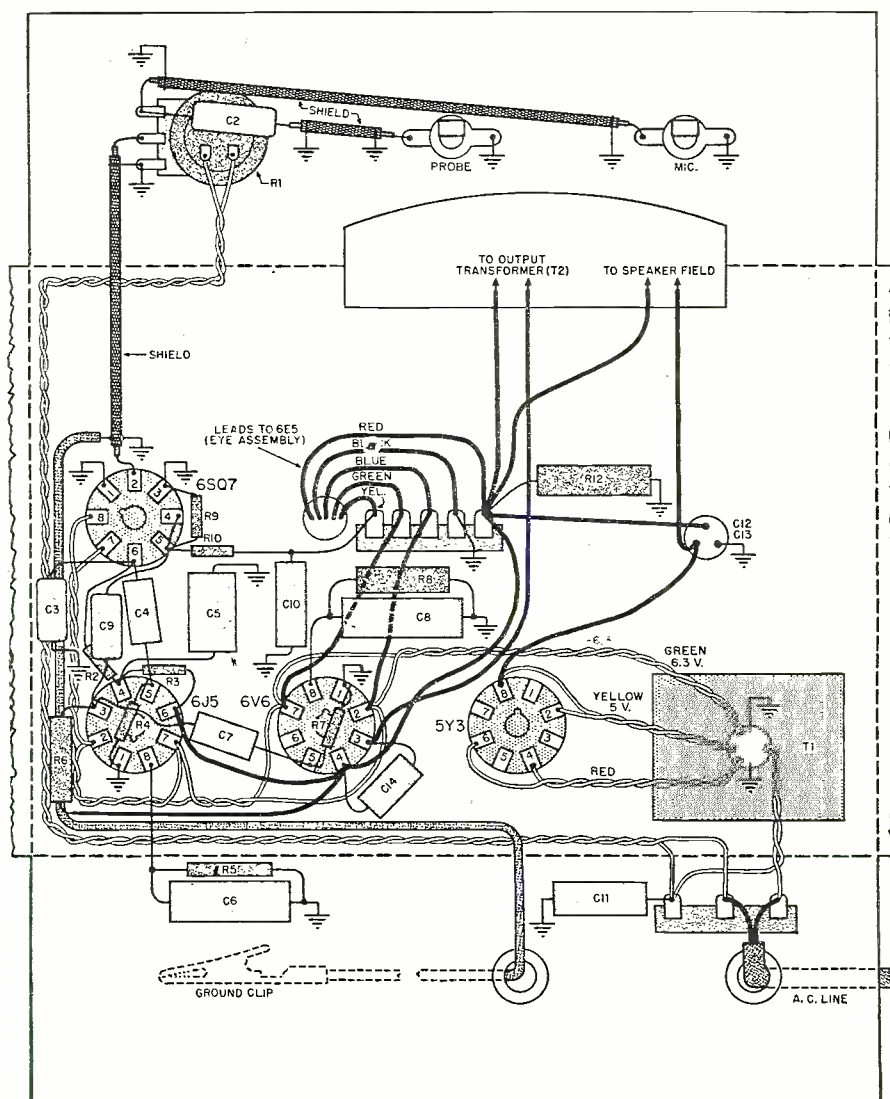

# Specified

BY AMERICA'S MOST CRITICAL SERVICE ENGINEERS



## TYPE BT INSULATED Metallized RESISTORS

## TYPE BW INSULATED Wire Wound RESISTORS

... the perfect combination for speedy, dependable servicing!

Almost any piece of carbon is a "resistor". But a really good resistor, scientifically designed to meet every requirement of exacting radio and other electronic servicing, is something else again. For example, users of the famous Type BT have found that IRC's exclusive Metallized filament-type construction is a far cry from ordinary resistors. Since the beginning of Radio, this unique design principle has made possible far greater stability, more rugged construction and complete dependability in a very compact, low-cost unit.

Now, two new BT types, the BTS and BTA, are available. Designed to meet all the exacting requirements of modern servicing, they are conservatively rated at 1/2 watt and 1 watt, respectively, and incorporate all the excellent characteristics of older, larger types in a much smaller, more convenient size.

For greater stability and all-around efficiency in the lower ranges, the IRC Type BW Insulated Wire Wounds are recommended. A stock of these units and the Type BT in assorted ranges and wattages give you the ideal combination to solve almost any servicing problem... quickly and profitably.

### The Resistor You Need . . . When You Need It!

Your local IRC Distributor now has quite complete stocks of BT's and BW's, in standard RMA ranges, ready for you. You'll find him a dependable source (and a very cooperative guy) for all of the IRC products shown on this page. He'll also be glad to give you your copy of IRC Service Catalog #50.

FOR BETTER-THAN-STANDARD QUALITY

Standardize on



## INTERNATIONAL RESISTANCE CO.

Dept. 20-D, 401 N. Broad Street, Phila. 8, Pa.

Makers of more types of resistance units, in more shapes, for more applications, than any other manufacturer in the world.

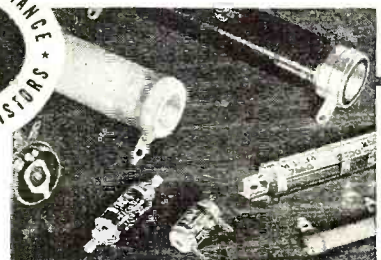
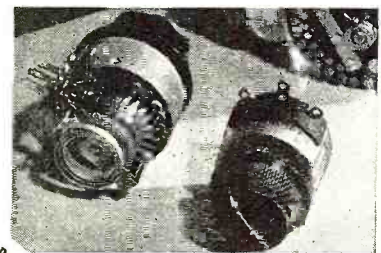
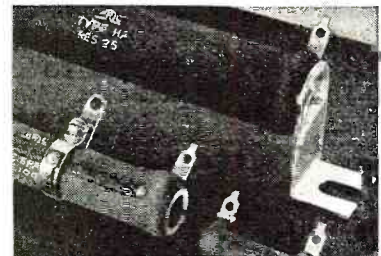
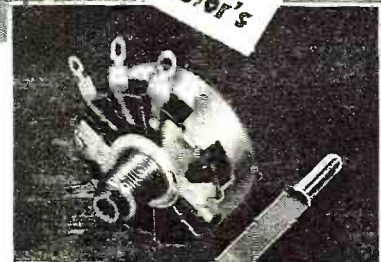

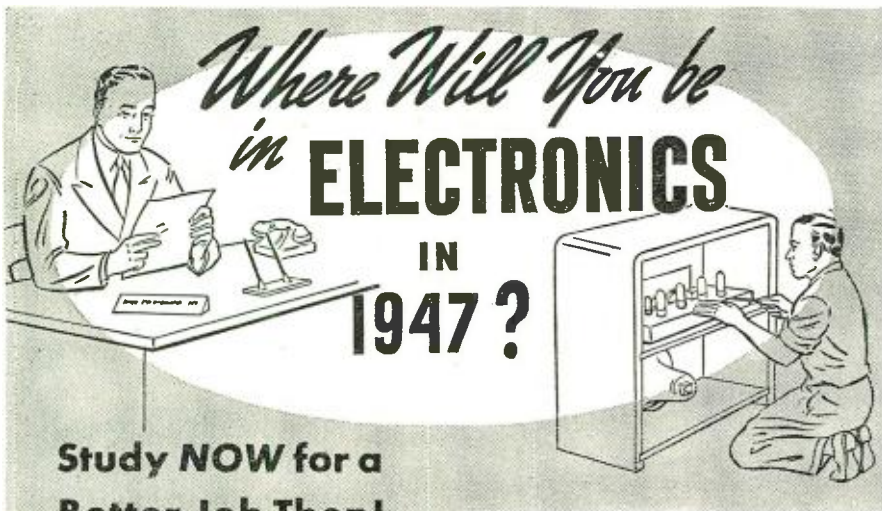

**Study NOW for a Better Job Then!**

THIS NEW WORLD OF ELECTRONICS is moving at a rapid pace. War born developments equivalent to twenty years of research are here. Still newer techniques are coming out with surprising speed. Have you the basic technical knowledge to keep pace with these developments?

MORE THAN EVER BEFORE, a sound basic knowledge of up-to-date, fundamental engineering of radio-electronics is an essential to a better job—promotion—increase in pay.

THESE NEW TECHNIQUES MEAN BRAND NEW JOBS in brand new fields! But they demand men who have knowledge and training—men who know the WHY as well as the HOW. Regardless of your past practical experience, the future demands that you must now acquire a solid foundation of theory if you expect to forge ahead in this new world of electronics.

IT COSTS YOU NOTHING TO INVESTIGATE—The coupon on a postcard will bring full information of the CIRE plan of personalized instructional aids and coaching service, with qualified competent instructors, and systematic, progressively arranged study assignments in recognized, approved texts—these are only a few of the many superior advantages of CIRE's plan of spare-time home study training for professional self-improvement.

**CIRE HOME STUDY COURSES COVER THE FIELD OF RADIO-ELECTRONICS—TELEVISION, ULTRA-HIGH FREQUENCY TECHNIQUES, AM AND FM BROADCASTING, COMMUNICATIONS ENGINEERING—**from simple treatment of fundamentals, through preparation for FCC commercial radio operators' license examinations, up to and including complete high level quantitative treatment of advanced radio-electronics and communications engineering. **Choose the course best suited to your needs, and start with the section you are qualified to enter. You pay for only the section or sections you need. Use the "Pay-as-you-go plan" patterned after ethical, educational practice. These features are unique with Cleveland Institute, and represent the best in the modern, post-war concept of home study training.**

Many CIRE students of advanced engineering courses today are broadcast chief engineers. Graduates of CIRE courses are eligible for the top jobs in radio-electronics.



Write today for free, descriptive booklet—**"THIS NEW WORLD OF ELECTRONICS HOLDS OPPORTUNITY FOR YOU."**  
No obligation—no salesmen.

**CLEVELAND INSTITUTE OF RADIO ELECTRONICS**

Contractors to the Canadian Broadcasting Corporation

Successors to

**NILSON RADIO SCHOOL,**  
Founded 1939

**SMITH PRACTICAL RADIO INSTITUTE,**  
Founded 1934

**RN-4 TERMINAL TOWER, CLEVELAND 13, OHIO**

(Mail this Coupon)

Cleveland Institute of Radio Electronics, RN-4 Terminal Tower, Cleveland 13, Ohio.  
Gentlemen: Please send information about your home study courses in Radio Electronics.

NAME .....  
ADDRESS .....  
CITY .....  
ZONE..... STATE.....

I desire training in.....  
I have had experience in broadcasting  servicing   
operating  mfg.  CAA  Army-Navy   
amateur  other..... I am a  
High School Grad.  College  I hold a.....  
degree in.....

unless an aerial connection is provided. This will increase the signal strength, so that it may be easily traced. In testing a.c.-d.c. receivers with a floating ground, strong hum may be experienced if the ground clip of the tracer is attached to the receiver chassis. Instead, connect the ground clip to the negative end of the filter condensers of the receiver. This connection is usually accessible at the "on-off" switch terminals. Make sure that no external ground is used on a.c.-d.c. sets.

Strict adherence to the points mentioned in this article will result in a smoothly operating signal tracer.

-30-

**International Short-Wave**

(Continued from page 45)

Cabuga No. 394, Recife, Pernambuco, Brazil. (While the Director-Presidente did not state that PRA-8 sends verifications, Swedish listeners report receipt of them from this station.)  
\* \* \*

**LRI RADIO EL MUNDO**

From the Manager, LRI Radio El Mundo, Buenos Aires, Argentina, comes this data:

Radio El Mundo is owned and operated by Editorial Haynes Ltd., publishers of "El Mundo" (illustrated daily), "El Hogar" and "Mundo Argentino" (weeklies), "Selecta" (fortnightly) fashion magazine.

Broadcasting hours are generally from 0730 to 2400 daily, Argentine Time. (Argentine Standard Time is 1 hour ahead of EST and Argentine Clock Time is 2 hours ahead of EST; it is believed these schedules were given in Standard Time, or 1 hour ahead of EST.)

The following wavelengths and hours (EST) are in force:

LR1, 1,070 kcs. (280.4 m.), 50 kw., 6:30 a.m.-11 p.m.

LRX, 9,660 (31.06 m.), 6 kw., 6:30 a.m.-11 p.m.

LRX1. 6.120 (49.00 m.), 6 kw., 10:45 a.m.-9:05 p.m.

"All broadcasts are in Spanish and the three wavelengths customarily broadcast the same station program. Occasional station identification is given in English; otherwise, all broadcasts are exclusively in Spanish. When relays are made from abroad, translations into Spanish of whatever material was broadcast follow immediately after the foreign language version. No foreign language newscasts are included in our program. Listeners in the United States and Canada, however, may be interested in programs of Argentine music, which are included throughout the daily broadcasts. Verification is sent to overseas listeners whether or not an International Reply Coupon is received."

Radio El Mundo's studios are located at Calle Maipu 555, Buenos Aires, Argentine Republic; the transmitting station is located at San Fer-

# COLLINS

# FM

Collins FM research, begun long before the war, went into high gear immediately following VJ day. An intensive engineering program is developing a series of FM transmitters to cover the power range of 250 watts to 50,000 watts.

These transmitters will be available, beginning with the 250 watt type 731A in midyear, 1946, and the 1000 watt type 732A soon thereafter. 3, 10, 25, and 50 kw transmitters are scheduled to follow in rapid succession.

With typical Collins thoroughness, these FM transmitters are designed to specifications well within FCC and RMA requirements and recommendations.

Notable achievements in circuit design assure efficient and dependable operation. Power output can be increased as desired, with a minimum of changes. The styling is attractively modern, and will blend well with up-to-date station layout.

Collins is prepared to supply your FM transmitter and all accessories. Our engineering staff is available at all times for consultation, and will assist you in effecting early installation and operation. Write today.

## **Collins Radio Company**

**Cedar Rapids, Iowa**

11 West 42nd Street      New York 18, N. Y.

**FOR BROADCAST QUALITY, IT'S . . . .**



# HENRY RADIO

Do business with the biggest and one of the best in the field. Enter your reservations for the following:

Skyrider Jr. S41 .....	\$ 33.50
Hallicrafters S22R .....	74.50
Hallicrafters S39 .....	110.00
Hallicrafters SX-25 .....	94.50
Hallicrafters SX-28A .....	223.00
Hallicrafters S36A .....	415.00
Hallicrafters S37 .....	591.75
Hallicrafters S40 .....	79.50
National N-2-40C .....	225.00
National One-Ten .....	56.10
National HRO Sr .....	197.70
RME-45 .....	166.00
Hammarlund HQ129X .....	129.00
Hammarlund Super Pro .....	318.00
HT-9 transmitter .....	225.00
HT-6 transmitter .....	110.00
HT4E BC-610 transmitter .....	695.00

Some models are available for immediate shipment.

AS MORE and more receivers become available Bob Henry will be able to serve you better and better. By dealing with the world's largest distributor of short wave receivers you are assured of the fastest delivery possible and the best of service.

Enter your reservation now. You can trade in your present receiver. You can order on our 6% terms. You can depend on Bob Henry also for a wide assortment and the best values in crystals, transmitting tubes, microphones, test equipment etc. Your inquiries welcomed.

BOB HENRY  
W9ARA

## HENRY RADIO

BUTLER, MISSOURI AND  
LOS ANGELES 25, CALIF.

"WORLD'S LARGEST DISTRIBUTORS  
OF SHORT WAVE RECEIVERS"

nando, F.C.C.A., just outside the city of Buenos Aires.

\* \* \*

### MADAGASCAR SCHEDULES

By airmail we have received the following schedules of Tananarive, Madagascar, as sent by Lars Kalderen, Sweden:

4.300—0.3 kw., 10-11 a.m.; 6.130—1.2 kw., 11:30 p.m.-12:30 a.m.; 3:30-5 a.m., and 10-11 a.m.; 9.693—0.3 kw., 11:30 p.m.-12:30 a.m. and 3:30-5 a.m.; 12.126—5 kw., 6-9 a.m.

\* \* \*

### HVJ, VATICAN CITY

Also from Lars Kalderen, Sweden, come latest schedules of HVJ, "Citta del Vaticano," Vatican City:

Daily—1:15 p.m., English, 9.660; 2 p.m., French, 9.660; 2:30 p.m., Italian, 5.969; 2:45 p.m., German, 5.969; and 3 p.m., Spanish, 5.969.

Tuesday and Friday—1:45 p.m., Polish, 9.660.

Tuesday—10 a.m., English, 17.445.

Thursday—1:45 p.m., Dutch, 9.660.

Saturday—1:45 p.m., Lithuanian, 9.660. (Other than Thursdays and Saturdays, at 1:45 p.m., Polish is heard on 9.660.)

Sunday—5:30 a.m., Holy Mass, 9.660 and 15.100.

On 17.445, HVJ is reported heard usually on Mondays and Saturdays, 8:15-9:40 a.m., in English to South Africa.

\* \* \*

### SUNSPOT ACTIVITY

Two large sunspots on the Eastern Limb of the sun (visible easily through dark smoked glasses or densely-fogged camera film negatives) caused bad to nil s.w. reception during the early part of February. (They produced an Aurora-Borealis at night.) This situation should have cleared up by this time and short-wave reception from most areas will be improving. There will be many seasonal changes right along now as to frequencies, time, and so on. The 25-meter band, which had been practically "dead" during the winter in many sections of the United States, is already opening up well again.

\* \* \*

### NEW

OLR3A, 9.550, Prague, Czechoslovakia, has inaugurated a broadcast to North America, daily, 8-8:30 p.m.; signals are poor and generally fade out. (May announce this transmission as "tests.")

OIX3, 11.780, Lahti, Finland, is back on the air, but so far has been reported heard only at 7:15 in the morning news in English for North America; reception is poor; in the same transmission, OIX2, 9.503, is heard fair to good.

An airmail letter received from Lars Kalderen, Sweden, lists a new station in Athens, Greece, on 7.295, heard testing with records between 4-5 p.m., with Greek and English announcements. He understood call as XBG2 (?). This station has not yet been reported in America.

OZF, 9.52, Skamleback, Denmark,

has been heard since December 12 in Danish, 12:35-5 p.m.; 6 kw. (Kalderen)

A new Oslo, Norway, transmitter on approximately 6.200 has been heard at 7:30 a.m. relaying BCB programs. (Kalderen)

Radio Audizioni Italia, 6.030, Rome, Italy, is being heard 1:30-6 p.m. in Italian. (Kalderen)

PHI, 17.775, a pre-war Dutch allocation, located at Huizen, Netherlands, is back on the air relaying PCJ's morning (15.220) transmission, 8-9:30 a.m. only; signal strength is good in East, but there is severe interference from Leopoldville, Belgian Congo, 17.770.

The Bern, Switzerland, transmission to Australia, 3-4:30 a.m., now uses a new frequency of 14.462, replacing 14.538; reception is poor; English is used on Tuesday, Swiss languages on Saturday (no transmission other days).

Several new frequencies allocated to the Geneva transmitters are HBQ2, 6.945; HBY, 7.696; HBX, 9.225; HBW, 11.465; HBJ2, 13.205; and HBV, 18.950; none are in current use. This information was recently received direct from Bern. (I am reliably informed, however, that HBY, HBX, HBW, and HBV are licensed for "A2 emission) (modulated radio telegraphy) only, so they will probably never be used for international short-wave unless licenses are altered.)

The new VLH transmitter at Melbourne, Australia, is now on the air, and the VLR schedule was adjusted late in January to accommodate the extension of facilities. VLR now relays the National Programs only, while VLH carries the Alternate Programs. The only exception to this is 1:30-3:30 a.m. on VLH4 when the National Program is relayed. The new ABC Home Service schedule is daily on VLR2, 6.150, 2:30-8:30 a.m. and 3-4:10 p.m.; VLR, 9.540 (changed from 9.580), 4:20-7 p.m. and 8:45 p.m.-2:20 a.m.; Saturday exceptions, 3:45 p.m. sign-on and 5:30 p.m. sign-off for VLR2, and VLR signs on at 6:30 p.m.; Sunday exceptions, VLR signs off at 3:30 a.m. and re-opens at 3:58 a.m. Schedule of the new VLH transmitter is: VLH5, 15.240, 7 p.m.-1 a.m.; VLH4, 11.880, 1:30-3:30 a.m.; and VLH3, 9.580, 3:45-8:30 a.m.; Saturday exceptions, VLH4 at 3:45-5:30 p.m. and VLH5 at 6-12 midnight; Sunday exceptions, VLH4 at 12:15-3 a.m. and VLH3 at 3:15-8:30 a.m.

From Hawaii it is reported that a Dutch-operated station on 9.360, located at Makassar, Celebes, transmits daily at 6:05-8 a.m., but some days opens earlier and signs off later.

Another Hawaiian report lists WXLJ, 5.510, as operated by the Signal Corps at Shanghai Racetrack, with studios in the British Cricket Club; heard with recordings to 6:50 a.m. and point-to-point with JVT, 6.750, Tokyo.

The new Chinese station on 6.230/6.235 (reported some weeks ago by Dilg) announces frequency as 12.2 (which is XLPAs channel) so may have been relaying XLPAs when the



# SILVER

# "VOMAX"

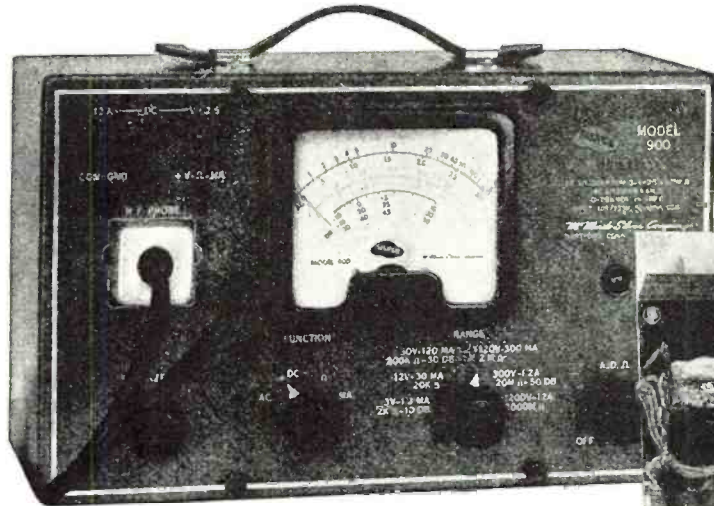

Of construction and quality unmatched by meters selling at far higher prices . . . giving performance exceeding that of three separate instruments costing nearly four times its price . . . it is no wonder we are told that "VOMAX" is today the standard of comparison.

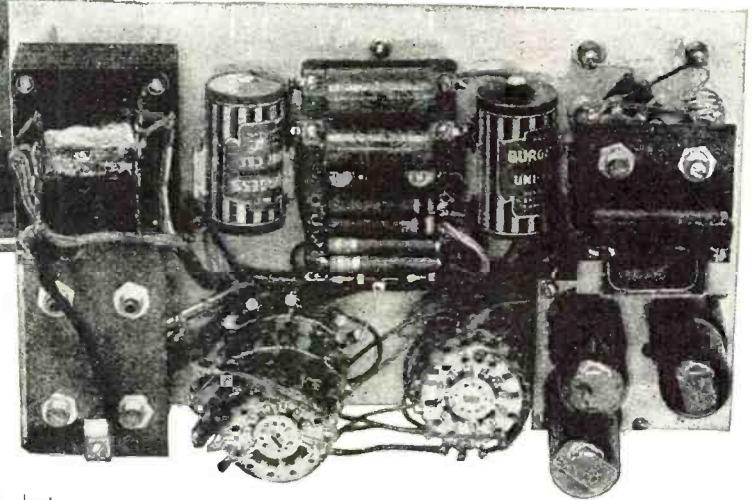

"VOMAX" is new . . . different . . . and outstandingly superior . . . because it is a brand new post-war v.t.v.m. . . . and truly universal. With "VOMAX" you can measure every voltage required in radio servicing . . . even in the design laboratory. Not only does it enable you to measure d.c. and a.c. voltage at meter resistance so high as not to affect the circuit being measured, but "VOMAX" at last lets you measure a.f. and r.f. voltages from 20 cycles to over 100 megacycles . . . resistance from .2 ohms through 2,000 megohms is "duck soup" with "VOMAX" . . . as is direct current from 50 microamperes through 12 amperes.

Add to all this new visual dynamic signal tracing . . . direct measurement of every voltage from receiver antenna to speaker voice coil . . . and you know why many government departments, serious industrial, radio engineering, university research laboratories . . . and service technicians by the thousands clamor for "VOMAX".

"VOMAX" makes you the master, no longer the victim, of tough service problems. Your favorite jobber . . . among nearly 500 progressive SILVER distributors all over the country . . . can give you prompt delivery from his regular monthly allotment . . . if you order now . . . for only

**\$59.85 net**

**ADVANCE ANNOUNCEMENT**—Model 904 Capacitance—Resistance Bridge will go into production in April. With  $\pm 3\%$  accuracy over the tremendous range of a fraction of one mfd/ohms through One Thousand mfd/megohms. Model 904 at last gives the serious service technician laboratory accuracy and range—in the new, postwar instrument matching "VOMAX" for only \$49.90.

OVER 35 YEARS OF RADIO ENGINEERING ACHIEVEMENT

*McMurdo Silver Company*

1240 MAIN STREET, HARTFORD 3, CONNECTICUT

April, 1946

## Measures EVERY Voltage

1. Brand new post-war design . . . positively not a warmed-over pre-war model.
2. More than an "electronic" voltmeter, VOMAX is a true vacuum tube voltmeter in every voltage resistance d.c. function.
3. Complete visual signal tracing from 20 cycles through over 100 megacycles by withdrawable r.f. diode probe.
4. 3 through 300 volts d.c. full scale in 6 ranges at 51 and in 6 added ranges to 3000 volts at 120 megohms input resistance. Plus-minus polarity reversing switch.
5. 3 through 1200 volts a.c. full scale in 6 ranges at honest effective circuit loading of 6.6 megohms and 8 mmfd.
6. 0.2 through 2000 megohms in six easily read ranges.
7. - 10 through + 50 db. 20 db. = 1 mw. in 600 ohms) in 3 ranges.
8. 1.2 ma through 12 amperes full scale in 6 d.c. ranges.
9. Absolutely stable—one zero adjustment sets all ranges. No probe shorting to set a meaningless zero which shifts as soon as probes are separated. Grid current errors completely eliminated.
10. Honest factual accuracy  $\pm 3\%$  on d.c.,  $\pm 5\%$  on a.c., 2000 through 100 megacycles  $\pm 2\%$  of full scale,  $\pm 1\%$  of indicated resistance value.
11. Only five color-differentiated scales on 4" D'Arsonval meter for 51 ranges (including d.c. volts polarity reversal) eliminate confusion.
12. Meter 100% protected against overload burnout on volts ohms db.
13. Substantial leather carrying handle. Size only 12" x 7" x 5".

Send postcard for free catalog of measurement and communication equipment.

# LAKE'S

## RADIO CABINETS & PARTS

**NOW AVAILABLE!**  
**Postwar 2 Post RECORD-CHANGER**

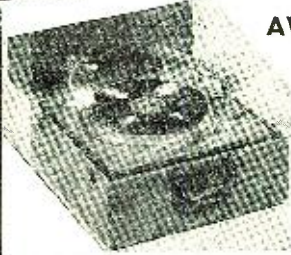

In luxurious brown leatherette portable case, 15" L. x 15" W. x 10"

D. Latest electronic developments make this modern record-changer the finest on the market today!

List price ..... \$49.95  
 Dealer's net ..... 29.97



**Deluxe PHONO CABINET**

Covered in luxurious, genuine, brown leatherette, has deluxe brass

hardware throughout, made completely of plywood with brown plastic handle, has padded top and bottom. Motor board 14" x 14 1/2". Overall dimensions 16" L x 15" W x 8" H. Your net price..... **\$8.95**



Portable Phono-graph case in brown leatherette covering inside dimensions 17 1/2" long 13" wide, 7 1/2" high. Has blank motor board and opening for speaker. As illustrated at left, specially priced at .....

**\$7.95**

Also blank table cabinets of walnut veneer in the following sizes, with speaker opening on left front side: (\*Note: \*7 has center speaker grill.)

*1	— 8 1/2"	L x 5 1/2"	H x 4"	D \$1.95
*2	— 10 1/4"	L x 6 3/8"	H x 5"	D \$2.75
*3	— 13 1/2"	L x 7 5/8"	H x 6 1/4"	D \$3.25
*7	— 10 3/4"	L x 7"	H x 5 1/2"	D \$2.50

\*Speaker Opening in center of front side.

All types of radio cabinets and parts are available at Lake's Lower prices. A large stock is listed in our catalog.



**SERVICEMEN—RETAILERS**  
 Join our customer list today.

Dept. A

Write for our NEW, 12 page, illustrated, elaborate catalog!  
 Order from Lake!  
 You'll make no mistake!

**Lake Radio Sales Co.**  
 615 W. Randolph Street  
 Chicago 6, Ill.

call XOPA was heard; Dilg was not certain that the second letter was "O." At other times, however, this station has been heard to announce in English as XNTS, Fifth War Zone. XNTS is supposed to be at Tsingtao and on 6.235, but since this city is remote from Changsha, it is doubtful that it would relay XLP A.

VUDS, 7.240, and VUD5, 7.290, Delhi, are reported opening a new European program at 10 a.m., runs to 10:30 a.m.

Singapore on 4.780 and relays now operate 5:30-10:30 a.m. without break and identify as the "Blue Network." According to announcement, a transmission at 9:30 p.m.-12:30 a.m. was added January 20. The Singapore transmitter on 7.180 (reported some weeks ago by Dilg) is not heard at present, but what may be the same transmitter is heard 5:30-10:30 a.m. on 7.215. This 7.215 transmitter is heard earlier also, at 3:20-4:30 a.m. in English and Dutch identifying as the Far Eastern Service. The 5:30 a.m. transmission is reported as mostly Malayan. The unidentified Malayan station on 6.090 has moved to about 6.180 (announced as 6.175) and closes its 5:30-10:30 a.m. transmission with separate announcement. Location may be Palembang, Sumatra, or similar sounding name in Malaya; it has been definitely established that this transmitter is *not* located at Penang.

Bangkok, 6.000, Siam, is reported from Hawaii with a weak signal to 8:45 a.m. sign-off with chimes.

In the East it is reported that international pelota matches—believed held in Buenos Aires, Argentina—were heard during the winter with running descriptions in Portuguese, irregularly

7:30-10 p.m. over LSM9, 9.980, LQA5, 10.350, LSA6, 10.367, and LSD8, 10.875, for Brazilian stations and networks, each with a different announcer. The same in Spanish for Paraguay (during Brazil-Paraguay match) was heard over LSC, 7.945. (According to Gutter and Johnson, Chicago, Brazilian stations carrying these special sports events included ZYB7, 6.095, Sao Paulo; PRE9, 6.105, Fortaleza; and PRL7, 9.72, Rio de Janeiro.

The new CE1190 transmitter in Chile uses 1 kw. and is located at Valparaiso, not Santiago, according to a verification letter received by a New Zealand correspondent.

St. Eustatius, Netherlands West Indies, is now on the air; first was on 11.900 identifying as "Statia" but now has moved to 9.045 with Saba and St. Martin for the daily contact with Curacao; all three are reported good on 9.045 after 8 a.m.

A new Moscow frequency of 9.045 is reported heard with press dictation to 1:58 a.m., resuming at 2:30 a.m.

KOFA, 7.215, Salzburg, Austria, is heard well now afternoons to 6 p.m. or later, relaying AFRS programs; English news from New York is carried at 6 p.m. Sometimes is badly QRM'd.

Teheran, 4.760, Iran, has English news at 10:45 a.m. (Kalderen)

CR7AU, 4.925, Lourenco Marques, Mozambique, is heard afternoons in Sweden. (Kalderen)

Nairobi, Kenya, 4.925, is heard 12 noon to 2 p.m. in English and relays BBC news at 1 p.m.

Direct from Sweden it is learned that the Swedish Broadcasting Corporation will soon inaugurate the use

## THE HIDDEN POWERS OF RADIO

BY MALCOLM HYATT

THE wonders of radio will never cease.

But according to Ed Franke, supervisor of WOR's transmitting station at Cartaret, New Jersey, there are greater and more astonishing wonders created by the electrical frequencies spawned by the station's 50,000 watt transmitter.

In the vicinity of the station is a small tributary which the radio men have dubbed "Casey's Creek." It seems that different kinds of music cause various electrical frequencies which are transmitted to "Casey's Creek" by the miles of underground wire. When a soprano manages to reach high 'C' the fish in the creek float belly-up. Apparently a soprano creates frequencies which gives the water a soporific quality. "The fish seem kind of paralyzed," says the baffled Ed. "They simply can't move! Just lie there till the soprano stops singing. Then they roll over sleepily and dive for the bottom."

Symphony music has a military effect on the creek's population, causing them to line up snappily as though they were about to execute a close order drill. "Of course, they don't really march," admits Ed, sheepishly.

Such manifestations of the magic of radio on mundane activities are part of Ed's daily routine. A realistic radio engineer, he nevertheless, is constantly amazed at radio's hidden powers. Recently a few home owners, living in the

vicinity of the station, complained that they heard the station every time their water faucets were turned on. It seems that the water picks up electrical energy as it flows from the faucet to the drain, creating "singing water." Then there was the farmer whose chicken-coop lights wouldn't turn off, resulting in greatly increased egg-production. The hens, thanks to the free current furnished by the radio transmitter, were put on a 24-hour shift.

What has really confounded Ed is what radio does for the grass on the station's 33-acre tract. Whatever it is, he opines, it is good, for neighboring farmers jump at the chance to graze their cows there. They claim their cows yield milk twice as rich as that produced by cattle grazing on other pastures.

One day last summer a man was found bathing his feet in one of the ponds on the transmitter property. They approached the trespasser who informed them that the water would be able to cure a bad case of athlete's foot. Upon investigation, it was found that the copper sulphate solution engineers dump into the pond is a recognized treatment for the ailment.

"Yes," says Ed, candidly, "we've got our problems, but there's more to radio than meets the ear. Who said life is dull around a radio transmitting station?"

-30-

# LIFE-EXTENSION BY THE GRAM

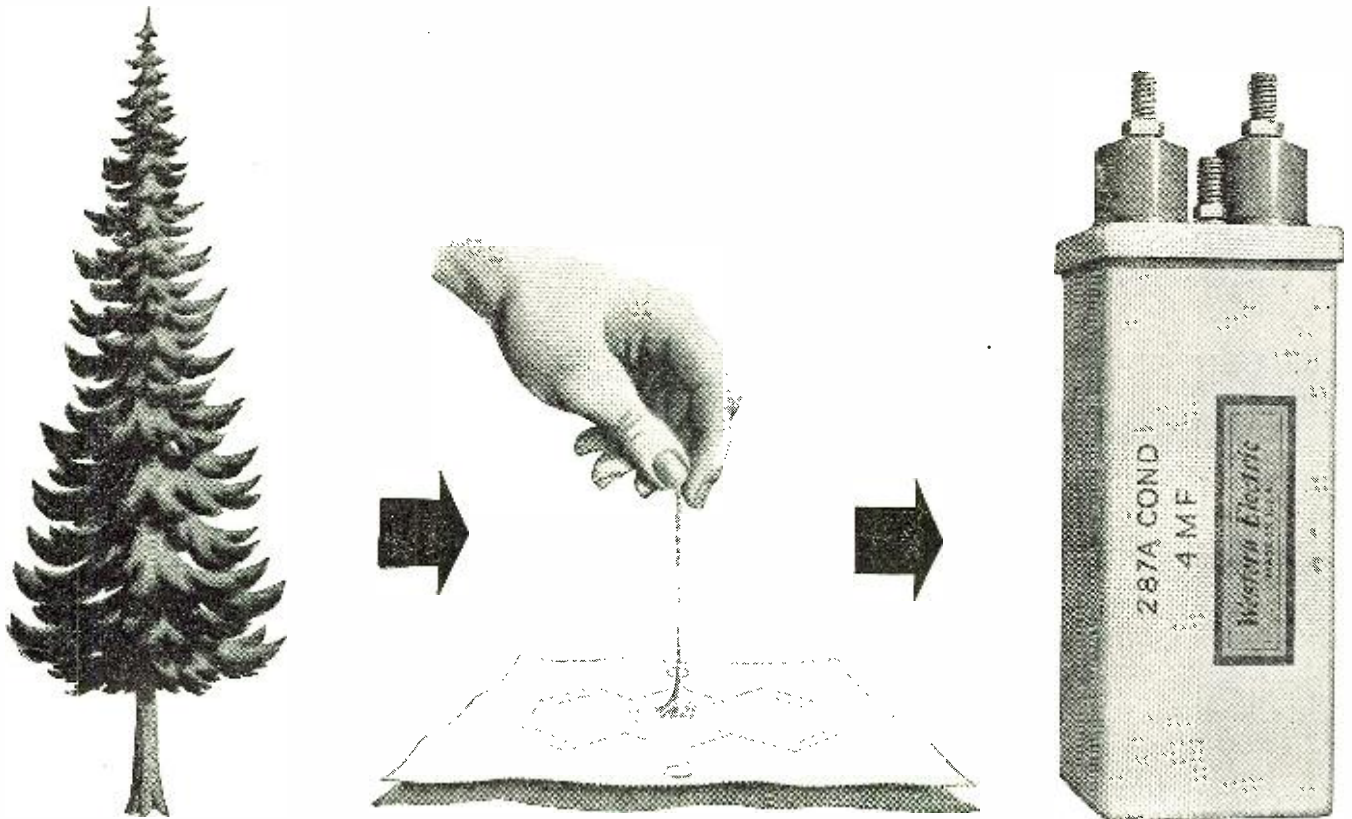

CRUCIAL links in every wire and radio system are paper capacitors — rolls of impregnated paper and metal foil. At least one is in every telephone — and more than 100 million are in the Bell System. A single failure can sever a telephone call, put a costly line out of service. So finding out how to make capacitors stand up longer is one of the big jobs of Bell Telephone Laboratories.

All-linen paper was once the pre-eminent material. Then wood pulp was tried — and found to last longer

under heat and direct voltage. But why? Something in the wood was helping to preserve life. What was it?

Ultra-violet light, delicate micro-chemical analysis and hundreds of electrical tests gave a clue. Researchers followed it up—found the answer by treating the impregnated paper with anthraquinone—a dye intermediate. A mere pinch of the stuff prolongs capacitor life by many precious years.

When war came, great quantities of capacitors were needed for military

equipment, where failures could cost lives, lose battles. The Western Electric Company, manufacturing for the Bell System, willingly disclosed the life-preserving treatment to other manufacturers. Today in communication capacitors, the new “life-extension” is helping to give more dependable telephone service.

Day by day, resources of this great industrial laboratory are being applied to perfect the thousands of components which make up the Bell System.



**BELL TELEPHONE LABORATORIES** EXPLORING AND INVENTING, DEVISING AND PERFECTING FOR CONTINUED IMPROVEMENTS AND ECONOMIES IN TELEPHONE SERVICE.

**QRG?**

**Crystalab**  
CALIBRATION SERVICE  
FOR HAMS

A SPECIAL SERVICE OF  
CRYSTAL RESEARCH LABORATORIES **60¢** per crystal

CRYSTAL RESEARCH LABORATORIES . . . C. R. L.  
Pack shipments carefully and insure . . . in transit to us.  
not responsible for damage.

Have your crystals checked for exact frequency at room temperature. Crystals are calibrated on representative "ham" equipment to  $\pm 5$  KC. Calibrating circuits are featured in Radio Amateur Handbook, Figures 403, 404, 406, 407, and 408 of the 1945 ARRL.

Further tests may be made to meet your special requirements. Upon inquiry, please state exact desired temperature. For further tests, prices will be quoted.

Mailing charges back to you are included.

Send money order or check  
— please do not send cash.

**Crystalab** ★ ★ ★

I am enclosing . . . Crystals for Calibration at room temperature.

Please Calibrate in circuit Figure No. \_\_\_\_\_

Name \_\_\_\_\_

Address \_\_\_\_\_

CITY \_\_\_\_\_ STATE \_\_\_\_\_

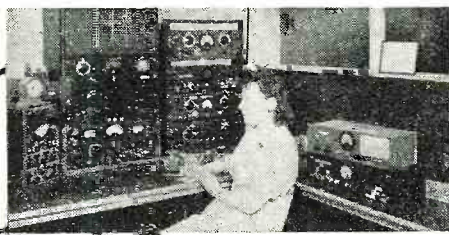

**CRYSTAL RESEARCH LABORATORIES INC.**

29 ALLYN ST., HARTFORD, 3, CONN., PHONE 7-3215

of QSL cards; address is Sveriges Radio, Stockholm, Sweden. (Want reports.)

Swedish listeners reporting Budapest, Hungary, on 3.400, say it may be a harmonic.

U. S. International Broadcasting is now conducted by the Office of International Information and Cultural Affairs of the State Department. KNBI, 6.060, San Francisco, has replaced KNBX and is scheduled 4-10 a.m. WOOW, 6.120, New York, is off the air. Present schedule of KCBA, 6.170, Delano, California, is 4-10 a.m. KNBA, 7.805, San Francisco, broadcasts 4-10 a.m. KNBA, 7.565, San Francisco, is off the air as is KCBA, 7.575, Delano. KNBX, 7.805, San Francisco, is off the air. KNBX, 9.490, San Francisco, verifies with a red, white, and blue card, present schedule is 5-6:45 a.m. and 7 a.m.-3:30 p.m. WCBN, 9.650, New York, is scheduled 5:45-7:30 a.m. and 1-4:45 p.m. WLWR1, 9.750, Cincinnati, WCBN, 11.145, New York, are off the air. KCBR, 11.770, Delano, is scheduled 10:15 p.m.-1 a.m., has vacated 13.050. KCBA, 11.770, Delano, is scheduled 1-4:45 and 5-7:30 p.m.

From C. E. Kelly, Deputy Director of Broadcasting, Dublin, Eire, we have this letter: "We cannot yet give you any details of short-wave transmission from Ireland. The new transmitter will not be erected and working for the better part of a year, if, indeed, so soon."

Confirmation has arrived from New Zealand of tests last autumn by two transmitters of the Post & Telegraph Department, Wellington, which beamed programs to North America, using 5,000 watts. ZLM5, 15.500, relayed 2YA, while ZLN4, 9.870, relayed 2YC during these tests. (The 2YA and 2YC calls are for BCB stations on 570 kcs., and 840 kcs. respectively, both located in Wellington.)

Incidentally, ZLT7, 6.715, is putting through a good signal daily, 4:30-4:45 a.m., when an English newscast and usually a sports summary are relayed from 1YA (650 kcs., 10 kw., Auckland) for the Forces. Lately, however, I have heard ZLT7 as early as 4:15 a.m. with classical music, preceding the 4:30 a.m. news period. Sign-off is rather abrupt, usually they say "ZLT7, operated by the Post & Telegraph Department, will cease transmission until 9:30 tomorrow evening." New Zealand stations operate on NZDST which is 1/2 hour ahead of New Zealand Standard Time, or 17 hours ahead of EST.

**CHANGES**

Paris to the United States and Canada in the daily North American Service, 8:55-10:45 p.m., is now heard regularly on 9.550; English program runs from 9-9:30 p.m., French repeat is at 9:30 p.m., French variety program comes at 10 p.m., and there is a repeat of the English news at 10:30 p.m. The parallel transmitter, 11.847, is generally inaudible at present due to seasonal conditions; should be heard better soon.

**FOR SAFETY'S SAKE**

Safety first for personnel is of the utmost importance. This protection can be guaranteed through the use of G-E Interlock Switches on radio transmitters, X-ray and therapeutic machines, burglar alarms, and signal controls for fire doors.

Safety first for equipment is important, too. G-E Indicator Lamps give visual evidence of what is going on inside equipment, and circuit troubles can be corrected before they become serious. Write: Electronics Department, General Electric Company, Syracuse, New York.

**GENERAL ELECTRIC**

# New!

## Series 200

# A RELAY BY GUARDIAN with Interchangeable Coils

### BUILT IN TWO PARTS

A.C. Coil Assemblies available for 6 v., 12 v., 24 v., 115 v.  
D.C. Coil Assemblies available for 6 v., 12 v., 24 v., 32 v., 110 v.

★ Two basic parts—a coil assembly and a contact assembly—comprise this simple, yet versatile relay. The coil assembly consists of the coil and field piece. The contact assembly consists of switch blades, armature, return spring, and mounting bracket. The coil and contact assembly are easily aligned by two locator pins on the back end of the contact assembly which fit into two holes on the coil assembly. They are then rigidly held together with the two screws and lock washers. Assembly takes only a few seconds and requires no adjustment on factory built units.

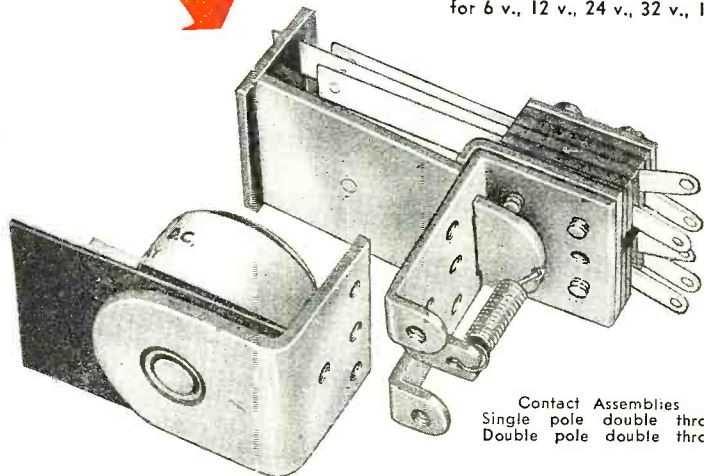

SERIES 200 RELAY

Contact Assemblies  
Single pole double throw  
Double pole double throw

## On Sale at Your Nearest Jobber NOW!

See it today! . . . this amazing new relay with interchangeable coils. See how you can operate it on any of nine different a-c or d-c voltages—simply by changing the coil. Ideal for experimenters, inventors, engineers.

### TWO CONTACT ASSEMBLIES

The Series 200 is available with a single pole double throw, or a double pole double throw contact assembly. In addition, a set of Series 200 Contact Switch Parts, which you can buy separately, enables you to build dozens of other combinations. Instructions in each box.

### NINE COIL ASSEMBLIES

Four a-c coils and five d-c coils are available. Interchangeability of coils enables you to operate the Series 200 relay on one voltage or current and change it over to operate on another type simply by changing coils.



Your jobber has this sensational new relay on sale now. Ask him about it. Or write for descriptive bulletin.

# GUARDIAN ELECTRIC

1630-D W. WALNUT STREET

CHICAGO 12, ILLINOIS

A COMPLETE LINE OF RELAYS SERVING AMERICAN INDUSTRY

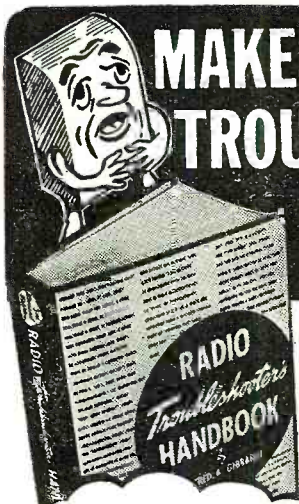

# MAKES 90 OUT OF 100 RADIO TROUBLES Easy to Repair!

Complete, Easy Instructions for Repairing Common Troubles in Practically Every Model and Make of Radio in Use Today

Eliminates Needless Testing—Enables You to Repair Two Radios in the Time Ordinarily Required for One

## PAYS FOR ITSELF ON THE FIRST JOB!

What's wrong with the radio you want to repair? A defective transformer? Wiring insulation trouble? A faulty capacitor or resistor? Don't guess! Don't waste time in needless, tedious testing! Just look up that particular make and model in Ghirardi's famous RADIO TROUBLESHOOTER'S HANDBOOK. Nine times out of ten, this big book will tell you exactly what is wrong—and exactly how to repair it. You don't have to be an expert to use the HANDBOOK—and there's no better way of getting invaluable, practical service training. Over 400 pages are chock-full of this factual Case History repair data on over 4,800 receivers, auto radios and record changers of 202 different manufacturers—practically every set in use today. Over 300 additional pages contain hundreds of repair charts, tube charts, data on tuning alignment, transformer troubles, tube and parts substitution data, color codes—all designed to help you repair any radio ever made EASIER, BETTER and FASTER. Ideal for either busy service repair shops or for beginners. Only \$5 complete—on our 5-Day Money-Back Guarantee basis.

**TELLS WHAT TO DO, EXACTLY HOW TO DO IT**

As valuable to a radio repair man as a recipe book is to a cook!

**\$5**

Ghirardi's RADIO TROUBLESHOOTER'S HANDBOOK (above) is the ideal book to have on hand for training new helpers, repairing either cheap or expensive sets quickly and profitably, eliminating needless test time and equipment—and MAKING MORE MONEY

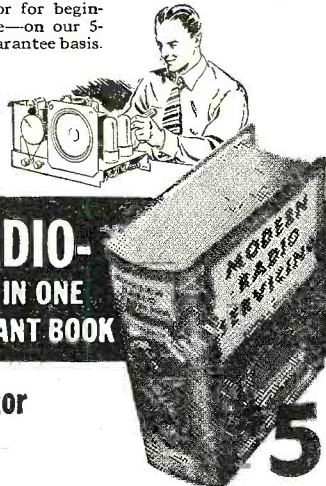

# ALL THE SCIENCE OF RADIO-ELECTRONIC SERVICING IN ONE GIANT BOOK

LEARN AT HOME... without an instructor

Alfred A. Ghirardi's MODERN RADIO SERVICING gives you a COMPLETE, MODERN EDUCATION in truly professional radio-electronic service methods of the kind that will be your "Open, sesame!" to the big-money opportunities that only well-trained servicemen are in a position to grasp. It is a complete, scientific servicing course from A to Z. You'll be surprised how easily understandable it makes every phase of the work even if you have had no previous service training. And, if you are already in the business, you'll be pleased to learn how this big 1300-page book will serve as a "refresher" course. Not only will it help you handle repair jobs quicker, better and more profitably, but it also will give you the necessary basic training to equip you for profitable industrial electronic work. 1300 pages; 706 clear illustrations; 720 Self-Test Review Questions. Only \$5 on our famous 5-Day Money-Back Guarantee.

## ENDORSED BY EXPERTS EVERYWHERE

From beginning to end, MODERN RADIO SERVICING brings you the kind of modern professional "Know How" that will pay big dividends for years to come. Gives complete data on test instruments and their use, preliminary trouble checks, scientific circuit analysis and trouble-shooting, parts repair and substitution, how to start and operate a successful service business and hundreds of other subjects.

## MONEY-BACK GUARANTEE

Murray Hill Books, Inc., Dept. RN-46, 232 Madison Ave., New York 16, N. Y.

Enclosed find \$..... for books checked; or  send C.O.D. (U.S.A. only) for this amount plus postage. I may return the books for refund within 5 days if not fully satisfied.

RADIO TROUBLESHOOTER'S  MODERN RADIO SERVICING HANDBOOK \$5 (\$5.50 foreign) \$5 (\$5.50 foreign)

MONEY-SAVING COMBINATION OFFER: Both of the above big books, only \$9.50 (\$10.50 foreign)

Name .....

Address .....

City & Dist. No. ....

State .....

## SPECIAL OFFER!

Let RADIO TROUBLESHOOTER'S HANDBOOK save you time on common radio service jobs! Let MODERN RADIO SERVICING train you for complete professional, electronic work. Get BOTH BIG BOOKS at the special price of only \$9.50 for the two. Send coupon today!

The French National Program from Paris is relayed daily on 11.886 and 9.620 now from noon to 4 p.m.; news is at 1:30 p.m. Paris on 11.700 has lately been used *only* between 5:30-6:45 a.m.

All Burma schedules were recently advanced one hour, due to time change in that country; complete schedule of Radio Rangoon on 6.035 is 11:30 p.m.-1 a.m., 5:45-7:15 a.m., and 7:15-8:45 p.m., with news at 12:30 a.m. (this is a weekday schedule). The 5:45-7:15 a.m. transmission is reported with powerful signals in the East. On 11.840 (also reported as 11.850), Radio Rangoon has a new schedule of 1:15-1:45, 7:30-9 a.m., and 9-9:30 p.m., with English news at 1:30, 7:45, and 8:55 a.m.; on Sundays is heard 8:30-10 a.m., but recently I have heard this transmitter signing off Sundays at about 9:12 a.m. with a march; has a ten-minute sermon Sundays at 9 a.m.; has been sending a good signal here since around the first of the year; sometimes there is slight interference from WGEA.

Colombo (not Southeast Asia Command), Ceylon, appears to have moved back to 4.900 from 4.890; heard late mornings with relays of the local medium-wave station. (Dilg)

XORA, Shanghai, China, does *not* transmit on 11.780, as indicated by Chinese sources, but is being heard on 11.690/11.700 (formerly XGOO/XGRS); English news is given at 7 a.m. XMHA, another Shanghai transmitter formerly using 11.860, is at present transmitting on medium-wave *only*.

PMH, 6.720, Bandoeng, Java, is being heard with better signal now on the West Coast to late sign-off at 9:30 a.m. Recently was heard at 9:20 a.m. saying in English that they were on 24 and 44 meters, announcement concluding with "Until tomorrow, good-night, everybody." The final sign-off at 9:30 a.m. is in Dutch or Indonesian. (Dilg, Balbi) Mr. Dilg reports that PMH really has good modulation now, not only for the phono-input, but on voice mike as well.

CBFX, 9.630, Montreal, has moved to 9.610 to make way for the new Sackville International station, CKLO, which has taken over 9.630 between 3:15 and 7 p.m. CBFX and ZYC8, a Brazilian on same frequency, interfere severely with one another evenings.

HJFK, Pereira, Colombia, which moved up to 6.115, has now returned to 6.100.

TGNA, Guatemala, has changed frequency from 7.170 to 6.255; TGOA from 7.495 to 6.497; TGWB from 6.460 to 6.540. TGWA has been off the air most of the time during late winter.

XEBT, Mexico, has changed frequency from 6.000 to 9.625; reception is good from 10:30 p.m.—when GWO, London, leaves the air—to sign-off of XEBT at 12 midnight.

The Venezuela station on 3.580 has been identified as YV3RS, moved from 3.490; transmitter trouble cleared up after the first week of operation on 3.580; they were still announcing 3.490.

The Berlin s.w. relay testing in mid-winter on 11.762 has moved to about 6.038 where it has been reported heard poorly between 3-6 p.m. and 12 midnight-4 a.m.; frequent time announcements are given in the morning period, with Central European time (6 hours ahead of EST) being quoted.

The ICA transmitter at Vienna, Austria, has been moved to Nuremberg to augment the DPGH station. DPGH thus may be heard on ICA frequencies. DSH4, approximately 7.110, Nuremberg, is reported heard 11 a.m.-12 noon with reports from BBC correspondents in English, German, Portuguese, and Arabic.

Radio SEU, Madrid, has been jumping about during the winter, mostly between 7.065 and 7.109, scheduled from about 3 to 7 p.m. sign-off.

SBO, 6.065, Motala (Stockholm), Sweden, has replaced SBP, 11.705, at 8-8:55 p.m. in the North American transmission; is reported as poor to inaudible in most of the United States; SBO is reported to be used now afternoons also, instead of SDB2, 10.780, weekdays scheduled 1:30-5 p.m., and on Sundays, 1:30-4:15 and 4:20-5 p.m. SBU, 9.535, is now *only* scheduled 8-8:55 p.m. to North America, paralleling SBO. SDB2, 10.780, is used now *only* 11 a.m.-1:15 p.m. SBP, 11.705, is scheduled 1:45-2:10, 6-7, and 8:45-9:25 a.m. SBT, 15.155, is scheduled now weekdays, 6-6:50, 10-11 a.m., 11:45 a.m.-12:55 p.m., and 1-1:15 p.m.; on Sundays and holidays SBT is heard 2:45-7 and 9-11 a.m., 11:05 a.m.-1:15.

HER3, 6.165, Bern, Switzerland, is reported heard after 3 a.m.; schedule is 12 midnight-9 a.m., 11 a.m.-1 p.m., and 4-6 p.m. with Red Cross messages. HEF4, 9.185, Bern, is reported to have English news now at 4 p.m., usual sign-off in afternoon being 5:15 p.m., but has been heard to 6 p.m.

TAQ, 15.195, Ankara, Turkey, is now reported heard 12-midnight-2 a.m.

Latest schedules reported for XUPA, 9.695, Taihoku, Formosa, are 5-9:20 a.m., 6-7:30 p.m., and 11 p.m.-12 midnight; the unlisted relay on approximately 6.015 is still reported on the morning transmission, best around 9

(Continued on page 116)

## GREATER NEW YORK HAMFEST

THE North Shore Radio Club of Long Island will sponsor the second annual "Hamfest" to be held in Greater New York, since the war, on Friday evening, April 26th at the Commercial Hotel, 96-43 Springfield Boulevard, Queens Village, Long Island, New York.

This "Hamfest" is open to all persons interested in amateur radio. The program, although informal in nature, will have as its theme "The Radio Amateur Looks to the Future" and will feature prominent speakers from both the amateur and professional communications field. Entertainment and door prizes are also included on the evening's program.

Tickets are available at a nominal fee at Greater New York radio stores handling amateur radio equipment, from North Shore Radio Club members, or at the door.

April, 1946



**ALFRED A. GHIRARDI**  
the man who has started thousands on successful careers by making Radio-Electronics easy to learn

**I'LL TRAIN YOU FOR  
RADIO-ELECTRONICS  
in a few short weeks  
FOR ONLY \$5 COMPLETE**

## NO PREVIOUS TRAINING NEEDED... LEARN AS FAST AS YOU CAN READ

This single, fully-illustrated 972-page RADIO PHYSICS COURSE book is a miracle of modern Radio-Electronic training—by an author who is famous throughout the world for making basic Radio-Electronics easy to learn. Actually, it is the equivalent of 36 complete courses in one. If broken into "course" form and sent in lesson style, you'd regard it as a bargain at \$50 or more. Instead, you buy it complete in book form for only \$5—and you progress as fast as you can read. Many students have completed it within a few weeks.

### COMPLETE—PRACTICAL—EASY TO LEARN

RADIO PHYSICS COURSE starts at the very beginning — with Basic Electricity. Then it guides you step by step through the entire field of RADIO-ELECTRONICS-TELEVISION to the latest, most modern developments. Nothing is omitted. Nothing is condensed. Everything is clearly and thoroughly explained. "I have read quite a few texts on Radio-Electronics," writes C. W. Redish of Astoria, Oregon. "Now, after reading RADIO PHYSICS COURSE, I can see that I wasted my time on the other ones!" Gerard Champagne of Montreal says that Ghirardi's RADIO PHYSICS COURSE at only \$5 explained things to him far better than a course for which he paid \$150!

Ask any successful Radio-Electronic man about RADIO PHYSICS COURSE. He'll know the book—because he probably got his start from it himself!

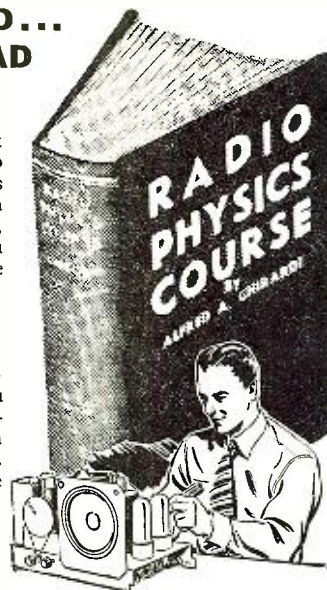

## THIS ONE BIG 3½ LB. BOOK DOES THE TRICK!

... the same book that is more widely used for home study, by more Signal Corps, Navy, and civilian schools and colleges than any other book or course of its kind!

No matter what phase of ELECTRONICS-RADIO-TELEVISION work you plan to enter, a knowledge of basic fundamentals is absolutely essential. Ghirardi's world-famous RADIO PHYSICS COURSE gives exactly what you need—at a price you can afford to pay! Sound, Speech, Music, Electron Theory, Current, Circuits, Resistance, Measuring Instruments, Vacuum Tubes, Detector & Amplifier Tube

Action; Superhets; Amplifiers, Auto & Aircraft Radio; P. A. Systems; Sound Pictures and Television are but a few of the subjects covered. No previous electronic training is necessary to enable you to understand every word.

Remember! RADIO PHYSICS COURSE has given more beginners their start in this fascinating field than any other book or course ever published. Send coupon today! Read the book for 5 full days. Then, if not more than satisfied, return it—and we'll refund EVERY CENT of your money without question!



## ← LEARN ALL ABOUT ELECTROLYTIC CAPACITORS

Want to know how to pick the right capacitor for a job? The advantages and applications of the different types at both high and low frequencies and voltages? How they are made? Their use on a-c or pulsating d-c? Ambient conditions, etc.? How to make measurements, tests, emergency repairs? Then send for Alexander M. Georgiev's "THE ELECTROLYTIC CAPACITOR"—the first book of its kind giving complete, modern data on this vital, widely used component. Fully illustrated. \$3 (\$3.25 foreign).

## HAVE A LOOK! You be the judge!

Murray Hill Books, Inc., Dept. RN-46,  
232 Madison Ave., New York 16, N. Y.

Enclosed find \$..... for which please rush my copy of Ghirardi's big 972-page RADIO PHYSICS COURSE book, or  send C.O.D. (to U.S.A. only) for this amount plus postage. If not more than satisfied, it is understood that I may return the book within 5 days of receipt for full refund of my money—and no questions asked.

\$3 enclosed (\$3.25 foreign) for a copy of Georgiev's THE ELECTROLYTIC CAPACITOR, or,  send C.O.D. (U.S.A. only) for this amount plus postage.

Name .....

Address .....

City & Dist. No. .... STATE.....

**5-DAY MONEY-BACK GUARANTEE**

# HARVEY

is now delivering  
reasonable quantities of  
**ALTEC LANSING**  
FM MONITORING EQUIPMENT  
and  
RECORDING AMPLIFIERS

Designed in the famous Altec Lansing Hollywood laboratories for film recording. Takes the guess work out of FM... the only equipment of its kind. HARVEY'S experienced staff can answer technical questions and advise on installation.

## 604 DUPLEX SPEAKER

... combining high and low frequency units in one horn, eliminating intermodulation effects and distortion through entire FM range, 50 to 50,000 cycles.



## A-323 AMPLIFIER

... compact, 6-tube, 18 watt linear amplifier, designed for operation with the Duplex speaker.



## A-420 PRE-AMPLIFIER

... high gain, low noise level pre-amplifier for use in connection with applications where high quality amplification is desired.

## A-255 AMPLIFIER

... for exacting demands of high quality audio frequency power, intended primarily for operating disc recording equipment requiring full power at all frequencies up to 10,000. 40 watts...65 db gain.

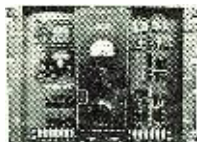

## A-127 AMPLIFIER

... a 15-watt power amplifier for disc recording, and as a monitor amplifier in recording work. Rated output, 1 db from 40 to 10,000 cycles; frequency response, 1 db from 20 to 20,000 cycles.



Telephone **3-HRC** Longacre 3-1800

# HARVEY

RADIO COMPANY

103 West 43rd St., New York 18, N. Y.

## What's New in Radio

(Continued from page 64)

the reception of standard broadcast has been utilized. The normal positions for standard broadcast reception are marked in red and when the controls are at those positions, only standard broadcasts can be heard. Mark-

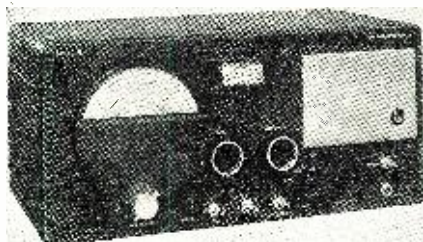

ings for other types of reception are in light gray.

The top section of the cabinet is of "aerodized" steel which swings open on a piano hinge. The cadmium-plated chassis may be removed as a unit with the panel without disconnecting any controls.

The receiver is housed in a steel cabinet, finished in deep satin gray with an external trim of satin chrome. Dials are a light translucent green to prevent glare.

Details and prices of the S-40 will be furnished by *Hallicrafters Company*, 2611 South Indiana Avenue, Chicago, Illinois.

## CRYSTAL PICKUP

*Shure Brothers*, of Chicago, has announced the development of a new crystal phonograph pickup, the "Glider."

This unit features two innovations, the lever-type cartridge and the low-mass tone arm. The cartridge houses



the lever-driven crystal which results in lower needle impedance and higher needle compliance. The lever is so designed that it gives greater shock immunity to the crystal.

The light aluminum tone arm is curved and is free from resonance. It has an adjustable swivel screw that prevents the needle from striking the turn-table if the arm is dropped.

The standard output voltage of the unit is 1.6 volts. Production on another unit with higher output voltage is under way. The "Glider" is designed for easy replacement of older type pickups.

Details of this unit will be sent upon request to *Shure Brothers*, Chicago, Illinois.

## MIDGET TRANSFORMERS

A new series of midget transformers for applications in hearing aids, vest pocket radios and other consumer items has been announced by *United Transformer Corporation*.

These transformers, the UTC Sub-Ouncers, measure  $\frac{1}{16}$ " x  $\frac{5}{8}$ " x  $\frac{7}{8}$ " and weigh only  $\frac{1}{8}$  ounce.

The coil is uniform layer-wound of Formex wire, on a molded nylon bobbin. Insulation is of cellulose acetate. The leads are mechanically anchored externally. Core material is Hiper-



malloy and the entire unit is triple (waterproof) sealed.

Five standard units are now available and details of the line will be furnished to those requesting them from *United Transformer Corporation*, 150 Varick Street, New York 13, New York.

## TUBE AND SET TESTERS

Two all-purpose radio tube and set testers have been announced by *Hickok Electrical Instrument Company*.

These testers have been designed to include the dynamic mutual conductance circuit engineered by the company. Model 532C is designed for counter use, while the Model 532P is a portable unit. Both of these testers test and reject all bad tubes.

The testers are fitted with easy-to-read scales having micromho ranges from 0-3000; 0-6000; 0-15,000 with leg-ends indicating "Replace", "Doubtful" and "Good".

The unit makes provision for noise, gas, and hot and cold shorts tests. Diodes are tested separately with low voltage to prevent paralysis of the elements. Line voltage from 100 to 130 volts is indicated on a large test meter. Rectified current is used to energize plates and grids, and tests can be made of grid controlled rectifier tubes.

Tests can be run on all present-day tubes, including octal, loktal, miniature, ballast and magic eye tubes. Pro-



# INDUSTRIAL POWER

IN A SMALL PACKAGE

**L-129R**

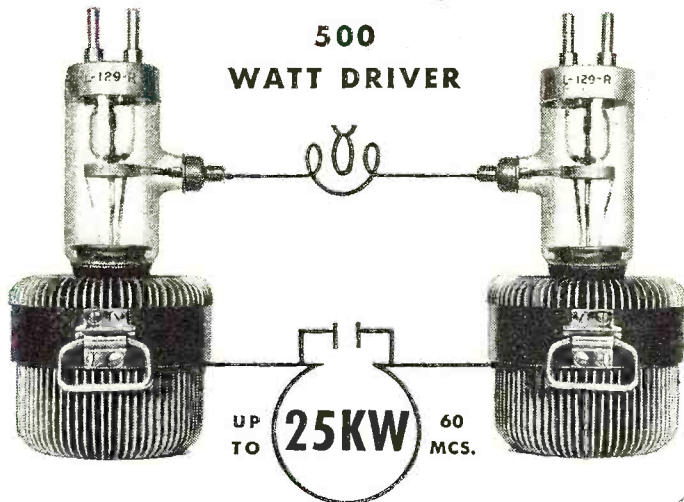

ANOTHER "Lewis at Los Gatos"  
TRANSMITTING TUBE

Licensed Under RCA Patents  
List Price \$375.00

Only 14 inches high and approximately 6 inches in diameter at maximum dimensions—yet two Lewis L-129-R transmitting tubes can deliver 25 kilowatts of useful power at industrial heating frequencies. This, with a self-excited oscillator or, if frequency stability is essential, with an external driver of only 500 watts capacity.

No extensive heat transfer unit is required as only 650 cubic feet of air per minute are necessary for forced air cooling of 2 tubes. Expensive water systems for anode cooling are eliminated.

Built "rugged and reliable" by "LEWIS AT LOS GATOS" the L-129-R will give long and trouble-free life under strenuous industrial operating conditions.

Wire or write for our representative.

There's a better

**Aireon**

## Cinaudagraph Speaker for Every Electroacoustical Application

Aireon Cinaudagraph Speakers, Inc., has the facilities, experience and engineering ability to design and produce better speakers for any purpose. Whether it is a two-inch unit for portable model radios, or a fifteen-inch for commercial phonographs, the same research, precision construction and superior materials are employed.

As a result, electroacoustical perfection never before achieved has been incorporated in Cinaudagraph Speakers—for public address systems, radio, commercial phonographs and many special purposes.

Another "Lewis at Los Gatos" Transmitting Tube  
Licensed Under RCA Patents. List Price \$375.00.

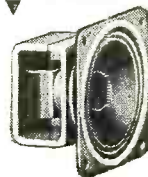

**Lewis Electronics**  
Los Gatos, Calif.

Subsidiaries of  
**Aireon**  
MANUFACTURING CORPORATION

**Cinaudagraph**  
Speakers, Inc.

3911 SOUTH MICHIGAN AVENUE  
CHICAGO, ILLINOIS



## in your area KNOWS HIS CONDENSERS

The right capacity with the right spacing in the final tank circuit raises the efficiency to where the other fellow says "There's a signal that is really outstanding!"

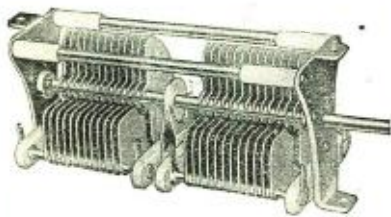

To reduce losses to an absolute minimum this condenser features BUD Electro-Soldered plate assemblies. This assures correct plate spacing, overall rigidity, and light weight. Rotor contact is made by a Four-Finger plated pressure spring placed at the center of the rotor shaft between the two sections, thereby providing perfect balance and improving the high frequency characteristics. The Tie Rods are insulated at both ends with Steatite insulators to prevent inductive loops in condenser frame.

### BUD Can Supply All Your Needs . . .

. . . with the latest types of equipment including: condensers, chokes, coils, insulators, plugs, jacks, switches, dials, test leads, jewel lights and a complete line of ultra-modern cabinets and chassis.



**BUD RADIO, INC.**  
CLEVELAND 3, OHIO

vision for future tube designs has been made.

Further details of this tube tester

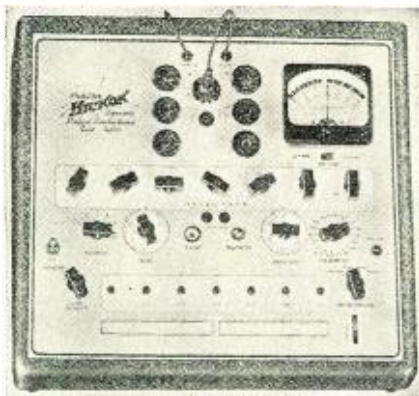

will be provided by *Hickok Electrical Instrument Company*, 10524 Dupont Avenue, Cleveland 8, Ohio upon request.

### SELF-TIMING INTERRUPTER

A new, enclosed self-timing interrupter unit is being offered by *Electronic Controls, Inc.* for applications as warning signals, flasher lights, industrial controls, life testing circuits,

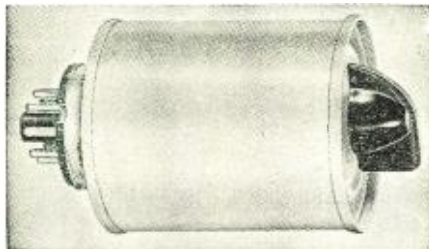

truck or bus blinkers, process timing and aging equipment controls.

The device can be supplied with a fixed, predetermined rate of interruption or with an external variable adjustment. The fixed unit is available in either open frame construction or in plug-in metal enclosures, dust

cover or hermetically sealed. The adjustable unit is available in plug-in dust cover enclosures only.

Time range is one to twelve pulses per second. The unit will operate on voltages up to 32 volts, d.c. or 125 volts, 60 cycle, a.c.

Additional data on this device may be secured by writing *Electronic Controls, Inc.*, 44 Summer Avenue, Newark 4, New Jersey.

### PORTABLE SPEAKER STANDS

*Walker-Jimieson, Inc.* of Chicago have announced the availability of a new type of portable speaker stand which is suitable for mounting public address speaker units, flood or spot lights, FM antenna, photographic reflectors in auditoriums, airfields, or temporary outdoor installations.

Four "music stand" type folding leg supports cover an area of about 10 square feet, which gives added stability. The unit is of all welded construction.

The stand will hold 100 pounds of equipment at any desired height up to 20 feet. The unit weighs 35 pounds.

Inquiries addressed to *Walker-Jimieson, Inc.* 311 South Western Avenue, Chicago 12, Illinois, will be handled promptly.

### PLUG-IN TEST LAMP

The *Hanlan Company* of Los Angeles has announced a new plug-in test lamp which is designed to fill the need for a portable test lamp which can be plugged into any outlet.

The lamp is capable of instantly locating grounds, shorts, or opens in any piece of electrical equipment. Recommended uses include the testing of appliances, motors, vacuum cleaners, radio circuits, all types of bulbs, fuses, radio tube filaments and other devices.

Complete details and prices will be

## INTRA-AUDITORIUM TELEVISION

By W. S. STEWART

FROM Hollywood comes a report of a new suggested use for television. For the convenience of remote members of audiences in large auditoriums, theaters, and even outdoor assemblies the intra-auditorium vision relay will do for the eye what the public address system now does for the ear.

This application of television would benefit the actor, the speaker, and especially the comedian whose facial expressions are an important part of a routine.

Eventually, the physical dimensions of such vision relay equipment may be reduced to the point where it is portable in the same sense that public address systems are portable today.

Motion picture exhibitors might relay, for short intervals, portions of the films being screened inside to a screen in front of the theatre. This could supplement the marquee as a patron "teaser."

Commercial development of such a

system will make opera glasses obsolete, as well as create new jobs in the manufacture, operation and maintenance of this equipment. —30—

Suggested scheme for relaying performer's features to remote audiences in large auditoriums or theaters.

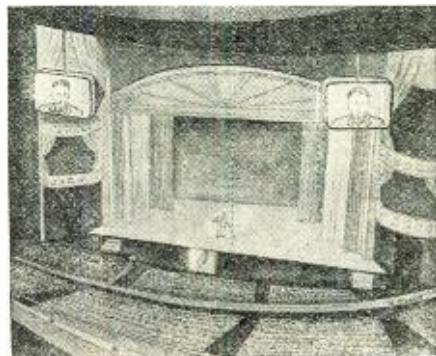

# MARION "HERMETICS" ARE HERE TO STAY

*because...*

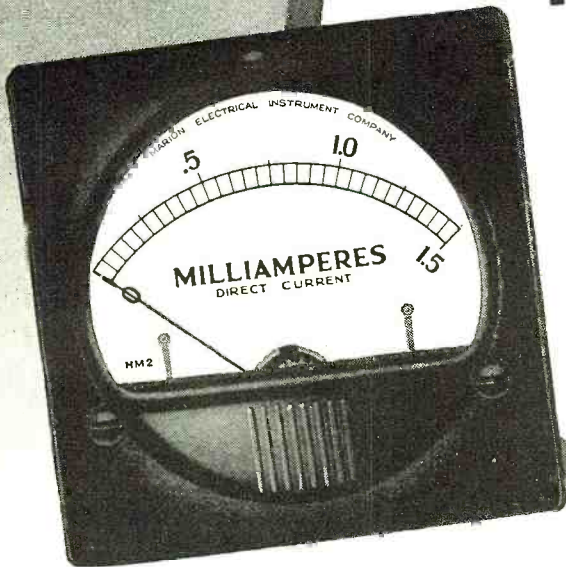

...they're **dustproof and moisture-proof** — foreign matter which oxidizes pivots and attacks bearings and thus shortens the life of an instrument cannot enter.

...**sustained performance** over a longer period of time is assured and rejects of complete equipment due to instrument failure are minimized, if not eliminated.

...**the magnetic and electrostatic shielding** obviates the need for special calibration for different types of panels or separate shielding of instruments in order to prevent RF leakage through the case.

...**interchangeable colored flanges**, in both round and square shapes, are available at no extra charge; finer in performance, Marion "hermetics" are also smarter in appearance.

...they are **100% guaranteed** for six months — after that, regardless of condition and provided the seal has not been broken, we will replace any 2½" or 3½" instrument from 200 microamperes upward for \$1.50; any 2½" and 3½" type with sensitivity greater than 200 microamperes for \$2.50.

## Marion Glass-to-Metal Truly Hermetically Sealed 2½" and 3½" Electrical Indicating Instruments

Note: Marion "hermetics" cost no more than most standard unsealed instruments—and they are positively interchangeable. Write for the new Marion Catalog.



# Attention GI JOE!

Here's Your Opportunity to be First to

## Start Your Own RADIO SERVICE SHOP

Complete Start-in-Business  
Package Stocks of

TEST EQUIPMENT  
TUBES, PARTS, TOOLS

**\$350 up**

Act quickly! Meet the pent up demand for radio service. Turn your special service training into a profitable business of your own. No fuss. No worry. Here's everything you need—\$350 up. Details upon request! Write, wire or phone

### RCP 448

"POCKET" VOM  
A.C.—D.C. Volts  
0-5-50-250-1000  
D.C. Mills  
0-5-10-100-1000  
Ohms  
0-2,000-20,000-200,000-  
2 Meg.  
Size 3" x 5 1/8" x 2 1/2"

**\$24.50 net**



### RECORD CHANGERS

UTAH-DETROLA \*550C ..... \$18.27  
WEBSTER-CHICAGO #56 ..... 27.20

### HALLICRAFTERS SX-28A

**\$223**



SUPER DEFIANT ..... SX25 \$94.50  
SKY CHAMPION ..... S20R 60.00  
SKYRIDER MARINE ..... S22R 74.50  
S40 NEW MODEL ..... Approximately 79.50  
SKYRIDER JR. S41 ..... 33.50

### HAMMARLUND HQ-129-X \$129

#### TRIPLETT 625-N

20000 ohms per volt D.C.  
10000 ohms per volt A.C.  
5" Scale-TOPMOST QUALITY  
(12) D.C. Volt Ranges to 5000  
(6) A.C. Volt Ranges to 5000  
(3) OHM Ranges 0-400-50000-  
10 Meg.  
(5) D.C. Current Ranges 1 Ma.  
to 10 Amp.  
PLUS OUTPUT and DB.  
RANGES

**\$45.00** with test leads.

### PHILCO BEAM OF LIGHT

Selenium Cell only, no holder ..... 1.30

20% deposit required on all C.O.D. orders. 2% transportation allowance on orders of \$25.00 or more accompanied by payment in full.

Write for  
FREE CATALOG

# RADIO SUPPLY & ENGINEERING CO., Inc.

129 SELDEN AVE. DETROIT 1, MICH.

furnished upon request to *Hanlan Company*, 1419 West Jefferson Blvd., Los Angeles 7, California.

-50-

## Radar Reaches the Moon

(Continued from page 27)

fore another pulse is transmitted to the moon.

And each radar pulse must be of appreciable duration—from 1/4 to 1/2 second—to insure a strong signal at the receiver after reflection by the moon.

A three-kilowatt radar transmitter was available for the experiments, and this was modified to supply an output of fifty kilowatts. Through the use of a high-gain antenna, effective radiation was raised to about 10 megawatts, or 10 million watts.

Strength of the received echo reflection has been estimated to be only a few tenths of a watt. Thus the most difficult step in contacting the moon was not so much in the transmission, but in the design and construction of an extremely sensitive receiver.

This receiver—using 34 tubes, and four different intermediate frequencies—has a sensitivity of about 0.01 microvolts.

A good idea of the over-all equivalent sensitivity is that the radar set could pick up an airplane at a distance of more than 1900 miles—assuming, of course, that the target was within the set's line of sight.

The complete radar set incorporates a number of new design techniques, thus a detailed analysis of the Diana Project is worthy of further study.

### Details of Components

The radar transmitter consists of a series of frequency multiplying stages

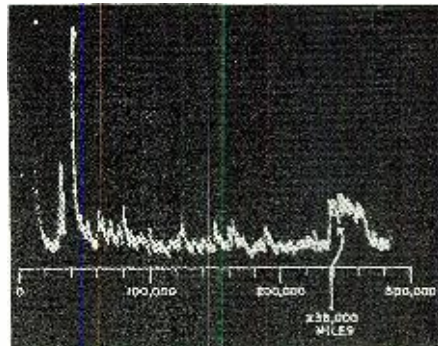

Photographic record of reception of radar signals reflected by moon on night of Jan. 22, 1946. Heavy pulse at 0 represents initial transmission of energy toward the moon. Jagged lines indicate general noise reception. Distinct echo at about 238,000 miles represents reception of radar echo 2.4 seconds later, after echo had actually traveled a round trip distance of over 477,000 miles between earth and moon. Actual mean distance from earth to moon is 238,857 miles.

which raise the frequency of a 516.20 kc. crystal to 111.6 megacycles (the carrier frequency). A pair of type WL-530 tubes are used in the output. These are driven by a pair of type 450-TH tubes (triplers) which, in turn, are driven by a pair of type 257-B tubes (doublers) which, in turn, are driven by an 807 which, in turn, is driven by tubes in the radar receiver.

The same crystal controls both the transmitter frequency and the heterodyne voltage for the receiver.

A pulse of variable width is supplied the transmitter by the electronic keyer or timer—a physical part of the indicator unit. A pulse duration of from 1/4 to 1/2 second can be used.

Pulse recurrence frequency is also variable. The electronic keyer or timer can supply a pulse once every three to five seconds. This is equivalent

## BEAM CENTERING CONTROL FOR 5" OSCILLOSCOPE

RADIO NEWS has received innumerable letters from its subscribers commenting favorably on the article entitled "5" Oscilloscope Design" appearing in the August, 1945 issue of RADIO NEWS. Interest indicated that many of those who constructed the unit would like to add beam centering

controls to their new instruments.

In view of this demand, we are presenting the schematic diagram for the addition of such controls. The circuit is exceptionally simple and consists of five components, namely three resistors and two potentiometers.

-50-

Schematic diagram for beam centering control to be used in conjunction with the 5" oscilloscope design appearing in the August, 1945 issue of Radio News.

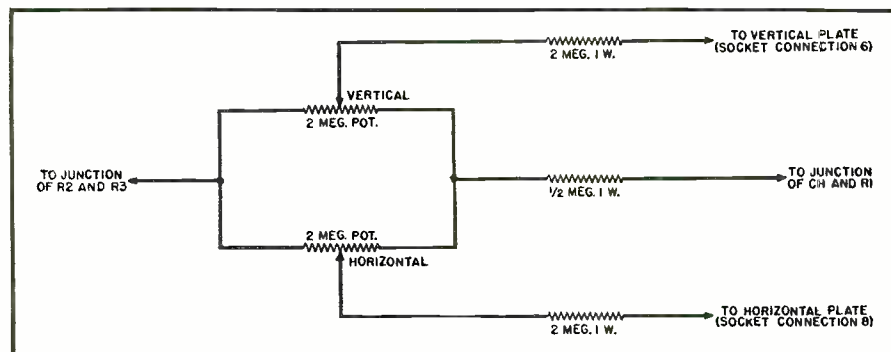

# 4 Good Reasons!

...why profit-minded dealers and distributors everywhere are stocking *E-L* Vibrators.

**SIMPLIFIED STOCK!  
LOWER STOCK INVESTMENT!  
FASTER TURNOVER!  
GREATER PROFITS!**

That's the story in a nutshell! With *E-L*'s unique standardization plan, now you need stock only 4 models to serve the 1122 auto-radio models which comprise 95 per cent of the vibrator replacement demand.

**LONGER LIFE . . . PROVEN DEPENDABILITY**

*E-L* Vibrators are of the balanced resonance type, with 8 contacts instead of 4—*twice* as

ASK ABOUT "UTILIPHONE": . . . *E-L*'s new, practical, low-cost 2-station intercommunication system. Ideal for offices, factories, homes and schools. No installation service is required . . . gives long-time, trouble-free operation.

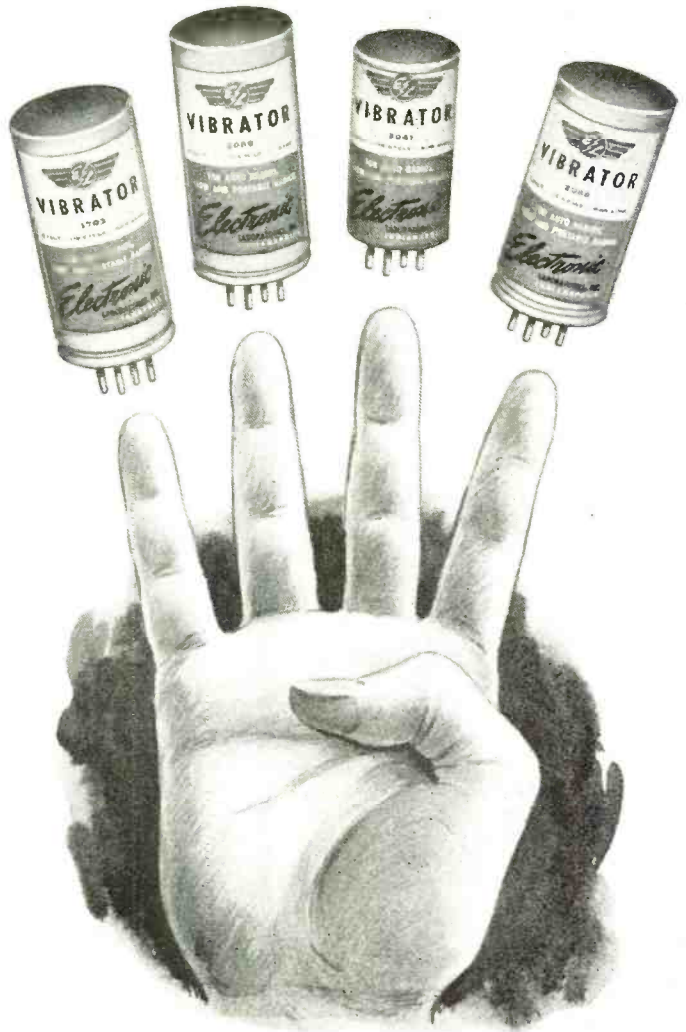

many as other makes in the non-synchronous types. Tests show they provide 33 per cent longer vibrator life, with output and starting voltages held virtually constant throughout the entire life-span. The exclusive features and outstanding performance of *E-L* Vibrators are a product of exhaustive research into auto-radio requirements.

Order from your *E-L* distributor today! Your shipment will include a free copy of the new *E-L* Auto-Radio Vibrator Replacement Guide designed for your handy reference.



*Electronic*

**LABORATORIES, INC.**  
INDIANAPOLIS

VIBRATORS AND VIBRATOR POWER EQUIPMENT FOR LIGHTING, COMMUNICATIONS, ELECTRIC AND ELECTRONIC APPLICATIONS

April, 1946

85

# Standard HAS IT IN STOCK! FOR AT ONCE DELIVERY ORDER NOW

• You bet! Standard Radio & Electronic Products Co. has the goods. We will make PROMPT shipments. Large complete stocks now on hand.

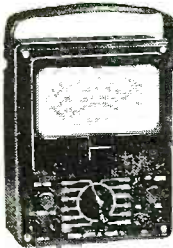

## SIMPSON MODEL 260

"HIGH SENSITIVITY"  
MULTIMETER for television and radio servicing. 20,000 ohms per volt.

**33.25**  
AT ONCE  
DELIVERY

## A.C.-D.C. ANTENNA WIRE

Excellent pre-war quality... Extremely flexible... Brown Cloth covered. "Make your own antenna hanks!"

500 FT. ROLL

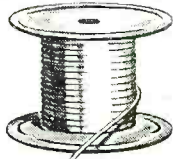

SPECIAL  
**3.49**

## ADVANCE RELAYS



1/4 inch silver contacts  
—10 amp. 115 volt...  
50-60 cycle.

≡ 953B Single pole—  
double throw... **2.45**  
≡ 964B Double pole—  
double throw... **2.95**

## ADJUST-A-VOLT

1/2 K. W. Isolation Transformer



- keeps AC-DC chassis neutral to ground.
- keeps AC-DC chassis neutral to grounded test equipment.
- lowers voltage to check intermittent oscillators.
- raises voltage to "pop" out stubborn intermittent parts.
- regulates voltage to service bench.
- boosts line voltage to portable P. A. systems.

115 V. 70-140-V.

ONLY  
**17.50**

# Standard RADIO & ELECTRONIC PRODUCTS COMPANY

135 E. SECOND ST., DAYTON 2, OHIO

MAIL ORDERS GIVEN PROMPT  
ATTENTION! WRITE US FOR  
INFORMATION ON ALL PARTS  
20% DEPOSIT ON ALL MAIL ORDERS

lent to p.r.f. of 1/3 to 1/5 cycles per sec.

The peak output of the radar transmitter during pulses is fifty kilowatts.

The transmitter feeds through a mechanical, low-loss T/R switch to the antenna system. The T/R switch consists of specially constructed relays to obtain positive low-loss action on the long and relatively low peak power pulse used.

The antenna consists of a broadside array of 64 half-wave dipoles. The array is movable and mounted 100 feet above ground.

The antenna system has a forward power gain of about 200. It has a beam width of 15 degrees at half power points—in both the vertical and horizontal planes.

Received echoes are applied to the radar receiver—the real secret of the set's ability to pick up reflections from such distant targets. The receiver is a 4-mixer superheterodyne, with all but one of the mixer injection frequencies directly controlled by the transmitter crystal—to provide locking with the transmitter frequency. Fourth mixer is provided with an adjustable frequency crystal; this sets exactly the final intermediate frequency and depends upon the actual radio frequency being received. The received frequency of the radar signal differs from the transmitted frequency by an amount depending upon the Doppler effect which, in turn, is caused by the moon's relative velocity.

Operating noise factor of the receiver is about 8 db. The receiver bandwidth is about 50 cycles.

A loudspeaker is coupled to the output of the last i.f. amplifier to provide audible indications of echoes.

A long-persistence oscilloscope is used to display the echo output from the detector. The scope uses a type "A" time base with a three to five second sweep, depending upon the desired pulse recurrence frequency. Di-



Servicing and aligning intricate circuits of the sensitive radar receiver. Col. DeWitt discusses procedure with Herbert Kauffman and Dr. Harold Webb.

rect coupling is used for both sweep and deflection circuits.

### New Equipment

Work has already begun on the design of new and more compact permanent equipment to replace the composite gear used on the first experiments.

The multi-dipole antenna array will probably be replaced by a parabolic reflector—forty or fifty feet in diameter—capable of movement in three dimensions. The base will be comparable in design to bases used for large telescopes at astronomical observatories.

It is also fairly certain that the operating frequency will be considerably increased, when the present radar transmitter is replaced with a more powerful one—possibly using magnets.

Other improvements will be incorporated in other components in an at-

One of the German radars successfully jammed by the Allies. Used for ground control of fighters and, later on in the war, for direction of anti-aircraft fire.

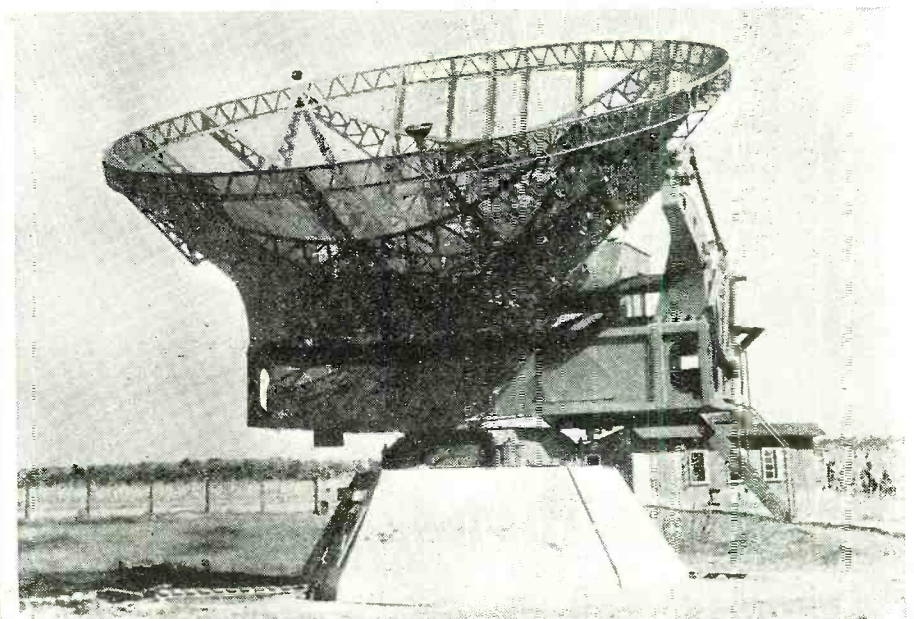

SNAP-ON WRENCHES . . . INDUSTRY'S STANDARD FOR PRODUCTION, ASSEMBLY, MAINTENANCE

## How Modern is Your Wrench Equipment?

Nut turning operations, straight through the plant, frequently offer unsuspected opportunities to cut costs, improve precision and promote safety. Ordinary wrench equipment does not measure up to modern production requirements.

For every nut-turning job there is an *engineered* Snap-on wrench unit that will handle the operation faster and easier, with utmost accuracy and safety. Check the savings, job by job, that can be made with this modern, *engineered* wrench equipment. Write today for the Snap-on catalog. SNAP-ON TOOLS CORPORATION  
8120-D 28th Avenue, Kenosha, Wis.

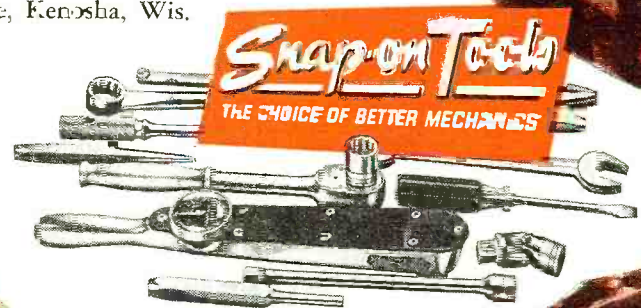

**NEW MODELS**  
*Available Now!*  
**of ATR**  
**QUALITY PRODUCTS**



**BATTERY ELIMINATORS**  
**FOR CONVERTING A.C. TO D.C.**

New Models . . . designed for testing D.C. electrical apparatus on regular A.C. lines. Equipped with full-wave dry disc type rectifier, assuring noiseless, interference-free operation and extreme long life and reliability.

- Eliminates Storage Batteries and Battery Chargers.
- Operates the Equipment at Maximum Efficiency at All Times.
- Fully Automatic and Fool-Proof.

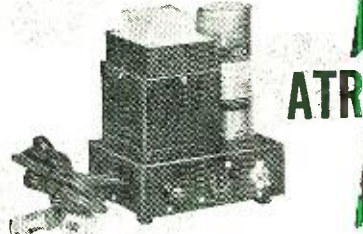

**LOW POWER INVERTERS**  
**FOR INVERTING D.C. TO A.C.**

Another New ATR Model . . . designed for operating small A.C. motors, electric razors, and a host of other small A.C. devices from D.C. voltages sources.



**STANDARD AND HEAVY DUTY INVERTERS**  
**FOR INVERTING D.C. TO A.C.**

Specially designed for operating A.C. radios, television sets, amplifiers, address systems, and radio test equipment from D.C. voltages in vehicles, ships, trains, planes, and in D.C. districts.

WRITE FOR NEW CATALOG—  
 JUST OFF THE PRESS!

**AMERICAN TELEVISION & RADIO CO.**  
 Quality Products Since 1931  
 ST. PAUL 1, MINN. U. S. A.

tempt to increase both the output power and the sensitivity of the lunar radar.

The Signal Corps intends to continue experiments in this fascinating new realm of exploration and discovery. The War Department has already embarked upon a long-range research program to develop more reliable and informative techniques for radar study of the moon and the ionosphere.

Study of the effect of radio waves in traveling through the atmosphere is of utmost importance. This includes bending and refraction of radio waves, and more complete data concerning the Doppler effect on radio signals passing beyond the earth's atmosphere.

Another valuable application of lunar radar will be the provision of new meteorological and astronomical information. Cosmic dust in space can be detected and located. And not only may it be possible to construct topographical maps of distant planets with the aid of radar data, but scientists may be able to determine the composition and atmospheric characteristics of other celestial bodies by means of long-range radar.

-30-

**Pulse Modulation**  
*(Continued from page 44)*

of marker pulses—makes use of two tubes, known as the "cyclodos" and the "cyclophone," developed specifically for this purpose. The essential features of these tubes are shown schematically in Fig. 10. Both tubes make use of an electron beam which, by means of an ordinary circular sweep circuit, is made to strike the aperture plate in a circular path. (For ordinary telephone communication,

8000 revolutions per second is a suitable frequency of rotation for the electron beam.) The aperture plate contains radial slits, so that during the time the beam is passing each slit the electrons go through and strike the collector segments, while at all other times they are intercepted by the aperture plate. Thus, once in each complete rotation of the electron beam a short pulse of current is passed to each collector segment. The tubes shown in the diagram, having aperture plates with four slits, would be suitable for a multiplex system having three channels, one slit serving for the marker pulse and the others for the three time-modulated signals.

In the modulating tube (the cyclodos) the slits are placed at an angle to the radius of the circular plate, as shown in Fig. 10A. It can be seen from the diagram that because the slits are tilted at an angle, the time when the beam crosses the open slit changes either forward or backward as the radius of rotation of the beam changes. Thus, audio-frequency amplitude variations may be converted into pulse-time variations by varying the instantaneous voltage on the deflecting plates and thereby changing the radius of rotation of the electron beam. The dotted circle in Fig. 10A represents the circular pattern obtained when all three channels are unmodulated. The solid path represents modulation in all three channels—instantaneous peak positive modulation in channels 1 and 3, negative modulation in channel 2. (The marker pulse, of course, is always unmodulated.)

In the demodulator tube (the cyclophone) shown in Fig. 10B, the slits are placed along the radius of the circular aperture plate instead of being tilted. To convert the time-modulated pulses into amplitude variations, the electron

Fig. 8. (A) Schematic diagram of pulse-time transmitter modulating circuit. (B) Diagram of pulse-time receiver demodulating circuit.

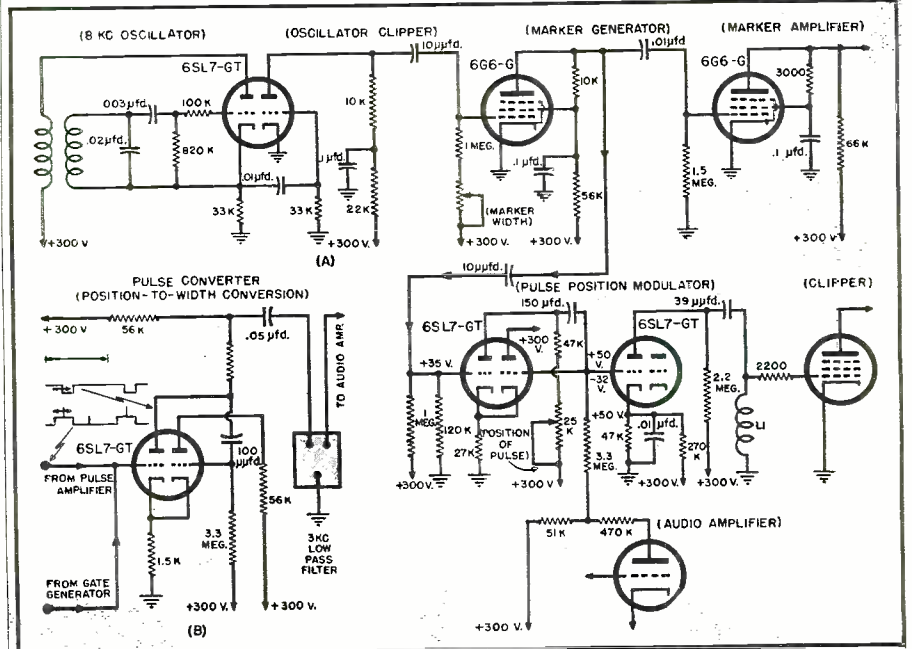





*for any type  
of application*

**BLILEY** has the crystals

**Bliley**  
CRYSTALS

To name all the engineers who "consult Bliley first" on frequency control problems would make a mighty impressive list.

They know from experience that Bliley engineers are always working in advance of the industry's requirements, and that the right crystal for

their particular application will be available without undue delay.

That is why Bliley acid etched\* crystals persistently show up wherever important developments are taking place in the communications field — and go with those developments to all parts of the globe.

Your products, too, will benefit if you make it a habit to "consult Bliley first" on frequency control problems. There's over 15 years of quartz crystal engineering experience at your beck and call.

\* Acid etching quartz crystals to frequency is a patented Bliley process.

For complete listing of Bliley crystals now available see Bulletin RN-27

**BLILEY ELECTRIC COMPANY** • UNION STATION BUILDING, ERIE, PENNSYLVANIA  
April, 1946 89

# SOUND VALUES at TERMINAL RADIO

## TRIUMPH Multirange Analyzer \$29.95 complete

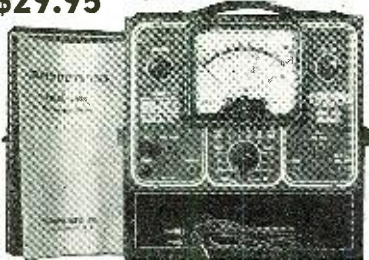

A full-size set tester for all general testing requirements. The large 4 1/2" 1000 ohm per volt meter with mirror backed scale provides well spaced divisions and eliminates error due to parallax. Housed in black crackle steel case, complete with cover and leather carrying handle. Overall size—9 1/4" sq. by 4 3/4" deep.

### RANGES:

A.C. Volts—0-3/15/150/600/3000 volts A.C.  
D.C. Volts—0-3/15/150/600/3000 volts D.C.  
D.C. Current—0-.6/6/60/300 Ma., 15 Amps.  
Ohms—0-10M/100M/1 Meg./10 Meg./100 Meg-ohms.

Accurate low ohms readings. 100 megohm range requires external D.C. voltage.

Output—-20 to +4, -6 to +18, +14 to +38, +26 to +50, +10 to +64 decibels (db.).

Model 333S, complete with high voltage test leads, self-contained batteries and full operating instructions.

Net. . . . . **\$29.95**  
When ordering by mail add 55c for shipping and ins.



## 60 Watt Universal OUTPUT TRANSFORMER

Kenyon T-110, matches a n y tube load to 500-200 ohm line or speaker voice coils ranging from 5 to 25 ohms. Size: 5" H x 3 1/2" W x 5" L. Special... Net. **\$8.17**

## Special! CARBON HAND MIKE!

Ideal for radio transmitters, mobile P.A. systems, etc. 200 ohm single button, high quality. Press-to-talk button operates relay and microphone. Guaranteed brand new in sealed cartons. Complete with 5 ft. 3 wire rubber cable and 3 circuit phone plug. Made by Shure for the U.S. Army Signal Corps. A real buy at Terminal!  
Type T-17... Net. **\$2.89**  
Add 15c for shipping when ordering by mail.



## BRUSH PL-20 Wide Range CRYSTAL PICKUP



Complete with equalizer and factory-installed permanent sapphire stylus. Net. **\$26.46**

## BRUSH "YM-1" VIBROMIKE

Miniature contact-type microphone for use with musical instruments, etc. Size only 3/8" x 3/8" x 5/8". Complete with mounting clamp and 25' cable... Net. **\$10.28**

**TERMINAL**  
Radio Corporation  
85 CORTLANDT ST. N. Y. 7, N. Y.  
Worth 2-4415

beam is made to rotate in a circular path, but the control grid is kept sufficiently, negative so that the beam is normally cut off except when one of the time-modulated pulses arrives. The pulses are applied to the grid and, depending upon where the electron beam is directed with respect to the slit at the time when the unblocking pulse arrives, there will be a variation in the amount of beam current passing through the slit and reaching the collector segment.

At the present time the cyclodos and cyclophone tubes are not commercially available. When they do become available the cost of the tubes, although expected to be moderate, will be a factor in determining their suitability for amateur use. For the time being, a reasonable substitute can possibly be improvised for amateur service by making use of an ordinary cathode-ray tube and phototube arrangement. This can be accomplished by cutting slits in a piece of black cardboard which fits over the face of the cathode-ray tube. Light shields and phototubes are placed in front of the slits so that each phototube records the light coming through one slit. In this manner, the slotted piece of black cardboard is made to act as an aperture plate and the phototubes take the place of the electron-collecting segments.

(b) A method of accomplishing pulse-time transmission and reception without requiring the use of the cyclodos

and cyclophone is shown in Figs. 7 and 8. A block diagram explaining the operation of the transmitter is shown in Fig. 7A with the basic details of the modulating circuit—the oscillator clipper, the marker pulse generator, and the pulse position modulator—given in greater detail in Fig. 8A. The recurrence frequency is determined by the 8000-cycle oscillator, which at the same time provides a waveform suitable for starting the marker pulse generator and the pulse position modulator circuits for each channel. The marker pulse is obtained from the 8000-cycle sine wave by means of the oscillator clipper and the marker pulse generator. The pulse position modulator consists of a double triode connected as a biased multivibrator, and a single triode used as a pulse generator. Its operation may be explained briefly as follows:

In the normal state (represented by the upper set of voltage values in the schematic) the second section of the multivibrator conducts current. The application of the marker pulse causes the first section to become conducting and the second section non-conducting, even after the initiating pulse has ceased. This condition persists until current flowing through the 3.3 megohm resistor charges the coupling condenser sufficiently to permit the plate current to flow in this section of the tube, at which point a rapid reversal takes place. Modulation is produced by variation of the potential to

Fig. 9. Transmitter (A) and receiver (B) for time-modulated pairs of pulses.

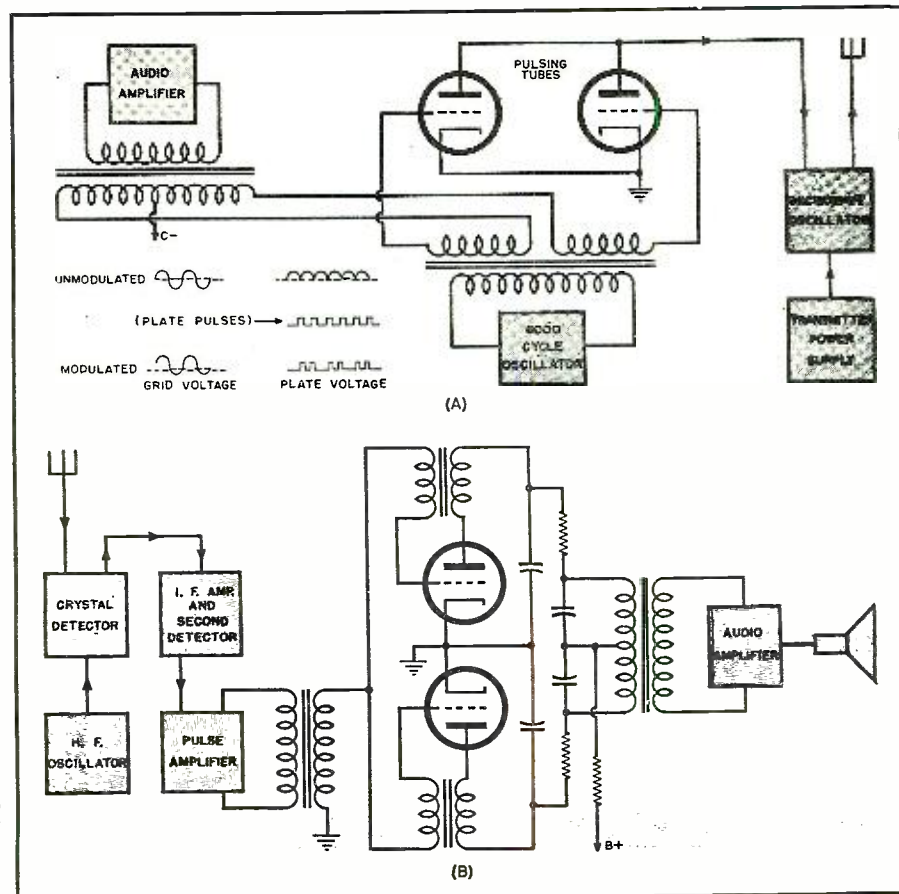



# BE A TELEVISION TECHNICIAN!

## Regularly Scheduled Programs are on the Air!

Two great broadcasting corporations have entered Television and are today producing programs. Other large organizations have applied for licenses to broadcast Television in all parts of the country! The sale of home receivers is now progressing. In other words, we believe it's the beginning of a vast and exciting new business. Regular Television broadcasting is *now* a reality!

Studio Photos Courtesy of Television Station WCBW

### TELEVISION AND YOU

The opportunity in Television is far greater for the properly trained man. You owe it to yourself to investigate Television and to prepare yourself to become a valued part of a fascinating new profession.

### PREPARE THE "AMERICAN" WAY

The American Television Institute is the oldest and largest training organization exclusively for Television. "American" students are trained by top Television engineers with the latest commercial equipment. You will train under actual Television studio conditions. You will learn by doing. You can qualify for your chosen field with the necessary fundamental knowledge plus real studio experience and skill.

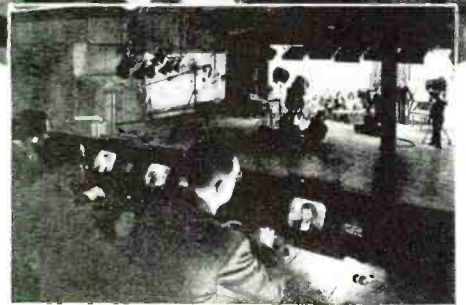

TELEVISION STUDIO CONTROL

#### VETERANS ATTENTION!

The American Television Institute has been approved for Veteran's Training under the G.I. Bill of Rights. During the war, thousands of Signal Corps men were trained under contract with the War Department. Our training methods have been developed to a high degree and our school has up to the minute facilities in every respect. If you are a veteran, mark the coupon for the G.I. Eligibility Questionnaire.

#### WHICH PHASE OF TELEVISION?

The American Television Institute's tremendous facilities offer a complete selection of Television study—broadcast studio and control, broadcast transmitter, receiver installation and service—in fact, all departments are thoroughly covered in our laboratories.

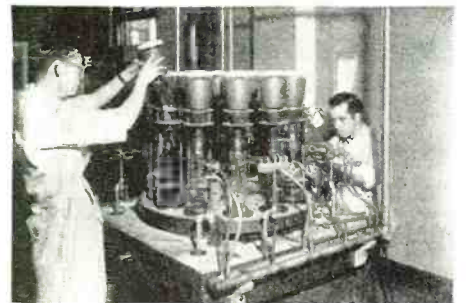

TUBE MAKING AT A.T.I.

#### WHEN DO YOU START?

The best time is right now! Immediately! New classes are forming every week. Use the coupon to get further details. Mail it today!

## American Television Institute

DIVISION OF

AMERICAN TELEVISION LABORATORIES, INC.

433 E. Erie Street Chicago 11, Illinois

**MAIL THE COUPON TODAY**

#### REQUEST FOR FREE INFORMATION

AMERICAN TELEVISION INSTITUTE  
433 E. Erie St., Chicago 11, Illinois

- I am interested in training under the G.I. Bill of Rights. Send Questionnaire.
- I am interested in your regular Television Training.

NAME.....

ADDRESS.....

CITY & STATE.....

April, 1946

BUILD YOUR 18 WATT HIGH FIDELITY AMPLIFIER FLAT  
FROM 30-12000 CYCLES  
WITH HIGH QUALITY DISTORTIONLESS

# Laboratory TRANSFORMERS



## DRIVER TRANSFORMER D-504

Any driver tube to Push Pull 6L6  
Uniform response  $\pm 1dB$  30-12000 cycles

## OUTPUT TRANSFORMER 18 R7

PUSH FULL 6L6 3800—4-5-6-8-13-500 ohms  
Uniform response  $\pm 1dB$  30-12000 cycles

COMPLETE CIRCUIT DIAGRAM SUPPLIED  
WITH EVERY OUTPUT TRANSFORMER

If your dealer cannot supply  
you, write directly to—

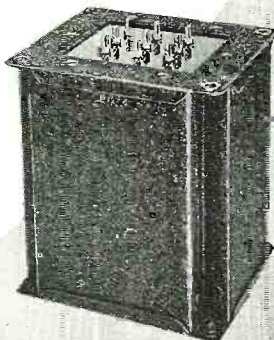

**INDUSTRIAL TRANSFORMER CORP.**  
(ELECTRONICS DIVISION)  
2540 BELMONT AVENUE, NEW YORK, N. Y.

which the 3.3 megohm grid resistor is connected, by connecting it to the output of an audio amplifier tube. The mean length of the square wave generated by the multivibrator is adjusted to place the channel pulse in its normal unmodulated position by means of the variable load resistor in the plate circuit, which adjusts the time constant of the multivibrator. The transient in the pulse generator tube when the reversal takes place causes the position-modulated pulse, by pulsing into one-half cycle of oscillation the tuned circuit formed by the inductance  $L_1$  and the input capacity of the following tube. The remaining features of the transmitting circuit are quite conventional, as can be seen from the block diagram.

The operation of the receiver circuit can be understood from the block diagram in Fig. 7B and the demodulator schematic in Fig. 8B. The pulse position modulation is converted to amplitude variation by first converting it to pulse length modulation, then filtering out the voice frequencies below 3000 cycles from the pulse length-modulated signal. This conversion is accomplished by means of a multivibrator circuit. For each multiplexed channel there is a gate pulse which is generated in a fixed relationship to the marker pulse, as shown. When the voltage of the modulation pulse is superimposed on the gate pulse, the multivibrator is triggered and remains operative until the end of the gate pulse interval. This results in an output square wave whose leading edge is varied at the voice frequency. The remaining features of the receiver circuit are quite conventional, as can be seen from Fig. 7B.

The circuits for pulse-time modulation and demodulation employing conventional tubes are seen to be somewhat more complicated than those making use of the cyclodos and cyclophone tubes, especially for multiplex communication. However, for single-channel operation the circuit is not too complex, and it has the advantage of using standard tubes which are readily available. At the same time, it affords the radio amateur an interesting opportunity to experiment with extremely useful pulse and non-standard wave-form techniques.

(c) Circuits for pulse transmission and reception by variation of the timing between pairs of pulses without the use of a reference pulse are shown in Fig. 9. In the transmitting circuit the pulses are generated by connecting the grids of the pulsing tubes in push-pull, and the plates in parallel. The manner in which the pulsing and pulse timing is accomplished can be seen from the wave-shapes shown in the diagram. With no modulation applied, one or the other of the pulsing tubes passes current at all times except when the input from the constant-frequency source is near the zero value. For near zero values, both tubes are simultaneously cut off and a short

for a PERFECT CONVENTION  
in Suburban Chicago—or a

# SPRING HOLIDAY

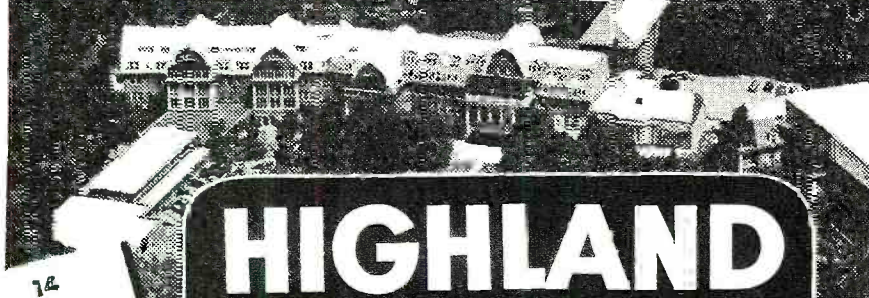

14  
ACRES  
ON LAKE  
MICHIGAN

# HIGHLAND PARK ILLINOIS

One of America's top-flight, year-round Resort Hotels, where conventions become a delightful event... The Moraine front on Lake Michigan, is spread out over 14 acres of picturesque ravine land and has 250 rooms of graceful Georgian architecture. It inspires concentrated effort and is conducive of leisurely living and outdoor recreation.

We can conveniently care for groups up to 150 persons. Conventions are accorded guest membership in our popular Beach Club.

Chicago is 32 minutes by fast transportation. Inquiries are invited. Address same to

HOTEL

*Moraine* - ON - THE - LAKE  
Highland Park, Ill.

*A powerful display...*



**RAYTHEON  
Bonded  
ELECTRONIC  
TECHNICIANS**

**THIS RADIO REPAIR SHOP IS BONDED, BY WESTERN NATIONAL INDEMNITY CO., TO:**

- 1 Guarantee all radio repair work for 90 days.**
- 2 Use only parts of recognized quality.**
- 3 Charge not over established prices for parts.**
- 4 Test customers' tubes as accurately as possible.**
- 5 Keep labor charges at a reasonable level.**
- 6 Perform only such work as is necessary.**
- 7 Maintain the highest quality service.**
- 8 Maintain proper equipment for good repair work.**



**...to KEEP CUSTOMERS COMING!**



*Excellence in Electronics*

RADIO RECEIVING TUBE DIVISION  
NEWTON, MASS. • NEW YORK • CHICAGO



Bringing radio repairing right out in the open for all your customers, this Raytheon Bonded Electronic Technician display tells them exactly how you operate in *their* interest. And that means *profitable* repeat business.

This is only one of many ways your prospects and patrons will learn to identify your shop with fair prices, quality work and guaranteed reliability. Find out how you can qualify to become a Bonded Electronic Technician. Bonded service means better customer relations. For full details, see your Raytheon distributor today.

**ANOTHER REASON WHY IT PAYS TO QUALIFY AS A RAYTHEON BONDED ELECTRONIC TECHNICIAN**

# Radio Headquarters

for 25 years



**We ship at once—parts, equipment, whatever you need!**

This house began its career almost as early as Broadcasting itself! Today, 25 years later, we're the world's largest radio supply house! **Standard Lines:** National, Hammarlund, R. C. A., Hallicrafters, Bud, Cardwell, Bliley, and all the others!



**SUPERSPEED SERVICE** Orders shipped out same day received, on most goods.



**ENGINEERING SERVICE** If your engineering problem requires special equipment, we'll make it

**FREE!**

Latest bargain flyer includes test instruments, record changers, communication receivers, ham transmitting tubes and a host of electronic items you need today.



Originators and Marketers of the Famous

*Lafayette Radio*

**Radio Wire Television Inc.**

NEW YORK 13 BOSTON 10 NEWARK 2

Cut out coupon, paste on penny post card, mail today

**R. W. T. Dept. RD 6**  
100 AVENUE OF THE AMERICAS, NEW YORK 13

Gentlemen: Send me FREE copy of your Latest Bargain Flyer C-36, packed with recent electronic equipment and components.

NAME \_\_\_\_\_

ADDRESS \_\_\_\_\_

CITY \_\_\_\_\_ ZONE \_\_\_\_\_ STATE \_\_\_\_\_

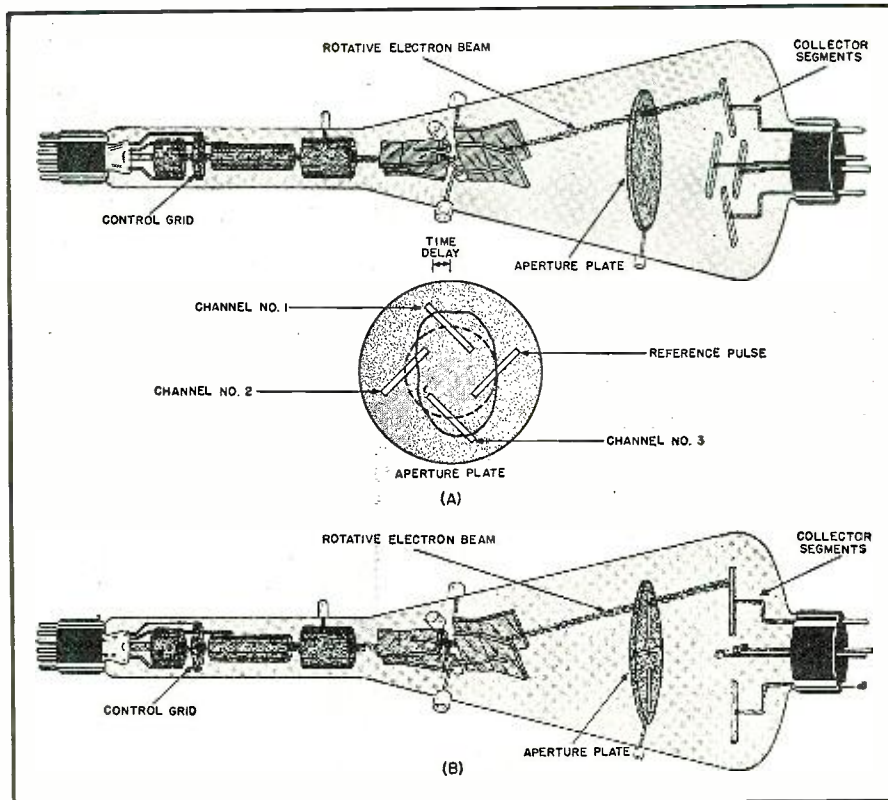

Fig. 10. Artist's illustration of the cyclodos tube (A) and the cyclophone (B).

pulse of relatively high potential is passed into the transmitter. With no modulation these pulses are uniformly spaced. When modulation is applied the bias potential of both grids is varied in opposite directions, thus drawing alternate pulses together. Reversing the polarity of the modulation potential causes the pulses to be pushed apart.

The demodulator in the receiver makes use of two pulsing oscillators of the type used to produce saw-tooth potentials in television receivers, each adjusted to the same frequency as the oscillator in the transmitter, with a common plate resistor to make them tend to operate 180° out of phase. The received pulses synchronize the operation of the oscillators, alternate pulses controlling each oscillator. Thus, when a received pulse advances the pulse of

one oscillator, it retards the pulse of the other. Since the received pulses modulate the phase or timing of the oscillations of each pulse oscillator, but not the frequency, they vary the average current through the tubes. Therefore once the oscillators have dropped into synchronism with the received pulses, the average plate current will be modulated by the pulse modulation. This provides the original audio signal which was transmitted.

From the above discussion of the theory of pulse-time modulation and from the circuits that have been described, the amateur who desires to experiment in microwave communication should be able to design and construct a pulse-time modulation rig to use on these frequencies.

—50—

## NEW ADDITIONS TO AMATEUR CALLS

W1HNN  
W3BIZ  
W3CJT  
W3DF  
W3KAI  
W3KAJ  
W3KAK  
W3KAL  
W3KAM  
W3KAN  
W4ERE  
W4IIS  
W4IIT  
W4IIV  
W4IIV  
W5KTB  
W6AIW

Solomon Smith  
Maurice Davis Corson  
James Alvin Sutherland  
George Edward Sterling  
William Lawson Vandal, Jr.  
George R. Boardman  
Morris M. Goodman  
Thomas Arens Pendleton  
Thomas William Kelley  
Charles Warren McDormand  
John Galbraith Cormack  
John Douglas Morgan  
Carl H. Hatch  
William E. Albert  
James Aaron Spraggins  
Grady Lee Breece  
John Wesley Crews

16 Parkman  
508—73rd, N. E.  
4950 Chesapeake  
1003 Noyes Dr.  
4336 Lily Ponds Dr.  
5416 Kansas Ave.  
557 E. Frederick  
7605 Dellwood Pl.  
906 Garland Ave.  
6708 Cockerille  
1411 Flagler Ave.  
2006 Ohio Ave.  
3075 N. Pollard  
601 Queen  
4851 Manchester  
3105 Metairie Rd.  
Lawndale Rd., 2½  
Mi. S. W. of  
720 N. Alpine Dr.  
7716 N. Marshfield

Brookline, Mass.  
Carmody Hills, Md.  
Chevy Chase, Md.  
Silver Spring, Md.  
Washington, D. C.  
Washington, D. C.  
Lancaster, Pa.  
Bethesda, Md.  
Takoma Park, Md.  
Takoma Park, Md.  
Key West, Fla.  
Augusta, Ga.  
Arlington, Va.  
Alexandria, Va.  
Jacksonville, Fla.  
New Orleans, La.  
  
Kenwood, Calif.  
Beverly Hills, Cal.  
Chicago, Ill.

W6QUT  
W9ECJ

Freeman F. Gosden  
Allen Don

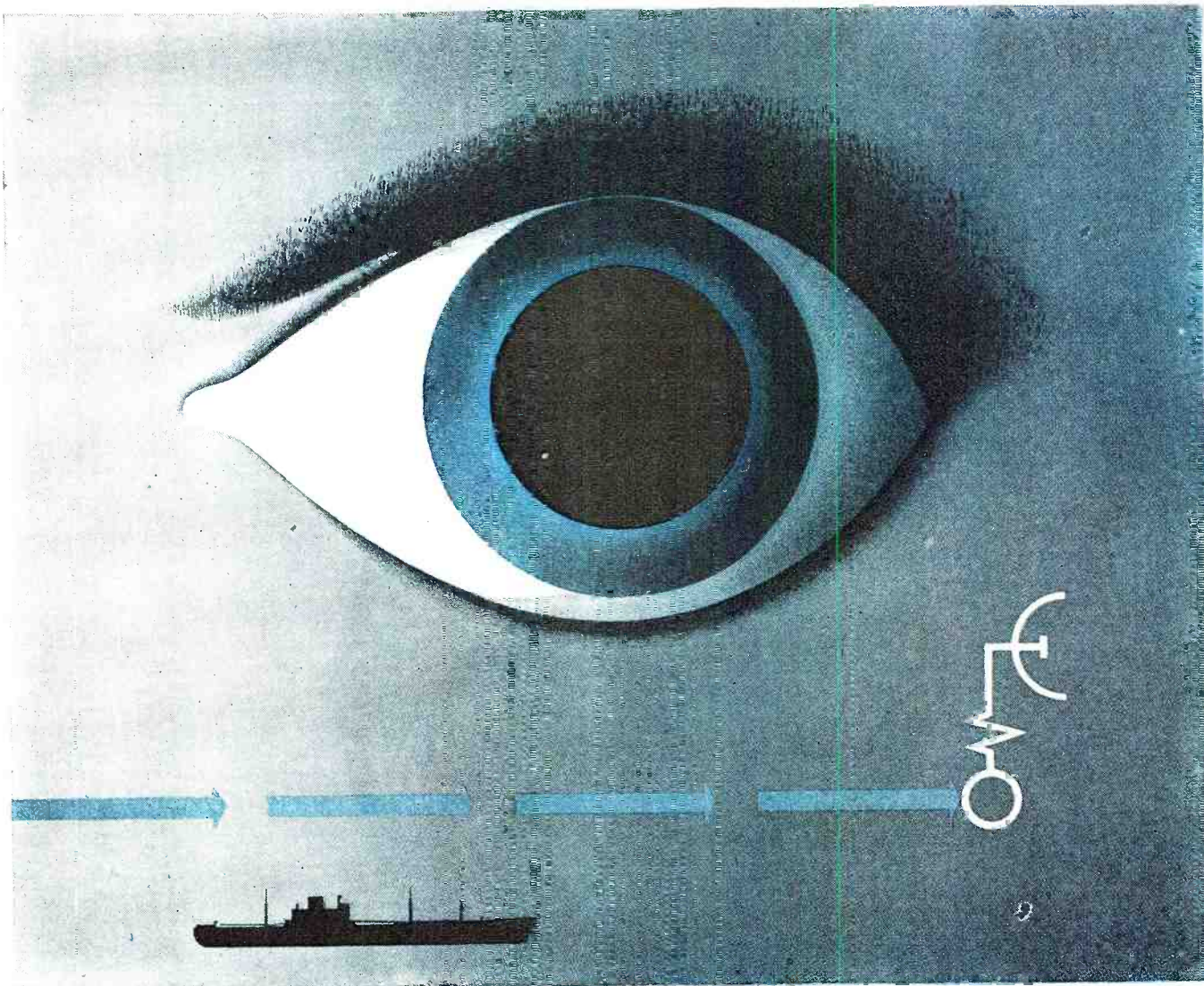

## Look ahead <sup>to</sup> / <sub>with</sub> Radar by Sperry

• This year, Sperry Gyroscope Company introduces its new *Radar* equipment for marine use.

*Sperry Radar* has been conceived to function better in this fundamental service: *To enable ships to operate on schedule regardless of visibility...through thick fog, heavy rain, dense smoke, darkness.*

As an aid to navigation it picks up channel markers and buoys; assists in making landfalls with assurance; spots icebergs, floating derelicts and other hazards projecting above surface. It also permits vessels to enter harbors and proceed with

all due safety and caution through fog. Another important feature: *Sperry Radar* provides a Gyro-Compass-controlled image and can be operated by bridge personnel without extensive technical background.

In design and construction, *Sperry Radar* reflects this company's many years of experience in precision manufacture of marine equipment—as well as its outstanding achievements in the field of electronics. In simplicity and dependability, this new *Radar* exemplifies again Sperry's ability to build superior products for merchant ship service.

### Sperry Radar Features:

- Designed to meet all Class A specifications of the U. S. Coast Guard.
- Maximum range 30 miles—minimum, 100 yards.
- 10-inch picture on a 12-inch screen.
- Images presented in true or relative relationship at option of operator.
- Gives accurate ranges read from indicator instead of estimated from scope.
- Backed by world-wide service.

**SPERRY GYROSCOPE COMPANY, INC.** GREAT NECK, N. Y.



*Division of the Sperry Corporation*

★  
LOS ANGELES • SAN FRANCISCO • SEATTLE • NEW ORLEANS  
CLEVELAND • BROOKLYN • HONOLULU

GYROSCOPICS • ELECTRONICS • RADAR • AUTOMATIC COMPUTATION • SERVO-MECHANISMS

for everything in  
**ELECTRONICS**  
and **EQUIPMENT**  
follow  
**ARROW!**

**The New Model  
CA-11  
SIGNAL TRACER**

Simple to operate . . .  
because it has only  
ONE connecting cable—  
NO tuning controls!



Signal Intensity Readings  
Are Indicated **DIRECTLY ON THE METER!**

**FEATURES:**

- **HIGHLY SENSITIVE**—uses an improved Vacuum Tube Voltmeter circuit.
  - Tube and resistor-capacity network are built into the Detector Probe.
  - Comparative Signal Intensity readings are indicated directly on the meter as the Detector Probe is moved to follow the Signal from Antenna to Speaker.
  - Provision is made for insertion of phones.
  - **COMPLETELY PORTABLE**—weighs 5 lbs. and measures 5 x 6 x 7 inches.
- Housed in beautiful, hand-rubbed wooden cabinet. Complete with Probe, test leads and instructions. Net. . . . . **\$18.75**

**Pocket Size  
Model A1  
VOLT-OHM  
MILLIAMMETER**

An Approved  
Electronic Instrument

A combination of precision, high sensitivity and low cost in a universal meter—an excellent switch-type pocket instrument. Removable leather strap. Size 1 3/4 x 5 3/4 x 3 inches.



Ranges:  
DC VOLTS: 15-150-300-1500.  
AC VOLTS: 15-150-1500.  
MILLIAMPERES: 1.5-15-150.  
DC RESISTANCE: 3000-300,000 ohms.

Net. . . . . **\$18.75**

**High Impedance  
HEADPHONES**

Made for the  
U. S. Signal Corps

Brand new, high quality super-sensitive headphones. Built to rigid government specifications—for service and sturdiness. One of the exceptional values found at **ARROW ELECTRONICS COMPANY.**



Headphones are equipped with **STANDARD PHONE PLUG.**

Net. . . . . **\$2.45**

20% deposit on C.O.D. orders. Please remit sufficient postage—excess will be refunded.

Write us for anything in **ELECTRONIC PARTS and EQUIPMENT.** Get on our mailing list and keep informed as merchandise becomes available.

Please mention Dept. RN when writing or ordering

**ARROW**  
**ELECTRONICS COMPANY**  
82 CORTLANDT ST., NEW YORK 7, N. Y.  
Whitehall 3-2696

..... **LETTERS** .....  
**FROM OUR READERS**

"I AM just a newcomer to the radio servicing field and your magazine is a godsend. Every little hint I get is very useful to me and the varied selection of articles just fits this need.

"Another point that I would like to mention is that many able radio and appliance repairmen work only in off hours as I do and do not want to lay out a lot of cash for test equipment and service Manuals. I have to get along with a VOM, tube tester, and signal generator. I cannot possibly afford a set of service manuals and, therefore, have to waste much valuable time in hunting up someone who does possess some. Many letters have been written to manufacturers asking, pleading, appealing to them to include circuit diagrams with their sets. Many have not complied and this feature could be added at such a negligible cost that it seems downright outrageous to us *off time* repairmen."

A. H. Ismach  
New York City

*We heartily agree that set makers should paste a schematic in every cabinet. It's inexpensive and practical.*

\* \* \*

**HIS SHACK INSTALLED**

"IN THE June 1945 issue of **RADIO NEWS**, a letter of mine was published, topic of which was postwar planning of 'ham shacks.'

"I have since been discharged from the Army, November 14, 1945 to be exact. I didn't go back to my former job until December 17, 1945. This gave me a month to get a 'shack' installed.

"The entire room and furniture is done in light blue and yellow. The various cabinets I have in the room hold my radio parts, supplies, tubes and my photographic equipment. Each drawer or shelf has certain items, all antenna equipment in one drawer, condensers in another, etc.

"I have branched out in my radio hobby since going into the Army, having gone into making recordings of radio programs, short-wave signals, this replacing letter writing in some cases. Thanks to **RADIO NEWS**, I was able to buy a GE Recorder from a lad in Pennsylvania. I also want to thank **RADIO NEWS** for publishing my letter in the June, 1945 issue. It brought me a letter from Henry (Hank) M. Henriksen, Model Radio & Sound Company of Racine, Wisconsin. He wrote me that he liked my letter and idea of a postwar 'ham shack.' We have been writing and sending each other recordings ever since. He gave me a lot of helpful hints in wiring my GE recorder to my Hallicrafter SX-28A receiver.

"My radio equipment consists of a

9-tube Postal short-wave set, speaker being at the bottom of the rack. Other radio is a Hallicrafter SX-28A which is working out swell. Speaker is on top of receiver. Earphones are used during late hours.

"The PA equipment is a homemade job, being a 10 watt outfit. Speaker for that is on top of rack, baffle board of said speaker has my initials. It was made by a ham in Oklahoma some years back. There is a double button mike to left of rack.

"I have three antennas. One a copper wire some 220 feet long, running east and west. Second antenna is a 62 inch car aerial with a twisted pair. Both of these antenna lead-ins go to a double-pole, double-throw switch. They are used with the Hallicrafter receiver. The third antenna is a wire run from a cold water pipe to my Postal receiver. This wire is connected to a single-pole, double-throw switch. The reason for that is, when I am not using the ground for an antenna, I use it as a ground to a filter I have on the power line to the Hallicrafter.

"One Sunday of recent date I tuned in Sweden and made a recording of some music. This made a hit with my wife and mother-in-law as they are Swedish.

"It sure feels good to get back to my short-wave hobby again and read my **RADIO NEWS** in the comfort of my shack and home.

"I intend to set up a speaker or two upstairs (my shack is in the cellar) so that when I get some 'hard to get' short-wave stations, others can hear them too. We are all 'radio minded' here.

"Might add that the Postal receiver is worked on a drawer system in changing coils for various bands. I expect to get my 5 meter receiver back into operation soon.

"I am always ready to swap shack photos with readers of **RADIO NEWS**."

Alfred G. King  
8010—97th Avenue  
Ozone Park, 17, Long Island

*Our thanks to Reader King for the photographs of his shack. Sorry we haven't space to publish them here.*

\* \* \*

**PARASITICS**

"**PARASITICS** to **RADIO NEWS** and to John S. Jackson for his article in the February issue on "Parasitics in Transmitters."

"Here at the northernmost spot of civilization on the North American continent I had no end of trouble in trying to cure the ills of a 1 kw. T/5 FRC transmitter. The unit was designed to work down to 150 kc. and specifications called for operation on 130 kc. on a point-to-point net. I had





**Thanks to  
7 tough  
Years...**

*... this greatest of test instruments has been tested into top ranking reputation*

The Simpson 260 has out-sold and out-performed every other even remotely similar test instrument in the electronic and electrical fields ever since its introduction in 1939. Through the ensuing seven years, covering the War period, circumstances gave it a gruelling test for accuracy never visioned by its makers. It stands today as irrefutable proof that Simpson design and Simpson quality produce accuracy that stays in an instrument year after year.

The demand for the 260 from men who first used it in the Armed Services (in laboratories of 300 government agencies and universities, and on the battlefields the world around) has now been added to its enormous popularity among radio servicemen. The Simpson 260 is easily the world's most popular high-sensitivity set tester for television and radio servicing.

The basic reason for this out-selling and out-performing by the Simpson 260 is this: It out-values every other similar instrument in the field. You cannot touch its precision, its useful ranges, or its sensitivity in any other instrument selling for the same price or even substantially more.

**SIMPSON ELECTRIC COMPANY**  
5200-5218 W. Kinzie St., Chicago 44, Ill.

**Simpson**

INSTRUMENTS THAT STAY ACCURATE

**SIMPSON 260, HIGH SENSITIVITY SET TESTER FOR TELEVISION AND RADIO SERVICING**

Ranges to 5000 Volts—Both A.C. and D.C.  
20,000 Ohms per Volt D.C.  
1000 Ohms per Volt A.C.

At 20,000 ohms per volt, this instrument is far more sensitive than any other instrument even approaching its price and quality. The practically negligible current consumption assures remarkably accurate full scale voltage readings. Current readings as low as 1 microampere and up to 500 milliamperes are available.

Resistance readings are equally dependable. Tests up to 10 megohms and as low as 1/2 ohm can be made. With this super sensitive instrument you can measure automatic frequency control diode balancing circuits, grid currents of oscillator tubes and power tube, bias of power detectors, automatic volume control diode currents, rectified radio frequency current, high- $\mu$  triode plate voltage and a wide range of unusual conditions which cannot be checked by ordinary servicing instruments. Ranges of Model 260 are shown below.

Price, complete with test leads.....\$33.25  
Carrying case ..... 4.75

Volts D.C. (At 20,000 ohms per volt)	Volts A.C. (At 1,000 ohms per volt)	Output
2.5	2.5	2.5 V.
10	10	10 V.
50	50	50 V.
250	250	250 V.
1000	1000	1000 V.
5000	5000	5000 V.

Milli-amperes	Micro-amperes	Ohms
D.C.		
10	100	0-1000 (12 ohms center)
100		0-100,000 (1200 ohms center)
500		0-10 Megohms (120,000 ohms center)

(5 Decibel ranges: -10 to +52 DB)

**ASK YOUR JOBBER**

# At Last!!

## A Complete, Practical Handbook of Present-day TELEVISION

Now, the tremendous opportunities in the field of television are brought within your reach—by means of this crystal-clear book. Written in plain English, concise and up to the minute, it makes television easy to understand. There is no mathematics to confuse you and make explanations difficult to follow. Hundreds of vivid illustrations bring every fact and point right before your eyes. You'll be amazed at how simple television can become with



# TELEVISION SIMPLIFIED

by MILTON S. KIVER

Associate Instructor in radio, U. S. Army Air Forces. Formerly Instructor in radio, Illinois Institute of Technology.

This brand-new, authoritative handbook not only contains all the information you need for success in television, but covers the trouble shooting and repair of radio sets. Beginning with a clear, overall picture of the entire field, it breaks down the television receiver into its component parts and circuits. It analyzes them, step by step, showing how they are formed, the roles they play, and their operating characteristics.

### BRIEF OUTLINE OF CONTENTS

The Television Field; Ultra-high Frequency Waves and the Television Antenna; Wide-band Tuning Circuits, Radio-frequency Amplifiers; The High-frequency Oscillator, Mixer and Intermediate-frequency Amplifiers; Diode Detectors and Automatic Volume-control Circuits; Video Amplifiers; Direct-current Reinsertion; Cathode-ray Tubes; Synchronizing Circuit Fundamentals; Deflecting Systems; Typical Television Receiver—Analysis and Alignment; Color Television; Frequency Modulation; Servicing Television Receivers; Glossary of Television Terms.

### EXAMINE THIS BOOK FREE

Let this book prepare you to take advantage of the brilliant opportunities television offers. Send for it NOW!

By the same author:  
U. H. F. RADIO SIMPLIFIED . . . \$3.25.  
A complete, up-to-date book on the methods and equipment used in ultra high frequency radio, that has so many applications in war and peace.

### MAIL THIS COUPON

D. VAN NOSTRAND COMPANY, INC.  
250 Fourth Avenue, New York 3, New York

Please send me the book or books I have checked

- Television simplified @ \$4.75  
 U. H. F. Radio Simplified @ \$3.25

Within 10 days I will either return the book or books, or send you the purchase price plus a few cents postage. (If you enclose check or money order with this coupon, we will pay the postage. Same return privilege and refund guarantee.)

Name .....

Address .....

City .....

State .....

Radio News—Apr. '46

tried a number of schemes, being hampered by the lack of practically everything in test equipment and the great distance to supply depots.

"I was at the end of my rope and was practically stumped. Then my eye fell on that copy of RADIO NEWS and in turning through the pages I came across Mr. Jackson's article. That was the spark I needed. Since the final in this transmitter consists of four 810's in parallel, I was convinced that the trouble I had encountered lay in the fact that no parasitic suppressors had been put in, either in the plate or grid circuits. Using a 350 ohm resistor with 5 turns of No. 12 wire around it, in series with the four plate connectors, and four 50 ohm resistors with 7 turns of No. 20 wire around them, one each in series with each grid, I was very pleased to find that my trouble had vanished. The values of the resistors probably are not critical, but they were all I had on hand.

"Since this is probably the largest installation of its kind north of the Arctic Circle, and probably the most northerly transmitter set-up on the continent, I thought you might be interested in the helpful part your magazine played. I have been a reader of RADIO NEWS for nearly ten years but I can assure you that no issue meant as much as the February issue did.

"Fairbanks reads us 5-5 and stations as far south as Great Falls have read us loud and clear. 130 kc. seems to be able to get through when all other frequencies are blocked by the Northern Lights.

"In closing, I join with Mr. Jackson in saying that while parasitics may be an "Act of God" it was certainly a similar "act" that brought that copy of the magazine at just the right time."

S/Sgt. F. B. Andrews  
U. S. Army Signal Corps

*Thank you Sargeant for your kind words. It's nice to know that occasionally the "crystal ball" is right.*

\* \* \*

### CORRESPONDENTS WANTED

THANK you for starting my subscription to RADIO NEWS. your review is very interesting, above all for us French who were cut off from the world for five years.

"Could you get for me the address of one or two young American engineers working as professional radio men (sending or receiving—one each) because I would like to have correspondence with them. I am, myself, a technician (the grade below engineer) for the sending of broadcasting."

M. Drieu  
19 rue de Turenne  
Brive, Correze  
France

*How about some of you broadcasting engineers writing to Reader Drieu? You should write him direct, at the address given.*

*Manufacturers  
Jobbers  
Inquiries  
Invited*

AVCO  
dependable

Standard  
Replacement  
Volume  
Control

Manufactured and Distributed By

**AMERICAN VOLUME CONTROL CORPORATION**

115 Liberty St., New York 6

**NIAGARA RADIO SUPPLY**

**SAVE MONEY BY BUYING THE NIAGARA WAY**

Wonderful Buy. This Meter has multipliers and shunts to build your own Volt-ohm-meter or Vacuum tube Voltmeter

**\$8.95**

Model 301  
Weston  
0-1 M I  
Movement

Release by U.S. Sig. Corps

813 Modulation output Trans. & Screen Will Mod. plate.....	<b>\$4.95</b>
Combination 3000 V. c.t. plate Trans. & 7½ Henry choke 300 M.	<b>\$13.95</b>
Combination trans & choke 1000 V. DC out of filter. Will deliver.....	<b>\$6.95</b>
2 MFD 600 V. oil filled cond .....	<b>49c</b>
Allied 110 V. AC relay 10 A. contacts .....	<b>\$1.65</b>

Send for Bulletin "A1"

**NIAGARA RADIO SUPPLY Corporation**

160 GREENWICH ST., N. Y. 6, N. Y.  
BOWLING GREEN 9-7993

# IT'S RIGHT.



for  
**VERSATILITY**

for  
**MODERN  
BROADCASTING  
TECHNIQUE**

for  
**DEPENDABILITY**

for  
**EASY  
OPERATION AND  
SHOWMANSHIP**

## The **GATES** 1-KILOWATT TRANSMITTER

It has everything you want in performance—modern broadcasting technique from circuit developments, now incorporated, which are the result of proved laboratory tests. It is versatile to meet all demands. Yes, and it is dependable under all circumstances. In addition to these mechanical perfections which Gates engineers assure, the BC-1E Transmitter combines easy operation and beauty in appearance to make your Station outstanding in showmanship. It is RIGHT for the 1-Kilowatt Station. Investigate it!

### CONDENSED SPECIFICATIONS

**FREQUENCY RANGE:** 530 to 1600 K. C.  
**FREQUENCY STABILITY:** Plus or minus 10 cycles maximum.  
**POWER OUTPUT:** 1000 Watts. May be operated as 500 Watt Transmitter. Power reduction for night operation may be incorporated to suit requirements.  
**POWER SUPPLY:** 230 Volts, 60 Cycles, single phase, regulation not to exceed plus or minus 5%.  
**FREQUENCY RESPONSE:** Within 1½ Db. from 30 to 10,000 cycles.  
**DISTORTION:** Less than 3% from 50 to 7500 cycles, 0-95% modulation.  
**NOISE LEVEL:** 60 Db. below 100% modulation.

**WRITE FOR COMPLETE SPECIFICATIONS**

**NEW YORK OFFICE:  
9TH FLOOR, 40  
EXCHANGE PLACE**

**GATES**

**RADIO CO.  
QUINCY, ILL.**

**SOLD IN CANADA BY:  
CANADIAN MARCONI CO., LTD.  
MONTREAL**

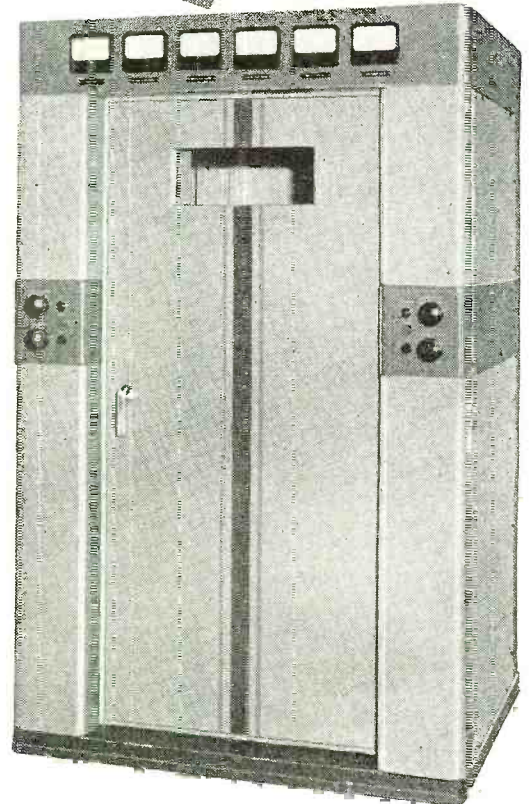

**EXCLUSIVE MANUFACTURERS OF TRANSMITTING EQUIPMENT . . . SINCE 1922**

**DRIVE AHEAD WITH**

*Smooth Power*

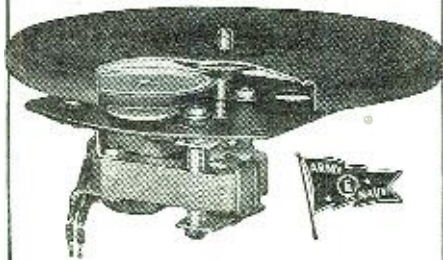

• You'll travel the roads to future markets faster and easier when you standardize on General Industries *Smooth Power* motors. Quick starting, uniform speed and quiet performance have for years made these motors leaders for phonographs, recorders and record-changers. From the GI complete line, select the proper motor for your new design. *For smooth performance, standardize on Smooth Power.*



**The General Industries Company**  
DEPT. M • ELYRIA, OHIO

**TECHNICAL BOOK  
& BULLETIN REVIEW**

**"TWO-WAY RADIO"** by Samuel Freedman. Published by *Ziff-Davis Publishing Company*, Chicago. 468 pages. Price \$5.00.

This book covers the various applications of two-way radio for railroads; police, fire and forestry services; highway and public transportation; marine applications; aircraft; and personal communications.

The author has developed the theory and construction of various types of two-way radio equipment, including AM, FM, carrier and microwave, and has then proceeded to discuss the various applications of this equipment to certain specific communications problems.

Included in the text is a discussion of power supplies, mobile stations, fixed stations, antenna systems, maintenance, repair, licenses and regulations.

While the book cannot be classified as an elementary text, much of the material included could be easily understood by the layman. This book is recommended as a source book for organizations employing two-way radio or those contemplating such an installation.

**"TELEVISION SHOW BUSINESS"** by Judy Dupuy. Published by *General Electric Company*, Schenectady, New York. 233 pages. Price \$2.50.

This book is a combination analysis of past television performances and a guide book for future television productions. Miss Dupuy spent seven and a half months at the General Electric television studio WRGB in Schenectady where she gathered information about video programs from the viewpoint of the producer, engineer, and actor.

Up to the time that this book was written, WRGB had produced 958 live talent shows, ranging from puppet shows to full length operas. The experience gleaned from these over-all productions has been carefully analyzed and catalogued by the author for the benefit of those who follow. The book is divided roughly into two parts, the first part dealing with the production and telecasting of programs at WRGB and the second part dealing with the engineering and production aspects of television from behind the scenes.

The book is complete, in that all types of programs are discussed on the basis of technical problems involved, techniques for color, lighting, costuming stage settings, and the use of moving pictures.

This book is recommended for those whose future plans call for their participation in some phase of the television industry, whether technical, production or acting. Written in clear-cut, understandable style, it should prove to be a valuable "guide book"



**TROUBLES?**

Send them to us. We're specialists in solving problems due to shortages in radio and electronic parts. We have thousands of items in stock for immediate delivery.

Write for Free 1946 Parts Catalog



731 West Washington Boulevard  
Dept. N CHICAGO 6, ILLINOIS

**POST-WAR  
Special**



**6 TUBE "SUPER HET"  
RADIO KIT**

Complete, including Attractive Walnut Cabinet. Diagram Furnished. Uses two 6ST—one 6SK—one 6SQ—one 25L6—one 25Z6.

**ALL PARTS MOUNTED**

To assemble, all one needs is a soldering iron and 30 minutes of your time.

**\$16<sup>95</sup>** LESS TUBES

Limited Quantity on Hand

TERMS: 10% DEPOSIT WITH ORDER—BALANCE C. O. D.

**LIBERTY SALES CO., INC.**  
115 WEST BROADWAY - NEW YORK 13, N. Y.

for the newcomer to the field as well as to the "seasoned" trouper in the industry.

**"PRACTICAL RADIO AND ELECTRONICS COURSE,"** M. N. Beitman, editor. Published by *Supreme Publications*, Chicago. 332 pages. Price \$3.95.

This volume is a combination of three previous publications by this company, namely, "Fundamentals of Radio and Electronics," "Receivers, Transmitters and Test Equipment" and "Applied Electronics and Radio Servicing."

This text has been designed for home study of the subject and progression is logical and orderly. Self-testing questions are included on each page of the text in order that the student can be assured of complete mastery of the subject matter before proceeding to advanced material.

The book is profusely illustrated with photographs and diagrams in order that the student may become completely familiar with various radio and electronic components, and their operation.

Each volume has its own index for easy reference to subject matter covered by the text. This book is suitable for home study by the layman without an extensive mathematical or scientific background.

**"TELEVISION SIMPLIFIED"** by Milton S. Kiver. Published by *D. Van Nostrand Company, Inc.* 369 pages. Price \$4.75.

Since the servicing of television receivers may well be a profitable source of income for the radio serviceman in the near future, it is not too early for the serviceman to become acquainted with some of the operating principles and servicing techniques for television receivers.

In this book, the author has presented an easily understood picture of the television art as it has been developed up to the present time. The discussion includes color receivers, black and white reception, projection type of equipment, and direct-viewing screen types of receivers.

The first chapter is an over-all picture of the television field at the present.

The book then treats specific subjects in detail; u.h.f. waves and the television antenna; wide band tuning circuits; the h.f. oscillator, mixer and i.f. amplifiers; diode detectors and AGC circuits; video amplifiers; d.c. reinsertion; cathode-ray tubes; synchronizing circuit fundamentals; deflecting systems; an analysis of a typical television receiver and alignment procedures, color television, frequency modulation and servicing television receivers.

This book is suitable for home study and is recommended for the radio serviceman to whom a working knowledge of television will mean his bread and butter in the future.

**NEW and** **ALLIED'S 1946**  
*Ready for you!* **CATALOG**  
*of Radio and Electronic Supplies*



**FREE**  
**Send for it Now!**

**LARGEST AND MOST COMPLETE STOCKS**

Today's handiest, most complete *Buying Guide!* Brings you latest, finest values in parts, tubes, kits, tools, books, test instruments, communications receivers, Ham gear, public address and other equipment. Places at your finger tips over 10,000 items of nationally known guaranteed quality. Makes available to you the world's largest and most complete stocks under one roof . . . ready for rush delivery. Enables you to get everything you need in radio and electronics from one dependable, central source. Send for this new 1946 Catalog now. Save time, work and money!



**NEW RADIO SETS**

Parade of new 1946 models, including phonoradios, and latest communications receivers covering broadcast, short-wave and amateur bands. Beautiful styles! Wonderful performance! Outstanding values!



**HANDY RADIO BOOKS**

Specially prepared by Technical experts for radio training and for helpful reference.

Radio Formulas & Data Dictionary of Radio Terms, Radio Circuit Handbook, Radio Builders' Handbook, Simplified Radio Servicing, Radio Data Handbook — Six Books No. 37-799, 75c.

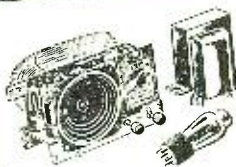

**OVER 10,000 ITEMS**

Biggest section of quality parts and equipment for engineers, dealers, servicemen, soundmen, amateurs, builders. All leading makes, at lowest prices. Send for Free Catalog now.



**NEW P. A. EQUIPMENT**

Sound systems for every public address requirement. Complete listing of amplifiers, speakers, microphones, accessories. Newest developments with many exclusive features.

**ALLIED RADIO CORP.**  
833 W. Jackson Blvd., Dept. 1-D-6  
Chicago 7, Illinois

Date .....

- Send FREE New 1946 Catalog.  
 Send Six Books No. 37-799 (75c enclosed)

Name .....

Address .....

City ..... Zone ..... State .....

**ALLIED  
RADIO**

*Everything in Radio  
and Electronics*

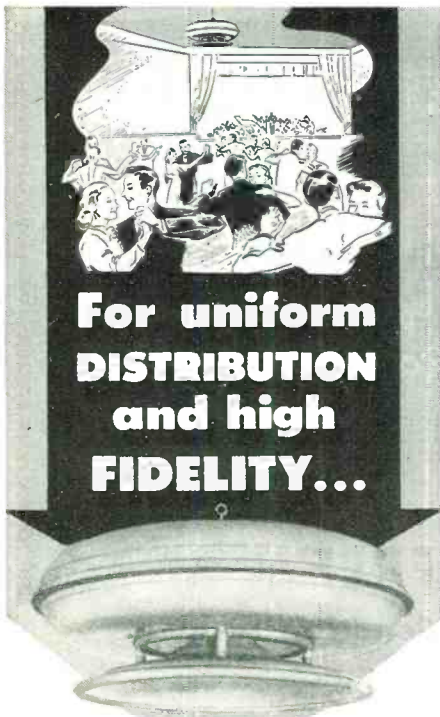

**For uniform  
DISTRIBUTION  
and high  
FIDELITY...**

*University*

**RADIAL CONE  
SPEAKER  
PROJECTORS**

The Model RBP 12 illustrated and the similar, but smaller RBP 8 are expressly designed for the high quality reproduction of music. Their exclusive infinite baffle design provides excellent low frequency response. All tendency towards mechanical resonance or rattle is eliminated through skillful engineering and rubber rim damping. Uniform sound dispersion is attained through radius of 360°, without concentration of sound directly beneath the speaker. UNIVERSITY radial cone projectors are pleasing in appearance, compact and completely "water-shedding". Continuous outdoor exposure is permissible. RBP 12 and RBP 8 are ideal for all indoor and outdoor installations where the advantages of a centralized sound source are desired.

Write today for complete information on this all-inclusive line of speaker and driver units.



**UNIVERSITY  
LABORATORIES**  
225 VARICK STREET  
NEW YORK 14, N. Y.

**Practical Radio Course**

(Continued from page 48)

The control voltage developed by the discriminator is fed to the oscillator frequency control stage. Various methods have been used to cause the positive or negative d.c. control voltage to alter the tuning of the oscillator stage to the correct value, but space limitations prevent a discussion of all of them here. In general, the final circuits are quite simple, but their design and a calculation of their constants is quite involved.

In general, the basic circuit arrangement shown in Fig. 6 is usually employed, although modifications of this circuit will be found in different commercial receivers. The control voltage supplied by the discriminator is used to control a second tube, termed a reactance tube, which is arranged to draw a reactive current (current changes lag behind corresponding voltage changes by 90°), having a value depending upon the control voltage developed by the discriminator.

The reactance tube usually is a pentode (the 6J7 is widely used for this purpose). Its plate-cathode circuit is shunted across the tuned circuit of the oscillator, and the control-grid electrode is supplied with an exciting voltage derived from the alternating voltage existing across the oscillator tuned circuit but 90° out of phase with it. In such an arrangement, the amplified grid voltage acting in the plate circuit draws an alternating plate current that is 90° out of phase with the voltage across the oscillator tuned circuit. The tube then acts as a shunting reactance having a magnitude depending upon the amplification of the tube, and hence upon the bias or control voltage developed by the discriminator system. The system is so arranged that when the i.f. carrier does not have the desired value of frequency, there results a control action in the reactance tube that shifts the frequency of the oscillator so that the i.f. carrier is closer to the desired frequency value. In this way, deviation of the i.f. carrier frequency can be reduced by a factor of 100 to 200.

The required 90° phase shift of the grid-exciting voltage of the reactance tube may be obtained by a resistance-capacitance phase splitter arrangement, as shown in Fig. 6. The potential divider consisting of  $R_2$  and  $C_2$  is designed so that the voltage at the grid is lagging behind the alternating voltage existing across the oscillator tuned circuit by nearly 90°, and hence the plate current of the control tube lags behind this voltage by the same amount. Consequently, the control tube behaves like an inductance. Blocking capacitor  $C_1$  keeps the d.c. plate voltage from the grid of the control tube.

The effect of the plate resistance of the oscillator-control tube paralleling the oscillator tuned circuit is illus-



**BIG SAVINGS**

Hundreds of specials  
for RADIO SERVICEMEN

- CATHODE RAY TUBES
- POWER & TRANSMITTING TUBES
- HEADPHONES, etc.
- HARD-TO-FIND TEST METERS

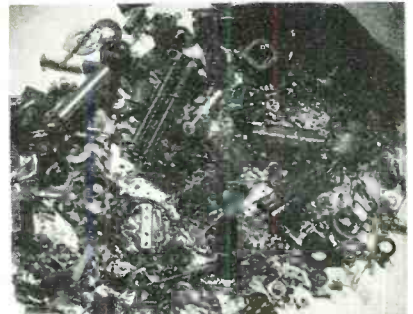

**7 LB. EXPERIMENTERS RADIO PARTS ASST.**

A "gold mine" for the experimenter, radio serviceman, handyman and repairman. Hundreds of valuable radio, radio and electronic parts, screw machine parts, bushings, sub assemblies, etc. More than your money's worth every time. An amazing value. Money-back guarantee.

**K130R — FULL 7 POUNDS ONLY \$179**

War Surplus Bargain Book

Page after page of war surplus and other bargains for the radio serviceman; a l.s.o. specials for home, shop and outdoors.

IT'S FREE! WRITE TO-DAY



**STARK'S** Dept. RN445 509 So. STATE STREET CHICAGO - 5, ILLINOIS

**CAREER**

*Radio*

**FOUR INTENSIVE COURSES**

Each one a chance for ambitious men and women to increase earning capacity and promote permanent employment.

1. RADIO TECHNICIAN. A general course including FM and Television. Students learn by constructing electronic and radio equipment under expert supervision.
2. RADIO COMMUNICATIONS. Prepare for FCC licenses. Includes telegraphy. Leads to position as merchant marine or flight radio officer.
3. AIRLINE COMMUNICATOR NON-TECHNICAL. Of special interest to YOUNG WOMEN. Prepares for employment in airport flight control offices.
4. RADIO & TELEVISION SERVICE. Employment as repairman on home-type equipment including standard broadcast and FM, as well as Television receivers.

**MELVILLE RADIO INSTITUTE**  
"the radio school managed by radio men"

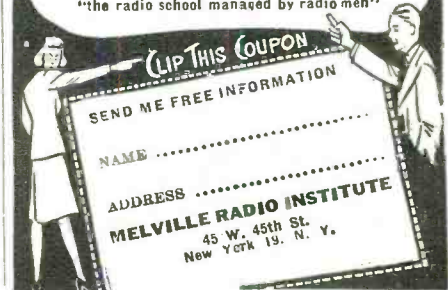

CLIP THIS COUPON  
SEND ME FREE INFORMATION  
NAME .....  
ADDRESS .....  
**MELVILLE RADIO INSTITUTE**  
45 W. 45th St.  
New York 19, N. Y.

trated in simple diagrammatic form in Fig. 7 by the automatically varying apparent inductance  $L_a$  in shunt with the oscillator tuned circuit. This apparent inductance is shown in dotted lines.

#### Summary of AFC Action

To summarize the entire AFC action, the osc. control tube is biased negatively to give a standing condition of impedance when the AFC control voltage received from the discriminator is zero, that is, when the oscillator frequency is the exact required value.

If the oscillator frequency drifts, the discriminator circuit develops a control voltage that is applied to the grid of the oscillator control tube, making it more, or less, negative according to the direction in which the tuning error lies. This makes the control tube behave virtually as a variable inductance, and this, being effectively shunted across the oscillator tuning circuit, alters the effective inductance of this circuit, and therefore its tuning. The oscillator frequency thus shifts until the AFC control voltage produced by the discriminator is reduced to zero, that is, until the i.f. carrier frequency is corrected, and the oscillator frequency therefore has been shifted to the correct value. Care has to be taken to arrange the circuits so that the d.c. control voltage applied to the oscillator control tube by the discriminator has the right sense, as otherwise the receiver pulls out, instead of pulling in to the received signal. It is evident that in receivers employing an oscillator frequency higher than that of the incoming signal, a drift in oscillator frequency towards lower frequencies makes it necessary that the discriminator apply a positive voltage to the negative grid bias circuit of the oscillator control tube. This reduces the value of the internal resistance of the control tube and so allows the plate current to increase, thus decreasing the apparent inductance effect of the tube and so decreasing the oscillator tuning inductance and causing the oscillator frequency to increase.

Fig. 6 shows how the oscillator control tube may be tied in with a conventional tickler-type oscillator circuit employing a separate oscillator tube. The AFC circuit of the *Grunow* Model 12-B receiver, illustrated in Fig. 8,

Fig. 7. The effect of the oscillator control tube is to shunt the oscillator tuning circuit with an automatically varying inductance (reactance)  $L_a$ .

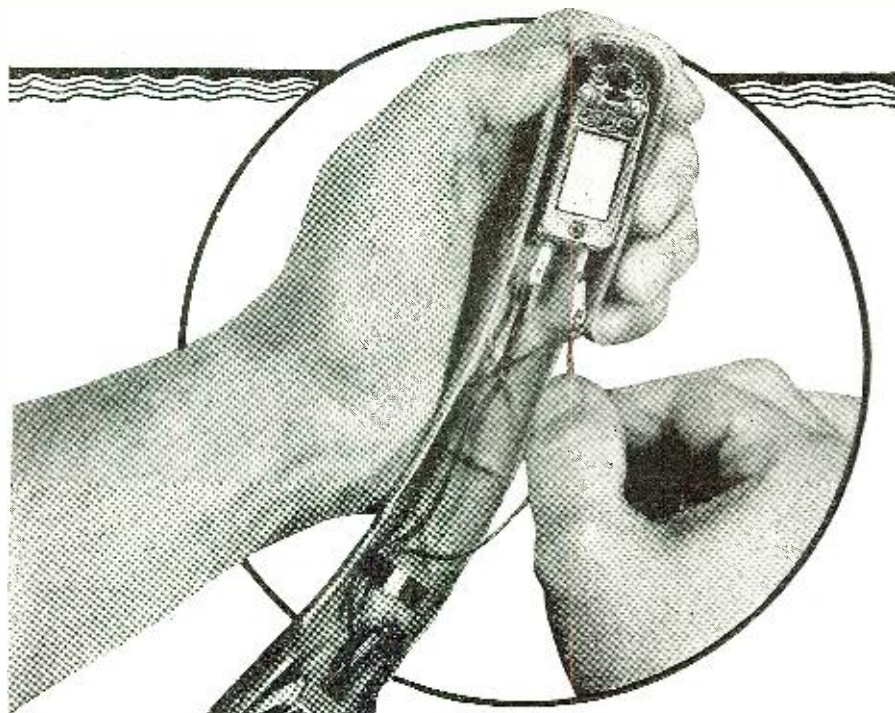
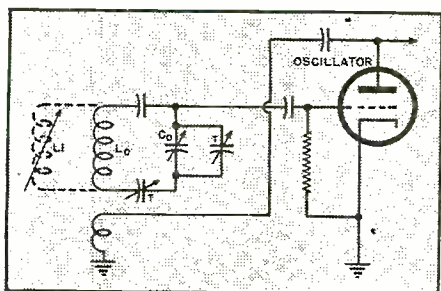

## QUICK DISCONNECT

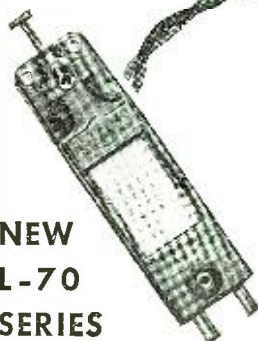

### NEW L-70 SERIES CARTRIDGES

Replaceable needle type.  
Streamlined housing.  
High output voltage.  
Low needle pressure.

Among other improvements in the design of new Astatic Phonograph Pickups is a QUICK-DISCONNECT feature for instant removal or insertion of Crystal Pickup Cartridges. Wire leads on the pickup tone arm are now equipped with special terminal connections which may be slipped on or off the cartridge pins without tools, soldering or unsoldering. Originally, these wire terminals were permanently attached to the cartridge. This new QUICK-DISCONNECT feature, used with both permanent and removable needle type cartridges in newly designed Astatic Pickups, eliminates messy soldering and saves valuable time in service work. Small details, such as this, coupled with the high operating efficiency of Astatic Pickups, contribute to their ever-increasing popularity and usage.

ASTATIC Crystal Devices manufactured under Brush Development Co. patents.

THE **Astatic** CORPORATION  
CONNEAUT, OHIO  
IN CANADA, CANADIAN ASTATIC LTD., TORONTO, ONTARIO



# Radio TUBES

Standard Brands  
ALL GUARANTEED

Available for Immediate Delivery

71A(01A) 54¢	6R7 . . . . .90¢	1T4 . . . . . \$1.20
26 . . . . .55¢	5X4 . . . . .99¢	3S4 . . . . . \$1.20
5Y3 . . . . .55¢	7A4 . . . . \$1.00	6K8 . . . . \$1.21
80 . . . . .55¢	7A5 . . . . \$1.00	XXL . . . . \$1.21
76 . . . . .60¢	7A6 . . . . \$1.00	XXD . . . . \$1.21
78 . . . . .60¢	7A7 . . . . \$1.00	6F7 . . . . \$1.21
6SF5 . . . .67¢	7B4 . . . . \$1.00	1A7 . . . . \$1.27
5Y4 . . . . .75¢	7B6 . . . . \$1.00	1N5 . . . . \$1.27
39/44 . . . .76¢	6A7 . . . . \$1.00	2A3 . . . . \$1.27
30 . . . . .76¢	7C6 . . . . \$1.00	35Z3 . . . . \$1.27
5Z3 . . . . .76¢	12K7 . . . . \$1.00	35A5 . . . . \$1.27
5U4 . . . . .76¢	14B6 . . . . \$1.00	7B7 . . . . \$1.30
6C6 . . . . .76¢	1A5 . . . . \$1.09	25Z6M . . . \$1.30
6D6 . . . . .76¢	1C5 . . . . \$1.09	7A8 . . . . \$1.30
6F6 . . . . .76¢	1H5 . . . . \$1.09	12K8 . . . . \$1.30
6H6 . . . . .76¢	6U5 . . . . \$1.10	11N5 . . . . \$1.41
6K7 . . . . .76¢	47 . . . . . \$1.10	6L6 . . . . \$1.41
6SA7 . . . .76¢	6E5 . . . . \$1.10	50A5 . . . . \$1.41
6SK7 . . . .76¢	0Z4 . . . . \$1.10	14Q7 . . . . \$1.41
6SQ7 . . . .76¢	1R5 . . . . \$1.20	14A7 . . . . \$1.41
5W4 . . . . .76¢	1S4 . . . . \$1.20	117L/M7 . \$2.27
3Q5 . . . . \$1.51	117Z6 . \$1.59	117N/P7 . \$2.27
	1S5 . . . . \$1.20	



## 5 TUBE KITS

50L6, 35Z5,  
12SA7, 12SK7, \$488  
12SQ7

FOR ALL 5



## TUBULAR CONDENSERS

EMERSON 20/20 MFD  
150 Volts  
GUARANTEED FRESH

55¢



## CRYSTAL PICKUPS

COMPLETE WITH  
HARDWARE LATEST  
DATE OF MANUFACTURE

\$287  
Each



## A GOLD MINE RADIO HARDWARE

Transformers . . . Coils . . . Sockets of all types  
. . . Screws, all sizes . . . Nuts . . . Bolts . . .  
Grommets . . . Angles . . . Wire . . . Resistors  
. . . Portable Battery Plugs . . . Connectors . . .  
Terminal Strips . . . Insulators . . . Lugs . . .  
Spaghetti, ETC.

A \$25.00 VALUE—DON'T MISS IT!

\$200  
Box

3 1/2 x 6 x 9" LOADED



And hundreds of other items. Send postal for  
free complete catalog of radio parts, tubes,  
batteries, record players, etc. Orders filled  
as received. We ship anywhere. Dept. RN.  
We do not back order

# FLANAGAN RADIO CORP.

America's Largest Stock of Radio Tubes  
N. E. Cor. 7th & Chestnut St., Phila. 6, Pa.

shows how the discriminator, oscillator-control circuit, and oscillator (a frequency converter type tube is used here) are arranged and tied together in a commercial receiver. Notice that the circuit arrangement differs little from the basic discriminator and oscillator control circuits explained here.

### Releasing AFC During Automatic Tuning Cycle

In those push-button tuned receivers that employ a conventional variable tuning capacitor (motor-operated types, etc.) and AFC, it is necessary to provide some means of rendering the AFC system inoperative during the automatic tuning cycle. The reason for this is that depending on the band width of the AFC control (as determined by the design of the discriminator system), a strong local station will continue to hold the AFC for a few channels beyond its point of tune, thus preventing the system from "locking" on the stations of nearby channels. This makes it necessary either to remove the AFC action during the automatic tuning cycle, or to remove it for an instant as tune is established on a desired station. It is also desirable to render the AFC system inoperative during manual tuning for the same reason.

Several methods have been applied to accomplish AFC release; the one that is used depends upon the particular system of automatic push-button tuning employed in the receiver. In many mechanically-operated types, and a few of the motor-driven types employing the latch-gate principle of stopping the motor by locking a pin in the latch gate, the gate is made to control a switch which shorts to ground the AFC voltage for an instant before the pin locks in the gate. The position of an AFC "release" switch in the AFC control voltage lead to accomplish this is illustrated in the circuit diagram of Fig. 8. In the *General Electric* motor-driven "Touch Tuning" series of receivers, a relay controls the switching off of the AFC. In other motor-driven types, control of the AFC circuit is effected by movement of the motor drive shaft. Another method is to apply a high negative bias to the r.f. and i.f. amplifier tubes to render the receiver insensitive during the automatic tuning cycle. This accomplishes the desired result, since the signal voltage at the discriminator is below the threshold of action even for strong local signals. Bias is returned to normal at the completion of the tuning cycle. The extra bias voltage may be obtained in any of several ways. In some receivers the tuning motor operates a switch that automatically removes a short from across an extra bias resistor. In receivers using low-voltage a.c. tuning motors the extra bias is obtained by diode rectification of the voltage applied to the motor's winding. In this way, as long as the tuning motor is running during the tuning cycle the additional bias voltage is produced and the r.f. and

# Roehr Distributing Company

St. Louis' Radio  
Mail Order House

ANTENNAS (Auto and Home)  
CONDENSERS  
RESISTORS  
MICROPHONES  
TUBES  
PHONO MOTORS  
BATTERIES  
(All Types—  
AB Packs)

PHONO NEEDLES  
TRANSFORMERS (All Types)  
VOLUME CONTROLS  
(Complete Stock Carbon  
and wire wound)  
ALL R. M. S. CABINETS IN STOCK

Write for our list of tubes,  
catalog package, and in-  
formation on how to secure  
a Speedex Tube Base Chart  
free of charge.

ST. LOUIS 3, MISSOURI

## JOB AHEAD

...and we're equal to it!  
Each day we are shipping  
more for civilian use.



# WIRES

MADE BY  
Engineers  
FOR  
Engineers

## cornish

WIRE COMPANY, INC.

15 Park Row,  
New York City





i.f. amplifiers are rendered insensitive. Consequently, the AFC control system does not function, due to absence of i.f. carrier. It is allowed to regain control when the tuning motor stops. The bias thereby returns to normal, and the amplifiers once again become sensitive.

### Limitations and Disadvantages of AFC

AFC does not make the need of precise oscillator frequency adjustment and stability entirely superfluous. There is a definite limitation to its ability to pull in a station that is only roughly tuned by the oscillator, or to keep a station tuned in if the oscillator drifts excessively off-frequency later due to temperature changes, vibration, or other causes. For example, if a receiver employing AFC has been tuned to a station for some time and the natural oscillator frequency has tended to drift away to such an extent that the station is held only by virtue of the AFC, a short break in the signal may be sufficient to lose the station permanently. This may happen when the natural oscillator frequency (and the frequency of the resulting i.f. carrier frequency) has drifted away more than half the width of the i.f. amplifier pass band so that the i.f. carrier will be so greatly attenuated that it will not be of sufficient strength to cause the discriminator to produce enough correc-

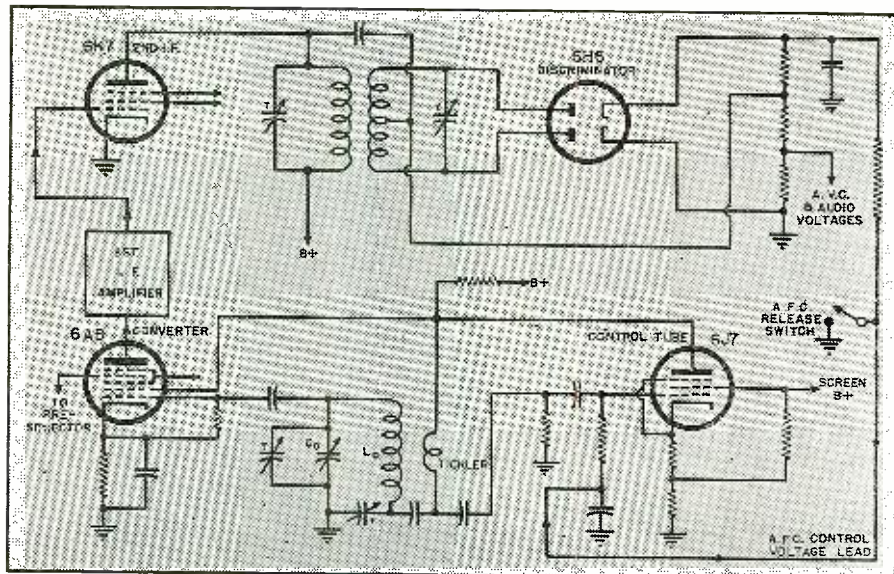

Fig. 8. AFC circuit of Grunow Model 12-B receiver. A conventional Foster-Seeley type discriminator is employed (see Fig. 4). However, the oscillator control tube circuit differs in some respects from the basic arrangement illustrated in Fig. 6.

tive voltage to pull the oscillator in tune. Even if the oscillator drift has been less than this, or the push-button controlled oscillator tuner is not well adjusted, during a short break in the signal the tuning may jump to receive the signal of a powerful neighboring station instead of the desired station. This is especially true if the AFC system employs a fairly wide bandwidth

(say 5 or more kc.). Similar problems also arise in case of strong fading of the signal, unless the AFC bandwidth is narrowed down, so AVC is always used in receivers employing AFC.

Owing to the fact that the AFC circuit involves the use of at least two extra tubes and associated resistors, capacitors, coils, wiring, etc., its cost has prohibited its use in all but ex-

# Fahnestock Clips

## RADIO'S GREATEST CONVENIENCE

### FAHNESTOCK SPRING BINDING POST GRIPS THE WIRE BY THE ACTION OF A SPRING



No tools required to make the connection. Grips the wire with just the right pressure for good electrical contact. Simply press down, insert the wire and let go. Does not injure wire, hence connection can be made or opened as often as desired. Available in large variety of types and sizes to fit any radio purpose and any requirement as to position, space or method of attachment. You will find them in the better sets.

Positive contact; cannot jar loose. Brass or bronze—nonrusting.

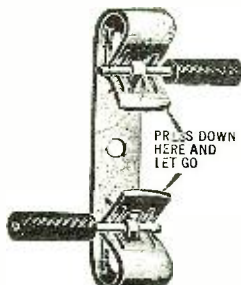
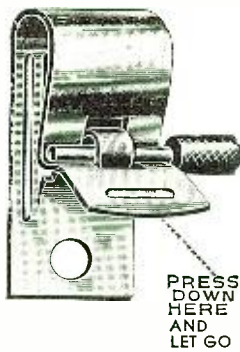

### FAHNESTOCK ELECTRIC COMPANY, Inc.

46-44 ELEVENTH STREET  
LONG ISLAND CITY 1, N. Y.

Please send us at once, Descriptive Literature, Prices and Delivery Schedule on

### FAHNESTOCK CLIPS

For .....  
Name .....  
Address .....  
City ..... State .....

# A VERSATILE TEST LABORATORY...IN ONE COMPACT UNIT!

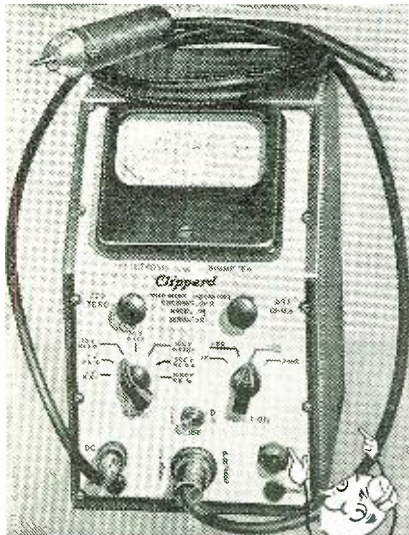

## Clippard ELECTRONIC VOLT-OHMMETER MODEL 406

**NEW BRIDGE-TYPE CIRCUIT**—fully balanced through 3 stages for maximum accuracy and stability. Tube complement: one 6X3GT rectifier, two 6SN7GT dual purpose tubes and 6AL5 dual diode in probe.

**PEN-TYPE DUAL-DIODE PROBE**—on detachable 36" shielded cable. High impedance, low capacity and convenient ground terminal assure accurate readings, A.F. thru U.H.F. ranges with minimum circuit disturbance.

**EXTREME RANGE**—full scale sensitivity of 0-1, 0-3, 0-10, 0-30, 0-100, 0-300 and 0-1000 volts A.C. and D.C. and 0-1,000 megohms in 7 ranges with ample overlap to eliminate guess-work. Decibel scale -20 to +51 in 3 ranges

**INCLINED METER**—for easier, more accurate readings with less parallax.

**HANDSOME APPEARANCE**—Satin Chrome panel, etched black self-explanatory markings, convenient controls, quarter-sawed oak case, folding leather carrying handle. Overall size 10" x 8 1/4" x 6 1/4".

**LABORATORY ACCURACY**—calibrated to 2% accuracy at plant. 5% accuracy guaranteed in field. An instrument of laboratory quality and ruggedness priced within reach of all who want the best!

Write today for **FREE** bulletin giving Complete Details!

Electro-Magnetic Windings

R. F. Coils

Sub-Assemblies



pensive types of receivers. It has been used particularly in push-button tuned receivers of the motor-driven type. AFC is both expensive and tricky. These are its most serious handicaps. While its use made possible those early forms of elaborate push-button tuned receivers in which an appreciable amount of oscillator tuning drift due to temperature effects and to lack of mechanical and electrical stability in the tuning circuits and devices employed was present, it is now used in only a very small percentage of receivers even of the push-button type. It served to show the value of good oscillator frequency stability. It was after the advent of the early push-button tuned receivers employing AFC (particularly those receivers using motor-driven automatic tuning systems) that designers began to drive into the possibilities of designing push-button tuning systems that would be sufficiently accurate and stable to make the use of AFC unnecessary. This encouraged the improvement of component parts and compensating techniques generally to the point where in most cases AFC is not necessary.

It might be mentioned here that some manufacturers of push-button tuned receivers get around the use of AFC by employing i.f. amplifiers having a fairly wide acceptance band, on the assumption that only strong local stations are set up for automatic tuning and therefore selectivity and sensitivity can be sacrificed. Also, the high-frequency audio response is thereby improved, providing better fidelity. Widening the i.f. acceptance band permits the i.f. carrier to be a little off frequency without spoiling the quality of reception.

It should be remembered that AFC is a purely electrical circuit arrangement for automatically pulling in the oscillator frequency to the correct value required for reception of a station that has already been tuned in. It will not, by itself, find the station required, but once the receiver has been tuned to some point within the sideband range occupied by the wanted station the AFC takes charge of affairs and will automatically bring the oscillator into exact tune—more exact, in fact, than can normally be accomplished by hand. This means that in an automatic tuned receiver employing AFC the receiver need not select the stations as accurately as would be necessary if AFC were not used. This is very important in some of the motor-driven types of push-button receivers, where precise stoppage of the motor-driven gang tuning capacitor is difficult to arrange and maintain.

AFC has been incorporated in some receivers of the manually-tuned type to enable unskilled persons to get the maximum results (from the point of view of tuning and tone quality) of which the receiver is capable, for mistuning and the distortion that accompanies it are eliminated and the best

# AMATEURS AND RADIO REPAIRMEN

We appreciate your bearing with us on the delay in deliveries, but hope you remember we accepted no orders for material we could not deliver.

Parts are coming in more freely now so the percentage of 100% filled orders is increasing. Thanks again.

EXCLUSIVE DISTRIBUTORS FOR STROMBERG-CARLSON AMPLIFIERS

Stanton Radio Supply

W9PSP W9JKE  
521 State St. HAMMOND, INDIANA  
Phone 2314



ITEMS NOW AVAILABLE!

THE BANTAM KIT

With 8 ft. cord and plug and 23 accessories: 4 abrasive grinding wheels, 2 wrenches, 2 collets (1/8" and 3/16"), 3 cleaning brushes, 1 felt wheel, 1 rubber wheel, 6 sanding discs, 2 mandrels, 1 drill, 1 accessory.

\$12.95

20,000 RPM GRINDER—A.C.  
SINGLE FM ANTENNA—Dipole with frame: \$1.75.

- |  |           |      |
|--|-----------|------|
| TUBES. 954, 955, 956, 957, 959.....  | each, \$  | 0.45 |
| (List prices from \$2.00 to \$4.00.)   | each      | .80  |
| 064.....   | each      | .48  |
| 6SA7.....  | each      | .48  |
| PLUG-IN COILS. 4 prong—all frequencies..   | ea.       | .15  |
| 5 prong—all frequencies..  | ea.       | .15  |
| 6 prong—all frequencies..  | ea.       | .15  |
| METERS. 0-500 milliamperes (2 1/8" face)...  | 8.50      |      |
| 0-150 volts (2 1/2" face), A.C.....  | 3.95      |      |
| WIRE. 7/22 Tinned Aerial Wire...100 feet,  | .60       |      |
| Stranded, rubber-covered, tinned wire,   | 100 feet, | .60  |
| TWO CONDUCTOR, shielded, with cloth cover—Polystyrene Insulated...100 feet,                                      | 2.50      |      |
| RESISTORS. IRC—20 watt—1000 ohms....   | .10       |      |
| ATLAS—10 watt—6000 and 2000 ohms....   | .09       |      |
| CABINETS. Leatherette covered—standard size  | .99       |      |
| AMPLIFIERS. BOGEN—SIGNAL CORPS.—6 and 110 volts with power supply built in—33/78 combination speed; 25 watt..... | 72.50     |      |
| CRYSTAL MIKE INPUT   | 15        |      |
| KIT #1. CONTENTS 100 PIECES.....   | 4.95      |      |
| 5 Precision Wire Wound Resistors—Shallcross, IRC, etc.   |           |      |
| 5 Oil Filled Condensers Tubular—Solar—Cornell—Aerovox  |           |      |
| 10 Mica Silver Type Condensers.  |           |      |
| 80 1-watt and 2-watt Resistors—Insulated.  |           |      |
| KIT #2. 100—1/2—1—2 watt 5% Insulated Resistors.....   | 2.75      |      |
| KIT #3. 100 Silver Mica Condensers—Aerovox—Cornell—Sangamo, etc.....   | 2.75      |      |
| KIT #4. 100 Tubular Oil Filled Condensers, all sizes, standard brands.....                                       | 4.95      |      |
| SANGAMO. .004—2500 working volts, 5000 test. Mica Condensers—Dealers' Net.....                                   | .49       |      |

THE LOUIS M. HERMAN CO.  
885 BOYLSTON ST. BOSTON 16, MASS.

RADIO NEWS

possible response is thus always secured without any necessity for precise manual tuning.

Furthermore, within the limits already mentioned, AFC will take care of errors due to mechanical wear and electrical drift in the oscillator tuning circuits.

Although at first thought it might not seem absolutely necessary to have the signal-tuning circuits of the pre-selector accurately aligned with each other in a receiver that employs AFC, a little thought will show that the operation is impaired by misalignment of these tuning circuits. The AFC control of the oscillator only assures that the i.f. carrier is of proper frequency. If the r.f. amplifier is very seriously off tune, the quality, sensitivity and signal-to-noise ratio of the receiver will be impaired, and adjacent-channel interference may be objectionably high.

(To be continued)

**QTC**

(Continued from page 49)

and accommodations offered by the foreign lines. Today these conditions do not prevail and U. S. shipping concerns have or will have shortly better ships than any foreign competitors and will be in a position to offer superior services. As for world-wide air travel American airways are acknowledged the finest. . . . The merchant fleet of the United States has emerged from the war with almost four times as many vessels as its prewar strength and its tonnage is almost five times the 1939 figure. Wartime building has left this country with 5529 seagoing merchantmen of 1600 tons or more compared with 1401 in 1939, at which time less than one quarter of the fleet was engaged in foreign trade. . . .

**D.** K. CROSBY was recently transferred from his Victory back to the old Talamanca, Jack Hajim and H. McKenzie are along with "Bing" as 2nd and 3rd. . . . Henry J. Decker arrived a while back all decked out with a new ship, the Sea Skimmer. . . . J. F. Welch was in town for a few days during an overhaul job aboard his Liberty. . . . Charles E. Fraser has taken out one of the "Cape" boats. . . . Herman Meyerhoff is now back on the Carrillo after much shifting around. . . . Frederick J. Bold took out a Liberty from the East Coast. . . . Carrol J. Jones, dropped dead just as he was leaving his "Victory" in San Francisco, we are sorry to report. . . . Another old timer, Eben S. Pitman, ex-chief of the Shawnee, Clyde-Mallory Lines, died recently at Scott Field where he had been teaching radio operating. . . . Jerry Travis, well known along the waterfront in both Eastern and Agwilines is still sailing his "Cape" craft out in the Pacific. . . . James J. Delaney, founder of ARTA sailed during the winter aboard a U. S. Lines Liberty . . . . 73

Here's a soldering iron with . . .

**HEAVY  
POWER**  
(225 WATTS)

**LIGHT  
WEIGHT**  
(14 OUNCES)

made possible by  
**KWIKHEAT'S  
BUILT-IN  
THERMOSTAT**

- ★ HEATS IN ONLY 90 SECONDS
- ★ MAINTAINS PROPER HEAT
- ★ CAN'T OVERHEAT
- ★ LESS RETINNING NEEDED
- ★ TIPS LAST LONGER
- ★ COOL, SAFE HANDLE
- ★ LIGHT WEIGHT

The Kwikheat Soldering Iron has ample reserve power for your soldering jobs—225 watts held in check by a thermostat built right into the iron\*—maintaining ideal temperature for perfect soldering—preventing overheating (which causes deterioration in other irons)—prolonging life of tips and eliminating the need for constant retinning. Besides these big advantages, the Kwikheat Iron is hot, ready to use only 90 seconds after plugging in. It is extremely light (14 ounces), well-balanced, and has a safe, cool handle. No wonder Kwikheat is a sensation wherever it is used. Ask your jobber. With choice of any one tip. **\$11.00**

**6 INTERCHANGEABLE TIP STYLES**

	#0		#1		#2		#3		#4		#5
	\$1.25		\$1.25		\$1.25		\$1.25		\$1.25		\$1.25

VANATTA

\*patented



**THERMOSTATIC SOLDERING IRON**  
A Division of  
Sound Equipment Corp. of Calif. • 3903 San Fernando Rd., Glendale 4, Calif

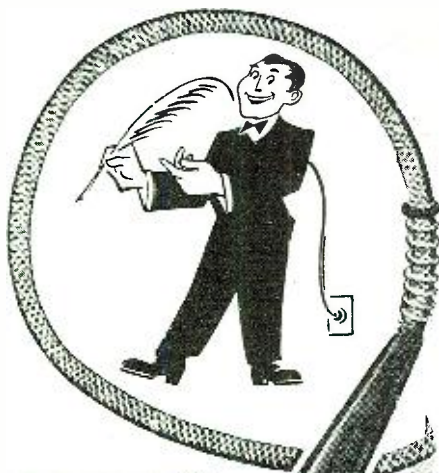

**LIGHT  
AS A  
FEATHER**

**UNGAR  
SOLDERING  
PENCIL**

...handles like a fountain pen and is a demon for speedy precision on intricate hard-to-reach jobs. And it takes plenty of punishment...weighs only 3.6 ozs., perfectly balanced; length 7 inches...heats in 90 seconds and draws only 17 watts. Unit complete with any of the four tips pictured sells at less than \$2.

No. 538 Chisel Tip, made from Elkaloy A, Tip 1/8 dia.

No. 539 Extra Hot, made from Tellurium

No. 536 Standard Tip, made from Hard Drawn Copper

Please order from your nearest Electronics distributor.

**Ungar**  
Electric Tools, Inc.  
Formerly Harry A. Unger, Inc.  
LOS ANGELES 54, CALIF.

**Grid Bias Modulation**

(Continued from page 60)

rent rating of the rectifiers is not exceeded, however, as a result of using too high a value of input capacitor.

**"Modulation Gaining"**

The power supply to the r.f. driver stage must be exceptionally well filtered, because of the "modulation gaining" characteristic of a class "C" stage driven to less than saturation. The same applies to the bias source. A small amount of ripple in either of these supplies will show up as a much greater percentage modulation of the radiated carrier. The condition is aggravated as the bias is raised, so that if 5 times cutoff bias is employed on the modulated stage, the ripple content of the bias pack and driver plate supply must not exceed a small fraction of 1 per-cent. Fortunately, the voltage and current involved in these power packs is comparatively small, and the expense of good filters is therefore a minor item.

**Bias Considerations**

The recommended bias for a grid modulated class "C" stage is between 3 and 5 times cutoff, the higher value giving slightly higher efficiency. The increase in efficiency resulting from a still higher value of bias is insignificant, and is not considered justified because of the greater driving power required. Also, with very high bias, correct transmitter adjustment is upset by moderate line voltage variations unless special precautions are taken.

The prime requirement for a bias source is that the voltage is not appreciably affected by grid current excursions during modulation. An audio bypass capacitor will take care of the variations over an *audio cycle*, but such a bypass of itself does nothing to keep the *average* bias from increasing with d.c. grid current, and such an increase has the same effect as lowering the carrier amplitude during heavy modulation. Under this condition it is impossible to take full advantage of the upward modulation capability without overmodulating on negative peaks.

**Bias Packs**

If the bias is supplied from a regulated bias pack, from batteries, or from any other source which does not vary in accordance with the line voltage, it may be necessary to "touch up" the r.f. excitation adjustment whenever the line voltage varies more than a few per-cent *unless* a regulated pack is used to supply plate voltage to the r.f. driver. However, if not more than 5 times cutoff bias is used on the modulated stage, slight variations in line voltage normally encountered will not require readjustment of the r.f. excitation.

The reason why variations in plate

**If Your Feed Line Is OK  
How's Your Antenna?**

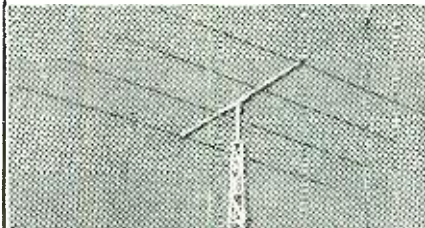

REMACO  
4-ELEMENT BEAM  
AT W60ZH

Have You Heard  
Him Lately?

GIVE YOUR RIG THE BENEFIT OF  
AN EFFICIENT ANTENNA

USE A **REMACO** BEAM  
WITH "T" MATCH FEED

Four Element Beam As Shown  
(Less Tower) \$40.00 (Net) F.O.B. Factory

Lightweight (Approx. 15 Pounds)  
Can Be Assembled in 20 Minutes

What Is Your Antenna Problem?  
Let REMACO Engineers Help You.

Mail, Phone or Wire Your Orders to  
**RESEARCH MANUFACTURING CORPORATION**  
BOX 757, DEPT. N4  
CHULA VISTA, CALIFORNIA

**WAR SURPLUS  
MATERIALS**

**All New Material**

**TUBES**

- 1. 813 tubes...\$12.95
- 2. 805 tubes... 6.95
- 3. 866 tubes... 1.40
- 4. 6AB7/1853 tu...\$9.5
- 5. 6J5.....tu... .45
- 6. VR105.....tu...1.05

**TRANSFORMERS**

- 7. Plate, pri. 210-230-250 sec. 2840-3450-4560 volts ct. at 400 MA: \$49.60
  - 8. Filament; pri. 210-230-250 sec. 5 V. ct. & 6.3 V. Ct. at 6 amps. test 2000 volts: \$7.60
  - 9. Driver; 500 ohm line to p.p. grids 12 watts: \$6.24
  - 10. Choke; 10 hys.; 225 MA; DC resistance 84 ohms; 2500 volt test: \$11.50
- Other types of 220 V. priv. transformers in stock.

**CONDENSERS**

- 11. Oil-filled IND. 4MFD 2500 w.v.....\$ 9.30
- 12. Oil-filled IND. 10MFD 1500 w.v..... 6.71
- 13. Oil-filled IND. 6MFD 600 w.v..... 2.75
- 14. Solar mica XHB .005 MFD 8000 volts... 11.50
- 15. Solar mica XR .002 MFD 3000 volts.... 3.78

**GE FLAMENOL WIRE STYLE F.L.**

- No. 18 L.V. ins. 500 ft. coils.....\$ 9.60
- No. 16 L.V. ins. 500 ft. coils..... 10.00
- No. 16 Hi voltage ins. 500 ft. coils..... 15.00
- No. 10 Hi voltage ins. 500 ft. coils..... 18.00
- No. 8 Hi voltage ins. 500 ft. coils..... 25.00

**FIXED RADAR XTALS**  
TYPE CHS 1N21....\$1.50

Special prices on quantity lots.  
Many other types of radio equipment—Write your requirements.

**S. F. Radio & Supply Co.**  
1280 Market St., San Francisco 2 Calif.

voltage to the r.f. driver have such an appreciable effect upon the correct adjustment and modulation capability of the modulated stage is explained as follows: When a fixed bias of several times cutoff is used in conjunction with comparatively low excitation (substantially less than saturation), it is necessary to reduce the r.f. driving voltage only by perhaps 20 per-cent (depending upon the number of times cutoff bias is employed) to reduce the output of the stage to zero. This same characteristic is responsible for the "modulation gaining" effect and consequent multiplication of driver power supply ripple previously mentioned.

It is possible to avoid this difficulty by employing an *unregulated* a.c. power pack for bias. Then, as the line voltage changes, both the bias and r.f. driving voltage will change in the same ratio, and the *effective* excitation to the modulated tube remains approximately correct even with a rather large line voltage change.

When using an unregulated a.c. power pack for bias, it is necessary to waste considerable power in a bleeder resistor in order to keep the bias voltage constant with modulation. If too high a value of bleeder resistance is employed, the increase in average grid current that occurs with heavy modulation will cause the operating bias to increase excessively. This is the chief disadvantage of using an unregulated a.c. power pack for bias. It is necessary to use a bleeder which draws at least 10 times the maximum d.c. grid current under modulation in order to have an acceptable bias pack.

#### The Inverted "B" Supply As Bias

A method sometimes used in the past to avoid the waste of power in the bleeder and to save the cost of a separate bias pack was to run the crystal oscillator with the *positive* high voltage grounded and the negative hot to ground. Sometimes another r.f. stage was run from the same pack, but not the r.f. driver for the modulated stage. However, by "inverting" the power pack *feeding the r.f. driver, an actual improvement is obtained.*

This is explained by the fact that when the pack voltage is altered in any way, whether from line voltage changes or from variations in d.c. grid current during modulations, the excitation and bias more or less track. This "tracking" occurs because the bias always is equal to the plate voltage on the driver, and the driver r.f. output voltage will vary in proportion to the plate voltage.

With this system the r.f. voltage at the grid of the modulated stage must be made greater than the r.f. potential at the plate of the driver, otherwise the grid would not be driven into the positive region under carrier conditions. This requires that a step-up arrangement be used. The only convenient method of making excitation adjustments with this biasing arrange-

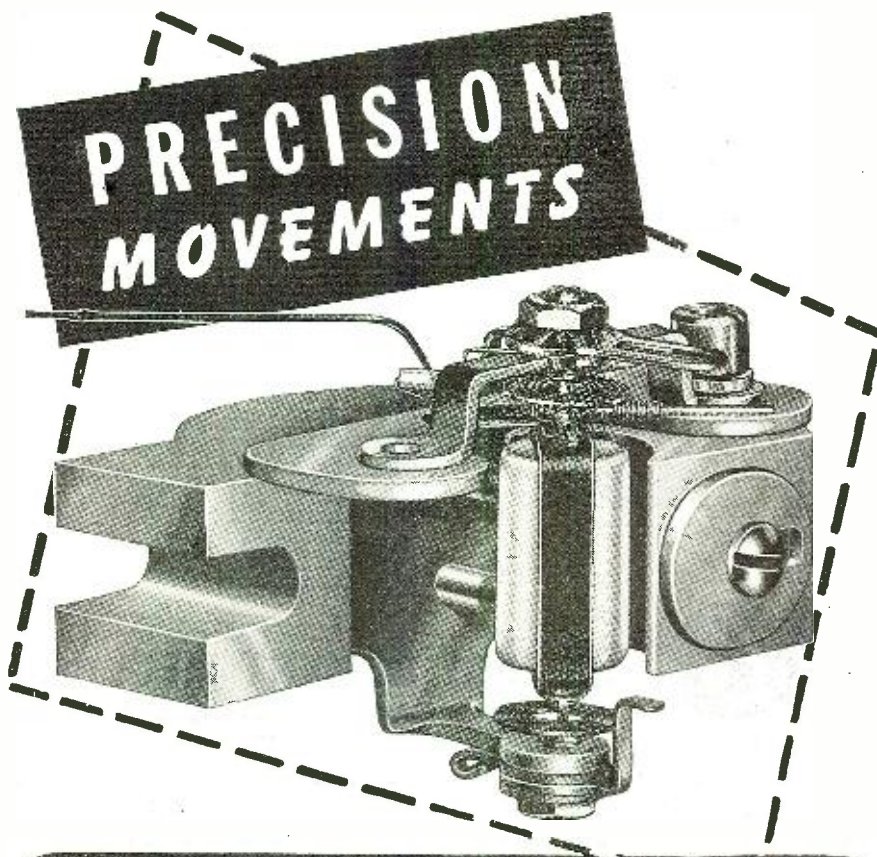

# Burlington

## PANEL INSTRUMENTS



The heart of every Burlington Instrument — and the reason for its high degree of dependability — is the Burlington Precision Movement.

Design, material, and manufacturing processes are selected in such a manner that Burlington gives you a rugged instrument — which may be subjected to rough usage — and still retain its original calibration characteristics. All DC instruments employ Alnico magnets which are known to be more highly resistant to shock, heat, vibration, and stray fields than any other magnetic material.

All ranges AC & DC are available in 2½", 3½" and 4½" sizes, both square and round, flush mounting.

*Engineering Service Furnished for Specialized Applications. No Obligation. Write Today for Further Information.*

## BURLINGTON INSTRUMENT CO.

904 FOURTH STREET BURLINGTON, IOWA

PANEL INSTRUMENTS • VOLTAGE REGULATORS • AUTOMATIC SYNCHRONIZERS • FREQUENCY REGULATORS



# SPEED UP REPAIRS WITH THESE G-C AIDS!

## Handle Dial Belt Replacements the Easy G-C Way!

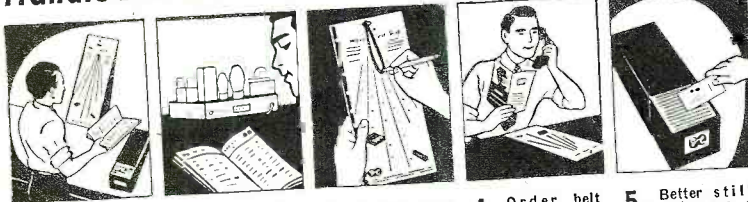

1. To determine proper belt for any radio, G-C supplies a complete Belt Replacement Guide and Measuring Scale.
2. By using G-C Belt Guide, just check model number of the set to determine correct G-C Belt.
3. If you don't know model number or make of the set, use G-C Measuring Scale and simple instructions to measure belt.
4. Order belt by number from your radio parts distributor. Phone or mail your order to receive prompt service — no waiting.
5. Better still — have a complete G-C Belt Kit on hand. Belts are indexed in permanent steel box with slide-in drawer.

**FREE TO ALL RADIO SERVICEMEN**—68 page G-C No. 345 Belt Guide and Service Book and Measuring Scale. Ask for them at your Radio Parts Distributor.

Get "Smooth-Strong-Correct Fit" G-C Dial Belts  
from Your Radio Parts Distributor



**GENERAL CEMENT MFG. CO.**  
ROCKFORD, ILLINOIS

# UNIVERSAL Model 501 RADIO TUBE TESTER

Advanced Styling — Finest Quality  
Materials and Workmanship.  
Designed to give lasting service and priced  
to **SAVE YOU MONEY.**

WRITE TODAY for SPECIFICATIONS and PRICES.

Please rush me full details and specifications  
on UNIVERSAL Radio Service Instruments.

Name.....  
Street.....  
City.....

## PRECISION ELECTRONIC INSTRUMENTS

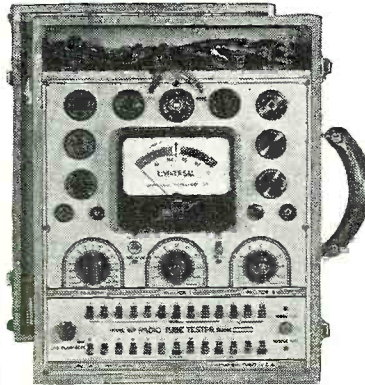

**UNIVERSAL INSTRUMENT CO.**  
306 E. McMILLAN STREET CINCINNATI 19, OHIO

## FLUORESCENT BED LAMP SPECIAL



\$3.95  
Less  
Bulbs

12 to a Packed Carton  
Available in the following: Brown wrinkle or  
flocked BROWN—BEIGE—BLUE—PINK.  
25% Required on all orders

**RISCO SALES CO.**  
224 E. 65th St., New York City 21, N. Y.

## RADIO ENGINEERING!

EX-SERVICE MEN can complete work here in shortest possible time. Special Prep. Dept. Also Refresher Courses. Courses also in Civil, Electrical, Mechanical, Chemical, Aeronautical Engineering; Business Administration, Accounting, Secretarial, Science, Tuition, living costs low. 63rd year. Cosmopolitan student body. Enter Mar., June, Sept., Jan. Catalog. **TRI-STATE COLLEGE** 1646 College Ave. ANGOLA, INDIANA

DEGREE IN  
27 MONTHS

## FILMGRAPH PAT'D Conference Recorders

UNINTERRUPTED  
Longtime (up to 12 hours) Conference  
& Telephone Recordings on Safety Film  
Models for Dictation "TALKIES"

ECONOMICAL  
PERMANENT  
INSTANTANEOUS  
PLAY-BACK

MILES REPRODUCER CO., INC. 812 BROADWAY, N.Y. 3 RN-4

ment (outside of using link coupling) is to employ several taps on the driver plate coil in conjunction with a switch, as illustrated in Fig. 2. Obviously it is not possible to vary the effective drive by altering either the bias on the modulated stage or the plate voltage on the driver stage with this arrangement, as the two are common and not separately adjustable.

### V.R. Tubes for Bias

Where the line voltage is reasonably constant and the resting d.c. grid current is not less than 5 ma., "V.R." tubes may be used as a sort of "fixed bias grid leak" as shown in Fig. 1A. The current through the voltage regulator tube(s) may kick up to 60 ma. or more on peaks under heavy modulation without appreciably shortening the life of the V.R. tube, as these tubes will stand considerably more than their rated 40 ma. without damage so long as it is intermittent. A combination of V.R. tubes should be chosen which gives the desired bias voltage.

The V.R. tube(s) must be bypassed for audio frequencies, because on negative modulation peaks there is no grid current for a fraction of an a.f. cycle, and a V.R. tube requires at least 2 ma. and preferably 5 ma. in order to function properly.

If the d.c. grid current kicks up to more than 60 ma. on heavy modulation peaks but less than 120 ma., the arrangement shown in Fig. 1B may be used for a push-pull stage. The resting current should be at least 5 ma. per tube for satisfactory operation.

When medium or medium-high mu tubes are biased as illustrated, no damage will occur to them should the excitation fail. However, in some cases the tubes will tend to "motorboat" due to relaxation oscillations of the V.R. tube(s). This will make it necessary to open the primary voltage on the plate supply to the modulated stage on "standby."

### Cathode Bias

Cathode bias is suitable for a grid modulated stage, because the plate current is substantially constant with modulation. The cathode resistor should be bypassed for audio frequencies. An 8  $\mu$ f. electrolytic will serve nicely.

Because considerable power is wasted in the cathode resistor, this arrangement should be confined to fairly high mu tubes and the bias limited to about 3 times cut-off. This will minimize the d.c. power dissipated in the cathode resistor. One disadvantage of this system of obtaining bias is that the stage will be highly sensitive to changes in loading, as might occur when the antenna system becomes wet or a rotary beam is rotated and the load on the stage is thus altered.

The reason for this is that when the load is increased slightly after being properly adjusted, the plate current will increase, increasing the bias and lowering the effective excitation, when in order to maintain 100 per-cent mod-

ulation capability the excitation actually should be *increased* slightly to compensate for the lower load impedance. In addition to making the stage very sensitive to changes in load, this effect makes the stage somewhat more difficult to adjust than a stage using a bias source which is not affected by antenna loading.

#### Battery Bias

Battery bias is one of the most straightforward methods of bias, and is satisfactory where line voltage variations are not excessive. Fresh 45 volt blocks in the heavy duty size will stand up to about 50 ma. average reverse current without damage, and give reasonably long life under such service.

One thing to keep in mind is that the voltage of a 45 volt block will build up to between 55 and 60 volts under typical reverse current conditions, often making an excitation readjustment necessary after the first few minutes of operation. The voltage then will stay near this value until an extended period of inoperation. Unless one happens to be in a position to get used but still good batteries free, other methods of bias are to be preferred to battery bias.

*(In the second part of this article which will appear in the May issue of Radio News, the author will discuss r.f. driver regulation, the disadvantages of link coupling, the a.f. modulator, cathode injection, a practical transmitter, standard adjustment procedures, and a design summary.)*

*(To be continued)*

#### Aircraft Radio Servicemen

*(Continued from page 31)*

ing the motor mounts, the motor, and all metal braces, etc., does not prove adequate.

It is important in any aircraft, that the primary, as well as the secondary of the ignition system be completely shielded.

In some cases, control surfaces or moving metallic parts will produce noise in the receiver. Bonding of such offending points will usually eliminate this interference.

#### Antennas

Antenna selection is a matter controlled by the flight operations of the ship in which the radio equipment is to be installed. Generally speaking, the results obtained with various antennas are as follows:

A whip antenna, while it gives the least signal pickup, does have the desirable characteristic for range or instrument flying of accurate and true radio range signals. It also gives a sharp "cone of silence" indication.

The fixed antenna, mounted either overhead from the vertical stabilizer to a mounting or mast, forward on the top of the fuselage or the "belly" version mounted underneath the fuselage to another mast or to the landing gear struts, is called a "T" antenna when

*Watch  
PermoFlux Speakers!*

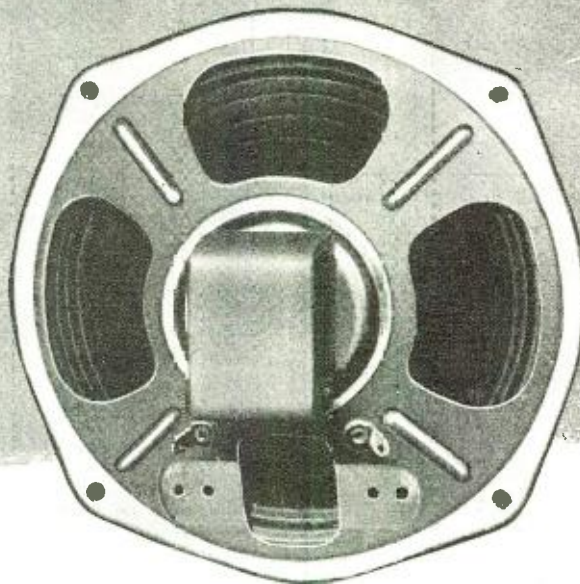

## PermoFlux Designs Assure Faithful Reproduction!

Because PermoFlux Speakers excel in translating the tone capabilities of carefully designed circuits, more and more of the country's outstanding radio manufacturers are specifying them as preferred equipment. Manufactured in a full range of true-dimensioned sizes for every power handling requirement, PermoFlux Speakers provide the answer to today's growing demand for better tone quality.

TRADE MARK  
**PERMOFLUX**

**PERMOFLUX CORPORATION**  
4900 WEST GRAND AVE., CHICAGO 39, ILL.



**PIONEER MANUFACTURERS OF PERMANENT MAGNET DYNAMIC TRANSDUCERS**

Available Immediately  
**PORTABLE, 2 WAY  
 RADIO TRANSMITTER  
 AND RECEIVER SETS**

No. SCR-583

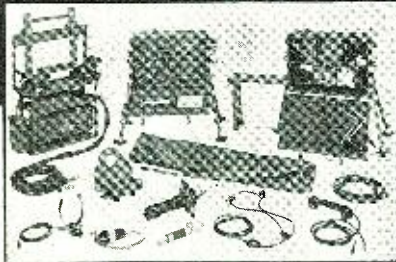

**COMPLETE with War Dept. Manual  
 and READY TO OPERATE . . .**

For pack, vehicular or ground operation. Entirely waterproofed; can be operated in driving rain. Power output up to 40 watts. Distance range to 80 miles. 12 Transmission Bands, Frequency range from 2.2 to 4.6 mc. Receiver 2.2 to 4.6 mc.

**EQUIPPED WITH**

- Radio Transmitter and Receiver Set with Tubes
- Accessory Chest
- Antenna and Roll Bag
- Power Unit and Power Converter Unit
- Mast Bracket
- Head Sets
- Built-in Speaker
- Microphones
- Hand Sets
- Plugs
- Cables
- Code Key

Government paid Approx. \$1775 for set . . .  
**OUR PRICE while quantity lasts**

**\$215.00**

Plus Crating  
 F. O. B. Chicago

**Super Special**

**BC-683—10 Tube FM  
 RECEIVER**

**COMPLETE WITH TUBES**  
 All You Need to Build Is an  
 Inexpensive Power Supply  
**Only \$25.00 Complete**

**LEONARD ASHBACH**

*Company*

**ELECTRONICS DISTRIBUTORS**

Phone WHitehall 2065

152 W. HURON ST. • CHICAGO 10, ILL.

**POCKET ADDING MACHINE**

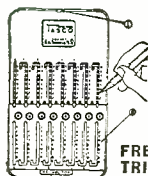

Sturdy steel construction for life-time use. Adds, subtracts, aids multiplication. Capacity 999,999.99. A real machine—guaranteed 5 years. Thousands of satisfied users. Send name and address. We ship immediately. On delivery, pay postman \$2.50 (plus C.O.D. and postage charges). If you send \$2.50 with order, we pay postage. Leatherette case 25c additional. Your money back after 10 days' trial if not satisfied.

**FREE TRIAL 250**

TAVELLA SALES CO., 25-SDA West Broadway, New York 7, N. Y.

**RADIO**

RADIO Technician and Radio Communications courses. Register now for new classes starting first MONDAY of each month. Day and Evening Classes.

**AMERICAN RADIO INSTITUTE**

101 West 63d St., New York 23, N. Y.  
 Approved under GI Bill of Rights.

the lead-in is taken off the center. When the lead-in is taken from the forward end, this is known as the "L" antenna.

When the receiver is mounted so that the antenna lead will be run nearly vertical to the "T" antenna, a truer range signal may be generally expected than with the "L" type. The signal pickup with both of these antennas is good.

The trailing antenna, whether of the retractable reel or of the permanent trailing type, will give the maximum signal, and consequently should be used when trying to receive long distance or weak stations. The use of the trailing wire antenna, when an accurate range signal is desired, is dangerous. This is especially true when "close in" or "on instruments."

It is feasible to have the benefits of all of the aforementioned antennas by the proper installation of a switching system. A suitable switch, or remote operated relays may be used for switching from whip to trailing.

The selection of antennas on such a switching system should be clearly marked to prevent using the wrong

Fig. 6. (A) The stipulated center of gravity of any particular plane should always be maintained. If, when adding radio equipment, the center of gravity shifts as depicted in (B), the plane will be rendered uncontrollable. (C) The maximum load limit of the plane should never be exceeded. In designing airplanes, the specified maximum load limit is considered when allowing for safety factor sufficient to cover all stresses and strains.

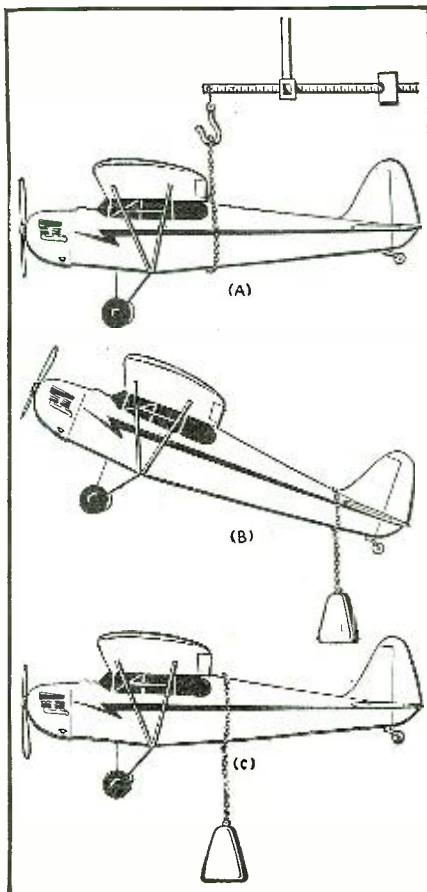

New  
**RESISTOR  
 DATA**  
 Just Published



Every resistor user needs this new Lectrohm Data Book and Catalog. It is right up to the minute with illustrations, diagrams and scientific data of reference nature. Here is complete data on Lectrohm's wide selection of Vitreous Enameled Resistors; including fixed, adjustable, "Rib-on-edge" and ferrule terminal types—power line and R.F. chokes, brackets, bushings, solder pots, etc., with illustrations and complete description. Write for your copy now!



5131 West 25th Street, Cicero 50, Illinois

Division of

The National Lock Washer Company, Newark, N. J.

Use these new books  
 to gain a **SURE** knowledge  
 of radio **EASILY** and at a  
**LOW COST**

1. Introduction to

*Practical Radio*

Gives you thorough training in the groundwork for radio engineering and technical work. Fully explains all necessary math at the points where it is used. Shows in hundreds of examples how to apply theory correctly in the construction and repair of radio circuits. Written in plain, easy-to-understand English by D. J. Tucker, a "ham" of 24 years' experience, now chief radio engineer for 3 Dallas stations. Fully illustrated. \$3.

2. Principles of

*Radio for Operators*

Very clear, easy-to-understand explanations of the operating principles of every part of radio, with full material on antennas. Teaches all the fundamentals of the construction, servicing and operation of radio equipment. Includes much practical reference data in appendix. Nearly 500 illustrations and other visual aids developed for Navy and Signal Corps training.

By Ralph Aberton \$3.75

**FREE EXAMINATION OFFER**

The Macmillan Co., 60 Fifth Ave., N. Y. 11

Please send me the books checked by number below with the understanding that my bill will be cancelled if I return them in 7 days.

1  2

Signed.....

Address.....

RN



antenna and possibly receiving erroneous range signals.

It is desirable to mount the antenna so that the lead-in will be kept to a minimum. Insulated ignition wire (unshielded) makes good lead-in wire.

### Power Supplies

Most aircraft radio equipment is operated from a 12-volt storage battery, with a generator being employed to charge the radio battery during periods in which the aircraft engine is in operation. Voltage regulators are used to maintain proper charging rate, as in the conventional automobile electrical systems.

The open lead from the volume control switch should be connected through a 10 ampere fuse to the nearest source of +12 volts. Most aircraft have a master switch or master fuse panel, with an additional fuse and connector provided for a radio circuit. All wire in this circuit should be number 14 or larger, copper stranded, and well insulated. Don't route this lead near any receiver antenna lead or near the magnetic compass.

The shield of this lead is the negative return and should be securely fastened to the nearest metal portion of the ship's fuselage.

Upon completion of installation, check the operation of the receiver and the dial calibration, with the ship's engine running.

Failure to operate or improper performance means that the installation wiring must be checked. Refer to troubleshooting recommendations on page 30.

### Operation

The on and off switch is incorporated in the receiver volume control and the battery power is supplied to the receiver through this switch.

One or more pairs of low impedance (200 ohms) headphones may be used, plugging them into either of the two headphone jacks, which are connected electrically in parallel.

The band selector switch is set to the number of the band to be tuned as indicated on the main tuning dial.

Control tower reception is facilitated on band 1 by the 278 kcs. frequency being "spotted" on the dial.

Sidetone connection is provided through a binding post on the power supply, permitting the pilot to monitor his transmissions over and above the receiver reception.

Interphone communication is possible through the INT. connection on either of the power units.

Code reception is possible by the use of the telephone-telegraph switch.

### Trouble Shooting

Servicing, with the exception of the aircraft itself or mechanical troubles, should be done by competent radio service personnel having technical ability and the necessary test equipment to perform such service.

Faulty operation should be localized in (1) the equipment, (2) attached

# New CANNON PLUG meets radio standardization demands

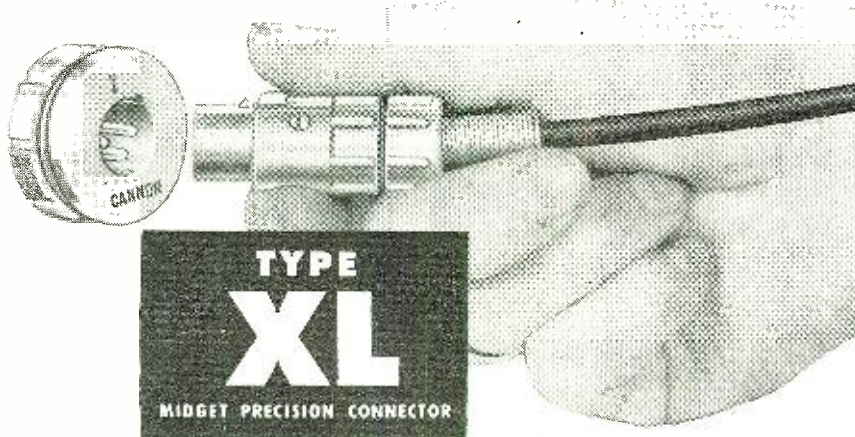

Designed for all low-level sound transmission circuits

... Cannon high quality at a new low price

For 15 years Cannon Plugs have been standard equipment on the best microphones, sound systems and other broadcast equipment. Now, with the trend toward parts standardization and the demand for more compact fittings, Cannon Electric introduces the new "radio universal" Type "XL"—manufactured with the well-known Cannon quality, at a new low price.

All the quality features you expect in any Cannon Plug are built into the new "XL"—ample voltage and amperage capacities, specially positioned grounding contact, all screw threads tapped in metal, high quality molded insulation.

Ready now are two plug types and four receptacle types with three contacts of 15-amp capacity for No. 14 B&S wire.

### Check these SPECIAL ENGINEERING FEATURES

1. Convenient latchlock to hold connection tight.
2. Extremely light weight (as low as 1½ ounces).
3. Compression gland with cable relief spring.
4. Polarized connection.
5. Smart, modern design.

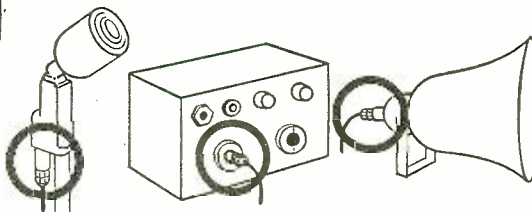

## CANNON ELECTRIC

Cannon Electric Development Co., Los Angeles 31, Calif.

Canadian Factory and Engineering Office:  
Cannon Electric Co., Ltd., Toronto, Canada

REPRESENTATIVES IN PRINCIPAL CITIES — CONSULT YOUR LOCAL TELEPHONE BOOK



Get this Special "XL" Bulletin. Write Dept. A-287, Cannon Electric Development Co., 3209 Humboldt St., Los Angeles 31, Calif.

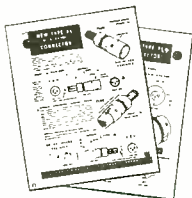

# Something New... A Tube Cooler



Here is a brand new idea in radio tube cooling. It is a high grade aluminum cooling device that is finned to operate much in the same manner as airplane engine cooling equipment.

Helps to reduce heat, increase efficiency and prolong life of tubes. Avoid hot spots. Available in standard radio tube sizes.

See it at your dealers now or write to **Terminal Radio,**  
85 Cortland St., New York, or . . .

THE  
**Sharpnack Engineering Co.**  
Lincoln, Nebraska

# Cyclohm

## POWER PLANTS

An opportunity  
for  
**DISTRIBUTORS  
AND DEALERS**

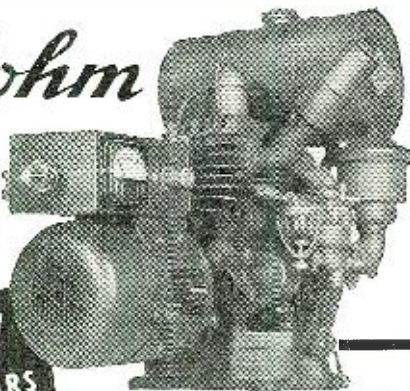

- **PORTABLE**
- **ALL-PURPOSE**

Cyclohm Power Plants, which proved their dependability and popularity with the Armed Forces of the Allied Nations, are now available for civilian use. Valuable distributorships and dealerships are open which offer a fine opportunity to sell these plants . . . powered by Briggs & Stratton air-cooled gasoline engines . . . embodying the most advanced features of power unit design . . . known for their efficient, dependable performance as **LIGHTING PLANTS** (portable or stationary) for homes, boats, fisheries, farms, mines, camps, etc. . . . **BATTERY CHARGERS** for mechanized equipment, industrial works, radio, farms, boats, mobile repair plants, truck fleets, etc.

When you sell Cyclohm units, you sell the best . . . powerful flywheel-blower air cooling . . . moisture-proof and dust-proof ignition . . . easy output control over a wide range . . . Formex insulation . . . and many other features. Write for details on exclusive representation in your territory.

**ATLAS AIRCRAFT PRODUCTS CORPORATION**  
5-17 Forty-Sixth Road, Long Island City 1, N. Y.

accessories, such as headphones, antennas, etc., or (3) in the aircraft, its battery, the engine, or the installation.

Trouble in the equipment itself should likewise be isolated in the following order—in power supply, audio and output section, second detector, intermediate frequency amplifier, or in radio frequency input section.

Unless it is definitely known that radio frequency circuits are in need of realignment and the necessary test equipment and tools are at hand, "tinkering" with these circuits should not be tolerated.

Shorted armatures are indicated by low output voltages and high input current. By disconnecting the output leads and running the dynamotor at its rated input voltage, if the input current of the G-3-AB dynamotor (without load) is in excess of 1.5 amperes, a shorted armature is usually indicated. Input current in excess of 3 amperes (without load) on the G-30-AB dynamotor is also the usual indication of a shorted armature. The armature should be removed and tested on a growler.

Trouble shooting noise in aircraft equipment is difficult because of the many possible sources. Noises must be isolated, such as (1) in the equipment; (2) in the installation; (3) at the antenna, battery, or other accessories; (4) in the aircraft or its engines, or finally, (5) whether the interference is of non-man-made sources, such as the various static conditions encountered.

### Alignment—Equipment Required

1. A good signal generator covering the range of frequencies used in the receiver.
2. An output meter, 0-50 milliwatts, 200 ohms impedance.
3. An insulated, non-metallic screwdriver for condenser trimmers.
4. A small metal screwdriver for r.f. coil core screws.
5. One .1  $\mu$ fd., and one 100  $\mu$ fd. condensers.

### Alignment Procedure

1. Connect signal generator ground on output lead to receiver chassis ground.
2. Connect output meter in parallel with audio output.
3. Allow receiver and signal generator to "heat up" for accurate alignment.
4. Connect recommended dummy antenna condenser in series with signal generator output lead.
5. Before aligning, set dial pointer to small dot at low frequency end of dial scale when rotor plates of tuning condenser are closed.
6. Receiver volume set to maximum unless noise level is excessive.
7. Signal generator output set to limit receiver output to 50 milliwatts or less.
8. 30% modulation on signal generator output.
9. BFO switch set to "phone."
10. Sensitivity—50 milliwatts output with 2 microvolts input; 4:1 signal-to-noise ratio.

### Maintenance

The length of time between periodic maintenance checks on aircraft radio equipment will vary under the particular conditions of usage, i.e., temperature, humidity, and corrosive elements, etc. An arbitrary period of 200 actual-equipment-operating hours may be used, checking the following:

### Dynamotor

When lubrication is needed, remove the end covers and bearing plates, clean with gasoline and apply enough *Royco* 6A grease (or equivalent) to cover bearings. Do not pack bearings. Keep grease off commutators.

The dynamotor should be given a periodic visual inspection for armature shaft alignment; smooth, free-running bearings and end play in armature.

The commutators, especially, should be inspected. Keep them clean by the use of "wet-or-dry" sandpaper. (Don't use emery cloth.) When commutators show signs of excessive wear, the armature should be removed and commutators "dressed."

Brushes must be kept well seated and not allowed to wear so short that the spring pressure is insufficient. Any

excessive sparking of the commutator should be investigated as to cause and the trouble then remedied.

### Relays

All relays should be checked and kept clean and the contacts trimmed only when necessary. Fine sandpaper should be used on heavy duty relay contacts, followed by carbon tetrachloride, to remove sand grit. When low current, small contact relays, are cleaned, special relay tools should be used whenever possible. Don't adjust relay arms and springs unless necessary.

### Dial Calibration

While the user will usually detect any error in dial calibration, it is well to check it closely during any inspection. This should include mechanical inspection of pointer and knob, as well as circuit alignment check. The 278 kc. control tower spot on the dial should not be overlooked.

### Sensitivity

When equipment is at hand, the receiver sensitivity should be checked and when low, proper service be effected.

### Field Etiquette

The aircraft radio serviceman will find it necessary, on many occasions, to check frequencies with the control tower while he is working on a ship, either on the line, or in the parking

area. He should familiarize himself with correct control tower and voice procedure.

Avoid personal remarks or "rag chewing," and limit each transmission to strictly business. Don't use a normal tone when speaking into the microphone; raise your voice slightly and make pronunciation distinct. Knowledge of the standard phonetic alphabet is very useful. The control tower may, at times, find it necessary to use of a signal light gun to flash you a warning or instructions. Learn to interpret signals properly and obey them, as your safety or that of someone else may be at stake.

For the "wide awake" radio serviceman, the foregoing will serve to reaffirm his belief in the future—a future filled with opportunities and compensations.

The era of the business lull being filled with toaster, washing machine, and vacuum cleaner fixing, is strictly passe. The radio serviceman is a bona fide member of the electronics fraternity, and as such, he should devote his time and energy to furthering his accomplishments there, leaving the maintenance of mechanical "household gadgets" to others.

Installing and servicing radio aircraft equipment is vital to air travel, destined to become even more so in the future. Being in on the "ground floor," established at a field with a "future" and making it pay, will be the reward of those who are far-

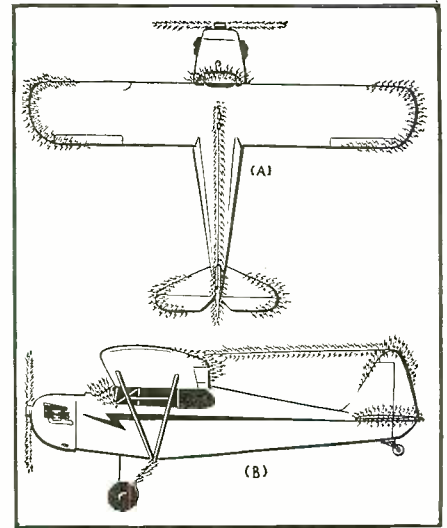

Fig. 7. Illustration of precipitation static collected on plane in flight.

sighted enough to reserve a "front seat center" for themselves, in the drama of tomorrow.

Contrary to widespread opinion, installation and servicing of aircraft radio is not as complicated or intricate as it might seem. Although there are problems, such as precipitation static, bonding, electrolysis, vibration, and a few others encountered in servicing aircraft radio, there is not a great deal of difference between its installation and maintenance and that of the household radio receiver.

## Sensational Bargains on Popular Merchandise

### A FEW OF OUR TYPICAL BARGAINS

Send Today for free catalog for complete list

ALMOST ALL TYPES OF TUBES IN STOCK. MAIL IN YOUR ORDERS FOR ALL TYPES NEEDED, NOT JUST THE CRITICAL NUMBERS. AND WE'LL TRY TO FILL THEM COMPLETELY.

**MICROPHONE STANDS**—Have heavy gray ripple-finish bases and beautifully plated tubing. Floor-type, adjustable from 36" to 66"—\$5.75; Desk stand, adjustable from 8 to 13"—\$3.95. **50" TEST LEADS**, with extra heavy phono-needle type black and red prods; 5 KV insulation—per pair—50c. **RF CHOKES**—2.5 MH, 150 MA, BNC wound—20c. **AUTO ANTENNAS**—Standard 3-section type, complete with leads; 66"—\$1.50; 96"—\$2.95. Fifty 2-Watt resistors, all standard, useful sizes—\$1.95. **CIRCUIT BREAKERS**—20 Amp.; made for military use—\$1.25 ea.

**"INSIDE THE VACUUM TUBE,"** by Rider; Just off the press—a valuable addition to your technical library—\$1.50. **CARBON MIKES:** Universal, Model "W"—\$2.40. "Home Broadcast" type, with built-in switch and instructions—60c. **GOLD-PLATED** midket type single-button Signal Corps mike, stretched duranuminum diaphragm, waterproof; just the thing for concealed pickups, as hand mikes, or wherever a compact, high-quality unit is needed—95c ea. **BULLET CRYSTAL MIKES**—\$5.45; **BULLET DYNAMIC MIKES**—\$7.45.

**ALL-PURPOSE NEON POCKET TESTER**, 60 to 550 volts. Indicates all kinds of current, AC, DC, or RF, and comes complete with instruction booklet outlining various tests on radio sets, including the location of fusing, dead stages, shorts, and making screen-grid and plate circuit tests—25c ea.; Per doz. on beautiful display card—\$3.50.

**TUBULAR CONDENSERS**—Guaranteed one year. Prices in lots of ten, either one type or assorted. 100 MF. 25V—35c; 50 MF. 150V—45c; 20-20 MF. 150V—40c; 20-20 MF. 150V—30c; 25 MF. 25V—20c; 20 MF. 150V—20c; 10 MF. 50V—15c. **PAPER CONDENSERS**, all 600V: .25 MF—20c; .1 MF—10c; .05 MF—9c; .02 MF—8c; .01 MF—5c; .005 MF—4c and smaller—7c ea. **MICA CONDENSERS**, 1000V test, 600 WV, any standard size—15c. **MOTOR STARTING CONDENSERS**, 110V, 85-115 MFd, 3-second start, universal type; for refrigerators, pumps, etc.—\$1.25. **110V—60 CY. TWO-POST RECORD CHANGER**—Plays 12—10" or 12" records INTERMIXED! The only low priced changer on the market with this feature. Includes high grade Shure Crystal Pickup—\$22.50. G.E. S.P.D.T. Microswitches—50c ea. Stromberg-Carlson 26 H, 250 MA, 35 ohm filter choke. Made for U.S. Navy—Fully shielded in black crackle-finish case—\$5.98 ea.

**RELAYS:** 4-pole (3 make, 1 break), 400 ohm AC or DC—\$1.50. DPDT, Heavy duty type, suitable for high-power switching, 50 ohm coil—\$1.50. SPST, AC or DC, 15 ohms—45c.

**BANISH PORTABLE BATTERY TROUBLES**—Replace now with a GTC Postpower. Converts 110V, AC to 1½ and 90 Volts DC, and fits average size battery compartment. No wiring changes necessary, as unit has sockets to fit standard battery plugs. The first cost, \$8.90, is the last cost. Beautiful Silver-tone Modern Walnut Cabinets, in original cartons—Large enough for most glasses and only \$1.50 each. 2 types available: #419, with glass and plastic enclosure, 9x6x1½" high, and #122, 11x13x2" high.

**ROTARY SWITCHES:** SPST shorting type, fiber insulation—15c; Single pole, 4 throw—15c. **CERAMIC INSULATED** switches for hi-frequency use: 3 pole double throw, and 4 pole double throw (shorting type), either type—47c ea. **METER RECTIFIERS**, 4-wave full-wave—90c. **AMPLIFIER FOUNDATION UNIT**, 7x17x9" size; chassis height, 3", finished in beautiful marine gray ripple finish—\$2.70. We have a complete stock JCA chassis and cabinets at comparably low prices.

### LOOKING FOR A TREMENDOUS BARGAIN IN SURPLUS RADIO EQUIPMENT?

Here is one that is really worth looking into. While they last, we are offering the Army model B-19, Mark II dual transmitter-receiver-intercom amplifier illustrated below for a fraction of its original cost of over \$900.

This unique equipment is built of standard type first grade parts, and has passed a rigid government inspection. Each unit consists of a 2-8 MC, 30 Watt transmitter and superhet receiver, a VIII transmitter-receiver which operates from 1.2 to 1.3 Meters, and a 5.5 Watt audio amplifier. The entire set is constructed on a heavy metal chassis, and is housed in a crackle-finished 17½x8¼x12½" steel cabinet.

The low-frequency transmitter features an 807 power amplifier, a buffer stage, and a highly stable electron-coupled exciter circuit. The receiver employs an RF stage, two IF stages using three iron-core transformers, and an adjustable beat frequency oscillator. The band-switching mechanism for both transmitter and receiver is controlled from the front panel. This section will cover the 40, 75, 80 and the proposed 160 Meter band, both Phone and CW.

The VIII section employs an E-1148 triode in a beautifully designed and constructed RF circuit, along with modulator, audio amplifier and oscillator tubes. By slightly increasing the tank circuit inductance, 1½ Meter band operation is possible.

The panel microammeter checks antenna current, transmitter current, transmitter and receiver plate voltages, heater voltages, and receiver signal strength (R-Meter) all by a flip of the selector switch. The audio-amplifier consists of a 6K7G-6V6G amplifier, and has a multitude of uses. Each of the three sections is independent of each other, except for the common power supply connections. Thus, both sets may be used at the same time, either receiving or transmitting, and the output of either receiver may be fed into the input of the other transmitter for relay operation. The operator's conversion can even be added to the rebroadcast.

Each unit comes complete with a set of fifteen tubes, instructions, and circuit diagram. The price on this sensational bargain is only \$39.95.

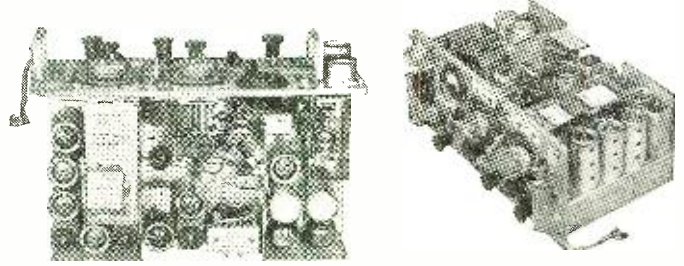

Power requirements for this unit are 6 or 12, 275, and 500 volts DC, 6 volts AC may be used for heater supply instead of DC by making a simple circuit change. The power supply is not furnished, but we can supply a complete kit for a very reasonable sum. 10% DEPOSIT MUST ACCOMPANY ALL C.O.D. ORDERS.

**BUFFALO RADIO SUPPLY, 219-221 Genesee St., Buffalo 3, N. Y., Dept. N-4**

# ELECTRICITY

FOR RADIO AND  
ELECTRONIC  
APPLICATIONS



● ONAN ELECTRIC GENERATING PLANTS supply reliable, economical electric service for electronics applications as well as for scores of general uses.

Driven by Onan-built, 4-cycle gasoline engines, these power units are of single-unit, compact design and sturdy construction. Suitable for mobile, stationary or emergency service.

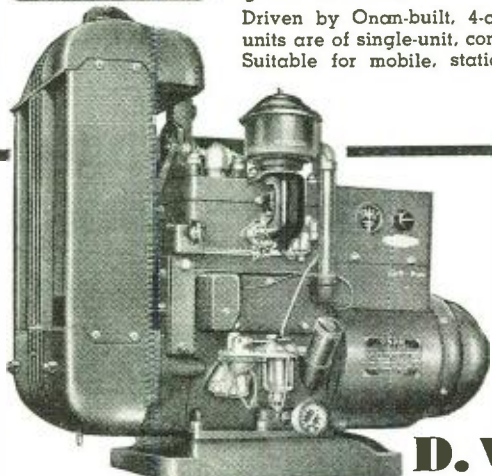

Models range from 350 to 35,000 watts. A.C. types from 115 to 660 volts; 50, 60, 180 cycles, single or three-phase; 400, 500 and 800 cycles, single phase; also special frequencies. D.C. types range from 6 to 4000 volts. Dual voltage types available. Write for engineering assistance or detailed literature.

Model shown is from W2C series, 2 and 3-KW. 60-cycle, 115 volt; powered by water-cooled 2-cylinder engine.

**D. W. ONAN & SONS**  
MINNEAPOLIS 5, MINN.

2171 Royalston Avenue

Many radio servicemen have veered from familiarizing themselves with the aircraft radio field—why, we don't know, as it is definitely a lucrative field, and one in which every "go-getting" serviceman should become interested. Of course, all servicemen will not be interested in changing their clientele—either because they are firmly entrenched in household radio servicing, or because of other interests. However, we have endeavored to awaken and kindle an interest for this vital field by showing that it is not only a profitable, but a long-lived enterprise.

Qualified radio men are needed now, and servicemen who have both sound and dependable training behind them should "climb on the bandwagon," in order to be assured of not "missing the boat" in the bumper field of electronics.

The author is indebted to a number of individuals and organizations for assistance rendered in the preparation of this article. Mr. Henry J. Hamm, of Lear, Incorporated, made many of the photographs, circuit diagrams, and much of the data on aircraft radio equipment available. Thanks are also due Piper Aircraft Corporation for the use of photographs, diagrams, and data.

-30-

## MINIATURE, EXTRA-SENSITIVE HEADPHONES!

IDEAL FOR Amateurs, Servicemen, Commercial Operators, etc.

Manufactured especially for Infantry and Armored Forces; cost the Government approx. \$35.00 per headset. Extremely sensitive phones, with good fidelity characteristics, with matching transformer built-in so that phones work into any hi-impedance output and at the same time are protected from any DC component. Practically indestructible. Light and Compact! Features: adjustable headband; flexible rubber phone cord to provide many years of wear and to guard against moisture; rubber spring clip for fastening to clothing; soft, flexible rubber ear-tips fastened to each phone for comfort and to remove extraneous noises, etc. Supplied with standard phone plug.

PRICE,  
COMPLETE **5<sup>95</sup>**

Send check or money order for postpaid delivery.

**TAYBERN EQUIPMENT CO.**  
118 GREENWICH ST., NEW YORK, 6, N. Y.



## International Short-Wave

(Continued from page 79)

a.m. when XGOY's English news pickup is carried.

Although not listed as such by All-India Radio, VUB2, Bombay, is being heard 8-9 a.m. on 4.880, and re-opening at 9:15 a.m. on 3.365 with market reports; signals have been quite strong on West Coast during the winter. VUC2, 3.305, Calcutta, has news in English at 8 a.m., followed by news in Hindu. Delhi's 8:30 p.m. Forces transmission has shifted from 6.190 to VUD7, 6.100, although still announced as 6.190, with 4.860 being heard weekly in parallel. (Dilg)

Radio Guadeloupe, Point-a-Pitre, Guadeloupe, has been wandering a great deal, latest reported frequency being 6.192, 6-7:30 p.m., weak modulation.

\* \* \*

### BEST BETS FOR BEGINNERS

Canada—Best Bets for Beginners in Toronto, Ontario, are listed by Albert E. Bromley of that city, as CKCX, 15.190, Sackville, N.B., around 2 p.m.; HCJB, Quito, Ecuador, daytime, also on 9.958 and 15.105; GRF, 12.095, London, afternoons; FZI, 11.970, Brazzaville, afternoons; CHOL, 11.720, Sackville, N.B., afternoons and evenings; PRL8, 11.720, Rio de Janeiro, Brazil, 9:30-9:55 p.m. except Saturday and Sunday; CSW6, 11.040, Lisbon, Portugal, afternoons; OTC, 9.745, Leopoldville, afternoons and evenings; VLC5, 9.54, Shepparton, Australia, mornings at 8-8:45 a.m.; XEWW, 9.500, Mexico City, mornings and evenings; KRHO,

## ATTENTION RADIO SERVICEMEN

Signal Corps surplus crystal chests. Each chest new—never used.

Perfect for parts chest for radio servicemen to carry spare parts on home service calls.

CHEST SIZE 7" wide, 10" high, 17½" deep. Made of heavy plywood painted O.D. Piano hinge, steel-reinforced corners, carrying handle. Bottom and sides reinforced. Each chest fitted with 2 drawers 8½" wide, 15¼" long, 2" deep. Heavy felt dividers separate each drawer into 100 compartments ½" wide, 1¾" long, 1" deep. Compartments may be easily enlarged, or dividers removed entirely.

\$5.45 EACH—SHIPPED C.O.D. EXPRESS plus express and c.o.d. charges

### QUANTITY LIMITED

Order now from **TERRY JAY**  
550 Arlington Place, Chicago 14, Illinois

## Amateur Radio WRITERS WANTED

To write articles on transmitters, receivers, antennas, test equipment, and any material of general interest to amateurs. Articles should be typewritten, between 2000 and 2500 words in length, accompanied by suitable diagrams, photos, and parts lists. Liberal payment made upon acceptance.

Address all communications to

Box 419

**RADIO NEWS**

185 North Wabash Avenue, Chicago 1, Illinois

RADIO NEWS

6 120, Honolulu, Hawaii, mornings; ZNS2, 6.090, Nassau, the Bahamas evenings; ZFY, 6.000, Georgetown, British Guiana, evenings; VONH, 5.970, St. John's, Newfoundland, evenings; ZRK, 5.885, Cape Town 3, South Africa, nights around 11:45 p.m.-1:30 a.m.; in addition to most other Canadian, American, British, and Cuban transmitters.

For beginners in the Preston, Ontario, area, Glynn Moss suggests PZH5, 5.75, Paramaribo, Dutch Guiana, 5-8:28 p.m., off with Dutch National Anthem; OAX4Z, 5.905, Lima, Peru, 6-11:30 p.m.; HJCT, 6.198, Bogota, Colombia, 6-11:15 p.m.; HI2N, 6.24, Ciudad Trujillo, Dominican Republic, evenings to 11:30 p.m.; Radio Nacional de Espana, 9.37, Madrid, Spain, afternoons and evenings, English news at 3 p.m.; OTC, 9.745, Leopoldville, Belgian Congo, evenings; XEWW, 9.500, Mexico City, day and night; HH3W, 10.105, Port-au-Prince, Haiti, evenings to 10:30 p.m.; CMCY, 11.74, Havana, Cuba, almost anytime in day and evenings; FZI, 11.97, Brazzaville, French Equatorial Africa, 11 a.m.-6:45 p.m., midnight-1:30 a.m., news in English at 5:15 and 6:30 p.m.; HCJB, 12.455, Quito, Ecuador, morning, late afternoon, evening to 10:30 p.m., relays news from San Francisco at 5 p.m.

Oklahoma — Don Brewer, Tulsa, sends along these Best Bets for Beginners for the spring; VLC5, 9.54, Shepparton, Australia, Eastern North America beam, 8-8:45 a.m., news at beginning and at 8:35 a.m.; FZI, 11.97, Brazzaville, English news at 3:45, 5:15, and 6:30 p.m.; YV5RM, 4.97, Caracas, Venezuela, in Spanish only, good between 7-10 p.m.; HCJB, 12.455 and 9.958, Quito, Ecuador, very good signal, 9-10 p.m.; PRL8, 11.72, Rio de Janeiro, Brazil, "Radio Nacional," 9:30-9:55 p.m. daily except Saturday and Sunday, in English; CKLO, 9.63, Sackville, N.B., good 3:15-7 p.m. sign-off, sends nice QSL card; Komsomolsk, 15.23, Siberia, relays Radio Centre, Moscow, 7-7:30 p.m. (English); GRH, 9.825, London, 4:15-9 p.m. in North American Service of BBC; OTC, 9.745, Leopoldville, Belgian Congo, heard best after 11:45 p.m.; GRC, 2.880, London, 9:30-11:45 p.m. in North American Service of BBC.

\* \* \*

#### LAST MINUTE TIPS

Radio Wein, Vienna, Austria, approximately 7.180, is reported fair with messages in German to 6 p.m. when London's GRX, 7.185, opens.

OLR2A, 6.010, Prague, Czechoslovakia, is scheduled 2-5:15 p.m.; OLR3A, 9.550, is scheduled 9:30-10 a.m., 12:45-1:55 p.m., and 8-8:30 p.m.; OLR4A, 11.840, is scheduled 3:45-4 and 5-5:30 a.m. Address for reports is Le Ministre des Postes de la Republique Tchecoslovaque, Praha, Czechoslovakia.

Call letters of Radio Club Portugues, Parede, Portugal, 12.405, are given as CS2WI in a letter of verification to Swedish correspondents. Re-

# TEN METER BAND!

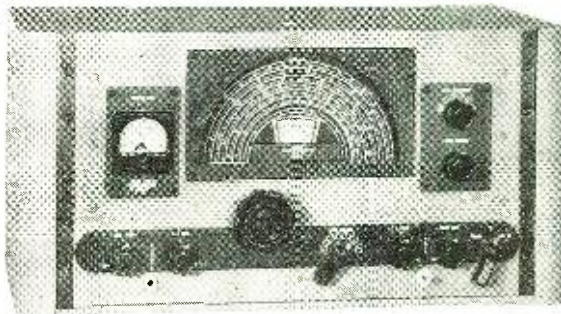

RME 45

## PROVING GROUND FOR RECEIVERS

### Features

- Calibrated band spread scale on all amateur frequencies from 10 to 80 meters.
- Fine adjustment through dual drive control mechanism which gives approximately five revolutions of smaller knob to one revolution of larger knob.
- Relay control and break-in terminals.
- Streamlined two-tone cabinet.
- Acoustically designed speaker housing.
- Relay rack mounting panel.
- Six bands, 550 to 33,000 K.C.

Brilliant receiver performance on ten meters is the goal everyone is seeking because peak performance on the highs usually means peak performance on all frequencies. Here's why the new RME 45 gives you exceptional performance on these frequencies:

**SENSITIVITY**—Most receivers are sensitive on low frequencies but only an exceptionally well designed receiver has the same degree of sensitivity on the highs. RME's peak performance on the highs is made possible by the use of loctal tubes, shorter leads, reduced distributed capacity, exceptionally well designed inductances, and a score of additional refinements—each making its individual contribution to increased efficiency.

**STABILITY**—Receiver drift is a nuisance making necessary repeated and continuous retuning—especially when working CW. With the RME 45, set the dial on the station and it stays tuned, thanks to accurate temperature compensating padders which are built right into the receiver. There are no dials to preset, no pre-adjusting of padders, no recheck points to observe. After a station is once logged, it remains logged until you wish to tune in another.

**Ignition QRM**—Ignition QRM on ten meters has long been a stumbling block to 100% QSO's on high frequencies. Not so with an RME 45. This modern receiver incorporates a highly efficient automatic noise suppressor which is always in the circuit—always on the job.

Little wonder that thousands of hams are insisting on the new RME 45!

LITERATURE SENT ON REQUEST



### LOCATES TROUBLE INSTANTLY IN ALL ELECTRICAL DEVICES

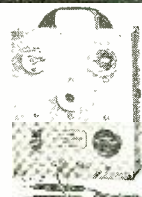

#### HANLAN APPLIANCE TESTER

In this single unit are combined all the necessary tests for examining every appliance. Checks thermostats under actual working conditions. Tells instant it opens or closes. Controls the heat on soldering irons—prevents overheating. Tests continuity, open circuits, etc. Checks automatic irons, vacuum cleaners, motors, shavers, bulbs, fuses, appliances with 3-way switches, etc. Great time, effort and money saver! Only \$9.50 complete. WRITE FOR CIRCULAR.

#### HANLAN COMPANY

1419-R West Jefferson Los Angeles 7, Calif.  
FREE with each Tester. New, Complete, Practical  
Course in electrical appliance repairing.

#### Surplus Government Purchase!

### RADIO TRANSMITTER

T/66CRN10, 100 Watt crystal controlled. 6./MC. crystal multiplied to 110 MC. Uses 807 oscillator, 807 tripler, 257B doubler, two-257B's push pull tripler power output. RF, Power, Tuning metered by two Weston meters. Approximate value \$500.00—Our price \$60.00 (less crystal and tubes).

### RADIO HAM SHACK

63 Dey St., New York 7, N. Y.

# NOW—A REALLY HIGH-POWERED— Radio Engineering Library



**NOTE:**

The Library comprises a selection of books culled from leading McGraw-Hill publications in the radio field.

- especially selected by radio specialists of McGraw-Hill publications
- to give most complete, dependable coverage of facts needed by all whose fields are grounded on radio fundamentals.
- available at a special price and terms

THESE books cover circuit phenomena, tube theory, networks, measurements, and other subjects—give specialized treatments of all fields of practical design and application. They are books of recognized position in the literature—books you will refer to and be referred to often. If you are a practical designer, researcher or engineer in any field based on radio, you want these books for the help they give in hundreds of problems throughout the whole field of radio engineering.

**5 VOLUMES, 3559 PAGES, 2558 ILLUSTRATIONS**

1. Eastman's FUNDAMENTALS OF VACUUM TUBES
2. Terman's RADIO ENGINEERING
3. Everitt's COMMUNICATION ENGINEERING
4. Hund's HIGH FREQUENCY MEASUREMENTS
5. Henney's RADIO ENGINEERING HANDBOOK

10 days' examination. Easy terms. Special price under this offer less than books bought separately. Add these standard works to your library now; pay small monthly installments, while you use the books.

**10 DAYS' FREE EXAMINATION—SEND COUPON**

**McGraw-Hill Book Co.,**  
330 W. 42nd Street, New York 18, N. Y.

Send me Radio Engineering Library, 5 vols., for 10 days' examination on approval. In 10 days I will send \$3.00 plus few cents postage, and \$3.00 monthly till \$24.00 is paid, or return books postpaid. (We pay postage on orders accompanied by remittance of first installment.)

Name .....

Address .....

City and State .....

Company .....

Position .....

**Start Your Own Service Shop  
WITH  
LITTLE MONEY**

**NEW BOOK TELLS YOU HOW**

Only **\$1.75** Postpaid

*Starting and Operating a Profitable*

**10 Days' FREE Trial**

Get this sensational new book, "Starting and Operating a Profitable Electrical or Radio Shop" on 10 days' FREE TRIAL. Full facts about starting with small capital, full or part time. Tells how to finance a business, choosing a location, selecting a name, how and what to buy, advertising, salesmanship, legal angles, record keeping. **Brand new—nothing like it.** Recommended for servicemen, or anyone seeking information on starting a good paying shop. Only \$1.75 postpaid. Order your copy of "Starting and Operating a Profitable Electrical or Radio Shop" today.

**RUSH THIS 10 DAY FREE TRIAL COUPON**

H. C. LEWIS, President  
**COYNE ELECTRICAL SCHOOL, Dept. 46-T4,**  
500 S. PAULINA ST., CHICAGO 12, ILL.  
O. K.—rush my copy of "Starting and Operating a Profitable Electrical or Radio Shop." I am enclosing \$1.75 remittance (Coyne pays postage). I understand I may return book in 10 days for full refund if I'm not entirely pleased.

NAME ..... AGE .....

ADDRESS ..... ZONE .....

CITY ..... STATE .....

Check here if you prefer to have book sent C. O. D. Pay postman \$1.75 plus small C. O. D. fee upon delivery. Same 10 DAY SATISFACTION GUARANTEE.

lays CS2ZA. This station is still heard regularly best around 2:30 p.m. Reported heard by Bromley in Toronto, Ontario, at 5 p.m. on a recent Sunday.

A Swedish correspondent also corrects power of Radio Falange, Alicante, Spain, 7.950, from 12,000 watts to 1,200 watts.

Radiations from Bern, Switzerland, of the Short Edition to North America, 2:20-2:50 p.m., over the new channel of HED4, 10.405, are sometimes marred by bad c.w. interference, although signal strength is good, particularly in the East. English news begins the transmission. The Full Edition to North America, 8:30-10 p.m. over HEK3, 7.380, and HEF4, 9.185, deteriorated greatly during the winter months, especially the 9.185 channel, but should be improved by now. (Bern's North American transmissions are heard daily *except* Saturdays.)

Radio Belgrade, 9.420, Yugoslavia, is reported with fair strength on the Pacific Coast daily, 11 a.m.-12 noon, in Eastern European languages.

Latest schedules of the Anglo-Egyptian Sudan transmitters are: Khar-toum, 9.220, and Omdurman, 13.320, in Arabic, daily *except* Thursday, 11:30 a.m.-1 p.m. and 2-2:30 p.m.; on Thursday the first period signs off at 12:30 instead of 1 p.m., second period remains the same; additional programs in Arabic are scheduled Friday, 3-4:30 a.m. and Sunday, 3-4 a.m.; the only English program listed is Thursday *only* at 12:30-1 p.m.

"Radio Somali," 7.126, Hargeisa, British Somaliland, is reported with a fair signal at 10 a.m. when the BBC news is relayed.

Johannesburg, South Africa, on 4.382, was recently reported as heard in Hawaii on Sunday at 10:40 a.m. to fade-out at 11:00 a.m.; according to the South African Broadcasting Corporation, power of this transmitter is only 200 watts.

Radio SEAC, Ceylon (reported as Kandy or Colombo), is being heard in Hawaii at 10 p.m. on 3.395 in parallel with 11.765.

XGOA, 5.918, Chungking, China, is being heard with a Chinese transmission (and possibly other Asiatic languages), 3-4:45 a.m.

The American Forces' station on 4.759 (announced), varying up to 4.810, is XUSA at Chungking, China; it is operated by the Signal Corps, rather than by the Armed Forces Radio Service; is heard with record request, 9:45 a.m. to sign-off at 11 a.m. or later.

New Zealanders report that Guam's KU5Q has often been heard on an unlisted frequency of 13.390, also that The British Forces' program on VUD10, 7.210, Delhi, India, is heard very well, 9:30 a.m.-12:30 p.m.

From Hawaii it is reported that Y15KG, 7.085, Baghdad, Iraq, is heard in Arabic, with clock striking four o'clock (p.m.) at 9 a.m.

Art Cushen, New Zealand, reports that the Armed Forces Radio Network in Tokyo verifies by letter from Program Director (Sgt. Earl Moreland),

**ATTENTION!**  
STUDENTS • SERVICEMEN • HOSPITALS  
Introducing Our First Post-War Radio Kit  
Professionally Engineered, Professionally Designed and Professional Looking  
It uses the universally accepted superheterodyne circuit containing the following tubes: 12SA7, 12SK7, 12SQ7, 50L6, 35Z5 and tunes from 550 Kc to 1600 Kc.



Complete Kit, including tubes, Bakelite Cabinet and four pages of diagrams and instructions. Ideal for use by students, schools, hospitals, amateurs and servicemen.

**Model S-5 @ \$19.95**

In addition our previous models of meters and Radio Kits are still available. Ohm-Volt Milliammeter Kit M-2

..... @ \$14.95

Radio Kit model TRF-4A, less cabinet ..... @ 10.95

Radio Kit model S-6, less cabinet ..... @ 17.95

**Special for This Month!**  
6 inch dynamic speaker 450 Ohm Field \$1.35 each

(25% Deposit on C.O.D. Orders)  
We carry a complete stock of parts.  
Export Inquiries Invited.

**RADIO KITS COMPANY**  
Dept. K 120 Cedar St. New York 6, N. Y.

**FOR IMMEDIATE DELIVERY!**  
**RECORD PLAYERS**  
**COMPLETE—SIMPLY INSTALL YOUR OWN MOTOR AND TURNTABLE!**



Record Player Complete without motor & turntable  
**\$32.50**  
per unit

**PLAYER CONTAINS:**

- Large electro-dynamic speaker
- Tone Control • Volume Control
- A. C. Amplifier with power transformer, and connecting cords
- 3 tubes—1-6V6, 1-6C5, 1-5Y3
- Astatic pickup with arm rest
- Permanent needle—Knobs
- Acoustically-built cabinet
- All in a handsome, leatherette-covered, sturdily-constructed case, 14" wide, 7 1/2" high, 16 3/4" long.

**DEALERS—Write for quantity discounts!**

**UNION RADIO CORPORATION**  
1636 W. VAN BUREN ST., CHICAGO 12, ILL.  
**RADIO NEWS**

Armed Forces Radio Network, GHQ, AFPAC, Advanced Echelon, APO 500, c/o Postmaster, San Francisco. Power of JLG4, 7.55, was given as 25 kw., JLP, 9.605, as 20 kw. Cushen reports that in December, AFRN programs were being heard on 5.765 to 9 a.m. sign-off with bad CWQRM.

Relay of correspondents from Tokyo to San Francisco is now heard mornings on JLS, 9.652, and a new Osaka frequency, JGF, 7.780.

AFRN, Tokyo, on an announced frequency of 3.075 now signs off at 9:03 a.m., and the other AFRN transmitter in Tokyo, JLR, 6.015, now signs off at 4:15 a.m.

Reception from the Soviet Union is reported as erratic in most parts of the country, with almost constant changes taking place. Kiev on 6.020 is reported heard 10 p.m. until after 3 a.m., as well as during the afternoon, with good signals. Moscow on 7.330 is reported from 1 a.m. until after 2:15 a.m.; I have heard this station in English some evenings around 10 p.m., poor quality. The only dependable Soviet transmitter in the evening broadcast to North America in English seems to be Komsomolsk on 15.230, which is at peak around 7 p.m. when English news is generally relayed. Moscow on 15.320 is reported on daily at 8 a.m. in French, and a Moscow station on 15.340 is reported irregularly to sign-off at 8 a.m. The 15.750 frequency, which was used widely for morning transmissions, now seems to be heard only irregularly; some mornings I do not even get a carrier on 15.750. Radio Centre, Moscow, on 9.480, is reported to be carrying the 8 a.m. news in English to North America, along with the Siberian transmitter located at Komsomolsk (9.565).

Algiers stations include Alger 1, 6.025, 12 noon-6 p.m., 50 kw.; Alger 2, 1.176, 10:30 a.m.-6 p.m., 50 kw.; Alger 3, 6.040, 12:30-6 p.m., 50 kw.; and Alger 4, 6.760, 12:30-6 p.m., 1 kw. (Kalderen)

Brazzaville's transmitter on 6.024 (measured) is reported heard well from opening of transmission in French at 12 midnight; I have heard this station opening around 6 p.m. in French, also.

Dakar's 2:15-2:25 a.m. French news transmission is still well heard on about 7.210 (FGY), and is usually preceded by fifteen minutes of flute-like interval signal.

Radio Noumea, 6.208, New Caledonia, is reported signing on at 2 a.m. in French, stating the broadcast is not only for local listeners but for France and Madagascar also; French news is given between 2:05-2:15 a.m.; sign-off reported was 4 a.m., but Australians report a concert of classical music precedes 5:05 a.m. sign-off. New Zealanders write that this station (FK8AA) is now controlled by the French Representatives, uses 80 watts, and is scheduled 7-8 p.m., 2:30-4 a.m., and 4:30-5 a.m.

Verifications are being widely received from ZFY, 6.000, Georgetown, British Guiana, which is heard well in

April, 1946

**PUR-A-TONE**  
Reg. Trade Mark

# ANTENNAS



Masterpieces of

## DESIGN AND CONSTRUCTION

A.M. — F.M. — TELEVISION



## for AUTOS • HOMES • MARINE

Brach Pur-a-tone Antennas have long been recognized as the standard by which all others are judged. They're a byword for Quality and a buy-word for Satisfaction. Please your customers and increase your profits—ask your distributor for BRACH ANTENNAS.

Special-purpose transmitting antennas designed for volume production to your specifications. Collapsible — sectional — direction-finding — radar — and coaxial type. All sizes, lengths and materials. Consult us on your needs.

**L. S. BRACH MFG. CORP.**  
200 CENTRAL AVENUE NEWARK, N. J.



WORLD'S OLDEST AND LARGEST MANUFACTURERS OF RADIO ANTENNAS AND ACCESSORIES.



### Check Pin Connections & Tube Data Instantly!

Two new and amazingly handy slide rules tell you at once the location and nature of pin connections, filament voltage, filament current, and uses for 176 radio tubes. Radio or electronic engineers, servicemen, students can't afford to be without these pocket-sized time-savers. SEND \$1.00 IN CASH OR MONEY ORDER TODAY and receive both prepaid by return mail. Your money back if not satisfied.

WRITE FOR QUANTITY PRICES

HARRY LANGSAM,  
12 S. 12th Street, Phila. 7, Pa.  
 I enclose \$1.00. Please send both Radio Tube Pin Data Rules.  
 Send Quantity Prices.  
Name \_\_\_\_\_  
Address \_\_\_\_\_  
City \_\_\_\_\_ State \_\_\_\_\_

## EASY TO LEARN CODE

It is easy to learn or increase speed with an Instructograph Code Teacher. Affords the quickest and most practical method yet developed. For beginners or advanced students. Available tapes from beginner's alphabet to typical messages on all subjects. Speed range is to 40 WPM. Always ready—no QRM.

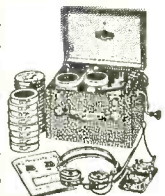

**ENDORSED BY THOUSANDS!**

The Instructograph Code Teacher literally takes the place of an operator-instructor and enables anyone to learn and master code without further assistance. Thousands of successful operators have "acquired the code" with the Instructograph System. Write today for convenient rental and purchase plans.

## INSTRUCTOGRAPH COMPANY

4711 SHERIDAN ROAD CHICAGO 40, ILLINOIS

# FOR ALL Electricians

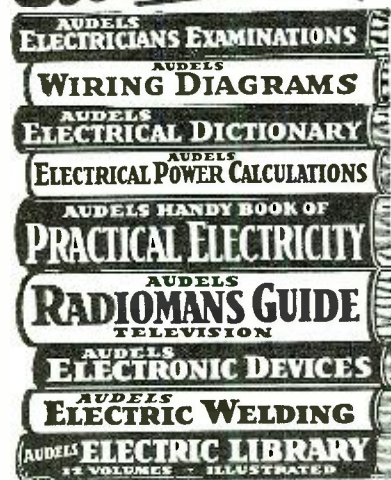

**PRACTICAL ELECTRICITY** at your finger ends. Answering your Questions and giving the facts and figures of your trade. AuDeLs Electrical Guides contain Practical Inside Trade Information in a handy form. Fully illustrated and Easy to Understand. Highly Endorsed. Check the books you want for 7 days' Free Examination. Send No Money. Nothing to pay postman. If satisfied pay only \$1 a month until purchase price is paid.

ASK TO SEE THEM.

Get This Information for Yourself. Mail coupon today. No obligation unless O.K.



CUT HERE

## MAIL ORDER

AUDELS, Publishers, 49 W. 23 St., NEW YORK 10, N. Y.

Please send me postpaid for FREE EXAMINATION books marked (x) below. If I decide to keep them I agree to mail \$1 in 7 Days on each book ordered and further mail \$1 monthly on each book until I have paid price.

- WIRING DIAGRAMS, 210 Pages . . . . . 1
- ELECTRICAL DICTIONARY, 9000 Terms . . . . . 2
- ELECTRICAL POWER CALCULATIONS, 425 Pages. 2
- HANDY BOOK OF ELECTRICITY, 1340 Pages . . . . . 4
- RADIOMANS GUIDE, 914 Pages . . . . . 4
- ELECTRONIC DEVICES, 216 Pages . . . . . 2
- ELECTRIC WELDING, 400 Pages . . . . . 1
- ELECTRIC LIBRARY, 12 vol., 7000 Pgs., \$1.50 Each

Name \_\_\_\_\_  
Address \_\_\_\_\_  
Occupation \_\_\_\_\_  
Employed by \_\_\_\_\_ RN

### RCP Model 802N Combination TUBE-SET TESTER

Immediate Shipment from Stock.

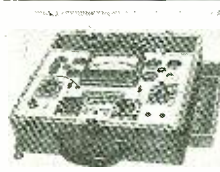

A complete tube tester and a complete set tester, with only 5 simple switches to operate for both tube and set tester combined.

#### RANGES

- DC voltmeter 0/10/50/500/1000 at 1000 ohms per volt.
- AC voltmeter 0/10/50/500/1000.
- DC milliammeter 0/1/10/100/1000 DC Ammeter 0/10.
- Ohmmeter 0/500/5000/1,000,000/10,000,000. Low ohm center.
- D.B. Meter—8/15/15 to 29/29 to 49/32 to 55 decibels.
- Four range output meter—same as AC volts.
- Size: 12 1/2 x 12 x 5 1/4 inches. Weight: 11 1/2 lbs.
- Complete in handsome hardwood case, with test leads, self-contained batteries, ready to operate. Net. . . . . **\$59.50**

Please remit 20% deposit.

**ADSON RADIO CO.**  
221 FULTON ST., NEW YORK 7, N. Y.

most parts of the U.S. now early mornings and to sign-off between 7:20-7:50 p.m., uses English.

Radio Rodina, 9.310, Sofia, Bulgaria, uses 600 watts power in a dipole antenna, relays 100 kw. station on 850 kcs. BCB, according to Swedish correspondents who do not give schedule.

ZOH, 4.890, Kandy or Colombo, Ceylon, is now being heard on this frequency, having moved from 4.900; local news in English is heard at 9 a.m. (Dilg). A letter verification received in the East from ZOJ, Colombo, states that both the 11.810 and 15.275 transmitters went off the air at the end of November; this does not apply to the Forces' broadcast heard announcing as Southeast Asia Command.

Swedish sources report that "The Voice of Ethiopia," 9.620, Addis Ababa, operates with 1 kw., 6-6:30 and 8:45-11:15 a.m. daily, and Saturdays only, 12:30-2 p.m. BBC news is reported relayed at 11 a.m.

Best signals in the East from Delhi lately have been in 8 a.m. English newscast on frequencies of 9.67/9.68 and 7.275.

ZQI, 4.700, Kingston, Jamaica, B. W.I., is reported to sign off at 6 p.m. with "God Save the King." Signals are usually poor to inaudible.

From Australia, it is reported that Headquarters Radio, SEAC, 15.450, Singapore, Malaya, is heard strongly at 3:15 a.m. with special programs for Delhi, India.

Complete schedule of JCKW, 7.220, Jerusalem, Palestine, is 11:30 p.m.-1:30 a.m. and 4 a.m.-4 p.m., news periods at 1 a.m. and 12 noon. Has been heard opening as early as 11:15 p.m. with a "Musical Clock" program and giving frequent time checks in Palestine Time (7 hours ahead of EST). After 4 months, I have just received a nice verification card from JCKW, signed by K.E.S. Ellis, Director, Forces Broadcasting, Middle East. Address is still given as AW3 GHQ MEF, and the veri was postmarked in Cairo, Egypt. Veri shows an antenna mast.

PY5, 9.305, Manila, Philippines, is reported heard 8-10 a.m. and occasionally relaying WXOI with the AFRS.

Phillipsburg, 11.900, St. Martin, N.W.I., is sometimes heard calling Curacao around 8 a.m. or 3:30 p.m.

Radio Tetuan, 6.067, "The Voice of Spain in North Africa," is reported heard well in the East, 2:30-3 a.m.

PZX3, 5.75, Paramaribo, Suriname, is reported signing off at 8:25 p.m.; verifications are being received from PZC, 15.405, also in Paramaribo.

ZRK, 5.885 (measured at 5.878), Cape Town 3, has been sending the most consistent daily s.w. signals from South Africa during the winter. Is heard 11:45 p.m. (comes on with bugle call, followed by exercises in Afrikaans—sometimes English is also used—with piano accompaniment, and a clock strikes 7 a.m. their time at 12 midnight EST) to 1:30 a.m. sign-off, with BBC news relayed at 1 a.m.; is also heard some afternoons and has

TO INSURE A  
**BIG** JOB IN A  
LITTLE SPACE  
SPECIFY **HI-O** COMPONENTS

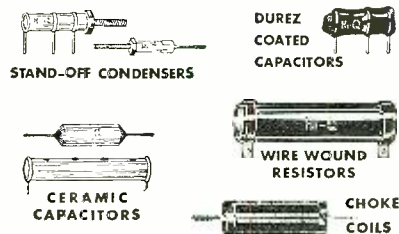

**ELECTRICAL REACTANCE CORPORATION**  
FRANKLINVILLE, N. Y.

## THIS MONTH'S SPECIALS!

	Your Net
6 Volt 4 prong universal vibrator, List \$3.95	\$1.89
10-12 tube power transformer 6.3 V. winding 100 Ma.	3.69
4" speaker case only for talk back or P.A. systems	.69
100 asst. 1 and 1/2 watt resistors up to 10% tolerance	2.45
New 6L6 metal tubes in original cartons	.89
Headphones, Signal Corps, 8000 ohms, List \$10.00	2.95
Telegraph keys with cutout switch	.95
2500 mfd. 3 volt F.P. condensers	.69
Tubular electrolytic condensers	
15 mfd. 450 W.V.	.42
20 mfd. 150 W.V.	.32
20-20 mfd. 150 W.V.	.55
50-30 mfd. 450 W.V.	.73
Tubular bypass condensers	
600 W.V.	
.01 and .02	.07
.05	.08
.1	.10
.25 mfd.	.15
.5 mfd.	.22

12A6GT-replaces 50L6 . . . . . 89¢

Plus shipping charges

Write for our illustrated literature featuring all types of radio parts. . . . Order from your jobber or write direct:

Dept. C  
**ARROW RADIO CO.**  
2205 W. Division Street  
Chicago 22, Ill.



BBC news relay at 3:45 p.m.; sign-off weekdays is 4 p.m., runs to 4:45 p.m. Sundays; some afternoons is entirely buried under aircraft communication signals. ZRH, 6.007, Johannesburg 3, parallels ZRK generally, and is sometimes heard around 11:45 p.m.-12:30 a.m. fade-out, but weak. The South Africans are reported heard on the West Coast around 10-11:30 a.m., with BBC news relay at 11 a.m. These stations send out beautiful veri cards.

ZAA, 7.850, Tirana, Albania, is still being reported 1:10-3:10 or 3:20 p.m., with last 10 minutes in English. (Howe)

From Sweden it is reported that ZNS2, Nassau, the Bahamas, has been heard with a noontday test on 4.770, paralleling 6.090.

A later report on the Makassar, 9.360, Celebes, transmitter mentioned elsewhere, indicates the schedule is Sunday, Tuesday, Thursday, and Saturday, 5:05-8:30, and on Monday, Wednesday, and Friday, 6:05-8 a.m.

The Yen-an (Communist) China station that has been heard for some time on 7.500 with a solid hour of Chinese (by a woman) between 5-6 a.m., has moved to 7.048 (varies to 7.090).

From Sweden comes a report that EQB, 6.155, Teheran, Iran, parallels 4.760 at 10:45 a.m. with English news.

It is reported that Lusaka, Northern Rhodesia, uses 7.220, 4.900, 3.800, 11:30 a.m.-2 p.m.

SUV, 10.05, Cairo, Egypt, heard at 3 p.m.; PRE9, 15.165, Fortaleza, Brazil, heard 6:30-8:30 p.m. (Croston).

\* \* \*

#### ACKNOWLEDGMENTS

ARGENTINA—LRI Radio El Mundo. AUSTRALIA—Radio Call, Rex Gillett, Hallett. BRAZIL—Radio Club de Pernambuco S/A. CANADA—Gauvreau, Quebec; Dolbec, Montreal; Kennedy, Bromley, Toronto; Moss, Ontario; CBC. CALIFORNIA—Curtiss, Kreisher, Dilg, Balbi, McCarthy, Teague. DISTRICT OF COLUMBIA—Havlca, Royal Egyptian Legation, Legge. EGYPT—Cairo Calling, Middle East Forces' Radio Times. ENGLAND—Harrison. EIRE—Director of Broadcasting, Dublin. FLORIDA—Rowland. ILLINOIS—Johnson, Gutter, Rand, Hester. INDIA—Wadia, The Indian Listener. INDIANA—Green. KANSAS—Seckler, Steinmetz. ITALY—Mohr. MASSACHUSETTS—Harris, Kernan. MICHIGAN—Johnson. MINNESOTA—Ecklund. MISSOURI—Fullerton. NETHERLANDS—Edward Startz, PCJ. NEW YORK—Kentzel, BBC, ABC, Yates, Taylor, Sink, Bogdan. NEW ZEALAND—Milne, Radio Hobbies Club, Coombe, N.Z. DX Club. OHIO—Sutton, Croston, Hacker, Leoni, Riggle. OKLAHOMA—Brewer. PENNSYLVANIA—Starry, Woodington, Black, Jones. SOUTH AFRICA—Eksteen. SWEDEN—Kaldere, Gilbert Anderson, Ekblom, Skoog. SWITZERLAND—Swiss Radio, Berne. TEXAS—Giles, Freund, Spoons, Ekstein. VERMONT—Greenwood. VIRGINIA—How, URDXC.

-30-



Now available to amateurs, this brilliantly performing antenna was originally designed for the Air Corps to operate at a much higher frequency. Skillful redesign has resulted in a remarkable antenna for these two new amateur bands. Merely screwing on an extra tip to each radial and the dipole converts it from the 220 mc to the 144 mc band. The graphs show the small loss encountered with 72 ohm coaxial cable, such as RG-10/U, and the even smaller loss with 50 ohm coaxial cable such as RG-8/U, 9/U or 10/U. The antenna is supplied ready for assembly with type "N" UG-21/U weatherproof connector for use with any of the above-mentioned cables.

**FOR IMMEDIATE DELIVERY** at your local dealer's, neatly packaged, complete with instruction leaflet. If he is unable to supply you, send us his address. Net List Price \$12.00.

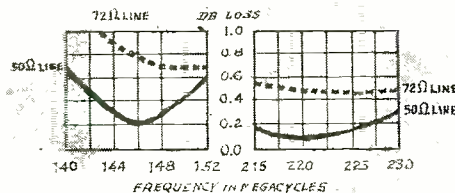

## The WORKSHOP ASSOCIATES

Specialists in High-Frequency Antennas

66 NEEDHAM STREET, NEWTON HIGHLANDS 61, MASSACHUSETTS



### Attention: RADIO SERVICEMEN

Here is the new Jensen Phonograph Needle Saleskit designed especially for the Radio Serviceman. It's colorful, compact and convenient—just the thing for slipping into the pocket and taking on service calls... a definite aid in demonstrating fine phonograph needles... the first real saleshelp ever offered exclusively to servicemen.

Now available at your jobber. WRITE TODAY for complete details and our better than usual discount to servicemen.

Contains 3 Jensen Concert Needles retailing at \$1 each and 3 Jensen Genuine Sapphire Needles at \$2.50 each. Install the needle that augments your work, assures full clear tone of the instruments you repair.

**JENSEN INDUSTRIES, INC., 329 S. WOOD STREET, CHICAGO 12, ILL.**

# Within the INDUSTRY

**GWILYM A. PRICE** has been elected to the post of president of *Westinghouse Electric Corporation*, succeeding George H. Bucher who resigned recently.



At the age of fifty, Mr. Price is one of the country's youngest directing heads of a major corporation. He was elected a vice-president of *Westinghouse* in 1943 and has been an executive vice-president since May, 1945.

Prior to his election as an officer of the company, Mr. Price was president of the *Peoples-Pittsburgh Trust Company* of Pittsburgh.

**CLAROSTAT MFG. CO., INC.** of Brooklyn has announced the election of new officers and directors, following the retirement of the three Mucher Brothers who founded the company 25 years ago.

The new president of the company is Victor Mucher, who formerly held the post of general manager; George

Mucher, in addition to retaining the post of chief engineer, has now assumed the duties of vice-president. William Mucher is the treasurer and Charles Burnell, who has been long associated with the firm in a legal advisory capacity, is the new secretary.

The company manufactures resistors, controls and resistance devices for radio and electrical assemblies.

**ALEXANDER NORDEN** has been elected president of *Interstate Manufacturing Corporation* of Newark, New Jersey.



Mr. Norden is the founder of the *Norden-Hauck Company* of Philadelphia and was, for many years, vice-president of the *L. S. Brach Mfg. Company* of Newark. He is a member of several engineering societies.

*Interstate* is the first post-war licensee of *Amy, Aceves & King* covering antenna system patents, and the new expanded activities of the company will include a complete line of

home and automobile antennas, as well as present line of wiring harness for automobile and appliances, aviation, and electrical specialties.

**JENSEN INDUSTRIES, INC.** has announced the removal of the entire company from 737 North Michigan Avenue, Chicago, to larger quarters at 329 South Wood Street, Chicago 12.

The company manufactures a line of phonograph needles.

**PHILLIPS CONTROL CORPORATION** of Chicago has announced its entry into the relay field through the acquisition of the design, manufacturing and selling rights of relays formerly made by *G-M Laboratories, Inc.* of Chicago.

John E. Mossman, co-founder vice-president of *C. P. Clare & Company* has purchased controlling interest in *Phillips Control Corporation*.

The company's line of relays will include light and heavy duty power relays, telephone, and midget multiple contact relays.

**FRY & ROBERTS**, West Coast representatives for leading manufacturers of electronic and electrical products have announced the removal of their offices to new and larger quarters.

The company's new address is 6516 Selma Avenue, Hollywood 28, California. In addition to enlarged office and display space, the new location provides a sizable parking area.

**CHARLES T. SARNECK** has returned from the Armed Forces to resume his position as assistant manager of the *Harrison Radio Corporation*, electronic equipment and parts distributor of New York.

Mr. Sarneck was associated with the company for four years prior to entering the Army.

**HOWARD T. HORWICH** has been named advertising manager of *Shure Brothers*.



In his new position Mr. Horwich will be responsible for publication advertising, catalogue designing, direct mail and jobber-help activities.

These promotion activities will include the company's line of microphones, phonograph pickups and pickup cartridges.

Mr. Horwich brings to his new position seven years of advertising experience and three years of military experience.

**PAUL J. BRAUN**, has joined the *Leonard Ashbach Company* of Chicago as vice-president and director of the firm.

Mr. Braun was formerly associated with *Western Electric Company*. During his 19 years with *Western Electric*, he held various positions, the last being that of buyer for the purchasing department.

The company also announced that

**RADIO NEWS**

## Attention RADIO SERVICE MEN

# RECORD PLAYER CABINETS

BEAUTIFUL PLASTIC  
EBONY FINISHED CABINETS

only \$3.89 completely drilled and ready for assembly with plastic bottom. Dimensions 13 3/8 x 11 1/2, 3 3/8 deep. Small 2- or 3-tube amplifier and 3 1/2" speaker fits perfectly.

Can be drilled and worked as easily as wood. Jobbers and distributors inquiries welcomed.

### \$3.89

Packed 1 or 10 to carton. F.O.B. Spfld.



Small Cabinet same dimensions, blanks only

### \$3.69

## VICTORIA RADIO & SOUND CO.

95 Dwight Street Springfield 3, Mass.



**RCA Institutes, Inc.**  
Offer thorough training courses in all technical phases of Radio and Television

WEEKLY RATES      DAYS—EVENINGS  
**VETERANS:** RCA Institutes is approved under G. I. Bill of Rights  
 For Free Catalog write Dept. RN-46  
 RCA INSTITUTES, Inc.  
 A Service of Radio Corporation of America  
 75 Varick St., New York 13, N. Y.

**Radio Servicemen:**  
**RADIO PARTS—TUBES**  
 BARGAIN PRICES—NO PRIORITIES

PHONO MOTORS (9 Inch T.T.)	2.99
CRYSTAL PICKUPS, 1 1/4 Oz.	2.79
FILTER COND., 20-20 Mcd. 150 V.	.39
BY PASS COND., .01, .02, .05, .1—600 V.	.07
LOOP ANTENNA (High Gain)	.59
ANT. & OSCIL. or ANT. and RF COIL SETS	.89
RESISTOR KIT—50 Ass'td. 1/4 to 1 Watt.	.99

Write Today for Bargain Bulletin  
**RADIO DISTRIBUTING CO., Pasadena 18, Calif.**

Roy C. Dahl, formerly with *Press Wireless* has been appointed secretary of the company. He also holds the post of director of the company.

**GEORGE D. CLARK** has been named to the post of chief engineer of the *Russell Electric Company*, Chicago manufacturers of phonograph drives, record changer motors and other fractional horsepower motors.



Mr. Clark is a graduate in engineering from Ohio State University and has done research and development engineering work with *Westinghouse* and *Delco*.

He also has served as an instructor in the Electrical Engineering School at the University of Wisconsin. Immediately prior to joining *Russell Electric*, Mr. Clark was Chief Motor Engineer of the *Packard Electric Division of General Motors*.

**S. A. KELSEY**, formerly director of distribution for *Templetone Radio Mfg. Corporation* of New London, Conn. has been named Sales Manager of the organization.

Mr. Kelsey is well-known in the industry, having served as sales manager of the *Connecticut Electrical Contracting Company*, district manager for *Nash-Kelvinator* and as division manager of *Bendix Home Appliances, Inc.*

During the early days of the war, he was in charge of all expediting, purchasing, and sub-contracting for the *Precision Mfg. Company*. Before joining *Templetone*, he served as an industrial specialist for the War Production Board.

**E. EUGENE WILLIAMS** has been appointed general sales manager of the *James Millen Manufacturing Company* of Malden, Massachusetts.



Mr. Williams comes to the *Millen Company* from *General Electric* where he held various engineering and sales positions since 1928. His most recent post at *General Electric* was that of sales manager of Laboratory and Measurement Equipment for the Electronics Department of the company.

**C. P. CLARE & COMPANY**, Chicago manufacturers of relays have opened new engineering and sales offices at 420 Lexington Avenue, New York and in the Commercial Trust Building, Philadelphia.

J. W. Concagh will be in charge of the New York office, while Frazier O. Stratton will be in charge in Philadelphia.

According to D. R. Dooley, vice-president in charge of sales for the company, these new offices will enable

**IT'S HERE!**

A Truly 100% Vacuum Tube

**VOLTMETER**



\$5250

Immediate Delivery

**SPECIFICATIONS**

D-C Electronic Voltmeter  
6 ranges—0 to 3, 10, 30, 100, 300, 1000 volts  
Input Resistance 11 megohms  
Sensitivity—3 volt scale  
—2,666,666 ohms per volt  
A-C Electronic Voltmeter  
6 ranges—0 to 3, 10, 30, 100, 300, 1000 volts  
Input Impedance—10.5 megohms shunted by 5 micro-micro farads  
Frequency response flat from 20 cycles to 2—K.C.  
Electronic ohmmeter:  
6 ranges—0.1 ohm to 1000 meg. ohms

Meter:  
200 micro amperes, D.C. of rugged construction  
Accuracy—or —2% of full scale  
TUBES:  
1—6SN7, 1—6H6, 1—6X5  
EQUIPMENT:  
1—cable "D.C." shielded with connector and probe  
1—cable "A.C." ohms with plug and probe  
1—cable "common" with plug and clip  
POWER SUPPLY:  
105/120 volts, 60 cycle

**96" AUTO ANTENNAS**

1. Seamless Brass Tubing
2. High polished Chromium Plating
3. Stainless Steel "Snap Back" Top Rod
4. Heavily Insulated Shielded Loom Lead
5. 100% Low Loss Construction
6. Sturdy Quality Design and Workmanship

\$3.49 ea. 10 or more \$3.25 ea. Lots of 100 \$3.00 ea.

**Complete line of Resistance Type Line Cords**

Complete line of Resistance type line cords standard 3 terminal AC-DC resistance line cords. Prompt delivery. Flexible, sturdy cords. 3 terminal type with color coded tinned leads. 45c each  
135 - 160 - 180 - 200 - 220 - 250 - 10 or more 42c each  
290 - 300 - 330 - 350 - 390 ohms

**JUST RELEASED! FINEST BALLAST TUBES**

L42B	K55B	165R4	39c Each
L42C	K55C	165R8	
K42B	L55B	185R	35c Each
K42C	L55C	185R4	
K49B	K80B	185R8	lots of 10 or more
K49C	K90B	250R	
L49B	K80C	100-77	
L49C	100-79	200R	
L49D	100-70		

We have the complete line of Alsam cabinets shown in this issue.

F. O. B. Chicago—Write Dept. N. for our latest catalogue. All foreign orders payable in U. S. funds.

**RADIO PARTS COMPANY** 612 W. Randolph Chicago 6, Illinois

**Crow Modern Slide Rule Dials**

Escutcheon with Crowglass Crystal, antique bronze finish, complete with pilot light sockets.



Model 341—\$3.23 ea.	Overall Dim. 3 1/8 x 8 7/8
Model 359— 2.85 ea.	3 1/8 x 6 3/8
Model 534— 1.33 ea.	2 7/8 x 4 1/8
Model 535— 1.56 ea.	Inside Dim. 1 3/8 x 5 1/8

We have in stock a complete line of radio tubes for immediate delivery. Quantity limited. All orders accepted subject to prior sale.

# 18 YEARS IN RADIO

GET THIS *New* CATALOG BY THIS *Old* FIRM



Here it is . . . one of the most interesting radio and electronic catalogs you have ever seen. Full of interesting ideas . . . packed with the things you have been waiting for.

## FREE for the Asking

Clip the coupon below and mail it at once. We'll send this new catalog FREE and put you on our list to receive new flyers and bargain sheets as they are issued.

BURSTEIN-APPLEBEE CO.,  
1012 McGee, Kansas City 6, Mo.

Send me new B-A Catalog advertised in Radio News.

I AM \_\_\_\_\_  
STATE CONNECTION IN INDUSTRY

NAME \_\_\_\_\_

ADDRESS \_\_\_\_\_

TOWN \_\_\_\_\_ STATE \_\_\_\_\_

*New*

## BURSTEIN-APPLEBEE CATALOG

*Now Ready*



- Latest developments in radio
- Electronic parts and supplies
- Newest "Ham" gear
- Gadgets for the experimenter
- Bargains in war surplus items
- Specialty items of great appeal
- Many of the things you have been waiting for

# TELEVISION TECH CORRESPONDENCE COURSE

**WANTED:** Radiomen to take a specialized television course. Instructions begin and end with television. Course has been written for the Radio Serviceman who wishes to learn television repair, and the radio commercial operator who wishes to prepare for this new field. A knowledge of basic radio is assumed. Write for information about Television Tech's economical, complete, comprehensive, television course.

Television Tech Enterprises  
Box 94, Hatboro, Pa.

Name.....  
Address.....  
City.....State.....

## FREE BOOK



ENDORSED  
BY CHAMPIONS

Skill, speed, accuracy free of nervous tension brings big pay.

### The One and Only Candler System

Nothing else like it. It is the course that has made code champions. Will help any sincere man gain greater speed, accuracy and skill. Learn the Candler way.

### Fast. Efficient Operators Needed

If you need additional speed to be classed as an expert, try the Candler method. It is endorsed by champions. It has produced phenomenal results with a minimum of effort. Why not learn the faster and easier way. Get your copy of the Book of Facts for Code students, Telegraph and Radio Operators.

### CANDLER SYSTEM CO.

P. O. Box 928, Dept. 2-D, Denver (1), Colo.

### Champion Endorses CANDLER SYSTEM

T. R. McElroy, Official Champion Radiotelegraph Operator of the world with a speed of 75.2 w.p.m., claims his success is due to the Candler System.

the concern to service Eastern manufacturers more promptly and completely.

\* \* \*

**ROBERT S. KNAPP**, son of A. S. Knapp, president and founder of *Knapp-Monarch Company*, was recently elected to the post of vice-president of the company.

Mr. Knapp has been associated with the company since 1938 and has been on a leave of absence with the U. S. Army since 1941. He served as an Industrial Officer of a gun plant in Houston, Texas. He recently completed a study of German industrial techniques in the iron and steel industry for the War Department.

\* \* \*

**DON E. PETTY** has assumed his new duties as General Counsel for the *National Association of Broadcasters*. He succeeds John Morgan Davis who resigned to devote full time to his law practice in Philadelphia.

Mr. Petty, who practiced law in Los Angeles from 1933 to 1943, was released from the Navy on January 10th with the rank of Lieutenant Commander. Mr. Petty entered the Navy as a Lieutenant (j.g.).

He is a partner in the Los Angeles law firm of Scarborough and Petty.

\* \* \*

**FRANK ROSE**, veteran appliance and radio sales manager, has been named sales executive in charge of the New Jersey territory for the *Electronic Corporation of America*.



Mr. Rose served as appliance and radio sales manager for the *General Electric Supply Corporation* of New Jersey from 1930 to 1941 at which time he acted as general manager of *Michael's Department Store* in Newark, New Jersey.

Mr. Rose has been in the radio and electrical industry since 1918 when he started working for the *Newark Electrical Supply Company*.

\* \* \*

**SAMUEL GUBIN**, formerly associated with the *Radio Corporation of America*, has joined the staff of *Spectrum Engineers, Inc.*, a newly organized engineering and consulting firm with laboratories in Philadelphia.

In his capacity of vice-president in charge of engineering, Mr. Gubin will assume responsibility for the design and development of electronic equipment.

His most recent activities at *RCA* included the supervision of the aviation advance development section and the supervision of the microwave beacon group.

\* \* \*

**RAY M. REILLY** has been named general manager in charge of sales and production for the *Kluge Electronics Inc.*, of Los Angeles, California.

Mr. Reilly is well-known in the radio and appliance field, having been employed by *Columbia Phonograph Com-*

## Unusual Buy Cathode Ray Tubes

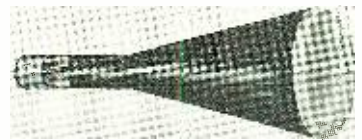

## & Television Parts New Factory Sealed Tubes for Television & Oscilloscopes

- Dumont 7EP4, price.....\$29.90
- RCA 5BP4, price..... 18.00
- Dumont 3BP1, price..... 15.00
- RCA Television switch with 5 Antennae RF transformers, price 5.60
- G.E. CR Power transformer 1700 V., 6.3 V., 2.5 V., price..... 9.90
- Cathode Ray tube Magnal socket 11 pole with H. Voltage wiring, price..... 2.40
- Cornell-Dubilier Oil Filter tubular Capacitor .1 mfd 3500 V., price..... 1.50
- .02 mfd 2500 V. Sprague tubular Capacitor, price..... .90

All types ceramic, mica and oil capacitors, trimmers, coaxial cable, etc.

Send 50c for complete catalog including diagrams for RCA, G.E., DUMONT and ANDREA Television Receivers, free with order \$5.00 and more.

RCA Parts and Equipment Distributors

World's First Specialized House  
In Television

**ELECTRONICS SERVICE & SUPPLY**  
262 W. 40th Street, New York 18, N. Y.

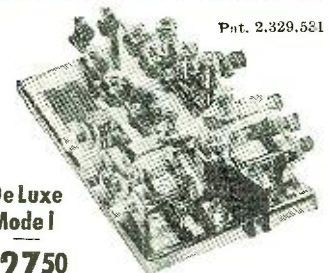

Deluxe Model  
\$2750

## THE MELEHAN VALIANT

Automatic Dots PLUS Automatic Dashes  
• Permits sustained high speed transmission • Fifteen to eighty WPM • No vertical play in handle unit • Eliminates "glass arm" condition • Length and speed of dots and dashes individually adjustable • Handle elevation, leverage action and spring tension fully adjustable • Purely mechanical in operation, self-contained and self-sufficient • Outstanding in design and craftsmanship • Massive base and cradle unit • Light, balanced working parts assure that precision movement and split-second response so essential to true super-speed sending • Completely chromed • Base 4x1½x7 • Shipping weight 7½ pounds •

**MELVINE E. HANSON**  
(W6MFY)  
MELEHAN RADIO 821 Main Street  
HUNTINGTON BEACH, CALIFORNIA

pany, Sonora Company, and Westinghouse.

Mr. Reilly joins Kluge Electronics, Inc. from the Westinghouse Company.

\* \* \*

**JEFFERSON-TRAVIS CORPORATION** of New York which recently announced its acquisition of the *Musicraft Corporation* has now announced that it has also acquired *Guild Records, Incorporated*.

The new plant provides a phonograph record pressing plant in South Norwalk, Connecticut and will be used to expand the *Musicraft* catalogue of released and unreleased recordings.

\* \* \*

**MAJOR FRANK O. BLAKE** has been named to the post of sales chief in charge of New York state by *Electronic Corporation of America*.



Mr. Blake will handle all of the New York territory with the exception of metropolitan New York.

Before entering the Army Air Forces, Mr. Blake was general manager of the *Albany Distributing Company*. Prior to this connection he was associated with *Graybar Electric Company* for 13 years as a merchandising executive.

\* \* \*

**STROMBERG-CARLSON** has announced the appointment of two new district merchandisers.

E. V. Hyde of Dallas, Texas will cover the South Central states from his Dallas office, while Donald E. Galloway of Rochester, New York will serve the upstate New York and New England area.

\* \* \*

**FRED E. DOLE**, recently associated with the Radiation Laboratory at M.I.T., has been appointed technical representative and research consultant for *The J. M. Ney Company* of Hartford, Conn.



In his new position, Mr. Dole will work on the application of precious

metal alloys to the radio and electronic parts field. He will be available for consultation by manufacturers and design engineers.

He is the author of the section on potentiometers in a publication being prepared on the research work done by the Radiation Laboratory during the war.

\* \* \*

**ARMIN E. ALLEN** has rejoined *Philco* as a product manager in the radio division after serving two years in the Navy.

Mr. Allen was on duty in Washington, D. C. as Procurement Officer for communications equipment, Bureau of Ships, Navy Department. Prior to entering the service he was connected with *Philco's* purchasing department.

April, 1946



R. C. (Dick) Hall  
W5EIB

**R. C. & L. F. HALL, INC.**

1015-17 Caroline St.  
Telephone C-9731  
Houston 2, Texas



L. F. (Lillian) Hall  
W5EUG

Hallcrafters' Sky Champion has been replaced by the S-40, of which we expect to have a large supply in April. The Echo-Phone is not being delivered but the S-41 Sky-Rider, Jr., is being shipped in fairly large quantities and is very similar. The new RME-45 has two speed tuning and calibrated band spread and is priced at \$186.00 complete with speaker.

**"THE HAM SHACK"**  
NATIONAL

- NC-2-40C less speaker..... \$225.00
- Speaker..... 35.00
- 1-10 less tubes, speaker & power supply..... 55.10
- SR56 power supply for 1-10..... 19.30
- Tubes for 1-10 (854, 955, 6C5, 6F8)..... 8.57
- HRO-5TA; HRO-5RA

HAMMARLUND

- HQ-129X less speaker..... \$129.00
- Speaker..... 10.50

Super-pro

- SPC-410-X (540 KC to 30 MC) cabinet model
- SPC-410-SX (1250KC to 40MC) cabinet model
- SPR-410-X (840 KC to 30 MC) rack model
- SPR-410-SX (1250KC to 40MC) rack model
- PS-CW-10 10 inch PM speaker

(O.P.A. prices not determined at this time)

HALLICRAFTERS

- S-40..... approx. \$ 79.50
- S-41 Skyrider Jr..... 33.50
- S-42 Marine..... 74.50
- S-39 Sky Ranger..... 110.00
- SX-25 Super Deafant..... 24.50
- SX-25A Super Skyrider..... 231.00
- S-37 (130-210MC) FMAM..... 511.75
- S-36A (28-143MC) FMAM..... 415.00
- Speaker for SX-25, SX-25A, S-36, S-37..... 15.00
- HT-9 transmitter (less coils, crystals, mike)..... 225.00

RME

- RME-45 with crystal, meter & speaker..... \$186.00
- DB-20 preselector..... 59.30
- VHP-152 (2, 4, and 10 meter converter)..... 29.70
- LF-90 (Low Freq. Inverter)..... 29.70

Wire, write or phone your order. We will ship C.O.D. with a \$3.00 deposit. We also offer easy terms and trade-in allowances for used equipment. State Tax not included in above figures.

"ACROSS THE OPERATING TABLE"

A postal card will place you on our mailing list to receive our amateur bulletin.

**A FEW OF THE MANUFACTURERS WHOSE PRODUCTS WE DISTRIBUTE**

Aerovox	Cinaudagraph	General Cement	Johnson	Millen	Radel	Thermador
Amphenol	Clarostat	GE	Kaar	Mueller	RCA	Thordarson
Astatic	Drake	Hallcrafters	Kelner	National	RME	Trimm
B&W	Dumont	Hammarlund	Leach	Ohmite	Sanamo	Triplet
Belden	Echophone	Hytro	Lectrohm	Peerless	Setnell-Carlson	Turner
Bliley	Eimac	Instrucograph	Les Logan	Petersen	Speed-X	Vaco
Bud	Electronics Lab.	Insuline	Littelfuse	Pioneer	Stancor	Walco
Centralab	Eric	Jensen	John Meck	Precision	Taylor	Ward
	Gammatron	JFD	Meissner	Premax		

**"ACROSS THE SERVICE BENCH"**

is the name of our dealer bulletin, which goes regularly to our service dealer customers. This bulletin keeps you in touch with the latest information on available equipment and supplies. A postal will place your name on this list and will also secure a "new customer tube allocation" if you request it.

**SPECIAL ATTENTION**

is being given to ex-servicemen entering business who need complete stocks. Such inquiries should be marked "for personal attention R. C. Hall."

**SPECIALS**

- Resistor Kits..... 52.95
- 100 1/4, 1/2, 1 & 2 watt sizes, carbon..... 2.32
- 25 10 watt and larger, wire wound..... 2.32
- 12 asst. volume controls..... 2.35

- 2 mfd. 2000 volt oil filled cond..... \$2.95
- Lewis Electronic 24G..... 3.75

**TEST EQUIPMENT IN STOCK**

Silver "Vomax"..... \$59.85

Ask for other brands and models, since we carry practically all of them and are re-stocking shipments from time to time.

**MARINE EQUIPMENT**

We are able to give good delivery on marine radio-telephones. Phone, write or wire for information.

**POLICE, GEOPHYSICAL & MOBILE**

radiotelephone equipment is available on good delivery. We welcome inquiries for your particular application.

**INDUSTRIAL ACCOUNTS**

are welcomed. Wire, write or phone. We have one of the largest electronic stocks in the country.

**POWER + Long Life**

The heart of any Magnetic Driver Unit is the magnet itself. The ROWE No. 7 has a cone-shaped ALNICO magnet weighing 3 lbs., 4 oz., providing more than ample power. In addition the ROWE has many improvements and refinements in design and construction that insure better performance, longer life and freedom from break-downs. It overcomes dozens of annoyances and failures that have heretofore plagued sound engineers.

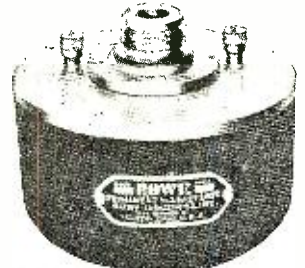

**ROWE NO. 7 PERMANENT MAGNET**

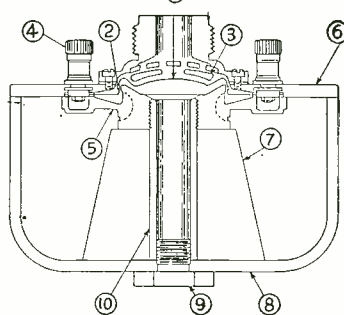

The Rowe is so engineered that, when necessary, repairs and replacements can be made with utmost ease and in the shortest possible time and by any average service man. Factory service is very, very seldom necessary. The ROWE No. 7 is assembled or taken apart by one large master screw. A diaphragm, voice-coil or any other part can be replaced in just a few minutes. This ease of maintenance, coupled with its EXTRA POWER and super long life make the ROWE No. 7 first choice of sound engineers everywhere. Write for illustrated circular RN 446.

**ROWE Industries** ELECTRONICS DIVISION  
3120 MONROE ST. TOLEDO 6, OHIO

For Soldering in  
Tight Places . . .

**DRAKE**

No. 400 Soldering Iron

Smallest Industrial Iron  
Ever Designed

60 Watts—1/4 in. Tip

Only 9 in. long—Wt. only 8 oz.

This mighty mite is backed by DRAKE'S 25 years of soldering iron manufacturing experience. The high quality and long service of DRAKE Soldering Irons have made them outstanding favorites with all types of radio men everywhere. The DRAKE No. 400 is an outstanding value at



Only \$4<sup>50</sup>  
List

Drake Has an Iron  
for Every Purpose.  
Ask Your Radio  
Parts Jobber.

**DRAKE ELECTRIC WORKS, INC.**  
3656 LINCOLN AVE. CHICAGO 13, ILL.

## CUT HOLES FAST



in radio chassis

No tedious drilling... no reaming... no filing! Saves hours of work. Cuts clean, accurate holes for sockets, plugs, other receptacles. Tool has three parts: punch cuts through chassis, die supports metal and prevents distortion, cap screw is turned with wrench to cut hole. Sizes for holes 3/4" to 3/2". For complete information write Greenlee Tool Company, 1884 Columbia Ave., Rockford, Illinois.

WRITE FOR FREE FOLDER S-119



REGISTERED TRADE

**GREENLEE**

FOR THE CRAFTSMAN

He first went to work for the corporation in 1934.

\* \* \*

**MAJOR H. H. "PETE" SEAY, JR.**, formerly vice-president of *Bell Sound Systems, Inc.*, has returned to the company to assume the position of executive vice-president and general manager of the company.



Major Seay, a reserve officer since 1932, was called into service in January, 1942. In the Army he served as Radar Production Coordinator for the Dayton Signal Corps Procurement District and later became production executive for the entire Airborne Radio and Radar equipment and Ground Radar equipment used by the Army Air Forces. His last job in the Army was a Chief, Radio and Radar Equipment, Supply Division, Spokane, Washington.

\* \* \*

**HERMAN N. LUBET** has been named Advertising Manager of the *Fada Radio and Electric Company, Inc.* of Long Island City, New York.

Mr. Lubet brings to his new position many years of experience in the consumer advertising field, having served as Advertising Manager of Lane Bryant, New York for three years, and prior to that he was an account executive with the Peck Advertising Agency.

Mr. Lubet will specialize in the promotion of the *Fada* line of radios.

\* \* \*

**JOHN F. RIDER**, Lt. Col. Signal Corps (retired), was recently presented with the Legion of Merit Medal at a formal military ceremony held at Fort Monmouth.

During Mr. Rider's service with the Signal Corps, he was responsible for the preparation of a total of 1906 different publications, of which 797 were packed with equipment going direct from manufacturers to the theaters of operation.

\* \* \*

**FRANK M. DAVIS**, general manager of the Research and Engineering Division of *Collins Radio Company* of Cedar Rapids, Iowa, passed away suddenly February 4th.



Mr. Davis was widely known for his research and development work in the field of radio communications. He held an engineering degree from the University of Arkansas and was a member of the A.I.E.E., the Acoustical Society of America and the I.R.E.

He was chairman of the Cedar Rapids Section of the I.R.E. during the first year of its formation and was a charter member of that section. He joined the *Collins* company in 1934.

-50-

NEW PRECISION ANTENNA NEW



F-M TELEVISION COMPLETELY

AMATEUR ADJUSTABLE

Enjoy the Finest in Radio Reception  
Made of Highest Grade Aluminum

Complete with 5 ft. Aluminum Mast and all necessary mounting hardware. Designed for complete adjustment to any frequency within the required band. Incorporates a broad-band feature ideal for television and FM reception. Electrically and mechanically superior to standard fixed type Di-Pole.

Type 701A (28-44MC) 10 Meter Amateur . . . . . \$8.95

Type 701B (44-88MC) Television 5 Meter Amateur . . . . . \$7.95

Type 701C (88-148MC) FM 2 Meter Amateur . . . . . \$7.45

(All Prices Less Transmission Line)  
100 Ft. Roll RG, 58 U Transmision Line . . . . . \$5.45

Immediate Deliveries

S. C. LABORATORIES, INC.  
20-22 Van Wagenen St., Newark 4, N. J.

Please send me  Postpaid;  C.O.D.  
Type  701A;  701B;  701C

Name .....

Address .....

City..... State.....

**NEW TINY POCKET SIZE RADIO!**

Slips in your pocket or purse —We only 3 oz. 1 Complete READY TO PLAY as shown with self-contained phone for personal use. Beautiful black plastic case. Has patented fixed Crystal-Slide Tuning Dial! NO TUBES, BATTERIES, OR ELECTRIC PLUG-IN REQUIRED. U.S. U A L L Y RECEIVES LOCAL BROADCASTS without outside aerial wires.

**GUARANTEED TO WORK** when collected and used according to instructions. Can be used in homes, offices, hotels, cabins, in bed after hours.

**SEND ONLY \$1.00** free on arrival or send \$3.95 for delivery. IDEAL GIFT FOR CHILDREN OR ADULTS ALIKE! Get your PA-KETTE RADIO NOW for real enjoyment. Dealers in most cities.

PA-KETTE ELECTRIC CO., Dept. RN-1, Kearney, Nebr.

**ELECTRICIANS! RADIO MEN!**

Earn More Money!

Get this new GIANT SIZE ELECTRICAL and RADIO TROUBLE SHOOTING MANUAL GUARANTEED BY COYNE

Yours 10 Days Free

Needed by war workers, maintenance men, beginners, old timers! Nothing else like it. Saves time, helps boost your pay... 4 GREAT BOOKS IN ONE! 1. New Step-by-Step Trouble Shooting Course. 2. 500 Shop Prints. 3. Elec. Radio Dictionary. 4. Spare Time Jobs.

**FREE!** 1 yr. Technical Counsel by mail from COYNE staff, on trouble-shooting problems.

**SEND NO MONEY!** See offer below. Satisfaction guaranteed by famous COYNE "Learn-by-Doing" Electrical School. Rush coupon now!

**OVER 500 Large Size Electrical and Radio Shop Prints -How to read and use them**

H. C. LEWIS, President, Dept. 46-73  
COYNE ELECTRICAL SCHOOL  
500 S. Paulina St., Chicago 12, Ill.

Send, with all shipping charges paid, your new COYNE Electrical and Radio Trouble Shooting Manual. Within 10 days after getting it I'll either return it or send \$3, then \$3 month 7 until total of \$8.95 is paid. (Cash price \$8.00 - you save over 10%. Same 10-day free trial and return privilege.)

NAME..... Age.....  
ADDRESS.....  
CITY..... Zone..... STATE.....

# HAM SPECIALS

- ACORN TUBES 954-955-956-957-959. NEW! GUARANTEED **89c ea.**
- Low Loss SOCKETS for Acorn Tubes **90c ea.**
- 150 mmfd TRANS. VARIABLE CONDENSERS; Mycalex Insulation; Double Spaced. . . . . **\$1.98**
- SOLAR Oil-Filled Trans. CONDENSERS—3 mfd—3000 V. . . . . **\$3.98**
- GENERAL ELECTRIC Trans. CONDENSERS—10 mfd—600 V. . . . . **\$1.98**
- GENERAL ELECTRIC Trans. CONDENSERS—4 mfd—600 V. . . . . **\$1.49**
- 8-8-8 Mfd 450V. Electrolytic CONDENSER CAN—Upright Mounting **94c**
- POCKET MULTI-TESTER-15-150-1500 V. AC-DC, 1.5-15-150 MA. 3000-30000 OHMS. . . . . **\$15.95**

● 3 Tube AC-DC PHONO AMPLIFIER—Complete with Tubes and Output Transformer. . . . . **\$7.50**

● High Quality TRANSMITTING KEY **98c**

**FEDERATED PURCHASER INC.**  
NATIONAL DISTRIBUTORS OF ELECTRONIC PARTS  
80 PARK PL. N. Y. 7, N. Y.

# RADIO PARTS AND EQUIPMENT



For The  
**SERVICEMAN**  
For The  
**AMATEUR**  
For The  
**EXPERIMENTER**  
On The

**WEST COAST IT'S**

**UNIVERSAL RADIO SUPPLY CO.**  
1404 VENICE BOULEVARD  
LOS ANGELES 6, CALIFORNIA

Write for SPECIAL BULLETIN

April, 1946

## Recording Studio (Continued from page 35)

When the playback machine is used the customer is warned as to the initial placement of the pickup arm. The pickup, similar to the recording arm should operate from the center of the disc outward. If, as is often the case, the client desires more than one copy of the disc both turntables are simultaneously employed to prepare the initial two copies. If more than two records are desired one of the original copies is placed on the playback unit—and with blanks placed on recording turntables any number of succeeding copies can be made as the client may desire.

Doyle advises that there are six potential markets in the typical community for "record-making services."

(1) The businessman who wishes to make records of a speech he has to give before a group of business associates—playing it back to ascertain correctness of copy and length of discourse. Many businessmen, on occasion, wish a recorder permanently installed so that recordings may be made of important sections of conversation. Doyle installs the recorder "on-off" controls in a business office desk drawer so that at the flick of a switch the recorder may be set in motion when it is desired to record a conversation. The recorder unit is installed in an adjacent or outer office and connecting wires run underneath the floor with desk switch providing instantaneous recording facilities. The microphone can be placed openly on the desk or hidden in a flower vase as the client desires.

(2) Everyone in the community has friends, and acquaintances, to whom they would enjoy sending a personal record carrying birthday greetings. In addition almost every resident has close friends or loved ones temporarily on the sick list to whom a "get well soon" record may be dispatched.

(3) Music instructors are interested in bringing their pupils to the recording studios so that they may prepare a record displaying proof of their mu-

Portable recorder and playback unit manufactured by RCA, used by Doyle when making recordings outside studio.



# SUPREME

TESTING INSTRUMENTS

AFTER A GREAT WAR RECORD

**BACK AGAIN!**

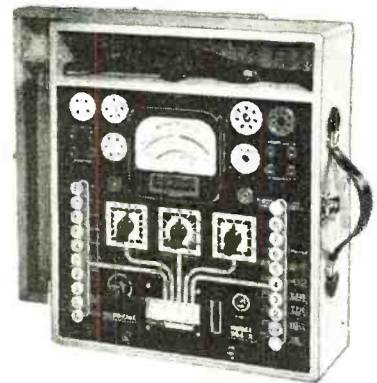

**SUPREME MODEL 504-A TUBE AND SET TESTER**

SUPREME regrets that war necessitated an interruption of service to its customers and friends. We are genuinely glad to get back into peacetime production—production for YOU.

**MANY SUPREME INSTRUMENTS NOW AVAILABLE**

—But not enough to take care of all orders at one time. Demand for accurate, dependable SUPREME equipment is such that we suggest you make arrangements for your needed new SUPREME models without delay.

**SEE YOUR NEAREST SUPREME JOBBER NOW!**

**SUPREME**

**SUPREME INSTRUMENTS CORP.**  
GREENWOOD, MISS.  
U. S. A.

Export Department:  
THE AMERICAN STEEL EXPORT CO., Inc.  
374 Madison Ave., New York 17, N. Y.

famous for

# GREAT VALUES

*Special—NOW!*

**CRYSTAL KIT . . . \$1.97**

**5-Tube SUPERHET . . . \$15.50**

Complete with Cabinet and Tubes, but excluding wire and solder.

**6-Tube SHORT WAVE Kit \$15.50**

2½ to 12 megacycles. Battery operated, complete with Metal Cabinet and Tubes, but excluding wire and soldering. Overall size, 7½"x4½"x2½".

All prices are F.O.B. New York City

Also a varied line of Test Equipment, Replacement Cabinets, Vibrators, Electrolytics, Tubes, Transformers, Soldering Irons, Radio Kits, Ham Supplies, etc.

We ship anywhere in the U.S.A. — promptly!

WRITE FOR OUR CATALOG NOW!

**RADIO DEALERS  
SUPPLY COMPANY**

135 LIBERTY ST., NEW YORK 6, N.Y.

**7 Days**

**Free Examination**

## PRACTICAL RADIO INFORMATION

Including Frequency Modulation—Television, etc.

Inside Radio Information for Servicemen—Aircraft Pilots, Students. AUDELS RADIO-MANS GUIDE contains 772 Pages, 400 Diagrams & Photos is complete—gives Authentic Principles & Practices in Construction, Operation, Service & Repairs. Covers clearly and concisely Radio fundamentals—Ohm's Law—Physics of sound as related to radio science—Measuring instruments—Power supply—Resistors—Inductors—Condensers—Transformers and examples—Broadcasting stations—Radio Telephony—Receivers—Diagrams—Construction—Control systems—Loud speakers—Antenna systems—Auto Radio—Phonograph pickups—Public Address Systems—Aircraft & Marine Radio—Radio Compass—Beacons—Automatic Radio Alarms—Short Wave—Coil Calculations—Testing—Cathode ray oscillographs—Static Elimination—Trouble Pointers—Underwriter's standards—Units and tables—Frequency Modulation—REVIEW QUESTIONS & ANSWERS. Ready Reference Index.

**\$4 COMPLETE • PAY ONLY \$1 A MO.** Get this practical information in handy form for yourself—Fill in and MAIL COUPON TODAY.

AUDEL, Publishers, 49 W. 23rd St., N.Y. Mail AUDELS NEW RADIO-MANS GUIDE for free examination. If O.K., I will send you 1 in 7 days; then remit \$1 monthly until \$4 is paid. Otherwise I will return it.

Name \_\_\_\_\_  
Address \_\_\_\_\_  
Occupation \_\_\_\_\_  
Reference \_\_\_\_\_

128

sical progress to take home to their fond parents. In addition local orchestras will wish to record various arrangements of top flight dance tunes to play back in advance of actual dance dates.

Doyle has air conditioned his recording studio, which is insulated throughout making it thoroughly soundproof. He used *Shure* microphones, *RCA* recording equipment and a *Webster* wall amplifier with *Jensen* wall speaker.

Doyle also provides a special home service which is also used at all meetings of fraternal organizations, business meetings, stockholders meetings and at recitals given by local music instructors. For a yearly retaining fee he waxes weekly meetings of Rotarians, Kiwanis, Elks, and Eagles.

On all service calls his "recorder" accompanies him so that when he has completed repairs on a home radio he may suggest bringing the recorder in and making waxings of a family group or of individual family members for playback on the family combination. For home recording he uses a crystal microphone, or for family groups, playing musical instruments two mikes are utilized.

Doyle visits the hospitals twice weekly with his apparatus. Many patients desire to issue instructions via record to associates at the office or "reassuring messages" to those at home. On these occasions he uses a hand mike which is convenient for the patient. On occasion hospital medical officials are interested in recording discussions on medical technique to be played back at group meetings of interns.

Radiomen who plan to operate a recording studio in their service establishment will do well to experiment considerably with seating arrangements for various musical instruments in relation to microphone placement. Faulty instrument placement will cause a "boomy or tinny" tendency which would be no credit to radioman or client. Where patrons use the desk for speech recordings, care should be taken to have the customer speak into the mike not once but several times before the records are placed in action.

Doyle uses various advertising maneuvers to publicize his recording activities. Each week he inserts a small newspaper ad listing the names of 15 great men and women and 15 local citizens enjoying a birthday during the ensuing week and suggests that well wishers pay their compliments via a "recording of congratulations" on the happy occasion. In addition he sponsors a weekly half hour program known as the "Community Presents." On this program local dance orchestras, musical conductors, vocalists and other local entertainers are heard.

This radioman has established a price for the "record sitting" of \$1.00 which includes one copy of the record. If additional copies are desired Doyle charges 60c apiece for a 3 minute recording.

# JUKE BOX RECORDS

## LATEST & HARD-TO-GET BACK NUMBERS

Some slightly used and some brand new—Victor, Bluebird, Columbia, Okeh, Decca, Capitol, etc. Such artists as Glenn Miller, Benny Goodman, Harry James, Bing Crosby, Frank Sinatra, Gene Autry, Duke Ellington, Fats Waller, Guy Lombardo, Andrews Sisters, Kate Smith, Ink Spots, Mills Bros., etc.

**BIG PROFITS** Your opportunity to cash in on this new field that is sweeping the country. Specify the type of music that sells best in your territory such as Swing, Sweet Music, Cow-boy, Hill-billy, Polkas, Blues, etc. Your price \$13.90 per 100 records, f.o.b. Chicago, 2% off for cash with order. All shipments made within 48 hours.

CHAS. HOODWIN CO.

4419 Broadway, L-15, Chicago 40, Illinois  
World's Largest Dealers in Used Records

**Immediate  
CARRON CONE  
SERVICE  
in the South**



**MANUFACTURERS OF SPEAKERS  
CONES - FIELD COILS - TEST EQUIPMENT**  
Speakers Repaired  
Regular Pre-War Discount  
**WHOLESALE RADIO & ELECTRIC SERVICE**  
Orangeburg, South Carolina



## TITAN SLIDE RULE

8" diameter. Easily read, clearly marked single index scales. Gives logarithms, reciprocals, squares, square roots, sines, and tangents. Continuous "circular" calibrations cannot go "off-scale." Invaluable in multiplication, division, proportion, conversion, all mathematical problems. Made of durable heavy pure white vinylite. Complete with instructions, \$2.95. Leatherette case 75c additional. Money-back guarantee.

PRECISION INSTRUMENT CO.  
Box 654, Dept. BD, Church St. Annex, New York 7, N.Y.

## SPEAKERS RECONED!

4"—\$1.15      6"—\$1.35      10"—\$2.25  
5"—\$1.25      8"—\$1.85      12"—\$2.50

Plus Transportation

Prompt Service—Expert Workmanship

*York Radio*

DISTRIBUTING COMPANY

Quality Parts for the Radio Profession

545 No. Water St. DECATUR 21, ILL.

## ELECTRICAL TRAINING

Intensive 8 months' residence course in fundamentals of industrial electrical engineering, including radio, electronics. Prepares for technician, engineering aides. Approved for veteran training. 53rd year. Catalog.

**BLISS** ELECTRICAL SCHOOL  
7638 Takoma Ave.  
Washington 12, D. C.

**Specify SAUERISEN  
ACIDPROOF CEMENTS—COMPOUNDS  
FOR**

Tanks, Sewers, Stacks, Floors  
Technical cements for all purposes.

Send sketches or samples  
Sauerisen Cements Company • Pittsburgh 15, Penna.

RADIO NEWS



**Precision Frequency Standard**

(Continued from page 37)

4600 or 1000 is not essential for the crystal frequency. All that is necessary is for the crystal and its circuit to produce stable check points without variation in frequency. Whenever a receiver is used with the meter for frequency measurements there is the possibility of a check point every 10 kc. between 630 and 1040 kc., using broadcast stations.

A rather good "find" came about in the selection of the broadcast coil  $L_2$ . Alternately, one of the replacement type "long-wave" coils could be used in its stead. This one was removed from the broadcast band antenna coil position of an RCA AVR-7H aircraft receiver when it was equipped with a loop antenna. The iron core slug was adjusted for maximum inductance and the shield removed. Antenna winding became the plate feedback coil and grid coil is tuned as such.

This coil,  $L_2$ , may be replaced by a small iron core i.f. transformer of the 175 kc. type, provided the windings are coupled more closely than originally. This may usually be accomplished by heating the dowel or tubing on which the windings are placed, by means of a soldering iron, and after the wax is softened, sliding the windings together until they are separated by about  $\frac{1}{8}$  inch.

$L_2$  and the home wound short-wave coil may be seen side by side in Fig. 5. The high frequency coil,  $L_1$ , has 18 turns of No. 18 enameled wire wound to a length of one inch on a  $\frac{3}{8}$  inch polystyrene tube, with a 10 turn plate feedback winding located at the "cold" end.

The choke coil,  $L_3$ , should be selected to be resonant to the frequency of the crystal used. An adjustable iron core type is desirable in this position, as the slug may be adjusted to tune the inductance to the correct frequency. If no commercially made chokes of the proper range are available, very often an iron core i.f. transformer may be pressed into service for this purpose, removing turns so that the correct frequency is covered.

$L_1$  and  $L_2$ , the plate reactors for the detector and amplifier, are microphone transformers originally used in SCR-274-N transmitters. Only the secondaries of these transformers are used. The grid winding of any small audio transformer may be used if units of this type are not available.

Tests performed upon this instrument indicate it is rather stable. Without any warmup period, it was adjusted to station WWV on short-wave range at 10 megacycles, and over a 10 minute period the frequency drifted 200 cycles low. Then for the next 10 minutes it drifted half way back to the initial setting and settled down. The broadcast band was much the same with a 20 cycle decrease from zero adjustment with a broadcast station

Where lasting appearance counts . . .

**SNYDER**  
Antennas

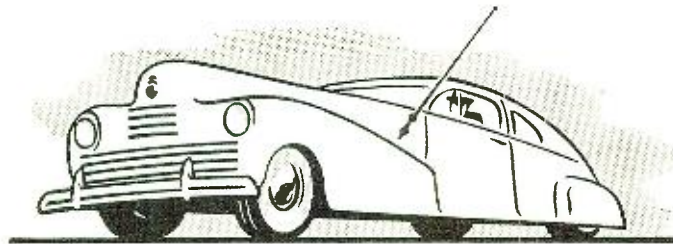

**SNYDER**  
MANUFACTURING COMPANY

PHILADELPHIA

**MANUFACTURERS . . . START TO FINISH**

**MICROPHONES**

Just received at **OLSON RADIO WAREHOUSE**: a large shipment of Government-released Single Button Carbon Microphones with headstraps and connecting wires. Noise-cancelling, designed for use in Army Tanks. Straps on the head, with mike above the lips. These lip microphones are NEW, direct from factory on a contract termination. Cost the Government much more than our price. Can be used with any low gain amplifier, or connected to any radio and used as a home microphone. Can be used with only a battery and headphones for inter-office telephone work, with no amplifier. Microphone current, 50 mils; resistance, 50-100 ohms. Excellent frequency response from 200-4,000 CPS; not affected by variation in position. Immersion proof. **ORDER NOW!**

**ATTENTION DEALERS**  
Order these Microphones for re-sale to amateurs and experimenters. We have a large quantity of both now, but when these are sold, no more will be available.

Reg. Retail Price, \$12.50  
**YOUR PRICE— \$1.05** POST PAID

**EXTRA SPECIAL!** Same Microphone without straps or wires. Can be used as above, and also as a contact or guitar mike. The package of 12 is a super-bargain!  
Regular Retail Price, \$8.00 ea. **50¢ EACH** PACKAGE OF TWELVE, \$5.00

This offer good only in U. S. A. Send for our **FREE Monthly Bargain Catalogs**

**MAIL TODAY OLSON RADIO WAREHOUSE**  
73 E. Mill St., Dept. 15, Akron, Ohio

Send me \_\_\_ Lip Microphones with Straps and Connecting Wires, @ \$1.05.  
Send me \_\_\_ Lip Microphones only, @ 50c.  Send me pack of 12 Lip Microphones for \$5.00. I enclose \$\_\_\_\_\_.

NAME . . . . .  
ADDRESS . . . . .

## CLARK PA-30 AMPLIFIER



With electronic equalization providing both bass and treble boost and attenuation over range of -12 db to +18 db.

Frequency Response—± 2 db, 50-10,000 Cycles. Overall Distortion—Less than 5%. Hum—55 db Below Full Output. Finish—Metalized Bronze Gray.

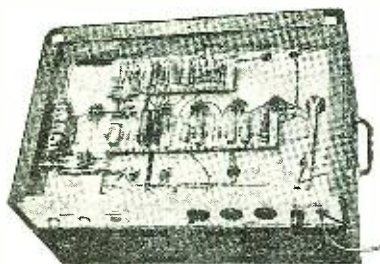

**CLARK RADIO EQUIPMENT CORP.**  
4313 North Lincoln Avenue  
Chicago 18, Illinois

## CAPACITORS - OIL, PAPER and ELECTROLYTIC



**Illinois  
CONDENSER COMPANY**  
1440 N. HOWE ST. • CHICAGO 10, ILL.

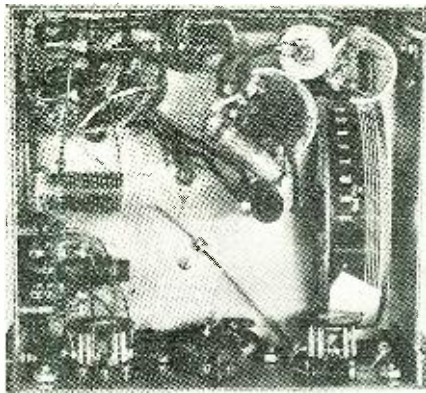

Fig. 5. Under chassis view showing wiring and placement of component parts. The triple .05 microfarad condenser is shown in upper right hand corner.

on 910 kc. over a 15 minute period. This action gave rise to a question of whether the check points were drifting too. A recalibration with the nearest check point of 910 kc. brought the signal back to within a few cycles when reset to the broadcast station. Next, the meter was thrust into a refrigerator for a cold treatment, and in 15 minutes the frequency rose to plus 250 cycles. Again a recalibration brought the dial frequency to within 5 cycles of 910 kc. This indicates the BT-cut crystal used for check points was being affected very little by temperature, and if the meter is checked and adjusted to the nearest check point of a frequency to be measured just prior to measurement, considerable accuracy can be attained.

Let's take a look around and see what this instrument can do. For measurements on 3105 kc. it is handy and fast to use since there are no warmup waits. At this frequency each division on the "tens" dial figures 349 cycles. Careful attention in reading tenths of the dial division will reduce the possible error of measurements to below 50 cycles or .0016% whereas the tolerance permitted aircraft stations on this frequency is .02%. Police services have a definite need for such a meter to measure their 30 to 40 megacycle mobile equipment. However for that specific higher frequency a better choice of coils and coverage might be made.

For spotting the amateur bands it quickly proves its worth. By using the broadcast band oscillator and harmonics any band up through the 14 mc. one can be located well within 1 kc. The 144 megacycle band is easily found between 14th and 15th harmonic of 10 megacycle fundamental of the short-wave coil after adjustment to station WWV, and any frequency within the band is measured by zero beating with a known harmonic of the meter. 144 megacycles, the upper range of a Hallcrafters S-27 receiver, was the highest frequency used with the frequency meter, yet it gave off a lusty signal at that point. And while with the amateurs, let's imagine what a good VFO (Variable Frequency Oscillator) it could make with slight variations. The

## "CRYSTALS" AMATEUR LICENSE HOLDERS ONLY

7000 to 7425 KC  
4th Harmonic for 10 Meter Band  
9000 to 9250 KC  
16th Harmonic for 144-148 MCS Band  
½" Square Blanks  
BT cut—Peak Activity  
Stable at 23°C

Blank only (in band).....\$1.50  
Blank only (your choice of frequency within 10 KC..... 2.00  
Blank and Electrodes (your choice of frequency within 10 KC..... 2.25  
Complete Cased Crystal Unit (your choice of frequency within 200 cy ..... 4.00

**BEAUMONT ELECTRIC SUPPLY COMPANY**  
1319 S. Michigan Ave. Chicago 5, Illinois

**NEW!**  
4-in-1  
**Job Card**  
Designed for Service Dealers  
Provides: 1. Radio or Appliance Tag  
2. Customer Clinic Card  
3. Estimate  
4. 2x5 File Card

Radio Press  
MORRISTOWN  
WEST VIRGINIA

## TEST EQUIPMENT

SHIPPED WHEN AVAILABLE  
(Subject to factory deliveries)

SIMPSON 260-volt-ohm-milliammeter.....\$33.25  
SIMPSON 305 tube tester..... 39.50  
TRIPLETT 2413-tube tester..... 45.00  
TRIPLETT 2432 signal generator..... 49.75  
RADIO CITY 705-signal generator..... 49.50  
RADIO CITY 802-N tube & set tester..... 59.50  
RADIO CITY 448 pocket V.O.M..... 24.50  
SUPERIOR 400-multimeter..... 52.50  
SUPERIOR CA-11-signal tracer..... 18.75  
DuMONT 164-E-3" oscilloscope.....105.00

Also many, many others available.

**WE ALSO STOCK AMPLIFIERS!**

Amplifiers and complete sound systems available from \$29.99 up. Write to us on your specific needs. Orders shipped C.O.D. upon receipt of 25% deposit.

**SCENIC RADIO & ELECTRONICS CO.**  
53 Park Place • New York 7, N. Y.

**BUILD YOUR OWN  
FAST FREEZER**

It's easy to build this household appliance and profitable to use. Save up to 75%. Operates on 110 or 32 volts. Plans show 5 sizes and are easy to follow. **ENJOY MAKING ONE OF** these freezers from new or used parts. No expert knowledge needed. Mail \$1.00 bill or check for complete plans and catalog.

**LE JAY MFG. CO.,** 454 Ledy Bldg., Minneapolis 8, Minn.

**RADIO COURSES**

- RADIO OPERATING
- RADIO SERVICING — ELECTRONICS
- REFRIGERATION SERVICING

Personal Counseling Services for Veterans  
Write for Latest Trade & Technical Catalog  
**Y.M.C.A. TRADE & TECHNICAL SCHOOLS**  
7 W. 64th Street New York City

**Ted McElroy**  
World's Largest Manufacturer of  
Wireless Telegraphic Apparatus  
COMPLETE CENTRAL OFFICE EQUIPMENT  
**McElroy Manufacturing Corp.**  
82 Brookline Avenue • Boston, Massachusetts

RADIO NEWS



**BC 653A**  
(Covers Removed)  
**MADE FOR SIGNAL CORPS**

**Frequency Range:** 2 to 4.5 mc in five quickly selectable frequencies.

**Power Output:** 90 watts CW, 22½ watts voice.

**Power Input:** 12 volts DC at 42 amps or 24 volts DC at 30 amps.

**Tube Line-Up:** Master oscillator type 1613; IPA type 807; PA PP type 814's; modulator type 1613; VR-105's as voltage regulators.

Complete with component antenna relay, dynamotor, less antenna and storage batteries. Immediately available at a remarkably low price. Write for further details.

Sales restricted to communications companies, manufacturers, distributors and dealers.



(Central Agents for War Assets Corp.)  
255 18th Street - Brooklyn 15, N. Y.  
702 Bartlett Building - 215 West 7th St.  
Los Angeles 14, Calif.

# ATTENTION HAMS!

Lee Kimberling—W8ESN—is now in charge of our amateur supply department and is here to help you solve your problems as well as to fill your orders. Send him your orders and ask him for any information you wish. He knows the answers.

## TUBE SPECIALS

6 AK5	\$ 1.74	5BP1A	\$12.50
5 R4GY	1.85	8005	4.95
VR-105	1.41	2API	4.95
9002	2.00	8025	8.95
9003	2.50	829B	8.95
9004	2.00	5FP7	10.00
9006	.99	955	2.95
307	1.75	7BP7	14.95
807	1.95	9001	2.50
866	1.50	954	4.95
		955	2.95

Many other tubes coming in daily. We carry a complete line of Ham equipment and parts . . . crystals, condensers, chokes, wires, cables . . . everything you need. If it's available LIFETIME can supply you. Write for latest bargain bulletin.

**Lifetime**  
**SOUND EQUIP. CO., Dept. 45**  
911-913 JEFFERSON AVE., TOLEDO 2, OHIO

"hundreds" dial might be calibrated in frequency, still keeping the "tens" dial for a band spread.

The short-wave listener could use an instrument of this kind to his advantage in spotting frequencies of DX stations he wishes to tune in. No trouble should be experienced in positively identifying any 10 kc. channel below 20 megacycles. He could even keep his receiving equipment in alignment with it. Intermediate frequencies may be aligned by adjusting the i.f. trimmers for maximum response of a local broadcast station when the receiver local oscillator is set to the sum of the local broadcast station frequency and the intermediate frequency of his receiver by using the meter.

-30-

## CIVILIAN TECHNICIANS SOUGHT TO RELEASE G.P.S.

**I**N AN effort to release enlisted technicians now stationed in the Philippines, Japan, and Korea for shipment home, the Army Signal Corps today announced that it is recruiting civilians to take their places. Attractive jobs are being offered civilians skilled in the maintenance and repair of radio, radar, telephone and electric power equipment, and in several other classifications.

These appointments, for a minimum of one year with transportation furnished both ways, carry salaries ranging from \$1.50 to \$1.70 per hour for a 40 hour week, with provisions for overtime and night work differential. Quarters and subsistence will be provided by the Army at a cost not to exceed \$40 a month. These civilian employees will participate in annual and sick leave credits. They will receive necessary medical care, hospitalization, and compensation for service-connected injuries. They may make purchases at quartermaster sales stores and outlets of the Army exchange service, and they may participate in Army recreational facilities.

Positions to be filled include electricians, electrical instrument repairmen, radio repairmen of several classifications, high speed automatic radio operators, fixed station transmitter attendants, cryptographic repairmen and technicians, and radar repairmen as well as installation and maintenance technicians for all types of telephone equipment.

Persons interested in any of these positions may secure additional information from any U. S. Employment Service office, or at these Signal Corps installations: Office of the Chief Signal Officer, Pentagon, Washington, 25, D. C.; Chicago Signal Depot, 1903 West Pershing Road, Chicago, 9, Ill.; Sacramento Signal Depot, North 7th Street, Sacramento 15, Calif.; Lexington Signal Depot, Lexington, Ky.; Holabird Signal Depot, Baltimore, 19, Md.; Signal Corps Engineering Laboratories, Bldg. 666, Fort Monmouth, N. J.; Signal Corps Photographic Center, 35-11 35th Ave., Long Island City I, N. Y.; Philadelphia Signal Depot, 5000 Wissahickon Ave., Philadelphia 44, Pa.; and Alaska Communications System, 550 Federal Office Building, Seattle, 4, Wash.

-30-

## Highest Quality RADIO & ELECTRONIC TESTING EQUIPMENT

Immediate Delivery from Stock Guaranteed

The New SUPERIOR Model CA-11  
**SIGNAL TRACER**  
Net Price **\$18.75**



- FEATURES:**
- ★ Signal intensity readings are indicated directly on the meter.
  - ★ Only one connecting cable—No tuning controls.
  - ★ Highly sensitive—uses an improved vacuum tube voltmeter circuit.
  - ★ Tube and resistor-capacity network are built into the Detector Probe.
  - ★ Completely portable—weighs 5 lbs. Measures 5 x 6 x 7 inches.
  - ★ Provision is made for insertion of phones.

The New SUPERIOR Model 400  
**ELECTRONIC MULTI-METER**  
Net Price **\$52.50**

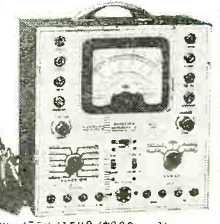

- RANGES:**
- DC V.T.V.M. Volts: 0 to 3/15/30/75/150/300/750/1500/3000 volts.
  - DC Volts: (at 1000 ohms per volt) 0 to 3/15/30/75/150/300/750/1500/3000 volts.
  - AC Volts: (at 1000 ohms per volt) 0 to 3/15/30/75/150/300/750/1500/3000 volts.
  - DC Current: 0 to 3/15/30/75/150/300/750 Ma. 0 to 3/15 amps.
  - Resistance: 0 to 1,000/10,000/100,000 ohms. 0 to 1/10/1,000 megohms.
  - Capacity: .0005-.2 .05-20 .5-200 mfd.
  - Reactance: 10 to 50M ohms 100-500M ohms .01-5 megs.
  - Inductance: .035-14 .35-140 35-4,000 henries.
  - Decibels: -10 to +18 +10 to +38 +30 to +58.

The New Model 705  
**SIGNAL GENERATOR**  
Net Price **\$49.50**



- RANGES:**
- From 95 kc to 100 mc, continuously variable.
  - Calibration accurate to 2% through broadcast bands, within 3% for high frequency bands. Planetary drive with 3% for high frequency bands. Planetary drive with 3% for high frequency bands. Planetary drive with 3% for high frequency bands.
  - capacitor, direct reading calibration, output modulated or unmodulated. Self-contained electronic modulation 400c sine wave available for external use. Special feature provided in having two degrees of modulation at both approx. 30% and 80%.

The New Model 802N  
**COMBINATION TUBE & SET TESTER**  
Net Price **\$59.50**



- RANGES:**
- DC Voltmeter: 0/10/50/500/1000 at 1000 ohms per volt.
  - Four Range AC Voltmeter: 0/10/50/500/1000
  - DC Milliammeter: 0/1/10/1000 DC Ammeter 0/10
  - DB Meter: -8/15/15 to 20/20/20 to 40/32 to 55 decibels
  - Four Range Output Meter—same as AC Volts
- SUPERIOR Model 1553 Volt Ohm Milliammeter** .....\$24.75
- SUPERIOR Model PB-100 Volt Ohm Milliammeter** .....\$28.40
- SUPERIOR Model PB-210 Multi Meter** .....\$35.75
- SUPERIOR Model 450 Tube Tester** .....\$39.50
- SUPERIOR Model 720 Multi-Range AC Ammeter** .....\$49.50
- McMurdo Silver Model 900 Vomax** .....\$59.85
- R.C.P. Model 488 Ultra-Sensitive Multimeter** .....\$71.50
- R.C.P. Model 805 Tube & Set Tester** .....\$89.50
- R.C.P. Model 668 Electronic Voltmeter** .....\$74.50
- R.C.P. Model 461A Sensitive Multimeter** .....\$39.50
- R.C.P. Model 447 AC-DC Multimeter** .....\$17.95
- R.C.P. Model 148 Pocket Multimeter** .....\$24.50
- Supreme Model 546 Oscilloscope** .....\$82.50

Send for our FREE New Post-War Catalog!

**Metropolitan**  
**ELECTRONIC & INSTRUMENT CO.**  
Dept. R, 6 MURRAY STREET  
NEW YORK 7, N. Y., U. S. A.  
Phone: BArlay 7-5556  
Cable Address: METRONICS

# MORE SMASH BUYS at National Radio Distributors

## IMMEDIATE DELIVERY

### REPLACEMENT CABINETS



All solid wood construction. Portable Electric Phono Case; Brown Leatherette covered; accommodates 12" records with lid closed. SPECIAL.....\$7.95  
 PAC-100 portable automatic record changer (will accommodate any make).....\$8.95

Replacement Cabinets to Suit Any Requirement.  
**WESTINGHOUSE EQUIPPED FLUORESCENT LIGHTS**  
 2-light 20-watt kitchen unit ready to plug in \$5.85 ea. In lots of 3.....\$5.25  
 2-light 40-watt standard industrial fixture 48 inches long \$11.95 each. In lots of 10.....\$11.25  
 Prices do not include lamps.

Also Fluorescent Desk and Bed Fixtures..\$5.85 each (including lamps)

**EXTRA SPECIAL—CONDENSER KIT (By-Pass)**  
 Consists of 100 Tubulars (all 600 Volt) from .0025 to .1 Mfd. inclusive. Fully Guaranteed. Fresh Stock. Per Kit.....\$5.95

**RADIO KNOB KIT**  
 Contains 50 assorted styles set screw Bakelite knobs for 1/4" shaft. A beautiful assortment of the most popular styles in present use. Per Kit.....\$3.95

**INSULATED RESISTOR KIT**  
 Contains 100 most popular sized DELUXE assortment of 1/4, 1/2 and 1 Watt, R.M.A. color coded, some Gold Band. Per Kit.....\$2.75

**AERIAL KITS (individually boxed) complete.....75c**  
 Webster Pickup Arm including C-2 Crystal Cartridge and all mounting hardware. SPECIAL.....\$2.49

**RADIO KITS 4 Tube T.R.F. including tubes, speaker and instructions.....Special \$10.95**

Please include at least 25% with all C.O.D. orders  
 Write for Our Latest Parts Catalog. Just Out!

## National Radio Distributors

1029 E. 163 St., New York 59, N.Y.

# SUPREME PUBLICATIONS

These are the practical radio manuals you need. Improve your radio knowledge. Speed up service work. Check manuals you want, write name below, and send this entire ad. as your order.

### MOST-OFTEN-NEEDED DIAGRAM MANUALS



1942,  1941,  1940,  1939 Radio Diagram Manual  
 Each manual has between 192 and 240 pages. 8 1/2 x 11". Price, each.....\$2.00  
 1926-1938 Radio Diagram Manual  
 240 pages. Price, only.....\$2.50

**RADIO Servicing Course—Book.**  
 22 lessons, 224 pages. Size: 8 1/2 x 11"......\$2.50  
 **Record Players & Recorders.**  
 A 11 makes. 8 1/2 x 11", 128 pages.....\$1.50  
 **Practical Radio Mathematics** 25c  
 **Refrigeration Manual**.....\$1.00  
 **Cyclopedia of Television**.....40c

**Practical Radio & Electronics Course.**  
 3 volumes in one. 53 lessons.....\$3.95  
 **Radio Repairing with Available Substitute Parts.** 25c  
 **How to Use Diagrams in Radio Servicing**.....10c

**Simplified Radio Servicing by Comparison Method**  
 New, revolutionary different method makes radio repairing twice as easy. Introductory training included. Simple picture suggestions tell you where to look for faults and how to make the repair. No testers needed for most jobs. With job-sheets, blue prints, hints, diagrams.....\$1.50

**SUPREME PUBLICATIONS, 9 S. Kedzie, Chicago 12, ILL.**  
 Check manuals wanted, send remittance with complete advertisement or write order in a letter. Books sent postpaid. Money back guaranteed.

Name: .....

Address: .....

## Saga of the Vacuum Tube (Continued from page 54)

and far between. Periodicals in particular were of limited circulation, aimed at the experimenter of high-school age and pocketbook and, except in a few cases, were not deemed of sufficient importance to be included in the permanent files of public libraries. Few books were written, since the men who were doing the work were too busy doing it to write about it.

With the advent of broadcasting and the great increase in adult popular interest in radio there came into being a number of widely circulated periodicals, technical and popular, both here and abroad, which published large quantities of information on current radio and vacuum tube development. These were preserved in most libraries of any size and are usually available to the earnest student of vacuum tube history.

For this reason little space has been devoted to cold-cathode, cathode ray, multi-grid, and higher powered transmitting tubes, such as the silica envelope type made by *Philips-Mullard*, the water-cooled copper-to-glass seal type developed by *Housekeeper*, and the larger radiation cooled types. Information on these phases of develop-

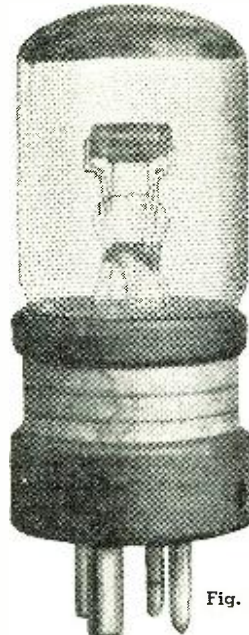

Fig. 244

ment can be obtained from these sources by the student or collector who seeks information on a specific type, and its collation and republication here is considered unjustified.

### References

- 312. *Martin*—"Telefunken Rohrentypen" *Telefunken Zeitung*, Vol. 4, No. 32/33, September 1923, pp. 51-55.
- 313. *Rukop, Hans*—"25 Jahre Telefunken—Die Telefunkenrohren und ihre Geschichte" *Telefunken Festschrift*—1928, p. 49.
- 314. *Banneitz, F.*—"Taschenbuch der drahtlosen Telegraphie und Telephonie" *Springer—Berlin*—1927, p. 476.
- 315. *Harper, A. E.*—"Amphifying Bulbs" *QST*, Vol. 4, No. 7, February 1921, pp. 27-28.

## UTICA TOOLS

ALL TYPES FOR MORE TOOL MILEAGE  
 Ask Your Dealer

### UTICA DROP FORGE AND TOOL CORPORATION

UTICA 4, NEW YORK

### Photo Electric Unit

For numerous control applications such as burglar alarms, industrial safety controls, automatic counters and in conjunction with a chime or bell to announce entrance of people in stores and offices. For AC. Complete with all tubes and SPDT control relay.  
 Net.....\$9.45

LIGHT SOURCE—Up to 30 feet. For use with above unit.  
 Net.....\$5.95

Write to Dept. RN

### ADSON RADIO CO.

221 FULTON ST., NEW YORK 7, N. Y.

### Correspondence Courses in RADIO and ELECTRICAL ENGINEERING

Get good electrical field. Prepare yourself at Low Cost. For secure future. Modern course. So simplified anyone can understand quickly.

**RADIO ENGINEERING** Extra fine course in radio, public address, photo-electric work. Training needed badly. Diploma on completion.

**WRITE** Send postcard or letter for Free Copies of school catalogs, full details, all about deferred payment plan, etc. **SEND NOW!**

**Low \$25 Either AS Course**

LINCOLN ENGINEERING SCHOOL, Box 931-R88, Lincoln 2, Nebr.

## RADIO BOOKS by mail

FAST SERVICE: 98% of all orders filled same day as received. We have one of the U.S.A.'s most complete stocks of electronic books. If you don't know the price, we'll send C.O.D., or remit sufficient and we'll refund excess.

Send stamp for catalog

### EDITORS AND ENGINEERS

1420 North Highland Ave., Los Angeles 28, Calif.

## PLUG-IN TEST LAMP

Tests Everything Electrical  
 Speeds Up Trouble-Shooting

Used by Radio Men, Electricians, Mechanics and Experimenters. Tests continuity, open circuits, etc. ALWAYS READY! PLUGS INTO ANY OUTLET! Only \$1.50 Postpaid. FREE CIRCULAR. (Post. Paid). HANLAN CO., 1419-R, West Jefferson, Los Angeles 7, Calif.

## PEN-OSCIL-LITE

Extremely convenient test oscillator for all radio servicing; alignment • Small as a pen • Self powered • Range from 700 cycles audio to over 600 megacycles. U.S. • Output from zero to 125 v. • Used by Signal Corps • Write for information.

GENERAL TEST EQUIPMENT CO.  
 38 Argyle Buffalo 9, N. Y.

## PRE-EXAM TESTS for FCC COMMERCIAL RADIO OPERATOR EXAMINATIONS

Determines your weak points—Enables you to brush-up before taking the FCC exam. Prepared by A. R. Nilson, famous co-author Nilson & Hornung's RADIO OPERATING QUESTIONS AND ANSWERS.

CLEVELAND INSTITUTE OF RADIO ELECTRONICS  
 RN-4 Terminal Tower Cleveland 13, Ohio

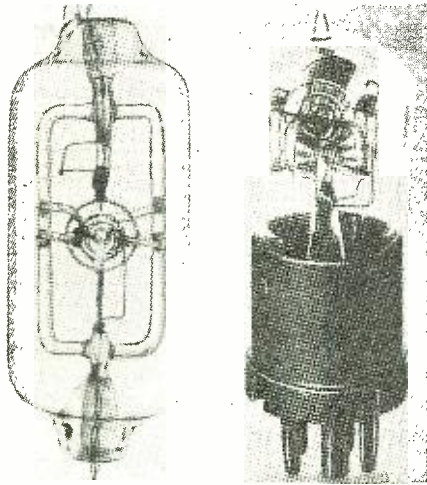

Fig. 245

316. Dr. Erich F. Huth Gesellschaft für Funkentelegraphie.  
 317. (H. J. W.) Seddig, Würzburg.  
 318. Auer Studiengesellschaft für elektrische Leuchtöhren.  
 319. Gorskowski, J.—“Les lampes à plusieurs électrodes et leurs applications en radiotechnique” Etienne Chiron—Paris—1925, p. 125.  
 320. Schottky, W.—“Über Hochvakuum Verstärker III Teil: Mehrgitteröhren” Archiv für Elektrotechnik, Vol. 8, No. 9, December 8, 1919, pp. 299-328.  
 321. D.K.P. 310605, issued March 19, 1915.  
 322. D.K.P. 87745, issued May 31, 1916.  
 323. See reference 323, p. 320.  
 324. Pöhlmann, B. and Gehrts, A.—“Verdampfung einer Verstärkeröhre” Elektrische Nachrichten-Technik, Vol. 2, No. 3, March 1925, pp. 65-74.  
 325. See reference 316, p. 142.  
 326. “TKD” is the trade mark of Süd-deutsche Telefon-, Apparate-, Kabel-, und Draht-Werke, Nürnberg.

**CAPTIONS FOR ILLUSTRATIONS**

- Fig. 234. RE11 tube with ballast resistor. Photograph courtesy Bell Telephone Laboratories.  
 Fig. 235. Telefunken RS1. Reproduced from Telefunken Festschrift—1928.  
 Fig. 236. Telefunken RS5. Photograph courtesy R. McV. Weston and Electrical Communication.  
 Fig. 237. TKD ST-12 tube.  
 Fig. 238. Huth LE219 tube, front and side views. Reproduced from Nesper's “Der Radio Amateur”—1924.  
 Fig. 239. Left—Seddig tube. Filament 0.56 ampere at 2.8 volts. Right—Auer receiving tube.  
 Fig. 240. Development of Telefunken RS17. Reproduced from Niemann's “Funkentelegraphie für Flugzeuge”—1921.  
 Fig. 241. Development of the SS (Siemens-Schottky) type tube. Reproduced from “Veröffentlichungen aus dem Gebiete der Nachrichtentechnik”—1935.  
 Fig. 242. Left RE20 tube. Right—RE26 tube. Reproduced from Banneitz “Taschenbuch der drahtlosen Telegraphie”—1927.  
 Fig. 243. Development of the space charge grid tube. Reproduced from “Veröffentlichungen aus dem Gebiete der Nachrichtentechnik”—1935.  
 Fig. 244. RE16 tube. The top is painted red. Reproduced from Nesper's “Der Radio Amateur”—1924.

**DESIGN FOR QUALITY**

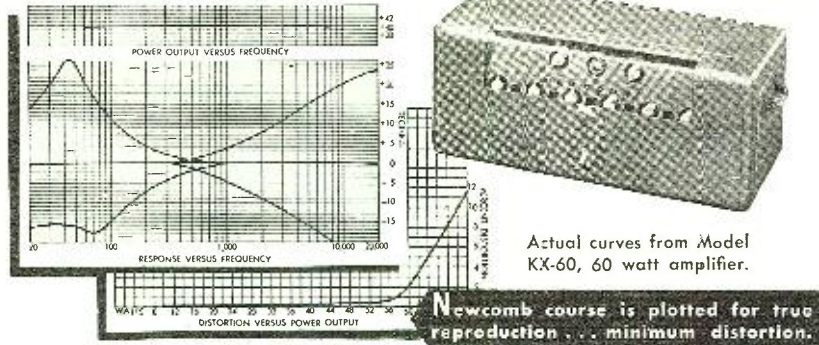

Actual curves from Model KX-60, 60 watt amplifier.

Newcomb course is plotted for true reproduction . . . minimum distortion.

Newcomb design goes beyond that of conventional amplifiers, whose power output is likely to be measured only at their most favorable frequency. Newcomb engineering considers it important that the power output curve versus frequency be as uniform as possible and that you get a full measure of power from any output tap. You are assured a full-powered sound system whatever frequency or output impedance is considered.

True reproduction . . . wide, smooth response characteristics . . . these qualities are not coincidence. They are carefully planned and built into every Newcomb sound system. Judged by the strictest standards . . . by any means you wish . . . a Newcomb amplifier is a powerful piece of sound engineering. It's built to give a brilliant performance on the toughest job . . . and it does.  
 Write for details on complete Newcomb line.

THE SOUND OF QUALITY

*Newcomb*

**AUDIO PRODUCTS CO.**

MANUFACTURERS

DEPT. F. 2815 S. HILL STREET, LOS ANGELES 7, CALIFORNIA

**NEW SOLDERING GUN**

**THE SPEED IRON\***



100 Watts 115 Volts 60 Cycles

*Soldering Heat in 5 Seconds*

Wherever you have a soldered joint in radio, electrical or electronic repair and service work, the Speed Iron will do the job faster and better.

The transformer principle gives high heat—in 5 seconds—after you press the trigger switch. Convenient to hold with a pistol grip handle, the compact dimensions of this new soldering tool permit you to get close to the

\*T.M. Reg. U. S. Pat. Off.

joint. The copper loop soldering tip permits working in tight spots. The heat is produced by the high current flowing through the soldering tip—permitting direct and fast transfer to the soldered connection.

If you want to save time on soldering jobs with a tool that is ready to use in 5 seconds, get a Speed Iron today. See your radio parts distributor or write direct.

**WELLER MFG. CO.**

517 NORTHAMPTON ST.

EASTON, PA.

# Alsam's CASES

## Regency Striped



**Model P-612**  
Portable  
Phonograph  
Case

**Model WB-12**  
Wall Speaker  
Baffle

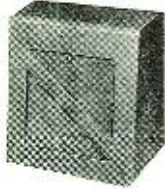

**Model L-200**  
**Model L-300**  
Table  
Radio  
Cabinets

The NEW Alsam Regency Striped Cases enhance the beauty of radios and phonographs. Write for illustrated literature featuring other models. Prices furnished on request.  
**ORDER FROM YOUR JOBBER!**

**ALSAM PRODUCTS COMPANY**  
805 MILWAUKEE AVENUE  
CHICAGO 22, ILL.

# RADOLEK

## Radio-Electronic Service Parts

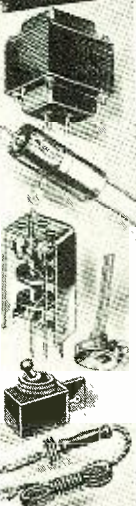

Large stocks assure the finest and most complete selections of all available items at lowest prevailing prices. Thousands of active buyers depend on us for their entire Radio repair and replacement requirements. Because we understand service problems, every order is expedited for delivery in double quick time. Everything we do is planned for convenience and satisfaction to our customers. You will find it profitable to make Radolek your buying headquarters.

### FREE BUYING GUIDES

Because of existing conditions we keep our customers right up to the minute on available merchandise by releasing supplements frequently instead of sending our regular Big Profit Guide once a year. Send the coupon now to get these Free Buying Guide Supplements as they are issued.

**FREE!**



### FAST SERVICE!

**RADOLEK CO., Dept. B-113**  
601 W. Randolph St., Chicago 6, Ill.

Please send FREE Buying Guide Supplements

NAME \_\_\_\_\_  
ADDRESS \_\_\_\_\_

**ORDER FROM RADOLEK**

Fig. 245. Development of the Schottky three grid tube. Reproduced from "Veroffentlichungen aus dem Gebiete der Nachrichtentechnik"—1935.

-30-

## Direct-Wire Television

(Continued from page 40)

apart from the oscillographs which translate light and power values to moving graph-like lines, three monitoring screens. Two show the image being picked up by the cameras. The third is the "output" image being fed to the other receivers or monitors attached to the direct-wire installation.

Switching relays, three simple push-buttons, at the console permit the operator to select which of the two camera's pick-up images is to be fed to the line amplifier, or he may choose a combination of both. To effect fades, he slowly cuts the gain, rides it all the way down to the light image and then, when the image is virtually imperceptible, he switches images. Lap dissolves and ghost images may also be accomplished by shifting the light levels.

From the engineer's control console, the signal is fed to a line amplifier and distribution panel. The line amplifier's function is to build the video signal to sufficient volume to feed the various monitors plugged into the distribution panel. In the department stores which will be equipped with many of the monitors, it may be desirable to have more than one line amplifier and distribution panel on other floors to intensify the signal and send it elsewhere to feed other monitor units or distribution panels. Such a system permits considerable saving in cable required and leaves distribution of monitors more flexible.

In operation, the monitors to receive the program at any one time can be selected at will. In the evening, after hours, the store may prefer to feed the program to monitors on the windows. Or it might prefer to concentrate its television appeal to audiences on different floors at different hours of the day.

It will be possible for the store to arrange to pick up the programs broadcast by local television stations by use of a receiver in the studio or by tapping a network line to bring selected programs to the store monitors or to relieve the store's programming staff at intervals.

The sound system for this television arrangement is entirely independent of the video system. It can be built into the video unit or handled as an autonomous public address installation with outlets adjacent to the monitors. It is important, though, whichever type of sound system is used, that the appearance of the sound coming from the characters speaking on the monitor be retained lest the whole illusion of television broadcasting be lost.

# Classified

Rate 20c per word. Minimum, 10 words

## RADIO ENGINEERING

RADIO Engineering, Broadcasting, Aviation and Police Radio, Servicing, Marine Operating and Electronics taught thoroughly. Expenses low. Write for catalog. Valparaiso Technical Institute, Dept. N. Valparaiso, Ind.

## FOR SALE

RECTIFIERS—Halfwave, 5 Amperes, \$4.50, 2.2 Amperes, \$2.25; 1.5 Amperes, \$1.85. Fullwave, 1 Ampere, \$2.50; .5 Ampere, \$1.85. Maximum 18 volts input. List free. Milton Bursma, Route 5, Grand Rapids, Mich.

1,000 PL 68 PHONE plugs. No reasonable offer refused. Communicate Box 429, % Radio News.

BEEDE Foundation Meters, 3" square, 425 Microamp movement with scale marked 60, 120, 150, 300 AC-DC Volts, also Decibels. Ohms—\$5.95; Same in a 2" square—\$4.95; 3" square, 150 Microamp movement with similar scale—\$5.95. Belmont Radio Supply, 1921 W. Belmont Ave., Chicago 13, Illinois.

VIBRO-PLEX, Bunnel Bugs-Army J-36, some new, some used, guaranteed good condition, \$5.95; Roller-Smith 3 1/2" round meter, 0-1 Milliamp movement, 0-4 kV scale, \$4.95; Westinghouse 2 1/2" meter, 0-200 Milliamp, \$4.95; Westinghouse oil filled condensers, 10 mike, 600 WV, rectangular can, \$2.49. Belmont Radio Supply, 1921 Belmont Ave., Chicago 13, Ill.

LOWEST Prices. Radio Tubes, parts. Bargain lists 3c. Potter, 1314 McGee, Kansas City 6, Mo.

U.S. NAVY Aircraft Surplus Control Boxes. Two types, both for \$2.00 postpaid. Radio parts worth \$10.00. Van Sickle Radio Supply, Indianapolis 6, Indiana.

VACUUM Tube Volt-Ohmmeter, \$6.95! Twelve ranges! 6000 volts! Billion ohms! Complete kit. Tubes. Instructions. Radiocrafters; 166 N. Sierra Bonita; Pasadena, California.

SURPLUS UHF Radar Transceiver, 13 Tubes, \$15; other items, list, 10c. Engineering Associates, Far Hills Branch Box 26, Dayton, Ohio.

CRYSTALS, all types. Blanks, Direct from Brazil's foremost crystal laboratories. For details write: Radio Cristais do Brasil, Ltda., Rua Dr. Satamini 84, Caixa Postal 1965, Rio de Janeiro, D. F. Brazil.

## CORRESPONDENCE COURSES

USED Correspondence Courses and Educational Books sold or rented. Inexpensive. Money-back guarantee. Write for Free Catalog listing 4000 bargains.—(Courses Bought.)—Lee Mountain, Pisgah, Ala.

CORRESPONDENCE Courses and self-instruction books, slightly used. Sold. Rented. Exchanged. All subjects. Satisfaction guaranteed. Cash paid for used courses. Complete information and 100-page illustrated bargain catalog FREE! Write Nelson Company, Dept. 2-59, Chicago 5.

USED Correspondence courses, Educational and Technical Books, bought, sold, rented. Catalog Free. Educational Exchange, Henagar, Ala.

AMATEUR radio licenses. Complete code and theory preparation for passing amateur radio examinations. Home study and resident courses. American Radio Institute, 101 West 63rd Street, New York City.

## PATENT ATTORNEYS

INVENTORS—Before disclosing your invention to anyone, send for Form "Evidence of Conception"; "Schedule of Government and Attorneys' Fees"; and instructions. Sent free. Lancaster, Allvine & Rommel, 414 Bowen Building, Washington 5, D. C.

PATENTS SECURED. Two valuable booklets sent free. Write immediately. Victor J. Evans & Co., 148-D Merlin Bldg., Washington 6, D. C.

## RADIO EQUIPMENT

RADIO Service men and experimenters send for our giant radio catalogue. Save dollars. United Radio Co. (1000M) Newark, N. J.

RADIO Tubes, parts. Write for bulletin Hershaw, 3313 Delavan, Kansas City, Kan.

YOUR New Free Catalog is Ready! Radionic's Catalog lists hard-to-get radio parts and books. All available for immediate shipment. Send today to: Radionic Equipment Co., Dept. M4, 170 Nassau St., New York 7, N. Y.

**RADIO NEWS**

CODE set! Sends real wireless signals! Shipped complete with telegraph key-high frequency buzzer and instructions. Now only \$1.00. For two-way communication or practice order two sets. Satisfaction Guaranteed! Immediate shipment! Please include 20c postage. Rathert Electric Co., Dept. N1, Cresco, Iowa.

**SURPLIS** Radio and Electronic parts and equipment. New and used. Write for free list. Highbridge, 312 Canal St., New York 13, N. Y.

**MISCELLANEOUS**

**SMALL** manufacturing company in the South desires contracts for building, assembling and testing of electronic parts or equipment. Work will be under the supervision of Electronic Engineer with twelve years experience in this line. Box 428, % RADIO NEWS.

**NEED 50L6's** etc.? Send us your old ones for repair. Heater type tubes of 12-25-35-45-50-70-117 Volt Series only accepted for repair. Min. order 12 tubes, 25c ea. or 20 for \$4.00. Returned C.O.D. Finest Radio Service, 307 Pipestone, Benton Harbor, Mich.

**SITUATIONS WANTED**

**RADIO Technician**, Army Warrant Officer, 5 years schooling and experience including FM and HF. Supervised tele-communications in Europe. Amateur license. Position desired. George W. Peity, 604 W. Broadway, Sedalia, Mo.

**RADIO-RADAR Technician**, Veteran, Ten Years' Experience, Navy School Grad., Army Signal Corps Instructor, age 37, married, desires position. W. S. Dickson, Box 128, Clayton, Georgia.

**HELP WANTED**

**MANUFACTURER'S** representatives for microphone line. Several good territories open. Contact St. Louis Microphone Company, 2636 Roseland Terrace, St. Louis, Mo.

**GRAB REE'S WHOLESALE RADIO**

2608 Ross Ave.

**DALLAS 1 TEXAS**

**Learn RADIO-ELECTRONICS-TELEVISION**



**12 WEEKS TRAINING IN COYNE SHOPS WHERE YOU "LEARN-BY-DOING"**

Trained Radio-Electronics men needed now. Steady work, good pay and a real future await you. Tremendous expansion in Radio, Electronics, Frequency Modulation and Television predicted—a world of new opportunities. Get Radio Training in the Coyne Shops in Chicago now, and BE READY.

**Student Finance Plan**

If you are short of money, you can get your training and pay most of your tuition after you graduate. Many earn while learning. Free Lifetime Employment Service to graduates. Training in INDUSTRIAL ELECTRONICS and Electric Refrigeration included. Also: how to start your own Radio business.

**FREE BOOK**

Whether you're 16 or up to 40, get the facts. Big illustrated book tells about your future in Radio-Electronics-Television. Mail coupon today. We also have facilities for men with physical disabilities whether due to war or other causes. Check coupon for details.

**VETERANS** Coyne also is equipped to train those who qualify for training under the G. I. Bill of Rights. Check coupon.

H. C. LEWIS, Pres., RADIO-ELECTRONICS DIVISION COYNE ELECTRICAL SCHOOL, 500 S. Paulina St., Dept. 42-1K, Chicago 12, Illinois. Send me FREE BOOK on COYNE RADIO-ELECTRONICS TRAINING and details of Student Finance Plan.  Send physical disability details.  Send special G. I. Bulletin.

NAME \_\_\_\_\_  
ADDRESS \_\_\_\_\_  
CITY \_\_\_\_\_ STATE \_\_\_\_\_

In the television sound pick-up unit, procedure is exactly like that of regular broadcasting or public address work save that care must be taken to keep the microphone out of the picture, just as they do in the movies.

Needless to say, these units are far less costly than those for broadcasts. No r.f. pick-up unit is needed. Monitors will probably be built-in installations, so the cabinet costs are obviated, no antenna or license is called for and the transmission system is greatly simplified over that for broadcast television. Yet, the application of much of the equipment to broadcast television is not difficult and, very probably, many a department store installation will serve as the nucleus for television broadcast stations of the future.

The possibilities of expansion are tremendous. In more advanced direct-line television systems, more than two cameras may be desired. Some will install motion picture television pickups of the 16 mm. or 35 mm. types. Monitors may be expanded in number; at any rate it's sound practice to put in twice the number of outlets anticipated to give the system flexibility.

The installation requires determination of the number of outlets required. It entails the running of the coaxial cable to key positions throughout the store or buildings. There will be major construction work in the studio to arrange for sound-proofing walls and shielding the console from sounds and some alteration work on the building may be needed to install concealed monitors and wires.

It will be necessary to charge some department of the operation with the necessity for planning programs, for translating the installation to entertaining or informative or otherwise useful purposes.

A maintenance job will exist and take up some of the time of the operators of the installation between broadcasts.

But, all in all, the direct-wire installation is one of the simplest and most significant applications of television. Certainly it justifies considerable attention on the part of prospective users of the medium and prospective workers for it. Soon it will be a major industry apart from and/or integrated with broadcast television.

-30-

**Photo Credits**

Pages	Credit
25, 26, 27, 86 (top)	Walter Steinhard, Staff Photographer
28, 29	Lear, Incorporated
31, 33	Julian Krupa
32, 35	Clark Radio Equipment Corp.
38, 39, 40	Allen B. DuMont Laboratories, Inc.
41, 43, 84, 86 (bottom)	U.S. Signal Corps
44 (left)	M.I.T. Radiation Laboratories
44 (center)	General Electric Company
44 (right)	Sylvania Electric Products, Inc.
46	Stromberg Carlson
127	RCA Victor

**FOR EVERYTHING IN RADIO**

WRITE

**Leo, W9GFQ**  
**For Fast Delivery!**



Get Leo's own personal, sudden service on your radio and electronic needs. Quick delivery, lowest terms, liberal trade-in allowances.

**SERVICE DEALER NEEDS**



**WRL MULTITESTER**

Steel case with 30-60% uncl. Cat. No. 13-491 Less Leads .. **\$1875**

Handles AC DC Voltmeter, 20 Milliammeter, high and low range Ohmmeter, 3" meter with sturdy D'Aronson movement. Size 5 1/2 x 8 x 3 1/4.

A complete stock of tools, replacement parts, test equipment, intercom and public address systems . . . everything for the progressive service dealer.

**FOR EXPERIMENTERS**

**PHONO AMPLIFIER KITS**



Complete with tubes, speaker, stamped chassis, and all resistors and condensers

Cat. No. 7-271 . . . . . \$9.50 ea. Lots of 3, ea. **\$915**

Crystal sets, Antenna Kits, Code Oscillator Kits, Transmitter Kits, and many other items for the experimenter and radio enthusiast.

**HAM NEEDS**

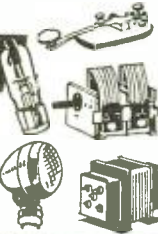

Transmitting tubes, condensers, miles everything for the Ham. One of the country's largest stocks of Ham equipment. Write Leo, W9GFQ, today, and be first with the latest. We invite inquiries for special equipment of all kinds.

**TRANSMITTERS**



For peak performance and more dollar for dollar value, get a WRL Transmitter Kit . . . designed in Leo's own laboratories . . . tested and proven. Available in 15, 35, 70, and 150 watt kits as well as kits custom built to your own specs. Write Leo today for complete details, prices and terms.

**RECEIVERS**



Here are just a few of the many well-known receivers offered by Leo:

Hallierafters SX-25	..... \$ 94.50
Hallierafters S-20R	..... \$ 60.00
Hallierafters SX-28A	..... \$225.00
Echophone EC-1A	..... \$ 29.50
Hammarlund HQ-129X	..... \$129.00
National NC-2-40C	..... \$225.00

Write for details of our trade-in plan and easy terms

**FREE! 52 PAGE FLYER**

52 pages packed with real buys in radio, electronic, and general merchandise.

Giant Radio Map (size 3 1/2 x 4 1/2) . . . . . 15c

Handy Tube-Base Calculator . . . . . 25c

Council Blu'ns, Iowa RN-4



Formerly Wholesale Radio Laboratories

ADVERTISER	AGENCY	PAGE
Adson Radio Co.	Mitchell Advertising Agency	120, 132
Aerovox Corporation	Austin C. Lescarboursa & Staff	81
Aireon Manufacturing Corporation	Potts-Calkin & Holden	13
Alliance Manufacturing Company	Foster & Davies, Inc.	101, 9
Allied Radio Corp.	Henry H. Teplitz	134
Alsam Products Company	Sander Rodkin Advertising Agency	134
American Phenolic Corporation	Burton Browne Advertising	65
American Radio Institute	Sternfield-Godley, Inc.	112
American Television Institute	Turner Advertising Agency	91
American Television & Radio Co.	Firestone Advertising Agency	88
American Volume Control Co.	Sternfield-Godley Co.	96
Arrow Electronics Company	Mitchell Advertising Agency	96
Arrow Radio Company	Sander Rodkin Advertising Agency	120
Ashbach, Leonard Company	Lieber Advertising Company	112
Astatic Corporation, The	Wearstler Advertising Agency	103
Atlas Aircraft Corporation	Freiwald & Coleman	114
Audel Company	Hart Lehman Advertising	8
Audal Publishers	Grant & Wadsworth, Inc.	120, 128
Beaumont Electric Supply Co.		130
Bell Telephone Laboratories	N. W. Ayer & Son	75
Bliley Electric Co.	Hardy Advertising	89
Bliss Electrical School	N. W. Ayer & Son	128
Brach, L. S.	United Advertising Agency	119
Bud Radio, Inc.	Allied Advertising Agency	82
Buffalo Radio Supply	International Advertising Agency	115
Burlington Instrument Company	Weston-Barnett, Inc.	109
Burstein-Applebee Company	Frank E. Whalen Advertising	123
Candler System Co.	Van de Mark Advertising	124
Cannon Electric Development Co.	Dana Jones Company	113
Capitol Radio Engineering Institute	Henry J. Kaufman Adv.	61
Clark Radio Equipment Co.		130
Cleveland Institute of Radio Electronics	Kenneth H. Kolpein	70, 132
Clippard Instrument Laboratory	Savage & Talley	106
Collins Radio Company	McCann-Erickson, Inc.	71
Concord Radio Corp.	E. H. Brown Advertising Agency	58
Cornell-Dubilier Electric Corp.	Reiss Advertising	19
Cornish Wire Co.	Hart Lehman Advertising	104
Coyne Electric School	The Phil Gordon Agency	118, 126
Coyne Electric School	McJunkin Advertising Agency	135
Crabtree's Wholesale Radio		135
Crystal Research Labs.	Post & Johnson, Inc.	76
DeForest's Training, Inc.	McDonald-Cook Company	15
Drake Electric Works, Inc.	William Hoffman & Associates	126
Editors & Engineers		132
Electrical Reactance Corp.	Scheel Advertising Agency	120
Electronics Laboratories	Burton Browne Advertising	85
Electronic Service & Supply	Burke & Wayburn Advertising	124
Fada Radio & Electric Co.	Sternfield & Godley, Inc.	6
Fahnstock Electric Co., Inc.		105
Federated Purchaser, Inc.	Burke & Wayburn Adv. Co.	127
Flanagan Radio Corp.	Stewart-Jordan Corp.	104
Gates Radio Co.	The Ridgeway Company	99
General Cement Mfg. Co.	Turner Advertising Agency	110
General Electric Company	Maxon, Inc.	76
General Industries Company	Fuller & Smith & Ross Inc.	100
General Test Equipment Co.	Suzanne B. Hayman	132
Greenlee Tool Company	Howard H. Monk & Associates	126
Guardian Electric Co.	Kennedy & Co.	77
Hallicrafters Company	Burton Browne Advertising	5
Hammarlund Mfg. Co., Inc.	Roeding & Arnold, Inc.	24
Hanlan Company		117, 132
Harvey Radio Company	Shappe-Wilkes, Inc.	80
Henry Radio	Burton Browne Advertising	72
Herman, Louis M. Co.	Franklin Advertising Service	106
Hoodwin, Chas. Co.	J. L. Stewart Agency	128
Illinois Condenser Company	Sander Rodkin Advertising Agency	130
Industrial Transformer Corp.	Altomari Advertising Agency	92
Instructograph Company	Turner Advertising Agency	119
International Resistance Corp.		69
Jay, Terry		116
Jensen Industries, Inc.	Allen D. Parsons	121
Johnson, E. F. Company	David, Inc.	Cover
Langsam, Harry	John Falkner Arndt & Co., Inc.	119
Lake Radio Sales Company	Sander Rodkin Advertising Agency	74
Lectrohm, Inc.	Merchandising Advertisers	112
LeJay Manufacturing Co.	Frizzell Advertising Agency	130
Leotone Radio Company	Altomari Advertising Agency	64
Liberty Sales Company	Sternfield-Godley, Inc.	100
Lifetime Sound Equipment Co.	Miller Agency Co.	131
Lincoln Engineering School	Buchanan-Thomas Adv. Co.	132
Maguire Industries, Inc.	City Advertising Agency	10, 11
MacMillan Company	Atherton & Currier, Inc.	112
Mallory, P. R. Co., Inc.	Aitkin-Kynett Co.	Third Cover
Marion Electrical Instrument Co.	Shappe-Wilkes, Inc.	83
Melehan Radio		124
Metzville Aeronautical Radio School	Seidel Advertising & Pub. Agency	102
Metropolitan Electronic & Instrument Co.	Mitchell Advertising Agency	131

ADVERTISER	AGENCY	PAGE
Miles Reproducer Co., Inc.	Altomari Advertising Agency	110
Millen, James Mfg. Co., Inc.	James Millen, Inc.	12
Moraine Hotel	Harry Atkinson Inc.	92
Murdock, Wm. J. Co.	John A. Smith & Staff	68
Murray Hill Books, Inc.	Harry P. Bridge Advertising	78, 79
McElroy Manufacturing Corp.	Shappe-Wilkes, Inc.	130
McGraw-Hill Book Co., Inc.		118
McMurdo Silver Company	The Stentor Company	73
National Company	Graydon Smith, Advertising	17
National Radio Distributors	Burke & Wayburn Adv. Co.	132
National Radio Institute	VanSant, Dugdale & Co., Inc.	3
National Schools	Mayers Company Advertising	20, 21
National Union Radio Corp.	Hutchins Adv. Co.	Second Cover
Newcomb Audio Products Co.	Gail Hall Advertising	133
Niagara Radio Supply Corp.	Sternfield-Godley Inc.	98
Ohrmite Manufacturing Company	Henry H. Teplitz	57
Olson Radio Warehouse	Jessop Advertising Agency	129
Onan, D. W. & Sons	Graves & Associates	116
Pa-Kette Radio Company	Arrow Advertising Agency	126
Permoflux Corporation	Turner Advertising Agency	111
Precision Instrument Company	Reuben Barkow Advertising	128
RCA Institutes, Inc.		122
R. C. & L. F. Hall		125
R-L Electronic Corp.	R. S. Wittenberg Advertising	100
Radio Corporation of America	J. Walter Thompson Company	59
Radio Dealers Supply Company	H. J. Gold Company	128
Radio Distributing Company		122
Radio Ham Shack	Seidel Advertising Agency	117
Radio Kits	Edward Hamburger Adv. Co.	118
Radio Manufacturing Engineering	Rudolph Bartz Advertising	117
Radio Parts Company	Sidney S. Lovitt Advertising	123
Radio Press		130
Radio Supply & Engineering Co.	Karl G. Behr Advertising Agency	84
Radio Wire Television, Inc.	S. T. Seidman & Company	94
Radolek Company	Turner Advertising Agency	134
Rauland Corporation	Roy D. Zeff & Associates	22
Raytheon Mfg. Company	Mitchell Advertising Agency	131
Raytheon Mfg. Company	Burton Browne Advertising	93
Research Manufacturing Corp.		108
Rider, John F., Publisher, Inc.	Lansford F. King, Advertising	23
Risco Sales	Mitchell Advertising Agency	110
Roehr Distributing Company		104
Rowe Industries	The Miller Agency Company	125
San Francisco Radio & Supply Co.	F. W. Spurgeon Adv. Agency	108
Sauereisen Cements Company	McCarty Company	128
S. C. Labs.		126
Scenic Radio & Electronics Co.		130
Sharpnack Engineering Co., The	Andrews Advertising, Inc.	114
Simpson Electric Company	Kreicker & Melloan, Inc.	97
Snap-On Tools Corporation	Scott-Telander Advertising Agency	87
Snyder Manufacturing Company	Abner J. Celula & Associates	129
Sound Equipment Corp. of Calif.	Beaumont & Hohman, Inc.	107
Sperry Gyroscope Co. Inc.	Charles Dallas Reach Co.	95
Sprayberry Academy of Radio	Harry P. Bridge Co.	7
Standard Radio & Electronic Products Company	Hutzler Advertising Agency	86
Standard Transformer Corporation	Burnet-Kuhn Advertising Co.	60
Stanton Radio Supply		106
Stark's	A. L. Addison Advertising	102
Stevens Walden	Howard Wesson Co.	14
Superior Instruments Corporation	Mitchell Advertising Co.	63
Supreme Instruments Corporation	O'Callaghan Adv. Agency, Inc.	127
Supreme Publications	Henry H. Teplitz	132
Sylvania Electric Products, Inc.	Newell-Emmett Company	16
Taybern Equipment	J. Louis Albert	116
Tavella Sales Company	Reuben Barkow Advertising	112
Television Tech Enterprises		124
Terminal Radio Corporation	Mitchell Advertising Agency	90
Triplett Electrical Instrument Co.	Western Advertising Agency	18
Tri-State College	Clem J. Steigmeyer Advertising	110
Ungar Electric Tools, Inc.	Milton Weinberg Adv. Co.	108
Union Radio Corporation	Milton Mendelsohn Adv. Agency	118
United Screw & Bolt Company	Fred Melis Advertising	67
Universal Instrument Company	B. & M. Printing Company	110
Universal Radio Supply	Kermmerer Advertising, Inc.	127
University Laboratories	George Homer Martin	102
Utica Drop Forge and Fuel Co.	Devereux & Company	132
Van Nostrand, D. Company	J. M. Hickerson, Inc.	98
Victoria Radio & Sound		122
Ward Products	Burton Browne Advertising	138
Weller Manufacturing Company	Beaumont, Heller & Sperling, Inc.	133
Wholesale Radio & Electric Supply		128
World Radio Laboratories Inc.	Pfeiffer Advertising Agency	135
Workshop Associates	Larcom Randall	121
YMCA Trade & Technical Schools	Cecil & Presbrey, Inc.	130
York Radio Distributing Co.		128



**BOOST KVA RATING BY FIVE OR MORE . . .**

**CUT PRESENT SIZES OF POWER CAPACITORS . . .**

**AEROVOX SERIES 1780**

*Water-cooled oil-filled*

## MICA CAPACITORS

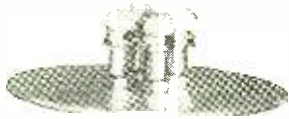

● This new water-cooled oil-filled mica capacitor handles exceptional KVA loads for its size. This means that more power can be handled than with previous capacitors of similar size or, conversely, capacitor size can be greatly reduced for given power ratings.

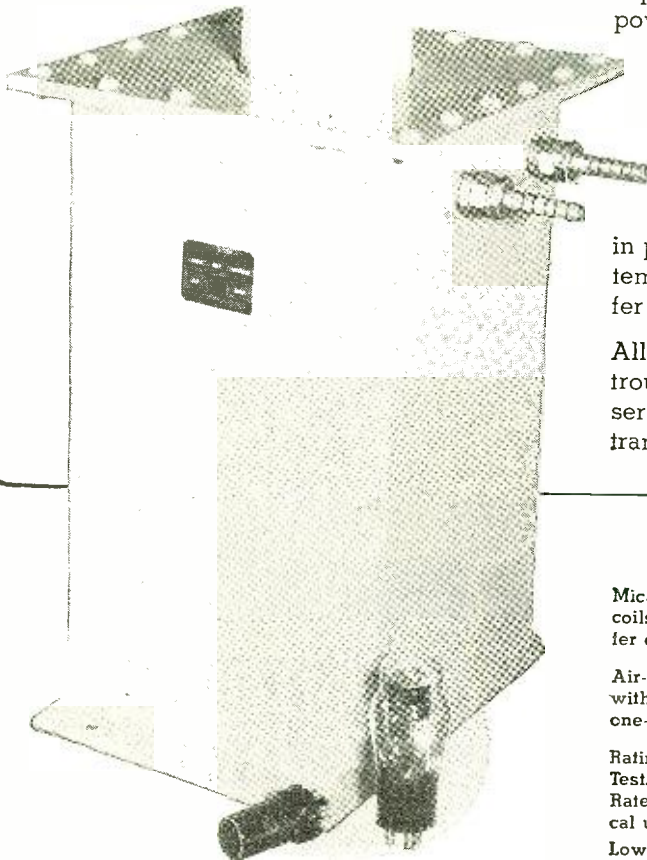

Series 1780 capacitors attain their higher KVA ratings in two ways: (1) By exceptional design such as critical arrangement and location of sections; choice of materials; specially-plated parts; large cross-section of conductors; careful attention to details and true craftsmanship in production. (2) By the use of a water-cooling system so designed as to provide maximum heat transfer from capacitor section to cooling coils.

All in all, here is a sturdy, compact, hard-working, trouble-free mica capacitor for extra-heavy-duty service, such as induction furnaces and high-power transmitters.

### *Featuring...*

Mica stacks in oil bath. Cooling coils in oil bath for efficient transfer of heat.

Air-cooled operation, 200 KVA; with water-cooling, 1000 KVA—a one-to-five ratio.

Ratings up to 25,000 volts A.C. Test. Capacitances up to .01 mfd. Rated loads up to 1000 KVA. Typical unit: 20,000 V. at .01 mfd.

Lower power factor (.01%). Long life and large factor of safety.

Provisions for making connections with high-current-capacity conduc-

tors. Four-stud terminal. Grounded case.

Heavy welded metal case, hermetically sealed. Exceptionally sturdy construction.

Series-parallel mica stack designed for uniform current distribution throughout.

Silver-plated hardware for minimum skin resistance. To minimize or eliminate corona, terminals are finished with large radii of curvature. Steatite insulator shaped to hold gradients below corona limits.

TECHNICAL DATA ON REQUEST



## FOR RADIO-ELECTRONIC AND INDUSTRIAL APPLICATIONS

AEROVOX CORPORATION, NEW BEDFORD, MASS., U.S.A.

SALES OFFICES IN ALL PRINCIPAL CITIES • EXPORT: 13 E. 40th ST., NEW YORK 16, N. Y.

Cable: 'ARLAB' • In Canada: AEROVOX CANADA LTD., HAMILTON, ONT.



# Dominant *Quality*

With **WARD PRODUCTS CORPORATION**, the word *quality* is more than just a symbol. It represents the highest standard of excellence and leadership achieved through many years' experience in the *exclusive* manufacture of precision-built antennas. **WARD** antennas are built by master craftsmen using the most modern equipment under ideal conditions. Top quality through and through they render highest efficiency for all automobile and home radio applications. That's why **WARD** is "first choice" the world over.

*Only WARD Gives You All  
These Important Features*

- ★ Easy One Man Installation
- ★ Patented Fluid Type Anti-Rattle Construction
- ★ Positive Silver-to-Silver Contacts
- ★ Extra Heavy Triple Chrome Rust-proof Plating
- ★ Top Section, Stainless Steel
- ★ Heavy Admiralty Brass Tubing
- ★ Hi-Q Detachable Low Loss Lead-ins With Polyethylene Insulation and Vinylite Covering
- ★ Complete with all Fitting and Conversion Kit for Torpedo Bodies
- ★ Smooth Action Telescoping Sections
- ★ 100% Shielded

*World's Finest for Car and Home Combining Precision and  
Streamlined Beauty*

# WARD "Hi-Q" *Antennas*

THE WARD PRODUCTS CORPORATION  
1523 East 45th Street  
CLEVELAND 3, OHIO

EXPORT DEPT. C. O. Brandes, Mgr., 4900 Euclid Ave., Cleveland 3, Ohio  
IN CANADA-Atlas Radio Corp., 560 King St., W., Toronto, Ont., Canada

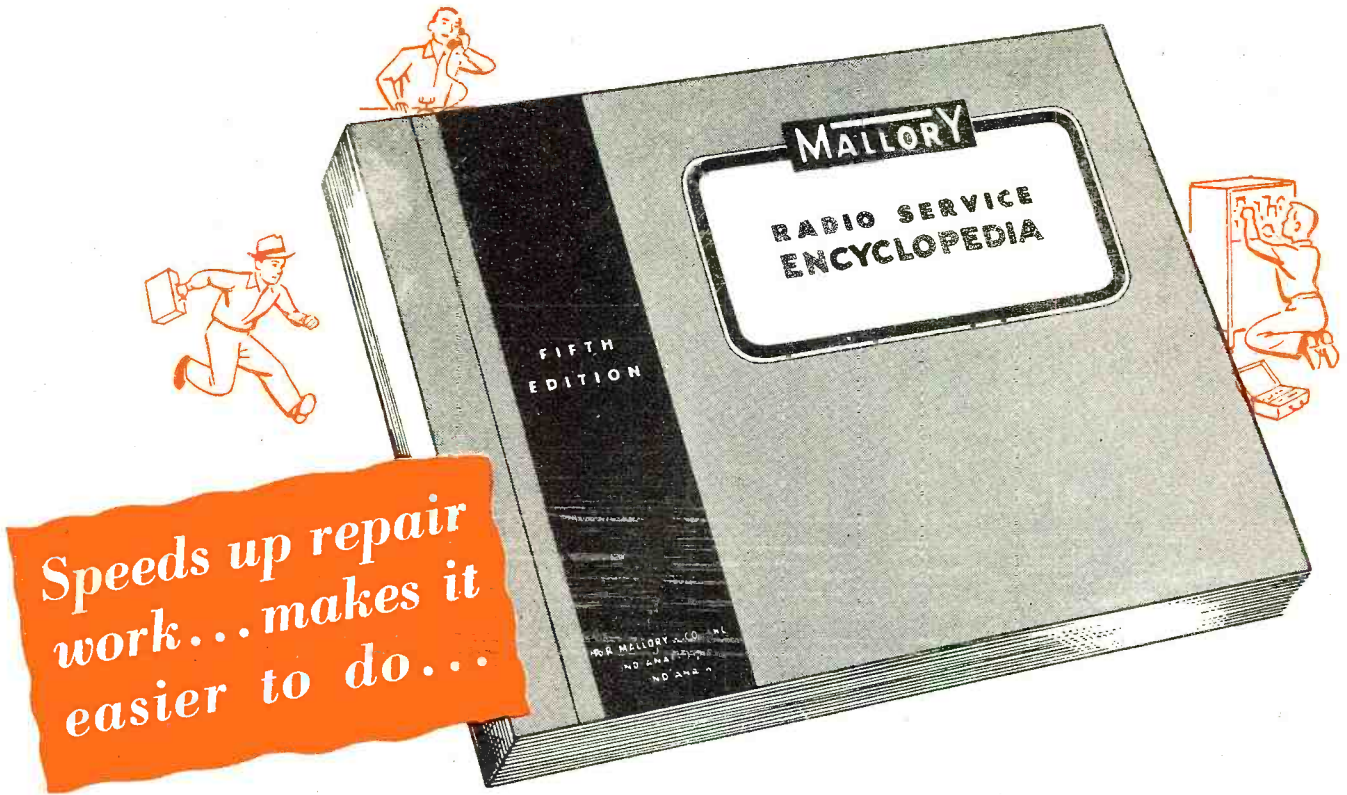

Speeds up repair work... makes it easier to do...

## The Most Valuable Edition Ever Published!

### You Expect More— and You Get More from Mallory

These typical Mallory publications are especially prepared to speed up your work, save valuable man hours. Others are in preparation. See your Mallory Distributor!

1946 Fifth Edition Radio Service Encyclopedia

Replacement Vibrator Guide

Mallory Technical Manual

Approved Precision Parts Catalog

**N**OW comes the most complete Mallory Radio Service Encyclopedia of all—listing 4,000 radio sets never before included—bringing your service information up to date on *every* pre-war model.

Complete tube complements. I.F. Peaks. Original part numbers and recommended replacements that are *readily available*. Circuit references. In short, everything you need to know to do a thorough service job—*quickly and profitably*.

At your cost of \$1.25 net, this new 1946 Fifth Edition of the Mallory Radio Service Encyclopedia is decidedly the buy of the year. It's another example of Mallory service beyond the sale—the kind of help you naturally expect from Mallory. Place orders now with your Mallory Distributor.

P. R. MALLORY & CO. Inc.  
**MALLORY**

VIBRATORS... VIBRAPACKS\*... CAPACITORS... VOLUME CONTROLS  
... SWITCHES... RESISTORS... FILTERS... RECTIFIERS...  
POWER SUPPLIES. ALSO MALLORY TROPICAL\* DRY BATTERIES,  
ORIGINALLY DEVELOPED BY MALLORY FOR THE U. S. ARMY.

\*Reg. U. S. Pat. Off.

**APPROVED PRECISION PRODUCTS**

P. R. MALLORY & CO., Inc., INDIANAPOLIS 6, INDIANA

# Tops in the Field



Write for  
**TUBE SOCKET  
GUIDE**

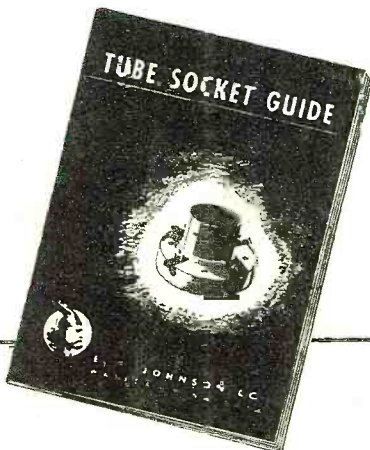

Johnson sockets are stocked by leading radio-electronic parts jobbers.

The latest addition to the famous line of Johnson tube sockets is the 275, Giant Five Pin tube socket with all the outstanding features which have made other Johnson sockets superior. A special feature of the 275 is the provision that has been made to allow forced ventilation from below the chassis, as required for the recently announced Eimac 4-125A and 4-250A. This socket may also be used for other Giant Five Pin tubes when a wafer type socket is desired.

Johnson sockets are engineered to meet the most exacting requirements of industrial, commercial broadcast and "Fam" applications. For more than 20 years Johnson engineers have designed, and Johnson production lines have produced, transmitting components known throughout the industry as tops in the field. With this background and the close association with tube manufacturers, Johnson is continually leading the way with tube sockets designed to meet the rigid requirements of present day electronic circuits and equipment.

If you have a special tube socket problem, write Johnson, today.

## JOHNSON

*a famous name in Radio*

F. JOHNSON COMPANY • WASECA • MINNESOTA