

RADIO NEWS



AUGUST
1945
35c

In Canada 40c

ONLY MECK HAS THE COURAGE TO KEEP TELLING THIS STORY TO YOUR CUSTOMERS

Buy Your New Radio
from Your Radio Dealer



Meck advertising in leading national magazines keeps telling one big important story—

Month after month these ads are seen by millions of sure prospects for the first postwar radios. Meck helps the independent dealer keep the radio set business.

The Meck Preferential Dealer Plan means—DELIVERIES—SALES—CO-OPERATION. See your MECK distributor today for full details—or write us.

EVERY MECK ADVERTISING
DOLLAR sells the Public
on the
Independent Radio Dealer

John Meck



MECK RADIOS

JOHN MECK INDUSTRIES, Inc., PLYMOUTH, INDIANA

TABLE MODELS • PORTABLES • AM-FM • TELEVISION • CONSOLE COMBINATIONS • PHONOGRAPHS



I Will Show You How to Learn RADIO by Practicing in Spare Time

**I Send You
6 Big Kits
of Radio Parts**

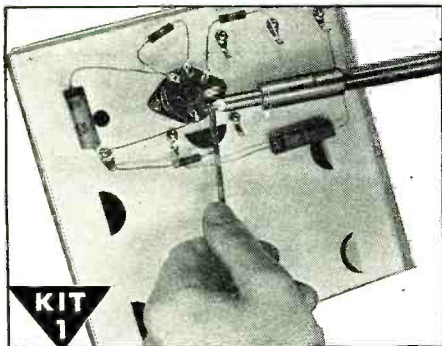

KIT 1
I send you Soldering Equipment and Radio parts; show you how to do Radio soldering; how to mount and connect Radio parts; give you practical experience.

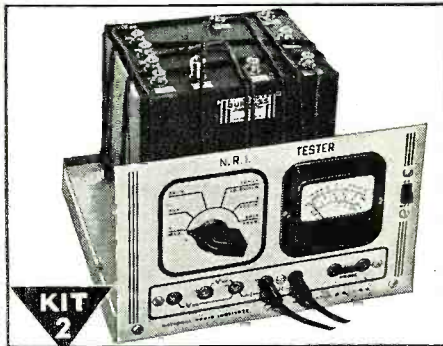

KIT 2
Early in my course I show you how to build this N.R.I. Tester with parts I send. It soon helps you fix neighborhood Radios and earn EXTRA money in spare time.

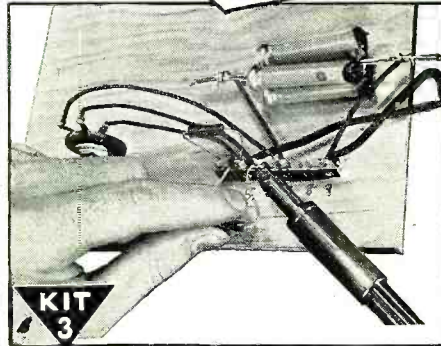

KIT 3
You get parts to build Radio Circuits; then test them; see how they work; learn how to design special circuits; how to locate and repair circuit defects.

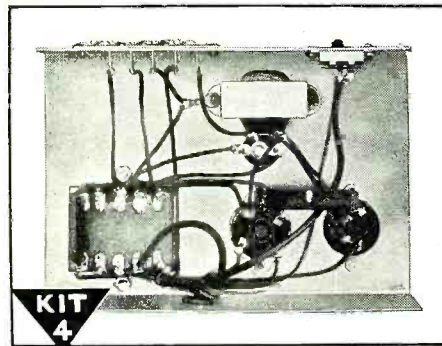

KIT 4
You get parts to build this Vacuum Tube Power Pack; make changes which give you experience with packs of many kinds; learn to correct power pack troubles.

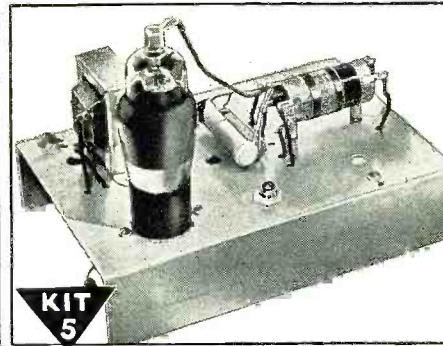

KIT 5
Building this A. M. Signal Generator gives you more valuable experience. It provides amplitude-modulated signals for many tests and experiments.

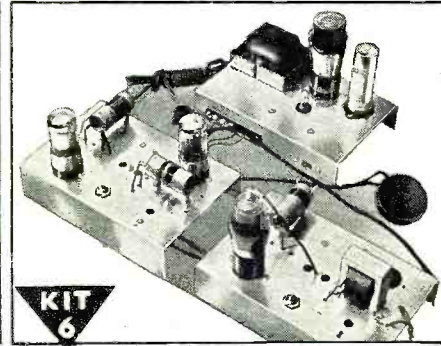

KIT 6
You build this Superheterodyne Receiver which brings in local and distant stations—and gives you more experience to help you win success in Radio.

I Will Train You at Home - SAMPLE LESSON FREE

Let me send you facts about rich opportunities in Radio. See how knowing Radio can give you security, a prosperous future. Send the coupon for FREE Sample Lesson, "Getting Acquainted with Receiver Servicing," and my FREE 64-page book, "Win Rich Rewards in Radio." See how N.R.I. trains you at home. Read how you practice building, testing, repairing Radios with SIX BIG KITS of Radio parts I send you.

GREATER opportunities when Television, FM, Electronics, can be offered to the public! Send for free book now.

Radio parts I send—USE your knowledge to make EXTRA money in spare time.

Many Beginners Soon Make \$5, \$10 a Week EXTRA in Spare Time

Find Out What N.R.I. Can Do for YOU
MAIL COUPON for Sample Lesson and my FREE 64-page book. It's packed with facts about opportunities for you. Read the details about my Course. Read letters from men I trained, telling what they are doing, earning. Just MAIL COUPON in an envelope or paste it on a penny postal. J. E. Smith, President, Dept. 5HR, National Radio Institute, PIONEER HOME STUDY RADIO SCHOOL, Washington 9, D.C.

The day you enroll I start sending EXTRA MONEY JOB SHEETS to help you make EXTRA money fixing Radios in spare time while learning. You LEARN Radio principles from my easy-to-grasp Lessons—PRACTICE what you learn by building real Radio Circuits with

Our 31st Year of Training Men for Success in Radio

Future for Trained Men is Bright in Radio, Television, Electronics

The Radio Repair business is booming NOW. There is good money fixing Radios in your spare time or own full-time business. Trained Radio Technicians also find wide-open opportunities in Police, Aviation, Marine Radio, in Broadcasting, Radio Manufacturing, Public Address work, etc. Think of the boom coming when new Radios can be made! Think of the backlog of business built up in ALL branches of Radio! Think of even

Good for Both—FREE

MR. J. E. SMITH, President, Dept. 5HR
National Radio Institute, Washington 9, D. C.
Mail me FREE, without obligation, Sample Lesson and 64-page book, "Win Rich Rewards in Radio." (No salesman will call. Please write plainly.)

Name
Address
City Zone State 4PR



**My Radio Course Includes
TELEVISION • ELECTRONICS
FREQUENCY MODULATION**



Reg. U. S. Pat. Off

AUGUST

1945

VOLUME 34, NUMBER 2

CONTENTS

AMATEUR

'QRM' A Threat to Amateur Radio... T/Sgt. George Mobus, W9UAO 28
Build This Victory Transmitter... Guy Dexter 30
Comparison of Visual and Oral Reception... Harvey Pollack 32
Television for the Amateur... Oliver Read, W9ETI 35
5" Oscilloscope Design... Rufus P. Turner 36
100 MC. Transmitter... William Maron 42
QTC... Carl Coleman 55

SERVICE

Let's Talk Shop... Joe Marty 45
Tone Control Circuits... J. Carlisle Hoadley 46
Practical Radio Course... Alfred A. Ghirardi 48
Television Sound Channel... Edward M. Noll 52
Plotting Engineering Data... R. G. Middleton 56
'Juke Box' Servicing Proves Successful... Eugene A. Conklin 78
Line Cord Voltage Bank... Sgt. H. L. Davidson 100

GENERAL

For the Record... 8
Spot Radio News... 12
Instrument Landing System... Lt. R. J. Hennessy 25
Practical Radar... Jordan McQuay 39
11,500 Mile Radio Net... 50
European News Review... Leon Laden 62
What's New in Radio... 68
Manufacturers' Literature... 104
Letters from Our Readers... 124
Within the Industry... 130
Technical Book & Bulletin Review... 143

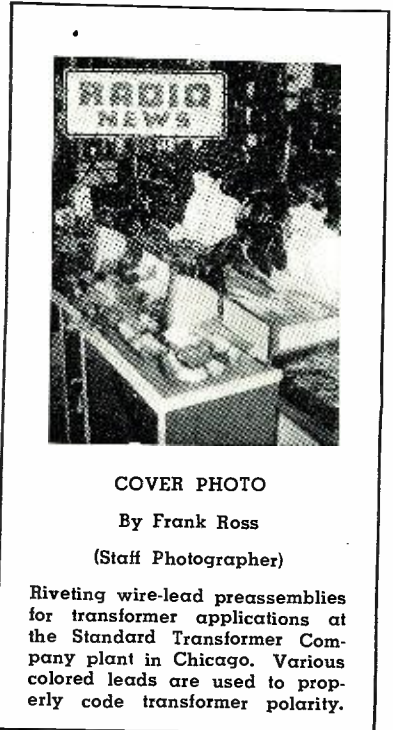

COVER PHOTO

By Frank Ross

(Staff Photographer)

Riveting wire-lead preassemblies for transformer applications at the Standard Transformer Company plant in Chicago. Various colored leads are used to properly code transformer polarity.

WILLIAM B. ZIFF
Publisher

B. G. DAVIS
Editor

C. R. TIGHE
Asst to Publisher

OLIVER READ, W9ETI
Managing Editor

WM. A. STOCKLIN
Associate Editor

HAROLD S. RENNE
Technical Editor

JOE MARTY, JR.
Eastern Editor

R. B. FRANK, W9JU
Western Editor

FRED HAMLIN
Washington Editor

HERMAN R. BOLLIN
Art Director

E. H. SEHNERT
Chief Draftsman

FRANK ROSS
Staff Photographer

GEORGE BERNER
Advertising Director

S. L. CAHN
Advertising Mgr.

L. L. OSTEN
Midwest Adv. Mgr.

H. G. STRONG
Circulation Director

H. J. MORGANROTH
Production Director

Copyright, 1945
ZIFF-DAVIS PUBLISHING COMPANY
Editorial Offices: 185 N. Wabash Ave., Chicago 1, Ill.
Member of the Audit Bureau of Circulation

RADIO NEWS is published monthly by the Ziff-Davis Publishing Company at 185 N. Wabash Ave., Chicago 1, Ill. New York Office, Empire State Building, New York 1, N. Y. Washington, D. C. Office, International Building, 1319 F Street, N.W. Washington 4, D. C. Los Angeles Office, William L. Pinney, Manager, 815 S. Hill St., Los Angeles 14, Calif. Subscription Rates: In U. S. \$3.00 (12 issues), single copies, 35 cents; in Mexico, South and Central America, and U. S. Possessions, \$3.00 (12 issues); in Canada \$3.50 (12 issues), single copies 40 cents; in British Empire, \$4.00 (12 issues); all other foreign countries \$6.00 (12 issues). Subscribers should allow at least 2 weeks for change of address. All communications about subscriptions should be addressed to: Director of Circulation, 185 N. Wabash Ave., Chicago 1, Ill. Entered as second class matter March 7, 1938, at the Post Office, Chicago, Illinois, under the Act of March 3, 1879. Entered as second class matter at the Post Office Department, Ottawa, Canada. Contributors should retain a copy of contributions. All submitted material must contain return postage. Contributions will be handled with reasonable care, but this magazine assumes no responsibility for their safety. Accepted material is subject to whatever adaptations, and revisions, including by-line changes necessary to meet requirements. Payment covers all authors', contributors' or contestants' rights, title, and interest in and to the material accepted and will be made at our current rates upon acceptance. All photos and drawings will be considered as part of material purchased.



RADIO NEWS

HOW hallicrafters EQUIPMENT COVERS THE SPECTRUM

MODEL SX-28A — from 550 kc to 42 Mc

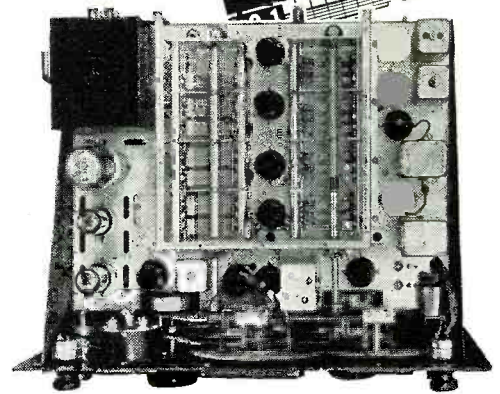

HALLICRAFTERS Super Skyradio, Model SX-28A, covers the busiest part of the radio spectrum — standard broadcast band, international short wave broadcast bands, long distance radio telegraph frequencies, and all the other vital services operating between 550 kilocycles and 42 megacycles. Designed primarily as a top flight communications receiver the SX-28A incorporates every feature which long experience has shown to be desirable in equipment of this type.

The traditional sensitivity and selectivity of the pre-war SX-28, ranking favorite with both amateur and professional operators, have been further improved in this new Super Skyradio by the use of "micro-set" permeability-tuned inductances in the RF section. The inductances, trimmer capacitors and associated components for each RF stage are mounted on small individual sub-chassis, easily removable for servicing.

Full temperature compensation and positive gear drive on both main and band-spread tuning dials make possible the accurate and permanent logging of stations. Circuit features include two RF stages, two IF stages, BFO, three stage Lamb-type noise limiter, etc. Six degrees of selectivity from BROAD IF (approximately 12 KC wide) for maximum fidelity to SHARP CRYSTAL for CW telegraphy are instantly available. Speaker terminals to match 500 or 5000 ohms are provided and the undistorted power output is 8 watts.



BUY A WAR BOND TODAY

hallicrafters RADIO

COPYRIGHT 1945 THE HALLICRAFTERS CO.

THE HALLICRAFTERS CO., CHICAGO 16, U.S.A., WORLD'S LARGEST EXCLUSIVE MANUFACTURERS OF SHORT WAVE RADIO COMMUNICATIONS EQUIPMENT
August, 1945

"PEACE PACT."

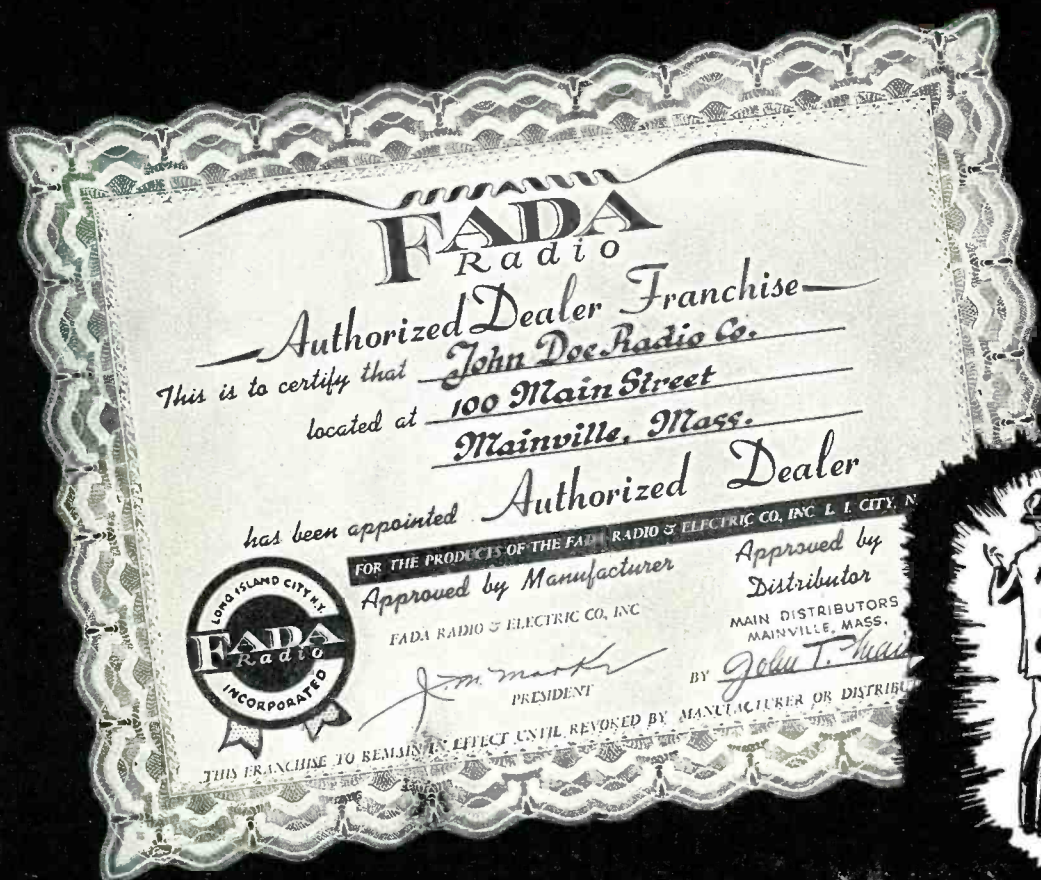

Now that V-E day is past, we look forward to the time when all our battle-scarred warriors return to their anxious families.

As quickly as Government restrictions are modified, Fada's great productive capacity will be ready to make available the finest in radio receivers.

The Fada dealer franchise will become a typical "Peace Pact" assuring you of your share of profitable business on Fada's electronic developments.

If your jobber has not told you about Fada's merchandising plan contact him or write us directly.

PLACE YOUR FAITH IN THE

FADA Radio

OF THE FUTURE

Famous Since Broadcasting Began!

FADA RADIO AND ELECTRIC COMPANY, INC., LONG ISLAND CITY, N. Y.



FOR A JOB

Well Done...

THIS button, soon to be worn by thirteen million men and women—honorably discharged members of the Armed Forces of the United States—is a symbol of honor, an insignia of respect.

Wherever it is worn, it eloquently proclaims a victorious fight for Country and principles. It is indeed the chevron of service—the reward for a job done well.



Jensen

SPEAKERS WITH *ALNICO 5*

Specialists in Design and Manufacture of Acoustic Equipment

JENSEN RADIO MANUFACTURING COMPANY • 6601 SOUTH LARAMIE AVENUE, CHICAGO 38, ILLINOIS

August, 1945

AUDAX

RELAYED-FLUX
Microdyne

The Importance of SPECIALIZATION

Aside from outstanding and long-acknowledged technical skill—our “Specialization Formula” is probably as fully responsible for the world-renowned AUDAX quality as any other single factor.

We proudly concentrate all our energies and resources upon producing the BEST pick-ups and cutters. Because we are specialists in this field, much more is expected of us. Because the production of fine instruments like MICRODYNE is a full time job, it stands to reason that we could not afford to jeopardize our reputation—EVER—by making pick-ups a side-line.

After Victory, you may expect AUDAX improvements, refinements . . . master-touches to heighten the marvelous *fac simile* realism of AUDAX re-production.

AUDAX COMPANY

500-N Fifth Ave., New York 18, N. Y.

Creators of Fine Electronic-Acoustical Apparatus Since 1915

Send for complimentary copy of our informative

“PICK-UP FACTS”

★ BUY WAR BONDS

“The Standard by Which Others Are Judged and Valued”



FOR THE RECORD

by the editor

TELEVISION manufacturers were undoubtedly amused when they read the column of Westbrook Pegler on June 6, 1945 when he literally tore this new service into many pieces and tossed them to the wind as being worthless.

Subheading his column “Television Not What Public Has Been Led to Hope It Is,” he says in part “Television will be, for several years, a crude and expensive disappointment and its clients, or consumers, will pay high for the slow improvements of a primitive experiment.”

Such statements coming at this time from misinformed crab artists can do much to hold back the very development of television. This isn't the first time the press has put the brake on television. It's simply a rehash of what has been said before.

MANUFACTURERS of television equipment have, for the most part, attempted to present Mr. and Mrs. America with an accurate picture of what might be expected from their postwar television sets. Some of them have pointed out that technical standards employed before the war were adequate for good pictures (and still are) and others have taken the reverse viewpoint that only by adopting higher technical standards can television have universal appeal.

An instrument as complicated as a modern television set requires a period of continued development before it can be considered as “acceptable.” Unlike the development of the radio receiver, which emerged from the crystal detector and earphones to the use of one tube sets, television must, of necessity, employ many vacuum tubes to perform the necessary functions for reception of a video signal.

When greater volume or sensitivity was required in radio sets, it was only necessary to add on more tubes and to refine the tuning circuits. Television cannot start on this same basis. Therefore, manufacturers should point out the absolute necessity for using a greater number of tubes and parts in a television set than would be required for an average radio receiver. If the public will realize the basic differences, he will expect to pay a higher price for television equipment. If this is not pointed out, the public may feel that they are actually contributing a considerable amount of money to the “programming” of television. We do

not agree with our ersatz informant that television will be a disappointment for several years. We insist that rapid development will improve the picture quality even without making changes in the sets then in service.

HE ALSO points out that “The radio apparatus of the more elaborate sets is no more efficient than the same device in the cheap editions, which is a manner of saying that most of them, whatever the price, are capricious and not dependable.” By the same token a \$5,000 automobile is no more efficient than a \$500 automobile. But, he would be the last to deny that the \$5,000 automobile has refinements of quiet operation, easier riding, finer upholstery, more comfortable seating and greater precision. Both of these automobiles use identical spark plugs just as radios employ common tubes. A defective plug can cause as much grief in the \$5,000 car as it could in the \$500 car.

We suggest that he visit one of the RID or FBIS stations of the FCC, where we find standard communications' receivers being used twenty-four hours per day month after month and, except on rare occasions, giving trouble-free performance and dependable reception. We do not know what kind of radio our overnight radio authority has and it really doesn't matter. Fortunately, he is one of a very small minority that fall under the following as covered in his editorial: “After all these years, they still crackle with static and cross-talk blurs reception. . . .”

Evidently “Mr. Knowitall” goes in for dx'ing on the standard AM band. At least it's been a long time since this writer has heard any cross-talk on practically any modern receiver whether it be of the \$8.95 variety or in the \$200.00 class. Yes—they do crackle with static, but only on rare occasions when circumstances beyond our control (commonly known as lightning) exist in the near vicinity of the receiver. He might be interested in knowing that there have been developed new and simple electronic devices which effectively reduce the reception of static noise or at least reduce it to a negligible amount.

NEXT to fall under the swinging axe is the record-changer mechanism. He says “In the phonograph (Continued on page 141)

RESERVE YOUR POS -WAR hallicrafters Communications Receiver NOW



Allied Radio's New Plan Makes it Easy for You to be Among the First to Own and Enjoy this Celebrated Receiver!

MODEL SX-28A—This is the latest model of Hallicrafters famous *Super Sky-Rider* . . . the finest communications receiver built to-day! Has a frequency range of 550 kc. to 42 Mc. continuous in 6 bands. With crystal, less speaker, net \$223.00

MODEL SX-25—The *Super-Defiant* . . . long-time favorite of amateurs who want fine performance at a moderate price. Has a frequency range of 545 kc. to 42 Mc. continuous in 4 bands. With crystal, less speaker, net \$94.50

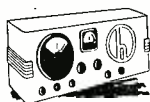

MODEL S-20R—Popular *Sky-Champion* offers top performance in low cost field. Has a frequency range of 550 kc. to 43 Mc. continuous in 4 bands. With built-in speaker, net \$60.00

MODEL S-39—*Sky Ranger* portable . . . operates from its own self-contained batteries or 115 volts a.c. or d.c. Has frequency range of 540 kc. to 30.5 Mc. continuous in 4 bands. Net \$110.00

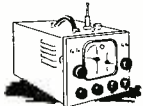

MODEL S-36—Covers both old and new FM bands. Operates on FM, AM, or CW. Outstanding for sensitivity, stability, high fidelity and versatility in the *very high frequencies*. Range from 27.8 Mc. to 143 Mc. continuous in 3 bands. Less speaker, net \$307.50

PM23 SPEAKER—For SX-28A, SX-25 and S-36 above, net \$15.00



HALLICRAFTERS
Honored for its Role in War Communications

On all fronts . . . on land, sea, in the air . . . in jungle, desert and arctic . . . Hallicrafters sets have performed gallantly for the Armed Forces of the United Nations. The fifth Army and Navy "E" award flies from Hallicrafters roof tops! Hallicrafters, you know, are *builders of the famous SCR-299*.



ALLIED RADIO

833 W. Jackson Blvd. Chicago 7, U. S. A.

Over 20 Years of Service to the Nation

August, 1945

TODAY, communications receivers are obtainable only for war use. But as soon as conditions permit, they will again be available for civilian use.

Pent-up demand by short-wave listeners and radio amateurs for world-famous Hallicrafters receivers is *so great that you would be wise to reserve YOUR Hallicrafters NOW!* The record of Hallicrafters performance in war communications is outstanding. Hallicrafters sets have "stood up" almost unbelievably in the most impossible conditions of climate and weather. Vital war-proved features of these sets . . . PLUS new advanced engineering developments . . . will be incorporated in your post-war Hallicrafters!

Now, through close cooperation of the Allied Radio Corporation and the Hallicrafters Company, a plan has been evolved that *makes it easy for you to reserve your Hallicrafters at once* . . . and be assured of earliest delivery!

HERE'S HOW TO RESERVE YOUR HALLICRAFTERS

1. All you have to do is enter your order now with Allied.
2. You don't have to pay the full amount in advance.
3. A deposit of only 10% of the current price will put you among the first in line to receive delivery of a Hallicrafters Receiver.
4. When your set is ready, easy payment terms may be arranged.
5. Any communications receiver, in good condition, will be accepted for a liberal trade-in allowance instead of cash down payment.
6. Even after your reservation is made, you may have your deposit back if you wish.

(Prices subject to possible revision at time of shipment.)

Just imagine how thrilled and proud you will be to rank among the *first* to have a Hallicrafters . . . "The Radio Man's Radio!" Picture the pleasure you'll have . . . for with a Hallicrafters at your fingertips . . . *all the world is your neighbor!* Certainly you want a receiver all your own! To be sure of earliest delivery, enter your order *at once* . . . without delay!

MAIL COUPON TODAY TO RESERVE YOUR HALLICRAFTERS

ALLIED RADIO CORP.

833 W. Jackson Blvd., Dept. 1-HH-5
Chicago 7, Ill.

Date _____

Please reserve Hallicrafters Model . . . for me. Enclosed is my 10% deposit \$ (It is understood I retain right to cancel order any time before delivery, and get my deposit back.)

Please send further information on your Communications Receiver Reservation Plan.

Please send latest free Allied Buying Guide on Everything in Radio and Electronics.

NAME

ADDRESS

CITY ZONE STATE



ALLIED RADIO "Arsenal of Supply"

for Everything in Radio and Electronics

Allied's complete service speeds vital needs to the Armed Forces and Industry. Concentrated here are the world's largest and most complete stocks of parts and equipment under one roof. And Allied has always been one of the leaders in the sale of communications receivers.

VITAMIN-Q

REG. U. S. PAT. OFF.

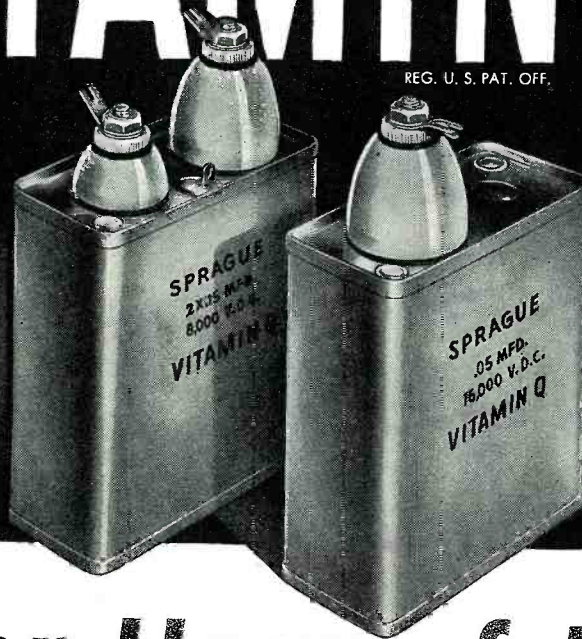

Ever Hear of It?

VITAMIN Q is an exclusive Sprague Electric Co. oil impregnant for capacitors that results in exceptional performance where thousands of volts and temperatures as high as 105° C. or as low as -40° C. are involved. Leakage resistance at room temperature is 20,000 megohms for one microfarad—or at least 5 times better than previous types!

This is only one of the many engineering and production achievements that have helped make Sprague a five-time winner of the coveted Army-Navy "E" award. And it is one that indicates plainer than mere words that, as always,

you can rely on Sprague for the finest, most modern engineering in ANY capacitor type for radio service, amateur or experimental work.

ATTENTION TRADING POST USERS!

Our free wartime advertising service, THE SPRAGUE TRADING POST, will be found on another page in this issue. It will continue as long as there is a need for this unique method of selling or buying hard-to-get radio things.

SPRAGUE PRODUCTS COMPANY

North Adams, Mass.

(Jobber Sales Organization for Products of the Sprague Electric Co.)



SPRAGUE





FOR INDUCTORS

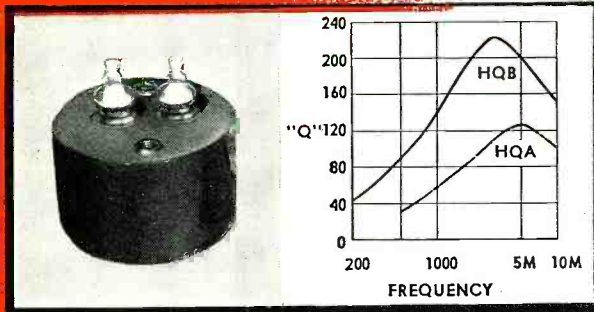

HQA AND HQB HIGH Q INDUCTORS

This series of toroid wound high stability inductors are available from 5 Mhy. to 2 Hys. Voltage stability is excellent, hum pickup is very low. Temperature effects are negligible. HQA units 1-13/16" in diameter by 1-3/16" high.

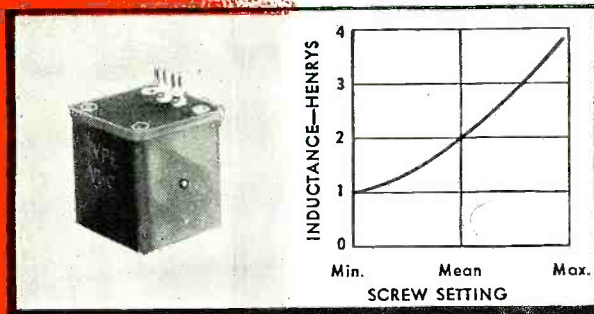

TYPE VI-C VARIABLE INDUCTORS

These inductors are available in optimum values from 10 Mhy. to 10 Hys. They are tunable over a wide range by inserting an Allen Head wrench in the adjusting screw. Units measure 1 1/4" x 1-7/16" x 1-7/16".

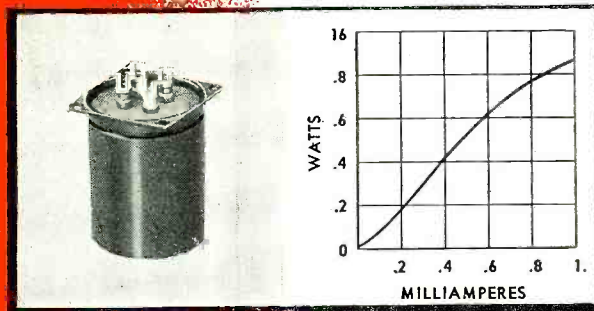

SENSITIVE SATURABLE INDUCTORS

UTC Saturable Inductors cover a wide range of application for magnetic amplification and control. These units are supplied to specific requirements. The curve shown illustrates a high sensitive type, showing DC saturation vs. AC watts into load.

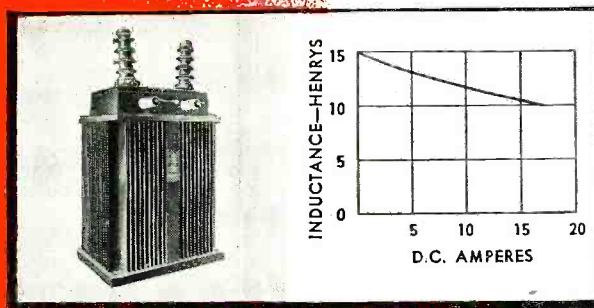

POWER SUPPLY INDUCTORS

UTC supplies power supply components for every type of application, ranging from a one-third ounce reactor, which measures 5/8" x 7/16" x 3/4", to the 10,000 pound, broadcast station, plate supply reactor, illustrated.

May we cooperate with you on design savings for your applications...war or postwar?

ALL POINTS



United Transformer Corp.

150 VARICK STREET

NEW YORK 13, N. Y.

EXPORT DIVISION: 13 EAST 40th STREET, NEW YORK 16, N. Y.,

CABLES: "ARLAB"

Designed for



Application

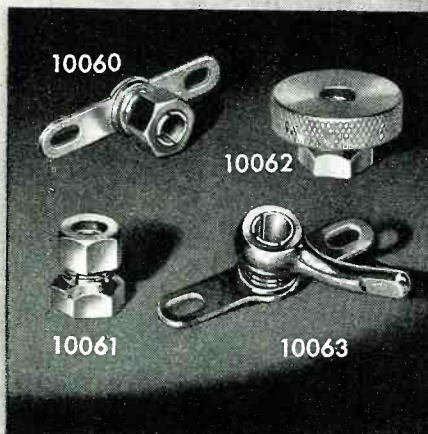

SHAFT LOCKS

In addition to the original No. 10060 and No. 10061 "DESIGNED FOR APPLICATION" shaft locks, we can also furnish such variations as the No. 10062 and No. 10063 for easy thumb operation as illustrated above. All types are available in bright nickel finish to meet Signal Corps requirements or black oxide to meet Navy specifications.

JAMES MILLEN MFG. CO., INC.

MAIN OFFICE AND FACTORY
MALDEN
MASSACHUSETTS



Spot Radio News

★ Presenting latest information on the Radio Industry.

By **FRED HAMLIN**

Washington Editor, RADIO NEWS

ALTHOUGH L-265, the war-sponsored limitation order prohibiting production of radio and other electronic devices for civilian use, will be revoked on or about October 1, volume production of home receivers can not be expected before the end of the first quarter of 1946. Supplying all military requirements will continue to take top priority over civilian production after L-265 is repealed, of course, and one of the major problems to be solved during the early phases of the reconversion program will be a serious shortage of component parts. An important factor in that problem is the current OPA reconversion price plan. At the first session of the OPA Radio Parts Industry Advisory Committee since revision of MPR 136, the order which transferred control of radio parts prices within OPA in March, 1945, the consensus was that the broad reconversion price formula laid down by Administrator Bowles in May of this year should be modified in its application to radio parts. The alternative discussed at the meeting was complete elimination of price ceilings on sales of radio components. Members of the Advisory Committee are convinced that competition in the sale of parts to be used in new radio receivers will be so spirited that supply and demand will hold down prices and, therefore, do away with the necessity for price ceilings. A statement by R. C. Cosgrove, president of Radio Manufacturers Association, that twice as many manufacturers will be turning out radios after reconversion than before the war supports the supply and demand argument.

OPA officials have not swung around to that way of thinking, although they have considered the possibility of eliminating control of parts prices. In that connection, members of the Advisory Committee have pointed out repeatedly that producing and selling parts for civilian use would be difficult under provisions of the OPA price formula. A few went so far as to declare that they would not accept civilian orders under present restrictive OPA regulations.

While the session in Washington between the Advisory Committee and the OPA did not solve the problem of pricing, it permitted thorough discussion of the difficulties and crystallized the thinking of the interested groups. Members of the Committee pointed

out that the OPA reconversion price formula did not allow for substantial increases in administrative expenses and overhead costs since the war started. Officials of OPA admitted that but announced increases in indirect labor and materials costs, plus direct labor and materials costs, were to be considered in fixing new prices. A good start toward ironing out points of difference was made when the Committee and the government agency agreed to a joint meeting of accountants of several radio parts manufacturers and OPA officials in New York several days after the Washington conference. Purpose of that meeting was to draft a cost survey questionnaire which will be sent to a cross-section of the parts industry following its approval by committee members and the Budget Bureau.

THE SURVEY QUESTIONNAIRE,

which will produce information to be used as a yardstick in determining price ceilings for the parts industry, was agreed on and forwarded to the Advisory Committee for study. Before the conferees turned to the job of specific questions on the questionnaire, there was lively discussion of the same problem injected into the earlier meeting in Washington—administrative costs. The question of that phase of the parts manufacturers' operations was dropped temporarily pending a ruling by the OPA. It probably will appear on the questionnaire, because of its importance in computing costs on which ceiling prices are to be based. The questionnaire will request the parts manufacturers to list profit and loss since 1941, wage increases since 1941, information on increases in prices of materials since 1941, and data on net profits and net sales in the period 1936-1939.

Whether the pricing program finally adopted as a result of the studies now being made will provide for industry-wide price adjustments or for increases based on smaller segments of the industry is problematical. It appears now, however, that a satisfactory modification of the over-all OPA reconversion pricing formula, which applies to all industries, will be evolved for the parts industry without upsetting any of the major objectives of the basic price control procedures. On the other hand, it is

you can't *put the squeeze*
on SEALDTITE
CAPACITORS

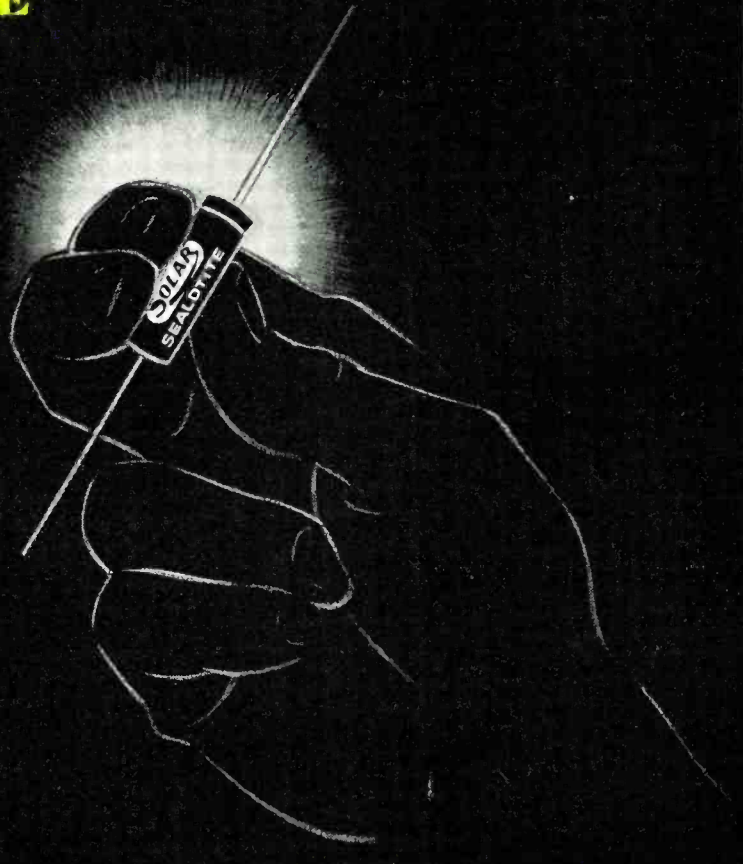

Just try it . . . Take a genuine "Sealdtite" capacitor and try to *squeeze* it. No results. You'll find it has no soft spots, which in ordinary tubulars provide room for moisture, the capacitor's worst enemy, because the Solar capacitor has an internal winding of high quality paper and foil, skillfully *molded* into *solid* plastic.

No moisture can penetrate this protective case and its substantial construction permits rough handling, assures long and *reliable* service.

Use "Sealdtite" capacitors. Send for your copy of Catalog V-4. Any Climate - Any Atmosphere - Any Service.



RAYONNE PLANT
WEST N.Y. PLANT

A TOTAL OF EIGHT ARMY-NAVY
EXCELLENCE AWARDS

SOLAR CAPACITOR SALES CORP.
285 MADISON AVENUE, NEW YORK CITY



"MIGIT"
SMALL TOOL
SET

**A Little Giant
For Business!**

**Saves carrying a lot
of tools**

**4 Single Hex, 4 Double Hex,
3 Double Square Sockets.
Range 3/16 to 7/16. Uni-
versal Drive with Sliding Bar
a Spintite Straight Drive all
in a pocket size nicely fin-
ished metal box. Ask for . .**

WALDEN WORCESTER

Set 3100A
and 3100

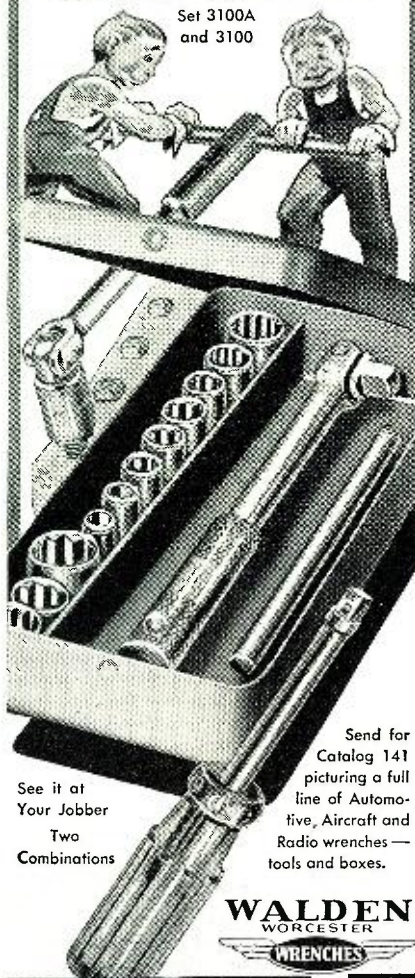

See it at
Your Jobber
Two
Combinations

Send for
Catalog 141
picturing a full
line of Auto-
motive, Aircraft and
Radio wrenches —
tools and boxes.

**WALDEN
WORCESTER
WRENCHES**

STEVENS WALDEN, INC.

468 SHREWSBURY STREET

WORCESTER, MASSACHUSETTS

conceivable that a study of the findings of the questionnaire may dictate the elimination of price ceilings on products manufactured by the radio parts industry. If the current OPA price formula is applied to the parts manufacturers, a price for every item sold probably will not be set. Rather, the prices would be calculated on a flat percentage basis either for the company's over-all products or for the products of one of its divisions.

ONE INTERESTING SIDELIGHT

on the problem of prices during re-conversion cropped up at the New York OPA cost accountants meeting. It concerned the factory making many different pieces that can be used in connection with non-radio products. Example cited was the capacitor, which is used in radio but could also be used to start a motor. Problem there is whether to place two prices on the capacitor, one to apply when it is used in radio and the other when it is used in non-radio activity.

Paralleling the cost studies in the radio parts industry is the OPA project designed to assemble factual data on costs of manufacturing radio sets and cabinets as a means of fixing ceilings. The two studies when they are correlated will determine the retail prices of radio receivers.

While OPA and the Advisory Committee are attempting to resolve their differences, WPB has perfected its plan for, first, easing the restrictions imposed by L-265 and, later, of revoking the order. The WPB formula for lifting controls is geared to a two-stage time table. First stage permitted modification of L-265 in July to permit unrestricted production of components, including tubes for replacement purposes, and all electronic equipment except broadcasting, receiving, and entertainment products. That step was, of course, dictated by a small decrease in military production.

The second stage of the WPB formula calls for complete revocation of L-265 in October to permit production of home receivers, broadcasting equipment and other civilian entertainment aids. This step will move only as fast as component parts become available. It should be remembered, however, that both steps, particularly the second one, were subject to approval of the military services.

THE TOTAL BROADCAST SERVICE

INCOME of 836 standard broadcast stations reporting to FCC was \$68,888,110 for 1944, and that figure constituted an increase of 47 per cent over the 1943 earnings and more than 125 per cent over the 1942 total. A break-down shows that the average broadcast income per station rose from \$36,488 in 1942 to \$55,848 in 1943 to \$82,402 in 1944. Only 33 stations lost during 1944, while 85 lost money in 1943 and 199 in 1942. Of the total reporting, 765 stations had increases

in 1944 (over 1943) amounting to \$22,678,087, and 71 stations had decreases amounting to \$562,558. Total increase in 1944 over 1943 was \$22,115,529.

In 1944 there were 919 standard broadcast stations operating in the United States, Alaska, Puerto Rico and Hawaii, of which 35 were non-commercial stations. Twenty-four of the 884 commercial stations have not sent in their 1944 financial reports to FCC.

LATEST REPORT FROM FCC

is that FM transmission program tests in the spectrum 44 to 108 megacycles, begun as part of the allocation studies, are to be continued to gather propagation information vitally necessary in determining standards for station frequency assignments. The recent allocation hearings revealed the need for that type of FM information. The additional research will substitute factual data for opinion testimony on propagation characteristics of FM frequencies. The tests are designed to develop information on the problem of the proper distance between stations operating on the same and adjacent channels and on the field intensities required for the various services under different conditions. After completion of tests in the 44 to 108 megacycle region, the FCC plans to extend studies, in cooperation with the industry, to higher portions of the spectrum.

SURPRISING FACTS AND FIGURES

have been uncovered by a survey among consumers in Canada, according to a report from *Canadian Facts, Ltd.* First outstanding fact uncovered is that although most Canadians expect great improvements in post-war radio they will not be in a hurry to buy new sets. Forty-two per cent of those interviewed said they plan to buy a new radio, but only 5 per cent said they would buy as soon as new sets become available. *Canadian Facts* estimates the immediate market in Canada as 135,000 sets, of which 65 per cent would be a.c. models, 20 per cent combination models, and 15 per cent battery sets. Canada has a population of about 11,500,000 and the survey covered a representative cross-section of 2,058 persons. Other facts on Canada: Nine out of 10 Canadian families own a radio set, and 1 out of 10 has more than one; 5 per cent of all sets now owned are out of order; principal buyer interest is in combination sets with tone first consideration and price second; only one in 10 has heard of FM, and half of those interviewed think television is not more than three years away.

FROM THE SIGNAL CORPS

comes word that streamlined antennas for vehicular radios have solved many problems that formerly caused seri-

(Continued on page 83)

Get into the **GOOD PAY** **BIG** **OPPORTUNITY** **FIELD OF ...** **RADIO** **ELECTRONICS**



A "LEARN-BY-DOING" EXPERIMENTS
YOU MAKE 133 FASCINATING EXPERIMENTS WITH THE USE OF 8 BIG KITS OF RADIO PARTS AND ASSEMBLIES

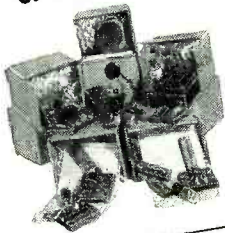

Build modern Radio Receiving Circuits that operate, right in your own "Home Laboratory." Build Electric Eye Devices, an Aviation Band Circuit, a Public Address System, a Wireless Microphone unit—and work out numerous other fascinating practical Radio and Electronic experiments . . . all in your own home, in your spare time.

B 90 "SYNCHRO-GRAPHIC" LESSON TEXTS*

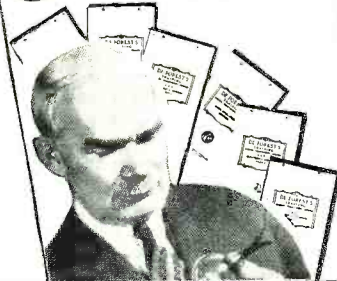

You get 90, well-illustrated lessons prepared under the supervision of Dr. Lee DeForest, the "Father of Radio," inventor of the Audion Tube, and holder of over 300 important patents.

*All lesson diagrams and charts are printed on sheets that fold out—keeping illustrations constantly synchronized to text. This valuable DeForest's "Synchro-Graphic" feature speeds your progress by eliminating frequent flipping of pages to refer back or ahead to illustrations mentioned in text.

C "LEARN-BY-SEEING" MOVIES AT HOME

To help you master important Radio fundamentals, you use the more interesting, easier to understand *visual* method of Movie Instruction—

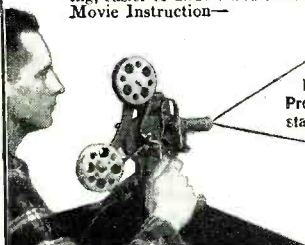

No Other Home Training Provides This Outstanding Advantage.

YOU GET THE USE OF A GENUINE DEVRY PROJECTOR AND SPECIALLY PREPARED RADIO AND ELECTRONIC TRAINING FILMS

SEE RADIO CIRCUITS IN ACTION—ELECTRONS ON THE MARCH!

DeFOREST'S TRAINING, INC.
CHICAGO 14, ILLINOIS

Cash in on the big opportunities for good pay, which the Radio-Electronics Industry offers now and after the war! Get started *today* towards a bright and profitable future in this fast-moving billion dollar field. Prepare now to start a business of your own, or for one of the many positions in FM Radio, Broadcast Radio, Electronics, Communications, Motion Picture Sound, etc.

DEFOREST OFFERS YOU THE MODERN "A-B-C" WAY

No other Radio-Electronics training provides *all three* important, basic A-B-C Training Aids at home. With DeForest's you use (A) 8 big kits of Radio Parts and Assemblies to make 133 fascinating, helpful experiments, (B) 90 "Synchro-Graphic" lesson texts, prepared under the supervision of Dr. Lee DeForest, the "Father of Radio," and inventor of the Audion Tube, (C) Use of a genuine DeVry 16mm. Movie Projector and specially prepared training films to help you learn Radio-Electronic fundamentals the *visual* way—proved faster, easier, more understandable. DeForest's offers all this PLUS effective *Employment Service* which helps you get started in this fast moving, *opportunity industry of the future!*

MAIL COUPON FOR COMPLETE INFORMATION

Let us show you how DEFOREST'S TRAINING can help YOU prepare for a Good-Pay Job or Business of Your Own. See how YOU can learn Radio-Electronics, DeForest's modern A-B-C way, in your *spare time at home* . . . how YOU can prepare *now* for the many opportunities the Radio Electronics industry offers the *trained man!* DeForest's Training can help YOU just as it has helped others year after year. Mail the coupon *today* for more complete information, including a *free* copy of the big book "Victory for You!" and Equipment Folder.



DEFOREST'S TRAINING INCLUDES INSTRUCTION IN MOTION PICTURE SOUND EQUIPMENT, FM RADIO AND TELEVISION . . . RESIDENTIAL TRAINING IN OUR MODERN CHICAGO LABORATORIES ALSO AVAILABLE—ASK US FOR INFORMATION!

E. B. DeVry, President
DeFOREST'S TRAINING, INC.
2535-41 North Ashland Avenue, Dept. RN-B8
Chicago 14, Illinois, U.S.A.

Please send me your "VICTORY FOR YOU!" BOOK and EQUIPMENT FOLDER



Name _____ Age _____

Address _____

City _____ Zone _____ State _____

If under 16, check here for special information.

If a veteran of World War II, check here.

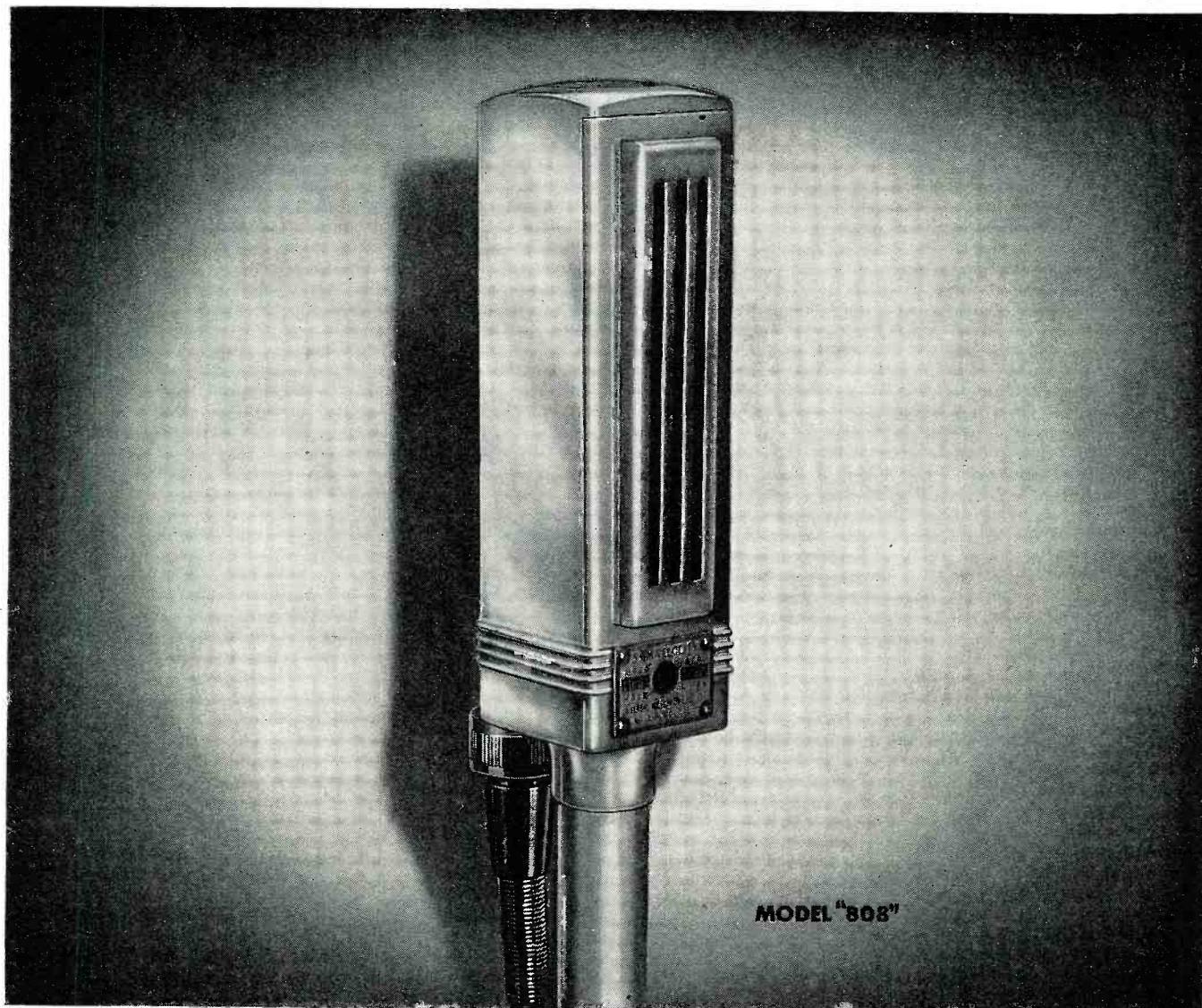

"808" VELOCITY MICROPHONE

TECHNICAL DATA

MODEL 808

IMPEDANCE: 40,000 Ohms (for operation direct to grid of tube)

FREQUENCY RESPONSE: 40-10,000 Cps.

OUTPUT LEVEL: 63 db below one volt per bar.

CORD: 25 feet long. Rubber covered, low capacity cable with locking type connector.

DIMENSIONS: 1 1/4 inches square by 4 1/2 inches high.

FINISH: Satin Chrome.

STAND COUPLING: 5/8 inch—27 thread.

SHIPPING WEIGHT: 2 pounds.

Available in only one high impedance model.

Another Universal first. Leagues ahead in modern design, this pre-war model, Velocity Microphone, wins acceptance as the latest in modern styling. The sensitive element . . . consists of a thin 5 millimeter ribbon, powered with four rugged magnets for added field strength and dependability.

The Bi-Directional response of the "808" Velocity Microphone makes it especially suited for stage presentations, orchestras, recording and indoor public address systems. Absence of sound pickup at the sides of the "808" Microphone reduces "feed-back" problems of most installations. Its slender design provides a striking and novel appearance without covering the performing artists' faces.

Universal "808" Velocity Microphones will soon be on the shelves of your local Radio Parts Jobber. Ask him to reserve one for you.

UNIVERSAL MICROPHONE COMPANY
INGLEWOOD, CALIFORNIA



REPRESENTATIVES: *New York, Chicago, Kansas City, Cleveland, Boston, Tampa, Houston, Philadelphia, Detroit, Seattle, St. Paul, Salt Lake, Los Angeles, San Francisco, and Asheville*

RADIO NEWS

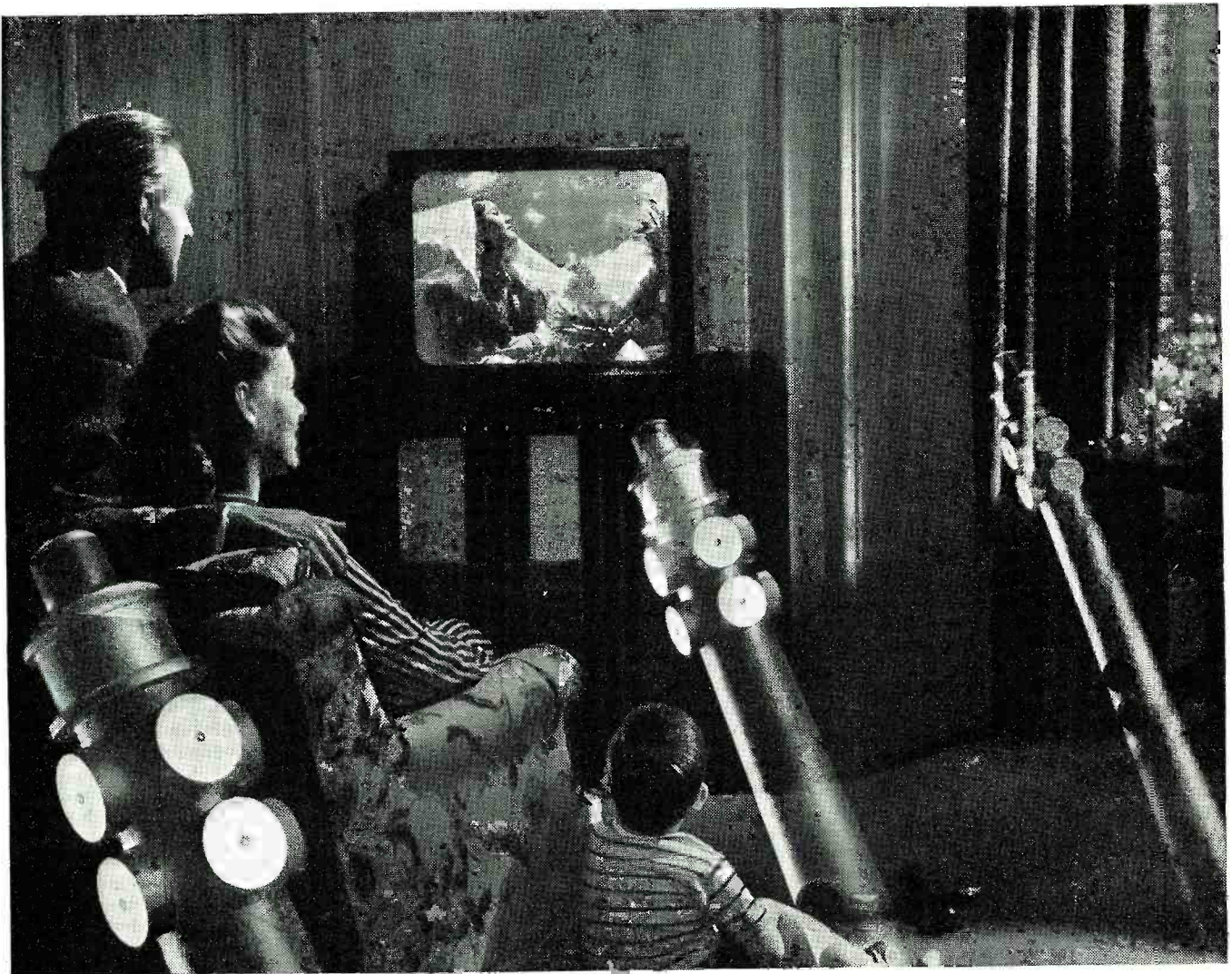

RCA radio-relay towers—like those phantomed above—will leap the hurdle of *distance* in post-war television.

Coast-to-Coast Television...through "Radio-Relay"

For a long time it looked as though post-war television might be confined to local stations. Only persons within a fifty-mile radius of New York, for example, would see the important television broadcasts from NBC's pioneer station WNBT, atop the Empire State Building.

That was because the ultra short waves that carry television do not bend with the curvature of the earth. They go in a straight line out to the horizon—and then keep on going into the sky.

But today, television's big handicap of short range has been completely overcome—by RCA scientists and engineers.

The *radio-relay* was developed—a tower that "bounces" television programs to the

next tower 30 to 50 miles away. Through a network of these automatic, unattended, radio-relays, coast-to-coast television is made practical.

This is but one more example of how RCA research constantly "makes things better." Such research is reflected in *all* RCA products. And when you buy a television set, or radio-phonograph, or anything made by RCA, you enjoy a unique pride of ownership. For if it's an RCA you can be sure it is one of the finest instruments of its kind that science has achieved.

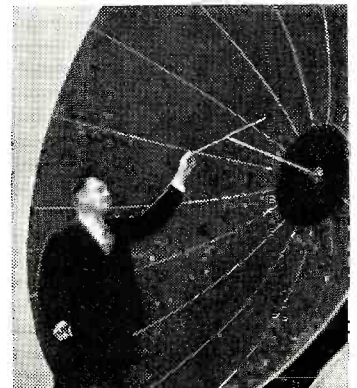

C. W. Hansell, RCA specialist in transmitters and relays, is shown here with a radio-relay reflector that can "bounce" radio messages, radiophotos and Frequency Modulation programs at the same time that it relays television!

RADIO CORPORATION of AMERICA

PIONEERS IN PROGRESS





Contact in transit

Surest with

AMPHENOL

Communication with, or between, moving vehicles becomes more important as this Age of Speed advances. Every factor is vital which promotes clarity of transmission. When trains, taxis, ships and passenger cars can contact each other or their "home stations" at will, Amphenol Cable Assemblies, Connectors and Sockets will do their share to provide good electrical contact *within the equipment*. Atmospheric and static condi-

tions excepted, successful radio communication in transit depends largely on low-loss stability and good design of the equipment's component parts. The name "Amphenol" indicates to the user that they have been designed, made and tested to give the best possible service in spite of interference, vibration and moisture. Detailed technical information on all Amphenol products in which you may be interested is available and will be sent on your request—ask for Catalog Section D.

Depend upon

AMPHENOL

Quality

AMERICAN PHENOLIC CORPORATION
Chicago 50, Illinois

In Canada • AMPHENOL LIMITED • Toronto

U.H.F. Cables and Connectors—Radio Parts—Cable Assemblies
—Conduit—Connectors (A-N and British)—Plastics for Industry

RADIO NEWS

I'LL SHOW YOU HOW TO SUCCEED IN RADIO

Here's the right training for Big Post-War Pay!



F. L. Sprayberry, one of the country's foremost Radio Teachers.



A RADIO SERVICE BUSINESS OF YOUR OWN

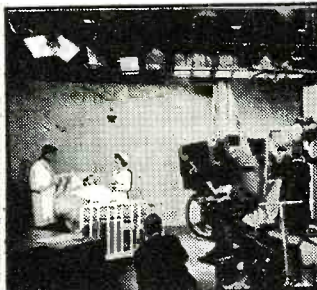

A GOOD JOB IN RADIO & TELEVISION BROADCASTING

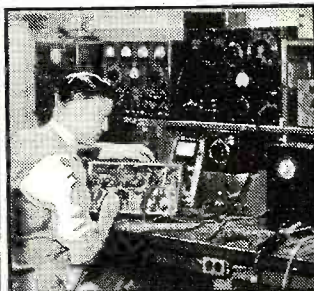

RADIO-ELECTRONIC SERVICE ENGINEER

BE A RADIO-ELECTRONICIAN

NOW YOU CAN PREPARE AT HOME IN SPARE TIME FOR AMAZING OPPORTUNITIES AHEAD IN RADIO — ELECTRONICS — TELEVISION



I SUPPLY A FULL RADIO SET for practical easy LEARNING

SPRAYBERRY TRAINING GIVES YOU BOTH TECHNICAL KNOWLEDGE—SKILLED HANDS

There's only one right way to learn Radio Electronics. You must get it through simplified lesson study combined with actual "shop" practice under the personal guidance of a qualified Radio Teacher. It's exactly this way that Sprayberry trains you... supplying real Radio parts for learn-by-doing experience right at home. Thus, you learn faster, your understanding is clear-cut, you acquire the practical "know how" essential to a good-paying Radio job or a Radio business of your own.

I'll Show You a New, Fast Way to Test Radio Sets Without Mfg. Equipment

The very same Radio Parts I supply with your Course for gaining pre-experience in Radio Repair work may be adapted through an exclusive Sprayberry wiring procedure to serve for complete, fast, accurate Radio Receiver trouble-shooting. Thus, under Sprayberry methods, you do not have one cent of outlay for manufactured Test Equipment which is not only expensive but scarce.

The offer I make you here is the opportunity of a Lifetime. It's your big chance to get ready for a wonderful future in the swiftly expanding field of Radio-Electronics INCLUDING Radio, Television, Frequency Modulation and Industrial Electronics. Be wise! NOW'S the time to start. Opportunities ahead are tremendous! No previous experience is necessary. The Sprayberry Course starts right at the beginning of Radio. You can't get lost. It gets the various subjects across in such a clear, simple way that you understand and remember. And, you can master my entire course in your spare time. It will not interfere in any way with your present duties. Along with your Training, you will receive my famous BUSINESS BUILDERS which will show you how to make some nice profits while learning.

Prepares You for a Business of Your Own Or Good Radio Job

My training will give you the broad, fundamental principles so necessary as a background, no matter which branch of Radio you wish to specialize in. I make it easy for you to learn Radio Set Repair and Installation Work. I teach you how to install and repair Electronic Equipment. In fact, you'll be a fully qualified RADIO-ELECTRONICIAN, equipped with the skill and knowledge to perform efficiently and to make a wonderful success of yourself.

Read What Graduate Says
"One Job Nets About \$26.00"

"Since last week I fixed 7 radios, all good-paying jobs and right now I am working on an amplifier system. This job alone will net me about \$26.00. As long as my work keeps coming in this way, I have only one word to say and that is, "Thanks to my Sprayberry training" and I am not afraid to boast about it."—ADRIEN BENJAMIN, North Grosvenordale, Conn.

DON'T PUT IT OFF!

Get the facts about my training—now! Take the first important step toward the money-making future of your dreams. All features are fully explained in my big, illustrated FREE Catalog which comes to you along with another valuable FREE book you'll be glad to own. Mail Coupon AT ONCE!

JUST OUT! FREE!

"How to Read Radio Diagrams and Symbols"
... a valuable new book which explains in simple English how to read and understand any Radio Set Diagram. Provides the quick key to analyzing any Radio circuit. Includes translations of all Radio symbols. Send for this FREE book now, and along with it I will send you another big FREE book describing my Radio-Electronic training.

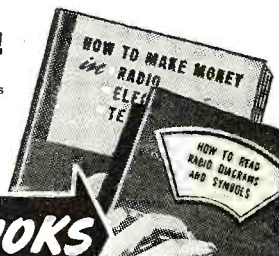

GET FREE BOOKS

SPRAYBERRY ACADEMY OF RADIO
F. L. Sprayberry, Pres.
Room 2585
Pueblo, Colorado

Please rush my FREE copies of "HOW TO MAKE MONEY IN RADIO, ELECTRONICS and TELEVISION," and "HOW TO READ RADIO DIAGRAMS and SYMBOLS."

Name Age

Address

City State.....

Tear off this coupon, mail in envelope or paste on penny postcard.

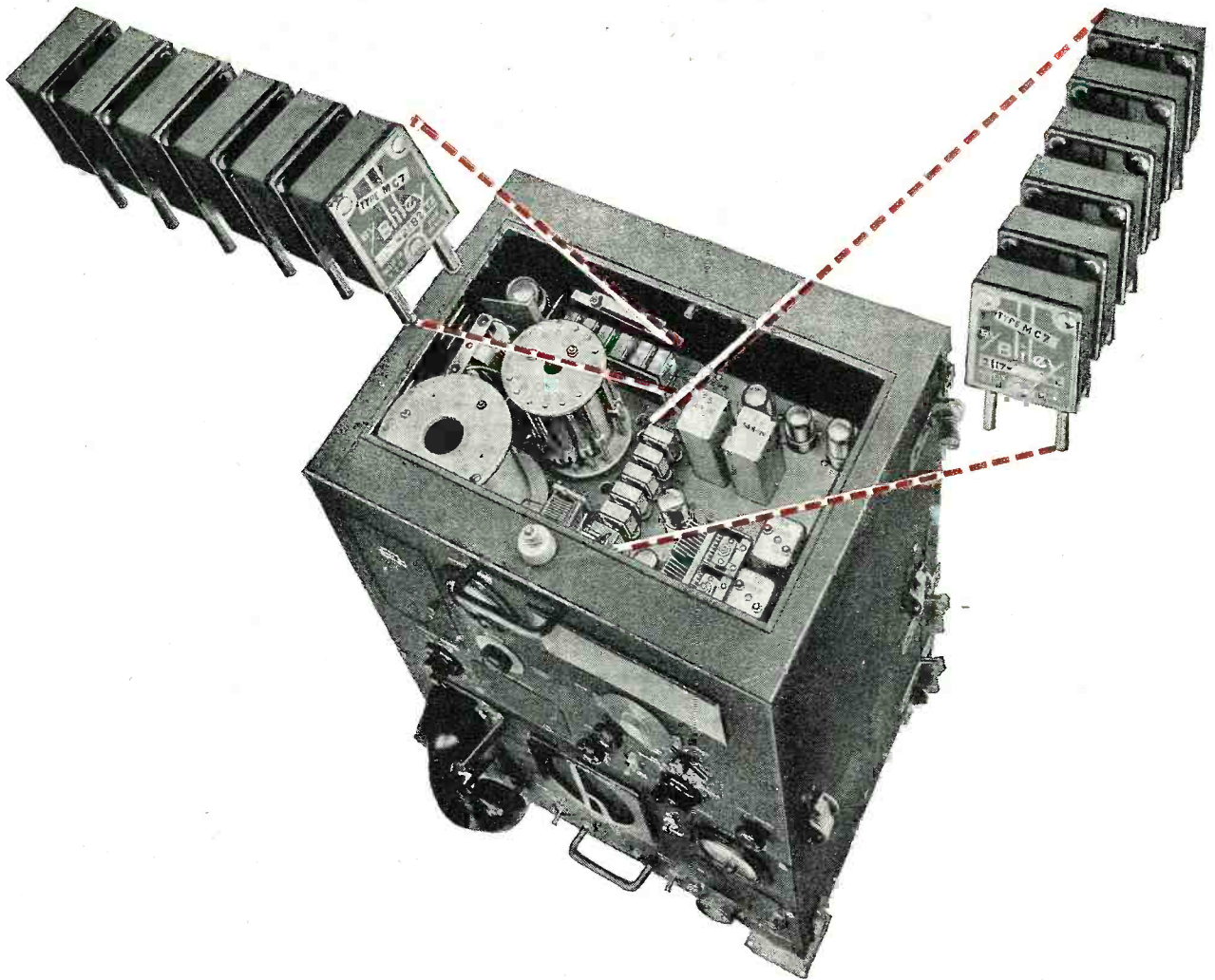

The 6 operating frequencies are **BLILEY CRYSTAL**-controlled

For dependable communications on the high seas here is a battle-tested set incorporating every modern feature that experience has shown to be most desirable for ship-to-shore and ship-to-ship radiotelephone service.

The six Bliley crystal-controlled operating frequencies permit instant and positive channel selection

in both transmitter and receiver. The Bliley *acid etched** Crystals used in this Hallicrafters HT-14 set were designed to meet specific objectives in the operation of two-way radiotelephone communications. They, too, have been battle-tested.

It's a habit with most communications engineers to specify Bliley for all crystal requirements. This is par-

ticularly true today when new applications and complex designs require technical excellence in every component. There is no substitute for the 15 years of experience offered by Bliley craftsmen and engineers.

+ + +

**Acid etching quartz crystals to frequency is a patented Bliley process.*



Bliley CRYSTALS

Do more than before ...

buy extra War Bonds

BLILEY ELECTRIC COMPANY
UNION STATION BUILDING • ERIE, PENN.
RADIO NEWS

Down an invisible road in the sky

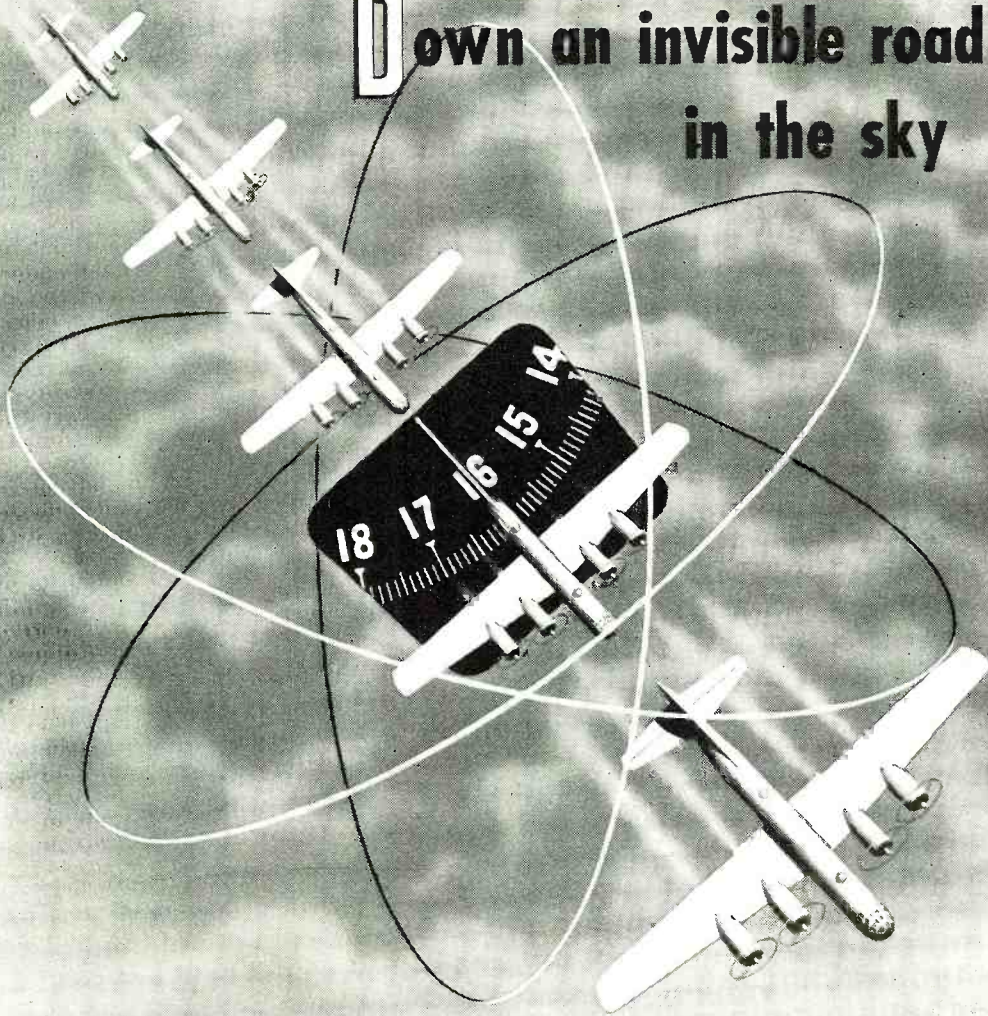

There are no road signs on clouds, yet Allied fliers, aided by electronic impulses, are daily arriving over the target after long flights over endless water. On accuracy in aerial navigation depends the success of a bombing run on Tokyo—and a safe return home. High-frequency impulses assure steady communication, aid in locating planes and ships, and coordinate movements of aircraft, armies and ships. Delco Radio Division is proud of its contribution to final Victory through the development and production of compact mobile radio sets and highly specialized electronic and radar equipment. Delco Radio Division, General Motors Corporation, Kokomo, Indiana.

Delco Radio
DIVISION OF
GENERAL MOTORS

WAR BONDS ARE FIGHTING BONDS



Yes...the "Lab" work is *Complete!*

OUR post-war plans, policies and perfected line of Eastern sound equipment have long ago passed the stage of draft-board design and laboratory tests! We're "in the groove"—ready to go! Based on our many years of experience, the new Eastern equipment incorporates the many

wartime techniques which we have been building into *quality* units for Uncle Sam.

For details and information please fill out and mail the Coupon today. Eastern Amplifier Corporation, 794 East 140th Street, New York 54, New York.

EASTERN AMPLIFIERS

This is Your Ticket

for complete information on our post-war line and the details of our proposition.

EASTERN AMPLIFIER CORPORATION, Dept. 8-E
794 East 140th St., New York 54, N. Y.

We are JOBBERS, DEALERS, A SERVICE ORGANIZATION, SOUND SPECIALISTS. We're definitely interested in your post-war line, your policy, your proposition. Mail us complete information, without obligation.

COMPANY NAME

ADDRESS

CITYZONE.....STATE.....

INDIVIDUALTITLE.....

HERE'S PROOF...

How Federal H-F Cable
Quality is Controlled by

Actual Test

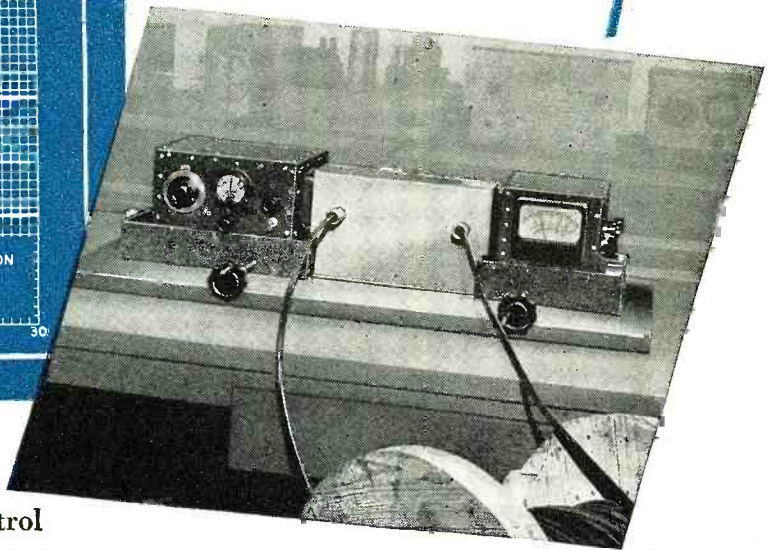
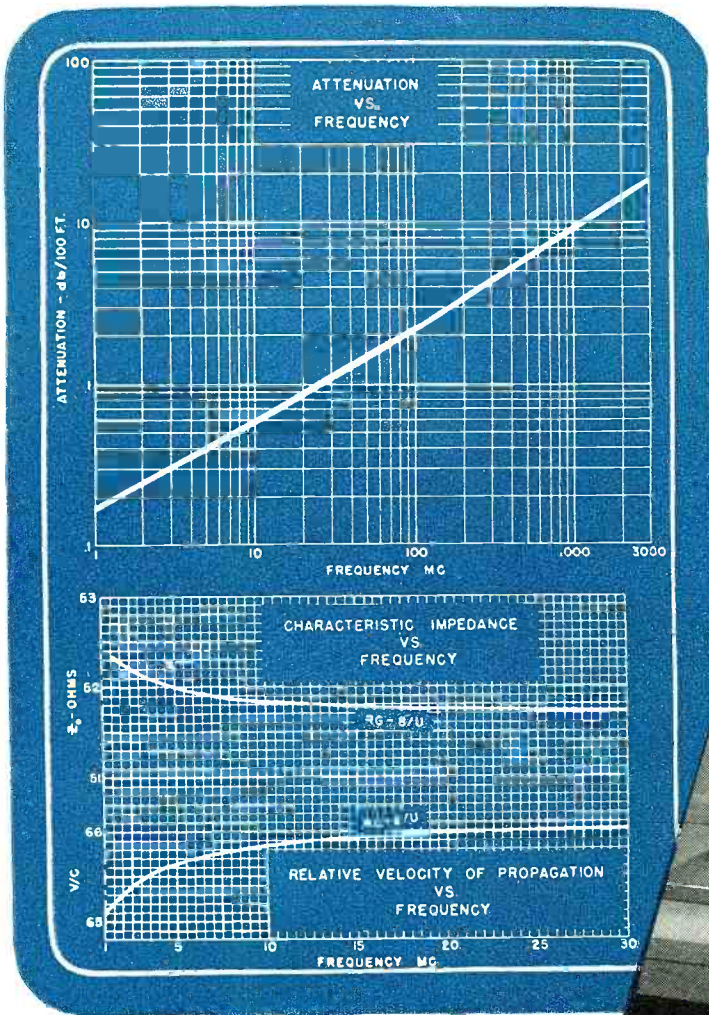

Precision engineering—plus careful control of all manufacturing operations... from raw materials to finished product—mean complete reproducibility in any given Intelin Cable type... and overall superior cables.

Take Intelin RG-8/U for instance... general purpose "work-horse" of high-frequency cables. Its characteristics are shown in curves obtained—not from nominal design values—but from thousands of actual measurements on cable samples, with special equipment developed and used exclusively by Federal's Intelin Product Line.



Intelin's Attenuation Meter is an example of such equipment. It's a precision instrument... accurate to .1 db... developed by Intelin to provide a constant check on production quality and "measured" data for the equipment designer.

For additional information regarding Intelin RG-8/U... write *today* for Report E-53 —and for cable you can count on... *always* specify INTELIN.

Federal Telephone and Radio Corporation

Newark 1, N. J.



RIGHT



... from the start

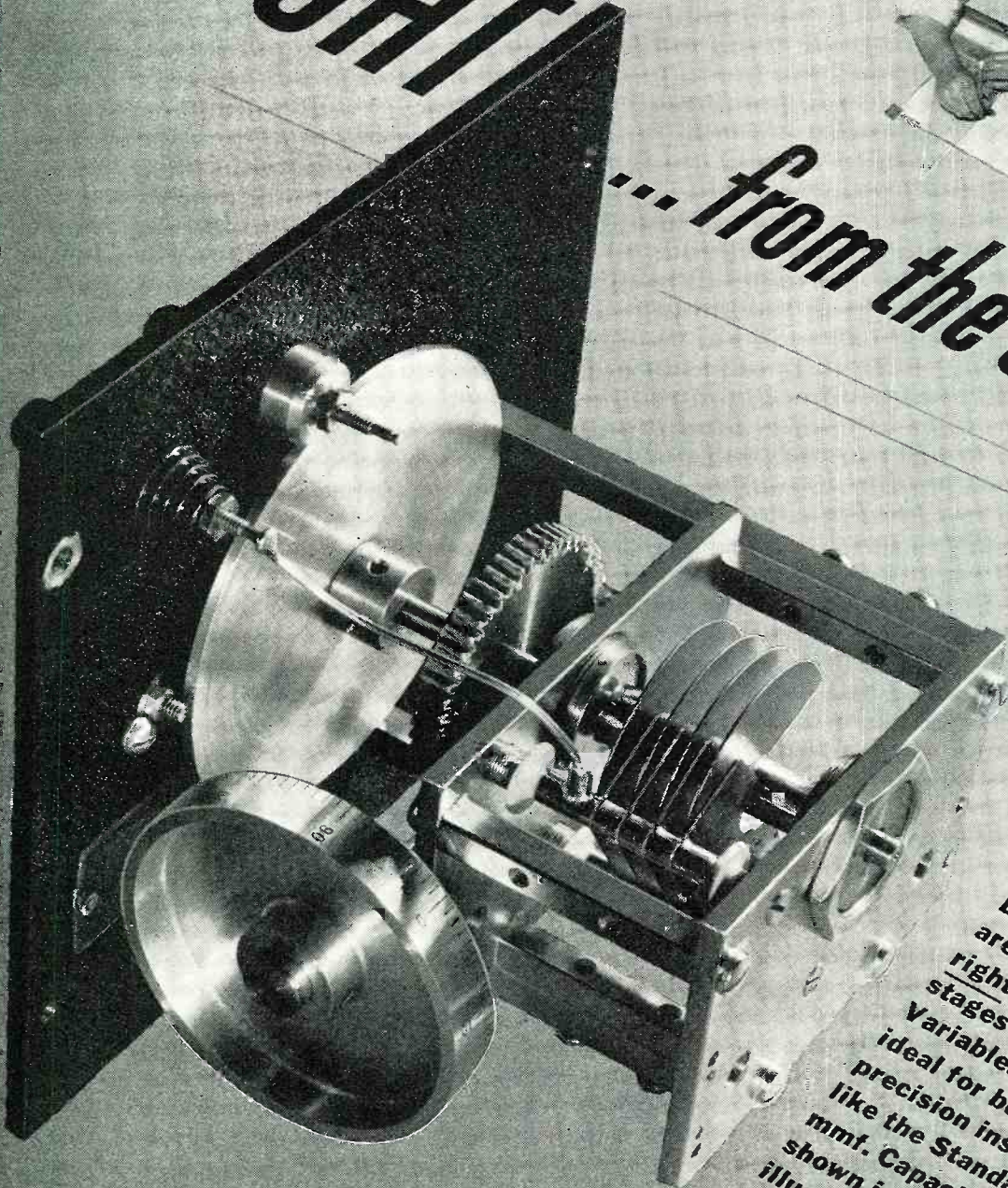

Because they are designed right in their early stages Hammarlund Variables are ideal for building into precision instruments like the Standard 25 mmf. Capacitor shown in the illustration.



HAMMARLUND

THE HAMMARLUND MFG. CO., INC., 460 W. 34TH ST., NEW YORK 1, N. Y.
MANUFACTURERS OF PRECISION COMMUNICATIONS EQUIPMENT

INSTRUMENT LANDING SYSTEM

By

1st Lt. R. J. Hennessy

Scott Field, Ill.

Scott Field, Illinois—the proving ground for the men who operate and maintain blind landing equipment for planes of our Armed Forces.

Mobile transmitter unit, housing directional radiators, is parked 1,000 feet from the far end of the runway.



NARK TWAIN'S remark concerning everybody talking about the weather and not doing anything about it certainly does not apply to the Army Air Forces technicians, for at Scott Field, Illinois, they are doing something about the weather every day. At this parent radio school of the AAF Training Command, ground technicians and pilots are being taught to ignore the weather!

Before the development of the almost supernatural instrument landing system which brings planes in flight to a safe landing even though visibility is zero, when a fog bank would roll in over the countryside and the flight control bulb in operation would snap to "N," air crews had no other alternative but to relax and "sweat" out the weather as the field was closed to all flying activities.

Today all that is changed for there is a small, highly-trained unit at many airfields which grasps at the oppor-

tunity to justify its existence when the "soup" closes in and the field is declared on instrument status. This group is the Instrument Landing Equipment crew. Its function is to provide a safe and reliable path to the runway for all aircraft which were unable to get in under the weather.

At Scott Field, commanded by Col. Neal Creighton, part of the vast laboratories and classrooms at this radio school are devoted to the training of the men who operate and maintain this system.

Students are selected graduates of Radio-Mechanic courses and officers and enlisted men who have acquired experience "on the line." These men are given a seven-week specialized instructional program on this equipment at this incubator for Air Force Radio Operators and Technicians.

The school is unique in that it is the only institution of its kind in the Army and until recently in the en-

tire service. The recent adoption of the system by the Navy, as taught at Scott, precipitated an influx of sailors to this field for training in this work. This marked the initial occasion on which the Navy saw fit to visit this mid-Western Air Force Post and indicated an increased cooperation between the branches of the service.

Unlike many schools which train men and send them out to the using agency, this institution follows the accepted Scott Field inclination to train the man on the job so that he arrives at the line with some experience in the task for which he is trained.

The popularly accepted program embodies a combined theoretical and practical application of the course material on localizer, glide path, and marker beacon transmitters and receivers, as well as a treatment in frequency-modulation transceivers.

Installation of the airborne localizer, glide path, and marker beacon receivers and antennas is coupled with

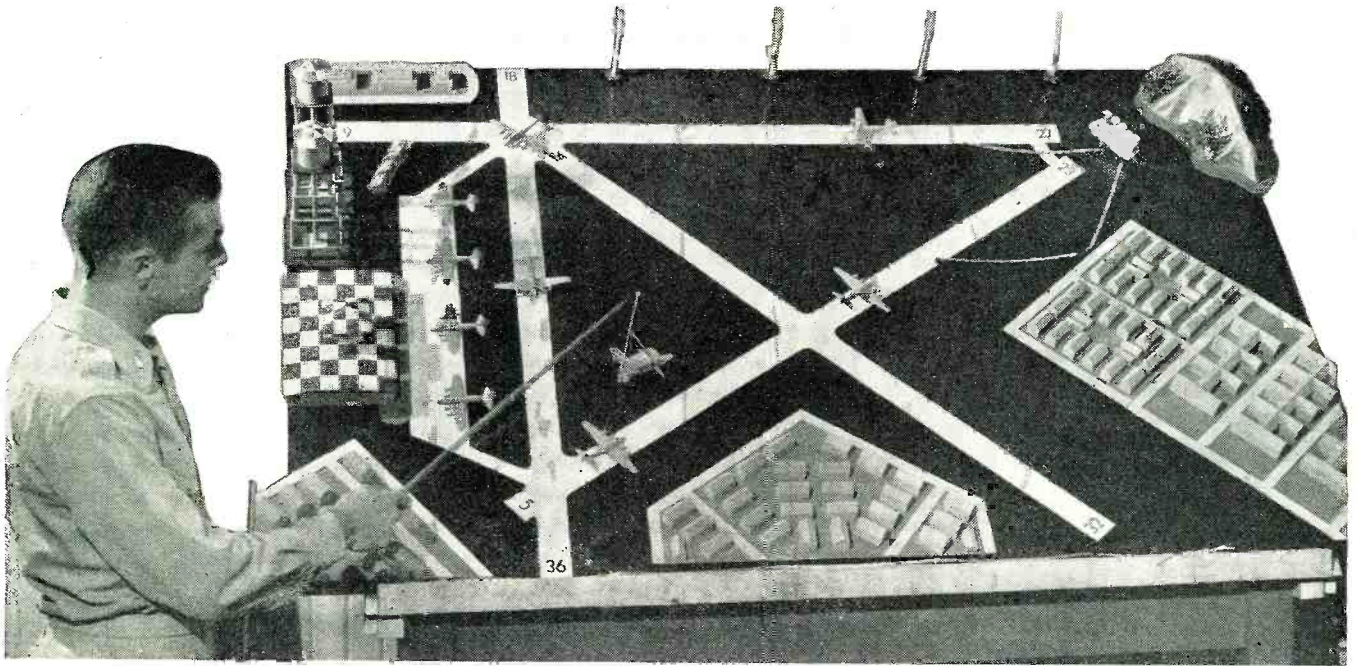

Miniature replicas of buildings, trees, and other obstructions, are moved about on a large magnetic board, representing a landing field. This training aid is used to brief students prior to flights and in working out instrument landing problems.

a short telephone procedure course, as is used in control towers.

Map reading, compass, and aerial photograph interpretation are also employed to provide the student with required knowledge to be used in the late phases of the program and in actual line activity.

Five weeks are devoted to classroom work and two weeks are spent on the Scott Field airport in actual work on the system.

Further, every Training Command student participates in several instrument landing problems, the progress of which he observes from a converted Bombardier's position in the nose of a B-17, assigned for training purposes.

A duplicate set of instruments has been provided for the student's benefit in this position.

The syllabus of instruction makes good use of electrically-actuated training aids and a life sized mock-up of a "B-26 Marauder" is utilized to teach installation of the airborne equipment under actual conditions usually encountered.

A mobile device is used to check the localizer and glide path courses prior to flight tests. This device consists of a standard Army "jeep" and is equipped with antennas, receivers, and indicators identical to those found in the plane, and powered directly from a storage battery.

By driving this strange-looking contrivance down the centerline of the runway to be used and varying the height of the antenna, the glide path and localizer courses are detected and positions of the cross-haired indicator needles are observed.

This very useful combination of a training aid and course monitor acts as a mobile classroom and serves to insure that the localizer is transmitting an accurately aligned pattern for the plane to follow and also determines the absolute angle of glide from the approach end of the runway to the point of contact. The plane usually crosses the boundary of the field at approximately 40 ft. and the antenna

In a blind landing, the pilot corrects his approach until both needles are at right angles to each other and both centered exactly on a horizontal and vertical axis.

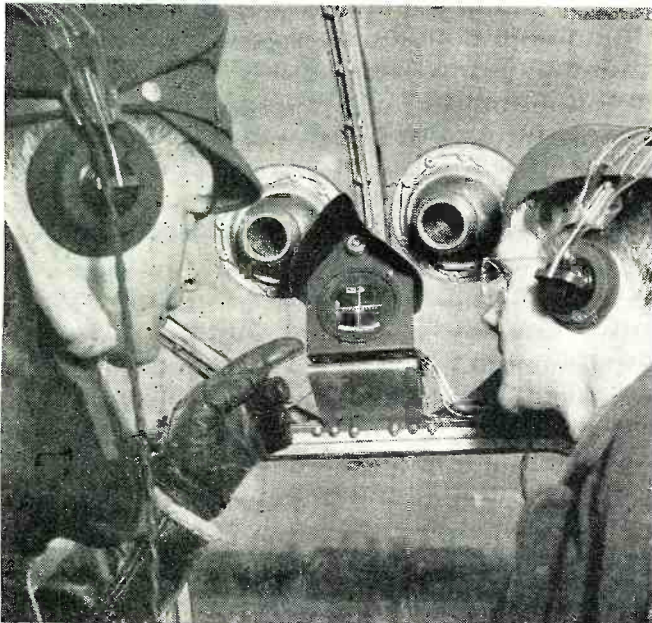

A fixed-course detector checks the signal sent out by the localizer truck. Should the course shift for any reason, an automatic alarm bell sounds in the localizer truck.

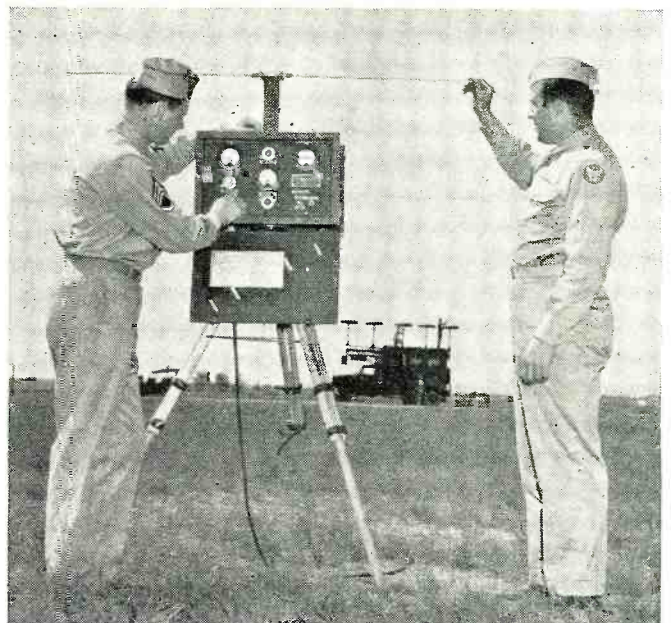

on the "jeep" can be telescoped to this height and follow the radiated course right to the ground.

Students set up and operate all positions and, after "sitting" the apparatus, then proceed to inspect the quality of their work with the "worry wart." This name is aptly applied to this monitor as it consistently displays reluctance to accept any but positive indications of a true course.

Instructors, having had considerable experience with the equipment, have learned certain course characteristics which manifest themselves in the form of definite troubles when the equipment is not properly set up. These "bugs" are purposely introduced in the apparatus from time to time and students observe the resultant effects while riding down the runway in this vehicle.

The Army Air Forces Instrument Approach system (designated SCS-51) as taught at Scott Field is a product of research extending back to 1919. At that time the Bureau of Standards, recognizing the need for a means to land planes under conditions of poor or zero visibility, combined a low-frequency radio range with a marker beacon transmitter and were able to affect low-level approaches to an altitude of 300 feet.

Later developments saw the introduction of a localizer transmitter and several marker stations. At this stage, by means of overlapping signals transmitted at low frequency, it was possible to provide a pilot with two-dimensional guidance. The localizer aligned his plane with the runway and the markers gave him "fix" points or distance from the runway. These markers were keyed differently for identification. This was an audible system of guidance.

Atmospheric conditions interfered with this method to such an extent as

to render it questionable and a more efficient system was sought.

The *Federal Telephone and Radio Corporation* in cooperation with the Army Air Forces and the Civil Aeronautics Authority finally produced the system best suited to the needs of the service in war time. This method, in which all the component ground units are mobile, employs a localizer transmitter mounted in a large truck and crystal controlled to operate in the very-high-frequency band.

A glide path transmitter was designed in similar fashion and mounted in a trailer unit. This unit was also crystal controlled and operates in the ultra-high-frequency band.

Three marker beacon transmitters, keyed at different intervals, are mounted in "jeeps." These send out the conventional 75-megacycle cone-shaped patterns.

The five components are laid out physically in the following arrangement: The localizer is sited off the far end of the runway. It is placed in such a manner so that its radiated course bisects the centerline of the runway and therein provides the pilot with horizontal or right and left guidance. This course extends out over the terrain off the approach end of the runway for the required usable distance.

The radiation pattern of this transmitter resembles two overlapped, pear-shaped lobes. These lobes have been formed by means of mechanical modulation at two separate audio frequencies. One is modulated at 90 cycles and the other at 150 cycles. The overlapping of these patterns provides an area in which these two frequencies are evenly distributed.

It is in this area that the plane is flown, because these audio signals, being essentially equal, do not provide

(Continued on page 136)

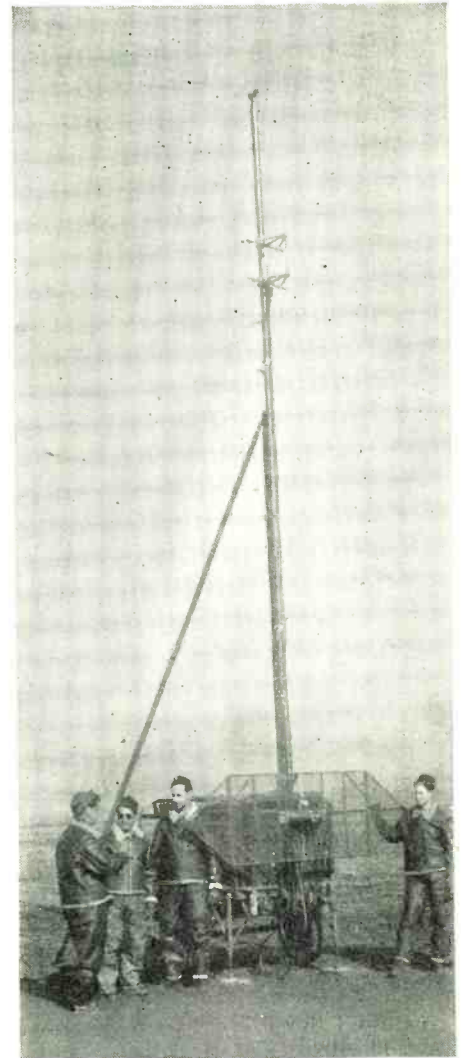

The glide-path transmitter. Like all other components of the system, this transmitter is mobile so that it can be quickly set up at whichever runway is in use.

Jeep, carrying same equipment as on aircraft, is used to check mobile transmitter. By varying the height of the horseshoe antenna, the vertical angle and glide-path can be checked.

Checking facility chart prior to a flight. All students are taken up on at least two flights so that they may see how the equipment guides their planes to a safe landing.

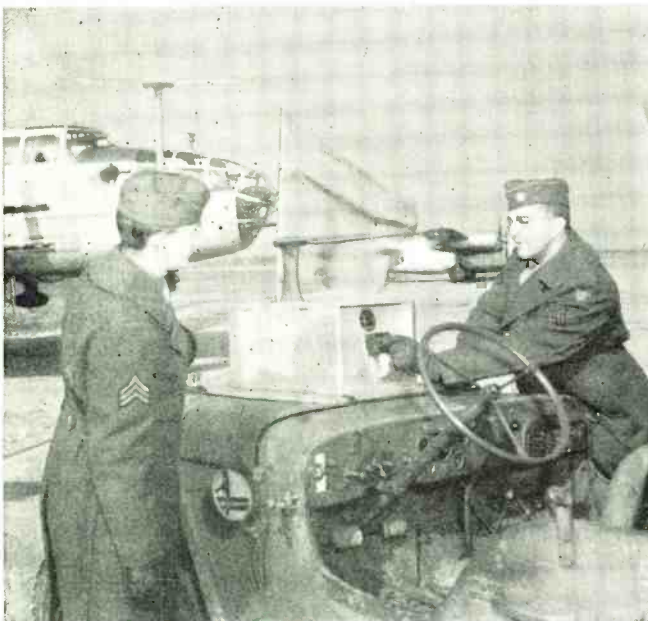

"QRM"

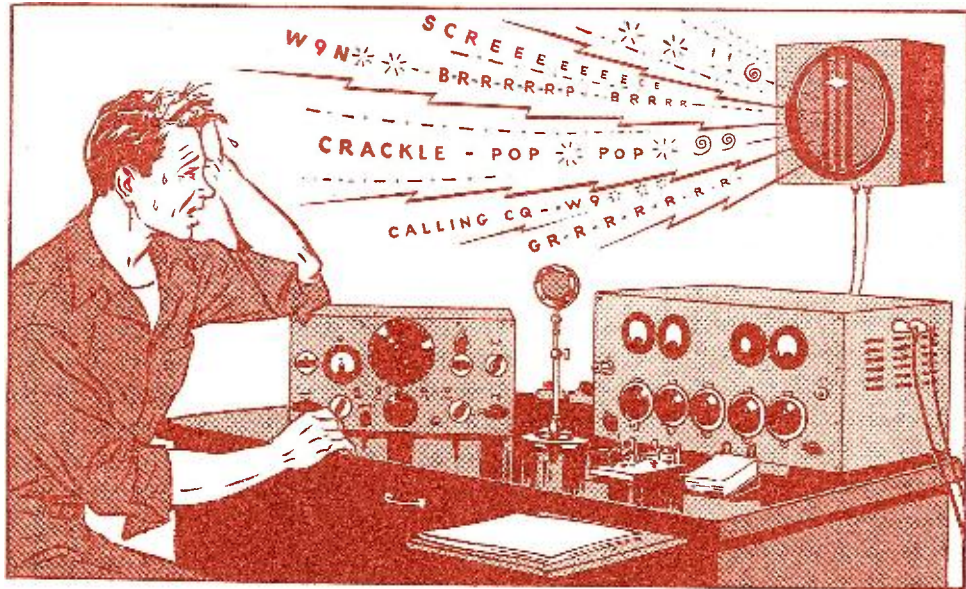

A Threat to Amateur Radio

By T/Sgt. GEORGE MOBUS, W9UAO

ONE of these days, and we hope it will not be far away, a goodly number of men—and women—in Army khaki, Navy blue and Marine forest green are going to lay down their walkie-talkies, SCR's and TBY's and kiss (or cuss—depending upon what and with whom they have been operating!) good-bye to military equipment and operating procedure.

Many of these folks were pre-war hams. Many of the others, having been bitten by the bug that few can resist, will want to become hams. All of them are radio operators.

After the daze of their sudden newfound freedom passes, these people are going to force the FCC Amateur Licensing Bureau to place a "HELP WANTED" ad in all newspapers. Thousands of old-timers on the ham bands will return to their too long neglected "rag-chewing." Additional thousands will flock to the folds within a few months after the lid is off and Amateur Radio will see such an influx of devotees as has no other hobby.

Hamming, before the war, had been pretty well whipped into shape. Equipment, on the whole, was of a good quality. While the junk-box ham had not completely disappeared, the quality of the signals on the air indicated that most fellows were making a conscientious effort to clean up their sigs by using better grade parts and engineering their rigs more carefully. Much of this house-cleaning was done voluntarily and through

the hams' own ingenuity although there were and are, at this time, a number of clubs and publications devoting a great deal of time and effort toward helping the ham in this project. However, in the final analysis it is going to have to be the man who built and is operating the station who will have to see to it that HIS signal is clear and that his operating habits are free of faults.

The ham-band picture has changed considerably from what it was twenty years ago. Back in the good old days (?) it did not matter so much if your signal was a trifle wobbly and sounded like a saw-mill. No one cared much, either, if you spent a couple of hours tuning your transmitter with the antenna radiating or if you used several hundred watts to talk to some other bird a couple of miles away. The high-frequency radio spectrum was something like the wild west back in the 1800's—plenty of room for all.

Like a two-gun bad-man in the panhandle, proudly cutting another notch in his six-shooters, a lot of the "old-timers" took pleasure in putting out a nice raw, broad signal. It was distinctive! Don't get me wrong now—those old-timers could not help it to any great extent. They just did not have the equipment to work with. The point of the whole thing is that they were not stepping on anyone's toes. What the heck—no one was fighting anyone else for the frequencies allotted the hams. Of the amateurs, they were few and in most cases far apart. Their sigs did not,

as a rule, travel very far and there just was no congestion problem. It was not until higher frequencies came into general use that the signal "QRM" came to have much significance for amateurs.

Yes, the Radio Amateur was free to do as he pleased for many years. True, there were certain laws he was asked to obey and certain limitations and restrictions he had to observe. As long as the ham stayed within the bands allotted him (and there was not much reason to crowd the edge in those days), he was smiled on benevolently by others, who regarded him as a harmless "bug." Possible exceptions to this were the irate owners of broadcast receivers whose misfortune it was to live in the near vicinity of said "bug."

This state of bliss was enjoyed by the fraternity prior to World War I and for a few short years after. However, with the advent of cheaper parts and the more general use of vacuum tubes plus the opening up of bands below two-hundred meters, this situation was changed. Signals from afar were added to those of a neighboring ham to create interference and the words "Sorri OM, qrm hvy nw. 73 es cul" became frequently heard as more and more amateurs joined the ranks—lured by the natural thrill of personal communications with far places and the decreasing cost of equipment.

Who, among those active, does not remember the chaos that existed on all ham bands just prior to the shut-down of amateur activity at the entry

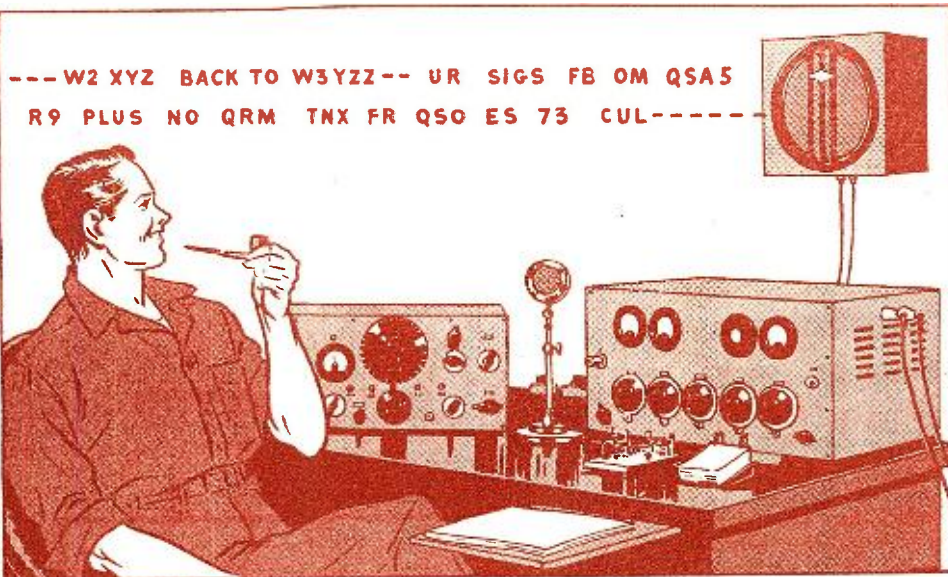

Only through the full cooperation of all hams in following sound operating techniques and by employing efficiently designed equipment can the discouraging effects of QRM be reduced.

of this country into World War II? Remember 40 and 80 meters in the evening about nine o'clock? Fun—wasn't it? You called some fellow and then hoped that you could hang on to him long enough to get a signal strength report through. Most of the time you could not. Just when you got going good some other fellow, who had as much legal right to the frequency as you or the station with which you were trying to "QSO," came blasting in like a ton of bricks calling "CQ" for five minutes or so or maybe just plain testing. You all know the way it went—no need for anyone to remind you.

Some fellows did not mind this so much. They had the "cabbage" so they just went ahead and built a more powerful final amplifier and drowned the other guy out. After all, there was not much system and it became a case of the survival of the fittest. Some of us were not so fortunate though. Money talked in amateur radio because it was with money that these "California Kilowatts" came into being. We tried various gadgets to shift our frequency and while we enjoyed some success in getting out from under the high-powered signals, we did not enjoy chasing a signal all over the band.

We were Radio Amateurs too! We had a license that gave us the privilege of using certain frequencies to transmit and receive radio messages. We were assigned call letters and were listed in the call-book. We had a radio station capable of putting out

a signal—a pretty decent sort of signal as a matter of fact. Yes, we were Radio Amateurs! The only trouble was, it just wasn't any fun anymore to sit and fight "qrm" all evening instead of being able to log a half-dozen "qso's" as completed. Some of us found a partial solution. We banded together, ten or twelve stations, on a common frequency and several nights during the week we operated as a net or a "roundtable." Generally, another ham would steer clear of a freq if he heard a net in operation thereon.

Of course, ham radio is not a matter of building or buying a piece of equipment and putting it into operation and then just sitting down to logging "qso" after "qso" with no further regard to the technical side of radio. The increase of interference on the amateur bands did this for radio. It spurred the radio industry and the hams themselves into greater effort toward the improvement of their old standard gear and the development of new equipment. Necessity, they say, is the mother of invention. This was never more clearly shown than in the field of radio communications. Crystal and single-signal receivers, to cite only two important innovations, were a direct outgrowth of the problem of conquering the enemy—QRM. The role of the radio amateur in this endeavor is legend. Countless improvements and inventions, accepted and put into use by the radio industry and by our Armed Forces, are traceable directly to the radio ham whose

sole idea, generally speaking, was to make some improvement in his signal or in his reception of the other fellow's signal.

All this was for the good of radio—both amateur and commercial. The improvements, however, did not go far enough. The increase in activity on the bands swept far ahead of the new equipment designed to alleviate the troubles of interference. We can assume that after the war a great number of further improvements in design and the invention of new equipment will be brought to light. These ideas and inventions were born of the necessity that our armed services and those of our allies have the undisputed superiority of communications material. We can only have a faint glimmer of what will be revealed after the last shot has been fired and the swords of war are beaten back into the plowshares of peace.

There is one development, in particular, however, that may be worth considerable attention. That is, VHF—"Very High Frequency"—or, as it was more generally known to hamdom, Ultra High Frequency. We were all aware of the limitations of the frequencies in the 56 megacycle band and we were just experimenting with those of 112 megacycles. These bands were okay for short-haul communications but the "Line of Sight" limitation characteristic precluded their use by all except those hams living in close proximity to each other.

But what of those frequencies even higher? How about two-hundred megs and up? Remember how dubious the radio world was regarding the frequencies above two hundred kilocycles? Maybe the vast unknown spectrum in the "Very Highs" holds some startling secrets also. As a matter of fact there has been considerable use of the "Very Highs" in this war and much research has been carried out. At this time, for obvious reasons, the findings of this research must be kept secret, but we have a hint of great results in the fact that the FCC has allocated frequency bands up in the hundreds of megacycles to the amateur and other radio services. *What a future ham radio has in this field!*

Even though we all remember the problem of interference in the days before the war, none of us know exactly to what extent we will be troubled by this same bug-a-boo after the war. Because we do not know the problem we cannot find a solution. However, we can look at it in the light of what we faced before the shut-down. The problem was simple enough then—there were too many amateurs putting out a signal on the same frequency at the same time.

There is no doubt that there will be even more signals competing with each other after the war—even with greater space in the radio spectrum having now been allotted. It all boils down to the fact that we, the ama-

(Continued on page 146)

BUILD YOURS VICTORY TRANSMITTER

Constructional details of an effective and flexible small transmitter to keep on hand for the grand reopening of amateur radio.

By GUY DEXTER

ALTHOUGH the war emergency has kept us off the air for very nearly four years, no ham's ardor for his transmitter has cooled down one iota. And with the war situation getting pretty well in hand, many amateurs already are straining at the bit. Many have kept their rigs intact, from key to antenna, ready to go the minute the lid is lifted. Many more have sold their gear to the armed services, training schools, or war plants.

One thought captures the fancy of each ham who does not have a transmitter of some sort set up to celebrate the grand reopening—and that is to assemble something as quickly as possible from the odds and ends in the junkbox. No one will want to be left out of the fun. The 64-dollar question is what to build.

We feel that a major portion of our activity still will be on the popular lower-frequency bands, although the new ultra-high spectrum is virgin territory for experimentation. Most of the "standby" victory transmitters which will be constructed within the next few months, in anticipation of the green light, are thus apt to be in-

tended for low-frequency use. Rumors regarding which bands we will retain are flying faster than the predictions of VJ Day. However, it is possible to build a flexible transmitter which, by means of wide-band, plug-in coils and suitable crystals, may be operated on any frequency for which we have crystals or may re-grind a present crystal.

Junkbox parts are not apt to yield a kilowatt, or anything even near that power. But a very effective little transmitter may be built from occasional material, mostly receiver components. While we were casting about mentally and looking over our own spare parts for an inspiration, we came across a unit built recently for the green light by Raymond Minichiello, W1HBR. It is this rig that is described in this article.

General Arrangement

The transmitter is a two-stage, crystal oscillator—beam power amplifier unit which may be used in a variety of ways. For example; the oscillator and amplifier may be operated at the same frequency without neutralization, or the amplifier may

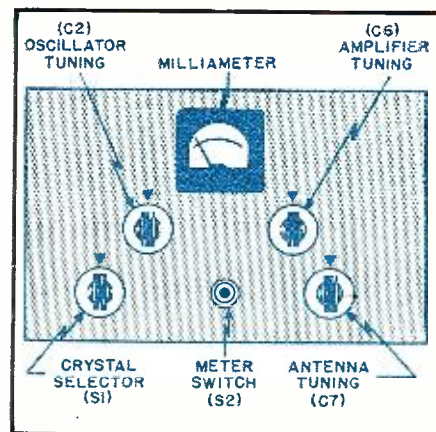
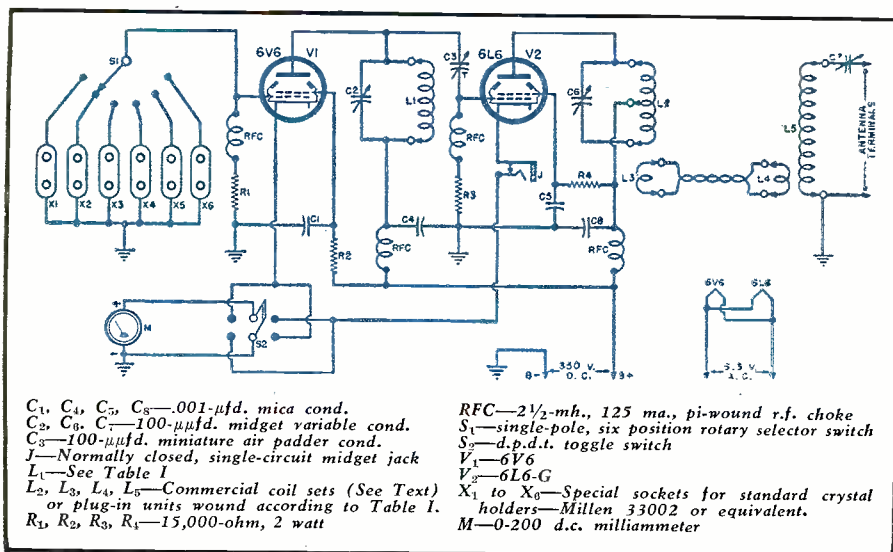

Fig. 2. Panel layout showing proper placement of the various controls.

Fig. 1. Complete diagram of the victory transmitter. This transmitter employs only two tubes and is designed for use with an external power supply.



be made to double, triple, or quadruple the oscillator frequency. Likewise; the transmitter may be used directly on c.w., or, by the addition of a simple external modulator (an audio amplifier with 500-ohm output will do), may be adapted to radiophone service. When the unit has no further use as a complete transmitter, it may be used readily as an exciter for a more powerful class-C amplifier.

For maximum flexibility and minimum size, the transmitter has been built without an internal power supply. The 350 to 400 volts d.c. required for plates and screens and the 6.3 volts a.c. required for the tube heaters may be obtained from an external power supply situated at any convenient point with respect to the transmitter. When the victory transmitter later is used as the exciter portion of a larger transmitter, these operating voltages may be obtained through voltage dividers and filament transformer windings in the main power supply section of the transmitter.

Some special features of the little unit are: The antenna tuning coupler is made integral with the transmitter and is tuned from the front panel; the milliammeter may be switched into either oscillator or amplifier circuit, by means of a front-panel switch, to check plate currents during tune-up adjustments; six crystal sockets are provided, and a front-panel rotary

switch permits either of the crystals semi-permanently mounted in the sockets inside the cabinet to be switched-in at will; and most of the components used are receiver parts, small in size, and usually found in amateur junkboxes. The tubes likewise are in the receiving category, but give good account of themselves when employed for r.f. power generation.

The complete victory transmitter is shown in the accompanying photographs and drawings. Fig. 3 shows the external view, while the layout drawing—Fig. 2—identifies the components appearing in the photograph. Fig. 3 also includes a top-chassis view, with the layout drawing—shown in Fig. 4—identifying the parts seen in the second photograph. Fig. 5 is an under-chassis view, showing wiring and the mounting of "hidden" circuit components.

The transmitter is housed in a 13½" x 7¼" x 7" general purpose steel cabinet. The chassis is the folded-

during tune-up adjustments, for proper excitation of the final amplifier.

The output amplifier tube, V_2 , a 6L6-G, is capacitively-coupled from the oscillator. The amplifier plate tank comprises a center-tapped coil, L_2 with end-link coil, L_3 , and the 100- $\mu\text{fd.}$ variable air capacitor, C_6 . L_3 is connected directly to a short length of twisted pair (made of hookup wire) which terminates in a similar link coil, L_1 , wound around the end of the antenna coil, L_5 . The antenna coil is

The jack, J , in the cathode circuit of the 6L6-G amplifier tube receives a key for c.w. telegraphy or the 500-ohm output of a 5-watt amplifier for cathode modulation. It is a normally-closed midget-frame jack which must be insulated from the metal front panel of the transmitter by means of a shoulder-type bakelite washer.

Operating Characteristics

The victory transmitter must be powered by a 350-to-400-volt 200-milampere d.c. unit having good filtra-

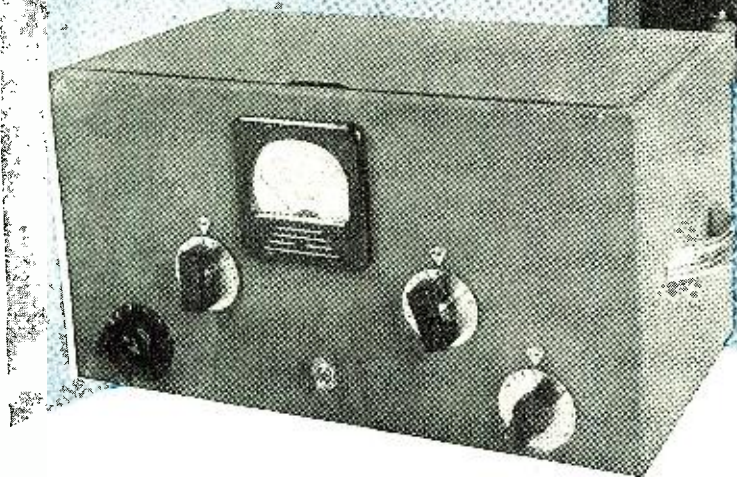

Fig. 3. Two views of the completed transmitter. Front view shows neatness of layout and placement of operating controls. Top view with cover removed shows placement of the various components.

edge inside tray supplied with this type of cabinet. All controls and circuit-access components are mounted on the front panel, with the exception of the keying and modulation jack, antenna terminals, and power cable outlet which are found on the back of the cabinet.

Circuits

The complete circuit schematic for the victory transmitter is given in Fig. 1.

The crystal oscillator is the conventional arrangement built around a 6V6 tube, V_1 . The crystals are placed in special sockets, X_1 to X_6 , which are connected to the contact points of the single-pole, 6-position rotary selector switch, S_1 . The oscillator tank is comprised of the plug-in coil, L_1 , wound on a 1½"-diameter bakelite form, and the 100- $\mu\text{fd.}$ variable air capacitor, C_2 . The coupling capacitor, C_3 , a 100- $\mu\text{fd.}$ midget variable air unit, is mounted inside the oscillator coil form and may be seen there in Fig. 3. A separate capacitor C_3 is provided in each plug-in oscillator coil and is set,

tuned by a third 100- $\mu\text{fd.}$ variable air capacitor, C_1 . L_2 and L_3 both are plug-in, air-wound coils, as shown in the photographs, but may be wound on bakelite, ceramic, or polystyrene forms if desired. If the prewar amateur bands are of interest to the builder, the following manufactured coil sets may be employed: *National* type AR, *Barker & Williamson* type MEL, or *Bud* type OEL. These coils plug into ceramic plug-in bases, visible in Fig. 3. If the builder desires to wind his own coils for wide frequency coverage, Table I accompanying this article may be followed.

The single 0-200 d.c. milliammeter is switched between the oscillator and doubler plate-cathode circuits by means of a double-pole, double-throw toggle switch, S_2 . When S_2 is thrown to the left-hand position, the meter is inserted in series with ground and the cathode of tube V_1 , while the cathode of tube V_2 is grounded. When S_2 is thrown to the right-hand position, the meter is inserted in series with ground and the cathode of tube V_2 , while the cathode of tube V_1 is grounded.

tion, and a 6.3-volt 2-ampere filament transformer. It will be desirable to have the filament winding separate from the plate-screen power transformer. Adequate by-passing and r.f. chokes have been provided in the transmitter, thus precluding shielding and by-passing in the power supply unit. The type 83 is recommended as the most suitable rectifier tube for the power unit.

At a d.c. plate voltage of 350, the 6V6 crystal oscillator draws approximately 15 ma., and the 6L6-G amplifier approximately 100 ma. Plate power input of the amplifier thus is approximately 35 watts d.c.

The circuit operates well at all frequencies up to 30 mc. without it becoming necessary to reduce the plate power input. Crystal heating is very slight.

The simple series-tuned antenna coupler permits use of a variety of simple and complex low-frequency antennas. Excellent results have been obtained with couplers of this type when feeding directly into a half wavelength of wire, working against ground.

The 6L6-G amplifier keys well, but a key-click filter must be installed in series with the key to eliminate click interference.

An external plate modulator may be employed, if desired, however an au-

(Continued on page 84)

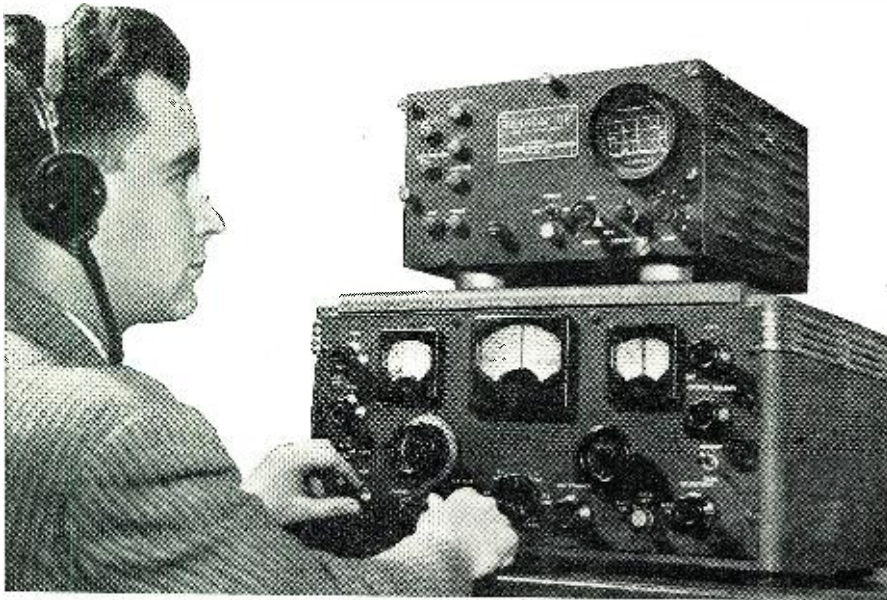

The panoramic unit is in the form of an adaptor to be employed in conjunction with your present receiver. Any number of signals can be seen for comparison.

Combining actual visual inspection and the added advantages of a panoramic adapter, many a "DX'ers" aural reception problems will be greatly simplified.

Comparison of Visual and Oral Reception

By
HARVEY POLLACK

Panoramic Radio Corp.

A NY SYSTEM which employs vision to convey intelligence through the use of external visual stimuli has a great advantage over methods involving the other senses. This is true because, of all our senses, vision is the only one capable of analyzing parts of a "blended" whole.

The extraordinary faculty of vision makes panoramic reception of outstanding significance to radio amateurs. Operators never try to copy more than one signal at a time because their sense of hearing is not capable of "describing the many components of the whole." On the other hand, the panoramic method of visual presentation of almost any number of signals simultaneously provides a composite picture that is completely open to piece-meal analysis.

The Screen of the Panoramic Receiver

Let's peek in through the window of a postwar ham shack. The operator's bench, replete with all the usual ham accessories, carries a mod-

ern panoramic superheterodyne. With regards to reception, this receiver behaves exactly as the prewar superhets did; its highly selective circuits enable the operator to listen to single signals without the distraction of interference. The receiver contains a CRT whose face is masked and filtered by an emerald plastic screen which is calibrated horizontally in terms of frequency. As the receiver is tuned, inverted-V deflections of the CRT trace move across the screen; just at the moment that a signal is heard on the loudspeaker, the deflection belonging to that signal is seen on the screen at the center, as shown in Fig. 1.

The other visible deflections indicate the presence of signals of which the operator would be totally unaware were it not for the broad vision of the panoramic. The position of each deflection along the baseline, its amplitude, and its shape convey to the operator, *immediately*, the frequency, strength and character of the signal producing it. Thus, panoramic grants the operator an insight that assists in eliminating the headaches and limitations of unisignal aural reception and permits him to see the *whole* band as it exists at that very moment.

Theory of Operation

The panoramic portion of the typ-

ical post-war ham superhet will consist of the stages shown in Fig. 2.

Special Bandpass Amplifier.—The aural converter feeds a series of signals picked up by the receiving antenna into the special r.f. amplifier of the panoramic section. The usual selectivity of converters, even when preceded by one or more tuned r.f. stages, is such as to produce a broad response. Of course, the resonant signal suffers the least attenuation while signals which differ from the resonant one in frequency are attenuated in proportion to this difference. One of the goals in panoramic reception is the visual reproduction of signals in the form of deflections whose amplitudes are *in the same ratio as the original signals*. Referring to Fig. 1, if the signal which produced deflection A was half as strong as the one which gave rise to signal B, and if signal C was about half the strength of A, then we have established the correct amplitude ratios. In order to accomplish this result, it is necessary that the special panoramic bandpass amplifier compensate for the selectivity of the r.f. section of the aural receiver; it must therefore amplify where the receiver attenuates, and attenuate where the receiver amplifies in order to produce a flat response over the entire visual band. If the visual band chosen is

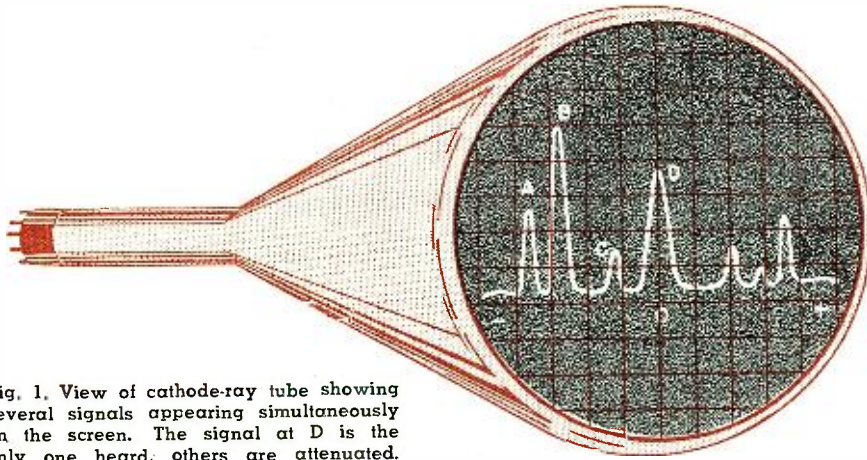

Fig. 1. View of cathode-ray tube showing several signals appearing simultaneously on the screen. The signal at D is the only one heard; others are attenuated.

200 kc. (100 kc. on each side of the zero line), then the combination of the bandpass amplifier's response and the aural r.f. response must approximate a straight line over a band of 200 kc.

The FM Oscillator.—Just as in the conventional superheterodyne receiver, the panoramic contains a local oscillator. However, this oscillator is frequency modulated (wobulated) over a range of frequencies corresponding to the pass band (200 kc. in our example) so that it successively heterodynes all of the signals which are fed to the mixer stage from the bandpass amplifier, producing a series of signals corresponding to the i.f. of the adaptor. These signals of the correct intermediate frequency are separated from each other by *time*. That is, as the oscillator sweeps over its range of frequencies, it beats with one after another of the signals in the mixer so that one after another of these signals produces the correct intermediate frequency to be amplified by the following sharply tuned i.f. stage.

The Reactor.—This stage performs as an artificial inductance which is made part of the tank circuit of the FM oscillator. By means of a phase shifting network, the current and voltage in the plate circuit of the reactor tube are thrown out of phase with each other so that, as far as the oscillator is concerned, an additional inductance now exists across its tank coil. Furthermore, as the grid voltage on the reactor changes (see Sawtooth Generator below) the amount of apparent inductance changes. This, of course, results in a variation of oscillator frequency which keeps perfect step with the variations of voltage applied to the grid of the reactor.

The Sawtooth Generator.—A blocking-tube oscillator is used to produce a sawtooth waveform which is applied as a sawtooth voltage to the grid of the reactor tube. Since the sawtooth voltage is linear, the frequency excursions of the FM oscillator have a linear form. This results in a set of screen calibrations which are equidistant from one another and represents a distinct advantage for determining the frequency of any deflection in terms of the frequency of

the center deflection. In effect, then, the steps which give rise to frequency modulation are: (1) production of a sawtooth voltage which is applied to (2) the grid of the reactor. This causes the apparent inductance of the latter to vary in step with the sawtooth voltage and hence, (3) the frequency of the local oscillator varies at the same rate.

It may be seen from Fig. 2 that the sawtooth amplifiers are connected to the horizontal deflection plates of the cathode-ray tube. The same sawtooth generator which produces frequency modulation of the oscillator is thus made to swing the CRT electron beam horizontally along the face of the tube. Thus, the successive peaks produced by the FM oscillator are separated from each other along a horizontal axis and, furthermore, always appear steady because of the synchronization between the FM action and the horizontal sweep action. It must be remembered that deflections which appear stationary and discrete are not actually that way; due to persistence of vision and persistence of fluorescence, signals which appear, disappear, and reappear with rapid periodicity seem to be present all the time.

Detector and Video Amplifiers.—The behavior of these stages is normal. Rectification of signal voltages takes place in the detector circuit. These voltages are then amplified and fed to the vertical deflection plates of

the CRT. The deflections which appear as a result of these voltages are evidently reproductions of the response curves of the i.f. stages of the panoramic.

Maximum Sweepwidth

The visual pass-band of 200 kc. mentioned in connection with Fig. 2 was purely arbitrary. Many types of panoramics are scheduled for postwar production. Pass-bands (we shall call these "maximum sweepwidths") ranging from 50 kc. all the way up to 10,000 kc. or higher will be available. The choice of any particular maximum sweepwidth will depend upon several factors, not the least important of which is the design of the aural receiver.

Variable Sweepwidth

Every panoramic receiver, regardless of type, will be equipped with a control for varying the sweepwidth from maximum, through all the intermediate positions down to zero. One reason that this is an extremely valuable feature is that it enables the operator to better analyze the characteristics of individual signals. Fig. 3A is a picture of a single signal as it appears on the screen at *maximum* sweep. In B, the sweepwidth has been reduced to about 20% of maximum. Notice how the modulation on the carrier is becoming visible as a secondary waveform superimposed on the original deflection. The panoramic, at zero sweep (Fig. 3C) becomes a perfect oscillograph for minute analysis of received signals.

Referring to Fig. 4A, two signals of adjacent frequency are interfering with each other, producing a pair of deflections which are almost merged. Under these conditions, neither signal can be studied satisfactorily. At about 20% sweep, however, the signal deflections separate (see Fig. 4B) and become readily accessible for analysis. For the amateur operator, this increase of visual selectivity (resolution) is exceedingly valuable because it enables him to determine the side (high or low frequency) where interference is taking place. Armed with this knowledge, he can advise the transmitting station to shift higher or

Fig. 2. Block diagram showing stage-by-stage operation of the panadapter.

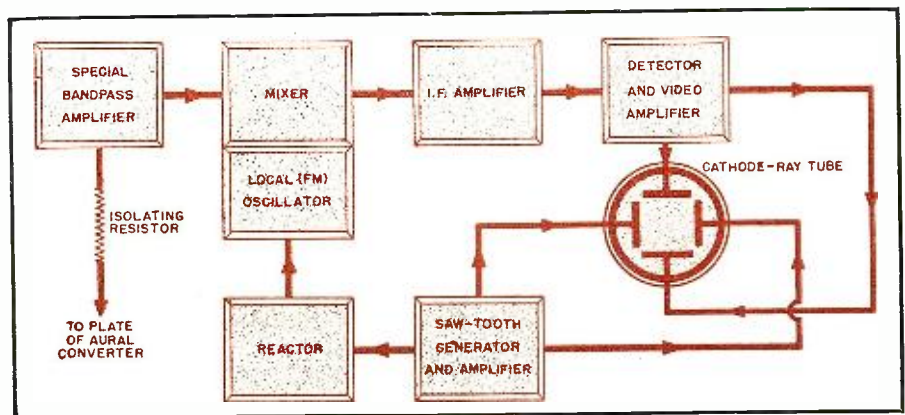

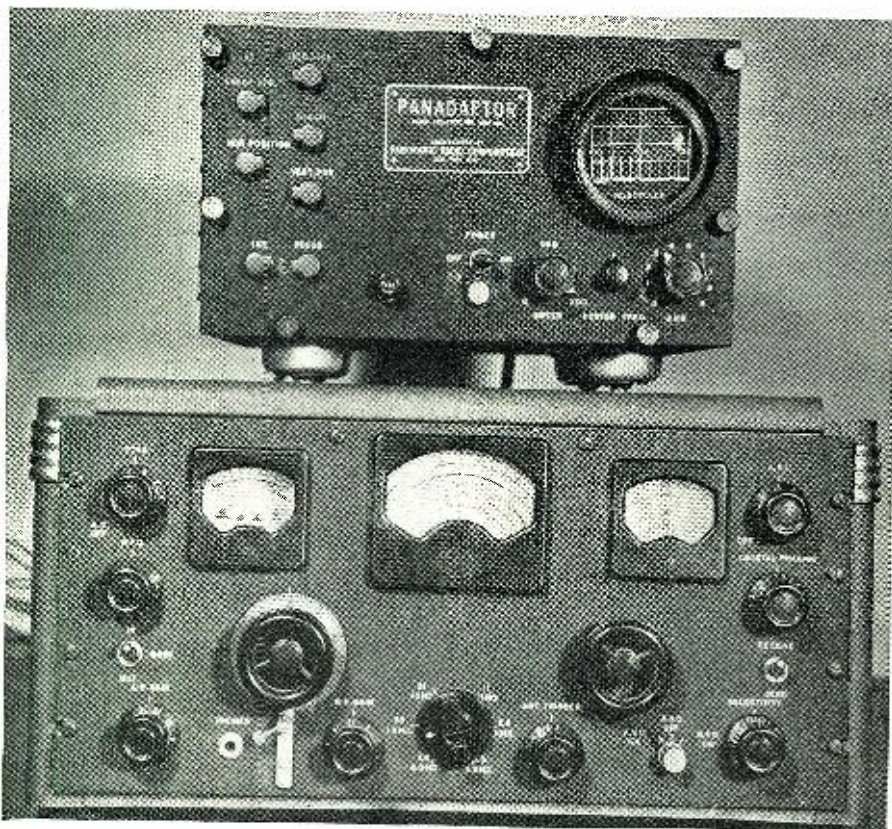

Proper placement of the panoramic adapter with relation to the shortwave receiver.

lower in order to clear his channel.

In Fig. 5 are shown reproductions of photographs of the panoramic screen taken under actual operating conditions and showing typical signals

that operators may find when they tune to the bands indicated.

1. Signal modulated at 3000 cycles. Sweepwidth 100 kc. The sidebands are too close to the fundamental to be

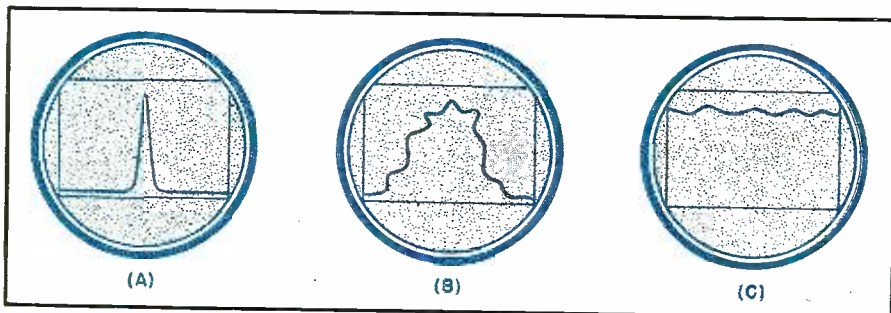
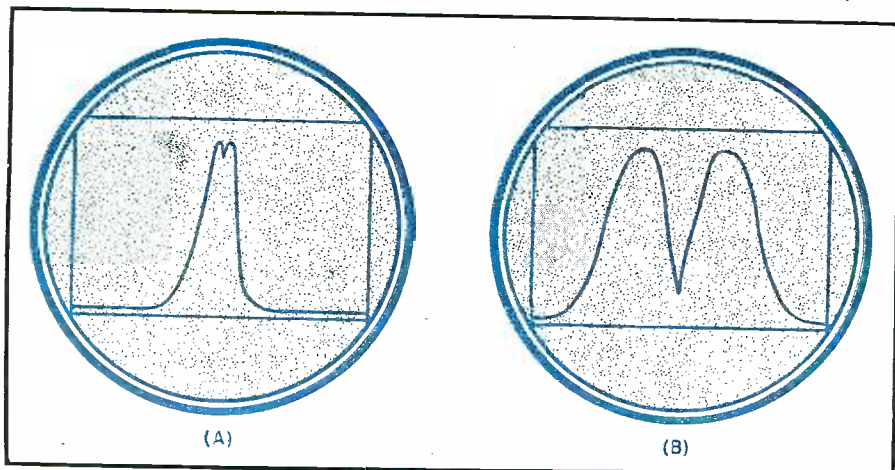

Fig. 3. Effect of reduction of sweepwidth on the appearance of a single signal.

Fig. 4. Two signals of adjacent frequency are shown interfering with each other.



resolved. Some irregularity at the base is the only indication of their presence.

2. Same signal as in 1. Sweepwidth reduced to 70 kc. The resolution is better and the sidebands are clearly separated on each side of the carrier.

3. Same signal as in 1. Sweepwidth reduced to 50 kc. The sidebands separate still more. The amplitude of the deflection has increased. Slight amount of overload is apparent by the flattening of the apex of the deflection.

4. Same signal as in 1. Sweepwidth reduced to 25 kc. The sidebands are still further away. (The gain of the panoramic receiver was somewhat reduced, to avoid overload).

5. Signal modulated at 15,000 cycles, sweepwidth 100 kc. The sidebands are quite distinct from the carrier.

Resolution versus Sweepwidth

6. Two carriers 5 kc. apart at full sweepwidth of 100 kc.

7. Same carriers as in 6 with sweepwidth reduced to 50 kc.

8. Same signals as 6 and 7 with sweepwidth reduced to 20 kc. (Gain slightly reduced to avoid overload.)

Deflection Amplitude versus Signal Strength

(100 kc. sweepwidth, no AVC control, fixed gain control.)

9. 10 microvolt signal.

10. 100 microvolt signal. Limiting amplitude has been reached.

11. 1000 microvolt signal. Base widens up. Limiting action causes square top.

12. 10,000 microvolt signal. Small spurious signal visible on the left. Some irregularity at the base is the only indication of its presence.

13. 100,000 microvolt signal. The deflection breaks up into three portions; one central portion flattened on the top and two "harmonic spurious."

Example of Actual Receiving Conditions

14. 14 mc. amateur phone band. About six modulated phone stations are visible.

15. A portion of the broadcast band. Stations are distributed at every 10 kc.

16. Three c.w. stations. Due to the rapid keying, the deflections appear closed at the bottom. On the left side a "key click" appears.

FM Signals (100kc. Sweepwidth)

17. Carrier during period of silence.

18. Very little modulation.

19. Increased modulation.

20. Heavy modulation.

Panoramic Aids Operating Efficiency

With his eye on the panoramic screen, the operator can watch the answers he has heard in tuning through the band; he gives them a fast dit dah dit dit the minute they sign, and holds them while he waits for the other calls to finish up.

(Continued on page 92)

Television

for the Amateur

By **OLIVER READ, W9ETI**

Managing Editor, Radio News

TELEVISION is not too complicated for the amateur—neither is it too expensive. The radio amateur, always inquisitive, and with a comprehensive knowledge of transmitter and receiver practical theory and operation, has only three obstacles in his path: study of high-frequency methods, study of circuits for non-sinusoidal waves, and study of the assembly of the various signal components which constitute the composite television signal. If he already has appreciable high-frequency and cathode-ray-tube experience, which I conservatively estimate 60% of the radio amateurs have obtained in their commendable war contributions, he is two giant steps closer to the television goal. A knowledge of patterns and internal electron'ricities of the cathode-ray test oscillograph is a step in the approach. A radio amateur with high-frequency relay or link experience and with radar design, construction, or repair experience, has the acme of pre-television instruction.

To learn how the receiver functions is a major portion of the task, for understanding exactly what occurs in the receiver entails a knowledge of the composition and arrangement of the transmitted television signal. This information can be obtained by studying the present and back installments of the receiver series now appearing in RADIO NEWS.

Function

What are the basic functions of the television system?

A. Transmission

1. Forms a picture signal which is a parade of electrical charges representing the light distribution on the object televised.

2. Forms a series of rectangular pulses, sync and blanking, of various amplitudes and durations, which are inserted into the picture signal at prescribed intervals, to hold the picture stationary or "in sync" on the receiver screen and to prevent picture from streaking.

3. Generation of a high-frequency

Television—a new field for the postwar ham—will provide additional interest to amateur activity.

carrier which is modulated by this composite television signal.

4. Generation of an associated sound carrier, which is, in commercial practice and possibly will be in amateur practice, frequency-modulated by the sound information.

B. Reception

1. The receiver in commercial practice picks up both picture and sound carriers and passes them into separate i.f. systems. The amateur can use the same method or two separate receivers, whichever is most convenient.

2. Picture signal is transferred back into light variations on the screen of the picture tube.

3. Sync pulses hold the reproduced image on the picture tube screen, prevent "tearing out" (horizontal displacement of picture elements) and "flopping over" (vertical displacement of picture elements).

Thus, the television system has two primary functions, namely: to get the light information to the picture tube, and to display it in proper sequence (synchronized) with stability.

Frequency

To transmit a picture with clarity

and definition, a wide-band of frequencies is necessary. Thus, if a signal is transmitted which contains two-megacycle components, a four-megacycle bandwidth is required, unless some elaborate scheme is used to partially suppress one sideband. If better definition is desired, the bandwidth must be proportionately greater.

Observation of the frequency bands allocated to the amateur shows that only the very high-frequency bands can accommodate such a wide channel. These bands are listed in the accompanying chart. One other band is five megacycles broad, 220 to 225 megacycles. This band could only accommodate one four-megacycle channel. It is not likely that television will be permitted in this band, because of interference between television stations and other types of communications on the band. It is desirable that the FCC allocate separate television sections on the high-frequency amateur bands, and specify bandwidths which become progressively wider (permitting higher definition) on the higher frequency bands. A tentative outline for such a system is shown in Table 1.

While these frequencies are considered—
(Continued on page 120)

Table 1. Frequency bands allocated to the amateur. Only the very high frequency bands can satisfactorily accommodate television transmissions.

| Amateur Band Megacycles | No. of Channels | Max. Band- Width per Channel Megacycles | Television Band Megacycles |
|----------------------------|--------------------|--|-------------------------------|
| 420-450 | 3 | 4 | 420-432 |
| 1125-1225 | 5 | 8 | 1125-1165 |
| 2500-2700 | 7 | 10 | 2500-2570 |
| 5200-5750 | 10 | 20 | 5200-5400 |
| 10,000-10,500 | 10 | 20 | 10,000-10,200 |
| 21,000-22,000 | 20 | 20 | 21,000-21,400 |

5" OSCILLOSCOPE DESIGN

By

RUFUS P. TURNER
Consulting Eng. RADIO NEWS



Oscilloscope tube of the type now offered for sale which may be obtained without priorities.

The design and construction of an oscilloscope employing five-inch government surplus tubes.

SURPLUS goods houses recently have advertised in the radio and mechanical magazines 5-inch oscilloscope tubes of the 5BP1 and 5BP4 types. These tubes, which are being offered at an attractive price and may be obtained without priorities, were bought originally by the Government for the armed radio services. They are the first oscilloscope tubes to be obtained so easily by the public since Pearl Harbor.

The 5-inch screen gives a magnificent view of all patterns. Such a tube is applicable to television reception, on an experimental basis, as well as to oscillography, and it is likely that many experimenters will use the Government surplus tubes in home-made equipment. We have received queries already by quite a few experimenters who want particular pointers on building a 5-inch oscilloscope of good design.

It is with these experimenters in mind that we offer the following article, describing 5-inch oscilloscope design and construction. In preparing this material, we have drawn largely upon our own experience and to some extent upon the previous literature. The leading facts have been digested into working data.

Tube Differences

Both 5BP1 and 5BP4 have been made available to the public. The main differences between these tubes are in certain of their operating volt-

ages and in the screen materials they employ. The 5BP1 screen is coated with phosphor No. 1 (green fluorescence), while the 5BP4 screen uses phosphor No. 4 (white fluorescence). There is a slight difference in anode voltages. The lowest anode #2 (high-voltage electrode) voltage common to both types, for a bright pattern, is 1500 volts d.c. Lowest common anode #1 voltage is 310 volts d.c. Both tubes have 6.3-volt, .6-ampere (a.c. or d.c.) heaters and have the same physical dimensions: over-all length $16\frac{3}{4}$ " plus or minus $\frac{3}{8}$ ", diameter $5\frac{1}{4}$ " plus $\frac{1}{16}$ " minus $\frac{3}{32}$ ". Both have medium persistence. The 5BP1 is similar to type 1802-P1, and the 5BP4 to type 1802-P4. Each type requires a large wafer mag-nal, 11-pin socket.

5-Inch Oscilloscope Circuits

Two arrangements are of interest to oscilloscope builders—the *basic* and *complete* circuits. These arrangements are shown in functional block diagrams in Fig. 1. Practical circuit schematics appear in Figs. 3 and 4. The first type embraces only the oscilloscope tube, power supply, and vertical and horizontal input terminals. This type is used only when simple observations are to be made. Such observations include those of modulation patterns or of resonance figures from relatively high voltage sources, and high-level signal voltages (a.c. or d.c.) which do not require amplification or a time base. The basic oscilloscope may readily be converted into a complete instrument on occasion by adding, externally, the horizontal and vertical input amplifiers and the linear-base sweep oscillator. The complete type includes, in addition to the oscilloscope tube and power supply,

internal vertical and horizontal signal amplifiers, internal saw-tooth sweep oscillator, gain controls, synchronizing control, and a complete set of input terminals and associated switching circuits.

Basic Oscilloscope

The circuit diagram of a practical 5-inch basic oscilloscope is given in Fig. 3. This unit is powered by two type 6X5 tubes and a small transformer, T, of the broadcast replacement type, having a 350-0-350 v., 180-ma. high-voltage secondary. The entire high-voltage winding is used (center tap left floating) and is connected with the two rectifier tubes and two 8- μ fd., 1000-volt oil-impregnated, oil-filled capacitors, C_1 and C_2 , to form a half-wave voltage doubler circuit. Two separate filament windings are employed, since use of a single winding would result in a dangerous heater-cathode potential in the 6X5's. The high d.c. voltage delivered to the #2 anode of the oscilloscope tube will be between 1500 and 2000 volts.

Voltages for the various d.c. electrodes of the oscilloscope tube are obtained from the voltage divider string $-R_1-R_2-R_3-R_4$. The focus control (R_2) and the brilliance control (R_3) are standard good-grade volume control-type potentiometers. R_1 and R_4 each must be rated at 2 watts.

One 6.3-volt winding of the power transformer supplies heater voltage to the two 6X5 tubes and the pilot light. The other 6.3-volt winding supplies the heater of the cathode-ray tube. The 5-volt secondary, commonly supplying rectifier filament voltage, is left floating.

Signal and sweep voltage sources, or separately-housed horizontal and

vertical amplifiers may be connected to the corresponding input terminals. Isolating capacitors, C_3 and C_4 , are inserted in the signal input lines, but may temporarily be shorted out when checking d.c. signal voltages.

When testing or operating the basic oscilloscope, it must be borne in mind that this is a high-voltage device which is potentially dangerous. Points, such as chassis and one leg of each input circuit, which normally are "cold" in ordinary radio sets and instruments, are at high positive potential in this oscilloscope. The operator must not probe about inside the 'scope with the power turned on, without first taking every precaution, including extra mental alertness and increased familiarity with the wiring diagram, to prevent electric shock.

To place the instrument into operation; (1) Turn brilliance control R_1 to lowest setting; (2) Insert line plug into 115-v. a.c. receptacle and throw switch S to "ON" position; (3) After waiting about 1 minute for tube heaters to reach normal operating temperature, advance brilliance control R_1 slowly, noting that luminous spot appears on screen end of oscilloscope tube; (4) Adjust focus control R_2 until spot is sharp and clear; (5) If spot is not bright enough for easy visibility, advance brilliance control further in direction of top setting. Signal voltages now may be applied to horizontal and vertical input terminals.

It is unwise to keep a bright stationary spot or pattern on the screen for any appreciable length of time, since the screen will be damaged thereby. When stationary patterns must be studied, brilliance should be reduced to the lowest possible level which will give accurate visibility with a minimum of eye-strain.

Suggested mechanical construction of the basic oscilloscope is shown in Fig. 2. Here, front, side, and top views are shown to indicate recommended placement of parts on the metal chassis, front panel, and back plate. For viewing the oscilloscope screen, a 5-inch-diameter hole is cut in the 7" x 14" front panel, 1 inch down from the top and 1 inch in from left and right sides. Directly behind this hole is mounted a retaining ring for holding the screen end of the tube in place.

The socket required by the oscilloscope tube is rather large, having its contacts in a circle a little better than 1 inch in diameter. A suitable socket is *Amphenol* type 49-SS11L. This is a steatite component requiring a mounting hole $1\frac{9}{16}$ " in diameter which is cut near the top of the 7" x 12" back plate shown in the drawings. On the same back plate, below the 'scope socket, a square cutout is made for the transformer. The latter is mounted with its shell to the rear of the instrument. It is imperative that the transformer be mounted below the rear of the 'scope tube, in order that hum fields may not distort the patterns on the screen.

Transformer leads pass through the

top of the chassis through a pair of grommet-lined holes. Leads from the 'scope-tube socket pass through a pair of similar holes in the back plate and then through grommet-lined holes in the top of the chassis. The leads from 'scope tube terminals 3, 6, 8, and 9 should be covered with a good-grade shield braid. These four leads must be kept clear of tube-heater and power line leads from which hum might be picked up. The power cord extends from the rear of the chassis.

The minimum chassis dimensions will be 7" x 22" x 2". The entire foundation unit—front panel, chassis, back plate, and an outer case to enclose the entire instrument—may be made from heavy-gauge steel, galvanized iron, or other sheet metal stock. The metal case is effective in shielding the oscilloscope from stray fields. However, if scarcity of sheet metal dictates, the instrument may be built on a wooden front panel, back plate and baseboard and housed in a wooden cabinet. But an instrument built in this manner is extremely sensitive to stray fields and hum pickup and must be kept clear of all sources of magnetic fields.

The basic oscilloscope is entirely practical but is adequate only in those applications where input amplifiers and a linear sweep circuit would seldom, if ever, be used. At an anode #2 voltage of 2000, the 5BP1 tube in the basic oscilloscope offers a horizontal deflection sensitivity of .30 millimeter per volt d.c. and a vertical deflection sensitivity of .33 millimeter per volt d.c. The 5BP4 tube, operated at the same anode #2 potential in the basic instrument, offers a horizontal deflection sensitivity of .17 millimeter per volt d.c. and a vertical deflection sensitivity of .21.

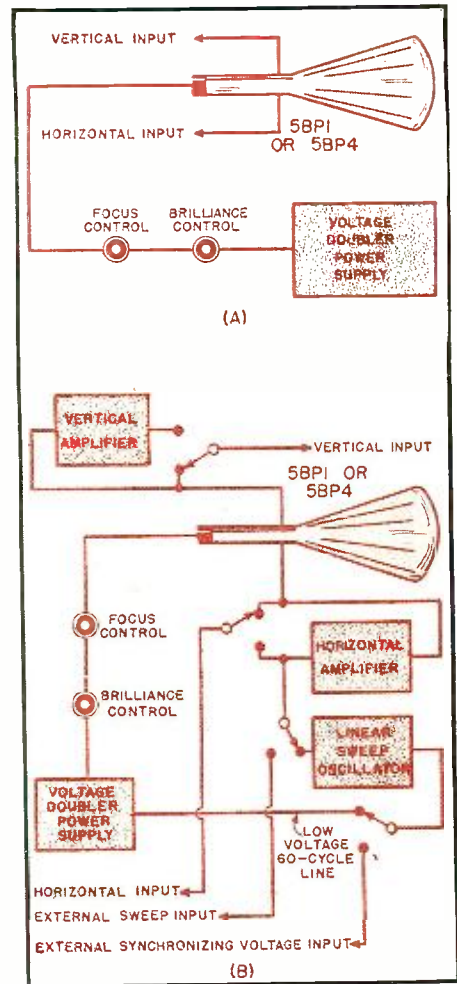
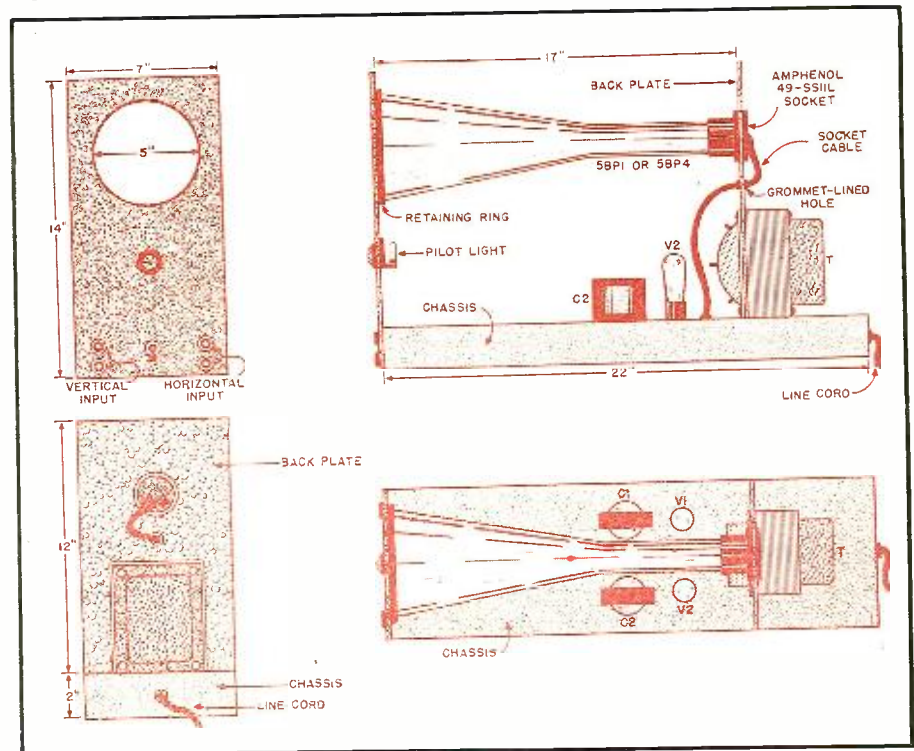

Fig. 1. Block diagrams of the basic oscilloscope (A) and the complete unit (B).



Fig. 2. Mechanical layout for basic oscilloscope showing proper component placement.



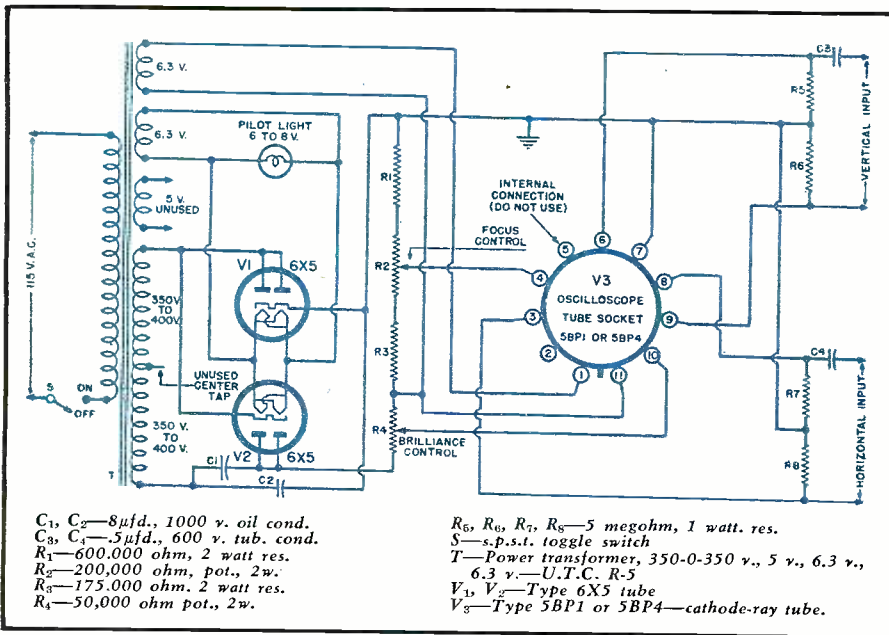

Fig. 3. Basic diagram of the oscilloscope with many of its possible features omitted.

The circuit schematic for a complete 5-inch oscilloscope with all amplifiers, linear sweep oscillator, controls, and input terminals, is shown in Fig. 4. Like the basic 'scope just described, this instrument may employ either

the 5BP1 or 5BP4 with the same circuit constants shown in Fig. 4.

As in the basic instrument, a voltage doubler type of power supply is employed. The unit in the complete oscilloscope uses two type 2X2 tubes, in

place of the smaller rectifiers, along with the two $8\text{-}\mu\text{fd.}$, oil-impregnated, oil-filled capacitors and the full high-voltage secondary winding of a small, compact transformer. The high-voltage secondary must deliver a slightly higher potential in this instance (385 volts each side of center tap), and the transformer must have two separate $2\frac{1}{2}$ -volt secondaries, as well as one 6.3-volt winding. Since the heaters of the cathode-ray tube and amplifiers cannot be operated from the same winding without introducing a destructive heater-cathode potential in the amplifiers, a separate miniature 6.3-volt transformer, T_2 , is included in the circuit expressly for the heaters of the two amplifier tubes (V_5 and V_6) and the sweep oscillator tube (V_4).

The power supply shown in Fig. 4, as well as the one in Fig. 3, is an emergency arrangement designed to make use of a regular, replacement type transformer. Special oscilloscope transformers are very scarce at this time. Other equally satisfactory arrangements will occur to individual builders who have components of other types on hand.

The horizontal and vertical input amplifiers are 6SJ7 pentodes, V_5 and V_6 respectively. The linear sweep oscillator is the type 884 gas triode, V_4 .

(Continued on page 127)

Fig. 4. Complete wiring diagram including the horizontal and vertical amplifiers, internal saw-tooth sweep oscillator, gain controls, synchronizing controls, and a complete set of associated switching circuits.

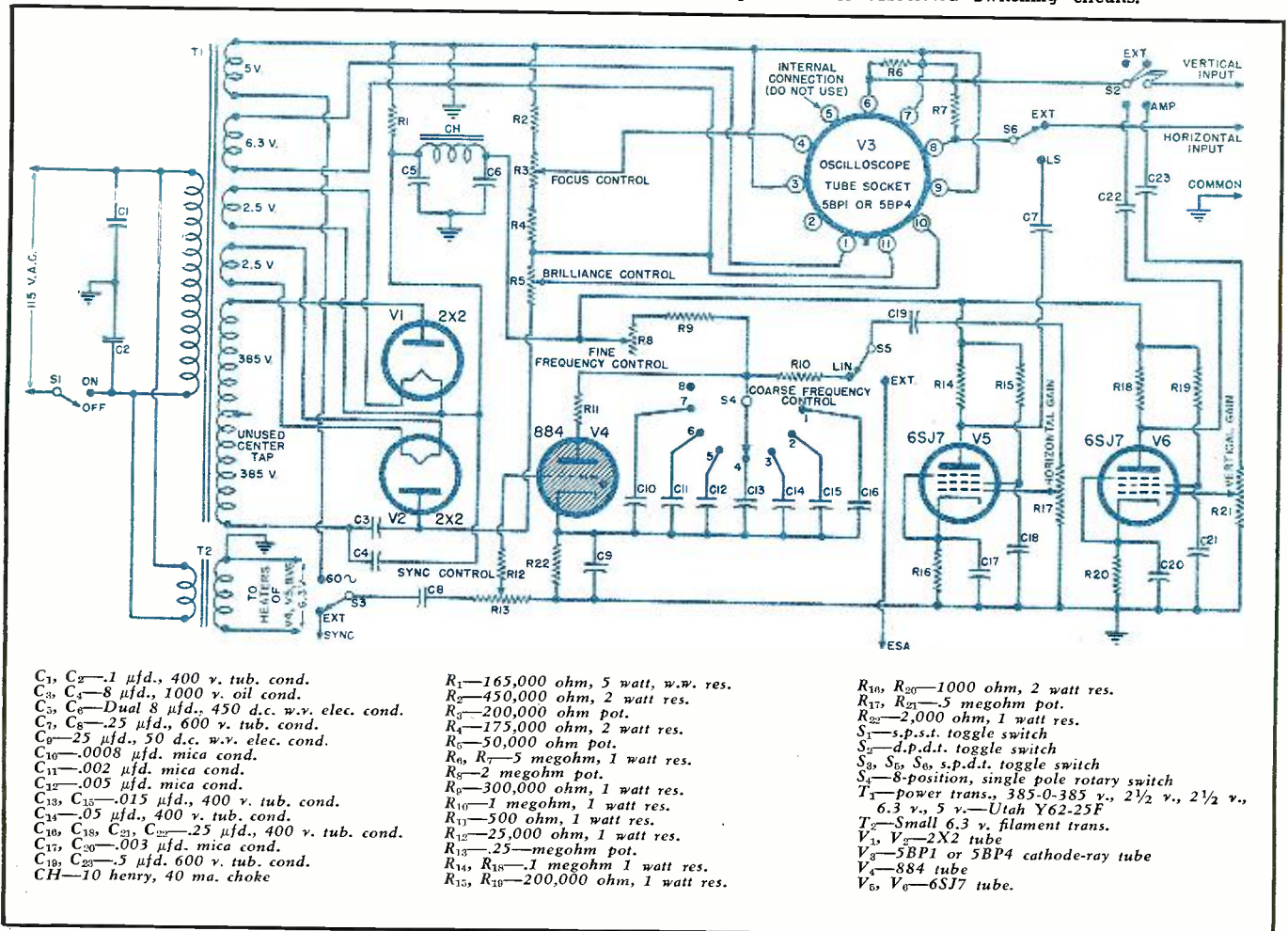

Practical RADAR

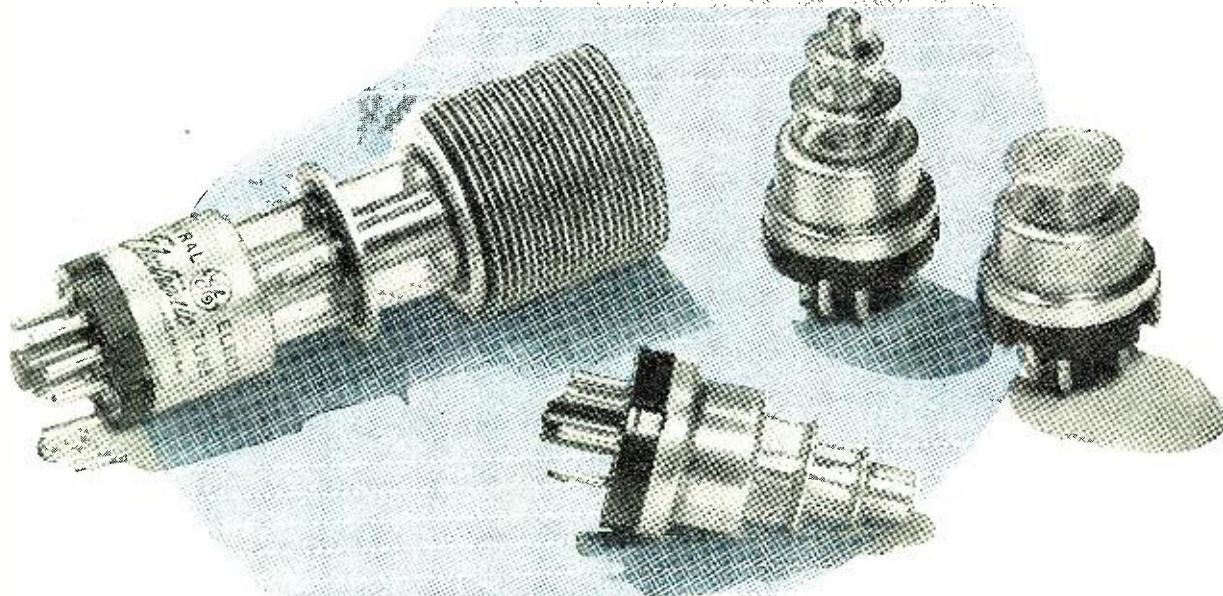

Four General Electric tubes based on the revolutionary disc-seal development. Tube at left is a transmitting type; others are receiving tubes.

By
JORDAN McQUAY

Part 3. Theoretical analysis of how precisely timed pulses of ultra-high r. f. energy are generated in sufficient strength to reach all targets.

RADAR'S ingenious method of detecting and locating targets in the sky or on the sea or land is based wholly on the transmission and reception of radio frequency pulses.

All components of a radar set—the transmitter, receiver, electronic timer, and indicator—play an equally responsible part in the generation, transmission, reception, and measurement of these pulses.

But much of the effectiveness of radar depends upon the ability of the transmitter to radiate pulses of sufficient strength to reach all targets within maximum range of the set. Thus, the radar transmitter plays an important and difficult role in the generation of brief, precisely timed, and extremely powerful pulses of ultra-high radio frequency energy.

These pulses are radiated into space by the antenna and travel at the speed of light until they strike an object or surface. The r.f. energy is then reflected or re-radiated in all directions from the object, and some of this reflected energy reaches the radar receiver in the form of *echoes*.

After radiating an r.f. pulse, the transmitter is turned off and there is a quiescent or "listening" period—during which echoes from targets within range of the set can be re-

ceived. Then the transmitter generates another pulse of u.h.f. energy and the complete cycle is repeated—always allowing sufficient time for echoes to return from targets within maximum range of the set.

The entire out-and-back cycle of an r.f. pulse takes place thousands of times per second, due to the high speed of radio waves in space. And the echoes are displayed on the radar indicator only a few microseconds after the original r.f. pulses have been transmitted.

The determination of the range and direction of objects or targets is based on the facts that radio frequency energy travels at the constant velocity of light (about 186,000 miles per second), and that the transmitting and receiving antennas of the radar set are movable and highly directional.

Since the speed of the r.f. pulses through space is known, the range or distance between the radar set and the target can be found by multiplying the speed of light by one-half the time a single radar pulse requires to complete a round trip cycle. This time is measured and displayed on the time base of a cathode ray oscilloscope and translated instantaneously into terms of distance; in yards or miles.

Having determined range or dis-

tance, the direction of the target in azimuth (relative to north) and in elevation (relative to the horizontal plane of the earth) can be determined by the physical position of the antenna system. And this gives us sufficient information—range or distance, azimuth or bearing, and angle of elevation—with which we can locate accurately the position of the target in space or on land or water.

Radar Pulses

Last month we discussed in detail the operation of the electronic timer and the creation of the all-important radar control voltage; a series of identical rectangular pulses, having a certain duration and recurring at an exact and unvarying rate of repetition. This pulse timing rate is known as the *pulse recurrence frequency* of the radar set—usually a value between 250 and 5000 pulses per second, depending upon the maximum range of the set.

The electronic-timer controls and synchronizes other components of the radar set, but its most important function is the creation of the basic control pulses which are applied to the radar transmitter.

A block diagram of this controlling action is shown in Fig. 1. The voltage control pulses from the electronic

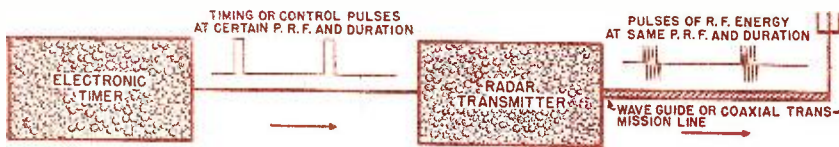

Fig. 1. Block diagram illustrating basic operation of the transmitter.

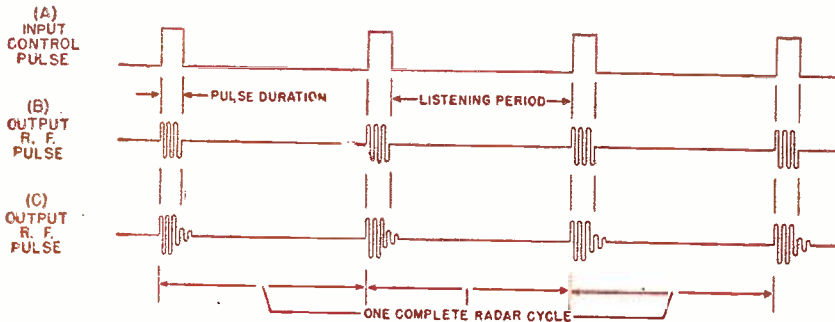

Fig. 2. Two types of radio-frequency pulses from a radar transmitter.

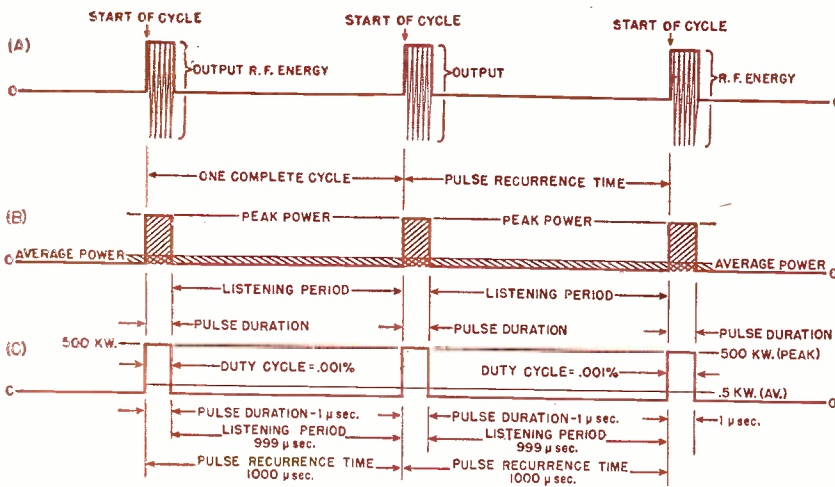

Fig. 3. Graphically illustrating three separate wave forms that in general represent the same basic radio frequency pulse that is used.

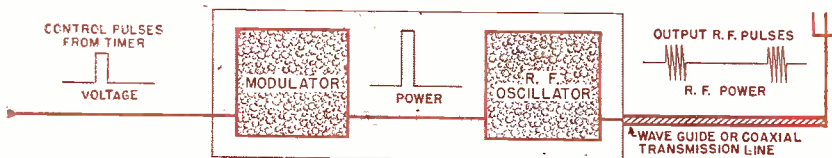

Fig. 4. Block diagram of radar transmitter showing wave form at each stage.

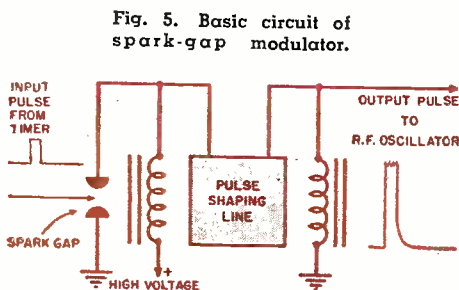

Fig. 5. Basic circuit of spark-gap modulator.

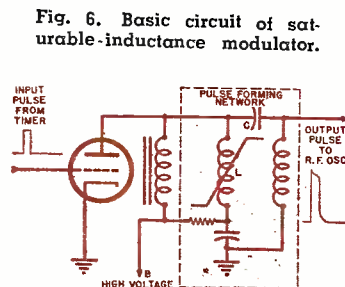

Fig. 6. Basic circuit of saturable-inductance modulator.

timer cause the radar transmitter to generate similar pulses of ultra-high radio frequency energy of extremely high power.

The output r.f. pulses from the transmitter have the same duration as the input control pulses. The output r.f. pulses also recur at the same pulse recurrence frequency as the input control pulses. And the output r.f. pulses have the same general shape or *envelope* as the input control pulses.

But in order to radiate energy into space, the output pulses consist of very powerful ultra-high frequency oscillations.

Thus, in considering the output pulses of a radar transmitter, two frequencies are involved: the u.h.f. carrier frequency at which the pulses are transmitted into space—and the relatively low pulse recurrence frequency—usually between 250 and 5000 pulses per second.

In other words, the ultra-high frequency carrier of the radar transmitter is modulated by means of the control pulses from the electronic timer.

The related effect of this type of modulation is shown by the wave forms in Fig. 2. The input control pulse A to the transmitter causes a series of u.h.f. oscillations B which start and stop according to the modulating voltage from the timer. In some cases, however, it should be noted that r.f. oscillations do not always cease abruptly C when the control voltage is removed from the transmitter; these r.f. oscillations manifest a damped or attenuated effect, resulting in the appearance of a "tail," due to imperfect characteristics of the transmitter.

For all practical purposes, however, the r.f. pulse forms shown at B and C of Fig. 2 are equally effective in the detection and location of targets.

From this point in our discussion it will be necessary to think of two frequencies taking place simultaneously every time a radar transmitter pulses; the carrier frequency of the ultra-high frequency oscillations, and the p.r.f. or pulse recurrence frequency of the pulses. We have previously discussed the creation and timing of the control pulses. Now we are concerned with the generation of u.h.f. oscillations at very high power, and the methods of modulating this output carrier according to the timer's control pulse.

Carrier Frequency

The ultra-high frequency at which pulses of r.f. energy are generated is known as the carrier frequency of the radar set. This frequency of operation will vary over a wide range depending on the tactical use of the different types of radar sets.

In general, however, there are only two factors influencing the choice of the carrier frequency: the difficulty in generating high-power u.h.f. energy, and the desired directivity of the radar set.

Reviewing briefly the radar method of determining azimuth and angle of elevation of the target, it will be remembered that these angular measurements are obtained from the actual, physical position of the antenna system *after* the target is detected by means of r.f. pulses. The antenna system is rotated in azimuth or tilted back at an angle, so that the full strength of the radar beam of pulsed energy falls upon the center of the target. We can determine this condition by observing the size of the echo on the cathode ray oscilloscope; the size of the echo will be greatest when the beam of pulsed energy is directly on the target.

Thus, with the antenna system facing toward the target, the antenna and the radar beam itself form an angle with the horizontal plane of the earth—giving us the angle of elevation. The antenna and the radar beam also point in a certain angular direction with respect to north—giving us the angle of azimuth or bearing.

This determination of the angles of elevation and azimuth is performed entirely by electro-mechanical means—without the use of radar pulses. After the radar set has been oriented with respect to north and properly levelled, compass-like devices measure the two required angles (in degrees or mils) from the physical position of the antenna system when its beam is on the target.

The degree of accuracy of this angular information will, therefore, depend largely on the directivity of the radar antenna system and the width of the radar beam of energy.

The radar antenna system should be highly directive, with the transmitted energy concentrated so that a greater part of it is useful in locating targets.

This desired directivity can be accomplished by reducing the physical size of the antenna system, which might well consist of a large number of dipole elements arranged in an array. The shorter the wave length of the dipoles, the smaller and more directional becomes the antenna array.

Thus, a high carrier frequency results not only in a greater concentration of r.f. energy in the radar beam and a more highly directive beam, but the radar antenna array will be relatively small from the physical standpoint.

The directional advantages of an extremely high carrier frequency are somewhat offset, however, by the many difficulties encountered in generating and amplifying such high frequencies.

Therefore, the carrier frequency selected for radar operation is usually a compromise between the directional advantages of u.h.f. energy and the generating difficulties in producing such frequencies.

Output Power

A radar transmitter does not generate r.f. oscillations continuously.

August, 1945

GLOSSARY OF RADAR TERMS

Azimuth—Bearing or angular direction relative to true north.
Beam width—The width in azimuth of the pulsed r.f. energy beam.
Bearing—See Azimuth.
Blocking oscillator—Tuned-grid, tuned plate r.f. oscillator in which the grid circuit controls the pulse duration.
Carrier frequency—The ultra-high frequency at which a radar transmitter operates.
Cathode follower—Distortionless, impedance-matching, isolating stage.
Charged line—A pulse-shaping network which reflects a steep-sided rectangular pulse of a duration determined by the electrical constants of the line.
Clamping circuit—A circuit which holds either the positive or negative amplitude extreme of a wave form to a given reference level of voltage.
Cut-off limiting—Limiting action of an amplifier when operated beyond the point of plate current cut-off.
D.C. restorer—See clamping circuit.
Delay circuit—Network or circuit which introduces a time or phase delay of a wave form.
Differentiator circuit—A short time constant (RC) circuit and amplifier which produces an output voltage with an amplitude pro-

portional to the rate of change of the input voltage. A circuit used to sharpen a wave form. Sometimes called a peaking circuit.
Dipole—A half-wave center-fed radiating element.
Duty cycle—The fraction of a complete radar cycle during which energy is transmitted.
Echo—That part of the r.f. pulse reflected back to the radar set by a target.
Electronic timer—The component of a radar set that originates the pulse recurrence frequency, and synchronizes the operation of other components with the radiation of r.f. pulses by the transmitter.
Elevation angle—The angle of the target with respect to the radar set and the horizontal plane of the earth.
Envelope—The general outline of a wave form.
Gate—A rectangular wave used to switch a circuit on or off electronically during certain portions of the radar operating cycle.
Grass—Static or noise appearing as intermittent, minute interruptions of the oscilloscope time base.
Ground return—That part of the r.f. pulse reflected by the ground surrounding the radar set.

(Continued on page 151)

Between the recurrent pulses of ultra-high frequency energy, the transmitter is quiescent for comparatively long intervals of time.

For example, a given radar transmitter might generate r.f. energy for only 1 microsecond and then be turned off for a period of 999 microseconds.

Since the useful output power of the radar transmitter is the power contained in the radiated pulses, the circuits of a transmitter are designed to concentrate as much power as possible into these brief and all-important r.f. pulses.

The maximum power output *during the time the pulse is being transmitted* is known as the *peak power* of the radar transmitter. And conventional reference to the "power" of a radar set is always intended to mean the peak power radiated during the transmission of a pulse.

Output power of most other radio devices is measured as an average value over a considerable period of time. But since the quiescent period of a

radar transmitter is comparatively long with respect to its operating time, the average power radiated by a transmitter during one cycle of operation is extremely low compared to the peak power radiated during the pulse.

A relationship exists, however, between the *peak power* during the brief time of a pulse and the *average power* during an extended period of time. The time of one complete radar cycle of operation is the reciprocal of the pulse recurrence frequency, or

$$T = \frac{1}{\text{p.r.f.}}$$

Other factors remaining constant, the longer the pulse recurrence time the lower will be the average power; and the greater the pulse duration the higher will be the average power. This gives us the ratio:

$$\frac{\text{average power}}{\text{peak power}} = \frac{\text{pulse duration}}{\text{pulse recurrence time}}$$

(Continued on page 108)

Fig. 7. (A) Basic tuned-grid tuned-plate oscillator. (B) Equivalent u.h.f. oscillator using concentric lines. (C) Equivalent u.h.f. oscillator (push-pull) using tuned transmission lines in the plate, grid, and cathode circuits.

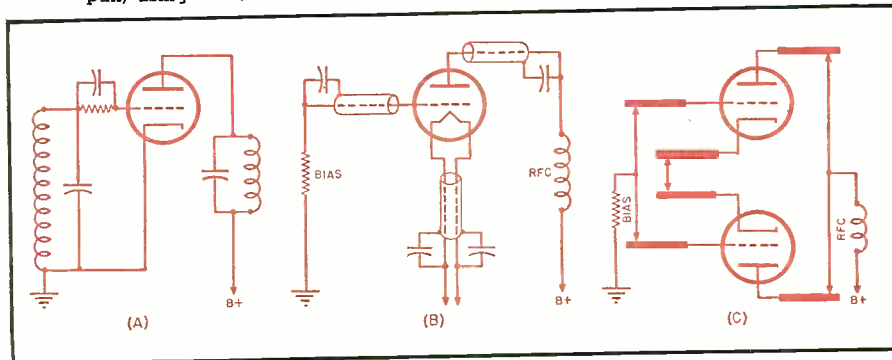

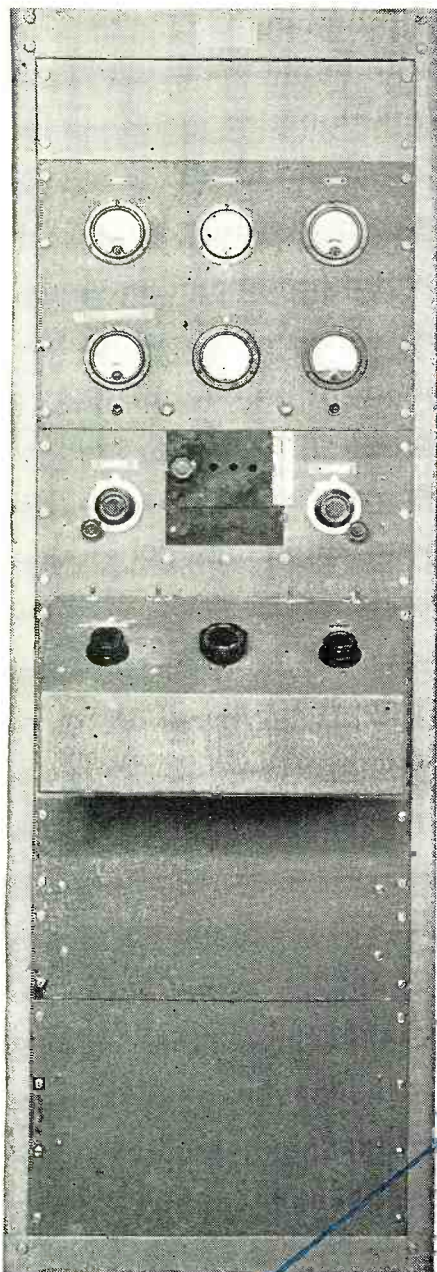

Fig. 1. Front view of the complete unit. All meters and controls are within easy reach of the operator.

AS THE trend toward higher and higher frequencies progresses, it seems opportune to present a design for a 100 megacycle transmitter.

Although 100 megacycles is not extremely high, as far as frequency is concerned, the circuit design and layout problems involved make it necessary to adhere strictly to high frequency engineering standards. Slight deviations from the path of proper design will result in the transmitter being plagued with faults too numerous to cure without complete rebuilding.

The transmitter has five r.f. stages; each will be described in detail. The final stage operates as a straight class

100 MC.

TRANSMITTER

By **WILLIAM MARON**
Senior Radio Engineer, North American Philips Co., Inc.

Many radio amateurs, through necessity, will swing towards the higher frequencies. Interesting features on high frequency design are presented.

"C" amplifier on 100 mc. with a power output of 35 watts or better. Fig. 4 shows the schematic diagram for the complete transmitter.

A detailed description of each stage follows:

First Stage — Crystal Oscillator — A 2A5 vacuum tube (and its associated circuit elements) is connected in a mildly-regenerative, crystal-controlled harmonic generating oscillator circuit. The plate tank of this stage is resonated to 12.5 megacycles, which is the third harmonic of the quartz crystal used in the control-grid circuit.

Second Stage — First Doubler — The r.f. power from the oscillator stage is injected (through a variable capacitor) into the control-grid of a doubler employing a 24G. The input of this stage is aperiodic. The output tank circuit is resonated at 25 megacycles.

Third Stage — Second Doubler — The r.f. from the preceding doubler is injected through a fixed capacitor into a second and similar doubler, using a 24G. The input is also aperiodic. The output tank is resonated at 50 megacycles.

Fourth Stage — Third Doubler and Buffer — The r.f. from the preceding stage is injected into the control grid of a doubler-buffer, also a 24G. The output circuit is a $\frac{1}{4}$ wave linear tank, loaded to $\frac{1}{4}$ wave by means of a variable capacitor.

Fifth Stage — Power Output — The r.f. power from the preceding doubler-buffer stage is inductively transferred from its linear plate-tank circuit to the $\frac{1}{4}$ wave linear-input circuit of the 24G output stage. The grid input cir-

cuit is loaded to $\frac{1}{4}$ wave by means of a variable capacitor.

Power Output Measuring

The r.f. power output of the final 100-megacycle amplifier stage and its consequent visual indication is measured by a photometric system.

The photometric system consists of a $\frac{1}{4}$ wave linear circuit inductively coupled to the tank circuit. This is shunted by a 60 watt, 120 volt incandescent lamp. It is loaded to resonance by means of a variable capacitor. The circuit is adjusted and then locked.

Inductive coupling between the $\frac{1}{4}$ wave linear circuit and the output-circuit of the final 100 megacycle amplifier is adjusted and held at an optimum value. Conditions affecting transfer of r.f. energy to the photometric system are fixed and invariable. Thus, it is obvious that the magnitude of voltage induced in this circuit is entirely dependent upon the amount of r.f. power developed in the final 100 megacycle amplifier. The induced r.f. power is utilized to heat the filament of the 60 watt bulb. Amount of light given off is a direct function (within certain limits) of induced r.f. voltage.

Light intensity is translated into measurable units of direct current through the use of a photo-electric cell, located in the beam of light generated by the 60 watt bulb. Current developed by the photo-electric cell is not a linear function of light intensity projected upon its sensitized surface. For this reason, it is neces-

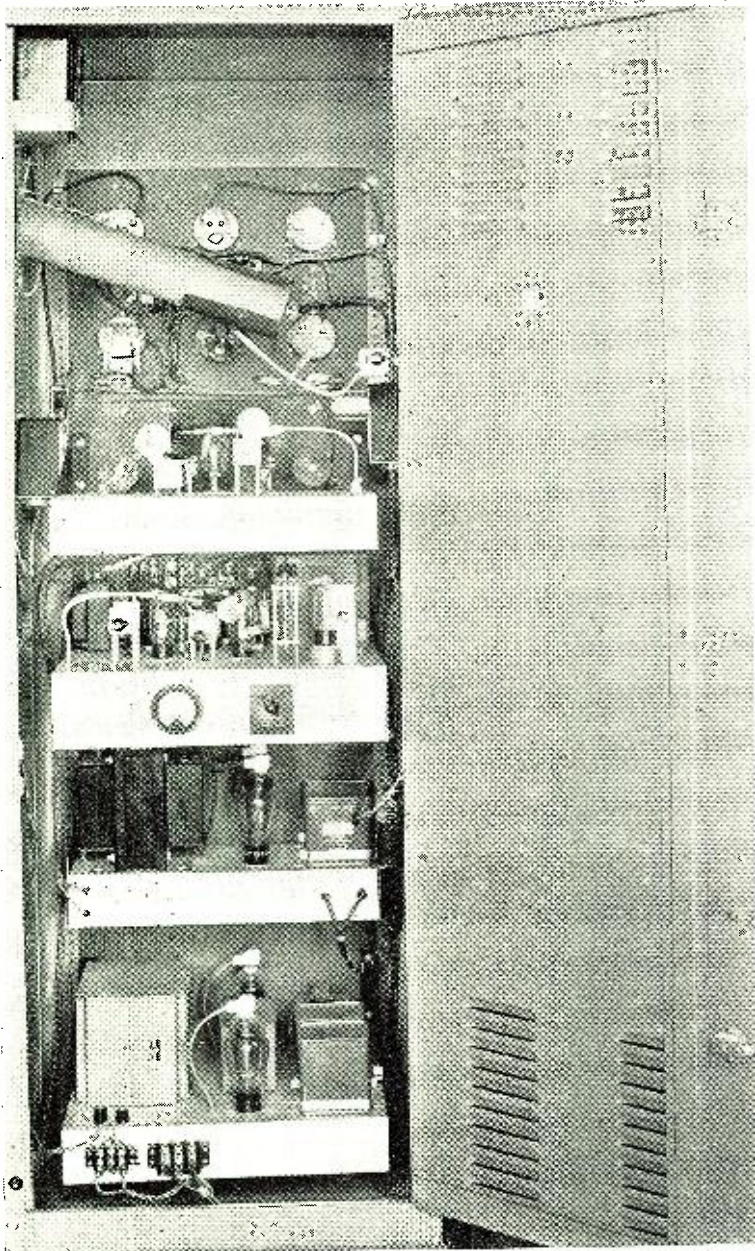

Fig. 2. Rear view of the transmitter shows proper placement of the various sub-assemblies. By combining two of the power supplies into a single unit, provision may be made for the addition of audio equipment.

sary to calibrate lamp and photo-electric cell combination. This is done by plotting e.m.f. (developed by the photo-electric cell) as a function of various measured power inputs to the lamp.

Naturally, the power-output measuring device need not be included when this unit is used as a transmitter. If installed, however, power output of the final stage tube can be checked quickly. Since tubes vary considerably in power output, at these frequencies, the additional expense of incorporating the measuring device would seem justified.

Fig. 3 is a block diagram for this transmitter. Power supply 1 is composed of transformer (T₁), a rectifier tube, 5U4G, and its associated circuit elements. This unit supplies plate and filament voltage for the oscillator. It also provides filament voltage for

the 25-megacycle and 50-megacycle stages. Power supply 2 delivers grid bias voltage to the 25-, 50-, and 100-megacycle stages. Power supply 3 supplies plate voltage to the last three mentioned stages. Power supply 4 supplies plate voltage to the 100-megacycle output stage.

It will be noticed in Fig. 4 that a relay (marked RY₁) is connected in series with the bleeder of the grid bias supply. This relay immediately opens the main power supply circuit if the grid bias supply fails.

Power supplies 3 and 4 each have individual variac control. This makes possible:

1. Adjustment of the grid driver to the final stage.
2. Compensation for line-voltage variations in the power supply of the final stage.

This transmitter, as will be seen

from Figs. 1 and 2, is constructed in a standard 6 ft. relay rack. Fig. 1, the front view, shows the six meters and two tuning controls for the grid and plate of the final stage, along with the associated switches controlling filament and inputs to the variacs in the plate supplies. They also handle the variac control and the filament voltage to the final stage. The control console extends forward from the front panel. This makes the variacs easily accessible and conserves space within the cabinet.

Fig. 2 shows the rear of the unit. The bottom chassis holds the power supply for the final stage. The next chassis contains the power supply for the 25-, 50-, and 100-megacycle doubler-buffer stages. Above that is the bias and oscillator filament and plate supplies. This chassis *also* contains the complete exciter unit and a meter with its associated switch. The meter is used to read grid and plate currents (by switching) in the 25-, 50-, and 100-megacycle stages. The top chassis contains the 100-megacycle power-output stage. Above the top chassis, the power-measuring coupling-tank is mounted. The slanting housing at one end encloses the incandescent bulb. The photo-electric cell is at the other end. Fig. 5 shows the location of all major components of the transmitter unit.

In developing the design, it was necessary to supply adequate grid drive to all stages in order to obtain sufficient power for the final stage. The oscillator, first doubler, and second doubler use coils and condenser tanks. The two 100-megacycle stages have tanks made of $\frac{1}{4}$ " copper tubing that is heavily silver-plated. It is of utmost importance to keep all leads as short as possible, particularly those carrying r.f. All r.f. leads are $\frac{3}{8}$ " copper strap, silver plated. When operating at this frequency, it is quite difficult to mount standard by-pass condensers so that they really by-pass. However, the following mounting method worked successfully:

Condensers are mounted flush against the underside of the chassis. A hole (large enough to prevent arcing of the d.c. voltage) was drilled above the hot end of the condenser, in the chassis. Thus the d.c. voltage enters through the underside of the condenser, passes through the condenser, through the hole in the chassis and then to the tank.

Initial Tuning

After carefully checking the entire unit for wiring errors, tubes are inserted, the line switch is turned on. The white pilot light should light. If it does not, it means that the rear door is not closed and the interlock is open. When the filament switch is turned on, all tubes should light. As soon as the bias supply begins to function, the red pilot lamp will light. At this point, C₁ is quickly rotated until meter M₁ indicates minimum current, indicating that the crystal

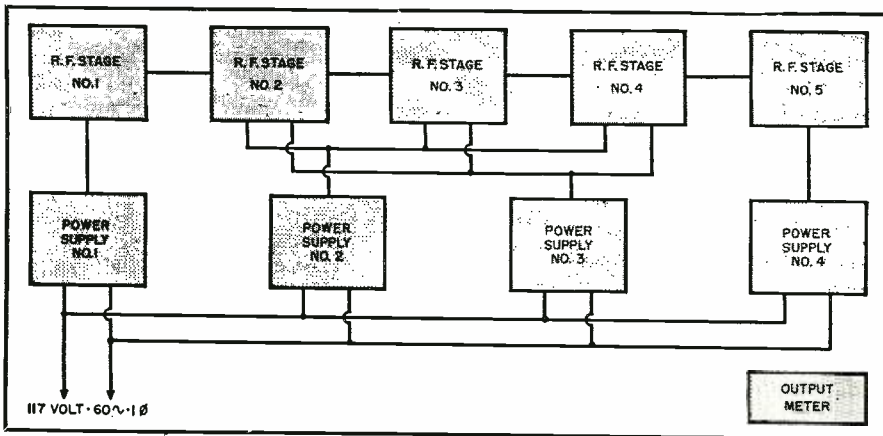
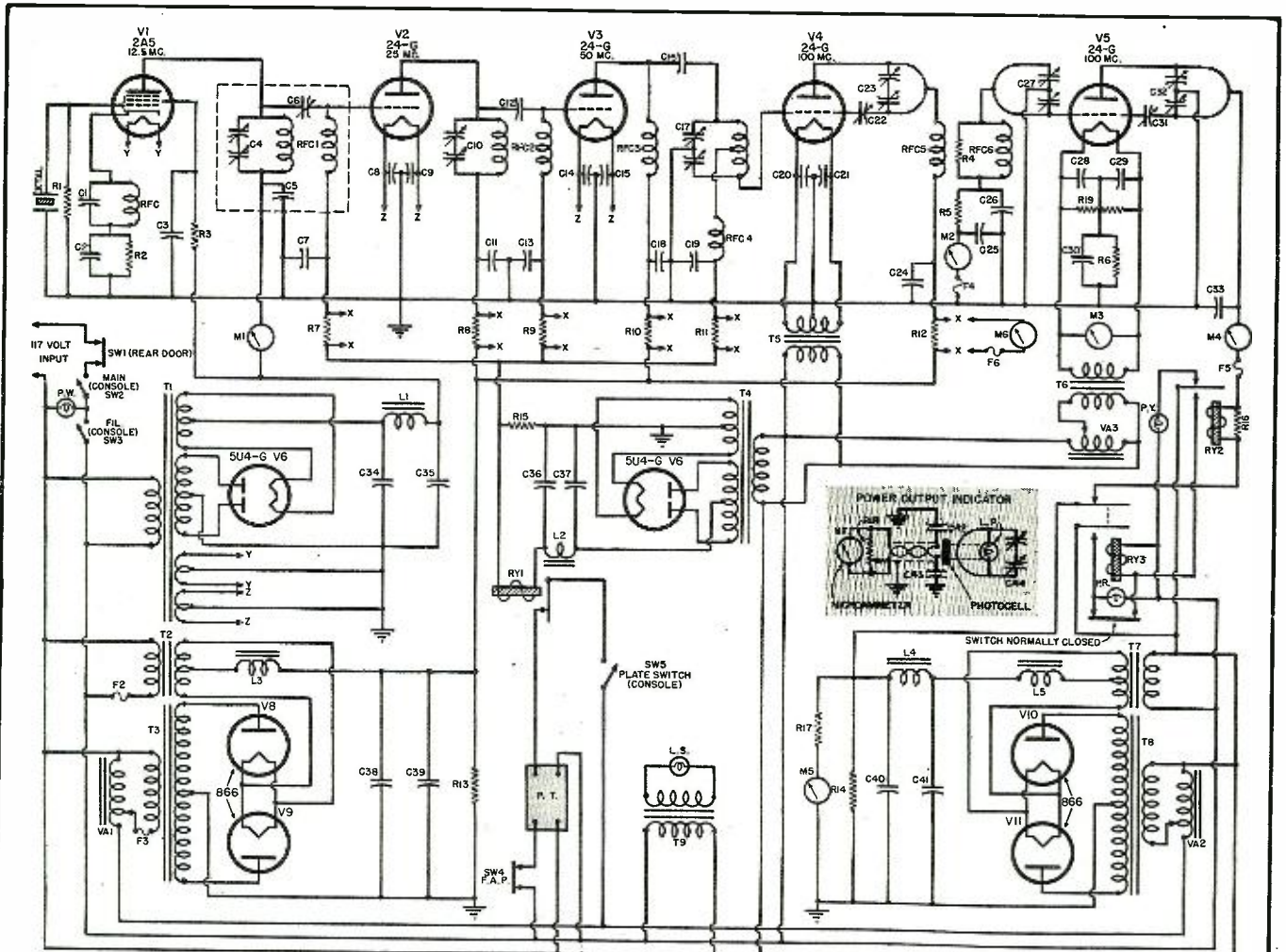

Fig. 3. Block diagram illustrating the stage by stage operation of the transmitter.

Fig. 4. Schematic diagram of complete unit. A 70 ohm coaxial cable may be connected in place of lamp, L.P., to feed the antennas.



- R₁—25,000 ohm, 1 w. res.
- R₂—300 ohm, 1 w. res.
- R₃—50,000 ohm, 1 w. res.
- R₄—500 ohm, 2 w. res.
- R₅, R₆—1,000 ohm, 20 w., w.w. res.
- R₇, R₈, R₉, R₁₀, R₁₁, R₁₂—47 ohm, 1 w. res.
- R₁₃, R₁₄—50,000 ohm, 100 w., w.w. res.
- R₁₅—1,000 ohm, 200 w., w.w. res.
- R₁₆—3,000 ohm, 1 w. res.
- R₁₇—w.w. meter multiplier res.
- R₁₈—500 ohm, 3 w., w.w. var. res.
- R₁₉—100 ohm, w.w., center tapped res.

- C₁—100 μfd. mica cond.
- C₂—0.1 μfd. mica cond.
- C₃—1 μfd. paper cond.
- C₄—150 μfd. (per section) var. cond.
- C₅, C₇, C₂₀, C₂₉, C₄₂, C₄₃—0.01 μfd. mica cond.
- C₆—100 μfd. var. cond.
- C₈, C₉, C₁₃, C₁₄, C₁₅, C₁₉, C₂₀, C₂₁, C₂₆, C₂₈

- C₂₅—0.01 μfd., 1,000 w.v., mica cond.
- C₁₀, C₁₇, C₂₃, C₁₁—35 μfd. (per section) var. cond.
- C₁₁, C₁₃, C₂₁—0.01 μfd., 2,500 w.v., mica cond.
- C₁₂—0.001 μfd., 2,500 w.v., mica cond.
- C₁₆—500 μfd., 2,500 w.v., mica cond.
- C₂₂, C₃₁—3-4 μfd. plunger neutralizing cond.
- C₂₇, C₃₂—15 μfd. (per section) var. cond.
- C₂₄—0.01 μfd., 5,000 w.v., mica cond.
- C₃₄—2 μfd., 1,000 v., paper cond.
- C₃₅—4 μfd., 1,000 v., paper cond.
- C₃₆, C₃₇—4-4 μfd., 425 v. elec. cond.
- C₃₈, C₃₉—2 μfd., 3,000 w.v. paper cond.
- C₁₀, C₄₁—2 μfd., 2,000 w.v. paper cond.

- T₁, T₃, T₄—Power Trans.
- T₂—Fil. Trans., 2.5 v. @ 10 amp., 10,000 v. insulation
- T₅—Fil. Trans., 6.3 v. @ 4 amp.
- T₆, T₇—Fil. Trans.

- T₈—Power Trans. 1200-0-1200 v. @ 150 ma.
- T₉—Light Source Trans., Photo Troller

- L₁—Choke, 20 h. @ 150 ma.
- L₂, L₄—Choke, 20 h. @ 200 ma.
- L₃, L₅—Choke, 10 h. @ 200 ma.

- M₁—Meter, 0-75 ma. d.c.
- M₂—Meter, 0-50 ma. d.c.
- M₃—Meter, 0-8 v. a.c.
- M₄—Meter, 0-150 ma. d.c.
- M₅—Meter, 0-1500 v. d.c.
- M₆—Meter, 0-100 ma. d.c.
- M₇—Meter, 0-500 microamperes d.c.

- PT—Photo Troller
- RFC₁, RFC₂, RFC₃, RFC₄—R.F. Choke, 2.5 mh.
- RFC₅—R.F. Choke, 10 microhenries
- RFC₆—R.F. Choke, 3 microhenries
- All pilot lights—Type S 6

oscillator is in operation. Since it is necessary to tune the entire driver from the back, the rear door interlock should be shorted out for this operation.

The meter insertion switch is turned to read grid current on the first 24G doubler. Without overloading the oscillator, C₆ is adjusted for maximum grid current. At this point it is advisable to wait 15 minutes in order to allow the 866 tubes to become thoroughly warm. VA₁ is now raised until there is a potential of about 500 volts on the plates of the 25-, 50-, and 100-megacycle stages. For the time being, no plate voltage is applied to the output stage. The meter insertion

(Continued on page 142)



WE HAVE talked many times about the future of the serviceman: his great opportunities and how he can help himself in the coming postwar world of tough competition in a returning buyers market.

Many business and professional firms have been making surveys in the field to determine, if possible, the extent of this market in the postwar era. Perhaps no accurate estimate can be given at this time due to the number of unknown factors.

One such survey has been released by a prominent manufacturer in the radio industry and paints a very rosy picture for the future of the radio service business. According to this survey there will be 30,000 radio shops. They will sell 60,000,000 tubes and employ about 90,000 men. We do not know whether to be glad or sorry about this announcement. If it means an added number of shops in a field already overcrowded, we are not very much enthused and an influx of untold numbers of these shops cannot help but have a very bad effect on an already overstaffed field.

Tube Types

A majority of all servicemen, as shown in the report, are in favor of reducing the number of types of replacement tubes carried in peacetime stores to less than 200. 89% thought there should be less than 200; 79% said less than 150. 65% thought there should be less than 100. Certainly no operating serviceman doubts or would question this statement since we all know from bitter experience the troubles we have had in the past in trying to stock all the slow movers that are needed only once or twice a year.

The report made it clear that the greatest cause of trouble in a receiver is the tubes, and consequently is the one item that provided the greatest sales possibilities for the serviceman. It has been the writer's experience that at least twice the number of tubes could be sold per call if the serviceman would use his selling ability. Too often the serviceman's sole thought is to get in and get out of the house in the shortest possible time due to the press of work thereby overlooking much that could be done to increase his rate of return per call. This must be corrected if a profitable operation is anticipated in the coming tough competition of postwar operation.

Labor Charges

The survey further pointed out that only 44% of the sets required labor.

With **JOE MARTY**

Eastern Editor, **RADIO NEWS**

This is a very interesting figure since it was given to the interviewers by servicemen themselves. Does this mean that 56% of the sets are repaired free of charge? If so then this is a most glaring weakness in the radio serviceman's way of doing business. It is the writer's opinion that there should be a labor charge on 100% of the repairs even though nothing is done except change a tube on a set that is brought into the store by the customer. The radio serviceman should remember that the only thing he has to sell is his labor and thus if he gives this away he will very shortly go broke.

Set Sales Possibilities

Servicemen influenced or accounted for 19% of the radios sold according to the report. This figure, if accurate, represents a very large amount of business over which the serviceman exercises some control. No doubt it can be increased if common sense principles of selling are used by the serviceman when making his calls. The radio serviceman is in the best position of anyone in the industry to make sales of radios. He is the only person invited into the home; he is always there at a psychological moment and he enjoys the confidence of his customer. Many great businesses have been built on this combination of successful sales elements. It cannot be too strongly emphasized that in

order to be successful in a peacetime operation a serviceman must become more and more of a salesman and a business man.

The most optimistic estimate we have seen is for 75 million radio homes after the war and for 25 million auto sets. This should tell the serviceman that there will be great opportunity provided he arranges his business to meet changing conditions. The feeling in the trade is that the majority of auto radio sets will be sold as original equipment by the various car manufacturers. However, we do not know at this point how much of the subsequent service will be done by the various retail auto dealers. It would seem that the local serviceman could make a very profitable arrangement with the auto dealer since he is on the spot, and has the necessary equipment and knowledge to take over this business from the auto dealer. The time to talk to him is right now.

One of the most startling statements made in the survey was to the effect that the public was almost unanimous in saying that they were satisfied with the work being done by the average serviceman. This statement is hard to believe, especially to the writer who has spent countless hours on the phone listening to such complaints as, "it never worked since you brought it back," or "I didn't know the plug was out." Maybe the

serviceman is getting better or the customer is easier to please, but we doubt it. If this statement is accurate, what about all the complaints of gyms and the need for licensing to protect the public. Perhaps the serviceman should take a copy of the survey with him when he goes to answer a complaint to prove it isn't so. All joking aside, these surveys help a lot and the more accurate ones we have, the better able we will be to tell where we are going.

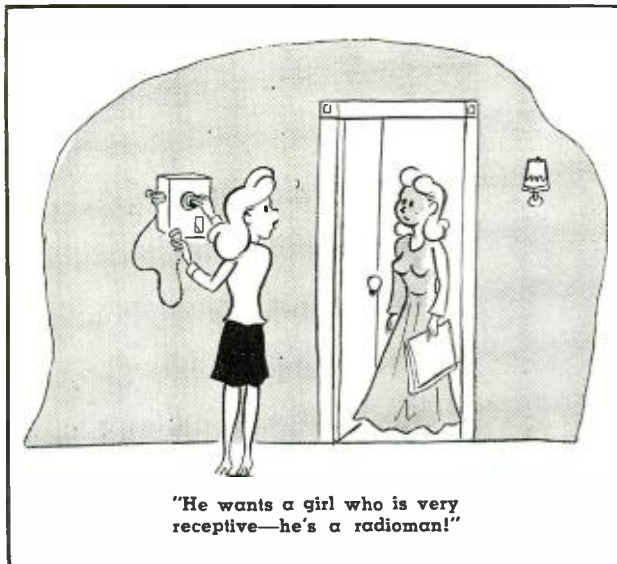

"He wants a girl who is very receptive—he's a radioman!"

-30-

The Control Circuits

By J. CARLISLE HOADLEY

Several unique types of high- and low-frequency tone-control circuits.

By employing two controls, any desired tonal response may be had.

▶ **ONE** controls, like the weather, will always be with us, the reason being the lack of uniformity of the ears of listeners and the highly varied tastes of different individuals, not to mention special applications such as sound effects, static and hum reduction, and compensation to make up for a deficiency in frequency response in some unit. We have a multitude of types to pick from, all the way from a simple high frequency attenuator which consists of a series resistor and condenser shunted from a grid or a plate of an amplifier tube to ground, to a complex multisection band pass filter. For the reduction of noise, etc., a simple high frequency attenuator is adequate, but where response is to be altered to fit personal tastes, more than attenuation is desirable.

A good compromise is two controls which may attenuate or boost either the high or low frequencies. The frequencies at which these controls start to be effective is a matter of taste and the quality of the audio system to which they are applied; *i.e.* there would be no point in boosting 20 c.p.s. in a system whose speaker could not reproduce frequencies lower than 50 c.p.s., nor would anything be gained in boosting 9000 c.p.s. response in a receiver whose i.f. system was so sharp as to limit the detector output to 4000 c.p.s. The points of boost and the amount then must be determined first. What is desirable there, and why must there be boost at all?

First we have the problem of the peculiar condition of the ear wherein the response curve changes with level. That is to say, if sounds are loud enough, your ear has a flat response

to them from say 30 c.p.s. to 10,000 c.p.s. If the level is lowered appreciably, the ear response falls off faster at 30 c.p.s. and 10,000 c.p.s. than it does at 3000 c.p.s. Now if we were present in the studio when a recording was made, we would hear the orchestra at its normal volume. If we were to play the recording of the same orchestra back at the same volume that we heard it, we would require a com-

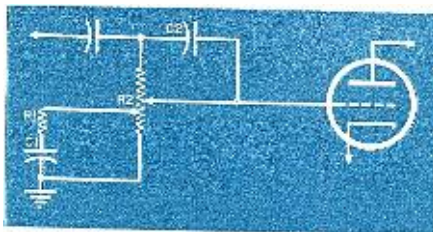

Fig. 1. Automatic tone-control incorporated in volume-control circuit.

pletely flat system from the recording microphone to the phonograph speaker. But unfortunately, we do not play back orchestral renditions at their original volume, particularly if we live in apartments. We therefore must replace the decreased sensitivity at high and low frequencies of our ear at this new low level. As people's ear-curves vary, the amount of compensation necessary is not a constant. Neither do all bands play at the same volume, so some variable means must be provided to give the individual listener that feeling of naturalness which is necessary for his complete enjoyment of recorded or broadcast music.

There is a second reason, too, for compensation. A great reduction in extraneous noise may be effected by the limiting of the range to that necessary for the program material. For instance, if one is listening to a trumpet solo, there is no benefit in having response down to 30 c.p.s., and if it is limited above 60 c.p.s. or 120 c.p.s., there will be a material reduction in hum. Conversely, if a phonograph record which is old and possesses a high scratch level is played, a flat response to 10,000 c.p.s. is undesirable. In connection with high frequency response, an interesting point is that if the response is limited to say 5000 c.p.s. with a boost between 3000 and 5000 c.p.s. and then cut off sharply, the effect to the ear is very nearly that of flat response out to a

much higher frequency, with, incidentally, a material reduction in surface noise of records, static, etc. Let us therefore discuss some methods for obtaining high and low frequency compensation in some specific circuits.

In Fig. 3 we see several high and low frequency tone control circuits. C_1 and R_1 comprise a low frequency attenuation circuit. The variable resistance R_1 places in the circuit or removes series condenser C_1 . As C_1 is low in capacitance the low frequencies are attenuated. The values in the diagram are correct for attenuation below 150 c.p.s. Between V_1 and V_2 we have a negative feedback type bass boost circuit, consisting of R_2 , C_2 , and R_3 . The output of V_2 is fed back through the RC combination to its grid and the amount of boost possible is determined by the μ of V_2 . As a method of control of the amount of boost without varying the gain of V_2 , we short out the condenser C_2 . This eliminates the high-pass nature of the network and it feeds back all frequencies equally. When R_3 is set at its maximum value, only the higher frequencies are fed back, determined, of course, by the value of C_2 , and the gain is only reduced at the higher frequencies effecting a bass boost.

In the cathode of V_2 we have a high boost circuit comprising R_4 , R_5 , and C_3 . The cathode resistor is made larger than usual and may even be larger than the plate resistor. We then bypass the cathode resistor with a condenser whose bypass effect is variable by the series variable resistor R_5 . The gain of V_2 is reduced by the degeneration introduced by the unbypassed cathode resistor. The value of C_3 determines at what frequency the degeneration will be relieved, and the tube operate at its full gain. Then we have a high boost whose starting frequency is determined by the value of C_3 . It is dependent, too, on the size of R_4 . The value can be arrived at by experimental insertion methods to fit a specific case much more readily than as if it were computed because of the assumption one must make in regards to the exact frequency we wish to boost to make a noisy record sound better for instance. Incidentally, one would not use the two circuits R_2 , C_2 , R_3 , and R_4 , R_5 , C_3 in the same tube, as drawn, as they are negative feed-

Fig. 2. Circuit combining both low- and high-frequency attenuation, depending on the position of the single control.

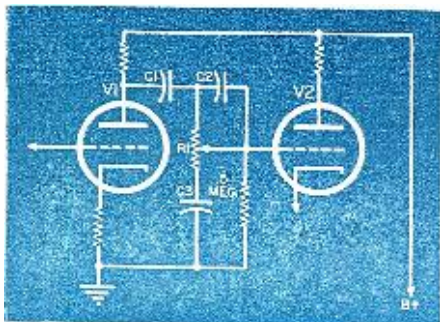

back controls and would defeat each other's purpose. These degeneration circuits are good in the respect that they actually reduce the distortion at the attenuated frequencies, and do not increase it at the boosted frequencies. Their disadvantage is that they consume gain and it may be necessary to add an extra stage of amplification to offset the loss. In R_6 and C_5 we have the time worn high frequency attenuating "tone" control which was standard equipment on nearly every radio in the past. It still has its uses, however, when the high frequencies are to be attenuated without too steep a cut off. In the plate circuit of the last 6J5 we have another bass boost circuit. It consists of R_7 , R_8 , and C_5 . R_7 and R_8 are the plate load resistors of V_3 . R_8 is partly bypassed by C_5 so that at low frequencies the gain of V_3 is that obtained with a load resistor equal to R_7 plus R_8 , while at high frequencies the gain is that obtained with only the plate load resistor R_7 . The ratio of their sizes determines the amount of boost, and C_5 determines the frequency at which it occurs. It must be borne in mind that Fig. 3 was drawn with the idea of presenting these different methods of tone compensation and does not represent a three tube amplifier as such, but merely serves as an illustration. These are the simpler types of tone controls which may be used where very sharp cutoff characteristics are not desired. If steeper transition slopes from boost to flat are desired, the same circuit may be used in successive stages, giving steeper transitions and greater boosts. Controls may easily be ganged such as duplicating the R_1 , R_5 , C_3 network in a later stage and then using a two gang variable control (R_5) so that the degeneration in both stages may be varied simultaneously.

So much for the general RC circuits which may be used, let us now consider some specific applications.

In Fig. 2 we have a simple tone control circuit which allows the lows to be attenuated, or the highs to be attenuated. When R_1 is turned all the way to the right, C_2 is shorted out and the low frequency response is determined by the size of C_1 . As R_1 is rotated to the left, C_2 is introduced in series with C_1 which causes a decrease in low frequency response. As R_1 is rotated even farther to the left, C_3 is shunted across the grid of V_1 attenuating the high frequencies. This gives the two functions all on one control. If, in addition, a high frequency and low frequency boost be incorporated in some other part of the circuit, it will permit any tone quality desired.

In Fig. 5 we have the typical pre-amplifier and output stage in a small receiver or automobile radio to which has been added two of our circuits. We find incorporated independent high frequency and low frequency boost controls. This is particularly advantageous when a small receiver is to be connected to a well baffled

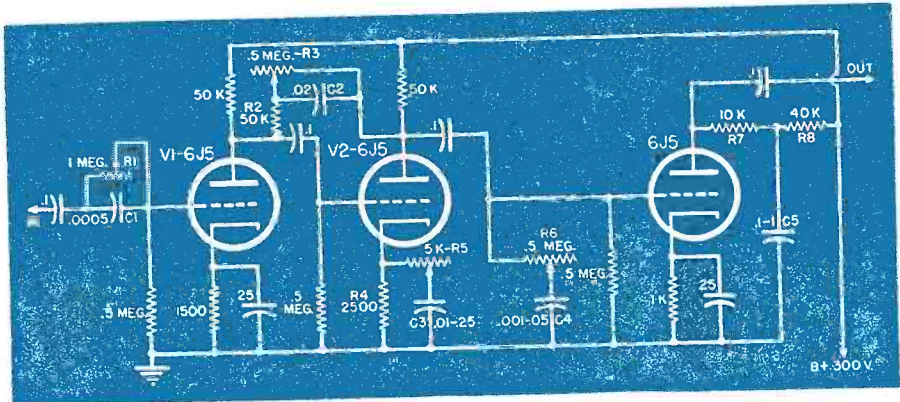

Fig. 3. Several methods of obtaining high- and low-frequency tonal compensation.

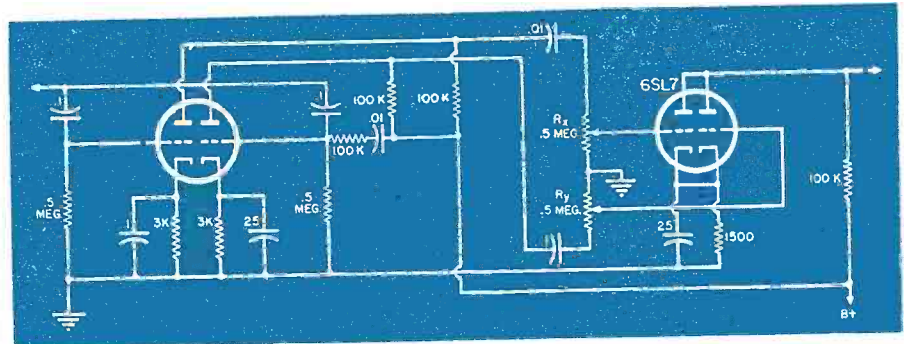

Fig. 4. Circuit employing separate amplifier stages for the high- and low-frequencies. By varying the gain of these stages, desired tonal response may be had.

10" or 12" speaker. It is amazing what can be done with the average six or seven tube table model radio in this respect. It is quite possible to enhance its tone quality to the point that it compares favorably with those in the \$200.00 class. The older automobile radios may be given the same treatment with great improvement in tone quality. The tone control system in Fig. 5 is of a negative feedback type. A voltage is fed back from the secondary of the output transformer through the high pass filter C_3 , R_1 , C_4 , R_2 to the cathode of the previous amplifier stage. This then reduces the tube gain at the high frequencies. The cathode resistor R_3 is bypassed with the network R_1 , C_1 which varies the degeneration in the circuit at the high frequencies.

R_2 is a variable resistor shunted across the high pass filter in the feedback network so that C_3 , C_4 may be shorted out and the circuit then becomes non-frequency discriminatory. This, then, effectively controls the low frequency boost while R_1 controls the high frequency boost. C_1 may be from .01-.25 μ fd. and C_3 - C_4 may be .01 to .1 μ fd. R_5 and R_6 are made as small as possible without oscillation occurring. If a violent oscillation occurs, reverse the connections to the output winding of the output transformer T_1 .

In Fig. 1 is another type of tone control. It falls in the automatic class. It consists of compensation in the volume control circuit so arranged by means of a tap on volume control R_2 , that as R_2 is turned away from
(Continued on page 98)

Fig. 5. Typical preamplifier and output stage of a small receiver, incorporating independent high- and low-frequency controls for obtaining desired tonal response.

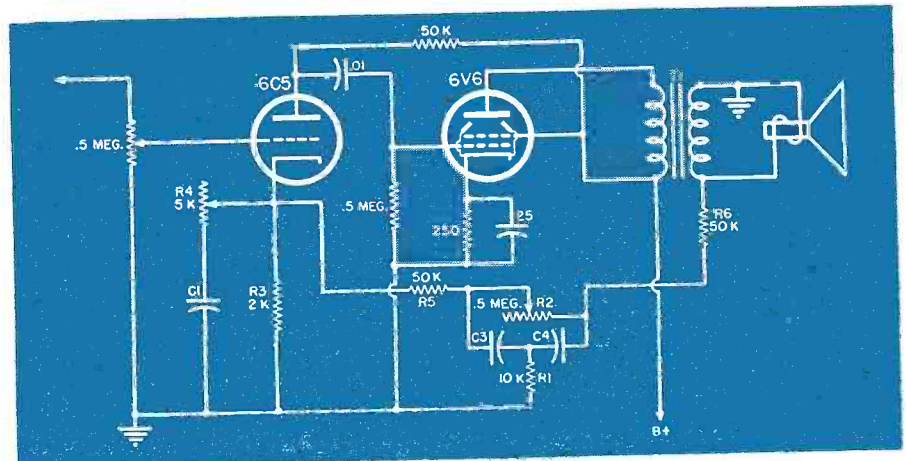

Practical RADIO COURSE



Part 36. An analysis of the methods employed in accurately "tracking" the oscillator and preselector tuned circuits of a superhet receiver.

Postwar table model home receiver cabinet design which may be molded from various colored plastic material. Designed and illustrated by Radio News staff artist, Julian Krupa.

By
**ALFRED A.
GHIRARDI**

IN ORDER to achieve single-control manual tuning in a capacitor-tuned superheterodyne receiver, the variable tuning capacitor of the oscillator must be "ganged" (operated by a common shaft) to rotate simultaneously with those of the closely "aligned" tuning circuits of the r.f. preselector.¹

If the receiver is to function as a sensitive superheterodyne, and if it is to be free from "image" interference, it is also necessary that the oscillator frequency be made to "track" higher (usually) than that of the preselector tuning circuits by a constant amount equal to the intermediate frequency employed in the receiver's i.f. amplifier—for all settings of the receiver tuning control. Furthermore, if the receiver is designed for multi-band reception, this same frequency difference must be maintained throughout each receiving band. This means that for best operation it is necessary to make the oscillator frequency "track" exactly i.f.-kc. higher than that of the preselector tuned circuits

—over the entire signal-frequency range of the receiver.²

Fig. 1 shows the preselector and oscillator tuning curves required for correct operation over the entire broadcast tuning band—assuming the receiver employs an i.f. of 455 kc. Notice that the oscillator frequency "tracks" always 455 kc. higher than the preselector frequency, over the entire tuning band of the receiver. The particular frequencies existing in the various tuned circuits of a superhet employing a 455-kc. i.f. when it is tuned to receive a 1200-kc. incoming signal are shown in Fig. 4. Notice that the oscillator frequency is 455 kc. higher than the signal frequency.

Any deviation from this frequency difference causes the i.f. carrier to be displaced in frequency from the center of the pass band of the i.f. amplifier. If the deviation is small, for an amplitude-modulated wave, frequency

¹ The methods employed to align the individual tuned circuits of the r.f. preselector were explained in the installment of this series appearing in the June, 1945, issue of RADIO NEWS.

² Although in most receivers the oscillator is designed to operate always at a frequency, higher, by an amount equal to the intermediate frequency employed in the i.f. amplifier, than that to which the preselector circuits are tuned, in some it is operated i.f.-kc. lower.

distortion, producing high-pitched shrill reproduction will be the result; if the deviation and resulting off-centering is excessive, the equivalent of single-sideband transmission occurs and amplitude distortion results.

Offhand, it would appear that the oscillator frequency could be made the required number of kc. higher than that of the preselector simply by employing in its tuning circuit either a smaller tuning capacitance, or a smaller inductance, than is used in the preselector tuned circuits. Let us assume that a combination of smaller oscillator tuning inductance with oscillator tuning capacitor of same size as those used for the preselector circuits is used. The tuning circuits of the preselector and oscillator will then be as illustrated at (A) of Fig. 2. Suppose further that the receiver i.f. is 455 kc. and that these tuning circuits are designed so the oscillator frequency is exactly 455 kc. higher than the preselector frequency when the tuning capacitors are all fully unmeshed (high-frequency end of the receiver tuning band. These two frequencies are at a dial setting of 100 shown in Fig. 2B. The oscillator and preselector tuning circuits would then definitely be "tied down" to the correct relative frequencies at this point on the dial, so for this position of the

tuning control the osc.-preselector frequency difference would be correct—equal to the i.f. of the receiver.

Now if the tuning control were slowly turned toward the low-frequency end of the tuning range, the frequency of the preselector tuning circuits would vary over the range of values approximately as represented by the solid-line curve of Fig. 2B. Simultaneously, the oscillator frequency would vary over the range of values represented by the dotted-line curve above this. Notice that the frequency difference (vertical separation) between the two curves does not remain constant, but diminishes as the receiver is tuned toward the low-frequency end of the dial. For example, at a dial setting of 60 the frequency difference is only 304 kc.; at a setting of 35 the frequency difference is 225 kc.; and at a setting of 0 it has diminished to 152 kc. Of course the sharply-tuned 455 kc. i.f. amplifier would provide little or no amplification for i.f. signals of such frequencies entering it. Accordingly, it is likely that only one or two stations close to the upper frequency range of the receiver (1500 kc.) would be received with such an arrangement, for only here would i.f. signals of the correct 455-kc. frequency be produced.

The attack might be made from the other end—the low-frequency end—by designing the oscillator tuning circuit to produce the correct frequency ($500 + 455 = 955$ kc.) required for exact tracking or “tie-down” at the low-frequency (500 kc.) end of the dial. If this were done, the oscillator frequency would be increasingly *too high* at every other point over the tuning range.

The reason for this mis-tracking of the oscillator frequency is that we are using variable capacitors of similar plate shape to simultaneously tune circuits of two *different* frequencies—those of the preselector and that of the oscillator. Consequently, as the tuning dial is varied, the oscillator frequency is always a fixed *percentage* above that of the preselector, instead of always being a fixed *numerical amount* in kc. above it.

Inspection of the preselector and oscillator tuning curves in Fig. 2B reveals that our trouble is caused by the fact that the capacitance of the oscillator *increases* at too fast a rate (frequency *decreases* too rapidly) as the receiver is tuned from the high-frequency end to the low-frequency end of the dial (right to left on the graph). What is needed is some arrangement that will automatically cause the oscillator frequency to decrease sufficiently *less rapidly* so that it will always be higher than that of the preselector by exactly the same number of kc.

Oscillator—Preselector Tracking Methods

This important problem of “tracking” the oscillator and preselector tuned circuits in manually-operated

capacitor-tuned receivers has been solved in three different ways,

1. by using the same amount of inductance and identical (ganged) straight-line-frequency tuning capacitors in both circuits. The rotor of the oscillator tuning capacitor is *advanced* in the gang by just as many degrees as is necessary to provide the desired frequency difference.

2. by using a ganged tuning capacitor with the plates of the oscillator-tuning section suitably shaped to give the proper rate of change of capacitance required to maintain the necessary *constant* frequency difference (equal to the i.f.) between the preselector and the oscillator as the tuning control is rotated from “minimum” to “maximum” position. This is known as a “cut-plate” type tuning capacitor.

3. by using a ganged tuning capacitor having identical sections, but providing a series-padding circuit arrangement for the oscillator tuning circuit in order to provide the required oscillator-frequency tuning curve for proper tracking at the low-frequency end of the band.

As the first method no longer is used because a very clumsy tuning capacitor plate shape must be employed, and it is difficult to manufacture economically such capacitors to sufficiently close tolerances in quantity production, it will not be considered further here.

Method of Producing Correct Oscillator Tracking

The second method of solving the oscillator-preselector tracking problem is really a mechanical one, and has been successfully used on hundreds of thousands of portable, home, and auto-radio single-band receivers.

Fig. 2. Special preselector-oscillator tracking provisions are required, because the simple tuning arrangement illustrated at (A) does not maintain the necessary constant preselector-oscillator difference over the entire tuning band.

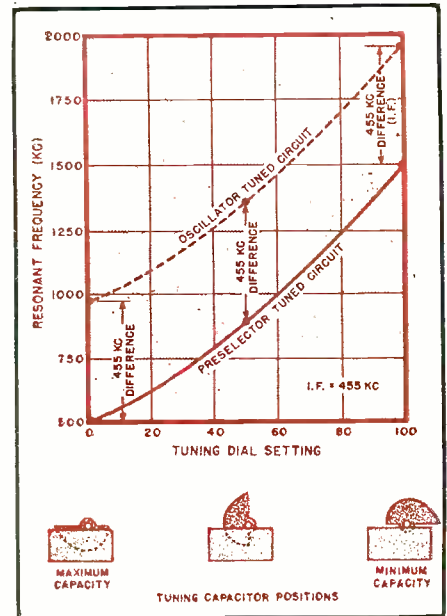
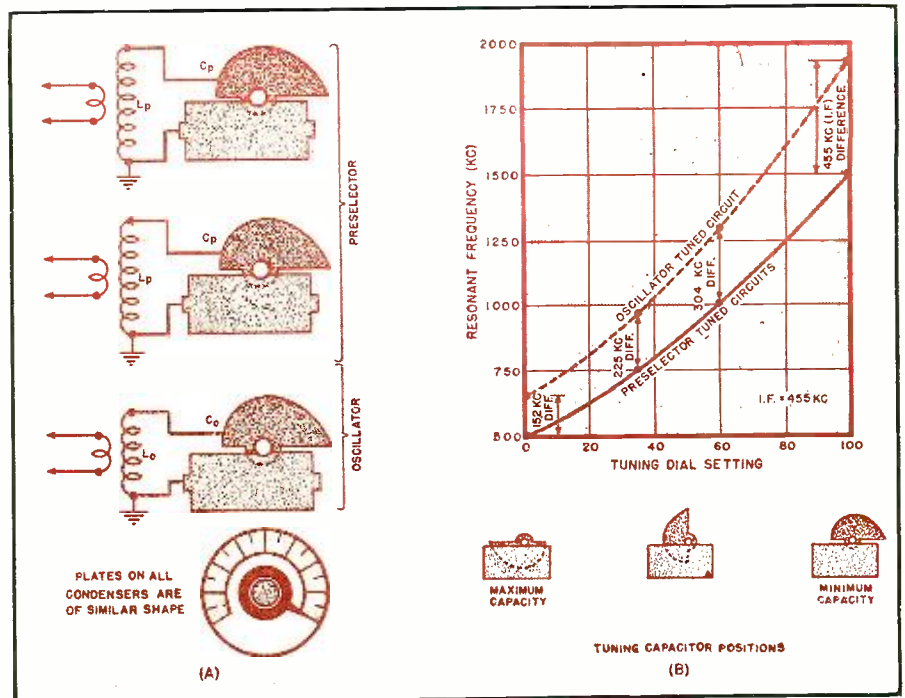

Fig. 1. Ideal oscillator and preselector relationship. The numerical frequency difference, over the entire receiver tuning band, must always be equal to the i.f. frequency employed.

If the oscillator frequency is to be always *higher* than the signal frequency, a lower value of inductance is used for the oscillator than is employed for the preselector tuned circuits. In addition, the rotor plates of the oscillator tuning capacitor are shaped differently from the corresponding plates of the preselector tuning capacitors. They are shaped so the proper *slower rate of change* of

(Continued on page 94)



11,500 mile RADIO NET

Planes operated by Pan American World Airways, under contract to the Air Transport Command, travel in relays and cover this 11,500 mile span in 84 hours.

Radio signals emanating from remote corners of the world guide our planes to their many military objectives.

WASTING shadows that hurtle across the face of the earth from the United States to India at the rate of two miles a minute, the Cannonball flyers speed American war materiel and military personnel to fighting American forces in the Southeast Asia battle zone. These giant, four-motored U. S. Army transport planes flown by *Pan American* crews are guided on their 11,500 mile flight over trackless oceans and impenetrable jungles by short-wave radio transmitters developed by *Bell Telephone Laboratories* and manufactured by the *Western Electric Company*. By locating these transmitters every few hundred miles along their flight lanes, the Army and *Pan American World Airways* have succeeded in constructing an efficient radio-communications network for supplying their crews with necessary flight information and essential navigational aids. So successful and effective has been the operation of these transmitters that following the

Allied invasion of North Africa the U. S. Army took over and used those that had already been installed there and subsequently ordered others of a slightly-modified design for their own ground station service.

By 1939 the *Pan American World Airways* had pioneered the remotest spots of all four quarters of the globe, a service to America and the world that will live forever in the annals of aviation history. Following this achievement was the problem of maintaining the best possible service over these far-flung air routes. One important phase of this problem consisted of procuring adequate ground-to-plane communications equipment that could withstand the vicissitudes of weather from the lands of torrential rains to hot, dry plateau country. Approximately 450 of these short-wave transmitters were required.

They consist of 100-350 watt, dual-channel three-frequency radio telephone and c.w. telegraph units which are designed to operate on frequen-

cies between 1.6 and 13.2 megacycles. The transmitter is self-contained and consists of a power supply, modulator, and radio frequency chassis mounted in a cabinet designed for tropical service that measures 5', 7⁵/₁₆" high, 1', 10¹/₈" wide, and 1', 6¹/₄" deep. The complete unit weighs approximately 393 pounds. As one protective feature against the elements, the unit is equipped with a fan and spun-glass dust filter mounted in the door of the unit for furnishing filtered air under forced draft to all parts of the set. All power for operating the transmitter may be obtained from a single-phase, 200-250 volt, 50 or 60-cycle a.c. source.

In view of the difficulty of the terrain, crossed by most of the *Pan American* routes, it was deemed advisable to design the transmitter so that it could be controlled either locally or from a remote point.

Remote control equipment used in conjunction with the transmitter was

(Continued on page 144)

grid, are clipped off. Although it appears as though the entire positive alternation is clipped, an average charge remains on capacitor C_1 , setting the limiter bias at some negative value which depends on the strength of the signal. Thus, a signal of greater amplitude will develop a greater average bias, increasing the voltage gradient between the average bias point and the positive level at which the grid clips. This does not mean that the grid is driven a great deal more positive when a strong signal is applied, but instead, means that the little bit further positive the grid is driven causes an increase in grid current sufficient to add an appreciable bias. These points are demonstrated in Fig. 2, which shows the increase in bias caused by a larger signal. Notice that the grid swings only slightly more positive, with the increase in signal strength, demonstrating how effective grid clipping is in removing severe amplitude variations. Fig. 2 also demonstrates the effects of the $R-C$ grid combination in setting the bias for two different amplitude signals. In the very first r.f. cycle, almost the entire positive alternation is clipped, but as quickly as the capacitor can charge, a bias forms which sets the operating bias negative. Capacitor C_1 is charged very rapidly by grid current flow and, during the negative alternation of the input cycle when no grid current flows, attempts to discharge through R_1 . Since the R_1-C_1 time constant is large

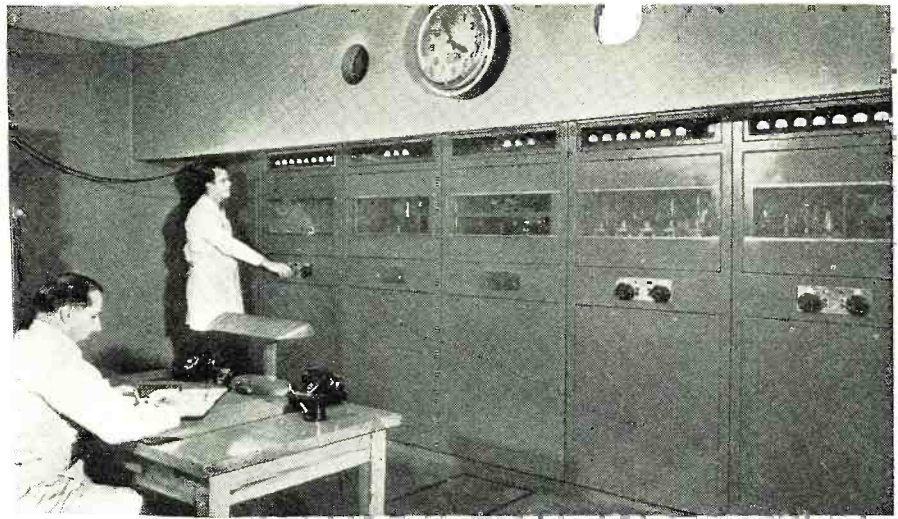

WBKB's DuMont audio-video transmitter of four kilowatt rated capacity located below a 200 foot steel antenna tower erected on the roof of the State-Lake Building in Chicago's Loop. Station WBKB operates on Channel 2 with a video frequency of 61.25 megacycles and an audio frequency of 65.75 megacycles.

in comparison to the period of the input cycle (time it takes capacitor C_1 to discharge through R_1 is many times longer than it takes one cycle of the i.f. frequency to appear on the grid of the limiter), the capacitor retains its negative charge almost in its entirety during the negative alternation. It is apparent, therefore, that the grid bias drops only an insignificant amount during the negative alternation before it is reinforced by grid current drawn on the next positive excursion of the input cycle.

Likewise, the low plate and screen voltages reduce the grid bias level at which the plate current cuts off, and, if the signal is great enough in amplitude, the negative alternations of the input cycle are cut off. Thus, the limiter levels amplitude variations on both the positive and negative alternations of the input cycle. Fig. 6 shows the effects on plate current of driving the grid beyond cutoff on the negative alternation. It is apparent that the applied signal can vary considerably in amplitude, but that the output plate voltage is confined between the narrow limits set by the plate current cutoff point and the point at which a further rise in instantaneous grid voltage causes no further increase in plate current. Furthermore, if plate and screen voltages are reduced further, the signal can be confined within a narrower region, as demonstrated in Fig. 7, and there will be limiting action on weaker signals. However, operating in this manner reduces the gain of the stage. A remedy, of course, is to use two stages of limiting, or to use more i.f. stages and do some limiting in earlier stages.

Leveling of the amplitude variations on an i.f. signal is demonstrated in Fig. 5. First the positive variations are leveled in the grid circuit by grid current flow, while the negative variations which swing the grid beyond cutoff are leveled by plate current cutoff. Thus, both sides of the modulation pattern are leveled. While at first it appears as though each cycle of the i.f. signal is being distorted (clearly shown in Figs. 2, 6 and 7, which show single cycles at the i.f. frequency), it must be remembered that the useful information for the frequency modulation detector is the frequency modulation, or variations in the frequency of the intermediate frequency, and not in its amplitude variations which the limiter is flattening off. Also the tuned resonant circuits and inherent capacities of the

Fig. 2. Curves illustrate grid leveling operation occurring in limiter stage.

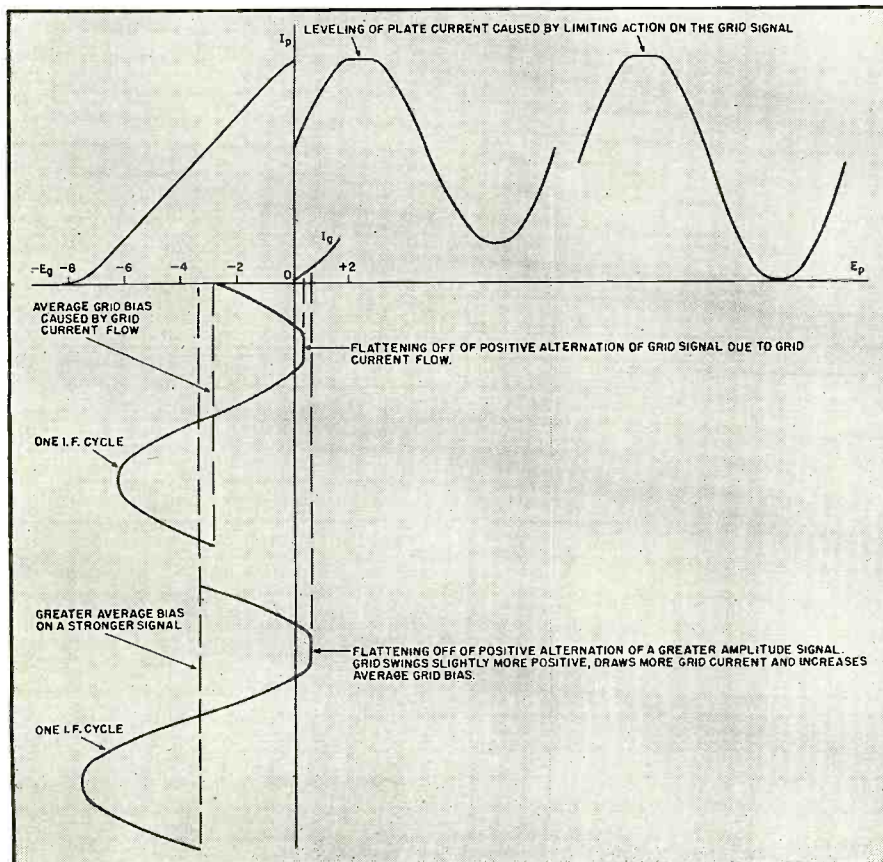

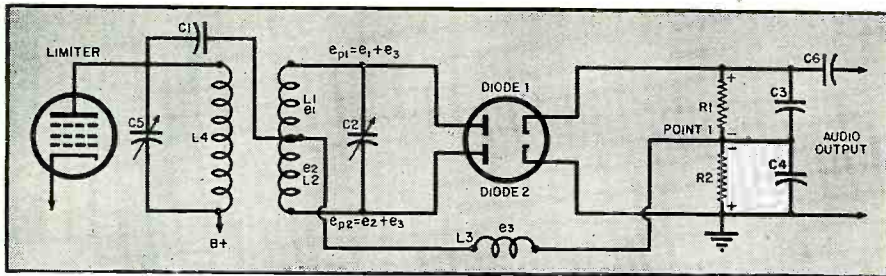

Fig. 3. Diagram of basic discriminator circuit employing a single dual-triode tube.

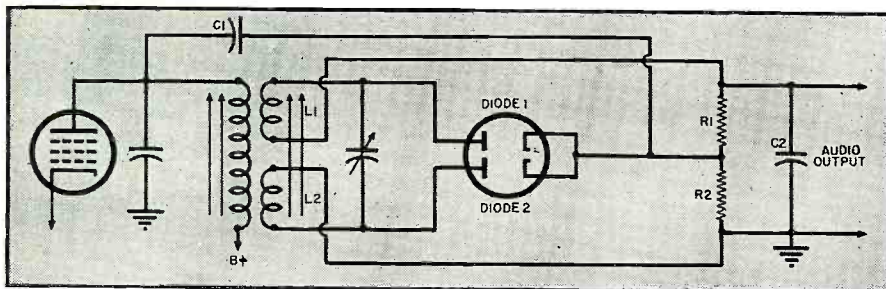

Fig. 4. Equivalent diagram of the discriminator employed in G.E. Model 90 receiver.

stages restore most of the original sine-wave characteristics to the i.f. signal. The time constant of the resistor-capacitor combination in the grid circuit of the limiter must have some optimum value which is not too long to prevent limiting of sharp impulse noises and not too short to prevent holding the grid bias constant

during the negative alternations of the input cycle.

Discriminator

The FM discriminator converts frequency variations of the i.f. frequency to audio variations. The amplitude of the audio signals is proportional to the extent of the frequency deviation

from the center frequency (8.25 mc.); the frequency of the audio signal, on the rate of deviation. Thus, if the i.f. frequency deviates between 8.2 and 8.3 megacycles ($8.25, \pm .05$ mc.) four hundred times per second, a four-hundred-cycle audio tone of a given amplitude appears at the output. Now, if the same signal deviates between 8.15 and 8.35 megacycles ($8.25, \pm .1$ mc.) four hundred times per second, a four-hundred-cycle tone of a greater amplitude appears at the output. Likewise, if the deviation is the same but the rate of deviation increases to six hundred times per second, a six-hundred-cycle tone appears in the output.

To understand the operation of the discriminator, first consider the action of the stage when an equal voltage is applied to each diode plate. Refer to Fig. 3. If there is plus ten volts applied to diode #1 plate, rectified diode current flows through L_1, L_3, R_1 , back to the cathode, developing a positive voltage across resistor R_1 . If, at the same time, positive ten volts is applied to diode #2 plate, rectified current flows through L_2, L_3, R_2 , back to cathode, developing a negative voltage (electrons always proceed toward the positive terminus) across resistor R_2 . If the circuit is balanced, therefore, it means that both voltages cancel across the output of the discriminator. Now, if we impress equal amplitude radio-frequency cycles on each plate, the same condition exists, although one plate may be going negative at the instant the other one is going positive. This becomes apparent when the action of capacitors C_3 and C_4 , which filter any r.f. variations, is considered. Consequently, the current flowing through R_1 and R_2 is an average current and, as long as equal amplitude r.f. cycles are applied to both diode plates, there is still no output from the discriminator. Equal voltages appear on both plates when the applied signal is the same frequency as the resonant frequencies (center frequency) of the limiter plate tuned circuit L_4 and C_5 , and the discriminator tuned circuit L_1, L_2 , and C_2 . When the input frequency departs from resonance, a greater r.f. voltage is impressed on one diode plate than on the other, producing a greater average diode current flow in one diode circuit than in the other. Thus, if the greater voltage is applied to diode #1, a larger voltage is developed across R_1 than across R_2 , and the differential voltage or output voltage is positive. If the greater voltage is applied to diode #2, the voltage across R_2 is the larger, and the differential or output voltage is negative. This is exactly what occurs when the i.f. frequency is varied at an audio rate, for on the positive alternation of the audio modulation, the i.f. frequency swings to one side of the center frequency, placing a greater voltage on diode #1, and causing a positive audio alternation at the output; on the negative alternation of the audio modulation, the i.f.

Fig. 5. Modulation envelopes used in illustrating how the leveling off of the amplitude variations on an i.f. carrier is obtained by the action of the limiter.

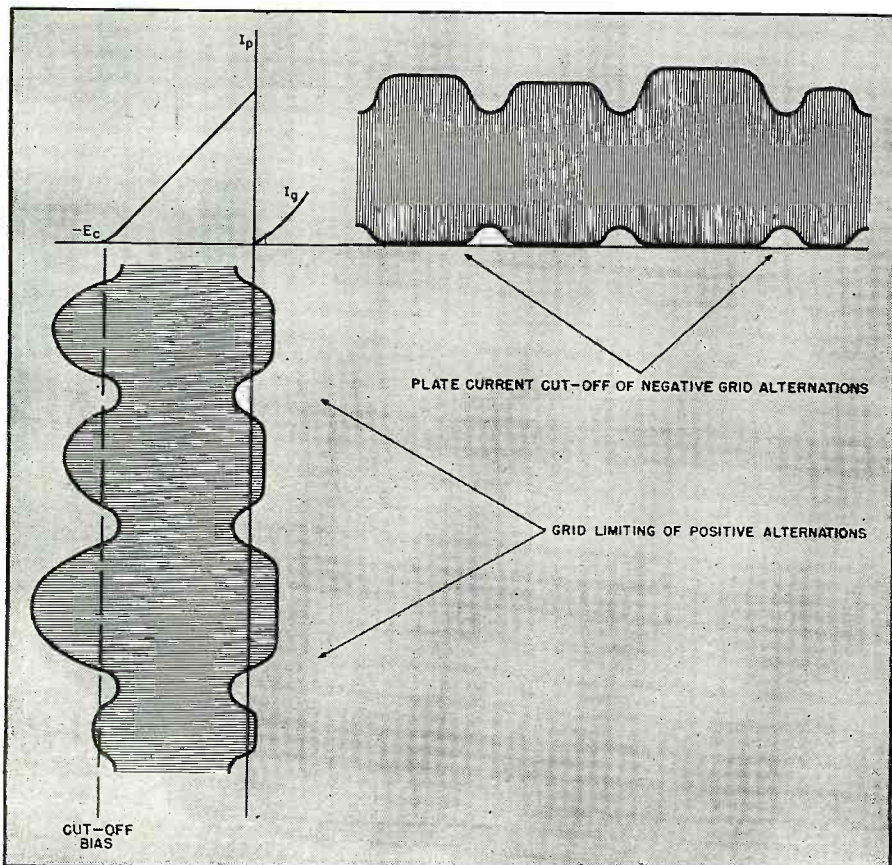

(Continued on page 138)

THE Federal Communications Commission reported recently a proposal to extend the present standard broadcast band by the addition of a ten kilocycle channel to the lower end of the band. This addition would extend the present band from 1600 kc. to 540 kc., the present limits being 1600 kc. to 550 kc. This increase would allow for one extra frequency assignment; in the report, FCC said that about 54 percent of the present receiving sets will be able to tune in on programs from stations which might operate on the 540 kc. channel. This frequency is now used for government services and it is not known how soon it can be made available for broadcasting use. Also in the proposal were provisions for 120 radio channels, some of which would be available to the United States; for direct international short wave broadcasting, allocations of frequencies for use by amateurs and others during times of disasters such as hurricanes, floods, etc., and increased emphasis on the use of radio by aviation communications such as navigational aids after the war. Also suggested was the establishment of a larger number of distress frequencies for use by aircraft and small surface vessels in distress and to provide more reliable coverage over long distances on radio distress calls. The above proposals were included in FCC's plan for allocation of frequencies to non-government radio services operating below 25,000 kc.

AFTER the completion of hearings in late June, the commission will issue a final allocations report covering non-government services in the range below 25 mc. FCC pointed out that frequencies below 25 mc. are so overcrowded it has been impossible to meet the requirements of all radio services in this range and added that wherever possible radio services are expected to move into the very-high and ultra-high frequency bands. At present there are 928 standard broadcast stations and there are 23 more under construction, and FCC has 180 applications pending for new stations as soon as materials and manpower are again available.

NATIONAL MARITIME DAY was observed throughout the country on May 22. . . . Secretary of the Navy Forrestal paid tribute to the men of the merchant marine saying "Without them, victory in Europe would not be an accomplished fact . . . with them and their task of transporting men, materials and weapons of war to strike the Jap, go the faith and trust of the men and women of the U. S. Navy, Coast Guard and Marine Corps." Observances were held in New York during the entire day from 10 a.m. until midnight. . . . Commodore F. G. Reinicke, Port Director of New York, speaking at the Maritime Service training station at Sheepshead Bay said that, "In a very real sense it was the Liberty ship, to-

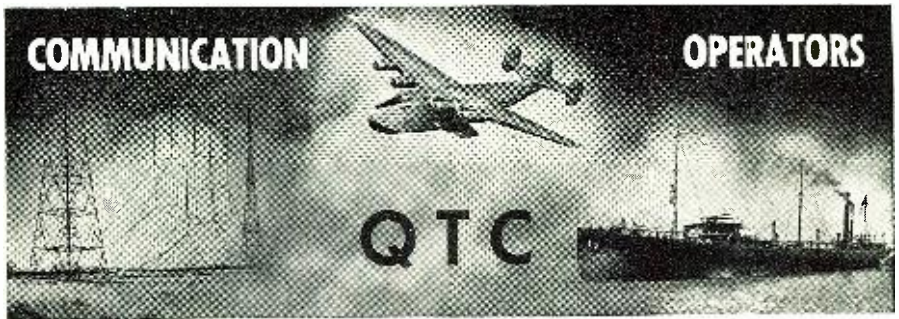

By **CARL COLEMAN**

gether with the tanker which beat Germany to her knees." "In no other war in history has the merchant marine played so powerful a role," "we cannot afford to gamble with the destiny of America. We can't afford to put the clock back." Commodore Reinicke added that "a strong America demands a strong merchant marine." The Port Director told an audience, which included more than 5,000 apprentice seamen, that three of every 100 men in the U. S. Merchant Marine have given their lives since the war began in transporting men and materials to war fronts.

K. LARSEN was in at an East Coast port recently aboard his cargo ship after a long voyage. Ted Dunal was in town having completed a trip aboard a tanker for a change. F. MacDonald has taken out a cargo assignment and expects to be gone for some time. S. Risken took out a freighter. O. Rone has been assigned a tanker.

MAYOR LA GUARDIA spoke at the Customs House following a parade of 800 men from the New York State Maritime Academy. The many speakers, both those representing government and shipping interests brought out the vital necessity of

maintaining an adequate U. S. Merchant Marine. Prior to the United States entry into this second world war, the merchant fleet of this country was of relatively small importance, as merchant fleets go, carrying only about one seventh of the world's commerce as late as 1939. . . . In 1937 the United States embarked on an expansion program to cover some ten years during which time the merchant fleet was to be increased by the addition of some five hundred ships. This, however, would also have been totally inadequate for a nation of our size. In the meantime however, the war in Europe broke out, which we subsequently entered and the problem of transporting the necessary men and materials to the battlefronts via the Atlantic became of prime importance to us, causing a very rapid expansion of our merchant fleet until today the United States finds itself carrying two thirds of the world's shipping which amounts to a near monopoly of world commerce. Such a fleet is a necessity to this country in time of war to carry the vast quantities of men and materials needed to carry on a war thousands of miles away. A merchant fleet such as this should never be allowed to deteriorate to the low standard set after the last war when ships

were tied up in "graveyards" to slowly rust away or be sold for near nothing to foreign shipping companies who were able, in many cases, to run our firms from the high seas with their lower rates due to cheap labor. Our present merchant fleet must be kept up and maintained in order for immediate use as an auxiliary to the military and naval forces of this nation . . . successful maintenance of peace can only be achieved through being powerful enough to resist attack, through being powerful to the

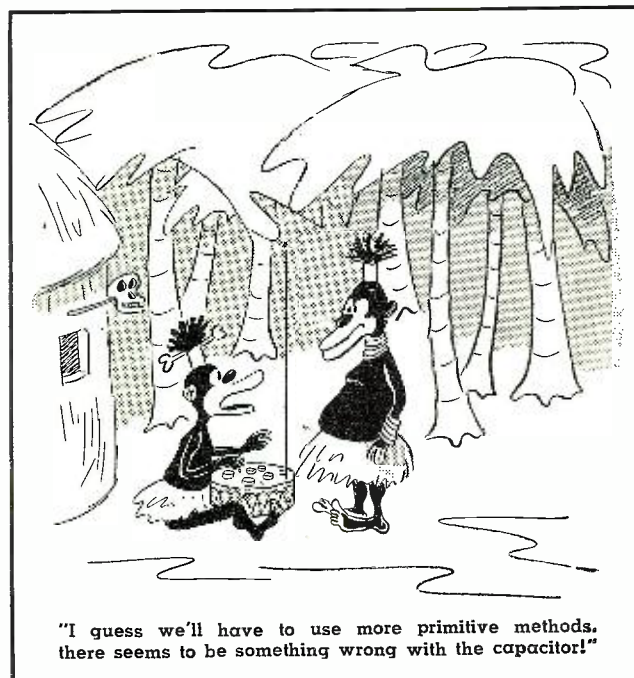

"I guess we'll have to use more primitive methods, there seems to be something wrong with the capacitor!"

(Cont. on page 60)

PLOTTING of ENGINEERING DATA

By R. G. MIDDLETON

Eng., Fen-Mer Co., Inc.

The author presents many important points to bear in mind when plotting engineering data in its simplest possible form.

OBSERVATIONS from an experimental or test set-up may be plotted on Cartesian coordinate paper, and a smooth curve drawn through the datum points. While such curves are always "true" providing a sufficient number of points have been determined, such curves may not always display their information in a useful form.

Various kinds of coordinate paper are available for engineering work, such as Cartesian-rectangular, semi-log, log-log, polar, triangular, and many special rulings.

As rectangular-linear coordinate paper is not always the most advantageous for experimental data, it is likewise not always the best ruling for theoretical reference charts, such as decibel curves, as will be seen.

An equation which plots as a straight line in Cartesian coordinates does not plot similarly upon other rulings, but appears as a curve. Conversely, curved graphs in Cartesian coordinates will plot as straight lines upon the proper rulings.

Fig. 3 illustrates the graphs of a straight line and a branch of a parabola in rectangular coordinates; the straight line has the equation $y = x$, and the parabola has the equation $y = x^2$. It is apparent that reading the graph and interpolating is easier in the case of the straight line.

Now the equation $y = x^2$ would be

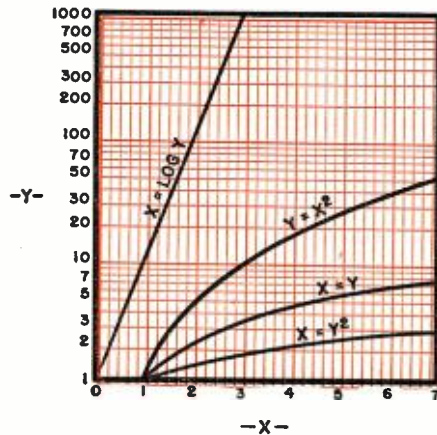

Fig. 1.

of the general form of a linear function if its logarithm were taken:

$$\log y = \log x^2 = 2 \log x$$

This is the same equation and says the same thing as $y = x^2$, but the information is merely presented in another form which renders the variables of the same order. The straight line ($\log y = 2 \log x$), Fig. 3, illustrates the graphical result.

We are primarily interested in y and x themselves rather than $\log y$ and $\log x$, and if Cartesian coordinates are retained the advantages of linearity will be outweighed by the necessity of logarithmic manipulation.

The logarithmic operations required may be performed automatically by using a logarithmic ruling rather than a linear ruling. In Fig. 4, it is illustrated how $y = x^2$ may be made to appear as a straight line, while y and x themselves are read directly from the coordinates. This ruling is log-log in which each successive division is ruled in logarithmic intervals. Any equation of the form $y = kx^n$ appears as a straight line on log-log paper.

It frequently happens that $\log y$ will be desired rather than y itself; that is, the equation which we want to plot may be of the form $x = \log y$. This type of equation will plot as a straight line on semi-log paper.

Fig. 1 graphs $x = \log y$, with $x = y$, etc., for comparison. Semi-log paper is ruled linearly along one axis, and logarithmically along the other axis. The linear variable should be taken along the linear intervals, and the

logarithmic term along the logarithmic intervals.

How semi-log paper may be put into practice is illustrated by Figs. 5 and 11. These are graphs for the decibel equation, plotted in both Cartesian and semi-log coordinates. It is at once apparent that the information presented in Fig. 11 is in far better form. It may be noted that one decibel is about the smallest volume change which is perceptible to the ear. V_1/V_2 is left as a ratio and regarded as a new variable. Thus, the decibel can have no absolute value until the reference level is specified, such as 1.9 volts in 600 ohms.

How log-log paper may be applied practically is shown in Fig. 6. A formula of the form $xy = k$ may evidently be linearized by taking logs, since $\log x + \log y = \log k$. The ratio of the ripple voltage across the first capacitor of a capacitive input filter to the d.c. output voltage is given to a good approximation by

$$\frac{\text{RMS ripple}}{\text{DC output}} = \sqrt{2}/(2\pi fRC)$$

where R is the load into which the filter works and f is the ripple frequency under consideration.

It is evident that this information can be most usefully presented by plotting on log-log paper, since the graphs are then linear as in Fig. 6. Filter design may be outlined rapidly with charts prepared in this manner.

When graphs are plotted from empirical data, the equation is usually unknown. To determine if such a set of data corresponds to an equation of the general form $y = kx^n$, the observed values may be plotted on log-log paper and connected with a straight line if possible. If a straight line runs through the points, the equation is determined and the exponent of the independent variable is equal to the slope of the straight line. Next, let $x = 1$, and k will equal y .

If the graph is not a straight line, but an upward curve, the equation may be of the form $y - k' = kx^n$; on the other hand, if the graph is a downward curve, the equation may be of the form $y + k' = kx^n$. If neither of these equations fit the curve, $\pm k'$ may be added to x , thus leading to equations of the forms $y = k(x \pm k')^n$.

The sensitivity and fidelity of radio

Fig. 2.

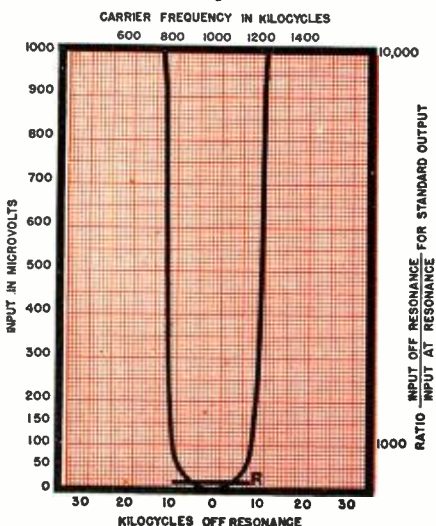

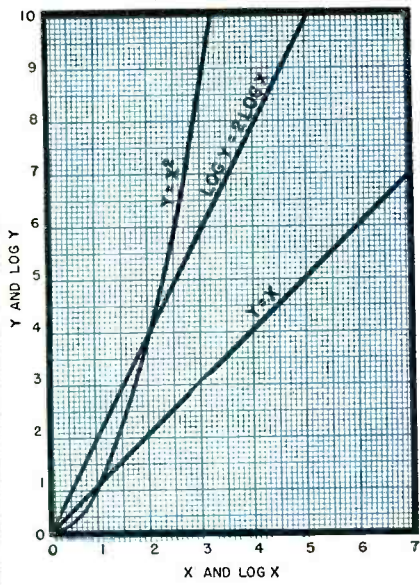

Fig. 3

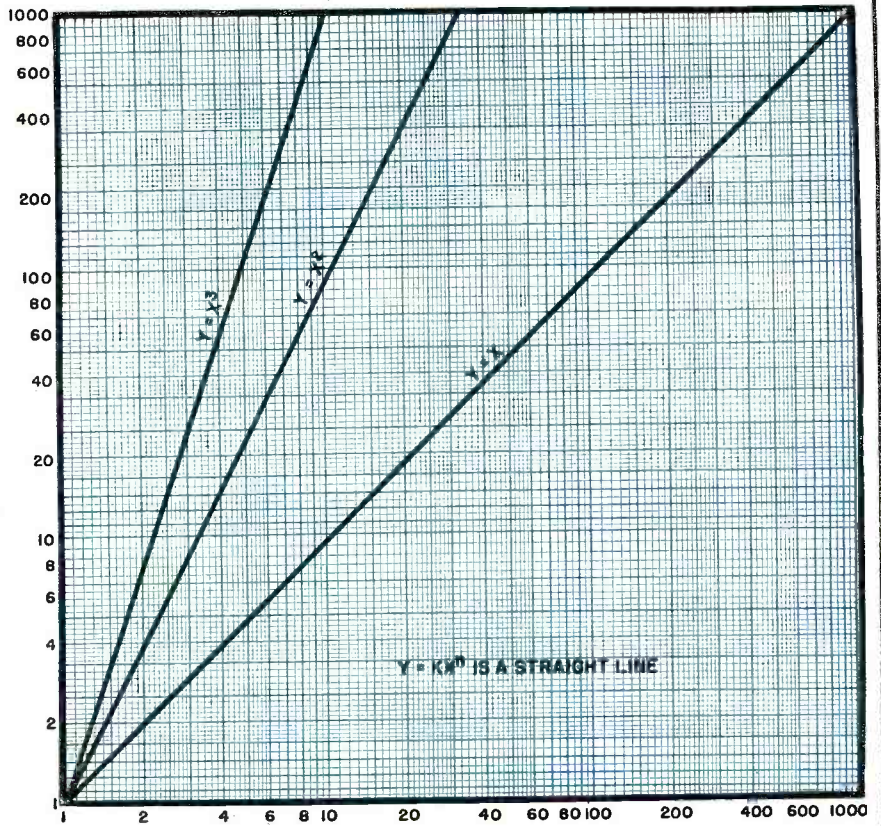

Fig. 4

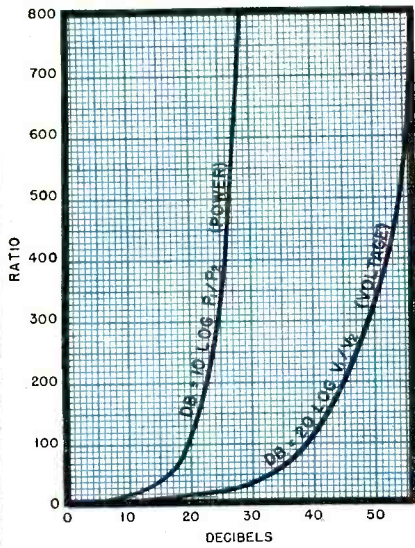

Fig. 5

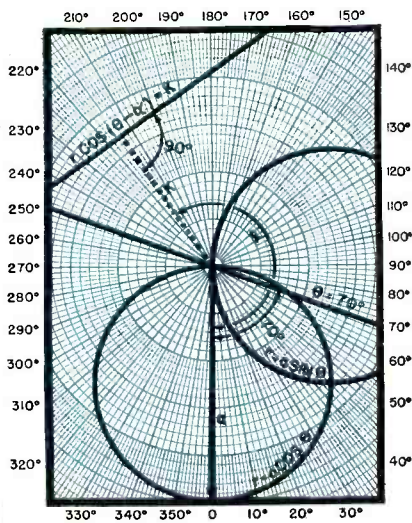

Fig. 7

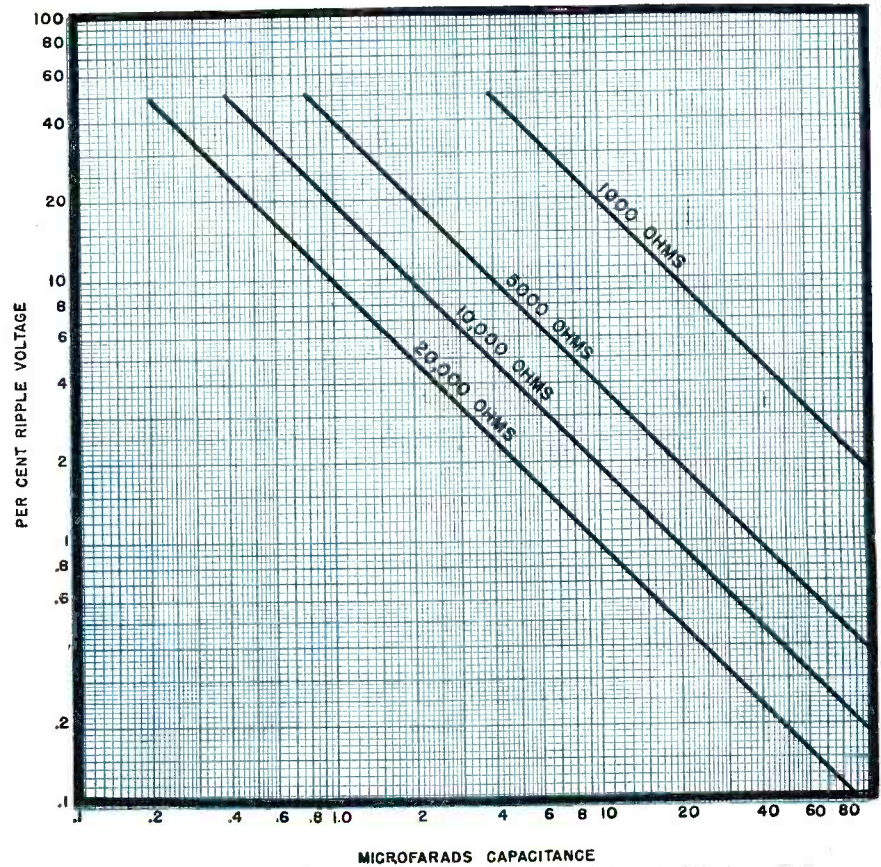

Fig. 6

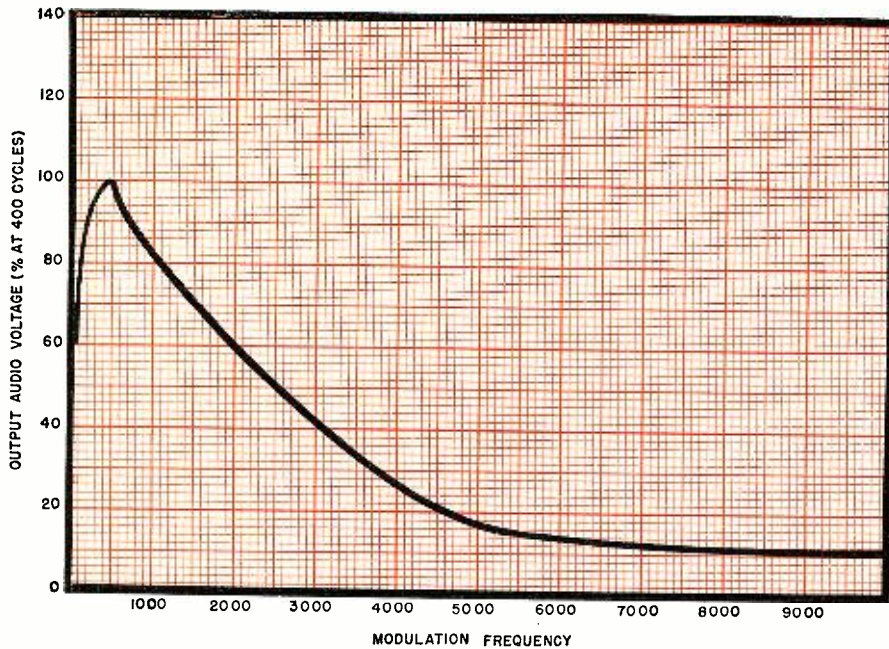

Fig. 8.

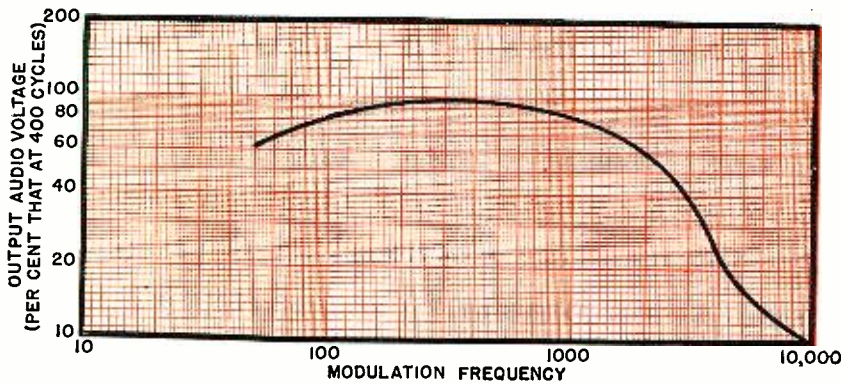

Fig. 9.

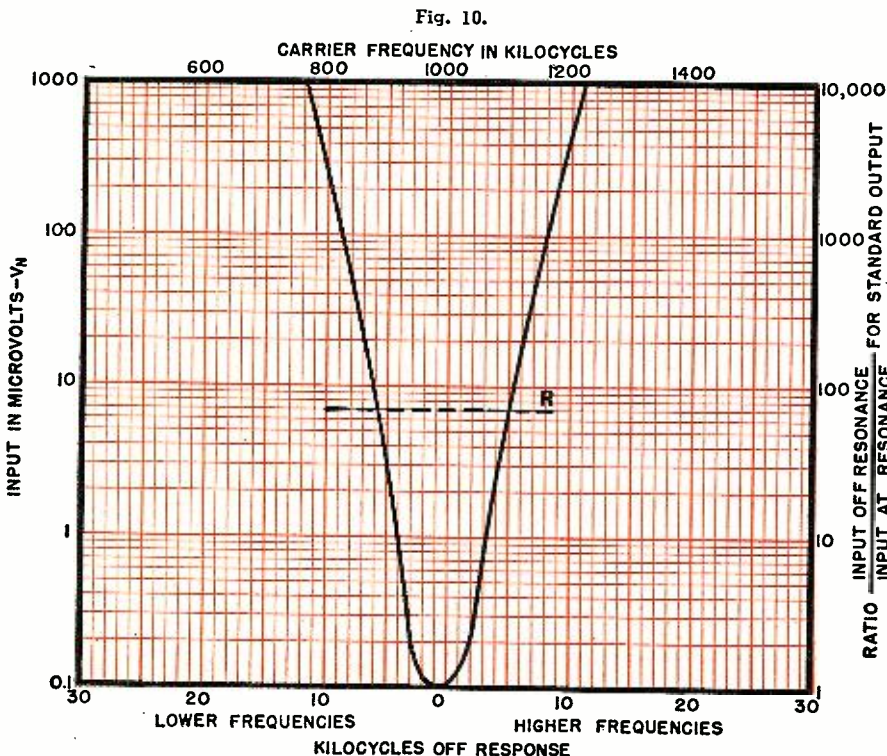

Fig. 10.

receivers are plotted on semi-log paper, although the fidelity may also be plotted on log-log paper. Fig. 10 shows the type of graph which may be expected. It is observed that the resonant response is not symmetrical about the center frequency. Neither is it the flat-topped band-pass characteristic that yields most faithful reproduction. We are interested in the steepness of the sides, and in the shape of the graph from *R* to the peak.

The same information is plotted in Fig. 2 on Cartesian paper, from which it is apparent that the data is presented in a form which is practically useless. The portion of the curve which is of the greatest significance has been so concentrated in a small area that the investigator cannot read it intelligently. On the other hand, the information higher up on the graph may be as easily found from Fig. 10 as from Fig. 2.

The fidelity characteristics plotted in Fig. 9 on log-log paper are plotted in Fig. 8 on Cartesian paper. In the latter graph, it is noticed that the curvature is far from uniform, varying with great rapidity about 400 cycles and showing little variation from 5,000 to 10,000 cycles. In Fig. 9, the fidelity graph is smoothed out markedly through the device of plotting on log-log paper.

In all these curves, linear distances have been compared with one another. It is frequently useful to graph data or equations in terms of a distance and a direction. If we are interested in determining the radiation pattern, for example, for a simple antenna, the data should be plotted on polar coordinate paper, as shown in Fig. 12. The curve is the field strength in any direction from the antenna, in the horizontal plane containing the antenna.

The equation which corresponds to a graph in polar coordinates is a function of r and θ such that the terminus of r traces the curve as θ varies from 0 to 360°. Thus in Fig. 7, $r = a(\cos \theta)$ and $r = a(\sin \theta)$ are equations of circles. The equation of a straight line through the origin in polar coordinates is $\theta = k$ (in the figure $k = 70^\circ$). The equation of a straight line in polar coordinates, not passing through the origin, is $r \cos(\theta - \alpha) = k$, where α is the angle to the normal through the pole to the line.

There are still other special rulings which find application in engineering work, such as power emission paper and triangular coordinate paper (not illustrated). The former is a curvilinear coordinate system on which the relation between cathode heating power and electronic emission plots as a straight line. Triangular coordinate paper will be found useful when the sum of three variable terms is equal to a constant.

It should be observed that selection of the proper ruling for the given
(Continued on page 126)

OHMITE

Control UNITS

GIVE ACCURATE, TROUBLE-FREE SERVICE

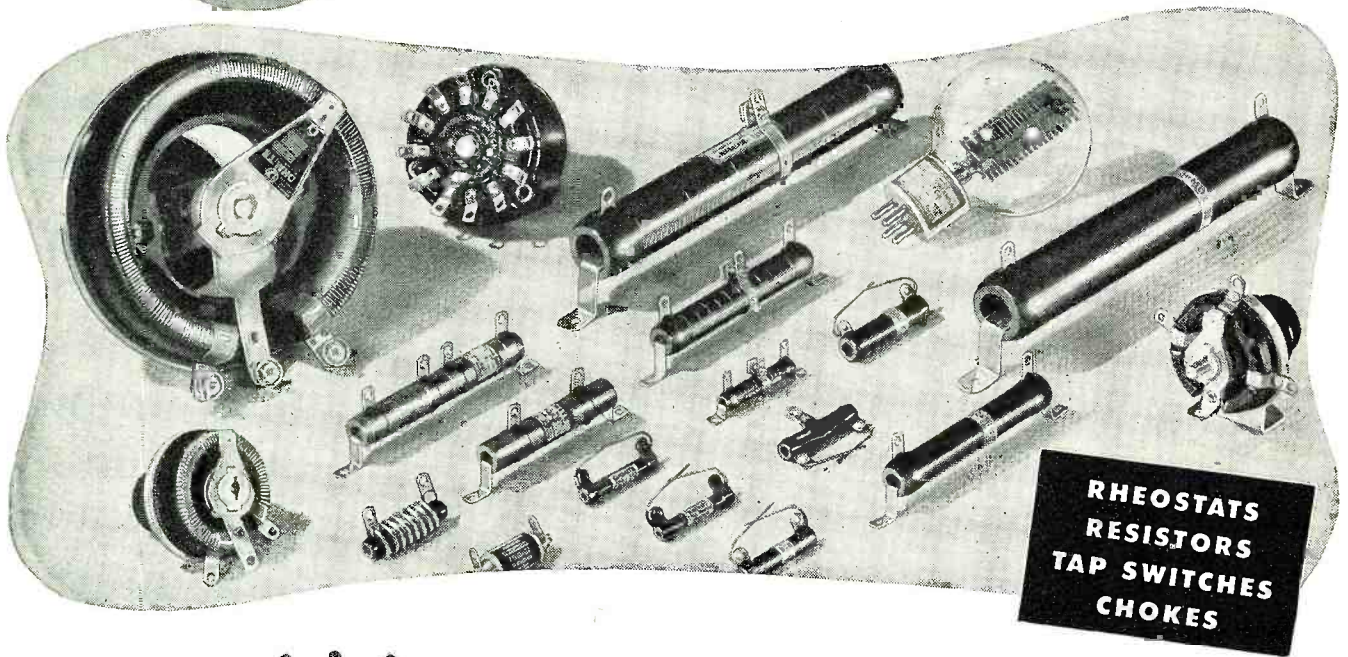

Designed and Built
to Withstand

**SHOCK
VIBRATION**

TEMPERATURE EXTREMES

HUMIDITY

ALTITUDE

Because they are so consistently reliable in actual service . . . Ohmite Rheostats, Resistors, Chokes and Tap Switches have become "the control engineer's control units."

Shown here are a few of the many types extensively used in military and industrial equipment. The wide variety of types and sizes in stock or special units provides a ready and exact answer to most applications.

In designing for war or postwar, let Ohmite experience help you.

OHMITE MANUFACTURING COMPANY
4884 Flournoy Street Chicago 44, U. S. A.

Send for Handy Ohm's Law Calculator



Set the slide once—read the answer! Solves any Ohm's Law Problem—quickly, easily. Send only 10c in coin to cover handling and mailing.

Be Right with **OHMITE**
RHEOSTATS • RESISTORS • TAP SWITCHES

MURDOCK RADIO PHONES

MAKE THIS
Listening
Test!



RADIO MEN!

The first time you listen with Murdock Phones, you know that here is clear reception with perfect comfort—and this is why:

1. MURDOCK "precisioneering" brings the message through naturally—without strain, chatter or distortion.
2. MURDOCK'S "solid-built" durable construction protects the fine, sensitive adjustments from shock.
3. MURDOCK'S "air-cushioned" phones provide long listening without head discomfort.
4. MURDOCK'S ventilation means cool comfort—prevents condensation.
5. MURDOCK'S two-way adjustment controls position for smoother performance.

Murdock's entire factory is now working for Uncle Sam. But as soon as victory is won, Murdock men, machines and materials will resume their peacetime position as a leading manufacturer of radio phones, telephone and electrical specialties for civilian use.

Plan for that peace now. Write today for new catalog.

MANUFACTURERS: We're at your service to help you turn out more Radio Phones and related parts. Our organization has had 40 years' experience. Write us today.

WM. J. MURDOCK CO.
172 Carter St., Chelsea 50, Mass.

QTC

(Continued from page 55)

extent where other nations would not dare attack. To operate a successful navy, it is of utmost importance that the U. S. maintain a high position with her merchant fleet which is very vital to the supply demands of a modern navy.

HARRY B. SMITH, Chief on a Liberty, writes from the West Coast and seems to agree with comments regarding the space, or lack of it, in the radio shack aboard the Liberty types since the addition of a short wave transmitter. Harry says he has just 2½ feet to swing around in, looks like "HB" has to start a diet shortly. P. B. Johannessen, ex-marine operator and east coast service man was in recently on a well-deserved vacation from his post with the Signal Corps way up north in the islands. W. J. Scott (Army), R. Jenkins (Navy) and B. W. Hill (Navy) are interested in getting into the merchant marine after the war and pounding brass as commercial oprs.

VARIOUS radio manufacturers throughout the country are getting set for post-war production of civilian equipment as cutbacks in government orders are expected and already received by some. . . . It is a possibility that a fifty percent cut in production of electronic equipment may take place; civilian and industrial customers must be found to take up the slack in this production in order to keep things going properly without long layoff periods and plant inactivity for radio manufacturing concerns. Manufacturers report that the addition of FM to the average receiver selling for over about fifty dollars would be one of the biggest improvements . . . and that better quality and tone range would be found due to this addition. Most concerns seem to feel that the phono-radio combination with the addition of FM seems to be the equipment that will be most in demand from the general public . . . better looking equipment with better tone is the general belief but it has been pointed out that the "super" radio with the fur-lined bath tubs some people seem to expect will not be in the offing for a long, long time. Television will be somewhat improved it is believed due to things learned during the war. Many things learned during war time will improve post-war equipment but there will be most likely many things of a secret nature that the government services will not release after the war.

WE HAVE received quite a few letters from the boys in the Army, Navy and other government services but very little from the fellows in the merchant marine during the last few weeks—let's hear from you.73

Announcing **THE NEW** ★
SUPREME MODEL 565
VACUUM TUBE VOLTMETER!

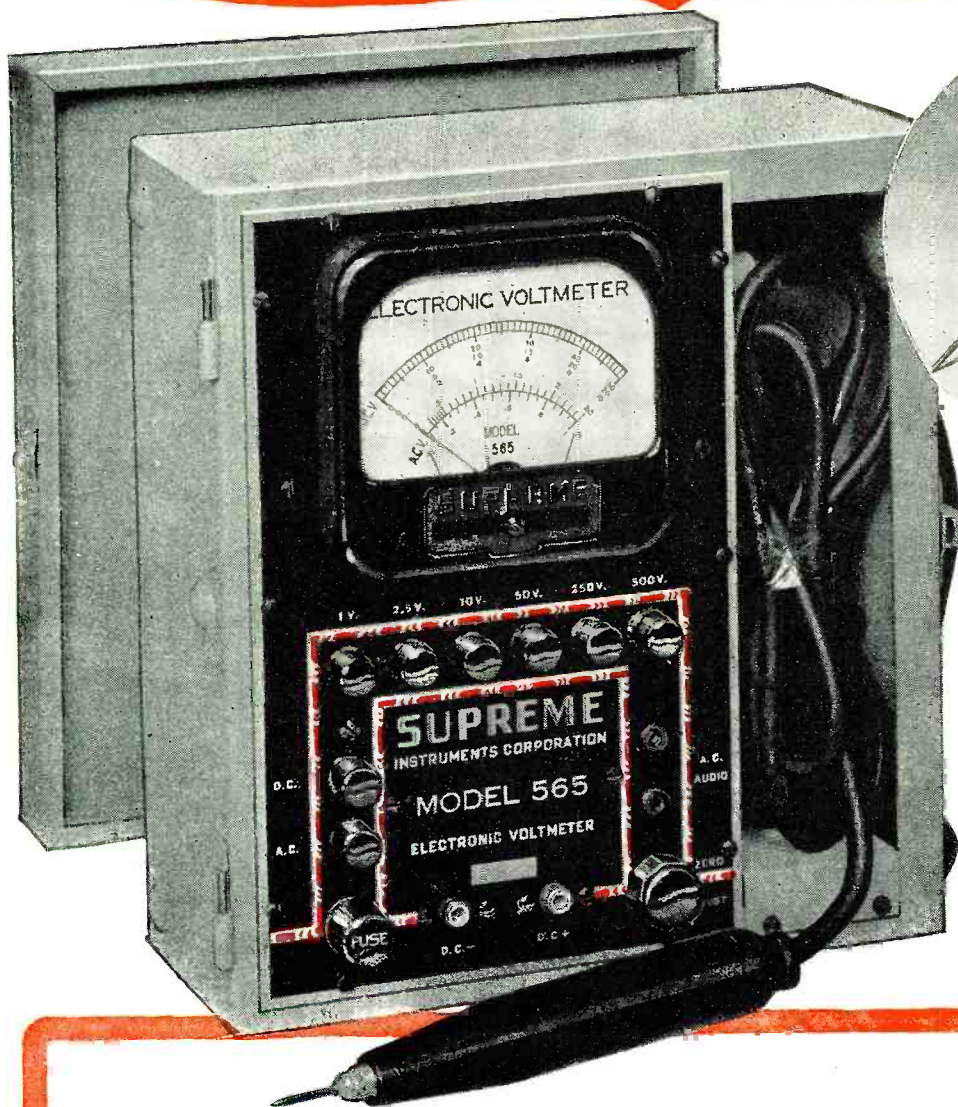

New type hand-fitting probe allows ease of measurements, handles just as any ordinary test lead. Probe incorporates new high-frequency diode giving best possible frequency response. Completely new, balanced, highly degenerative bridge circuit allows higher input impedances (less detuning on RF circuits) and greater stability than ever before.

RANGES:

DC 0-1, 2.5, 10, 50, 250, 500
 AC 0-1, 2.5, 10, 50, 250

EXTENDED TO 5000 VOLTS BY EXTERNAL MULTIPLIERS

INPUT RESISTANCE:

DC—80 megohms on 1 volt range; 40 megohms on 500 volt range
 AC—40 megohms on 1 volt range; 20 megohms on 250 volt range

INPUT CAPACITY OF PROBE: 5 micro-micro farads

FREQUENCY RANGE:

Negligible frequency error from
 50 cycles to 100 megacycles.

SUPREME INSTRUMENTS CORPORATION GREENWOOD MISSISSIPPI

EUROPEAN News Review

By **LEON LADEN**

London, England

A survey of some of the more important wartime developments in radio-electronics.

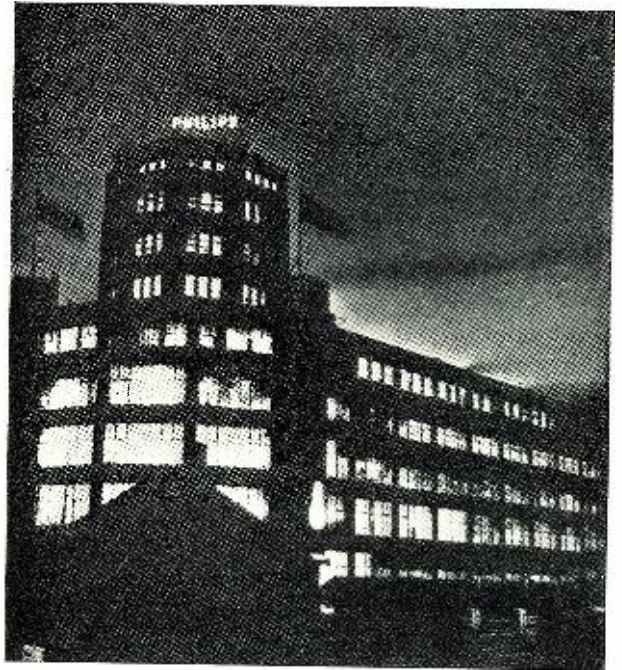

Philips' Incandescent Lamp Factory in Eindhoven, Holland.

THE snowballing demands of modern warfare have undoubtedly stimulated radio science and developed the scientific, research and manufacturing potential of the radio-electronics industry. Nevertheless, an evaluation of progress in this field of applied science reveals that wartime radio-electronic applications are generally based on well-known principles or else were developed from theories evolved prior to the outbreak of the war.

In fact, it can be assumed that no single discovery of a fundamental character bearing directly on radio and electronics has been made during this war.

Of course, this lack of new discoveries hardly belittles the tremendous wartime contribution made by radio scientists, research workers and manufacturers in providing, in the aggregate, an endless stream of equipment for the armed forces but it does emphasize once again the necessity of long-term policies of patient research and development work required for obtaining any results of scientific or outstanding commercial value.

Just how uphill a task the application of new scientific knowledge to practical engineering is, is being brought home to British physicists and radio-engineers working on the development of a new technique of communication engineering.

This new technique—which comes as the climax of a slow trend in line telephony—aims at providing a multitude of channels for telephony, broadcasting, television, and various other purposes by the aid of completely empty and hollow metal tubes equipped with small terminal aeri- als radiating from one end of a pipe to the other or alternatively, radiating into the open.

To the layman it might perhaps appear obvious that radio waves can be transmitted down pipes in the same way as sound waves are sent down speaking tubes.

However, as soon as it is realized that sound waves are longitudinal oscillations of air parallel to the direction of propagation and radio waves transverse oscillations of electro-magnetic variations at right angles to the direction of propagation, it becomes

evident that the analogy does not hold good since a sound wave travels irrespective of tube width whereas the wavelength of a radio wave has to fit into the diameter of the tube through which it passes.

This means that only frequencies less than about 10 centimeters in wavelength (3,000,000,000 c.p.s.) can be piped through tubes without distortion.

Obviously, the technical problems involved in the use of such very high frequencies are formidable in terms of practical engineering.

The replacement, therefore, of multi-wire "phantom circuits," double-wire carrier-current telephony, single-wire coaxial cables or radiators and receivers of conventional type by the new technique of "guiding" waves through pipes is bound to take time.

Nevertheless, it is generally anticipated that piped radio will be put into operation sometime after the war and make the transmission and reception of television programs to screens in the cinema and home as easy as the sending and receiving of, say, cablegrams.

In fact, it is alleged that a \$25,000,000 company which was recently formed in this country for the commercial exploitation of tapped television on a grand scale has already acquired a large number of cinemas all over Britain for post-war conversion to television as well as a 10,000-acre estate near London as a site for an after-the-war British Television Hollywood.

A 1,000-line French Television System

It is now known that the world's most powerful pre-war television transmitter radiating from the high-

RADIO NEWS

Another view of the vast incandescent lamp factory of Philips in Eindhoven, Holland.

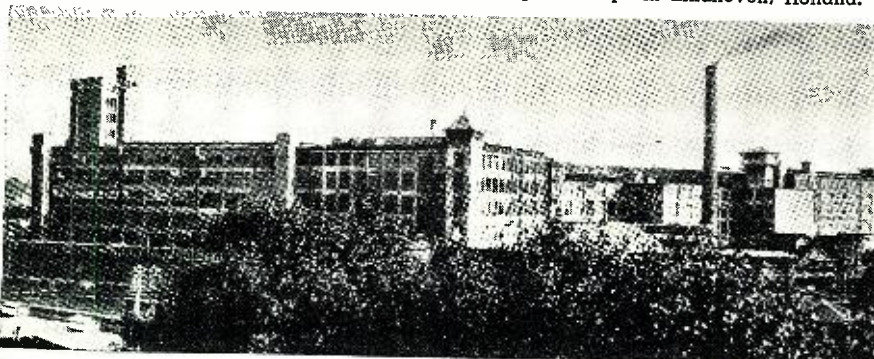

MAKE MORE MONEY

IN Radio TELEVISION & ELECTRONICS

Now!

GET THESE 2 BIG BOOKS

FREE!

You men already in Radio know how great the demand is for trained, experienced service men, operators and technicians. You know how fast the field is growing and how important it is to keep up with developments—F.M. Receivers, Electronics and Television. You know, too, a fellow cannot learn too much about any industry for REAL SUCCESS. Whether you have experience or are merely INTERESTED in radio as an amateur, you must recognize the WONDERFUL OPPORTUNITY right within your grasp to cash in on your natural abilities. Make them pay dividends. Get into the EXPERT RADIO SERVICE FIELD. Be an F.M. and TELEVISION specialist—OWN A BUSINESS OF YOUR OWN, if you prefer. Fill out and mail the coupon below for all the details of our plan.

- Here's Just a Few of the Interesting Facts You Learn with the FREE MANUAL
1. Routine for diagnosing Radio Troubles.
 2. Preliminary Inspection of Receivers.
 3. How to Check Power Supply.
 4. How to Identify Various Stages of Receiver.
 5. How to Trace the Circuit and Prepare Skeleton Diagram.
 6. How to Test and Measure Voltages.
 7. How to Test Speaker in Audio Stages.
 8. How to Test Detector, I.F., R.F., and Mixer Stages.
 9. Complete Reference Table for Locating Receiver Troubles.

Get the Latest Inside Information—Short Cuts—Trade Secrets by

SHOP METHOD HOME TRAINING FROM A REAL ESTABLISHED RESIDENT SCHOOL.

Now the famous National Schools brings its exclusive Shop-Method of training right into your own home. You can learn the most up-to-date, approved projects, systems and circuits step by step in your spare time. This is the sound practical training you want and need—the development of experienced instructors working with thousands of students right in shops, NEW F.M. broadcast studios and experimental laboratories of NATIONAL SCHOOLS—one of the most advanced trade educational centers in the world.

National Trained Men Now Making the Best Money in History
The real value of National training shows up on the quick progress our men make on the job. Incomes that seemed fantastic only a short time ago are now being reported by National graduates. And this is only a sample of what the future holds for the MAN WHO KNOWS RADIO, ELECTRONICS, F.M., TELEVISION and allied subjects. National is proud of the progress its graduates are making all over the world. Read the facts—the actual proof in the books we send you FREE.

Be Sure of Your Success and Security After the War

Don't let your post-war ambitions lag. Don't let YOUR future depend on others. Build a career for yourself. Never in all history has the returning serviceman, or war worker been confronted with such a great future if he reaches out and grasps it NOW. Here is a new world opening before you. Get ready now while you are still in uniform—while you are on your war job. Then you can soon step into an essential, well paid position or, with little capital, GET INTO BUSINESS FOR YOURSELF. It isn't a bit too soon to start now. Radio men are vitally needed. Fill out and mail the coupon immediately and examine the NATIONAL SHOP METHOD HOME TRAINING COURSE carefully, without obligation.



Learn by Doing

Work with Real Experimental Equipment Furnished without Extra Cost as Part of Your National Training

Experience is the best teacher. You learn by experience with the exclusive National Shop-Method of Home Training. In the course of your study you actually build various types of receivers—a powerful super-heterodyne, a signal generator, an audio oscillator and others—you make tests and conduct experiments that show you the why and how of things. You understand what makes the various elements of electronics operate because you actually see them work for you. Not only do you gain marvelous experience by this method of learning but you receive valuable equipment you will use on the job in the practice of your profession as an electronics expert. Mail the coupon and learn what this means to you.

Send the Coupon and prove to yourself what YOU can do in RADIO!



FREE LESSON INCLUDED

NATIONAL SCHOOLS

LOS ANGELES 37, CALIFORNIA EST. 1905



MAIL OPPORTUNITY COUPON FOR QUICK ACTION

National Schools, Dept. 8-RN, Los Angeles 37, California. (Mail in envelope or paste on penny post card)

Mail me FREE the books mentioned in your ad including a sample lesson of your course, without obligation. I understand no salesman will call on me.

NAME..... AGE.....

ADDRESS

CITY..... STATE.....

Include your zone number

Examine the exclusive National Shop Method of Home Training. See for yourself how sound and practical it is. Be convinced that you can learn Radio, Electronics, Television—quickly and easily in your spare time. You can't tell until you try. This trial is ABSOLUTELY FREE. Fill out the coupon immediately while you are thinking about it and drop it in the mail at once.

Mail the coupon here for the books that tell you the complete story of the marvelous new system of training in Radio, Electronics and Television. Learn the facts of this exclusive shop-method of home training. See

for yourself! DECIDE FOR YOURSELF!

This is the MODERN SYSTEM OF TRAINING; it matches the rapid progress constantly being made in Radio, Television and Electronics. It is TIME TESTED, too. National Schools has been training men for more than a third of a century. It is the very same training that has helped thousands to more pay and greater opportunity.

You owe it to yourself—your future—to read the book "Your Future in Radio, Electronics and Television"—FREE to you when you send in the coupon.

One Central Source FOR Everything in RADIO and ELECTRONICS



REPAIR and REPLACEMENT PARTS AVAILABLE without priority

Over 10,000 items from all leading manufacturers . . . for the Armed Forces, Radio Training, Laboratories, Industry, Service Replacements.

NEW! Parallel Resistance & Series Capacitance

CALCULATOR
Solves Every-day Problems—Quickly!
No. X37-960
Postpaid . . . **25c**



R. F. Resonance and Coil Winding CALCULATOR
No. 37-955
Postpaid . . . **25c**



6 Radio Books for 75c

| | | | |
|---|-----|---|-----|
| Dictionary of Radio Terms. No. 37-751 | 10c | Radio Data Handbook. No. 37-754 | 25c |
| Radio Circuit Handbook. No. 37-753 | 10c | Radio Builders Handbook. No. 37-750 | 10c |
| Radio Formulas & Data Book. No. 37-752 | 10c | Simplified Radio Servicing. No. 37-755 | 10c |
| All Six Books No. 37-799 . . . 75c <i>Write for Quantity Prices</i> | | | |

ALLIED RADIO CORP., Dept 1-H-5
833 W. Jackson Blvd., Chicago 7, Ill.

Please send following books (..... enclosed)
 FREE Guide 37-750 37-752 37-754
 Calculator 37-955 37-751 37-753 37-755
 Calculator X37-960 No. 37-799 (All 6 Books)

Name.....
Address.....
City.....State.....

ALLIED RADIO

est structure in Europe, the Eiffel Tower in Paris, was used for a time by the Germans during the occupation of France for transmitting television programs to their canteens and soldiers' rest centres.

This was made possible by the fact that the Paris television transmitter—built by the *Laboratoire Le Materiel Telephonique* in 1937-8—consists of *Telefunken-Philips* equipment operating on 46 mcs. with a bandwidth of 5 mcs. and sending out 441-lines, interlaced, pictures that could be received without difficulty on German-made telesets.

Despite the occupation of their country, prominent French radio scientists and engineers managed to carry on with their research and development work at two experimental television transmitting stations at Lyons.

Important discoveries were made, in consequence, and a 1,000-line television system using direct all-electronic projection and viewing was developed by Rene Barthelmy, chief engineer of the *Companie Francaise de Television*, and his associates.

Soviet Television

The part played by radio and electronics in the Soviet Union's fight against the Germans can only be measured against the scale of that country's pre-war radio industry which was then mainly limited to the manufacture of standardised one-wave radio sets and some research and development work centred round the universities of Leningrad and Moscow.

As soon as the war broke out, however, a tremendous effort was made to improve the technical efficiency of existing equipment and to develop communication gear for special military purposes.

The intensive program of research work which was inaugurated and the new production methods which were adopted yielded excellent results.

Among the highlights of Russian mass-production of to-day are metal triode oscillators and amplifiers capable of efficient operation on centimeter wavelengths with a power output of from 4 to 6 watts and water-cooled power tubes up to a hundred kilowatts.

Special attention was also paid to the development of television—pre-war Russia had only two experimental television stations although successful experiments had been conducted in that country as far back as 1907—and Sergei Ivanov, a well-known Soviet radio engineer, was recently able to demonstrate in Moscow an all-electronic cinema-television projector casting a three-dimensional picture onto a "mirror-like screen consisting of some 2,000 microscopic lenses.

These images, the inventor explained, are depicted at different angles by the aid of a special stereoscopic system throwing six to eight pairs of pictures simultaneously onto

the screen and foreshortening them at various angles.

According to reports, the USSR plans to install television equipment of this type in the proposed building of the Palace of the Soviets after the war.

Swiss Large-screen Television Projector

The *Swiss Institute of Applied Physics* in Zurich has been able to develop in the course of the last few years a television projector capable of producing large screen images.

The projector is based upon the principle of the point-to-point deformation of the surface of a thin film of liquid by means of electrostatic forces.

This system deviates from other systems in that the process is accomplished by the aid of a modulated cathode-ray beam charging the surface of the liquid with electricity and thus giving rise to the forces needed to effect the deformation.

Dr. Fischer of the *Swiss Federal Institute of Technology*—under whose supervision the projector was developed—claims that this new system of television is suitable for presentation to cinema theatre audiences.

Dutch Electro-Acoustic Aids

The *Philips Research Laboratories* at Eindhoven, Holland, have carried out during the war, successful experiments with electro-acoustic methods of obtaining amplification of the sound of a solo violin playing against an accompanying orchestra in larger concert halls.

In practical application, the new method permits a musician of exceptional skill appearing as a soloist to increase the volume of sound emanating from his Stradivarius or Guarnerius without extra effort or distortion.

The basis of this method is amplification of the solo performance through multiplication by a given number of other violins.

The contraption used is simple in construction and consists merely of a special type of piezo-crystal pick-up suspended onto the dead end of the G-string of the violin bridge.

This crystal executes vibrational movements when the bridge vibrates producing piezo-crystal voltages which are amplified and fed to the bridges of a series of other violins lined up next to one another and connected together.

The bodies of these violins act as loudspeakers and reproduce in unison the sounds radiated by the strings of the solo violin.

Another wartime development of the *Dutch Philips Company* is a microphone which uses the mechanical vibrations of the throat as an exciting agent instead of the usual air vibrations which occur in front of the mouth.

This new pick-up device enables telephone conversations to take place in aeroplane cabins, boiler factories,

RADIO NEWS

IN **TELEVISION,** MORE THAN EVER, IT WILL PAY TO **SELL THE TUBES WITH** **THE BEST-KNOWN NAME**

Television servicing is going to be big business.

It's also going to be profitable business. For it's a complex and skillful operation and your customers are going to pay more... and *expect* to pay more... than for ordinary radio servicing.

Renewal tubes will account for a large share of the increased cost, for television sets require many more tubes. In addition, each set must have a large picture tube which, while costing much less than pre-war types, thanks to continuing RCA research, is bound to be many times the price of the ordinary receiving tube.

When your customer pays out that kind of money for a single tube, you can bet he'll insist on having *the best*. And the prestige of the tubes you give him will go a long way towards establishing your shop in his mind as *the* place for television service.

RCA tubes give you the prestige you need to make *occasional* customers *regular* customers. RCA tubes are accepted... your customers know them and rate them tops, because, year after year, the RCA name has been associated with leadership in tubes.

Television is no exception. RCA television-tube developments like these *made electronic television possible*... and they will bring television profits to you years earlier. They also built television prestige for RCA, which, in turn, is passed on to you every time you display the RCA seal... every time you put an RCA tube in a customer's set.

Give your servicing business every break you can after the war. Make the most of your chances by identifying yourself with the *best-known name in tubes*.

The Fountainhead of Modern Tube Development is RCA

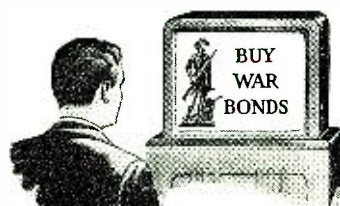

August, 1945

Listen to "THE
MUSIC AMERICA
LOVES BEST,"
Sundays,
4:30 PM, EWT,
NBC Network

RCA TUBE ADVANCES THAT MADE TELEVISION HISTORY

| | |
|---|--|
|  <p>Iconoscope Tubes</p> <p>—the camera tubes that made all-electronic television possible, bringing high definition to the television screen.</p> |  <p>Kinescope Tubes</p> <p>—first step in electronic television—have been speeded in development by RCA research.</p> |
|  <p>Orthicon Tubes</p> <p>—specially developed by RCA as camera tubes for outdoor work where light intensity cannot be controlled—a big step forward in outside pickups of special events.</p> |  <p>High-Intensity Projection Tubes</p> <p>—an exclusive RCA development that helped make possible large-screen television for home use, as demonstrated by RCA early this year.</p> |



62-0036-94

RADIO CORPORATION OF AMERICA

RCA VICTOR DIVISION • CAMDEN, NEW JERSEY

LEADS THE WAY . . . In Radio . . . Television . . . Tubes
Phonographs . . . Records . . . Electronics

AMPLIFIERS INTERCOMMS RECORDERS

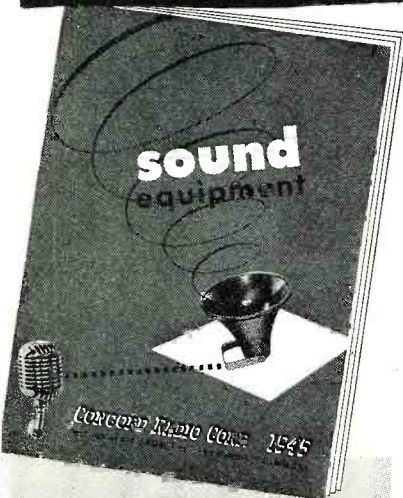

Write for This Important New CONCORD Presentation

"Sound Equipment"—ready now—a new up-to-the-minute Concord folder illustrating and describing our complete line of Amplifiers, Intercomms and Recorders AVAILABLE FOR IMMEDIATE SHIPMENT.

Amplifiers—ranging in output ratings of 17 watts to 75 watts A.C.—also 6-volt units with and without built-in phonograph. Complete listing of speakers, microphones and essential equipment also included.

Intercommunication Systems—master and sub-station combinations for every purpose from 2 to 100 stations. Push button control, universal operation, "busy signal" and "call waiting light" features.

Recording Equipment—professional type for microphone recording, radio recording, transcriptions, public address.

Engineering Service—Our engineering service is at your command, without charge, to answer any and all "Sound Equipment" questions.

Mail the coupon below for your copy of "Sound Equipment" now.

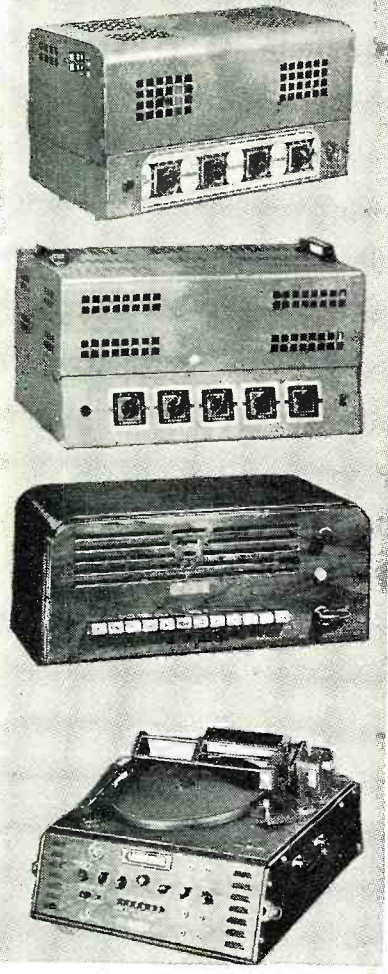

CONCORD
RADIO CORPORATION
Lafayette Radio Corporation
 CHICAGO 7, ILL. ATLANTA 3, GA.
 901 W. Jackson Blvd. 265 Peachtree Street

CONCORD RADIO CORP.
 901 W. Jackson Blvd., Dept. E-85
 Chicago 7, Illinois

Please send me at once copy of your new "Sound Equipment" folder.

Name.....
 Address.....
 City.....State.....

ship building yards, mine shafts and other places where deafening noise drowns the human voice.

Two different laryngophones — as these microphones are called—have been developed; a crystal type using Rochelle-salt for the reversal of the electric charges and a more sensitive carbon type in which the current variations are produced by pressure of the carbon grains.

Swedish Electronic-Eye Device

A Swedish company, working in close co-operation with prominent Swedish ophthalmologists, has perfected an electronically-controlled device for the removal of iron particles from human eyes.

The new device has extra fine tips for insertion into the vitreous body and combines a small air gap with a large range of the magnetic field.

It is apparently entirely automatic in operation and exceeds in strength many times electro-eye magnets of the conventional type.

Germany's Wartime Developments

A scrutiny of Germany's radio-electronic developments since 1939 discloses that as far as can be ascertained very little worth recording was produced in that country apart from automatic and remote-control radio devices for the launching of V-2 rockets and the steering into position and exploding of driverless tanks or mines.

Of course, a considerable amount of research and development work took place in Germany during the war years and there remains a remote possibility that some startling inventions of great significance were made by Nazi scientists and research workers which failed to pass the test of practical application and are still shrouded in secrecy. There is no doubt but what much of this data will be released in the near future.

However that may be, it is certain that at the beginning of the war television was fairly regularly relayed from the Rundfunk transmitter in the Berlin area by the aid of di-pole aerials picking up the 441-line images and passing them on through special cables to redistribution amplifiers installed near the top floors of larger blocks of flats.

These amplifiers were adjusted to distribute signals automatically to miniature sets equipped with post-card-sized screens manufactured by the Telefunken company installed in individual flats occupied by Nazi big shots.

As post-war Germany will in all probability be deprived of most of the 36 wavelengths she managed to secure by rather dubious means at the international radio conference in 1938 at Montreaux, Switzerland, it can be anticipated that television will not reappear in that country for some years to come.



HERE'S THAT NEW
TRIPLETT
625-N

LONG SCALE, WIDE RANGE VOLT-OHM-MILLIAMMETER

DOUBLE SENSITIVITY

D. C. VOLT RANGES

0-1.25-5-25-125-500-2500 Volts,
 at 20,000 ohms per volt for greater accuracy on
 Television and other high resistance D.C. circuits.

0-2.5-10-50-250-1000-5000 Volts,
 at 10,000 ohms per volt.

A. C. VOLT RANGES

0-2.5-10-50-250-1000-5000 Volts,
 at 10,000 ohms per volt.

OHM-MEGOHMS

0-400 ohms (60 ohms center scale)
 0-50,000 ohms (300 ohms center scale)
 0-10 megohms (60,000 ohms center scale)

DIRECT READING OUTPUT LEVEL DECIBEL RANGES

-30 to +3, +15, +29, +43, +55, +69 DB

TEMPERATURE COMPENSATED CIRCUIT FOR ALL CURRENT RANGES D. C. MICROAMPERES

0-50 Microamperes, at 250 M.V.

D. C. MILLIAMPERES

0-1-10-100-1000 Milliamperes, at 250 M.V.

D. C. AMPERES

0-10 Amperes, at 250 M.V.

OUTPUT READINGS

Condenser in series with A.C. Volts for output readings.

ATTRACTIVE COMPACT CASE

Size: 2½" x 5½" x 6". A readily portable, completely insulated, black, molded case, with strap handle. A suitable black, leather carrying case (No. 629) also available, with strap handle.

LONG 5" SCALE ARC

For greater reading accuracy on the Triplet RED • DOT Lifetime Guaranteed meter.

SIMPLIFIED SWITCHING CIRCUIT

Greater ease in changing ranges.

Write for descriptive folder giving full technical details



Triplet

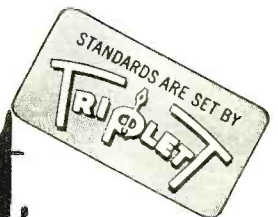

ELECTRICAL INSTRUMENT CO. BLUFFTON, OHIO

WHAT'S NEW IN RADIO

New products for military and civilian use.

The products described herein are available, in most cases, only through high priority ratings. It is suggested that readers apply for further information on company letterheads, stating full details as to priorities available.

MINIATURE INSTRUMENTS

A complete line of miniature voltmeters, ammeters, milliammeters and microammeter has been introduced by the *MB Manufacturing Company, Inc.*

These indicating instruments measure one inch in diameter and weigh

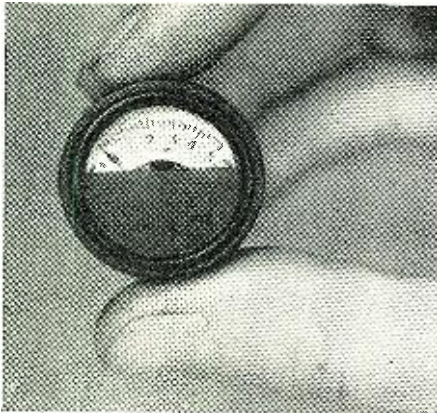

only 1¼ ounces. Of the moving coil type, these instruments are hermetically sealed in an anodized aluminum case which also has provision for hermetically sealing the instrument case to the mounting panel.

In addition to this line, a companion line of 1½" instruments is also available. The weight of these instruments is 1½ ounces.

Details may be obtained from Department S, *MB Manufacturing Company, Inc.*, Instrument Division, 250 Dodge Avenue, East Haven, 12, Conn.

NEW HEADPHONE

A new headphone and microphone assembly which incorporates several new features is being manufactured by *Aviometer Corporation* of New York.

A flexible head and chin strap allows wide latitude for adjustment of earphones to the most comfortable position on any head. The tiny lightweight anti-noise 100 ohm carbon microphone, in a plastic closure, is assembled with a swivel boom. Easy movement permits correct positioning for clear transmission and frees the hands for other duties. The microphone unit disappears from the face and rests parallel with the headband or under the chin when not in use.

The complete assembly weighs less than 12 ounces. The unit is fitted with chin slide clasp for centering ear cushions, convenient cordage, small disconnect plug and a new pistol-grip control switch.

The unit is being manufactured by

Aviometer Corporation, 370 West 35th, New York, New York.

NEW VOLTOHMYST

The *RCA Victor Division* of the *Radio Corporation of America* has announced a new Voltohmyst, the RCA 195-A, which in one compact unit provides the means for measuring d.c. or a.c. voltage, resistance, audio level, and FM discriminator balance.

The Voltohmyst includes a six-range d.c. voltmeter, an ohmmeter which reads from .1 ohm to 1000 megohms, a six-range a.c. voltmeter, a linear audio frequency voltmeter, an audio level meter, and an FM discriminator balance indicator.

The six-way usefulness of this instrument is due to the use of electronic measuring circuits. The use of such circuits also provides other important advantages, including high input resistance, which makes it possible to test radio receivers with the signal present, ability to measure high values of resistance, and protection against meter burnout. Improvements over the original Voltohmyst include a diode for a.c. measurements, linear a.c. scale for all ranges, a new crystal-clear plastic meter case with one-piece unbreakable front and a shielded a.c. cable and probe.

A bulletin describing the RCA 195-A Voltohmyst can be obtained from the

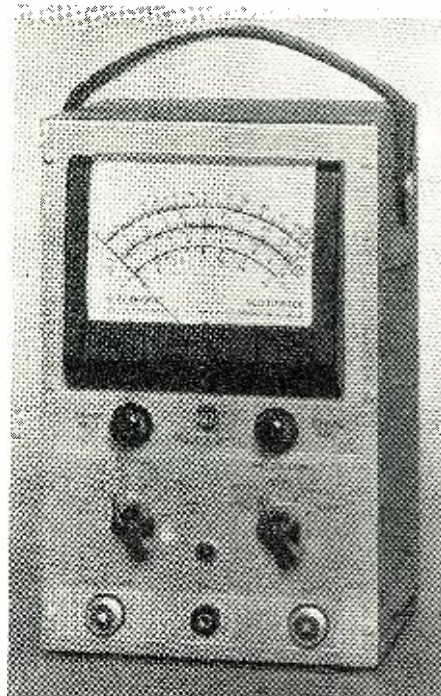

Test and Measuring Equipment Section, *RCA Victor Division*, Camden, New Jersey.

RECORDING GALVANOMETER

A new recording galvanometer which makes a direct ink on paper chart recordings of wider frequency range and greater sensitivity than heretofore attainable is being announced by *The Brush Development Company*.

This instrument embodies a low mass, 3" long tapered tube recording

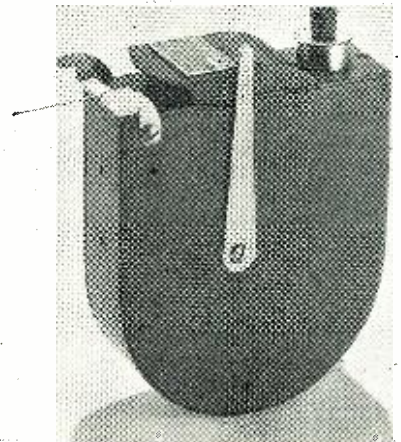

pen, actuated by a permanent magnet penmotor utilizing newly developed materials and techniques. The pyrex tipped pen records directly in ink on a moving paper chart, pressures, vibrations, strains, currents and voltages of frequencies from d.c. to 120 c.p.s. It has no overshoot up to 70 c.p.s. at a maximum swing amplitude of 20 mm. each side of center line. The frequency response is flat to 70 c.p.s., accurate to 120 c.p.s. The pen can be conveniently centered on, or raised from the chart.

Full details of this instrument will be furnished by *The Brush Development Company*, 3405 Perkins Avenue, Cleveland 14, Ohio.

CIRCUIT TESTER

A new, self-contained, portable testing unit for acceptance tests of residential and commercial wiring has been announced by the *Connecticut Telephone and Electric Division* of *Great American Industries, Inc.*

Basically, it is used for testing insulation between wires or from wires to ground for defects or failures and the continuity of wires with audible positive answers at the point where the test is made. With a special indicator attachment, it also determines

RADIO NEWS

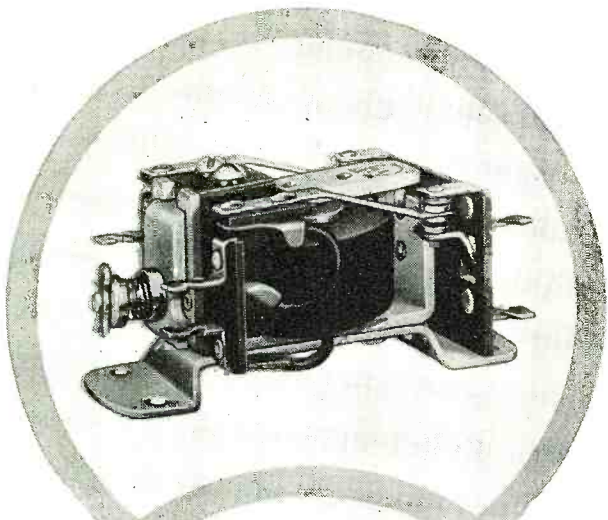

for design

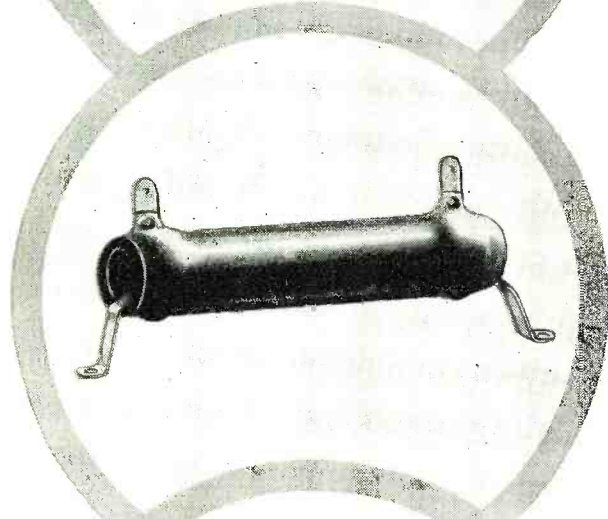

for repair

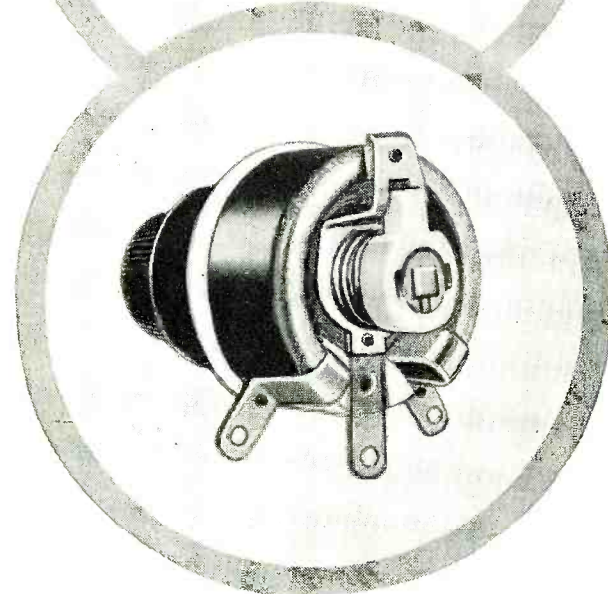

for maintenance

Use Ward Leonard Vitrohm Wire-Wound Resistors and Rheostats—made to conform to the most rigid specifications for use in any application—in transmitters and industrial equipment. Relays, too, are built to the same exacting standard that marks all Ward Leonard products. Write us for our new catalog now being compiled. A copy will be sent you as soon as it is off the press.

WARD LEONARD ELECTRIC CO.

Radio and Electronic Distributor Division

53 WEST JACKSON BLVD., CHICAGO, ILL.



WARD LEONARD
ACCEPTED MEASURE OF QUALITY

**RESISTORS
RHEOSTATS
RELAYS**

ENGINEERS! DRAFTSMEN! ACCOUNTANTS! STUDENTS!
ORDER TODAY! Sensational NEW

MULTI Slide Rule

WITH **8** ADDITIONAL, EXCLUSIVE TABLES!
 NOW FIGURE ANYTHING... WITH ONE RULE!

\$1
 (Obtainable only from Stancor Jobber in your area)

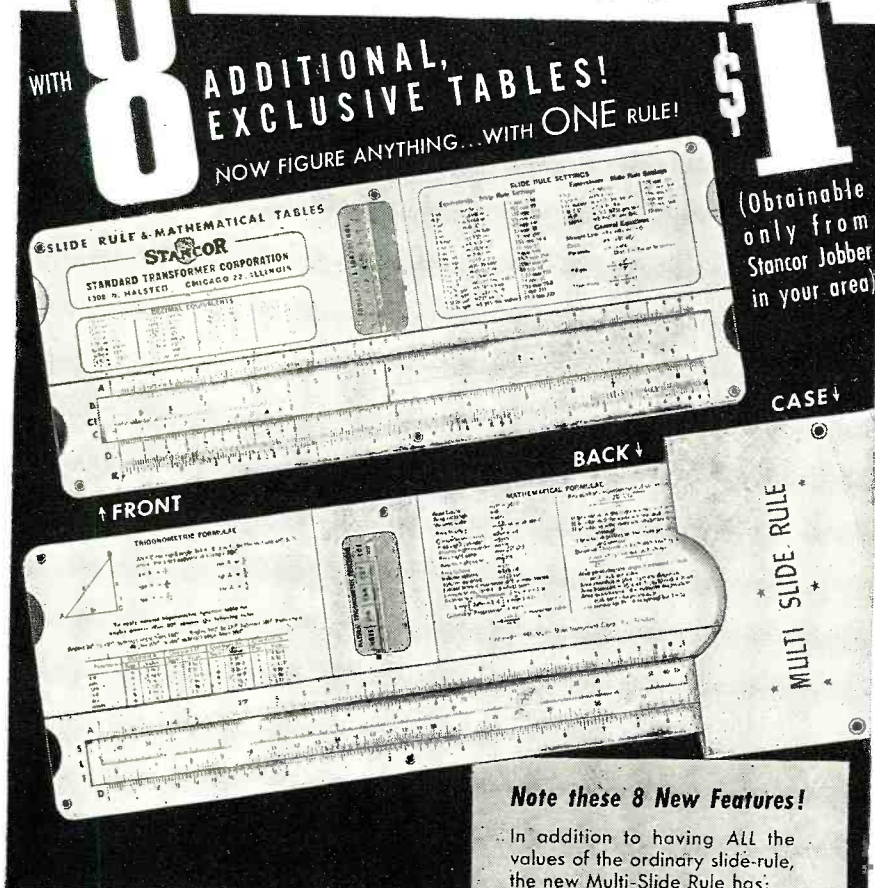

Clear, legible print... Tough, durable for long wear... Size 10" x 4"... Fits 3-ring binder... In case... Full instructions... **TRANSPARENT PLASTIC INDICATOR...**

STANCOR now offers the entire electronic industry the new Multi-Slide Rule. First developed for our own use, it is today made available to all... Greatly simplifies calculation of unlimited range of problems... A genuine professional rule—not a toy. This rule is obtainable **ONLY THROUGH STANCOR JOBBERS. PLEASE DO NOT ORDER DIRECT.** See your local directory for the name of the Stancor jobber in your city or, write for his name. Price of Stancor Multi-Slide Rule: One Dollar!—America's biggest slide-rule bargain—a service to the trade by Stancor.

STANDARD TRANSFORMER CORPORATION
 1500 N. HALSTED ST. CHICAGO 22, ILL.

ORDER FROM YOUR JOBBER

Note these 8 New Features!

In addition to having ALL the values of the ordinary slide-rule, the new Multi-Slide Rule has:

- 1 Four-place LOGARITHM TABLE
- 2 SIGNS and LIMITS of VALUE assumed by trigonometric functions
- 3 Table of NATURAL TRIGONOMETRIC FUNCTIONS
- 4 Table of TRIGONOMETRIC FORMULAE
- 5 Table of SLIDE-RULE SETTINGS
- 6 Table of GENERAL EQUATIONS
- 7 Long list of common MATHEMATICAL FORMULAE
- 8 DECIMAL equivalents of a fraction

OFFERED AS A SERVICE TO THE TRADE BY

STANCOR

the polarity of the wires, visually. It operates on a hand cranked generator which develops 500 volts, d.c. which is regulated to assure uniform test regardless of cranking speed. A comparatively simple instrument, this

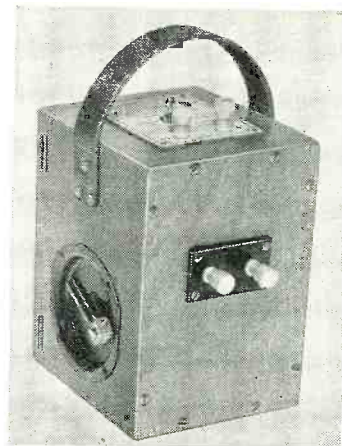

unit contains no commutators, slip rings, gas tubes, calibrated meters, rheostats or adjustment knobs which might get out of order.

Test procedure is sufficiently simple that an inexperienced operator may use the instrument.

Complete information on the multi-purpose Circuit Tester will be furnished upon request to *Connecticut Telephone and Electric Division*, Meriden, Conn.

CAPACITOR MOUNTING

A new universal capacitor mounting clip, which can be attached to the chassis instantaneously with one simple hand motion and without assembly tools of any kind, has been announced by the *Prestole Division, Detroit Harvester Company*.

No nuts or bolts are used to attach the clip to the chassis, thereby eliminating this assembly operation. The pointed retaining tongues bite into the chassis firmly and prevent any loosening due to vibration. The clip is designed to give maximum engagement between capacitor and clip.

The only requirement for application is a provision for a simple embossure in the chassis. Blue prints of the embossure are provided by the company. Clips may also be riveted to

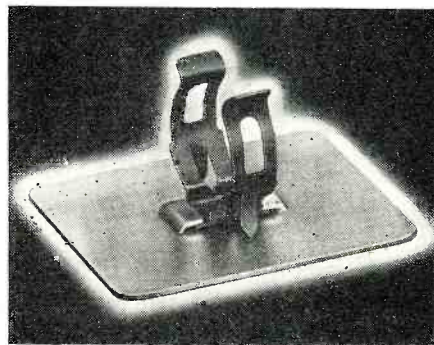

the chassis wherever an embossure has not been provided. All clips are designed to fit chassis thicknesses from .032 to .062 which means that all clips,

RADIO NEWS

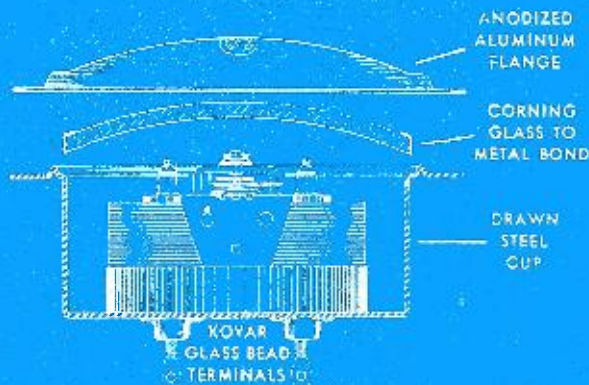

YES!

They're totally sealed. The Marion design and glass-to-metal sealing process assure true hermetic sealing. And the bond between the metallized glass rim and the steel case is capable of withstanding extreme thermal shock.

YES!

They're interchangeable. Magnetic shielding permits interchangeability on any type of panel without affecting calibration. The Type HM 2 is directly interchangeable with AWS Types MR 24 and 25. The Type HM 3 is directly interchangeable with AWS Types MR 34 and 35.

YES!

They're priced right. As a matter of fact, Marion Glass-to-Metal Truly Hermetically Sealed Electrical Indicating Instruments cost no more than standard unsealed instruments — yet, they'll perform more satisfactorily over a longer period of time.

YES!

They're a postwar potential. Because they afford complete protection against the effects of temperature and humidity, these instruments can simplify many production problems, particularly in regard to export sales. Call us. Our hermetic sealing experience may be of value to you.

Marion Glass-to-Metal Truly Hermetically Sealed 2½" and 3½" Electrical Indicating Instruments

Write today for complete information. Not only do we offer these instruments in standard ranges, but we also specialize in supplying them with special and unusual characteristics for new and unusual applications.



regardless of diameter, will fit one standard chassis embossure. The clips may also be used for mounting tubes or wires in other applications.

Further information on these mounting clips will be forwarded upon request to *Prestole Division, Detroit Harvester Company*, 4500 Detroit Avenue, Toledo, Ohio.

WATERPROOF MICROPHONES

In order to overcome the previously encountered difficulties experienced with microphones and headsets during amphibious landings, *Western Electric Company, Inc.* is now manufacturing a "submersion-proof" lip microphone and headset combination for these operations.

Equipped with an especially designed gland, the *Bell Telephone Laboratories* have developed this unit which will pass air but exclude water. The new microphone is capable of withstanding a submersion cycle of 25 minutes under 10 inches of sea water followed by baking in an oven at 125 degrees F. The gland permits



equalization of air pressure under altitude changes which allows for safe transport of this equipment to the fighting fronts via cargo plane.

Not much larger than a half-dollar and less than one-half inch thick, the microphone employs the differential principle of operation. When the microphone is properly adjusted before the lips of the user, noise enters from the front and rear in phase and cancels out, thereby making the microphone relatively unresponsive to unwanted sounds, yet sensitive to desired speech.

The whole assembly, including the harness for holding the lip mike firmly but comfortably in position, weighs less than 20 ounces and affords the wearer absolute freedom of his arms.

JENSEN SPEAKER

Jensen Radio Manufacturing Company of Chicago has announced the addition of a new speaker to their line.

Known as the Type NF-300 reproducer, this unit was originally designed as a loud speaker and microphone (talk back) in ship intercom-

municating systems. A unique reflex horn, the rim of which provides for



panel mounting, gives unusual compactness while carrying the protective screen assembly. The Alnico 5 permanent magnet material is used, giving exceptional field strength in minimum space. The diaphragm is of molded phenolic and the sound chamber is a combination of molded bakelite and metal castings. The voice coil impedance is 12 ohms, nominal value. The maximum power handling capacity for speech is 10 watts.

This unit is particularly recommended where there is a need for speech reinforcement, understandable through high ambient noise and where severe weather and trying operating conditions must be met.

Details of this unit will be forwarded upon request to *Jensen Radio Manufacturing Company*, 6601 S. Laramie Avenue, Chicago 38, Illinois.

WELDING TWEEZERS

A new accessory for facilitating the production of radio tube elements and other small electronic components is being offered by *New Jersey Jewelers' Supply* of Newark.

This accessory consists of a pair of insulated, forged, copper tweezers with plastic covered flexible copper leads terminating in a pair of lugs which connect in place of regular welding electrodes. Developed originally to

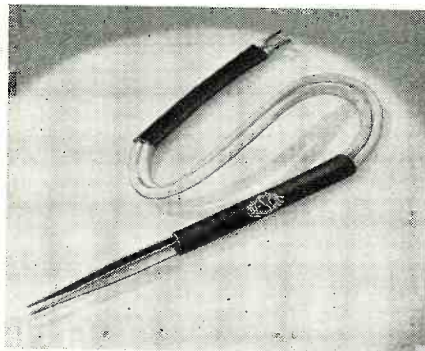

weld radio tube wires .003" o.d., the Spot Welding Tweezers may be applied in the manufacturing of instruments, optical goods, etc.

Electrodes may be applied to the elements to be joined. They operate

HOW TO "TEST" A RADIO IN 2 MINUTES

Want to repair radios—without months of specialized service training? Or, if you are already a radio serviceman, do you want to learn how to diagnose troubles in 2 minutes or less and fix most sets TWICE AS FAST and TWICE AS PROFITABLY without unnecessary testing? Then order Ghirardi's RADIO TROUBLESHOOTER'S HANDBOOK today. See opposite page for description—USE COUPON AT BOTTOM.

SAVE MONEY ON THIS SPECIAL OFFER

Have a complete Radio-Electronic Service Library at your fingertips! Know how to work fast—and work right. Have complete reference data on test instruments, trouble-shooting and repair so that you can quickly look up any type of work that may puzzle you. Stop waste time—lost motion. Make more money! Get both Ghirardi's RADIO TROUBLESHOOTER'S HANDBOOK and his MODERN RADIO SERVICING at the special bargain price of only \$9.50 (\$10.50 foreign) FOR THE TWO BIG BOOKS. See Money Saving Combination in coupon on opposite page.



JUST! OUT!

"TELEVISION Programming & Production"

Television is coming—and coming fast—BUT, what kind of programs is it going to have? How will they be prepared and handled? What are the technical difficulties involved and how can these be overcome? How and where can YOU fit into this fascinating work as Radio's latest and greatest development steps into full-fledged growth? This new book by Richard Hubbell, an "old timer" at the game gives you the answers!

Prepare for Television Now!

"Television Programming and Production" not only acquaints you fully with the most advanced techniques, but discusses technical problems and their relation to program handling, and provides a wealth of other material invaluable to all who want to participate in Television's coming of age. Contains 207 pages and more than 50 selected photos illustrating all program production phases, etc. \$3 (\$3.25 foreign).

USE COUPON ON OPPOSITE PAGE

RADIO NEWS

WE'LL "LEND" YOU ANY OF THESE 3 GREAT BOOKS *for* 5 FULL DAYS

Every Cent of Your Money Cheerfully Refunded
if You're Not More Than Satisfied

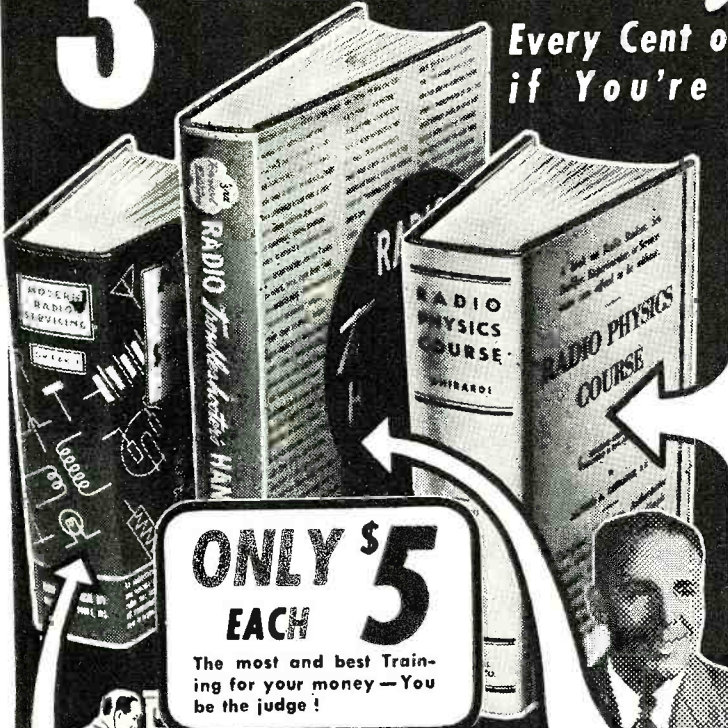

**ONLY \$5
EACH**

The most and best Training
for your money — You
be the judge!



Get a better job — start a
business of your own in
fascinating Radio-Electronics!

LEARN PROFESSIONAL SERVICING WORK at home

A. A. Ghirardi's big, 1300-page MODERN RADIO SERVICING is the finest, most complete instruction course on Radio-Electronic service work for either the novice or professional serviceman—**bar none!** Ask anyone in the business! Read from the beginning, it is a COMPLETE COURSE IN SERVICING by the most modern methods. Used for reference, it is an invaluable means of brushing up on any servicing problems that puzzle you.

COMPLETE DETAILS ON TEST INSTRUMENTS, TROUBLESHOOTING AND MODERN RADIO REPAIR

Gives complete information on all types of test instruments; how they work (with wiring diagrams); When, How and Why to use them; how to build your own; preliminary trouble checks; circuits and parts analysis; parts repair, replacement, substitution; obscure troubles; aligning and neutralizing—and hundreds of other subjects including How to Start Your Own Successful Radio-Electronic Service Business. 706 self-testing review questions help you check your progress every step of the way. 706 illustrations and diagrams. \$5 complete (\$5.50 foreign). 5-DAY MONEY-BACK GUARANTEE. See our Money-Saving Combination Offer in coupon.

ALL THE SCIENCE OF BASIC RADIO-ELECTRONICS in one big 3½ lb. Book

For Beginners—36 Courses in One

Here is the big book that makes it easy for beginners to start in the fascinating field of Radio-Electronics! Actually, A. A. Ghirardi's 972-page RADIO PHYSICS COURSE book gives you just the basic training you need—ALL YOU NEED—easier, better, faster—for ONLY \$5 COMPLETE. Actually, this giant book is 36 courses in one. If sold in monthly lessons, you'd regard it as a BARGAIN AT \$50 OR MORE!

You'll be surprised how easily RADIO PHYSICS COURSE helps you master subjects that other courses make seem very complicated. You'll be delighted how soon

it will have you doing experiments, building equipment, etc. Step by step it carries you from the very beginning through Basic Electricity to the most modern Radio-Electronic developments. Hundreds of readers have completed it in a few weeks. All you need is a little reading time plus a desire to get started now for a better paying future in broadcasting, aviation radio, F-M, Television, radio servicing, manufacturing—or other fast-growing Radio-Electronic branches. 5-DAY UNRESERVED MONEY-BACK GUARANTEE!

Radio's Greatest Training Buy!

THIS AUTOMATIC TEACHER SHOWS EXACTLY HOW TO REPAIR OVER 4,800 DIFFERENT MODELS!

Ghirardi's big RADIO TROUBLESHOOTER'S HANDBOOK is the ideal manual to show you exactly how to repair radios quickly, without a lot of previous experience and without costly equipment. This 744-page manual-size HANDBOOK brings you specific repair data for the common faults that account for almost 90% of ALL troubles in practically every radio in use today! You don't study it. Simply look up the make, model, and trouble symptom of the Radio you want to repair. No lost time! Clear instructions tell you exactly what the trouble is likely to

be, exactly how to fix it. Specific instructions cover over 4,800 of the most popular models of Home and Auto-radio receivers and Automatic Radio Changers of 202 manufacturers!

Also, RADIO TROUBLESHOOTER'S HANDBOOK has hundreds of additional pages of repair charts, tube charts, data on tuning alignment, transformer troubles, tube and parts substitution, etc., etc., all designed to help you repair all makes and models of radios, faster, and more profitably! Only \$5 (\$5.50 foreign). 5 DAY UNRESERVED MONEY-BACK GUARANTEE!

Make Money in Your Spare Time!

5-DAY MONEY-BACK GUARANTEE

Technical Division, MURRAY HILL BOOKS, Inc.,
Dept. RN-85, 232 Madison Ave., New York 16, N. Y.

Enclosed find \$..... for books checked; or send C.O.D. (in U.S.A. only) for this amount plus postage. If not fully satisfied, I may return the books within 5 days and receive my money back.

- RADIO PHYSICS COURSE. \$5 (\$5.50 foreign). RADIO TROUBLESHOOTER'S HANDBOOK. \$5 (\$5.50 foreign).
- TELEVISION PROGRAMMING & PRODUCTION. (See adv. on opposite page.) \$3 (\$3.25 foreign). MODERN RADIO SERVICING. \$5 (\$5.50 foreign).

MONEY-SAVING COMBINATION: MODERN RADIO SERVICING and RADIO TROUBLESHOOTER'S HANDBOOK (both books) only \$9.50 (\$10.50 foreign).

Name

Address

City & Dist. No. State.....

TRAIN NOW FOR THE BEST OF ALL POSTWAR INDUSTRIES

*Crystals for
the Art...*

Headquarters for SPECIAL Crystals!

The men of The James Knights Company have been designing and making special precision crystals since 1932. Their extensive experience with crystals for every conceivable purpose, coupled with an active participation in Radio dating back to 1913, is available to you. These men are interested in your special crystal problems — they have the knowledge, equipment and research facilities to help you. Why not get them working on your special crystal problem today?



CRYSTALS

The JAMES KNIGHTS Co.
SANDWICH, ILLINOIS
Sixty Miles South West of Chicago

on from ½ to 1 kva. on 10 amp. current and are used with a timer which cuts the current and times the length of the weld.

The copper jaws are held like any ordinary pair of tweezers. They are brought in contact with the parts to be welded; these are lightly but firmly brought together; the foot switch is pressed, current applied and the weld is made.

Standard leads are 18", but the unit may be furnished with leads up to 36".

The tweezers will unite copper parts, nickel, steel, tin, tin alloys, brass, monel, zinc, bronze, nickel to tungsten and copper to nickel.

Details, prices and other information on these units may be obtained from *New Jersey Jewelers' Supply*, 280 Plane Street, Newark 2, N. J.

DRIVER UNITS

A new permanent magnet driver unit is being announced by *University Laboratories*, incorporating several exclusive design features.

Some of the new features include molded diaphragm flexing surfaces, heatproof voice coil suspension and hermetically sealed dust covers. The molded diaphragms outlast metal diaphragms three to one, and contribute materially to the long life of these units. The hermetically sealed dust covers are spun over the entire unit structure, resulting in permanent waterproof protection under all adverse conditions.

Another important feature is the rim centering of the voice coil assembly in the magnetic gap, instead of the use of aligning pins. The rim centering method results in permanent position of the voice coil assembly. Regardless of any shock or vibration, it is virtually impossible for the voice coil to shift its relative position to the gap walls.

This driver unit is available in two styles, Model PAH, rated at 25 watts, 15 ohms impedance, frequency response, 100 to 6000 cycles, diameter 5¼", height 5", weight 9 pounds; Model SAH, 25 watts, 15 ohms impedance, frequency response 100 to



6000 cycles, diameter, 4½", height 5" and weight 5 pounds.

Further details of these units may be secured by writing to *University Laboratories*, 225 Varick Street, New York 14, N. Y.

(Continued on page 90)

RADIO NEWS

**"YOO HOO, BABY... YOU AND I
AND ECHOPHONE GOTTA DATE
IN THE NEAR FUTURE ON THE
CITIZENS' RADIOPHONE BAND"***



HOGARTH MAKES A DATE

Hogarth's date with the future embraces new possibilities for Echophone. There will be Echophone equipment for use on the citizens' radio communications service band. It is certain to be low in price, high in performance and completely dependable. The present EC-1 covers from 550 kc. to 30 Mc. on three bands . . . electrical bandsread on all bands . . . self-contained speaker . . . 115-125 volts AC or DC.

ECHOPHONE
"The Ears of the World"

*Citizens' radio communications service band, 460-470 Mc., recently proposed by the F.C.C.

ECHOPHONE RADIO CO., 540 NORTH MICHIGAN AVE., CHICAGO 11, ILLINOIS

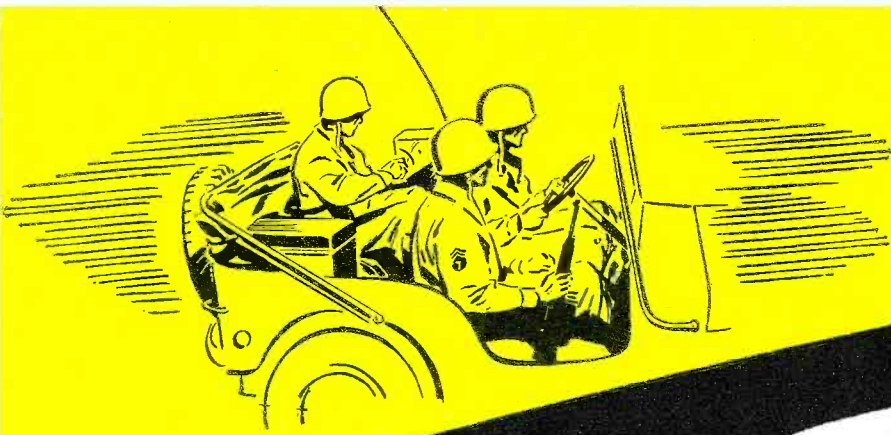

The POWER Behind

Working with the Signal Corps in the creation of the now famous SCR-694, RAULAND Engineers had to solve many a knotty problem. None, however, proved as tough as producing the heart of the Vehicular Power Supply . . . the *Vibrator*. That power supply had to operate from a vehicular battery at 5.4 to 8 volts, 10.8 to 16 volts or 21.6 to 32 volts while maintaining filament voltage within the limits of $\pm 5\%$ from nominal value. In addition it had to be fully immersion proof! The full story of how they licked a job that "couldn't be done" packs as dramatic a punch as anything in this man's war, but RAULAND Engineers *did it!* They designed and built the *highest frequency heavy-duty vibrator ever made . . .* to operate on 200 cycles $\pm 1\%$.

The development of the PE-237 Vehicular Power Supply Unit, and especially the Rauland Vibrator JV-0014, is a typical example of RAULAND engineering thoroughness . . . the kind of electronic planning and craftsmanship that will be available for full cooperation with industry after this war.

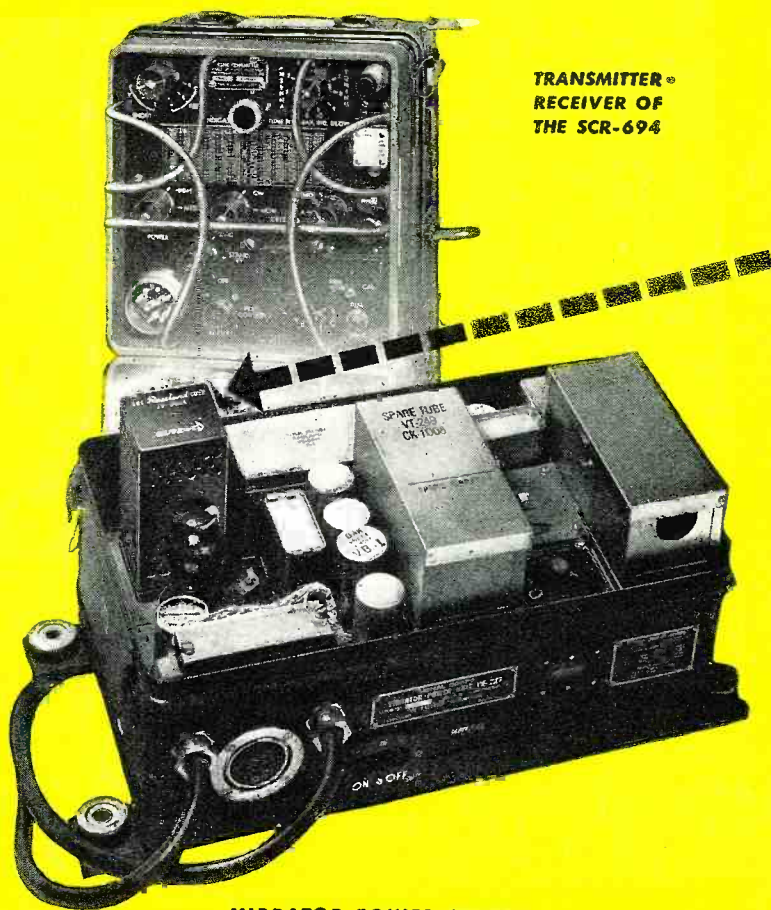

TRANSMITTER
RECEIVER OF
THE SCR-694

VIBRATOR POWER SUPPLY
FOR THE SCR-694

RADIO • • RADAR • • COMMUNICATIONS •

The SCR-694...

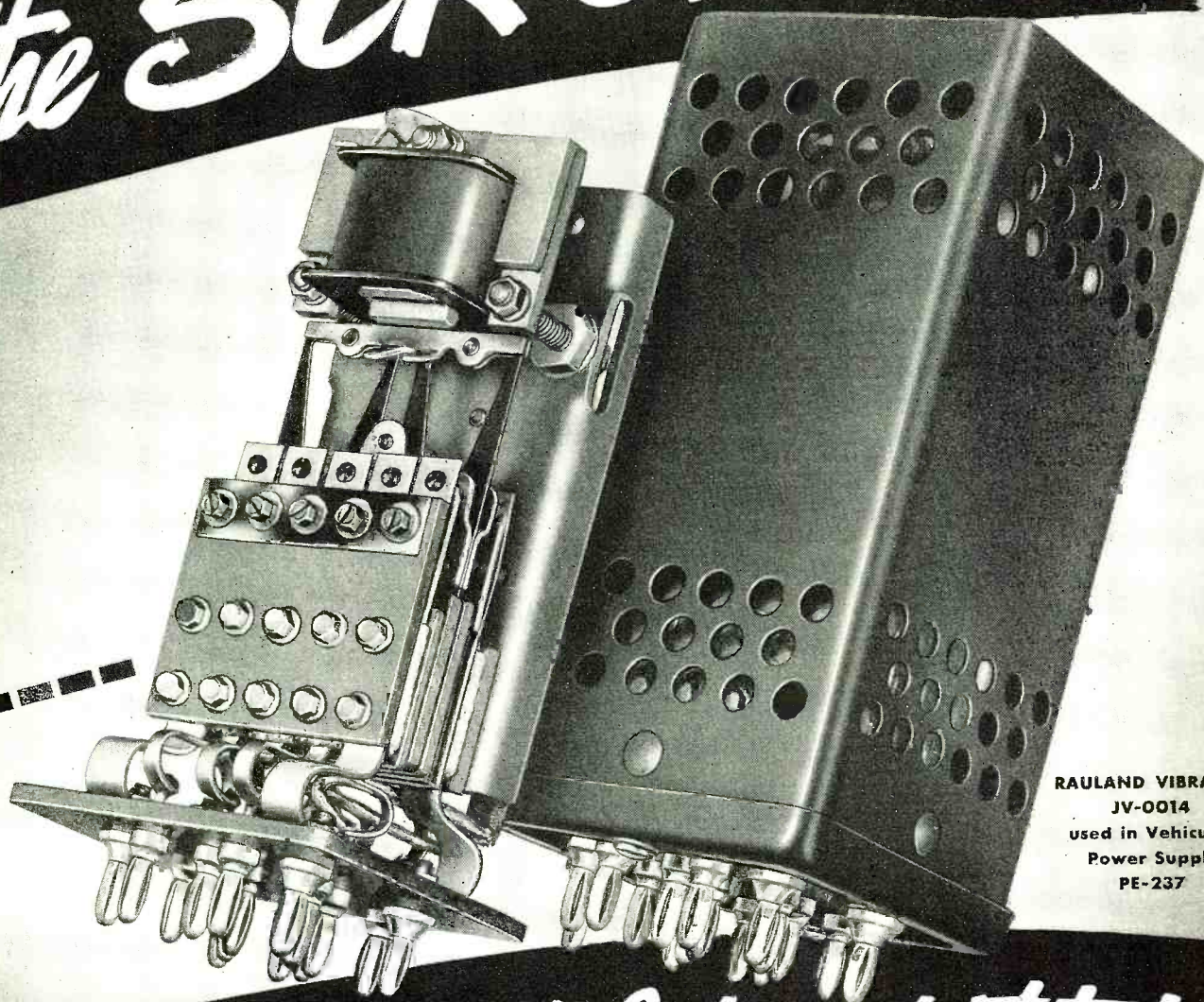

RAULAND VIBRATOR
JV-0014
used in Vehicular
Power Supply
PE-237

...The "HEART" that made it tick!

RAULAND VIBRATOR

- A POWER VIBRATOR IN WHICH ARE COMBINED THESE DESIRABLE FEATURES:
- HIGH CURRENT CAPACITY — 35 amperes continuous duty
 - MULTIPLE VOLTAGE — 6, 12, or 24 volt input to same vibrator
 - HIGH FREQUENCY — 200 cycles
 - WIDE TEMPERATURE RANGE — minus 40 to plus 70° C
 - MULTIPLE CONTACT — 20 power contacts
 - MAXIMUM UNIFORMITY OF LOAD DIVISION — each contact brought out to a separate base pin
 - MINIMUM TRANSMISSION OF VIBRATION — heavy wall extruded case

Electroneering is our business



SOUND

Rauland

TELEVISION

THE RAULAND CORPORATION • CHICAGO 41, ILLINOIS

"JUKE BOX" SERVICING PROVES SUCCESSFUL



A modernistic automatic phonograph, produced by the Rock-Ola Mfg. Corp.

Helpful hints to servicemen who maintain and service juke boxes as a profitable sideline.

By **EUGENE A. CONKLIN**

BOY FORREST, of Johnson City, New York, has a radioshop which, like many other servicecenters, has felt the effects of war, both in personnel and replacement parts available.

Forrest has a wartime specialty which is well worth spotlighting. He devotes three nights weekly, and two full days to the servicing of "juke boxes" in restaurants, hotels, taverns,

grills, and the like. Jukes are particularly important these days because they keep the war workers who patronize eating establishments happy after a lengthy day or night shift.

This serviceman charges \$1.00 for a weekly inspection of the juke box—said inspection lasting from 5 to 15 minutes. Any minor headaches in its operation are alleviated during this weekly "check-over" period. If tubes

or components must be replaced they are charged for at the regular retail pricing. Forrest has nearly 80 jukes which require a weekly going over.

In addition to his own community he covers smaller towns over a period of 35 miles. His "A" coupons allow him to make short trips into these regions. On these trips he also picks up radios belonging to farmers and inhabitants of small living centers too tiny to boast the service of a radioman.

More to the point, each of these grills and restaurants act as a miniature branch of the Forrest service shop. Patrons of an eatery bring their sets there and leave them for Forrest to pick up when he calls in for his juke box inspection.

Jukes are usually owned by an operator in groups of a dozen or more which are placed in eating and drinking establishments on a percentage basis. Forrest receives his \$1.00 from each restaurant or grill owner who, in turn collects it from the juke box operator. In this way Forrest receives cash on the barrelhead for each inspection he makes.

When an emergency occurs and Forrest is called back on a juke which he has inspected during the week—no charge is made for his first half-hour's labor. If replacements are needed they are made at no charge. But any labor over and above the initial half-hour period is paid for at the rate of \$1.50 for each and every labor hour. Forrest is on tap at any hour of the day or night. When a juke goes on strike and refuses to play the operator loses money while the installation remains unplayable and the customers become dissatisfied.

Essentially the amplifier is the chief source of trouble when a juke becomes quiescent. Forrest reports that tubes for jukes are fairly plentiful—more so, at any rate, than those used in routine set servicing. At the same time Forrest, for an additional 50¢ gives the eatery p.a. or intercommunication system the once-over. The average establishment puts on an occasional floor show or uses a communicator between chef and outer counter.

Forrest advises that at present 75% of his weekly revenue is received from such activities. Naturally he isn't able to handle a considerable amount of standard set servicing. But after the war he believes that dining establishments will expand and will need new juke boxes of the "soundies" variety. He is running across a num-

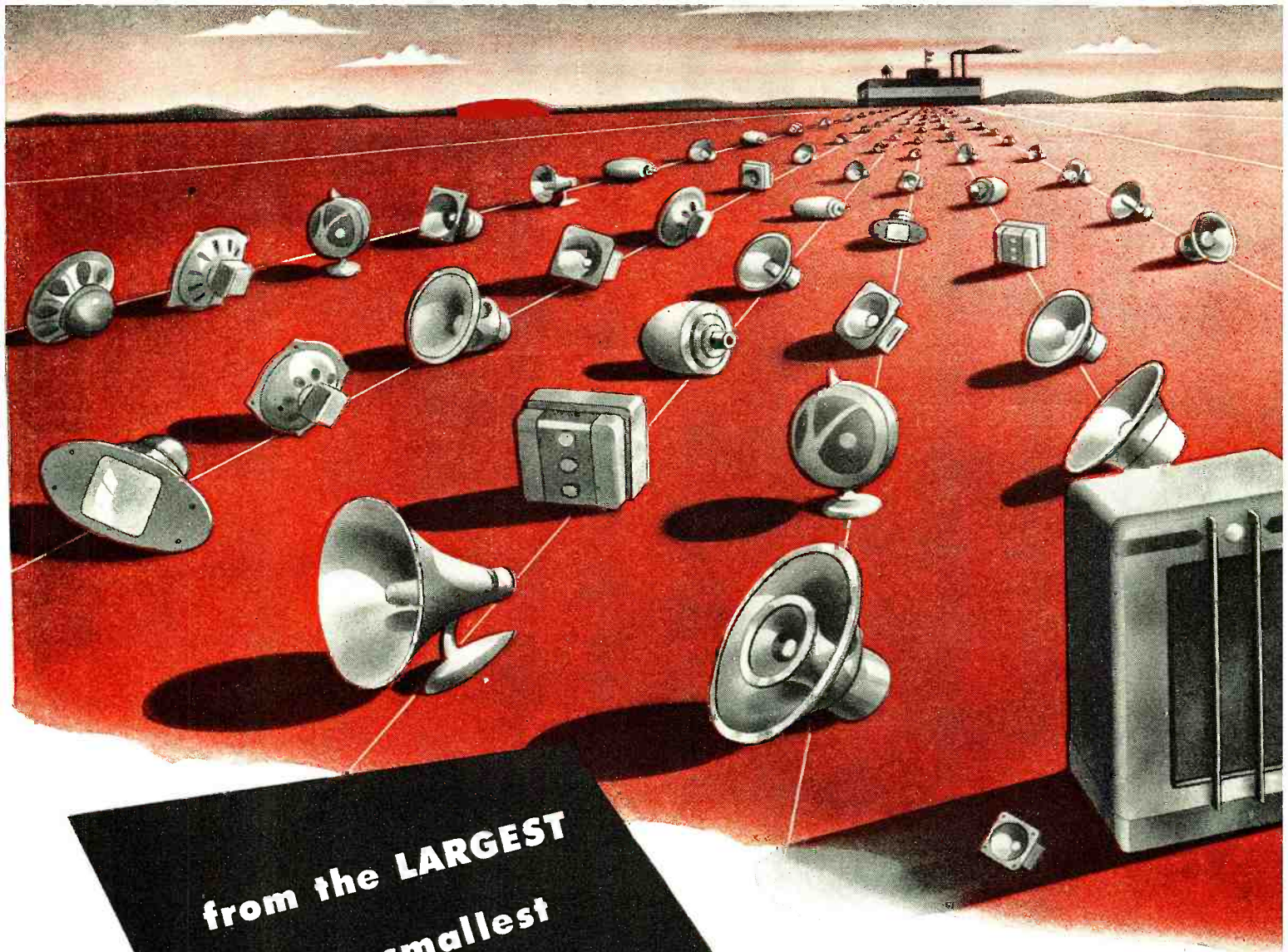

**from the LARGEST
to the smallest**

Utah's post-war line of quality speakers . . . the most complete ever available . . . will include standard and high fidelity PM's, all using ALNICO 5.

Ever since radio speakers have been made, Utah has been a leader. Electro dynamic and P.M. speakers, (based on the new industry standards) . . . wide range (ideal for FM reception) . . . dual speakers . . . cabinet speakers . . . trumpets . . . whatever your speaker requirements might be, Utah can meet your needs. That's why the Utah Franchise is the most valuable franchise a radio parts distributor can own.



UTAH RADIO PRODUCTS COMPANY • 820 ORLEANS STREET • CHICAGO 10, ILL.

Utah Electronics (Canada) Ltd., 300 Chambly Road, Longueuil, Montreal (23) P.Q. • Ucoa Radio, S.A., Misiones 48, Buenos Aires

Immediate Delivery

from **LAKE**

RADIO CABINETS & PARTS

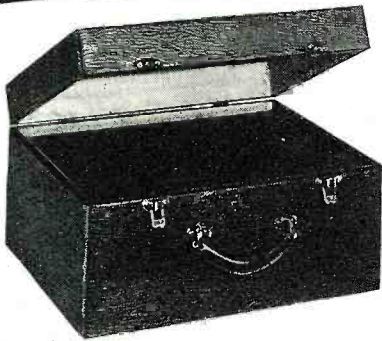

Portable Phonograph case, of sturdy durable plywood, in handsome brown leatherette finish. Inside dimensions 16 1/2" long, 14" wide, 9 1/2" high. Has blank motor board. As illustrated above, specially priced **\$6.95** at



Portable Phonograph case in brown leatherette covering. Inside dimensions 17" long, 14" wide, 8 1/2" high. Has blank motor board and opening for speaker. As illustrated above, specially priced at **\$8.95**

Also blank table cabinets of walnut veneer in the following sizes, with speaker opening on left front side: (*Note: *7 has center speaker grill.)

| | | | | |
|-----|---------|------------|-------------|----------|
| #1 | 8 1/2" | L x 5 1/2" | H x 4" | D \$1.95 |
| #2 | 10 1/4" | L x 6 3/8" | H x 5" | D \$2.75 |
| #3 | 13 1/4" | L x 7 7/8" | H x 6 1/4" | D \$3.25 |
| #7* | 10 3/4" | L x 7" | H x 5 1/2" | D \$2.50 |
| #8 | 17" | L x 9" | H x 9 3/4" | D \$4.50 |
| #9 | 21" | L x 9 1/4" | H x 10 1/2" | D \$5.50 |

*Speaker Opening in center of front side. Cabinets available in Ivory color and Swedish Modern. Write for prices.

POWER TRANSFORMERS

4, 5, or 6 Tube—6.3V at 2 amp. **\$2.45**
50 Mill Power Transformer...

7, 8, or 9 Tube—6.3V at 3 amp. **\$2.65**
70 Mill Power Transformer...

All types of radio cabinets and parts are available at Lake's Lower prices. A large stock is listed in our catalog.



SERVICEMEN—RETAILERS
Join our customer list today.

Write for Our Free, New Illustrated Catalog!
Dept. A

Lake Radio Sales Co.
615 W. Randolph Street
Chicago 6, Ill.

ber of these "sight and sound devices" which present no special servicing headaches.

This radioman has had to acquire a knowledge of repairs extending to toasters, refrigerators, percolators, and other restaurant electrical equipment because he is frequently confronted with such items. He has secured the services of an electrician who makes the rounds with him and handles such electrical items repairs as Forrest is unable to cope with.

The combination of a radioman and an electrician make it possible to tackle many jobs which would otherwise have to be bypassed. Forrest pays the electrician a guaranteed weekly salary plus a reasonable commission on electrical item repairs above a prearranged specified level.

On such radio set repairs as he handles he charges \$1.75 an hour labor plus replacements, but issues a 60-day guarantee that the set will stay playable, after a Forrest repair job. Forrest eliminates much portable radio repairing by charging a reasonably high labor fee which discourages owners of inexpensive sets.

Forrest does not issue free estimates nor does he practice flat-rate servicing of home radios. If a set is brought in for an estimate, the estimate-requester is charged \$1.75 and for that amount receives correction of minor flaws and an estimate on the probable number of hours and possible replacements needed to complete the task. Few service patrons request an estimate—they prefer to trust Forrest's judgment.

-30-

AN A.C.-D.C. CODE PRACTICE SET

By Sam Beatty

THIS set, while designed primarily for radio students and experimenters, is excellent for advanced amateurs who wish to improve their code speed. By using a small magnetic speaker it works very well for group practice. There is sufficient volume for the average room and when the volume control is turned down the signal is low enough so that it will not disturb other people. A tone control has been added for convenience in practicing.

The set built by the author was built from an a.c.-d.c. t.r.f set and the cost for additional parts was small. The experimenter can usually find most of the necessary parts by obtaining a second-hand set. This furnishes the cabinet, speaker, and many of the

small parts at a minimum of expense.

The set is designed to use a 12A7 tube as a combination rectifier and oscillator. The r.f. choke and .1 μ fd. condenser (C₁) form a filter which prevents key clicks from disturbing nearby radios. Potentiometer (R₅) and condenser (C₂) form the tone control. The frequency is lowered as the resistance is increased.

Resistor (R₃) is not critical and is added to raise the pitch of the note. The values of (R₁) and (R₂) are correct for a 600 ohm speaker. They may have to be varied slightly if a speaker of different resistance is used.

However, none of the values given are at all critical and this makes it ideally suited for construction from spare parts.

-30-

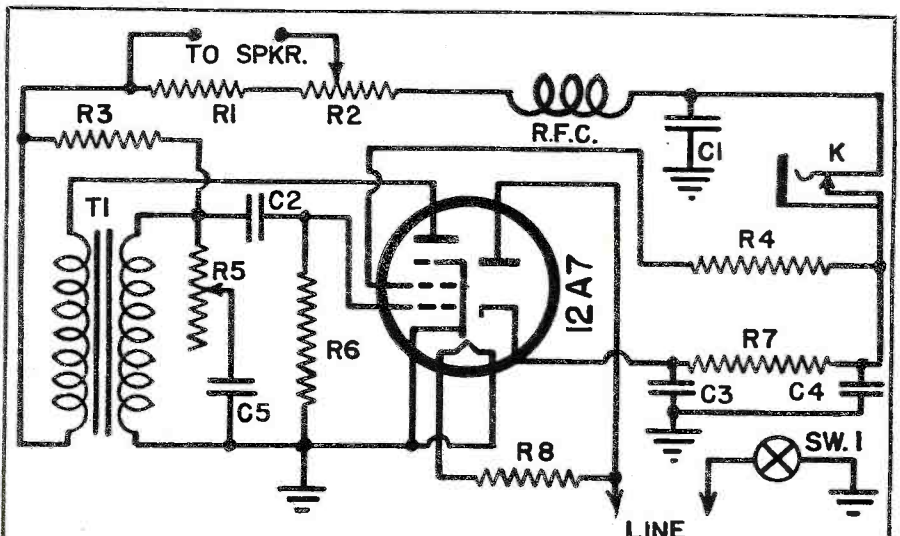

- R₁—500 ohm, 1/2 watt res.
- R₂—5,000 ohm, w.w. low wattage pot.
- R₃—750,000 ohm, 1/2 watt res.
- R₄—5,000 ohm, 1/2 watt res.
- R₅—100,000 ohm rheostat with a.c. switch
- R₆—1 megohm, 1/2 watt res.
- R₇—400 ohm, 1 watt res.
- R₈—360 ohm, 35 watt, w.w. res. or line cord

- C₁—1 μ fd., 200 v. cond.
- C₂—250 μ fd., mica cond.
- C₃, C₄—8-8 μ fd., 250 w.v. elec. cond.
- C₅—0.002 μ fd. mica cond.
- T₁—Audio trans. 1-3 ratio
- K—Closed circuit jack
- SW₁—a.c. switch on R₅
- R.F.C.—r.f. choke coil
- Spkr.—600 ohm, magnetic type

SPRAGUE TRADING POST

A FREE Buy-Exchange-Sell Service for Radio Men

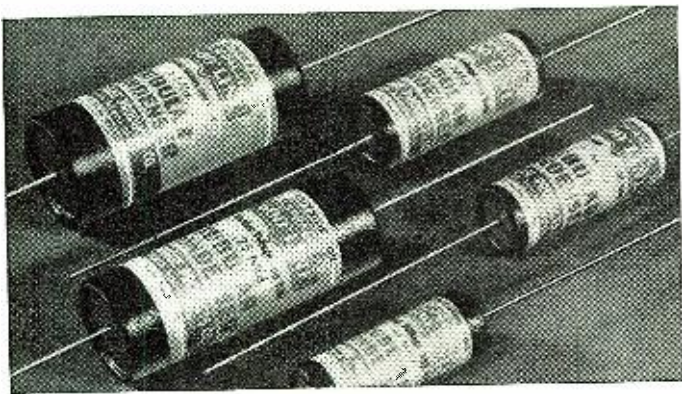

SPRAGUE T C TUBULARS

The most famous, most widely used by-pass capacitors in the entire history of Radio. Ask for them by name!

"Not a Failure in a Million"

WANTED—Cash in advance for Hallcrafters SX-24; SX-25 or S-20R. State condition and price first letter. Warren Chase, Vermont Sanatorium, Pittsford, Vt.

BUSINESS FOR SALE—Have operated a successful radio service business for 15 years and would now like to retire. Would like to sell to a good serviceman who is doing a good business and would like to acquire a place of his own that is well established. Write for details. R. M. Rouse, 395 St. John St., Spartanburg, S. C.

WANTED—Operating instructions and wiring diagram for Radio City multimeter #408 and #602. Raymond McNally, 712 Monson St., Peoria, Ill.

FOR SALE—Used 300v., 100 ma. 6v. Malory vibrapacks with OZ4 tube, \$12 ea., and used 550v., 250 ma. 12.5v. belt driven generators, \$15 ea. Ben Ruyie Radio Repair, 1703 Washington Ave., Alton, Ill.

WANTED—V-O-M similar to Triplett #666 or equivalent. G. W. Nichols, P.O. Box 1473, Station A, Bremerton, Wash.

FOR SALE—12A8, 12SA7, 12SR7, 12K8, 5Y3, 80, 6D6, 6CG, 23Z5, 25Z6 tubes in sealed cartons. Murray Koch, 47 N. Main St., Patterson, N. J.

WANTED—Sig. tracer, oscilloscope, phono record player in good condition. Mayfield Radio & Elec., 3330 Lawrence St., Denver 5, Colo.

FOR SALE—Simplified Radio Service; Radio Servicing Course, Beitman; and How to Build and Repair Radio receivers. Popular Science; \$4. Frank Bou, Bot. Dent., University of Pa., 38th & Woodland Ave., Phila. 4, Pa.

WILL TRADE—Weston #301 meters for photographic equipment or wireless record player. Cpl. S. Radwanski, Squadron C, Box 499, George Field, Ill.

WANTED—Audiometer, any condition. C. J. Thompson, Box 82, Bluefield, W. Va.

FOR SALE—Carrier current communication system complete with tubes; Westinghouse 0-10 milliammeter. Howard L. Funk, 41 Marlboro Court, Rockville Center, N. Y.

TO TRADE—12-7Y4, 1-7B7, 1-7ST, 1-7J7, 1-11C6 and 2-1299 tested tubes. Want good dynamic microphone. Walter H. Lonvik, 2439 N. Parkside Ave., Chicago 39, Ill.

WANTED—V-O-M and instructions on how to use. John Impagliazzo, 73 Harrison St., Providence, R. I.

WANTED—Riders 6 to 13 complete. Also sig. gen. Don Roehning, Main St., Northome, Minn.

FOR SALE—Weston #264, \$15; old sig. corps wave meter incl. 0-100 hot wire galvanometer, \$7.50; SW coils. G. Kennedy, 2239-35th Ave., San Francisco 16, Calif.

WANTED—Home recorder and Superior sig. gen. #1230. L. E. Smith, Route 2, Box 217, Somerville, Ga.

FOR SALE—Meissner 12-tube, 5-band superhet shortwave receiver. Al Diedricksen, 11 Vine St., New Britain, Conn.

WANTED—Two 95Z5 tubes. Martin McGarrity, 53 North St., West Warwick, R. I.

FOR SALE—Complete lesson texts for Sprayberry Academy of Radio and National Radio Institute. Paul Chinn, 92 N. High St., Columbus 15, Ohio.

WANTED—30 h choke coil and 6SJ7, 6SC7, 5Y3 and 6V6 tubes. John Retau, P. O. Box 628 P.E.A., Exeter, N. H.

FOR SALE—3" Westinghouse 0-1 ma. meters with copper oxide rect. Will supply V-O-M a-c scale. Gordon phono motor geared speed control, \$19.50; Indust. Quietone Comm. filter, \$6; Webster xtal pickup and arm, \$5.25. A. O. Gioia, 41-18 29th St., Long Island City 1, N. Y.

WANTED—Tube tester for regular and GT tubes. L. M. Rockefeller, 353 Blohm St., West Haven, Conn.

FOR SALE—Triplett #1200E V-O-M; Precision #E200 slip. gen.; #1900 tube checker and analyzer; Simpson #220 rotor-ranger meter; #325 tube checker tests all tubes and various 2.5, 5 and 6.3v. used tubes. Leonard B. Wachman, 1220 Shakespeare Ave., New York 52, N. Y.

FOR SALE—308 tubes in cartons; Precision E-200 sig. gen.; Solar condenser tester BQC-1-66. Paul L. Rodgers, Rodgers Appliance Shop, Red Lion, Pa.

FOR SALE—RCA #94, BP-1, 4-tube portable, pick up, battery operated receiver, less batteries. New \$10. Magnus Norgran, Box 15, Barksdale, Wisc.

WANTED—Repair parts of all kinds and test equipment. Lawrence Helms, Box 381, Ephrata, Wash.

WANTED—New or used RK6Z tubes. Paul Sirrer, R. D. #2, Brackney, Pa.

FOR TRADE—S meter, 110v. a-c generator and 110v. d-c to a-c converter. Want amateur television transmitting and receiving equipment, recorder and amplifier, commercial transmitter and receiver. K. H. Stello, 925 Monroe St., N.E., Washington, D. C.

WANTED—Echophone EC-1 or Sky Buddy and crystal pickup and motor. Will trade or sell Triumph #400 tube tester and VTVM. Gordon Boyer, 6240 Tessenenden Ct., San Diego 10, Calif.

FOR SALE OR TRADE—Meissner 7-tube 110 a-c F-M converter complete with cabinet. \$40 or will trade for small camera. 35mm or V.P. William Miller, 693 Union Ave., Providence, R. I.

WANTED—Meissner #10-1153 television set or kit. Radio & Television Service, 821 Porter St., Philadelphia 48, Pa.

FOR SALE—Magnetic phono-pickup, built-in matching transformer permits direct connection to grid; 12" straight metal arm, adjustable pressure. \$7. J. Heitzman, 93 Hoffman St., Kingston, N. Y.

WANTED—6R4G and 6AS8 tubes and service manual on all tubes; diagrams for 1, 2, or 3 tube DX-ers. Wendell Plum, Mt. Morris, Ill.

WILL TRADE—50L6, 12SA7, 35Z5 tubes for 32L7 tubes. Joseph Lattose, 6611 Maxwell Ave., Detroit 13, Mich.

WANTED—Late model tube tester. W. F. Harmon, 1301 S. 19th St., Birmingham, Ala.

FOR SALE—19 panel type meters. George's Radio Service, 420 S. 60th St., Philadelphia, Pa.

WANTED—Bogen PV-20 expander-amplifier. F. J. Henry, FCC, 609 Stangenwald Bldg., Honolulu, T. H.

FOR SALE—National all-wave receiver, \$75, or will trade for tube and set tester. Also have Zenith to trade for ac-dc battery radio or sell, \$30. Isaac Jackson, 18804 Roscoe, Northridge, Calif.

WANTED—Portable sig. gen. to service radio alignments and dynamic stage by stage tests; and tube tester. Frank S. Horzewski, 213 XI 47, 3324 S. Burrell St., Milwaukee 7, Wisc.

FOR SALE—1R5, 1T4, 3S1, 185 tubes. Mrs. Robert L. Wenk, Gen. Del., Smyrna, Tenn.

WANTED—V-O-M and late tube tester R.C.P. or Superior preferred; also condenser tester. H. R. Arnett, 820 S. Gordon St., Piqua, Ohio.

WANTED—Test charts for Million tube tester. Harry Alter & Bros., 1728 S. Michigan Ave., Chicago 16, Ill.

FOR SALE—Complete shop equipment and instruments; tubes and parts. Joe Murray, P. O. Box 411, Rantoul, Ill.

URGENTLY NEEDED—Tester for all tubes including miniature. George L. O'Brien Jr., 641 Maple St., Fall River, Mass.

WILL TRADE—Bogen 20-watt amplifier or banjo and case. Want RCA Jr. Volt-ohmyst, tube tester, 3" oscillograph, recorder or automatic record changer. H. E. Housholder, Box 413, Beloit, Wis.

FOR SALE—Used Weston meters #489, 478, 506; Marion 3" sq. meters; Jewel #54, 33, 74; General Radio and 2" Ideal meters. O. C. Merkle, 4370 Somerset, Detroit 24, Mich.

WANTED—Good tube tester. Earl Woodle, P. O. Box 135, Malcom, Iowa.

FOR SALE OR TRADE—SX25 with speaker. Want retina two f:2 lens. George C. Ide, Route #1, Zillah, Wash.

FOR SALE—32v. Delco cabinet radio. Electric Shop, Forest City, Iowa.

YOUR OWN AD RUN FREE!

This is Sprague's special wartime advertising service to help radio men get needed parts and equipment, or dispose of radio materials they do not need. Send your ad today. Write **PLAINLY** or **PRINT**—hold it to 40 words or less. Due to the large number received, ads may be delayed a month or two, but will be published as rapidly as possible.

Sprague reserves the right to reject ads which do not fit in with the spirit of this service.

HARRY KALKER, Sales Manager

Dept. RN-85, SPRAGUE PRODUCTS CO., North Adams, Mass.

Jobbing Sales Organization for Products of the Sprague Electric Company



SPRAGUE CONDENSERS KOOLOHM RESISTORS

TM, REGISTERED U. S. PATENT OFFICE

Obviously, Sprague cannot assume any responsibility, or guarantee goods, services, etc., which might be exchanged through the above advertisements

August, 1945

**NO OXIDATION
NO CONTAMINATION
NO MOISTURE . . .**

**3 MORE REASONS WHY
FEDERAL MAKES
BETTER TUBES**

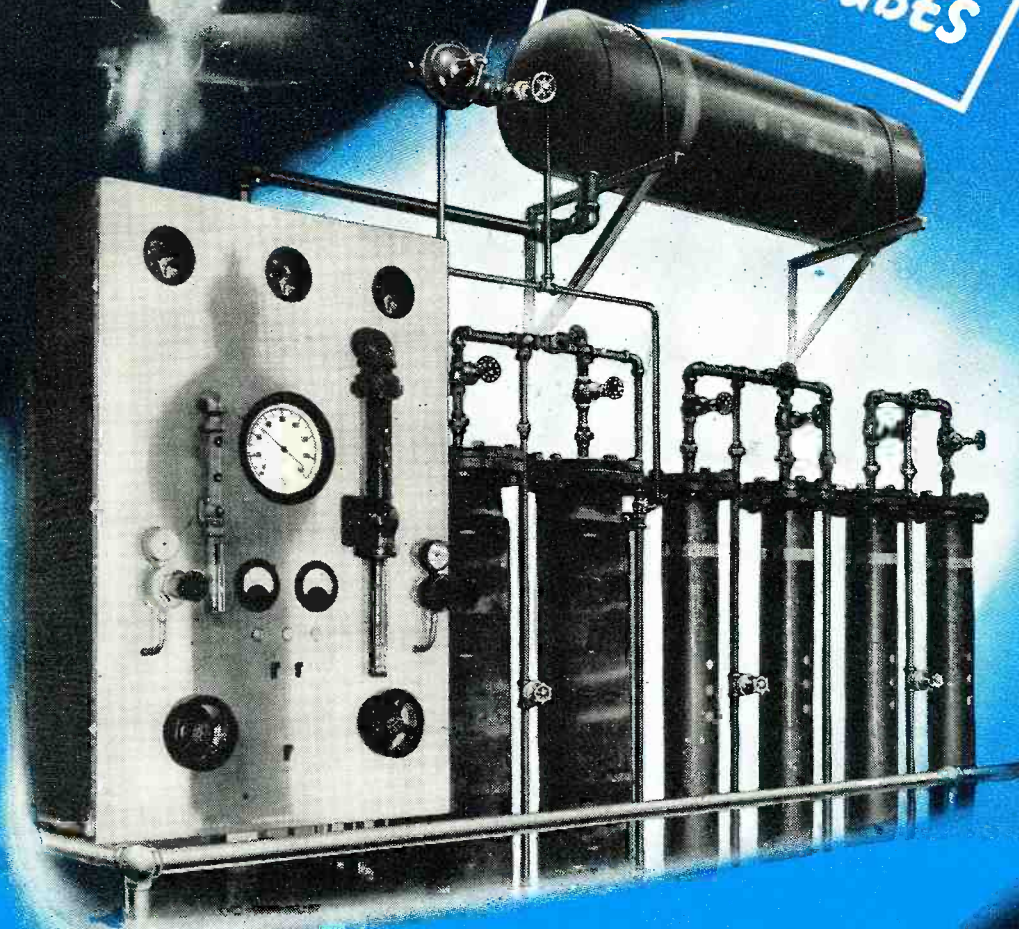

**FEDERAL HAS DEVELOPED
THE FIRST NITROGEN PURIFIER**



Injelin Ultra High Frequency Coaxial Cable, developed and manufactured by Federal, has extreme ruggedness and meets all specifications with precision, accuracy, uniformity and dependability.

No oxidation, no contamination, no moisture!

Another Federal First adds extra performance guarantees to FTR vacuum tubes.

In a corner of the new FTR tube plant is this automatic nitrogen purifier. During the process of sealing the anode to the stem, the elements of every FTR tube are now protected from oxidation, contamination and moisture in a

scientifically controlled atmosphere of automatically mixed nitrogen and hydrogen.

Here is another reason why you get higher operating efficiency and still longer life when you use FTR tubes. Another evidence of the ability, brains and technical understanding which have earned the reputation that "Federal always has made better tubes."

Now is the time to know Federal.

Federal Telephone and Radio Corporation

Newark 1, N. J.



Spot News

(Continued from page 14)

ous communication difficulties. They do not shake and whip to any extent when the vehicles cover rough ground, nor do they drip water over the mast base and onto the radio set. They also are much smaller and lighter than the old type. The design for the 6-foot and 9-foot antennas replaces the clumsier design which used a mast base capable of supporting a 15-foot antenna regardless of the length actually needed. The spring of the new mast bases consists of a bundle of piano wires inclosed in a flexible metal sheath. The wires are fastened at one end while the other ends are held in a race which allows free linear movement as the antenna mast is deflected. With this type of spring, the antenna mast is quickly returned to its normal position after being deflected and the damping effect is sufficient to prevent the antenna mast from oscillating more than a few times. The flexible metal sheathing which provides lateral support of the wires is approximately $\frac{3}{4}$ of an inch outside diameter, including a $\frac{1}{16}$ of an inch bonded neoprene covering used as a lubricant retainer and for protection against the elements.

RADIO HAM'S DEMANDS for a greater transmitting range in stations of simple construction will be helped after the war through the war-time development of a hurricane-proof radio mast of molded plywood. The height of radio masts was not always considered of great importance because short waves and skywave reflections emphasized the value of other features in the transmitter station. However, the development of ultrahigh frequency (30,000 to 300,000 kilocycles) and micro-waves now stresses the need for height. This, in turn, has made the lightness and strength of masts important. The new molded plywood mast, used by the Signal Corps, is so light that a single man, using boom and tackle, can erect a 55-foot stick. Two men can raise a 75-foot or a 90-foot mast, yet they are so strong that with proper guying they can withstand a gale of 125 miles per hour.

THE FCC ANNOUNCED THE REMOVAL of FM broadcasting from its present location in the 42-50 megacycle band to the 88-106 megacycle band.

This allocation is even higher than the originally proposed 84-102 megacycle band, which has been under fire for over a month.

According to the FCC, the change in frequency will not become effective until receiving sets capable of tuning in the higher frequencies are available.

The new allocation of the frequencies in the 42 to 108 megacycle band are as follows: 42-44, non-government,

fixed and mobile; 44-50, television Channel 1; 50-54, amateur; 54-60, television Channel 2; 60-66, television Channel 3; 66-72, television Channel 4; 72-76, non-government, fixed and mobile; 76-82, television Channel 5, 82-88, television Channel 6; 88-92, non-commercial, educational FM; 92-106, commercial FM and, 106-108 facsimile.

This is apparently the final decision with regards to the allocation of frequencies and thus ends the hearings, appeals, etc. which have been in session more or less continuously for over six months.

PARTS AND SET MANUFACTURERS OF RMA are now considering a proposed standard warranty for parts makers, designed for incorporation in future parts sales contracts with set companies. It has the unanimous approval of the RMA Parts Division's Executive Committee and Section chairman. Main objective is a uniform sales warranty for parts manufacturers, to avoid multiplicity of individual contract provisions.

THE SURGEON GENERAL OF THE ARMY SERVICE FORCES has approved public address systems in all Army general hospitals for both transcribed and script and the ASF is preparing programs. Technical and other information is supplied by a special RMA committee under L. A. King of Chicago. The same committee is promoting such installations in schools and other educational institutions. Signal Corps reports that 38 of the Army's 65 general hospitals in the United States will be equipped with a standard radio program distribution system by the end of 1945.

The system consists of a central control point in each hospital, which offers either direct amplifier service or service to individual headphone units. Four programs can be handled simultaneously, and any type of program other than television can be rebroadcast.

Personals

Philip Fuhrmann, veteran radio time sales executive, has been appointed sales manager of DuMont television station WABD in New York . . . Following the merger of Belmont Radio Corp. with Raytheon Manufacturing Co., **Laurence K. Marshall**, president of Raytheon, announced the election of these men to the board of directors: **P. S. Billings**, president of Belmont; **Harold C. Mattes**, vice-president of Belmont; **Joseph Pierson**, founder and former president of Press Wireless; **Emmons Bryant, Jr.**, New York Manager of N. A. Woodworth Co. of Detroit; and **George L. Langreth**, for 16 years with Woods Struthers & Co. . . . **Allen B. DuMont Laboratories, Inc.**, is conducting field tests in Washington, D. C., preliminary to establishing a television station in the nation's capital. **Dr. Thomas T. Goldsmith, Jr.**, director of research, and members of his staff are conducting tests to determine field strength and propagation data in the Washington Area . . . **David B. Smith**, director of research for Philco Corporation, and **Palmer M. Craig**, chief engineer of Philco's radio division, have just been named chairman and secretary-treasurer, respectively, of the Philadelphia Section of the Institute of Radio Engineers. -50-

An interior view of the Electronics Field Laboratory which is used by the Rock Island Railroad for the servicing of two-way radio equipment installed on the line. Every modern device for trouble-shooting and recording is included in this rebuilt Pullman car. The handset shown on the wall connects to a remote console and can be used to communicate with the railroad's bases and certain stations. The oscillograph is a standard unit and directly to the left is a portable audio amplifier. To the right of the oscillograph are two recording meters which make a permanent record of voltages and currents of equipment under observation. Beside the recording units is one of the Motorola walkie-talkies used to contact ambulatory personnel. 115 volt a.c. is furnished by a portable power plant.

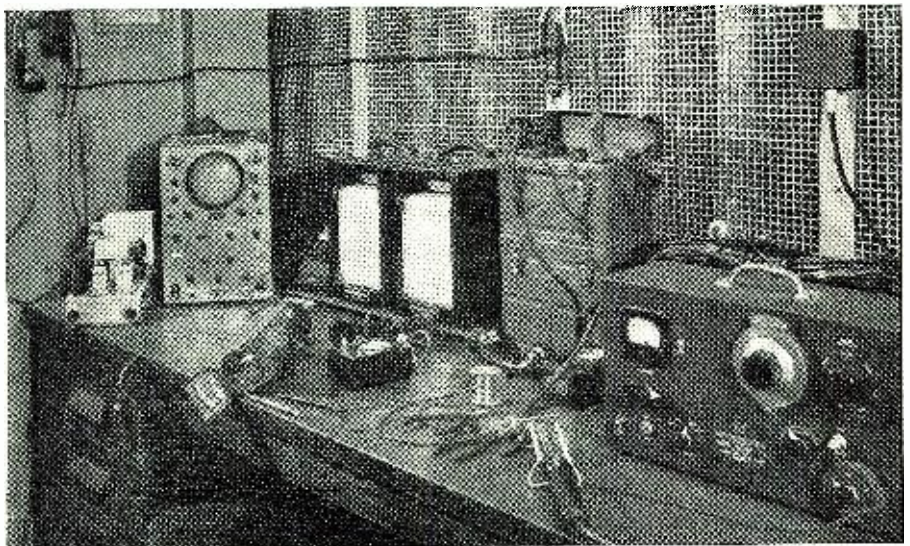

DESIGN COUNTS



COMPARE a modern sewing machine with the old-time model shown here: The difference is an example of how careful attention to design brings about a high level of efficiency.

Realizing this, design is one of the most carefully considered factors in the production of antennas at THE WARD PRODUCTS CORPORATION. It is only through superior design that the benefits of experience and the finest production facilities can be best brought to the user.

For the finest antennas for all applications... for home and automobile use... look to WARD.

WARD

Antennas
 BUY WAR BONDS
 THE WARD PRODUCTS CORPORATION
 1523 EAST 45TH STREET • CLEVELAND 3, OHIO

Export Dept. C. O. BRANDES, Mgr.
 4900 Euclid Avenue
 Cleveland 3, Ohio
 Canadian Office ATLAS RADIO CORP.
 560 King Street, W.
 Toronto 1, Ont., Can.

Victory Transmitter

(Continued from page 31)

dio amplifier plugged into the keying jack, *J*, provides satisfactory cathode modulation.

Mechanical Construction

The photographs (Figs. 3 and 5) and the layout drawings (Figs. 2 and 4) show clearly the location of the various parts on the panel, above chassis, and below chassis.

Oscillator and amplifier tuning capacitors, C_2 and C_6 (seen in the top-chassis view, Fig. 3), are mounted on

in a row to the right of the crystal oscillator coil, in Fig. 3. A crystal holder is plugged into the rear socket. Each of these sockets (*Millen* type 33002) requires two clearance holes and one screw hole for mounting.

Antenna coil L_5 is mounted to the left side of the amplifier (Fig. 3) and is set at right angles to the tank coil. Directly to the rear of the antenna coil in Fig. 3 may be seen the ceramic-insulated feed-through antenna terminal which passes through the rear wall of the cabinet.

Both tubes are mounted to the rear of the chassis, where holes have been cut in the cabinet for ventilation.

The cabinet handles are plated, two-

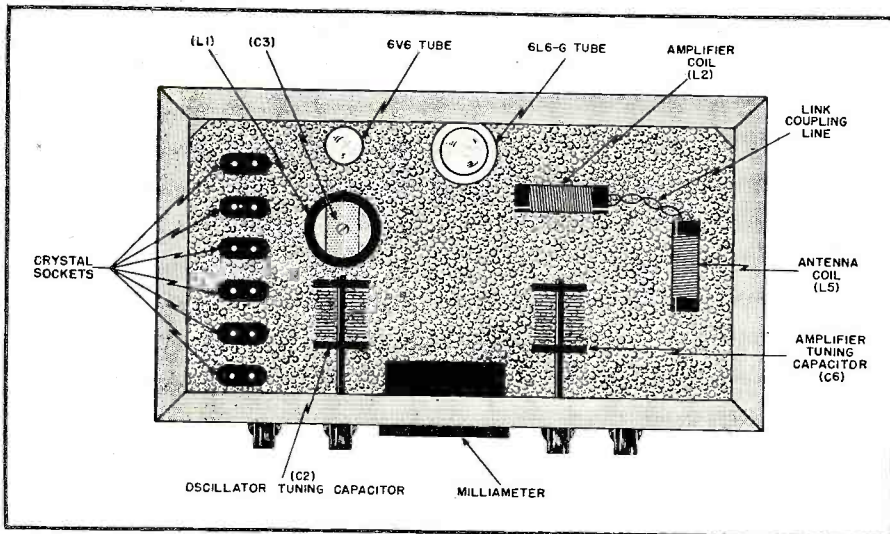

Fig. 4. Chassis layout showing proper placement of component parts.

short ceramic standoff insulators. Busbar leads connect C_6 directly to the plug-in base of L_2 . However, spaghetti-covered busbars from C_2 pass through grommet-lined clearance holes in the chassis to bottom contacts on the 4-pin coil socket holding coil L_1 .

The six crystal sockets may be seen

color drawer pulls obtainable at hardware and ten-cent stores.

The under-chassis view (Fig. 5) shows how the four pi-wound r.f. chokes and three of the four resistors used in the circuit are mounted on a small subpanel.

The variable capacitor in the upper right-hand corner in this photograph

Fig. 5. Bottom view of completed unit emphasizes neatness in assembly.

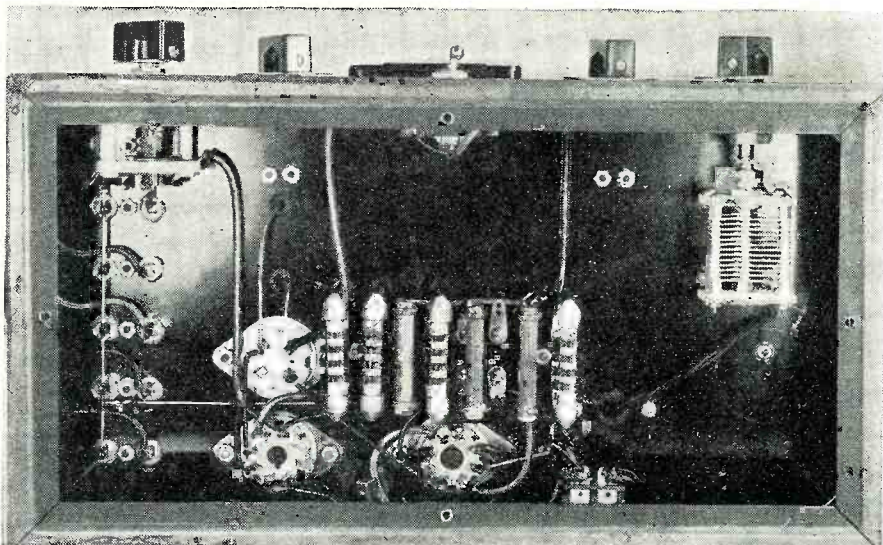

Announcing—

The New Model 400

ELECTRONIC MULTIMETER

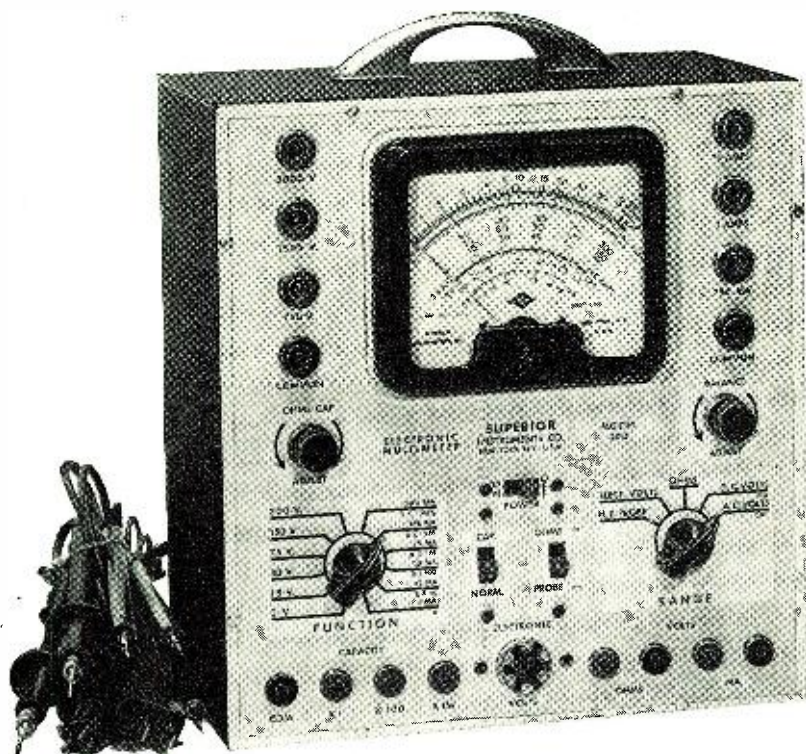

A COMBINATION
ELECTRONIC
VOLTMETER
AND
VOLT-OHM
MILLIAMMETER
PLUS
CAPACITY
INDUCTANCE
REACTANCE
AND
DECIBEL

Measurements

Specifications:

D.C. ELECTRONIC VOLTS:

(At 11 Megohms input resistance)
0 to 3/15/30/75/150/300/750/1500/3000 Volts.

D.C. VOLTS:

(At 1,000 Ohms Per Volt)
0 to 3/15/30/75/150/300/750/1500/3000 Volts.

A.C. VOLTS:

(At 1,000 Ohms Per Volt)
0 to 3/15/30/75/150/300/750/1500/3000 Volts.

D.C. CURRENT:

0 to 3/15/30/75/150/300/750 Ma.—0 to 3/15 Amperes

RESISTANCE:

0 to 1,000/10,000/100,000 Ohms—
0 to 1/10/1,000 Megohms

CAPACITY: (In Mfd.)

.0005—.2 .05—20 .5—200

REACTANCE:

10 to 5M (Ohms) 100—50M (Ohms)
.01—5 (Megohms)

INDUCTANCE: (In Henries)

.035—14 .35—140 35—14,000

DECIBELS:

—10 to +18 +10 to +38 +30 to +58

The Model 400 comes housed in a rugged crackle-finish steel cabinet complete with batteries, two sets of test leads, one set of V.T.V.M. probes and instructions. Size 5½"x9½"x10". Net.....

\$52⁵⁰

SUPERIOR INSTRUMENTS COMPANY

DEPT. R. N., 227 FULTON STREET, NEW YORK 7, NEW YORK

SILVER

Presents
"VOMAX"

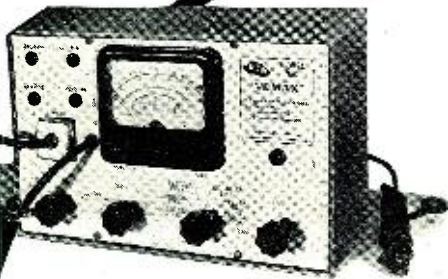

1. Brand new post-war design . . . positively not a "warmed-over" pre-war model.
2. More than an "electronic" voltmeter, VOMAX is a true vacuum tube voltmeter in every voltage/resistance/db. function.
3. 3 through 1200 volts d.c. full scale in 6 ranges at 50, and in 6 added ranges to 3000 volts at 125, megohms input resistance.
4. 3 through 1200 volts a.c. full scale in 6 ranges at honest effective circuit loading of 6.6 megohms and 8 mmfd.
5. 0.2 through 2000 megohms in six easily read ranges.
6. -10 through +50 db. (0 db. = 1 mw. in 600 ohms) in 3 ranges.
7. 1.2 ma. through 12 amperes full scale in 6 d.c. ranges.
8. Complete signal tracing from 20 cycles through over 100 megacycles by withdrawable r.f. diode probe.
9. Absolutely stable—one zero adjustment sets all ranges. No probe shunting to set a meaningless zero which shifts as soon as probes are separated. Grid current errors completely eliminated.
10. Honest, factual accuracy: $\pm 3\%$ on d.c., $\pm 5\%$ on a.c., 20 μ through 100 megacycles; $\pm 2\%$ of full scale, $\pm 1\%$ of indicated resistance value.
11. Only five color-differentiated scales on 4 $\frac{1}{2}$ " D'Arsonval meter for a total of 38 ranges eliminate confusion.
12. Meter 100% protected against overload burnout on volts/ohms/db.

Possessed by no other instrument, these are features only Silver can give you — revolutionary features for others to copy.

Providing amazing advances in radio receiver servicing, VOMAX is new and fresh as today. It's not an "improved" pre-war model. VOMAX is a brand new instrument born of six years' direction of classified (secret, confidential, restricted) design and production projects for Air Corps, Army, Navy, O.S.R.D. . . . special equipments designed and produced for F.C.C., C.A.A. and other government agencies. Into it has gone the distilled genius which won Grand Prix at 1937 Paris International Exposition for McMurdo Silver for the world's best radio receiver.

That sums up VOMAX in a nutshell. It's the most complete answer to radio servicing and design ever offered . . . conceived and built by a world-famous receiver engineer specifically for receiver servicing. It starts where all competitive instruments leave off.

Deliveries begin in August upon AA-5 or higher priority. Better place your order with your jobber today to insure early delivery . . . be first to get radio's newest, most complete "service station" all in one small, easily carried instrument. By itself VOMAX is the key to service profits for you.

NET PRICE **\$59.85**

McMurdo Silver Company
1240 Main Street,
Hartford 3, Connecticut

Please RUSH free copy of your catalog.

NAME _____

ADDRESS _____

CITY _____ STATE _____

OVER 34 YEARS OF RADIO ENGINEERING ACHIEVEMENT

McMurdo Silver Company

1240 MAIN STREET, HARTFORD 3, CONNECTICUT

L₁—2-6 mc.

46 turns of No. 22 enamelled wire close-wound on 1½" diameter form.

L₂—6-20 mc.

11 turns of No. 20 enamelled wire spaced to winding length of 1¼ inch on 1½" diameter form.

L₃—10-30 mc.

4 turns of No. 14 enamelled wire spaced to winding length of 1 inch on 1½" diameter form.

L₂—Same as L₁ for each frequency coverage, except tap center turn.

L₃—Same as L₂.

L₃ & L₁—Each 2 to 3 turns of No. 18 enamelled wire wound around "cold" end of L₂ and L₃. These link windings must be separated from the main coils by not more than ¼ inch.

Table I. Coil specifications.

is the antenna tuning unit, C₇. Spaghetti-covered leads from C₇ pass through grommet-lined clearance holes in the chassis to the antenna coil, L₅, mounted above chassis.

The crystal selector switch, which also is mounted below chassis, is seen in the upper left corner of the picture; and the protruding connectors of the crystal sockets, together with their mounting nuts, are seen directly to the rear of the selector switch.

The meter changeover switch may be seen in the center of the panel in the under-chassis view, directly under the milliammeter.

Construction of the victory transmitter must be solid, in order to prevent shifting of adjustments or loosening of connections. Heavy hookup wire must be employed in all parts of the circuit where flexible wiring is used, but the r.f. circuits (leads from tank coils and tank tuning capacitors, coupling leads, antenna leads, etc.) must be wired with No. 12 busbar. All bus lines must be covered with high-grade spaghetti to prevent acci-

NEWS FOR THE AMATEUR

A RECENT communication from George E. Sterling, Chief of the RID, gives some interesting information, and requests data on listings.

Mr. Sterling reports that of the G7's now operating in the 7 and 14 mc. bands that the calls G7FA through G7FK are operating under special authorizations from the British, as is 12BM.

The RID representative in Brazil advises that the amateurs in that country have been authorized to operate on 56-60 mc. and on 112-116 mc. on an experimental basis. The LABRE station in Rio is operating on 1800 to 3500 kc. one hour per transmission, three times per week. Traffic or communication with any station beyond the border of Brazil is prohibited.

Mr. Sterling requests that information on any listings of amateur calls heard, together with the frequencies, times and dates of operation be forwarded to him. Communications should be addressed to Mr. George E. Sterling, Chief, Radio Intelligence Division, Federal Communications Commission, Washington, 25, D. C.

LEARN ELECTRICITY
12 WEEKS SHOP TRAINING

"LEARN BY DOING" IN COYNE SHOPS
Electricity offers you opportunity for the best job today — with a real peace time future. "Learn by Doing," on real machinery. Earn while learning. Right now I'm offering extra training in Industrial Electronics at no extra cost. Lifetime employment service after graduation. Get all-around practical training at Coyne in 12 weeks. If you are short of money I'll finance your training. Mail coupon now for Free Book. **VETERANS** — Coyne is equipped to train those who qualify for training under G. I. Bill of Rights. We also have facilities for men with physical disabilities whether due to war or other causes.

H. C. Lewis, President, **COYNE ELECTRICAL SCHOOL**
500 S. Paulina St., Dept. C5-83, Chicago 12, Illinois

Free book, details. Physical disability G. I. Bulletin

NAME _____
ADDRESS _____
CITY _____ STATE _____

SERVICEMEN ATTENTION

50L6, 12SA7, 35Z5, 25L6, etc. Forget the shortage in above and similar tube types by availing yourself of our tube repair service. Tubes fully tested after repairing in radios. Send no money. Repaired tubes returned C.O.D. Only 25c each or 20 tubes repaired for \$4.00. Ship us a boxful today and take advantage of OUR VERY LOW PRICE. Minimum order, \$2.00.

WHOLESALE RADIO REPAIR dealers avail yourself of our expert radio service. Radios repaired and on their way back to you within 48 hours after arrival in most cases. 30% discount to dealers.

FINEST RADIO SERVICE

307 Pipestone, Benton Harbor, Michigan

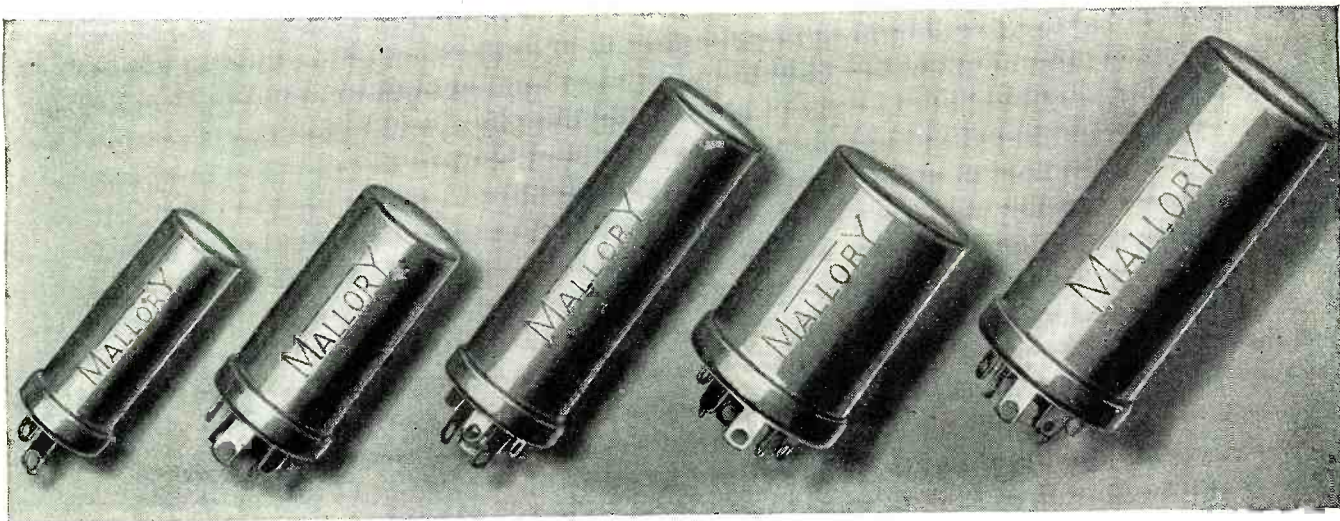

To Earn Customer Confidence— Use Mallory "FP" Capacitors

COMPACT, precision-built, hermetically-sealed, they're an official standard of the RMA. No other capacitors can compare with them for vertical mounting on top of the chassis. That's why you'll find them in so many radio transmitters and receiving sets — in laboratory equipment, test instruments too!

So when it comes time to replace an "FP" type capacitor, make sure a Mallory "FP" goes in. Long on life, easy to install, no other capacitors do the job so well. Mallory "FP" Capacitors are available in ratings from 10 mfd. to 3000 mfd. at operating voltages from 10 volts (3000 mfd.) to 450 volts. See your Mallory distributor!

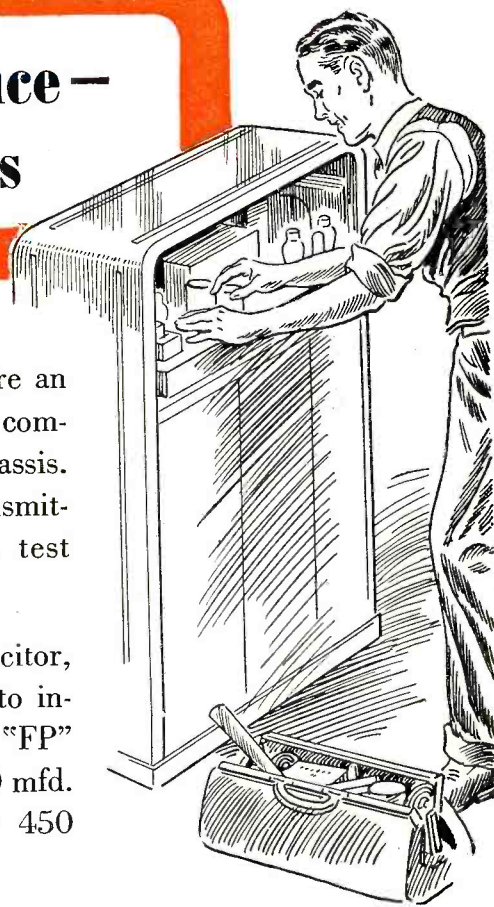

P. R. MALLORY & CO., Inc., INDIANAPOLIS 6, INDIANA

More than ever—
**ALWAYS
INSIST ON**

P. R. MALLORY & CO. Inc.
MALLORY
APPROVED
PRECISION PRODUCTS

**VIBRATORS • VIBRAPACKS* • CONDENSERS
VOLUME CONTROLS • SWITCHES • RESISTORS
FILTERS • RECTIFIERS • POWER SUPPLIES**

ALSO MALLORY "TROPICAL"* DRY BATTERIES, ORIGINALLY DEVELOPED BY MALLORY FOR THE U. S. ARMY SIGNAL CORPS, NOT PRESENTLY AVAILABLE FOR CIVILIAN USE.

*Trademarks

dental contact as they pass through chassis clearance holes. All clearance holes must be at least six times the diameter of the lead and should be lined with rubber grommets.

Operation

To adjust transmitter: (1) Plug-in crystal and coils for desired frequency. (2) Set C_3 at half maximum capacitance. (3) Throw switch S_2 to left-hand (oscillator) position. (4) Connect power supply and turn on heater voltage. (5) After waiting about 1 minute for tube heaters to come up to normal operating temperature, switch on d.c. plate power, noting that milliammeter is deflected. (6) Adjust C_2 for plate current dip and continue ad-

justment beyond point of minimum deflection until meter pointer rises slightly out of dip. (7) Switch milliammeter to amplifier circuit by throwing S_2 to right. (8) Adjust C_6 for plate current dip. (9) Switch S_2 back to left-hand position and readjust oscillator tuning capacitor C_2 for greatest plate current dip, then return milliammeter to amplifier circuit and readjust C_6 for minimum plate current. (10) Adjust C_7 for still lower dip in amplifier plate current. (11) Connect 50-watt incandescent lamp bulb to antenna output terminals and adjust variable capacitor C_7 , noting that dip occurs higher on milliammeter scale (indicating loading) and that lamp reaches maximum brilliance at lowest

plate current dip. Transmitter now is in operation and is loaded, in accordance with F.C.C. regulations, by a dummy antenna. (12) To test keying, insert key plug into jack J . (13) If oscillator goes out of operation during keying, readjust C_2 so that oscillator plate current is slightly on other side of complete dip—Check keying by listening in on oscillating receiver or c.w. monitor coupled *very loosely* to one of antenna output terminals. (14) To check modulation; insert output plug from 500-ohm terminals of 5-watt audio amplifier into jack J , speak into amplifier microphone, and listen to radiophone signal with non-oscillating receiver or 'phone monitor coupled *very loosely* to one of the antenna output terminals.

When checking either c.w. or 'phone operation, as described above, the dummy antenna (electric light bulb) must be connected. The dummy antenna must be in operation at all times when this transmitter is being adjusted or tested. An inside or outside antenna or ground wire must not be connected to the transmitter while the latter is in operation until such time as amateur station operation has been re-authorized by the Government and even then only when the transmitter has been duly covered by an amateur station license, is being adjusted by a licensed radio operator, and when the station call letters are actually being signed to the test signals.

Conclusion

We feel that the little victory transmitter described in this article will have a particular appeal to the man who has disposed of his regular rig, but would like to assemble a low-powered transmitter, in anticipation of the re-opening of amateur radio, from spare parts or from components that are readily obtainable. The design is such that it is not mandatory to use the specified parts. The ingenious builder who reads the technical description will see immediately how

PORTABLE POWER PROBLEMS

THIS MONTH—THE SOUND-LEVEL METER

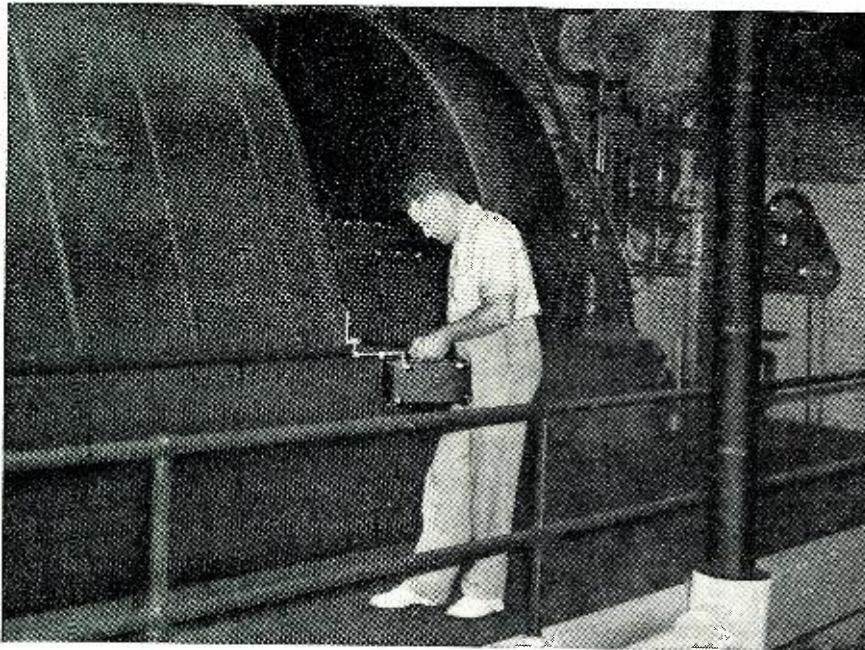

BURGESS INDUSTRIAL BATTERIES meet every power requirement for the conveniently portable sound-level meter. Used for qualitative measurement of sound, the meter consists essentially of a sound pickup, a special electronic amplifier and an indicating instrument. Burgess Industrial Batteries give dependable, long service life in hundreds of electronic industrial applications.

ENGINEERS CHOOSE BURGESS Industrial Batteries for the operation of portable instruments—recent surveys of dry battery preferences reveal that Burgess is the first choice of electronic experts! Burgess engineers will develop batteries for any special problem you may have, although most needs can be served from the standard line available through your Burgess distributor. *Burgess Battery Company, Freeport, Illinois.*

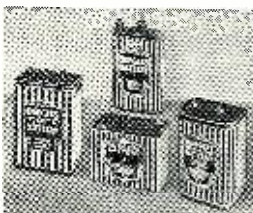

CAREFUL BUYING KEEPS PRICES DOWN!



BURGESS BATTERIES

VOTED FIRST BY ENGINEERS IN NATION-WIDE INDUSTRIAL BATTERY SURVEY

CHICAGO HAMFESTERS RADIO CLUB

The twelfth annual picnic of the Hamfesters Radio Club of Chicago will be held August 5th at Dolton Picnic Grove, Dolton, Illinois.

Long an outstanding event with amateurs of the Central Division, this year's picnic, in keeping with the tradition, will be a family affair. Games, contests, good eats, and demonstrations of WERS equipment will be features of the day.

Dolton may be reached by South Suburban Safeway Busses which leave the depot at 20 East Randolph Street every 40 minutes after 8 AM and will stop at the grove on request. The best automobile route is south on Halsted, east on 147th, and north on Chicago Road to the picnic grounds.

All hams, ex-hams, going-to-be-hams, WERS operators and SWLs are cordially invited. Bring your family, come early and spend the day!

**AFTER THE WAR—
MORE THAN BEFORE!**
... FROM NATIONAL UNION TO YOU ...



MORE instruments, meters and tools ... an improved version of the famous N. U. Equipment Plan that was OK'd 60,000 times by service dealers before the war.

MORE dealer advertising ... newspaper mats, telephone book advertising, mailing pieces, road signs, window displays to make your business prosper!

MORE technical data ... in the form of Service Engineering Bulletins, manuals, charts and other up-to-date information prepared by N. U. scientists.

MORE sales appeal ... through a striking new package design, styled to make National Union a recognized emblem for quality merchandise.

MORE business helps ... new and tested ideas for store layout, stock arrangements, workbench plans, inventory record keeping, and business forms.

MORE tubes and parts ... to capitalize on the increased use of radio, television and electronic appliances and equipment in homes and industries.

YES, a greater peacetime profit plan is coming ... to build new business for radio service dealers and parts jobbers. This plan to build more business for you is backed by the resources of a great and growing company, with front rank engineering and production facilities. National Union can and does assure you ...
"After the War, More than Before!"

NATIONAL UNION RADIO CORPORATION
NEWARK 2, NEW JERSEY



**NATIONAL UNION
RADIO AND ELECTRON TUBES**

Transmitting, Cathode Ray, Receiving, Special Purpose Tubes • Condensers • Volume Controls • Photo Electric Cells • Panel Lamps • Flashlight Bulbs



Here is the practical way to

SAVE MONEY

ON
HARD TO GET

RADIO PARTS

Capacitors . . . transformers . . . tubes . . . meters . . . speakers and thousands of other hard to get National radio parts are in our stock awaiting immediate delivery. And, every item guaranteed the finest quality at a price that saves you real money.

Look at the sample listing below . . . these are just a few of the many money saving bargains Radio Men have found at National. Why don't you take advantage of these savings by ordering today . . . we'll ship tomorrow.

SPECIAL . . .

AEROVOX
Dual section Aerovox, 4-2 MFD at 600 WV oil filled, hermetically sealed in metal containers 2 1/2 in. x 1 1/4 in. x 4 3/4 in. 1 g h - lug terminals. Each, \$3.49; lots of 100, \$1.15 each.

ORDER TODAY FROM THIS MONEY SAVING LIST!

A superior Mike Cable, single conductor, shielded and pre-war natural rubber cover.
13c per ft.; 100 ft. \$9.90

Dual conductor and shield as above
18c per ft.; 100 ft. for \$15.95

CONTINENTAL CARBON RESISTOR KIT No. C6
Assortment, 100 RMA coated 1/2 and 1 Watt resistors (%'s are one watt). Unusual bargain at \$3.35

20 MFD 150 WV Tubular Pigtail Electrolytic. One year guarantee. . . . 35c; 10 for \$3.30

10 MFD 450 WV Tubular Pigtail Electrolytic. One year guarantee. . . . 43c; 10 for \$3.95

50 MFD 150 WV Tubular Pigtail Electrolytic. One year guarantee. . . . 49c; 10 for \$4.45

Heavy Duty GE Pyranol 10 MFD 600 WV (900 Pk) Oil filled paper filter condenser in Hermetically Sealed metal container 3" x 4 1/2" x 1" with connections brought through ceramic bushings. List \$9.80 Our price \$3.30; 10 for \$28.50

Assortment of 200 pcs. Special Radio Hardware including Tube Sockets, Terminal Strips, Grid Caps and Plugs. . . . Kit \$1.49

20 x 20/150 WV Tubular Electrolytic. First Line Condenser. One year guarantee. Each 61c; 10 for \$5.60

OUTSTANDING OFFER

An assortment of 20 high grade Vitreous Enamelled Wire Wound Resistors in 5, 10 and 25 Watt sizes, ranging from 30 to 30,000 Ohms. Selected as to popular usage. Ohmite, Electrohn, Sprague, Utah, etc. Kit #E77. List price, \$9.60. Your cost is only \$2.99.

COD orders require 20% deposit. We accept no orders for less than \$2.50, and pay all shipping charges only on prepaid orders of \$25.00 or more. L-265 or AA-3 certificates are required.

FREE—Our latest money saving bulletin is ready NOW; get your copy today. You'll save.

Dept. RN-8

NATIONAL ELECTRONIC SUPPLY · 622 KINZIE · CHICAGO 10, ILLINOIS

TOUGH!

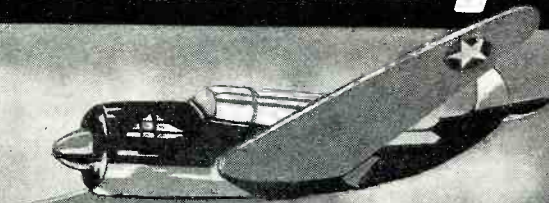
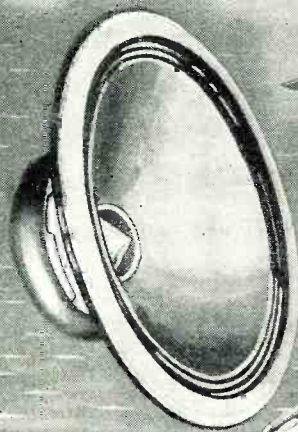

Cinaudagraph Speakers are made to take the tough raps. This is the built-in result of better manufacturing experience. Look at the record of achievement and you'll put Cinaudagraph Speakers at the top of your list.

Watch Cinaudagraph
Speakers After Victory!



Cinaudagraph Speakers, Inc.

3911 S. Michigan Ave., Chicago
Export Div., 13 E. 40th St., New York 16, N. Y.

"No Finer Speaker in all the World"

parts that he has on hand may be substituted and a transmitter of equal efficacy obtained.

Specifications given in Table I are for coils with wide frequency coverage, so that they might be expected to fill the bill regardless of the actual values of low frequencies to be dealt out to the hams. If the frequencies differ markedly from those we used prior to the war, then many hams will find it convenient to re-grind a few of their old crystals and to match them in the victory transmitter with the specified coils.

-50-

What's New

(Continued from page 74)

MILITARY HEADSETS

A new type of headset for the Armed Forces is now being produced by National Scientific Products Company of Chicago.

This unit was designed and devel-



oped in cooperation with the U.S. Signal Corps to fit under military helmets, and meets all requirements outlined in T.B. SIG. 109.

Detailed information on the new headset may be obtained from National Scientific Products Company, 5013-25 N. Kedzie Avenue, Chicago 25, Illinois.

RCA LIFEBOAT RADIO

New lifeboat radio equipment which automatically transmits SOS and radio direction-finder signals has been developed by Radiomarine Corporation of America.

This model which is capable of operating over distances of 1000 miles or more was designed to meet the wartime demand for dependable communication between victims of maritime disasters and the rescue forces. The hand-driven power generator, which replaces storage batteries, and its two-way radio telegraph and telephone facilities are combined in a single waterproof housing.

The transmitter, which may be used for either voice or code communications, delivers five watts of power to the antenna on frequencies of 500 and 80 kc.

When two-way communication is desired, the radio receiver which is

RADIO NEWS

HOW WE SAVE 45 MINUTES OUT OF AN HOUR

When Connecticut Telephone & Electric Division began to make aircraft ignition terminals for a famous engine manufacturer, we knew that standard testing procedure could not keep pace with our mass production methods. Even a score of trained inspectors, each equipped with high-voltage testing equipment, would soon fall hopelessly behind.

Again Great American Industries engineers overcame a stubborn wartime bottleneck. They designed an electro-

mechanical tester which accurately checks four parts faster than former methods could check one. Five such testers, operated by unskilled persons, have a capacity of 12,500 tests an hour... with a degree of error almost too small to measure.

This is but one of many new methods, contributed by G. A. I. engineering to speed the war effort. It will be equally important to efficient electrical manufacturing in time of peace.

HERE'S HOW IT'S DONE

Operator places terminals to be tested in slots at edge of turntable. As each part reaches test point, one electrode of a 10,500 v. circuit contacts the conductor element of the terminal... while another encircles its insulating shell. Current leakage through minute cracks or porous sections of the insulation operates a relay which ejects the faulty piece. If the terminal meets specifications, it automatically falls into a chute and is conveyed to the packing bench. This swift, foolproof tester lends itself to many production tests of insulation.

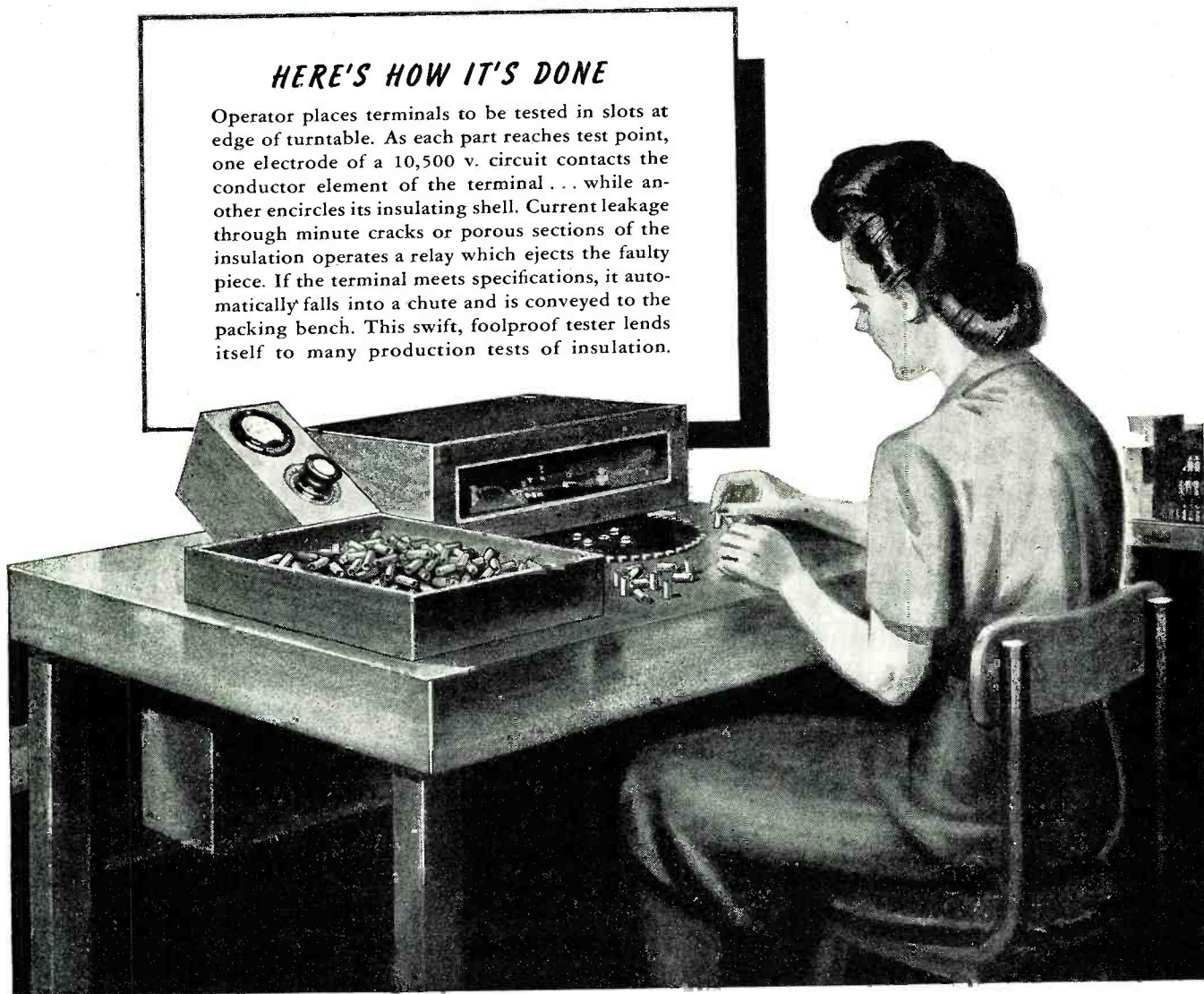

CONNECTICUT TELEPHONE & ELECTRIC DIVISION

GREAT AMERICAN INDUSTRIES, INC. • MERIDEN, CONNECTICUT

IMMEDIATE DELIVERY FROM STOCK

SPRAGUE - CORNELL DUBILIER AEROVOX CONDENSERS



| | |
|------------------------|--------|
| 8 mfd 450v Tubular | .. 44¢ |
| 10 mfd 450v Tubular | .. 50¢ |
| 16 mfd 450v Tubular | .. 65¢ |
| 20 mfd 450v Tubular | .. 70¢ |
| 20 mfd 150v Tubular | .. 44¢ |
| 30 mfd 150v Tubular | .. 47¢ |
| 40 mfd 150v Tubular | .. 50¢ |
| 20-20 mfd 150v Tubular | .. 76¢ |
| 40-20 mfd 150v Tubular | .. 82¢ |
| 30-30 mfd 150v Tubular | .. 79¢ |
| 50-30 mfd 150v Tubular | .. 94¢ |
| 10 mfd 50v Tubular | .. 32¢ |
| 25 mfd 25v Tubular | .. 35¢ |

SPRAGUE Money-Saving Kits

| | |
|------------------------------|--------------|
| 8 ATOMS 8mfd 450v Tubular | \$2.36 |
| 15 TC-11 .01mfd 600v Tubular | 1.59 |
| 15 TC-12 .02mfd 600v Tubular | 1.59 |
| 15 TC-15 .05mfd 600v Tubular | 2.12 |

TEST EQUIPMENT!

Volt-Ohm-Milliameters
GE UM-3 31.50
Superior PB-100 28.40
Precision 832-S 19.48
 Servicemen's Priority
AA-5 MRO CMP5A
 Delivery—3 weeks



SPEAKER BUYS!



| | |
|--------------------|--------------|
| 4" PM square | \$1.35 |
| 4" 450 ohm, square | 1.40 |
| 5" PM 2 watt | 1.25 |
| 5" 450 ohm | 1.50 |
| 10" PM 11 watt | 7.20 |
| 12" PM 16 watt | 10.14 |
| 12" PM 17 watt | 14.25 |

TURNER MICROPHONES

| Model | Type | Cord | Level | Each |
|-------|---------|------|-------|--------|
| BX | Crystal | " | -55 | \$5.85 |
| 22X | Crystal | " | -52 | 10.88 |
| 33X | Crystal | 20' | -52 | 13.23 |
| BD | Dynamic | " | -52 | 8.33 |
| 33D | Dynam. | 20' | -54 | 14.70 |



RADIART VIBRATORS

| Type | Equal | Base | Size | Used in | Each |
|-------|-------|---------|-------------|-----------|--------|
| S-1 | 4-4 | 4 Prong | 1 1/2-3 1/2 | Universal | \$1.35 |
| 5300 | 294 | 4 Prong | 1 1/2-3 1/2 | Universal | 2.09 |
| 5326P | 509P | 4 Prong | 1 1/2-2 1/2 | Philco | 1.76 |
| 5334 | 868 | 4 Prong | 1 1/2-3 1/2 | Decca | 2.09 |
| 5341M | 901M | 4 Prong | 1 1/2-3 1/2 | Motorola | 1.76 |
| 5400 | 248 | 6 Prong | 1 1/2-3 1/2 | Truetone | 3.50 |
| 5426 | 716 | 5 Prong | 1 1/2-3 1/2 | Buick | 3.50 |

ORDER OTHERS BY MAKE AND SET MODEL

TRIMM ACME DELUXE PHONES



| | |
|----------------------|--------------|
| 2000 ohm | \$1.50 |
| Cannon-Ball Dixie | 1.56 |
| Brandes Superior | 1.86 |
| Brush Crystal Phones | |
| Type "A" | 7.95 |

CRYSTALS - PICKUPS - MOTORS

| | | | | | |
|-----------------|-------|-------|-------|-------|------------------|
| CRYSTALS... M22 | 2.94 | L40 | 2.35 | LP6 | 4.70 |
| PICKUPS | | | | | 2.97, 3.30, 3.90 |
| MOTORS | | | | | 3.17, 3.33 |

PHILCO BEAM OF LIGHT

Selenium Cell only, no holder 1.80

AC-DC RESISTANCE CORDS

| | |
|-----------------------------|-----------|
| 135-160-180-220-250-290 OHM | |
| Each | 48¢ |
| 10 for | 4.50 |
| Universal 22-330 ohm | 73¢ |
| 580 ohm for 3-way Portable | 73¢ |

BALLAST TUBES

K42B K49B K55B K55C
 K92B L42B L49B L49C
 L49D L55B M61B M73B
 100-70 100-77 100-79
 Each 45¢ 10 for 4.20
 Clarostat Universal 23-55A
 (octal) each 59¢

20% deposit required on all C. O. D. orders.
 2% transportation allowance on orders of \$25.00 or more accompanied by payment in full.
 Write for FREE CATALOG.

RADIO SUPPLY & ENGINEERING CO., Inc.
 129 SELDEN AVE. DETROIT 1, MICH.

pretuned to the international distress frequency of 500 kc. is brought into use. It can also be tuned to sweep the short-wave band from 8,100 to 8,600 kc. Once communication has been established, the two-way feature permits the boat's occupants to exchange information that will expedite rescue operations. These units may be operated by untrained personnel by following instructions attached to the equipment.

The lifeboat radio is a product of Radiomarine Corporation of America, a subsidiary of Radio Corporation of America, 30 Rockefeller Plaza, New York 20, New York.

-30-

Visual and Oral Reception

(Continued from page 34)

With a sizeable slice of the band before him, the unique rhythm of a CQ will be just as evident in a pulsating panoramic deflection as it is to the ear. Just think of the operator being able to watch for CQ's without touching the receiver tuning dial!

The Panadaptor will spot residual frequency modulation on an amplitude modulated signal, and check the other fellow's quality at a glance, because it will perform just like an oscillo-

graph when the sweepwidth is reduced to zero. No guess work will be necessary to figure out his percentage modulation, either. The adaptor will measure it for you! And along the same lines, the operator can tell immediately from the screen what kind of QRM is blanketing his reception during a QSO, and can advise the transmitting end just how much, and where, to shift frequency.

In reading signal strength, the Panadaptor provides a lagless, accurate, and sharp indication of how great the strength of a received signal is compared to any chosen. It represents an unbeatable way to help friends adjust output stages and directional antennas for maximum efficiency.

For the logging of friendly frequencies, a strip of paper, lightly cemented to the screen, just below the panoramic baseline will enable the operator to indicate the place where friends appear on the screen when the receiver is set on a predetermined frequency. In exactly the same manner, schedules become visible without any manipulation of the receiver.

For a more detailed explanation of panoramic theory, send for Panoramic Radio Corp.'s free booklet "Panoramic Reception." Write to 242-250 W. 55th Street, New York, N.Y.

-30-

Fig. 5. Reproductions of photographs of the panoramic screen showing typical signals that operators may find when they tune to the bands indicated.

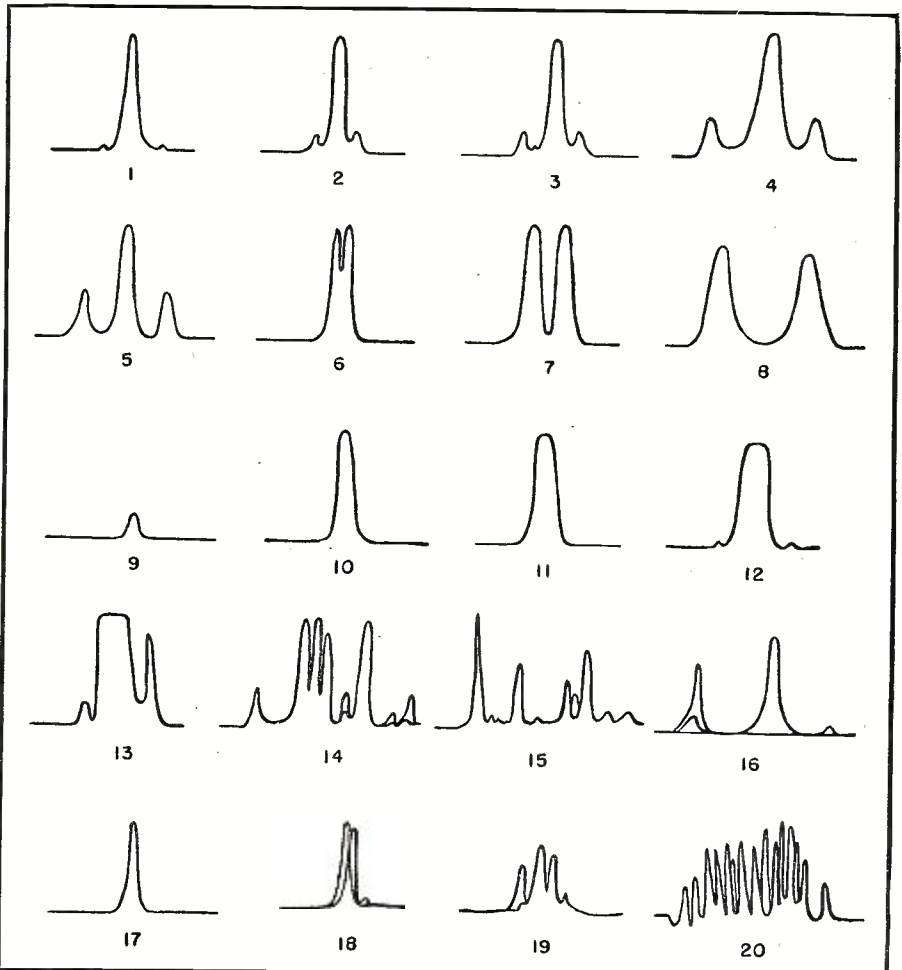

THIS SEA-GULL LIVES ON THE GROUND

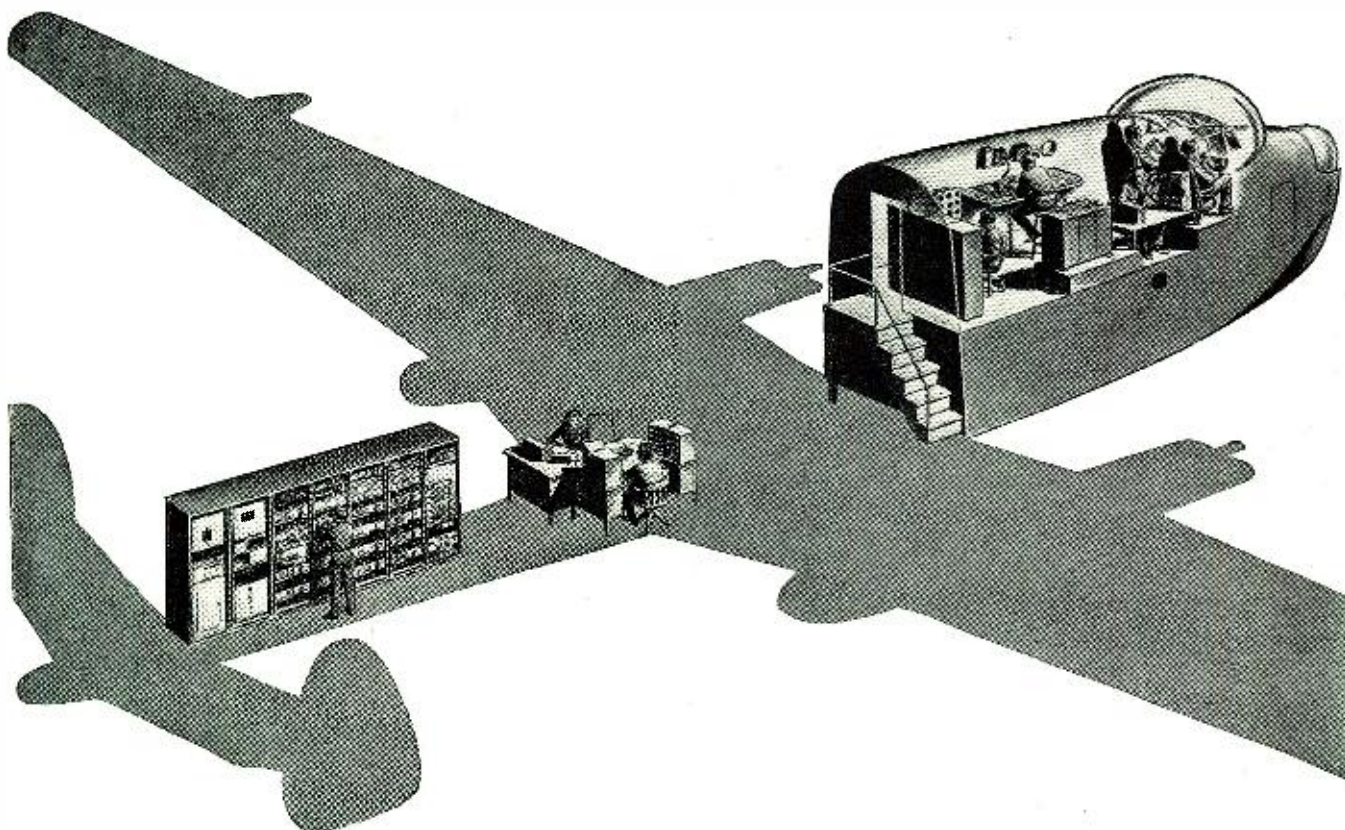

This is a "flight trainer"—an electronically operated replica of the PBM-3 flying boat. It was conceived by the Bureau of Aeronautics and developed by Bell Telephone Laboratories to train Navy bomber crews on the ground.

The new crew climb a few steps to get in and from then on it is like being in a big plane at night. Controls tug against the pilot's grasp and "engines" roar in response to the throttle. From his desk, the instructor creates every situation of real flight — even to iced-up wings, conked-out engines and sudden air-pockets. The novice pilot and his crew get the feel of danger without the hazard.

Once the control dials are set, the various effects are automatically organized and set in motion by concealed machinery which includes 200 vacuum tubes, 60 motors, loudspeakers and hundreds of associated parts. Twenty Laboratories engineers worked more than a year developing the project. Drawings covered an area equal to 15,000 square feet.

This is only one of the 1200 projects in which our experience has been able to help the Armed Forces. What we have learned in devising electronic circuits to train flyers will help build better telephones.



BELL TELEPHONE LABORATORIES

Exploring and inventing, devising and perfecting for the Armed Forces at war and for continued economies and improvements in telephone service.
August, 1945

LEO'S SPECIAL!



Quality Test Leads for this Unit 60c

Immediate Delivery!

MONEY BACK GUARANTEE! ON THIS ALL-PURPOSE

MULTITESTER

Handles AC and DC Voltmeter, DC Milliammeter, High and Low range Ohmmeter. Overall size, 5 1/2 x 8 x 3 1/4 inches. Overall bakelite case with sturdy D'Aronsvial movement. Write for priority information today!

Model WRL 300 ONLY **\$18.75** Less Leads

SEE LEO FOR QUALITY WRL RADIO KITS! PRIORITY REQUIRED



PHONO AMPLIFIER KITS
Complete with tubes, speaker, resistors, condensers, and instructions; No. 1059. . . **\$9.50**



CODE OSCILLATOR KITS
Complete with tube, circuit diagram, instructions. Easy to assemble. 3"x6". No 66-200. **\$4.95**

WE SPECIALIZE IN HALLICRAFTERS
"The Radio man's Radio"
We are one of the nation's largest distributors of HALLICRAFTERS. Available for immediate delivery on priority. Write for details today!



44 pages packed with hard-to-get radio parts . . . all in stock for immediate delivery to radio repairmen. Usual priorities apply. Experimenters write Leo, W9GFQ for details on how to get radio repair parts.
Tube and Circuit Reference Book. 10c
Tube substitution data; technical data.
Handy Tube-Base Calculator. 25c
Shows tube characteristics which enable you to substitute available tubes for those hard to get.
Giant Radio Reference Map. 15c

QUICK SERVICE

"Same Day" delivery service from the heart of the nation. . . on everything in radio! We've remodeled our store, doubled our shelf space, and increased our stock many times. Thousands of hard-to-get items are now available to new and old customers. Write today. You'll like our quick, personal service.

Sincerely,
Leo S. Ferguson



WHOLESALE RADIO LABORATORIES
744 West Broadway
Council Bluffs, Iowa



Time zones, amateur zones, short wave stations, etc. Size 3 1/2 by 4 1/2 feet.

MAIL TODAY

Wholesale Radio Laboratories
744 West Broadway RN-S
Council Bluffs, Iowa.

Please rush Multitester No. 300. \$18.75 is enclosed, or Enclosed is \$_____ Balance C.O.D.

Send your reference book "Tubes and Circuits." Here's my 10c.

You bet I want a Tube-Base Calculator. 25c is enclosed.

Ship me your radio map. 15c is enclosed for packaging and mailing.

Send your free flyer of hard-to-get radio parts.

Name _____

Address _____

Town _____ State _____

I am an amateur; experimenter; service man.

Practical Radio Course
(Continued from page 49)

oscillator tuning capacitance required to maintain the constant frequency difference (i.f.) between the preselector and oscillator tuned circuits is obtained.

From the discussion of tracking requirements already presented here (see Fig. 1 and Fig. 4) it is evident that the plates of the oscillator tuning capacitor must be so shaped that its capacitance varies *less rapidly* than does that of each preselector section. The general relationship between the required plate shapes of the preselector and oscillator tuning sections of the gang capacitor will be somewhat as illustrated at (A) of Fig. 5. The exact plate shape required for any given receiver design and i.f. usually is arrived at by mathematical computation checked by actual trial. If the design is right, close tracking can be obtained with this arrangement, and the ideal oscillator and preselector tuning curve relationship shown at (C) of Fig. 5 will be approximated. Notice that the oscillator frequency is maintained exactly 455 kc. higher than the preselector (signal) frequency throughout the entire tuning range. This means that the desired signals passed by the preselector will always be heterodyned to the correct i.f. value of 455 kc., to which the i.f. amplifier tuning circuits are peaked, and will therefore receive maximum amplification.

Disadvantages of Cut-Plate Tracking Method

This method of oscillator tracking appears to be ideal, yet it has certain disadvantages. A gang capacitor containing one section with plates of a special accurate size and shape is more expensive to manufacture than is one employing similar plates in all sections. Also, a tuning capacitor having an oscillator tuning section with cut plates of a special shape designed for a receiver employing one value of i.f. is not suitable for use in another receiver model made by the same manufacturer but employing a different value of i.f., for the relative difference between the plate shapes required for the oscillator and the preselector capacitor is a function of the frequency-difference to be maintained—that is, the i.f. employed in the receiver. Cut-plate capacitors rarely are used for capacitor-tuned multi-band receivers providing more than two receiving bands—and even then, only when the two frequency bands are such that the preselector and oscillator inductances required for them can be so proportioned that the ratio is almost the same for each band. Otherwise, a different oscillator-section plate shape is required for the different set of coils employed for each band.

Fig. 3. Two-gang tuning capacitor having oscillator-tuning section provided with specially shaped plates (cut plates) to give proper preselector-oscillator frequency tracking over the entire tuning range.

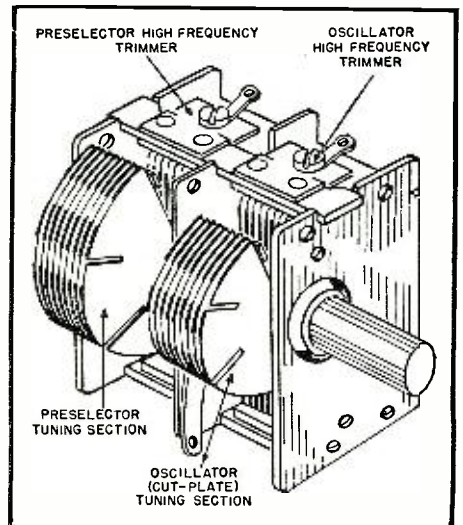

to oscillator circuit inductance a change in the shaping of the cut-plates — even though the frequency difference (i.f.) is to remain the same. Naturally, it would not be economical in space or cost to provide a separate gang tuning capacitor for each tuning band.

SUN-UP!



**Bright Path
Ahead for
TEMPLE DEALERS**

A new day dawns in the world of Radio! And an old, respected name shines brightly over the horizon...casting its golden beams far forward. ☪ Yes, there's a "place in the sun" for every Temple Dealer... especially for the radio merchant who intends building for the future on a solid, permanent basis—the way Temple, itself, has builded. ☪ Good radios, yes! The finest that human minds and hands can produce. Priced at both dealer and consumer levels to meet all or any competitive price ranges on all types of models—from handsome table sets to magnificent radio-phonograph consoles. And supported by a sound, protective sales and profit policy that has YOU, the Dealer, foremost in mind. ☪ Yes, Mr. Radio Retailer, you'll find it will pay you to "team up with Temple". Templetone Radio Manufacturing Corporation, New London, Conn.

"WHERE FM WILL ALSO MEAN FINEST MADE"



Mr. Radioman: CREI Training Can Equip You to Step Ahead of Competition and Gain the Confidence Born of Knowledge!

WILL YOU BE READY? CREI Can Prepare You Now for a Better Job and a Secure Post-War Career in RADIO-ELECTRONICS

CREI Technical Home Study Training Prepares You for the Secure Radio Jobs That Pay Good Money for Ability.

MR. RADIOMAN: You can be ready to enjoy the security of an important engineering position and take advantage of new career opportunities . . . *if you prepare yourself now.*

Join the ambitious radiomen who are assuring themselves of secure, good-paying jobs with a planned program of advancement made possible by CREI home study training in Practical Radio-Electronics Engineering.

You can study at home—in your spare time—develop your technical ability—increase your knowledge to keep

pace with important developments now taking place in the industry.

CREI home study courses are being constantly revised and kept up-to-date with the rapid developments in the industry. What do you know today about U.H.F. circuits, cavity resonators, wave guides, Klystrons, Magnetrons and other tubes? U.H.F. as well as all other basic principles of modern, practical radio-electronics engineering are covered in CREI home study courses.

When the war is over, the good jobs will go to the "survival of the fittest," so make sure that you will not be left behind. Get ready now, for a secure job in the coming new world of Electronics.

**Servicemen—
Discharged Veterans**

**CREI RESIDENCE TRAINING
NOW AVAILABLE UNDER
PROVISIONS OF "G. I." BILL**

CREI now offers Residence School courses in Radio-Electronics Engineering, Broadcast & Television Engineering and Broadcast & Television Servicing under the Serviceman's Readjustment Act of 1944 ("G.I. Bill.") Classes now in session. Enter at any time. Write for details.

Those interested in CREI residence school after the war should write for information about the CREI Priority plan.

WRITE TODAY FOR FREE 36-PAGE BOOKLET

"Your Opportunity in the New World of Electronics"

TELL US ALL ABOUT YOURSELF, so that we can intelligently plan a course best suited to your needs. If you have had professional or amateur radio experience—let us prove to you that we have something you need to qualify for a better radio job. To help us answer your inquiry intelligently—PLEASE STATE BRIEFLY YOUR BACKGROUND OF EXPERIENCE, EDUCATION AND PRESENT POSITION



CAPITOL RADIO Engineering Institute

HOME STUDY COURSES IN PRACTICAL RADIO-ELECTRONICS
ENGINEERING FOR PROFESSIONAL SELF-IMPROVEMENT

Dept. RN-8, 3224—16th Street, N. W., Washington 10, D. C.

Contractors to U. S. Navy—U. S. Coast Guard—Canadian Broadcasting Corp.
Producers of Well-trained Technical Radiomen for Industry.

VANATTA



America's Only Soldering Iron
WITH BUILT-IN THERMOSTAT

225 WATTS POWER in a Mere 14 ozs.

HOT IN 90 SECONDS

Ready for use 90 seconds after plugging in! The Kwikheat Soldering Iron cannot over-heat... adds to life of tips... requires less retinning time, because Kwikheat's built-in patented thermostat maintains proper, even heat for most efficient, economical operation. Powerful—225 watts—yet light weight (14 ozs.). Well balanced with cool, protecting handle. Six interchangeable tip designs adapt the Kwikheat Iron to most any soldering job. Iron with choice of #0, 1, 2 or 3 tip, \$11.00



6 Interchangeable tip styles

6 TIP STYLES—QUICK-HEATING ELEMENT—BUILT-IN THERMOSTAT—WELL-BALANCED—LIGHT-WEIGHT—COOL, PROTECTING HANDLE

ALLIANCE "Even-Speed" Phono-motors

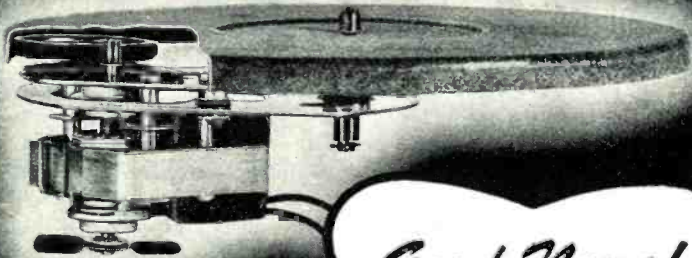

Good News!

ALLIANCE RESUMES PRODUCTION on One Standard Model

• We are now able to return to production of one standard variation of Alliance Model 80 Phono-motor, according to the following definite specifications and on the production plan explained below.

STANDARD SPECIFICATION No. 811—Turntable No. Y-278-S2; 110 Volt, 60 cycle, 9" Model 80
Production must be on the following practical basis under present conditions where there are no large volume priority orders—namely, by accumulating a sufficient quantity of small orders with necessary priority and making periodical single production runs at such time as the quantity of accumulated orders is enough to make this practical. Priority orders (currently only orders of AA-3 or higher, with GOVERNMENT CONTRACT NUMBER and MILITARY END USE, or where certified to be used in Sound Systems, Intercommunications or Paging Systems, as exempted from under M-9-C) must allow delivery time required to obtain a minimum practical production run; to procure material for all orders in hand, and make one production run of the one type standard unit only, for shipment on the various accumulated orders. • Check the above against your requirements, and if you have proper priority, communicate with us.

REMEMBER ALLIANCE—Your Ally in War as in Peace!

AFTER THE WAR IS WON, WE WILL TELL YOU ABOUT SOME NEW AND STARTLING IDEAS IN PHONO-MOTOR

ALLIANCE MANUFACTURING COMPANY
ALLIANCE, OHIO

frequency is an *electrical* method, and is the more widely used of the three. It will be explained in the next lesson of this series.

(To be Continued)

Tone Control Circuits

(Continued from page 47)

ground, the amount of compensation is decreased. R_1 , C_1 tend to give a bass boost while C_2 increases the high frequency boost as the volume is decreased. This circuit is in common usage in commercial radios.

Fig. 4 presents a different approach to the problem. Here we effectively build an amplifier stage for low frequencies, and an amplifier stage for high frequencies, and we mix their outputs, and we connect their inputs to a common source. We merely vary the gain of each circuit to vary the amount of high or low frequency response. In Fig. 4, R_2 would control the high frequency response, while R_1 controls the low frequency boost or attenuation. This circuit has many variations such as resonant LC networks in the plate circuits of the first 6SL7. Then we came to the LC types of tone control circuits. The difficulty in obtaining iron core inductances at this time decreases their desirability and makes the RC type easier to procure the parts for.

The circuit in Fig. 6 can be used, however, and old audio transformers or a.c.-d.c. chokes substituted for the proper chokes. The *Thordarson Company* make several inductors for this purpose which resonate at 40 and 5000 c.p.s., respectively, with the two recommended values of condenser C_1 , C_2 . R and R_1 vary the amount of boost at each frequency. Three or more inductors could be used so that several frequencies could be boosted at will to compensate for the combined deficiencies of a poor pickup and a small speaker.

All in all, however, these RC tone control circuits may be applied to nearly any audio circuit, and will give very satisfactory control of high and low frequency response.

-30-

Fig. 6. Tone-control circuit, employing inductors and capacitors.

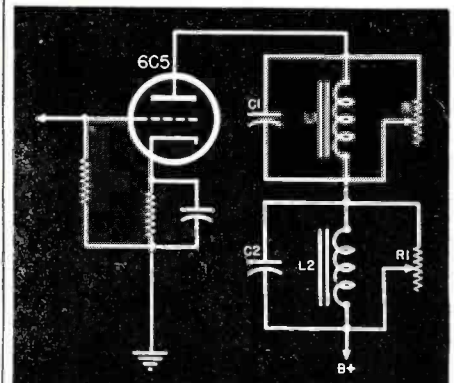

With **STROMBERG-CARLSON**
the Main Radio in your customer's
mind . . .



You'll want to make **STROMBERG-CARLSON**
the Main Radio Line in your showroom!

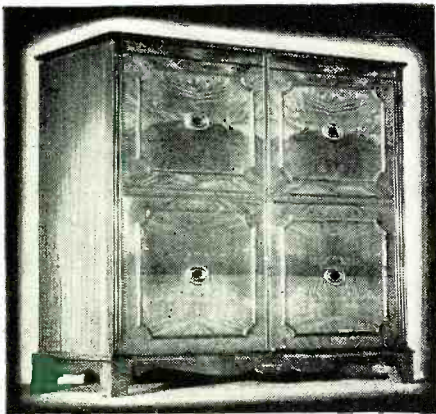

There's a tremendous pent-up demand for Stromberg-Carlson radios—fine musical instruments for the *main radio* in any home. This is currently being stimulated even farther by vigorous national advertising which carries this *main radio* message to your customers through some 475,000,000 impressions in thirteen leading magazines.

Make this profitable market your own, by becoming an authorized Stromberg-Carlson dealer under the very favorable Franchise Agreement now being offered. Get in touch with your local distributor for details, or write us at once. For Stromberg-Carlson is:

—the important radio unit—the radio unit carrying real profit opportunity
—the radio unit with easy-selling public acceptance.

Become an Authorized Dealer now, and organize your postwar business around the Stromberg-Carlson *main radio*—a consistent profit maker whether in an outstanding table model, console, or radio-phonograph combination.

STROMBERG-CARLSON • ROCHESTER 3, N. Y.

RADIOS, TELEVISION, TELEPHONES, AND SOUND EQUIPMENT

RADIO PARTS FOR IMMEDIATE DELIVERY

We carry a complete supply of all types of radio parts and electronic equipment.

Extra Special!

SPEAKERS

10" PM 12 Watts Output

Extra Heavy Slug
lots of ten or more
\$4.50
\$5.35 ea.



12" PM 15 WATTS OUTPUT

Extra Heavy Slug
lots of ten or more,
\$6.50
\$7.50 ea.

OSCILLATOR COILS

Center tapped oscillator coils 456 KC. **35c**
Standard oscillator coils 456 KC. ea.

2 BURNER ELECTRIC HOT PLATE

High quality materials used throughout.



\$5.50 each

SPECIAL!

Output Transformers for 50L6-35L6-43-25L6, etc. **59c** ea.

CHASSIS

Blank

8" x 5" x 1 1/2"
With Four Holes
8" x 4" x 1 1/2"
8" x 5" x 1 1/2"
With Five Holes
9" x 6" x 1 1/2"
10" x 5" x 1 1/2"
9" x 4" x 1 1/2"

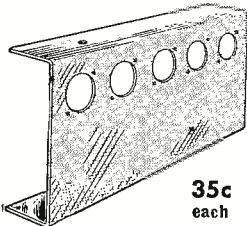

35c each

CONDUCTOR CORDS

- #18-2 Conductor Rubber Zipp cord.
Price \$18.00 per thousand
Quantity 5000 or more. \$15.00 per thousand
- #18-2 Conductor Rayon Lamp Cord
Price \$18.00 per thousand
Quantity 5000 or more. \$15.00 per thousand

BARGAIN SPECIAL AUTO AERIALS

Three section—66" long—side cowl mount—complete with shielded lead. 30 to a case.

Each, **\$2.95**. In Lots of 10 or more, **\$2.50** ea.

FOB Chicago

WRITE FOR OUR LATEST CATALOGUE
All foreign orders payable in U.S. funds.

RADIO PARTS COMPANY

612 W. RANDOLPH ST.
CHICAGO 6, ILLINOIS

Line Cord Voltage Bank

By Sgt. H. L. DAVIDSON

WHILE the voltage bank described in this article was designed especially for the beginner and experimenter, this unit may also be used to advantage by the radio serviceman.

The small voltage bank drops the a.c. line power voltage to the proper value for receivers, experimental uses and for servicing radio receivers that employ line-cord resistors.

The unit is very simple in design and construction. A universal line cord is used with a single-pole, four-position switch and three small insulated phone jacks. The universal cord contains six flexible wire leads, the leads being color coded as follows: long brown lead, 330 ohms; yellow wire, 308 ohms; blue wire, 264 ohms; and the green wire, 176 ohms. The other two leads are black and red. The red terminal is internally wired to the resistance side of the line, while the black wire is the other side of the line.

The wiring of the voltage bank is very simple and may be completed in a few minutes. After the unit is wired, it is ready for a performance test. One excellent method of checking the wiring is to use a small ohmmeter with one terminal lead in No. 5 and the other ohmmeter lead in the resistance jack. The small switch can then be rotated and the ohmmeter will indicate the actual resistance.

If a small ohmmeter is not available, vacuum tubes may be used to indicate correct application. At terminal 4, as shown in Fig. 1, the voltage drop is 52.8 volts at .3 amperes, allowing 57.2 volts for external application. For example, it would be possible to use two 25-volt tubes plus one 6.3 volt vacuum tube, or five 6.3-volt tubes plus one 25-volt vacuum tube to obtain the correct heater voltage drop. Of course, all of these tubes are wired in series and must have the same current drain. Equivalent diagrams are shown in Fig. 2. This small unit was constructed primarily for .3 ampere vacuum tubes.

At terminal 3, which equals 264 ohms, the line voltage drops to 30.8 volts with a drain of .3 amperes. Here, a 25-volt tube could be used, plus one 6.3-volt vacuum tube or five 6.3-volt tubes. Terminal 2 contains 308 ohms which drops the line voltage to 17.6 volts. With this setup, three 6.3-volt tubes could be heated. Terminal 1 has the greatest resistance in ohms and thus the greatest voltage drop, decreasing the a.c. line-cord voltage down to 11 volts. At this switch position, two 6.3-volt vacuum tubes could be used.

If it is deemed desirable to connect,

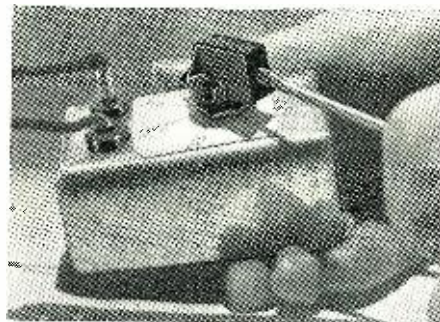

The completed unit shows simplicity of construction and its compactness.

in series, tubes which have different current and voltage ratings, the following formula may be used to find the required shunt resistance. This shunt resistance goes across the vacuum tube having the smallest current rating. The correct formula for such a determination is:

$$R_s = \frac{E_1}{I_2 - I_1}$$

where R_s is the shunt resistance
 E_1 is the filament voltage of the vacuum tube with the lowest current drain
 I_2 is the current drain of the tube with the highest drain

Fig. 1. Wiring diagram.

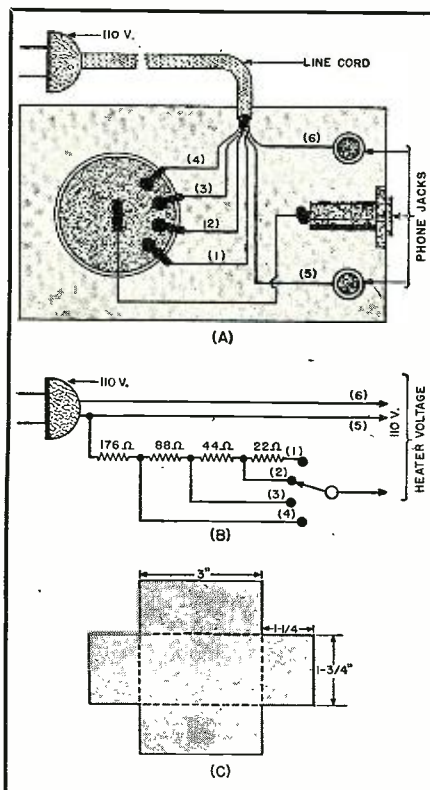

10

POINTS OF Superiority

10. THICK, ROUNDED EDGE, ALUMINUM PLATES FOR MECHANICAL STABILITY AND INCREASED VOLTAGE BREAKDOWN.

1. REMOVABLE BRACKETS FOR MOUNTING COILS ON TOP OR MOUNTING CONDENSER INVERTED

2. STAINLESS STEEL, GROUND STOCK, SHAFTS

9. STATORS MOUNTED ON TOP SIDE FOR LOW STRAY CAPACITY

8. LOW RESISTANCE ROTOR CONTACTS OF LONG LIFE, PHOSPHOR BRONZE, SPRING MATERIAL

7. GRADE L4 STEATITE LOW LOSS INSULATION CORRECTLY PLACED FOR LONG LEAKAGE PATH AND SMALL DIELECTRIC LOSS

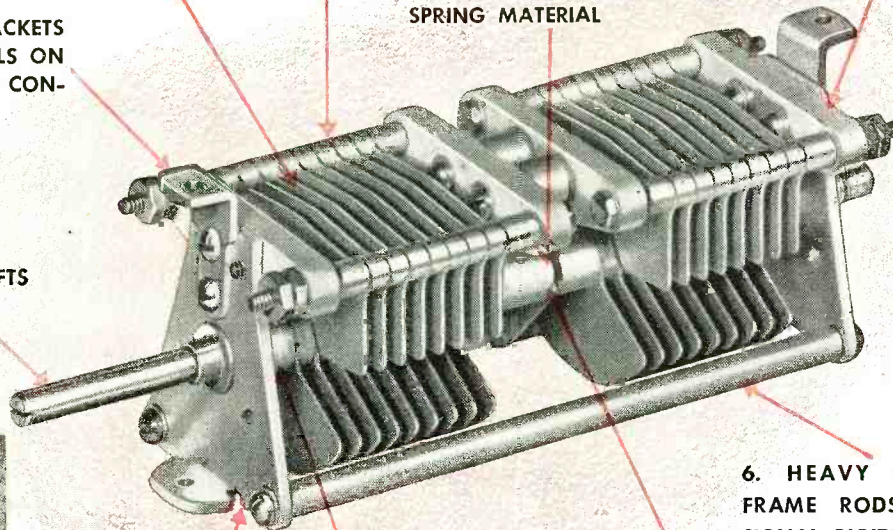

6. HEAVY ALUMINUM FRAME RODS FOR TORSIONAL RIGIDITY.

3. HEAVY END PLATES FOR STRENGTH

CATALOG NO. 100FD20

5. CENTER CONTACT BETWEEN SECTIONS FOR SHORT R. F. LEADS

4. PERFECTLY ALIGNED ROTOR SHAFTS FOR CALIBRATION ACCURACY

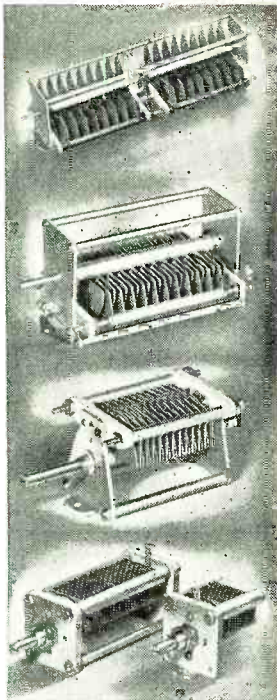

| | |
|--------------------------|----------------|
| C - Plate spacing | .125" - .500" |
| Maximum frame dimensions | 5½" x 5-13 32" |
| D - Plate spacing | .080" - .250" |
| Maximum frame dimensions | 4½" x 4" |
| E - Plate spacing | .045" - .125" |
| Maximum frame dimensions | 2¾" x 2-19 32" |
| H - Plate spacing | .030" & .080" |
| Maximum frame dimensions | 1½" & 1-9 16" |

Type "F" single and dual condensers are stocked with plate spacings of .045 to .075" in 19 different models. Maximum capacity range is from 34 mmf. to 255 mmf. and the ratios of maximum to minimum run from 7:1 to 15:1. Maximum frame dimensions 2-1 16" by 2".



JOHNSON

a famous name in Radio

E. F. JOHNSON COMPANY • WASECA • MINNESOTA
August, 1945

KEEP A TIGHTER REIN ON OFFICE EFFICIENCY with BELfone "INTERCOM" SYSTEMS

OFFICE SALES PRESIDENT TREASURER

BELfone instantly allows you to talk with any department, or several at once, with just the touch of a switch. Like talking "across the desk", you avoid waiting for replies to orders or inquiries. Keeps telephone lines clear of internal traffic and free for outside calls. Office transactions are speeded up.

With BELfone you can keep a tighter rein on office efficiency. Write TODAY for details on how economically standard BELL units can be combined to fit all your needs.

BELL SOUND SYSTEMS, INC.
1200 Essex Ave., Columbus 3, Ohio
Export Office: 4900 Euclid Ave., Cleveland 3, Ohio

I_1 is the current drain of the tube with the lowest drain. For example, consider two tubes connected in series, such as a 12SA7 and a 6J5. The required line-cord voltage bank is 308 ohms, which is terminal 2 or the yellow wire. The 6J5 draws .3 ampere of current, while the 12SA7 draws .15 amperes from the line. Using the formula given above, the required shunt resistance for the 12SA7 is 80 ohms.

To determine the amount of resistance needed to drop the voltage to the proper value for the vacuum tubes being used, the Ohm's Law formula should be applied. The tubes to be hooked in series must have the same current rating or employ a resistance shunt. The voltage drops of the various tubes must first be added together, this value is then subtracted from 110 volts and the result is then divided by the same current value to find the correct dropping resistance. A tube manual is a handy reference for this purpose.

The line-cord resistance will get fairly warm, but this condition should not be considered abnormal.

The constructional data for the chassis is given in Fig. 1. The chassis material is soft aluminum. The all-over size of the unit is extremely small. A small black pointer knob adds to the appearance of the voltage

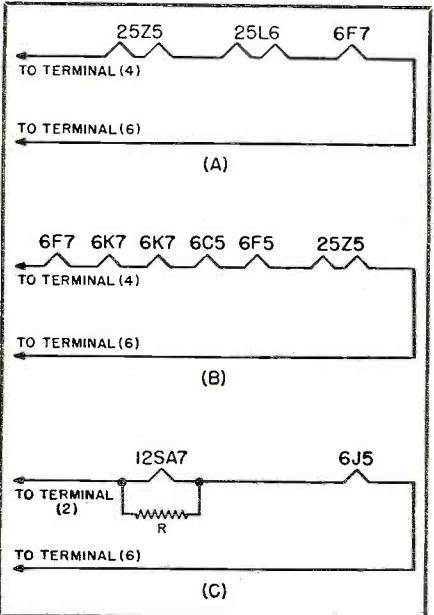

Fig. 2. Typical series filaments that may be operated directly from this unit. Other tube combinations may be used.

bank. Two red, insulated phone jacks and one black jack gives the unit a commercial appearance.

This unit is valuable for the serviceman as well as the beginner and experimenter. When a line-cord resistor goes out on an a.c. receiver, this unit can be switched into the circuit rapidly. The required dropping line-cord resistance can then be read directly from the voltage bank dial.

UTC JUST ARRIVED—The Little Tools for Really Big Jobs

UNIVERSAL MIDGET SERVICE TOOLS

USE UNIVERSAL MIDGETS WHERE OTHER TOOLS WON'T GO

| | | |
|---|---|---|
| <p>SET A</p> <p>NEW UNIVERSAL OPEN END WRENCHES 4 Wrenches — 8 sizes in pocket roll..... \$3.95</p> <p>DEAL 1</p> <p>NEW UNIVERSAL Miniature Mite 1/4" Square Drive 11 pc. Socket Set — \$7.95 7/32" to 7/16" MITEY-HANDY</p> | <p>SET B</p> <p>NEW UNIVERSAL 6 pc. Midget Punch and Chisel Set in pocket roll..... \$4.95</p> <p>DEAL 2</p> <p>NEW UNIVERSAL Midget 1/4" Square Drive Socket Set— 12 pc. 3/16" to 1/2" New Socket \$12.95 Starter..... A-HONEY</p> | <p>SET C</p> <p>NEW UNIVERSAL 5 pc. Set—3 Midget Pliers, Screwdriver and Screw-holder..... \$6.95</p> <p>DEAL 3</p> <p>NEW UNIVERSAL 3/8" Cub Square Drive —12 pc. Socket Set— 3/8" to 3/4" \$19.95 Only..... A-DANDY</p> |
|---|---|---|

5 Sets A, B and C Plus Deals 2 and 3, Complete 39 Pc. Set, with all steel case **\$48.75** ONLY

ORDER TODAY! EASY AS ABC—123

Send names of 3 friends needing tools now and you will receive a useful gift.

From the Heart of America—
Overnight by Air to Anywhere in U. S. A.

UNIVERSAL TOOL CO. O. B. Dematteis President
1527 Grand RN Kansas City 8, Mo.

PRECISION is a weapon in MT. CARMEL, ILL.

They use it effectively, too, these men and women who make up Meissner's *precision-el*, for many of them have sons, brothers and loved ones on the battle fronts. The photographs on this page show a few of these precisioneers who fight on the home front with precision and electronic skill as their weapons.



Precision is a family affair at Meissner. Here a letter from the front lines affects two families, and you can see that it's good news that will be reflected in the quality of their work when their rest period is over.

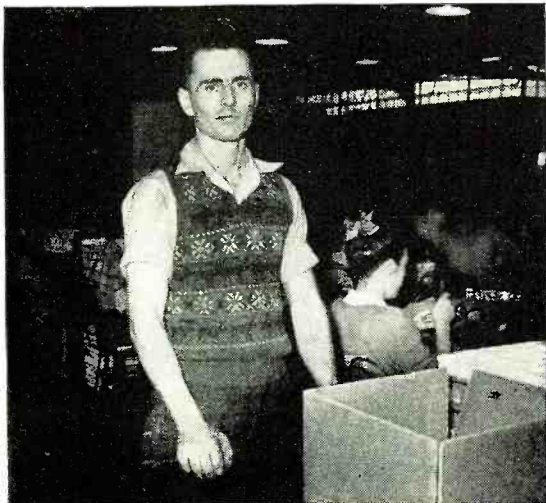

He's a veteran back from active service in the Pacific, but he's still fighting—this time on the home front with the men and women of Meissner. The traditions of precision quality he's learning here will be a weapon he can use after peace.



He splits thousandths of an inch as he does his war job. The "know how" that he and hundreds of Meissner *precision-el* have acquired is one more reason why you will be able to depend on Meissner quality after V-Day.



On the way to battle are three cartons of electronic war equipment. He sends them off with a smile, for he knows that the work of Meissner's *precision-el* will help bring his family together again soon.

August, 1945

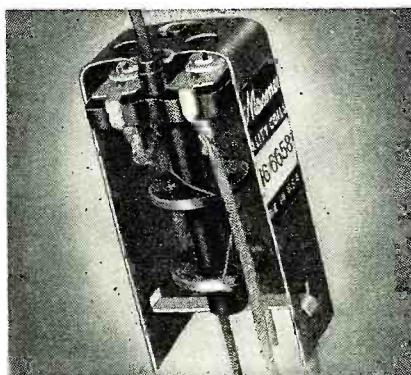

"Step Up" Old Receivers!

These Meissner Ferrocort I. F. input and output transformers are getting top results in stepping up performance of old worn receivers. Special powdered iron core permits higher "Q" with a resultant increase in selectivity and gain, now available for frequency range 127-206. Ask for numbers 16-5728 input, 16-5730 output. List \$2.20 each.



MEISSNER

MANUFACTURING COMPANY • MT. CARMEL, ILL.

ADVANCED ELECTRONIC RESEARCH AND MANUFACTURE

Export Division: 25 Warren St., New York; Cable: Simontrica

10,000 PARTS

Ten thousand different
radio and electronic parts immediately
available on priorities

SERVICE

Trained expeditors select
and ship same-day your order
is received

EXPERIENCE

Known since 1922 as reliable
jobbers, wholesalers and manufacturers of
radio and electronic equipment

**Radio Wire
Television Inc.**

100 Sixth Ave. (Dept. R-8) New York 13, N. Y.
Boston, Mass. Newark, N. J.
World's largest Radio Supply House

Originators and
Peacetime Marketers
of the celebrated

Lafayette Radio

Write today for our bargain
flyers and special bulletins

Manufacturers' Literature

Readers are asked to write directly to the manufacturer for the literature. By mentioning RADIO NEWS, the issue and page, and enclosing the proper amount, when indicated, delay will be prevented.

In view of the present paper shortage, a limited number of copies of the booklets described herein are printed. Manufacturers will endeavor to comply with all requests; however, if your copy is not received after proper request has been made, it most likely will indicate that the supply is exhausted.

C-D CATALOGUE

A new catalogue covering all types of replacement capacitors has been issued by *Cornell-Dubilier Electric Corporation*.

Known as Catalogue No. 195, this 24-page book contains complete data on capacities, sizes and prices of *Cornell-Dubilier* electrolytic capacitors, can-types and cardboard tube types, paper capacitors, wax impregnated and Dykanol tubular capacitors, drawn metal shell units, replacement paper units, photo-flash units, auto radio units and transmitting paper types, also various types of mica capacitors. Capacitor test instruments and interference filters are also included.

Copies of Catalogue No. 195 may be secured by requesting them from *Cornell-Dubilier Electric Corporation*, South Plainfield, New Jersey.

SLIDE RULE

Standard Transformer Corporation of Chicago has issued a new, enlarged slide rule which incorporates many features of value to the engineers and technician.

In addition to the values of the regular slide rule, eight mathematical tables have been included to facilitate necessary computations.

This new Multi-Slide Rule is available from Stancor jobbers only and orders for the rule must not be sent to the company. The slide rule, complete with carrying case is priced at one dollar. Stancor jobbers have supplies of this rule on hand now.

SPRAGUE RESISTORS

A new catalogue featuring *Sprague* Koolohm Resistors for all radio and general service uses has just been issued by the *Sprague Products Company* of North Adams, Mass.

All resistors listed are the new Koolohm types having the "Tropicalized" glazed outer protecting shell and new type moisture-proof end seals which make them applicable for use under any climatic conditions.

A copy of the new catalogue which gives details on 5, 10, 25, 50 and 120 watt fixed as well as 10 watt adjustable types will be sent on request. Address such requests to *Sprague Products Company*, North Adams, Mass.

UNIVERSAL BULLETINS

Universal Microphone Company of Inglewood, California, has two new

bulletins available for distribution.

Both bulletins are four-pages in length and illustrated in two colors. Nineteen different models of microphones are described including technical data and price lists. The listed items are either currently in production or are scheduled for production in the immediate future.

These bulletins are issued in lieu of the 1945 catalogue which will not be published this year.

Bulletin No. 1463 is for general trade distribution, while No. 1465 is for jobbers only. Requests for the bulletins should be addressed to the company at Inglewood, California.

RESISTOR CATALOGUE

A new 32-page resistor catalogue, describing and illustrating various types of units, has been issued by *Ward Leonard Electric Company*.

Data on the proper selection of resistors, sizes and ratings and other pertinent information is included in easy reference form. This catalogue will be of assistance to engineers and designers.

A copy of this catalogue will be sent upon written request to *Ward Leonard Electric Company*, Mount Vernon, New York.

PRECISION CATALOGUE

Precision Scientific Company of Chicago has recently issued Catalogue 325 listing various types of constant temperature equipment manufactured by the company.

Included in this 48-page illustrated booklet are standard cabinets for electric drying operations, humidity control cabinets, paraffin embedding ovens, as well as many other types for the heating of plastics, etc. The company is equipped to design and manufacture special units for specific applications.

A copy of this catalogue will be forwarded upon request of *Precision Scientific Company*, 1750 N. Springfield Avenue, Chicago 47, Illinois.

SHALLCROSS CATALOGUE

A complete guide to accurate fixed wire-wound resistor selection and use in all types of modern equipment has been incorporated in the 28-page engineering bulletin recently issued by the *Shallcross Manufacturing Company*.

In addition to a complete listing of all *Shallcross* Akra-Ohm Resistor

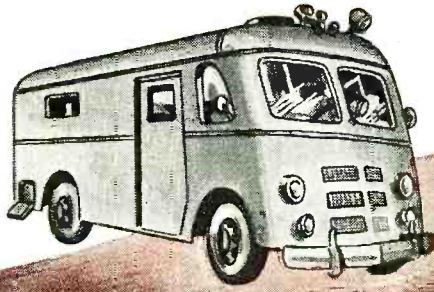

OWI uses RAYTHEON tubes
IN UNIQUE MOBILE RECORDER

• This "traveling recording studio" of the Office of War Information has *everything* for making recorded pickups for broadcasting on international short wave. Such important equipment must be the finest that science can provide, so Raytheon High-Fidelity Tubes are used to assure the highest quality reception.

Wherever they are employed, Raytheon Tubes live up to their reputation for fine performance. That is why they are first choice among electronic engineers planning post-war products . . . and first choice among radio service-dealers who are building soundly for the future.

There's a real promise of greater profits and greater customer-satisfaction for service-dealers who feature Raytheon Tubes. And there's a revolutionary Raytheon merchandising program planned, too . . . to help you be more successful than ever before.

Switch to Raytheon Tubes now!

Increased turnover and profits, plus easier stock control, are benefits which you may enjoy as a result of the Raytheon standardized tube type program, which is part of our continued planning for the future.

Raytheon Manufacturing Company

RADIO RECEIVING TUBE DIVISION

Newton, Mass. • Los Angeles • New York • Chicago • Atlanta



All Four Divisions Have Been Awarded Army-Navy "E" With Stars



Listen to
"MEET YOUR NAVY"
 Every Saturday Night
AMERICAN BROADCASTING CO.
 Coast to Coast
 181 Stations

RAYTHEON
High Fidelity

ELECTRONIC AND RADIO TUBES



DEVOTED TO RESEARCH AND THE MANUFACTURE OF TUBES FOR THE NEW ERA OF ELECTRONICS
 August, 1945



UP

Snyder's aim is ever upward
—There has been a healthy
growth in the past five years,
our high standard of manu-
facture has been recognized
and appreciated by the armed
forces—civilians will benefit
from our experience.

ANTENNAE

by

SNYDER
MANUFACTURING CO. • PHILADELPHIA

COMPLETE MANUFACTURERS
FROM START TO FINISH

types, the bulletin includes information on resistance alloys, maximum resistance and temperature coefficient charts, dimensional specifications, mountings and terminal designs, power dissipation, moisture and fungus-proofing data, hermetic sealing information and resistors designed to meet JAN-R 93 specifications.

A copy of this bulletin will be forwarded upon request to *Shallcross Manufacturing Company*, Collingdale, Pa. Please specify Engineering Bulletin R.

BELT AND CABLE BOOK

A new pocket size, 68-page book containing several thousand radio dial belt and drive cable listings and specifications has been published recently by the *General Cement Mfg. Co.*

In addition to the listings, the new G-C No. 345 book contains many time-saving dial belt and drive cable service instructions as well as detailed information about the repair of finishes on radio cabinets.

The book is available without charge to radio men by writing *General Cement Co.*, Rockford, Illinois, or by contacting *General Cement* jobbers direct.

RELAY MANUAL

An elaborate 55-page catalogue describing the company's complete line of relays has been issued by *Guardian Electric Manufacturing Company* for the guidance of engineers and equipment designers.

Information on relays for different applications and uses is given completely in tabulated form, along with dimensions and blueprint drawings.

Included in the manual are a.c. relays, mercury switch relays, d.c. relays, snap-switch relays, telephone type relays, interlocking relays, ratchet and stepping relays, to mention a few.

Copies of the manual are available upon request to *Guardian Electric Manufacturing Company*, 1400 W. Washington Boulevard, Chicago 7, Illinois.

TEST EQUIPMENT

A four-page bulletin, containing data regarding four types of test equipment, has been issued by *Metropolitan Electronic and Instrument Company* of New York.

Included in this bulletin are a signal tracer, signal generator, resistance-capacity bridge and a Speed-O-Meter which is a multi-purpose unit.

Copies of this bulletin will be forwarded to servicemen, maintenance men and engineers who request it. The equipment described in the bulletin is currently available on priority. Requests for the folder should be sent direct to *Metropolitan Electronic and Instrument Company*, 277 Broadway, New York 7, New York.

PLASTIC BOOKLET

A new publication, entitled "A Businessman's Guide to the Molding of Plastics," has been issued by *Kurz-*

Kasch, Inc., for the guidance of executives faced with problems in the molding of plastics.

The story is told in question and answer form and much valuable data regarding methods, engineering, and advantages of using plastics in some applications is included.

Various types of plastics are listed, along with their molding properties and applications for various types of requirements.

Copies of this booklet may be secured by writing on business letterhead to *Kurz-Kasch, Inc.*, Dept. 7R, 1415 South Broadway, Dayton 1, Ohio.

SOCKET CATALOGUE

Lenz Electric Manufacturing Company has recently issued a new catalogue of their line of dial light sockets for radio receivers, transmitters, test instruments and various types of electrical equipment.

This fourteen-page catalogue includes specifications and dimensions for 28 different standard mounting brackets. Four different styles of *Lenz Dial Light Sockets* are described and illustrated.

The Catalogue No. 101 is available to engineers and purchasing agents upon request to *Lenz Electric Mfg. Company*, 1751 N. Western Avenue, Chicago 47, Illinois.

TROPICALIZATION

Zophar Mills, Inc., manufacturers of tropicalized waxes, has issued a new technical bulletin for the information of engineers and plant executives.

The results of various laboratory tests for humidity, toxicity and applications are included in this bulletin.

Copies of this publication will be forwarded upon request to *Zophar Mills, Inc.*, 112-30 26th Street, Brooklyn 32, New York. Please specify the bulletin entitled, "More About Your Needs for Tropicalized Wax," when making requests.

CALCULATOR

A new parallel-resistance and series-capacitance calculator has been released by *Allied Radio Corporation* of Chicago.

This new calculator is essentially a slide-rule device, designed to provide a rapid and accurate means of determining the reciprocal of the sum of two reciprocals as expressed by the formula: $1/x = 1/a + 1/b$. A single setting of the slide automatically aligns all pairs of a and b values which will satisfy the equation for any given value of x .

This calculator indicates in one setting the numerous pairs of resistances which may be connected in parallel, or capacitances in series, to provide any required resistance or capacitance value. The range is from 1 ohm to 10 megohms; 10 $\mu\text{fd.}$ to 10 $\mu\text{fd.}$

The slide rule is available from *Allied Radio Corporation*, 833 West Jackson Blvd., Chicago 7, Illinois. The price is \$0.25.

-50-

RADIO NEWS

*“Supervisory control helps
put the finger on trouble”* ★



*C. W. Burtis, Chief Engineer
WPEN, Philadelphia*

This statement by Mr. Burtis, on the value of well-designed supervisory control, brings into sharp focus the extra dependability featured in all Westinghouse transmitters. *For Westinghouse transmitters have more supervisory control than any other type manufactured today.*

Indicator lamps, for example, tell at a glance which circuit has been overloaded, even though the transmitter has returned to the air. “De-ion” circuit breakers supply full overload and undervoltage protection, automatically reduce outage time. Controls reset automatically. Circuit checkup is simplified.

This dependability and efficiency in Westinghouse transmitters are products of on-the-job knowledge gained in 25 years of building and operating radio stations. Your nearest Westinghouse office can give you all the facts on Westinghouse transmitters . . . 5, 10 and 50 kw, AM, and 1, 3, 10 and 50 kw FM. Westinghouse Electric Corporation, P. O. Box 868, Pittsburgh 30, Pa. J-08117

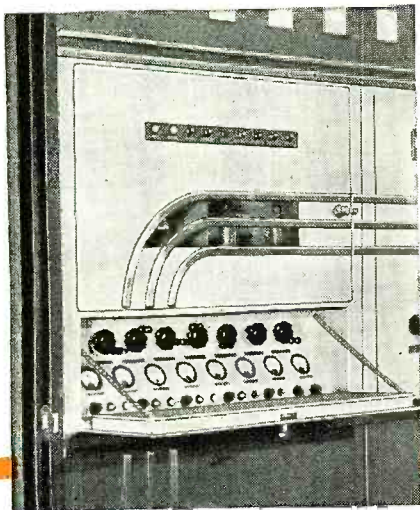

★ “Without a doubt, supervisory control is one of the more worth-while additions to the indication devices on a transmitter. It definitely helps put the finger on any trouble that develops by approximating the sphere of that trouble.”

(Signed) C. W. Burtis



Westinghouse
PLANTS IN 25 CITIES . . . OFFICES EVERYWHERE

Electronics at Work

XXV RADIO'S 25th ANNIVERSARY KDKA



HERE MR. RADIO SERVICEMAN IS A NATURAL FOR YOU

descriptive literature sent on request

SPEED IRON. Patent Pending. The successor to the Electric Soldering Iron. 115 volt, 60 cycle, 100 watt. **IT'S REALLY FAST!** Soldering heat in 5 seconds after pressing the trigger!

You don't wait for the speed iron to heat. It waits on your bench, cold, for you. When you pick it up and press the trigger it goes to work with a surge of power and speed that is amazing.

Speed irons have been tested and used in hundreds of war plant applications over a four year period and are now available to radio repairmen.

PRICE \$12.95 plus mailing costs, terms 25% with order. Balance C.O.D.

ORDER YOURS TODAY

WELLER MANUFACTURING CO.

Dept. N, EASTON, PA.

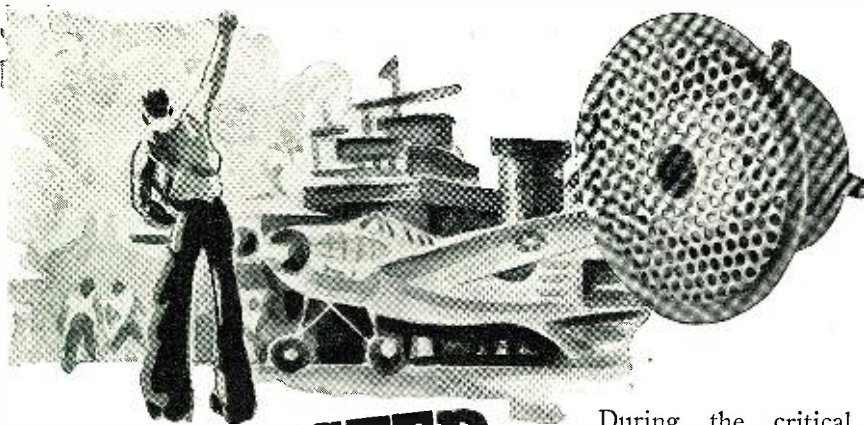

WAR-TESTED



During the critical stress of battle, men and equipment prove themselves. Materiel that has performed dependably under the highly abnormal War conditions has stamina to spare in normal peacetime operation. Atlas Sound Loud Speakers have come through their War tests with flying colors. War-tested Atlas Sound Speaker manufacturing facilities and personnel will soon again be ready to go to work for you on new designs or minor conversions. Contact them for details.

COMPLETE CATALOG ON REQUEST

ATLAS SOUND

CORPORATION

1447 39th Street

Brooklyn, N. Y.

Practical Radar

(Continued from page 41)

The three wave forms shown graphically in Fig. 3 represent the same basic r.f. pulse wave form. And the above relationships are illustrated by wave forms A and B, the envelope of B representing one half the full envelope value of wave form A.

A complete radar operating cycle can be considered in terms of the fraction of the total time that the r.f. energy is radiated, and this time relationship is known as the *duty cycle*. Thus:

$$\frac{\text{pulse duration}}{\text{pulse recurrence time}} = \text{duty cycle}$$

For example, assume that a 1 microsecond pulse is radiated by a radar transmitter at the rate of 1000 times per second. Since the time for one complete radar cycle is 1/1000 second, or 1000 microseconds, the *duty cycle* (by the above equation) will be 0.001.

In a similar manner, the ratio between the average power and the peak power may be expressed in terms of the *duty cycle*.

$$\frac{\text{average power}}{\text{peak power}} = \text{duty cycle}$$

Referring to our example again, assume the peak power output of the radar transmitter to be 500 kilowatts. Therefore, during 1 microsecond 500 kilowatts of power are being radiated, and during the following 999 microseconds no power is being radiated. A restatement of the above equation shows that the average power output is equal to the product of the peak power and the *duty cycle*. Thus, the average power being radiated by this radar transmitter will be only 0.5 kilowatts, or 500 watts.

All of these power relationships are illustrated by wave form C in Fig. 3.

It should be noted that a high value of peak power is necessary to produce strong returning echoes from targets within range of the radar set.

A low *average power* requirement of a radar transmitter enables the output tubes and circuit components to be made physically smaller. For this reason it is advantageous to have a low *duty cycle*.

The total amount of *peak power*

Fig. 8. Basic magnetron circuit.

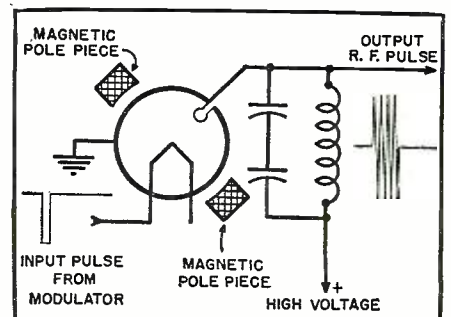

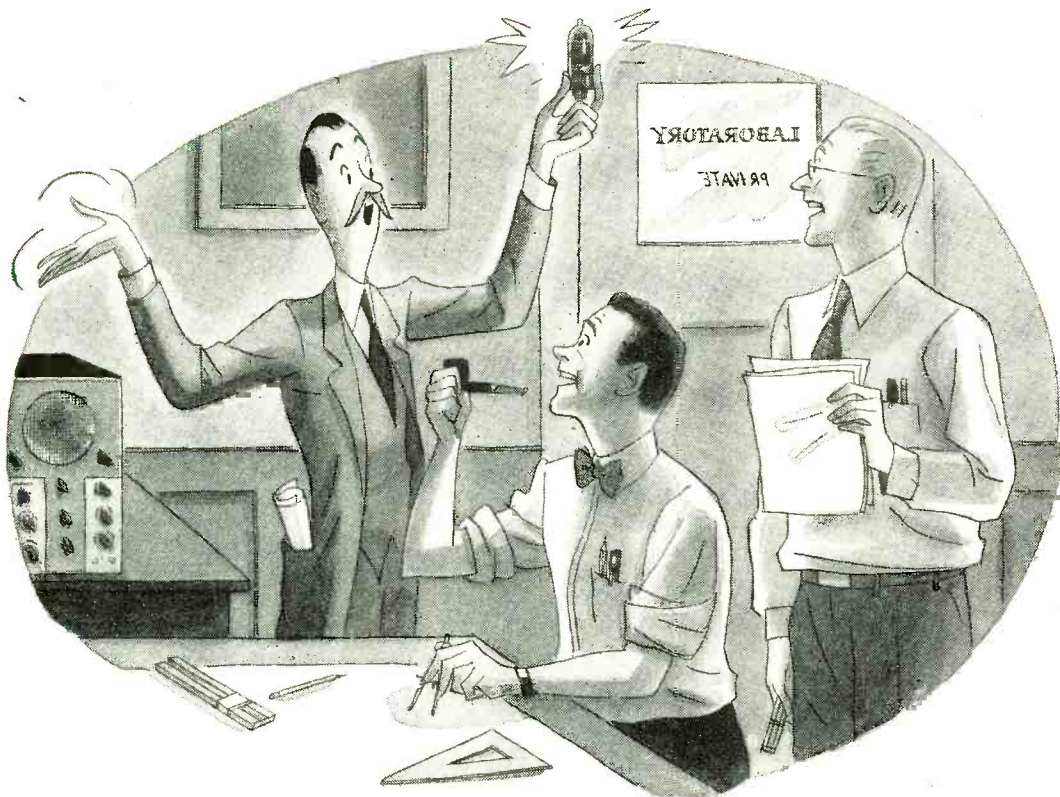

“HYTRON Tubes Are Good—SO WHAT!”

Sure, Hytron tubes are good — so what! All tubes made for Uncle Sam are good. They have to be, or he wouldn't accept them.

But Hytron goes further. Not satisfied just to meet Uncle Sam's JAN-1A specifications, it always sets factory testing specifications to tighter tolerances than the Services require. In this way, Hytron assures top quality

despite slight meter inaccuracies and the human element. When more uniform adherence to specifications can be attained, tests simulating actual equipment performance are added.

This same insistence on the best will continue after the war. Then, too, we shall say, "Hytron tubes are good — so what! They have to be good to be good enough for you."

OLDEST EXCLUSIVE MANUFACTURER OF RADIO RECEIVING TUBES

HYTRON

RADIO AND ELECTRONICS CORP.

MAIN OFFICE: SALEM, MASSACHUSETTS
PLANTS: SALEM, NEWBURYPORT, BEVERLY & LAWRENCE



BUY ANOTHER WAR BOND

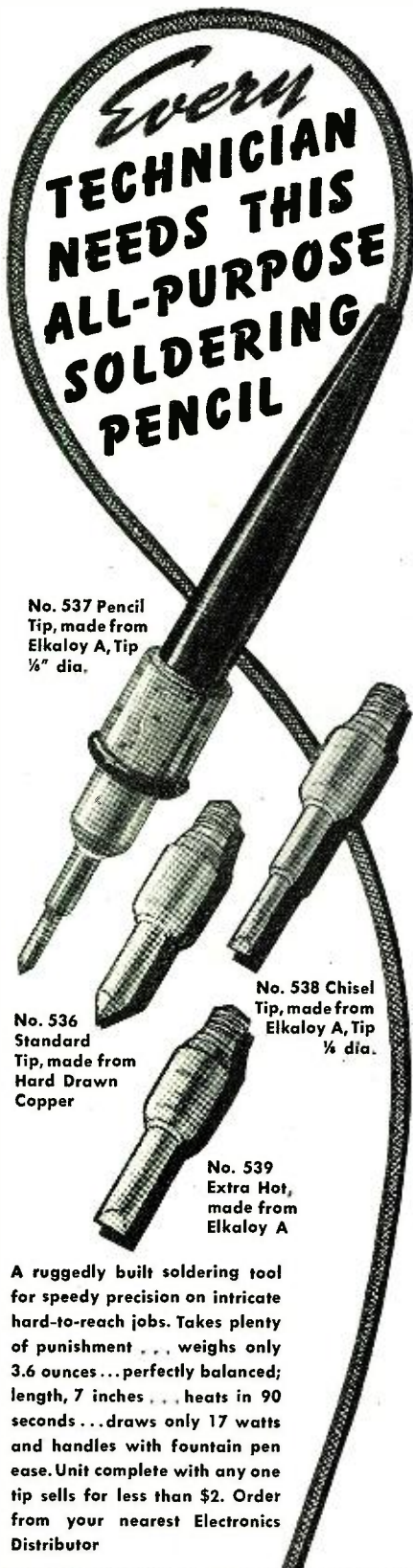

Every
TECHNICIAN
NEEDS THIS
ALL-PURPOSE
SOLDERING
PENCIL

No. 537 Pencil
Tip, made from
Elkaloy A, Tip
1/8" dia.

No. 536
Standard
Tip, made from
Hard Drawn
Copper

No. 538 Chisel
Tip, made from
Elkaloy A, Tip
1/8" dia.

No. 539
Extra Hot,
made from
Elkaloy A

A ruggedly built soldering tool for speedy precision on intricate hard-to-reach jobs. Takes plenty of punishment . . . weighs only 3.6 ounces . . . perfectly balanced; length, 7 inches . . . heats in 90 seconds . . . draws only 17 watts and handles with fountain pen ease. Unit complete with any one tip sells for less than \$2. Order from your nearest Electronics Distributor

Ungar
Electric Tools, Inc.
Formerly Harry A. Ungar, Inc.
LOS ANGELES 54, CALIF.

which can be developed is dependent upon the interrelation between peak power and average power, pulse duration and pulse recurrence time, or duty cycle.

Actual values of peak power output for different radar sets will vary over a considerable range. Some lightweight, portable sets require less than a few hundred watts of peak power while larger radar sets may generate peak power in excess of a megawatt.

Modulating the Transmitter

The transmitter component of a radar set normally consists of two separate stages: a *modulator* and a *radio-frequency oscillator*, as shown in Fig. 4.

The r.f. oscillator is always the final or output stage of the radar transmitter. The purpose of the r.f. oscillator is to generate pulses of u.h.f. energy at a fixed frequency of repetition. And since no further amplification is possible at such a high frequency of operation, the r.f. oscillator must also deliver tremendous amounts of peak power.

Under ordinary circumstances the voltage control pulse from the electronic timer does not possess sufficient power to control the operation of the r.f. oscillator. And therefore, additional amplification of the control pulse is necessary before it can be used to modulate the output stage of the transmitter.

This power amplification of the control pulse is performed by the modulator stage, which supplies a high-amplitude rectangular pulse of the same duration and the same p.r.f. as the original control pulse.

The application of this high-amplitude rectangular pulse to the r.f. oscillator stage permits the output tubes to generate an ultra-high radio frequency determined by the electrical constants of the tubes and the output stage. The length or duration of these u.h.f. oscillations may be determined by the duration of the rectangular power pulse from the modulator.

There are several methods of applying a modulator pulse to an r.f. oscillator stage.

One method requires that the r.f. oscillator tubes normally be biased by such a high negative voltage that it is impossible for the tubes to oscillate. Then, when a high-voltage, positive-going rectangular pulse from the modulator stage is applied to the grids of the r.f. tubes, they are permitted to oscillate for the duration of the modulator pulse. Then the r.f. tubes cease to oscillate until another strong positive-going pulse from the modulator is received.

Another method of controlling the r.f. oscillator requires that the full value of plate voltage normally not be applied to the output tubes, thus preventing the tubes from oscillating. Then, when a high-voltage, positive-going rectangular pulse is applied to the plates of the r.f. tubes, the plate voltage is raised to its normal value

and the tubes will oscillate for the duration of the modulator pulse.

In some cases a *negative-going* modulator pulse may be applied to the cathode or filament of the r.f. oscillator tubes, so that the output stage is permitted to oscillate under optimum operating conditions.

Thus, the modulator can be considered as a sort of powerful electronic switch which directly controls the operation of the r.f. oscillator tubes.

The modulator stage may appear in any of several different forms.

The simplest type of modulator consists of one or more power amplifier stages which introduce little or no distortion to the pulse form they amplify. Any of a large number of types of power-amplifying vacuum tubes may be used for this purpose, since radio frequencies are not required to be handled by the modulator.

Another type of modulator employs a fixed or rotary spark gap and a pulse-shaping line to create high-voltage pulses suitable for modulating the r.f. oscillator stage. The basic circuit for this type of modulator is shown in Fig. 5, and is equivalent to the rotary-spark-gap timer described last month. A control pulse from the electronic timer causes the fixed or rotary spark gap to charge a pulse-shaping line consisting of a number of series coils and shunt condensers arranged in a pi- or H-ladder network. This energy is reflected back from the short-circuited charged line as a very steep-sided high-voltage pulse having a duration dependent only upon the electrical constants of the pulse-shaping line. This high-voltage pulse can then be used to modulate the r.f. oscillator stage of the transmitter.

Another type of "tubeless" modulator stage employs a *saturable inductance* as a switch to charge and discharge a pulse-forming network. This network is *not* the same as the pulse-shaping line described above, and the output of the network is a distorted rectangular wave. The basic circuit for this type of modulator stage is shown in Fig. 6. The saturable inductance *L* functions as an electronic switch since it has either a very high or a negligible impedance, depending upon its operating conditions. These operating conditions—which control the saturation of the inductance—can be controlled by the input wave from the electronic timer. The output pulse form is developed across the condenser *C* (Fig. 6) and then used to modulate the r.f. oscillator stage.

The principal advantage of using either spark-gap or saturable-inductance modulation is that modulator vacuum tubes—with their very heavy filament drain—are not required to drive the r.f. oscillator stage.

However, a more important disadvantage of both the spark-gap and saturable-inductance methods of modulation is that there is no opportunity to control or improve the shape of the

SYLVANIA NEWS

RADIO SERVICE EDITION

AUGUST Published by SYLVANIA ELECTRIC PRODUCTS INC., Emporium, Pa. 1945

SYLVANIA SERVICEMAN SERVICE

by
FRANK FAX



As another service to servicemen, and in further support of Sylvania's big advertising campaign designed to broaden the postwar radio market, Sylvania Electric is widely distributing to the public the new booklet "They Know What They Want."

In it the radio serviceman will find the answers to questions concerning Television, F.M., how many people are planning to buy new radios after the war, and many more — giving him a variety of pertinent facts that are bound to bear directly upon his future welfare.

In addition, "They Know What They Want" is being widely circulated to consumers in response to inquiries stimulated by the questionnaire-type advertisements appearing in national magazines — advertisements through which Sylvania Electric is continuing its study of public preferences in radio. This general distribution is expected to maintain popular interest in postwar radio sets — an interest that will gradually influence the number of sets that will need servicing in the postwar years to come.

Send for your copy now.

NEW BOOKLET SUMMARIZES AND STIMULATES POSTWAR RADIO MARKET

Servicemen Can Obtain Helpful Information On National Radio Trends

Here is a booklet that gives a handy summary of the public's postwar radio wants—a result of Sylvania's nationwide survey and questionnaire-type advertisements. Copies for servicemen are available on request—Sylvania Electric Products Inc., Emporium, Pa.

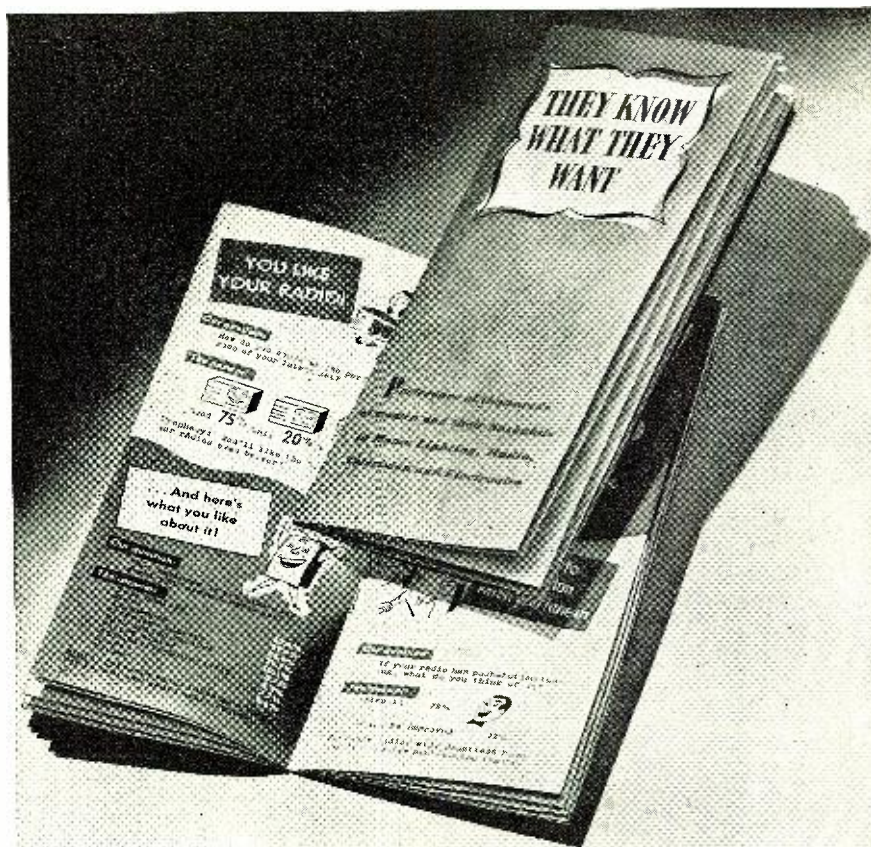

SYLVANIA ELECTRIC

Emporium, Pa.

MAKERS OF RADIO TUBES: CATHODE RAY TUBES: ELECTRONIC DEVICES: FLUORESCENT LAMPS, FIXTURES, ACCESSORIES: ELECTRIC LIGHT BULBS
August, 1945

**don't wait
ask**

SLATE

**specializing in
HARD-TO-FIND**

**RADIO and
ELECTRONIC
PARTS**

immediate delivery

**SUPERIOR
VOLT-OHM
MILLIAMETER**

PB 100

\$28⁴⁰ net



**Complete line
MARION millimeters
and panel meters . . . 0-1
millimeter 50 ohms . . . \$6.99 net**



TURNER
U-9S
4 in 1 mike
\$22⁰⁵ net

50 ohm—200/500 or Hi-impedance

ATLAS ADJ. BANQUET STAND
with velvet action clutch \$3⁹⁰ net

Other SLATE Items

| | |
|--|--|
| Webster Pickup #AJ-1 incl. perm. needle FREE. net \$3.90 | Port. Phono Cab. PA-12 for 10" & 12" records, Leatherette covered. net \$9.75 |
| Phono-Motors 110-220 v. self starting, rim drive. net \$11.50 | Ant. R. F. Matched Coils. per set .55 |
| Flashlight Batteries size C & D—\$6.00 per 100— per M. \$52.50 | 12" PM Speaker ext. heavy slug. net \$7.50 |
| 20 x 20 Condensers 150 w.v. per 100 \$24.00 | Sheldon Fluorescent Starters for 20 or 40 W. lamps. 10 for \$1.80 |
| 50 W. Pencil Soldering Irons with adj. tip. \$1.55 ea., lots of 10—\$1.35 ea. | Standard size. Linen Dial Cable. per 100' \$1.35 |

Write for Catalog J-1



2553 Webster Ave., New York 58, N. Y.

112

output pulse after it has been generated in the charged line or network. For this reason it is desirable, whenever practicable from the standpoint of physical size, to employ vacuum tubes to modulate the r.f. oscillator stage of the transmitter.

It should be noted that the output pulse shape from any type of modulator may be either positive-going or negative-going, depending upon the requirements of the r.f. oscillator tubes. Magnitude of the output pulse is important, but not its polarity—since positive-going and negative-going pulse shapes can be considered equivalent, if all other characteristics of the pulses remain constant.

U. H. F. Technique

The generation of ultra-high-frequency oscillations in the output stage of the radar transmitter involves a number of u.h.f. techniques which we should consider before discussing the types of r.f. oscillators.

In working with ultra-high frequencies it is desirable to have a visual conception of the actual wave lengths being generated and transmitted, because the physical size of the oscillation and transmission circuits is inevitably of the same order as the actual wave length.

Every piece of connecting wire—no matter how short—acts as some portion of a transmission line at these ultra-high frequencies. Lumped inductance and capacitance are of less importance than distributed inductance and capacitance. Tuned sections of transmission lines are usually used as oscillatory or "tank" circuits. And a coaxial cable or wave guide is used to transfer u.h.f. energy from the r.f. oscillator to the transmitting antenna to prevent radiation losses.

For these reasons ultra-high-frequency circuits are generally analyzed from the standpoint of transmission lines.

Ordinary vacuum tubes will not generate oscillations at the frequencies required by radar. And frequency doubling, tripling, or quadrupling have no practical value due to the losses, complexity, and relatively low output power of such circuits.

Important factors influencing the operation of a vacuum tube oscillating at an ultra-high frequency are; (1) the electron transit time from cathode to plate, which increases the effective grid conductance of the tube and shifts the phase of the plate current with respect to the input grid voltage; (2) the high power losses of the tube's circuit because of skin effect, electromagnetic radiation, lead inductances, and stray capacitances; (3) the dielectric losses in the tube base; and (4) the limitation of the upper frequency of oscillation by the minimum possible physical size to which the tube and its associated oscillating circuit can be reduced.

A consideration of the above factors has led not only to the development

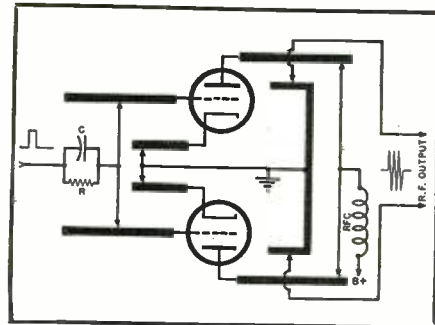

Fig. 9. Tuned-grid tuned-plate u.h.f. oscillator with load coupled to plate circuit.

of new types of u.h.f. tubes but also new u.h.f. circuit techniques, all much too involved and lengthy for this discussion.

Among the many tubes developed for operation at ultra-high frequencies are the types 832, 834, 887, 888, and 1628. Tubes of radically new or special design include the W.E. types 316A and 368A, the G.E. Lighthouse, the Sperry Klystron, and the magnetron.

Because of the important output requirement of extremely high power, however, only a few of these tubes would seem to have any practical use as generators of ultra-high-frequency radar pulses.

For generating r.f. oscillations in the lower u.h.f. band with relatively high peak power, high-frequency triodes may be used—the tubes functioning as negative-grid oscillators in tuned-grid, tuned-plate circuits. Two tubes are connected in push-pull, or any number of pairs of tubes can be connected in series push-pull. The high-frequency triode becomes impractical at the extreme higher frequencies, however, due to troublesome interelectrode capacitances, lead inductances, and miscellaneous distributed or stray capacitances.

A special type of triode known as the Lighthouse triode can be used to generate r.f. oscillations in the lower range, but the output pulse is of fairly low power, and the use of the tube would thereby be limited to extremely small radar sets requiring no great amount of peak output power.

The Barkhausen-Kurz and similar positive-grid triode oscillators are probably not used in radar sets, because of their low efficiency and extremely small output power.

Fig. 10. Tuned-grid tuned-plate u.h.f. oscillator with load coupled to grid circuit.

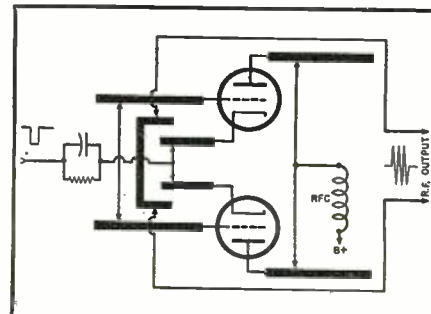

PERFECTION IS OUR ONLY AIM!

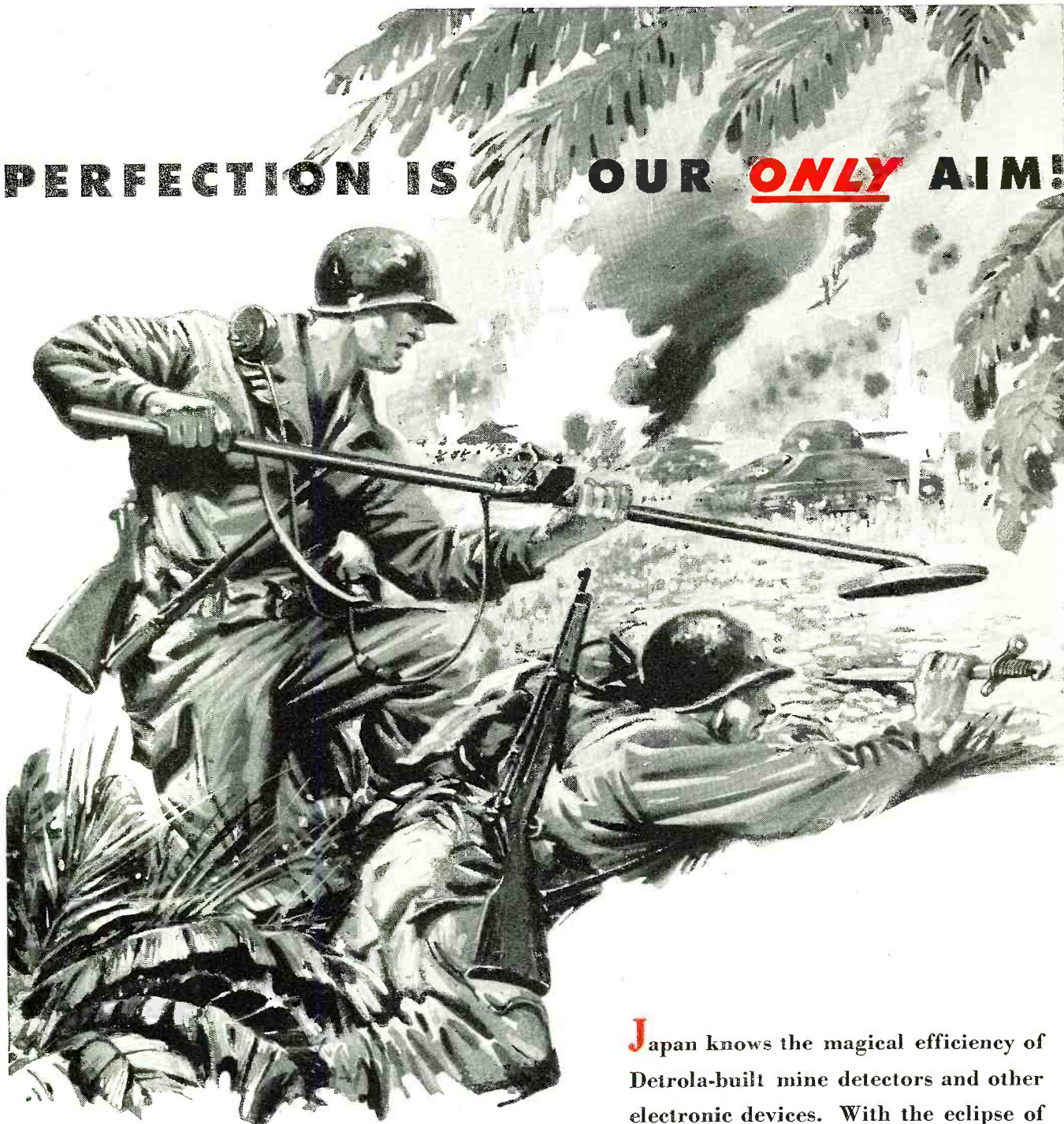

REMEMBER AND BUY IN THE 7TH!



Japan knows the magical efficiency of Detrola-built mine detectors and other electronic devices. With the eclipse of the Rising Sun, Detrola will manufacture distinctive radio and television receivers... sturdy record changers... all of unparalleled value.

DETROLA RADIO

DIVISION OF INTERNATIONAL DETROLA CORPORATION
DETROIT 9, MICHIGAN

DEALERS

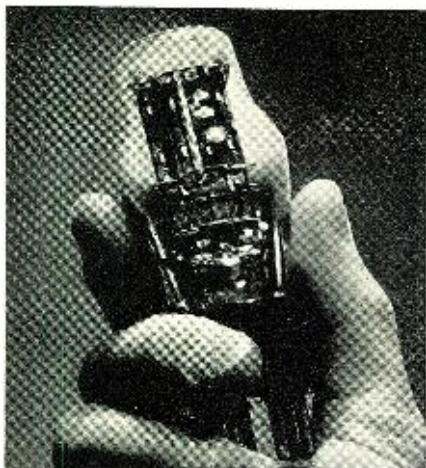

STOP! don't
throw it away!

Let **RTS** reprocess
your dead

RADIO TUBES

NEW Scientific Process

**REACTIVATES THORIUM
CONNECTS OPEN FILAMENTS
CLEARS SHORTS and
MICROPHONICS**

(NOT the old "flash" trick)

MINIMUM ORDER 6 TUBES

SEND NO CASH **50¢** EA.

C. O. D. ONLY 1 v. & 3-Q5 \$1.00

30-Day Guarantee
Every tube fully tested in checkers & sets before playing
Prices Approved by O. P. A.

Send itemized list with order

Make sure glass, base & prongs are intact... flashed, exploded or open cathodes **REJECTED** and **NOT RETURNED**

RTS RADIO TUBE SERVICE CO. INC.

6805 20th Avenue, Brooklyn 4, N.Y.

Velocity modulated tubes—such as the Sperry Klystron, the Hahn-Metcalf tube, and the Haeff tube—can be operated as fairly efficient u.h.f. oscillators, but the relatively low power output of such circuits makes doubtful their use as r.f. generators in the output stages of radar transmitters.

A single solution to the problem of generating large amounts of power at radio frequencies high in the megacycle range is a device called the magnetron. The magnetron is capable of producing r.f. oscillations at any given frequency up to and exceeding 20,000 megacycles, with any required peak output power up to one megawatt.

Triode Oscillators

Negative-grid triode oscillators are widely used in radio transmitters for generating large amounts of peak power at low megacycle frequencies.

A negative-grid triode oscillator is a u.h.f. oscillator in which the average voltage on the grid of the tube is negative with respect to the cathode. The triode is used in some form of tuned-grid, tuned-plate circuit to sustain oscillations at the required resonant frequency.

A basic tuned-grid tuned-plate oscillator circuit is shown in A of Fig. 7. The grid and plate circuits are coupled through the interelectrode capacitance of the tube, and therefore part of the plate energy is fed back into the grid circuit. The tube thus supplies its own input, fulfilling the initial requirement of any oscillator, and the stage oscillates at a frequency determined by the grid and plate "tank" circuits.

To increase the operating frequency of a tuned-grid, tuned-plate oscillator,

the value of the components of the two "tank" circuits must be decreased. This generally requires that the physical size of these "tank" circuits also be reduced.

This size reduction and considerable stabilization of the oscillator circuit may be effected by the use of quarter-wave concentric lines. A basic u.h.f. oscillator using concentric lines is shown in B of Fig. 7.

From the standpoint of stability, efficiency, and power output, however, the most satisfactory u.h.f. tuned-grid, tuned-plate oscillator uses one or more pairs of triodes in a push-pull circuit, the "tank" circuits of which are composed of short-circuited sections of two-wire transmission lines. These sections are usually quarter-wave parallel rods, as shown in C of Fig. 7.

The grid and plate, and even the filament circuits, of such a u.h.f. oscillator can be tuned individually. The grid shorting bars may be varied to obtain maximum stability; the plate bars can be adjusted for maximum output, and the effect of troublesome filament-lead inductance is virtually eliminated by making this inherent inductance a part of a tuned line.

Even though the two triode plates (C of Fig. 7) are connected directly to the ends of the shorted lines, the loading effect on the plate lines is of no consequence since the tubes appear to be operating as if in series.

Radio frequency oscillations may be inductively coupled out of the u.h.f. oscillator from either the filament, grid, or plate circuit.

Two simplified tuned grid, tuned-plate u.h.f. oscillator circuits are shown in Figs. 9 and 10.

Fig. 11. A typical ring type oscillator.

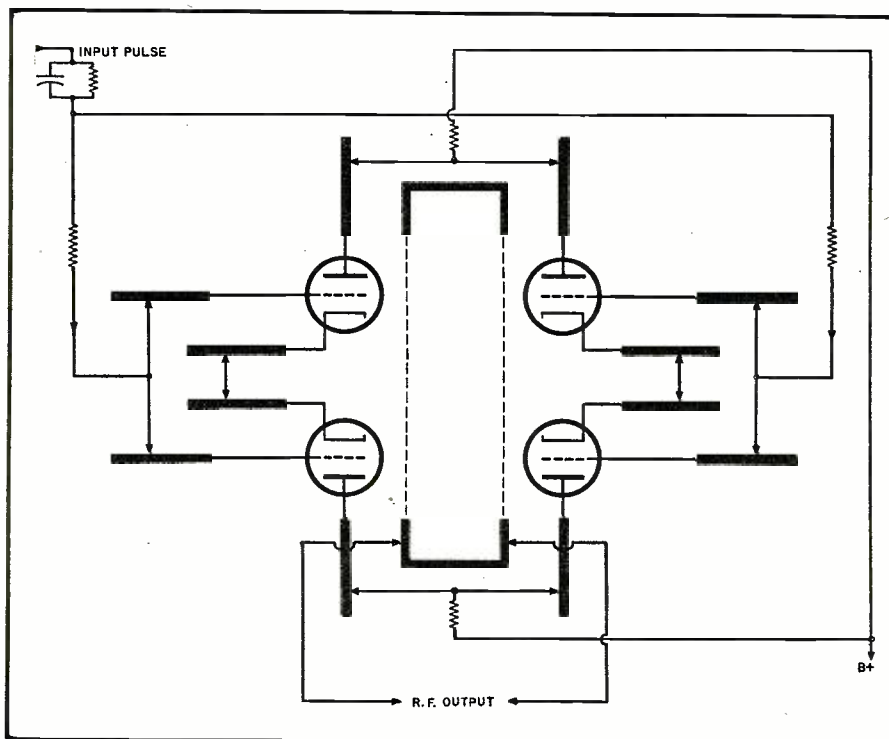



Wondering about tube testers?

*...Here's what Simpson has ready
and waiting for your postwar needs*

Sensational? Yes . . .

1. This new Simpson Mutual Conductance Tube Tester tests tubes with greater accuracy than any commercial tube tester ever designed.
2. Provides greater flexibility for future tubes than any other tester.
3. Tests tubes with voltage applied automatically over the entire operating range.
4. Simplifies as never before the interpretation of tube condition from mutual conductance readings.

Simpson
INSTRUMENTS THAT STAY ACCURATE

SIMPSON ELECTRIC COMPANY
5200-18 Kinzie Street, Chicago 44, Ill.



During quiescent periods between pulses from the modulator stage the oscillator, shown in Fig. 9, cannot function, because a fixed negative bias of several hundred volts is applied to the grids of the tubes. However, when the control pulse from the modulator is applied to the grid circuit, the high voltage of the positive-going pulse nullifies the fixed bias on the tubes and the triodes are permitted to oscillate at a resonant frequency determined by the system of tuned transmission rods. The r.f. oscillations take place only for the duration of the input control pulse, ceasing abruptly when the modulating pulse is removed.

The input capacitance-resistance network of the circuit (Fig. 9) consists of a grid leak of fairly low value and a blocking condenser of several hundred micromicrofarads. There is no grid blocking action by this network.

The u.h.f. output pulses from this oscillator (Fig. 9) are coupled inductively from the plate circuit, and can then be passed to the transmitter antenna by means of a transmission line or, more probably, a wave guide.

A slight variation of the circuit shown in Fig. 9 permits the oscillator to control the duration of the u.h.f. oscillations after the leading edge of the modulating pulse has triggered

the circuit into operation. To accomplish this, a higher value of grid-leak resistor and a much lower value of blocking condenser are used in the input capacitance-resistance network of the oscillator grid circuit. When the modulator pulse is applied to the grid circuit, the triodes are permitted to oscillate as previously described. However, at the same time a charge is quickly built up on the condenser of the network, causing the grids of the triodes to become more and more negative with respect to the cathodes. And the condenser rapidly acquires sufficient voltage to stop or block oscillations completely.

This damping or grid-blocking action is known as "squegging," and such an r.f. oscillator as described above is more popularly known as a *squegging oscillator*.

The principal effect of this squegging action on the r.f. output pulse is that the u.h.f. oscillations do not cease abruptly but have a damped or attenuated effect, resulting in the appearance of a "tail."

In the basic oscillator shown in Fig. 10, the filament and plate circuits are unbalanced with respect to each other. During quiescent periods between modulator pulses the oscillator is unable to function, because the potential difference between the filament and plate of each tube is not sufficient for the tubes to operate. Several hundred (positive) volts on the plates may be required to permit oscillations. This unbalanced condition can be rectified, however, when a negative-going modulation pulse of several hundred volts is applied to the filament circuit. Since allowance is made for balancing the grid circuit accordingly, this procedure is exactly the same as applying a high-voltage positive-going pulse to the plate circuit.

In either case the potential difference between the filament and the plate is corrected, and the circuit is permitted to oscillate at a resonant frequency determined by the tuned transmission rods. The u.h.f. oscillations will take place only for the duration of the modulator pulse, and will cease abruptly when the control pulse is removed.

The r.f. output pulses from this oscillator (Fig. 10) are coupled inductively from the grid circuit, and can reach the antenna by means of a transmission line or a wave guide.

There are several variations of the two basic r.f. oscillators described above (Figs. 9 and 10), but they all function in much the same manner; the ultra-high frequency oscillations being controlled by a high-voltage control pulse from the modulator stage of the transmitter.

Ring Oscillators

The power output of a single pair of triodes arranged in a push-pull tuned-grid, tuned-plate oscillator will be limited by the plate current that can flow in the tubes and by the power dissipation of the triode plates.

ELECTRICITY

FOR RADIO AND ELECTRONIC APPLICATIONS

- ONAN ELECTRIC GENERATING PLANTS supply reliable, economical electric service for electronics applications as well as for scores of general uses.

Driven by Onan-built, 4-cycle gasoline engines, these power units are of single-unit, compact design and sturdy construction. Suitable for mobile, stationary or emergency service.

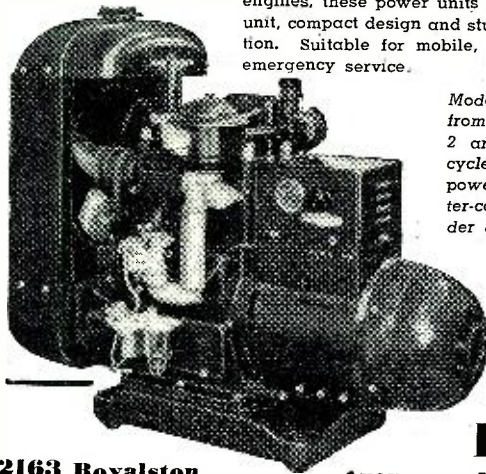

Model shown is from W2C series, 2 and 3-KW, 60-cycle, 115 volt; powered by water-cooled 2-cylinder engine.



Models range from 350 to 35,000 watts. A.C. types from 115 to 660 volts; 50, 60, 180 cycles, single or three-phase; 400, 500 and 800 cycles, single phase; also special frequencies. D.C. types range from 6 to 4000 volts. Dual voltage types available. Write for engineering assistance or detailed literature.

2163 Royalston

Avenue.

D.W. ONAN & SONS
MINNEAPOLIS 5, MINN.

SPEED UP REPAIRS WITH THESE G-C AIDS!



FREE
STEEL
CABINET

G-C Dial Belt Kits

Exact replacement woven fabric belts. Easy to install — no stretching — no adjustments — a perfect fit every time. Kits come with 25, 50, 100, 200 or 300 belts.

Get This New **FREE Dial Belt — Drive Cable and Cabinet Repair Guide!**



Pocket size 68 page book contains thousands of listings, specifications — time saving service instructions. Invaluable to every radio man. Get a copy from your jobber. If he cannot supply you, write us.

Immediate delivery on G-C Belts and Cables

Order From Your Radio Parts Jobber
ALWAYS ASK FOR G-C PRODUCTS



GENERAL CEMENT MFG. CO.
ROCKFORD, ILLINOIS



THORDARSON

*celebrates its 50th. Anniversary
by joining hands with*

MAGUIRE INDUSTRIES

A
GREAT PAST
LINKED TO

A
GREATER
FUTURE
1895 - 1945

Throughout the past half century, the name "THORDARSON" has been a synonym for highest quality in transformers and other electrical equipment.

Under the banner of Maguire Industries, this tradition of leadership will be maintained in even fuller measure.

Thordarson's new plans include outstanding improvements in present lines... new products and services to meet the expanding needs of the radio and electronic industries... vigorous and liberal merchandising policies... and a generally forward-looking viewpoint with regard to all of the industries we are privileged to serve.



A Subsidiary of Maguire Industries

THORDARSON
ELECTRIC MFG. COMPANY
500 WEST HURON STREET
CHICAGO 10, ILLINOIS

A RADIO RIOT! TUBE and ADAPTOR SPECIALS!

★ YOUR CHOICE OF LISTED TUBE-ADAPTOR COMBINATIONS AT A "LOWER-THAN-EVER" PRICE

• Jobbers! Wholesalers! Dealers! Here's your opportunity to obtain the hard-to-get tube and adaptor combinations you need so badly. All tubes are branded, including famous makers like RCA, KEN-RAD, TUNG-SOL and SYLVANIA. Quantities are limited and subject to prior sale. 25% deposit required with order, together with your L-265 Certification. Minimum order must be for 50 units each or assorted. **RUSH YOUR ORDER! SAVE WHILE THESE UNUSUAL VALUES ARE STILL AVAILABLE!**

Each Tube and Adaptor Individually Boxed

| To Replace | Use Tube & Adaptor | List Price | BOTH ONLY |
|------------|--------------------|------------|-----------|
| 1A5 | 1T4 & Adaptor | \$3.10 | \$1.00 |
| 1N5 | 1T4 & Adaptor | 3.10 | 1.00 |
| 1T5 | 1T4 & Adaptor | 3.10 | 1.00 |
| 1H5 | 1S5 & Adaptor | 3.10 | 1.00 |
| 47 | 3A4 & Adaptor | 3.10 | 1.00 |
| 45 | 3A4 & Adaptor | 3.10 | 1.00 |
| 3Q5 | 3S4 & Adaptor | 3.10 | 1.00 |
| 1N5 | 1L4 & Adaptor | 3.10 | 1.00 |
| 1Q5 | 3Q4 & Adaptor | 3.10 | 1.00 |
| 3Q5 | 3Q4 & Adaptor | 3.10 | 1.00 |
| 1Q5 | 3S4 & Adaptor | 3.10 | 1.00 |

TUBE SPECIALS

| | | | |
|-------|----------|------------------|----------|
| 1S5 |65c | 1633 |85c |
| 1T4 |55c | Perfect 35Z5 | |
| 3S4 |55c | with Adaptor | |
| 1A3 |55c | 1632 |60c |
| 3Q4 |55c | Check RCA | |
| 39/44 |45c | for 25L6 Sub. | |
| 6H6 |51c | VR53 |90c |
| 6N7 |76c | Perfect Sub. | |
| 6V6GT |51c | for 12K7 without | |
| 6AC7 |65c | adaptor | |

CONDENSATOR SPECIALS

| | | | |
|------------------|-----|------------------|-----|
| 8 MFD—450 V.... | 28c | 20 MFD—150 V.... | 23c |
| 10 MFD—450 V.... | 29c | 50 MFD—150 V.... | 25c |
| 30 MFD—450 V.... | 38c | 100 MFD—25 V.... | 24c |

SPEAKER SPECIALS

Send us your requirements. All sizes in P. M. or Dynamics at exceptionally low prices.

Order Today!
IMMEDIATE DELIVERY

LEONARD ASHBACH
Company
ELECTRONICS DISTRIBUTORS
Phone WHIttehall 2065
152 W. HURON ST. • CHICAGO 10, ILL.

RADIO

RADIO Technician and Radio Communications courses. Register now for new classes starting first MONDAY of each month. Day and Evening Classes.

AMERICAN RADIO INSTITUTE

101 West 63d St., New York 23, N. Y.
Approved under GI Bill of Rights.

THE BEST VIBRATOR

A small vibrator with a great future!
QUIET! COMPACT! EFFICIENT!

A revolution in Postwar VIBRATOR design. Till materials are more plentiful, we will continue to rebuild old vibrators at \$1.00 each. Include return postage. Send vibrators to

BEST VIBRATOR CO.

BOX 5802 CLEVELAND 1, OHIO

If this power output is not of a sufficient value, it may be raised by enlarging the current-carrying capacity of the tubes or, more simply, by increasing the number of tubes in the oscillator circuit.

Additional pairs of triodes may be connected in series, creating a u.h.f. oscillator with almost any desired high output power. Such an arrangement of four triodes is shown in the basic circuit of Fig. 11.

When more than one pair of triodes is used in this manner, the resulting circuit is known as a *ring oscillator*—since the tubes are physically arranged in a circle or ring with the plate tank circuits on the inside of the circle.

This mechanical arrangement permits symmetrical connections between tubes and other elements of the circuit, and considerably simplifies the problem of coupling the output of the r.f. oscillator to a transmission line or wave guide.

The interelectrode capacitances for a number of pairs of tubes in a ring oscillator are considerably lower than for a single pair of tubes connected in a push-pull circuit. Therefore, the addition of pairs of tubes to the ring oscillator permits any given type of triode to be used at much higher operating frequencies.

The ring oscillator functions much in the manner of the basic tuned-grid, tuned-plate oscillator previously discussed. But, of course, the ring oscillator circuits are more complex and require a high degree of adjustment.

The Magnetron Oscillator

The magnetron is widely used as a generator of ultra-high frequencies for two very significant reasons. It can produce stable r.f. oscillations of any frequency up to and exceeding 20,000 megacycles. And it can produce radio frequency pulses having phenomenally large amounts of peak power.

Certain types of magnetrons have an output exceeding a megawatt when operating at wave lengths of only a few centimeters. And the output of most other magnetrons is seldom less than 500 kilowatts at *any* operating wave length or frequency.

All of this is possible because of the magnetron's unique manner of operation: *the control of electron movement by means of an electromagnetic field.*

The magnetron is essentially a diode having a cylindrical anode, along the axis of which is located the filament of the tube. When the ends of the cylinder are closed, the interior of the device acts as a resonant chamber.

Around the outside of the magnetron is wound a coil capable of producing a very strong axial field. The lines of magnetic force are approximately parallel to the axes of the filament and the anode, and the magnetic field functions much in the manner of a grid in retarding the passage

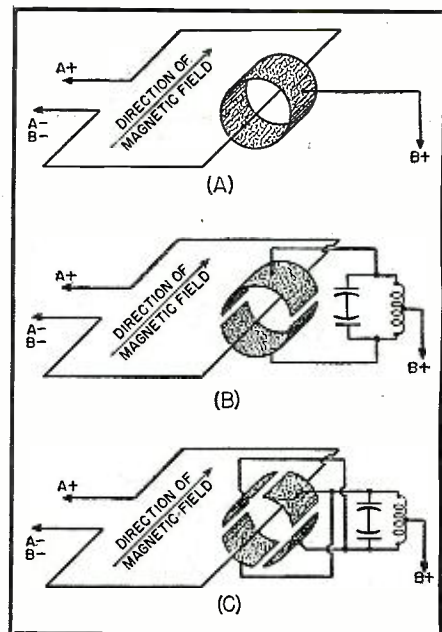

Fig. 12. Three basic types of magnetrons—(A) single anode, (B) split anode, (C) slotted anode.

of electrons to the positively charged plate or anode.

Although some types of magnetrons have complex filament and anode structures, the physical structure of the basic magnetron, in general, is fundamentally simple, as shown in A of Fig. 12.

Sometimes the anode is divided into two segments (B of Fig. 12), and the tube is known as a *split-anode magnetron*. When the anode is divided into four segments (C of Fig. 12) or a greater number of segments, the tube is known as a *slotted-anode magnetron*. But regardless of the number of anode segments, the practical operation of the device remains much the same.

Electron paths viewed from the open end of a simple magnetron are shown in Fig. 13.

In the absence of a magnetic field

Fig. 13. Electron paths within a magnetron employing static fields. (A) Electron path with no magnetic field. (B) Path of electron with slight magnetic field. (C) Electron path with magnetic field at critical value. (D) Path of electron with magnetic field well beyond critical value.

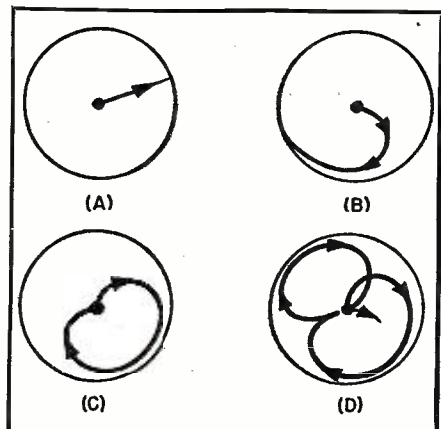

**When a laboratory
instrument goes
to war** ☆ ☆ ☆

Use of mineral-oil-impregnated, hermetically-sealed, paper capacitors.

Increase in voltage rating of certain capacitors for greater factor of safety.

Addition of mounting straps on capacitors subject to breakage in transit.

Use of high-voltage wire in high-voltage circuits in place of previous standard wire.

Addition of tube clamps for tubes subject to jarring loose in transit.

Addition of flange on chassis assembly to provide extra strength against rough handling.

Addition of four bank supports to prevent breakage of banks during rough handling.

Numerous mechanical refinements - better sockets, elastic stop nuts, rolled bead on cathode-ray tube shield, additional brackets.

Change of negative rectifier from Type 1V to Army-Navy preferred Type 6X5GT/G.

Change from 1/4-watt neon tube to Army-Navy preferred Type 991 voltage regulator tube for greater stability.

Inclusion of frequency range adjustment potentiometer in time base as a factory adjustment, for accurate time-base frequency setting.

Change from Type 6F8G tubes to Army-Navy preferred Type 6SN7GT, with improved performance.

All composition resistors operated at less than 40% of power rating; capacitors at less than 80% of voltage rating.

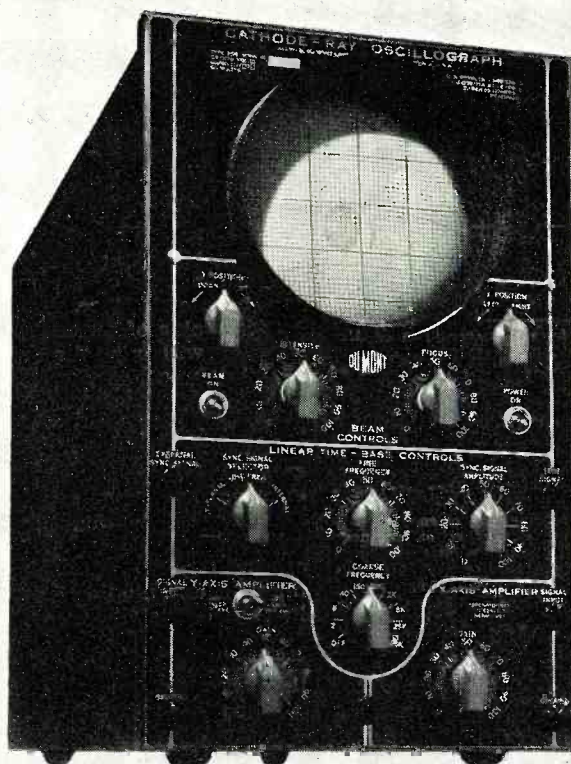

Du MONT Type 208B OSCILLOGRAPH

Out of the rigorous trials of military service there emerges a better Type 208 DuMont Oscilloscope.

Listed herewith are some of the major design changes and refinements effected during the past two years and currently incorporated in the Type 208B. In every instance the change or refinement has been incorporated in order to improve electrical or mechanical performance.

Thus an already popular oscilloscope which has found the widest usage in peace times becomes a better, more rugged, and more dependable instrument under the trying conditions of field service.

Write for literature

© ALLEN B. DUMONT LABORATORIES, INC.

DUMONT Precision Electronics & Television

ALLEN B. DUMONT LABORATORIES, INC., PASSAIC, NEW JERSEY • CABLE ADDRESS: WESPEXLIN, NEW YORK

NOW—A REALLY HIGH-POWERED— Radio Engineering Library



NOTE:

The Library comprises a selection of books culled from leading McGraw-Hill publications in the radio field.

- especially selected by radio specialists of McGraw-Hill publications
- to give most complete, dependable coverage of facts needed by all whose fields are grounded on radio fundamentals.
- available at a special price and terms

THESE books cover circuit phenomena, tube theory, networks, measurements, and other subjects—give specialized treatments of all fields of practical design and application. They are books of recognized position in the literature—books you will refer to and be referred to often. If you are a practical designer, researcher or engineer in any field based on radio, you want these books for the help they give in hundreds of problems throughout the whole field of radio engineering.

5 VOLUMES, 3559 PAGES, 2558 ILLUSTRATIONS
1. Eastman's FUNDAMENTALS OF VACUUM TUBES

2. Terman's RADIO ENGINEERING
3. Everitt's COMMUNICATION ENGINEERING
4. Hund's HIGH FREQUENCY MEASUREMENTS
5. Henney's RADIO ENGINEERING HANDBOOK

10 days' examination. Easy terms. Special price under this offer less than books bought separately. Add these standard works to your library now; pay small monthly installments, while you use the books.

10 DAYS' FREE EXAMINATION—SEND COUPON

McGRAW-HILL BOOK CO.,

330 W. 42nd Street, New York 18, N. Y.

Send me Radio Engineering Library, 5 vols., for 10 days' examination on approval. In 10 days I will send \$3.00 plus few cents postage, and \$3.00 monthly till \$24.00 is paid, or return books postpaid. (We pay postage on orders accompanied by remittance of first installment.)

Name

Address

City and State

Company

Position

Learn RADIO-ELECTRONICS-TELEVISION



12 WEEKS

TRAINING IN COYNE SHOPS WHERE YOU "LEARN-BY-DOING"

Trained Radio-Electronics men needed now. They will be needed too when the war is over. Tremendous expansion in Radio, Electronics, Frequency Modulation and Television predicted—a world of new opportunities. Get Radio Training in the Coyne Shops in Chicago now, and BE READY

Ill Finance Your Training

If you are short of money, you can start now and pay most of your tuition after you graduate. Many earn while learning. Free Lifetime Employment Service to graduates. EXTRA training in INDUSTRIAL ELECTRONICS—no extra cost.

FREE BOOK

Whether you're 16 or up to 40, get the facts. Big illustrated book tells about your future in Radio-Electronics-Television. Mail coupon today.

VETERANS! Coyne is equipped to train those who qualify for training under the G. I. Bill of Rights. Check coupon. We also have facilities for men with physical disabilities whether due to war or other causes.

H. C. LEWIS, Pres., RADIO-ELECTRONICS DIVISION
COYNE ELECTRIC SCHOOL
500 S. Paulina St., Dept. C5-1K, Chicago 12, Illinois

Send me FREE BOOK on COYNE RADIO-ELECTRONICS TRAINING and details of "Pay-After-Graduation" Plan. Send physical disability plan. Veteran—send special G. I. Bulletin.

NAME

ADDRESS

CITY

STATE

around the tube, the electrons will travel in a straight line from the filament to the anode according to A of Fig. 13. But the introduction of a slight magnetic field—of small but stable value—will cause a curvature in the electron path (B of Fig. 13). The stronger the magnetic field, the greater the curvature of the electron path and the longer it will take for an electron to reach the anode—since the electron is being affected by two forces at right angles to each other.

The strength of the magnetic field can be slowly increased until, at a critical value of the field strength, the electron will miss the anode cylinder completely (C of Fig. 13) and, after describing a heart-shaped circular path, will return to the filament.

If the magnetic field intensity is increased beyond this critical value, the electron may be repelled by the cathode after completing its heart-shaped orbit. The electron may then make one or more excursions between the filament and the plate—each time following orbits in the interelectrode space—before finally coming to rest at the filament. This phenomena is illustrated by D of Fig. 13.

When the magnetron is operated with a magnetic field intensity just above the critical value, an electron will leave the filament, circle the resonant chamber, and return to the filament. Then the process will be repeated by the electron, and in this manner oscillations will be sustained.

One cycle is equivalent to an electron's journey out toward the anode and back to the filament, thus establishing the resonant frequency of the sustained oscillations.

By increasing the anode voltage of the magnetron, the electron can be speeded up. And thus, after a suitable readjustment of the magnetic field intensity, the magnetron can be made to sustain oscillations at any given frequency.

The action of a single electron in the resonant chamber of a magnetron is the identical action of the countless numbers of electrons actually emitted by the filament. In practical operation, the resonant chamber of a magnetron is dense with many electrons; each describing its own heart-shaped orbit, each moving at the same speed, and each taking the same amount of time in completing its interelectrode journey.

The combined result of this electron movement is a stable u.h.f. oscillation of very high power.

This output of the magnetron can be taken by means of a small loop inserted in the interelectrode space between the filament and anode.

A basic circuit showing the use of the magnetron as an r.f. pulse generator is given in Fig. 8.

In practical operation the magnetron does not oscillate during the quiescent period between modulator pulses, because the potential difference between the filament and the anode is not of sufficient value to sustain oscillations in the resonant

chamber of the tube. However, when a high-voltage, *negative-going* control pulse from the modulator is applied to the filament of the magnetron, this has the same effect as applying an equally high positive voltage to the anode. With operating voltages and the magnetic field intensity at their optimum values, ultra-high-frequency oscillations will take place in the resonant chamber of the magnetron. When the modulator pulse is removed from the filament, the magnetron will cease oscillating.

It is important to note that the modulator pulse applied to the magnetron must rise to its full voltage value as soon as possible, remain at that full value for the duration of the pulse, and then decrease to zero as soon as possible. In other words, a very steep-sided, flat-topped, rectangular pulse form is required to control the oscillation of the magnetron.

The magnetron is a highly efficient u.h.f. oscillator, delivering r.f. pulses of extremely high power to a transmitting antenna.

(To be continued)

Television for the Amateur

(Continued from page 35)

erably higher than the bands on which the amateur is accustomed to operate, many of the circuits have become more or less conventional because of the much improved efficiency of the miniature and lighthouse type tubes, and the improved quality of insulating materials. Thus, the amateur can start out using essentially conventional circuits on the lower-frequency television bands, and, as his experience increases and his knowledge improves, he can gradually convert to waveguides and resonant cavities and progress to the higher frequencies.

It would be of great benefit to the amateur and possibly to television itself, if the FCC would allocate two or three television channels for the amateur in the 200-megacycle region. Here his range would be greater and his r.f. circuits absolutely conventional, permitting him to concentrate almost entirely on the television concepts. At the start, the FCC should also permit the amateur to establish his accompanying sound on some prescribed lower frequency channel. This leniency would considerably reduce equipment costs for the amateur and would avoid the additional complexities arising from possible interaction between picture and sound transmitters. In fact, a small "peanut whistle" on 5 or 160 meters would adequately cover the same range as the television transmitter. At some later date, when cost of high-frequency equipment is less, the sound transmitter can be moved up adjacent to the picture transmitter. The above allocations and regulations would encourage amateur television experimentations, because it holds the initial cost down.

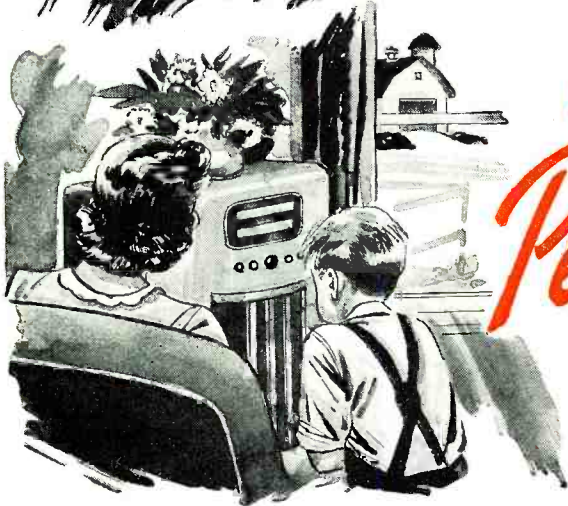

*In War—
In Peace..*

RADIART VIBRATORS (INDIVIDUALLY ENGINEERED FOR PROPER REPLACEMENT)

GIVE Exceptional Service!

The high quality of RADIART VIBRATORS is well known to servicemen everywhere. That high quality has characterized all Radiart Products that have been and are being used by the Armed Forces on all fronts. As production for civilian users expands it will continue to increase the demand for RADIART VIBRATORS.

LIMITED SUPPLY UNTIL V-J DAY

While production for civilian users may increase gradually, by far the greater part of our production will continue to be required for U.S. Armed Forces. We must and will meet all of their schedules on time.

FEWER VIBRATOR TYPES SIMPLIFIES STOCK PROBLEM

By eliminating many little used types of vibrators Radiart has been able to increase production of all popular types. *Now the dozen or so types of RADIART VIBRATORS necessary for over 7/8ths of all replacements are more readily obtainable.*

Consult the Radiart Vibrator Catalog for complete information on all vibrators for all installations. The Radiart Line is the most complete for all replacement purposes.

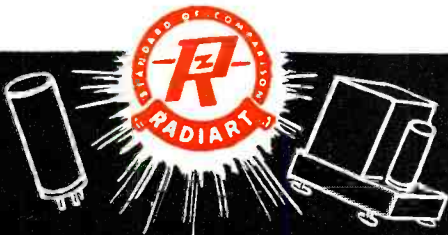

Radiart Corporation

3571 W. 62nd STREET • CLEVELAND 2, OHIO
EXPORT DIVISION: 25 Warren Street • New York 7, N.Y.

Meters

CONVERTED

FOR SPECIAL NEEDS

It's no trick making an old meter perform a new job . . . it's all in the know how!

Our skilled meter experts know how to convert any A.C. or D.C. meter to perform any specific task with precision. We have the know how on meter repair too . . . that's why an Alpha repaired meter carries a six-month guarantee!

Hundreds of firms look to Alpha for meter conversion and repair. We can help you too!

Write for Bulletin 69-45



Alpha Meter Service
division of
ELECTRONIC DEVELOPMENT LABS.
71 Nassau Street, New York 7, N. Y.

7 Days

Free Examination

PRACTICAL RADIO INFORMATION

Including Frequency Modulation—Television, etc.
Inside Radio Information for all Servicemen—Aircraft Pilots, Students. AUDELS RADIO-MAN'S GUIDE contains 772 Pages, 400 Diagrams & Photos is complete—gives Authentic Principles & Practices in Construction, Operation, Service & Repairs. Covers clearly and concisely Radio fundamentals—Ohm's Law—Physics of sound as related to radio science—Measuring Instruments—Power supply—Resistors—Inductors—Condensers—Transformers and examples—Broadcasting stations—Radio Telephony—Receivers—Diagrams—Construction—Control systems—Loud speakers—Antenna systems—Auto Radio—Phonograph pickups—Public Address Systems—Aircraft & Marine Radio—Radio Compass—Beacons—Automatic Radio Alarms—Short Wave—Coil Calculations—Testing—Cathode ray oscillographs—Static Elimination—Trouble Pointers—Underwriter's standards—Units and tables—Frequency Modulation—REVIEW QUESTIONS & ANSWERS, Ready Reference Index.

\$4 COMPLETE • PAY ONLY \$1 A MO.
Get this practical information in handy form for yourself—Fill in and

MAIL COUPON TODAY—
AUDELS, Publishers, 49 W. 23rd St., N.Y.
Mail AUDELS NEW RADIO-MAN'S GUIDE for free examination. If O. K., I will send you \$1 in 7 days; then remit \$1 monthly until \$4 is paid. Otherwise I will return it.

Name _____
Address _____
Occupation _____
Reference _____ (N. Y.)

122

Once started, the amateur is certain to contribute to the sum total, just as he has in the war, and will progress to high-definition television and, some day, color television.

The Amateur Station

The amateur station need not be expensive. A complete station can be constructed for approximately \$200, if there is a standard home television receiver available. Considerable sums can be knocked off this total if the amateur has an elaborate junk box, some power supplies, and a generous supply of resistors and capacitors.

The transmitter of the television station is most likely to be some sort of stable high-frequency oscillator, frequency multiplier, and final amplifier. The oscillator will have a resonant chamber or concentric tuned circuits for stability. The final amplifier will have transmission-line sections as tuned circuits and, generally, will be grid modulated by the composite television signal. Fortunately, there is no necessity for high power at these frequencies, as long as sufficient signal is delivered to the receiver input to overcome inherent tube noises. In fact, because of line-of-sight limitations, radiation at these frequencies is primarily an obstacle course and is more dependent on antenna placement and efficiency than on radiated power. The amateur has a fertile field for antenna experiments because the physical size is small and the cost of materials low. Highly directional transmitting and receiving antennas will greatly improve signal strength, and reduce interference. Field work (glider meets, etc.) with mobile and portable equipment will arouse considerable interest.

The most costly items of the video and pulse circuits of the transmitter are the iconoscope, special transformers, and tubes. The video amplifiers and sync generator, while reasonably complex and delicate of adjustment, contain relatively inexpensive component parts. An oscilloscope is almost a must in tuning up these circuits, although a television receiver known to be in good operating condition can be used as a satisfactory test circuit.

The receiver can be a very simple and effective piece of gear if the amateur has a home television receiver. To receive the signals from a higher frequency, an additional mixer, local oscillator, and possibly an i.f. amplifier is attached ahead of the home receiver. This double-superheterodyne television system performs satisfactorily if the composite television signal is properly constructed at the transmitter. Under certain circumstances, the signal construction at the transmitter can be simplified and still a satisfactory picture received, if a few minor adjustments and changes are made on the receiver. Some sort of a switching arrangement can be used to change over between amateur and commercial reception. Conse-

quently, if the received signal is on 430 megacycles, the local oscillator is set on 497¼ megacycles, producing a 67¼-megacycle i.f. frequency which is amplified and fed into the antenna input of the home receiver. This frequency is the picture carrier frequency when the receiver is set on commercial channel three. If the amateur has no receiver available, he can build his own and adapt it for both amateur and commercial use.

Study Outline

What is an effective study outline for the amateur in preparation for ham television?

A. Review fundamentals. Stress the following:

1. Voltage distribution as frequency varies, for any arrangement of resistors, capacitors, and inductors, or shunt and series combinations of them. Effect of time constants on instantaneous voltages.

2. Properties of series and parallel resonant circuits.

3. Principles of vacuum-tube operation.

B. Operation of the cathode-ray oscilloscope.

1. Understand vertical and horizontal amplifiers, sweep circuits, and synchronization.

2. Oscilloscope operating circuits and power circuits.

3. Origin and information contained in various scope patterns.

4. How to use the test oscilloscope to its fullest.

C. High-frequency techniques.

1. Understand high-frequency oscillators, r.f. amplifiers, class C amplifiers, and methods of modulation.

2. Importance of correct physical layouts for high-frequency equipment. Be familiar with quarter-wave tuned lines, resonant chambers, transmission lines, and high-frequency antenna techniques.

D. Special circuits. Understand basic principles of the following:

1. video amplifier.
2. wide-band r.f. and i.f. amplifier.
3. wide-band antenna.
4. sawtooth generator.
5. pulse and sawtooth amplifiers.
6. pulse separator.
7. counter circuit.

8. multivibrator and blocking-tube oscillator.

9. d.c. restorer.
10. direct-coupled amplifier.

11. scope operating circuits.
12. clippers, limiters, and shapers.

13. keying circuits.
14. mixer and combining circuits.

E. General over-all function of the television system.

1. Trace the various signals from iconoscope to picture tube.

2. Contents and construction of the composite television signal.

F. Detailed circuit-by-circuit study.

1. Study each circuit carefully. Know how it operates and how it fits into the entirety.

2. Review and expand. Keep up with the latest developments.

—50—

RADIO NEWS

You'll hear it over and over again



KEEP YOUR EYES ON BELMONT

People are looking to Belmont for noteworthy contributions to peacetime electronics. And their confidence will be fully justified. Belmont skills that have been heightened by their successful application to wartime electronics will yield new benefits for millions of buyers. And Belmont's national advertising is telling the public about these coming benefits now.

Belmont will offer the magic of television on large screen receivers. There will be Belmont radios inspiring in performance and beauty. Music lovers will be able to enjoy new worlds of tone delight with Belmont FM receivers and Belmont Radio and Phonograph combinations. Keep your eyes on Belmont! Belmont Radio Corp., 5929 W. Dickens Ave., Chicago 39, Illinois.

Belmont Radio

RADAR * TELEVISION * F.M. * ELECTRONICS

FOR *Better Performance!*

Rowe No. 7
Permanent
Magnetic
Driver Unit



7 OUTSTANDING ADVANTAGES

- (1) Designed for high peak amplifier output. 18 to 20 watts continuous duty.
- (2) Central cone-shaped magnet of ALNICO. Does not deteriorate in strength through shocks or ageing.
- (3) Flux strength of 12,000 gausses in the magnetic gap.
- (4) One-piece metal diaphragm especially processed to eliminate internal strains and stresses.
- (5) Voice coil wound directly on diaphragm. No loose wires.
- (6) After complete assembly the unit is charged with a force of 10,000 ampere turns per inch.
- (7) Long life, free from breakdowns and trouble.

Write for illustrated circular giving complete details. Address

ELECTRONICS DIVISION, Dept. RN8

ROWE Industries
3120 MONROE ST., TOLEDO 6, OHIO



Better get on our

MAILING LIST!

If you haven't sent us your name and address, do it now. This will insure your receiving our monthly **BARGAIN BULLETIN** and any special Publication we offer.

No Charge...it's Free!

CLIP THIS COUPON TODAY

OLSON RADIO WAREHOUSE
73-A MILL ST., AKRON, OHIO

Sure, put us on your List. We want to save time and money.

NAME _____
ADDRESS _____

..... **LETTERS**
FROM OUR READERS

MORE PROS AND CONS

FOR some time I have been reading the various articles and letters appearing in your magazine concerning screwdriver mechanics, licensing, etc.

"For a long time I have kept my thoughts to myself, but now I feel moved to make some comment.

"I was in the radio repair business before the war and I intend to be in it after the war. Screwdriver mechanics, local unions or cliques, licenses, etc., have never bothered me. I have attended to my own business and tried to be an honest and progressive businessman. Anytime I could be of service to my customers and business associates, I was always ready. From experience I know that servicemen can be of great help to one another if they so desire. So why maintain an unfriendly attitude toward your competitors? Down in your heart you may class him as a screwdriver mechanic and he may class you the same. This is no insult. We all started out as screwdriver mechanics.

"Truly I am not in favor of licensing radio servicemen. However, if it should come to pass, I feel that all legitimate servicemen can take it in their stride.

"However, I am in favor of local associations similar to the RETA of Indiana. It sounds like a good deal and should be of great service to the public as well as the service business.

"Here are a few lines to express my feelings for my chosen profession.

"I am proud of my profession, therefore, I will strive to make my profession proud of me.

"I am proud of my ability to service electronic equipment, consequently, I am going to keep up with my electronic education in order to maintain a high standard of service.

"I am proud of my shop and my test equipment, and I will always keep it clean and up-to-date.

"In other words, I am going to have a good shop, do good work, use good parts, be honest with my customers and get a fair price for my work."

W. F. Babcock, W.O. (j.g.)
Somewhere Overseas

MAYBE I'm pretty late with this, but if the big howl about 'screwdriver mechanics' is still raging, I'd like to throw my 'two cents' in.

"I think that the average neutral observer reading both sides of the argument as presented by the letters you have published, would agree that two distinct types of 'screwdriver mechanics' are under discussion. Those who are opposed to them are probably thinking of the type of serviceman who doesn't know his beans, who is a gyp like those who precipitated

onto the trade the unfavorable glare shown by the *Reader's Digest*. Those who support the screwdriver mechanic are for the most part thinking of the serviceman who has no expensive equipment or a shop, no spare parts supply, no manuals and does most of his work with perhaps a half-dozen tools and a multimeter.

"... The serviceman with all the equipment in the world may not know the fundamentals of servicing while the home tinkerer with a screwdriver and a meter, buying his parts from dealers as he needs them may be very adept at fixing sick sets.

"Of course, the majority of servicemen with established shops are capable. Many home tinkerers are incapable, but on the whole, I don't believe they are harmful. They certainly don't get a huge cut of the trade, nor are they too well trusted. The inexperienced home tinkerers should practice on their own sets or construction kits until they know their stuff and on the other side, no serviceman should practice a regular shop business unless he knows what he is about.

"I think licenses, if properly applied and possibly in graded qualifications, with two or more license ratings, could be very beneficial to the trade. Their objective should be not to eliminate the tinkerers, but the people who *don't know how*, whether established radio men or ignorant tinkerers."

Ted Chisholm, A/S USNR
Ithaca, New York

I GET quite a bang out of the letters about the licensing of radio servicemen.

"We once had a proposal like that brought before the Washington legislature—but it did not pass.

"The writer is 46 years old and built the first tube radio in this town in May, 1922. I have been repairing radios off and on for 23 years.

"Most of my customers would tell you that I fixed up their sets pretty well, and an occasional one would tell you his set played better than when he first purchased it.

"In 23 years of servicing, I have never ruined anyone's set, although I can remember in the old days of burning out a tube occasionally. (Let all those who haven't, please stand.)

"One of my best recollections is of being called to a house to repair a radio. When I arrived, I found the electrical engineer of a large movie theater who was visiting these people at the time and he had attempted to repair the set; a battery Atwater Kent. He was unsuccessful. I found the trouble in a few minutes and charged the lady 25 cents. This engineer drew a salary of \$300.00 per month.

"I got my first radio instruction

RADIO NEWS

How to make **BIG** plastic parts seem LITTLE



Radio cabinets, housings, washing machine agitators and such—all the larger and more complicated pieces we used to mold before the war—all will go on the production schedules of smaller, simpler pieces when we get into normal production again. They will have better finishes, more uniform cure, truer color and freedom from internal stress. In other, shorter, words, "Happy Day!"

All we'll have to do is hook up our battery of Heatronic units (first in the

industry—and still growing) to serve our 500-ton presses.

Better start figuring now on how Plastics plus Heatronics can fit into *your* postwar production plans. But figure it with a custom molder whose reputation for molding already combines with real Heatronics knowledge—a molder like Kurz-Kasch. We mold all materials by compression and transfer—we handle the whole job from design to delivery—our experience with Heatronics dates back to the first unit

RCA sold—and we've been growing with the plastics industry since it began.

Isn't that the kind of organization you'll want for your plastics production? Yes? Just write!

"A Businessman's Guide to the Molding of Plastics"

Send for your free copy of this illustrated brochure. Just write to Dept. 7 on your letterhead and we'll send it with our compliments.



Kurz-Kasch

For over 28 years Planners and Molders in Plastics

Kurz-Kasch, Inc., 1429 South Broadway, Dayton 1, Ohio. Branch Sales Offices: New York • Chicago • Detroit • Indianapolis • Los Angeles • Dallas • St. Louis • Toronto, Canada. Export Offices: 89 Broad Street, New York City

125



August, 1945

For Soldering in
Tight Places . . .

DRAKE

No. 400 Soldering Iron

Smallest Industrial Iron
Ever Designed

60 Watts— $\frac{1}{4}$ in. Tip

Only 9 in. long—Wt. only 8 oz.

This mighty mite is backed by DRAKE'S 25 years of soldering iron manufacturing experience. The high quality and long service of DRAKE Soldering Irons have made them outstanding favorites with all types of radio men everywhere. The DRAKE No. 400 is an outstanding value at



Only \$4.50
List

Drake Has an Iron
for Every Purpose.
Ask Your Radio
Parts Jobber.



DRAKE ELECTRIC WORKS, INC.
3656 LINCOLN AVE., CHICAGO 13, ILL.

FIX ANY RADIO
Amazing New Invention



Learn to repair radios in minutes instead of hours. Revolutionary, different Comparison technique permits you to do expert work almost immediately. Most repairs can be made without test equipment or with only voltmeter. Simple point-to-point, cross reference, circuit suggestions locate faults quickly and easily. You may try the plan without any risk or obligation

FOR BEGINNERS OR EXPERTS

Find any radio fault with ease. Follow the comparison tests given on 24 trouble-shooting circuit blue-prints. 76 fact pages. Over 1,000 practical repair hints. Hundreds of simplified tests using a 5c resistor and a filter condenser. Covers every radio set—new and old. Introductory material for beginners and to serve as a review for experienced radio men. Also several chapters on test equipment. Presented in manual form, $8\frac{1}{2}$ x 11 inches. Entire plan is stark new and will change servicing methods. Used in schools, Armed Forces, and by thousands of radiomen.

SATISFACTION GUARANTEED

Take advantage of our "no-risk" trial. Send coupon today. Use this time-saving, money-making radio servicing method for 10 days without any obligations. See how much time you will save every day on every radio job. Learn new short-cuts in radio servicing. Then decide to keep Comparison Method Manual or return it and receive a cash refund. You cannot lose—but you owe yourself a chance to look at this plan. Price complete, only \$1.50.



NEW 1945 EDITION

The training will more than pay for itself on the first radio job. Examine and use this unique plan for 10 days at our risk. Send coupon right now—receive and use the plan this week.

Developed by M. N. Beitman, radio engineer, teacher, author, & serviceman.

NO RISK TRIAL COUPON

SUPREME PUBLICATIONS, 9 S. Kedzie Ave., Chicago 12, Ill. Ship the new manual, Simplified Radio Servicing by Comparison Method, for examination. I am enclosing \$1.50, full price, send postpaid. I must be satisfied or you will refund my money.

NAME:

ADDRESS:

126

from the *Portland Oregonian* and from RADIO NEWS and other magazines and from hard experience. I know I am no wonder at radio, but I also know that I am no worse than some of these radio designers who certainly must get on an awful binge before designing a set.

"Why don't radio designers build a 'mock up' and then try to repair it before turning it out on the public?"

"I hope no American radio company will ever turn out a set again with a dial cable. Geared dials with split gears and springs to spread the teeth to stop back lash are best.

"Also, no more tubes with caps to pull off the top, I hope.

"Now, it may interest these licensing boys to know that the writer has been a bedfast invalid for the past three years, but I have never stopped servicing radios except when I was too ill."

Ellsworth Price
Castle Rock, Washington

* * *

READING over the letters published in your last issue and noting that you ask for more, I am taking this moment to do a little advising on my own account.

"My complaint is against all manufacturers of radio receiving sets. To begin with, an ordinary useful radio set is a piece of apparatus used to bring in an intelligible signal which should be as near like that transmitted as possible. Nothing more or less. We have displayed several thousands of ways of doing this, one no better than the other in the aggregate. This causes quite a lot of useless trouble to the serviceman in small communities as he has to be almost a radio

engineer for every factory in the whole United States.

"I note pages and pages in Riders for many big manufacturers which all bring the same results. (Let me state right here that it is impossible to service any radio without Riders Manuals and fourteen volumes are expensive for the small radio shop.) There seems to be no standard place for putting any of the parts.

"There never was any need of manufacturing so many different tubes. The tube manufacturers seem to have used this method of forcing upon the distributor a lot of useless tubes which is reflected on down to the serviceman's cost.

"I have been running this small, out-of-the-way radio shop ever since the WD 11 came onto the market. I now have on hand one of these tubes. In all these years, I have managed to keep my friends' and neighbors' radio sets going. I am past sixty-five now and getting ready to quit within the next ten years. I have never found it good policy to knock a competitor. The 'knockers' have drifted off into nothingness. I have seen some screw driver radio men turn out to be experts in the line and for that reason, I believe this licensing scheme is all 'bosh.' I have learned much from these so-called screwdriver mechanics and I have given quite a few of them a leg up. More strength to them. At present I have all the work and more than I am physically able to do, and I am looking forward to the time when the boys will be back to take over."

W. Harvey Merwin
Jensen, Florida

-30-

Plotting Eng. Data

(Continued from page 58)

graph involves less labor in preparation as well as greater utility in reading. Referring to Figs. 5 and 11, the former may be drawn precisely only when a large number of points are known; two accurately determined points will enable the curve to be

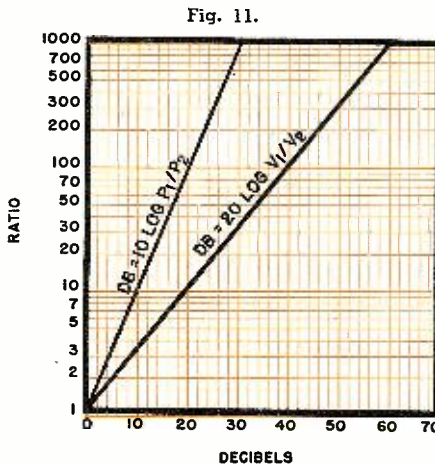

Fig. 11.

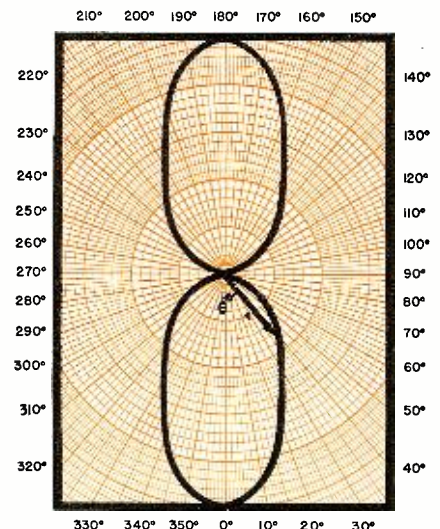

Fig. 12

drawn as that illustrated in Fig. 11. A few minutes spent to analyze the data from the standpoint of graphic display frequently saves much time in the end, and almost always results in greater utility.

-30-

5" Oscilloscope

(Continued from page 38)

Vertical Input. When switch S_2 is in the "EXT" position, the vertical deflection plates of the oscilloscope tube are connected directly to the vertical input terminals, "V" and "COM" and are in position to receive a signal directly without amplification. When S_2 is at "AMP," vertical input terminal "V" is connected to the grid of the vertical amplifier tube, V_6 , through coupling capacitor C_{23} and gain control R_{21} . The vertical deflection plates then receive their excitation voltage directly from the output of the amplifier. The degree of amplification of the input signal may be adjusted by gain control R_{21} .

Horizontal Input. The horizontal input terminals, "H" and "COM," are connected directly to the horizontal deflection plates of the oscilloscope tube when switch S_5 is in the "EXT" position. The horizontal plates thus may receive a signal directly from the input terminals without amplification. When S_5 is at "LS" (linear sweep), the horizontal deflection plates are connected to the plate-output circuit of the horizontal amplifier, V_5 , through coupling capacitor C_7 . In the grid circuit of this amplifier is located switch S_3 which in the "LIN" (linear sweep) position selects linear sweep voltage from the saw-tooth oscillator, V_4 . When S_5 is at "EXT," the grid of the horizontal amplifier is connected

through coupling capacitor C_{10} to terminal "ESA" (external sweep amplifier) to which, in turn, may be connected a source of ordinary or special sweep voltage. This sweep voltage then will be amplified by V_5 before it is applied to the horizontal deflection plates.

Sweep Oscillator

Linear Sweep Oscillator. The linear sweep (linear time base) circuit is the saw-tooth oscillator comprised by the gas triode V_4 , the coarse frequency control consisting of rotary selector switch S_1 , and the associated capacitors C_{10} to C_{16} , the fine frequency control consisting of rheostat R_8 , and the syn-

chronization control consisting of potentiometer R_{13} .

The following frequency ranges are covered by the fine frequency control (R_8) when the coarse frequency control (S_1) is in its various positions: Position 1, 20 to 59 cycles; position 2, 43 to 132 cycles; position 3, 109 to 340 cycles; position 4, 280 to 880 cycles; position 5, 670 to 2180 cycles; position 6, 1500 to 4900 cycles; and position 7, 3600 to 11,400 cycles. Position 8 is an "OFF" position, but since the inherent switch and circuit capacitance (a small value) is in the circuit when the switch is in this position, the circuit oscillates at a higher rate than that shown for position 7.

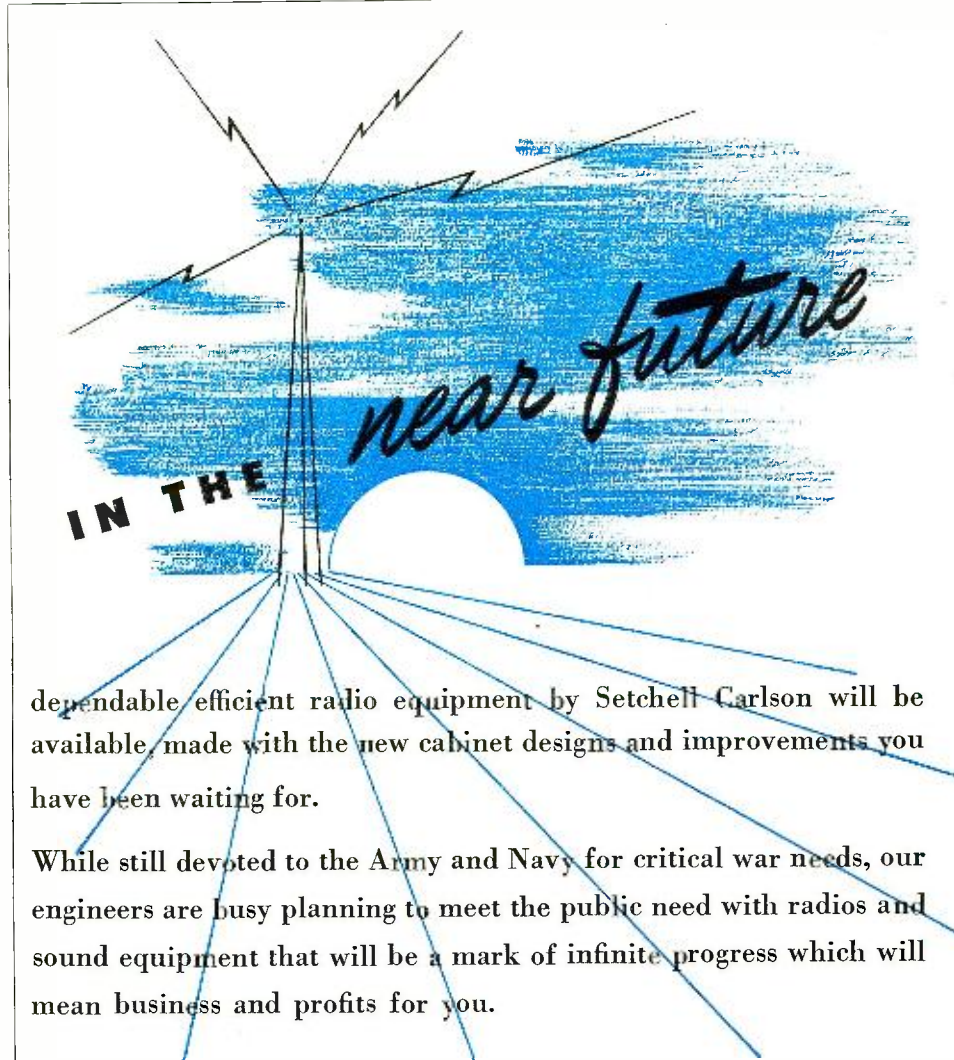

dependable efficient radio equipment by Setchell Carlson will be available, made with the new cabinet designs and improvements you have been waiting for.

While still devoted to the Army and Navy for critical war needs, our engineers are busy planning to meet the public need with radios and sound equipment that will be a mark of infinite progress which will mean business and profits for you.

SETCHELL CARLSON, INC. 2233 University Ave., St. Paul, Minn.



REPRESENTATIVES:

DISTRICT OFFICES:

Barstow and Doran.....1406 So. Grand Ave.,
Los Angeles 15, Cal.
A. L. Berthold...4627 West Side Drive, Dallas, Texas
R. J. Bork.....2494 University Ave., St. Paul, Minn.
M. D. Ealy.....1425 South Flower Street,
Los Angeles 15, Calif.
Edwards Sales Co. ...530 Erie Bldg., Cleveland, Ohio

Ben Joseph.....258 Broadway, New York, N. Y.
Don R. Lewis....P. O. Box 512, Salt Lake City, Utah
Robert Milsk.....Kerr Bldg., 642 Beaubien St.,
Detroit, Mich.
B. J. Mockenaupt and Co.723 West Lake St.,
Chicago, Ill.
Bursell-Chermak.....2233 University Ave.,
St. Paul, Minn.

EXPORT DEPARTMENT • Harry J. Scheel, 2654 Morse Ave., Chicago 45, Ill.

GREATER NEW YORK AMATEURS TO HOLD HAMFEST

THE North Shore Radio Club of Long Island has announced that it will sponsor the first "Hamfest" to be held in the Greater New York area since the war on Friday, August 24th, at the Community Gardens Ballroom, 215-32 Jamaica Avenue, Queens Village, Long Island, New York.

In announcing the event, Mr. John DiBlasi, president of the club, pointed out that this meeting should be good news to all those who follow amateur radio as an avocation as the meeting will provide an opportunity to discuss mutual interests. The meeting will be open to all radio amateurs in the Greater New York and Long Island areas.

While the "Hamfest" program for August 24th will feature one prominent speaker on "What the Hams Have Done in the War Effort and What They Can Expect Post-War," the evening's program will be mostly informal and will include entertainment, movies, door prizes, and an opportunity for all interested in the art to get together for exchange of ideas.

Tickets at fifty cents are available at Greater New York radio stores dealing in amateur radio equipment or from North Shore Radio Club members and at the door. Communications for the North Shore Radio Club should be addressed in care of F. A. Long, 46-41 Forest Drive, Douglaston, Long Island, New York.

CUT HOLES FAST



in radio chassis

No tedious drilling... no reaming... no filing! Saves hours of work. Cuts clean, accurate holes for sockets, plugs, other receptacles. Tool has three parts: punch cuts through chassis, die supports metal and prevents distortion, cap screw is turned with wrench to cut hole. Sizes for holes $\frac{3}{4}$ " to $3\frac{1}{2}$ ". For complete information write Greenlee Tool Company, 1888 Columbia Ave., Rockford, Illinois.

WRITE FOR FREE FOLDER S-119 \blacktriangleright



FREE TO YOU

COLOR CODE and OHMS LAW CALCULATOR

Great Time Saver

Burstein-Applebee of Kansas City offers you this great convenience FREE. Easy to work. Solves many problems in a jiffy. FREE to Radio men, electronic engineers and others in the business. Attach coupon to your letterhead.

MAIL COUPON NOW



BURSTEIN-APPLEBEE CO.
1012 MCGEE ST.
KANSAS CITY 6, MO.
Send me FREE Color Code and Ohms Law Calculator along with latest catalog.

I am _____
STATE CONNECTION IN INDUSTRY
NAME _____
ADDRESS _____
TOWN _____ STATE _____

Synchronization. The linear sweep oscillator may be synchronized at the frequency of an external voltage, the source of which is connected to terminals "SYNC." and "COM." by throwing switch S_3 to "EXT." and adjusting potentiometer R_{13} .

Synchronization may be obtained at 60 cycles by throwing S_3 to the "60-CYCLE" position and adjusting R_{13} . In this position of the switch, a 60-cycle voltage, supplied by the 5-volt secondary of transformer T_1 , is delivered to the grid of the gas triode through the coupling capacitor (C_5), gain control (R_{13}), and limiting resistor (R_{12}).

If an input signal (at the vertical input terminals) is to synchronize itself, an external jumper must be run between the "V" and "SYNC." input terminals, and switch S_3 thrown to "EXT."

Construction

Mechanical Construction. It is suggested that the layout of the complete oscilloscope follow the same lines recommended for the basic instrument (See Fig. 2). However, the chassis, panel, and case of the complete oscilloscope must be somewhat larger than in the preceding instance.

The power transformer, T_1 , will occupy the same position as shown in Fig. 2. But, the extra filament transformer, T_2 , will be mounted under the chassis, as will also the small filter choke, CH . T_2 and CH should not be mounted closer together than 3 inches.

The two rectifier tubes will be mounted, as in Fig. 2, toward the rear of the chassis, close to the upright back plate. The doubler capacitors (C_3 and C_4) will be in the same position as in Fig. 2, and the dual filter capacitor (C_5 - C_6) as close as possible to C_3 and C_4 . The amplifier and sweep oscillator tubes will be mounted near the front panel.

All of the switches (S_1 to S_6), controls (R_5 , R_6 , R_8 , R_{13} , R_{17} , and R_{21}), and the input terminals ("H," "V," "COM," "ESA," and "SYNC") are mounted through the front panel. It is advisable to enclose the frequency range capacitors (C_{10} to C_{16}) in a can mounted directly behind the selector switch, S_4 .

Shielded leads must be run from all points of switches S_2 , S_6 , and S_5 and of controls R_{17} and R_{21} . This is in order to minimize hum and stray field pickup.

Manipulation of Complete Oscilloscope

To place the complete oscilloscope into operation: (1) Turn brilliance control R_6 and gain controls R_{17} and R_{21} to lowest settings; (2) Set S_3 , S_5 , and S_6 to "EXT" positions; (3) Insert line plug into 115-volt a.c. receptacle, and throw switch S_1 to "ON" position; (4) Allow about 1 minute for tube heaters to reach normal operating temperature; (5) Advance brilliance control R_6 slowly, noting appearance of luminous spot on 'scope-tube screen

—do not increase brilliance beyond point of good visibility, as a bright stationary pattern will damage the screen; (6) Adjust focus control R_3 until luminous spot is clear and sharp. Oscilloscope now is ready for use and may be used in any of the ways described below.

D.C. Signal—No Sweep. (1) Set R_6 , R_{17} , and R_{21} to lowest positions; (2) Set S_2 , S_3 , S_5 , and S_6 to "EXT"; (3) Insert line plug into 115-volt a.c. receptacle, and throw switch S_1 to "ON" position; (4) When tubes have heated, adjust brilliance and focus controls for clear luminous spot on screen; (5) Note position of spot; (6) Apply d.c. test voltage to vertical input terminals "V" and "COM," noting that spot is deflected upward on screen when terminal "V" is positive and downward when "V" is negative. The distance over which the spot is displaced is proportional to the value of applied d.c. voltage.

A.C. Signal—No Sweep. (1) Set R_6 , R_{17} , and R_{21} to lowest positions; (2) Set S_2 , S_3 , S_5 , and S_6 to "EXT"; (3) Insert line plug into 115-volt a.c. receptacle, and throw switch S_1 to "ON" position; (4) When tubes have heated, adjust brilliance and focus controls for clear luminous spot on screen; (5) Apply a.c. test voltage to vertical input terminals "V" and "COM," noting that spot is rapidly deflected up and down to trace a vertical line on screen (length of this line is proportional to the peak-to-peak value of the applied a.c. test voltage); (6) If a.c. test voltage is too low to produce a readily measured line on the screen, use vertical amplifier by throwing switch S_2 to "AMP" position and adjusting gain control to a predetermined value which will afford the desired gain.

A.C. Signal—Linear Sweep. Operate oscilloscope with or without vertical amplifier in manner described in the preceding section, except: (1) Switch-in linear sweep oscillator by throwing S_3 to "LIN" and S_6 to "LS"; (2) Adjust S_4 and R_8 for best sweep frequency; (3) If stationary pattern is desired, synchronize sweep oscillator. For 60-cycle synchronization, throw S_3 to "60-CYCLE" position and adjust R_{13} . For synchronization at frequency supplied by external oscillator (connected to terminals "SYNC" and "COM"), throw S_3 to "EXT" and adjust R_{13} . For self-synchronization of signal, run jumper externally between "SYNC" and "V" terminals, throw S_3 to "EXT," and adjust R_{13} .

A.C. Signal—Non-Linear Sweep. Operate oscilloscope with or without vertical amplifier in manner described in preceding sections, except: (1) Connect source of non-linear sweep voltage to terminals "ESA" and "COM"; (2) Throw S_3 to "EXT," S_6 to "LS," and S_5 to "EXT." This method is used frequently for the comparison of two frequencies by means of Lissajou's figures, one signal source being connected to terminals "V" and "COM" and the other to terminals "ESA" and "COM," as described above.



**No Brass Hats
Here --
JUST BRASS TACKS!**



OURS is a moderate-sized, compact organization in which everyone from the chief executives to the kid who runs the blue print machine is dedicated to just one purpose. That purpose—to design and build efficient, dependable Radio Transmitting Equipment—our exclusive specialty.

We have been at it successfully since 1922—long enough to gain genuine, practical

GATES RADIO CO.

know-how in every phase of the business. That experience, plus engineering ability and precision workmanship, add up to the kind of Equipment which appeals to Engineers and Station Managers alike.

Let us tell you more about GATES Transmitting Equipment—and about the GATES Priority System for Prompt Post-War Delivery! Write today!

QUINCY, ILLINOIS

GATES ONE KILOWATT BROADCAST TRANSMITTER

This new Transmitter, utilizing many wartime developments, will meet the exacting demands of peacetime broadcasting. Its proven dependability—plus its modern, streamlined appearance—fit it perfectly into tomorrow's Radio Station. Accurately engineered, with all parts conveniently accessible. The pressure-type cabinet keeps out dust and helps assure cool operation. High fidelity performance.

Detailed bulletin on the GATES 1 KW Transmitter will soon be available.

PROGRESS REPORT

Wartime limitations prohibit the sale of new broadcasting equipment without priority. Hence the above equipment is presented only to familiarize you with another new GATES development.

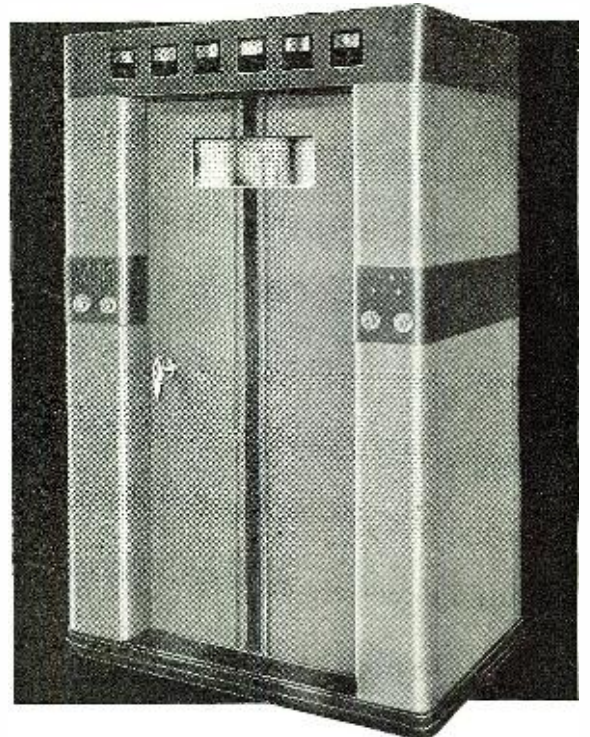

GATES RADIO CO. QUINCY, ILLINOIS

EXCLUSIVE MANUFACTURERS OF RADIO TRANSMITTING EQUIPMENT SINCE 1922

R-L SPECIALS

Electric Soldering Irons

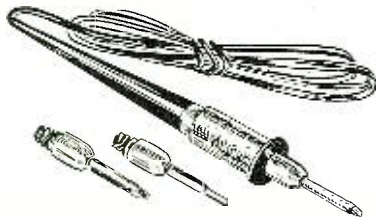

Complete with three different size interchangeable tips. Very light in weight. Heats almost at once. Can be used as a trouble shooting light by inserting Neon bulb. **\$2.95**
COMPLETE.....

CORD SETS

An excellent replacement for worn-out cords. Will fit most all radios, lamps, fans, etc. Six foot, 2 conductor cord with rubber insulation over each conductor. Brown silk weave over all. Complete with bakelite plug. Special value. Each..... **22c**

Include your L-265 or AA3-V3 Certification with order Write for Free Illustrated Folder



731 West Washington Boulevard
Chicago 6, Illinois

For Radio
at its Best



Again, when the war is won, we will be on call

.. To DESIGN, DEVELOP and MANUFACTURE ..

Radio Receivers and Transmitters
Industrial Electronic Equipment
Airport Radio Control Equipment
Marine Radio Telephone Equipment

Your inquiries will receive immediate action

ISLIP RADIO MFG. CORPORATION

ISLIP, L. I., NEW YORK

Within the INDUSTRY

S. GORDON TAYLOR has joined the staff of *Murray Hill Books* as manager of the Technical Division.

For the past year, Mr. Taylor has been associated with the Columbia University Division of War Research at the U.S. Navy Underwater Sound Laboratories at New London as a member of the scientific staff and technical editor.



In 1930 he was appointed technical editor of *RADIO NEWS* and in 1934 became managing editor. In 1938 he established his own organization for technical writing and promotion work in the radio and electronics field.

Since the entry of this country into World War II, Mr. Taylor has been connected with the Signal Corps in various capacities.

GRENBY MANUFACTURING COMPANY of Plainville, Connecticut and *The Allen D. Cardwell Manufacturing Corporation* of Brooklyn, New York have announced the consolidation of the two companies. Both companies will maintain their present corporate identity and will continue their present management.

The Grenby Manufacturing Company manufactures precision machine tools and radar equipment, while *The Allen D. Cardwell Manufacturing Corporation* have been producers of electronic equipment for many years.

J. HARROLD BLAIR has been appointed Sound Communications Engineer for *Walker - Jimieson, Inc.* of Chicago, according to the announcement of Paul H. Chauncey, manager of the Sound Communications Department.

Mr. Blair comes to *Walker-Jimieson* from *Operadio Manufacturing Company* where he held the position of Sales Engineer. Mr. Blair has been responsible for the installation of many industrial music and paging systems in the Chicago area.



CLAROSTAT MANUFACTURING COMPANY, INC., has announced the appointment of two new sales representatives for their line of resistors, controls and resistance devices.

Wood and Anderson Company of St. Louis, Missouri, will represent the *Clarostat* line in both the industrial and jobbing fields in their territory

while *Henry P. Segal Company* of Boston, Massachusetts, are to represent the company throughout the New England territory.

JOHN MECK INDUSTRIES of Plymouth, Indiana has announced the appointment of Bert L. Bethel to the post of Director of Purchases.

Mr. Bethel was formerly associated with the *Bendix Aviation Corporation* in the Pacific Division as Chicago and Eastern representative.

RAYTHEON MANUFACTURING COMPANY has announced that the Radio Receiving Tube Division office has been moved from 420 Lexington Avenue to the Lincoln Building, 60 E. 42nd Street, New York, N.Y.

The general sales headquarters of the division will remain indefinitely at 55 Chapel Street, Newton, Mass.

BERNARD S. TUCKER has been appointed California district merchandiser for the Radio and Appliance Division of *The Sparks-Withington Company*, manufacturers of *Sparton Radios*.

Mr. Tucker joins *Sparton* after some twenty years in the radio and appliance field. He has been associated with *Radiobar Company of America*, *Sherman Clay Company* and *Benwood-Linze Company* of St. Louis.

Mr. Tucker plans to make Los Angeles his headquarters for the California sales promotion work on *Sparton Radios*. His new office will be located at 3748 W. 9th Street, Los Angeles, California.

GOTHARD MANUFACTURING COMPANY of Springfield, Illinois, are erecting a new, daylight plant to house the company's engineering and manufacturing activities.

The plant will include an enlarged engineering and research department. The company manufactures pilot light assemblies for electronic and electrical equipment and appliances.

BENDIX RADIO DIVISION of *Bendix Aviation Corporation* has announced that a complete line of radios and radiophonograph combinations for marketing in West Coast trading areas will be manufactured by the company on the Pacific Coast.

The new move, according to W. P. Hilliard, general manager of the Radio Division, will give Far Western dealers and the Pacific Coast radio

Only
Cornell-Dubilier
could build
this Giant
Tank Capacitor



When an unusual problem in capacitors arises, engineers think first of C-D. A case in point is this giant mica tank capacitor for a transoceanic transmitter. It is now in use and combines space-saving design with the capacity of much larger units.

No matter what kind of capacitor you require, C-D can design and build it for you. Discuss your capacitor requirements with our engineers. They will welcome the opportunity to help. Cornell-Dubilier Electric Corporation, South Plainfield, N. J.

FROM THE LARGEST TO THE SMALLEST — WE MAKE THEM ALL

*Other plants at:
New Bedford, Brookline, Worcester,
Mass. and Providence, R. I.*

CORNELL-DUBILIER
First in Quality **CAPACITORS**

MICA • DYKANOL • PAPER • ELECTROLYTICS

110-VOLTS AC from DIRECT CURRENT

with KATO CONVERTERS. Furnish standard 110-volt AC from 32, 110, or 220-volts DC. Good deliveries on sizes 350 through 1500 watts.

PIONEERS IN THE BUILDING
OF SMALL ROTARY CONVERTERS



Katolight Rotary Konverter, 225 Watt

Good deliveries on 5, 7½, 15 and 25 KW AC generators. Mfg.'s DC generators, motor generators, frequency changers, high frequency generators.

Kato's entire production at present must be confined to orders with priorities.

KATO ENGINEERING CO.
120 Rock Street Mankato, Minnesota

Capacitors of Time-Tested Quality

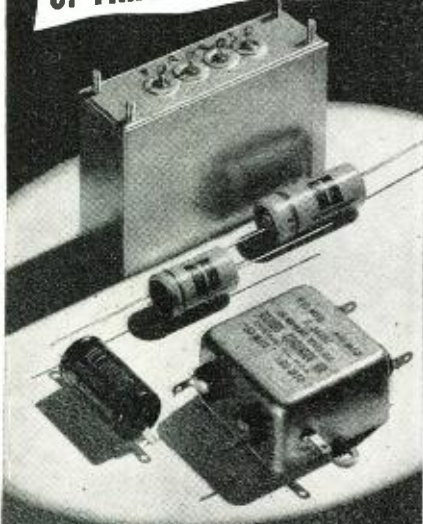

Illinois CONDENSER COMPANY

1160 N. HOWE ST. • CHICAGO 10, ILL.
Manufacturers of Oil, Paper
and Electrolytic Capacitors

buying public the benefits of more efficient delivery service and lower costs made possible by reduced shipping charges on both materials and finished products.

* * *

ANSLEY RADIO CORPORATION has announced the appointment of fourteen new representatives throughout the United States to handle the company's line of *Dynaphone* radio-phonographs and electronic pianos.

The following companies will be Ansley representatives: R. A. Adams of Detroit, Frank H. Barstow of Los Angeles, C. A. Clinton of Albany, New York, Reid H. Cox and Company of Atlanta, Georgia, Hal Elthorn of Chicago, W. G. Landes of San Francisco, Fillmore and Fillmore of Buffalo, Earl Goetze of Kansas City, Missouri, W. A. Leiser and Co. of Philadelphia, P. F. McMorro of Cleveland, J. O. Olsen of Cleveland, Harry D. Schoewald of Chicago, Fred A. Siebe of St. Louis and Donald D. Wood of Dallas.

* * *

GODFREY WETTERLOW has been named Eastern sales manager of the radio-phonograph division of the *Meissner Manufacturing Company* of Mt. Carmel and Chicago, Illinois, according to the announcement of Oden F. Jester, vice-president.



Mr. Wetterlow comes to Meissner with a diversified background in radio and sales promotion. He was formerly assistant to the president of *Philharmonic Radio Corporation* of New York and for several years headed his own advertising agency in New York and Boston.

Mr. Wetterlow will make his headquarters in Greenwich, Conn., and will cover the entire Eastern seaboard for *Meissner*.

* * *

THE TURNER COMPANY, of Cedar Rapids, Iowa has appointed William A. Baldwin to the newly-created post of Comptroller.

In his new position as Comptroller for the *Turner Company*, Mr. Baldwin assumes charge of all purchasing and takes over credit and availability matters formerly handled by William J. Nezerka who has been advanced to assistant manager in charge of sales.

* * *

GENERAL TELEVISION AND RADIO CORPORATION has announced the removal of the company to a new building recently purchased at 2701-17 Lehmann Court, Chicago.

This building was formerly occupied by *Press Wireless*. *General Television* took possession of the property on June 10th.

* * *

HERMAN L. HIRT, assistant to the president of *International General Electric Company*, died recently of a heart attack. He was 41 years old.

Mr. Hirt joined the *General Elec-*

tric organization as a student engineer. In 1930 he became patent attorney for the company in Washington, D.C. In 1937, he was named assistant counsel of the *International General Electric Company* and five years later he was appointed assistant to the president.

* * *

R. J. WILSON has been named Sales Manager of the Jobber Division of *The Alliance Manufacturing Company*, Alliance, Ohio, according to the announcement of R. F. Doyle, General Manager of the company.



Mr. Wilson, who served as a captain in the Army, received his discharge recently and will now take on the jobber line as part of the new expansion program of the company.

Mr. Doyle also announced the appointment of John Bentia to the post of Sales Manager of the Manufacturing Division of the company.

These two appointments were the last in a series of organizational changes made by the company in preparation for the postwar period.

* * *

STUPAKOFF CERAMIC AND MFG. COMPANY has announced the appointment of *Electrical Specialty Company* as their sales representatives in the West Coast area, comprising the states of Oregon, Washington and California.

The *Electrical Specialty Company* will be agents for *Stupakoff's* complete line of insulators of steatite and other ceramic materials, Kovar metal and Kover-glass seals for hermetic sealing applications.

The main offices of *Electrical Specialty Company* are located in San Francisco, with branch offices in Seattle, Portland and Los Angeles.

* * *

W. A. PATERSON has joined the staff of *Webster-Chicago Corporation* in the capacity of mechanical and electrical engineer.

Mr. Paterson holds his Master's degree in electrical engineering from the University of Minnesota and comes to the *Webster* organization from *Victor Research Laboratories*.

He was formerly associated with *Minneapolis-Honeywell* and *National Mineral Company* as an engineer.

* * *

THE ELECTRONIC CORPORATION OF AMERICA has completed detailed plans for the disposal of electronic and communications equipment and components released by the Armed Forces, according to the announcement made by S. J. Novick, president of the company.

The company has acquired a six story building at 353 West 48th Street in New York which will be

Again KAAR is FIRST!

fm

INSTANT

HEATING



KAAR makes 50 and 100-watt mobile FM practical with instant-heating tubes

Kaar engineers—who pioneered instant-heating AM radiotelephones—have done it again! In presenting the new KAAR FM-50X and FM-100X, they now give you the advantages of FM *plus* instant-heating tubes... greater power and range

with lower battery drain! Standby current is zero. Yet the instant you press the button microphone, you are on the air with a full 50 or 100 watts output, improved voice quality, and minimum distortion—sending out a strong, clear message that insures excellent reception.

KAAR FM TRANSMITTER
MODEL FM-50X
50 WATTS OUTPUT

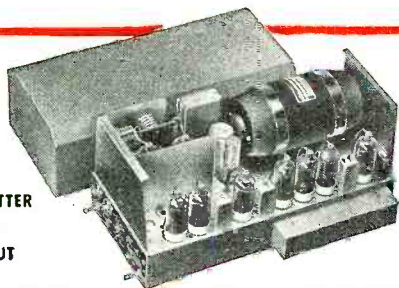

KAAR



ENGINEERING CO.

PALO ALTO • CALIFORNIA

Export Agents: FRÁZAR & HANSEN • San Francisco, California

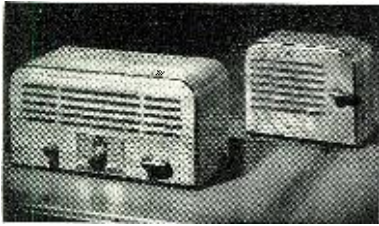

LINE UP NOW

With the Line of Inter-Comm that "Has Everything"

T
a
i
k
-
A
-
P
h
o
n
e

Talk-A-Phone, the World's Most Advanced and Complete line of Inter-communication that has *what it takes* to secure volume sales with a minimum of sales effort. There's a unit for every requirement . . . engineered to meet the most exacting demands of efficiency, convenience and economy. Easily and quickly installed. Effective "door opening" sales helps furnished dealers. Backed by hard-hitting national advertising. Good deliveries now.

See Your Jobber Without Delay

Line up with the line of inter-communication that "Has Everything."

Talk-A-Phone Mfg. Co.

1512 S. Pulaski Road, Chicago, Ill.

IMMEDIATE DELIVERY

RADIO PARTS

And Sound Equipment

| | |
|--|--------|
| 3 1/2" P.M. Speaker | \$1.49 |
| 4" P.M. Speaker | 1.69 |
| 5" P.M. Speaker | 1.39 |
| 5" P.M. Speaker H.D. | 1.79 |
| 6" P.M. Speaker | 2.25 |
| 4" 450 ohm Speaker | 1.68 |
| 5" 450 ohm Speaker | 1.80 |
| 6" 450 ohm Speaker | 2.58 |
| Hookup Wire, 100 ft. | .89 |
| 10 assorted colors | 7.80 |
| Short Lengths hookup wire—2 lb. package | 1.69 |
| Single cond. shielded, rubber covered mike cable, 6 to 60 ft. lengths, per ft. | .08 |

Write for latest bulletin listing hundreds of items for radio service and sound men. FREE!

LIFETIME SOUND EQUIPMENT CO.

DEPT. 31 - TOLEDO 1 OHIO, U.S.A.

used exclusively as a factory and warehouse in connection with the processing and distribution of electronic equipment as an agent of the Defense Supplies Corporation.

* * *

MORRIE W. ROSENFELD, field manager of *Emerson Radio and Phonograph Corporation*, has temporarily assumed the duties of general sales manager of the company.



He succeeds Charles Robbins who recently resigned to engage in business for himself.

Mr. Rosenfeld was formerly district manager of the New England and New York State territory for the company.

In his new work, Mr. Rosenfeld is now enlarging the sales and field service staffs of *Emerson Radio* and is directing the company's distributor-dealer-salesman training program preliminary to the firm's announcement of postwar promotion campaigns.

* * *

HOFFMAN RADIO CORPORATION of Los Angeles has announced the appointment of *Radio Parts*, as the Arizona distributor for the company products.

Radio Parts is owned and operated by Kenneth Sloan and is located at 36 Madison Street, Phoenix, Arizona.

* * *

BELMONT RADIO CORPORATION has announced the leasing of additional factory space in Chicago to accommodate the surplus military electronic equipment which they will handle as an agent of the Defense Supplies Corporation. The plant, which will ultimately occupy 72,000 square feet of floor space, will serve as a regional redistribution center for electronic and radio material that is obsolete or surplus for military needs or has been salvaged.

Equipment to be disposed of through the *Belmont*-operated plant will be that released by the Signal Corps or the Navy and not returned to the original manufacturers for disposal as agents of the Defense Supplies Corporation.

The plan for the establishment of the central redistribution plants was developed by Lester L. Kelsey, executive in charge of war contracts negotiations for *Belmont*.

* * *

R. M. BROPHY, president of *Rogers Majestic Limited* and *Rogers Electronic Tubes, Limited*, has been reelected president of the *Radio Manufacturers Association of Canada*.

Also reelected to the vice-presidency was S. L. Capell, vice-president and general manager of *Philco Corporation of Canada, Limited*. W. W. Richardson was re-appointed general manager of the association.

In his annual report to the association, Mr. Brophy revealed that in 1944

the Canadian radio industry produced for Canada and its allies, 200 million dollars worth of electronic equipment as compared to an annual prewar production of approximately 15 million dollars.

* * *

WARWICK MFG. CORP. has announced the appointment of *Western Reserve Distributors* of Cleveland, Ohio, as distributors for the company's line of Clarion radios.

Western Reserve Distributors will handle 24 counties in Northeastern Ohio, according to Reau Kemp, General Sales Manager of *Warwick*.

In addition to the Clarion line, the company handles Deepfreeze and Crown ranges.

* * *

JOHN B. HARLOW, contract license manager of the Electrical Research Products Division of *Western Electric Company* passed away recently at his home following an acute heart attack.

Mr. Harlow, who was 61 years old, was associated with the *Bell System* for over 35 years.

He entered the engineering department of *Western Electric* in 1910 and by 1923 had advanced to telephone sales engineer. In 1936 he became contract license manager of the company, a position he retained when Electrical Research Products became a division of *Western Electric Company* in 1942.

* * *

H. H. VAN LUVEN is the new sales representative for the *Operadio Commercial Sound Division* in southern California and Arizona, according to the announcement made by F. D. Wilson sales manager of the Division.



Mr. Van Luven, who is well known in the electrical engineering field in the Los Angeles area will not only act as a sales representative but will maintain a complete line of *Operadio* equipment. He will stock Plant-Broadcasters, Flexifone inter-office communication systems, loudspeakers and amplifiers as soon as priority regulations are relaxed.

* * *

THE RADELMA COMPANY has recently been organized in New York by Harry Adelman, advertising and sales promotion manager.

The new company, which is located at 53 Park Place, New York 7, New York, will specialize in export of radio equipment.

Mr. Adelman was associated with *Sun Radio and Electronics Company* of New York for five years as advertising and sales promotion manager of the company.

The Radelma Company will handle a complete line of radio and electronic components as well as complete receivers and transmitters for the export trade.

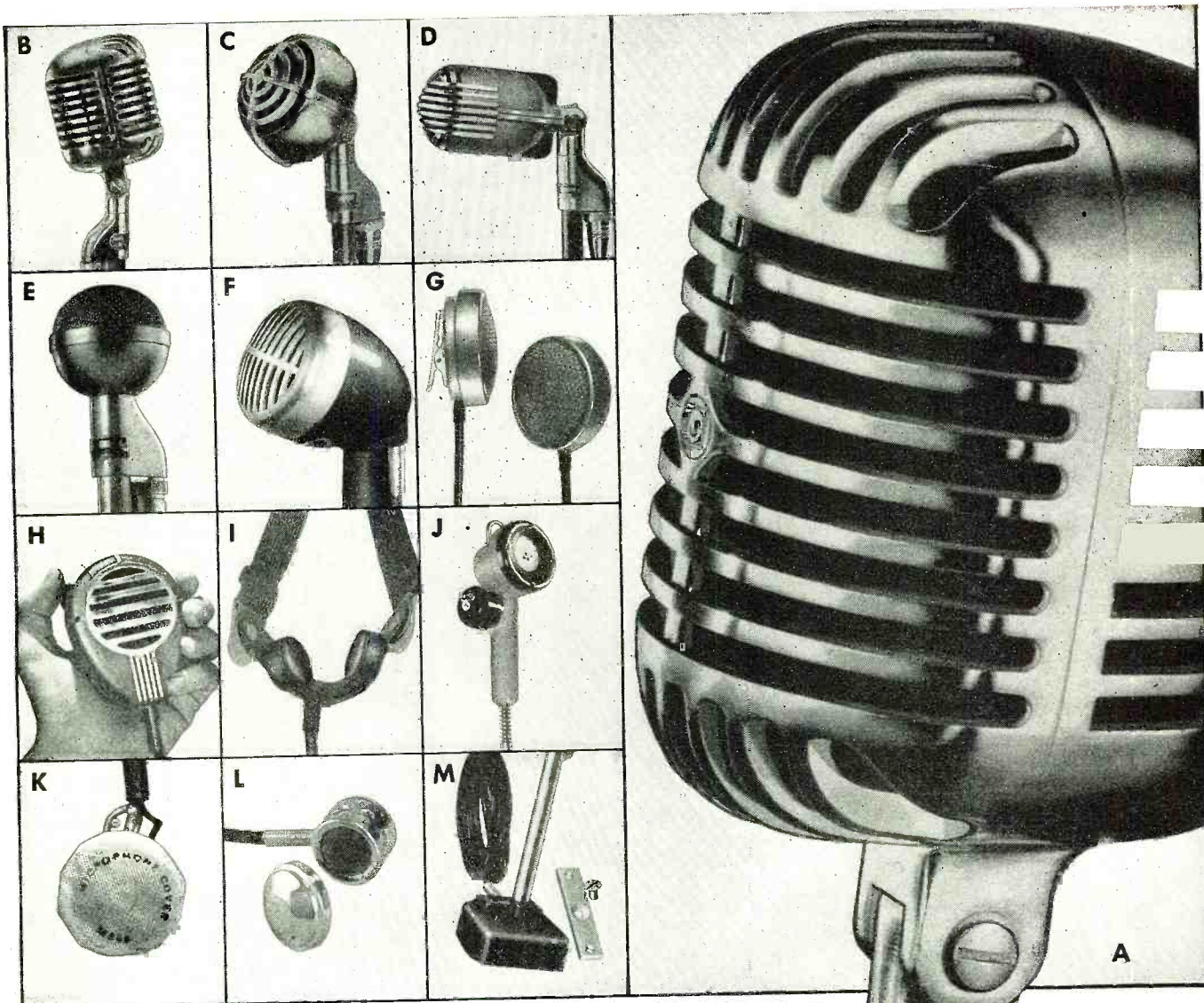

—Your *Microphone is here*

As outstanding manufacturers of microphones for war —Shure offers a complete microphone line. You will find the proper microphone for every need above. A complete description of any model will be furnished upon request.

- | | |
|-------------------------------------|---------------------------|
| A. Super-Cardioid Broadcast Dynamic | G. Lapel Microphone |
| B. Unidyne Cardioid Dynamic | H. Military Carbon |
| C. Uniplex Cardioid Crystal | I. Throat Microphone |
| D. Stratoliner Dynamic | J. Carbon Hand Microphone |
| E. Laboratory Non-Directional | K. Mask Microphone |
| F. "Economy" Crystal | L. Stethophone |
| | M. Vibration Pick-up |



SHURE BROTHERS

Designers and Manufacturers of Microphones and Acoustic Devices

225 West Huron Street

Chicago 10, Illinois

August, 1945

135



BIG SAVINGS

Hundreds of specials
for RADIO SERVICEMEN

- CATHODE RAY TUBES
- POWER & TRANSMITTING TUBES
- HEADPHONES, etc.
- HARD-TO-FIND TEST METERS

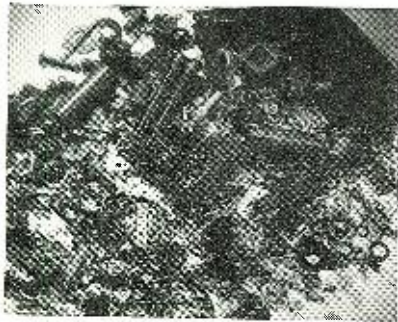

7 LB. RADIO PARTS ASSORTMENT

A "gold mine" for the radio serviceman. Hundreds of valuable radio parts, including rivets, soldering lugs, sockets, coils, resistors, condensers, switches, transformers, etc. An amazing value. Money-back guarantee.

K130R — FULL 7 POUNDS ONLY \$1.79

War Surplus Bargain Book
Page after page of war surplus
and other bargains for the radio
serviceman; a 1 & 6 specials for
home, shop and outdoors.

IT'S FREE! WRITE TO-DAY

**FREE
CATALOG**

STARK'S Dept. RN-4 509 So. STATE STREET
CHICAGO 5, ILLINOIS

The IMPROVED KELNOR electric SOLDERING IRON

REG. U. S. PAT. OFF.



about 1/2
actual size,
weighs 1/2 lb.

PATENTS
APP. FOR

special
designed
for most
efficient
soldering
in the

**ELECTRONIC,
RADIO AND
INSTRUMENT
manufacturing and
repairing fields**

Easily solders hard-to-reach connections.
Cuts down fatigue, increases accuracy.

ORDER FROM YOUR JOBBER, OR DIRECT.
GENERAL OFFICES, CENTRAL TOWER, SAN FRANCISCO 3

KELNOR MANUFACTURING COMPANY

Instrument Landing

(Continued from page 27)

actuation for the needle on the pilot's indicator. The resultant is a controlled attitude of the needle or "on-course."

The glide path equipment, which operates in the same fashion, is sited near the approach end of the runway and to one side. The antenna is rotated away from the runway to avoid the possibility of the plane's following the path into the transmitter.

Since the radiation of the localizer provides horizontal guidance its lobes are laid side by side with the usable area lined up with the runway. The glide path antennas are so arranged as to stand these lobes on end, thus placing the usable area on an inclined plane down which the plane can fly to the ground.

The markers, mounted on "jeeps," are sited as follows: The boundary marker is on the approach end of the runway and is unkeyed, providing a steady indication on the pilot's bulb; the middle marker station is driven one mile from the approach end and in line with the same runway (this position is keyed at six dots or flashes per second); the outer marker is situated in line with the runway at a distance of approximately four and one-half miles from the point of contact, and is keyed in slow dashes (two per second).

All units being mobile, they are powered by gasoline-driven power supplies and the entire system can be set up for operation on a choice of runways in one-half hour's time.

Each component unit is supplied with a frequency-modulated transceiver by means of which the operators are informed of developments by the control tower. Voice communication is used over this short range.

Pilot procedure for the system is a tribute to the efforts of the designers. Consideration was accorded to the fact that a pilot completing a combat mission would not be in the proper physical or mental condition to successfully negotiate a tedious, drawn out procedure involving critical calculations, dial manipulation and variance from his usual flight habits. The result is a simple visual checking of two needles against his directional gyro and observation of the flashing of his marker beacon bulb.

Provided a plane has been "homed" or flown to an area near the airport (as is the usual case) the pilot calls the tower and requests landing instructions.

The tower operator provides the ship with the compass or gyro heading of the runway to be landed upon. The pilot is also instructed to snap on his instrument landing equipment switch and select the crystal frequency being used. This is also accomplished by the simple expedient of snapping a selector switch.

When the plane's receivers are warmed the localizer needle will be noted for deflection.

The pilot maintains normal flight altitude and attempts to straighten up the needle by flying against it (opposite direction) and checks his compass or gyro heading with the reciprocal of that on which he intends to land. If the ship is to be landed on runway 180° or No. 18 he will first establish a heading toward 360° or No. 36.

When this heading has been established he will be flying in line with but away from the runway he intends to use for the landing. He is able to test this by checking his localizer needle for reverse action. If he flies right the needle should deflect to the left.

If he discovers he is flying in the wrong direction a standard rate 180° turn will correct same. Inspection of his gyro will serve as a double check, if desired.

As he flies the localizer course away from and in line with the runway he will note the keyed flashing of his bulb as he passes over each marker station.

After crossing the outer position (4½ miles out) he continues to fly out for an additional 45 seconds and then starts a standard rate turn and let down into his final approach. This turn is usually accomplished at approximately 1200 ft.

Heading back toward the runway and flying the localizer course again he calls the tower for final approach instructions and if cleared to land attempts to cross the outer station at about 800 ft.

At this point he adjusts his flaps and throttles as in a normal landing.

He also notes that his glide path needle (cross-haired with the localizer in true course position) is now active.

Using the localizer needle to bracket his heading and checking with his gyro he now attempts to establish an acceptable angle of glide with the aid of the needle which deflects up and down.

He is now approaching the runway and transmitters and therefore he observes true sensing or follows the needles.

It is important to note that pilots who are unable to establish an acceptable heading at this point are recommended to reject the attempt and initiate a new approach. Experience has revealed that continued effort to change the ship's attitude at this stage usually results in failure and is extremely hazardous.

After passing the two remaining markers at 200 ft. and 50 ft. respectively he adjusts his throttles as in normal landing technique and follow the needles right on down to the runway.

This complete procedure is strictly adhered to and practiced daily at Scott Field on a B-17 plane for the student's benefit.

It is through this method that he learns not only the result of his ef-

RADIO NEWS



**AN EAR
FOR AN ANTENNA**

HAROLD E. EDGERTON

The night flight of a bat is controlled by a high-frequency system not unlike Radar . . . very simple . . . very effective . . . perfectly adapted to the needs of a bat.

Antennas play a highly important part in Radar as well as communications. Like the bat's ear, they should be designed to fit the needs of a particular situation. We at the Workshop have been manufacturing antennas to meet the most exacting electrical and mechanical specifications. Our facilities include electronic test equipment for measuring antenna gain, pattern, and impedance, enabling us to fill nearly any antenna need.

If you have an antenna problem in the very high, ultra high, or microwave frequencies, whether it be for war today, or peace tomorrow, drop us a line — we are anxious to serve you.

August, 1945



**The WORKSHOP
ASSOCIATES**

Antenna Manufacturers

FOR THE ELECTRONIC INDUSTRY

66 NEEDHAM STREET • NEWTON HIGHLANDS 61, MASS.

— M A C O — Featherweight Switch

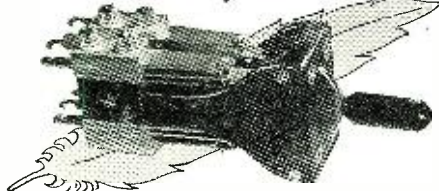

A Featherweight Doing a Heavyweight Job!

Maco featherweight switch frame, molded of high impact phenolic. Weight of frame 3 oz.

- Connecting lugs — hook type finned.
- Contacts — coin silver.
- Spring leaves — Phosphorbronze, nickel-plated.
- Mounting bushings — locked in non-rotating insert with full 1/4" depth 4-40 standard thread. Special thread to order.
- Amperes AC 10 Volts 115
 DC 2

Contacts may be ganged in any desired number and combination and for locking or spring return in either lever position.



METALLIC ARTS CO.
243 Broadway
CAMBRIDGE 39, MASSACHUSETTS

Unusual Buy Cathode-Ray Tubes



New, Factory sealed, for
TELEVISION & OSCILLOSCOPES
RCA 5BP4 price.....\$18.00
N-U 3API price.....\$12.00

Amphenol Coaxial Cables

Polystyrene headed & Polyethylene solid dielectric. 72 Ohm for low losses and freedom from interference.
Type 21B-290-7/26-XXV, list price \$0.85, your price \$0.25 p. ft. Many other types. Ask for list.

Television Parts

RCA Deflection yokes compl. with hardware & cable.....\$19.50
RCA High and Low Voltage complete in one unit Television power supplies, oversize unit.....\$90.00
AEROVOX Type 3009 Capacitor .5 MFD, 3000 V.w.....\$ 2.40
G.E. Pyranol Capacitor 2 x .1 MFD, 7000 V.w.....\$ 9.00
All types of ceramic, mica and oil Capacitors. Many other television parts, ask for complete catalogue.

RCA Parts and Equipment Distributors
WORLD'S FIRST SPECIALIZED HOUSE IN TELEVISION
ELECTRONICS SERVICE & SUPPLY
262 West 40th Street, New York 18, N. Y.
Phone: Pennsylvania 6-8730

ports on the ground but more important he acquires a sense of responsibility as he becomes acutely aware of the pilot's dependence on the efficiency of the landing crew.

A contributing factor also is that he has now actually landed a plane on the system and is in a fine frame of mind to convince the skeptical of the ability of the system to do its specified job.

Perfection is the keynote throughout the course at Scott Field for there is no such thing as "fairly close" when it comes to setting a couple of tons of speeding bomber onto a narrow runway. When Scottsmen finish the instrument landing course they know they can set a plane down as gently as they would an egg, only their eggs carry a live brood.

—30—

Television Sound Channel

(Continued from page 54)

frequency swings to the other side of center frequency, placing a greater voltage on diode #2 and causing a negative audio alternation at the output. Therefore, if there is 400-cycle modulation, which means the i.f. frequency is being shifted above and below the center frequency this many times per second, one diode contributes the greater output on one alternation of the modulation cycle, and the other diode contributes the greater output, of opposite polarity, during the other alternation.

Two voltages are transferred to the input circuit of the discriminator; one a direct voltage which is capacitively

coupled through C_1 , and the second a resonant voltage which is induced into the discriminator tuned circuit by mutual coupling from the primary or limiter plate tuned circuit. The direct voltage appears across choke L_3 and therefore is impressed as an equal diode voltage on each plate. This impressed voltage is equal to, and in phase with, the limiter plate voltage, and can be compared rather loosely with a resistor-capacitor coupled stage in which the choke is replaced by a resistor as shown in Fig. 8. While it first appears as though the voltage across L_3 would lead the signal current, it must be remembered that L_3 has a very high reactance (L_3 is commonly called a choke) at the i.f. frequency and is in shunt with the lower reactance inductor of the plate-tuned circuit. Consequently, the voltage across L_3 assumes essentially the phase of the voltage across the tuned circuit. This voltage appears equally on both diodes, Fig. 3, and therefore, there would be no output from the discriminator if it were the only voltage in the discriminator circuit. The choke itself presents a high reactance to the i.f. frequency, but does not impede the flow of rectified diode current, improving diode efficiency.

A second voltage, which also divides equally between the two diodes, is induced by mutual coupling into the discriminator tuned circuit. This voltage divides equally, but out-of-phase, across L_1 and L_2 . Here again, if it were the only voltage in the discriminator circuit, both diodes would draw the same average diode current and there would be no output, regardless of the frequency of the i.f. Thus,

Fig. 6. Leveling operation occurring in the limiter stage.

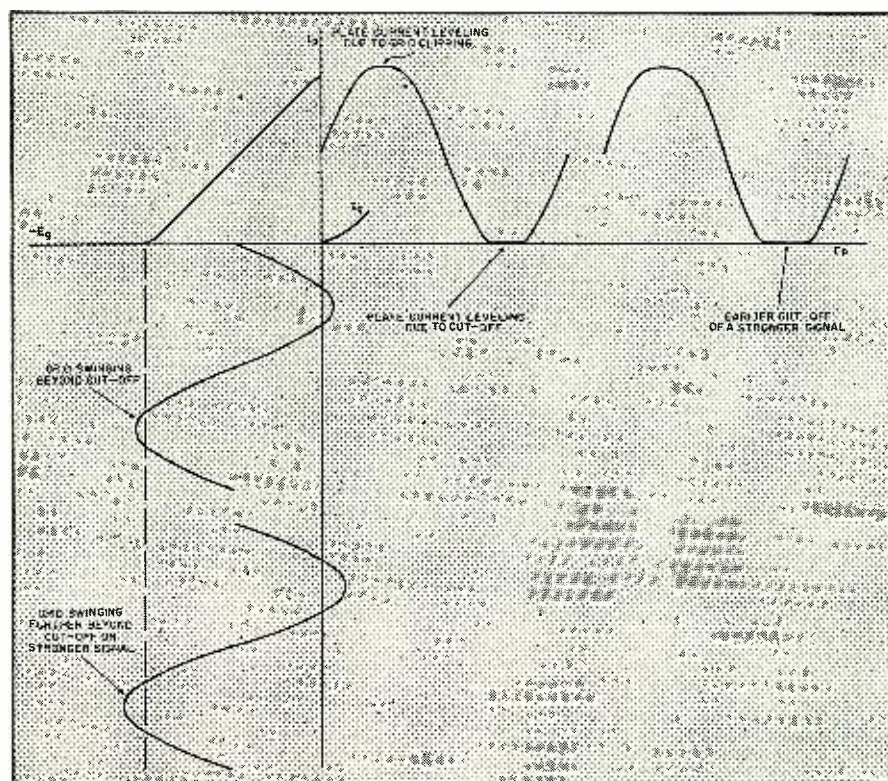

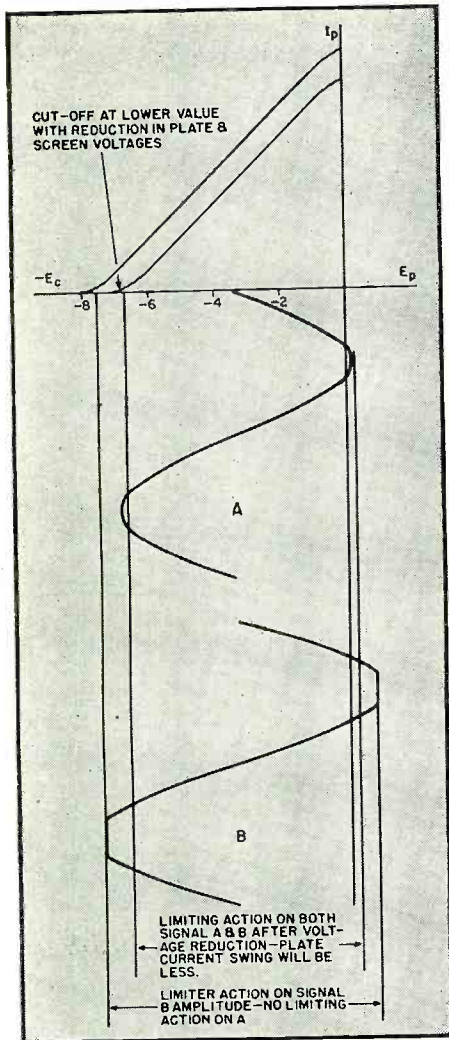

Fig. 7. By reducing the plate and screen voltages the limiting action is compressed to a narrower region.

there are two voltages, a direct and a mutually coupled, which individually contribute equal signals to both diodes, resulting in zero output; but which, collectively, because of their phase relationship, cause a greater voltage to appear on one diode than on the other when the i.f. frequency departs from resonance. At resonance, the phase relationship is such that equal voltages appear on both diodes.

When a signal of the resonant frequency is applied to the primary side of a double-tuned transformer, the secondary voltage leads the primary voltage by 90 degrees. This is substantiated when it is considered that the magnetic flux from the primary induces a current into the secondary in phase with the primary voltage. However, there is a voltage lead of 90 degrees involved while the resonant current builds up and decays through the tuned circuit inductor. Consequently, diode #1 plate voltage, e_{p1} , consists of the in-phase voltage, e_s , plus the 90 degree leading voltage, e_1 , as shown in the first vector of Fig. 9; and diode #2 plate voltage e_{p2} , consists of the in-phase voltage, e_s , plus the 90-degree lagging voltage e_2 . Actually, the voltage e_s , as it appears

August, 1945

Post-War Performance!

Permoflux Midget Transformers Conserve Vital Space and Weight!

• Because of their exceptional operating efficiency and uniform frequency response characteristics, Permoflux midget transformers have literally hundreds of practical applications where size and weight are determining design factors. Developed by Permoflux engineers, with new materials and manufacturing methods, they are available unshielded, shielded or hermetically sealed for your specific requirements. Why not let us design a unit for you?

Permoflux Speakers Assure the Best in Tone Reproduction

Their wide frequency response, extreme sensitivity and rugged mechanical design have established new concepts of tone realism. Permoflux speakers in sizes from 2" to 15", with power handling capacities from 1 to 20 watts, are available for your post-war developments.

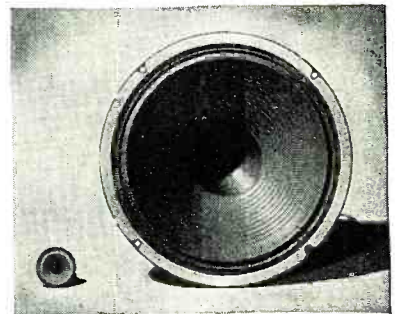

TRADE MARK

PERMOFLUX

PERMOFLUX CORPORATION
4900 WEST GRAND AVE., CHICAGO 39, ILL.



PIONEER MANUFACTURERS OF PERMANENT MAGNET DYNAMIC TRANSDUCERS

Radio Tubes!

**HARD TO GET
FOR THE NEXT SIX MONTHS**

Available
**FOR IMMEDIATE DELIVERY
TUBES & ADAPTORS**

To replace

| | | | | | |
|------|-----|---------|------|------|------|
| 1A5 | use | adaptor | with | 1L4 | Tube |
| 1H5 | " | " | " | 1S5 | " |
| 1N5 | " | " | " | 1L4 | " |
| 1Q5 | " | " | " | 3Q4 | " |
| 1T5 | " | " | " | 1L4 | " |
| 3Q5 | " | " | " | 3Q4 | " |
| 45 | " | " | " | 3A4 | " |
| 47 | " | " | " | 3A4 | " |
| 6Q7G | " | " | " | 6B8G | " |

**TUBE WITH ADAPTOR
BOXED COMPLETE
Guaranteed to work** **73c**

Minimum Shipment 25 Each or Assorted
We Pay Transportation Charges
Terms Net Cash
Send Form L-265 with order.
Can supply other tubes without adaptors.

Write For Prices In Lots of
500 or Over

Art Radio Corp.

115 LIBERTY ST. NEW YORK, 6 N.Y.

For the Finest
in
Sound Equipment
Watch ...

NEWCOMB

... the sound of quality

Announcements of special interest to discriminating buyers of sound equipment may be expected in the near future. Send us your address to receive these mailings as they become available.

Newcomb

AUDIO PRODUCTS CO.
Manufacturers Since 1938
2815 So. Hill Street, Dept. F
Los Angeles 7, California

across inductor L_2 , is leading the primary voltage (same as e_3) by 90 degrees; however, so far as diode #2 is concerned, it is lagging e_1 by 180 degrees and e_3 by 90 degrees because the diode #2 conducts on the negative alternation of the induced voltage. Using the j operator, the diode plate voltages would be written as follow:

$$e_{p1} = +e_3 + je_1$$

$$e_{p2} = +e_3 - je_1$$

The important factor to observe from the vector is that the resultant voltages, e_{p1} and e_{p2} , are equal at resonance when the phase shift is exactly 90 degrees.

Now, at the time the frequency departs from resonance, the current induced in the secondary leads or lags the primary voltage and, consequently, the secondary voltage leads the primary voltage by more or less than ninety degrees. Thus, as shown in Fig. 9B, voltage e_2 is lagging the direct voltage e_3 by less than 90 degrees, and voltage e_1 , leading e_2 by 180 degrees, leads the direct voltage e_3 by more than 90 degrees. When the resultant vector is completed, it is clear that diode #2 is receiving the greater plate voltage and the instantaneous output of the discriminator is negative. Now, if the frequency departs from center frequency, the same amount on the other side of resonance, the voltage e_2 lags the direct voltage e_3 by more than 90 degrees, and the voltage e_1 leads the direct voltage by less than 90 degrees. As a result, diode #1 receives the greater voltage and the instantaneous output of the discriminator is the same amplitude but positive in polarity. It is apparent that as the frequency deviates equally at a sinusoidal rate above and below center frequency, a sinusoidal reproduction of the frequency variation appears at the output of the discriminator.

The discriminator of the Model 90 receiver has the same basic concepts, but uses a circuit having a single cathode, permitting the use of a dual-diode triode tube as discriminator and first audio. An equivalent simplified circuit of the discriminator is shown in Fig. 4 and is taken directly from the main schematic of the Model 90 sound channel, Fig. 1. In this discriminator, the direct voltage appears equally across resistors R_1 and R_3 . Capacitor C_2 holds the high side of resistor R_1 at radio-frequency ground potential, and acts as a filter. The induced voltage appears across L_1 and L_2 ; diode #1 draws rectified current through resistor R_1 , producing a negative output, while diode #2 draws rectified current through resistor R_2 , producing a positive output.

Audio Amplifier

The full capabilities of the FM sound channel are realized only if the audio amplifier is properly designed to handle linearly a wide range of frequencies (at least as high as 8,000 to 10,000 cycles). The theory and methods of maintaining a linear re-

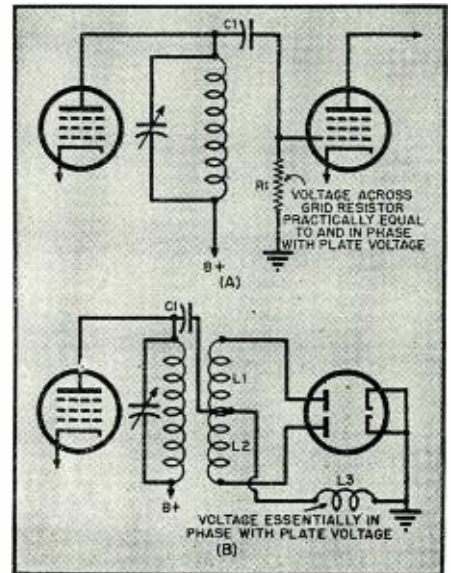

Fig. 8. Showing how the in-phase voltage is developed across coil L_2 of Fig. 3.

sponse over a wide range of frequencies will be detailed in next month's installment on video amplifiers.

Major points to observe in the Model 90 audio amplifier are:

1. The frequency compensating network in the grid circuit of the first audio, consisting of capacitor C_3 and resistor R_6 . This combination, because of its increasing reactance to low frequencies, helps to hold them up to the same level as the highs—compensating for the loss of lows across the coupling capacitors.

2. Capacitor C_4 and tone potentiometer R_8 , which can be adjusted for the most pleasant response. A decrease in the potentiometer resistance increases the effectiveness of capacitor C_4 in shunting the highs to ground. The lows meet a higher reactance from C_4 and are not shunted. Consequently, the degree to which the highs are suppressed is set by adjusting potentiometer R_8 .

3. The inverse feedback divider resistors, R_9 and R_{10} , which shunt the secondary of the output transformer. Since resistor R_{10} is also the cathode resistor of the first audio amplifier, a portion of the audio output voltage sets up a degenerative feedback voltage across the cathode resistor, reducing the effectiveness of the audio amplifier grid signal. The greater the output signal becomes, the more effective the feedback becomes, and consequently, the output of the amplifier is somewhat reduced, but the fre-

Fig. 9. Discriminator voltage vectors.

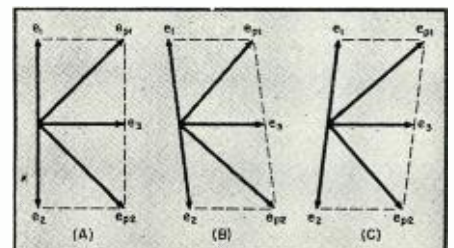

quency response (relative amplification at various audio frequencies) is leveled off. Another advantage of feedback taken off the secondary is that the frequency discrimination of the output transformer itself (which is always considerable) is compensated for in this arrangement.

(To be continued)

For the Record

(Continued from page 8)

department, a device has been exploited as the greatest mechanical marvel since the invention of the wheel, which is, in fact, a clumsy, faulty travesty on the commonplace timer that is a part of the cheapest auto. This thing has from 90 seconds to several minutes to make up its mind, move into position and do its simple little job of turning the pancake and lifting it up and away."

We didn't realize the American public had such patience. We are beginning to wonder if his original manuscript wasn't written back in 1920. At least, we haven't seen such a lazy mechanism as he describes for many a year. If his statement were true, there would have been little demand, if any, for radio-phonograph combinations with changers. Ask the man who owns one!

To further pour salt in the wound, he says "But the latest statistics on the subject, which I just made up and personally guarantee, reveal that 72 per cent of them haven't worked since Pearl Harbor and that, on the average, they worked only 24 times before the need arises for a mechanic at \$4 an hour plus transportation to and from the job." Wow—the servicemen certainly must be wealthy. The 72 per cent that Mr. Pegler figured out must indicate that almost 72 per cent of owners of record players have young kids having a yen for mechanical things. It is very interesting to note that mechanics (servicemen) are earning \$4 an hour plus transportation, isn't it? This admission—"which I just made up and personally guarantee" is, in our opinion, a direct confession of the inaccuracy of his statements.

He terms the procurement methods employed by the Armed Forces to secure radio and radar technicians "gaudy come-on" and belittles the training given these men comparing the results to auto mechanics employed in the automotive industry. We doubt that he has ever had the opportunity to observe the type of training given these radio technicians in the Armed Forces' schools—we further doubt Mr. Pegler's ability to evaluate this training were he given the opportunity to observe it, (we might even include a strenuous doubt that our self-made Steinmetz could pass the Eddy test).

HE ALSO intimated that the radio manufacturers were defrauding

August, 1945

SOUND VALUES at TERMINAL RADIO

AMPLIFIERS! IN STOCK! RAULAND

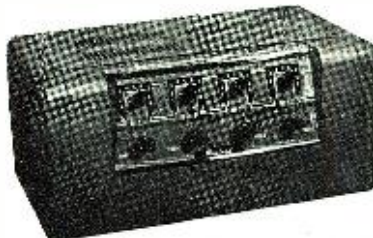

SUPER-LUXE SYSTEMS

Model W-835
35 Watt Amplifier
4 Mike Inputs
2 Phono Inputs
with Dual Fader
Illuminated Panel

Model W-851
Bi-Power 60 Watt
Complete mixing
and fading on all
6 Inputs
Cap. 50,000
people Indoors
100,000 sq. ft.
Outdoors

FREE CATALOGS . . . TERMINALS' LOW PRICE ON REQUEST

DE LUXE UNIVERSAL AMPLIFIER with RECORD CHANGER

30 Watts . . . 2 Mike Inputs . . . 4-8 or 500 Ohm Output
OPERATES WITH FULL OUTPUT ON 110V AC-60
Cycles or 6V-DC Storage Battery
CONSTANT DUTY . . . NEW TYPE RECORD
CHANGER

Loads 10-12" records or 12-10" records

Model 6370 RC

OUR NET
PRICE

10900

F. O. B. NEW YORK

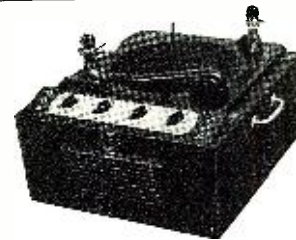

STROMBERG CARLSON MODEL 20 HIGH FIDELITY AMPLIFIER

A 30 Watt Amplifier with 3 Position Mixer
. . . Bass and Treble Controls . . . 3 Inputs
. . . Universal Output Matching . . . Free
Catalogs . . . Terminals' Low Price on Request.
Other Models and Sizes in Stock.

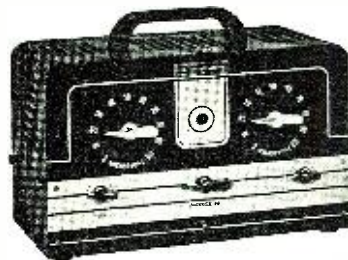

BOGEN MODEL E-10

DeLuxe Economy
Amplifier—10 Watt

Push Pull Output . . . Mike and Phono .
Mixer Input . . . Tone Control . . . Universal
Output Matching. Free Catalog. Terminals' Low Price on Request. Other
Models in Stock



THORDARSON Model 30W20 20 Watt AMPLIFIER

2 Input Circuits . . . Bass & Treble
. . . Tone Control . . . A very
popular HiFi Unit. Free Catalogs.
Terminals' Low Price on Request.

Large quantities of microphones, speakers,
baffles and other sound accessories in stock!

All at Terminal's low prices . . . Free catalogs on request

Priority requirements change frequently:

Write Dept. Q7 for latest information.

Terminal Radio Corporation

85 CORTLANDT STREET, NEW YORK 7, N. Y. Telephone WOrth 2-4415

RADIO TUBES

We have radio tubes combined with adaptors, sold as complete units, for the following critical numbers:

| | | |
|------|------|--------|
| 1A5 | 1N5 | 6K7 |
| 1C5 | 3Q5 | 1T5 |
| 1H5 | 6A7 | 1Q5 |
| | 6A8 | |
| 6Q7 | 6SC7 | 6X5 |
| 6SQ7 | 6R7 | 84-6Z4 |
| | 75 | |

\$1.15—lots of dozen
 \$1.10—lots of 25 to 49
 \$1.05—lots of 50 or more

Regular tubes—not substitutes.

| | | |
|------|-------|-------------|
| 7T7 | | \$1.00 each |
| 6SN7 | | .65 each |
| 1T4 | | .75 each |
| 3S4 | | .75 each |
| 1S5 | | .85 each |
| 27 | | .35 each |

Signed supplier's certificate No. 1-265 must accompany all tube orders.

ADAPTORS

We manufacture a complete line of radio tube adaptors. Don't let your old tubes be idle, use our ADAPTORS.

50c each—doz. lots of any one type
 60c each—smaller quantity

Send for our complete list of over 125 different types of adaptors.

Manor
Electric & Appliance Co.
 3238 Southport Ave., Chicago 13, Ill.

NO PRIORITY

For Harco Radio MASTS & TOWERS

Revocation of Order M-126 permits manufacturing from surplus inventories. We have adequate surplus stocks to make...

**IMMEDIATE
 SHIPMENTS**

HARCO
 CO. INC.

ELIZABETH 4, NEW JERSEY

Catalog mailed on request

the public. In speaking of "audio radio" (this must be the stuff known as AM or FM) he says "It has victimized the public to the extent of millions of dollars, with false promises and high prices for a device whose internal works in mass production should sell profitably for a few dollars backed by reliable guarantees." We cannot help but wonder then, if this is true, why most of the newspapers of the country, including many of those carrying his column, continually solicit advertising from manufacturers within such an industry ???

We suggest that Mr. Pegler have his radio fixed.....O.R.

100 MC. Transmitter

(Continued from page 44)

switch is placed in proper position, and C_{10} is tuned to resonance as indicated by M_1 .

The next two stages are quickly tuned in order to avoid tube damage, due to overload in the out-of-resonance condition. Although a neutralizing condenser is provided for the 100-megacycle doubler-buffer, it was not found necessary to neutralize this stage.

The grid tank of the final stage is now coupled to the buffer stage and C_{21} is adjusted for maximum grid current, as indicated by meter M_2 . Next, C_{22} is tuned to resonance, as indicated by a dip in grid current. This dip will not occur if, by some coincidence, the stage is neutralized. Neutralization can be accomplished in one or two ways, and the method to be used depends on the transmitter's ultimate use.

The first method is to apply grid drive and adjust C_{21} until the plate tank r.f. is at its lowest possible level. The other, or dynamic, means of neutralizing is to remove the grid drive and apply plate voltage to the final

stage. Then C_{21} is adjusted so that there is no indication of grid current on M_2 . If the dynamic means of neutralizing is used, r.f. will be found in the plate tank when grid drive is applied and plate voltage is removed from the final stage.

All preceding stages should be retuned after the final stage is neutralized. The crystal oscillator drifting (due to temperature) also makes periodic retuning of the entire transmitter advisable under continuous operation.

Bias on the final stage is more than adequate for class "C" operation. Plate modulation may be used, if desired. The output (comprising the hair pin and C_{11}) is moved up and down to adjust load on the output stage. In place of L.P., shown in Fig. 4, a 70 ohm coaxial cable may be used to feed the antennas.

All important circuits are protected against overloads. Relay (RY_1) is connected in the "C" bias power-supply (power supply No. 2). Plate voltage for r.f. stages Nos. 2, 3, 4 is immediately removed if the "C" bias supply fails. Overload relay (RY_2) and hold-down relay (RY_3) are connected in the (B+) lead of r.f. stage No. 5. Contacts of the hold-down relay are reset through depression of a momentary break switch connected in the circuit.

This article outlines the design and construction of a low-power 100-megacycle transmitter. By eliminating the output-measuring device and several of the meters, the entire transmitter can be placed in a 5 ft. cabinet with room to spare. The power supply requires more than half of the space available.

It should be possible to replace two of the power supply units with one having equivalent current capacity. The chassis thus left vacant could be used for audio equipment.

-30-

Fig. 5. Diagram shows location of component parts on their individual chassis.

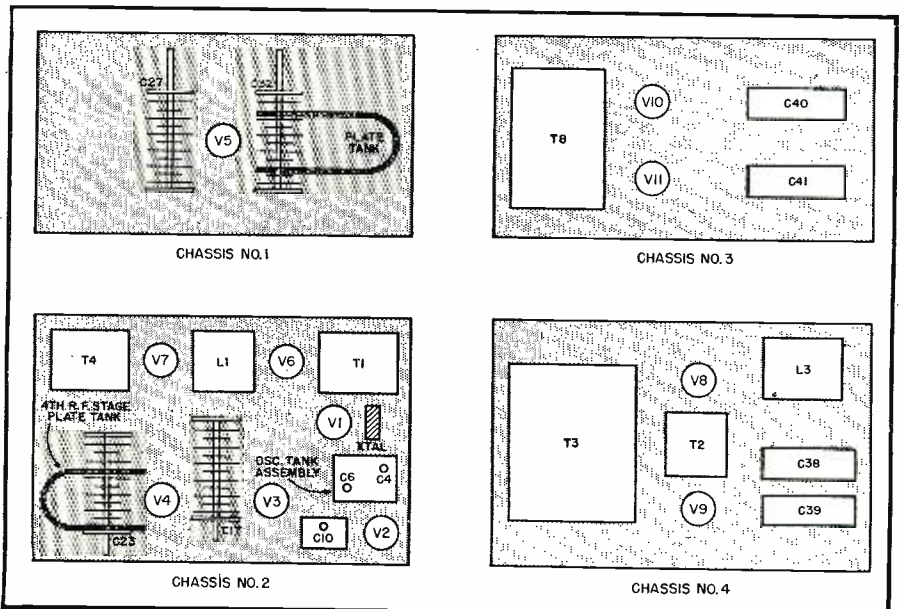

**TECHNICAL BOOK
& BULLETIN REVIEW**

"APPLIED PRACTICAL ELECTRICITY" by The Technical Staff, Coyne Electrical School. Published by *Coyne Electrical School*, Chicago, Illinois. Seven Volumes, Price \$19.75 the set.

A great deal of practical knowledge has been included in this set of pocket-sized books.

This set may be used either as a home-study course or as a reference work for practical electricians, repairmen or home owners. The material is presented in a logical sequence beginning with elementary concepts of electricity and magnetism.

The first volume deals with circuits, relays, telephone, signal systems, and rules. The second book covers construction, lighting, signs, neons, fluorescents, and appliance repair. Volume 3 covers direct current, while Volume 4 deals with alternating current. The fifth volume covers armature and stator winding, installation, maintenance, and repair, while Volume 6 treats the subjects of electrical refrigeration, air conditioning, fans, blowers, and radios. The final volume handles automotive electricity, Diesel, batteries and installation, and service.

Each volume is complete in itself, with all the material germane to the subject included. Thus, if the student or repair man wants to study all phases of a.c. circuits, appliances, equipment, etc., he could study Volume 4 and have the material at his fingertips without having to refer back to previous volumes.

The entire set is written in easy-to-understand language and the text is profusely illustrated with pictures and diagrams. The home study student should have no difficulty in mastering the subject of practical electricity from these books.

"UHF RADIO SIMPLIFIED" by Milton S. Kiver. Published by *D. Van Nostrand Company, Inc.*, New York. 228 pages. Price \$3.25.

Since radio in the higher frequencies will become increasingly important in the postwar period, it is essential that amateurs, servicemen, technicians, and engineers understand the basic principles of u.h.f. theory and application.

In order to meet the demand for a basic text, Mr. Kiver has presented an interesting and highly readable book which covers all of the points necessary for the average person to know who depends on electronics for fun or profit.

The author has accomplished in this work what might be considered impossible, considering the nature of u.h.f. theory and practice, namely, a rigorous simplification of the subject. The book is almost wholly devoid of mathematics, yet by means of correlation with familiar circuits and theories,

August, 1945

CARE "Custom-Built" Mounting Bases Simplify Assembly and Maintenance

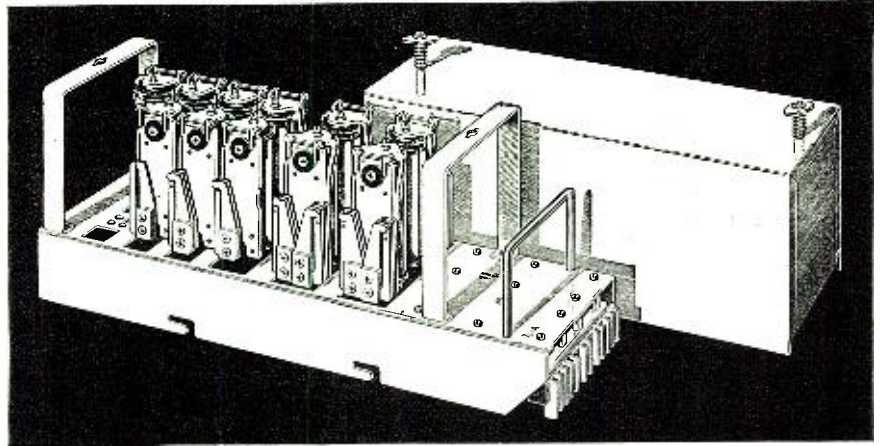

Pictured here is a typical Clare Relay Mounting Base with built-in connector strips. This method of mounting relay components provides greatly simplified maintenance, permits a complete bank of relays to be removed at any time for easy readjustment or replacement.

Under side of the mounting base, shown below, illustrates the wiring and three 24 point base connectors. The bayonet slots shown on the side of the base are locked into protruding frame pins, allowing the base connectors to be aligned with the frame connectors. This also provides a mechanical mounting of the assembly and relieves any stress on the connectors.

The 24 point jacks shown are made of nickel silver and make a firm friction contact with the frame jack. Insulation between jacks is linen base bakelite which provides good mechanical and electrical characteristics.

In keeping with the Clare principle of "custom-building", various sizes of mounting bases are available and special bases are easily provided. Standard jacks are: 12, 16, 20, 24 and 32 point sizes.

Call on Clare engineers to assist you with standard or special mountings in keeping with the requirements of your design. Address C. P. Clare & Co., 4719 West Sunnyside Avenue, Chicago 30, Illinois. Sales engineers in principal cities. Cable address: CLARELAY.

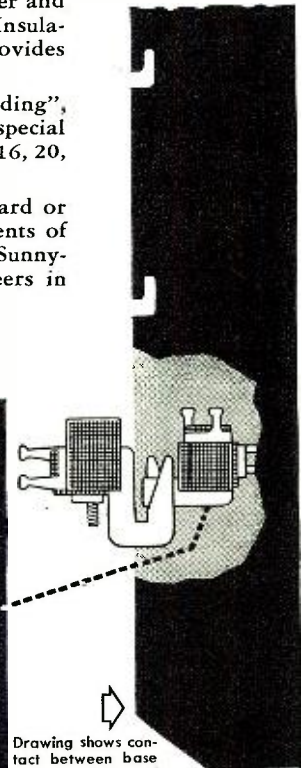
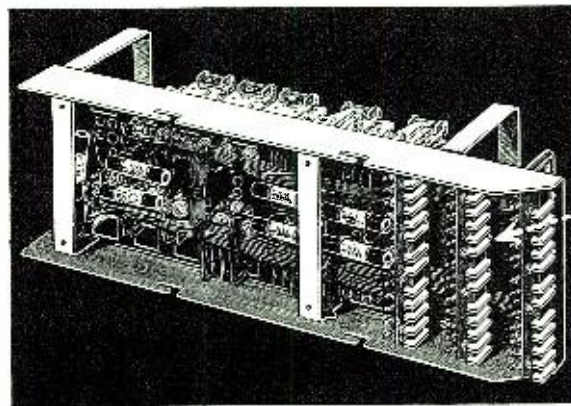

Drawing shows contact between base mounting jack and frame jack.

CARE RELAYS

"CUSTOM-BUILT" Multiple Contact Relays for Electrical, Electronic and Industrial Use

143

SOLID SILVER CONDENSER PLATES

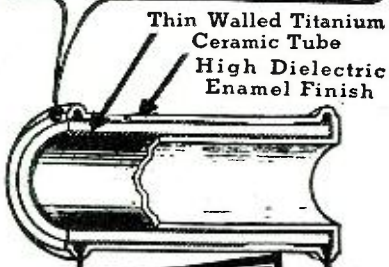

Hi-Q



CERAMIC CAPACITORS

**ELECTRICAL REACTANCE
CORPORATION**
FRANKLINVILLE, N. Y.

**THIS MULTITESTER
IN STOCK
IMMEDIATE DELIVERY**

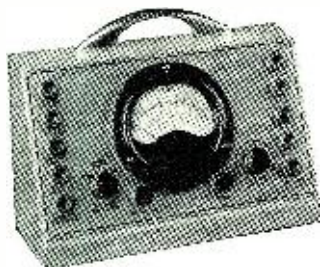

**YOUR
COST
ONLY**

\$18.75

Less
Test Leads

Model
No. MT 100

**UNCONDITIONALLY GUARANTEED
SATISFACTION OR MONEY BACK**

Latest meter design in all metal case; compact-rugged; the answer to your need for an all purpose, accurate Multitester. Case measures 3½" x 8" x 5". Complete with self-contained batteries.

**RADIO REPAIR MEN
ORDER THIS TESTER TODAY**

OMAHA RADIO PRODUCTS CO.
300 Saunders-Kennedy Bldg.
Omaha, Nebraska

Enclosed is full remittance of \$18.75, or my deposit of \$..... and ship Multitester #MT 100 C.O.D. for balance.

NAME
ADDRESS
CITY..... STATE.....

the author has achieved a clarity of presentation which will not be lost on the average reader.

The book is divided into nine chapters covering the magnetron oscillator, the Klystron, transmission lines, wave guides, cavity resonators, u.h.f. antennas, u.h.f. measurements, and wave propagation, in addition to the introduction which concerns the transition from the low frequencies to the ultra-high frequencies.

Mr. Kiver is familiar to readers of RADIO NEWS as the author of a series of articles on ultra-high frequencies, and those who read and enjoyed this series, will undoubtedly wish to read his text on the same subject.

-50-

11,500 Mile Radio Net

(Continued from page 50)

designed and supplied by Pan American engineers and consists of two types; one which permits operation of the transmitter over a cable which may be as much as 2,000 feet in length, while the other type permits complete control over a single pair of telephone wires which may be approximately 65 miles in length.

To facilitate the understanding of the r.f. circuits used in the transmitter and the methods used in the selection of the desired channel for operation of the unit, it is suggested that the schematic diagram (Fig. 1) be used in conjunction with the reading of the text.

Power to the transmitter is controlled by a main line switch (D_2) located on the front panel of the set. When closed, a control relay transformer (T_1) and its associated copper oxide rectifier ($X_{1,1}$) are energized. This furnishes a protective bias of 29 volts on the grids of the power amplifier tubes (V_2, V_3) and makes available current for operating the relays. When the frequency selector switch is set for any of the three available frequencies, it operates the filament contactor main power relay (S_5) which closes the line circuit to the filament and autotransformer (T_2). This transformer, which applies current to all vacuum-tube filaments, energizes the 115 volt rectifier (V_{15}) that supplies bias to the modulator tubes (V_7, V_8), and starts the time-recording meter (M_2) connected across the 10 volt modulator filament circuit and records total hours of transmitter operation.

A winding on the transformer (T_2) supplies 100 volts to the time-delay tube (V_{10}). When the filament of this

tube has been in operation for approximately 25 seconds, the paralleled plate and grids will pass sufficient rectified current through the time-delay relay (S_6) to cause the relay to operate and close the 115 volt circuit through the door switch (D_1) to the high voltage contactor relay (S_7), which then completes the power circuit to the 700-volt rectifiers (V_{13}, V_{14}) and the 1600 volt rectifiers (V_{11}, V_{12}) and starts the ventilating fan in operation.

The primary winding of the filament and 115 volt bias rectifier transformer is tapped to deliver proper voltages when the supply is between 200 and 250 volts. This transformer winding also serves as an autotransformer for adjusting the line voltage applied to the high-voltage rectifier plate transformer (T_3). The proper transformer tap for any line voltage between 200 and 250 volts may be selected by means of a tap switch (D_3) and line voltmeter (M_1) located on the front of the set.

The oscillator (V_{16}) is of the Colpitts type with the quartz plate connected between ground and control grid. The plate of the oscillator tube is coupled through a stopping condenser (C_5) to the grid of the buffer tube (V_1) and this circuit is tuned to the fundamental or second harmonic of the quartz plate by means of a plug-in coil. The plate of the buffer amplifier is coupled through a stopping condenser (C_{22}) to the grids of the power amplifier stage (V_2, V_3) and this circuit is then tuned to the carrier frequency (which may be the fundamental, second or fourth harmonic of the quartz plate frequency) by means of a plug-in coil and condenser combination. The plate circuit of the power amplifier stage is tuned by means of a plug-in coil assembly (L_6) and a permanently installed dual-section variable condenser (C_{11}). Straps are provided on the power amplifier plate coil assemblies so as to select one or both sections of the variable condenser, and in channel one only an additional fixed condenser is provided for frequencies in the range between 1.6-1.715 megacycles.

However, all channels may be operated in the frequency range from 2.80 to 3.085 and from 4.00 to 13.50 megacycles. The antenna for the transmitter is coupled to the power amplifier by means of a rotatable coupling coil inside the plate coil (L_{10}).

A protective bias of 29 volts is applied to the grids of the power amplifier through two power amplifier grid leak resistors ($R_{6,1}, R_{6,2}$). When grid current is present, these resistors pro-

Table I. Input power to the transmitter for various operating conditions.

| TYPE OF OPERATION | V.A. | WATTS | P.F. |
|---|------|-------|------|
| Standby | 1040 | 940 | 0.90 |
| Full Carrier, unmodulated | 1600 | 1440 | 0.89 |
| Full Carrier, 80 per cent, average modulation | 1870 | 1660 | 0.89 |

vide self bias necessary for proper operation.

Selection of the desired channel which connects the proper quartz plate, oscillator, buffer, and power amplifier coils to their associated circuits is accomplished by means of three frequency-changing relays (S_1 , S_2 , S_3) and a tank circuit switching relay (S_4) all of which are controlled by the frequency selector switch located on the front panel or by a similar switch at a remote point when the local selector is at some distant location. Operation of the selector switch to "Frequency 1" closes the 29 volt circuit to the filament contactor relay (S_5) which furnishes the power to start the transmitter in operation on channel one, utilizing quartz plate (Y_1), oscillator plate tuning coil (L_{11}), buffer tuning unit (L_{C11}), and power amplifier plate tuning coil (L_6). With the selector switch in "Frequency 2" position, frequency-changing relays (S_1 , S_2) and tank circuit switching relay (S_4) operate to select channel two with its associated quartz plate (Y_2) and tuned circuits consisting of an oscillator plate tuning coil (L_{12}), buffer tuning unit (L_{C12}), and power amplifier plate tuning coil (L_{10}). In the case of "Frequency 3" the position of the switch serves only to operate an additional frequency-changing relay (S_2) which transfers the grid of the oscillator from quartz plate (Y_2) to plate (Y_3), the frequencies of these two quartz plates being within one percent of each other.

The keying of the carrier is accomplished on the plate and screen grid of the oscillator tube (V_{10}) and in the plate circuit return of the power amplifier stage. When in operation, the keying relay (S_1) removes the ground from the d.c. supply to the plate and screen grid of the oscillator tube through a 10,000 ohm resistor (R_{55}) and a 25,000 ohm buffer grid resistor (R_{56}), and thence completes the plate return circuit to the power amplifier. In the "key up" condition a high cut-off bias is applied to the power amplifier. The shaping of the keyed character is accomplished by a .1 μ fd power amplifier grid by-pass condenser which tends to slow up the change in bias voltages applied to the power amplifier tubes.

The audio amplifier employs three stages: volume limiter, driver, and a class "B" modulator with an inverse feedback included between the latter two stages. With no speech applied, the volume-limiter stage adjusts itself to full gain. However, when speech voltages developed in the windings of the modulation transformer are sufficiently high to produce complete modulation of the carrier, a small amount of speech current flows through a winding in the modulation transformer, the volume limiter rectifier tube (V_9), and the time constant resistor (R_{26}) and condenser (C_{20}). The rectified voltage developed across this time constant resistor is applied to the control and mixer grids of the

(Continued on page 150)

NOW AVAILABLE
(without priority)

Duotone Aluminum Base Recording Blanks!

Retailers are invited to avail themselves of this new, improved, high-quality aluminum base, nitrate coated recording blank—now available for the first time without priority! Duotone's mass production facilities place us in the position of accommodating your requirements without delay. Write today for specific prices and literature. Immediate deliveries.

RELATED PRODUCTS: *Duotone Cutting Needles* for better cutting quality; *Duotone Hardening Fluid* which preserves the recording; the *Duotone "Star" Sapphire; Shadowgraphed Transcription Needles* for quality playbacks.

Duotone

DUOTONE COMPANY, 799 BROADWAY, NEW YORK 3, N. Y.

FREE

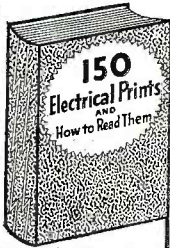

THIS VALUABLE ELECTRICAL BOOK

Big set of Shop Prints and Wiring Diagrams—Yours to Keep! FOR LOOKING OVER NEW 7-Vol. Set

APPLIED PRACTICAL ELECTRICITY

This 7-Vol. set, just off the press, covers everything electrical—wiring, lighting, A.C., D.C., motors, automotive, radio, refrigeration, air conditioning, RADIO, ELECTRONICS. Big section on home appliance repairs. Easy, practical, fully illustrated. Beginner or old-timer, you need this great set!

SEND NO MONEY! Coupon brings complete set for 7 DAY FREE TRIAL. Examine it, use on job. FREE 150 Shop Prints Book is YOURS to KEEP REGARDLESS OF WHETHER OR NOT YOU DECIDE TO KEEP THE 7-VOL. SET. Get out of the "one-operation" type of job—handle all kinds. Send for Set and FREE 150 Shop Prints Book NOW. Coupon is not an order, just a request to see the books!

COYNE ELECT. SCHOOL, Dept. C5-T3, 500 S. Paulina, Chicago 12, Illinois
Send postpaid 7-Vol. APPLIED PRACTICAL ELECTRICITY and FREE BOOK of 150 Shop Prints. In 7 days I'll return 7 vol. and owe nothing, or send \$3.00 and \$3.00 monthly until \$21 is paid, (cash price \$19.75—you save \$1.25). The 150 Shop Prints Book is mine to keep FREE regardless whether or not I keep the 7-Vol. Set.

NAME _____ AGE _____
ADDRESS _____
FIRM EMPLOYED BY _____

QRM-A Threat

(Continued from page 29)

teurs who expect to be active, will have to, in some manner, change our operating system and habits to conform to whatever situation we might face.

The time has passed, I believe, when a radio amateur can use just any old procedure of operation he happens to favor. Unless we practice self-discipline on the air we shall surely throttle ourselves.

Now, many of us have seen service, in one branch or another, with the armed forces—some of us in the field of publishing or in radio communications. We have seen how efficient and smoothly these communications have functioned in spite of the complexity of the job. How could this efficiency and smoothness be created? The answer, I would say, lies in discipline, cooperation, and, above all, in a carefully worked out technique.

Most of us have had enough regimentation to last us a life-time. We certainly do not want it to continue over into our peace-time lives and especially in the pursuit of our hobby. It should not be necessary. Why cannot we practice, without force, the clean operating habits we learned (in most cases—the hard way) while working with or for Uncle Sam.

The extent of self-discipline which we must practice to insure the fullest benefits of our hobby to all participating need not mean the sacrifice of any rights or privileges. Being citizens of a democratic country, we understand the principles involved in close cooperation with our fellow-men. All of us practice daily some form of self-discipline that benefits the nation as a whole, because it first benefits us as an individual. Since amateur radio is a hobby in which anyone can indulge (provided he can fill the requirements necessary to obtain a license) the same precepts of democracy can and should apply.

Personally, I believe it would be foolhardy for any one person to attempt to outline or set up a system that would be designed to eliminate entirely such a problem as the "qrm" of pre-war ham operating. However, a word of advice from one who battled this same problem should not be thought presumptuous. I think that participation of 25 years or so in a hobby gives a person the privilege of having a few ideas and opinions. So too—the hams of lesser duration.

So then—having briefly outlined what I personally consider a real threat to happy, trouble-free ham operating I would now like to offer several suggestions, the practice of which I feel will go far in alleviating much of our difficulty.

These suggestions are merely basic and are not intended as a cure-all or a complete solution to the problem.

JUKE BOX RECORDS

LATEST & HARD-TO-GET BACK NUMBERS

Some slightly used and some brand new—Victor, Bluebird, Columbia, Okeh, Decca, Capitol, etc. Such artists as Glenn Miller, Benny Goodman, Harry James, Bing Crosby, Frank Sinatra, Gene Autry, Duke Ellington, Fats Waller, Guy Lombardo, Andrews Sisters, Kate Smith, Ink Spots, Mills Bros., etc.

BIG PROFITS Your opportunity to cash in on this new field that is sweeping the country. Specify the type of music that sells best in your territory such as Swing, Sweet Music, Cow-boy, Hill-billy, Polkas, Blues, etc. Your price \$14.50 per 100 records, f.o.b. Chicago, net cash. All shipments made within 48 hours.

CHAS. HOODWIN CO.
4419 Broadway, E-15, Chicago 40, Illinois
World's Largest Dealers in Used Records



FILMGRAPH

AMAZING ALL-PURPOSE SOUND ON FILM CONTINUOUS RECORDER INSTANTANEOUS PLAYBACK

For Educational, Industrial, Commercial Purposes
Ideal for recording lengthy conferences, telephone conversations, sales talks, interviews, radio broadcasts, etc.
CONTINUOUS RECORDING—PLAYBACK
15 MIN. TO 11 HRS.

A sound-on-film recorder with a thousand-and-one uses. Unique patented features permit high fidelity recording without background noise for as low as 12 1/2 cc per hr.!

FILMGRAPH recordings are permanent; no technical knowledge or mechanical skill required for successful operation.
Other models available for making "talkies," office dictation, etc. Descriptive circulars and full information gladly furnished upon request—no obligation on your part. Write today.

MILES REPRODUCER CO.

812 Broadway New York 3, N. Y.
"MILES AHEAD OF OTHERS"

MASTER THE CODE with MASTER TELEPLEX



All A. C. operated. The only all-in-one instrument that will record your own sending and repeat it back.

Records signals from the air and repeats back at any speed.

The perfect instructor for both sending and receiving.

A postcard will bring full details and how you may secure MASTER TELEPLEX for ten day free trial. Ask for Booklet Q 12.

TELEPLEX CO. 107 Hudson St. Jersey City 2, N. J.

LES Correspondence Courses in RADIO and ELECTRICAL ENGINEERING

ELECTRICAL ENGINEERING Get good electrical field. Prepare yourself at Low Cost, for secure course. So simplified anyone can understand quickly.
RADIO ENGINEERING Extra fine course in radio, public address, photo-electric work. Train you to be super-service man, real vacuum-tube technician. Servicemen needed badly. Diploma on completion.
WRITE Send postcard or letter for Free Copy of school catalogs, full details, all about deferred payment plan, etc. **SEND NOW!** **LOW \$25 Either Course AS**
LINCOLN ENGINEERING SCHOOL, Box 931R-80, Lincoln 2, Nebr.

Specify SAUERISEN ACIDPROOF CEMENTS—COMPOUNDS FOR

Tanks, Sewers, Stacks, Floors
Technical cements for all purposes.
Send sketches or samples
Sauereisen Cements Company • Pittsburgh 15, Penna.

SAVE WASTE PAPER

● Save every scrap. Turn in old paper, dead files and records. Military and home front requirements are so great everyone must save.

GRAB TREE'S WHOLESALE RADIO

2608 Ross Ave.
DALLAS 1 TEXAS

RADIO NEWS

First: Remember the clean operating habits you picked up in the service. To you who are not acquainted with military communications procedure, these points can be stated very simply. (A) Send as little as possible consistent with getting your message through. (B) Make no unnecessary transmissions. (C) Use a dummy antenna when tuning and adjusting your transmitter. (D) Keep your transmitter tuned to peak efficiency. (E) Engineer your gear, if home built, to the highest degree possible. (This last is particularly important in the case of radio telephone. The phone bands are narrow enough and it does not take many broad phone signals on any of the bands to ruin that band for hundreds of other hams.)

Second: Choose, with care, the time best suited for the type of "qso" you want to carry on. Pick the later hours for your "DX" work, but if you are interested solely in local "rag-chewing" try to get on the air earlier. Of course, this will not be practical for all hams due to their breadwinning obligations. However, if practiced by all hams, when possible, a big difference will in all probability be noticed.

Third: Whenever possible, work in with a net. Ham nets can be roughly divided into two categories. There are the various traffic nets—organized to facilitate the handling of messages in times of emergency. These nets normally function smoothly and everyone has opportunity to chew the rag and exchange ideas with the other fellow. The experience gained in this type of operating is invaluable and it can be safely said that the aid we have given the nation in times of stress is the main reason we bask so much in the favor of our governing bodies.

The other type of net is the good old "round-table." Of this type, there were more or less permanent nets organized before the war that occupied one frequency and were in operation several times each week. Just an informal get-together. Then there were the same sort of nets that just "happened" whenever and wherever three or more hams found themselves bucking signals on the same frequency. Give these nets a try. I will guarantee they are interesting and very informative.

Fourth: Steer clear, if you can, of the more congested lower frequencies. Experiment with the "Very-highs" and let's chalk up more successes for hamdom in research and invention.

That's the story, fellows. There is nothing new in what I have written but the suggestions I have set forth here are based on experiences. If what I have suggested is practiced by the majority of active hams after the war I am sure that, while the "qrm" enemy may not be entirely licked, more hams will get more enjoyment out of their hobby—the incomparable Amateur Radio.

MORE QSO's WITH
The New **RME 45**

You'll have more QSO's with the new RME 45 — more schedules that you can keep — more elusive DX that you can enter in your log. Thanks to CAL-O-MATIC tuning you'll be listening to more stations in the band, too. And you'll log the frequency of these signals effortlessly on a hairline calibrated scale.

The RME 45 has been so engineered that it delivers peak performance on all frequencies — 550 to 33,000 K.C. Loctal tubes, short leads, temperature compensating padders, triple spaced condensers and advances made while producing for the armed forces — all these details have collaborated to give you the "hottest" and most stable reception you have ever listened to.

There's bandspread aplenty for the most exacting ham or commercial operator. The 20 meter band, 14,000 to 14,400 K.C., for instance, covers 20 divisions on the translucent dial — equivalent to 72 degrees on a five inch diameter disc.

The appearance of the RME 45 is consistent with its performance. The receiver is housed in a new streamlined two-toned cabinet and supplied with a matched acoustically designed speaker housing. These and a multitude of additional features make the new RME 45 the receiver that's definitely well worth waiting for.

Literature Describing the New RME 45 Will Be Gladly Sent You Upon Request.

RME RADIO MFG. ENGINEERS, INC.
Peoria 6, Illinois U.S.A.

SINCE 1933 TIME WITH TELL

NOW SOLD ON PRIORITY TO ESSENTIAL SERVICES

Electrical Training at Bliss

NOW OPEN TO VETERANS AND CIVILIANS
AFTER 3 YEARS OF WAR TRAINING

BLISS

Intensive 8 months' residence course in fundamentals of industrial electrical engineering, including radio and electronics. Extensive laboratory practice in electrical measurements; testing power equipment; circuit tracing; wiring techniques; radio and industrial electronics; use of machine tools; motor construction; drafting. Basic training meets industry's requirements for engineering aides, laboratory assistants; operating, production and maintenance technicians; customers' engineers; draftsmen.

Graduates hold responsible technical and executive positions in communications, power and manufacturing. Modern buildings, dormitories, dining hall, campus. Moderate cost. 54th class begins November 5. Catalog, 288 Takoma Ave., Washington 12, D.C.

ELECTRICAL SCHOOL
A TECHNICAL INSTITUTE



ENGINEERS WANTED

Here's an opportunity to join one of America's largest manufacturers of electronic and communications equipment.

Radio
 •Electrical
 Electronic
 Industrial
 (Job evaluation)
 •Mechanical
 •Factory Planning
 Materials Handling
 Manufacturing Planning

Work in connection with the manufacture of a wide variety of new and advanced types of communications equipment and special electronic products.

Write giving full qualifications, or apply to:

R. L. D., EMPLOYMENT DEPT.

Western Electric Co.

100 CENTRAL AV. KEARNY, N. J.

•Also: C. A. L.

Locust St. Haverhill, Mass.

Applicants must comply with WMC regulations

ENGINEERS

FOR DESIGN WORK
 ON RADIO RECEIVERS,
 AUDIO AMPLIFIERS,
 TELEVISION

Men with substantial experience wanted, preferably those having Degrees in Electrical or Communications Engineering. Write, giving details of experience and salary expected, to:

FREED RADIO CORPORATION

Makers of the Famous Freed-Eisemann Radio-Phonograph

200 Hudson Street
 New York 13, N. Y.

★ INDUSTRIAL ★ MAN-POWER BUREAU

FIELD SERVICE ENGINEERS

For Domestic and Foreign Service.
 And

INSTRUCTORS

Must Possess Good Knowledge of Radio
 Essential workers need release

HAZELTINE CORPORATION

58-25 Little Neck Parkway
 Little Neck, Long Island, N. Y.

ADVERTISING MANAGER FOR RADIO COMPONENTS MANUFACTURER

All-around, thoroughly experienced advertising man, familiar with graphic arts techniques and sources; all phases of trade and technical publication advertising; direct mail, preparation of sales promotion material, catalogs, internal and external house organs, publicity, and cooperation with advertising agency. Locate in Southeastern Massachusetts with long-established and leading manufacturer of radio-electronic components. Radio or electrical experience or knowledge desirable but not essential. Excellent opportunity for right man. Give details and salary requirements, with candid photo, in first letter. Write Box 407, % Radio News, 185 N. Wabash, Chicago 1, Ill.

WANTED

RADIO ENGINEERS
 SPEAKER ENGINEERS
 COIL ENGINEERS
 CHIEF INSPECTOR
 FOREMAN—coil winding dept.
 FOREMAN—speaker dept.
 Men and Women for Quality Control Department

Write giving details about age, experience, past salaries to

TRAV-LER KARENOLA RADIO & TELEVISION CORPORATION
 ORLEANS, INDIANA.

RADIO STATION TECHNICIANS

MEN AND WOMEN

for Point-to-Point International Radio-Telegraph Stations in the United States.

Applicants must possess FCC radio-telegraph commercial license, and ability to copy International Morse code at about 20 wpm.

WMC rules observed

Apply weekdays except Saturdays between 10 am and 3 pm or write

PERSONNEL DEPARTMENT

RCA COMMUNICATIONS, Inc.

64 Broad Street
 NEW YORK 4, N. Y.

WANTED

RADIO ENGINEERS
 SPEAKER ENGINEERS
 COIL ENGINEERS
 CHIEF INSPECTOR

Men and Women for Quality Control Department

FOREMAN—coil winding dept.

FOREMAN—speaker dept.

Work in connection with manufacture of radio sets and components.

Write giving details about age, experience, past salaries to

KEITH RADIO PRODUCTS
 BEDFORD, INDIANA.

CHIEF ENGINEER

Prominent, old and established Radio Manufacturer in the East seeks services of top Chief Engineer, able to take over entire department, thoroughly experienced in designing straightforward radio receivers in small, medium and large brackets; must be up-to-the-minute in knowledge of FM and Television. Salary commensurate with ability. Wonderful opportunity for right man.

Write Box 406

% RADIO NEWS, Empire State Bldg., New York 1, N. Y.

"This section is designed to help the radio industry obtain trained, experienced, technical men to facilitate vital war production. Before applying for any of these positions consult your local United States Employment Service office to determine War Manpower Commission regulations concerning the changing of jobs. If you are already employed in war work at your highest skill, stick to your present job."

ELECTRONIC ENGINEERS!

War-Winners Today, Post-War Builders Tomorrow!

Leaders in NATIONAL UNION RADIO CORPORATION'S staff of engineers, scientists and technicians have brought us far out in front in the electronic industry. We have a research laboratory and two manufacturing plants in Newark, N. J., and a manufacturing plant near Philadelphia, Pa. We invite you to consider your opportunities with us for professional advancement, stimulating, friendly associations, and a future with promise.

NATIONAL UNION NEEDS:

SENIOR TUBE ENGINEERS: These men **MUST** have actual experience with radio tube manufacture. The pay and opportunities are commensurate with your ability.

COMMERCIAL ENGINEERS: Engineers interested in developing electronic tube applications, who may represent us among radio manufacturers upon occasion.

QUALITY CONTROL MEN AND WOMEN: Here you need an interest in the practical application of statistical and/or engineering procedures to many factory processes.

TEST EQUIPMENT ENGINEERS: Men experienced with meters or electronic test equipment to work either as **TEST EQUIPMENT DESIGN ENGINEERS** or as **MEASUREMENT LABORATORY ENGINEERS**.

JUNIOR ENGINEERS—MEN AND WOMEN: Do you have a college degree in Physics, Electrical Engineering, Chemical Engineering, Mechanical Engineering, Mathematics or Chemistry? This company offers an opportunity for young, ambitious graduates to assume responsibilities and to exercise initiative.

WOMEN!

We have a number of fine young women engineers with us now. We need more. If you have a degree in Electrical Engineering, Chemical Engineering, Mechanical Engineering, Physics, Chemistry or Mathematics and are seeking career opportunities, investigate.

If you have thorough training in your field, as evidenced by job experience in radio or allied industries, or by a college degree—if you have ambition, initiative and resourcefulness—if you have the ability to inspire your co-workers, then . . .

Phone or Write

DR. L. GRANT HECTOR

Director of Engineering

NATIONAL UNION RADIO CORPORATION

Plane St. at Raymond Blvd.

Newark 2, New Jersey

WMC RULES OBSERVED

Technical Writers Wanted!

Engineers and physicists who have had experience in (spare time) writing technical manuscripts on electronic design or applications including radio, television, facsimile, etc.

Reply Box 310, c/o RADIO NEWS, 185 N. Wabash Ave., Chicago 1, Ill.

OPENINGS FOR RADIO ENGINEERS ELECTRICAL ENGINEERS MECHANICAL ENGINEERS

In the development and production of all types of radio receiving and low-power transmitting tubes. Excellent post-war opportunities with an established company in a field having unlimited post-war possibilities.

Apply in person or in writing to:

Personnel Manager

**RAYTHEON
MANUFACTURING CO.**

**Radio Receiving Tube Div.
55 Chapel St., Newton, Mass.**

WANTED RADIO ENGINEERS FOR

- Radio circuit design
- Mechanical chassis and cabinet design
- Coil design

**TRAV-LER KARENOLA RADIO
& TELEVISION CORPORATION**
571 W. Jackson Blvd.
CHICAGO 6, ILLINOIS

Now for EVERY WORK SHOP!
NEW Invention Electroplates by BRUSH



Easy to Plate CHROMIUM GOLD, SILVER, NICKEL, COPPER
For Pleasure and Profit!

If you have a workshop—at home or in business—you need this new Warner Electroplater. At the stroke of an electrified brush, you can electroplate models and projects—you can replat worn articles, faucets, tools, fixtures, silverware, etc with a durable, sparkling coat of metal—Gold, silver, Chromium, Nickel, Copper or Cadmium. Method is easy, simple, quick. Everything furnished—equipment complete, ready for use. *By doing a bit of work for others, your machine can pay for itself within a week.* So make your shop complete by getting a Warner Electroplater right away. Send today for FREE SAMPLE and illustrated literature. **ACT AT ONCE!**

WARNER ELECTRIC CO., Dept. C-58
663 N. Wells St., Chicago 10, Illinois

FREE Details & Sample!

WARNER ELECTRIC CO., 663 N. Wells St., Chicago 10, C-58. Gentlemen: Send Free Sample and Details to:

Name _____
Address _____
City _____ State _____

FREE BOOK SHOWS SHORT CUT TO CODE SPEED

ENDORSED BY CHAMPIONS
Skill, speed, accuracy free of nervous tension brings big pay.
The One and Only Candler System
Nothing else like it. It is the course that has made code champions. Will help any sincere man gain greater speed, accuracy and skill. Learn the Candler way.
Fast, Efficient Operators Needed
If you need additional speed to be classed as an expert, try the Candler method. It is endorsed by champions. It has produced phenomenal results with a minimum of effort. Why not learn the faster and easier way. Get your copy of the Book of Facts for Code students, Telegraph and Radio Operators.
CANDLER SYSTEM CO.
P. O. Box 928, Dept. 2-J, Denver (1), Colo.

BUILD YOUR OWN! FAST-FREEZER It's Easy and Fun

Every amateur will be proud to build this modern household necessity. It just takes a few hours of your spare time to build, and operates electrically on any voltage. There's fun in building and profit in using this handy freezer. Saves up to 75%.
NO EXPERT KNOWLEDGE NEEDED
Our plans are simple and easy to follow and this 8 to 40 cubic foot size can be built of new or used parts. Mail \$1 bill, check or money order for complete plans and catalog.
LEJAY MFG., 454 LeJay Bldg., Minneapolis 8, Minn.
150

11,500 Mile Radio Net
(Continued from page 145)

volume limiter tubes. Thus, any tendency of speech to increase beyond the value which produces full modulation results in high bias applied to the volume limiter and a consequent reduction in the gain of this stage.

The transmitter may be modulated by means of the hand-set microphone (MK₁) located on the front panel of the set. Operation of a "press-to-talk" button located on the hand-set handle operates the carrier control relay and furnishes current to the microphone from a high voltage divider on the 115 volt bias circuit.

Also located on the front panel of the set is a test key (K₁) for locally controlling the carrier during the tuning process or for routine checking of the operation of the transmitter.

With regard to the necessary input requirements, the transmitter is normally furnished for operation on 200 to 250 volt, 60-cycle a.c. supply. When 50-cycle operation is desired, the only change necessary in the transmitter is replacing the time-recording meter (M₁) with one designed for 50-cycle operation. The input power to the transmitter for various operating conditions is shown in Table I.

The farsightedness of Pan American Airways' officials in procuring an adequate supply of these transmitters was dramatized in 1941, when several months before Pearl Harbor President Roosevelt directed the establishment of an aerial highway across Africa to the Middle East, the main purpose of the directive being to establish an aerial transport service by means of which defense-aid aircraft and supplies could be delivered swiftly and safely into the hands of the hard-pressed Allied forces. The service quickly became an impressive reality.

Today this "Cannonball" service helps to supply our own forces as well as the Allies. It is operated by Pan American World Airways under contract to the Air Transport Command of the United States Army Air Force.

-30-

Photo Credits

| Pages | Credit |
|------------|--|
| 25, 26, 27 | A.A.F. Training Command Scott Field, Illinois |
| 36 | RCA |
| 39 | General Electric Company |
| 50 | Pan American World Airways |
| 53 | Station WBKB, Chicago |
| 62 | Dutch Philips Company |
| 78 | Severance Studios |
| 83 | Magazines, Inc. |

Erratum
The screen voltages to two tubes shown in the diagram on page 102 of the July, 1945, issue of RADIO NEWS have inadvertently been omitted. The screens should have been connected to the main "B" voltage supply.

Classified
Rate 20c per word, Minimum, 10 words

RADIO ENGINEERING
RADIO Engineering, Broadcasting, Aviation and Police Radio, Servicing, Marine Operating and Electronics taught thoroughly. Expenses low. Write for catalog. Valparaiso Technical Institute, Dept. N, Valparaiso, Ind.

PATENT ATTORNEYS
RANDOLPH & Beavers: Registered Patent Attorneys, 331-E Columbian Building, Washington, D. C. In order to Protect your invention and reap the reward that should be yours, Patent your invention without delay, and at the same time have Rights to sell as Manufacturers convert to Civilian Production. Write for Information and Record Form Today.

PATENTS SECURED. Two valuable booklets sent free. Write immediately. Victor J. Evans & Co., 948 H Merlin Bldg., Washington 6, D. C.

RADIO EQUIPMENT
RADIO Service men and experimenters send for our giant radio catalogue. Save dollars. United Radio Co., (1000M) Newark, N. J.

CORRESPONDENCE COURSES
USED Correspondence Courses and Educational Books sold or rented. Inexpensive. Money-back guarantee. Write for Free Catalog listing 4000 bargains.—(Courses Bought.)—Lee Mountain, Pisgah, Ala.

CORRESPONDENCE Courses and self-instruction books, slightly used. Sold. Rented. Exchanged. All subjects. Satisfaction guaranteed. Cash paid for used courses. Complete information and 92-page illustrated bargain catalog FREE. Write Nelson Company, Dept. 2-59, Chicago 4.

FOR SALE
RECTIFIERS—Halfwave, 5 Amperes, \$4.50; 2.2 Amperes, \$2.25; 1.5 Amperes, \$1.85. Fullwave, 1 Ampere, \$2.50; .5 Ampere, \$1.85. Maximum 13 volts input. List free. Milton Bursma, Route 5, Grand Rapids, Mich.

BZZER Code Practice set complete with key, battery and instructions. Sends real wireless signals. Only \$1.65. Two sets \$3.00. Guaranteed. Rathert Electric, Dept. N, Cresco, Iowa.

LOWEST Prices. Radio Tubes, parts. Bargain lists 3c. Potter, 1314 McGee, Kansas City 6, Mo.

UNIVERSAL Midget Tools. Dandy Sixteen Piece Set. Midget Pliers, Diagonal Cutters, Four Midget End Wrenches, Needle-nose Pliers, Screwdriver, Six Punches and Chisel, Round File, Midget Crescent Wrench, \$14.85. Immediate shipment—Overnight by Air to anywhere USA. Remit today. Mfr. Price List and Order Blank Free. Universal Tool Company, 1527 Grand RN, Kansas City, Mo. Remember: We have it, can get it, or it isn't made.

BUILD radio complete with tubes \$10.95, details. Radio, 9418a Avenue "A", Brooklyn, N. Y.

LEADING radio retailers, buy our hobby, sporting, toy, game, other fast-selling merchandise. Boost radio business. Riolem, Riolem Bldg., New Rochelle, N. Y.

WANTED

SONG Poems wanted to be set to music. Send poem for immediate consideration. Five-Star Music Masters, 420 Beacon Bldg., Boston 8, Mass.

ENGINEERS, interested in affiliation with national engineering service organization as consultants. Write Box 1065-D, Los Angeles 28, Calif.

MANUSCRIPTS Wanted. Radio servicing book manuscripts wanted. Prompt consideration. Supreme Publications, Chicago 12, Illinois.

EXPORT TO Scandinavia. We are buyers of every kind of Radio Tubes, television tubes, radio parts and small radio receivers. Payment cash against documents by the Svenska Handelsbanken, Stockholm. Offers and samples to Ake Setterlund Co., Importers, Radio Dept. Ehrenstrahlsveg 23, Stockholm, Sweden.

MISCELLANEOUS

MAGAZINES (back dated) — foreign, domestic, arts. Books, booklets, subscriptions, pin-ups, etc. Catalog 10c (refunded). Cicerone's, 863 First Ave., New York 17, N. Y.

RADIO Book Catalog. Out soon: new complete Catalog of radio books and manuals for beginners and experienced radio men. Write for your free copy of Catalog 4. Radionic Equipment Co., Dept. RN-8, 170 Nassau St., New York 7, N. Y.

Radar Terms

(Continued from page 41)

Indicator—Any of several types of cathode ray oscilloscopes.

Indicator gate—See Gate.

Isolating circuit—A stage which passes signals in only one direction through a circuit.

Klystron—A velocity modulated tube used to produce low-power u.h.f. oscillations.

Lighthouse tube—A high-frequency triode of special design used to produce u.h.f. oscillations of medium power.

Limitter—A circuit which limits, clips, or removes either (or both) the positive or negative extremities of a wave form.

Listening period—The time during which a radar transmitter is quiescent or not radiating energy.

Magnetron—A high-frequency magnetic-field diode of special design used to produce u.h.f. oscillations of very high power.

Main pulse—See transmitter pulse.

Master oscillator—A source of timing oscillations which control or affect all other radar circuits.

Microsecond—One millionth of a second.

Modulator—A circuit which directly controls or triggers the radar transmitter.

Multivibrator—A relaxation oscillator which oscillates of its own accord (a free-running multivibrator), or which oscillates only when triggered by an external voltage.

Overdriven amplifier—Amplifier circuit in which the combination of cut-off limiting and saturation limiting of a sine wave produce a rectangular voltage wave.

Peaking circuit—A differentiator circuit used to sharpen a wave form.

Peak power—The maximum output power of an r.f. pulse at the transmitter.

Presentation—The form in which radar echoes appear visually on an oscilloscope.

Pulse—A sudden change of voltage (or current) of brief duration.

Pulse duration—The time duration of a pulse.

Pulse generator—See Electronic timer.

Pulse rate—See Pulse recurrence frequency.

Pulse recurrence frequency or p.r.f.—The timing rate of radar pulses, originating in the electronic timer.

Pulse recurrence time—The reciprocal of pulse recurrence frequency.

Pulse width—See pulse duration.

Quiescent period—See Listening period.

R.F. oscillator—Output stage of the radar transmitter in which u.h.f. oscillations are generated.

Range—The direct-line distance between a radar set and a target.

Receiver—The component of a radar set which receives, detects, and amplifies echoes reflected from targets.

Receiver gate—See Gate.

Recurrence rate—See Pulse recurrence frequency.

Repetition rate—See Pulse recurrence frequency.

Ring oscillator—Any number of pairs of high-frequency triodes operated as an r.f. oscillator in a tuned-grid tuned-plate circuit.

Rotary spark gap—A pulse-producing device in which circularly arranged electrodes are rotated past a fixed electrode producing periodic high-voltage arc discharges.

Saturation limiting—Limiting action of an amplifier when operated beyond the point where grid current flows.

Scanning—The direction of pulsed r.f. energy over or across a given region or area.

Sea return—That part of the r.f. pulse reflected by water surrounding a sea-borne radar set.

Spark gap—An arrangement of two fixed electrodes between which a high-voltage arc discharge takes place.

Squaring amplifier—See Overdriven amplifier.

Squegging oscillator—An extreme form of grid blocking in an r.f. tuned-grid tuned-plate circuit.

Synchronism—The relationship between two or more periodic or recurrent wave forms, when the phase difference between them is zero.

Synchronizer—See Electronic timer.

Tail—Attenuated decay of an r.f. pulse.

Target—Any object which produces a radar echo.

Time base—The trace produced on the screen of a cathode ray tube by deflection of the electron beam.

Time constant—An indication of the speed with which a circuit can be charged or discharged.

Timer—See Electronic timer.

Transmitter pulse—Burst of r.f. energy radiated by the radar transmitter. The pulse appears as a strong signal at the left end of the oscilloscope time base.



LECTROHM RESISTORS

differ —

- (1) in being the only specialty of Lectrohm.
- (2) in being a product of specialized experience.
- (3) in being produced under personalized supervision.

—all of which totals up to the highest standard of dependable operation obtainable in a production item. Then, too, the Lectrohm Line offers you a wide selection of fixed, adjustable, ferrule terminal and "Rib-on-edge" resistors, Power line and RF plate chokes. Send your specifications for recommendations.



5131 West 25th Street, Cicero 50, Illinois
Division of The National Lock Washer Co., Newark, N. J.

RADOLEK

Radio- Electronic Service Parts

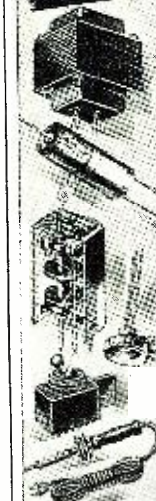

Large stocks assure the finest and most complete selections of all available items at lowest prevailing prices. Thousands of active buyers depend on us for their entire Radio repair and replacement requirements. Because we understand service problems, every order is expedited for delivery in double quick time. Everything we do is planned for convenience and satisfaction to our customers. You will find it profitable to make Radolek your buying headquarters.

FREE BUYING GUIDES

Because of existing conditions we keep our customers right up to the minute on available merchandise by releasing supplements frequently instead of sending our regular Big Profit Guide once a year. Send the coupon now to get these Free Buying Guide Supplements as they are issued.

FREE!



FAST SERVICE!

RADOLEK CO., Dept. B-105
601 W. Randolph St., Chicago 6, Ill.
Please send FREE Buying Guide Supplements

NAME _____
ADDRESS _____

ORDER FROM RADOLEK

**In the Rocky Mountain Region
it's**

RADIO & TELEVISION SUPPLY CO.
810 EUCLID AVE., PUEBLO, COLO.

*"If we don't have it, we'll get it—
or it can't be had!" Phone 5729"*

RCA INSTITUTES

Offer thorough training courses in all technical phases of
Radio and Television

WEEKLY RATES DAYS—EVENINGS

VETERANS: RCA Institutes is approved under G. I. Bill of Rights.
For Free Catalog write Dept. RN-45
RCA INSTITUTES, Inc.
A Radio Corporation of America Service
75 Varick St., New York 13, N. Y.

TEST EQUIPMENT
—NOW AVAILABLE—

With AA-5 or higher priority.

SUPERIOR PB-100—volt-ohm-milliammeter \$28.40

SUPERIOR CA-10—signal tracer with tube 14.85

RADIO CITY 805 tube and set tester 89.50

25% deposit with order, balance C.O.D.
Write for Bulletin G-1

SCENIC RADIO & ELECTRONICS CO.
53 Park Place New York City 7

PATENTS and TRADE MARKS

Protect and profit by your ideas. Full information on request. Prompt expert service. 30 years' experience.

LESTER L. SARGENT
Registered Patent Lawyer
Post Office Box 3156
1115 K. St., N. W., Washington, D. C.

PEN-OSCIL-LITE

Extremely convenient test oscillator for all radio servicing alignment. • Small as a pen • Self powered • Range from 700 cycles audio to over 600 megacycles u.h.f. • Output from zero to 125 v. • In use by Signal Corps.

GENERAL TEST EQUIPMENT CO.
38 Argyle Buffalo 9, N. Y.

Ted McElroy

World's Largest Manufacturer of
Wireless Telegraphic Apparatus

COMPLETE CENTRAL OFFICE EQUIPMENT

McElroy Manufacturing Corp.
82 Brookline Avenue • Boston, Massachusetts

| ADVERTISER | AGENCY | PAGE | ADVERTISER | AGENCY | PAGE |
|--------------------------------------|--------------------------------------|--------------|---|--|----------------|
| Aerovox Corporation | Austin C. Lescarbourea & Staff | 153 | Miles Reproducer Co. | Altomari Advertising Agency | 146 |
| Alliance Manufacturing Company | Campbell-Sanford Adv. Co. | 98 | Millen, James Mfg. Co., Inc. | Millen, James, Inc. | 12 |
| Allied Radio Corporation | Henry H. Teplitz | 9, 64 | Murdock, Wm. J. Company | John A. Smith & Staff | 60 |
| Alpha Meter Service | Burke & Wayburn Adv. Co. | 122 | McElroy Manufacturing Corp. | Shappe-Wilkes, Inc. | 181 |
| American Phenolic Corporation | Evans Associates, Inc. | 18 | McGraw-Hill Book Company | | 120 |
| American Radio Institute | Sternfield-Godley, Inc. | 118 | McMurdo Silver Company | Charles Brunelle | 86 |
| Art Radio Corp. | Sternfield-Godley, Inc. | 140 | National Company | Graydon Smith Advertising | 154 |
| Ashbach, Leonard Company | Leiber Advertising Company | 118 | National Electronic Supply | Louis B. Didier | 90 |
| Atlas Sound Corporation | Burke & Wayburn Adv. Co. | 108 | National Radio Institute | Vansant, Dugdale & Company | 3 |
| Audak Company | Hart Lehman | 8 | National Schools | Mayers Company, The | 63 |
| Audel, Publishers | Grant & Wadsworth, Inc. | 122 | National Union Radio Corporation | Hutchins Advertising Co. | 89, 149 |
| Bell Sound Systems, Inc. | Wheeler-Kight & Gainey, Inc. | 102 | Newcomb Audio Products Co. | Gail Hall Advertising | 140 |
| Bell Telephone Laboratories | N. W. Ayer & Son, Inc. | 93 | Ohmite Manufacturing Co. | Henry H. Teplitz | 59 |
| Belmont Radio Corporation | Beaumont & Hohman, Inc. | 123 | Olson Radio Warehouse | Jessop Advertising Agency | 124 |
| Best Vibrator Co. | | 118 | Omaha Radio Products Company | | 144 |
| Bliley Electric Company | Hardy Advertising | 20 | Onan, D. W. & Sons | Graves & Associates | 116 |
| Bliss Electrical School | N. W. Ayer & Son, Inc. | 147 | Permoflux Corporation | Turner Advertising Agency | 139 |
| Burgess Battery Company | Howard H. Monk & Associates | 88 | R.C.A. Communications, Inc. | Albert Frank-Guenther Law, Inc. | 143 |
| Burstein-Applebee Company | Frank E. Whalen Adv. Co. | 128 | RCA Institutes, Inc. | | 151 |
| Candler System Company | Van De Mark Advertising, Inc. | 150 | R-L Electronic Corporation | R. S. Wittenberg Advertising | 130 |
| Capitol Radio Engineering Institute | Henry J. Kaufman Advertising | 97 | Radiart Corporation | Kenneth H. Kolpien | 121 |
| Cinaudagraph Speakers, Inc. | Michael F. Mayger, Advertising | 90 | Radio Corp. of America Victor Div. | Kenyon & Eckhardt, Inc. | 65, Back Cover |
| Clare, C. P. & Co. | Hamilton Advertising Agency, Inc. | 143 | Radio Corporation of America | J. Walter Thompson Company | 17 |
| Concord Radio Corporation | E. H. Brown Adv. Agency | 66 | Radio Mfg. Engineers, Inc. | Rudolph Bartz Advertising | 147 |
| Connecticut Telephone & Elec. Div. | Wilson & Haight, Inc. | 91 | Radio Parts Company | Sidney S. Lovitt | 100 |
| Cornell-Dubilier Electric Corp. | Reiss Advertising | 131 | Radio Supply & Engineering Co., Inc. | Karl G. Behr | 92 |
| Coyne Electrical School | McJunkin Advertising Company | 86, 120, 146 | Radio & Television Supply Co. | | 151 |
| Crabtree's Wholesale Radio | | 146 | Radio Tube Service Co., Inc. | Daniel De Koven | 114 |
| DeForest's Training, Inc. | MacDonald-Cook Company | 15 | Radio Wire Television, Inc. | Diamond Seidman Co. | 104 |
| Delco Radio Division General Motors | Campbell-Ewald Company | 21 | Radionic Equipment Co. | Hirshon-Garfield, Inc. | 146 |
| Drake Electric Works, Inc. | William Hoffman & Associates | 126 | Radolek Company | Turner Advertising Agency | 151 |
| DuMont, Allen B., Laboratories, Inc. | Austin C. Lescarbourea & Staff | 119 | Rauland Corporation, The | Roy D. Zeff Associates | 76, 77 |
| Duotone Company | Maxon, Inc. | 145 | Raytheon Manufacturing Company | Burton Browne Advertising | 105 |
| Eastern Amplifier Corporation | Roberts & Reimers, Inc. | 22 | Raytheon Manufacturing Co. | | 149 |
| Echophone Radio Company | Burton Browne Advertising | 75 | Rowe Industries | Miller Agency Company, The | 124 |
| Electrical Reactance Corporation | Schel Advertising Agency | 144 | Sargent, Lester L. | | 151 |
| Electronic Laboratories, Inc. | Burton Browne Adv. Third Cover | | Sauerisen Cements Company | McCarty Company | 146 |
| Electronic Service & Supply | Burke & Wayburn Adv. Co. | 138 | Scenic Radio & Electronics Co. | | 151 |
| Federal Radio and Electric Co., Inc. | Sternfield-Godley, Inc. | 6 | Setchell-Carlson, Incorporated | Geer-Murray Company | 127 |
| Federal Telephone & Radio Corp. | Marschalk & Pratt Co. | 23, 82 | Shure Brothers | Phil Gordon Agency, The | 135 |
| Finest Radio Service | | 86 | Simpson Electric Company | Kreicker & Meloon, Inc. | 115 |
| Freed Radio Corporation | Lawrence Fertig & Co., Inc. | 148 | Slate & Company | Daniel De Koven | 112 |
| Gates Radio Company | Ridgeway Company | 129 | Snyder Manufacturing Company | Philip Klein Adv. Agency | 106 |
| General Cement Mfg. Co. | Turner Advertising Agency | 116 | Solar Capacitor Sales Corp. | O. S. Tyson Company, Inc. | 13 |
| General Test Equipment Co. | Suzanne Hayman Advertising | 151 | Sound Equipment Corp. of California | Beaumont & Hohman, Inc. | 98 |
| Greenlee Tool Company | Howard H. Monk & Associates | 128 | Sprague Products Company | Harry P. Bridge Advertising | 10, 81 |
| Hallicrafters Company, The | Burton Browne Advertising | 5 | Sprayberry Academy of Radio | Harry P. Bridge Advertising | 19 |
| Hammarlund Mfg. Co., Inc., The | Roeding & Arnold, Inc. | 24 | Standard Transformer Corporation | Burnet-Kuhn Advertising Co. | 70 |
| Harco Co., Inc. | Lewis Advertising Agency | 142 | Stark's | C. Wendel Muench & Co. | 136 |
| Harvey Radio Company | Shappe-Wilkes, Inc. | 96 | Stevens Walden, Inc. | Howard-Wesson Co. | 14 |
| Hazeltine Corporation | Equity Advertising Agency | 148 | Stromberg-Carlson | McCann-Erickson, Inc. | 99 |
| Hoodwin, Chas., Company | Stewart, J. L., Agency | 146 | Superior Instruments Company | Loewy Advertising Agency | 85 |
| Hytron Radio & Electronics Corp. | Henry A. Loudon Advertising | 109 | Supreme Instruments Corp. | O'Callaghan Adv. Agency, Inc. | 61 |
| Illinois Condenser Company | Sander Rodkin Adv. Agency | 132 | Supreme Publications | Henry H. Teplitz | 126 |
| International Detrola Corporation | Zimmer-Keller, Inc. | 113 | Sylvania Electric Products, Inc. | Newell-Emmett Company | 111 |
| Islip Radio Mfg. Corporation | Kotula Company | 130 | Talk-A-Phone Mfg. Company | Dwight M. Blish | 134 |
| Jensen Radio Manufacturing Co. | Burton Browne Advertising | 7 | Technical Division, Murray Hill Books, Inc. | Harry P. Bridge Advertising | 72, 73 |
| Johnson, E. F. Company | David, Inc. | 101 | Teleplex Co. | Terrill Belknap March Asso. | 146 |
| Kaar Engineering Co. | Conner Company, The | 133 | Templetone Radio Mfg. Corp. | Peck Advertising Agency | 95 |
| Kato Engineering Co. | | 132 | Terminal Radio Corporation | Sternfield-Godley, Inc. | 141 |
| Keith Radio Products | | 148 | Thordarson Electric Mfg. Company | Duane Wanamaker Adv. | 117 |
| Kelnor Manufacturing Company | Kelso Norman Advertising | 136 | Trav-Ler Karenola Radio & Television Corporation | | 148, 149 |
| Knights, James Company, The | Turner Advertising Agency | 74 | Triplett Electrical Instrument Co. | Western Advertising Agency | 67 |
| Kurz-Kasch, Inc. | Kircher, Lytle, Helton & Collett | 125 | Ungar Electric Tools, Inc. | Milton Weinberg Adv. Co. | 110 |
| Lake Radio Sales Co. | Sander Rodkin Adv. Agency | 80 | United Transformer Corp. | Shappe-Wilkes, Inc. | 11 |
| Lechtrohm, Incorporated | Merchandising Advertiser | 151 | Universal Microphone Company | Ralph L. Power, Ph.D. | 16 |
| LeJay Mfg. | Frizzell Adv. Agency, Inc. | 150 | Universal Tool Company | R. J. Potts-Calkins & Holden Agency | 102 |
| Lifetime Sound Equipment Co. | Miller Agency Company, The | 134 | Utah Radio Products Company | Abbott Kimball Co., Inc. | 79 |
| Lincoln Engineering School | Buchanan Thomas Adv. Co. | 146 | Ward Leonard Electric Co. | E. M. Freystadt Asso., Inc. | 69 |
| Mallory, P. R. & Co., Inc. | Aitkin-Kynnett Co. | 87 | Ward Products Company | Burton Browne Advertising | 84 |
| Manor Electric & Appliance Co. | Sander Rodkin Adv. Agency | 142 | Warner Electric Company | Mason Warner Co. | 150 |
| Marion Electrical Instrument Co. | Shappe-Wilkes, Inc. | 71 | Weller Manufacturing Company | | 108 |
| Meck, John, Industries | Fensholt Co., The | Second Cover | Western Electric Company | Deutsch & Shea | 148 |
| Meissner Manufacturing Company | Gardner Advertising Co. | 103 | Westinghouse Electric Corporation | Fuller & Smith & Ross, Inc. | 107 |
| Metallic Arts Company | Cory Snow, Inc. | 138 | Wholesale Radio Laboratories | Pfeiffer Advertising Agency | 94 |
| | | | Workshop Associates | Larcom Randall | 137 |

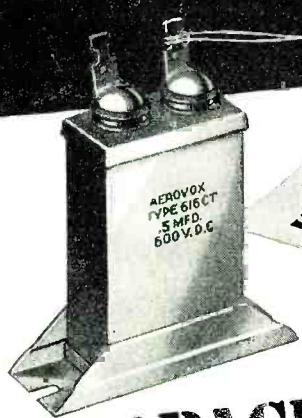

Just another of the quality controls that put the final OK on AEROVOX

CAPACITOR CRAFTSMANSHIP

• "Leakers" are few and far between in Aerovox oil capacitors. And here's why: Each and every oil-filled capacitor is examined under ultra-violet or so-called "black" light. The slightest trace of impregnating oil seeping through seams or cracks in containers, shows up as a bright fluorescent spot as the operator peers through the cabinet window. A "leaker" just cannot get by.

Such typical Aerovox quality inspection

means much to the oil capacitor user. The life of such capacitors is dependent upon perfect hermetic sealing. This prevents the entry of moisture. Also, even a slight oil leak might damage or interfere with the operation of associated equipment.

Outstanding quality control — from incoming raw materials through each step in production and on to final inspection — is the final endorsement of Aerovox Capacitor Craftsmanship.

• Submit your capacitance problems and requirements.



AEROVOX



Capacitors

INDIVIDUALLY TESTED

AEROVOX CORPORATION, NEW BEDFORD, MASS., U. S. A.

SALES OFFICES IN ALL PRINCIPAL CITIES

Export: 13 E. 40 ST., NEW YORK 16 N. Y. • Cable: 'ARLAB' • In Canada: AEROVOX CANADA LTD., HAMILTON, ONT.

August, 1945

153

NATIONAL RECEIVERS ARE THE EARS OF THE FLEET

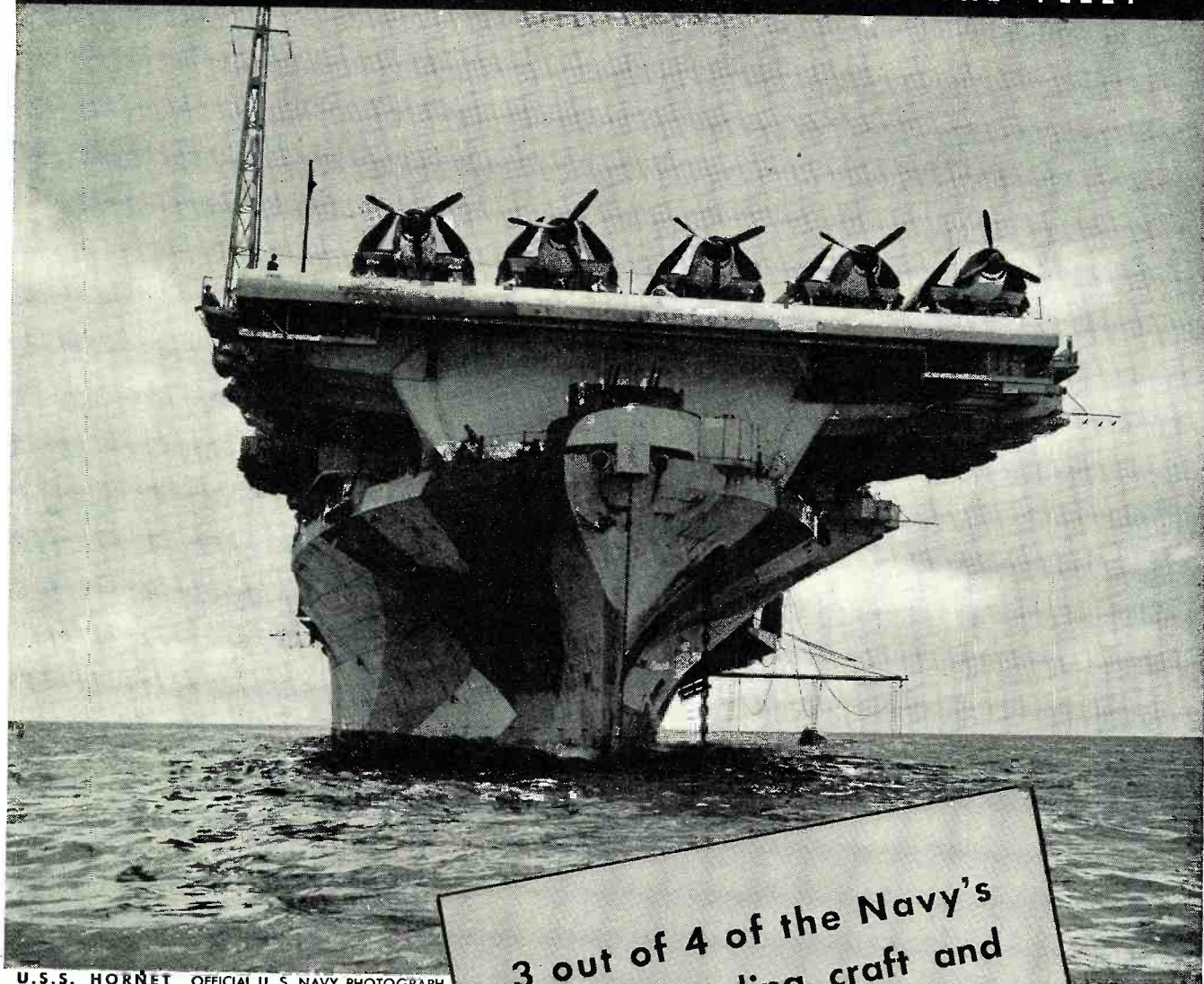

U.S.S. HORNET OFFICIAL U. S. NAVY PHOTOGRAPH

3 out of 4 of the Navy's
ships—landing craft and
larger—use receivers
designed by National.

A capital ship is no place
to use anything but the
finest in radio equipment.



NATIONAL COMPANY

MALDEN MASS, U. S. A.



NATIONAL RECEIVERS ARE IN SERVICE THROUGHOUT THE WORLD
Printed in U. S. A. RADIO NEWS

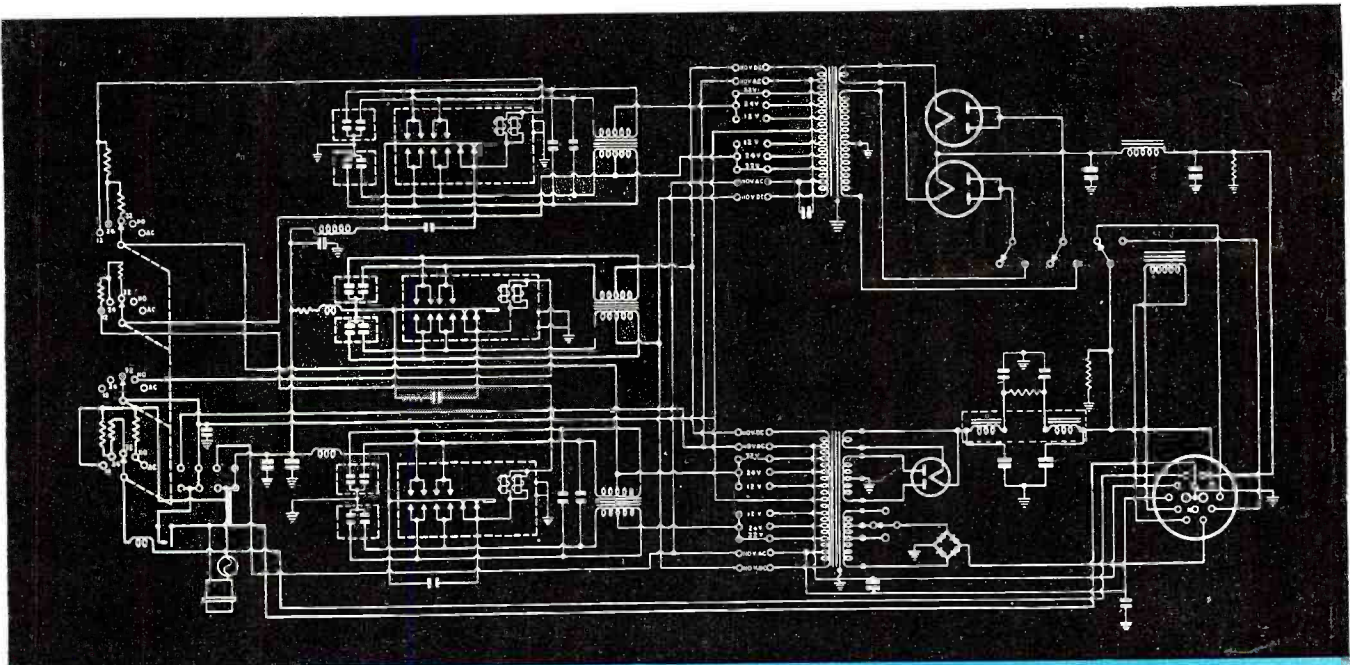

***EL* DEVELOPMENTS PROVIDE MULTIPLE INPUTS AND OUTPUTS IN VIBRATOR POWER SUPPLIES**

● Electronic Laboratories has greatly increased the flexibility of power supply design and versatility of power conversion circuits, through special new developments during the war period. One of these, resulting from intensified research to meet military needs, is vibrator power equipment capable of delivering various voltages, currents and frequencies from a variety of input voltages. This naturally has vastly broadened the field for vibrator power conversion equipment.

The typical circuit diagram shown above illustrates a multiple input and output system. This power unit is designed to be operated from either 12, 24, or 32 volts from storage batteries, or 110 volt DC or AC power lines. Various outputs are available to supply the high voltage plate current required for the grid, and the AC voltages suitable for operation of the filaments. In addition, a source of alternating current power for the operation of the automatic tuning system which is incorporated in this unit, has been provided. There is a current division system associated with the contacts of the vibrators and the circuit is so designed that the phase displacement provides equivalent performance of a two-phase rectifier system, assuring low

hum level with a minimum amount of filter.

During the war period, *EL* has designed many other similar units having a multiplicity of input and output voltages. In addition to DC sources, in many cases, AC sources of any frequency between 18 and 180 cycles have been made available to meet specific engineering problems.

The requirements for power equipment reach into many fields as war born inventions are applied to postwar needs. *EL* Vibrator Power Supplies will have wide application because they are the most economical, efficient and versatile means of solving the many power supply problems that will arise. Electronic engineers will soon be at your service to help meet the power requirements presented by postwar industry.

***EL* STANDARD POWER SUPPLY MODEL 1200**

This EL unit is a typical Vibrator Power Supply with multiple inputs and outputs and was designed for transmitter and receiver use. Inputs: 12 volts DC, 24 volts DC, 32 volts DC, 110 volts DC and 110 volts AC, 50-60 cycles; Outputs: 600 volts DC at 150-250 MA; 300 volts DC at 75-150 MA; 6-8 or 10 volts DC at 1 amp; and 110 volts AC (50-60 cycles) at 75 watts. Dimensions: 26-1/16" x 15" x 13-9/16". Weight: 160 pounds.



Electronic
LABORATORIES INC.
INDIANAPOLIS

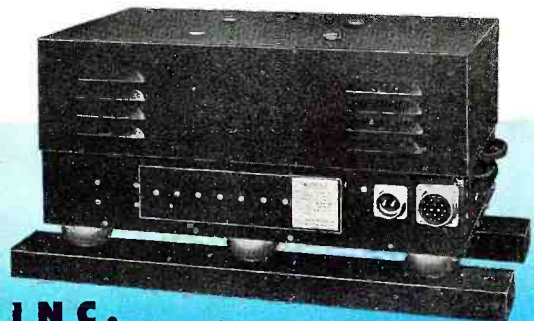

VIBRATOR POWER SUPPLIES FOR LIGHTING, COMMUNICATIONS, ELECTRIC MOTOR OPERATION • ELECTRIC, ELECTRONIC AND OTHER EQUIPMENT

RN-35-J41190-28
JAY A BIXBY
R 3 BOX 291A
TACOMA WASH
F



Top: 195-A Voltohmyst—162-c Chanalyst

Bottom: 170-A Audio Chanalyst—155-c Oscilloscope

PREVIEW

HERE are the test equipment units service men will want after the war. New models of the well-known Voltohmyst, the Chanalyst, and the RCA 3-inch Oscilloscope, a favorite trio for r-f and general-purpose testing; and a new Audio Chanalyst for the sound specialist.

And who wouldn't? For these units have all the proved advantages of prewar RCA equipments, plus many new features. And they've been tested by widespread wartime usage.

Radio men in the military services and in war industries are using these instruments today—getting the feel of them—learning their qualities firsthand. After the war, they'll want these well-designed, convenient, attractive-appearing equipments for their own shops.

Today these equipments are available only on priority. But, as soon as restrictions are removed, your RCA distributor will be ready to fill your order with these new models, currently being manufactured. Why not ask him today for literature on them—or write Test & Measuring Equipment Section, RCA, Camden, N. J.

BUY MORE WAR BONDS



RADIO CORPORATION OF AMERICA

RCA VICTOR DIVISION • CAMDEN, N. J.

In Canada, RCA VICTOR COMPANY LIMITED, Montreal

www.americanradiohistory.com