

RADIO NEWS

FEBRUARY
1943
25c
In Canada 30c

*How to use the
Slide rule for
Calculations*

AIRPORT TRAFFIC CONTROL TOWER

WARTIME PROGRESS in ELECTRONICS

- ★ TRAINING RADIO OPS FOR COMBAT
- ★ THE NAVAL RADIOMAN-GUNNER

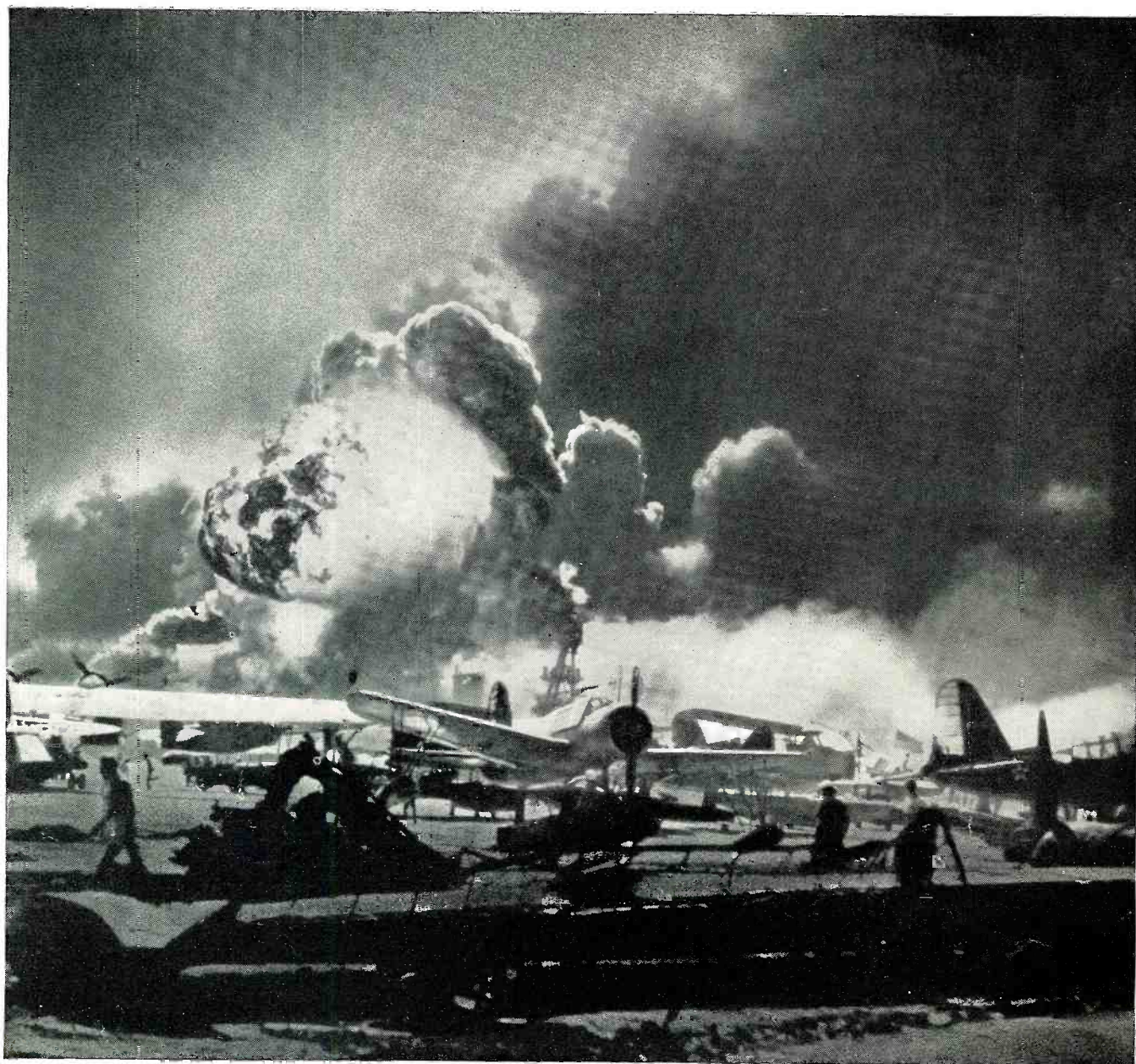

U. S. Navy Official Photo

Minus Sound Effects

If you were receiving radio broadcasts from men in the midst of ear-splitting battle noises, you'd hear crisp speech undistorted by background sound effects.

Electro-Voice Microphones, in military service, are helping to make it possible. Similar microphones, designed to achieve such results, will be available for specific commercial applications . . . after our wartime job is done.

Electro-Voice MICROPHONES

ELECTRO-VOICE MANUFACTURING CO., INC.

1239 SOUTH BEND AVENUE, SOUTH BEND, INDIANA

J. E. SMITH
President
National Radio
Institute
Established
28 Years

WILL RAIN YOU TO SART

A SPARE TIME OR FULL TIME

RADIO SERVICE BUSINESS

WITHOUT CAPITAL

FREE LESSON
I will send you FREE a Sample lesson, "Getting Acquainted with Receiver Servicing," to show you how practical it is to train for a good-pay Radio job at home in spare time. It's a valuable lesson. Study it—keep it—without any obligation whatsoever. This lesson tells how Superheterodyne Receivers work—why Radio Tubes fail—how to fix Electrodynamical Loudspeakers and Output Transformers—how Gang Tuning Condensers work. Gives hints on I.F. Transformer Repair—how to locate defective soldered joints—Antenna Oscillator Coil facts—Receiver Servicing Technique—dozens of other hints, facts, explanations. Illustrated with 31 photos, sketches, drawings. Get your copy at once—mail the coupon NOW!

I Trained These Men

These Men Have SPARE TIME BUSINESSES



"I repaired some Radio sets when I was on my tenth lesson. I really don't see how you can give so much for such a small amount of money. I made \$600 in a year and a half. I have made an average of \$10 a week—just spare time."—JOHN JERRY, 1337 Kalamath St., Denver, Colorado.

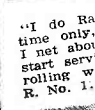

"I do Radio Service work in my spare time only, operating from my home, and I net about \$40 a month. I was able to start servicing Radios 3 months after enrolling with N.R.I."—WM. J. CHERMAK, R. No. 1, Box 287, Hopkins, Minn.



"I am doing spare time Radio work, and I am averaging around \$50 a year. Those extra dollars mean so much—the difference in living comfortably."—JOHN WASH, KO, 97 New Cranberry, Hazleton, Penna.

I Trained These Men

These Men Have FULL TIME BUSINESSES



"For several years I have been in business for myself making around \$200 a month. Business has steadily increased. I have N.R.I. to thank for my start in this field."—A. E. J. FROEHNER, 300 W. Texas Ave., Goose Creek, Texas.

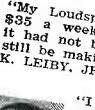

"My Loudspeaker System pays me about \$35 a week besides my Radio work. If it had not been for your Course I would still be making common wages."—MILTON K. LEIBY, JR., Topton, Pa.

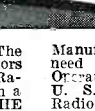

"I started Radio in the Marines in 1917. I also built and started studying Radio with N.R.I. Later I started my own business. I recommend N.R.I. for a living. I now have my own business."—CHARLES F. HELMUTE, 16 Hobart Ave., Absecon, N. J.

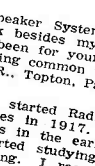

"I started Radio in the Marines in 1917. I also built and started studying Radio with N.R.I. Later I started my own business. I recommend N.R.I. for a living. I now have my own business."—CHARLES F. HELMUTE, 16 Hobart Ave., Absecon, N. J.

"I started Radio in the Marines in 1917. I also built and started studying Radio with N.R.I. Later I started my own business. I recommend N.R.I. for a living. I now have my own business."—CHARLES F. HELMUTE, 16 Hobart Ave., Absecon, N. J.

Is This What You Want to Know?

Knowing answers to the 22 questions below, and others which arise while doing Radio jobs has spelled the difference between success and failure for many men. Such knowledge represents the difference between a skilled, well-paid Radio Technician or Operator and the too common "Radio screwdriver mechanic." If you do not know all the answers; if you want to make more money in Radio, I will train you at home to be a Radio Technician or Operator whether you are already in Radio, or are just a beginner without knowledge or experience.

- How to read Radio diagrams and analyze them.
- How to run a Radio service shop successfully.
- How to use and operate electronic controls.
- How to locate parts in a chassis with and without service data.
- How to know the cause of receiver trouble from observed effects.
- How to make tests which isolate the defective stage and parts.
- How to align Radio receivers without reference to specific instructions.
- Short cuts in servicing midget universal receivers.
- Learning how Radio circuits work through home demonstrations.
- How to obtain additional basic Radio training for military, naval and war industry Radio jobs.
- How accurately timed pulses are produced and used.
- How the cathode ray tube works and is used.
- How to adjust a Radio transmitter for best operation.
- How to service without specialized servicing equipment.
- How w transmitters are modulated and keyed.
- How Radio-electronic devices are used commercially as controls.
- How Radio meters and testers work and how to use them.
- How Radio waves are beamed and intercepted.
- How Radio equipment is automatically and remotely controlled.
- How a frequency modulated system works.
- How tuned circuits effect Radio circuit operation.
- How the superheterodyne receiver works.

Now is the time to get ahead—in RADIO! The wartime shortage of Radio Technicians and Operators gives you a great opportunity to open your own Radio Business, or to go after a good Radio job with a bright peacetime future. Start at once. MAIL THE COUPON for a FREE Lesson from my Radio Course, plus my big, 64-page book, "Rich Rewards in Radio." See for yourself how I will train you in spare time to be a Radio Technician or Operator!

You'll read how my Course can help you—just as it helped the six men above—to start your own Radio business on money you make while learning—you'll see how N.R.I. also prepares you for a good job in many of Radio's profitable branches—Broadcasting, Radio Manufacturing, Public Address Systems, Aviation, Police, Commercial Radio, etc. MAIL THE COUPON NOW!

How the "N.R.I. Method" Helps Many Win Jobs
Paying \$30, \$40, \$50 a Week
The up-to-the-minute Radio Technician or Operator must have BOTH theoretical knowledge and a practical understanding of how to apply Radio principles. I give you thorough training in Radio Theory—show you how to use your knowledge. N.R.I. trains you "from the ground up"—covers fundamentals thoroughly. Radio Terms, Symbols, Diagrams; Receiver Troubles, Servicing; Television; FM Receivers, Transmitters; Cathode Ray Oscilloscopes; Electronic Controls, etc. These are just a FEW of the subjects you'll cover before you finish my Course!

Beginners Quickly Learn to Make \$5, \$10 a Week Extra in Spare Time
Many N.R.I. students make \$5, \$10 a week extra money fixing Radios in spare time while still learning. I send EXTRA MONEY JOB SHEETS that tell how to do it. Many N.R.I. graduates start their own full time Radio businesses. Others take interesting jobs with Broadcasting Stations. Radio TRAINING MEN FOR VITAL RADIO JOBS

Manufacturers, rushing to fill Government orders, need more trained men. Radio Technicians and Operators are needed for good Civilian jobs with the U. S. Government. Aviation, Police, Commercial Radio and Public Address Systems need trained Radio men. And think of the NEW Radio jobs that Television, Frequency Modulation, and Electronics will open after the war! I give you the Radio knowledge required for these jobs.

Extra Pay in Army, Navy, Too
Men likely to go into military service, soldiers, sailors, marines, should mail the Coupon NOW! Learning Radio helps men get extra rank, extra prestige, more interesting duties, much higher pay. Also prepares for good Radio jobs after service ends. Over 1,700 service men now enrolled.

Let This Great Organization Help YOU
Throughout your training, the staff and resources of the world's largest institution devoted to training men for Radio will be squarely behind you. N.R.I. has stuck to the one job of teaching Radio for 28 years. My entire staff devotes full time to Radio training. Our combined efforts have made the Course so interesting, with hundreds of pictures, charts, and diagrams—so easy-to-grasp, with special teaching methods designed especially for home training—that we believe you will be "old friends" with Radio almost before you know it.

START NOW—Mail Coupon for FREE Lesson and Book
MAIL THE COUPON—I'll send you the FREE lesson and my 64-page illustrated book, RICH REWARDS IN RADIO. No obligation. You'll see what Radio offers YOU. And you'll have my FREE lesson to keep. No salesman will call. Just MAIL THE COUPON NOW!—J. E. SMITH, President, National Radio Institute, Dept. 3BR, Washington, D. C.

GOOD FOR BOTH 64 PAGE BOOK FREE
SAMPLE LESSON

RICH REWARDS IN RADIO

J. E. SMITH, President, Dept. 3BR
National Radio Institute, Washington, D. C.

Without obligating me, mail your Sample Lesson and 64-page book FREE. I am particularly interested in the branch of Radio checked below. (No salesman will call. Write plainly.)

<input type="checkbox"/> Radio Service Business of My Own	<input type="checkbox"/> Aviation Radio
<input type="checkbox"/> Service Technician for Radio Stores and Factories	<input type="checkbox"/> Operating Broadcasting Stations
<input type="checkbox"/> Spare Time Radio Servicing	<input type="checkbox"/> Army, Navy Radio Jobs
<input type="checkbox"/> Auto Radio Technician	<input type="checkbox"/> Operating Police Radio Stations
	<input type="checkbox"/> Operating Ship and Harbor Radio

(If you have not decided which branch you prefer—mail coupon for facts to help you decide.)

Name..... Age.....

Address.....

City..... State..... ZIP-2

★ *Leading the Industry Since 1919*

The Technical Magazine devoted to Radio in War, including articles for the Serviceman. Dealer. Recordist. Experimenter and Amateur

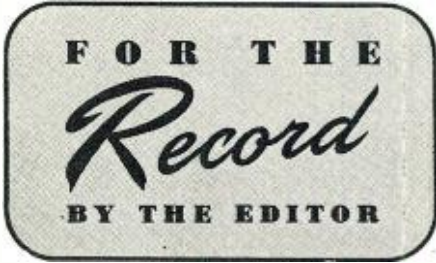

Contents

F E A T U R E S

OUR NAVY'S JEKYLL-HYDES.....	Lieut. Fred Tupper, Jr.	8
TRAINING RADIO OPS FOR COMBAT.....		10
FUNDAMENTAL ATOMIC PHYSICS.....	C. D. Prater	11
RADIO KEEPS 'EM PLOWING.....	T. M. Dennis	14
MAKING RADIO TECHNICIANS.....		16
RECORDING WAR NEWS WITH THE SX-28....	Oliver Read	18
HOW TO USE THE SLIDE RULE IN CALCULATIONS.....	Rufus P. Turner	22
WARTIME PROGRESS IN ELECTRONICS....	Robert Eichberg	24
INEXPENSIVE PORTABLE CAPACITY BRIDGE.....	Harry L. Poling	26
NEW DEVICES FOR INDUSTRY.....	Willard Moody	30
FROM OUR FIGHTING FRONTS.....		32
SUPER-HET TUNER FOR THE DYNAMIC DEMONSTRATOR.....	David Gnessin	33
USE THOSE OLD METERS.....	Gerald L. Manning	36

D E P A R T M E N T S

PRACTICAL RADIO COURSE, PART 11....	Alfred A. Ghirardi	28
THE TUBE COLLECTOR.....		35
AVIATION RADIO COURSE, PART 10.....	Paul W. Karrol	39
BOOK REVIEW.....	34 QRD? de Gy.....	34
MFRS. LITERATURE....	40 24 YEARS AGO IN RADIO	40
SPOT RADIO NEWS.....	Lewis Winner	41
WHAT'S NEW IN RADIO.....		38

Copyright 1943

ZIFF-DAVIS PUBLISHING COMPANY

Member of the Audit Bureau of Circulations

WILLIAM B. ZIFF <i>Publisher</i>	B. G. DAVIS <i>Editor</i>	C. R. TIGHE <i>Ass't to Publisher</i>
-------------------------------------	------------------------------	--

OLIVER READ, W9ETI <i>Managing Editor</i>	R. B. FRANK, W9JU <i>Tech. Ed. (on leave)</i>	WM. A. STOCKLIN <i>Associate Editor</i>
--	--	--

HERMAN R. BOLLIN <i>Art Director</i>	S. L. CAHN <i>Advertising Mgr.</i>	J. M. ECKERT <i>Midwest Adv. Mgr.</i>	H. G. STRONG <i>Circulation Mgr.</i>
---	---------------------------------------	--	---

RADIO NEWS is published monthly by the Ziff-Davis Publishing Company at 540 N. Michigan Ave., Chicago, Ill. New York Office, 270 Madison Ave. Washington Bureau, Occidental Hotel, Lt. Col. Harold E. Hartney, Mgr. Subscription Rates: In U. S. \$3.00 per year, single copies, 25 cents; in South and Central America and U. S. Possessions, \$3.00 per year; in Canada \$3.50 per year, single copies 30 cents; in British Empire, \$3.75 per year; all other foreign countries \$6.00 per year. Subscribers should allow at least 2 weeks for change of address. All communications about subscriptions should be addressed to: Director of Circulation, 540 N. Michigan Ave., Chicago, Ill. Entered as second class matter March 9, 1938, at the Post Office, Chicago, Illinois, under the Act of March 3, 1879. Entered as second class matter at the Post Office Department, Ottawa, Canada. Contributors should retain a copy of contributions. All submitted material must contain return postage. Contributions will be handled with reasonable care, but this magazine assumes no responsibility for their safety. Accepted material is subject to whatever adaptations, and revisions, including "by-line" changes, necessary to meet requirements. Payment covers all authors, contributors or contestants rights, title, and interest in and to the material accepted and will be made at our current rates upon acceptance. All photos and drawings will be considered as part of material purchased.

The Shellac Situation

THE production of records is becoming more and more of an acute
(Continued on page 59)

3 hrs - 22

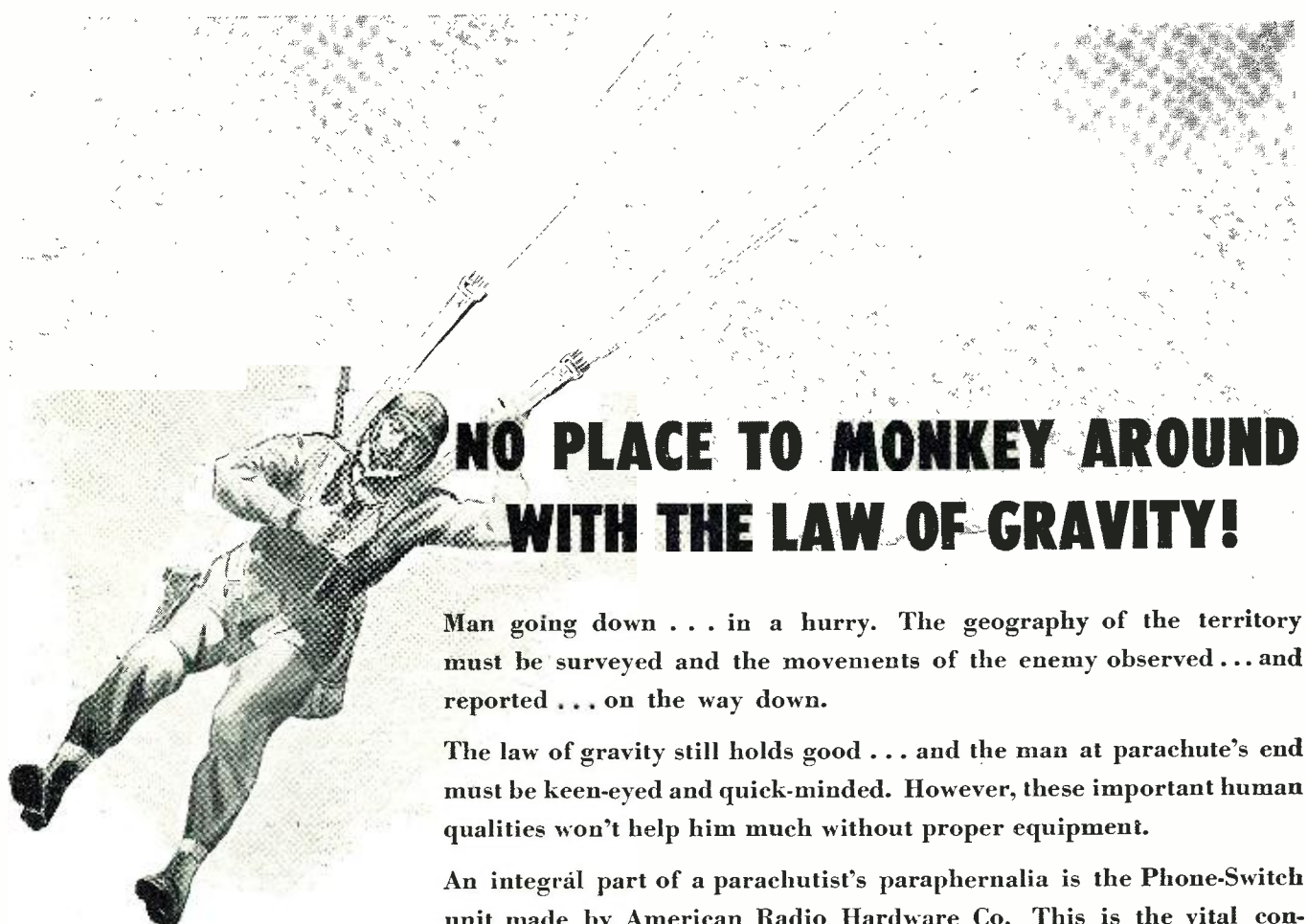

NO PLACE TO MONKEY AROUND WITH THE LAW OF GRAVITY!

Man going down . . . in a hurry. The geography of the territory must be surveyed and the movements of the enemy observed . . . and reported . . . on the way down.

The law of gravity still holds good . . . and the man at parachute's end must be keen-eyed and quick-minded. However, these important human qualities won't help him much without proper equipment.

An integral part of a parachutist's paraphernalia is the Phone-Switch unit made by American Radio Hardware Co. This is the vital connecting link between air and ground communications—and it has got to work. It does!

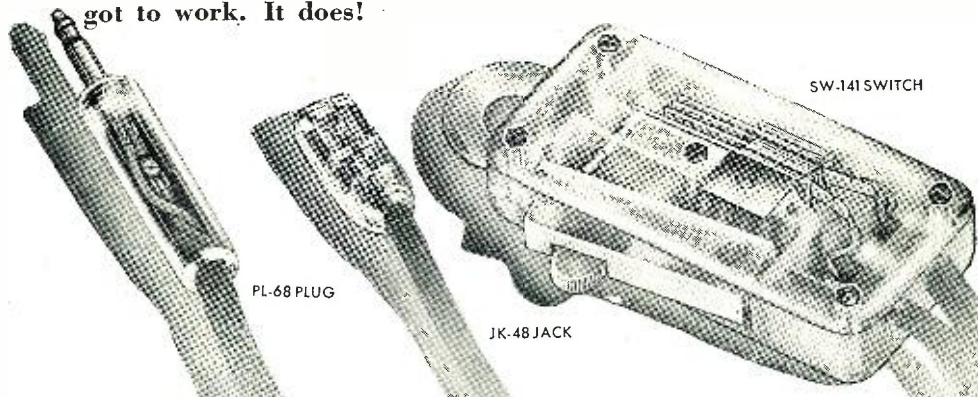

The Phone-Switch Assembly is but one of the many precision instruments which are our contribution toward winning this war. Someday when it becomes a parachutist's job to report a picnic rather than a battle the Phone-Switch, along with all others of our products, will be an important influence in the field of civilian communications. God speed the day.



BUY WAR BONDS AND STAMPS

American Radio Hardware Co., Inc.
476 BROADWAY, NEW YORK, N. Y.

Write for Catalogue

MANUFACTURERS OF SHORT WAVE • TELEVISION • RADIO • SOUND EQUIPMENT

February, 1943



One Year

We have come a long way since Christmas 1941, all of us. American Amateurs have flocked to the colors — made themselves the backbone of the great Army Signal Corps and Navy Communications. Makers of Amateur equipment have put their entire effort into design and construction of Military communications units. For example, the Hallicrafters have, since Pearl Harbor, turned out production that would normally have taken seven years! ☆ We can all be proud that we have in one short year turned the tide of battle from almost unopposed conquest by the enemy to the first stages of the victory drive on every front. And, let us all fervently hope that another wartime Christmas will be unnecessary.

W. J. Halligan

the hallicrafters co.

CHICAGO, U. S. A.



Let Hytron Break that Bottleneck!

700%

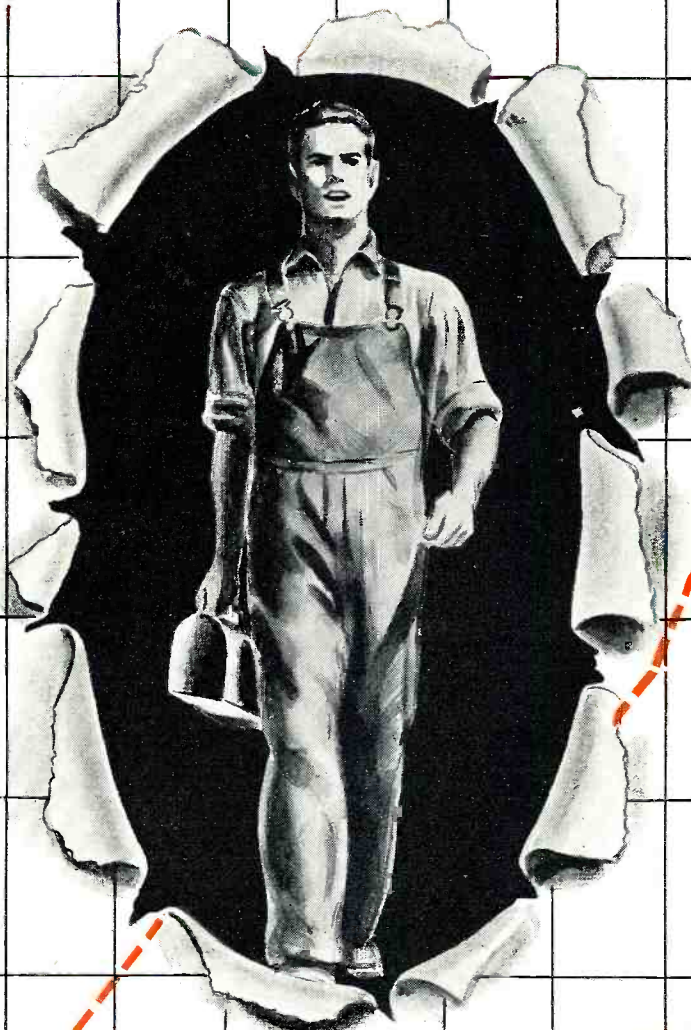

HYTRON

WAR-PRODUCTION SHIPMENTS UP 700%

In spite of this big increase, Hytron has available:

IMMEDIATELY — large capacity for certain types of radio and electronic tubes.

IN SECOND QUARTER — still larger capacity for almost all types which Hytron is tooled to make.

IN THIRD AND FOURTH QUARTERS — capacity almost unlimited for all types suited to Hytron's production lines.

If you place your orders now, Hytron's fast-rising productive capacity can smash those bottlenecks caused by tube shortages.

JANUARY 1942
EQUALS
100%

JAN FEB MAR APR MAY JUNE JUL AUG SEPT OCT NOV DEC

HYTRON CORP., Salem and Newburyport, Mass.

Manufacturers of Radio Tubes Since 1921





OUR NAVY'S

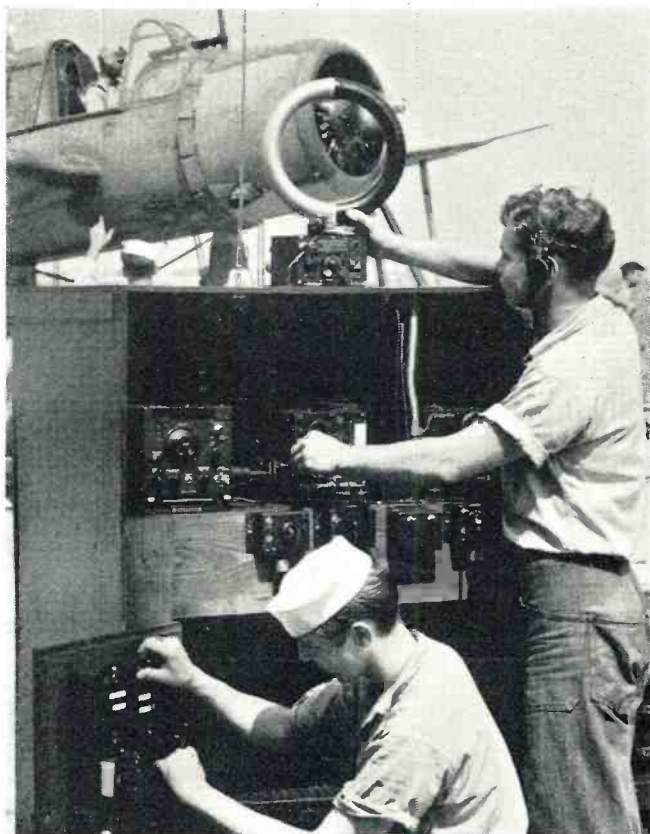

Learning the intricate parts of the direction-finder and communications sets that are used in Navy planes.

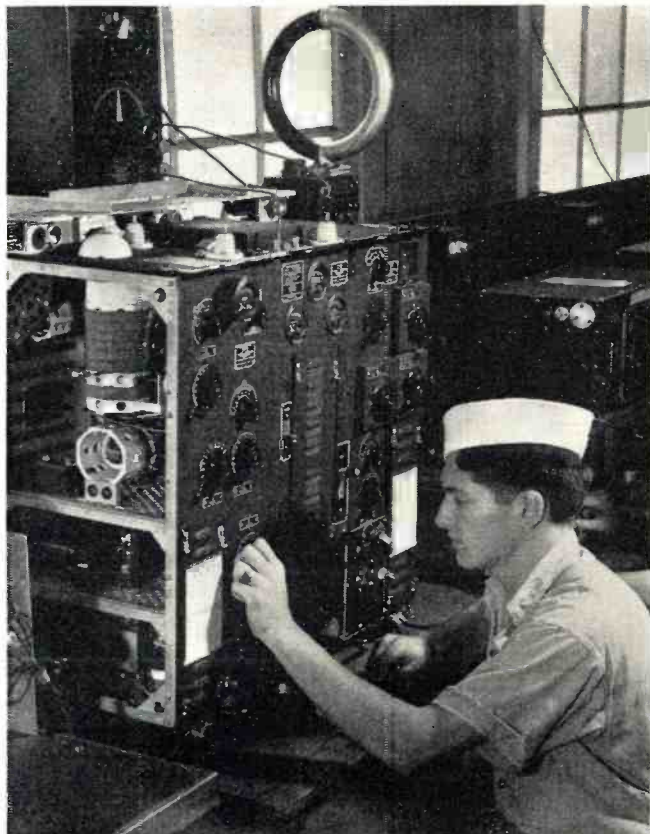

Students learn to operate and maintain transmitting equipment in one of the many shops of the service.

by **Lieut. FRED TUPPER, JR.**

The Radioman-Gunner on our heavy bombers must be skilled in fighting enemy planes and in handling all radio communications.

HERE'S a dual personality fighting in this war—a sort of Dr. Jekyll and Mr. Hyde. He's the naval aviation radioman-gunner and his record in action over the Pacific is a story all of its own. No other Navy "rate" has even approached his performances. To date he holds seventeen Distinguished Flying Crosses and has won innumerable Navy Crosses and Air Medals.

He is multiple, as the Japs will testify. He's the radioman who sits at his controls in a combat plane and reports the presence of an enemy task force. He's the rear gunner that switches to the .50 calibers and fights that plane back home again when Zeros attack. He is such men as John Liska, who collected three Japanese scalps in the Battle of the Coral Sea; J. D. Godfrey, ARM3c, who, from the rear-seat in a dive-bomber, knocked off one Naki-

jama on the way in to attack, then calmly collected another on the trip back to the carrier near the Solomons; and Forrest G. Stanley, Frank Wook, Allen Brost and a host of others who have been credited with one or more "certains" in battle.

When the Navy talks in terms of 27,000 combat planes, it is talking not only of pilots to fly them but of aviation technicians to man and fight them. Aviation radio, one of the four principal classifications, calls for 13,000 men to be trained this year and every year until victory is achieved. And so, at huge training schools in Memphis, Tennessee, and Jacksonville, Florida, thousands of men are graduated to active duty with the fleet as third class ARMs. Hundreds more who are physically and mentally qualified go to gunnery school for training as members of flight crews in scout planes, dive-bomb-

ers and torpedo bombers. The finished product, the graduate of both schools—is the backbone of naval aviation. He's the protection for the carrier-based striking force. On his radio reports hinge the chances for victory; on his guns depend the lives of the pilots up front.

First, then, he attends a qualified naval aviation radio training school, where for fourteen weeks, six days a week, he picks up general knowledge of basic radio theory, squadron and base radioman duties and installation features of radio gear in aircraft. He becomes qualified to stand a radio watch in aircraft. He is cognizant of the safety factors and qualified in the performance of such jobs as code, typing, radio procedure, practical operation of radio equipment, maintenance, signal flags, semaphore and blinker.

(Continued on page 71)

JEKYLL-HYDES



Finding the null point on a signal with a compact shielded loop. Note calibrated scale on base of loop.



Studying mechanism of high-calibre guns on a fast Navy plane. Radio antenna may be seen above students.

Getting the "bead" on an enemy plane. The radioman-gunner is an excellent marksman.



Loading cartridge belts is an exacting procedure and of greatest importance to trouble-free gun operation.

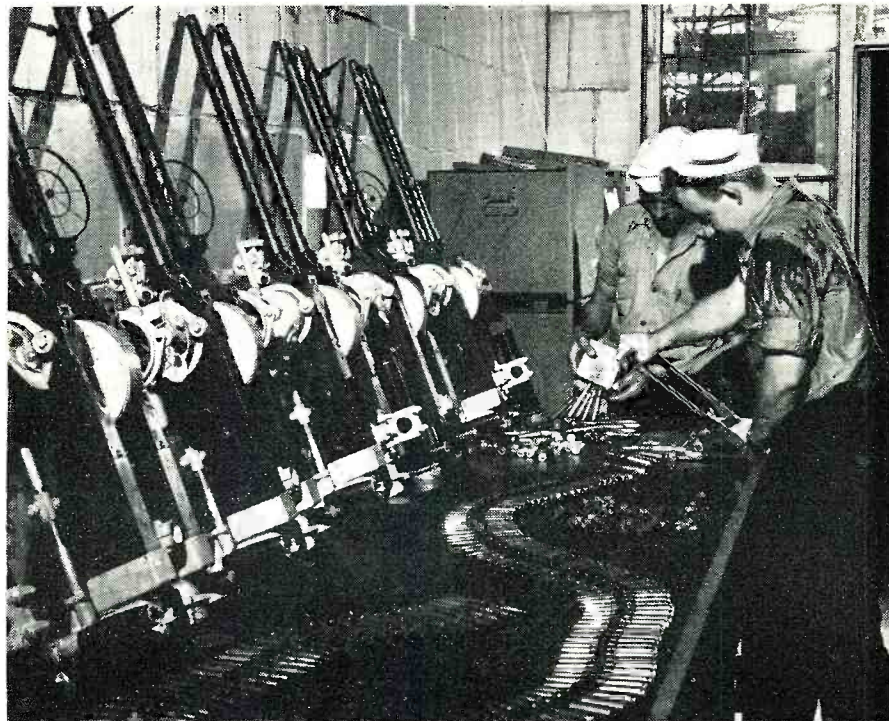

TRAINING RADIO OPS FOR COMBAT



1 This advance detail is headed for a location that has been picked as a site for high-power transmitter.

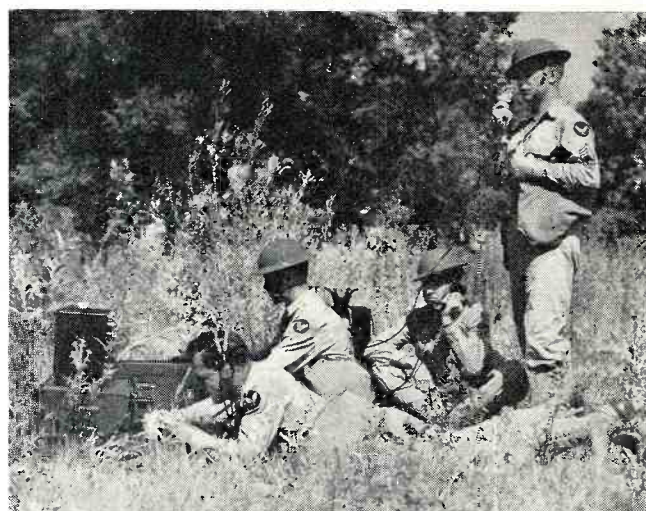

2 Radio communications equipment is set up rapidly at a secluded spot in the thicket after reaching post.



3 Smoke, simulating a gas attack, does not prevent the forces from moving up the rest of the radio equipment.



4 In operation. The high-power field transmitter is now in use. Men maintain lookout for enemy forces.



5 All attacks stopped cold. This advance communications post will prove of great value to the main air base.

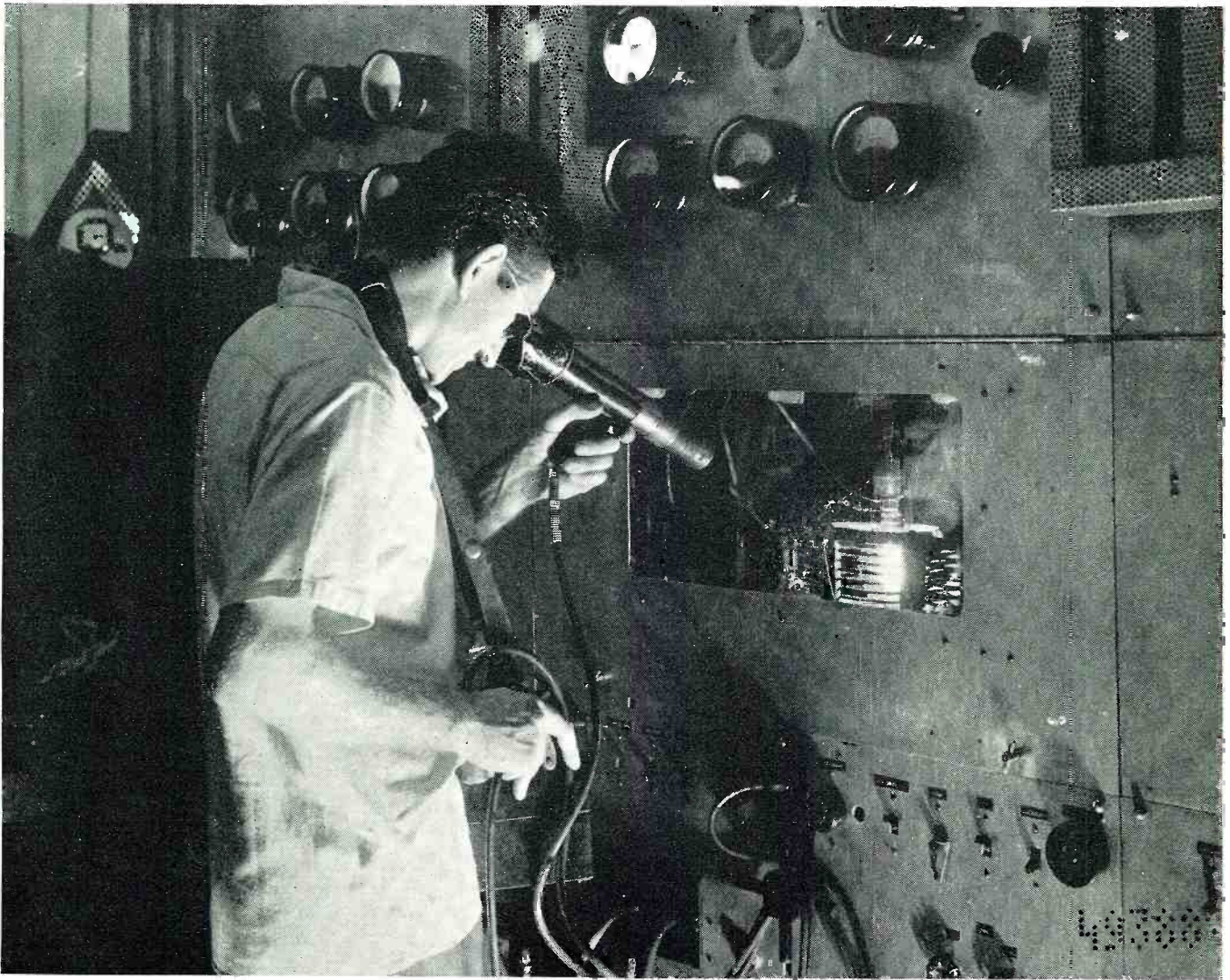

Operator is making an optical pyrometer test to obtain temperature of tube anode.

Fundamental Atomic Physics

by **C. D. PRATER**

Bartol Research Foundation

Conditions that exist in a high-vacuum tube are somewhat simpler than those existing in the majority of other devices.

At the present time the high vacuum tube is probably the most important, as well as the most familiar, of the electronic devices, and since the conditions that exist in a high vacuum tube are in many ways simpler than those that exist in the majority of electronic devices, the high vacuum tube is the logical starting point of a study of electronic devices.

The physics of a high vacuum tube can be divided conveniently into two parts: the source of electrons and the field conditions which govern the

behavior of the electron in the tube. In this article the source of electrons and, in the next, the field conditions will be discussed. The emission of electrons from hot bodies and the emission of electrons by the grid, plate and glass walls of the tube when these parts are struck by a fast-moving electron coming from the hot body, constitute the most usual sources of electrons. The electrons liberated by electron bombardment are called secondaries and were mentioned in the first article of this series. These sec-

ondaries are detrimental to most tube operation and means of keeping them to a minimum are often incorporated into the tube as will be seen in the next article. In a few instances, the secondaries are put to use in a high vacuum tube. A tube of this kind will be discussed in the next article.

Thomas Edison, in 1883, made the observation that if an electrode which corresponds to the plate in the present day tube, was placed in an evacuated light bulb and connected to the positive end of the hot filament, a current



After completed tubes are sealed and exhausted, they are placed in a rack and operated for a time sufficient to stabilize electrical characteristics.

would flow in the circuit, but if the connection was made to the negative end of the filament, no current would flow. It was not until Sir J. J. Thompson and others showed that the flow of current in Edison's bulb was due to electrons emitted from the hot filament, that any progress was made in the understanding of what was taking place in the bulb. At the time Edison made this observation, the electron as it is known today was not even known. When the plate was connected to the positive end of the filament in Edison's experiment, the plate was positive with respect to the filament, and any electrons which had escaped from the filament moved under the influence of the electric field to the plate, but when the plate was connected to the nega-

tive end of the filament, the plate was negative with respect to the filament and the electrons would be repelled by the plate so no current could flow.

In 1916, a book, "Emission of Electricity by Hot Bodies," was published by a scientist, O. W. Richardson. In this book an equation was derived of such importance that it might be said to have the same importance in the study of the emission of electrons from hot bodies as Ohm's Law has in the study of electricity. This equation is known as Richardson's equation in honor of its discoverer. It is

$$I = AT^2 e^{-\frac{b}{T}}$$

where I is the maximum current that can be drawn from the hot body at a given temperature T, A and b are con-

stants, and e is the base of the natural logarithm. This equation means that as the temperature of the body is increased, the current which can be drawn from it will increase very slowly at first, then more and more rapidly. Figure 1 shows the kind of curve this equation represents. The constants A and b determine the value of I at a given point and how rapidly the curve will rise. Figure 1 shows graphs of this equation for three substances having different b's.

A change in A will not affect the equation much, but a small change in b will make a great difference in the value of I. A has the nature of a universal constant, with a value of 120. A is composed of some of the constants associated with the electron as well as some other universal constants. The constant b is dependent on the work the electron must do before it can escape from the metal. This work was discussed in the first article, and is called the work function. A mastery of the mathematics of this equation is not necessary, but the shape of the curve which it represents should be kept in mind, and the effect of changes in the constant b on the curve should be remembered. It must be kept in mind that the current I represents only the maximum current that can be drawn from a cathode at a given temperature. This maximum is called the saturation current. How a low current can be drawn and the meaning of the saturation current will be discussed in the next article.

There are three hot cathodes in use in the present day commercial tubes; pure tungsten, thoriated tungsten, and oxide cathodes. The oxide cathode is the most important of the three: If a piece of tungsten wire is heated in a vacuum by passing an electric current through it to 1800° C., it will be found that the tungsten will begin to emit an appreciable number of electrons. As the temperature is raised, the emission from the tungsten follows the curve for Richardson's equation for tungsten as shown in Figure 1. In this equation b has the value of 5.2×10^4 . It might appear from this curve that any emission desired could be obtained if the temperature was made sufficiently high, but since the melting point of tungsten is 3382° C., it is impossible to go above this temperature practically. In fact, the temperature must be below 3100° C., otherwise, the tungsten evaporates so rapidly in a vacuum that its life is very short.

The limiting temperature imposed by the evaporation of a metal has a very important bearing on cathodes. There are a number of substances such as thorium, cesium, barium, strontium and calcium which are very good emitters, but the evaporation of these substances is so great at such low temperatures that it would be impossible to use them if it were not for one property, a metal such as these can be absorbed on the surface of another metal in a layer one molecule thick. It will be found that the absorbed

Fig. 1. Graph of Richardson's equation (See text).

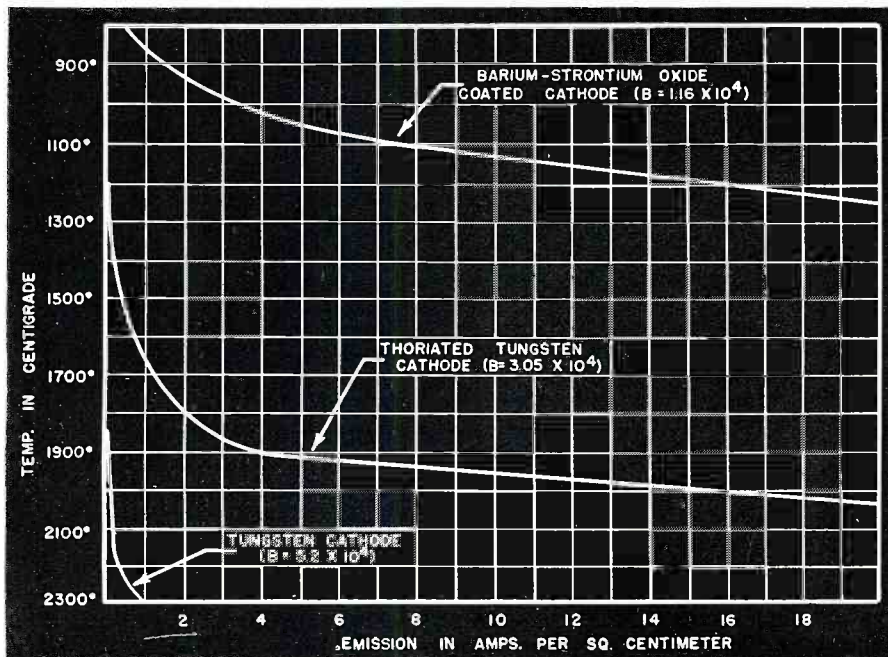

metal will not evaporate to any appreciable extent up to, and in some cases well beyond, the melting point of the absorbed metal. This means that one of the high emitting metals can be absorbed onto the surface of some metal such as tungsten and then used as a cathode with far superior properties to either one made of the absorbed metal or the metal core.

Thoriated tungsten is an example of this. The tube manufacturers, a number of years ago, put thoria (thorium oxide) into the tungsten metal from which the wires of the cathode were made in order to improve its mechanical properties. It was very often found that cathodes made from this thoriated tungsten gave emission much greater than could be obtained from pure tungsten. An extensive study was made in the laboratories of the General Electric Company to determine the reason for this, and to see if the emission could be improved.

It was found that if the thoriated tungsten wire was flashed (heated for a short time) at 2500° C., some of the thorium was reduced to pure metallic thorium. Then it was found advan-

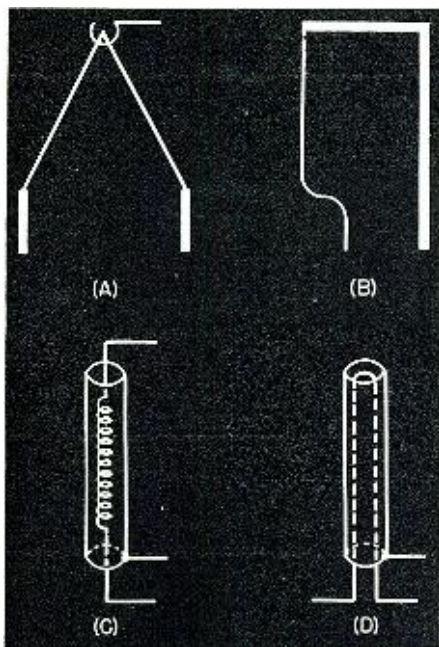

Fig. 2. Types of VT cathodes.

tageous to lower the temperature to 2200° C. for a few minutes. At this temperature, the thorium formed during the flashing process diffuses to the surface of the wire, where it formed a layer one molecule thick. The cathode was then operated at about 1725° C. At this temperature the emission from the thoriated tungsten wire was as much as the emission from pure tungsten at 2350° C. At 1725° C. the pure tungsten gave only about 1 ma.

The temperature of the thoriated tungsten wire was lowered from 2500° C. to 2200° C., because at 2500° C. the rate of evaporation of the thorium from the surface of the tungsten is so great that it is impossible to form a layer of thorium on the surface. At



Radio transmitter tubes are operated at GE factories before they are tested and shipped to our armed forces. Seasoning of tubes is essential.

2200° C. the rate of diffusion of the thorium from the interior of the tungsten is still great enough to cover the surface with thorium, and the evaporation of the thorium is low enough that the surface may become completely covered.

At 1725° C. the rate of diffusion of thorium is great enough to maintain the layer of thorium upon the surface. The evaporation of the thorium from the surface limits the operating temperature to a maximum of 2200° C. Figure 1 shows a curve for the emission from a thoriated tungsten cathode; the emission of thoriated tungsten can be compared with that of pure tungsten in Figure 1. It will be noted that the thoriated tungsten is a much more efficient emitter than pure tungsten. At any given temperature the emission from the cathode is determined by the amount of thorium upon the surface.

At first thought it would seem more logical to suppose that the more thorium on the surface, the greater the emission, but this is not the case. The emission rises from a very low value when the surface of the tungsten has no thorium on it, to a maximum when the surface is completely covered by a layer one molecule thick. As more thorium diffuses to the surface and becomes more than one molecule thick, the emission falls off.

The rate of evaporation of thorium from a tungsten wire can be lessened if the tungsten wire is heated in an atmosphere of naphthalin vapor. This forms a shell of tungsten carbide on the wire. The thorium molecules stick much tighter to the surface of tungsten carbide than they do to pure tungsten, and the rate of evaporation will be much less at any given temperature than before. This makes it possible to operate the thoriated tungsten carbide cathode at a much higher temp. without evaporating too much of the thorium and consequently get a higher emission from the cathode.

In 1904, Wehnelt found that a piece of platinum wire coated with the oxide of barium and strontium would emit electrons at a very low temperature. Investigations were made upon various oxides, and it was found that the oxide of barium, strontium, and calcium were good emitters in the order named. The barium was much superior to either the strontium or calcium. It was found, however, that a mixture of barium and strontium oxides containing 50 percent barium oxide gave a much better emission than pure barium oxide alone.

The oxides of barium and strontium are not stable in the atmosphere, so a mixture of barium and strontium carbonates is used to coat the cathode. This coating, on evacuating the air from the tube and heating, decomposes into barium and strontium oxides. The oxide cathodes are in some ways similar to the thoriated tungsten cathode in that they depend upon a layer of free barium that is formed upon the surface of the oxide, but in many respects they differ since the oxide cathodes are semi-conductors, whereas tungsten is a conductor. Pure metallic barium can not be formed by simply heating as in the case of the thoriated tungsten, but some other means have to be found in order to provide a sup-

(Continued on page 73)

Fig. 3. Graph shows emission characteristics.

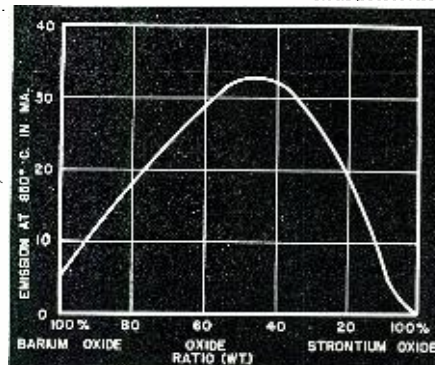

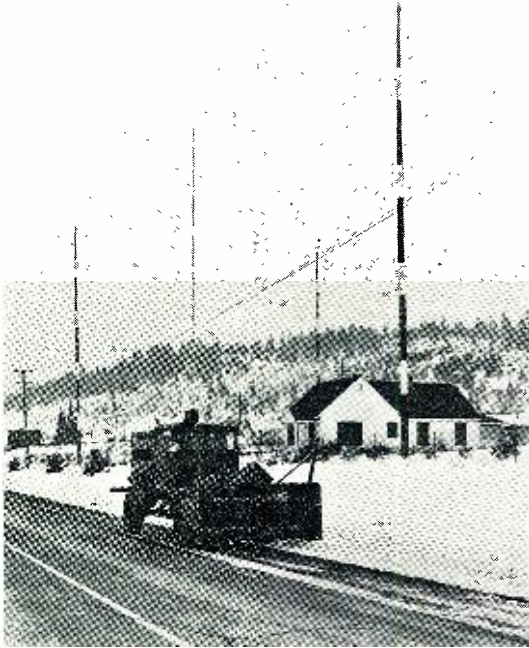

Ordered out from KATR, a plow heads for a heavily snow-packed highway.



Carrying-out job of removing snow after receiving orders by radio from headquarters. Truck is completely equipped.

RADIO KEEPS 'EM PLOWING

by **T. M. DENNIS**

Maintenance Engineer, California Division of Highways

Vital war materials must be kept moving over our snow-covered highways. Radio transmitters and receivers speed snow removal.

NO paraphrase that time-tried axiom of the letter carriers, the traffic must go through. Come snow or rain storm, we must keep vehicles moving, whether they be military or civilian. During war days, it is particularly vital that highways must be kept clear. The nation's safety may depend upon quick and safe travel.

Snow plows of various types get this important assignment in winter. But plows alone are not enough. Radio supplies the missing link, the means of communication that directs them to the areas of heavy snow fall and keeps 'em plowing until the big job is done.

Until recently one of the most troublesome problems faced by highway maintenance crews in the mountainous areas of California has been their annual fight to maintain open roads no matter how much snow may descend upon these thoroughfares. With the first storm of winter, wires go down in many sections, not to be repaired until spring. Elsewhere, communication facilities either are too limited, or do not exist at all. Messengers cannot move along the blocked roads. At a

time when swift and sure communications are most needed, they virtually cease to function—except, of course, for radio.

What roads are traversable? Should lines of cars be held at barricades an extra hour, or perhaps an extra day? Or are the cars released too soon, only to run into drifts? Conditions during a snow storm may change in a half-hour, marooning travellers far from habitation.

Sometimes as much as 30 feet of snow will fall during the winter on a California mountain highway, packing perhaps to a depth of 15 feet. Too, one-fourth of the snow removal mileage in the state lies within a single highway district, No. 2. In an effort to solve the problem, particularly important because this district maintains the main north and eastern gateways to the state, radio stations were established at the district headquarters, Redding, and on all rotary snow plows. (Later other districts were similarly equipped). A test car was equipped with radio in mid-summer and tests were made to provide data on which

to base estimates of the kind of equipment and power required to provide reliable communication between the plows and their base, and between Redding and the maintenance stations. Not only are air-line distances great in District No. 2—105 miles from Redding to Alturas, 140 miles from Quincy to Yreka—but the rough terrain hides sections of highway in deep canyons. These conditions combine to make reception difficult, but we have found through experience that our present equipment overcomes them satisfactorily.

Fifty-watt telephone and telegraph transmitters operate at Mt. Shasta City, Burney, Alturas, Mineral, Susanville, Quincy and Pulga. These sets work on either standard line supply of 110 volts, 60 cycles or on a 12-volt truck battery. The change-over is almost instantaneous, involving only the insertion of the power plug into another socket. These transmitters are duplicates, in size and control the snow plow receivers.

Transmitters for the plows operate
(Continued on page 46)



District engineer talks with plow operators giving up-to-the-minute instructions via radio.

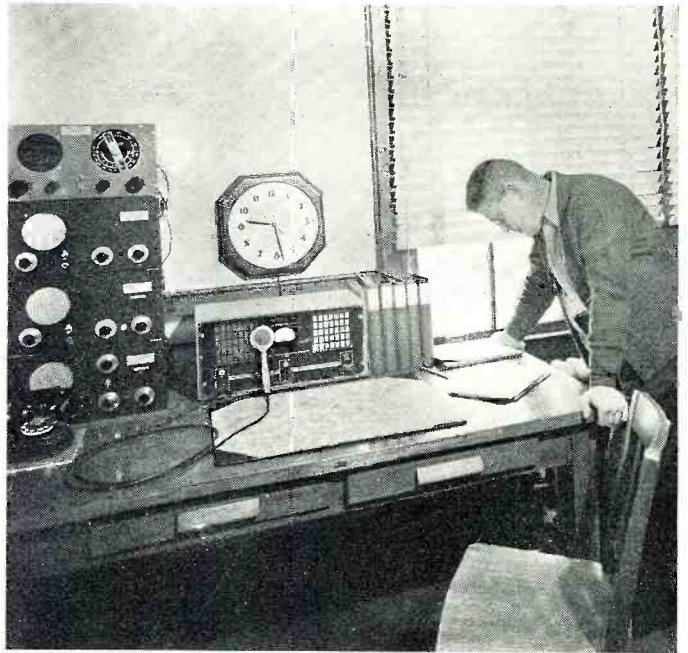

This radio installation is located at the main district office. Operator is checking his log.

Below: Radio-equipped snow plow with antenna in position.
Insert: Plow operator hears instructions from headquarters.

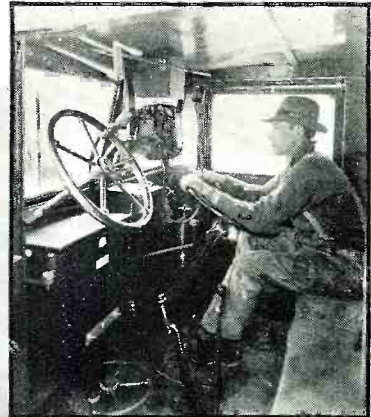

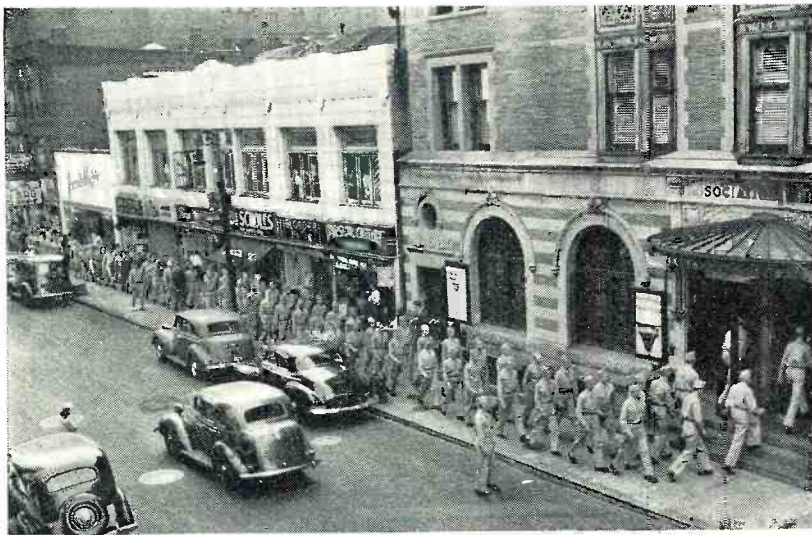

A group of radio students marching into the restaurant of the Newark YMCA where they partake of nutritious food.



Students are classified and given various tests to determine their aptitude for various phases of radio.

MAKING RADIO TECHNICIANS

MEN who have shown special aptitude for radio subjects arrive at the United Radio-Television Inst. in Newark, N. J., after receiving a few weeks of basic training at Signal Corps Training Centers. Classes of 50 men arrive at regular intervals. The rigid schedule begins at eight o'clock in the morning and continues to four in the afternoon. Special periods are set aside for physical training and recreation in order to assure students that they will have clear heads to absorb intricate details of radio subjects. A number of students are married. One of them was 48, the father of a full-grown family. He was a railroad signalman. He is now a graduate of the school and is a proficient radio technician.

Plenty of good food is the rule in the cafeteria where radio students relax from the classroom "glass arms."



Students find time to discuss radio problems or to get in a bit of ribbing while engaged at their mess.





Students receive training in basic theory and practice. They learn to assemble small battery-operated receivers.

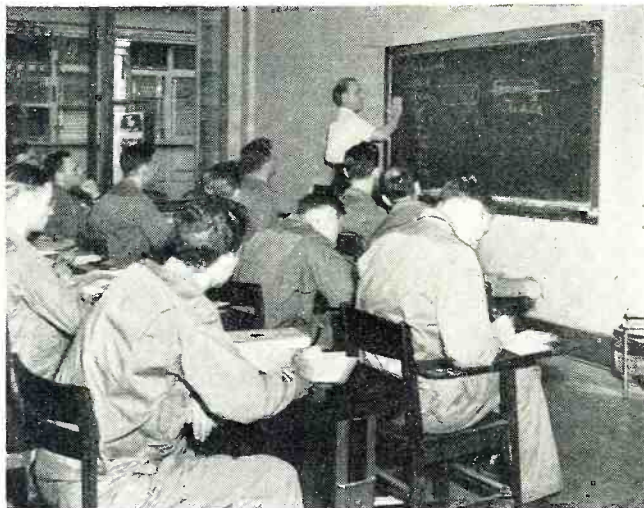

A class in radio theory learns how to determine the value of carbon resistors. Instructor explains the color code.



Tracing simple circuits with the aid of diagrams. Each student must understand all symbols used in their work.



Happy days! Mail from home brings welcome relief from the monotonous code signals and the classroom studies.

Much of a student's spare time is taken up with private discussions of radio matters and prospects for dates.

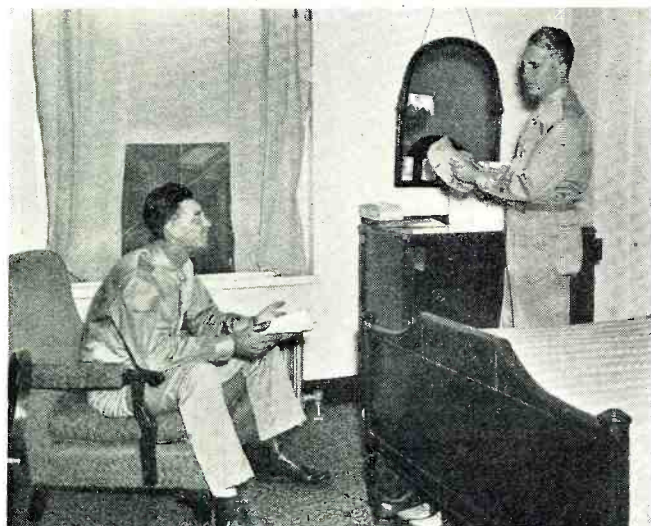

Healthy bodies are essential to an Army's morale and efficiency. Every student must engage in calisthenics.

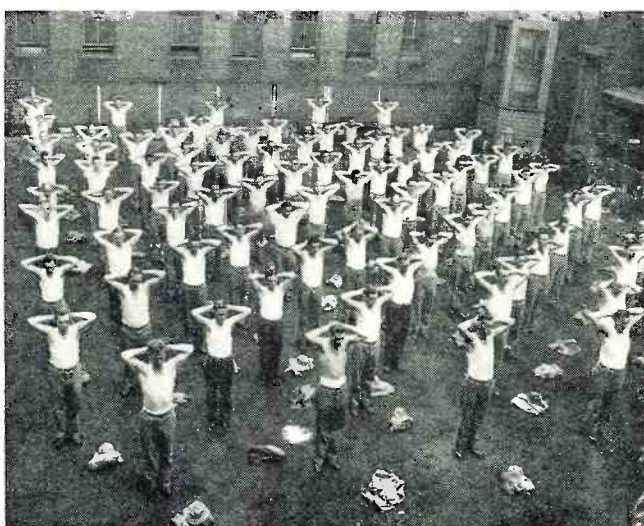

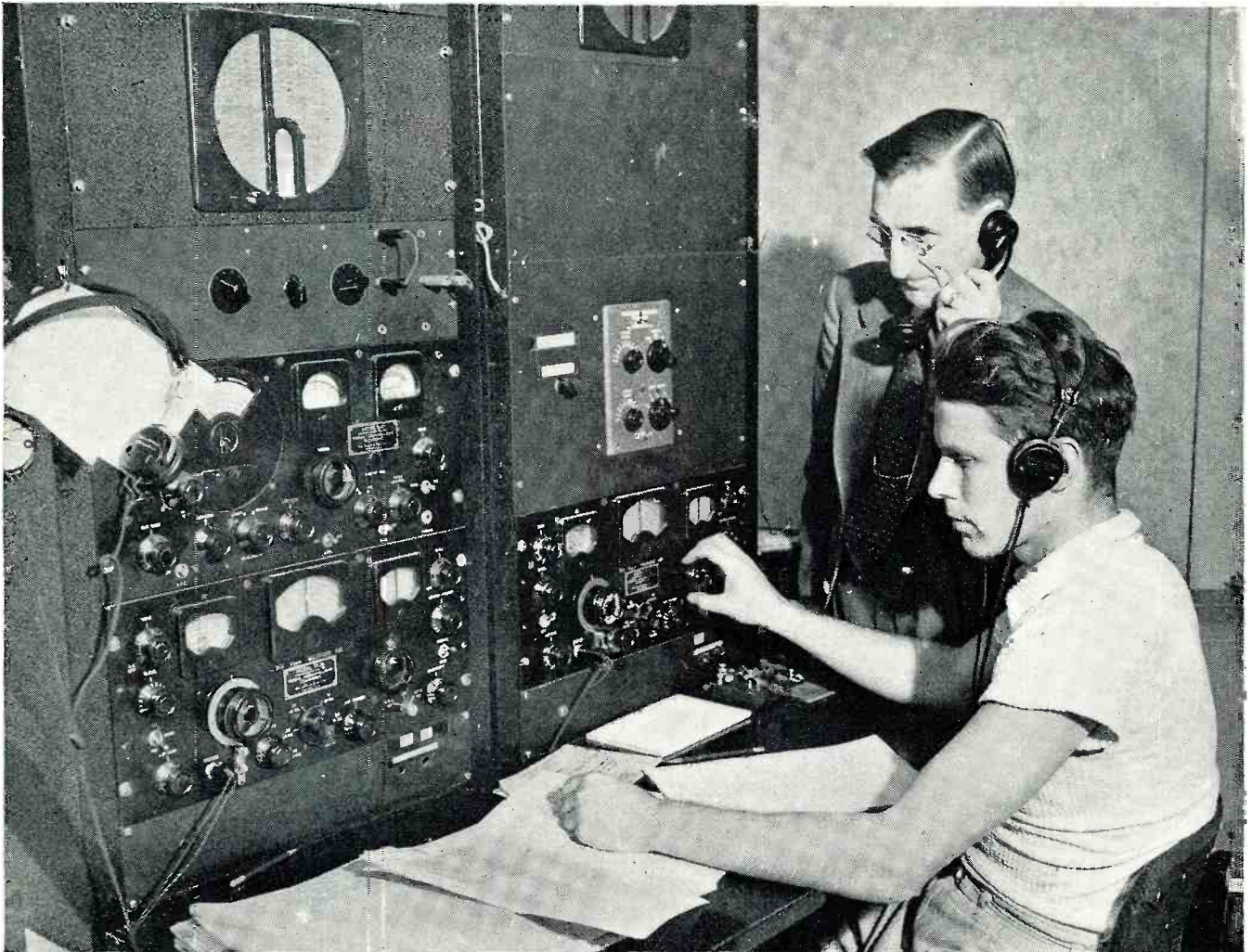

Acme Photo

Important war news being received on elaborate setup which includes three receivers, crystal-controlled frequency standard and group of monitor units.

RECORDING WAR NEWS WITH THE SX-28

by **OLIVER READ**

Managing Editor, RADIO NEWS

The audio amplifiers of the better communications receivers are well suited for use with record cutters and phono pickups.

ONE of the chief problems which faces the recordist of "off the air" news, historical broadcasts, etc., is in the purchase of amplifying equipment due chiefly to the scarcity of certain parts and tubes and to the priority situation in general. High-fidelity amplifying equipment is becoming more and more difficult to obtain, and the layman is faced with the problem of finding suitable sub-

stitutes wherever possible. There are hundreds of communications receivers still in the hands of the public, particularly within the broadcast stations, recording studios and amateur establishments which may be used to good advantage.

These receivers that are equipped with suitable amplifiers of sufficient power for recording are highly suited to "off the air" recording. The better

receivers, such as the *Hallicrafters* SX-28, are usually designed for sufficient power to drive large speakers to full output. Any amplifier having a power output of approximately 5 watts is suitable for recording providing it possesses sufficient frequency range and includes other incidental features which are desirable for proper cutting technique.

We have, for many months, recorded



Transcription table and 500 ohm magnetic cutter used with the Hallicrafters SX-28.

many outstanding world events. These transcriptions will some day be a valuable reference library in sound, and will reveal to the observer the entire step-by-step phase of the present conflict beginning with the invasion of Poland. We make it a practice to record these events at least three times a week and to file them in proper sequence. Whenever special occasions arise, extra discs are cut. An example is the "scuttling" of the French fleet in recent weeks. Another, and one from out of the past, is King Edward's Fare-



Typical communications receiver with plenty of power output for driving any type cutter.

well Address. These, plus hundreds of other outstanding events, may be recorded with good fidelity using a standard communications receiver to do the job.

In order to ascertain what requirements must be met, we will discuss the particular amplifier used in the SX-28 receiver. First we find that the second, or output stage of the audio amplifier, employs two 6V6GT tubes connected in push-pull. These tubes are driven by the 6SC7 double triode. One of the triode sections of the 6SC7 tube

is used as the inverter to the 6V6GT output tube. A portion of the signal from the plate circuit of the first 6SC7 triode is fed to the grid of the other 6SC7 triode section, thereby giving two output voltages in opposite phase suitable for exciting the push-pull 6V6GT output amplifier. The output of this stage is eight watts undistorted and is ample for driving any magnetic or crystal cutter.

Inasmuch as most cutting is confined to those subjects which do not require wide frequency range, we find that we

Partial schematic of SX-28 shows audio end of the set. The tonal range is fully adjustable.

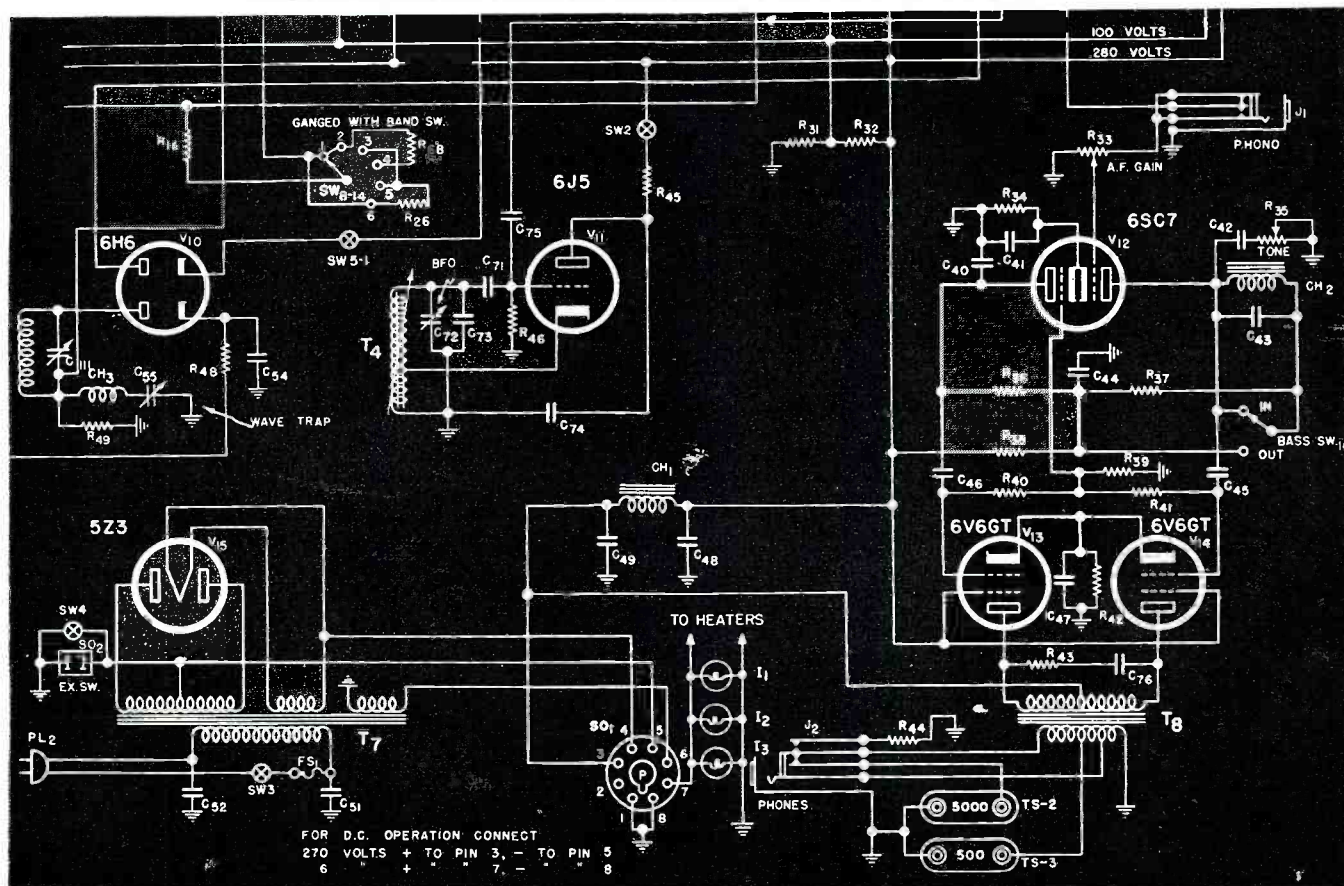

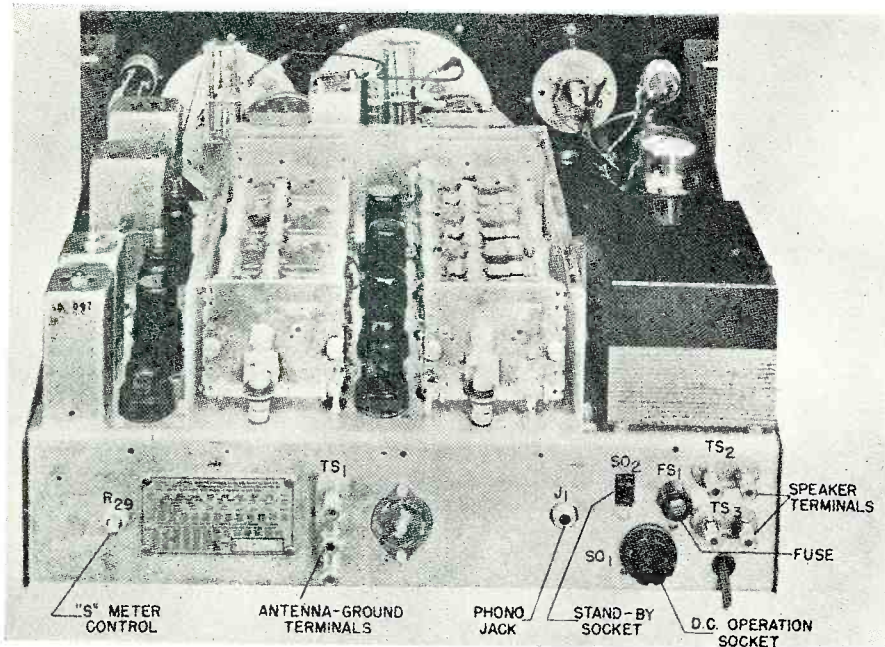

Terminals on rear of chassis showing location of phono jack and outputs from the audio amplifier with choice of impedance.

are able to combat interference from closely-spaced short wave stations by taking full advantage of the selectivity characteristics built into the receiver. For example, six ranges of selectivity are provided in the model SX-28 receiver. They are:

1. Broad i.f. (for high fidelity reception).
2. Medium i.f. (more selectivity—less highs).
3. Sharp i.f. (reduces annoying interference—far less highs).
4. Crystal Broad (similar to sharp i.f. but cleaner cutting of side bands).
5. Crystal Medium (next selectivity step to No. 4—greatly increased side-band cutting—more pronounced crystal "slot" for interference—very little highs present).
6. Crystal Sharp (position of extreme selectivity—practically no side-band content—very pronounced crystal "slot").

While the reception of high-fidelity programs is possible with the equipment, there are several precautions which must be observed in order to take full advantage of the tonal range. Reference to Fig. 1 shows the effects on the audio fidelity curve when the controls governing the i.f. circuits are set at different positions. In position No. 1, the response is fairly flat to approximately 2000 cycles where it then drops rapidly. In position No. 2, the response begins to drop off below 1000 cycles; and in position No. 3, the bass is up slightly and the curve falls rapidly, dropping off at approximately 300 cycles. Examination of this chart indicates that in order to get satisfactory response, it would be desirable to incorporate a network at the cutter to reduce slightly the bass response of the output in order to compensate for the loss of highs. This would be necessary only if one were to make a seri-

Fig. 1. Audio response curve of the Hallicrafters SX-28.

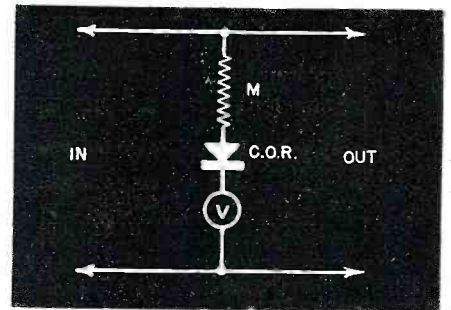
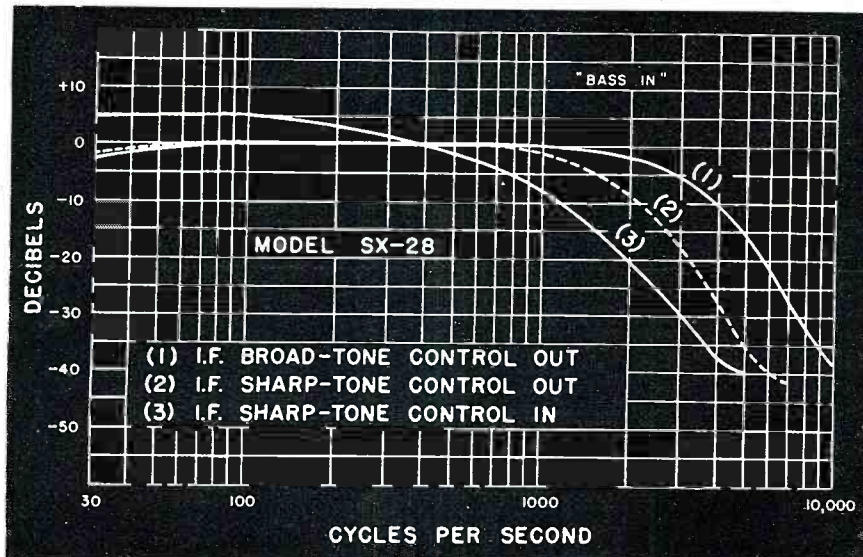

Fig. 2. Connections for db meter.

ous attempt to use the receiver for recording symphonic music, etc., but would not be necessary for the recording of voice frequencies.

It is common knowledge that the average speech range does not require high fidelity circuits, in fact, speech will be clear and understandable when any of the three positions is employed. The choice of which one to use is a matter of personal discretion, and should be selected so that interfering heterodyne whistles are reduced most effectively.

The second chart shown in Fig. 5 is also representative of the audio curve of the SX-28, and shows the effects

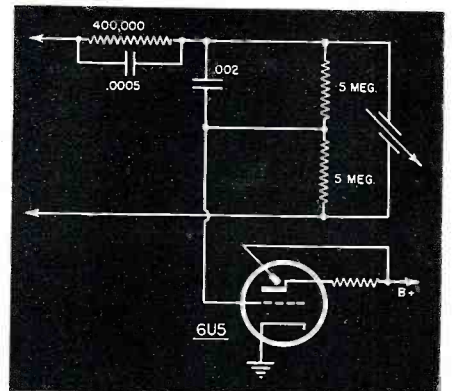

Fig. 3. Simple tuning-eye monitor.

when the bass switch is either in or out. Note how the response is changed. Here we find that the response of the low frequency portion has been greatly accentuated while all of the highs have been greatly reduced, if not entirely eliminated.

Other features of interest to the recordists are found in this receiver, among them being a crystal phasing control and the automatic noise eliminator. Both of these have definite advantages, particularly when recording foreign transmissions.

The phasing control is in the circuit on three positions of the selectivity control; namely, Xtal sharp, Xtal medium and Xtal broad. This control is used to remove heterodyne interference as well as to minimize other forms of interference having a predominance of high frequency components such as static and interference from electrically operated devices.

The A.N.L., or automatic noise limiter, contributes materially to the satisfactory operation of the receiver by eliminating objectionable interference caused by ignition systems or other

man made causes of electrical disturbances. With the control retarded to the left, as far as it will go, or until the A.N.L. switch is heard to operate—the noise limiter circuit is not functioning. Turning the control to the right closes the switch which is mounted on the control. The noise limiter is now operating, progressively turning the control clockwise varies the threshold at which the noise limiter starts to take hold.

The setting at which the control will be left depends entirely on the type and amount of interference present as well as the signal strength. The noise limiter should be judiciously adjusted because through its operation the desired signal can even be eliminated or badly distorted which destroys its usefulness. Once the operator becomes familiar with the technique of this control by actual practice, he can tell easily how far it should be advanced until the best compromise between noise and signal is obtained.

Noise Limiter

The principle of operation of the

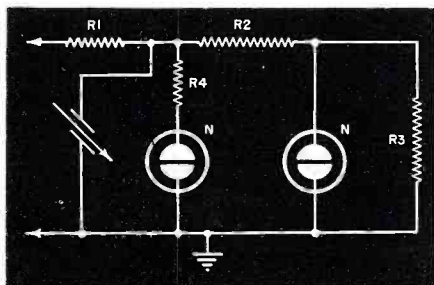

Fig. 4. Neon lamps indicate peak voltages.

limiter is very similar to that of the *Lamb* limiter. The carrier of the received signal is first converted over to the intermediate frequency and then fed into the 6L7 amplifier and 6B8 AVC amplifier and 6AB7 noise amplifier. A broadly tuned i.f. transformer is used in the plate of the 6B8 with its primary and secondary closely coupled. The secondary feeds into the 6B8 diode where rectification of the carrier furnished AVC voltage for the r.f. and mixer tube as well as for the 6AB7 noise amplifier. A broadly tuned i.f. transformer is used in the plate of the 6AB7, the secondary feeding into the 6H6 noise rectifier. A 455 kc. wave trap (CH3 and C55) is used which allows the passage of the higher audio frequencies without attenuation.

In the form of further explanation of the approach toward noise elimination, it must be remembered that noise in general is composed of a random mixture of high and low frequencies. Of this mixture the predominating higher frequencies are the most objectionable. It is to our advantage to retain the high frequency components. Thus, these transients will be allowed to rise to a point far above the carrier level with the result that they will be applied to the injector grid of the 6L7 tube without being reduced in value.

Transients, such as ignition interference having a steep wave front,

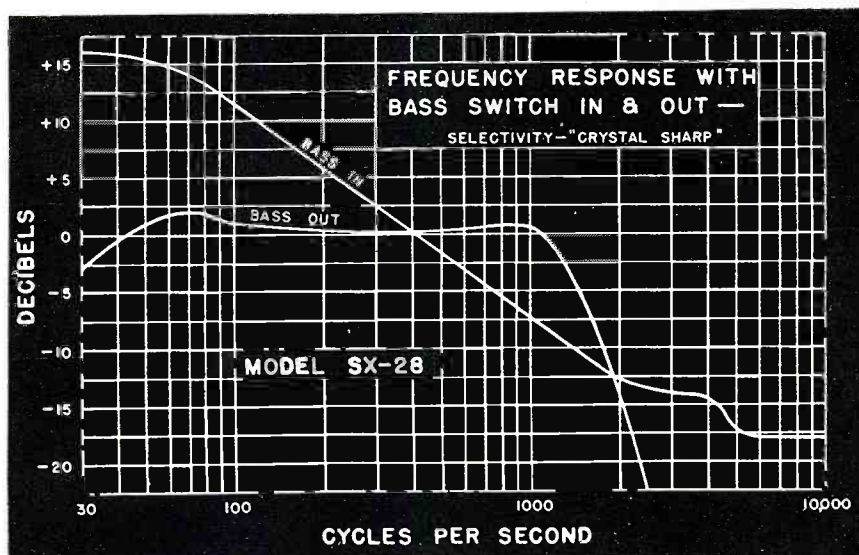

Fig. 5. Effects on frequency response with bass switch in use.

consist largely of high frequency components. The voltage applied to the grid of the 6L7 tube has a negative polarity because of the 6H6 noise rectifier. By varying the ANL control, we raise or lower the negative voltage applied to the 6L7 tube until it is barely sufficient to overcome the noise impulses applied to the grid of this tube without allowing the modulation peaks of the carrier to become badly distorted.

If the noise limiter adjustment permits too great a value of transient voltage to be applied to the 6L7 injector grid, detection will take place and rectified components of this modulated carrier will appear in the 6L7 plate circuit. This effect will appear as distortion in the output of the receiver. If, on the other hand, not enough noise voltage is applied, then the momen-

the particular carrier and noise level being received.

Connecting Cutter

Two outputs are provided on the receiver, one of 500 ohms, the other of 5000 ohms. Normally, the speaker connects to the 5000 ohm output terminals on the receiver. Fig. 6 shows representative circuits for magnetic cutters. Fig. 6A is used to match a 500 ohm cutter to the 500 ohm output terminals of the receiver. Satisfactory impedance match will be obtained for all but high-fidelity cutting. Inasmuch as the impedance of the cutter varies with frequency, the modulation in the groove will not be of constant reflected impedance but will vary considerably over the normal range. This will not present any great handicap to the average listener and the quality

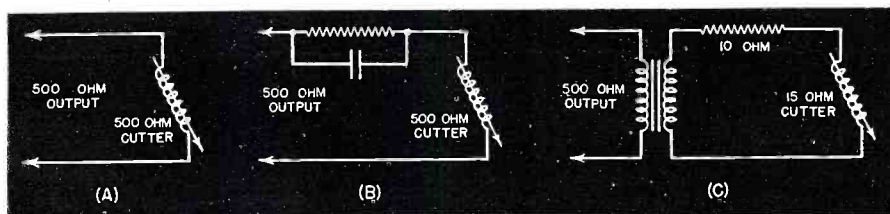

Fig. 6. Several ways for connecting magnetic cutters to receiver.

tary decrease in sensitivity will not be great enough to stop the noise from getting through and some of it will appear in the plate circuit of the 6L7 tube and consequently in the output of the receiver. As a result the noise limiter must be carefully adjusted to

may be considered quite satisfactory.

Fig. 6B is an improved circuit and includes a series resistor, shunted by a 1 μ fd. condenser, and provides a suitable filter network to reduce the amplitude of the bass frequencies. It

(Continued on page 72)

Fig. 7. Satisfactory results with crystal cutters may be had on voice.

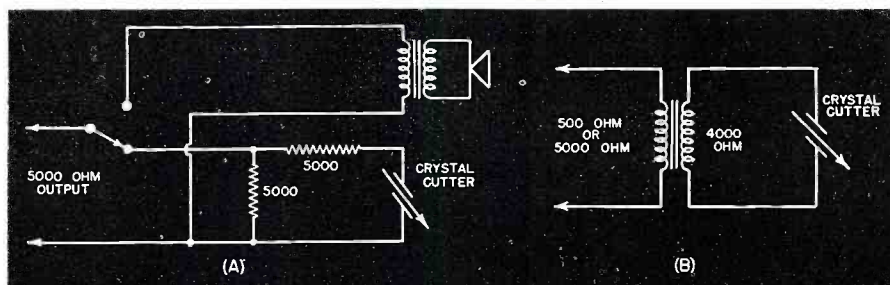

HOW TO USE THE SLIDE RULE

ANY authors have rated the slide rule as the engineer's number-one instrument. Certainly this useful device has reduced the drudgery of computations to such an extent that a technician would no sooner be caught without his slide rule than would a doctor without his stethoscope. The slide rule reduces long minutes of paper-and-pencil calculations to a few simple manipulations of the "slip-stick" and "runner."

Today, more than ever in peace time, the slide rule is a ranking time saver. Our production of war goods, as well as much of military operation itself, has deep roots in mathematical soil. There is little time now for burdensome paper arithmetic with its equally burdensome checks and proofs.

It is not the purpose of this article to explain the fundamentals of slide rule operation, since this information may readily be obtained from mathematical textbooks and the handbooks accompanying new slide rules. A serious student may survey elementary slide rule principles in a single evening and may gain mastery of the subject in a few additional evenings of practice. On the other hand, we will explain how to make specific radio and electronic calculations. Actual directions will be given for manipulation of the rule in each case.

A selected number of examples have been chosen. These embrace most of the problems commonly handled by radio and electronic technicians in military service and civilian pursuits and are typical of the other problems. Other examples solvable by the same processes will readily occur to the reader.

We find that the type of slide rule possessed by most radio and electronic workers is the *polyphase*. Our discussion will, therefore, be limited to that type. However, any rule equipped with A, B, C, D, CI, and L scales may be employed.

In order that the reader may not be confused by placement of the decimal point and by the number of digits in the answer, rules governing the decimal point and number of digits are given at the end of the article, and the arithmetic process is given in parentheses after each operation. Abbreviations used are: *mult.*, multiplication; *div.*, division; *inv.*, raising to a power; *evol.*, extraction of a root; *recip.*, finding the reciprocal.

Ohm's Law (D. C.)

1. To find resistance when current and voltage are known:
 - A. Set current value on C scale to voltage value on D scale (div.).

- B. Under C index, read resistance value on D scale.
2. To find current when resistance and voltage are known:
 - A. Set resistance value on C scale to voltage value on D scale (div.).
 - B. Under C index, read current value on D scale.
3. To find voltage when current and resistance are known:
 - A. Set C index to current value on D scale.
 - B. Set hair line to resistance value on C scale (mult.).
 - C. Under hair line, read voltage value on D scale.
4. To determine value of cathode resistor for any tube:
 - A. Set tube plate current value (total of plate and screen currents for tetrodes and pentodes) on C scale to value of desired grid bias voltage on D scale (div.).
 - B. Under C index, read cathode resistor value on D scale.
5. To determine value of grid resistor for a radio-frequency power amplifier tube:
 - A. Set recommended d.c. grid current value on C scale to desired d.c. grid voltage value on D scale (div.).
 - B. Under C index, read grid resistor value on D scale.

Ohm's Law (A. C.)

6. To find current when reactance (or impedance) and voltage are known:
 - A. Set reactance (or impedance) value on C scale to voltage value on D scale (div.).
 - B. Under C index, read current value on D scale.
7. To find voltage when current and reactance (or impedance) are known:
 - A. Set C index to current value on D scale.
 - B. Set hair line to reactance (or impedance) value on C scale (mult.).

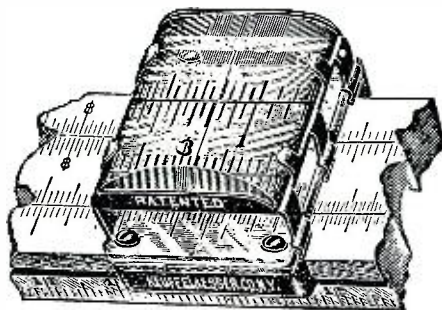

Details of slide rule indicator.

by

RUFUS P. TURNER

Consulting Engineer, RADIO NEWS



- C. Under hair line, read voltage value on D scale.
 8. To find impedance (or reactance) when voltage and current are known:
 - A. Set current value on C scale to voltage value on D scale (div.).
 - B. Under C index, read impedance (or reactance) on D scale.
- ### A. C. Conversions
9. To determine effective (RMS) value of alternating current or voltage from peak value:
 - A. Set C index to peak current or voltage value on D scale (mult.).
 - B. Set hair line to 0.707 on C scale.
 - C. Under hair line, read effective (RMS) value on D scale.
 10. To determine average value of alternating current or voltage from peak value:
 - A. Set C index to peak current or voltage value on D scale (mult.).
 - B. Set hair line to 0.636 on C scale.
 - C. Under hair line, read average value on D scale.
 11. To determine peak value of alternating current or voltage from effective (RMS) value:
 - A. Set C index to effective (RMS) value on D scale.
 - B. Set hair line to 1.414 on C scale (mult.).
 - C. Under hair line, read peak value on D scale.
 12. To determine peak value of alternating current or voltage from average value:
 - A. Set C index to average value on D scale.
 - B. Set hair line to 1.57 on C scale (mult.).
 - C. Under hair line, read peak value on D scale.
 13. To determine effective (RMS) value of alternating current or voltage from average value:

IN CALCULATIONS

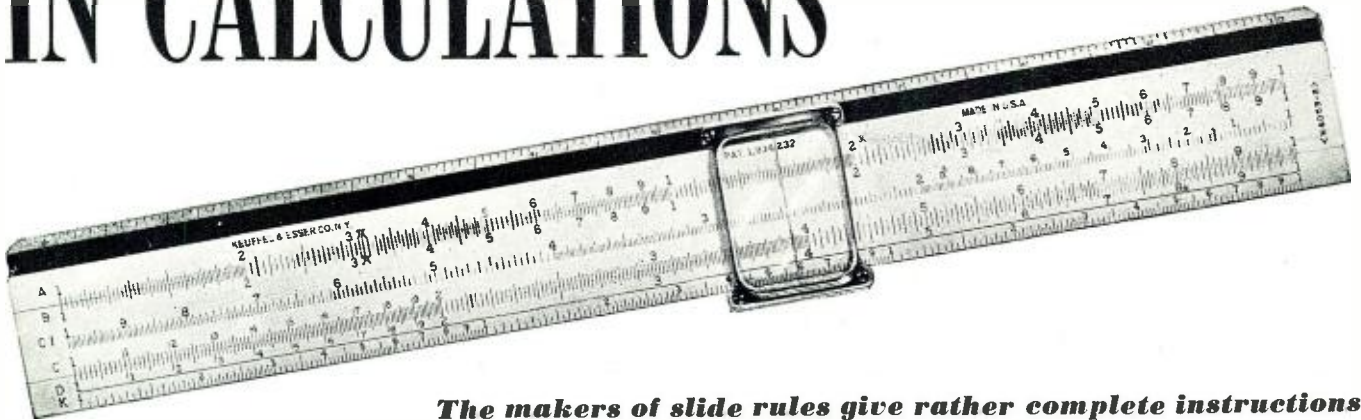

The makers of slide rules give rather complete instructions for their use. This article deals with radio formulae work.

- A. Set C index to average on D scale.
 - B. Set hair line to 1.11 on C scale (mult.).
 - C. Under hair line, read effective (RMS) value on D scale.
14. To determine average value of alternating current or voltage from effective (RMS) value:
- A. Set C index to effective (RMS) value on D scale.
 - B. Set hair line to 0.9 on C scale (mult.).
 - C. Under hair line, read average value on D scale.

D. C. Power

15. To find watts when current and voltage are known:
 - A. Set C index to current value on D scale.
 - B. Set hair line to voltage value on C scale (mult.).
 - C. Under hair line, read power value in watts on D scale.
16. To find power in watts when current and resistance are known:
 - A. Set hair line to current value on D scale (inv.—the hair line now indicates the square of the current on the A scale).
 - B. Set B index to hair line.
 - C. Set hair line to resistance value on B scale (mult.).
 - D. Under hair line, read power level in watts on A scale.
17. To find power in watts when voltage and resistance are known:
 - A. Set hair line to voltage value on D scale (hair line now indicates the square of the volts on the A scale—inv.).
 - B. Set resistance value on B scale to hair line (div.).
 - C. Under B index, read power value in watts on A scale.

A. C. Power

18. To find power in watts when current, voltage, and power factor are known:
 - A. Set C index to current value on D scale.

- B. Set hair line to voltage value on C scale (mult.).
 - C. Set C index to hair line.
 - D. Set hair line to power factor value on C scale (mult.).
 - E. Under hair line, read power value in watts on D scale.
19. To find reactive power value in volt-amperes when current and impedance are known:
- A. Set hair line to current value on D scale (the hair line now indicates the square of the current on the A scale—inv.).
 - B. Set B index to hair line.
 - C. Set hair line to impedance value on B scale (mult.).
 - D. Under hair line, read power value in watts on A scale.
20. To find reactive power value in volt-amperes when voltage and impedance are known:
- A. Set hair line to voltage value on D scale (hair line now indicates the square of the voltage on the A scale—inv.).
 - B. Set impedance value on B scale to hair line (div.).
 - C. Under B index, read power value in watts on A scale.

Reactance

21. To find the reactance of a coil of negligible resistance when inductance and operating frequency are known:
 - A. Set C index to 6.28 on D scale.
 - B. Set hair line to frequency value on C scale (mult.).
 - C. Set C index to hair line.
 - D. Set hair line to inductance value on C scale (mult.).

- E. Under hair line, read reactance value on D scale.
22. To find the reactance of a capacitor when capacitance and operating frequency are known:
- A. Set C index to 6.28 on D scale.
 - B. Set hair line to frequency value on C scale (mult.).
 - C. Move C index to hair line.
 - D. Set hair line to capacitance value on C scale (mult.).
 - E. Close slide and read reactance value under hair line on CI scale.
23. To find the reactance of a coil of negligible resistance or of a capacitor when the voltage across and the current through it are known:
- A. Set current value on C scale to voltage value on D scale (div.).
 - B. Under C index, read reactance value on D scale.

Q

24. To find the Q of a coil or capacitor when reactance and A.C. resistance are known:
 - A. Set resistance value on the C scale to reactance value on D scale (div.).
 - B. Under C index, read Q value on D scale.
25. To find the Q of a coil when inductance, A.C. resistance and operating frequency are known:
 - A. Set C index to 6.28 on D scale.
 - B. Set hair line to frequency value on C scale (mult.).
 - C. Set C index to hair line.
 - D. Set hair line to inductance value on C scale (mult.).
 - E. Set resistance value on C scale to hair line (div.).
 - F. Under C index, read Q value on D scale.
26. To find the Q of a capacitor when capacitance, A.C. resistance, and operating frequency are known:
 - A. Set C index to 6.28 on D scale.
 - B. Set hair line to capacitance value on C scale (mult.).

(Continued on page 52)

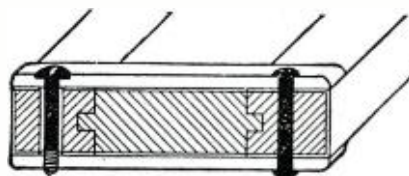

Cross section of typical slide rule.

WARTIME PROGRESS IN ELECTRONICS

by **ROBERT EICHBERG**

Electronic Research Engineer.

The analysis of recent patents indicates that there is a great deal of activity in the electronic field. Several are discussed.

HISTORIANS of the world divide the Ages into the Stone Age, the Bronze Age and the Iron Age; some have said that our own era would be known as the Electric Age or—more recently—the Plastics Age. But if current trends are any indication, it will more likely be called the Electronic Age, for many and marvelous are the inventions now being disclosed on the application of electronics to various phases of daily life.

Whether or not Frequency Modulation will replace Amplitude Modulation is still a highly debatable point. True, FM has certain distinct advantages, the most highly publicized of which is its freedom from interference

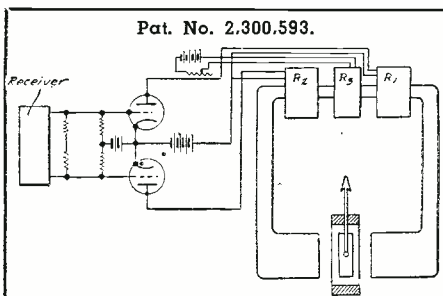

and, secondarily, the wide band of frequencies which it reproduces with amazing fidelity. Yet tests conducted by the Police Department of a large Eastern city showed that *if the same band were used*, AM transmissions gave results which could not be told from those attainable with FM, as analyzed by the average observer.

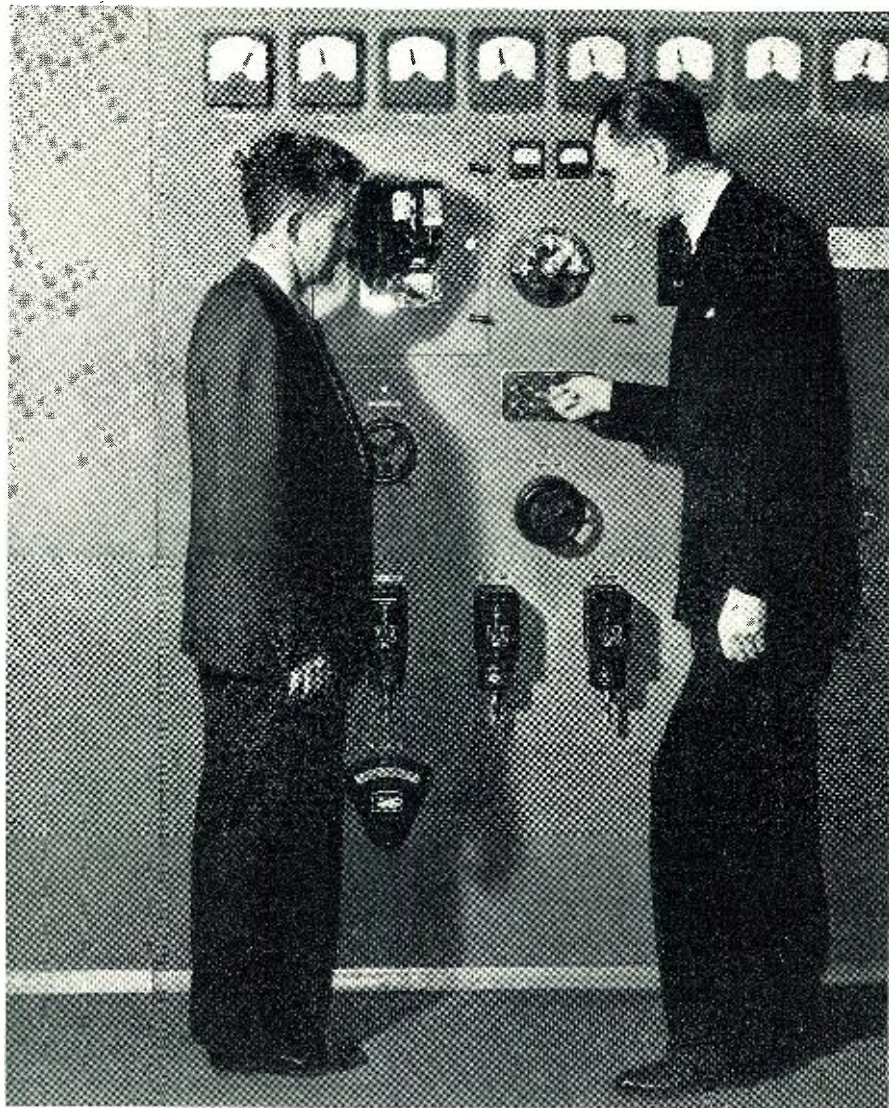
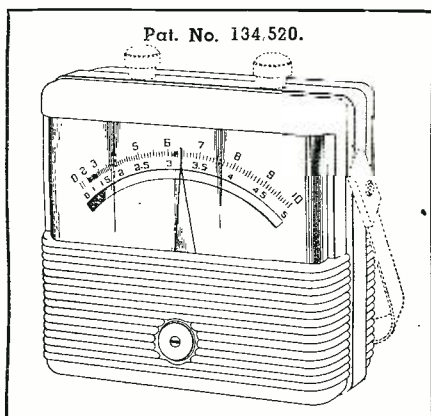

R. E. Sherwood, Director of Overseas branch of OWI, examines new GE 100 kw. transmitter.

Precision tests might have told a different story.

While FM has already been used commercially for the transmission of television sound, it is to its use as a video frequency carrier that many engineers look, for they believe that the larger number of tubes required for FM reception will not matter so much in receivers where price is not a major factor, and that its increased freedom from interference will be noticeable in

the reproduction of visual programs.

A great deal of thought has been given to the elimination of interference in television broadcasting, both here and abroad, and more will be said on this subject later. Indeed, much has already been written on the vertical polarization of propagated waves as compared with horizontal polarization—a controversy which seems, to this reviewer, of minor importance, due to the tendency of both types to

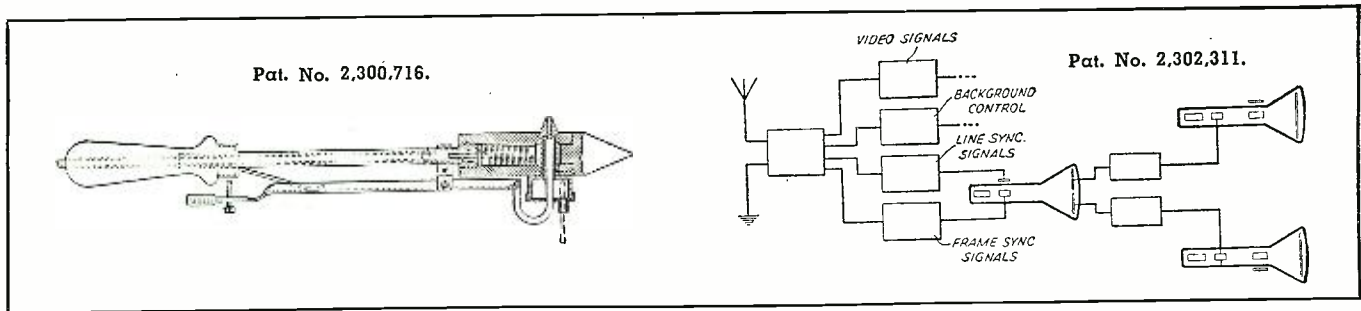

rotate upon their axes. In short, a wave which leaves the transmitting antenna in vertically polarized form may be horizontally polarized, or may appear at any angle, by the time it reaches the receiving antenna.

In England, legislation has been formulated to obviate one of the most annoying forms of interference: that from automobile ignition systems. Here there has been considerable discussion of the same problem, one group believing that the wide acceptance of auto-radio would make compulsory installation of interference suppression systems unnecessary, while another held that the installation of suppressors be a prerequisite to obtaining an automobile license. Suppressors, however, do only a partial job; they may prevent spark oscillations from entering the ignition wiring system, from which they may be readily radiated, but they do not pre-

plug, as explained in Patent No. 2,300,714, has a tubular metallic sleeve which screws into the shell, between it and the insulation, and extends up beyond the top of the plug. Thus, by using either a suppressor or a shielded ignition lead, a far greater portion of the spark interference is prevented from radiating. This device, incidentally, is designed primarily to mini-

Speaking of beams, patent No. 2,301,012 covers an original method of beam control in a vacuum tube. This tube, the invention of Richard S. Briggs, has the usual cathode, grid, and plate, to which an additional element—an integral metal shield—has been added. The shield surrounds all the other elements of the tube, and is so shaped as to have two recesses, diametrically opposite each other, formed lengthwise in it. The plates of the tube (two of which are shown in the model) are positioned in these recesses, and the inventor claims that, besides confining the electrical field within the tube, the shield acts as a beam confining plate, to modify the electron stream. This tube may provide shielding characteristics not unlike those of a metal tube, though using a glass envelope and thus requiring less metal in its construction.

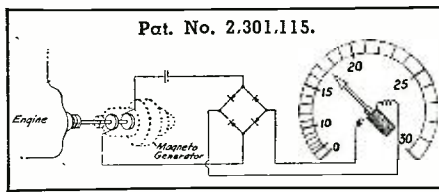

mize radio interference on airplane installations.

Another device suited to airplanes—or, for that matter, any vehicle—is termed a “radio guiding system” by its inventor, G. E. M. Perroux, of Paris, France, who has assigned the patent, No. 2,300,593, to the International Standard Electric Corporation, of New York. It gives the operator of the vehicle a visual indication of whether he is to the right or left of a given course, and is attractively simple in design.

Instruments, too, are undergoing development in these war years. Weston, for example, has recently acquired two new ideas. The first, Design Patent No. 134,520, covers a particularly

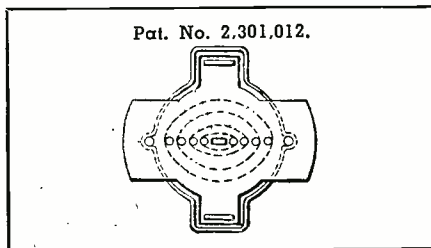

vent radiation from the spark plugs themselves.

A patent newly granted to Tullio Tognola and assigned to the Bendix Aviation Corp. will remedy that situation, for it contemplates complete electrostatic shielding built into the spark plug. As in conventional plugs, there is one electrode mounted on the threaded metal shell which screws into the cylinder block of the internal combustion engine, the other electrode being centered in the shell and insulated from it by some form of heat-resistant dielectric. However, this

A signal, which may be termed a “beam,” is picked up on a radio receiver, the output of which is a pulsating d.c., as is that of all receivers. This d.c. varies above or below an average level, depending upon whether the vehicle is veering to the right or left of the beam. The impulses are fed to the grids of two triodes, the plates of which feed into a system of coils. One tube is so connected as to move the visual indicator in one direction, the other to move it in the opposite direction. In addition, there is a third coil, the current through which is manually adjustable, to permit the centering of the visual indicator.

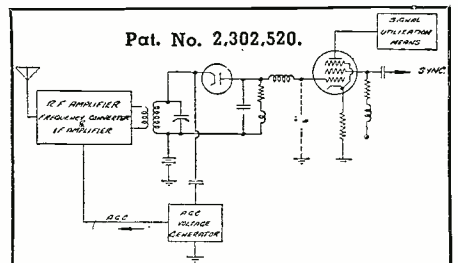

handsome and practical plastic case for portable meters. The carrying handle, also of plastic, may be swung down out of the way when the meter is stood upright, or may be left projecting at the rear, so that the instrument can be tilted for easy reading.

The other invention, on which Patent No. 2,301,115 was granted to R. W. (Continued on page 62)

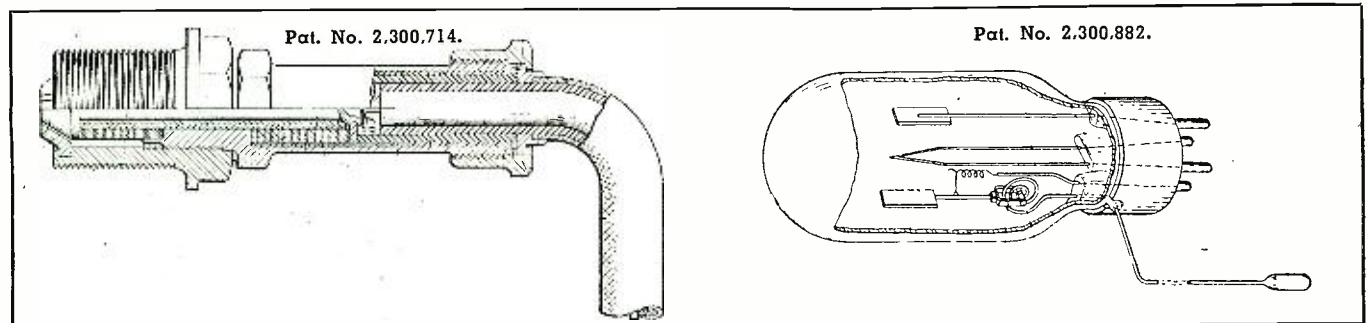

INEXPENSIVE PORTABLE CAPACITY BRIDGE

by HARRY L. POLING

Every part needed for the construction of this handy bridge should be found in the junk box. It saves many hours of work.

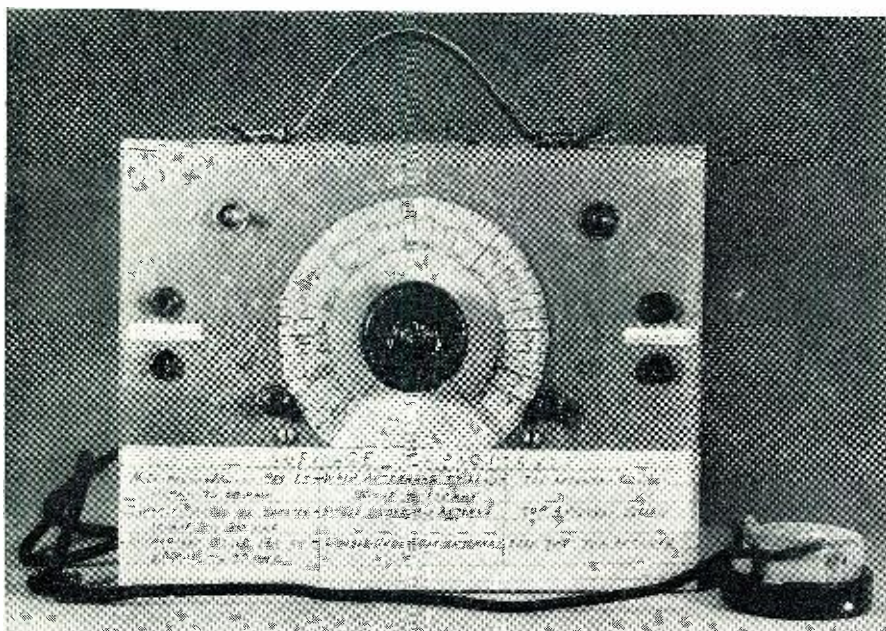

A home-made calibrated dial and a wood or metal box complete the instrument. Note single headphone.

A regular C battery supplies all the necessary power for the operation of the bridge. Few parts are required.

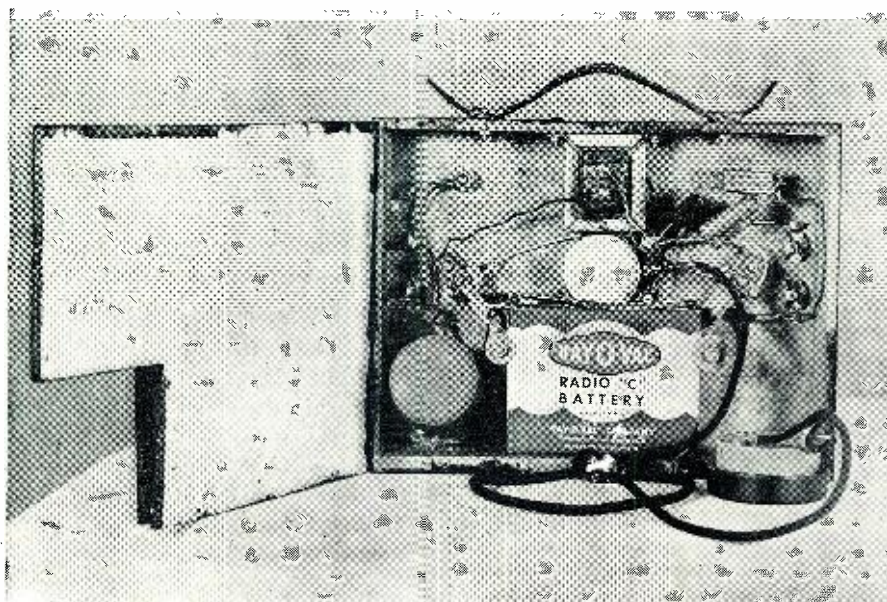

THIS unit was constructed to fill the need for a portable, low range capacity bridge. While this unit has been found useful for all ordinary capacity measurements within its range, its portability and freedom from power line connection has made it especially valuable for two types of work. These are testing auto-radio antenna systems and locating breaks in cables.

When used for testing auto-radio antenna systems, it measures quickly the capacity of the antenna and lead-in. Also, it gives a definite indication of leakage in the antenna system. The continuity test circuit will check opens and shorts in the antenna system. When the capacity reading of the auto-aerial is transferred to the dial of the Alignment Unit, the auto-radio can be completely aligned on the service bench. This eliminates the need for the acrobatic performance which is usually required to adjust the antenna compensator on the set after it is re-installed in the car.

This capacity bridge is highly useful for measuring capacity, checking continuity and locating breaks in microphone cables, line cords, etc. The location of a break in a fifty-foot microphone cable can usually be determined within four to six inches if care is taken in making the measurements.

Circuit

The circuit consists of a conventional bridge arrangement. A midget output transformer is used with a 10,000 ohm, linear taper potentiometer connected across the plate winding. A headphone is used as a "Null" indicator. The ranges are selected by a single-pole, double-throw toggle switch. A .01 μ fd. tubular condenser and a .0001 mica are used as "standards." A number of both sizes should be checked on a good capacity bridge to insure the capacities being just right. If the capacity of the larger condenser is not exactly 100 times that of the smaller, the capacity scales will not coincide, making calibration a more difficult task.

The signal source is a conventional code practice buzzer, energized by a three volt "C" battery. The buzzer and battery are connected in series with

the voice coil winding on the output transformer. The output transformer, working backwards, matches the impedance of the buzzer to the testing circuit. The operation of the buzzer is controlled by a non-locking push-button switch. This prevents the buzzer from being accidentally left running.

The buzzer should be adjusted to operate at its highest possible frequency. The higher the audio frequency signal, the less reactance it will encounter in testing low capacities and the sharper will be the null point as heard in the headphone. 750 to 1,000 cycles per second will be about right.

With the standards used, we obtained a working range of from 10 $\mu\mu\text{fd.}$ to .2 $\mu\text{fd.}$ It is important to use very short test leads. It would have been quite practical to have added another high capacity range, but the uses for which this instrument was built did not require a maximum range of more than .1 $\mu\text{fd.}$

A continuity and short tester using a lamp indicator is incorporated. The lamp is a pilot bulb drawing sixty milliamperes for full brilliancy. Continuity tests are made through a separate pair of tip jacks and the same battery that operates the buzzer is used for continuity testing. A resistance of 25 ohms in the circuit will reduce the brilliancy of the lamp somewhat. 50 ohms will permit about half brilliancy. 75 ohms will permit a faint glow. This circuit is not intended to function as an accurate ohmmeter, but to indicate short circuits, continuity and the condition of "booster coils" used in some auto-radio antenna in-

Wiring diagram of the capacity bridge.

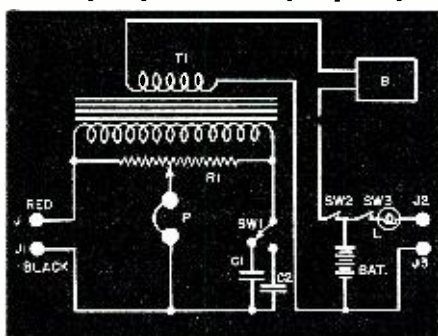

R₁—10,000 ohm linear taper pot., Mallory
 C₁—0001 $\mu\text{fd.}$ mica cond., Aerovox
 C₂—01 $\mu\text{fd.}$ cond., Aerovox
 T₁—Midget output transformer (see text), Thor-darson
 SW₁—SPDT toggle switch, Arrow
 SW₂, SW₃—Non locking push switches, Arrow
 J₁, J₂, J₃—Tip jacks
 L— $\text{E}49$ Pilot light, Mazda
 B—Code practice buzzer, Signal
 Bat.—3 v. "C" battery, Ray-O-Vac
 P—Headphone, Trimm

stallations. The resistance of these booster coils is usually from 20 to 50 ohms. The continuity test circuit is also controlled by a non-locking push button switch. The input terminals J₂ and J₃ are to be used for capacity measurements.

The Alignment Unit provides a means of connecting a signal generator to a car-radio so that the antenna stage in the set can be aligned just as

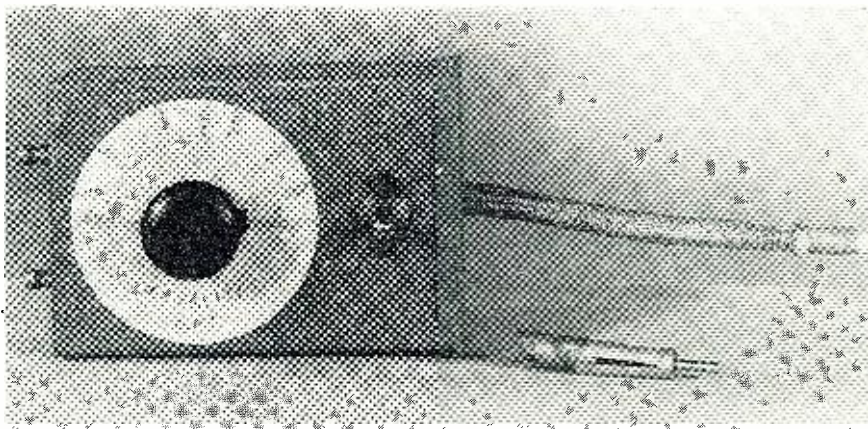

The alignment unit is built into a metal shield can measuring 5x3½x2½". Dial is cut from cardboard.

if the set were connected to its own antenna. It consists of a short length of shielded antenna lead connected in parallel with a calibrated variable condenser. A booster coil provided with a shorting switch permits duplication of operating conditions whether or not the antenna lead-in to the set contains a booster coil. The output of the signal generator is fed into this circuit through a 50,000 ohm resistor to prevent the signal generator test leads from adding any additional capacity to the circuit.

The variable condenser was salvaged from a junked midget radio and the one we finally selected had a minimum capacity of 12 $\mu\mu\text{fd.}$ after the trimmer was removed. The section of antenna lead used for the connection cable is about six inches in length and has a very low capacity.

Our alignment unit has a total minimum capacity of 25 $\mu\mu\text{fd.}$ and a maximum capacity of 420 $\mu\mu\text{fd.}$ This range will permit the duplication of any auto-radio antenna capacity that we have encountered.

Construction

We built our capacity bridge into the lid of an old test instrument case. This gave us a wooden box 9½"x7"x2". The top of the lid was used as the front panel of the capacity bridge. The output transformer is a midget and was mounted at the top center of the case. The potentiometer is mounted just below the transformer near the center of the panel. Mounting the "C" battery at the bottom center of the case leaves room on one side for the buzzer assembly and room for the headphone on the other side. The push switches are mounted one on each side, just above the "C" battery.

To reduce mechanical noise from the buzzer, it was removed from its bakelite base and, by means of two washers, bolted in the center of a sponge rubber disc 2" in diameter. This disc was then glued on top of a similar disc with rubber cement. After the connecting wires were attached to the buzzer, it was covered by a sponge rubber cup. This cup was cut from the insulating rubber in an old vibrator can. The rubber cup is glued in place with rubber cement. This forms

a complete sponge rubber case for the buzzer which was then glued in place in its corner of the case.

The continuity indicating lamp was mounted by drilling a hole through the panel and glueing the bulb in place so that its top end just comes through the panel. A bakelite washer with ½" hole was glued on the panel over the bulb for additional protection against breakage.

The capacity tip jacks and the capacity selector switch are mounted in a position allowing very short wires to the potentiometer. The leads were made up with red and black tip jacks and alligator clips. Three inch flexible leads were used. These leads should be as short as possible to eliminate any additional capacity.

A back was made for the case from a piece of plywood 9½"x7". A square 3"x3" was cut out of one lower corner and hinged, forming a door. A solder lug attached by a screw makes a catch to hold the door closed. This door was provided so that the headphone and test leads may be placed inside the case when not in use.

The back and sides of the case were painted black and the front panel grey crackle. A leather handle was attached to the top of the case.

The dial is a cardboard disc 5" in diameter glued to the panel. The pointer is made from a piece of celluloid 2½"x1" with a line scratched through the center. A hole ¼" in diameter was made near one end and the celluloid strip was then glued to the back of a large wooden knob. When the scratched centerline was filled with white paint, we had a fairly neat

Diagram of the portable alignment unit.

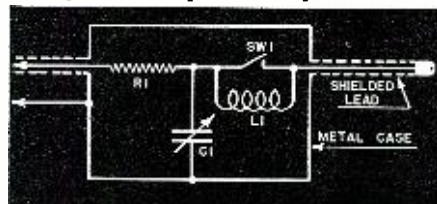

R₁—50,000 ohm ½w. Res., IRC
 C₁—10 to 420 $\mu\mu\text{fd.}$ variable cond., Meissner
 L₁—Standard replacement type booster coil, Meissner
 SW₁—SPDT toggle switch, Arrow

loid 2½"x1" with a line scratched through the center. A hole ¼" in diameter was made near one end and the celluloid strip was then glued to the back of a large wooden knob. When the scratched centerline was filled with white paint, we had a fairly neat

(Continued on page 65)

PRACTICAL RADIO COURSE

by ALFRED A. GHIRARDI

Part 11 of the present series gives further data on the characteristics of vacuum tubes and shows how the various elements function in circuits.

THE term *characteristic* is used to identify the important electrical features and electrical values of a radio tube which distinguish it from other tube types. These values may be shown in graph, or they may be tabulated. When given in graph form they are called *characteristic curves*; when tabulated they form the familiar tube *characteristic charts* supplied by the various tube manufacturers. The various characteristics listed in tube charts are rather confusing to the uninitiated, as little or no explanation of them accompanies the chart. The meanings of some of them are of course obvious, so only those apt to cause confusion will be explained here.

Amplification Factor

One of the most important characteristics of any electronic amplifier tube is its *amplification factor*, commonly expressed by the Greek letter μ (mu). This characteristic is one of the most important and, perhaps, the least understood.

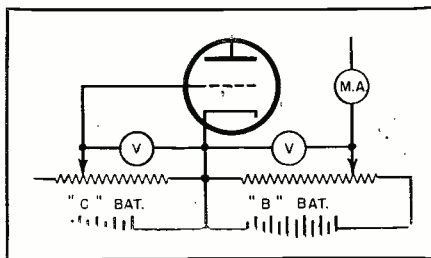
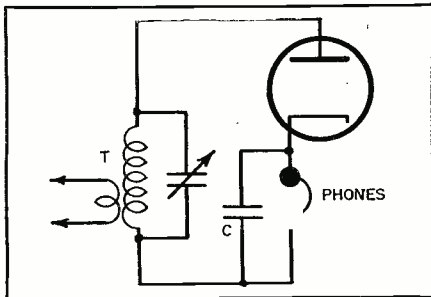

Fig. 1.

The amplification factor is the ratio of the change in plate voltage to a change in control grid voltage in the opposite direction, under the conditions that the plate current remains unchanged and that all other electrode voltages are maintained constant. It is a measure of the effectiveness of the control-electrode voltage relative to that of the plate voltage, upon the plate current. For example, if, when the plate voltage is made 5 volts more *positive*, the control-grid voltage must be made only 0.1 volt more *negative* to

Fig. 2.



hold the plate current unchanged, the amplification factor of the tube is 5 divided by 0.1, or 50. This illustrates that a small voltage variation in the control-grid circuit of the tube has the same effect on the plate current as a much larger plate voltage change would have (50 times larger in this case)—the latter equal to the product of the grid voltage change and the amplification factor. The μ of a tube is

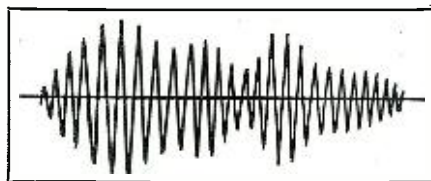

Fig. 3.

useful for calculating the gain produced by one stage of electronic tube amplification.

An experimental setup that may be used to determine the μ of a tube is shown in Fig. 1. As the grid voltage is made more negative by a certain amount, it will be found that the plate voltage will have to be raised by a much larger amount in order to maintain the plate current at its initial value.

Plate Resistance

The resistance of the path between the cathode and plate of a tube to the flow of alternating current is known as *plate resistance*. It is the quotient of a small change in plate voltage by the corresponding change in plate current it produces (with a fixed grid voltage) and is expressed in ohms, the unit of resistance. If a change of 1 volt in plate voltage produces a change in

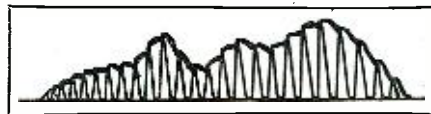

Fig. 4.

plate current of 0.2 milliamperes (.0002 ampere), the plate resistance would be 1.0 divided by 0.0002, or 5000 ohms. As with any electrical circuit the maximum output may be obtained when the load resistance matches that of the source.

Mutual Conductance (Transconductance)

Mutual conductance, or as it is more commonly called, *transconductance*, is probably the best indication of the merit of a tube to use in comparison. It is best defined as the ratio of a small change in plate current (amperes) to

the small change in control-grid voltage producing it, under the condition that all other voltages remain unchanged. For example, if a grid-voltage change of 2 volts causes a plate-current change of 1 milliampere (0.001 ampere), with all other voltages constant, the mutual conductance would be 0.001 divided by 2 or .0005 mho. A "mho" is the unit of conductance and the name was obtained by spelling ohm backwards. Usually for convenience, a millionth of a mho, or a *micromho*, is used to express transconductance. In this case 0.0005 mhos would be expressed as 500 micromhos.

Conversion Transconductance

In converter tubes (used for mixer functions in superheterodyne receivers) the relative efficiency in converting from one frequency to another is expressed as the conversion transconductance. It is best defined as the quotient of the intermediate frequency (i.f.) current in the primary of the i.f. transformer by the radio frequency (r.f.) voltage (applied) producing it.

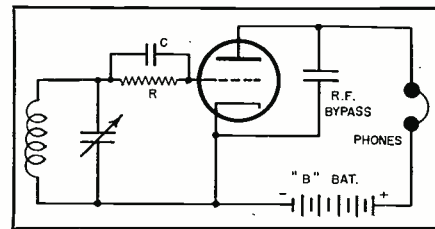

Fig. 5.

Other factors being equal, the converter with the highest conversion transconductance will give the highest gain as a converter.

Plate Dissipation

Plate dissipation is the power dissipated in the form of heat by the plate as a result of the bombardment of the electrons reaching it. It is the difference between the power supplied to the plate of the tube and the power delivered by the tube to the load. As heat is the limiting factor, the physical size of the plate and how effectively it is cooled determines to a great extent the safe plate dissipation a tube can stand. In tubes that handle any appreciable amount of power the plate is usually provided with radiating fins to aid in dissipating the heat from the plate.

In the case of the larger transmitting tubes where the plate dissipation may be considerable (sometimes on the order of kilowatts), either forced air or a water-cooled jacket is used to keep the temperature of the plate

down to a safe value. In addition, metals that will stand high temperatures are used for the construction of the plate and other elements. In this manner it is possible to keep down the physical size of the tubes and in turn reduce the interelectrode capacities. If

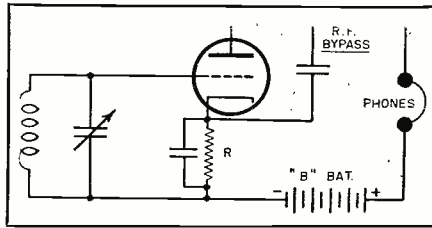

Fig. 6.

no provision were made to keep the plate temperature at a safe value the plate might become hot enough to emit electrons itself. In addition, some metals release gas when heated to high temperatures and the presence of this gas may produce serious undesired effects on the vacuum and the operating characteristics of the tube. Metals such as tantalum, used in transmitting tubes have the property of absorbing this gas if any is released.

Screen Dissipation

A factor equally as important as plate dissipation is *screen dissipation* in tetrodes and pentodes. It is the power dissipated in the form of heat by the screen as a result of electron bombardment. Due to the construction of these tubes the screen is in a very unfavorable position for direct heat radiation, and provision in the form of a radiating fin at the top of the grid support wires is usually provided in those tubes used as output tubes, or for r.f. service in transmitters. Excessive

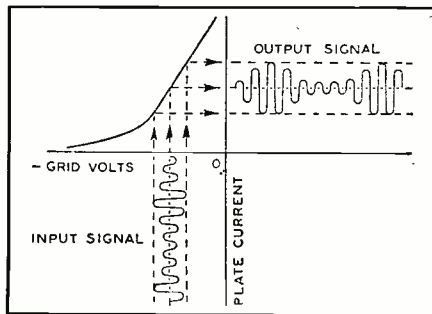

Fig. 7.

grid temperature in a screen grid tube can be much more serious than excessive plate temperature, as the location of the screen grid between the control grid and the plate has a much greater effect on the operation of the tube if the temperature of the screen grid should become great enough to cause it to emit electrons itself.

Plate Efficiency

Power amplifier tubes have another characteristic known as *plate efficiency*. Of course, this also applies to other tubes, but it is only in tubes used to supply power to a load that it is important. The plate efficiency of a power amplifier tube is the ratio of the a.c. power output to the product of the av-

erage d.c. plate voltage and d.c. plate current at maximum signal. It is also expressed by the formula

$$\text{Plate efficiency \%} = \frac{\text{power output watts}}{\text{ave. d.c. } V_p \times \text{ave. d.c. } I_p} \times 100$$

Power Sensitivity

The ratio of the power output in watts to the square of the input signal voltage (r.m.s.) is known as the *power sensitivity* of the tube and is expressed in mhos. The formula for power sensitivity is.

$$\text{Power sensitivity (mhos)} = \frac{\text{power output watts}}{(\text{input signal volts, RMS})^2}$$

The Electronic Tube as a Diode Detector

In general, all radio tubes (with the exception of some special types) may be grouped broadly according to the

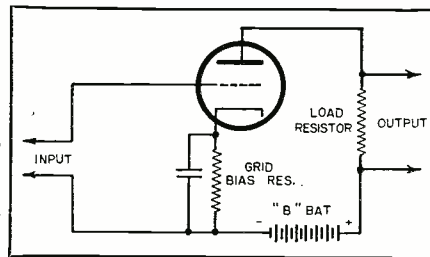

Fig. 8.

five kinds of operation in which they are employed. These are: rectification, detection, amplification, oscillation, and frequency conversion. As the earliest uses of tubes were as detectors, the subject will be treated first.

Referring to Fig. 2 we see the circuit of a simple diode detector. Operation is as follows: The signal voltage developed across the secondary of the r.f. transformer T is applied between the plate and cathode of the diode. As the diode is a unidirectional device, only the positive half cycles (those during which the plate becomes positive) will be rectified. On the first positive half cycle the condenser C will charge up to the peak value of the r.f. voltage developed across the phone. As the r.f. voltage dies down to zero, the condenser retains most of its charge temporarily, draining off only slowly through the high impedance of the phones during the short interval of time until the next positive half cycle of the signal voltage arrives.

On the next positive half cycle the condenser again receives a charge equal to the peak value of the r.f. volt-

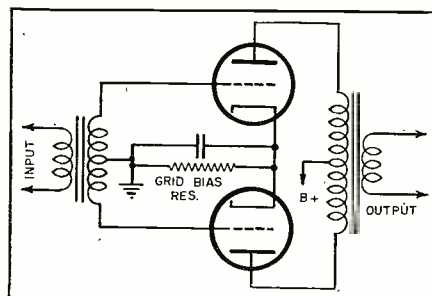

Fig. 9.

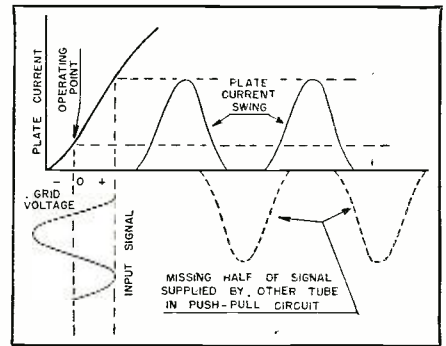

Fig. 10.

age developed across it. The capacity of the condenser is large enough to smooth out the variations caused by the r.f., but not too large to allow the voltage across it to follow the a.f. variations. A modulated r.f. wave is shown in Fig. 3, while Fig. 4 shows the detection action taking place as indicated by the heavy jagged line following the general outline of the modulated wave. In practice the jagged line representing the audio signal is relatively smooth. The signal appearing in the phones represents the varying voltage appearing across the condenser C.

One of the advantages of the diode detector is that large signal voltages may be handled with very low distortion. However, due to the loading effect of the diode circuit, there is a tendency to lower the r.f. voltage appearing across the tuned circuit, with a subsequent loss of gain and selectivity of the tuned circuit. Because of these drawbacks it is necessary to have considerable amplification preceding the detector circuit when a diode de-

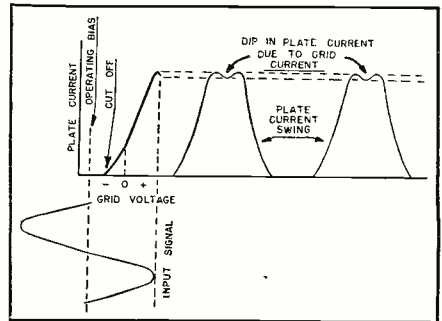

Fig. 11.

detector is used. One of the advantages of the diode detector is that by its use simple automatic volume control circuits are possible without need for an additional voltage supply by filtering the audio signal to remove the audio variations and applying this filtered voltage to the r.f. stages as variable grid bias, in this way controlling the gain of these stages and making possible a relatively constant output with varying signal voltages. The diode detector has poor selectivity, however, the linearity is considered good compared to other types of detectors. The diode method of detection is preferred over all other methods of detections in broadcast receiver work.

(Continued on page 75)

NEW DEVICES FOR INDUSTRY

by WILLARD MOODY

**There are many uses for photo-cell equipment in industry.
War plants are protected by their invisible infra-red rays.**

THE term "electronics" is taken by many people to mean something connected with photo-electric cells and doors being opened or closed, alarms being set off and similar somewhat spectacular applications. While it is true enough that "electronics" is the means by which all of these tasks may be performed, it is equally possible for this infant but fast growing science to do many jobs of great utility with little fanfare. These applications may involve use of the electron tube, without in any way depending on a photo-cell. Acoustic systems or radio-oscillator devices may be electronic.

As one practical application of the acoustic system, take the case of a geologist mapping an oil field. He may explode a small charge of dynamite which will set sound waves into motion. These waves may be recorded on an oscillograph, giving a picture of the sub-strata conditions, since the reflection of the sound will vary according to the depth the sound waves reach. Areas which are relatively dense at a certain level reflect the sound quicker than areas which are dense at a relatively lower level than in the first instance.

At the present time there is some interest in air raid control devices. For example, a man may want to have some form of system which will automatically turn out the lights in his home when the street lamps go off, or the man may want to have the electric sign of his barber shop, jewelry store, drug store or similar establishment extinguished when an air raid alarm sounds. If the street lamp is reasonably near by, a photo-cell may be used to pick up the light of the lamp. When the lamp light goes out, the resistance of the photo-cell changes and a signal pulse is supplied an amplifier which builds up the signal and trips a relay. The relay then cuts in an auxiliary circuit illustrated in Fig. 1 which allows a bell to go off, opens the power supply line or does any other required job.

The operation of the relay could also be controlled by a microphone setup. The sound of the air-raid siren would be picked up by the microphone, fed into an amplifier with a selective L-C filter and the amplifier would then operate the relay. Where there is some possibility of picking up sound

from other sources than the desired one, this scheme is not practical. In a small town, where the average noise level is low, the scheme would be practical, but in a large city or other place where the sudden dropping of an ash can, the blowing of a loud auto horn, streetcars, train whistles or other noise might cause false operation of the acoustic system, the system could not be used.

In order to break the lighting or power circuit, the relay should have the same contact rating as the fuse in the power circuit. An important point is that wiring of buildings in cities is carefully controlled and any tampering, if done at all, with the electric circuits must be the work of a licensed electrician. In practically all instances it will be highly advisable to

how many foot-candles intensity or light force will be required for satisfactory control. An ordinary meter, as used for photography, will help in getting measurements of light intensity. Assuming that the lamp is not too far away, 20 or 30 feet, a circuit such as that in Fig. 1 could be used.

Another fact which few seem to have taken advantage of, is that a super-sonic audio oscillator can be built relatively cheaply, and the wavelength at 20,000 cycles would be relatively short, so that a directional radiator could be used, just as in the case of a short wave antenna. A tuning fork might be used, driven by an audio oscillator, to send out ultra-high sound waves which would have a pitch above audibility. The sound waves could not be seen, and if interrupted by an object getting in the way, they would permit operation similar to that obtained with photo-electric devices. The wavelength at 20,000 cycles would only be about $\frac{1}{4}$ ". A parabolic projector could be used to project a beam of sound.

Many air raid gadgets have popped up which are dependent for their operation on the break in the carrier wave of a radio station. In a practice air raid, such gadgets don't function for the reason the stations remain on the air. By sending out a radio signal of about 2,000 kc. over the power line, to which would be tuned air raid alarms, individual consumers reached by the power line could be warned when an air raid drill or actual raid is in progress. A selective L-C circuit would not allow tripping of the relay or operation of the alarm device except in the presence of the 2,000 kc. air raid official signal.

Some of the simplest applications of electronic control do not involve complicated circuits at all. For example, suppose that you want to open your garage door without getting out of the car. One way of doing it would be to have a photoelectric cell outfit hooked to an amplifier, which would work into a relay, the turning off or on of an electric motor then being accomplished, or if the door is pneumatically operated (by compressed air) a valve could be opened or closed.

A gentleman farmer I know works in the city during the week and at times finds it inconvenient to go home

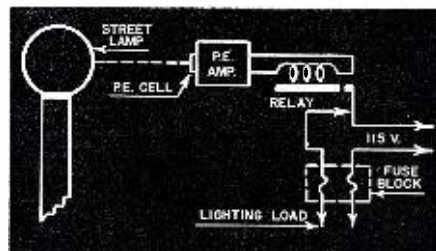

Fig. 1. Using street lamp for photo-cell control.

get permission and co-operation of the local power company. The manufacturers of the relays and control devices are, too, generally most willing to help. Advice on planning, quotations on costs, are given to all legitimate parties without cost as a general rule. If used in the home, the wiring must be BX cable, installed in a safe, workmanlike manner. The ordinary home cannot afford such luxury and most practical applications will be related to installations in stores or shops.

The first thing to do in setting up any job is to get a clear picture in mind of what is to be done, and then decide whether electronic control will be reasonable. For example, in the case of our hypothetical street lamp, how far is the lamp from the installed light pick-up? Will the amount of light received at the cell be sufficient for operation of the control circuit? When the units are purchased ready made, as they will be in most practical work, the manufacturer will tell you

early and feed his two great Danes and his pigs and other livestock. At home he has a telephone whose number is confidential. When he expects to stay in the city, he throws a switch which puts an amplifier into operation (in the morning, before going to work). A microphone is hooked to the amplifier and has a selective L-C filter which narrows the response to the sound of the telephone. The amplifier controls a relay which in turn operates a plunger solenoid electromagnet. The lid on the feed box is released and drops down when the telephone rings and the pigs get their food. A somewhat similar system is arranged for the dogs.

One of the most practical and useful applications of electronics is found in the stroboscope. This device is used in the study of periodically functioning systems of motion, such as an airplane propeller tip, the flywheel of an engine, the motion of oil, or to locate vibration in different parts of an automobile. The objects are illuminated in synchronism with their movements, and when properly illuminated they appear to be stationary, hence can be observed since they are illuminated only at one point of their motion.

In the case of a rotating object, if the light flash frequency is below the synchronous point the object will appear to be moving forward, while the opposite holds true in the case where light flashes are faster than the synchronous speed. The object would then appear to be moving backward. Using the older form of stroboscope, which depended upon mechanical means in timing the flash, the light impulse had a duration that was too long and at high speeds the object blurred. The grid-glow tube permits high speed observations due to the short time interval characteristic.

Each time the object reaches a selected position in its operating cycle, it is lighted by a flash of light from the grid-glow tube apparatus. An image free from flicker then results, due to the persistence of vision of the eye. The image the eye perceives during the instant of illumination is retained during the dark period until the object is again illuminated and the same image is seen by the eye. The net result is the object appears to remain stationary and to be illuminated by a steady light.

Under conditions of rest, a cracked engine wheel may not be observable, yet under the centrifugal force of rotation the crack may be apparent and the stroboscope shows the defect. An airplane propeller may bend or distort at high speeds if improperly balanced, and the stroboscope permits getting a picture of the behavior of the prop. An automobile may be placed on an endless tread, and the stroboscope can be put on different parts of the car to check vibration, the frequency of vibration being read off a calibration chart. The action of any part may be checked by flashing the lamp just a little above or below the synchronous

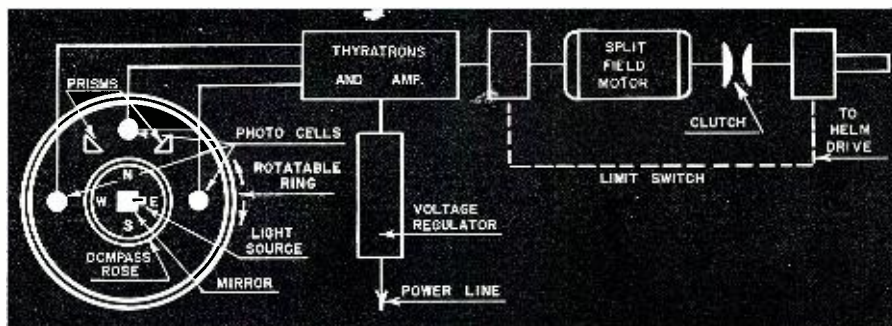

Fig. 2. Diagram of automatic ship steering mechanism device.

frequency and slow movement of the part will indicate vibrations if present.

The image obtained by the action of the stroboscope depends upon the time interval. An airplane propeller 7 ft. in diameter and revolving at 1,200 r.p.m. will have a tip velocity of 5,280 inches per second. A 20 micro-second flash would illuminate the tips while moving a distance of 1/10th inch. This would cause an image blurred by that amount. The stroboscope will provide a flash which is but a fraction of 1 micro-second in length.

A complete stroboscope consists of a foundation unit, oscillator unit, pair of grid-glow lamps and a contactor of mechanical type. A complete set may be housed in a pair of portable carrying cases. The transformer is built into the foundation unit. In this section is included the rectifier tube and filter, receptacles into which are plugged the cables of the pair of hot cathode and grid-glow lamp units, either one or both of which may be employed for a given task. To concentrate the beam the lamp units have reflectors, so recurring flashes can be directed on the object being investigated.

To allow lamp movement, a flexible cable connection between the foundation unit and lamps is used.

Two means are available for securing the proper flash frequency: an oscillator for the range 400 to 10,000 flashes per minute and a mechanical contactor unit for getting lower frequency flashing. The contactor can be

driven from any machine having a lathe center. When electrically connected to the foundation unit, the contactor provides electric make and break (synchronized) impulses. Containing a pair of oscillator tubes, the oscillator unit includes resistors and condensers for varying the frequency, as well as rheostat and voltmeter to permit accurate anode adjustment and allow proper voltage to be applied to the oscillator tubes, which is essential to hold true the calibration of the instrument. Elimination of variations (due to fluctuation of the power supply potential) then results. Frequency stability in this way is of utmost importance as any fluctuations in frequency will result in a blurred image and give erroneous effects.

Automatic Ship Steering Indicator

In Fig. 2 is shown the basic operating system of an automatic ship control. The compass has on it a mirror which reflects a beam of light from a source. This beam is then directed upon the prisms and when the ship is on course, the middle photocell is illuminated and this cell's output current renders the steering mechanism inoperative. A deviation in course throws the beam of light on to one or the other of the cells away from the center and produces corresponding currents which control the deflection of the ship's rudder and hence its course. When the light returns to the middle cell, the automatic system be-

(Continued on page 58)

Fig. 3. A modern hydraulic flow indicator circuit.

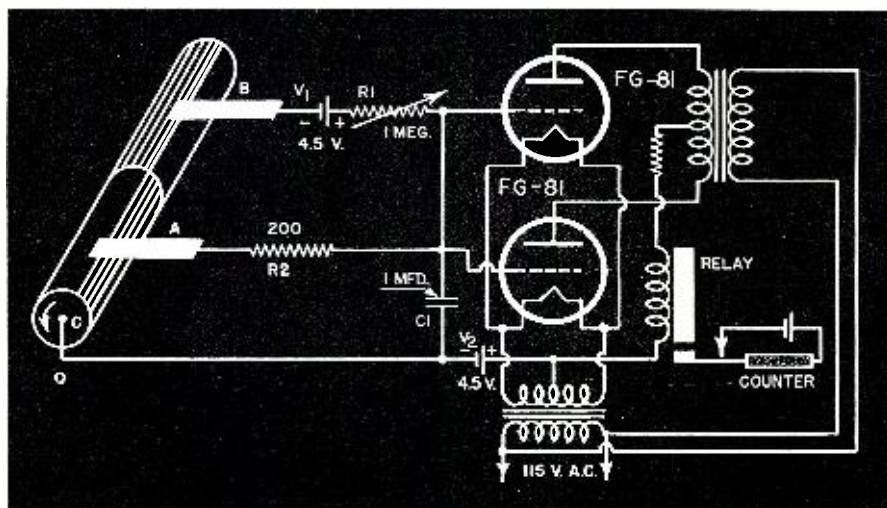

FROM OUR FIGHTING FRONTS

Thousands of miles from their homeland, hemmed in by the tropics, our radiomen are doing their share to hasten victory.



Setting up communications in the heart of the jungle at Guadalcanal.

Acme



A British mine detector used by specially-trained crews.

Acme

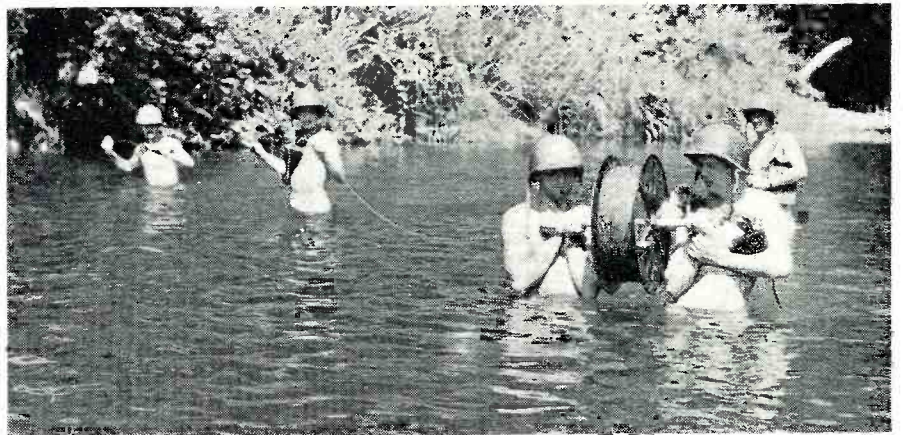

It takes more than a jungle river to stop telephone line layers in action.

Acme



Tall coconut trees are used for telegraph poles at Guadalcanal.

Acme



Messages are relayed 24 hours a day through this communications center.

Acme

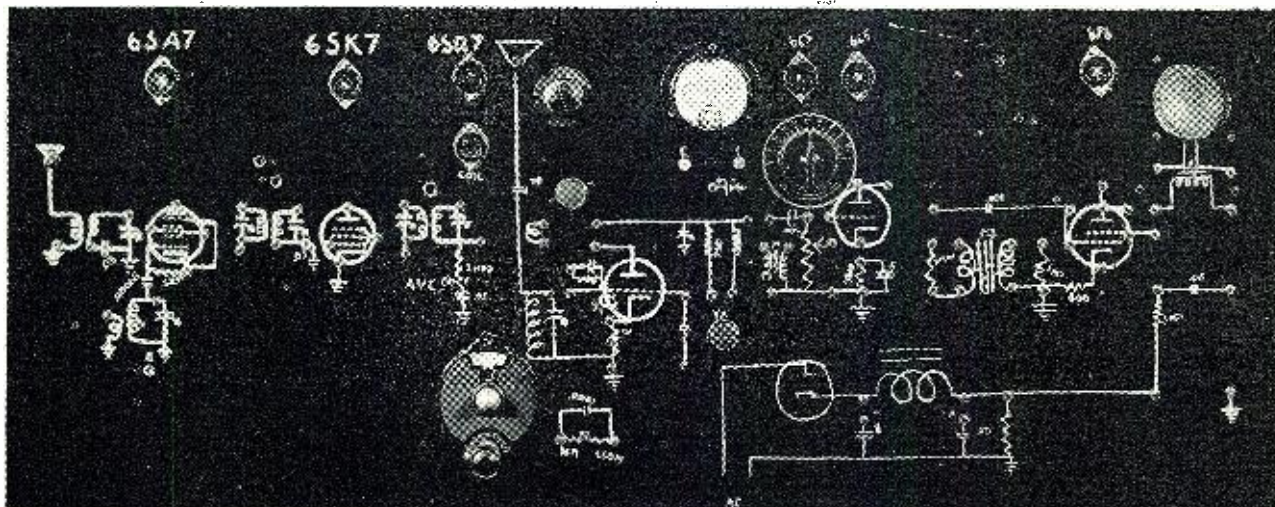

The additional tuner circuit may be seen at the left side of the mounting board.

THE April and June (1942) issues of RADIO NEWS featured the "Beginner's Dynamic Demonstrator." Further interest evinced by the readers has prompted this sequel. The Dynamic Demonstrator now gets a mixer and intermediate frequency stage and thus becomes a superheterodyne. These two new stages just fill up the space purposely left in the original model for this expansion.

Considerable difficulty has been encountered in getting the r.f., oscillator and i.f. coils. If it is impossible to buy them, get a discarded superheterodyne (any model) and strip the coils, i.f. trimmers, oscillator padder and ganged condensers. Since these have the proper frequency relationship, you can be certain they will work in the demonstrator. This method was used in the model shown.

Past experience with the demonstrator has shown the 6C5 tube used for rectifier is not efficient for this function. Since the entire plate current

Super-Het Tuner for the Dynamic Demonstrator

by DAVID GNESSIN

By popular demand—a superhet tuner has been designed for the home-built dynamic demonstrator.

drain of the demonstrator is furnished by this tube, one with a huskier cathode is indicated. A 6X5 will do the work very well, carrying the additional two tubes with ease. Connect terminals 3, 4, 5 and 6 together on the rectifier socket. No other change is

necessary. The 6X5 will fit the old 6C5 rectifier socket.

The old 6C5 regenerative detector stage is now a 6SQ7 diode detector, a.v.c. and first audio stage combined. (If used as regenerative detector sim-

(Continued on page 80)

Schematic diagram of the superheterodyne tuner.

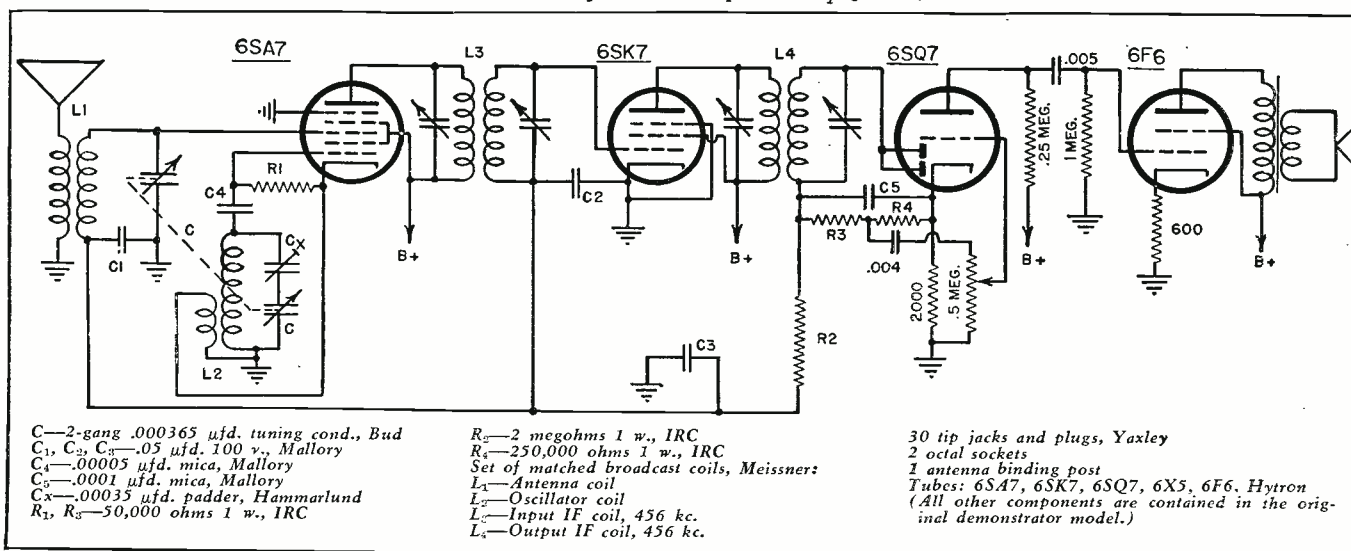

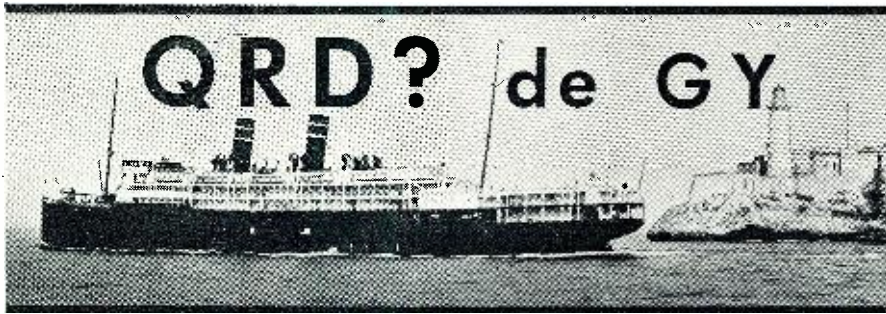

by **JERRY COLBY**

FOR the twelve years we have been pounding out this colyum we have tried to beat the deadline on Xmas and New Years so that our greetings to all our friends would be published in the January issue. But try as we would we were never able to get into that "spirit" which denotes and gives to one that thought of Xmas. Without the spirit of festivity which makes this one of the highest and best-loved holidays of the year, ye Ed hasn't been able to set himself down and bring out the high-flown thoughts that are connected with the season's greetings. At this time of year everyone also does a lot of predicting what will happen in the following year. The new equipment and ideas which are bound to be perfected, etc. and etc. But we feel our friends can appreciate the difficulties attendant upon one to forgive one's seeming forgetfulness . . . because they usually find them only a few issues later.

OF COURSE, this Xmas something special has been added by St. Nick. We are giving our enemies a bit of their own medicine plus a few added dashes of poison for good measure. We have left defensive tactics far behind and are on the offensive with a bang. We are naturally apt in getting ahead and remaining there. This is one American trait which is definitely American and on which no other nation can say they've a copyright. All this has come to pass because of our better fighting forces and better equipment—equipment that has not as yet come out in print because an inkling may give our enemies a lead to work on.

AND speaking of equipment let us not forget that radio communications equipment has been equally responsible for many of the victories now being chalked up by our armed forces. New radio transceivers for our ground forces as well as for our planes, microphones, tubes, etc. have aided greatly in bringing these victories to the front. And let us not forget the men who man this equipment whose background and education have enabled them to give performance to this apparatus. Right now Brother H. R. Williams, we note, has just perfected a radio apparatus which when installed in a plane will be able to signal down

to ground men every stress and strain which that plane is undergoing in the air. This will make our planes the finest fighters yet known.

RADIO today has reached the point where it is recognized as an essential in every department of economic, political and industrial endeavor. Even laymen have become cognizant of this fact and with this recognition goes like thoughts for the men who manage this equipment as well as the men who have perfected the apparatus. Radiomen after this war will be recognized as professional men of high caliber instead of their past reputations of tinkers. With so many youngsters who were Hams and who are being given instruction at government expense in the finest schools of the country in higher radio technique, a veritable deluge of radiomen will be let loose on this country to bring joy and happiness and good health to everyone from the farmer down to the multimillionaire. We believe that the coming years will be known as the "radio era" and as such all those participating in the wonders yet to come will garner their just rewards for their services.

IN THE field of marine radiomen, those men who are manning the radio shacks on vessels which are making it possible to bring supplies to our armed forces, these men are the unsung heroes of this war. Without them
(Continued on page 75)



"Couldn't we just say—Help!"

TECHNICAL BOOK & BULLETIN REVIEW

"SCIENCE REMAKES OUR WORLD," by James Stokley, published by *Ives Washburne, Inc.*, 27-29 W. 57th St., New York, N. Y. 288 pages plus index. Price \$3.50.

In simple, non-technical language, this book tells you what science today is creating in the industrial laboratories of the nation. You don't have to be a science major to be thrilled by it; for whether you know it or not, your daily life may already have been influenced by the results of those experiments. Your wife may have a pair of nylon stockings tucked away in her bureau drawer; perhaps the toothbrush you use has éxton bristles; in your living-room may be lucite ashtrays and ornaments or furniture or woven tenite; and in the kitchen your maid may wear neoprene gloves as she washes your unbreakable plastic dishes. Next year your car may have new tires of Ameripol, Chemigum or butyl rubber, and your wife's next new dress may well have originated in a test tube. There is no aspect of your daily living which will not feel the impact of these marvelous discoveries.

America is going through a new industrial revolution which is creating new jobs for thousands, adding new words to our language and building up new industries all over this country of ours.

In war-time as in peace-time, science continues to discover and develop these possibilities. As priorities occasion the withdrawal of some kinds of consumer goods from the market, the men in the laboratories fill the breach, not with inferior substitutes, but with new materials, better than those they replace. Due to these advances, America has a chance to build up a nationally self-contained economy, independent to a large degree of foreign sources of supply.

While not a radio book, this publication has particular interest in closely allied fields and includes much material of interest to the non-technical reader.

"RADIO OVER THE U. S. A." by Norman Woelfel, published by the *Ohio State University*, Columbus, Ohio. Price 50c. 39 pages.

These short essays, critically appraising radio in America today, appeared originally as monthly columns under the general title "Radio Over U. S. A." in the professional educational journal, *Frontiers of Democracy*. One essay, "The Education of Youth by Radio," appeared originally in the spring, 1942 issue of *Child Study*.

The issues raised are immediately relevant to American life, to the successful prosecution of the war, and to
(Continued on page 82)



Many an old tube that has value to bona fide tube collectors is tucked away in an attic or basement. It is the purpose of this Club to aid its members by appealing to owners to trade or swap extras.

THE following tubes are among those included in the collection at the editorial offices of RADIO NEWS.

DeForest Tubular Audion
 Marconi (DeForest) ser. No. 547001
 Marathon AC-608R
 CG-1162 and CG-890
 Radiotron UV-200
 Moorehead VT (Navy SE1444)
 Marconi VT
 DeForest OT1A
 SJ-1 Detector
 Cunningham C-301
 Aerotron S-319561
 Amplion D
 Radiotron WD11
 Radiotron UV 201A
 French Fotos
 Radiotron UV 202
 DeForest DV3A
 DeForest DV2
 DeForest Audion DV3
 DeForest Battery
 Raytheon type B
 Weagant Valve (diode)
 French R
 Myers Universal with UV adapter
 Western Elect. Peanut
 Stenode Quartz Plate Det.
 Osram G.E.C. (English)
 Marconi Valve (MO Valve Co.)
 Donle B-8
 Sodian D-21
 Sodian S-13
 Raytheon BH
 X-112A
 CG-1787 (Navy)
 VanDyke 171 UX Power
 QRS Red Top
 Musselmann 5ED (Cushion base)
 Multivalve
 Mullard ORA
 479J (side-heaters)
 Sovereign A-C
 Cunningham CX-374
 Van Dyke X-222
 CeCo AC Pentode
 Speed Triple-Twin 295
 Eveready Raytheon ER224
 Sparton 585-P (mesh plate)
 Arcturus Detector 127
 Majestic Duo-valve G-6A7
 Sparton 450
 DeForest type 20
 Electrad Diode
 Telefunken AL-4
 Barium Tube
 Telefunken ACH-1

Mullard ACO-44
 Telefunken AD-1
 Van Dyke 281
 Cunningham CX-381
 Cardon C-182-B
 Cunningham CX-322
 Cunningham C-327
 Sylvania 82
 Ken-Rad KR-1
 Welsch Dollar Detector
 Supertron Precision 99
 GE-199
 Radiotron UX-199
 Radiotron UX-120
 Radiotron VR 150/30
 Speed 230
 Cetron 110
 Luxtron type L
 Radiotron WD-11
 Welsch Peanut (with UV adapter)
 Valvo-AM-2
 Telefunken AB-2 (DRP)
 Valvo AM-2
 Mazda H-210 (BVA)
 Telefunken RE 144
 Osram HL-610
 Telefunken CF-7
 Phillips 505
 Valvo AF-7
 Mullard PM 24 B
 Osram DEP-610
 Mullard AC-084
 Osram DE-5
 Mullard CL-4
 Valvo AZ-1
 Telefunken DRP
 Western Electric 101B, 101D, 101F,
 102A, 102D, 102F, 102G, 104D, D-
 86327, D-90278, 205E, 277A, 269A,
 205D, 101F, 323A, 244A, 235D, 253A,
 244A, 247A, 272A, 274A, 256A, 262A,
 246A, 300B, 245A, 283A, 259A, 300A,
 290A, 310A, 293A, 275A, 262B, 292A,
 294A, 314A, 211E, 245A, 253A, 257A,
 269A, 277A, 310A, 231D, 244A, 246A,
 256A, 259A, 311A.

THE following is a partial listing of tubes wanted by two members:

Amrad "S" tubes, both cylindrical and pear shaped
 A-P Rectifier
 Audiotron
 Bartley
 Connecticut Detector
 Corcoran tube

De Forest Audion-spherical bulb single grid single plate type-candelabra base
 De Forest Audion-spherical bulb double grid, double plate type-candelabra base
 De Forest Audion-cylindrical—Type T—
 with or without adapter.
 De Forest Audion-pear shape—"Singer type"—Shaw base
 De Forest Oscillions
 Donle B6, B8, BA2, BP71, BR4
 Electro Importing Company Audion
 Emerson Multivalve
 Fleming Valves
 Liberty Valve
 Lieben-Reisz "LRS" Repeater
 Marconi V24, Q, QX
 Margo Detector
 Moorhead Electron Relay (cylindrical, unbased)
 Moorhead Electron Relay—Shaw Base
 Moorhead cylindrical tube with external grid
 Moorhead A-P Amplifier
 Rectobulb R3, 6EX
 Roome Thermotron, Oscilaudion
 Sovereign AC
 Strongson Copper Plated Tube
 WRC 20, WRC 22
 Wunderlich
 Kellogg (top-heaters)
 All foreign tubes

THE following are duplicate specimens available for trade:

Northern Electric R215A Peanut
 French Fotos
 Myers Universal
 DeForest Tubular Audiotron
 Standard Tele. 4282B (British)
 Western Elect. 101D
 Sodian S13
 Pliotron CG-1162
 CG-890
 Raytheon BH
 Mazda H 210
 Marconi MO valve
 CeCo M-26

Membership in the Club is limited to those having at least 200 different types made prior to 1933. We will publish lists of tubes available for trade from time-to-time. Bona Fide Collectors are requested to send photo of their entire collection and list of available tubes to The TUBE COLLECTOR, RADIO NEWS, 540 N. Michigan Avenue, Chicago, Ill.

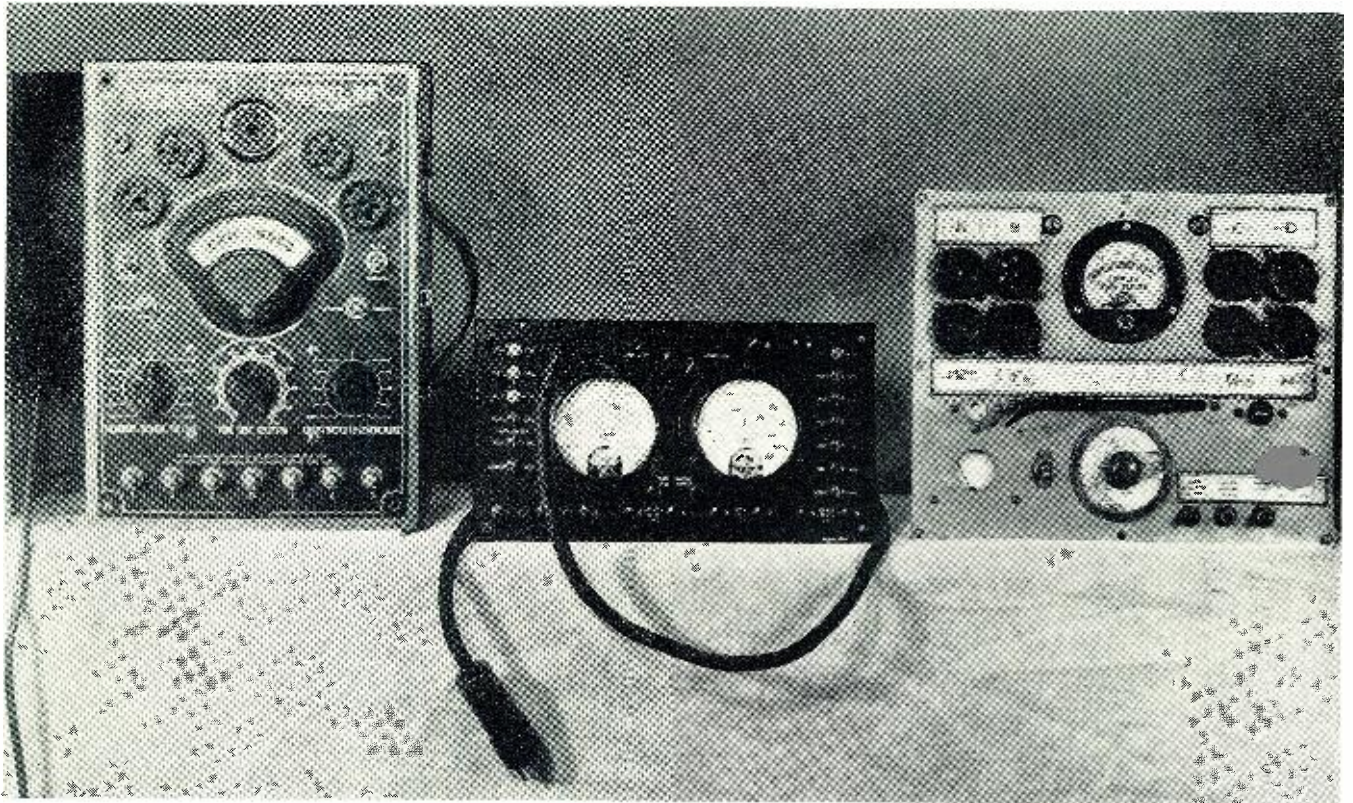

Typical examples of obsolete equipment that can be torn down for the salvage of old parts and meters.

Use Those OLD METERS!

by **GERALD L. MANNING**

There are thousands of old meters and testers gathering dust in service shops. They contain valuable merchandise.

NOW that new meters and test equipment are very difficult to obtain, many of us will have to postpone the purchase of that new meter or analyzer that we have been wishing for. However, the situation is not quite as hopeless as it first appears. For, by exercising a little skill and constructive ability, we can convert some of our almost discarded meters into very usable servicing instruments.

Nearly every radio service man has a few dusty meters lying about or knows where he can pick up one at little cost. These old meters are usually found in obsolete analyzers, tube testers, battery testers or other old equipment. After the meters have been dusted off, they will be found to fall into two general classes. First are meters having fairly high sensitivity which are most often obtained from obsolete analyzers, and second, those of lower sensitivity recovered from other sources.

The meters salvaged from obsolete analyzers will ordinarily be the easiest to use because they often have a 1 ma. or better movement. All that these meters need is to be checked for sensitivity and mechanical defects and they are ready to be made into excellent instruments. If the instrument to be constructed is an analyzer, the meter must be wired into a more modern circuit with additional ranges and a better switching system. Circuit schematics and constructional information for many different types of analyzers have appeared from time to time in most radio magazines and books. A new dial scale may be made to suit individual requirements. Many of the undamaged parts from the old analyzer may be utilized in the new one. These usable parts include the precision multipliers and shunt resistors for those ranges originally incorporated, ohmmeter zero adjusters, hardware, knobs, etc. If the meter is to be used as the indicator in one of

the popular vacuum tube voltmeter circuits one should try to find a circuit which calls for a meter of the same sensitivity. Usually the dial of a home built vacuum tube voltmeter must be hand calibrated, but this will depend upon the circuit used. A few of the older tube testers had good-bad meters with a 1 ma. movement. These meters may be used in the same application as any other sensitive meter.

The majority of the good-bad meters rescued from old tube testers and similar sources will present a somewhat different problem and it is to the solution of this problem that this discussion is dedicated. These meters usually have a sensitivity of 5, 10, 20 ma., or what is worse, some odd value such as 7.8 ma. These meters are generally considered too insensitive for any present day servicing application. But, let us consider their case. Most of the tube tester and allied meters are fundamentally d.c. milliammeters of excellent construction. Often they

are large meters with a long, easily read scale. Usually they have over-size movements and are very ruggedly built, making them especially adaptable for portable use. Their accuracy is surprising. Their sole disadvantage is that it takes too much current to run the hand over to the full scale mark. For many practical applications this will not be a serious disadvantage.

After the meter has been removed from the obsolete instrument, it should first be checked to determine the sensitivity, or in other words, the amount of current required for full scale deflection. All shunts or multiplier resistors must be removed or disconnected when the meter is being tested to avoid false indications. The old meter is connected in series with a 0-10,000 ohm adjustable resistor, a bat-



Fig. 1. Calibration setup.

tery of six to ten volts and an accurate milliammeter. The circuit is shown in Figure 1.

Adjust the resistor from maximum resistance downward until the old meter reads full scale. The amount of current required for this full scale reading is then indicated on the accurate milliammeter. If, for example, the milliammeter indicates 5 ma. when the hand of the old meter is at full scale position, the old meter has a 5 ma. movement and can be used directly as a 0-5 milliammeter.

After the sensitivity has been measured, the information gained may be used to determine the instrument or circuit in which the meter will operate most satisfactorily. We next list a few of the possible uses.

Milliammeters and Ammeters

Perhaps the simplest application of old meters is to use them as milliammeters. If the old meter, when checked for current, indicated a full scale current of 5 ma. Its range may be increased to any desired value by merely connecting a low resistance shunt in parallel with the meter movement. The resistance value of these shunts may be determined by measuring the d.c. resistance of the meter and using it in the following formula:

$$R_x = \frac{I_0 R_m}{I_n - I_0}$$

R_x : Shunt resistor in ohms

R_m : Resistance of meter in ohms

I_0 : Old maximum current of meter in amperes

I_n : New maximum current in amperes.

If desired, the shunt values may be

found by experimentation. If the latter course is chosen, the meter is again connected into the test circuit and a variable shunt resistor is connected in parallel with the old meter.

The 10,000 ohm resistor is adjusted until the calibrated milliammeter indicates the value at which it is desired for the old meter to read full scale. The shunt resistor is then varied in value until the hand on the old meter indicates full scale.

The shunts may be made from stock resistors or they may be made from resistance wire salvaged from old rheostats or other resistive devices. If the meter is to be used for only one range, the shunt may be attached permanently to the meter terminals or even placed inside the meter case if space permits. If the meter is to be used for several ranges, the proper shunt may be connected by means of a selector switch.

A few extra milliammeters are very useful, especially if they are made portable. In addition to measuring d.c. current in the various receiver circuits, they are useful to check the current drain of battery operated receivers, current output of power supplies, etc. When the dial is calibrated in reverse, they make entirely satisfactory tuning meters.

If the resistance value of the shunt resistor is made sufficiently low, the meter may be used as an ammeter of any desired range. This makes a useful application for very insensitive meters such as 0-50 ma. or 0-100 ma. The shunts in this case are so low in resistance that for the higher ranges the proper length of hook-up wire will offer sufficient resistance. Various sizes of wire will offer different resistances per foot, and if too much of one size is required a smaller amount of a smaller gauge will usually suffice. Care must be taken not to use wire too small to safely carry the current to be measured. It is sometimes rather difficult to obtain the exact value of shunt resistor for ammeter ranges and it is sometimes helpful to use a resistor of from 50 to 200 ohms in series with the meter movement. This will permit the use of higher values of shunt resistors. If the formula is used, the value of the series resistor is added to the resistance of the meter. However, this is not advisable where the additional voltage drop due to the added resistor would change the characteristic of the circuit under test.

Ammeters are useful around the shop to check the current drain of au-

Fig. 2. Determining shunt resistance.

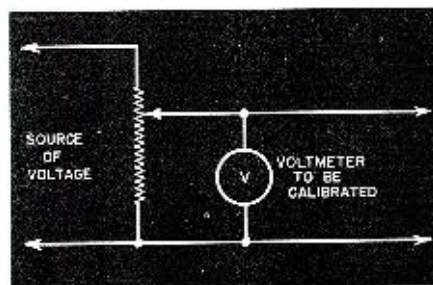
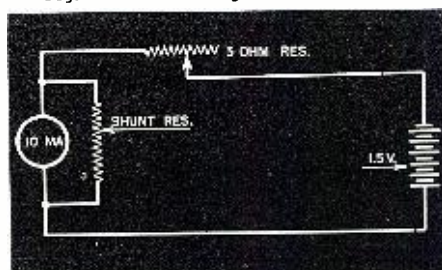

Fig. 3. Circuit for voltmeter calibration.

tomobile receivers and other six volt battery operated receivers, battery charging current etc.

New dial scales may be made to suit any desired range or ranges.

D.C. Voltmeters

Meters of low sensitivity lend themselves admirably to the construction of voltmeters for testing low resistance circuits. To convert the meter into a d.c. voltmeter of any desired range all that is necessary is to connect the proper resistance in series with the meter. The resistance value of this resistor is found as follows: Decide what voltage you want the meter to indicate when the hand is at the full scale position. Divide this voltage by the current in mils required to cause full scale deflection on the meter. Multiply the answer by 1,000 and the result will be the required resistance of the resistor in ohms.

The power dissipated in the multipliers may be determined as follows: Multiply the full scale current of the meter in mils by the same value (i.e. I^2) and divide the product by one million. Multiply this by the value of the series resistor and the answer will be the number of watts dissipated in the multiplier. To insure permanent calibration, the power rating of the multiplier resistor should be at least twice the power dissipated in it.

If more than one voltmeter range is to be incorporated, use the above process for determining the resistance and power rating of each resistor. Voltmeter ranges may be selected either by tip jacks or by a switch.

If the exact value of the series resistor is not available, sometimes two or more resistors may be connected in series or parallel with one another in order to obtain the desired value. If carbon multiplier resistors are used and the value is slightly too low, the resistance may be increased somewhat by filing a flat notch in the side of the resistor. When the resistance has been raised to the proper value, the notch may be painted over with varnish or shellac to prevent moisture from entering. Another method is to raise the current drawn by the meter to a higher but more workable value. For example, a meter requiring 4.3 mils for full scale deflection can be shunted by the proper size resistor to raise its current to 5 mils. This will permit the use of more standard values for multiplier resistors.

(Continued on page 77)

WHAT'S NEW IN RADIO

New Phone-Switch

The *American Radio Hardware Company* . . . leaders in the manufacture of precision instruments . . . introduce the SW-141 Phone-Switch. This Phone-Switch is a vital connecting link between air and ground communications. It is a double circuit microphone switch designed for use by an operator wearing heavy mittens

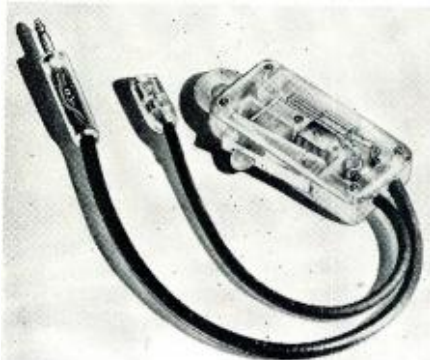

and so constructed as to permit easy on and off switching. It remains in open position normally and can be locked into closed position.

The SW-141 Switch is $4\frac{15}{32}$ " overall in length x $\frac{3}{4}$ " thick x $1\frac{1}{4}$ " wide. High impact strength Tenite II is used in its construction. The switch is mounted on sturdy brass brackets . . . with blades made of a Phosphor Bronze material. It is heavily Nickel plated, with Bakelite insulation. Cordage clamps for taking up cable strain are provided as an integral part of the housing.

Because of its precision-perfect qualities, and unflinching performance, it is used primarily by aircraft radio operators.

For additional information write to *American Radio Hardware Company*, 476 Broadway, New York City.

New Aircraft Relay

The B-2-A relay described is one of a series in *Guardian Electric's* new line of units which have been designed for remote control of aircraft electrical circuits. Built to U. S. Army Air Force specifications, unit has a contact rating of 25 amperes continuous and

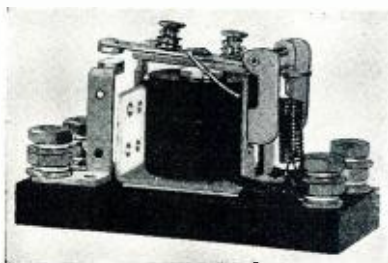

100 amperes surge at 24 volts d.c. It has single pole, single throw, normally open contacts. Weighs 6 ounces.

Manufacturer claims unit has acceleration and vibration resistance over 10 times gravity. Metal parts are heavily plated to withstand 200-hour salt spray test. Designed primarily for aircraft, unit is said to have numerous applications in other industries. Descriptive bulletin and full details are available from *Guardian Electric*, Dept. B-2-A, 1630 West Walnut Street, Chicago, Illinois.

New Sylvania Service Kit

Sylvania has put a new dress on the radio service kit. It is an attractive gray tweed-mixture aeroplane cloth—washable and smooth-finished. It features the same sturdy construction, removable tool tray, metal lock and fittings, leather corners and handle, and plenty of room for tubes, parts and small tools. Inside dimensions are 17x10x7 inches.

Many servicemen find the *Sylvania* Service Kit an indispensable part of their equipment, because of its convenience and neat professional appearance. The new cover adds a modern



note to this long-time favorite of the modern servicemen.

They are available at \$3.00 each from *Sylvania* jobbers or by writing directly to *Sylvania* Technical Help, *Sylvania Electric Products, Inc.*, Emporium, Pa., specify Kit 1A. All letters will be handled promptly.

Black leatherette covered *Sylvania* Kits in two sizes are still available. Kit No. 1 is identical with 1A, except for the covering. Price \$3.00. Kit No. 2 has almost twice the carrying capacity. Inside dimensions are 14x22x8 inches. Cover has a leather flap to hold contents in place. Price \$5.00. *Sylvania* jobbers have samples of both styles.

New Stackpole Iron Cores

New materials recently developed by the *Stackpole Carbon Company* of St. Marys, Pa., have resulted in the introduction of molded iron cores which show outstandingly favorable characteristics at frequencies as high as 150



to 175 megacycles. Combining a permeability of approximately 5 with high Q, the new *Stackpole* iron cores represent a big forward step in matching the needs of much of the present day high frequency equipment.

Like other *Stackpole* cores available in practically every type for frequencies up to 50 megacycles, these newer units are outstanding for their uniformity. All engineering samples are made on the same equipment that is used in actual quantity production.

Engineering details on any type will gladly be sent upon request, from the *Stackpole Carbon Co.*, St. Marys, Pa.

Ward Leonard Rheostats

Ward Leonard Bulletin 69 Pressed Steel Rheostats meet the need for a small, sturdy, power rheostat having a large number of steps and ample current carrying capacity.

These rheostats are 4 inches in diameter with as many as 43 steps of control and are rated for 100 watts. Spacings through air and creepage distances between parts of opposite polarity and between current carrying and grounded parts meet the requirements of A.I.E.E., NEMA and Underwriters' Labs. for 300 volt service.

(Continued on page 50)

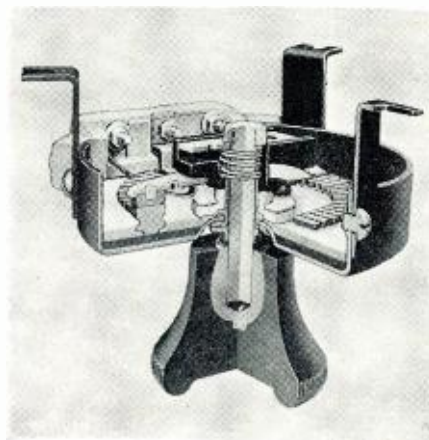

AVIATION RADIO COURSE

by PAUL W. KARROL

Part 10 of the course discusses various safety devices and shows how marker stations play such an important role in both military and civilian traffic.

ABOUT fifteen years ago when it became evident that air transportation was the coming thing, much thought was given to the perfection of many aids to aerial navigation. Various private research organizations and governmental agencies began intensive research which has given the aviation field many devices which have lessened accidents to a very remarkable degree.

Unceasing research was conducted on various range systems, marker systems, airport radio traffic control systems, radio operated altimeters (absolute altimeters), general aviation communications systems, radio operated weather reporting systems, and instrument landing systems (blind flying).

Out of this maze of research came much of the present day knowledge of systems used by the largest air transport corporations, our military and naval aviation services, and private aircraft concerns, which have contributed much toward the safety of aircraft.

It has been said innumerable times that, "without radio, the high efficiency of our aviation services as it exists today would have never been possible!" That statement causes very little rebuttal.

Every air transport plane whether it be military or commercial contains radio equipment designed and constructed to exacting specifications; radio equipment which keeps the pilot in touch with ground stations and enables him to fly from one destination to another regardless of weather conditions.

Among the many radio aids to aerial navigation and flying which are coming into greater prominence every day because of the increase of air traffic, are those which assist the pilot in making instrument or "blind" landings. Modern day blind landing equipment makes it possible for the pilot of an aircraft to land his aircraft at an airport which is properly equipped, i.e., blind landing aids, without seeing the ground.

Now that aircraft is designed which will fly at great heights over bad weather, it is necessary that they not only be provided with marker and general communications equipment but it is also mandatory that they be provided with blind landing equipment if they are to make many successful landings under conditions of poor visibility.

It is quite true that an aircraft (if flying over any one of the numerous radio ranges) if properly navigated,

will, if equipped only with a radio range receiver arrive at a field destination. However, after arrival, if conditions of poor or zero visibility are encountered (where it is impossible to see any object on the ground from the air) it would be difficult if not an impossible task to consummate a successful landing or even a "break through."

In 1929, the Bureau of Standards (B of S) produced a blind landing system which was installed at Mitchel Field, N. Y., and experiments were carried out. The first awe inspiring blind landing was made by our own Gen. J. H. Doolittle (then a lieutenant)!

The system used at that time was not overly elaborate. It consisted essentially of a radio range whose course was aligned with the runway and a marker transmitter. The runway localizer (low power range transmitter) gave the pilot the information he needed to "line" his plane up with the runway and the marker gave the necessary approach information. That is, he knew when he passed over the marker beacon which was placed at a certain distance from the runway that he then had a certain distance to begin his descent. Using his altimeter for indicating his vertical distance from the ground and the marker his horizontal distance from the runway, the plane was successfully landed on the runway even though he could not see the ground. However, this system had drawbacks and was not foolproof. As time went on modifications to the system were made.

The old system did not provide for "landing angle." That is, it did not contain the elements essential for providing guidance of the plane as it gradually came down on the runway.

The new system contained the necessary equipment which made it possible for the aircraft to descend at a given rate of speed at the proper gliding an-

gle. This was done by using ultra high frequency (UHF) glide paths which were distorted so that they would provide the proper descent guidance. However, it was known that material (especially steel) which was used to construct hangars, reinforce concrete, towers, power lines, railways, etc., did affect the desired wave form of the projected beams. The undesirable effects created by various structures were eliminated in most cases by placing the radiating equipment in spots far removed from offending obstacles.

While tests were being conducted in the United States on various types of instrument landing systems, European engineers were also busy with the problem of perfecting a fool-proof landing system. We in the United States finally received information concerning one of the European systems which was given much credit not only because of its simplicity but also because it was demonstrated successfully time after time without a mishap. This system is known as the Lorenz system and was developed by an outstanding German scientist by the name of Kramar. However, for operation in the United States it had many disadvantages. Vertically polarized waves were used and were transmitted in the 30 mc. bands. (These bands were being used in the United States for various services.) Under certain conditions when the weather was bad, excessive moisture would cause certain troublesome effects to be introduced with resultant loss in the efficiency of the system. The system was tested in this country and certain modifications were made which greatly improved it.

However, because vertically polarized waves were being employed and because these are susceptible to bends, abrupt angle cut-offs, etc. (all caused by conductive material) it was thought that the system would not be safe under all circumstances. Because one receiver only is used; and because only one transmitter and one vertical dipole radiator are utilized to produce the runway localizer pattern and the glide path it is apparent that the system is quite simple. After much research, however, it was decided that horizontally polarized waves should be utilized regardless of the increase in the number of pieces of equipment.

The Army Air Corps developed its own system about ten years ago which was tested at the Army's aeronautical testing center, Wright Field, Ohio. This system made use of a radio com-

(Continued on page 48)

General Electric's new Power Package.

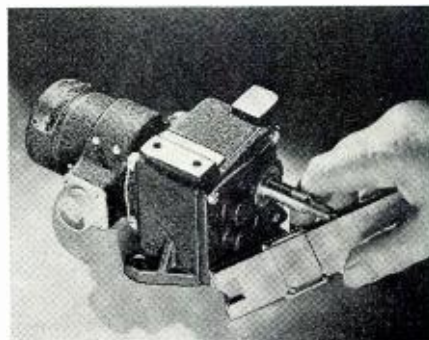

24 YEARS AGO in RADIO

CONDENSED FROM RADIO NEWS, 1919 ISSUES

Audio Frequency and Radio Frequency

(The 1919 version)

ALTERNATING Currents are generated at various frequencies, covering a remarkably wide range. Depending on their application, the frequencies in practical use fall into three well defined classes:

(a) Commercial frequencies, which nowadays generally mean 25 or 60 cycles per second.

(b) Audio frequencies, around 500 to 1,000 cycles per second.

(c) Radio frequencies, usually between 100,000 and 1,000,000, but extending in extreme cases down to perhaps 10,000 and up to several million cycles per second.

Commercial frequencies are used for lighting and power. The great machines in the central stations which supply our cities with current operate at these frequencies.

Audio frequencies are those conveniently heard in the telephone. When alternating currents are sent through a telephone, the diaphragm of the latter vibrates. The vibrations are heard as sound. The more rapid the vibrations, the shriller the tone. Vibrations at the rate of 4,000 or 5,000 per second give a shrill whistle, while the lowest notes of a bass voice have somewhat under 100. If a 500-cycle generator supplies current to a spark gap and the spark jumps once on the positive and once on the negative half-wave, then at the receiving station, the signal is heard in the telephone as a musical tone of 1,000 vibrations per second.

Radio frequencies occur in the circuits of radio apparatus, for instance in an antenna. They are too rapid to cause a sound, in a telephone which can be heard by the human ear. They may be generated by dynamo-electric machines of highly specialized construction, but are usually produced by other means. *How different now, Ed.*

High Voltage Audion Battery

AN AUTHOR describes a primary battery which appealed to the experimenter who wanted a high-voltage battery for general laboratory use of low amperage. It was found ideal for audion sets. The 30 cells give about 40 volts. The cells are made of carbons from old dry cells, drilled to receive the zinc electrode. The carbons are dipped into boiling paraffin to make them leak proof. They should be heated before dipping in the wax so that it will penetrate into the carbon a little before it gets hard. No paraffin must enter the hole. The carbon acts as a container for the active elements, and is the negative electrode (positive pole) at the same time. It presents the largest possible surface to the electrolytic, which is an advantage. The carbons should be forced into holes in the base board to hold them.

The wood base should be treated with hot wax after the holes are made to prevent the liquids from going into the wood and causing trouble if any should be dropped, in filling the carbons.

The zinc electrodes are cut from 1/16" zinc sheeting or even 1/32", which may be obtained at a tinsmith's shop. The lower end of the zinc is forced into a piece of soft rubber tubing.

Near the top another piece of tubing is placed to prevent the zinc from touching the carbon.

When the zinc strips are placed in the carbons, there is no fear that they will touch the carbon, although there is most of the zinc surface exposed to the electrolytic. After the battery

is assembled all the exposed metal should be coated with the wax.

Paraffin oil should be put on the surface of the electrolyte to keep the water from evaporating.

The electrolyte consists of one pint of water in which is dissolved 3 ounces of sal-ammoniac and 1 ounce of chlorid of zinc.

A Boy's Experience with Wireless Telegraph

I NEVER knew how fascinating an art wireless telegraphy was until I visited a friend one day who owned a new and up-to-date set of instruments. When I put his wireless phones over my ears and listened to calls that he said came from stations over one hundred miles away, I determined to have a station of my own, but the one objection was the cost of the instruments. My friend had new, highly finished apparatus that cost quite a lot of money, while I had only a few dollars at my command.

The only way out of it, as far as I could see, was to make my own apparatus. I had my friend explain to me the fundamental principles of his apparatus, and after eliminating some, I decided to make a tuning coil and detector.

The detector seemed the easiest, so I started that first. I mounted a brass upright with the top bent over on a base. A hole was made in the middle of the bent part. Directly under the hole, on the base, I screwed a piece of brass that had a hole 1/2" in diameter in the middle. In this hole I inserted a piece of galena. Then I suspended a fine brass wire from the top hole in such a manner that one end of the wire came into contact with the galena. I placed two binding posts on the base, one connected to the brass upright and the other to the piece of brass holding the galena. My detector was now finished and I turned my attention to the tuning coil.

First I bought a rolling pin and sawed the ends off. Then I nailed a square board to each end of the wooden core. Next I wound the core with No. 24B & S cotton covered copper wire to the end, taking care to wind the wire evenly. I then scraped off the insulation in a straight line across the top and side of the coil. Each line was 1/4" wide. Directly over the uninsulated part of the wire I arranged brass rods fitted with small brass cubes for sliders. The sliders had small springs that came into contact with the uninsulated wire. The wire and rods were connected to binding posts on each end of the coil.

My friend helped me to erect the aerial which consisted of two "Antenium" wires 50 feet long and 75 feet high. The wires were kept apart by spreaders which were attached to two chimneys. The lead in came to a lightning switch on the outside of the building. I connected up the instruments properly, using a No. 4 copper wire in wiring from instruments to the gas pipe. . . .

A Good Galena Detector

THE parts of this instrument are found around the "haunts" of any "bug". The cat-whisker is held by an old nut and lock-nut off some ancient doorbell screwed on a brass bolt after the head has been cut off. This bolt is put through the wire hole in a brass binding-post and has a black knob on the other end. The binding-post may be elevated if not high enough. The mineral cup is the butt of an old powder-shell and is threaded for a lock-screw. The parts are assembled on a hard rubber base with two binding posts and connections made.

-30-

Manufacturers' Literature

Our readers are asked to write directly to the manufacturer for this literature. By mentioning RADIO NEWS and the issue and page, we are sure the reader will get fine service. Enclose the proper sum requested when it is indicated. This will prevent delay.

New Profit-Boosting Display

The accompanying illustration shows the first of a brand new series of eye-catching counter and window cards which is being offered free to radio jobbers by the *Radio & Technical Publishing Co.*, 45 Astor Place, New York, N. Y.

The new unit, typical of others to follow at regular intervals appears at a time when the interest in *Ghirardi* books for radio training is at an all-time peak. It is a display dramatic in its colorful 3-dimensional appeal. An attractive die-cut front card with the vivid lightning streak carries the main message. Mounted behind this to give 3-dimension effect is a second

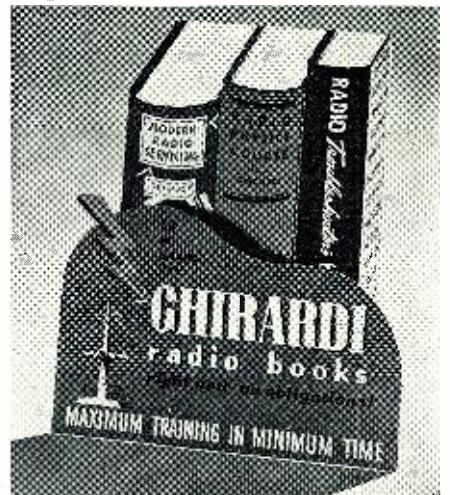

card bearing life-size reproductions of the colorful backs of the three most popular *Ghirardi* radio books. The entire display is made of heavy, die-cut cardboard; it is a silk-screened reproduction in five striking oil colors with an overall protective film of transparent varnish which not only enhances the brilliance of the oil colors but lends a sparkling lustre of its own.

A pair of these new displays, one for the window and one for the counter, is available to jobbers free of charge by addressing the publisher direct, as above.

Ward Leonard Bulletins

Four new bulletins have just been issued by the *Ward Leonard Electric Co.*, Mt. Vernon, New York. They are numbers 23, 60A, 69 and 104. They describe in detail a complete line of industrial rheostats suitable for motor speed control and other applications.

-30-

Spot Radio News

I N D E F E N S E A N D I N D U S T R Y

Presenting latest information on the Radio situation.

by **LEWIS WINNER**
RADIO NEWS WASHINGTON CORRESPONDENT

A NEW TYPE OF RADIO MANUFACTURER has been born, but soon may die, too. It seems as if dealers and distributors found, after the issuance of that limitation order curbing receiver manufacture, that they could do a little manufacturing themselves with what material they had on hand. This procedure applied particularly to the production of combination consoles using phonograph mechanisms and receivers. Many dealers and distributors, finding themselves with a considerable stock of cabinets, record players and receivers, felt that assembling them into combination units would provide them with a very substantial source of merchandise. It did, and it has, and will probably continue to do so, unless WPB and OPA declare that it is a violation. Actually, there is nothing in the ruling that prevents such a manufacturing procedure. The original ruling called for the cessation of manufacture by manufacturers or others directly involved in the assembly of components. Dealers and distributors whose work formerly consisted only of selling and servicing certainly could not be regarded or classified as a manufacturer.

Probably the most interesting part about this conversion practice is that it is a violation of the price ceiling ruling. For that regulation stipulates that all such equipment must comply with a predetermined pricing format before sales are made. And this format has not been complied with by these conversion manufacturers. Of course the situation does not become a complex one until real production is achieved. Unfortunately, this has been true in many instances. Where, of course, conversions have been made and ceiling prices of parts and labor are maintained as of March 1942 levels, such conversion work could continue without affecting a violation. This would come under the heading of service work, since it is really similar to a modernization process. In any event, we will soon have an official interpretation of the ruling outlining the exact status quo of dealers and distributors who have been or intend to be affiliated with conversion work.

Conferences thus far held indicate that rebuilding on a personalized scale and involving "on-hand" parts will be permitted, provided the price ceiling schedules are adhered to. It is the large scale projects that concern Washington. This will be quite ap-

parent in the supplementary L-183 rulings that will come soon.

IT WAS BROADCASTING that played a major role in the successful occupation of North Africa recently, for not only did the speech of our President provide that impetus to our gallant soldiers, but a broadcasting system of our Army also played its role and in a very unusual way. A powerful transmitter employed by the Army and identified as "the voice of the U. S. Army" beamed messages at the French public for several days before the actual landing took place. This transmitter even broadcast President Roosevelt's proclamation. Every effort was made by the German Armistice Commission to track down and demolish the station, but to no avail. Even the annoying method of jamming was resorted to, but fortunately, with very little success.

According to reports now coming into Washington, broadcasts were used at many periods just prior to invasions of port cities. In this way, civilians were notified to take cover so that should any action occur, civilian fatalities would be nil.

This is the first time that such a

unique method of transmission has been employed. That it is a most effective medium and a vital aid to military strategy is clearly evident. Thus once more, radio has shown what a powerful tool it is today.

THE CREATION OF AN ARTIFICIAL FREQUENCY response to provide both high-fidelity and a synthetic increase in db has long been a pet project of engineers. Last year, for instance, an effective application of a system of this nature was announced by Frank H. Shepard, Jr. This year another system has been developed and introduced by Louis A. DeRosa.

In Mr. Shepard's system the characteristics of the human ear hearing mechanism has served as the basis of the development. Research workers have found that a non-linear characteristic is possessed by the hearing mechanism of our ear. It appears, for instance, that the input-output response of the ear is such that the sensitivity of the ear is great in small amplitude signals and greatly reduced for high amplitude signals. This odd non-linear characteristic is also the cause of harmonic generation. It is also responsible for the fact that non-

How the Army soldiers in the field in an emergency. Note tie covers.

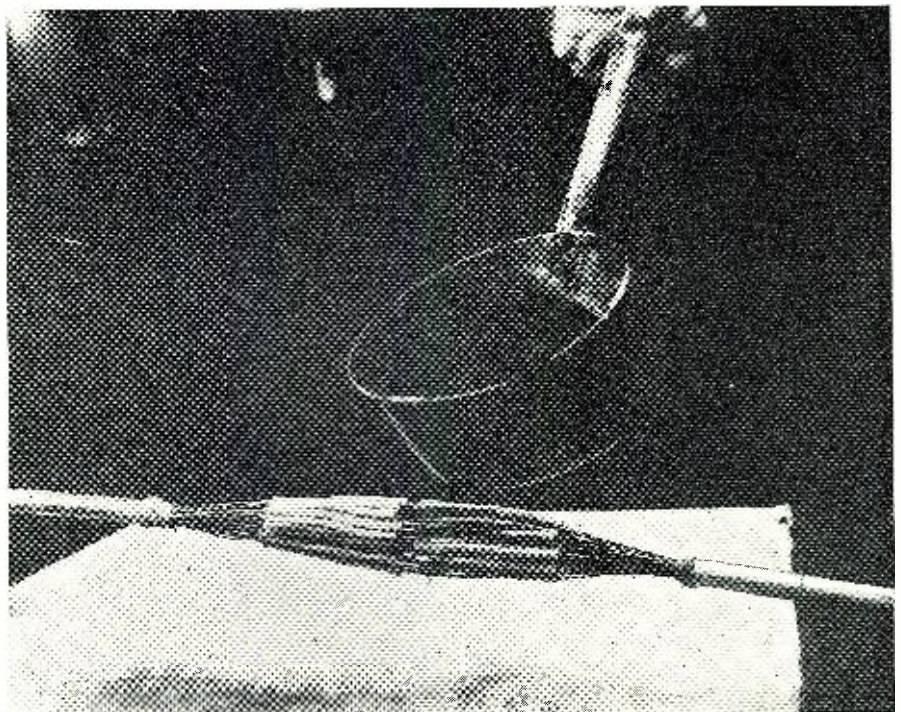

linearity is different at different sound intensity levels. In this way the ear corrects for all sound absorption effects in nature, so as to keep the timbre of sound generated at various distances or nearly constant as heard by the brain.

Mr. Shepard points out that since the ear is in itself non-linear in varying amounts, it permits the introduction of the proper type of non-linearity into an amplifying system. This permits the handling of increased amplitude ranges and at the same time, gives the illusion that certain frequencies that it is impossible to radiate, are present. Thus, by introducing a type of distortion similar to that of the human ear into an amplifier audio system, it has been possible to compress the signal level and obtain synthetic reproduction of certain frequencies, particularly those frequencies to which the listener may be deaf, or which the reproducing system will not handle.

Human ear distortion at any particular frequency may be roughly considered as a power function. That is, the output raised to a power is a direct function of the input. Accordingly, in small receivers, the plate load of the driver is limited in value so that the driver has little more than enough output voltage to drive the output tube. In this way an effective degree of non-linearity was introduced, even before regeneration has been utilized. The use of suitable filter resistors and condensers in a low-pass filter arrangement in the feed-back circuit with proper control of this feed-back is one way of providing synthetic reproduction, according to Mr. Shepard. Degeneration to help damp undesirable speaker effects at higher frequencies may also have to be used. This lowers the output impedance of the circuit and thus current variations due to speaker and cabinet resonances are more efficiently reflected in that part of the circuit from which regeneration is derived.

The peculiar properties of the human ear are also used by Mr. DeRosa to obtain the required results. He supplies the hearing mechanism with sounds consisting principally of those generated externally, that produce, nevertheless, apparently distortion-free results.

STANDARDIZATION AND SIMPLIFICATION ARE ON THE MARCH AGAIN. For over a year civilian and military committees have devised many programs that were supposed to provide a simplified format of component design and manufacture. Some have been put into practice with modest success, while others have fallen to the wayside because of their loose structure. Each, nevertheless, contributed its share towards the effective continuance of manufacture and distribution. With, however, the coming of the unprecedented requirements of the military, a new program was necessary and it is now in view. Having

the official sanction of the WPB and OPA, and the professional talent of the American Standards Association, this new plan should become the most successful and most lasting of all.

From tentative lists submitted, the program appears to be one of extremely drastic nature. However, such is essential today in view of manufacturing and materiel problems. Any leniency or weakness in the plan would only destroy its basic principle of design.

When the first list of available tubes for 1942 was issued, several hundred types appeared in the approval column. The 1943 production schedule at this moment allows for the manufacture of only 118 types of tubes. In this listing, of course, are those tubes that serve a multitude of purposes and which can therefore be used as alternates for many types that will no longer be made. Many popular types of tubes will still continue to be made. These include, for instance, the 2A3, 6L6G, 57, 80, 24A, etc.

The stringency of the plan is really evident from the tentative list of available parts. For instance, only 11 types of dry electrolytic capacitors will be available instead of the 357 types that were normally made. In place of 300 types of paper tubulars, only 11 will be available and instead of 2700 types of volume controls, 61 will have to do the job. The 200 types of transformers and chokes have been reduced to 8 and 3, respectively.

This new standardized allotment of parts which will be popularly known as the "V" line will not be available for normal use until material, design, manufacturing, and distribution problems have all been ironed out. This may take many months. However, since such a plan will eventually go into effect, manufacturers, distributors, dealers, servicemen and the con-

sumer will have to begin to plan accordingly. This planning has particular significance for the consumer. Now, finally aware that these limited parts will be the only ones available, careful attention by the consumer to their radio or radios, is more important than ever before. Neglect may mean a useless receiver. Undoubtedly, campaigns advising of this possibility will soon swing into action. Our advice, therefore, is, if your radio seems to ail, be sure it receives the proper attention from a specialist, at once.

ALTHOUGH NO PERMITS FOR NEW STATIONS were granted for the month of October, 1942, there are still 909 broadcasting stations in the United States. This compares with 877 stations that were operating on November 1st, 1941. At that time 38 stations were under construction while in the month of November only 10 were under construction. Thus, although manpower and materiel problems have been severe, broadcasting stations have, nevertheless, maintained their status. This is indeed creditable and a tribute to American ability. While no official tabulation of "off-period" periods is available, the consensus is that but an insignificant percentage of time has been lost during the past year. Ingenious alternate circuit designs and uses of materials have kept the broadcasting stations very much "on the beam." Even in those incidents where damage caused by havocs of nature has been very severe, few stations lost much time. Emergency units have been pressed into service immediately in accordance with schedules.

A NEW TERM HAS BECOME A VITAL MEMBER of the priority family. In fact, it is now a leading member of the family. We refer to the "prece-

150 foot antenna towers used in short-wave transmissions to Central America.

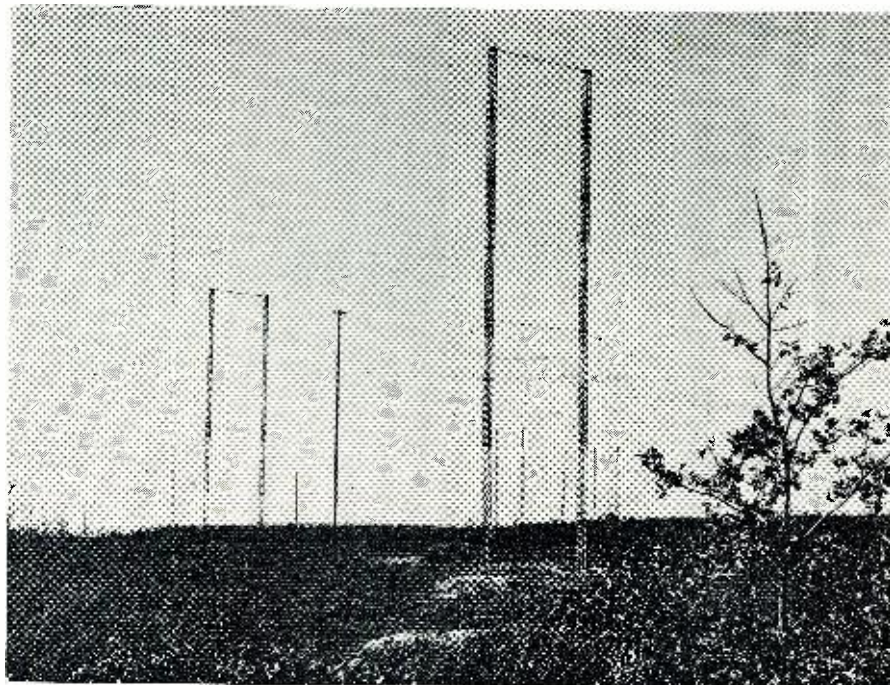

dence list designations." This new control which became effective the first of the year makes it mandatory for producers to schedule within any single priority rating, production and deliveries of electronic, communication, detection, and signalling equipment according to numerical designations assigned by the "precedence list" of the Joint Communications Board of the Army and Navy. These designations set forth the relative urgency on deliveries of certain types and quantities of electronic equipment and operate only within any one priority rating category. They do not affect the scheduling of purchase orders, having different priority ratings, nor purchase orders not included in the "precedence list." The "precedence list" which was established by the order L-183-A is restricted and not available for publication. On it each item is assigned a numerical designation beginning with PL-A1. This is the highest order of urgency. From then on it runs through a series of letters and numerals covering more than 400 items.

COPPER IS STILL VERY MUCH THE VITAL METAL and every means is being taken by the Government to gain every ounce possible. Where holders of copper have refused to sell, and during a recent conference it was revealed that some sixty-four million pounds were being held in this way, requisitioning action by the Government is being taken. There is no denial that this is a very firm step, but in view of the extreme need for this very essential metal, no procedure can be severe enough.

In the New York office of the Copper Recovery Corporation, a national inventory of all copper products reported in idle and excessive inventories is maintained. A few minutes with the requests received here, for as much as five hundred thousand pounds a day, will quickly reveal to anyone, not only how much is required but how quickly it must be placed into the hands of those in need. As a result of this office's efforts, war plants have been able to maintain schedules. In view, however, of the idle stock still available but not reported, such aid may be interrupted. It is hoped, therefore, that the requisitioning processes will be few and far between and voluntary reports substituted instead.

RADIO CONTROL OF VESSELS AND PLANES has formed an important link in military planning for a long time. While no applications in the present war have been made public, it is known that control by radio has served effectively in many instances. In a recent demonstration in the East, one of the most important developments of radio control was revealed. This new system provides for the control by radio of cargo-carrying ships built of concrete and of submarine characteristics. They will be directed by a control ship. Such a ship, of

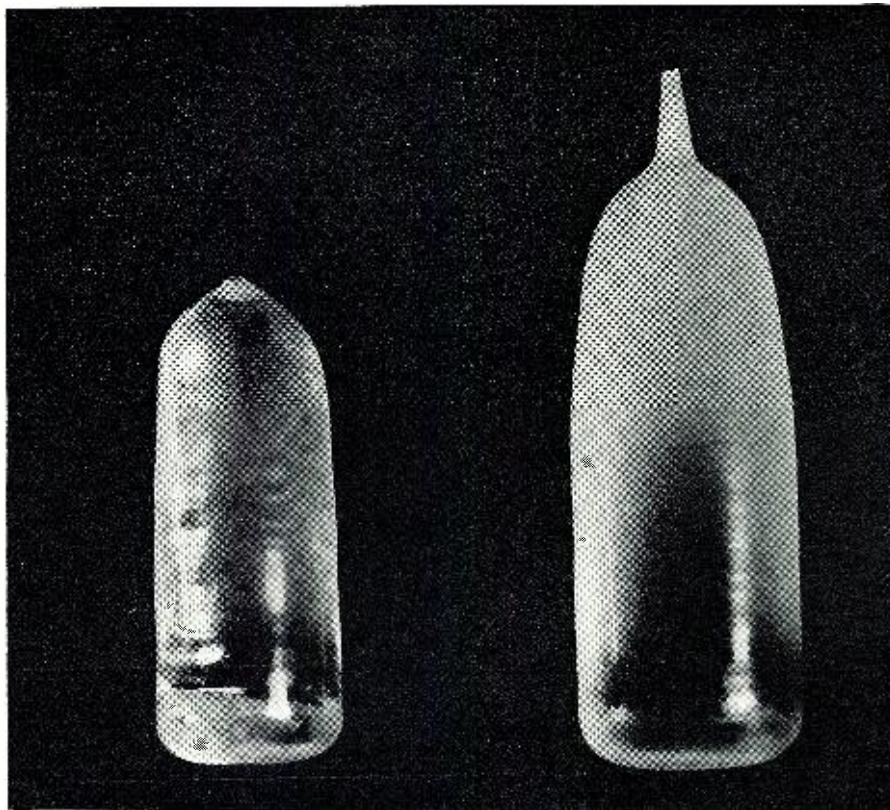

Synthetic sapphire specimens, alternates for precious jewels in variety of instruments.

course, must of necessity be one that is either well-armed or camouflaged sufficiently to effect complete innocence of purpose.

In the sample model containing this control, which was some 91 feet long, a trip from Florida to Washington was completed under complete radio control.

If this revolutionary system of conveying can be employed successfully in trans-oceanic travel, radio control will have achieved a true victory.

Tests of these vessels of radio control will be made in Washington or other accredited port for the approval of the United States Maritime Commission and other Government bodies. We await with interest the opportunity to report to you the result of these and successive tests of this sensational development.

A NEW BULLETIN that explains pricing under OPA Service Regulations has been issued. It is a very comprehensive release and should be in the shop of every service man, dealer and distributor. It is known as the OPA Service Trade Bulletin No. 1 covering repair, maintenance and rental of radios, gas and electrical appliances. Copies are available from regional or state offices of the OPA and not from Washington. Be sure to ask for your copy immediately.

ELECTRON MICROSCOPES HAVE BECOME POPULAR items. A year ago these marvels of the century were laboratory and special installation projects. Today, they are being made in portable and mobile sizes. RCA, for instance, has developed an electron

microscope that is only 16" long and capable of magnifying up to 100,000 times. This latter property was a feature of the huge electron microscope of two years ago. The *General Electric* laboratory has also developed a mobile electron microscope that is capable of producing 10,000 times magnification, considerably more than has ever been reached before.

In the G.E. microscope, electrostatic focusing to the beam of electrons is used instead of electromagnetic focusing. According to Doctors C. H. Bachman and Simon Ramo, who are responsible for the development of this new device, this new method of focusing supplies a fixed magnification regardless of voltage variations. It is also possible with this device, to provide an enlargement of the 10,000-time picture to 100,000 times, or even better. As a matter of fact, say the developers, the total enlargement employed is dependent upon how the resulting picture is to be used. The measure of a microscope, say the experts, lies in how small an object can be seen, rather than how much an image can be magnified, for magnification alone does not make a picture clearer.

Both of these unusual electronic developments were exhibited at the recent chemical convention in Chicago for the first time. It was the first time, too, that the chemical industry and the electronic industry became so closely allied in their research work. This amalgamation of thought can be considered a true forecast of the importance of electronics in the chemistry world and other scientific fields in the near future.

PLASTICS AS A STEEL REPLACER was at one time more of a Jules Verne type of a story. Today, however, it is an actual fact. We have many materials that are able alternates for steel, not so much in that they have the properties of steel, but in that they serve in place of steel in a very effective way. One of the most recent developments of this nature is a resin powder known as vinsol. Extracted from the southern pine tree, it has a thermo-plastic fibrous resin composition and is hard, dense, stiff, yet light-weight. Probably the most important of its advantages is that it is available without priorities.

Existing conventional paper-making machinery can be used to produce sheets containing this resin. When heavier sheets are required, ordinary insulation board machines can be used.

An excellent example of its steel replacement properties is contained in the tubing of three-inch diameter that is now replacing steel pipe in oil-field exploration work.

For radio antennae, panels and other similar communication instruments this unusual product is also finding merit. It is said to saw, punch and drill just like bakelite.

In England, G.E. has also produced an alternate tubing for steel. There, it is known as plasduct. Like vinsol, it also has exceptional mechanical strength, and in addition, is a good insulator. This material comes in small diameters from $\frac{3}{8}$ " up to 1", and is being used for a variety of purposes in electrical and communications work.

LIGHTNING HAS ALWAYS BEEN A SUBJECT OF INTRIGUE. Its properties have been the cause of study for years. Recently, Westinghouse conducted an interesting investigation during which radio towers served as the major portion of that investigation. The tower of WWSW of Pittsburgh, for instance, which is 100 ft. high, was found to have only been struck once in the three years of its life, for an average of .33%. However, the tower of WADC, which is 360 ft. high, was struck six times in its three-year life for a percentage of two. And the famous tower of the Empire State Building, which is 1250 ft. high and contains those television antennae, has been struck 68 times in the past three years, for an average of 23%. It is thus evident that the heights of towers are important factors in attracting lightning. Ord-

nary buildings, those having comparatively small towers, will suffer little lightning danger, according to this investigation. Of course, proper grounding really eliminates the so-called danger, but the attraction is minimized with a mast of low height.

NO MORE ADVERTISING FOR REPAIR MEN in London, says the most recent order of the Ministry of Labor and National Service. Previously, such advertising was permitted, provided a suitable explanation satisfying the board, preceded the advertisement. Now, however, it will be unlawful to publish advertisements seeking help for repair or maintenance. There is no restriction, at the present time, on advertisements covering positions wanted. In addition, it is also legal to advertise for women who are 31 and over.

Those who advertise for a position must first register at the local employment exchange and obtain any employment through that employment exchange. If contact is established as a result of this effort, the new employee must go to the local labor exchange and make the necessary arrangements for employment. And we say we have problems here!

NEW YORK STATE HAS BECOME one of the most fertile suppliers of technicians. Close to 4,000 persons have taken courses in radio specifically, with over 15,000 having taken radio courses in colleges and other educa-

tional institutions. Teaching these courses are 65 station engineers.

The educational projects in New York State began just before the end of December, 1941 and was made possible by funds available through the *United States Department of Education*. The courses were of 32-week length, and of course, were for nights only. The broadcasting stations furnished the instructive help without which it would have been impossible to complete the project. Many of those who completed the course were used by broadcasting stations as replacements, and others went into the services. This mass production basis of teaching is truly unique in educational annals. It proves that the impossible is still possible, and thus warrants the commendation of everyone in and out of the industry.

At the present time, an unfortunate problem has occurred; that of equipment allotment. Priorities have made it difficult, and in many instances impossible to obtain the necessary pieces of apparatus. A plea is thus being made for such equipment. Amateurs and the public, too, who believe they have equipment that will serve this worthy cause should immediately contact their local colleges, schools and even high schools. This request cannot be made too strongly. If you have a part that you think can be used in instruction work, donate it at once!

ON THE PATENT FRONT THIS MONTH WE FIND frequency modulation, television and electronics, the featured

players. In the electronics patents appear a variety of measuring instruments that serve in many unique ways to guide the manufacture of arms today. While the use of electronics in this particular manner is not new, never before have gunmakers used electronics so extensively.

Color television, which has long been considered a dormant project, receives revived interest in the patent of Madison Cawein. His method, employing the scanning successive elemental areas in accordance with an interlaced scanning pattern, having at least three fields of consecutively scanned lines per frame, provides an effective reproduction in natural color.

To Alfred N. Goldsmith, veteran radio inventor, has been awarded a patent for a new multiple frequency modulation system and a new modulation system. (Continued on page 56)

Measuring the elasticity of a steel bar, using mirror and photocell.

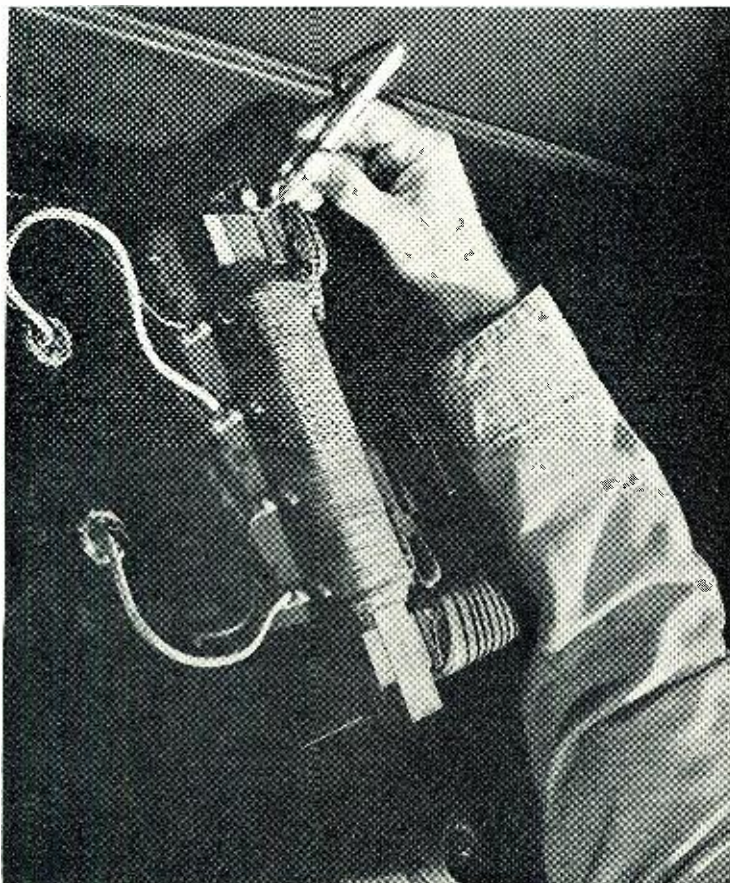

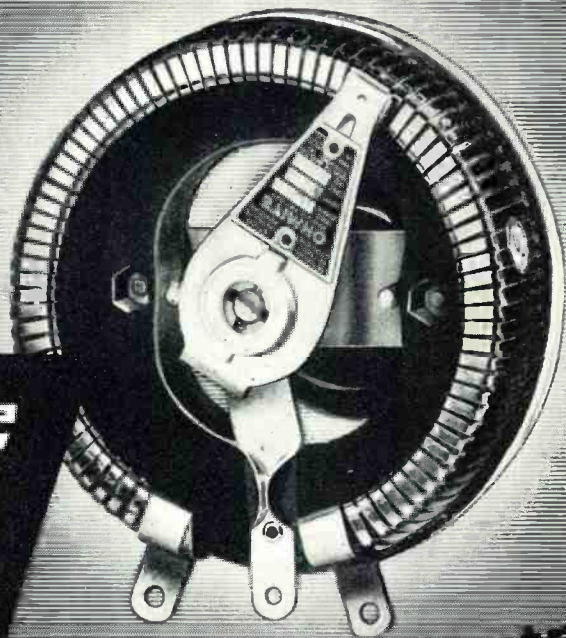
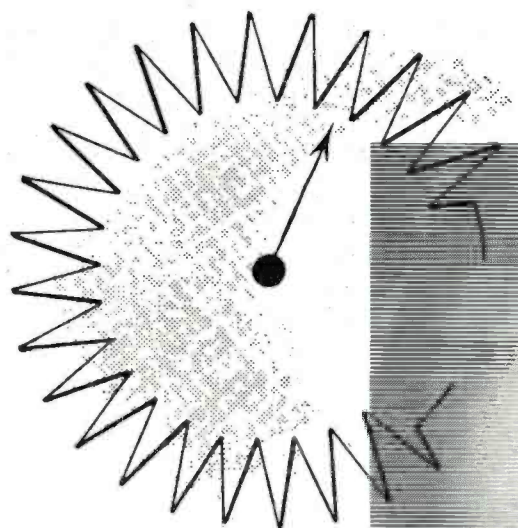

OHMITE

All-Ceramic Vitreous-Enameled

RHEOSTATS

for **PERMANENT** Smooth Control . . .

There is a basic difference in Ohmite rheostat design that becomes more and more apparent in actual service . . . a difference in smoothness of action, in long life, in trouble-free performance that means *permanently* smooth, close, electrical control. Every design feature has been time-proved under the most critical conditions, in every climate, on land, at sea and in the air. This soundness of design, plus the wide range of types and sizes, has made Ohmite Rheostats readily applicable to today's vital needs in war and industry. It also makes them ready to serve in the design of new devices to defeat the enemy and build for tomorrow's peace.

SEND FOR THESE HANDY AIDS

Free Quick-Reference Catalog 18— Gives helpful information on Ohmite stock resistors, rheostats, chokes and tap switches for all types of applications.

Ohmite Ohm's Law Calculator— Helps you figure ohms, watts, volts, amperes—quickly, easily. Solves any Ohm's Law problem with one setting of the slide. All values are direct reading. Available for only 10c. (Also available in quantities.)

OHMITE MANUFACTURING CO., 4884 FLOURNOY ST., CHICAGO, U.S.A.

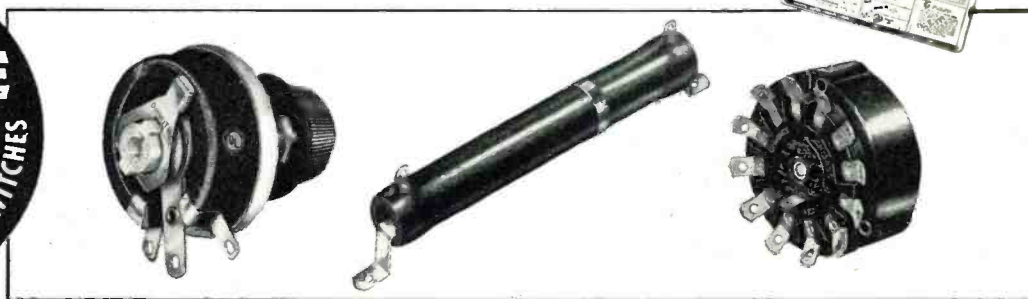

"HOT OFF THE PRESS"

SYLVANIA SERVICEMAN SERVICE

by
FRANK FAX



As you know, we've been busy revising and improving our technical data to help you keep radios informing and entertaining the home front.

Hot off the press is a new revised edition of the Technical Manual on Sylvania Radio Tubes. This is the basic up-to-the-minute stuff—in detail. You'll want it just as much as the Correlation for Substitution Chart, the Characteristics Sheet and other free technical helps. I can recommend it even to those who already have earlier editions of the same publication.

For only 35 cents you get 275 pages of technical "know how." More than 400 types of tubes—their characteristics, operating conditions and circuit application—are covered. In addition, there are definitions, typical circuits, charts, graphs and illustrations.

Before you send for it, you might take a look at what is offered below. Maybe your jobber was unable to supply you with this or that free technical or sales help. For a full shipment, write to Frank Fax, Dept. N-2, Sylvania Electric Products Inc., Emporium, Pa.

WARTIME PROMOTION ITEMS



A winner of the 1942 American Direct Mail Association Contest for the best wartime jobs.

- | | |
|----------------------|--|
| 1. Blackout button | 5. Air raid precautions folder and window poster |
| 2. First aid index | 6. Direct mail letter |
| 3. War Bond poster | |
| 4. Radio and canteen | |

REGULAR ITEMS

- | | |
|--|--|
| 1. Window displays, timely window streamers, etc. (From your Sylvania jobber only) | 14. Technical Manual—New Revised Edition (35c) |
| 2. Electric clock signs | 15. Tube base charts |
| 3. Electric window signs | 16. Price cards |
| 4. Outdoor metal signs | 17. Sylvania News |
| 5. Window cards | 18. Characteristics sheets |
| 6. Imprinted match books | 19. Interchangeable tube charts |
| 7. Imprinted tube stickers | 20. Tube complement books (35c) |
| 8. Business cards | 21. Large and small service carrying kits |
| 9. Doorknob hangers | 22. Service garments |
| 10. Newspaper mats | 23. 3-in-1 business forms |
| 11. Store stationery | 24. Job record cards (with customer receipt) |
| 12. Billheads | |
| 13. Service hints booklets | |

SYLVANIA

ELECTRIC PRODUCTS INC.
RADIO TUBE DIVISION
Formerly Hygrade Sylvania Corporation

Radio Keeps 'Em Plowing

(Continued from page 14)

on telephone only, with a power of 50 watts. The power is supplied from the battery of the plow, high voltages being developed by a genemotor. So efficient is the design of these 50-watt transmitters that the drain on the battery, while transmitting, is less than the maximum charging rate of the generators on the plows. The transmitters are mounted on rubber washers to minimize shocks, and are practically waterproof.

Transmitters at Yreka and Redding are of 200 watts on the voice frequency and 350 watts on telegraph to insure constant communication with plows in the deep and winding Sacramento River Canyon.

Receivers are of the fixed-frequency type, permanently tuned to the assigned frequencies of 2726 kilocycles for voice and 3190 kilocycles for telegraph. Those in the stations have speakers mounted in them, while rotary plow receivers, being of remarkably small size, utilize a separate speaker mounted on the wall of the cab. The station receivers can be changed from 110-volt a.c. to 12-volt d.c. operation by turning one panel knob. The rotary plow receivers are of course, for 12-volt operation only.

One of the difficulties encountered in the design of these stations was to plan efficient antennae for the land stations and the mobile units. It was found that there was a fine stand of red fir timber at various locations in the district, so at each of five of the stations, three 100-foot poles were erected in the form of a triangle.

At Mineral, Quincy and Pulga advantage was taken of standing trees. The land station transmitting antenna is a half wave (171'6" long), the receiving antenna being of the doublet

type 140 feet long with a coil in the middle.

Plow antennae presented a much more difficult problem. After consideration of all the types heretofore used or available, development work was started on a new type. When not in use the antenna lies back over the cab and body of the plow. In this position it extends only 12 inches above the cab, and does not extend back beyond the bumper.

When it is desired to transmit, the operator raises the antenna by means of a lever in the cab, so that it stands 12 feet vertically, then turns a small crank which extends it to a height of 23 feet. The operation requires less than ten seconds. This part of the equipment was built in the Sacramento shops. It is very rugged in construction, and has proved to be a highly efficient radiator.

As soon as announcement was made in the district that a radio system was to be installed, the question naturally arose as to who was going to operate the stations. A call was sent out for volunteers to study for the examination for *Federal Communications Commission* licenses. The result was amazing and showed the fine spirit of loyalty and cooperation that pervades the maintenance personnel.

Not only did the snow plow drivers and helpers, office workers and executives begin to study, but their wives too, prepared for the examination, which was held at various points in the district.

The operating procedure has been greatly simplified by the use of printed forms upon which the daily road and weather report is compiled. A "round-robin" rapid fire exchange of information is accomplished in about 15 minutes each morning before the men go to work. At the end, each station in the system knows the condition of all roads in the district, the weather and temperature at each point, and the

The vertical antenna is pictured in its collapsed position.





IN the manufacture of precision instruments for the Armed Forces we strive for short cuts in production—but not in *quality*. There can be no expediency, no compromise, no half-way measures. The success of the bomber's mission depends as much upon the efficiency of the instruments as it does upon the skill of the officers and men.

Meeting the specifications of the United States Armed Forces

is in itself an eloquent testimonial to the *quality* of DeJur meters, potentiometers and rheostats. However, we do not rest upon these laurels alone. Behind DeJur workers is the stern tradition of New England . . . honesty of craftsmanship, pride of skill, the deep, personal delight in doing a job and doing it better than anyone else—anywhere.

in war as in peace . . . nothing takes the place of quality. *Your inquiries are invited.*

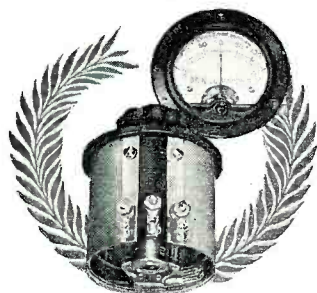

DeJUR-AMSCO CORPORATION

SHELTON, CONNECTICUT

Manufacturers of DeJur Meters, Potentiometers, Rheostats and other Precision, Quality Electrical Instruments

Can You Use These Radio Tools?



CREI Technical Training Equips You With the Ability to Hold and Improve Your NEW RADIO JOB!

These "tools" are the symbol of the trained engineer. Knowing how to use and apply them as a radio engineer is an important part of the training you enjoy as a CREI student . . . and an indication that you are equipped for the better-paying jobs that lead to secure futures in all branches of radio.

In our practical radio engineering course, you learn not only *how* . . . but *why!* Your ability to solve tough problems on paper and then follow up with the necessary mechanical operation is a true indication that you have the *confidence* born of *knowledge* . . . confidence in your ability to get and hold the new, better radio jobs that are crying for good, well-trained technical radiomen today.

Here is what the typical CREI student has to say:

"Being employed in the radio industry at the time of my enrollment, I had constant opportunities to apply my training to my daily work, with gratifying results both to myself and my employer."
39-29-12—H. B. SEABROOK, Station CJOR

"I have been helped by the course far beyond my expectation and the lessons have been particularly timely for me."

42-9-3—K. M. HOLLINGSWORTH,
General Electric Co.

• WRITE FOR FREE 32-PAGE BOOKLET

If you have had professional or amateur radio experience and want to make more money—let us prove to you we have something you need to qualify for a better radio job. To help us intelligently answer your inquiry—please state briefly your background of experience, education and present position.



CREI Students, Graduates—ATTENTION!

The CREI Placement Bureau is flooded with requests for radiomen. Employers in all branches of radio want trained men. Your Government wants every man to perform his job, or be placed in a job, that will allow him to work at maximum productivity. If you are or will be in need of re-employment write your CREI Placement Bureau at once.

CAPITOL RADIO ENGINEERING INSTITUTE

Home Study Courses in Practical Radio
Engineering for Professional Self-Improvement
Dept. RN-2, 3224—16th Street, N. W.
WASHINGTON, D. C.

Contractors to the U.S. Signal Corps—U.S. Coast Guard
Producers of Well-trained Technical Radiomen for Industry

weather forecast for the next 24 hours.

Throughout the day there is an hourly time check, and plows in operation report each hour. A constant standby is maintained at all stations, and by all plows on duty, so that the district has an hour-by-hour picture of what is going on at the front, and the snowfighters know that they can report break-downs or call for assistance at any time. Only during storms is there a day and night watch.

Operation of this system is a tribute to Mr. Average American. The chief operator and service man at Redding is the only employee whose time is devoted exclusively to radio work, the operation of all other equipment being performed by regular employees as part of their routine duties. All details of planning the system, manufacture of the sets and their installation, and their operation have been handled by regular employees of the Division of Highways maintenance department.

—30—

Aviation Radio

(Continued from page 39)

pass in the aircraft and two transmitters which were placed in line with the runway which is to be used by the aircraft. These transmitters were located about 1500 feet apart and approximately two miles from the runway's edge. In conjunction with these two transmitters (transmitting on frequencies capable of being picked up by the radio compass), two marker beacon transmitters operating in the UHF spectrum were also used.

These were near the r.c. transmitters. By making use of the aircraft's altimeter and using the r.c. transmitters' signals to line the plane up with the runway and the marker beacons to indicate when the craft had passed over each transmitter, the plane could be successfully landed; providing the altimeter used was accurate and the pilot was thoroughly acquainted with the "landing characteristics" of his ship.

It is thought that the margins of accuracy and safety could be greatly increased if automatic direction finders in conjunction with absolute altimeters (WE 1B) were used in aircraft utilizing the Army's system. However, it is to be remembered that no definite gliding path angle is established other than the one which is chosen by the pilot according to the type of craft he is flying and its load. Too, the point of immediate contact with the landing strip is never definitely known as it is when a glide path pattern is being flown. If the pilot does not know the length of the runway he may run into difficulty.

Essentially, a blind landing system consists of the localizer, markers, and glide path. These will enable the pilot to know when his aircraft is in line with the proper runway (according to the wind), when he should start to

"let-down," and whether or not he is coming down properly. In conjunction with the indicators he must use to effect an instrument landing utilizing the newer systems, the pilot may or may not use the automatic pilot.

Visual and aural indicators of aircraft position have been designed and used conjunctively; double indication enabling the pilot to know exactly how the system is operating. In addition, monitoring systems on the ground enable attendants to keep check on the system operation twenty-four hours per day, thus assuring consistent service. In case the system is inoperative and bad weather exists necessitating the use of the blind landing system, communications stations (operated by CAA, commercial and military agencies) would convey information by radio to the pilots of aircraft in the air relative to other possible landing sites equipped with blind landing aids, or direct them to fields which could be utilized without blind landing aids.

The utilization of ultra high frequencies for an efficient blind landing system is deemed necessary. When low frequencies are used, multiple course phenomena, bends, etc., tend to make systems unsafe and cannot be relied upon. Too, where ultra high frequencies are employed interference is greatly reduced and more systems may be located relatively near each other, thus assuring added installations at the smaller airports. (Depending upon the particular frequencies chosen.)

The equipment used in the blind flying systems must be designed and constructed with service requirements in mind as are the other aviation radio aids. Frequency stability is of paramount importance and cannot be emphasized too much. One can see the disastrous results if a localizer transmitter or glide path transmitter should shift frequency. Ruggedness is essential and the safety factors involved must be high.

It must be borne in mind that instrument landing systems are not always in operation, they being operated only during inclement weather and upon call from pilots. Of course, some systems are constantly operated in order to give pilots experience in using them and are only interrupted for maintenance.

Based upon experience with past installations, the CAA's Radio Technical Committee finally decided what every good efficient blind landing system should be capable of doing and laid down certain standards. These standards were adhered to and certain installations were made at various airports throughout the United States. The first installation was made at Indianapolis and proved highly successful.

Now that new developments have taken place, it is believed that one day soon a new system will be evolved using television. This system will either enable the pilot to see the runway he desires to land on or his air-

WE ASKED 817 MEN TO NAME THE *Best* RADIO TRAINING BOOK THEY KNOW!

UNUSUAL SURVEY REVEALS WHAT RADIO MEN THINK OF RADIO BOOKS

Men! Here's your chance to get started on the right track in your study of Radio—without guesswork and without investing a lot of money!

We contacted a mixed group of 817 radio men composed of Radio instructors, Servicemen, Radio men in the U. S. Military and Naval Forces, in radio manufacturing plants, etc.—asked them to tell us without prejudice or favor just what they think of the

various books and courses offered to beginners for the study of Radio fundamentals. WE'VE MADE A DISCOVERY! Nine out of ten of these men—728 to be exact—wrote back that Ghirardi's RADIO PHYSICS COURSE is their choice—the most understandable, thorough, and inexpensive Radio book there is—far better than any other book or course they have ever seen!

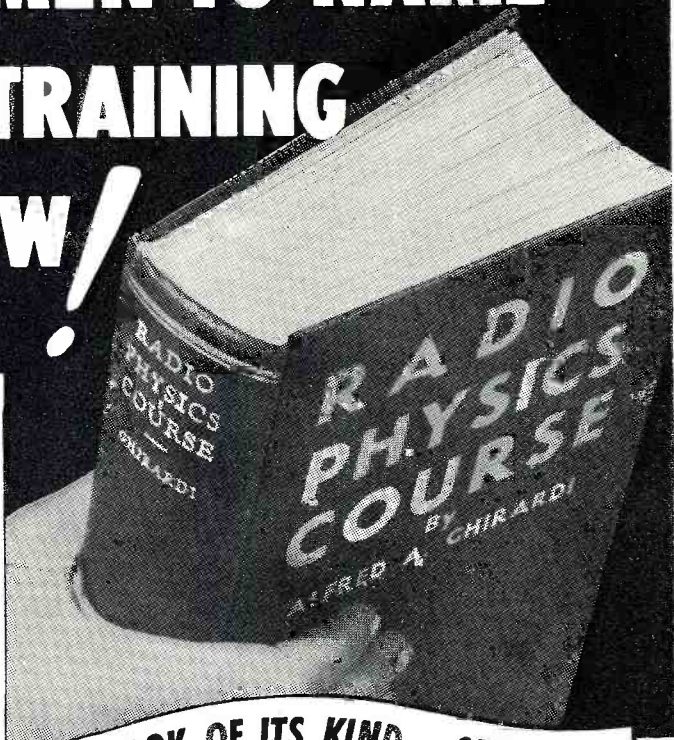

THE ONLY BOOK OF ITS KIND... 972 Pages

Your Money Back

YOUR MONEY BACK! . . . If Ghirardi's big 972-Page Radio Physics Course doesn't teach you the fundamentals of Radio and Electricity faster, easier, and at less cost than any other Radio book!

Are you one of the thousands of men who'd like to learn Radio but can't seem to make up their minds about just what to do or how to get started for a profitable, interesting career? If so, cheer up, for Ghirardi's famous RADIO PHYSICS COURSE—the simplified, down-to-earth book from which thousands just like you have learned Radio—is exactly what you need to teach yourself the easiest way, right from the ground up, at home in spare time—and help you check your own progress every step of the way. It's the easiest, quickest, and most inexpensive method of learning the required Radio essentials. That's why it is used and recommended as the text for U. S. Army Signal Corps training courses in Radio fundamentals.

NO OTHER RADIO COURSE LIKE IT

You've never seen any Radio Book like Ghirardi's RADIO PHYSICS COURSE—because there isn't any other like it anywhere, at any price. Starting right at the beginning—over 300 pages devoted to the all-essential Electrical fundamentals alone—Ghirardi teaches you EVERY important branch of this fascinating subject. He takes nothing for granted, but illustrates and explains every last detail step-by-step and so carefully that it is crystal clear before you go on to the next. That's the big difference between RADIO PHYSICS COURSE and other Radio Courses which take too much for granted. That's why both civilian and military Radio Instructors everywhere report that their students learn Radio far more quickly and easily from this than from any other Radio text—

it's practically a self-teacher. That's why Ghirardi's famous RADIO PHYSICS COURSE is used by more U. S. Army Signal Corps, Navy, civilian school and college radio training courses, and for more home study uses than any other basic Radio book published!

SCOPE OF 36 COURSES IN ONE BIG BOOK

Because Ghirardi's RADIO PHYSICS COURSE is so comprehensive, and so thorough in its explanations, it is a large volume—larger by far than any other book of its type. Actually, it gives you the scope of 36 different courses in one—packed into nearly 1,000 pages, made easily understandable by more than 500 specially prepared illustrations, and containing 856 self-testing review questions.

5 Days to See for Yourself—AT OUR RISK

Get started at once by mailing the coupon below—now! Our 5-day MONEY-BACK Trial Offer enables you to examine this great book without assuming any risk whatever. Prepare now for a fascinating Radio Future—in the Signal Corps, in the Navy, in Aviation, Broadcasting, Electronics, Manufacturing or any of the many other branches! Send the coupon below—AT ONCE!

Other Ghirardi Books to Help You

★ **MODERN RADIO SERVICING**—A complete, 1-volume home-study Course explaining to the last "why" every phase of the entire art of Troubleshooting and Repairing radio equipment by the most advanced methods. 706 illustrations. Price \$5.

★ **RADIO TROUBLE-SHOOTER'S HANDBOOK**—

A big, new 710-page Revised Edition of Radio's most popular factual Data Handbook for repair work. Now contains 62 big sections of invaluable tabulated and charted troubleshooting and repair data for over 4,500 receiver models. Saves hours of troubleshooting and repair time. Pays for itself the first time you use it! (8 1/2" x 11" size). Price \$5.

Get both of the above servicing books at a real saving! Over 2,000 pages of vital knowledge in MODERN RADIO SERVICING and TROUBLE-SHOOTER'S HANDBOOK—\$10.00 value—for only \$7.50 if purchased together. Use coupon below.



SAVE MONEY!

THE 3 GREATEST VALUES IN MODERN RADIO TRAINING!

Sold at 1/10th the price you might expect to pay for such complete instruction.

RADIO AND TECHNICAL PUBLISHING COMPANY, Dept. RN-23
45 Astor Place, New York, N. Y.

Enclosed find payment for books checked below. I understand that, if I am not fully satisfied, may return them at the end of 5 days and receive my money back.

- Ghirardi's RADIO PHYSICS COURSE \$5.00. (\$5.50 foreign)
- Revised RADIO TROUBLE-SHOOTER'S HANDBOOK \$5.00. (\$5.50 foreign)
- MODERN RADIO SERVICING \$5.00. (\$5.50 foreign)
- MONEY-SAVING OFFER—THE HANDBOOK and MODERN RADIO SERVICING at special price of only \$9.50 for the two. (\$10.50 foreign)
- Rush free literature on all of above.

Name

Address

City..... State.....

MONEY-BACK GUARANTEE!
YOU BE THE JUDGE



ALFRED A. GHIRARDI
World-famous Radio Authority



MAIL NOW

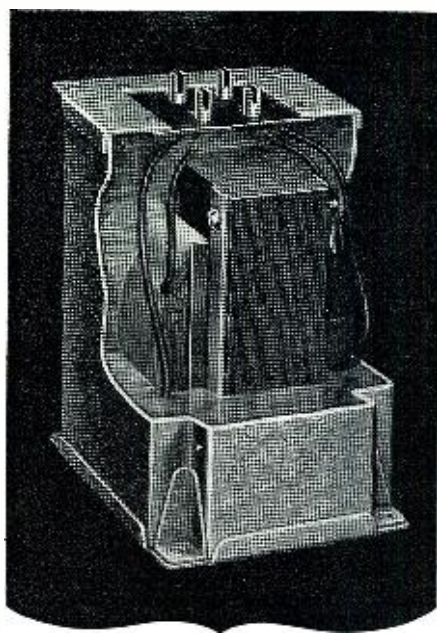

*For Dependability...
Stamina... Adaptability*

STANCOR

PROFESSIONAL SERIES TRANSFORMERS



BUILT TO MEET STRINGENT WARTIME REQUIREMENTS

THE Stancor Professional Series Transformers are the logical choice of Radio Engineers, Broadcast Engineers, Governmental Agencies, Radio Manufacturers and other equipment designers and users. They are built to meet stringent wartime requirements.

STANCOR quality assures you of sound engineering design, the finest obtainable raw materials, thorough inspections, and high standards of craftsmanship.

★ **GENERAL SPECIFICATIONS** ★

CASE DESIGN—A rugged physical construction featuring reversible mounting has been combined with a smart uniform appearance.

INTERNAL MECHANICAL CONSTRUCTION—Special brackets and/or blocks added in assembly prevent shifting of coil and core inside of case.

IMPREGNATION—The traditional STANCOR vacuum impregnation provides thorough protection against the effects of humidity and moisture. The special compound, sealing each unit in its case, gives additional protection and adds to the long life and service obtainable from these units.

FOR MORE DETAILS WRITE FOR CATALOG No. 240



craft will appear as a dot on a calibrated screen which will represent the airport. As the aircraft approaches the airport the dot will move to a corresponding position on the screen representing the sector over which the aircraft is flying. Two screens may be employed, i.e., one showing the position of the aircraft with respect to the ground in terms of feet, and the other giving the position of the aircraft with respect to the territory over which it is flying. Regardless of weather conditions, a complete outline of the field (including runways) will appear on the screen and will enable the pilot of an aircraft to make a "sight" landing. The writer believes that this is entirely possible; and as the state of the art progresses, it is believed that the equipment which will be employed will neither be bulky or large and will occupy little room. The possibilities are unlimited.

In bad weather aircraft flying near mountains, other aircraft, etc., would not be jeopardized because the pilot could not see what is ahead. Using the same television landing system, it would be possible to have the "television-absolute altimeter" operating in a horizontal plane and advise the pilot of other aircraft, mountains, etc., in his path.

The application of ultra high frequencies to those problems encountered in aviation communications and navigation are many. The technician who diligently studies ultra high frequency technique now has much in store for him. The military and naval services offer much to the young men of today in the way of training to prepare them for better things to come, and it is certainly true that in wartime the army, navy, marines, coastguard and other services always have the best there is to be had in the latest types of equipment.

As time takes its toll, more ultra high frequency developments will be made. Much progress has been made by the CAA in various experiments among which are those which concern UHF fan markers, UHF radio ranges, UHF airport communications, etc. Private industry is not to be outdone. United Airlines, Western Electric, RCA, Bendix, Lear Avia, just to mention a few, have made notable progress in the perfection of UHF equipment for use by the aviation services.

In order for a technician to be qualified for work with modern instrument landing equipment it is necessary that he have had specific training in the following: theory of modern day radio; UHF antenna systems, transmitters, receivers, and instruction on the systems which he will either maintain or install. This instruction will necessarily be given by factory engineers or by engineers employed by the using services.

(To be continued)

What's New in Radio

(Continued from page 38)

In addition to these characteristics, Bulletin 69 Rheostats feature balanced contact arm, "dead" shaft construction, copper graphite contact shoes and front or back-of-board mounting in single and multiple assemblies.

Manufactured by the *Ward Leonard Co.*, Mt. Vernon, N. Y.

Aldis Portable Morse Lamp

The Aldis Portable Morse Lamp is manufactured by the *Arnessen Electric Company* maintaining offices and plant at both New York City and Clifton, N. J. This lamp is designed for Morse signalling over a ten-mile range day or night. The equipment consists of a signal lamp with interchangeable lens and mounted in a portable carrying case. The equipment also includes a 12 volt storage battery in a portable carrying case. The lamp is designed for operation on either 22 or 24 volt circuits also.

Three interchangeable front lamp screen lenses are supplied in white, red and blue for use over different ranges at various times of day or night and during fog. A four-power telescopic sight is fitted to the lamp in order to provide good visibility of signals being received. Watertight fittings are provided for on the cover of the battery



box together with a plug on the cable from the lamp. Two trigger controls are provided on the handle of the lamp. The lower makes connection with the battery and immediately lights the bulb with a steady beam of light as long as it is pressed. The upper trigger on the pistol grip, which may be operated at the same time, oscillates the curved mirror reflector up and down in order that fast signaling by means of the Morse code may be accomplished. An adjustment is provided to regulate the light beam and telescopic sight for either long range or short distance work.

The Aldis Lamp's telescope was originally designed in England for a bombsight. The lamp, manufactured under license by *Arnessen Electric Company*, is used by United Nations land, sea and air forces. It also has many uses for civilian communications as a portable light source.

(Continued on page 82)

When You Enter the Armed Forces

You Still Can Help the Home Front



Keep your test equipment working.

Sell it; don't store it . . .

A critical shortage of radio test equipment exists, which seriously handicaps repair work . . . Your equipment is needed badly.

Sell your meters, signal generators and other test equipment so that it functions where it will do the most good. In storage, it will only deteriorate and become obsolete; if you sell it, it will help "keep 'em listening".

Your test equipment will bring a fair price. Your Mallory distributor will help you dispose of it. List the inventory with him. And the proceeds, invested in War Bonds, will be a neat little nest egg when you come marching home.

If you're not sure of your Mallory distributor's name, get in touch with us.

P. R. MALLORY & CO., Inc., INDIANAPOLIS, INDIANA

P. R. MALLORY & CO. Inc.
MALLORY



Approved Precision Products

Slide Rule

(Continued from page 23)

- C. Set C index to hair line.
 - D. Set hair line to frequency value on C scale (mult.).
 - E. Set C index to hair line.
 - F. Set hair line to resistance value on C scale (mult.).
 - G. Close slide and read Q value under hair line on CI scale recip.).
27. To find A.C. resistance of a coil or capacitor when Q and reactance are known:
- A. Set Q value on C scale to reactance value on D scale (div.).
 - B. Under C index, read resistance value on D scale.
28. To determine power factor of a capacitor at any operating frequency when Q at that frequency is known:
- A. If Q value is 10 or higher, close slide and set hair line to Q value on D scale.
 - B. Under hair line, read power factor value on CI scale (recip.).

Capacitance

29. To determine the capacitance of a parallel-plate capacitor:
- A. Set C index to length of one plate (inches) on D scale.
 - B. Set hair line to width of one plate (inches) on C scale (mult.).
 - C. Set C index to hair line.
 - D. Set hair line to dielectric constant value on C scale (mult.).
 - E. Set C index to hair line.
 - F. Set hair line to number of plates minus 1 on C scale (mult.).
 - G. Set 4.45 on C scale to hair line (div.).
 - H. Set hair line to C index.
 - I. Set to hair line the value of the separation (in inches) between plates, on C scale (div.).
 - J. Under C index, read capacitance on D scale.

Wavelength-Frequency

30. To find wavelength when frequency is known:
- A. Set frequency on C scale to 3 on D scale (div.).
 - B. Under C index, read wavelength on D scale.
31. To find frequency when wavelength is known:
- A. Set wavelength on C scale to 3 on D scale (div.).
 - B. Under C index, read frequency on D scale.

In the above operations, the D-scale figure of 3 represents 300,000,000 when frequency is in cycles; 300,000 when frequency is in kilocycles; 300 when frequency is in megacycles. In each case, wavelength is in meters.

Resonant Circuits

32. To determine the resonant frequency of any coil-capacitor combination:
- A. Set B index to inductance value on A scale.
 - B. Set hair line to capacitance value on B scale (mult.).
 - C. Set C index to hair line (evol.).
 - D. Set hair line to 6.28 on C scale (mult.).
 - E. Close slide and read resonant frequency under hair line on CI scale (recip.).
33. To find the capacitance required to tune a coil of known inductance to a given frequency:
- A. Set C index to 3.141 on D scale.
 - B. Set hair line to 3.141 on C scale (mult.).
 - C. Set C index to hair line.
 - D. Set hair line to 4 on C scale (mult.).
 - E. Set C index to hair line.
 - F. Set hair line to frequency value on C scale (mult.).
 - G. Set C index to hair line.
 - H. Set hair line again to frequency value on C scale (mult.).
 - I. Set C index to hair line.
 - J. Set hair line to inductance value on C scale (mult.).
 - K. Close slide and read capacitance value under hair line on CI scale (recip.).
34. To find the inductance required to tune to a given frequency with a known capacitance:
- A. Set C index to 3.141 on D scale.
 - B. Set hair line to 3.141 on C scale (mult.).
 - C. Set C index to hair line.
 - D. Set hair line to 4 on C scale (mult.).
 - E. Set C index to hair line.
 - F. Set hair line to frequency value on C scale (mult.).
 - G. Set C index to hair line.
 - H. Set hair line again to frequency value on C scale (mult.).
 - I. Set C index to hair line.
 - J. Set hair line to capacitance value on C scale (mult.).
 - K. Close slide and read inductance value under hair line on CI scale (recip.).
35. To find the time constant of a resistance-capacitance combination:
- A. Set C index to capacitance value on D scale.
 - B. Set hair line to resistance value on C scale (mult.).
 - C. Under hair line, read time constant (seconds required for current to fall to 37% of its initial value) on D scale.
36. To find the time constant of an inductance capacitance combination:
- A. Set resistance value on C scale to inductance value on D scale (div.).
 - B. Under C index, read time con-

stant (seconds required for current to rise to 63% of its final value) on D scale.

Wheatstone Bridge

37. To determine unknown resistance:
- A. Set B-arms resistance on C scale to A-arm resistance on D scale (div.).
 - B. Set hair line to standard-resistor value on C scale (mult.).
 - C. Under hair line, read unknown resistance value on D scale.

Maxwell Bridge

38. To determine inductance in D-arm:
- A. Set C index to A-arm resistance on D scale (div.).
 - B. Set hair line to C-arm resistance on C scale (mult.).
 - C. Set C index to hair line.
 - D. Set hair line to B-arm capacitance on C scale (mult.).
 - E. Under hair line, read inductance value on D scale.
39. To determine resistance in D-arm:
- A. Set B-arm resistance on C scale to A-arm resistance on D scale (div.).
 - B. Set hair line to C-arm resistance on C scale (mult.).
 - C. Under hair line, read resistance value on D scale.

Schering Bridge

40. To determine capacitance in D-arm:
- A. Set A-arm resistance on C scale to B-arm resistance on D scale (div.).
 - B. Set hair line to C-arm capacitance on C scale (mult.).
 - C. Under hair line, read capacitance on D scale.
41. To determine D-arm resistance.
- A. Set C-arm capacitance on C scale to B-arm capacitance on D scale (div.).
 - B. Set hair line to A-arm resistance on C scale (mult.).
 - C. Under hair line, read capacitance value on D scale.

Wien Bridge and Parallel-T Networks

42. To determine null frequency:
- A. Set C index to 6.28 on D scale.
 - B. Set hair line to resistance value on C scale (mult.).
 - C. Set C index to hair line.
 - D. Set hair line to capacitance value on C scale (mult.).
 - E. Close slide and read frequency value under hair line on CI scale (recip.).

Quartz Crystals

43. To determine crystal frequency (Mc.) when thickness and type of cut are known:
- A. Set thickness (mils.) on C scale to the factor k (112.6 for X-cut; 77 for Y-cut; 66.2 for AT-cut) on D scale (div.).
 - B. Under C index, read frequency on D scale.
44. To determine crystal thickness for a desired frequency, when type of cut is known:

Engineers • Technicians • Teachers • Students Send for this NEW SHURE REACTANCE SLIDE RULE

Saves Time in Solving Resonant Frequency, Capacitive Reactance, Inductive Reactance, Coil "Q" and Dissipation Factor Problems

Here's how it works

FRONT	EQUATION	SOLVES	RANGE
Resonant Frequency problems	$\omega^2 LC = 1$	1. Resonant Frequency if L and C are known 2. Various L and C values for desired resonant frequency	Frequency 5 cycles to 500 megacycles Capacitance .001 mmf. to 1,000 mf. Inductance .00001 mh. to 10,000 henrys
BACK	$X_L = 2 \pi f L$	Any single unknown variable, providing remaining variables are known in equations for Inductive Reactance, Capacitive Reactance, Coil "Q", Dissipation Factor	Frequency 0.1 cycle to 10,000 megacycles Capacitance 1 mmf. to 100 mf. Inductance .001 mh. to 100 henrys
Reactance problems	$X_C = \frac{1}{2 \pi f C}$ $Q = \frac{2 \pi f L}{R}$ $D = 2 \pi f C R$		

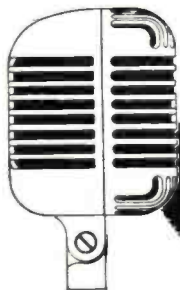

SHURE

Write Shure Brothers, Dept. 174X, 225 W. Huron, Chicago, U.S.A.
Sending 10c in Coin or Stamps to cover cost of handling and mailing

Shure Brothers, designers and manufacturers of Microphones and Acoustic Devices, are supplying our Armed Forces and our Allies with rugged military microphones for duty on land, on the sea, and in the air. However, you can still obtain our standard line of microphones for vital civilian needs. See your local radio parts distributor—or write for catalog 154X.

RADIO PARTS BARGAINS!

★ ★ ★
BUY NOW!
★ ★ ★

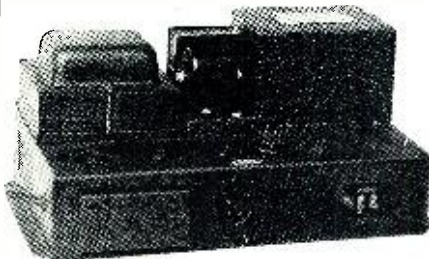

PHONO-AMPLIFIER—by well known manufacturer. Push-pull 2A3, 12 Watt. Tube complement 1-56, 1-53, 2-2A3s, 1-5Z3. Supplies current for 1 or 2 2500 ohm fields. Operates on 117 Volt AC 60 cycles. With slight change of volume control can be used with high impedance magnetic or crystal pick-up. Perfect working condition. Schematic furnished. Only **\$7.95 each**



ASTATIC CRYSTAL PICK-UPS!—high grade, low pressure pick-up. Statuary brown finish with single hole mounting bracket. Mounting center 7". Plays up to 12" records . . . your new low price. **\$2.95 each**

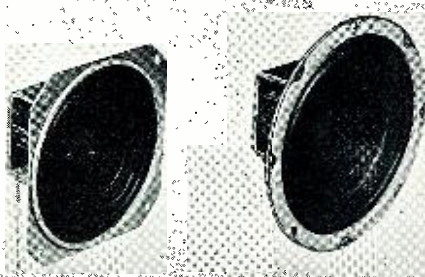

P.M. SPEAKERS!—All new—thousands in original cartons. 4" and 5", good heavy construction. V. C. impedance 3-4 ohms. (Less transformers) 4" at . . . **89c each** 5" at . . . **\$1.10 each**

SPECIAL RESISTOR ASSORTMENT ¼-½-1-2-3 wt. ALL VALUES — R. M. A. Coded-100. **79c while they last.**

SERVICEMEN'S SPECIAL! — 10 lbs. Radio Parts Kit. An assortment of controls, switches, coils, variables, resistors, condensers, etc.. all perfect and brand new! **only \$2.95**

FREE! Servicemen write today for free catalog listing thousands of parts bargains . . . hardware and replacement parts.

**WE SAVE YOU MONEY! . . .
DROP A POST CARD TODAY**

RANDOLPH RADIO
609 WEST RANDOLPH ST., CHICAGO, ILL.
"Millions of Parts for Millions of Radios"

- A. Set frequency on C scale to factor k (see example 45 for values) on D scale (div.).
 - B. Under C index, read required thickness on D scale.
45. To identify type of cut when frequency and thickness are known:
- A. Set C index to frequency value on D scale.
 - B. Set hair line to thickness (mils.) on C scale (mult.).
 - C. Under hair line, read factor k on D scale. (The answer will be near 112.6 for X-cut; near 77 for Y-cut; near 66.2 for AT-cut.)

Placing the Decimal Point

Placing the decimal point correctly in slide rule answers is not a difficult operation, but nevertheless is an art which may be fully acquired only by diligent practice. It is not necessary that the operator keep before him an unfolding mental image of the proceeding arithmetic in the sense that he visualizes the working of the example on paper. If he were to do this, he would need no slide rule, but might apply straight mental arithmetic instead.

The following easily-understood rules are offered to simplify placing of the decimal point and determination of the number of digits in the answer. By learning these simple rules and referring to the process note-words (such as div., mult., etc.) given in the preceding 45 examples, the operator will be able to keep a running acquaintance with the position of the point as the example proceeds toward solution:

1. Multiplication

If slide moves to left: Number of integral digits in product equals sum of integral digits in multiplier and multiplicand.

If slide moves to right: Number of integral digits in product equals sum of integral digits in multiplier and multiplicand minus 1.

2. Division

If slide moves to left: Number of integral digits in quotient equals difference between number of integral digits in divisor and those in dividend.

If slide moves to right: Number of integral digits in quotient equals difference between number of integral digits in divisor and those in dividend plus 1.

3. Involution

When squaring a number, if answer appears on left half of A scale: number of digits in power equals twice number of integral digits in original number, minus 1.

If answer appears on right half of A scale: number of integral digits in power equals twice number of integral digits in original number.

4. Evolution

When extracting a square root:
A. Separate the original number by inspection into as many two-digit

groups as possible, starting from the decimal point and proceeding in each direction. In some numbers a one-digit group will be left over. The left-end group (whether one- or two-digit) will be designated the leading group.

B. All odd numbers have a one-digit leading group and are located (with the hair line) on the left half of the A scale.

C. All even numbers have a two-digit leading group and are located (with the hair line) on the right, half of the A scale.

D. The number of digits in the root, or answer equals the number of complete groups marked off in the original number.

E. If there is a decimal point in the original number, the position of the decimal point in the answer is determined thus: (A) When the leading group follows the decimal point (that is; the original number is a decimal), the first digit in the answer will likewise follow the decimal point. (B) When the original number has been marked off with groups both before and after the decimal point, the number of digits preceding the decimal point in the answer will equal the number of groups preceding the decimal point in the original number, and the digits following the decimal point in the answer will follow in the same order as the marked-off groups follow the decimal point in the original number.

5. Reciprocals

A. Numbers larger than 1: Reciprocals are decimals. Number of ciphers between decimal point and first significant figure in the answer will be 1 less than number of integral digits in the original number.

B. "One" Numbers: Pointing-off of reciprocals of "one" numbers is obvious. For example; the reciprocal of 1 is 1; of 10 is 0.1 of 100 is 0.01; of 1,000,000 is 0.000001, etc., etc.

C. Numbers smaller than 1: Reciprocals are larger than 1. The number of digits in the answer is equal to 1 more than the number of ciphers between the decimal point and the first significant figure in the original number.

Guide Abbreviations

The following guide abbreviations are used throughout the examples in this article, in order that the reader may be able to determine the number of digits in the answer to each example and the proper placing of the decimal point: *mult.* (multiplication), *div.* (division), *invol.* (raising to a power), *evol.* (extracting a root, and *recip.* (taking the reciprocal).

-30-

**PRIZE WINNERS
ANNOUNCED
on Page 60**

A NEW *Motorola* BUILDING

DEVOTED EXCLUSIVELY TO ELECTRONIC

Research and Engineering

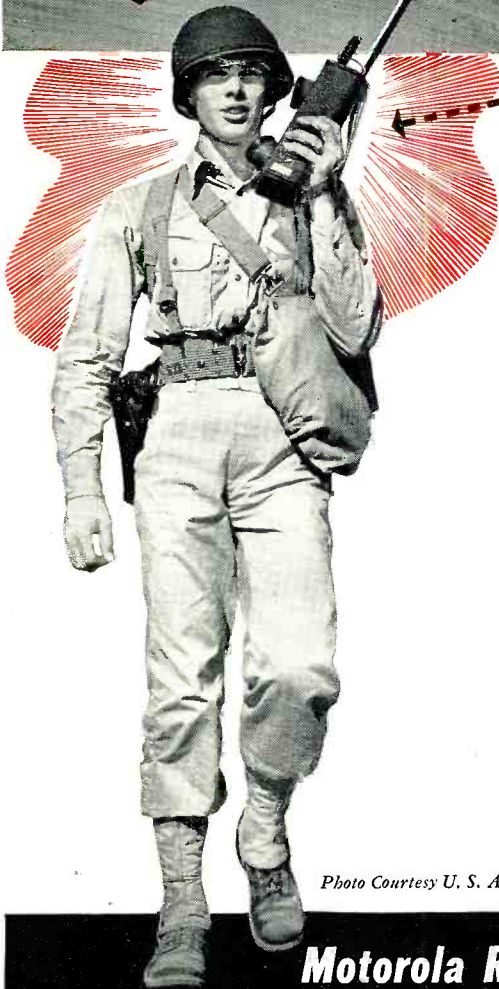

When war came, Motorola research and engineering was already at work around the clock on special assignments for our Armed Forces. Now in its new home, the Motorola staff of engineers and technicians is by specific government assignments at work on problems which embrace many important phases of electronic knowledge. This new Motorola engineering building increases many times our capacity for service of the highest order.

THE ARMY-NAVY "E"

Awarded for excellence in the production of Communications Equipment for America's Armed Forces



Photo Courtesy U. S. Army Signal Corps

**Motorola Radio Communication Systems
Designed and Engineered to Fit Special Needs**

GALVIN MFG. CORPORATION • CHICAGO

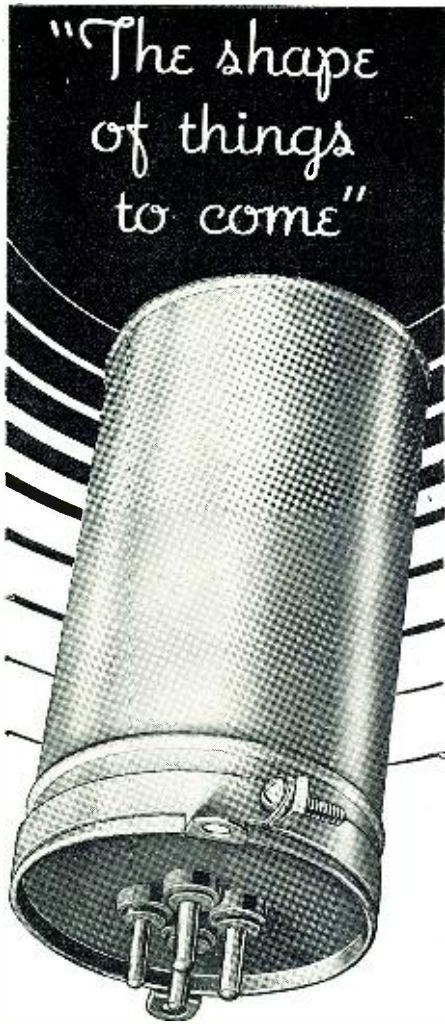

• There's something prophetic about this Aerovox capacitor. The plug-in feature denotes ready check-up and replacement. It signifies continuous, gruelling, accelerated-wear service that wears out the best of capacitors in months instead of years. Just as the demountable-rim wheel marked the transition from Sunday motoring to everyday essential transportation, so this plug-in capacitor spells infinitely expanded usage of radio technique, components, manpower.

Our first job is to win the war. Aerovox is now concentrated on just that. And while tens of thousands of radio men are gaining invaluable training and experience and, indeed, compressing decades into years, so we at Aerovox are laying the foundation for vastly expanded radio and electronic opportunities in the coming peace. Thus "The shape of things to come."

• Ask Our Jobber . . .
If you are not already getting the monthly Aerovox Research Worker, ask our jobber for a free subscription. Or write us direct. Also ask for latest "Victory" catalog.



The second trimmer tunes the output into the diode plates. The plate resistance here is so low that it is almost impossible to get a sharp resonance peak. Thus the receiver from which this stage was taken was designed without a first trimmer. "X" below the oscillator on the board shows the oscillator ladder trimmer.

The trimmers on the r.f. and oscillator ganged tuning condensers are generally built right on the condensers and have to be reached from behind the demonstration board. However, if small trimmers are placed in parallel with them these could be mounted so they can be reached from the front, permitting all adjustments within sight of the observers before the board.

-30-

Book Review

(Continued from page 34)

democratic reconstruction in the America which emerges after the war.

"SHORT WAVE RADIO," Third Edition by J. H. Reyner, B.Sc. (Hons.), A.C.G.I., D.I.C., A.M.I.E.E., M.I.R.E., published by Sir Isaac Pitman & Sons, Ltd. 183 pages plus index. Price, \$3.25.

This book forms, to a large extent, a companion volume to the author's well known standard work, "Modern Radio Communication". It presents a non-mathematical account of the development of the short wave and the processes involved. A glossary is included giving explanations of the more specialized terms.

-30-

What's New in Radio

(Continued from page 50)

Dim-E-Roid Lamp

The use of the Dim-E-Roid panel and signal lamp, manufactured by the American Radio and Hardware Co., is eliminating the incorporation of transformers and resistors in electrical systems for the purpose of dimming intensity of signal lights. Polarized discs and shuttered metal discs control the intensity without interference with the electrical circuit proper.

The Dim-E-Roid, made entirely of non-ferrous metals, utilizes a plastic jewel in any color desired for differential signal purposes. Two models are available—No. 1874 has the shuttered metal disc and can be adjusted from a total blackout to full intensity. The opposing discs, contained in the head of the instrument, are easily adjusted by turning a knurled ring just below the jewel.

If further information is desired please communicate with the American Radio Hardware Company, Inc., 476 Broadway, New York City.

-30-

Index to Advertisers

COMPANY	PAGE NO.
Aerovox Corp.	82
Allied Radio Corp.	79
American Radio Hardware, Inc.	5
Amperite Corp.	75
Audel, Publishers	79
Bliley Electric Co.	63
Browning Radio Laboratories	73
Candler System Co.	80
Capitol Radio Eng. Inst.	48
Centrab	66
Classified	80
Colen-Gruhn Co., Inc.	57
Commercial Radio Inst.	80
DeJur-Amsco Corp.	47
Dodge Institute	68
Electro-Voice Mfg. Co., Inc.	Second Cover
Fada of New York	81
Federal Radio and Telegraph Corp.	72
Galvin Mfg. Corp.	Third Cover
Fred E. Garner Co.	74
Gothard Mfg. Co.	78
Hallcrafters Co.	6
Hammarlund Mfg. Co., Inc.	65
Hytron Corp.	7
Indiana Technical College	76
Insuline Corp. of America	77
Lafayette Radio Corp.	74
Lake Radio Sales Co.	72
Lincoln Eng. Schools	68
Maedel Publishing House	75
P. R. Mallory & Co., Inc.	51
McBroy Mfg. Corp.	67
McGraw-Hill Book Co.	76, 80
John Meek, Industries	69
Meissner Mfg. Co.	69
Melville Aeronautical Radio School	71
Metropolitan Tech School	81
James Millen Mfg. Co., Inc.	81
Murdock Mfg. Co.	59
Mutual Radio Products Co.	78
National Company, Inc.	56
National Radio Institute	3
National Schools	63
National Union Radio Corp.	68
Nelson Co.	69
New York Y.M.C.A. Schools	80
Ohmite Mfg. Co.	45
Polymet Condenser Co.	81
R. C. A. Institute, Inc.	81
Radio & Tech. Publ. Co.	49
Radio-Television Institute	71
Radolek Co.	81
Randolph Radio	54
John F. Rider Publ. Co.	60
Shure Brothers	53
Snyder, Inc.	73
Solar Mfg. Co.	Back Cover
Sprague Products Co.	62
Sprayberry Academy of Radio	77
Standard Transformer Corp.	50
Supreme Publications	55
Sylvania Electric Products Inc.	46
Teleplex Co.	76
Thordarson Electric Mfg. Co.	68
Triplett Electrical Instrument Co.	64
Tri-State College	81
United Transformer Co.	58

While every precaution is taken to insure accuracy, we cannot guarantee against the possibility of an occasional change or omission in the preparation of this index.

PHOTO CREDITS

Page Numbers	Credits
8, 9 . . .	Official U. S. Navy Photographs
10	U. S. Army Air Forces
13, 24	General Electric
16, 17	United Radio-Television Institute
41	U. S. Army Signal Corps
43	Linde Air Products Co.

MODERN PARTS for MODERN CIRCUITS

THAT HAVE BEEN

*"Designed for
Application"*

CATALOG UPON REQUEST

JAMES MILLEN  MFG. CO. INC.
150 EXCHANGE ST. MALDEN, MASS.

FADA SERVICE DEPT.

has replacement parts for all FADA models manufactured during the last 10 years. Call, write, phone or send 10c for our latest Replacement Parts Catalog.

FADA OF NEW YORK

30-20 Thomson Ave., L. I. City, N. Y.
Ironsides 6-5400

RADIO

PRE-MILITARY TRAINING for MEN of MILITARY AGE



CIVILIAN TRAINING
for MEN and WOMEN
seeking Careers in Radio
Complete Course up to 8 Months

Write, Phone or Call 9 a.m. - 9:30 p.m.

METROPOLITAN TECHNICAL SCHOOL

RADIO DIVISION, Dept. T
7 CENTRAL PARK WEST, N.Y.
Circle 7-2515 Licensed by State of N.Y.

RADIO ENGINEERING DEGREE IN 2 1/2 YEARS

• Complete Radio Engineering Course in 27 months. Bachelor of Science Degree. Radio (television, talking pictures and the vast electronic field) offers unusual opportunities for women as well as men. Demand exceeds the supply. Courses also in Civil, Electrical, Mechanical, Chemical, Aeronautical Engineering, Business Administration, Accounting, Secretarial Science. Tuition, living costs low. During the War 3-yr. high school students with good record admitted. Special Preparatory Dept. Enter March, June, September, January, 60th year. Write for catalog.

1623 COLLEGE AVE. ANGOLA, IND.



TRI-STATE COLLEGE

RADIO TECHNOLOGY

RCA Institute offers an intensive two-year course of high standard embracing all phases of Radio and Television. Practical training with modern equipment. Also shorter specialized courses in Commercial Radio Operating, Radio and Television Servicing, and Aviation Communications. For Free Catalog write Dept. RN-43.

RCA INSTITUTES, Inc.
A Radio Corporation of America Service
75 Varick St., New York

If you have a signal generator and output meter align in the usual manner. First align the i.f. stage (L4) by connecting the generator to the grid of the 6SK7 tube. Then align L3 and re-check L4 with the generator connected to the grid of the 6SA7 tube. Short the oscillator tuning condenser during the alignment. Then, using a signal of about 1,600 kcs. (or some similar frequency of your local broadcast station), disconnect the shorting wire from the oscillator and tune the main dial until the signal is heard. Adjust r.f. and oscillator trimmers and oscillator padder. The receiver is now ready.

No provision is made here for calibrating the tuning dial so that stations will come in on the appropriate mark on the dial. Our original dial is calibrated in regular degrees to 100. Thus it is only necessary to tune in a station, then either mark the station or frequency directly on the dial or list it on a log sheet or graph, using this for future reference in tuning.

However, since the demonstrator in actual use will be connected for only a while then re-connected for another circuit, by the time it is again resolved into a superheterodyne the new alignment may place these stations a few degrees away from the original calibration. Since it is not expected the demonstrator will be used regularly as a receiver, calibration will not be a problem.

If you don't have a conventional signal generator and output meter connect an interstage audio transformer to the unused 6C5 audio stage and use it as a meter rectifier as shown in Fig. 2. With a d.c. voltmeter connected in the cathode load circuit an effective output meter is provided.

A substitute signal generator can be made from an external receiver whose intermediate frequency is the same as that of the demonstrator. Connect the output of the i.f. stage of the external receiver to a strong local station. Select a program of music whose amplitude doesn't vary too greatly, if possible. Remove the output tube of that receiver to avoid the interference from its output. Connect this makeshift signal-generator exactly as indicated with the conventional generator. Instead of the hum in the output here will be heard music as though the demonstrator receiver were tuned to that station. A final check can be made by tuning the demonstrator receiver to a station with the external receiver removed.

Adjust trimmers using a minimum of volume until maximum peak performance is achieved. Note that the components are mounted so that the trimming condensers are reached from the front panel through holes in the board. These are lightly circled in the photograph.

It will be seen that although the second i.f. transformer in the schematic diagram on the board shows two trimmers only one is actually built in.

For VICTORY Buy
United States Savings
Bonds and Stamps



POLYMET

CONDENSER CO.

699 EAST 135th ST.,
NEW YORK, N. Y.

JOBBER & DISTRIBUTORS

If you can furnish us with your suitable ratings,* we can supply your condenser needs.

**CONTINUOUS
DEPENDABLE
SERVICE**

* Ratings A3 and higher on P.D.1x Forms supplied.



RADIO PARTS SOUND SYSTEMS ELECTRONIC APPARATUS

Depend on RADOLEK

Send Now for the Big RADOLEK Buying Guide!

Make Radolek your dependable source for essential radio, sound and electronic replacement parts—tubes, condensers, volume controls, resistors, transformers, etc.—all at low prices. Orders for industry, Government services and war training programs are given special attention. Thousands rely on Radolek for their entire requirements. Send for the big Radolek Buying Guide NOW!

**FREE! Lowest Prices
Fast Service**



Radolek quality, low prices and prompt service save valuable time and money. For complete satisfaction send your orders to Radolek.



SEND TODAY! PASTE ON A POST CARD

RADOLEK CO., Dept. B-75
601 W. Randolph St., Chicago, Ill.
Please send the Big FREE Buying Guide

Name

Address

DEALER SERVICEMAN SOUND ENG.

SAVE AT RADOLEK



Good pay, adventure, interesting work! Army, Navy and Commerce need thousands of men who can send and receive Radiotelegraph Code. Learn Code at home or improve your proficiency and rating through the famous Candler System . . . the same easy, simple system used in training Radiotelegraph Specialists in Signal Corps, Navy, Marines, Coast Guard, Naval Reserve, Airlines and Amateurs.

Qualify quickly. No long-drawn-out studies. Candler System established over quarter century. Candler has trained world's champions, experts in telegraph communications, can give you fast sending and receiving technique. Tremendous new field for operators both in and out of Armed Services.

Instruction for beginners and operators. You can learn code or increase your w.p.m. speed and improve proficiency. We help you qualify in half the usual time for amateur or commercial license and a good rating. Write today for FREE Candler Book of Facts. It costs you nothing.

CANDLER SYSTEM CO.

P.O. Box 928, Dept. 2-B
DENVER, COLORADO, U.S.A.
Craven House, 121, Kingsway, London, W.C. 2.

NOW!

You can get the math you need for solving everyday radio and electrical problems



Radiomen and electricians know that the language and the habit of mathematics are essential for real progress in their chosen field. They know mathematics is a tool that they are helpless without.

NOW out of the U.S. Navy Radio Materiel School at Naval Research Laboratory comes a complete home-study book that is so thorough and so detailed that any reader "who can perform arithmetical computations rapidly and accurately is capable of mastering the principles laid down in this text."

MATHEMATICS for ELECTRICIANS and RADIOMEN

By N. M. COOKE, Chief Radio Electrician, U. S. Navy
604 pages 6x9, \$4.00

This book teaches you mathematics from elementary algebra through quadratic equations, logarithms, trigonometry, plane vectors and elementary vector algebra with direct applications to electrical and radio problems. It teaches you how to apply this mathematical knowledge in the solutions of radio and circuit problems. In other words, it gives you the grasp of mathematics you need and then shows you how to use your knowledge.

Based on over 8 years' experience teaching mathematics to U.S. Navy electricians and radio operators, the book gives you 600 illustrative problems worked out in detail and over 3000 practice problems with answers so you can check your work.

10 DAYS' FREE EXAMINATION

McGraw-Hill Book Co., 330 W. 42nd St., New York
Send me Cooke's Mathematics for Electricians and Radiomen for 10 days' examination on approval. In 10 days I will send you \$4.00 plus few cents postage, or return book postpaid. (We pay postage if remittance accompanies order.)

Name
Address
City and State
Position
Company R.N. 2-43

Super-Het Tuner

(Continued from page 33)

ply connect all plates together.) Paint in on the demonstrator board the diode plates of this tube and add the detector load resistors and filter below as shown in the photograph. Now, note carefully; re-wire the 6SQ7 socket entirely, even the filament terminals are different.

Now replace the tuning condenser with the two gang condenser. Attach the condenser leads to one of the condensers. This will be the r.f. tuning condenser and will be used for tuning in all circuits. The other condenser in the gang is the oscillator tuning condenser. This is used only in the super-heterodyne.

These are all the changes necessary in the old design. The new part of the board must be attacked like the original design. A quick reference to the original article will remind you of the procedure. Sketch in the mixer and i.f. stages. Drill, sandpaper and seal the holes. Then carefully paint in the new stages on the panel.

After a period of drying the board

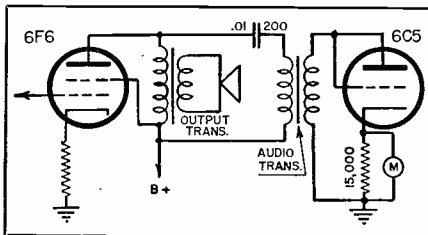

Fig. 2.

is ready for mounting and wiring. Attach the filament terminals to the filaments on the old board. Connect the antenna and ground to similar parts on the old design.

The 6SA7 mixer is conventional. Although the board diagram shows the suppressor grid connected to cathode it actually is grounded and not connected to cathode. Note that the oscillator section (shown below and left of the tube) permits connection of the cathode either to a tickler winding on the oscillator coil or to a tap on the secondary winding itself. In the coil used in the original model the secondary was unwound a little and a tap taken off about a third of the way up from the ground connection. (The exact point isn't critical.) Rewind the coil (scramble winding) as before. Thus both types of oscillator feedback are provided. Changing from one type to the other will require some slight re-alignment.

A few precautions might not be

Fig. 3.

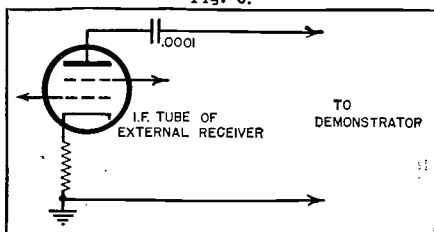

amiss here: Keep input and output wiring in any stage well separated (especially in the i.f. stage). Tie down the wiring and use as heavy wire as you can. The sections which are sensitive to self-oscillation have purposely been wired in back of the board to cause less trouble in hooking up the circuit. In connecting the circuits from the front with the tip plugs use as short lengths of connecting line as practicable.

Check, then re-check all connections for correctness and continuity. Hook up the circuit, plug it in and let it warm up. Warm up the signal generator (about a half hour is fine).

COMMERCIAL RADIO INSTITUTE

A radio training center for over twenty years. Well equipped. Excellent faculty. Practical RESIDENT COURSES in Radio Telegraphy, Broadcast, Servicing, Industrial, Television, Aeronautical, Drafting, Mathematics and Studio Technique. Placement Bureau. Day and Evening Classes Now Forming. Catalog upon request.

Dept. C, 38 W. Biddle St., Baltimore, Md.

Pre-Induction RADIO COURSES

for Civilians and those entering Military Service
New classes now starting

- Radio Operating • Code
- Radio Servicing

NEW YORK Y.M.C.A. SCHOOLS
7 West 63rd Street, New York City

Classified

Rate 15c per word. Minimum, 10 words

CORRESPONDENCE COURSES

RADIO Communications courses qualifying for all Federal licenses. Home study and resident courses. American Radio Institute, 1123 Broadway, New York, N. Y.

USED Correspondence Courses and Educational Books sold or rented. Inexpensive. Money-back guarantee. Write for Free Catalog listing 4000 bargains.—(Courses Bought.)—Lee Mountain, Pisgah, Ala.

CORRESPONDENCE Courses and self-instruction books, slightly used. Sold. Rented. Exchanged. All subjects. Satisfaction guaranteed. Cash paid for used courses. Complete details and \$4-page illustrated bargain catalog free. Write Nelson Company, 500 Sherman, Dept. B-237, Chicago.

INSTRUCTION

COMMERCIAL Radio Operator's Questions and Answers. \$1.00 Per Element. G. C. Waller, W5ATV, 6540 E. Washington Blvd., Tulsa, Oklahoma.

LEARN Code: Actually hear signals, alphabet, messages. E. Z. record, \$1.00. Dwight Studios, 102 Hancock Ave., Jersey City, N. J.

LEARN Radio Code easily with KolorKards. Complete shortcut memorizing, practice system, \$1.00. KolorKards, (RN243), Bluffton, Ohio.

RADIO Service men and experimenters send for our giant radio catalogue. Save dollars. United Radio Co. (1000M), Newark, N. J.

MISCELLANEOUS FOR SALE

MICROPHONE Cable, single conductor. Also Copper Wire, enameled, No. 42-0027. Available without priority. Oahu Publishing Company, 2108 Payne Avenue, Cleveland, O.

PATENT ATTORNEYS

INVENTORS—Before disclosing your invention to any one send for Form "Evidence of Conception"; "Schedule of Government and Attorneys' Fees" and instructions. Sent free. Lancaster. Allwine & Rommel, 414 Bowen Building, Washington, D. C.

RADIO ENGINEERING

RADIO Engineering, broadcasting, aviation and police radio, servicing, marine and Morse telegraphy taught thoroughly. All expenses low. Catalog free. Dodge Institute, Elm St., Valparaiso, Ind.

RADIO EQUIPMENT

OSCILLOSCOPE and other radio parts wanted for cash. Send list with prices to John Hart, 1123 Broadway, New York, N. Y.

voltmeter it should be connected to the proper multiplier for the range to be calibrated. A variable voltage should be applied to the test leads.

The amount of voltage supplied to the voltmeter to be calibrated may be adjusted by means of a potentiometer as shown in Fig. 3.

The potentiometer may have a resistance of five thousand ohms or more. The voltage supplied to the new voltmeter must be measured by another voltmeter of known accuracy wired in parallel to the new voltmeter test leads. The potentiometer is then varied until the known voltmeter indicates a value which is to be marked on the new dial. For example; if the new dial is being calibrated up to 100 volts, the dial will usually be numbered at ten volt intervals, 10, 20, 30 etc. The position of the needle in each instance is marked on the dial. These markings should be made lightly in the form of a tiny vertical line by means of a very sharp pencil. After the main calibration points have been established, it is best to subdivide the spaces between the main points. This is best done by varying the voltage to the desired value as indicated on the known voltmeter and making a dot for each subdivision. Use dots this time to keep these markings from getting mixed up with the main divisions. This method of calibration works equally well with d.c., a.c. or vacuum tube voltmeters.

The scales of d.c. voltmeters are usually linear and after a few main points have been established, the subdivisions may be located by measuring distances along the scale with a pair of dividers or a finely calibrated ruler. This method will give fair accuracy but not as good as the former method.

When calibrating ohmmeter scales, the best standard is a variable resistor of known accuracy which can be set to predetermined values of resistance.

After the desired number of calibration points have been located, the calibration should be rechecked. If some of the points are found to be slightly off, move them and recheck. When you are satisfied that the calibration is ok, the scale is ready to be marked. The tiny lines and dots are raised into higher vertical lines with a light touch of the sharp pencil. Reference to a manufactured dial will indicate proper relative heights of the main points and the subdivisions. Then the arc and the lines are filled in with India ink. Usually black ink is to be preferred, although some very nice appearing dials may be made by using other colors.

After the calibration points have been inked in, you are ready to place the figures above or below the main calibration points. Care must be taken to get all the figures the same size. The figures are also finished with India Ink. After the dial has been calibrated, any other desired information may be printed on the face of the dial. This usually consists of the words "ohms," "d.c. volts," "amperes" or any

other desired markings that will serve to more clearly indicate the purpose of the meter.

It is our advice that the beginner in dial construction try his hand at a few experimental models before serious work is started on a real dial.

Construction

Regardless of the type of meter used or the kind of instrument to be constructed, a new panel and subpanel will usually be needed. These may be made from plywood, masonite or sheet steel with desirability in the order named. Of course the actual kind of material used will be determined by the materials available and the working facilities of the constructor. The panel should not be made so large as to make the new instrument appear bulky, nor should it be made so small that the component parts are unduly crowded. If the best size appears to be near that of some other instrument which may be used on the same bench, it would be desirable to make the new instrument of the same dimensions.

After the panel has been cut and drilled it should be sanded smooth. It may be left plain or finished in any one of different colors that the constructor may desire. Lettering the panel to indicate the function of the controls is somewhat of a problem. It is often this one feature which marks the difference between home made equipment and commercial instruments. If the panel is left plain or covered with flat enamel, the letters and numerals may be outlined on the panel in pencil and carefully filled in with lacquer or enamel of a color different from that of the panel. In the case of crackle-finished panels, white cardboard glued to the panel in the right places works fairly well. The notations may be printed on with India Ink and the cardboard covered with transparent celluloid.

In many types of home grown test instruments, the switches are somewhat of a problem. If the meter used was salvaged from an old tube tester, there should be one or more good heavy selector switches somewhere among the wreckage. In other cases band switches salvaged from old radios and reassembled can be used very satisfactorily. Incidentally, certain types of pushbutton switches used for station selection in receivers make excellent selector switches for test instruments. The function of the pushbutton may be indicated in the place usually used for station call letters.

Discarded radio receivers and obsolete test equipment can furnish quite a lot of good sockets, power transformers and other power supply equipment, tinned hook-up wire, indicator lamps and sockets, knobs and miscellaneous hardware.

So, rather than spend our time in wishful thinking, let us assemble some worthwhile testing equipment from old equipment that has merely been in our way these many years.

7 DAYS Free Examination

PRACTICAL RADIO INFORMATION

Including Frequency Modulation—Television, etc.
Inside Radio Information for all Servicemen—Aircraft Pilots, Students. AUDELS RADIO-MANS GUIDE contains



772 Pages, 400 Diagrams & Photos is complete—gives Authentic Principles & Practices in Construction, Operation, Service & Repairs. Covers clearly and concisely Radio fundamentals—Ohm's Law—Physics of sound as related to radio science—Measuring instruments—Power supply—Resistors—Inductors—Condensers—Transformers and examples—Broadcasting stations—Radio Telephony—Receivers—Diagrams—Construction—Control systems—Loud speakers—Antenna systems—Auto Radio—Phonograph pickups—Public Address Systems—Aircraft & Marine Radio—Radio Compass—Beacons—Automatic Radio Alarms—Short Wave—Coil Calculations—Testing—Cathode ray oscillographs—Static Elimination—Trouble Pointers—Underwriter's standards—Units and tables—Frequency Modulation—REVIEW QUESTIONS & ANSWERS. Ready Reference Index.

\$4 COMPLETE • PAY ONLY \$1 A MO.
Get this practical information in handy form for yourself—Fill in and

MAIL COUPON TODAY—
AUDEL Publishers, 49 W. 23rd St., N.Y.
Mail AUDELS NEW RADIO-MANS GUIDE for free examination. If O.K., I will send you \$1 in 7 days; then remit \$1 monthly until \$4 is paid. Otherwise I will return it.

Name _____
Address _____
Occupation _____
Reference _____ RN



Reach for
your ALLIED
Catalog . . .

Get Everything in Radio and Electronics from this one central arsenal of supply—over 15,000 items for the Armed Forces, for Radio Training, for Research Laboratories, for War Industries, and for Service Replacement. Our large complete stocks speed delivery. Our experienced staff can help you. Send for your Free Allied Buying Guide.

Send for the
New ALLIED'S
RADIO-FORMULA
and DATA BOOK

For Radio Students, Instructors, Technicians, Engineers. Contains valuable Formulas, Tables, Data and Standards commonly used in Radio and Electronics. **10c**

ALLIED RADIO CORP.
833 W. Jackson Blvd., Dept. 1-B-3, Chicago

ALLIED RADIO



Best Selling Radio and Intercommunication PILOT LIGHT ASSEMBLIES

Gothard No. 300 line are standard models (require a 7/16 inch diameter hole for mounting). You can have IMMEDIATE DELIVERIES FROM GOTHARD... if you want special models send us your specifications— you will receive a prompt reply.

There is a New Gothard Catalog available—write for your copy today.

Gothard
MANUFACTURING COMPANY
 1350 N. NINTH STREET, SPRINGFIELD, ILLINOIS

RADIO KITS

Nationally Advertised

1942 SUPERHETERODYNES



- ★ 6 Standard Tubes
- ★ 8 Tube Performance
- ★ AC-DC Current
- ★ Dynamic Speaker
- ★ Loop Antenna
- ★ Cabinet 11"x7"x6"
- ★ Broadcast Band
- ★ Complete with Tubes: 1—3Z5, 1—50L6, 2—7B7, 1—12SQ7, 1—12SA7.

Model No. 322 Complete.
 Net Price **\$24⁹⁵**



- ★ 6 Standard Tubes
- ★ 8 Tube Performance
- ★ AC-DC Current
- ★ 5" Dynamic Speaker
- ★ Loop Antenna
- ★ Two Bands
- ★ Cabinet 11"x7 1/2"
- ★ Complete with Tubes: 1—25A6, 1—25L6, 1—6SA7, 1—6SK7, 2—6SQ7.

Model No. 324 Complete.
 Net Price **\$27⁹⁵**

The above units are complete with high quality, precision-built component parts. Ideal for radio service replacement parts. Essential for Defense Radio Training. Diagram included with each kit.

MUTUAL OFFERS QUALITY MERCHANDISE

WRITE TODAY FOR CIRCULAR

MUTUAL RADIO PRODUCTS CO.
 1579 Milwaukee Avenue
 Chicago, Illinois

cuit calls for a 1 mil meter, ten tubes in parallel would permit a 10 mil meter to work equally well, providing resistors in the circuit are changed to suit the new currents. However, it is not necessary to use that many tubes. Three or four tubes in parallel will permit the usage of a 10 mil meter in many vacuum tube voltmeter circuits. The principle involved here is very simple, a given amount of grid voltage can control the plate current of a number of tubes just as easily as that of one tube. It is not practical to use a meter of more than 10 mils in a vacuum tube voltmeter circuit, and of course, if a more sensitive meter is available, it is the one that should be used.

When using several tubes in parallel, some of the resistors will have to be changed. The cathode resistor, if any, will be the specified value divided by the number of tubes in parallel. To avoid complications, it will be best to use a vacuum tube voltmeter circuit utilizing a triode type tube.

This type of circuit using tubes in parallel actually has one advantage. The replacement of a tube will not have nearly as much effect on calibration in this circuit as it will in a circuit employing only one tube.

Nearly all vacuum tube voltmeter circuits require a hand calibrated dial.

Meter Repairs

Meters which operate improperly or not at all may be subject to any one or more of several different troubles. If the meter does not operate at all, the movement may be stuck, connecting wires may be broken or the meter coil may be burned out. If the movement of the hand is sluggish and erratic or if it sticks at some point in its travel, the hand may be bent and touching either the dial or the glass. Dirt, filings or other foreign substances may have worked their way into the movement, or the coil assembly may be off center and touching the magnet.

The meter should first be removed from its case and examined carefully, preferably with a small magnifying glass. Do not blow your breath into the movement. If dirt is present it may usually be removed by means of tiny strips of sticky paper such as Scotch Tape or moistened strips cut from the gummed flap of an envelope. If the coil assembly is off center, the mounting bolts may be carefully loosened and the movement recentered. If the hand is bent it may be straightened with a pair of tweezers. Broken glass may usually be replaced by your local glass cutting store. We have had several meter glasses made, even including those with a small hole near the edge for the zero adjuster.

There are other troubles with which meters may be afflicted that are not so easily repaired. If there is sluggishness present which cannot be traced to a visible cause, it is probable that the pivot bearings are worn or dulled. Broken jewels may also cause this trouble. Broken or tangled hairsprings

are usually beyond repair and a burned out meter coil cannot be rewound without special equipment. If a meter is a victim of any of these last mentioned troubles, it can be repaired only by a meter repair specialist. The cost of this, though not prohibitive, may be more than a doubtful meter is worth. However, if the meter is one taken from an analyzer, it will usually have enough value that it may profitably be repaired.

Making New Dial Scales

Making new dial scales for your old meters is not as difficult as it looks, yet it requires quite a lot of care if the finished product is to be accurate and neat in appearance. The first step is to take the meter out of the case and carefully remove the old dial scale. This is usually held in place by two small screws. Be very careful not to bend or damage the hand and do not allow dirt or dust to get into the movement. It will be best to put the small screws in a box or other safe place, as you won't find duplicates for these in the junk box! The new dial should be made from thin, smooth, white cardboard. The old dial is laid on the cardboard and with a pencil, an outline is drawn around it. When the cardboard has been carefully cut out just inside the pencil line, we have a new dial the same shape and size as the old one all ready for marking and lettering.

The next step is to locate the position of the arc over which the tip of the needle will travel. Place the old dial back on the meter temporarily and, with a pair of dividers, carefully measure the distance from the meter pivots to the arc on the old scale. Then it will be easy to locate the proper position for the arc on the new scale. The arc should be made lightly with a pencil. After the arc has been drawn in, the zero and full scale points must be located on it. This is best done by measuring the distance from these points on the old scale to the edges of the dial. When these measurements are transferred to the new dial scale, the zero and full scale points can be marked on in pencil. The distance between the zero and full scale points should be measured on the old scale and then checked on the new scale to make absolutely certain that the distances are the same.

After the arc and the extreme scale points have been located, the new dial scale should be carefully glued over the old one. This is because the old dial is usually made of metal and this forms a solid backing for the new scale. Ordinary service cement may be used to cement the two dials together, or any other quick drying cement may be used.

Calibrating the new scale is the most tricky part of the whole job. The best way to start is to put the dial in its proper position on the meter and attach it with the original screws. Then connect the meter into the circuit in which it is to be used. For example, if the meter is to be used as a

desired in r.f. circuits, a class C amplifier is used. A Class C amplifier is one in which the grid bias is appreciably greater than the cut-off value (usually twice the cut-off value) so that the plate current in each tube is zero when no alternating signal grid voltage is applied, and so that plate current flows in a specific tube for appreciably less than one-half of each cycle when an alternating grid voltage is applied. The a.c. component of the plate current is directly proportional to the plate voltage while the power output is proportional to the square of the plate voltage.

Plate current flows only during a fraction of the positive excitation cycle. As it is necessary to drive the grid highly positive to cause plate saturation, the number of electrons attracted to the grid at the peak of the cycle rob the plate of some that would normally reach it causing an indentation in the plate current pulse that can be seen in the graphical analysis of Fig. 11. This distortion of the output wave, however is eliminated by the "flywheel" effect of the output circuit. A class C amplifier is invariably used for plate modulation because of the high efficiencies and power outputs that may be obtained by its use. Another advantage it possesses is that it offers a pure resistive load to the modulator.

-50-

Use Those Old Meters

(Continued from page 37)

While low sensitivity voltmeters are not satisfactory for receiver testing, they are very useful for checking output voltage of power supplies, voltage of automobile and other storage batteries, etc.

By the addition of another switch to connect proper value load resistors across the voltmeter test leads, low sensitivity voltmeters make excellent dry battery testers. The load resistors are used to put the battery under a load while the voltage is being checked. In general, a different value of load resistor will be required for each type of battery tested. This type of tester is especially useful to servicemen in rural areas where there are a large number of battery operated receivers.

A.C. Voltmeters

Many of the older tube testers incorporated a separate meter for determining the proper setting of a line voltage control. These are a.c. voltmeters and most of them have a full scale range of about 35 to 40 volts. In the tester, they were usually wired in parallel with the 25 or 32 volt winding of the filament transformer, although occasionally one will be found incorporating a multiplier and connected across the primary of the transformer. In any event, with the proper series resistor and a new dial scale, these meters make excellent line voltage indicators.

Ohmmeters

Meters with a sensitivity up to ten mils make very good ohmmeters. It is usually necessary to use a somewhat higher battery voltage than with a one mil job to get high enough ranges. It will be rather difficult to obtain ranges extending into the megohms, but they are excellent for the lower ranges. There are many different ohmmeter circuits and these meters may be used in nearly all of them except those specifying an extremely sensitive meter.

There is one simple type of ohmmeter that we believe deserves more notice than it receives. This is the low range, high current type. This circuit reads low values of resistance from about $\frac{1}{10}$ ohm to around 100 ohms, depending on how carefully the dial is calibrated. Instead of using one mil or ten mils through the circuit under test, this circuit (Fig. 2) operates with a current up to five hundred mils.

The meter is first equipped with a shunt to raise its full scale current to 500 mils. The battery is a $1\frac{1}{2}$ volt No. 6 dry cell or preferably, two of these in parallel. The zero adjuster is a three ohm 2 watt rheostat.

Due to the low values of resistance measured, it is very important that short, heavy test leads be used with this type ohmmeter.

In fact, it is preferable to solder the leads into the circuit instead of using tip jacks for connection in order to eliminate contact resistance at this point. Sharp test prods or clamps should be used for testing.

This ohmmeter will have the 3 ohm point at about center scale and is useful for checking resistance of soldered connections and testing suspected coil windings. Also it is helpful in checking contacts on wave-band switches, push-button switches and other moving contacts.

Due to the low voltage used to operate this ohmmeter, it will be virtually impossible to damage any radio components, even with the high current used in the tests.

The long dial scale found in most tube tester meters is very desirable both in the calibration and reading of this type ohmmeter.

Vacuum Tube Voltmeters

One of the most useful radio servicing instruments is the vacuum tube voltmeter. There are many types of vacuum tube voltmeter circuits and they usually call for a fairly sensitive meter such as $\frac{1}{2}$ ma. or 1 ma. We have found that in most circuits a 2 or 3 mil meter will work satisfactorily. In some circuits, the accuracy may not be so good after the hand goes past the three quarter mark on the scale. However, once the dial is calibrated properly, this slight disadvantage is gone.

But a 2 or even 3 mil meter is still a long, long way from a 10 mil job. And surprising as it may seem, 10 mil meters can be used in vacuum tube-voltmeter circuits. The answer is to use several tubes in parallel! If a cir-



GREATER POWER

BEHIND THE WAR EFFORT!
With enlarged plant and facilities, INSULINE is putting vastly increased effort behind the manufacture of these Electronic Products and Parts for the Armed Forces —

- Metal Cabinets, Chassis, Panels • Metal Stampings • Plugs and Jacks • Completely Assembled Screw Machine Products • Hardware and essentials
- Antennas for "Walkie Talkies," etc.

Mfrs. and Contractors: Send specifications for estimates.

Write for this 12-page Industrial Catalog now!



INSULINE

CORPORATION OF AMERICA
INSULINE BUILDING
(36-02 35th AVENUE)
LONG ISLAND CITY, N. Y.

SPRAYBERRY

RADIO TRAINING

includes

FULL EQUIPMENT

Experience Easily Acquired at Home



You Do Practice—
Giving Experiments,
Many Special Features
ALL Designed to Help
You Make Fast Progress.

SPRAYBERRY Training starts right at the beginning of Radio... unfolds each subject in a simplified, logical, understandable style. You easily learn Television, Frequency Modulation, Signal Tracing, Mobile Radio (Auto-Tank), Aviation Radio, Electronics, Facsimile Radio, Radio Set Repair and Installation Work.

Training Prepares You for a Business of Your Own... or Good Radio Jobs—Civilian or Military

The important and fascinating field of Radio offers many opportunities to the man who wants to get ahead. My Training will help you win quick promotion in the Army or Navy... will fit you for a bright civilian career. SPRAYBERRY Methods are thorough and practical. Your Training will not interfere with your present duties. No previous experience is needed.

You Get a Dual-Purpose Radio Set

I supply you with Radio Parts which you use to gain pre-experience in Repair work. These same Parts are used as a Modern Signal Generator and for Signal Tracing, etc. You'll find my Course and Equipment fully described in the catalog offered below.

Earn While You Learn

My BUSINESS BUILDERS show you how to put your equipment to actual use in handling money-making Radio Service Jobs shortly after you begin Training.

THE SPRAYBERRY COURSE IS SOLD UNDER MONEY-BACK AGREEMENT



RUSH COUPON for BIG FREE BOOK

SPRAYBERRY ACADEMY OF RADIO
F. L. Sprayberry, President
625-B University Place, N. W.
Washington, D. C.

Please rush my FREE copy of "HOW TO MAKE MONEY IN RADIO."

Name Age

Address

City State

(Mail in envelope or paste on penny postcard)

NOW—A REALLY HIGH-POWERED— Radio Engineering Library

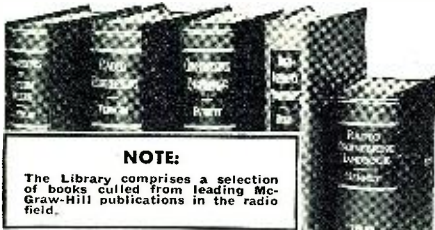

NOTE:

The Library comprises a selection of books culled from leading McGraw-Hill publications in the radio field.

- especially selected by radio specialists of McGraw-Hill publications
- to give most complete, dependable coverage of facts needed by all whose fields are grounded on radio fundamentals
- available at a special price and terms

THESE books cover circuit phenomena, tube theory, networks, measurements, and other subjects—give specialized treatments of all fields of practical design and application. They are books of recognized position in the literature—books you will refer to and be referred to often. If you are a practical designer, researcher or engineer in any field based on radio, you want these books for the help they give in hundreds of problems throughout the whole field of radio engineering.

5 VOLUMES, 3319 PAGES, 2289 ILLUSTRATIONS

1. Eastman's FUNDAMENTALS OF VACUUM TUBES
2. Terman's RADIO ENGINEERING
3. Everitt's COMMUNICATION ENGINEERING
4. Hund's HIGH FREQUENCY MEASUREMENTS
5. Henney's RADIO ENGINEERING HANDBOOK

10 days' examination. Easy terms. Special price under this offer less than books bought separately. Add these standard works to your library now; pay small monthly installments, while you use the books.

10 DAYS' FREE EXAMINATION—SEND COUPON

McGraw-Hill Book Co., 330 W. 42nd Street, N. Y. C.

Send me Radio Engineering Library, 5 vols., for 10 days' examination on approval. In 10 days I will send \$3.00 plus few cents postage, and \$3.00 monthly till \$24.00 is paid, or return books postpaid. (We pay postage on orders accompanied by remittance of first installment.)

Name

Address

City and State

Position

Company RN-2-43

LEARN CODE the way you'll be using it



by SOUND

The best way to learn to read code is by listening to code. The best way to learn to send code is by hearing your own

sending repeated back to you. With the new All-Electric Master Teleplex Code Teaching Machine, you learn code the natural, easy, fascinating way. Only instrument ever produced which records your sending in visible dots and dashes—then SENDS BACK your own key work at any speed you desire. There are NO PERFORATIONS—NO INK. Far superior to anything ever developed... a marvel of simplicity. That's why practically every school teaching code uses MASTER TELEPLEX. We furnish complete course, including the All-Electric Master Teleplex, give you personal instruction with a MONEY-BACK GUARANTEE—all at a surprisingly low cost. Write today for FREE catalog RN-2. No obligation.

TELEPLEX CO., 107 HUDSON ST. JERSEY CITY, N. J.

RADIO ENGINEERING DEGREE IN 27 MONTHS

Intensive, specialized course, including strong basis in mathematics and electrical engineering, advanced Radio Theory and Design. Modern Laboratory. Low tuition. Self-help opportunities. Also 27-month courses in Aeronautical, Chemical, Civil, Electrical and Mechanical Engineering. Participation in Civilian Pilot Training Program. Enter March, June, September, December. Catalog.

INDIANA TECHNICAL COLLEGE
723 E. Washington Blvd., Fort Wayne, Ind.

application covers r.f. amplifier stages in receivers, and most of the audio amplifier stages used in them.

Class A Amplifier

A class A amplifier is one in which the grid bias and alternating grid voltages are such that plate current in a specific tube flows at all times. Consequently, a tube operating as a class A amplifier is operating sensitively over the straight portion of its grid-volts plate-current characteristic at all times, so the distortion produced in it is low. The salient characteristics of a class A amplifier are high voltage amplification, low distortion, low plate efficiency and low power output for the size of the tube used. A graphical illustration of the operation of a class A amplifier is shown in Fig. 7, while Fig. 8 is the circuit of a typical amplifier.

In practice, the grid bias is chosen to operate the tube on the straight portion of its grid voltage-plate current curve over the complete range of grid voltage swing. An applied signal at the grid of the tube causes alternating current variations to appear across the load resistance in the plate circuit which are faithful reproductions of the applied signal. Since the voltage variations obtained across the load resistance are much larger than those required to swing the grid, amplification of the signal is obtained. The ratio of this voltage variation produced across the load resistance to the input signal voltage is the voltage amplification or gain provided by the tube.

If the value of the load resistance is made large with respect to the plate resistance of the tube, the active gain obtainable from the tube approaches the amplification factor of the tube itself. The actual voltage amplification due to the tube may be calculated from the formula

$$\text{Amp.} = \frac{\mu \times R_L}{R_L + R_p}$$

This formula shows that the gain actually obtainable from the tube is less than the tube's amplification factor, but that the gain obtained approaches the amplification factor of the tube when the load resistance is made larger compared to the tube's plate resistance. The value of load resistance that may be used with a given tube is limited by the plate voltage available, as the flow of plate current through the resistance causes a voltage drop, reducing the actual voltage applied to the plate. The available output voltage from the tube is accordingly reduced, as the extent of the plate current variations is limited by the low plate voltage.

Class AB Amplifier

A class AB amplifier is one in which the grid bias and alternating grid voltage are such that the plate current in a specific tube flows for considerably more than a half but less than the complete electrical cycle. Because of this unbalanced condition, tubes used in such service are always operated in push-pull to balance out the even har-

monics which would appear in the plate circuit.

Class AB amplifiers are used only in audio work where relatively large outputs are required from small tubes; and is an intermediate step between class A and class B. The general theory of this type of amplifier is that the tubes are so biased that at low inputs they will operate as class A amplifiers, while at higher signal levels they approach class B operation. This type of amplifier may be divided into two classifications: the AB₁, which at no time draws power from the exciting source (no grid current), and the AB₂, which draws grid current at the higher signal levels and consequently must be furnished power by the driving source.

The large variations in plate current occurring in an amplifier of this type make it essential that the plate supply have excellent regulation to maintain a constant plate voltage. The circuit shown in Fig. 9, is similar to that of any push-pull amplifier.

Class B Amplifier

A class B amplifier is one in which the grid bias is approximately equal to the cut-off value so that the plate current is approximately zero when no exciting signal grid voltage is applied, and so that plate current in the specific tube flows for approximately one-half of each cycle when an alternating signal grid voltage is applied.

Fig. 10 shows class B operation with the tube biased almost to cutoff. It may be seen that plate current flows only during the positive half of each signal cycle, while the output waveform is essentially the same as that of the exciting signal. As only alternate half cycles of the signal are reproduced in the plate circuit of one tube, it is necessary to use two tubes in push-pull to reproduce both halves of the signal cycle. When used in this manner one tube is "resting" while the other is furnishing power.

As the plate current is driven near the saturation point on positive peaks it is necessary for the grid to be driven positive with respect to the cathode during part of its swing with the consequence that power is drawn from the driving source and a driver with considerable reserve power must be used. Inasmuch as the plate current varies from almost zero to extremely high values on peaks, the power supply must have excellent regulation in order to maintain steady plate voltage.

Another type of class B amplifier is used in r.f. service either singly or in push-pull. This usually follows a modulated stage and is used as a linear amplifier to raise the output power level. It is possible to use a single tube in class B in this service, as the "fly-wheel" effect or energy storage characteristic of the output furnished sufficient stored power to supply the missing half cycle, and furnish energy to the load during those periods when the plate current of the tube is cut off.

Where high power output, high plate efficiency, and medium power gain are

mal operating conditions until its characteristics become constant. One photo shows some metal tubes undergoing aging in a large manufacturing plant. (To be continued)

QRD? de Gy
(Continued from page 34)

all the victories would never have been possible. And many who have cheerfully gone out into the horizon never to return are continually being replaced by others so that supplies and equipment in an ever endless stream can reach our boys and our allies over seas. We bow our heads to these 61 radio officers who have given their all:

- | | |
|-----------------------|------------------------|
| John J. Bellom | Leon J. Rouz |
| Alonzo M. Carter | Fred G. Smith |
| Joseph Davis | Louis Taiz |
| Dennis M. Posner | Benj. G. Tempset |
| Francis E. Siltz | Joe R. Thomas |
| Russell N. Aiken | Charles M. Vicerman |
| Joseph E. Ballard | Isadore Weinstein |
| Ignatius Camiolo | John A. Browne |
| James Clark, Jr. | Stephen P. Eyers |
| Isaac Margolis | Clifford Chesley |
| Ralph A. Posmontier | James T. Cotton, Jr. |
| Francis J. Abele | Bernard K. DeDominicis |
| Clarence E. Armstrong | Franklin H. Dutton |
| Francis J. Beaton | Walter D. Fisher |
| Ted J. Blazewicz | Roger I. Fontana |
| Henry L. Brock | Lawrence Gianella |
| Wilfred Clarkson | Fred C. Hanson |
| Kirillos C. Corekos | Thomas R. Hensley |
| Edwin P. Davis | Paul B. Kappus |
| J. P. DeVleeschouwer | Stone V. Lowry |
| Lawrence E. Donohue | Bernard H. Masters |
| James J. Flynn | James G. McNair |
| Francis T. Gentil | Harry K. Nichols |
| Theodore F. Haviland | Jonathan Ring |
| Saul Halpern | Joseph H. Simpson |
| August J. Joseph | Frank Stelwagon |
| Rudolph Lenhardt | Frank Talley |
| Charles E. Macomber | Rocco Terra |
| John J. McIntyre | Leslie G. Vail |
| Vernon W. Minzey | Meyer E. Wechsler |
| Spencer I. Richter | Wm. H. Wolfskeill |

SO ANOTHER year comes to an end as all past years have ended, boisterous in some spots and equally quiet in others, according to the amount of joy or sorrow inhabiting each. But with the knowledge of ultimate victory in the grasp of the United Nations a subdued but joyous New Year will ring out all over this nation. We extend the season's greetings to all and may the coming year bring to all their fondest hopes. So with a cheerio and 73 . . . ge . . . GY.

-30-

Radio News Writer Honored!

Rufus P. Turner, radio research engineer with the Aerovox Corporation, was in New York recently to receive the National Association of Manufacturers acclaim as one of 16 "honor workers" in the war effort.

Mr. Turner was cited by the organization for special secret work in the wartime radio field. The tribute was paid to him at N.A.M.'s War Congress of American Industry.

The local engineer is a well-known contributor to such technical radio magazines as RADIO NEWS and is editor of the Aerovox Research Worker. Before joining the Aerovox Corporation a year and a half ago, he was engaged in research in radio transmitting equipment for the National Company of Malden.

Congratulations Rufus, we're proud of your record.—Ed.

BUY MORE BONDS!

Practical Radio

(Continued from page 29)

Grid-leak and Condenser Detector

The grid-leak detector, little used nowadays because of its high distortion and low power handling ability, is shown schematically in Fig. 5. The condenser C is known as the grid condenser, while the resistor R is the grid leak, usually of the order of a megohm. The condenser in the plate circuit is an r.f. bypass condenser. On the positive half cycles of the r.f. signal, the control-grid becomes positive and current flows from the control-grid to the cathode. The grid and cathode thus act like a diode detector, with the grid-leak resistor as the diode load resistor and the grid condenser as the r.f. bypass condenser.

The varying voltage across the grid condenser then reproduces the a.f. modulation in the same manner as has been explained for the diode detector. This voltage appears between the grid and cathode and is therefore amplified in the plate circuit. The output voltage thus reproduces the original a.f. signal. Essentially this form of detector is the same as a diode with an amplifier following it, as can be seen by comparing Figs. 2 and 5, substituting the grid leak for the headphones shown in Fig. 2.

Grid-bias Detector

Grid-bias detectors, so called because the grid is operated at a high initial negative bias with respect to the cathode are very satisfactory where relatively high power handling ability, fair sensitivity, and light circuit loading are desired. A typical circuit for this type of detector is shown in Fig. 6. The initial negative bias (almost the value required for plate current cutoff) is furnished by the cathode-bias resistor R (or a C-battery or a bleeder tap may be used). Because of this bias, only the positive half cycles of r.f. signal voltage can cause plate current changes and are amplified by the tube.

The negative half cycles produce no plate current change because the tube is negative-biased originally to the zero. As the modulated envelope varies from zero to maximum, the variations in the plate current follow and cause an audio signal to appear in the phones. Filtering of any r.f. that may appear in the plate circuit is accomplished by the bypass condenser connected from plate to ground. The grid-bias detector has the advantage of amplifying the signal, besides detecting it, and since it does not draw current from the tuned input current, it does not lower the selectivity of the tuned circuit.

Classes of Amplifiers

Amplifiers may be divided into four general classes, A, AB, B, and C. The most common of these is the class A which is generally used when the highest gain per stage is required. This

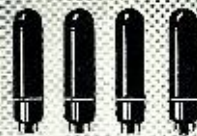

4 STANDARD TYPES

of Amperite Regulators replace over 400 types of AC-DC Ballast Tubes now in use.

Amperites are real REGULATORS . . . have patented Automatic Starting Resistor which prevents initial surge and saves pilot lights . . . Ask Your Jobber.

AMPERITE
THE *Simplest*
WAY TO REPLACE
BALLASTS
WRITE FOR REPLACEMENT CHART
AMPERITE CO. 541 BROADWAY, NEW YORK, N. Y.

MATHEMATICS FOR RADIO AND COMMUNICATION

by **GEORGE F. MAEDEL, A.B., E.E.**

Chief Instructor, N. Y. School, R. C. A. Institutes

To master the technicalities of radio—to read engineering literature intelligently—you must have the mathematical groundwork covered by these absorbing books prepared for home study. Book I (314 pp.) covers the algebra, arithmetic, and geometry; Book II (329 pp.) covers the advanced algebra, trigonometry, and complex numbers necessary to read technical books and articles on radio.

MAEDEL PUBLISHING HOUSE Room 109
593 East 38 Street, Brooklyn, New York

Send me MATHEMATICS FOR RADIO AND COMMUNICATION as checked below. I enclose payment therefor with the understanding that I may return the book (s) within 5 days in good condition and my money will be refunded.

Name

Address

- Book I at \$3.75 plus 3c postage.
 - Book II at \$4.00 plus 3c postage.
 - Books I and II at \$7.75 postage prepaid.
- Foreign and Canadian prices 25c per volume higher.

**BUY YOUR
RADIO PARTS
FROM**

LAFAYETTE

Send Lafayette your priority orders for Radio, Electronic, and Sound parts and equipment . . . quick deliveries on small or large orders. Large selection of Radio Training Kits in stock!

Ask Lafayette for those hard to find parts—your order will receive immediate attention.

FREE — 130 page illustrated catalog — contains thousands of items — send for your free copy today! Write Dep't 2E3 at 901 W. Jackson Blvd., Chicago.

★ Camera Fans: Photographic Equipment at lowest prices. Write for **FREE PHOTOGRAPHIC CATALOG.**

LAFAYETTE RADIO

901 W. JACKSON BLVD., CHICAGO, ILL.
265 PEACHTREE ST., ATLANTA, GA.

TEST with

TELRAD

**SECONDARY
FREQUENCY
STANDARD**



Used by U.S. Army Signal Corps

- ★ Exact Frequency Measurement 100 to 60,000 K.C.
- ★ The Ideal Crystal Controlled Signal Generator for I. F. or R. F. Alignment Purposes.
- ★ Checks Factory Test Oscillator Accuracy.
- ★ Checks Receiver and Transmitter Calibration. Unexcelled for setting Electron-coupled Oscillator Transmitter Frequency to Close Tolerance, substituting for Spot Frequency Crystals.
- ★ Signal at Every 1000 K.C. provides Rapid Location of 100 and 10 K.C. Beats.
- ★ Ideal for Portable Use. Weight 12 lbs. Size 5" x 8" x 8 1/2".

Operates on 115, 130, 150, 220, and 250 volt 25 to 60 cycle A.C. Supplied complete with Bliley 100 and 1000 K.C. duo-frequency crystal and one 6V6 oscillator, one 6N7 harmonic generator, one 6L7 harmonic amplifier and one 6X5 rectifier. (Price Complete \$39.50)

Write for details

FRED E. GARNER CO.

Radio and Marine Equipment

43 E. Ohio St. Chicago, Ill.

become more and more rapid until an equilibrium becomes established between the rate of evaporation of barium from the surface and the formation and diffusion of barium from the interior. This method of barium formation probably serves to maintain the supply of barium on the surface of all oxide cathodes after the layer has been formed.

There is a type of cathode called a combined cathode which always has to be activated in this way because any reducing agents that might have been present in the coating are burnt out by heating the cathode in air to a red heat. This causes the barium and strontium oxides that are formed momentarily to combine with the oxide of the core metal, usually nickel. These cathodes have more mechanical strength than an ordinary oxide cathode.

The oxide cathodes are operated in the range of 800-900° cent. This makes them a very efficient cathode from the standpoint of power consumption. Figure 1 shows a curve for oxide cathodes. These may be compared with those for the thoriated tungsten and pure tungsten cathodes in order to see how much more efficient the oxide cathodes are than either the thoriated tungsten or the pure tungsten cathode. The oxide cathodes also have another advantage; since they do operate at such low temperatures, they can be made into sleeve cathodes and heated by a coil of tungsten wire in the center. Then the cathode is all at the same potential in relation to the plate. The advantage of this will be seen in the next article in which the field conditions will be discussed. A typical heater cathode is shown in Figure 2.

The heater is usually made of tungsten wire surrounded by some insulating material having a very high melting point. Nickel is the core metal usually used for all types of oxide cathodes because the oxide seems to combine with the nickel during operation to form a compound. This makes the coating stronger mechanically. Cathodes made on nickel cores are also much more easily activated, probably because of some reducing agents contained in the nickel.

Barium oxide evaporates from the coating much more rapidly than the strontium oxide causing a depletion of the barium oxide in the coating. Studies have been made of the relationship between the amount of barium oxide present in the barium oxide-strontium mixture, and the emission that can be obtained at any given temperature.

A graph of the results is shown in Figure 3. This shows why the 50 percent barium oxide was chosen as being the best mixture to use. Since the barium oxide evaporates in preference to the strontium oxide, the emission of the barium oxide will fall off due to the depletion of the supply of barium oxide. It is not well understood why some oxide cathodes show great fall in emission long before the barium oxide

supply has fallen to a low value. The diffusion of barium metal takes place along the boundaries between the grains of barium and strontium oxide, and if these grains grow in size, there will be fewer boundaries for the barium to diffuse along, and consequently, a point will be reached at which the diffusion of barium cannot keep up with its evaporation from the surface. This will cause the emission to fall off.

It will be well to examine the procedure used in pumping, activating and sealing off a tube. The assembled tube is sealed onto some type of diffusion pump described in the first article, with a constriction in the glass lead for sealing off. The pumps are turned on and the system is exhausted to a pressure of about 10^{-4} mm of mercury. The glass is then baked at about 450° C. to remove gases from it. When the gas has been removed from the glass and the pressure has fallen to 10^{-4} mm of mercury or less, the metal parts are heated by means of an induction furnace to 200° C. or 300° C. above the highest temperature the parts will encounter during normal operation. This removes the gases which would come from these metal parts during normal operation.

When the pressure gets to 10^{-5} mm of mercury, the cathode is turned on and heated to about 900° C. until its gases have been removed. Most of this gas will be carbon dioxide from the decomposition of the barium and strontium carbonates. The temperature of the parts of a tube is measured with an instrument called an optical pyrometer. A photo shows one in use measuring the temperature of an anode during the out-gassing of the metal parts. The color of a filament of a bulb within the instrument is matched against the color of the body whose temperature is to be measured after the light from these bodies has passed through suitable filters incorporated in the instrument.

The current through the filament of the bulb of the pyrometer is calibrated against temperature by the makers of the instrument. This provides the most convenient means of determining the temperature of the parts within a vacuum tube. After the gas has been removed from the cathode, the temperature is raised to from 1000° C. to 1050° C. for a few seconds. Then the temperature is dropped to 900° C., and a potential of several hundred volts is applied to the tube with all electrodes other than the cathode connected together. The current flowing will rise from a few microamps to a maximum value within a few minutes. When this has happened and the pressure has fallen to 10^{-5} mm of mercury, the plate potential is turned off, the getter flashed, and the tube sealed off.

The getter is put in the tube in the form of a pellet in a nickel holder, and it is evaporated on to the walls of the tube by heating by some means. This is called flashing the getter. After the tube is sealed off, it is aged under nor-

of 100 volts indicated on the meter as being representative of most units. Several tries will soon indicate the maximum volume which can be safely applied to the cutter.

Fig. 4 illustrates a very simple arrangement whereby two small neon lamps are connected with suitable series and parallel resistors which flash when certain peak voltages appear at the cutter. One neon lamp should be adjusted, after determining satisfactory volume range for the cutter, so that it glows during average modulation levels. The other lamp is used to indicate overload peaks and serves as a warning beacon to the operator telling him to reduce the volume at the amplifier.

Fig. 3 shows a circuit design for crystal cutters in conjunction with a suitable tuning eye tube such as the 6U5, etc. A voltage dividing network is provided by two 5 megohm resistors connected in series across the cutter. Part of the voltage is fed to the control grid of the tuning eye.

A series resistor of approximately 400,000 ohms, shunted by a condenser of .0005 μ fd. completes the network. A variable resistance may be included in series with the control grid of the tuning eye in order to provide exact adjustments. Once set, it is left in permanent position.

There is no reason why the average recordist should not undertake to use his present communications receiver for recording especially when the manufacturers have provided him with sets fully capable of giving such excellent results. Our experience with the SX-28 indicates that there should be many suitable receivers which may be utilized and in many cases they will give results comparable to, if not better than many amplifiers designed especially for recording purposes. It has been our experience too that many of the so-called special amplifiers fall far short of doing a good job of cutting, and the manufacturer evidently had overlooked many of the features which have since been included by communications receiver manufacturers.

Although the practice of employing separate tuners and amplifiers is the ideal solution to high-fidelity cutting, nevertheless many of the tuners used are incapable of combatting interference unless they are of the f.m. variety. Here is where the communications set is outstanding. The recordist need not fear that his record will be ruined by such interference or lack of selectivity.

We would like to hear from those of you who are now utilizing your present communications sets for recording purposes and to know what results you have obtained. We will be happy to receive your letters.

-30-

EXCLUSIVE!
First Presentation of the New
Illinois State Police Mobile Unit
NEXT MONTH!

Atomic Physics

(Continued from page 13)

ply of metallic barium from the oxide. One of the methods of doing this is to have a reducing agent present that will react with the barium oxide to liberate free barium.

In ordinary tube manufacturing processes, a binder is added to the barium and strontium carbonates to make the coating adhere to the surface of the core metal before heating. The binder is usually an organic substance which on heating decomposes giving free carbon which acts as a reducing agent on the barium oxide. If no organic binder is used, some organic substance such as cane sugar might be added as a reducing agent. Too much reducing agent, and in some cases any reducing agent at all, can be detrimental to the operation of the tube, because too much barium can be formed and diffused to the surface where it is evaporated off. This barium will deposit on the cooler parts of the tubes including the plate and the grid, and when the plate and grid are heated in normal tube operation, the barium will emit electrons which will have a detrimental effect in much the same way as the electrons emitted as secondaries.

There is another method, depending on the fact that barium and strontium oxide are semi-conductors, which may be used to activate a cathode. Since they are semi-conductors, if a barium oxide molecule dissociates into a positively charged barium ion, and a negatively charged oxygen ion, these ions need not capture or lose an electron immediately and recombine as in metals, but may exist for a while as ions. If the coating is heated to from 900° C. to 1000° C., the emission will be enough to give a few microamps of current flowing through the tube when the potential on the plate of the tube is about a thousand volts. This current will flow through the oxide coating where it will cause a movement of the ions of barium and oxygen.

The barium ions will move towards the core metals and the oxygen ions will move towards the outside. They will move in this manner because the outside surface will be positively charged with respect to the core metals when the current is flowing in the tubes. The barium ion moves inward until it captures an electron, thus becoming free barium. This free barium diffuses to the outside surface of the oxide to form a layer. The oxygen ions lose their extra electrons and become oxygen gas which diffuses through the surrounding gas and is pumped away. In this way a layer of barium can be built up.

The current flowing through the tube will steadily rise as the surface of the oxide becomes more and more completely covered with barium. This causes the formation of free barium to



**PROUD
TO SERVE**

SNYDER
MANUFACTURING CO.
PHILADELPHIA, U. S. A.

**RADIO
ANTENNAE**
AND
ASSOCIATED PRODUCTS

RIGHT ON THE NOSE!



That's what Browning Frequency Meters do for transmitters — put them "right on the nose." Write for complete literature on Types S-1 and S-2, with over-all accuracy of, respectively, .01% and .005%.

BROWNING
Laboratories, INC.
WINCHESTER, MASS.

ENGINEERS WANTED TRANSFORMER DESIGN ENGINEERS

Unusual opportunity with national manufacturer for several thoroughly experienced Transformer Design Engineers capable of Audio & Power up to 15 K.V.A.

A WAR JOB—NOW! A FUTURE—LATER!

We are at present manufacturing vital war equipment for our fighting forces and our peace time activities and expansion program should provide steady employment and promotional opportunities to capable men.

Those now employed in war industry at full skill need not apply

Write to Personnel Manager

FEDERAL TELEPHONE & RADIO CORP.

Manufacturing unit of the International Telephone and Telegraph Corp.

1000 Passaic Ave., E. Newark, N. J.

SAVE MONEY ON CABINETS and RADIO PARTS

"LAKE SPECIAL" CABINET



A beautiful hand rubbed, walnut veneered combination cabinet. Smart modern design. 42" high, 32" wide. Record changer compartment has 16" depth, and dual panel is 10" high. Lower left door for record storage. Supplied with baffle and ready cut for 12" speaker. An outstanding value at only...

\$2495

14" SPEAKERS

14" electro-dynamic speakers. 900 ohm field' 6-8 ohm voice coil. 6V6 push-pull transformer. 15 watt output. Special, only...

\$449

Victory Special . . . — . . . — V

NATIONALLY-KNOWN, HEAVY DUTY MOTOR. Silent, dependable, induction type, self-starting motor; 9" turntable. 78 RPM. Enclosed gears. For 110 v. 60 c. \$11.50 List. Now only...

\$465

New Bargain Bulletin lists Money Saving Values in Radio Parts. Send for it TODAY!

LAKE RADIO SALES CO.

615 W. Randolph St.

Chicago

three months training and has graduated as a fully qualified Aviation Radioman third class. Now, since he is under 5'10", weighs less than 165 pounds and has 20-20 eyesight (maximum requirements to get into a gun turret) he has the opportunity of volunteering for gunnery training.

It's an established fact that at Jacksonville more than half of each radio class volunteers for this type of instruction. These men want to get up into the air, want to fly and fight. Those who are physically qualified go on for a month's course at one of four schools.

These are the men who will double in brass, the radioman-gunners who will fly in scouts, dive-bombers and torpedo-planes. Under the revolutionary new gunnery training program inaugurated by the Navy, they will become proficient shots by the time they get out in the combat area. Through use of "Secret" synthetic devices, all designed to simulate aerial problems on the ground, a thorough classroom schedule in theory and practical operation plus hour after hour of range firing, these men will be completely at home in a gun turret long before they ever take off on their first plane ride.

There are four requisites to becoming a good aerial gunner—good health, good eyes, steady nerves and the will to hit. These and the ability to hit. The Navy teaches the "lead" principle, most important secret to becoming a crack gunner. When a Jap Zero makes a high side run at over 300 miles an hour, a rear gunner never scores by shooting directly at him. He leads with his "bursts."

Radiomen start with trap and skeet, firing hundreds of rounds at clay targets, then move on to an ingeniously devised shotgun with spade grips to make the transition to machine gun firing easier. Finally they fire the .30s and .50s, first from a stationary platform at a moving object, then from a moving platform at a moving target, as they must when they are in air combat.

To simulate the actual problems of air gunnery is nearly impossible; the Navy does the next best thing. The moving target is a sleeve nine feet long—half the length of the towed sleeve used in plane practice—which streams out from above a hand car circling a track at 40 miles per hour. In front of the track is an abutment built high enough so that the gunner, crouching in his turret to fire some 400 yards away, sees only the moving sleeve. The gunner himself is in a turret, mounted on a truck racing down a highway at speeds ranging up to 60 miles an hour. The target is elusive. He has split-seconds to line it up in his sights, aim and fire. If he hits, he will hit later when he is in actual battle. The Navy sees that these radiomen hit and hit consistently before they move on to the operational theatres.

With such concentrated training, an enlistee becomes a skilled technician. He is now a radioman-gunner, ready

for action. In the Solomons, in New Guinea, all across the vast Pacific from the Aleutians to Australia, he is writing his signature in code and bullets, a new hero in the epic story of naval aviation.

—30—

Recording War News

(Continued from page 21)

is used to prevent overcutting of these frequencies on the disc. We have had excellent results using this circuit when the controls of the receiver were set in position No. 1 (Fig. 1). The value of the series resistor will be approximately 100 ohms although several values may be tried in order to find the one most suitable for the desired effect.

Fig. 6C shows connections for a 15 ohm cutter, and requires a matching transformer between the cutter and the output of the amplifier from the receiver. This may be a unit designed to match a 500 ohm line to Universal voice coils, and should include sufficient iron to handle the power without distortion. Here too we find that the impedance of the cutter varies, in fact, even more than the 500 ohm cutter, and we must include a suitable series resistor of approximately 10 ohms in order to offset this mismatch. If a 5 ohm cutter were substituted, the series resistor would be approximately 4 ohms.

Fig. 7A shows one way in which a conventional crystal cutter is connected to the output of the amplifier. A single-pole, double-throw toggle switch is added which will enable the user to select either the speaker or the cutter. A resistance network is required when a crystal cutter is employed. The values of the two resistors, one in series and the other in parallel with the cutter, have a definite effect on the range of the cutter. Several values should be tried and test cuts made in order to determine the most suitable values.

Another and yet simpler arrangement is to use a transformer which will match the output of the receiver and one having a 40,000 ohm secondary. Most crystal cutters may be connected directly across the secondary, and satisfactory quality may be had. Such a transformer would be one designed to match a 40,000 ohm load into a 500 ohm line. It would be used in reverse, the 500 ohm winding going to the output of the receiver.

Volume Indicators

The remaining requirement is that we provide the amplifier with some device to indicate the actual volume being applied to the cutter. The simplest would be a 0-150 a.c. voltmeter connected directly across the cutter. A 0-1 ma. may be used in conjunction with a copper-oxide rectifier and a series resistance, and this combination could also be connected as shown directly across the cutter. In the case of crystal cutters, we find an average

Navy's Jekyll-Hyde's

(Continued from page 8)

Proficiency in code is, by all odds, the most important part of his training. In fact, instructors at the Jacksonville radio school base two-thirds of his final mark on his ability to send and receive code. Because of this, attrition is very high — sometimes amounting to as much as 20 per cent of a class. The rules at the school are strict—90% of the graduating group will check out able to receive 22 words a minute. Actually, an ARM will never have to take code that quickly out in the fleet. Fourteen or fifteen words a minute is perhaps as fast as he will ever get it in air operations. But "if he can take 22 words a minute, he can certainly take 15—and get it absolutely correct," say instructors. That's the aim. There can be no mistakes when lives hang in the balance.

Take Donald Reynick of Minneapolis, for example. He is 17 years old and got as far as his sophomore year in high school. He has had no previous radio experience. For the first two weeks, he learns code—the "dah's and dit's"—and gets elementary code instruction in hand sending. Now he starts to receive. His progress the rest of the way depends completely on ability and application. Gradually, he moves from eight words a minute to ten—from 10 to 12 and so on. Code classes are arranged so as to permit the students, beginning with their fourth week of instruction, to receive code at a rate of speed, in words per minute, commensurate with their individual code speed abilities. Reynick takes ten tests of two minutes each a week. When he gets three "solid" (correct) copies, he may move on to another "wpm" (words per minute) table.

After Reynick and his particular class reach the 12 wpm stage, they progress to automatic tape transmission of code groups. Earphones plugged on their heads, they sit at a series of tables in the code room and receive their code from a machine in another room. Any table or combinations of tables can be plugged in to the sending machine and the men receive at various speeds representing their state of advancement. From "Cyco" (jumbled words) they move on to plain language and then, at the beginning of the 11th week, they learn to send. By graduation time, they will be able to handle a key at the rate of some 16 words per minute.

Because there is so much to learn and so little time to learn it in, a radioman keeps going at top speed during the entire course. His day begins as early as 4:30 in the morning and lasts until late afternoon. Another shift begins in the afternoon and works until late evening. The war won't wait and these men are pushed through as rapidly as possible commensurate with

sound training. Actually, Reynick gets seven hours of instruction a day, eight if he is behind his classmates. Add to that an hour of military drill, another hour for voluntary physical exercise.

Reynick gets an overall general education that will serve him well in action and in the years afterwards when the war is won. He is a typist, too, learning the touch system at the rate of 40 words per minute; he is a signalman; and he is also a mechanic.

His ability to send and receive code is no good to the Navy until he masters radio procedure. When he is alone in the rear seat of his scout plane, high above the Japanese carriers, and Zeros are roaring in to attack, there are certain things he must know and do immediately. They include calling and answering a station, knowing the composition of the call, heading and text of a message, knowing the use and purpose of certain signals, and other information which the Navy cannot necessarily talk about in detail. Keeping a log, knowing the meaning and use of prosigns, the classification of Navy radio traffic, lost plane procedure and the use of the U. S. Navy Call Sign Book are all part and parcel of radio procedure training.

Reynick may know all these things but they are no good to him if his equipment doesn't work. So he turns mechanic and learns about the practical operation of radio equipment. This phase of instruction covers complete familiarity with all types of radio receivers, transmitters, direction-finder and power supplies employed in Navy aircraft. It also includes the mastery of the detailed procedure in calibrating, adjusting and placing on frequency the radio transmitting and receiving equipment aboard planes and a knowledge of the plane interphone system.

Synonymous with operation is radio maintenance—a course that is concerned with the use and handling of tools and test instruments; upkeep, servicing and repair of transmitting and receiving equipment and power supplies; testing of vacuum tubes; installation and removal of equipment in planes; and care and upkeep of batteries.

Because emergencies are the order rather than the exception in warfare, Reynick must be prepared for anything. He learns how to send and receive semaphore messages with proficiency—as high as ten words a minute—and he gets, too, a thorough course in signal flags and blinker.

Then, as preparation for his gunnery training, providing he goes on to that phase of aerial warfare, there is a brief course in ordnance covering disassembling and assembling of the .30 and .50 calibre machine guns that includes complete field stripping familiarization; sighting problems in aerial gunnery and familiarization firing on the range.

That's a preliminary to what is to come. Reynick has completed his



*Say it
with Transmitters*

Never in history were so few words used to say so much! The Army and Navy orders that flash around the world today by radio are vital, important communications that must be handled with speed, skill and courage . . . and these are the characteristics drilled into operator students at Melville School because its founder, Frank Melville, is himself a practical world-experienced operator! That is why Melville School stands so high among Army, Navy and Airline officials.

MELVILLE

AERONAUTICAL RADIO SCHOOL, INC.
45 West 45th Street New York City
Training Men & Women for Radio in the Service of
AIRLINES - ARMY - NAVY - MARINES - MERCHANT
MARINE-COAST GUARD-INDUSTRY

Coming! A NEW WORLD of RADIO and TELEVISION

What Part Will You Play In It?
(An Opportunity for Men and Women
of All Ages)

• War has accelerated the pace of development in Radio and Television . . . has opened up unheard-of fields of opportunity for men trained for tomorrow's New Radio and Television careers.

• Here, at Radio and Television Institute, farsighted men are working together to supply the demand for radio television experts who will be needed to occupy key positions in a new world.

• What about you? Will you invest a small portion of your present earnings—a few hours of your time in a sound future . . . train under experts who have kept pace with every modern development in Radio and Television?

Call or write today! Let us prove to you that a career may be yours—with a little effort and expert guidance.

TRAIN AT

RADIO-TELEVISION INSTITUTE

Grand Central Palace Building
48th and Lexington Avenue New York City
★Licensed by the State of N. Y.

KEEP 'EM PLAYING!

FLYING

IS PROUD TO PRESENT THE
FIRST COMPLETE REPORT OF

U. S. NAVAL AVIATION AT WAR

Featuring 16 pages in brilliant full color, a 16-page salon section in beautiful blue-black gravure, and an 8-page insert of outstanding photographs in rich duotone—the Special February Issue of *FLYING* deserves a permanent place in your library. As a historical record of U.S. Naval Aviation since our entry into the war, this 312-page volume is of vital interest to every American. For in 39 exclusive articles, *FLYING* brings an authoritative and comprehensive account of U.S. Naval Aviation at War . . . the first complete report graphically portrayed by ranking Naval officers. Get your copy today. Your favorite newsdealer is now featuring the

Special

FEBRUARY ISSUE

FLYING

AT ALL NEWSSTANDS—50c PER VOLUME

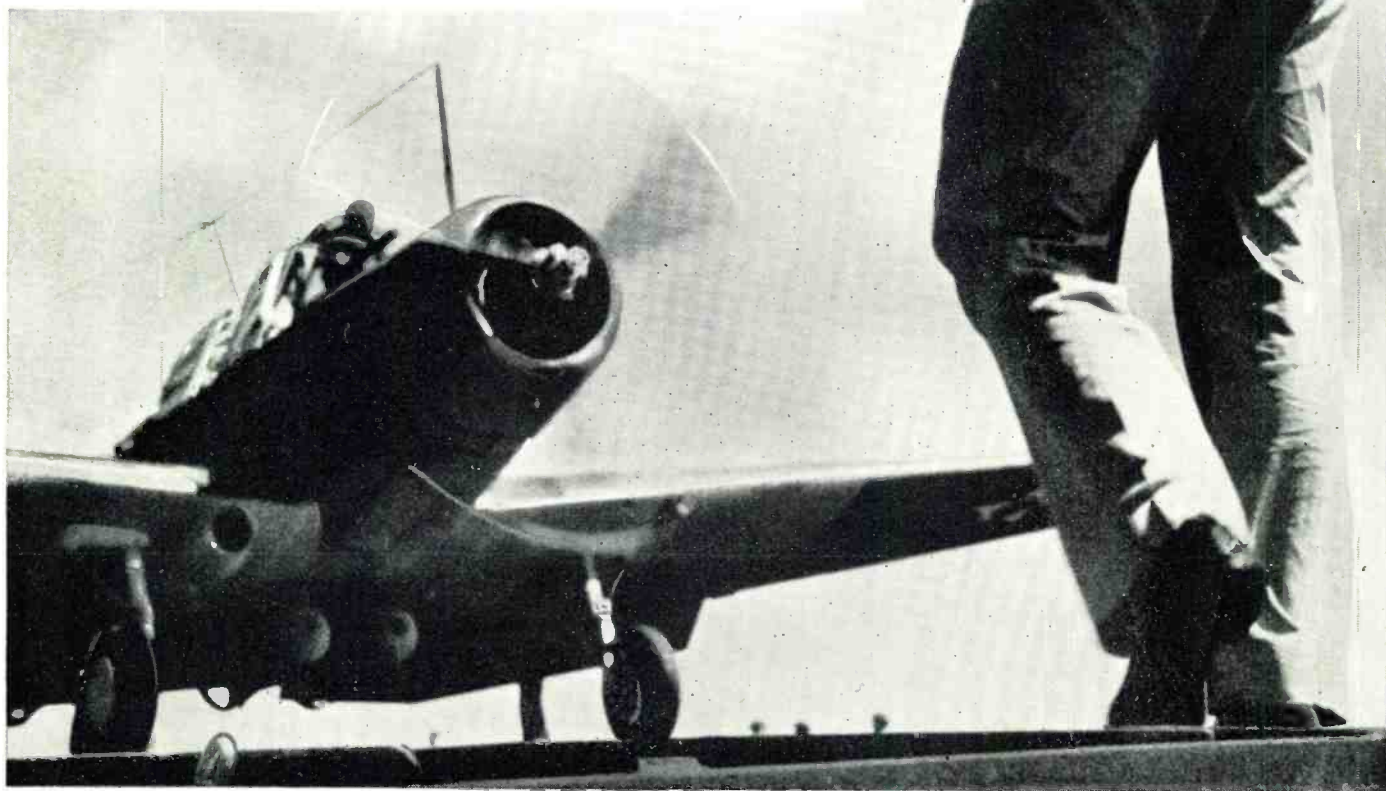

Due to the fact that the capacity of the bridge may be accurate only to two or three percent, it is useless to carry decimals out very far in these calculations. In the above example, the capacity 8.33 may be called 8.3 μfd . without causing an error of more than two or three inches. Of course, the more accurate the calibration of the bridge, the more accurate will be the exact location of the break.

If the capacity reading from one end of the cable is practically zero, the break will be located within a few inches of that end. When checking a cable that has been spliced with another cable having a different capacity per unit of length, it will be necessary to take them apart at the splice and then locate the break in the defective section.

If the cable under test consists of two or more single wires instead of a shielded conductor, the capacity is measured between the defective conductor and one that is known to be good.

Occasionally the need arises to know the capacity-per-foot of a cable. This can be obtained either by measuring the total capacity of the cable and dividing by the length in feet, or a one foot section may be cut off the cable and its capacity measured. The former method is preferred.

If there is known to be more than one break in a cable, then it will be necessary to know the capacity per foot and measure the capacity from either end of the cable. When this capacity is divided by the capacity per foot, you will have the distance to the first break.

The continuity test circuit of the capacity bridge is useful to check the cables for continuity after the breaks have been located and repaired. We have some very long test leads made up for this purpose.

We use the system outlined to check the location of breaks in all types of cables. When testing a line cord, we make the measurements in inches instead of feet. The resistance section of some line cords cannot be tested for continuity with the test lamp in the bridge as the resistance will be too great.

This bridge was not built to serve as a "standard" for capacity measurement, but to supplement the use of the regular bench type capacity bridge. If carefully built and calibrated, it will save a surprising amount of time and headaches.

-30-

NEXT MONTH!
NAZI RADIO EQUIPMENT
 A most revealing article
Don't Miss It!

MEISSNER INTERCOMMUNICATIONS KIT

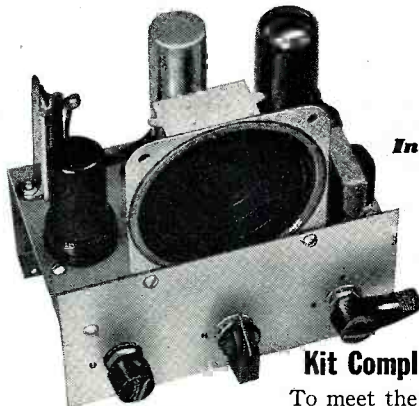

**Meissner
 Intercommunications Kit
 Chassis (Assembled)**

Kit Complete, No Parts to Buy!

To meet the increasing demand for defense Classroom Training in Intercommunications, Meissner Engineers have designed an Intercommunications unit in Kit form. The Kit is complete, including all necessary parts, tubes and cabinet. Designed to cover a wide variety of requirements, the Master unit will communicate with 11 stations—regardless of type, Master or Substations mixed in any proportion and in any order. If all are Master Stations, the maximum number of stations possible on the system is 12.

Each Master Station is supplied with a special 13-wire 5' flexible cable complete with connectors. The Intercommunications Kit, when completed, occupies a minimum of space. The Station indicator plate on the Master unit is designed to permit frequent changes in markings without damaging the surface. Each Kit contains unusually complete instructions, including data on construction of a junction box.

Meissner Intercommunications Kit operates on 110-125 Volts AC-DC. Shipped complete with tubes (one each 70L7GT and 12SC7). Chassis 5 $\frac{3}{4}$ " High. 6" Wide. 3 $\frac{3}{8}$ " Deep.



*Model No. 10-1182
 Meissner Master Station
 Kits, including all parts,
 tubes, cabinet, etc. . . .
 School Net Price . \$18.90*



*Model No. 10-1183
 Meissner Substation Kit...
 includes cabinet speaker,
 switch, and all mounting
 hardware, etc. . . .
 School Net Price . . \$6.75*



Meissner
 MT. CARMEL, ILLINOIS

"PRECISION-BUILT PRODUCTS"

NEW CATALOG

OF SOUND AMPLIFYING SYSTEMS

AUDIOGRAPH Sound Systems represent the latest in Public Address equipment—a complete line plus pre-tested accessories.

NEW LOWER PRICES

Outstanding quality and performance at prices that help you meet any competition.

WRITE FOR YOUR FREE COPY

AUDIOGRAPH
 THE FIRST NAME IN SOUND

John Meck Industries—Liberty at Pennsylvania Ave., Plymouth, Ind.

Short-Cut Mathematics

COMBINED WITH
Practical Mechanics Simplified

NEW 2-in-1 reading course! Now you can learn the speedy, simplified system of calculation used by draftsmen, engineers, accountants, "master minds" on the stage. Learn easy way to multiply 4 figures by 4 figures without using old-fashioned multiplication; add long columns of figures this lightning short-cut method. Learn horsepower, slide rule, micrometer, logarithms, wood measure, puzzles, etc., etc. Large illustrated volume complete with answers, only \$1 postpaid. Satisfaction or refund. Amaze your friends with your magic-like mental powers.

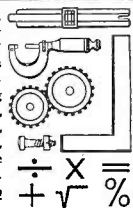

FREE Complete details... mail coupon TODAY!

NELSON CO., 500 Sherman St., Dept. 309B, Chicago
 Please send free details about "Short-Cut Mathematics and Practical Mechanics Simplified." No obligation.
 Name _____
 Address _____

NATIONAL UNION IS READY TO GREET ELECTRONIC SERVICE MEN

**FROM THE SMOKE AND TRIAL OF BATTLE SHALL ARISE
A GREATER, STRONGER SERVICE INDUSTRY**

Every ounce of National Union energy is thrown into the battle for victory. Our engineering, our production, our manpower and machinery are in the fight. As we battle on the research and production front we see the dawn of great new horizons as new products, new and better methods develop; we see the Radio Service man to whom we have devoted ourselves through the years standing on the threshold of a greater opportunity than he has ever known. National Union is deeply grateful for the loyalty of the service profession to National Union products. National Union is learning, watching every advancement in the electronic art, so when the day of Victory comes, the many thousands of service men who have grown with us in the past shall benefit in the future.

NATIONAL UNION RADIO Corp. 57 STATE STREET, NEWARK, NEW JERSEY

both the set and the signal generator to about 1400 kc. and adjust the trimmer for maximum output. The same procedure is followed for the 600 kc. antenna compensator if one is used. Some sets have a capacity switch for adapting the antenna circuit for antenna systems of various capacities. If the set under alignment has such a switch, it should be adjusted before the compensators are moved. As with usual alignment procedure, it will be found advisable to keep the output of the signal generator as low as possible. When the antenna trimmers have been adjusted in this manner, no further adjustment will be necessary when the set is re-installed in the car. As we pointed out before, this alignment process will work in all cases except those installations having a transformer coupling type of antenna lead.

If desired, an ordinary antenna and ground may be connected to the input posts of the Alignment Unit, permitting the receiver to be adjusted just as if the set were operating on its own aerial. The capacity dial and the booster switch are set as outlined above. In most cases, the fifty thousand ohm coupling resistor will reduce the pick-up of the antenna sufficiently to prevent the receiver from receiving more r.f. energy than it would receive from its own antenna.

There are many problems which confront the radio serviceman and the rapid location of breaks in cables is not the least of them. These cables include auto-radio lead-ins, microphone cables, line cords including those with resistances, short telephone lines, cables used for intercommunicating systems, lead-ins for doublet antennae and many other types of parallel wiring.

To locate a break in one of the conductors in a cable, first disconnect all equipment from both ends. Then, with the portable capacity bridge, measure the capacity from each end. Then measure the length of the cable. The total of the two capacities will be the total capacity of the cable and the capacity of the cable on each side of the break will be proportionate to the length of each end of the cable. This is worked out as follows: For example, let us assume a microphone cable 30 ft. long with the inside conductor broken. Measurement of the capacity at end "A" gives 50 μ fd. Measurement from end "B" gives 200 μ fd.

Capacity from "A" end	50 μ fd.
Capacity from "B" end	200 μ fd.
Total Capacity	250 μ fd.
Total length	30 ft.

$$\text{Capacity per ft.} = \frac{250}{30} = 8.33 \mu\text{fd.}$$

Distance from "A" end:

$$\frac{50}{8.33} = 6 \text{ ft. (approximately)}$$

Distance from "B" end:

$$\frac{200}{8.33} = 24 \text{ ft. (approximately)}$$

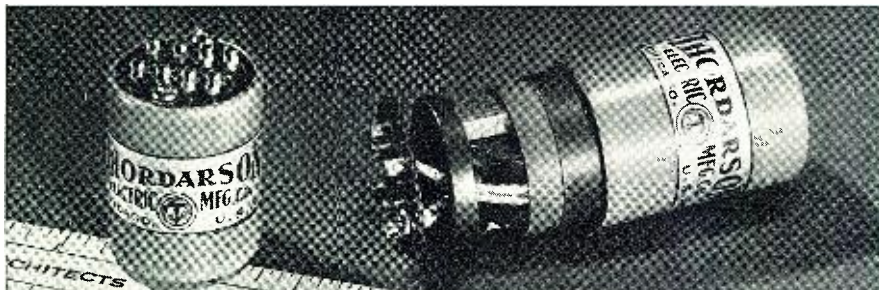

If You Lack Transformer Space ... You Need a Thordarson Incher

Thordarson Tru-Fidelity Incher Series Audio Transformers are specially designed for use where weight and size are as important as quality. There are many types with frequency response performance within—1.5 db from 30 to 15,000 c. p. s. Single plate to grid types for dc in primary are available for voice frequencies.

For 48 years Thordarson engineers have been designing and building better transformers . . . no matter how complicated your transformer requirements may be, send your specifications to Thordarson.

INCHER CASE DIMENSIONS
Diameter 1 5/16 in., Height (incl. lugs) 1 1/4 in., Height (Case alone) 1 1/8 in., Weight 1 1/4 oz., Mounting Centers 2 3/32 in.

Many other types illustrated and described in Catalog No. 500



TRANSFORMER SPECIALISTS SINCE 1895

GOOD JOBS in RADIO for young men age 17 to 20

As older men leave for the Army, RADIO calls for recent high school graduates. Prepare now for jobs in Radio Engineering; Broadcasting; Marine, Aviation, Police Radio; Servicing; Radio Manufacturing. Our streamlined courses give excellent preparation for Army and Navy Service. Expenses low. Write for free catalog.

THE DODGE TELEGRAPH & RADIO INSTITUTE
409 Monroe St., Valparaiso, Indiana

LET'S GET TOGETHER

Correspondence Courses in RADIO and ELECTRICAL ENGINEERING

ELECTRICAL ENGINEERING Get good grasp of wide electrical field. Prepare yourself at Low Cost, for secure future. Modern course. So simplified anyone can understand quickly.

RADIO ENGINEERING Extra fine course in radio, public address, photo-electric work. Training you to be super-service man, real vacuum-tube technician. Experimental kits furnished. Diploma on completion.

Send postcard or letter for Free Copies of school catalogs, full details, all about deferred payment plan, etc. **SEND NOW!**

WRITE **LOW \$25** **Either AS \$25** **Course**

LINCOLN ENGINEERING SCHOOL, Box 931-R50, LINCOLN, Nebr.

leakage of about 1 megohm. In general service work, a condenser or capacity which will not balance on the bridge is worthless and should be replaced. This does not necessarily apply to electrolytic condensers, but not many electrolytics will be found within the capacity range of this bridge. When checking a condenser or capacity with one side grounded, connect the test lead from the black tip jack to that side of the metal case.

When checking auto-radio antenna and lead-in systems, remove the antenna plug from the set. Connect the lead from the red tip jack to the *inside* conductor in the antenna lead and connect the lead from the black tip jack to the *shield*. Then measure the capacity. Reference to the average capacity chart on the front panel will inform the operator whether or not the capacity may be considered correct for the type of antenna under test. If no null point can be obtained, there is a serious leak in the antenna or lead-in. This will have to be corrected before the auto-radio will function properly. The one type of antenna system which will not respond to measurement in this way is the type that uses a coupling transformer at the point where the antenna joins the lead-in. Only a few installations will be found using this circuit. Do not confuse the booster coil, which many auto installations use, with the transformer coupled types. The capacity bridge will work o.k. with the booster coil type antenna.

The continuity test circuit is useful to test for open circuits and shorts in auto-radio antenna and lead-in systems. The condition of the booster coil, if one is used, can easily be determined. If the test lamp glows at full brilliancy when testing between the antenna plug and the antenna, the booster coil is shorted. If there is no glow at all, either the booster coil is open or there is a break in the antenna lead. If the lamp glows with some-

what reduced brilliancy, the booster coil may be assumed to be o.k.

The Alignment Unit was designed to allow the antenna circuit of the auto-set to be aligned under the same conditions it would meet in the car. When a receiver is removed from the car for service, the capacity of the antenna system should be measured with the Capacity Bridge. When the set has been repaired and aligned with the exception of the antenna circuit, con-

nect the alignment unit to the antenna socket in the set. Connect a signal generator to the alignment unit input posts and turn both set and signal generator on. Set the dial on the alignment unit to correspond to the capacity of the antenna. If the antenna system in the car includes a booster coil, throw the booster switch to the "on" position.

If the set has an ant. adjustment for the high freq. end of the dial, tune

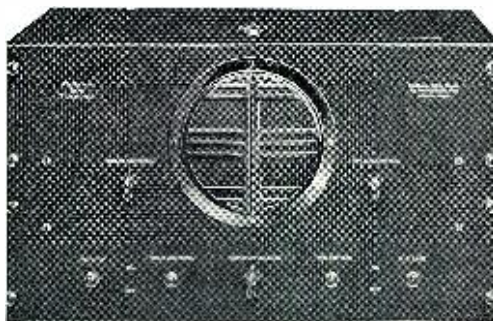

May We Serve You, Too?

If you have a wireless transmission problem which requires the services of a specialist, the McElroy organization may be of assistance to you. We make only telegraphic equipment. Apparatus that is recognized as the world's finest. In addition to manufacturing our standard line, we are always available for special design assignments that are within the scope of our activities.

These photographs illustrate our latest product, a Radio Beam Keyer, model RBK 1142, developed for one of America's largest aircraft manufacturers.

★ ★ ★

As creative telegraphic engineers, we are leaders in our field. We create. We design. We build. We do not imitate and we do not copy. And we can deliver. Our corps of experienced engineers and craftsmen are at your disposal.

McELROY MANUFACTURING CORPORATION

82 BROOKLINE AVENUE

★

BOSTON, MASSACHUSETTS

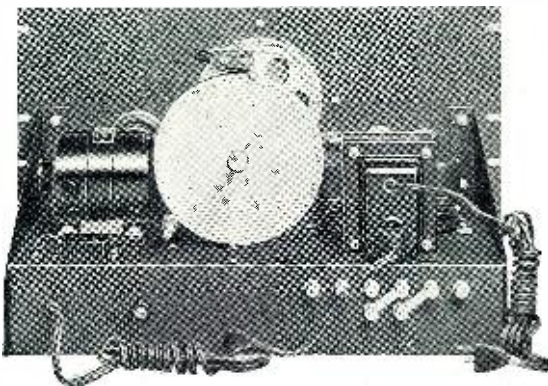

the switch around. So, when the switch is thrown to the "on" position, the contacts are open and the booster coil is in series with the circuit. When the switch is in the position marked "off," the contacts are closed and the booster coil is shorted out. This connection allows the booster coil to be either in or out of the circuit without affecting the total capacity of the Alignment Unit.

The signal generator is connected to a pair of posts at the end of the unit nearest the dial. One of these posts is grounded to the case and the other goes through an insulating washer. This post connects to the 50,000 ohm coupling resistor. The 6" length shielded antenna lead has a male connector on one end. The other end goes into the Alignment Unit and the shield is grounded to the case. The male plug on the end of the cable will fit the majority of car radios. A pair of antenna coupling adapters is used to connect the unit to sets which have different types of antenna sockets.

The dial on the Alignment Unit is a 3" cardboard disc glued to the panel. The pointer knob is made the same as the one for the capacity bridge, except that the celluloid pointer is only 1½" long. The case was finished in grey.

Calibration

The capacity bridge can best be calibrated by making tests upon an accurately calibrated variable condenser, or with a number of fixed condensers of known value. If fixed condensers are used, they should first be checked on a reliable capacity bridge. Very short connecting leads must be used when making these checks to avoid adding capacity to the circuit and introducing an error in the capacity reading. If the condensers used as "standards" in the bridge are of the value we stated and the wiring inside the bridge spaced well apart, calibration will be somewhat simplified. When checking a known capacity of, say, .05 on the portable bridge, we push the "cap" button and rotate the capacity

dial until a point is reached where no sound is heard in the phone. This will be too high a capacity to read accurately on the low scale, so the capacity switch is thrown to high position. When the "Null" point has been reached, the point indicated on the high scale may be marked .05 μ fd. A line can be drawn from this point down into the low scale and marked .0005 μ fd. or 500 μ fd. This procedure can be used for any value checked on the high scale. The reverse is also true. A point on the low scale established, for instance as .00003 μ fd. or 30 μ fd., may be drawn on up into the high scale and marked .003 μ fd.

After a couple of calibration points have been made on either scale, the scale should be examined to determine whether the capacity is increasing from left to right. The scales will be easier to read this way. If the capacity increases from right to left, reverse the connections to the potentiometer, erase calibrations and start over.

After the dial has been calibrated, mark off a space about a quarter of an inch wide at each end of the scale. In the space at the low capacity end, print the word "open." In the space at the high capacity end, print the word "short."

The calibrations should be made first with a pencil, marking lightly. After calibrating, the marking of both scales should be rechecked. When the calibrations have been decided correct, fill them in with India Ink. If the figures are made slowly and carefully, a neat and easily readable dial will result.

The Alignment Unit is best calibrated by setting its dial to various positions and measuring its capacity on a reliable bridge. Connection to the alignment unit must be made at the end of the coupling lead. This is preferable to calibrating it from the home-made bridge because there is likely to be a slight error in any home calibration and calibrating one home-made instrument from another is likely to double the error.

Operation

To measure capacities within the range 10 μ fd. to .2 μ fd., connect the condenser or capacity to be measured to the "cap" tip jacks. Push the "cap" button and rotate capacity dial until a point is reached where no sound is heard in the headphone. The reading on the dial at this point will be the value of the capacity under test. If no null point can be found on one range, throw the capacity selector switch to the other range. If the null point can only be found at the extreme low end of the low range, the condenser or capacity may be considered open. If the null point can be obtained only at the extreme high end of the higher range, the condenser is either open or beyond the range of the instrument. If no null point can be found, the capacity under test is leaking or partially shorted. If a dip in volume is obtained at one point, that point is the capacity reading, but it will have a

"Still Doing Business at the Same Old Stands"

SERVICEMEN
... your Distributor can **STILL** Supply you with
Centralab
MIDGET RADIOHM REPLACEMENTS

Fortunately . . . your distributor can still supply you with Midget Radiohms for replacements.

The smooth wall-type resistor for which Centralab Radiohms are famous will keep that now-precious radio in good working condition.

Stick to OLD MAN CENTRALAB for Replacements . . . and always specify "CENTRALAB".

- RADIOHMS • FIXED RESISTORS
- FIXED AND VARIABLE CERAMIC CAPACITORS
- SELECTOR SWITCHES

CENTRALAB; Div. of Globe-Union Inc., Milwaukee, Wis.

is in operation! The cathode is in fixed position, as usual, but the plate is mounted on the end of a Bourdon tube (this is something like the tube used in needle-type pressure gauges), from which it is, of course, insulated. Connection to it is made from a rigid lead through a pigtail, or light spring connection.

The end of the Bourdon tube which does not support the plate extends through the glass envelope and terminates in a closed reservoir which, like the Bourdon tube itself, is filled with fluid. When the fluid is heated and caused to expand, the Bourdon tube tends to straighten out in the coiled portion just below the plate, and so moves the plate farther from the cathode. This permits the spacing of cathode and plate to be close when the tube is first put into operation, and the distance between them to be increased as the tube warms up; there are numerous applications in which this and other reasons for varying inter-element spacing would be extremely valuable. The patent is No. 2,300,882.

Not strictly electronic, but of such interest to the servicemen as to be worthy of inclusion, is a new type of soldering iron patented by M. Vawryk. It includes a small soldering pot, built as part of the iron and containing molten solder, heated by the same coil that heats the iron's tip. There is a nozzle at the side of the iron, controlled by a simple valve actuated by a lever extending down to the handle. Thumb pressure on the lever permits a drop or more of solder to be deposited on the work; a screw is provided to regulate the amount of solder delivered at each pressure of the lever. The device, as described in Patent No. 2,300,716, should prove an aid in servicing, for it makes it unnecessary to hold the solder in one hand, the work in another, and the iron in a third—with which most of us are not equipped.

-50-

Portable Capacity Bridge

(Continued from page 27)

pointer knob. The calibrations on the dial were first made in pencil and then filled in with India Ink.

Below the dial is a chart which shows the average capacities which we have encountered in our service work. This chart was made from a piece of cardboard 9½"x3", which was ruled and then glued onto the panel.

The Alignment Unit was built into a metal shield can 5"x3½"x2½". A salvaged two-gang condenser was used. Only one section is connected. The trimmer was removed to reduce the minimum capacity. A replacement type antenna booster coil was mounted directly onto the toggle switch lugs. Due to the fact that the toggle switch shorts the booster coil, instead of opening the circuit, the off-on markings on the switch plate read backwards. This was overcome by removing the guide pin from the switch plate and turning

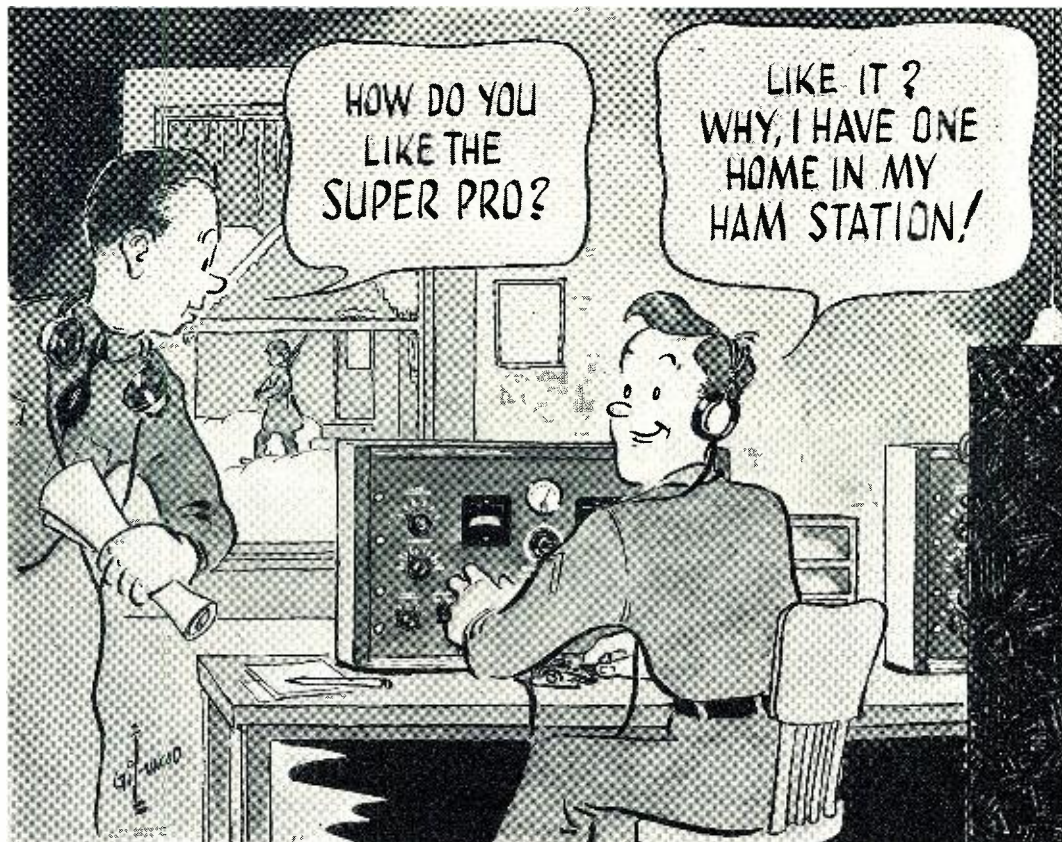

ELMER, JUNIOR, like thousands of other amateurs who are now serving as skilled radio operators and technicians, finds his long association with Hammarlund products unbroken by his enlistment in the Signal Corps.



HAMMARLUND

THE HAMMARLUND MFG. CO., INC., 460 WEST 34TH STREET, NEW YORK, N. Y.

image complete with all the details.

Though Bell Telephone is not much associated with television in the public mind today, it was one of the pioneers some dozen or more years ago, when the writer recalls seeing a Bell demonstration of color television, antedating John Logie Baird and CBS by about a decade. Which brings us to the fact that Dr. P. C. Goldmark's system, assigned to CBS, has been granted Patent No. 2,304,081.

You may recall this invention, widely publicized a year or two ago. In it, a color wheel is placed close to the screen of a cathode ray viewing tube, between the tube and the audience. The wheel, as shown in the pat-

ent, has six segments. Their colors, as the writer recalls the apparatus, were magenta, blue-green, and yellow. The shape of the segments is such that they progressively obscure each scanning line on the tube at about the same uniform speed as that at which the scan takes place. The results, as witnessed, were amazingly good, especially when the relative crudity of the apparatus—a revolving disc more than double the diameter of the cathode ray tube—is considered, although operation was somewhat noisy. The patent describes the invention more fully.

Noise is being utilized by M. I. Hull, in Patent No. 2,304,095. No, not to wake you up in the morning, but to put

you to sleep at night—and to keep you asleep once you get there. His device consists of a pair of headphones (to be worn by the sleeper) to which is connected an audio oscillator and an automatic relay which not only varies the frequency and volume of the oscillations, but also permits adjustment of their periodicity to a slightly lower rate than the pulse or the respiration. You may remember reading in the papers of experiments conducted some years ago at one of the universities, wherein a humming sound of varying volume was tested as a means of producing sleep; the tests were successful, so perhaps Mr. Hull has something there.

Probably one of the most prolific inventors of today is Dr. Alfred N. Goldsmith, editor of the *Proceedings* of the I.R.E. It would seem that just about every other issue of the *Patent Gazette* carries a new Goldsmith patent. Two

TRIPLETT
NEW Combat Line INSTRUMENTS

THESE NEW DELICATE REPRODUCTIONS ARE HALF SIZE.

MODEL 437-JP
A.C. VOLTS
TRI-PLETT
MODEL 437-JP
MADE IN U.S.A.

MODEL 437-JP
FREQ. METER
MODEL 437-JP
MADE IN U.S.A.

MODEL 372
FREQ. METER
MODEL 372
MADE IN U.S.A.

3 5/8" 1 45/64" 2 1/4" 3 1/4" 1.453" 2 5/8"

SIMPLE INSTALLATION DIAGRAMS

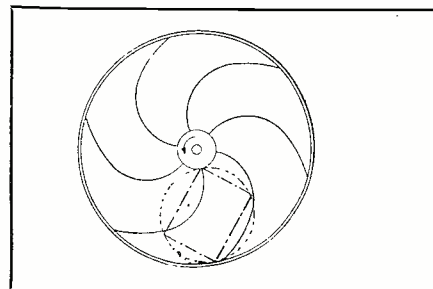

Pat. No. 2,304,081.

of his most recent deal with television. No. 2,304,163 covers a modulation system for television reception; No. 2,302,311, a very ingenious method of operating a plurality of cathode ray television image tubes from a single receiver, using what might be termed an "electronic relay" tube to divide the image between the various image tubes. This relay tube includes a cathode ray "gun" and a target consisting of as many segments as there are image tubes in the set-up. Each segment of the target is connected to an image tube, and the beam scans these segments much as the electron beam scans the screen of an ordinary image tube. While each segment is being scanned, the tube connected to it is operative in the ordinary way, and as the various segments overlap, though insulated from each other, there is no time lapse between the operation of the several image tubes. At least two uses are possible with this system: several rows of several tubes each would provide a giant-size television picture, or a number of different programs could be received simultaneously from a single transmission. The first-mentioned patent, on the modulation system, has been assigned to RCA.

Another interesting tube has been patented by J. P. Ferguson, and assigned to Westinghouse. This tube is most unusual in that the position of the plate can be changed from the outside of the tube—even while the tube

Maximum Service in Minimum Space
TRIPLETT Thin Line INSTRUMENTS

Precision performance by new *thin* instrument with standard Triplet movement housed in either metal or molded case. No projecting base; wider shroud to strengthen face; simplified zero adjustment, balanced bridge support; metal bridges at both ends; doubly supported core. For "Precision in limited space" write for Triplet Thin Line Bulletin.

The Triplet Combat Line

New Answers to specialized needs of War: Production Speed-up and Standardization; Performance under the Stress and Vibrations of Combat Service.

Model 437 J P—A rectangular line of meters to meet dimensions shown (see diagram). Wide-open scale for maximum readability. Complete coverage AC-DC Voltmeters, Ammeters and Wattmeters. Magnetic or static shielding provided on order. Molded Plastic Case for maximum protection in high voltage circuits. Pivots, Jewels and other component parts designed to meet severe vibration requirements.

Model 372—Frequency Meter—"All-American make" Vibrating Reed Frequency Meter. Maximum readability by grouping of Reeds. Range-Frequency-Voltage to meet specific requirements. Protected against excessive panel vibration. In standard 3 inch mounting or on special order in any cataloged Triplet Case.

A WORD ABOUT DELIVERIES

Naturally deliveries are subject to necessary priority regulations. We urge prompt filing of orders for delivery as may be consistent with America's War effort.



THE TRIPLETT ELECTRICAL INSTRUMENT CO., BLUFFTON, S. C.

of this company's newer patents is a noise limiter which will keep the noise level below the signal peak at which the AVC is set. From the i.f. stages of a superheterodyne, conventional inductive means are used to couple the output to a diode detector, which is also coupled to the AVC circuits that feed back into the r.f.-i.f. portion of the receiver. The diode output is connected to an audio amplifier which has a relatively sharp cut-off, and is so biased that the plate current will cut off at the level for which the AVC is set. Thus, according to Patent No. 2,302,520, the noise will be prevented from over-riding the signals.

Speaking of noise, plenty of volume should be obtainable from a new type of loud speaker which R. C. Sanders, Jr., has invented. As described in Patent No. 2,304,022, assigned to RCA, the unit has much the appearance of an

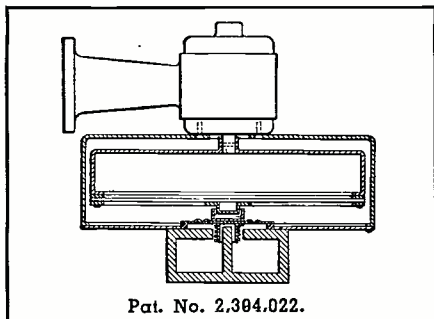

electric fan and, as a matter of fact, the diaphragm rotates. This diaphragm is normally flat, and has a hub with a number of sections something like fan blades, their outer ends being affixed to a large spider driven by the "fan" motor, while their inner ends are attached to a voice coil which is actuated by means of the usual sort of

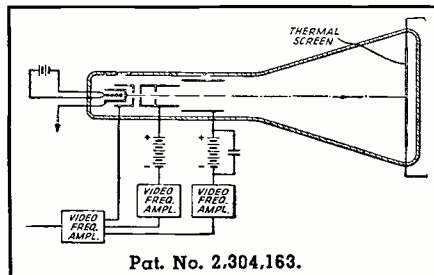

dynamic speaker driver unit. It is doubtful that a reproducing unit of this sort will ever make its appearance in home receivers, but it may prove sensational in certain outdoor installations, where great volume of sound is the prime requisite.

More likely to be used indoors is a very simple television system which has been assigned to Bell Telephone Laboratories by Frank Gray, of New York. Patent No. 2,303,930 illustrates it as requiring but two tubes in addition to a video frequency amplifier; this includes both the transmission and reception ends, for the circuit is a "wire television" job—perhaps the first indication that people making telephone calls may be able to see as well as hear each other.

Basically, the arrangement calls for

a pair of mechanical scanners—the familiar Nipkow disc—one at each end of the circuit. The pick-up tube encloses a thin, high resistance conducting plate with a photo-emissive coating. When the image of the person placed before this tube is projected onto the plate through an optical system, positive charges appear on the portions of the plate, their intensity depending upon the brilliance of the various areas of the subject; these charges appear simultaneously, unlike the successive charges obtained by scanning in an iconoscope. Close to and parallel to this plate is another which is not only photo-emissive, but also translucent; when an electron ray

is emitted from the second plate, it passes directly to the first plate, so close is the spacing. A spot of light from a point source is caused to scan the second plate by means of a revolving disc, pierced with a spiral of holes.

The output of this pick-up tube is fed into a control and coupling system which matches it into a line over which it may be transmitted for a considerable distance, for the video frequencies need not be very high. At the receiving end, the impulses are again amplified and fed into some form of glow tube. This tube is viewed through a revolving disc similar to that used at the transmitter, and the scan is thus translated back into a



GET ON THE TECHNICAL FRONT

NOW, as never before, the urgent need for Trained Radio Men has created a tremendous shortage. Man-power is being mobilized for duty on the TECHNICAL FRONT: Radio Engineers, Service men and operators. Experts in shops, in laboratories and countless, undreamed-of other applications are on the "MUST HAVE" list. The war has stimulated demand in both Civilian and military fields. Regardless of whether you remain a civilian or enter Military Service, National Radio Training will qualify you for a real future, a good pay job, responsibility and marvelous opportunity for advancement.

LEARN AT HOME

NOW you can learn AT HOME in your spare time. National's VICTORY training plan speeds up your progress right from the start, yet omits absolutely nothing vital to your preparation.



WITH BIG FIRM

An employed at General Electric plant as inspector on Radio for Armed Forces. I owe a great deal of my success to National Training. Wish I could see your instructors and tell them of my good luck. National has brought me.

Chas. Plunkett, Connecticut

Draft Age Men: Train before entering Service.



More than 37,000 Graduates

SEND NO MONEY

MEN WANTED: AGES—16 to 50

In Radio, age is not a factor. Training is the main requirement.

BE A RADIO TECHNICIAN WITH PREPARATION FOR CIVILIAN OR U.S. GOVT. SERVICE

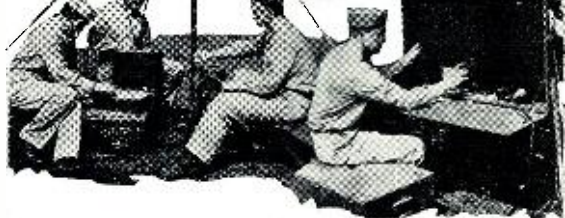

TESTED HOME TRAINING BY PROVED SHOP-FIELD METHOD

For 38 years National Schools has trained ambitious men for Top Pay trades. Squarely behind our Home Training are the modern, completely-equipped Training Shops of National Schools where we develop and prove every Shop Method Assignment sent to you. Every phase of your training is personally supervised by an established Faculty of practical, experienced instructors and engineers. They have developed progressive methods of training you in your own home, based on actual shop practice. Unique training facilities give you Home Training based on Resident School Shop principles—methods not available from any other source, to our knowledge. You'll be amazed when you receive our Complimentary Lesson and full details.

KEEP PRESENT JOB WHILE LEARNING

Regardless of previous education or age, you can Train for Radio. Continue your present job. Earn while you learn. If subject to Military Service, all the more important that you get pre-training.

SPECIAL OFFER

So that you can demonstrate to yourself the ease and rapidity of learning Radio at Home, National Schools will present to you one Complimentary Lesson free, accompanied by Opportunity Book of Facts and Details about all branches of Radio. Use the Coupon. Mail it today.

NATIONAL SCHOOLS

Los Angeles California

ESTABLISHED 1905



MAIL OPPORTUNITY COUPON FOR QUICK ACTION

National Schools, Dept. RH-2
4000 S. Figueroa, Los Angeles, Calif. (Mail in envelope or paste on penny postal.)

MAIL me FREE, without obligation, one Lesson and Opportunity Book, with full details about how I can become a Radio Technician.

NAME _____ AGE _____
ADDRESS _____
CITY _____ STATE _____

terial. We will continue to include the best of them. Several outstanding engineers are now in the process of preparing entirely new and authentic manuscripts covering topics of greatest radio interest. We feel sure that you will welcome them, and will benefit greatly from their special knowledge of these subjects to be covered.

We are also hard at work planning other special issues, and we feel that these too will be most welcome by our many thousands of readers.

Beginning with the March issue, RADIO NEWS will feature four-color covers, and we are selecting many unusual Kodachromes covering all phases of radio . . . both military and civilian.

The Tube Collector

THE response to our request for suggestions and opinions regarding the formation of a Tube Collectors' Club has met with the wide approval of many of our readers. Full particulars are given on Page 35. We expect that several more will be able to qualify for membership. This department will appear each month.

We're a bit short of breath this month. Our deadline was moved up, and we are preparing to enjoy the forthcoming holidays. We'll be back with more later.

73, OR.....

-30-

Progress in Electronics

(Continued from page 25)

Gilbert, is an electrical tachometer—a device which indicates the number of revolutions per minute being made by a motor or similar device. A conventional magneto, developing alternating current which varies in voltage and frequency according to the speed at which it is driven, is coupled to the motor shaft.

Its output is fed through a full-wave rectifier, which changes the current to a pulsating d.c., the voltage and rate of pulsation determined by the generator's speed. This d.c. passes through a coupling coil, the impedance of which is so designed that it depends upon the pulsation frequency. Thus the voltage and the rate of pulsation control the amount of current passing through the coupling coil, which in turn acts upon an indicating device not unlike a milliammeter. The higher the speed

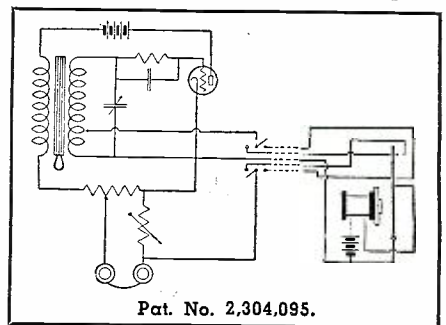

at which the magneto revolves, the higher the reading on the indicator. Simple and positive as this device is, who can say that the automobiles of tomorrow may not have electronic speedometers of this sort?

The Hazeltine Corporation, which was perhaps one of the greatest of radio companies in the days of the neutrodyne circuit, appears to be making preparations to become an important factor in the post-war television field for it is collecting a number of patents in this art, at least two from H. M. Lewis. One of these, No. 2,300,452, covers a combined power supply and scanning generator system; the other, No. 2,300,942, is for a carrier-signal receiver control system. Both are too complex to be fully described in the space available here. However, the former includes a relaxation oscillator for generating a periodic voltage; coupled to this oscillator is a rectifier and a two-part filter circuit which has unequal time constants in each part. Thus one part of the circuit provides a saw-tooth wave, while the other puts out a high-voltage d.c. The former component affords a scanning frequency; the latter provides a space charge.

The second of Mr. Lewis' patents also deals with reception. It may be summed up as a means of cutting the peaks off excessively high signal amplitudes.

Philco is also highly active, and one

THE CONDENSERS YOU NEED

When You Need Them

You can handle 90% of all dry electrolytic condenser replacements with Sprague ATOM Midget Dries and Sprague El Prong-Base Dries. They fit anywhere. They're more dependable than the big condensers they replace. Equally important, your Sprague jobber has them in stock in a full line of voltages and capacities, as well as in dual and triple combinations.

Speed up your work—insure greater customer satisfaction by using Sprague ATOMS on every job!

SPRAGUE PRODUCTS CO., North Adams, Mass.

SPRAGUE

ATOMS

"Mightiest Midgets of All"

they may see fit. Later we hope to publish some of the prize winning articles, providing they do not reveal information which will be of help to our enemies.

It was gratifying to look over the large number of entries from men in our armed services. In spite of their heavy training programs, they have found time to make their personal contributions in so grand a style.

Heartiest congratulations, fellows! You did a swell job, and your efforts show that you did a great amount of work.

Looking Back!

THE past year, we feel, has been the most interesting, editorially, that we have had the pleasure of witnessing during our association with RADIO NEWS. It wasn't so far back that editors were wondering how they would fill their allotted space with technical and other material due to the exigencies of war. The first blow was the rigid censorship imposed by the authorities on all publishers of technical books and magazines. At first this appeared to be a definite handicap, but later proved no obstacle whatsoever in presenting up-to-the-minute information on radio and electrical developments in general, and in presenting exclusive and authentic information regarding our war effort from the radio viewpoint. We are grateful on one hand that in this country we do have a rigid censorship, and we have found that in all but few cases, photos and other material have been censored justifiably. We must not forget that radio may well be our Number One item in winning this war. The release of any information to the enemy on developments of vital importance would be most hazardous. Uncle Sam cannot take chances!

On the other hand, we find much criticism being directed to those responsible for censorship with the claim that they are not able to present factual data without revealing military secrets. We see no reason for this reaction.

1942 was a banner year for RADIO NEWS, and was climaxed with the publishing of the *Special U. S. Army Signal Corps* issue in November. This was our answer to a demand for complete information on the activities of our communications branch. Each and every article was carefully scrutinized by proper authorities, and released through the regular channels of censorship. This should be the answer to the question whether or not radio material of military nature can be disclosed without going into highly technical aspects.

Looking Forward!

WE anticipate another banner year for RADIO NEWS in 1943. In keeping with our policy of expansion, we have added many more pages to each issue, in order to cover editorially the rapidly growing radio and electronic field. In fact we are faced each month with an overabundance of ma-

FROM that high resolve was born the Army-Navy Production Award which stands today as our fighting forces' joint recognition of exceptional performance on the production front . . . of the determined persevering, unbeatable spirit which can be satisfied only by achieving today what yesterday seemed impossible!"

We're sincerely proud of our award — its significance will always be our goal.

BLILEY
FREQUENCY CONTROL
SERIAL NUMBER
115555
TESTED BY
7411 KF
MADE IN U.S.A.
ERIE PA.

BLILEY ELECTRIC COMPANY · ERIE, PA.

Bliley Crystals

record production for next year. Whether or not shellac will not be available, they say the industry will come through with records, and good ones too.

The Phantom Antenna

DUMMY antennae have won their spurs. Long a valuable aid to those in laboratories, the dummy antenna, now more familiarly known as the phantom antenna, has become a device of importance to many, particularly to those in the aircraft. The phantom antenna is a device that provides the electrical results of a larger out-door device. In this way, it serves

as an able substitute for the study of the transmission and reception characteristics of devices. It is easy to see how important this is to aeronautical work where the antennae are not only peculiar as to physical structure, but unusual in an electrical way. In addition, since the characteristics of antennae on a plane will vary in flight, it is necessary to duplicate these characteristics in a stable way and in a laboratory where an accurate study of the results can be made.

Some of the phantom antennae designed cover the very high frequencies of 2 to 10 megacycles. The increased interest in this form of antennae will

lead to its wide-spread use in the post-war era, resulting in receivers and transmitters of an exceedingly high efficiency. This will be particularly true with receivers where dummy antennae have been used in a very restricted way, and on television and other ultra-high-frequency developments.

Cash Prize Winners

WE are happy to announce the following prize winners in the *National Competition For Radio Inventions*:

FIRST PRIZE of \$300.00 goes to Thomas M. Morse and John M. Petty of 520 East C St., Belleville, Ill., for their outstanding entry. While we cannot reveal full details of this entry, we feel sure that they have made a definite contribution, not only to radio in general, but as a possible item of military value and one which will eventually be of immeasurable value to the country.

SECOND PRIZE of \$125.00 goes to Samuel E. Bohrer of the 79th School Squadron, Chico Army Flying School, Chico, Calif.; and third prize winners of \$75.00 are Charles J. Schauers and James E. Potts of the 113th Signal Radio Intelligence Company, Camp Crowder, Mo. (One entry)

Prizes of \$10.00 each have been awarded to the following:

Donald F. Kleinschmidt, 3636 Grand Blvd., Brookfield, Ill.

Willard R. Moody, 2035 Park Road, Washington, D. C.

Edward M. Arand, 3125 N. Emerson St., Franklin Park, Ill.

Donald A. Thorhaug, Mt. Horeb, Wis.

Beryl L. Dassow, Radio Station WIBC, New Augusta, Ind.

Orville C. Crossland, General Delivery, Hooser, Kan.

Abe Berman, 213 Governor St., Paterson, N. J.

John H. Homrighous, 1029 Wenonah Ave., Oak Park, Ill.

Bill Benner, 145 S. Maple St., Webster Groves, Mo.

James W. Burnside, 1035 N.W. 49th St., Miami, Fla.

All entries have been forwarded to the *National Inventors Council*, Washington, D. C., and no manuscripts are being retained by this office at the present time until the council has had sufficient time to take whatever action



"Sure, I'd Rather Wear Shorts..."

... certainly, I'd rather have the house heated to 75, but if those fighting planes need the oil, I'll do with less."

★ That's the patriotic attitude your customers will take if you explain how the armed forces need radio parts. They'll be grateful you got their sets into operation; willing to accept that occasional repair job that might be a little less than perfect.

★ For, there will be jobs where the shortage of duplicate replacements will make it necessary for you to improvise in order to get a set operating at all. This will be most frequent with those 8-10-12-year-old sets coming to your shop today.

★ To improvise efficiently—to know what sections of a set can be eliminated, what parts can be substituted for—you must have complete information on what's in the set.

★ That's where Rider Manuals help you. They guide you quickly to the cause of receiver failure and furnish the data necessary for a quick repair.

★ Don't waste time guessing out defects and experimenting with "possible" ways to improvise repairs. Reach for one of your thirteen Rider Manuals when you begin every job. It's your duty today to service more sets—"Keep 'em playing" in more homes.

RIDER MANUALS

Volumes XIII to VII.....\$11.00 each
 Volumes VI to III.....8.25 each
 Volumes I to V Abridged.....\$12.50
 Automatic Record Changers and Recorders... 6.00

OTHER RIDER BOOKS YOU NEED

The Cathode Ray Tube at Work.....\$3.00
 Frequency Modulation.....1.50
 Servicing by Signal Tracing.....3.00
 Meter at Work.....1.50
 Oscillator at Work.....2.00
 Vacuum Tube Voltmeters.....2.00
 AFC Systems.....1.25
 HOUR-A-DAY-WITH-RIDER SERIES—on "Alternating Currents in Radio Receivers"—on "Resonance & Alignment"—on "Automatic Volume Control" on "D-C Voltage Distribution." 90c each

JUST OUT!

A-C CALCULATION CHARTS—Two to five times as fast as a slide rule—and more fool-proof. All direct reading—operative over a frequency range of from 10 cycles to 1000 megacycles. 160 Pages—2 colors—9½x12 inches.....\$7.50

FOR EARLY PUBLICATION

Inside the Vacuum Tube—complete elementary explanation of fundamentals of vacuum tubes.

JOHN F. RIDER PUBLISHER, Inc.

404 Fourth Avenue, New York City

Export Division: Roche-International Electric Corp.
 100 Varick St., New York City • Cable: ARLAB

**YOU NEED ALL THIRTEEN
 RIDER MANUALS TO "CARRY ON"**

in the drawing, the thyatron tube grids are biased to a sufficiently negative potential by battery V2 to prevent the flow of anode current through the counter, but as the commutator rotates brush A breaks contact with C, while brush B makes contact with C and in this position battery V1 charges C1 through R1. If the potential across C1 reaches a value large enough to neutralize the negative potential of V2, the thyatrons fire and the anode currents operate the relay. Time required to charge C1 is a function of the setting of variable R1. To adjust the instrument, commutator C is rotated at normal velocity and R1 is set so the thyatrons are on the point or verge of firing. If the commutator rotates at a more rapid rate than is considered normal, brush B is in contact with C so short a time that the thyatrons cannot fire under any anode voltage condition, and should the commutator rotate slower than is normal, the charging time of C1 is increased, causing the tubes to fire. This results in the counter operating once each cycle so long as subnormal conditions of liquid flow remain in effect.

-30-

For the Record

(Continued from page 4)

problem. Allotments of shellac are being reduced to an increasingly small percentage. In October, for instance, the allocation was only 15%. In November, it was about 5% of last year's normal consumption. And it is problematical as to what the future months will bring. Efforts are being made to establish at least some proportionate supply, but with shipping becoming restricted more and more, it is naturally difficult to prepare any prediction as to what will be available. Fortunately, scrap has been an excellent source of shellac. The recent campaigns have been of inestimable help in providing sufficient material to maintain at least some substantial degree of production. If, of course, the restriction on shellac becomes more intense, it may be impossible to buy a new record without returning an old one.

There have been some reports in Washington that one of our record manufacturers has found a suitable alternate for shellac. That manufacturer, upon interrogation, refused to comment. However, there is a general feeling in the industry that a suitable substitute will be found and very soon, too. And this substitute will be one that cannot be dismissed as a crude alternate. Neither the record manufacturers nor the public would condone such a practice. It is simple to see that the recordings must be efficient in order to provide reproductions to which we have all been accustomed.

Dealers feel quite optimistic about

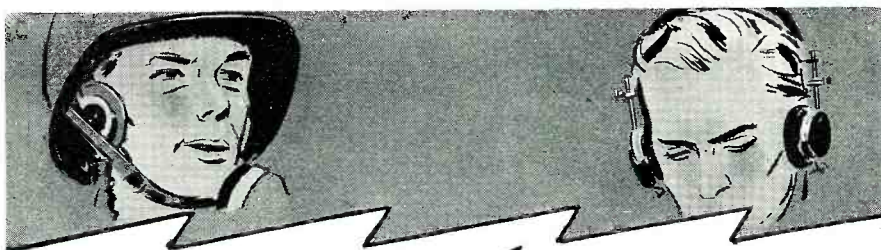

Everybody in Radio Knows Murdock!



BEHIND today's war production at Murdock is 39 years of "know how"!

In 1904 William J. Murdock saw clearly that sensitive Radio Phones could be made only by precision methods. He manufactured each part with scientific exactness.

In each year since, requirements for Radio Phone sensitivity and durability have become increasingly strict. Murdock has kept pace.

Today the U. S. Army Signal Corps and Air Corps take most of our production. Murdock Radio Phones must be right to meet their specifications.

Ask anybody in Radio—they know Murdock! Catalogue on request—write to Dept. 39.



Murdock RADIO PHONES

**MURDOCK MANUFACTURING CO.
CHELSEA, MASSACHUSETTS**

One of the most important men of radio recently died, Major General Charles McKinley Saltzman. As chief signal officer in the Army from 1924 to 1928 and chairman of the *Federal Radio Commission*, his knowledge of communications brought outstanding success to these branches of the service. It was his interest in telegraphy that brought him into radio and to the military post, where he achieved such distinguished success. In Washington and throughout the world his loss is mourned by all. . . . D. W. May, formerly sales manager of the metropolitan dis-

tributing branch of G.E., has been named Eastern Regional Manager of the receiver division. . . . Henry C. L. Johnson, of *Sylvania Electric*, is back in the Navy again as an ensign. When Mr. Johnson graduated from Northwestern in 1932 he was also an ensign in the Naval Reserve and served on the Battleship *Wyoming* and the destroyer *Fairfax*. . . . George K. Throckmorton, chairman of the executive committee of RCA, manufacturing company, has been elected a director of RCA. . . . Dr. Ralph L. Power, well-known advertising manager of Univer-

sal Microphone is now an inspector in the U. S. Army Signal Corps. In World War 1 Dr. Power served overseas as a warrant officer. . . . Madison Butler, assistant chief inspector of Stromberg-Carlson, recently received a WPB award for individual production merit by President Roosevelt at the White House. Mr. Butler's development was a testing device that reduced testing time from 80 man hours to one man-hour, saving on one order, according to officials of the company, close to 87,000 man-hours. . . . E. L. Bragdon (Bragg) for years radio editor of the

New York Sun is now serving as a trade news editor at NBC. . . . Joseph E. (Dinty) Doyle formerly radio editor of the *New York Evening Journal* is now publicity director of WABC. . . . Arthur Perles, formerly in charge of CBS short-wave information, is now assistant director of CBS publicity, with George Crandall as director of CBS publicity. . . . A recent visitor to Washington was Commander Pierre Boucheron who is on a leave of absence from Farnsworth Television where he is Assistant Vice President. Commander Boucheron was in active service for more than twelve months.

-50-

Devices for Industry

(Continued from page 31)

comes inoperative until again the ship departs from its true bearing.

Fig. 2 illustrates the general mechanical and electrical mechanism.

Hydraulic Flow Indicator

Industry uses flow indicators widely, and the device of Fig. 3 is most useful. Some processes require a continuous indication of the rate of flow, while others only demand an indication when flow becomes subnormal or abnormal. This electronic system operates a counter when the rate of flow is below normal. The length of time during which subnormal flow takes place may be calculated. The commutator, C, is rotated by the flowing liquid. When it is in the same position shown

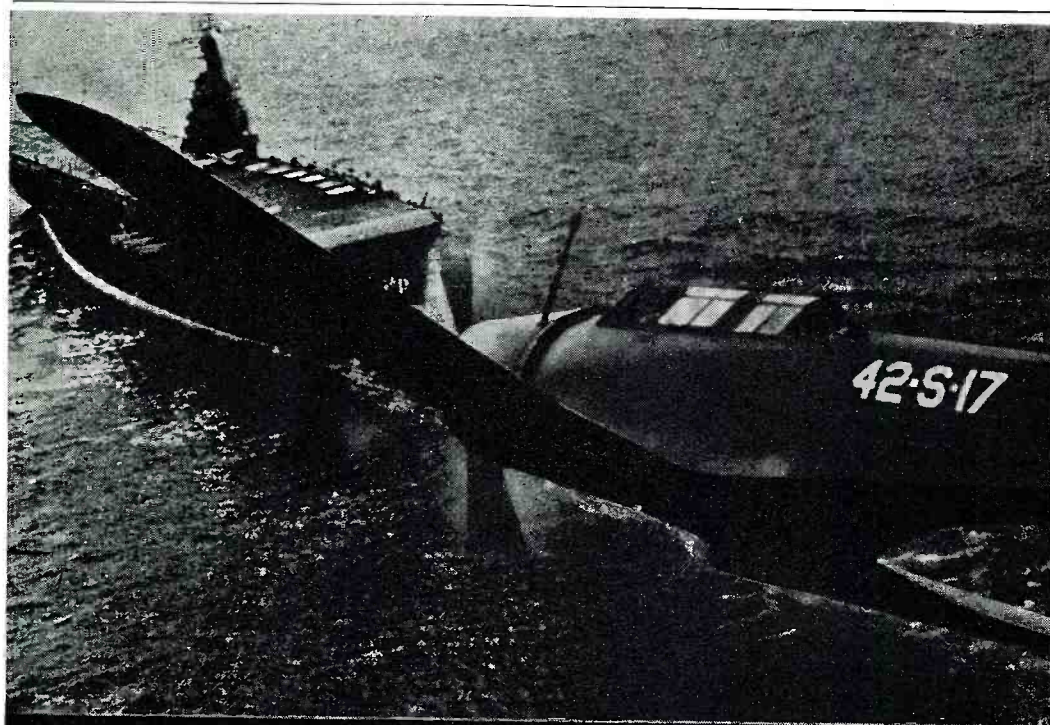

DESIGNED FOR SPECIFIC APPLICATIONS

U. S. NAVY OFFICIAL PHOTO

The bulk of U.T.C. production is on special units constructed to precise customers' requirements. It is naturally impossible to describe all of these thousands of designs as they become available. Many of them are unique.

In most cases, today, a major design factor is the conservation of material, or provision of substitutes for critical materials. All in all, it is significant that the difficult transformer jobs find their way to U.T.C.

MAY WE ASSIST YOU IN YOUR PROBLEM?

UNITED TRANSFORMER CO.

150 VARICK STREET

NEW YORK, N. Y.

EXPORT DIVISION: 100 VARICK STREET NEW YORK, N. Y. CABLES: "ARLAN"

ATTENTION—AMATEURS!
FOR SALE
QUANTITY OF
SEEBURG DELUXE
AUTOMATIC RECORD CHANGER
and
HOME RECORDER

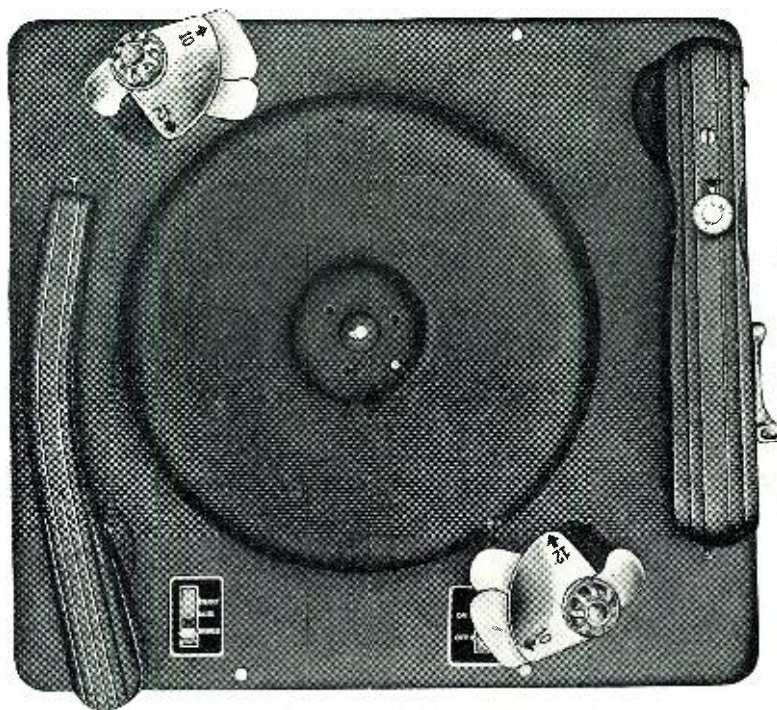

Model No. BR 29 (for AC only)

These are brand new units in original factory cartons. They are completely equipped including mounting bolts and coil spring supports, and each unit has an elaborate instruction booklet. But the units are minus needles and AC and pick-up wires which can be attached quite simply. Terms of payment are by money order or certified check accompanying each order.

This offer is being made subject to prior sale.

PRICE \$3295
ea., net cash

F.O.B. our warehouse in N. Y. City
Approximate Retail Value \$95.00

COLEN-GRUHN CO., Inc., 387 Fourth Ave., New York, N. Y.

Spot News

(Continued from page 44)

The late Roy A. Weagant is also recipient of a patent on a superheterodyne receiver wherein proper control of modulated and unmodulated carriers are affected. This system provides, for instance, for the removal of modulation side bands from modulated

carrier frequencies to provide a substantial unmodulated carrier energy of a different frequency, the results of which are combined to produce a composite frequency desired.

Pre-set frequency rejection and intermediate frequency amplifiers are the subjects covered in the patent awarded to Emerick Toth. A method of dividing coupled pre-determined frequency resonant circuits into two

parallel branches with correct voltage and load sources controlled.

A microphone that can be conveniently carried in the pocket of a coat or under the clothing without absorbing vibrations imparted to the case by scratching or similar causes has been invented by Joseph R. Cubert. This unique development provides a new method of sound pick-up in which only the audio signal directed is involved.



IF THIS WERE AN OFFICIAL ARMY OR NAVY PHOTOGRAPH...

If this were an official Army or Navy photograph it would be on the restricted list, with publication prohibited. Actually it is from the National Catalogue published before the war. Yet basically the receiver is the same. True, it is now built to government specifications rather than the amateurs'. There are new refinements that we cannot even tell you about, but which make it a better receiver than the one you have known. But basically it is still the same receiver.

When you turn to it after the war as to an old friend, you will find that it looks different, performs better and handles more easily. Yet you will find that it is still designed and built in the tradition that made a receiver engineered for peace meet the rigorous demands of war.

NATIONAL COMPANY, INC., MALDEN, MASS.



ONE OF THE MOST IMPORTANT CONTRIBUTIONS TO ELECTRONICS has been the use of high-frequency induction heat for brazing. Previously, this operation was performed with torches. And because a quality joint was necessary, only skilled workers could be used for this work. With, however, the application of electronic high-frequency induction heat, a quality joint can be made in 40 seconds instead of 4 minutes and by women operators. Probably one of the most effective explanations of induction heat was made recently by J. P. Jordan of General Electric. He compared induction heat with that of the radiant heat of the sun. He said the sun's rays passed through space with little loss and yet when they strike a dark body, the surface is heated. In a similar manner the high-frequency pulsating magnetic waves radiated from the induction heater coil passed through all insulating materials with little loss and yet they create heat when they strike any metallic body. In actual use, the part to be heated is placed in a water-cooled copper tubing coil and current is passed through the coil at frequencies of ½-million cycles per second. It is this current which generates the pulsating magnetic field that heats the part. And like the sun's effects, the intervening air is not affected. Neither is any part of the human body which may be in the magnetic field affected by the heating action of the high-frequency pulsating field.

FIX ANY RADIO

Amazing New Invention

**Simplified
Radio
Servicing
by
Comparison
Method**

Learn radio by a simplified method. Repair radios in minutes instead of hours. Revolutionary, different Comparison technique permits you to do expert work almost immediately. Most repairs can be made without test equipment. Simple point-to-point, cross-reference, circuit suggestions locate faults quickly and easily.

COMPLETE
\$1.50
ONLY
SPECIAL OFFER
READ THE DETAILS

FOR BEGINNERS OR EXPERTS

Understand radio principles; find any radio fault with ease. Follow the comparison tests given on 16 large trouble-shooting blueprints. Over 1,000 practical repair hints. Hundreds of simplified tests using a 5c resistor and a filter condenser. Covers every radio set—new and old. Introductory material for beginners and to serve as a review for experienced radio men. Also several chapters on test equipment. Presented in manual form, 112 fact pages 8½ x 11 inches. Entire plan is stark new and will help you get ahead in radio quickly.



Developed by
M. N. Beitman,
radio engineer,
teacher, author,
& serviceman.

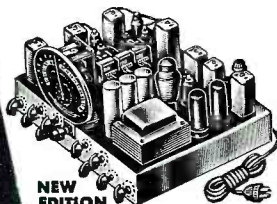

NEW EDITION

REPAIR ANY RADIO IN MINUTES

Learn how to localize the trouble without any equipment. Make tests, measure voltage, trace the signal with a resistor, small condenser, and a crystal detector. Inject signals without any signal generator. Test parts by the new Comparison method. Test tubes without equipment. Repair any radio expertly following illustrated, simplified plans. Improve your radio servicing ability. Examine the plan without obligations—without risk. Send coupon.



PRACTICAL USEFUL FACTS AND HINTS

Hundreds of service hints, trouble-shooting ideas, simplified tests, repair suggestions, and alignment methods are included. Benefit by the experience of others. Use the most practical method for finding the fault and making the repair. Save time on every job.

FIX MOST SETS WITHOUT TESTERS

Follow the COMPARISON technique and repair 4 out of 5 sets without equipment. Speed up your work; locate faults quickly; make repairs efficiently. Be fair with yourself and try this new plan without obligation. Take advantage of our "no-risk" trial. Send coupon today. Use this time-saving, money-making radio servicing training for 10 days without any obligations. See how quickly you will learn helpful methods. Save time every day on every radio job. Learn new short-cuts in radio servicing. Get ahead in Radio. Repair sets for fun and profit. Prepare for higher rank and better pay in the Army. Act today.



MONEY-BACK GUARANTEE

You must be entirely satisfied or your money will be refunded without a question. The training will more than pay for itself on the first radio job or with higher rank in the Army. Examine and use this unique plan for 10 days at our risk. Send coupon right now—use the plan this week.

Other Practical Radio Manuals

How to MODERNIZE RADIOS for Profit



Cash in by improving audio circuits, modernizing cabinets, adding features usually found on late model sets. Practical job-sheets with schematics and photographs make the work easy. You are told how to obtain modernization work, what to charge, and how to complete the job quickly and efficiently. Large size, 8½ x 11 in. manual is priced at only **\$1.00**

MOST-OFTEN-NEEDED RADIO DIAGRAMS



The most popular radio diagrams available in low priced manuals. Large size: 8½ x 11 inches.
1942 Manual, Volume 5, 204 pages.... **\$2.00**
1941 Manual, Volume 4, 192 pages.... **each NET**
1940 Manual, Volume 3, 208 pages.... **\$2.50**
1939 Manual, Volume 2, 192 pages....
1926-38 Manual, Volume 1, 244 pages, alignment, hints, parts lists.....

PRACTICAL RADIO MATHEMATICS



Introduces and explains the use of arithmetic and elementary algebra in connection with units, color code, meter scales, Ohm's Law, alternating currents, ohmmeter testing, wattage rating, series and parallel connections, capacity, inductance, mixed circuits, vacuum tubes, curves, the decibel, etc., etc., and has numerous examples. Net..... **25c**

SEE YOUR RADIO JOBBER OR SEND COUPON

Supreme Publications

PUBLISHERS OF RADIO BOOKS, MANUALS, AND DIAGRAMS

328 South Jefferson Street

Chicago, Illinois

"NO RISK" TRIAL ORDER COUPON

SUPREME PUBLICATIONS, 328 S. Jefferson St., Chicago, Ill.

Ship my copy of the complete Simplified Radio Servicing by COMPARISON Method manual. I must be entirely satisfied or you will refund my total remittance.

- I am enclosing \$1.50, full price. Send postpaid.
- Send C.O.D. I will pay the mailman \$1.50 and a few cents postage.
- Also send other Supreme Publications books as listed on attached paper.

NAME

ADDRESS