

RADIO NEWS

JUNE
1940
25c

Putting up a
Cheap Antenna

Serviceman's
1-Tube Signal Tracer

A Receiver for
Your Cycle

"Mobile on 10"

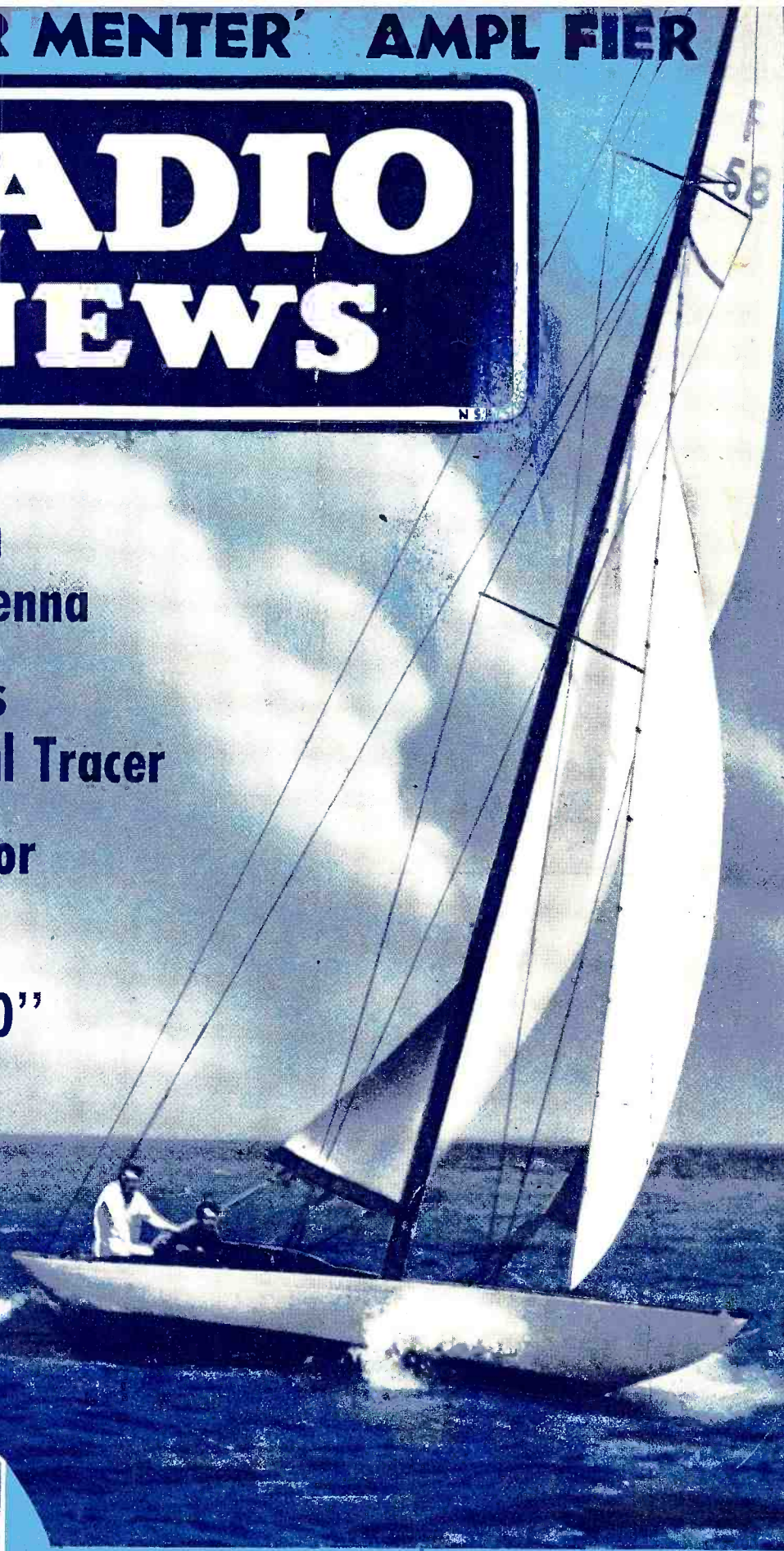

BUILD THIS
MAR NE RECEIVER
FOR YOUR BOAT

SEE P.

FREE COURSE IN AMATEUR RADIO

Read about this amazing offer to DAVEGA Customers!

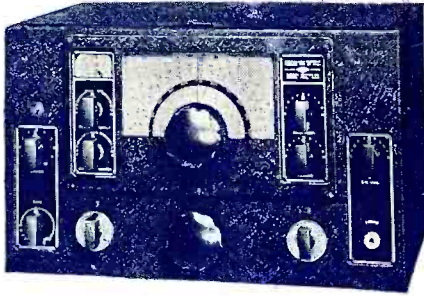

NATIONAL NC 100 A

11 tubes—5 bands—full vision dial.
 Model NC-100 A \$120.00
 Model NC-10X A 129.50



HALLICRAFTER SX23

8 bands—4 amateur, 4 general coverage. No drift I.F. circuit. Complete with crystal and speaker **\$127.50**

DAVEGA has the most complete stock of RME in America

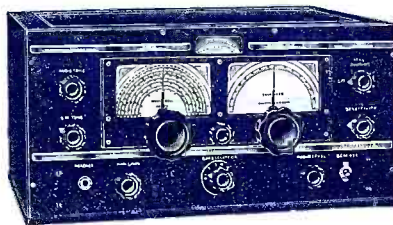

RME-70. The late development of RME laboratories is proving itself to be one of the finest communications receivers.

in Cooperation with

AMERICAN RADIO INSTITUTE

[**\$25** VALUE]
 REGULAR VALUE

Now, Davega - City Radio, in cooperation with Mr. John Hart, President of the American Radio Institute, offers you a free course in amateur radio reception and transmission. This course which regularly sells for \$25 is yours absolutely free with the purchase of a standard communications receiver selling for \$80 or more. With this course we will lend you a code transmitting machine with specially cut tapes using Mr. Hart's famous rhythm method of sending. A small deposit for this equipment will be required. This will be returned at the completion of the course. Hundreds of amateurs on the air today owe their success to Mr. Hart's famous teaching method. Take advantage of this Davega offer while it lasts. Send for literature.

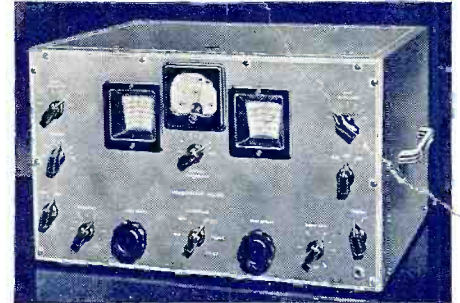

HAMMARLUND HQ120X

6 Bands—Calibrated bandspread—Crystal filter—Chosen by Admiral Byrd. Complete **\$138.00**

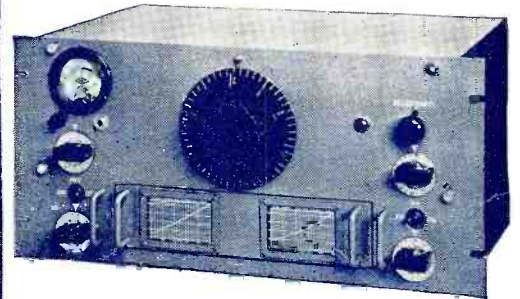

NATIONAL HRO

Two preselector stages. World famous for years. Complete with speaker and power supply **\$205.50**

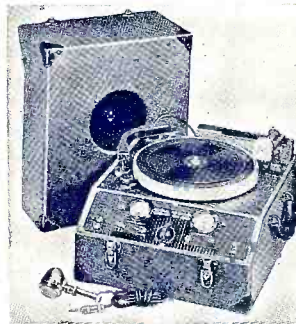

Federal Recorder PR-12

(Illustrated)

Portable model with 12" turntable, 78 RPM heavy duty constant speed synchronous motor, 8" Wight-DeCosta Dynamic speaker, and built-in radio. Includes \$25.00 crystal microphone and \$12.00 chromium plated stand. Weight of recorder, approximately 55 pounds.

LIST PRICE **\$249.00** **\$110**

McMURDO SILVER 15-17 High Fidelity & D.X. Champion



25 Watt Hi-Fi Audio system. Giant Jensen Silver 15" spkr. Solid welded chassis 20 x 12 3/4. Reg. \$205.00 **\$109.50**
 McMurdo Masterpiece VI. Giant 18" Silver Jensen spkr. Volume Expansion, 40 Watt undistorted output. Reg. \$355.00 **\$199.50**

DAVEGA

Easy Terms Arranged
AMATEUR DIVISION
63 CORTLANDT ST.

New York City, N. Y.
 World's Largest Retail Radio Dealers

Yours for Better Pictures

A well-rounded photographic education in
TEN POCKET-SIZE TEXT BOOKS

Camera fans, let the Little Technical Library PHOTOGRAPHIC SERIES guide you through every phase of amateur photography; teach you the masterful photographic technique of such experts as Ivan Dmitri, Herbert C. McKay, Harold Lambert and many others. Here, in understandable form, is up-to-the-minute counsel on everything you've always wanted to know about photography. Each of the ten authoritative volumes is complete in itself; each deals simply, clearly, thoroughly with its chosen subject. This grand photographic library is beautifully printed, richly bound in blue leatherette, and brilliantly illustrated with a profusion of color plates, half-tones, line drawings, graphs, charts, etc. With this handy set of ten pocket-size text books at your fingertips, you need no longer grope for guidance. Now you can enjoy photography to the fullest! Now you can get more pleasure out of your hobby! Yes, the Little Technical Library PHOTOGRAPHIC SERIES is yours for better pictures!

Little Technical Library PHOTOGRAPHIC SERIES

- COMPLETE
- ILLUSTRATED
- AUTHORITATIVE

**50¢
EACH**

NO. 1—YOUR CAMERA AND HOW IT WORKS by W. E. Dobbs and Charles A. Savage, with a Foreword by C. B. Neblette, F.R.P.S. Selection, use, focusing, composition, lens, shutters, roll film translators, cut film and film packs, accessories, etc. 132 pages.

NO. 2—DEVELOPING, PRINTING, and ENLARGING by Al and DeVera Bernson. Elementary and advanced developing, chemicals, types of printing, enlarging equipment, elementary and advanced enlarging, care of prints, etc. 96 pages.

NO. 3—FILTERS AND THEIR USES by W. Bradford Shank. Types, selection, use, requirements, advantages, problems, suggestions, the care of, etc. Informative and up-to-the-minute. 96 pages.

NO. 4—COMPOSITION FOR THE AMATEUR by Kenneth Heilbron. This book is complete and workable. It covers the joining of subject and picture, tones, lines, rhythm, problems, suggestions, etc. 96 pages.

NO. 5—MOVIE MAKING FOR THE BEGINNER by Herbert C. McKay, F.R.P.S. Modern movies and cameras, use, movies versus photography, producing, editing, processing, projection, etc. 100 pages.

NO. 6—COLOR IN PHOTOGRAPHY by Ivan Dmitri. Types of subjects, natural color film, mounting, projection, color separation, density scales, printing, etc.

NO. 7—CHILD PHOTOGRAPHY by Harold Lambert. Cameras and equipment, posing, types of pictures, finishing and processing, in natural color, problems, etc. 96 pages.

NO. 8—HOME PORTRAITURE AND MAKE-UP by Maurice Seymour and Syd Symons. Part I: Lighting, camera, model, posing, background, and suggestions. Part II: Re-styling contour, eyes, eyebrows, lips, powdering, equipment, etc. 112 pages.

NO. 9—TRICKS FOR CAMERA OWNERS. An outstanding collection of the latest and most valuable kinks and hints, covering every phase of amateur photography. 160 pages.

NO. 10—A GLOSSARY FOR PHOTOGRAPHY. Compiled by Frank Fenner, Jr. Over 3000 words having photographic significance are defined. They cover still and motion-picture photography in black-and-white and color. 152 pages.

**AT ALL LEADING BOOK SELLERS,
CAMERA AND DEPARTMENT STORES**

NOTE: If your dealer cannot supply you, order direct, enclosing your check or money order. Write to:

ZIFF-DAVIS PUBLISHING COMPANY
Book Dept., 608 S. Dearborn St., Chicago, Ill.

(60c Each outside of U. S. A.)

**ATTENTION DEALERS! ORDER FROM
YOUR PHOTO SUPPLY JOBBER TODAY!**

WITHIN

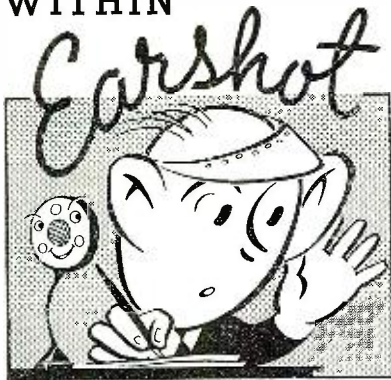

OF THE EDITOR

YEARs ago we used to watch Walter Winchell prepare his daily stint. Sometimes he would sit in front of his typewriter with a blank piece of paper in the machine, and a similar look on his face.

"Say, Walter," we'd ask, "what do you do when you can't think of anything?" "You write just the same," he said "because you have to eat, and you know that umpteen thousands of people are waiting for your typewriter to start."

Well, we feel just like Walter did on those occasions, with one exception . . . no matter what we write it won't have the pith, nor the "punch" the old Master has in his pen. Sometimes we just wish we hadn't met Walter . . . he's so hard to emulate!

* * *

SUGGESTION to *RADIO* and *QST*: Please put out some information in your respective handbooks on what *should* happen to the rectified mils in the grid circuit of an amplifier when the final is loaded down. We here at *RN* have been making experiments towards discovering just what percentage of the non-loaded rectified mils the final figure should be, but have made very little headway because of our limited facilities. Inquiry among the other engineers in this city revealed that they, too, had very little information. Why not help all the hams with the dope since you each have the labs and the man-power to do the job. We know from listening on the air and from our mail that the outstanding subject, next to antennae (Ah, there, Mr. Webster!) is "Rectified Mils."

* * *

WATCH the new department, "For Immediate Release." In it we will be able to feature all the "hot" and "spot" news that comes our way. For the very latest and most interesting shorts in the radio industry, don't fail to read, "For Immediate Release."

* * *

GOT a pet? Interested in pets? Want to know something about pets? Catch the new addition to the Ziff-Davis Publishing Company family, "Popular Pets." Swell for the kiddies and grand for anyone who ever had a pet, or who has one now. Some very interesting information about all animals, too.

* * *

SCORe one for *RN*. Sometime ago we said that the police would welcome the frequency modulation. We also suggested that they would like a working model. We were right. Chicago's Finest are experimenting with FM and (*Turn to page 55*)

RADIO NEWS

Including Articles on POPULAR TELEVISION

The Magazine for the radio amateur
experimenter, serviceman & dealer
VOL. 23, NO. 6

Contents for June, 1940

FEATURES

- Build Your Own Marine Receiver . . .** Raymond P. Adams, W6RTL **6**
Summer boating will be more enjoyable and safer with this receiver.
- A Small Experimenter's Amplifier . . .** William D. Hayes, W6MNU **8**
An amplifier for a multitude of small jobs and uses.
- A Serviceman's One-Tube Signal Tracer . . .** Charles R. Merchant **9**
A single tube is all that is needed for trouble shooting equipment.
- Modernizing Old Receivers, Part 4 . . .** Charles Leutz **10**
Accessories improve the old set and bring the serviceman extra dividends.
- For Immediate Release . . .** **13**
A new department for hot and spot news.
- Let's Try 112 Megacycles . . .** Harold D. Millen, W1JOM **15**
For portable gear, short distances, 2½ meters is fine.
- "Mobile on 10" . . .** R. J. Hagerty, W6JMI **16**
Describing a complete mobile ham station.
- A Home-Built 1-10 Meter Receiver . . .** Paul Popenoe, Jr. **25**
A special receiver for the extreme ultra short wave reception.
- "Cheap at Half the Price!" . . .** Horace E. Eddy, W8MTZ **26**
Constructing an inexpensive yet efficient vertical antenna.
- Save That Old Cabinet . . .** Clyde D. Kiebach **27**
Converting old cabinets into a good source of revenue for the serviceman.
- Music While You Cycle . . .** H. G. Cisin **28**
Motorcycles and bicycles can be equipped with a radio, similar to an automobile.
- Doubling in Oscillators . . .** H. W. Kline **31**
Two oscillator tubes in parallel double your output.
- Increasing Loop Sensitivity . . .** Charles A. Thoman **37**
Using a loop as a sensitive direction finder.
- How About That Antenna? . . .** Ernest A. Vogt **38**
A timely discussion on the most popular subject today.

Cover Picture courtesy Agfa Ansco; photographed on Agfa Film.

DEPARTMENTS

Book Review	30	QRD?	30	Serviceman's Experi-
What's New in Radio . . .	20	Bench Notes	19	ences
Radio Physics Course . . .	60	Manufacturer's Literature	42	Serviceman's Cases . . .
Hamchatteer	32			"Remotes"
				24

Copyright, 1940
ZIFF-DAVIS PUBLISHING COMPANY
Member of the Audit Bureau of Circulations

RADIO NEWS is published monthly by the Ziff-Davis Publishing Company at 608 S. Dearborn St., Chicago, Ill., William B. Ziff, Publisher; B. G. Davis, Editor; J. Fred Henry, Vice-president; Karl A. Kopetzky, W9QEA, Managing Editor; Oliver Read, W9ETI, Technical Editor; Raymond B. Frank, W9JU, Laboratory Technician; Eugene O. Gleason, W9FXK, Engineering Draftsman; Herman R. Bollin, Art Director; John H. Reardon, Circulation Director; S. L. Cahn, Advertising Manager, New York Office, 381 Fourth Ave. Subscription \$1.50 per year, single copies, 25 cents; foreign postage \$1.00 per year additional except Canada. Entered as second class matter March 9, 1938, at the Post Office, Chicago, Illinois, under the Act of March 3, 1879. Contributors should retain a copy of contributions. All submitted material must contain return postage. Contributions will be handled with reasonable care, but this magazine assumes no responsibility for their safety. Accepted material is subject to whatever adaptations, and revisions, including "by-line" changes, necessary to meet requirements. Payment will be made at our current rates upon acceptance and, unless otherwise specified by contributor, all photographs and drawings will be considered as constituting a part of the manuscript in making payment.

It's a small world with hallicrafters

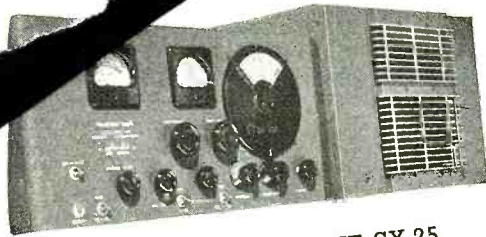

NEW SUPER DEFIANT SX-25

FEATURES: Compensation in oscillator circuit for frequency stability. DC operation socket—battery or vibrapack. Automatic noise limiter. Six step variable selectivity covering wider range from extreme CW crystal to high fidelity. S meter calibrated in "S" and DB units. 2 RF Preselection stages.

CASH PRICE with speaker **\$99.50**
 OUR NEW LOW EASY PAYMENT PLAN
 DOWN PAYMENT \$9.95 per MONTH
 \$7.91 for 12 MONTHS

BUY ON EASY TERMS
MAIL ORDERS PROMPTLY FILLED
 Write for **FREE 100-page CATALOG**

SKY RIDER DEFIANT SX-24

Frequency meter tuning—General coverage: 43.5 to .54 MC in 4 bands—Built-in Noise Limiter—Crystal Filter—Variable Selectivity—Frequency Stability—Break in Relay Operation—9 TUBES—S Meter calibrated in S units and DB—Main Tuning Dial directly calibrated

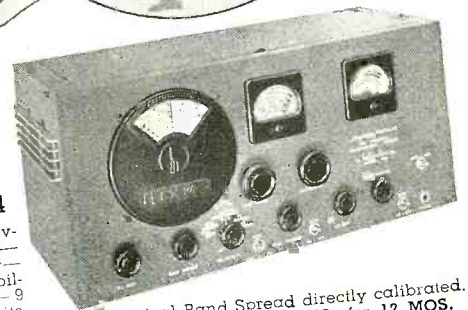

Electrical Band Spread directly calibrated. PER MO. for 12 MOS. **\$5.53**
DOWN PAYMENT \$6.95
8.15



RADIO SHACK CORP.
 167 WASHINGTON STREET • BOSTON, MASS.

Check for catalog or information.
 1940 FREE 100 PAGE CATALOG
 INFORMATION ON HALLICRAFTER MODEL

NAME
 ADDRESS
 CITY
 AMATEUR EXPERIMETER SERVICEMAN



SKY CHAMPION S-20 R

1 Additional Stage of I.F. (2 I.F. stages in all); 1 Additional Tube (making 9 tubes in all); Automatic Noise Limiter; Separate Electrical Band Spread—Inertia Controlled; Drift-Compensated High Frequency Oscillator; 3 Watts output.

CASH PRICE **\$49.50**

EASY PAYMENT PLAN
 DOWN PAYMENT **\$9.50**
 PER MO. FOR 6 MOS. **\$7.33**

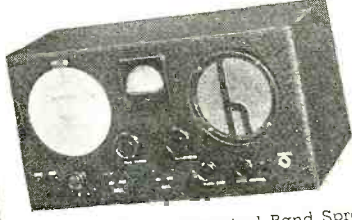

LATEST SKY BUDDY
S-19
 CASH PRICE **\$29.50**

10 Meter Band; Electrical Band Spread; 6 Tubes with 8 Tube Performance; Complete Coverage 44 MC to 545 KC; Separate Band Spread Dial; Built-in Speaker; Beat Frequency Oscillator; Pitch Control; Send-Receive Switch; Phone Jack; Band Switch; AVC Switch.

PER MONTH FOR 6 MONTHS **\$4.83**
DOWN PAYMENT \$5.50

The RADIO SHACK
 167 WASHINGTON ST., BOSTON, MASS., U.S.A.

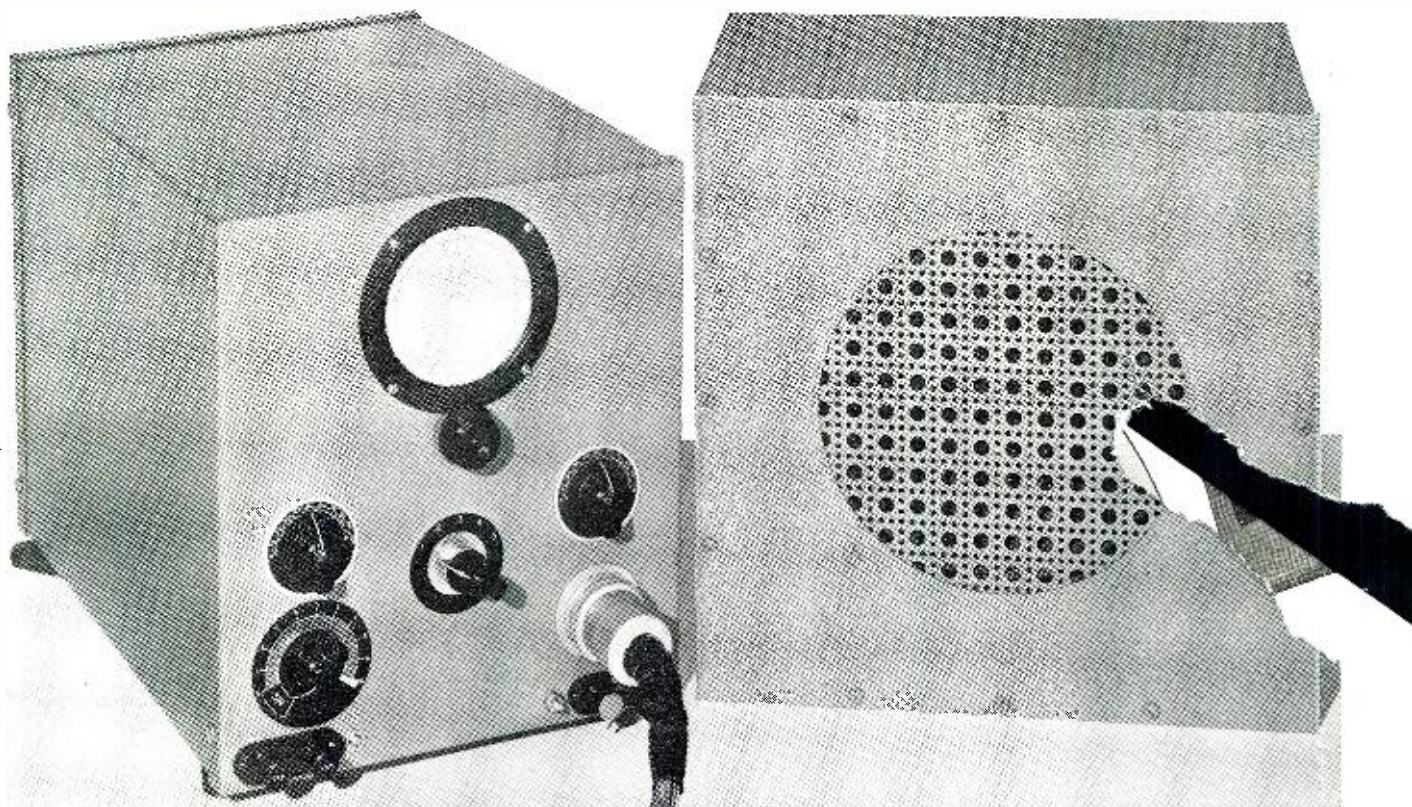

Compact in appearance, the receiver will not take up too much room aboard your boat.

Build Your Own MARINE RECEIVER

by **RAYMOND P. ADAMS, W6RTL**
Hollywood, California

This fine receiver will take in everything from 132KC to 42.3MC. It will cover from marine beacons to u.h.f. police.

IN THE August and September (1938) issues of RADIO NEWS, the writer described the construction and application of a special all-wave receiver suitable to both ham and fan use aboard ship. This particular job was really quite complete, providing for general reception on all frequencies from 132 kc. to 42.3 mc. and featuring loop-antenna input on the longer waves so that the instrument might be useful in direction-finding.

Many correspondents wrote in explaining that while they remained interested in a good all-band set for marine application, they were not particularly concerned about taking bearings at sea and wondered if the writer would not get out a much simpler design—something which less experienced radio builders might duplicate

with relative ease—retaining its all-wave tuning features but eliminating loop input and all tubes and circuits not definitely necessary to the reception of ordinary long and short wave signals of entertainment and informational value. In other words, they sought something reduced to LCD layout—compact, easy to operate, yet primarily developed for long-time use under adverse atmospheric conditions. Perhaps the writer's 1940 marine receiver will meet these requirements.

The tuning range of this simpler version of the initial all-band job will depend upon whether a 410 mmf. per section gang condenser and matching coil set or a 280 mmf. per section condenser and similarly matching coil assembly are used by the individual builder. There is definitely a choice

here; and the selection will largely depend upon the builder's own tuning requirements. If he is primarily interested in the amateur bands, then very probably the latter tuning condenser-coil assembly layout would be most suitable, as it places these bands in the most favorable LC relationships and provides for preselection at 10 meters. On the other hand, if long wave coverage is desired, then the first-mentioned tuning layout would be requisite as it alone of the two includes coils for 132-405 kc. Actual coverage for all coils in both assemblies is given in the parts list and need not be repeated here.

Electrically, the receiver is reduced to the simplest possible circuit terms: r.f. stage; mixer stage; single i.f. stage; second detector-AVC-first audio; beam

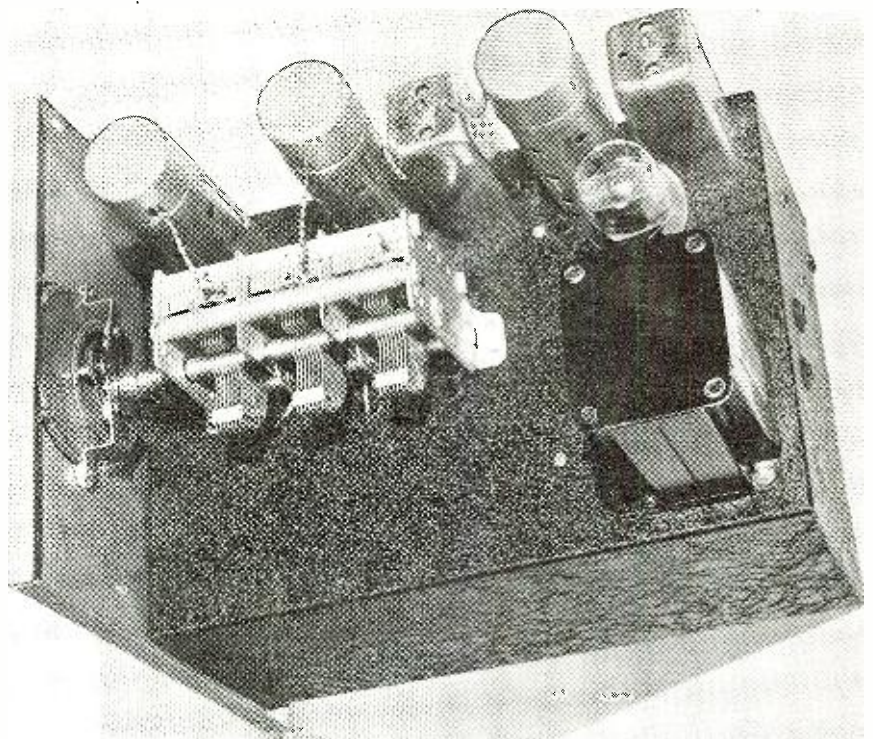
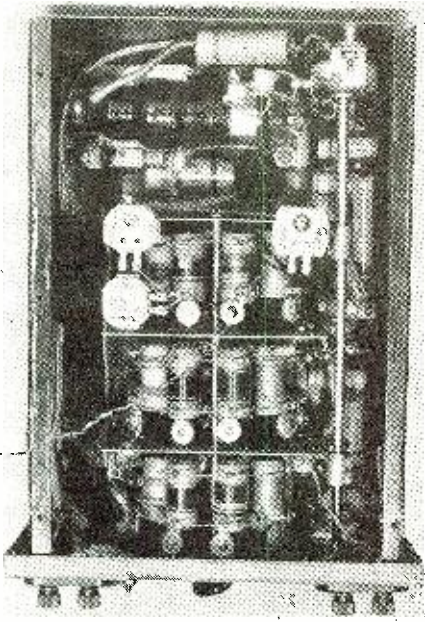

Underchassis view and a topside view of the marine receiver. Note the compactness of assembly and the lack of stray wiring in set.

power output; p.m. speaker; power supply. The circuit is straightforward and in every way familiar and features but five tubes, three of which are of the low filament drain type (the two 6S7G's and the 6T7G) and one of which (the 6J8G) provides for excellent all-band conversion when self-excited. Physically, the set is divided into three separate assemblies: tuner and audio amplifier; speaker; and power supply. All three units are compact and the

various incorporated components are well protected from humid and salt atmospheres. As for controls, they are few in number: the main tuning knob; a knob for sensitivity adjustment; one for volume control and receiver on-off (the switch on the control closes both the filament circuit and the relay circuit for the Vibrapack power supply); and a rocker knob for antenna load compensation and precision r.f. stage alignment. One shielded recep-

tacle on the front of the tuner panel permits plug-in connection to power supply and battery, while twin binding post assemblies provide for antenna input and speaker output ties.

The total "B" current is well within the 100 ma. limit of the Vibrapack and the total filament current is down to 1.20 amperes. Overall drain on the required 6 volt storage battery does not exceed 6 amperes.

(Continued on page 50)

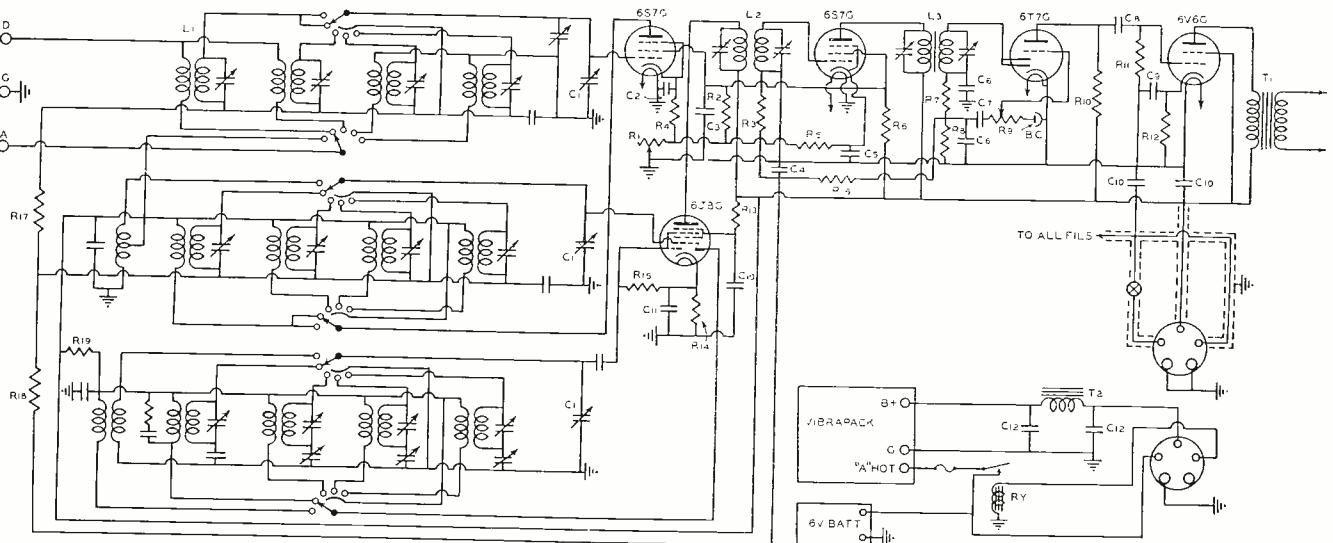

- L₁—Meissner 13-7610 coil assembly "7.15 to 2270 meters" or Meissner 13-7603 coil assembly "9.25 to 565 meters"
- C₁—Meissner 3 gang condenser 21-5230 "Used with 13-7610 coil assembly" or Meissner 3 gang condenser 21-5227 "used with 13-7603 coil assembly"
- NOTE—Assemblies, wired and aligned with all trimmers, etc.
- L₂—456 kc. input trans. Meissner 16-5740
- L₃—456 kc. output trans. Meissner 16-5742
- T₁—Output trans. Kenyon T-104
- T₂—Filter choke. Kenyon T-152
- R₁—25,000 ohms pot. Yaxley
- R₂—25,000 ohms 1 w. IRC

- R₃—100,000 ohms 1 w. IRC
- R₄—300 ohms 1 w. IRC
- R₅—300 ohms 1 w. IRC
- R₆—20,000 ohms 3 w. IRC
- R₇—20,000 ohms 1/2 w. IRC
- R₈—250,000 ohms 1/2 w. IRC
- R₉—500,000 ohms Yaxley type N
- R₁₀—250,000 ohms 1 w. IRC
- R₁₁—500,000 ohms 1/2 w. IRC
- R₁₂—400 ohms 3 w. IRC
- R₁₃—40,000 ohms 1 w. IRC
- R₁₄—400 ohms 1 w. IRC
- R₁₅—50,000 ohms 1 w. IRC
- R₁₆—500,000 ohms 1/2 w. IRC
- R₁₇—100,000 ohms 1/2 w. IRC

- R₁₈—100,000 ohms 1/2 w. IRC
- R₁₉—30,000 ohms 1 w. IRC
- C₂—1 mfd. 400 v. Sprague
- C₃—1 mfd. 400 v. Sprague
- C₄—.05 mfd. 200 v. Sprague
- C₅—1 mfd. 400 v. Sprague
- C₆—.00025 mfd. mica Sprague
- C₇—.05 mfd. 200 v. Sprague
- C₈—.05 mfd. 400 v. Sprague
- C₉—10 mfd. 50 v. electro. Sprague
- C₁₀—5 mfd. 600 v. Sprague
- C₁₁—1 mfd. 200 v. Sprague
- C₁₂—8 mfd. 600 v. electro. Sprague
- RY—6 v. DC relay—Ward Leonard 1061114
- V—Mallory 552 Vibrapack

A Small Experimenter's AMPLIFIER

by **WILLIAM D. HAYES, W6MNU**
Oakland, California

**Just the thing for the experimenter to build.
Makes a fine basic electro-phono unit.**

ALMOST everyone who has ever worked, experimented, or even twiddled with radio has felt the need of a small audio amplifier when none was available. The usual solution for this predicament is to throw together a makeshift amplifier in the hope that it will fill the bill, and because it is makeshift and thrown together, it generally turns out to be both an eyesore and an earsore. The logical solution is to build up a small amplifier to keep as a permanent piece of equipment, and to resolve not to dismantle it no matter how you pine for one of the component parts. Then when the need for an amplifier next arises, your pride and joy will be safe and sound, ready to plug in.

The amplifier described here has proven its usefulness on numerous occasions. It has served as a phono-amplifier, a modulator for five mighty watts of 160 meter r.f., the audio end of several experimental receivers, and last but not least as a code-practice oscillator. A glance at the circuit will show nothing unusual, with the possible exception of the feed-back arrangement that permits its use as an audio oscillator. A little audio from the plate circuit of the 25L6 is fed back to the grid terminal of the input transformer through a .0005 mf. condenser (C_2), and an open-circuit jack. Although a condenser of .0005 mf. may seem rather small for the passing audio frequencies, it provides just about the right amount of feedback for a nice 800 or 1000 cycle note with the gain control almost all the way down. All that is necessary is to plug in the key and fire away. If the leads to the key are more than a few inches long, it is best to use two separated wires rather than twisted pair, because the distributed capacity in the twisted pair has a tendency to maintain oscillations with the key up.

The shielding on the lead from the grid circuit of the 76 to the jack is not necessary if the lead is reasonably short, but it is put on just as a precaution against any possible regenera-

tion when the key is not plugged in. Some experimenting with C_2 may be necessary in order to obtain a note to suit your particular ear, but it shouldn't be hard to find one that's "just right," as Goldilocks would say.

When a low impedance source such as a single or double button mike is used, the regular input terminals can be employed for connection. No high impedance terminals are provided, but when using a high impedance phonograph pickup for instance, it is quite simple to clip onto the secondary terminals of the input transformer, leaving the primary open. The gain of the amplifier is ample for ordinary purposes; about .05 volts across the 200 ohm input will drive the 25L6 to full output. No output transformer is included on the chassis inasmuch as the usual procedure is to mount the transformer on the speaker itself. This arrangement also provides greater flexibility. In conjunction with a small modulation transformer, the unit makes a nice modulator for a five watt peanut whistle.

To be convenient the amplifier should have a self-contained power supply. A 25Z5 is used as a half wave rectifier in the conventional AC-DC circuit. The heaters of the three tubes should be connected as shown with the 76 at the negative end, because a high potential difference between the heater and cathode of the 76 would be undesirable, and might introduce serious hum. The input filter condenser of 24 m.f. may seem unnecessarily large, but it keeps the output voltage up where it should be; and with the introduction of the new compact electrolytics, a high capacity condenser can be fitted in almost anywhere. The actual condenser used measures 11/16" x 29/16". Speaking of dimensions, the chassis itself is 4x8x2 inches.

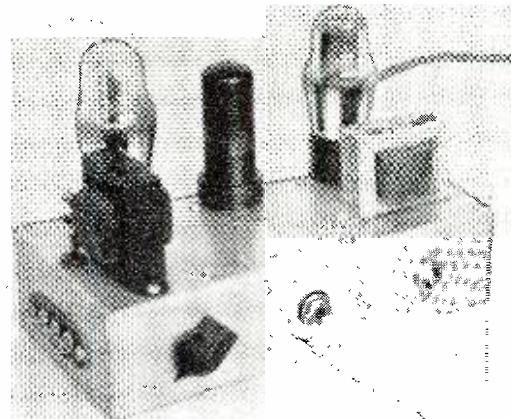

The unit is simple to build and trouble-free in its operation. Reproduction is rather good.

And now a word of explanation about the filter choke. The one shown in the photographs is a small Stancor 15 mil. job (C-1515). It happened to be on hand and was installed without reference to its characteristics, on the assumption that it was a 50 mil. choke. After the amplifier had been in operation for several weeks, I happened to be looking through a catalog and was much surprised to learn that the poor little choke was only supposed to carry 15 mils. I have never bothered to change it because there is no undue heating in spite of the 250% overload, and the filtering action is adequate. However I would advise anyone building the unit to use a 50 mil. choke such as Stancor C-1003 because the 15 mil. choke is undoubtedly operating in a super-saturated condition, and is probably so busy passing the d.c. that it can't pay much attention to stopping the ripple. For this

(Continued on page 57)

- R_1 —250,000 ohms pot. Centralab
- R_2 —7500 ohms $\frac{1}{2}$ w. IRC
- R_3 —100,000 ohms $\frac{1}{2}$ w. IRC
- R_4 —500,000 ohms $\frac{1}{2}$ w. IRC
- R_5 —150 ohms $\frac{1}{2}$ w. IRC
- R_6 —180 ohms line cord Ohmite
- C_1 —1 mfd. 200 v. paper Aerovox
- C_2 —.0005 mfd. mica Aerovox
- C_3 —.006 mfd. 400 v. paper Aerovox
- C_4 —25 mfd. 50 v. electro Aerovox
- C_5 —.02 mfd. 400 v. paper Aerovox
- C_6 —16 mfd. 150 v. electro Aerovox
- C_7 —24 mfd. 150 v. electro Aerovox
- T_1 —D.B. microphone to grid transformer. Stancor A-4703
- CH_1 —30 H. at 50 mils. Stancor C-1003
- SW_1 —S.P.S.T. toggle switch
- J_1 —Open circuit jack. Yaxley

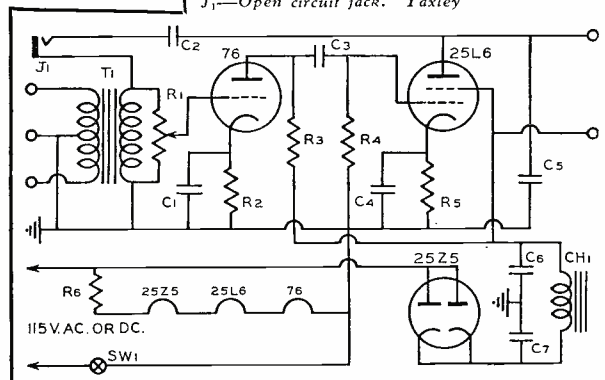

A Serviceman's 1-Tube Signal Tracer

by CHARLES R. MERCHANT

Columbus, Ohio

Try this extremely simple signal-tracer which only uses one tube. While it will not be as good as a multi-tube rig, it works.

IN servicing radios, it is almost a truism that a totally inoperative set is easier to fix than one that "sort of works,"—i. e., is noisy, distorting, or weak. It was to make it easier to diagnose these headaches that the following device was constructed, and judging by tests on a considerable number of actual cases it does all that it was intended to do.

It is essentially a signal-tracer which makes it possible to follow a signal, either from a broadcast station or from a modulated test oscillator, from stage to stage and from component to component through a set and find out just where it goes wrong. When that is settled, it is seldom much trouble to figure out what's the matter.

The hook-up used is a pentagrid converter circuit whose oscillator section generates frequencies which lie in the regular broadcast band. This is coupled to the antenna and ground of a good set, either a T.R.F. or super-heterodyne, but one preferably without A.V.C. A signal fed into the input of the set to be repaired may then be examined anywhere in its career, either as r.f., i.f., or audio, by being fed into the input of the converter circuit through special test cables. If the signal is to be examined in the r.f. stage, the oscillator of the converter is rendered inoperative and the signal is simply amplified and passed on to the test set. If the signal is in the i.f. stages, it is changed back to broadcast frequency in the converter, and if the signal is in the audio stages it is used to modulate the oscillator frequencies in the same manner as a phonograph oscillator. Thus any defective stage may be located quickly.

One prerequisite in such trouble shooting is that the device used shall not load the circuit. That was one of the great difficulties of the analyzer method of set-checking; the extra capacitances introduced by the analyzer cables were generally sufficient to throw the set into an entirely different frame of mind, and with a sheet of analyzer readings on hand it was often more difficult to figure out what they indicated than it would have been to diagnose the trouble "by ear."

That difficulty is avoided in this instance by using a probe which puts such an infinitesimal load on the circuit that the effect is practically zero. In fact, if the set under observation is operating strongly at all, it is not necessary to touch the probe to the components; by simply holding the probe near them, enough energy can be picked up from the stray fields to enable one to judge the quality of the signal at that point.

The probe is constructed of a five-inch length of bakelite or fiber tubing of an inside diameter just large enough to admit a flat-headed metal thumb-

tack. Two of these thumb-tacks, separated by one-sixteenth inch, make up a minute air-gap condenser in the body of the probe, which very effectually shields the probe tip from the ground capacity of the shielded cable used to transfer the signal to the input of the converter.

To the point of one thumb-tack a one-inch length of stiff piano wire—gauge 20 or 21 is right—is soldered and the other end sharpened. A piece of wooden dowelling, of a diameter just large enough to fit snugly in the tubing, is cut one-half inch long, and a one-thirty-second inch hole is drilled from end to end down the center. The piano wire is pushed through this until the thumb-tack is all the way in, and a turn or two of bare copper wire is wrapped around the free end of the piano wire, flush with the dowel, and soldered to hold the piano wire in place.

The center wire of a piece of shielded cable about three feet long is pushed through another similar piece of dowelling, and soldered to the pin of another thumb-tack. The wire is then pulled back through until the head of the thumb tack is flush with the end of the dowel, and the wire is secured in the same manner as the other.

A very thin coating of speaker cement is then applied to the second piece of dowel and it is pushed through the bakelite tubing until the head of the thumb-tack is just five-eighths of an inch from the other end. A very small hole is drilled through both the tube and the dowel and a small brad nailed through to hold the dowel in place. The other piece of dowel is then pushed into the open end of the tube, thumb-tack first, until the two thumb-tacks are separated by one-sixteenth inch. By pushing it in until the two thumb-tacks touch and then withdrawing it, this distance can be judged quite accurately. A few drops of cement and a brad hold it in place. The shielding on

the cable is then brought up about an inch over the other end of the probe and a couple of turns of friction tape wrapped around to hold it in place. A regular phone jack is fastened to the free end of the cable, the inside wire going to the tip and the shielding being connected to the ground side. It is then complete. This is the r.f.-i.f. probe.

Another cable is made up exactly like the first except for the probe, which in this case has a .00025 mf. mica condenser set into a slot in the end of another similar bakelite tube and taped fast. The inside wire of the cable is soldered to one terminal of the condenser, and a one-inch length of piano wire is soldered to the other. This is the audio probe.

As to the converter itself, its construction is not difficult. The 6A7 should be well shielded, and the current well filtered; any hum which is introduced into this tube will be very confusing when you're using it to locate hum somewhere else. L and C in the diagram are any ordinary broadcast band r.f. transformer with its primary cut down to about a dozen turns, if it has more than that, and the tuning condenser that goes with it.

(Continued on page 55)

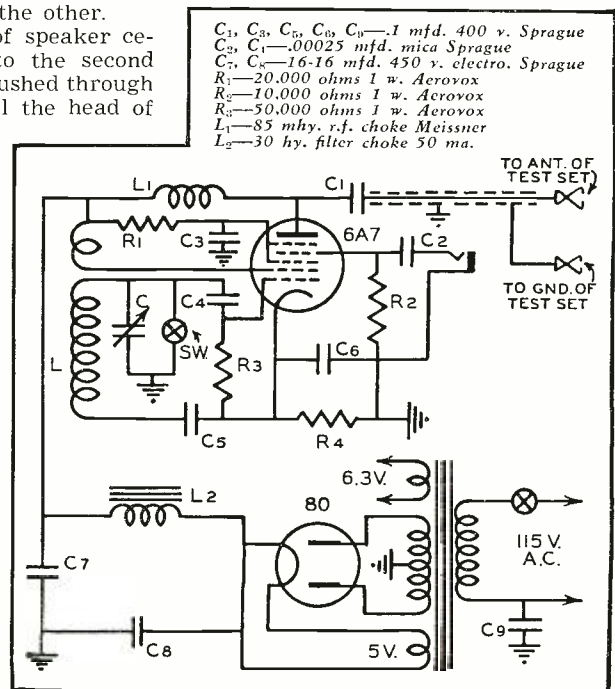

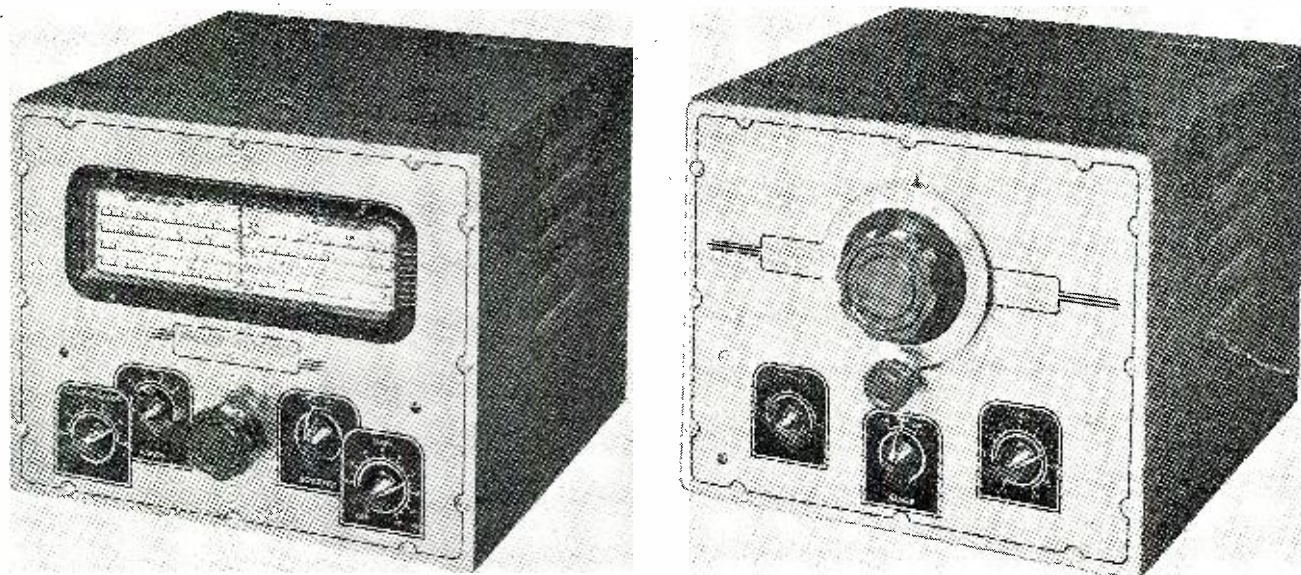

A signal booster (left) and a frequency marker, described by the author.

Modernizing Old Receivers

by **CHARLES R. LEUTZ**

Glendale, L. I., N. Y.

PART 4

By adding various accessories to the old receiver, the serviceman can not only make a fine profit, but the finished model will equal the latest 1940 set.

THE possible addition of useful accessories to existing radio receivers covers considerable territory. Customers and dealers alike should be well informed on the various accessories available and able to weigh the technical limitations as well as the advantages. No one book gives complete data on all radio attachments, but the different manufacturers go to considerable trouble and expense to prepare comprehensive literature covering their products. Most of this valuable literature is available simply for the asking; in a few cases a nominal sum is asked to off-set part of the cost. Every serious radio receiver owner, radio dealer or service technician should invest a dollar or two and make a complete collection of these booklets which are invariably right up to the minute in new developments.

Dealers and service men can secure substantial accessory business by simply going out after it; volume sales cannot be made by remote control from behind a desk or bench. Personal calls must be made on old customers and prospective new customers, to determine just what items they can use to advantage and also can afford. For example, the customer may be interested in trying a record player. In that case it is most essential to determine the prospect's musical tastes and send appropriate recordings. A set of "swing" or "classical" discs may either make or break the sale, depending wholly upon the customer's likes and dislikes. Where the customer already has a record player, there is an opportunity to sell a modern pickup for

same, or possibly an automatic changer. In any event there is an opportunity to demonstrate the advantages of a simple phonograph oscillator.

For customers in the upper income brackets, the Expansion-Compressor-Phonograph Oscillator shown schematically in Fig. 21 is suggested. This device is not on the market yet and there is an opportunity for qualified dealers to make same up to order.

During the past year the sale of record players and discs has continually increased at an impressive rate. Further sales increases along this line can be expected. Music lovers can accumulate a record collection suiting individual tastes, play them any time desired, secure musical reproduction comparable to the best broadcast reception and most important, completely eliminate the annoying, obnoxious "commercials". Furthermore, it is possible to secure some good records which are never heard over the radio.

Previously, several obstacles impeded the sale of record players. Originally it was necessary to place the player close to the receiver and either alter circuit connections or use makeshift adapters. The advent of phonograph oscillators has changed all this and dealers can sell easily manual and automatic record changers by applying modern merchandising methods. Telephone, letter or even postcard invitations addressed to local customers or prospects can suggest dropping in for a demonstration or offering to install a unit on trial. As previously mentioned, during a demonstration, the use of a good quality amplifier and the right selections will greatly simplify closing the sale.

The value of the home recording feature, originally regarded as a novelty, is now being appreciated as a valuable adjunct in connection with voice culture, diction, word pronunciation and public speaking lessons.

Record players and recorders are

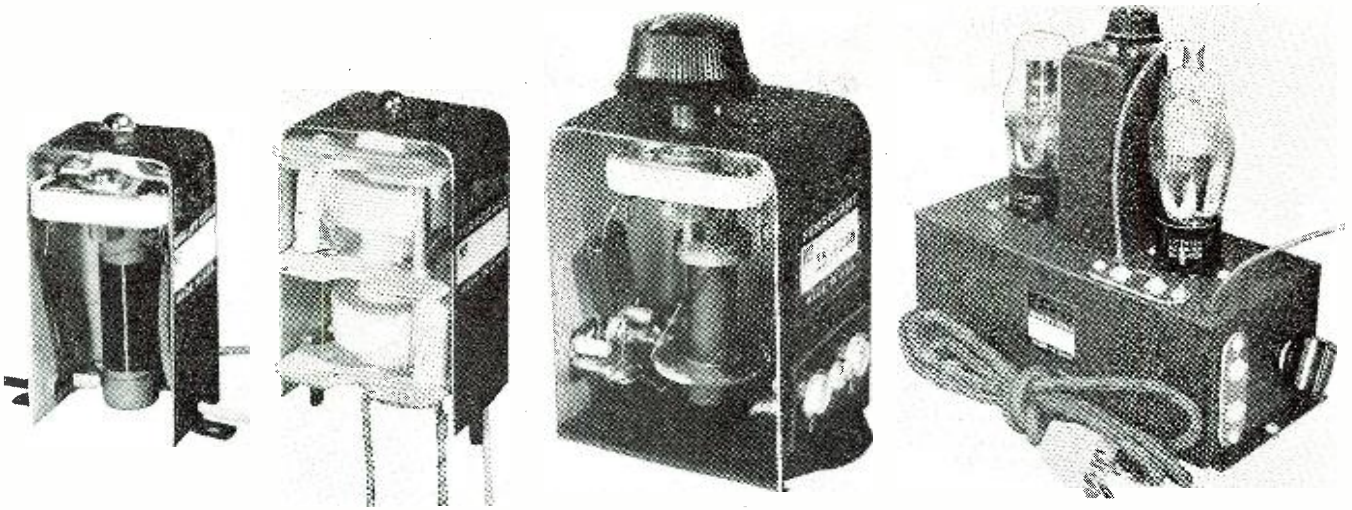

Various types of additions which can be easily put in an old receiver to improve it.

subject to some limitations which cannot be completely overcome without considerable expense. It is not a simple matter to construct a single pick-up which will produce uniform gain over the entire audio frequency range, at a reasonable cost. A double pick-up, one to cover the lower frequencies and the other to handle the higher frequencies, each working in a separate groove is a future possibility.

It is generally known that at the present stage of the art, neither wax or film recordings can be made to cover the full maximum sound levels involved, except by applying "compression". In compressing music of a very large volume during recording, it is anticipated that these records will be reproduced through a system employing corresponding volume expansion, such an amplifier being shown in Fig. 21. This amplifier, in the "expansion" position, does have a variable gain and will amplify the higher amplitude signals more than the low amplitude signals, but the exact rate of reproduction or discrimination between low and high signal levels cannot be expected to exactly recreate the original musical rendition. Some means is needed to continuously record the amount of "compression", so this variable value can later be used to regulate the proper amount of "expansion", during reproduction. This is also a future possibility and can be accomplished by using a separate head and groove from that used for the music or voice.

So far, all of the volume expanding circuits are limited to relatively small signal input voltages on the order of that obtained from a phonograph pick-up. Accordingly if the expansion circuit is built in as an integral part of the broadcast receiver, it may be a serious source of distortion in the hands of a non-technical operator. For that reason, it is suggested that provision for volume expansion be confined to the phonograph pick-up mixer circuit, as shown in Fig. 21.

This same circuit can be used for a microphone pick-up, in which case the switch is placed in the "compression" position to prevent blasting or overloading and otherwise compensate for differences in sound level produced by movements of microphone performers. In this circuit, the 6H6 tube is used as a voltage doubler, the D C output being applied across the 1 megohm potentiometer, which in turn is connected to the D. P. D. T. (Expansion-Compression) switch to permit reversing the polarity of the voltage taken from the potentiometer.

Changes in signal level change the D C voltage across the potentiometer;

with increased signal level the potentiometer voltage increases, and vice-versa. This voltage is applied in series with the control bias of the master mixer tube. In the "expand" position, the voltage becomes opposite in polarity to the bias of the control tube, accordingly increasing the tube amplification factor. In the "compress" position, the potentiometer and bias voltages add, providing increased negative bias with corresponding decreased amplification factor.

The above circuit can be used without the modulated phono-oscillator, if desired, by taking the audio output at the plate of the master mixer tube and connecting it to the input of any receiver or P. A. audio amplifier.

Push Button Tuners, both the built-in and remote controlled types, are subject to certain limitations as well as advantages. The pros and cons should be explained clearly to prospective purchasers. Push button tuners, operated at a location relatively close to a group of broadcasting stations, provides a convenient and rapid means to change from one program to another. The built-in type tuner is readily adapted to any super-heterodyne or TRF receiver having a two gang condenser, and will give excellent results with such sets. Most of these tuners only act on two circuits and if

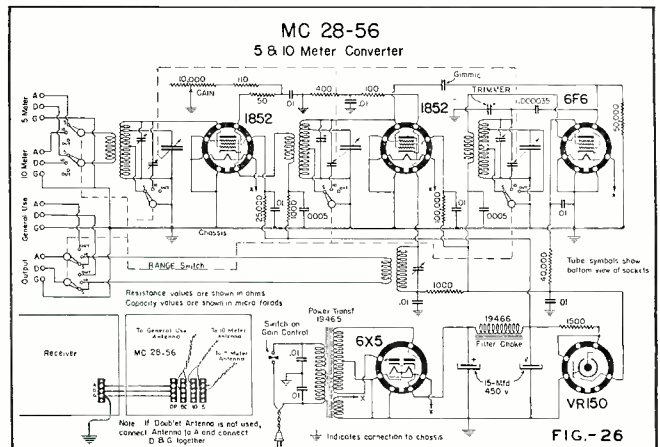
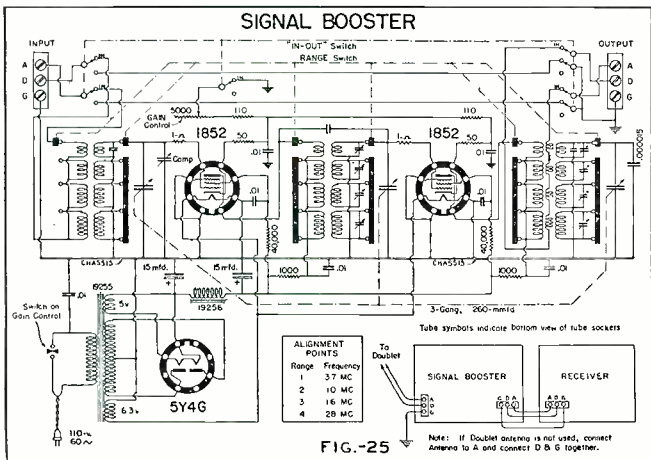

Circuit diagrams of addition to the old receiver.

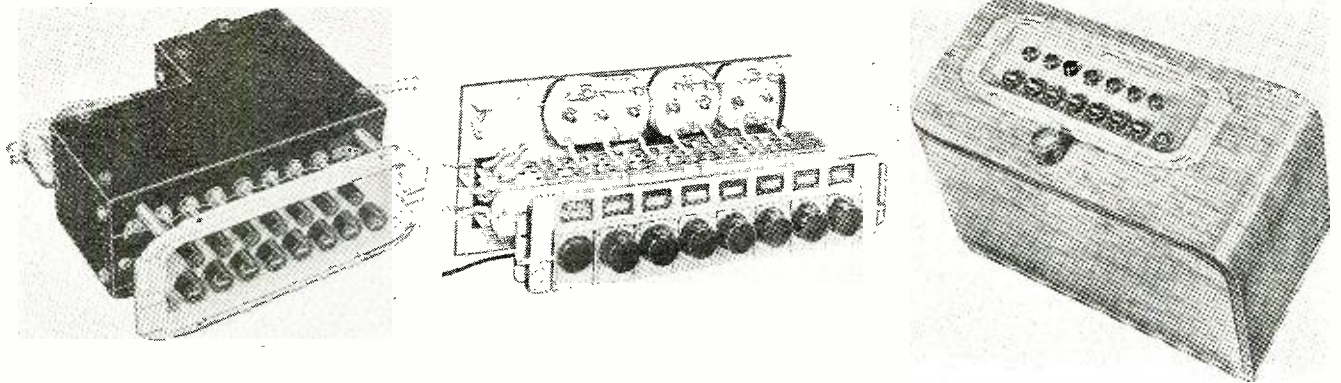

Three types of push-button renovating controls discussed by the author.

used with receivers having a three gang condenser, some loss of performance must be expected. The loss is not serious if the desired stations are locals or other strong signals.

Practically all remote control push button tuners consist simply of a duplicate super-heterodyne converter tube, operable at the end of a remote control cable, to replace the receiver's built-in converter tube. This application is strictly a "local station" tuning convenience and ordinarily unsuitable for DX operation.

In spite of the limitations outlined above, the applications are often extremely useful for sets to be tuned by children, elderly people or invalids.

Personal chats with customers often bring out details of reception difficulties that can invariably be readily eliminated. For example, a receiver may be subjected to interference from one station, either from the main carrier or a harmonic. The interfering signal may be within the broadcast band or it may be on a frequency in the vicinity of the inter-

mediate amplifier, and get through. Simple interference of this nature can be corrected by the use of a single wave trap as shown in Fig. 22, or in severe cases, by the use of a dual wave trap as shown in Fig. 23.

Receivers capable of wide band pass and used for DX reception will pick up interference caused by inter-carrier 10 KC "whistles". This difficulty can be corrected as shown in Fig. 24, wherein two filters are used for a push-pull output circuit. For this application, care must be taken to select well designed and constructed filters that will not detract from the receiver's audio frequency response range, other than in the immediate vicinity of 10 KC.

Several accessories, designed primarily for amateur traffic, can be readily sold to some broadcast listeners.

One of the most useful adjuncts to any all-wave super-heterodyne receiver is a TRF pre-amplifier or signal booster. A typical modern unit of this type is shown schematically in Fig. 25. The circuit consists of two stages of tuned radio frequency amplification covering a frequency range of from 1.6 to 31 megacycles, divided among four bands. For the broadcast listener interested in picking up foreign news flashes direct from the European cities, the addition of this unit facilitates more consistent reception. The image ratio and over-all signal-to-noise ratio are both substantially improved. Both of the above factors are maintained at the most favorable condition by adjusting the signal booster for maximum sensitivity and using a corresponding lower gain in the receiver IRF amplifier. (Next page)

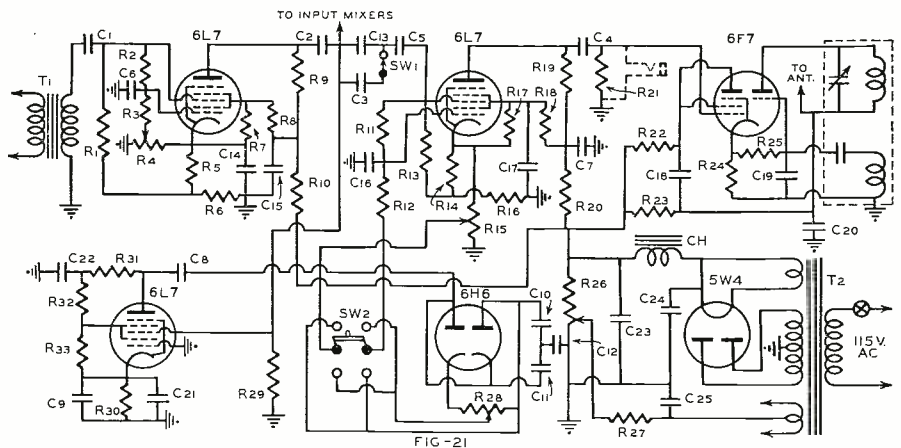
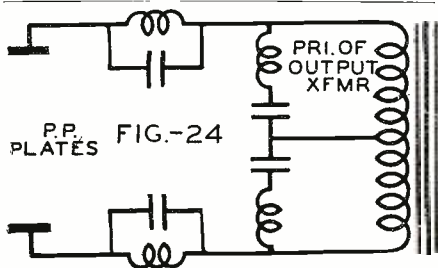
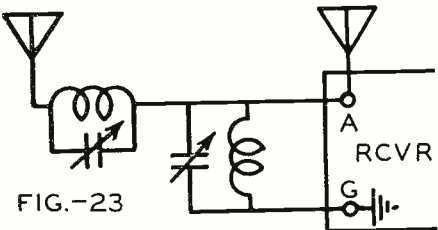
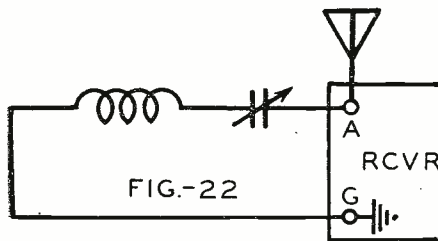

- R₁—50,000 ohms, 1 w., Centralab
- R₂—1,200 ohms, 1 w., Centralab
- R₃—75,000 ohms, 1 w., Centralab
- R₄—250,000 ohms, pot. Clavostat
- R₅—1,000 ohms, 1 w., Centralab
- R₆, R₇—30,000 ohms, 1 w., Centralab
- R₈—150,000 ohms, 1 w., Centralab
- R₉—300,000 ohms, 1 w., Centralab
- R₁₀—50,000 ohms, 1 w., Centralab
- R₁₁—1,200 ohms, 1 w., Centralab
- R₁₂—75,000 ohms, 1 w., Centralab
- R₁₃—100,000 ohms, 1 w., Centralab
- R₁₄—1,000 ohms, 1 w., Centralab
- R₁₅—250,000 ohms, pot. Centralab
- R₁₆, R₁₇—30,000 ohms, 1 w., Centralab
- R₁₈—150,000 ohms, 1 w., Centralab
- R₁₉—300,000 ohms, 1 w., Centralab
- R₂₀—50,000 ohms, 1 w., Centralab
- R₂₁—500,000 ohms, 1/2 w., Centralab
- R₂₂—40,000 ohms, 1 w., Centralab
- R₂₃—400,000 ohms, 1 w., Centralab
- R₂₄—2,500 ohms, 1 w., Centralab
- R₂₅—75,000 ohms, 1 w., Centralab
- R₂₆—25,000 ohms, 50 w., Ohmite
- R₂₇—100,000 ohms, 1 w., Centralab
- R₂₈—1 meg. pot. Clavostat

- R₂₉—150,000 ohms, 1 w., Centralab
- R₃₀—500 ohms, 1 w., Centralab
- R₃₁—30,000 ohms, 1 w., Centralab
- R₃₂—100,000 ohms, 1 w., Centralab
- R₃₃—40,000 ohms, 1 w., Centralab
- C₁, C₂, C₃, C₄, C₅, C₆, C₇, C₈, C₉, C₁₀, C₁₁, C₁₂—0.05 mf. 400 v. paper, Mallory
- C₁₃—0.0015 mf. mica, Mallory
- C₁₄, C₁₅—8 mf. 450 v. electro., Mallory
- C₁₆—0.25 mf. 600 v. paper, Mallory
- C₁₇—0.05 mf. 600 v. paper, Mallory
- C₁₈—0.1 mf. 400 v. paper, Mallory
- C₁₉—0.1 mf. 400 v. paper, Mallory
- C₂₀—0.00025 mf. mica, Mallory
- C₂₁—0.5 mf. 200 v. paper, Mallory
- C₂₂—4 mf. 450 v. electro., Mallory
- C₂₃—16 mf. 450 v. electro., Mallory
- C₂₄—0.1 mf. 600 v. paper, Mallory

- T₁—Input Transformer, UTC-0-1
- T₂—Plate and fil. trans., UTC-1-R-6
- CH—Filter choke, UTC-R-14
- SW₁—SPST Toggle. Cutler-Hammer
- SW₂—DPDT Toggle. Cutler-Hammer

From the diagram it will be noted that a special output transformer enables connecting the booster unit to any receiver having a standard or doublet input circuit. A two way switch throws the booster in or out of the circuit, as required. The use of a two stage booster on the broadcast band, even with a mediocre receiver, eliminates the need of any wave traps previously mentioned.

A signal calibrator is another valuable and interesting unit useful to short wave DX fans and European news report listeners. One well designed standard signal calibrator is shown schematically in Fig. 27; although this circuit requires six tubes, the necessary parts are contained within the compact space of 8"x8"x12" deep.

The calibrator can be operated unmodulated to check the frequency of any incoming signal, by the zero beat method. Modulated, the calibrator is useful to pre-set or tune a receiver to any desired signal frequency. In other

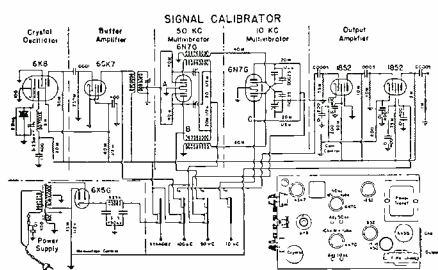

FIG. 27

words it eliminates "fishing" for a desired signal. For example, by setting the receiver to the desired frequency a minute or two before the station is scheduled to start operating, the very opening announcement is available in full intensity. In amateur work, a calibrator of this type is required by law to maintain an accurate check on the transmitted frequencies.

Some broadcast listeners find diversion in tuning in various non-broadcasting signals, airway traffic, police signals, amateurs, etc. In this connection a 5 and 10 meter converter adds to the interest. The 5 meter range is ordinarily limited, but the 10 meter band provides plenty of opportunity for signal explorations. Fig. 26 gives the schematic wiring diagram of a modern 5 & 10 meter converter which includes the desirable features of a high gain r. f. stage (6AC7/1852), a high-C oscillator (6F6) and a stable oscillator (6AC7/1852). Freedom from frequency drift and stable amplifier operation are insured by the voltage regulated power supply which consists of a 6X5 rectifier and VR-150 regulator tube. Using the new "television" type tubes provides a combination of low noise level and high signal gain on these high frequencies involved. Even when used with an old existing receiver that tunes to 5 and 10 meters, a decided improvement can be expected by using the converter

(Continued on page 59)

FOR IMMEDIATE RELEASE...

Hot & Spot News will be found in this column every month. Don't fail to read it!

COMMENTING on Frequency Modulation, E. F. McDonald, Jr., President of Zenith Radio Corporation, stated:

The company commenced broadcasting from its Frequency Modulation Station, using the new Armstrong System under which it is licensed, on February 1st and is now transmitting daily programs of approximately sixteen and one-half hours duration, from its permanent location in the tower of the Chicago Towers Club on North Michigan Ave.

With regard to the company's new line, Mr. McDonald advised:

The company's new combination battery electric portable receiver incorporating the removable Wavemagnet, an exclusive Zenith feature, was announced to its distributors early in March. Orders received from distributors for April and May delivery greatly exceeded the expectations of the management. Shipments of substantial quantities of these receivers are now going forward to distributors and dealers. Zenith Portables equipped with the Wavemagnet will perform where other portables fail, such as on trains, in airplanes, boats and metal structures. This performance is being guaranteed. The company is protected against imitation of its removable Wavemagnet feature by a strong patent and no other manufacturer has been licensed to use it.

BY providing for flexible reception now and in the future in his television receivers presently coming off the assembly line, Allen B. Du Mont, pioneer television manufacturer of Passaic, N. J., believes he has struck the happy compromise between fear of freezing the art on the one hand, and premature obsolescence of receivers on the other, indicated in recent opinions and decisions of the Federal Communications Commission. He states:

"I am the rare exception in upholding the F. C. C. in its television citation of March 23, ordering a leading company to explain its high-pressure merchandising of inflexible television receivers. Frankly, I'm not in accord with the widespread criticism of the F. C. C.'s action by other television interests and by an obviously misinformed or at least inadequately informed press. It is patent that all the facts in the case are not being considered by those who hasten to accuse the F. C. C. of autocratic handling of television."

IT has been brought to the attention of the Federal Communications Commission through complaints from police departments and other parties that certain automobile repair men, ambulance operators, and other unauthorized persons are making a practice of intercepting police shortwave radio messages relating to automobile accidents, crimes, etc., and using them for their own benefit, or for the benefit of other parties not entitled thereto, with the result that police investigation of mishaps and crimes is being hampered.

It would appear . . . that any person who intercepts a local intrastate message and divulges the existence of same or uses the same for his own benefit or for the benefit of another not entitled thereto acts in violation of this section.

The Commission's inspectors are being instructed to investigate complaints alleging

violations of this nature in order that the Commission may refer to the appropriate United States Attorney for prosecution the cases in which it appears an indictment should be sought. . . .

MR. BERNAL C. PAYNE, 5022 Maple Avenue, St. Louis, Mo. would like the Editors to identify the headphones worn by Paul Whiteman in his picture on the cover of the March, 1940 issue of *RADIO NEWS*. We are unable to do so. Can you readers help both Mr. Payne and us out?

Incidentally, the headphones worn by the British sailor on the right in the cover of the May, 1940 issue of *RADIO NEWS* are those manufactured under the name of "Brown" in England. They are the same general type as those worn by the "boy" in the January, 1939 issue of *RADIO NEWS*.

THE Federal Communications Commission has been notified that the United States Admiralty Court, Norfolk, Va., has ordered the barkentine-rigged vessel *Marsala* sold to satisfy a \$5,500 penalty incurred when it cruised 11 days outside of port without radiotelegraph transmitting equipment as required by the Communications Act.

The violation occurred November 16 to 26, 1938. It was made known when the vessel ran into a storm off the Virginia capes and lack of radio facilities imperiled students and crew. On March 27, 1939, the Commission notified the owner, the American Nautical Academy, Nautical Training School for Merchant Marine Officers, Washington, D. C., of the forfeiture. The school, on April 8, filed application for mitigation, but the Commission after full consideration denied the request and advised that the forfeiture was payable immediately. Payment was not forthcoming, so the matter of collection was referred to the Department of Justice.

On September 18 proceedings were instituted by the United States District Attorney for the Eastern District of Virginia, and on February 19 the case was heard by the Admiralty Court.

R. K. WHEELER, serviceman-author of *Indianapolis, Ind.*, predicts for the serviceman the following for the balance of 1940:

Daily business in 1940 will consist of one \$5.00 job, and several cheap ones. Anything over \$5.00 will be considered strictly as an Act of Providence. Customers will continue to lug in auto radios bought "wholesale" and expect to have them installed for \$1.10. Tube checkers bought this year may be obsolete before they are paid for. The service man will be called a "screwdriver mechanic" at least once a month by equipment manufacturers. Filter condensers in Christmas midgets will fry out in August resulting in a minor boom. Tube prices will bob up and down as usual, with profit to the printers. Business will be much the same as 1939.

IN March, 1940, the Editors wrote to the Federal Communications Commission requesting information regarding the so-called station WHD reported in the then current issues of *TIME* magazine. This station was operating at Dartmouth College, with the knowledge of the College authorities. The means used to broadcast was by what is generally known as a "phono oscillator." We were struck by the fact that the station had a regular listening audience, and that it had

(Continued on page 56)

Serviceman's Experiences

by LEE SHELDON

Chicago, Illinois

What to do with customers who always expect something extra in the way of a discount.

EVERY time I decide I've seen everything in the radio business, something new happens to astonish me all over again.

One day last week I explained a dandy sales stunt to my partner.

"First," I said, "we hang pluggers on door-knobs. They read 'Who knows the evil lurking in the heart of your radio? The shadow knows!' That starts them wondering. Then we follow up with a personal call, handing out a card saying 'This is the Shadow in person, come to take care of your set.' Like it?"

"The set owner," Al replied, "will probably tell you never to darken her door again." My partner lives to discourage talent.

"You mean," I asked incredulously, "you don't like the idea?"

"Wonderful idea—simply marvelous!" Al said, waving his arms. Then, in a lower voice: "Confidentially, do you mind if I breathe through my mouth?"

Believe me, Al would have been stung by some very pointed remarks if we hadn't been interrupted just then.

Two customers came in—twins. They were dressed alike, kept in step from the door, and stopped before the counter with four heels that clicked as two. I sort of expected them to cross their legs and raise bamboo canes.

"We," they announced simultaneously, "are Ken and Ben."

They were as unsophisticated as a couple of butter-molds. My jaw was still hanging when Al said:

"Well, gentlemen—what's the difference?"

This pleased the hay-shakers, and they laughed in phase.

"No difference," the chanted, "except for our fingerprints!"

"Taking care of you," Al commented, "will be a double pleasure. What's on your minds?"

"About ten years ago," Ken solo'd, "I bought a *Colonial 31*."

"And I bought—" began Ben.

"Let me guess," Al said, covering his eyes. Then "A *Colonial 31*?"

"Right," Ken said, amused. "A friend of ours worked for a distributor, and gave us cards so we could get them wholesale."

"We did business with the janitor," Ben added, "and he let us in on the ground floor."

"Forty off," Ken continued. "Seeing that we're neighbors of yours and that the publicity will do you good, we've decided to let you supply our new sets—at the same discount."

Then I understood what "doubling in brass" meant. What nerve!

"Hmmm," Al said tolerantly, instead of throwing them out on their collective ears, "perhaps I could work out some sort of trade-in."

"Well," Ken said, "we—"

"Uh-uh!" Ben interrupted, "My turn. If you take our sets, we of course expect an *extra* discount."

That was too much. I groaned loudly, but Al frowned me quiet. Al always says never to discourage a fellow after cut rates, because there's always some way to get around him. But I know he's wrong.

"Let's go look at those sets. Maybe we can work out some sort of a deal," Al suggested, playing dumb. He knew as well as I we couldn't take off forty plus, no matter what we sold them.

"Excellent—come along," they agreed, and walked out to the truck and Al's personal car. While we were locking the store, Al turned to me and said:

"You look bored. Been seeing too much of yourself lately?"

"You're wasting your time with those chiselers," I shot back. "What do you expect to get from your half of the team?"

"Ben's in the truck," Al said. "Go

with him and use your head; no matter what profit we make, it will be double!"

I was about to answer, but two horns honked.

"You fellows live together?" Al asked.

"Same building," Ken replied.

"You—ah—married?" I asked.

"Sisters," they said quickly.

I knew I was wasting time, but went to Ben's apartment just to show him he couldn't pull any fancy business on me.

"You can have a five-tube table model," I said, rapping the console expertly, "for this job and thirty bucks cash."

He went up in the air so fast his fountain pen leaked.

"Why, man!" he shouted, "know what this set listed for when it was new?"

"What's the difference?" I asked. "You didn't pay list!"

"And the quality is wonderful!" he added.

"Sure, sure," I agreed, "that's why you're trying so hard to get a new one. Don't bother turning it on for me!"

On the way out I noticed Al's car was still in front of the house. I made up my mind to bawl him out if he stayed too long.

Al finally came back to the store. For some reason, he wasn't mad when I let him have it, and I felt a bit foolish for rubbing it in.

"Anyway," I comforted, "you had sense enough not to let Ken talk you into a silly sale. We haven't lost anything."

"Ken's a very good talker," Al replied owlishly. "It was a tough struggle, but he finally landed me!"

"Don't tell me you bit on that 'publicity' line he was stringing us along with!" I shouted.

"Not exactly," Al explained. "You see, I didn't know just what to do until after I met his wife. She said she didn't want a new set."

"From this we make a living?" I asked. "The husband a cheapskate, the wife refusing to buy? What sort of a sale does that make?"

"I found out," my partner continued, "the reason the missus didn't want a new set was because she liked the cabinet, and didn't want to give up such a beautiful piece of furniture."

"It gets worse and worse," I said. "She won't let go of her furniture, and he won't let go of his money."

(Continued on page 59)

AIN'T IT THE TRUTH?

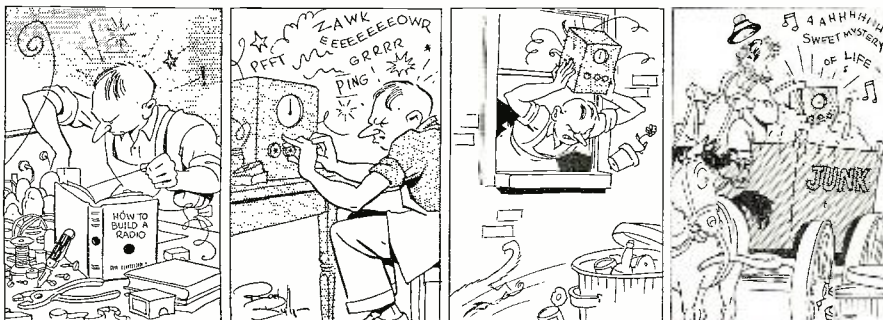

THE 112 MC

by HAROLD D. MILLEN, W1JOM
Boston, Massachusetts

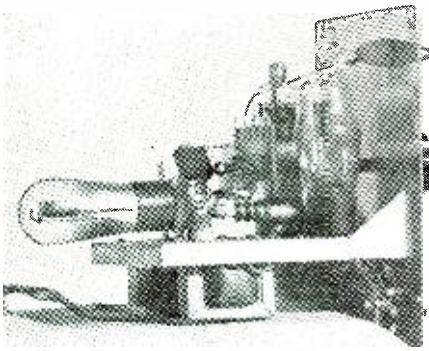

The "works" of the rig look like the average 5M transceiver used to.

WITH summer just around the corner, many a ham's thoughts are again turning to the idea of mobile operation. The ten meter band would seem to be the ideal band for such operation because it is an everyday occurrence to work the West Coast and the Cubans, and also can be depended on to give consistent communication locally for a distance of 25 or more miles while traveling along the highway.

From what the reader has just read, it might seem that we had forgotten the title and decided to build a different job. But after building a complete station for our own buggy and getting the results mentioned, we found that too many of our fellow hams turned thumbs down on mobile operation on ten after hearing the cost of the equipment.

Five meter mobile operation was out of the question for the same reason, since the new regulations require that the signals on five be equal in quality to those on ten.

This left only 2½ meters for our consideration. Frankly, until I had built a receiver for the band and heard the signals that the boys were putting out and also the distance that

the signals traveled, I had never given the band a moment's thought as far as mobile operation was concerned.

After listening on the band for a few weeks we came to the conclusion that there were enough stations on the band to warrant the construction of the transceiver to be described.

At this point I might mention that the signals on 112 mc. are much better than five meter signals were at the same period of its development. Instead of starting from scratch, the boys have benefited from their experiments with the u.h.f. and have gone ahead from the point they left off in December, 1938.

The chassis, front panel, and cabinet for our transceiver comes from the well-known "Barr" transceiver, which was very popular a few years ago.

In its original form, it used a 49 det.-osc., 30 first audio, and a 19 as Class B audio. It had the disadvantage of poor sensitivity, could not run a speaker, and could only be operated with batteries.

In the revised circuit, the tubes used are; a 76 or if desired a 6C5 det.-ocs., 76 or 6C5 first audio, and a 79 or 6N7 Class B Audio. There is now plenty of audio to run a permanent magnetic speaker, and the unit runs equally well from an a.c. supply or when mobile, from a motor generator or vibrator supply.

While this unit has as its foundation the commercial transceiver previously mentioned, there is no reason why a similar job can not be duplicated by the reader from parts available at the regular sources of supply.

The metal cabinet is approximately 11" long, 6½" wide, and 9½" high. It is large enough to hold the a.c. power supply and when portable can be used to hold spare parts and the microphone.

The audio portion is relatively simple and no special attention need be given to the wiring. The r.f., on the

other hand is tricky to get going and should be constructed exactly as shown in the photographs.

The detector socket, which must have ceramic or other low loss insulation is mounted directly behind the variable condenser for the shortest possible leads. It is raised off the chassis by two angle brackets to put it on the same level as the condenser.

(Continued on page 56)

For short hauls, for summer outdoor uses, there is nothing that can compare with 2½ meters. If you will but try this band, you will be pleased.

The circuits of the various components of the two & a half M. transceiver set.

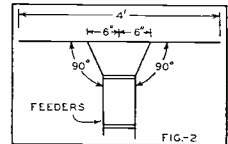

- C₁—10 mmfd. ceramic padder Cardwell
- C₂—.0001 mfd. mica Micamold
- C₃—.01 mfd. 400 v. Micamold
- R₁—500,000 ohms ½ w. IRC
- R₂—500,000 ohms pot. Centralab
- R₃—2500 ohms ½ w. IRC
- T₁—Transceiver trans. Thordarson T-72A59
- T₂—Class B input Thordarson T-67D50
- T₃—Class B output Thordarson T-17M59
- L₁—4 Turns No. 14 Wire, Space to 1", ⅜" dia.
- RFC—Ohmite 5 meter choke

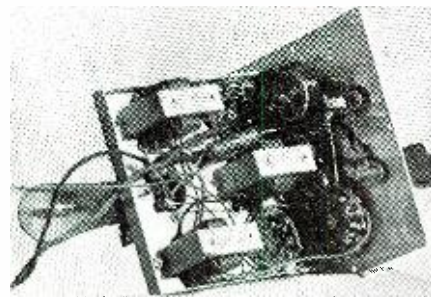
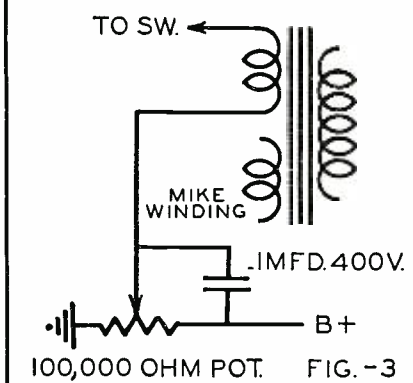

Underchassis view.

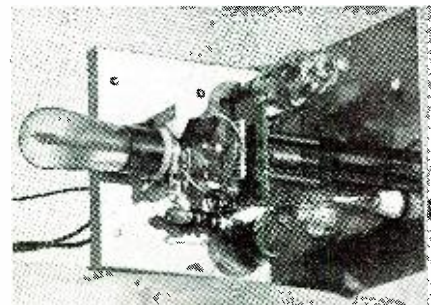

Topside chassis view.

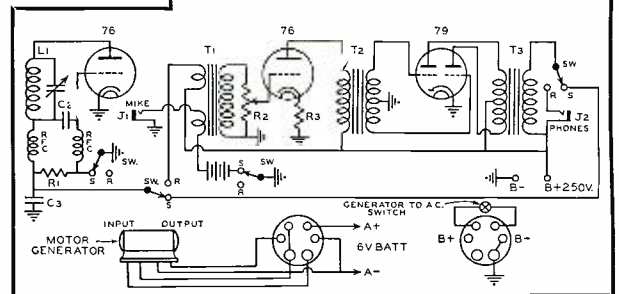

"MOBILE ON 10"

by R. J. HAGERTY, W6JMI

San Diego, California

In spite of the skip, 28 megacycles still presents the best mobile band. The average car can be remodeled to house a complete low-powered transmitter and receiver.

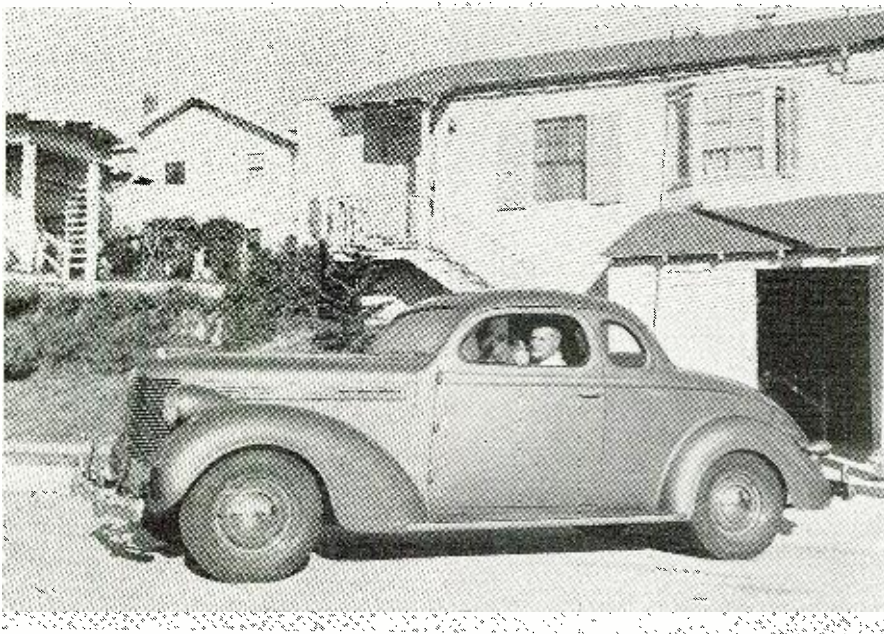

The author in his radio equipped car ready for the road. Notice the antenna sticking out from the after deck, where it is easily carried.



The 10 meter receiver fits into the glove compartment and is so well built in, that it does not destroy the beauty of the car's dashboard.

TODAY portable-mobile gear is definitely attracting the amateur's attention. It offers diversified thrills and experiences that are without number and at the same time offers the most practical solution for emergency communication equipment. The author has had a mobile unit of some kind or other in his car for over five years and the described "layout" is the result of dozens of ideas, combinations, tubes, etc. Its performance can be best attested to by the following facts: It has been installed in the car over ten months and has traveled 11,500 miles—6,000 of which were on a transcontinental trip. The log book shows that to date there has been 103 QSO's.

Briefly, this rig consists of a 6J5G with a ten meter crystal driving an RK-34 push-pull final amplifier to 15 watts input. The audio uses a single button carbon mike with a 79 Class A speech amplifier and a 79 class B modulator. The receiver is a ten meter converter, using a single 6J8G, the output of which is fed into the automobile radio for the necessary I.F. and audio amplification. The antenna is a quarter-wave Marconi with a concentric line feeder. Power for the transmitter is furnished by a motor-generator and the necessary voltages for the converter is obtained by tapping into the auto radio power supply. Simple, isn't it, but all who have seen and heard it agree that it works wonders.

Sad experiences of other hams as well as myself say that for portable-mobile operation just any old thing *won't do*. It is the last place in the world that hay-wire and poor connections can be tolerated. Tricky circuits, super-critical adjustments and the like are definitely out of the question. Simplicity is the watchword with ruggedness a close second. And a little previous thought and preparation will avoid remodeling the car to put the rig in. If you think the photographs are unusual just remember that the transmitter was built on a masonite chassis that fits perfectly in a shelf behind the driver's seat. Its power socket lines up with a hole in the rear of this shelf through which a plug-in cable connects with the associated power supply in the rear.

The converter is mounted in the glove compartment on the left side of



the dash and its output feeds directly to the radio installed on the car's bulkhead. The antenna is mounted on the turtle deck of the car and the concentric line feeds to an antenna change-over relay. Back contact of this relay feeds through a low capacity shielded cable to the antenna connection on converter. A single O-150 millimeter is mounted in the car's instrument panel in the space provided for the electric clock. The microphone and its cable comes out between the seats.

If you plan on going portable-mobile plan the layout so that it is accessible—just in case—and so that you don't have to go through a bunch of contortions when you switch from send to receive. In our case the switch on the microphone does the whole thing with the aid of two relays. The antenna relay should have good insulation and the power relay should have heavy points. Incidentally, good adaptations can be made from old battery charger relays if the coils are rewound with Number 30 wire so as to keep the current drain down.

The circuit diagram of the transmitter, (and please note the absolute minimum of parts), is shown. The 6J5G is a standard triode crystal oscillator with the series resistor R2 to lower the voltage to about 200 volts. Note particularly that a high C tank circuit is used—both for maximum output and stability. This tank consists of 5 turns Number 12— $\frac{3}{4}$ " di-



This is how the author's auto trunk is filled with 10 meter radio gear.

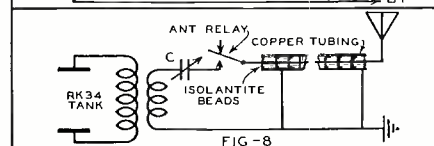
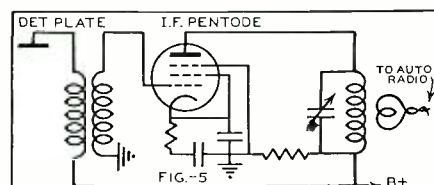
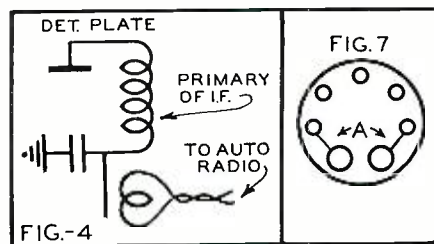
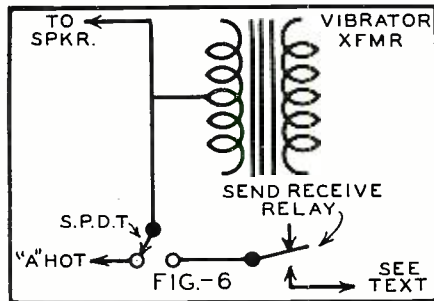

ameter and 1" long. It is soldered directly onto the plate prong of the 6J5G socket. The tuning condenser, C1, resonates at about 70% of full capacity. All parts are mounted underneath the chassis and near the tube socket so as to make short connections. The crystal choke, RFC1, while not critical, is important. It is best to experiment with different types and makes in this position as it has quite an effect on the crystal stage current. The one in use at present showed a 12 ma. decrease in plate current over some that were tried.

A word here about ten meter crystals would not be amiss. They are not critical and handle very much like lower frequency crystals. But out of a half dozen that were tried the output in all cases was improved as much as 200% just by cleaning and grinding the plates perfectly flat. You can be sure the plates are true when they stick on a wet piece of glass held vertically.

The amplifier stage is the result of many, many experiments. Pentodes and tetrodes all have their places but for care free and non-critical operation there isn't anything like a good triode, in the final RF stage. The RK34 fills this bill admirably—being a fine high frequency tube, easy to excite and neutralize, and very efficient. We spent a month trying to neutralize a 6L6 and never did get it neutralized to our satisfaction. But once the RK34 was wired in, it took less than 3 minutes to neutralize it right "on the nose" and the adjustments have never needed to be changed.

The grid of the RK-34 is inductively coupled to crystal tank. The grid tank, L2, consists of 19 turns Number 12, $\frac{3}{4}$ " diameter and 3" long, and mounts on the grid prongs of the RK-34 socket. C3 is a 3-30 mmf. compression type trimmer condenser also soldered onto the same grid prongs. The grid leak, R3, connected at the center of the coil,

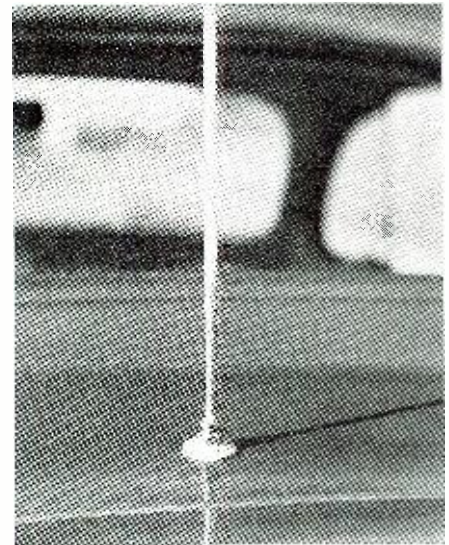

Closeup view of the antenna installation (above). Below, the topside and front view of the 28 mc. receiver.

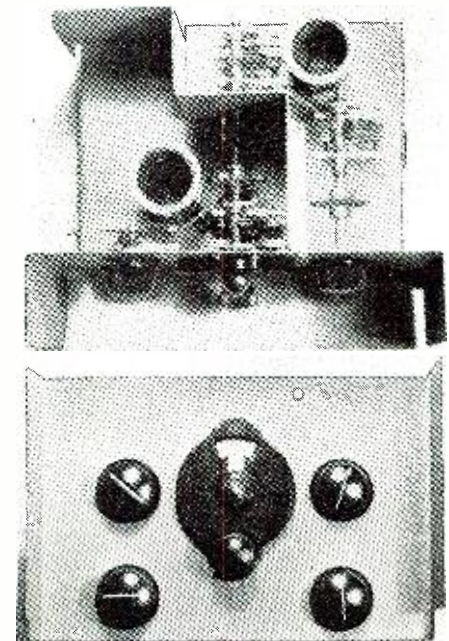

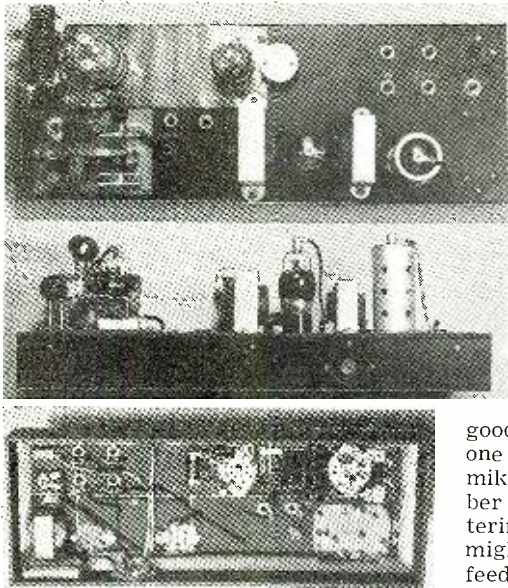

Three views of the 28MC transmitter.

also serves to steady the coil mounting. The plate tank circuit, C5 and L3, is mounted above the chassis so as to make short RF leads and provide the necessary isolation. In the top view of the transmitter may be seen a thin sheet of copper fastened to the top of the masonite chassis and this provided all the shielding that was necessary.

The neutralizing condensers, C4, are 3-30 mmf. compression type trimmers with their screws removed, and the movable plates turned out to an angle of approximately 45 degrees. By cross-connecting the plate leads instead of the more usual cross connected neutralizing leads the latter were short-

ened more than two inches. As is consistent with good practice in each stage the ground return was made to some convenient point near the associated apparatus. Then these grounds were wired to a common ground bus.

The modulator is simple and straight forward. Low gain microphones have no place in portable gear as the necessary equipment required to bring their level up to a usable value results in too many parts as well as increasing the filament drain. Suffice to say that in a single button carbon mike a good one can be very good and a poor one can be awfully bad. The necessary mike voltage can be obtained in a number of ways such as dropping and filtering the car battery but difficulties might be encountered from hash and feed-back. Flash light cells are not dependable enough for consistent operation. Standard dry cells are cheap and can be mounted in the rear with the power supply using a relay contact to break the current while receiving. These dry cells after ten months of operation show little signs of wear.

As to why 79's were chosen for modulators instead of 6A6's or 6N7's the reasons are: First—79's at this voltage have 8 watts of audio output which is more than ample for 15 watts RF input. Second—their static plate current is lower giving a few more mills for RF. Third—their filament drain is lower. The first 79 is connected with its elements in parallel making it a high mu triode with plenty of "sock" to drive the second

79 class B. Incidentally, the entire modulator has a resting plate current of 16 mills and kicks up to 35-40 mills for 100% modulation. If one wishes to use the newer type tubes the 6Y8G is the octal base version of the 79 and differs only in that all connections are brought out the base. The class B transformers should be heavy enough to carry the load as the smaller variety have the annoying habit of saturating and burning out.

The question of a receiver for portable-mobile operation is undoubtedly the cause of many headaches. The super-regenerator for ten meters is definitely out of the running these days. T.R.F.'s proved too critical and lacking in selectivity. Simple superhets did not provide sufficient "umph" and large ones were too cumbersome. Some had a terrific amount of hash and others had too high noise level. Finally, most receivers would not take the jolting and jarring around and everything happened from tube shields coming off to getting out of alignment.

One converter we made up was almost the answer but wasn't so hot on ten meters, and wouldn't work at all on five meters. We had been considering the automobile radio for some time. It had a power supply with efficient hash filters already built in. Also most auto radios are perfect examples of how a portable receiver should be built. They are rugged, stable, and had the ability to take a lot of bumps. Right here let it be said to the prospective builder of this type of apparatus that if he will take the cover off of an automobile receiver and notice how everything is tied down it will probably save him many troubles.

(Continued on page 43)

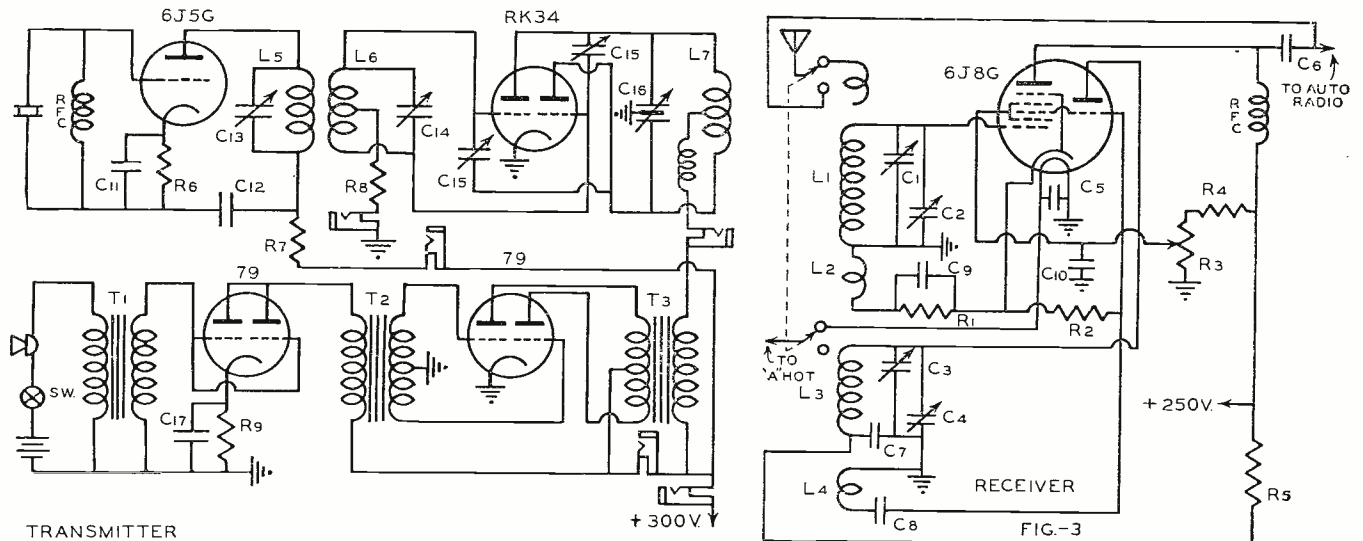

- L₁—5 turns No. 18—3/4" long
- L₂—1 3/4 turns No. 26—1/2" long
- L₃—2 1/2 turns No. 18—1/2" long
- L₄—2 3/4 turns No. 26—1/4" long
- All coils wound on 1 1/2" dia. plug-in forms.
- L₂ in opposite direction to L₁.
- "No spacing between windings."
- C₁—20 mmfd. variable Hammarlund
- C₂—15 mmfd. variable Hammarlund
- C₃—30 mmfd. variable Hammarlund
- C₄—100 mmfd. variable Hammarlund
- C₅—1 mfd. 400 v. Solar
- C₆—0.02 mfd. mica Solar
- C₇—0.05 mfd. mica Solar

- C₈—50 mmfd. mica Solar
- C₉—0.01 mfd. 200 v. Solar
- C₁₀—1 mfd. 200 v. Solar
- C₁₁—0.005 mfd. mica Solar
- C₁₂—0.005 mfd. mica Solar
- C₁₃—100 mmfd. var. Hammarlund
- C₁₄—3-30 mmfd. trimmer Hammarlund
- C₁₅—3-30 mmfd. neutralizing cond. Hammarlund
- C₁₆—25-25 mmfd. split-stator, Hammarlund
- C₁₇—10 mfd. 50 v. electro. Solar
- R₁—300 ohms 1 w. Centralab
- R₂—50,000 ohms 1/2 w. Centralab
- R₃—50,000 ohms pot. Yaxley
- R₄—25,000 ohms 1 w. Centralab

- R₅—50,000 ohms 1 w. Centralab
- R₆—200 ohms 10 w. Ohmite
- R₇—3000 ohms 10 w. Ohmite
- R₈—2000 ohms 2 w. Centralab
- R₉—1000 ohms 1 w. Centralab
- T₁—Mike Trans.
- T₂—Class B input
- T₃—Class B output "Modulation"

Transmitter Coil Data

- L₅—5 turns No. 12, 3/4" dia., 3/4" long
- L₆—19 turns No. 12, 3/4" dia., 3" long
- L₇—19 turns No. 12, 3/4" dia., 3" long
- "All self-supporting."



by **LEE WARD**
Service Manager, San Francisco, California

**The answer to the No. 5 Repairman's Riddle; and
the start of No. 6 Riddle are this month's features.**

AS soon as a serviceman sets himself up in business, he is surprised to find technical training plays only a small part in the conduct of his store routine. Accounting, salesmanship, advertising, and protection of cash and investment are equally important.

Repair stores are usually located in a low-rent section—which means few passers-by. Receipts often accumulate for a week or more. Both these conditions make the shop appealing to a robber. In the story below, how would YOU prevent a robbery if the store was YOURS?

This is an unusual hold-up; you have a chance of GETTING something instead of having it taken from you.

Simply tell us how to make it tough for the gunman. Without unduly extending the narrative, state what you think would be the best action to be taken at the point where the story leaves off. Address entries to Repairman's Riddle No. 6, Radio News, 608 S. Dearborn Street, Chicago. Answers must be received not later than June 25, 1940, and the winners will be announced in the September issue.

Entries will be judged for logic and expediency. Duplicate prizes to tie winners.

Everyone is eligible except employees of Ziff-Davis Publishing Company or their families.

FIRST PRIZE: Choice of either a Triplett

Model 426 0-1 d-c milliammeter, 4" square, or a Simpson Model 29 0-1 d-c milliammeter $4\frac{5}{8} \times 4\frac{1}{8}$ ". Or any other meter you choose having the same retail value.

SECOND PRIZE: Ghirardi's headache preventer for servicemen, the Radio Trouble Shooter's Handbook.

THIRD, FOURTH, and FIFTH PRIZES: Each a year's subscription to RADIO NEWS. If you are already a subscriber, a twelve months' extension.

Well, let's not stand around—a guy's comin' in with a gun!

Lights! Action!! Camera!!!

WE had an unfortunate accident in a customer's house last week. Cliff, walking down-stairs with a *Fuda 50*, didn't notice one of the 10's worked out of a socket. When he saw the tube roll off the chassis, he let go with one hand; the 10 was smashed, and the set came in with a bad dent.

"You're as awkward as a stumped ballerina," Pete, the Signal Chaser, announced. Pete's a swell mechanic, but he doesn't get along with Cliff very well.

"Naturally," Cliff admitted, "I was excited when it happened. But I'd like to see you in a situation where you had to use your head on the spur of the moment. You'd show less presence of mind than an expectant father! The tightest squeeze I've ever seen you in came when that customer wanted to wait while you installed a *Majestic* drive cable!"

"Yeah?" Pete snarled, turning to me. "Tell him, Lee. Tell him what happened right here in this store before he started working with us!"

"Well," I said, remembering an exciting night, but wishing the boys would think of such things on their own time, "we were open late one winter evening. I was behind the front counter, tidying up stock and waiting for Pete to clear away a sudden surge of chassis.

"We had noticed a seedy fellow walking back and forth

past the show window for several hours. Neither of us recognized him, so we knew he didn't live in the neighborhood; he carried no sign, so we knew he wasn't a picket. I noticed one of his overcoat pockets sagged—and it wasn't because it was full of half-dollars either.

"I told Pete. He said not to worry, but to stick behind the cash register and cough if the bloke walked in. Sure enough, he did; looked up and down the street, came in, and stood so the till was between us. Asked a few dumb questions about tubes that

showed he didn't want any, but only wanted to stall. I coughed, and was afraid to turn my back. At last, though, he asked to see a reel of wire on the top shelf, and—"

"Wait a minute," Pete interrupted. "I got a better idea. Let's act this thing out. Lee, you stand right where you were that night. I'll go back to the workbench. Cliff, you be the thug. Here's a pair of diagonals; that's the gun. Careful, they're loaded!"

"Oh, boy!" Cliff said sarcastically, "now we're playing cops and robbers!"

"Walk in to the register," Pete instructed, "and then I'll come in and do my stuff."

"Not fisticuffs!" Cliff said. "No—no rough stuff," Pete replied. "I'm simply going to show you a handy trick that can be done without calling for outside help, without weapons or violence, that has prevented many a well-planned one-man stick-up. You'll find it would be darned inconvenient to do anything you shouldn't and you'll wish you were out of the place. Now—got any idea, my quick-witted friend, what's going to occur when you try to 'hist the jint?'"

"Sure, *Belasco*," Cliff laughed, "the till will be tapped."

"Go try it!" Pete challenged. Cliff walked in and stopped at the register. I coughed. Pete went into action.

(Continued on page 57)

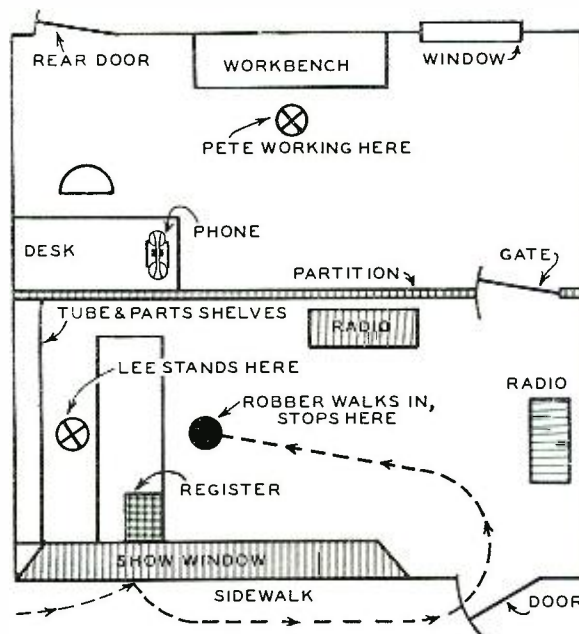

What's NEW in Radio

National Union Radio Corporation announced from their Newark, N. J. headquarters this week that they are prepared to supply *Sound extra*, a special line of tubes for use in Sound Amplifiers. In making the announcement, Mr. H. A. Hutchins, N. U.'s General Sales Manager, states: "Our chief requirement for these tubes is that they must be demonstrably better to the ear. We are now prepared to supply thirteen types after several months of field experience in addition to engineering and laboratory work. The tubes are branded *Sound extra* on the base to plainly identify them and are specially packaged in the largest size National Union cartons with special labels to make them stand out in stock. It should be noted that *Sound extra* types can be substituted in all cases for the like type of tube in the regular line which means that they can be sold for special audio work for any amplifiers, public address, inter-office systems, or other audio work where the identical type number is specified."

In order to accomplish the demonstrable difference in performance of these tubes, modifications in construction and details of engineering were incorporated. Emission limits are very high to insure exceptional uniformity, long life and adequate power handling capacity. Gas and grid current are held to exceptionally low limits to insure minimum distortion, uniformity and stability. Every tube is carefully tested for hum and microphonics and, where necessary, changes have been made in construction such as the use of special micas, extra rugged supports, double helix heaters, special insulation for minimum hum, etc.

The types of tubes as announced, cover a major percentage of replacement requirements, and while it is possible that additions may be made to this list from time to time, every effort will be made to keep the number of tubes in the line to the lowest possible figure consistent with industry requirements. No tubes will be added that are not demonstrably better.

The Model RC-2-P Bell *Record-o-fone* is a complete, self-contained, portable combination recorder and phonograph. Remarkably simple to operate, incorporating its own high fidelity amplifier it assures professional results in the recording of any sound, lending itself to innumerable uses for the home or business. No auxiliary equipment is required and it may be connected to any AC outlet. Recordings can be made on



any standard disc and played back immediately. It will reproduce any commercial made record or its own transcriptions with excellent faithfulness of tone and provides for a sufficiently wide range of amplification to be used as a public address system. The compact, leatherette covered carrying case has compartment for microphone, cables and records. Truly a revolutionary development of the highest quality construction and with wide utility and attractively priced.

The Biley Elect. Co. of Erie, Pa. announce a new unit known as Vari-X. The purpose of the Vari-X is to provide a variable frequency exciter having the frequency stability of a crystal controlled oscillator (so difficult to approach with a self-excited oscillator). Since the Vari-X is basically a crystal controlled oscillator, designed for use with our VF2 Wide-range Variable Crystal Unit, it is immediately apparent that crystal stability with crystal control is an actual fact.

The Vari-X, like other variable frequency exciters, is intended for installation at the station operating position. For ease of operation, a sloping front panel is used. The metal cabinet is

attractively finished in ripple gray and has external dimensions of 8" x 8" x 8".

Coupling to the transmitter is accomplished by means of a concentric cable supplied with each instrument. A 2-prong plug is furnished such that the cable can be connected to the plug and the Vari-X plugged into the present crystal socket in existing transmitters. The Vari-X has its own power supply which works from 110 volts 60 cycle A.C.

The "heart" of the Vari-X is, of course, the VF2 Wide-range Variable Crystal Unit. This



80-meter crystal unit, a direct development by our engineers, has a total adjustable frequency range of approximately 12kc. The variation approaches 24kc. when frequency doubling to 40 meters and 48kc. when quadrupling to the 20-meter band. The VF2 unit can truly be termed a "rubber crystal."

Descriptive circular D 2, a copy of which is attached, can be obtained from any Biley distributor or directly from the factory where desired.

Webster-Chicago announces the addition of this popularly priced 60 watt amplifier to their standard line. The unit, housed in a modern wrinkle finish case, incorporates such features as electronic mixing of two high gain microphone inputs, multi stage inverse feed back, voice coil and line impedance outputs, no-glare illuminated

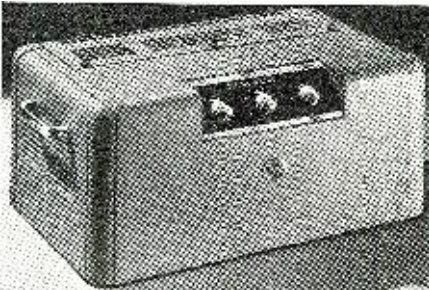

glass panel and locking type input plugs. The amplifier, conservatively rated at 60 watts, utilizes four 6L6 beam power output tubes with a 6X5 rectifier tube for bias—flat from 50 to 10,000 cycles and with a gain of 125DB it is an ideal high power amplifier for large auditoriums and outdoor installations.

Montgomery Ward, announces a new addition to their popular *Airline* Equip. Great savings are accomplished by designing these Amplifiers around a standardized Pre-amplifier and mixer unit. This unit has four individual mike channels and two phonograph inputs. It also has

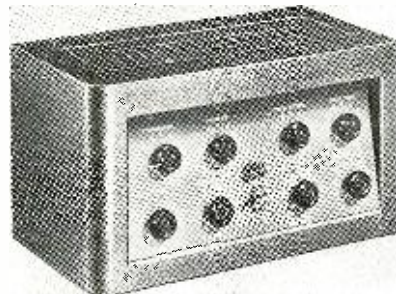

separate bass and treble controls. The four mike inputs use four input tubes and individual volume controls. One master phone volume control is used for the two phonograph inputs and a second master control with provisions for remote operation is used to adjust the overall volume of all channels. The individual bass and treble controls are of the booster type, permitting raising or lowering the amount of bass or treble individually.

This standardized Pre-amplifier when attached to the chassis of the 60 or 100 watt Amplifiers becomes an integral part of the Amplifier. When more than 100 watts is wanted, extra 100 watt chassis are connected to the Pre-amplifier. Provisions are made for using up to five 100 watt chassis, giving a total power output of 500 watts.

Where low cost is of major importance, the Pre-amplifier and 100 watt chassis may be bought as individual units—or—if a Deluxe installation is desired, a combination of Pre-amplifier and 100 watt units can be supplied, mounted in a steel rack cabinet. The large illustration shows a Deluxe installation, including a high fidelity radio tuner, an automatic record changer, and a 300 watt Amplifier (three 100 watt units).

This equipment was developed by Montgomery Ward, Chicago, Illinois, and will be described in their new Sound catalogue, ready about May 1.

A new Cardioid Microphone specially engineered for Broadcasting and Recording is now offered by Shure Brothers, "Microphone Headquarters," Chicago.

This new Model 555 Unidyne utilizes the exclusive "Uniphase" principle developed by Shure



Engineers. It provides true cardioid uni-directional pick-up—reduces the pick-up of troublesome reflections, reverberation effects, or random background noise—and solves most of the sound pick-up problems encountered in studio and remote applications.

The 555 Unidyne gives wide-angle front-side coverage, but is "dead" at the rear. It gives prominence and definition to the direct sound, stops the pick-up of unwanted sounds. As a result, it assures truly fine reproduction of voice and music.

The Shure 555 is functionally designed in the modern manner and finished in satin chrome. Construction is rugged throughout. It employs a specially suspended double wind-screened moving-coil system. Built-in flexible rubber-cushioning unit provides effective transverse vibration isolation. Microphone tilts forward as well as rearward through an angle of 150 degrees. Easily mounted or demounted from stand.

Call Letter Plate is optional. Fits on the case of the microphone easily and snugly. Makes call letters visible from all four sides.

The "555" Unidyne is available in 35-50 ohm and 200-250 ohm models (or in high impedance model). List price is \$60.00. For complete information, write to Shure Brothers, 225 West Huron Street, Chicago, Illinois.

Of interest in the educational field and industrial field is Victor's new Two Speaker Unit in one case under one handle (as shown above). This exclusive Victor arrangement permits the use of two speakers when they are required, and avoids the inconvenience of carrying two cases in addition to the projector. In addition to the superior sound from two speakers, it is unquestionably the greatest advance in portability of sound movie equipment ever designed.

The Victor engineering department also takes

pleasure in announcing new engineering developments in the Animatophone units. The model 40 A Amplifier output has been doubled—and the model 40 B Amplifier output has been increased 50%. Both models have separate "mike" control built in.

In addition to Victor's Famous Film Trip, there is now even more film protection. In these new

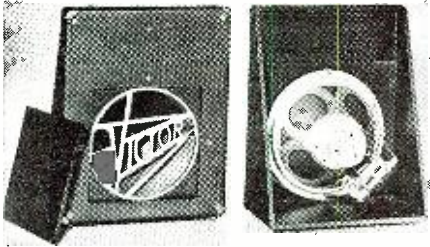

models no picture or tract area is in contact with plates, shoes or rollers. The new Victor Filter also completely eliminates "Wows" or flutter. Complete information on all of these details, as well as many other improvements that Victor is constantly making, is available by writing Victor Animatograph Corporation, Davenport, Iowa.

You can't forget to tune in your favorite program, and you can also use the radio for an alarm clock in the morning. If you equip the set with a new timer switch, or control clock just placed on the market. The timer switch will turn the radio on and off at any time you may designate for music or silence.

This time switch resembles, also actually is an accurate time piece. It turns on and off the electric current actuating any appliance or thing connected to an ordinary wall outlet. The appliance, or thing to be controlled, is then plugged into the time switch which then will turn on the current at any time for which it is set and also turn off at such later time as may be designated. The time switch has a time range of 2 1/2 hours.

When the lady of the house goes to bridge or the movies, she plugs the electric roaster into

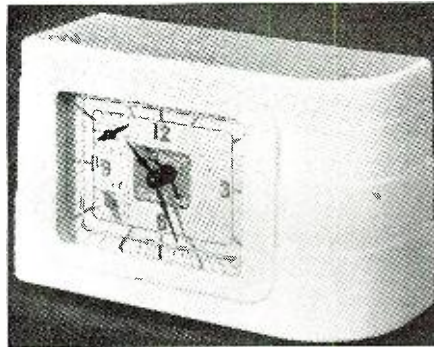

the time switch, sets it, say for on at 3 and off at 5, and comes home to find dinner ready to serve. If Father likes to waken to music, he tunes in his favorite radio station before he goes to bed and plugs it into the clock set for the hour at which he wishes to rise and the time switch turns on the radio at the desired time. Some go to sleep by radio, and let the time switch turn off the instrument.

Merchants use the time switch to turn on and off electrically operated displays, window and store lights. The same service is performed for inside and outside lights of homes. Farmers use it to control an almost infinite number of farm devices, and lights in barns and other farm buildings.

The time switch is manufactured by The Schwartzbaugh Mfg. Co. of Toledo, Ohio, in two models priced at \$5.95 and \$6.95 respectively.

The new *Haliocrafters SX-25 "Super DeLant" Communications Receiver* although selling in the medium-price class (slightly under a hundred dollars) offers an array of features unusual in this class. Included among these are two pre-selector stages, four degrees of selectivity including broad and sharp crystal filter circuits, temperature and line voltage compensation with con-

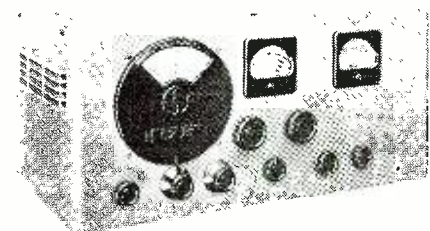

sequent freedom from tuning drift, frequency calibrated bandspread on ham bands from 80 to

100 meters, inclusive, automatic noise limiting, single signal c.w. reception, a continuous range of 538 kc. to 42 mc. in four bands, "S" meter calibrated in "S" units and decibels, a 6-position switch which in one movement selects the type of reception desired (phone or c.w.) the selectivity desired and automatically cuts the a.e.c. in or out depending on the type of reception selected, provision for operation from the a.e. line or for instant changeover to a battery-vibrator combination for mobile or emergency work, etc., etc.

The circuit employs 12 tubes in 2 r.f. stages, mixer-oscillator, 2 i.f. stages, detector-a.v.c.-1st audio, noise limiter, b.f.o., phase inverter, push-pull output, and rectifier circuits. It is enclosed in a cradle-finished metal cabinet with satin steel trim. A separate loudspeaker in matching cabinet is included.

Sensitivity (equivalent noise-sideband-input) averages 0.3 microvolt throughout the tuning range, with a minimum of 0.6 at 1500 kc. and maximum of 0.17 at 30 mc. Image ratio is 32 db. at 30 mc., 56 db. at 14 mc., 78 db. at 7 mc., 103 db. at 3 mc., etc.

Claimed to be one of the most popular amplifier foundation chassis of the 1940 season is the Deluxe Sloping Front unit shown here. This new foundation, manufactured by *Parmetal Products Corp.*, 326 1/2 49th St., Long Island City, N. Y., follows the latest trend in Amplifier design and enables one to build up a job similar to that used in commercial amplifiers.

All parts are finished in slate gray ripple



enamel, trimmed with red striped chrome finished mouldings and handles. Front panel is removable and extends 3" from the face of the screen cover. Chassis are supplied complete with bottom plates. Available in 3 chassis sizes: 10 x 12 x 3, 10 x 17 x 3, 13 x 17 x 3. Screen covers are 6 1/2" high.

Sonora Radio & Television Corporation, Chicago announces the introduction of an ingenious new type of radio receiver. Known as the "Candid," it has been designed for "America-on-the-Go." As its name implies, it is a personal type of radio, resembling a camera in appearance

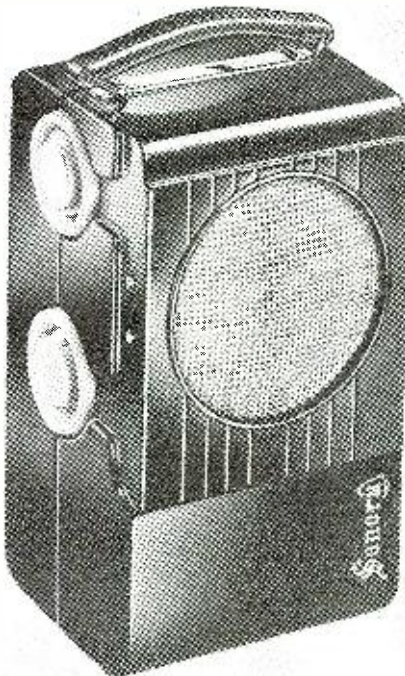

and construction. The sturdy case is molded of Durez, and is available either with carrying handle or shoulder strap. Everything is built-in; plays anywhere—nothing to add or connect. Has built-in batteries; uses the new miniature tubes in a Superheterodyne circuit includes "Sonorascope" built-in aerial; Dynamic Speaker; Automatic Volume Control. Tunes the standard Broadcast band. Has headphone plug-in connection for privacy listening or long-distance reception. Uses ordinary flashlight cells for "A" supply, and regular portable "B" battery; unusually economical. The "Candid" is the answer to the wide demand for a miniature self-playing radio—an ideal companion for traveling, for out-of-

door or for indoor radio enjoyment. The measurements are 8 1/4" x 5" x 4", carrying weight is only 4 1/2 pounds. The "Candid" is the forerunner of a new trend in the already enormous portable radio field. It has been made possible by the introduction of the new miniature tubes and by improvements in circuit design and battery capacity. It represents a remarkable advance in radio receiver design progress.

A new and very unique home workshop and industrial tool has just been developed by The *Barron Tool Company*, 415 Brainard Street, Detroit, and is being marketed under the name, Barron Multi-Purpose 5-in-1 Rotary Wood Planer. The extreme novelty and added usefulness of this tool lies in the fact that it not only planes and finishes to a satin smoothness all types of woods and plastics, but it goes a long step farther in paneling, rabbeting, routing and tenoning.

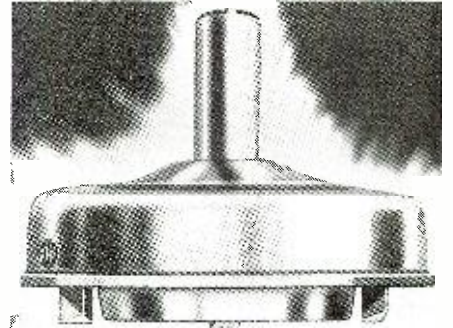

This tool is beautifully streamlined and engineered. It is designed to fit any 1/4 h.p. or larger table or pedestal model drill press. No adjustment or change is required to obtain any one of the five distinct operations. It is a precision tool, planing and paralleling to within .002 of an inch. It converts the normal wood-working drill press into a most versatile workshop tool.

The Barron Multi-Purpose Planer eliminates the need for manual planing and sanding. It provides unlimited scope in paneling door and drawer fronts and special furniture effects. It rabbets with amazing speed and accuracy. It tenons to precision tolerances and it routs and grooves to serve a variety of purposes.

The *Transformer Corporation of America*, through its nation-wide organization of Sound Distributors, the *Clarion Institute of Sound Engineers*, has just announced a complete new line of Sound equipment for 1940 designed with individuality, as evidenced by the Model A-95. 71 watt Super power unit illustrated above; having a peak wattage of over 100, facilities for 4



microphones, 2 phono inputs, all of which may be operated simultaneously, maximum gain of microphone input, 127 db, individual bass and treble equalizers, master gain control, special low distortion inverse feedback circuit, 4 beam power tubes, remote control, impedance selector switch, optional DB meter or 2" monitor speaker, studio control panel, and optional model with built-on phono table and pick-up. This new Clarion unit is claimed to be far ahead of the field. Amplifier complete with tubes and phono equipment lists at only \$174.90.

Three new dual capacity midsize dry electrolytic condensers with separate positive and separate negative leads have been added to the well-known line of *Sprague Atoms*. These are especially adapted as duplicate replacements for auto radio receivers and common positive condenser requirements.

Like the other Atoms, these new units are unconditionally guaranteed. Although surprisingly



small, they may be used to replace old-style condensers much larger in size and costing a great deal more.

The new units include Type TU-220, 20-20 mfd., 150 volts, 1" x 2 3/8", list \$1.35; Type TU-216, 16-16 mfd., 250 volts, 1" x 2 3/8", list

\$1.65 and Type TU-88, 8-8 mfd., 450 volts, $1\frac{1}{8}$ " x $3\frac{3}{8}$ ", list \$1.35.

A new folder listing the complete line of Atom midgelet condensers will gladly be sent upon request to the *Sprague Products Company*, North Adams, Mass.

The *United Cinephone Corporation*, Long Island City, N. Y., recently introduced new controls that are housed in compact (9 " x $6\frac{1}{2}$ " x $4\frac{1}{4}$ "") battleship grey enclosures, having half-inch knock-outs in the bottom for power connections, and a fourth knock-out on the top as provision for wiring in an external photo-cell. Rugged telephone type relays are ordinarily provided, permitting a maximum non-inductive load of three amperes alternating current at operation speeds up to ten per second; however a Micro-switch to carry eight amperes, or another contacting device handling fifteen amperes at 110 volts will fit the same housing, and are available at slight additional cost.

In Model No. 60, listing for \$24.00, the photo-cell is separately housed, making possible the convenience of mounting the control as much as

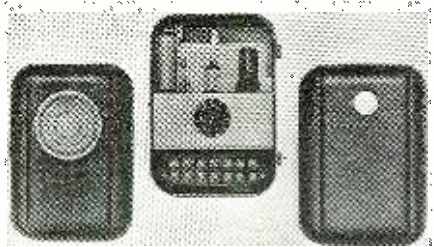

five feet from the electric eye. Model No. 62 lists at \$27.00, and Model No. 64 is priced at \$29.00, the latter employing a three inch collector lens to the photo-cell for applications demanding response from as little as one-half foot candle with zero residual illumination. Units utilize a commonly available and inexpensive amplifier type tube (6J5), and the photocell tubes used have life expectancies of upwards of 10,000 hours, making for low maintenance costs. Generally built for operation on 110 volt 50/60 cycle A.C., higher priced models are obtainable to work from 110 volts D.C. or 220 volts A.C. lines.

We are also making available at this time a complete line of light sources, designed to be used in conjunction with our new "No. 60 series" line of photoelectric controls.

For applications calling for very high capacity values at very low voltages, seven popular values and voltage ratings are now offered in the midgelet metal-can electrolytics by *Aerovox Corporation* of

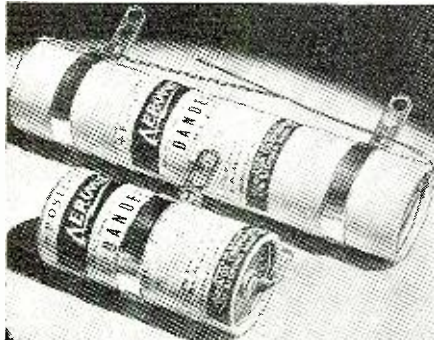

New Bedford, Mass. The capacities range from 1000 to 300 mfd., with working voltages of 6, 12 and 13 D.C. The metal can is full protected and insulated by the paper sleeve extending for the full length and rolled over the can edges, to preclude shorting of leads on the can. Units are supplied with mounting straps, except for a larger can size unit which has a standard mounting ring.

The *Cinema Engineering Company* of Burbank, California announces the appointment of Norman B. Neely as exclusive sales representative. This company has been supplying precision attenuators and resistors, plugs and patch cords, relays, jacks, jack strips, gain sets and similar units to the motion picture industry in Southern California for several years. Strict adherence to high standards of quality and accuracy have built a very good acceptance for *Cinema Engineering* products and Mr. Neely's appointment as technical sales representative marks the beginning of an expansion campaign made possible by increased manufacturing facilities. A new catalogue has just been released and is available upon request to Norman B. Neely, 5334 Hollywood Boulevard, Hollywood.

A new series of "Airwound" Adjustable Link Oscillator and Buffer Coils has recently been announced by *Bud Radio Inc.* of Cleveland, Ohio. These coils are designed for use in circuits where it is desirable to adjust excitation or antenna loading by varying the link coupling.

Each coil is individually linked, and coupling is varied by pushing the link in or out of the main winding. In view of the fact that each

coil has its own link the coupling adjustment for each band can be left permanently set at the proper value.

All coils in this series fit standard 5-prong sockets and are designed for operation in stages where the input power does not exceed 50-watts. Coils are available for all amateur bands.

Currently featured by *Allied Radio Corporation*, Chicago, is an 8-Tube *Knight* Commode radio, Model A10773. This radio strikes a new note in charming period design. It is housed in a beautiful cabinet of choice mahogany veneers, finished in a rich high lustre. The doors at the front, which are fluted on the surface, open to give access to the instrument panel. The speaker grille is at the bottom.

The *Knight* "8" covers two wave bands from 5.7 to 18.3 M.C. and from 540 to 1600 K.C. It incorporates the new built-in "Air-Magnet," eliminating the need for aerial and ground. Other



features include: Push-button tuning on six stations; Giant Slide-Rule dial; Electric Eye; Television Connection; A.V.C.; 5 Watts Output; Big Dynamic Speaker; Bass Compensation. Fully licensed by RCA and Hazeltine, uses the following tubes: 6SA7, 6SK7, 6SQ7, 6SP5, 2 6K6G, 5Y4G, 6U5 (Electric Eye). These are dual-purpose and triple-purpose tubes. Operation is from 110 volts, 50-60 cycles A.C.

The *Knight* 8-tube Commode Model Radio is a product of *Allied Radio Corporation*, 833 W. Jackson Blvd., Chicago, Illinois.

The *Kennon Transformer Co., Inc.*, of 840 Barry Street, New York have just announced a complete new series of transformers made in both standard and submersion proof types. They are designed to plug into an 11 prong octal socket and are extremely neat in appearance, being finished in black alumilite. Case sizes are standard, being a round drawn can $2\frac{1}{4}$ " high and $1\frac{1}{2}$ " in diameter. Units are manufactured covering the following types of transformers: Line to line, Crystal mike to line, low impedance source to

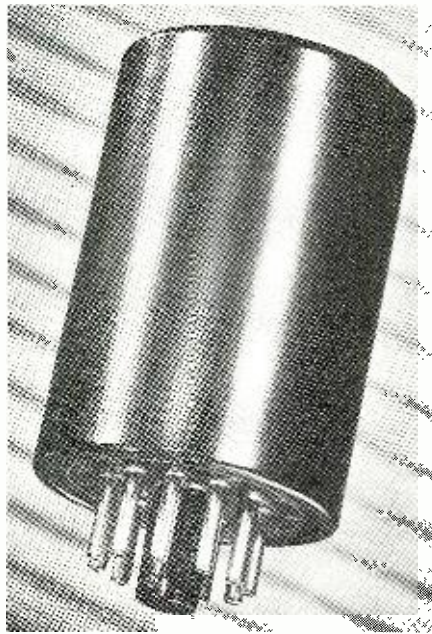

grid, interstage transformers, and output transformers and chokes with no D.C. in the winding the frequency response is plus or minus 2 db 30 to 20,000 cycles.

21 new units offer a wide range of applications.

All but four are of the hum bucking construction type.

These units will find widespread application in light portable equipment, such as aircraft, portable broadcasting, marine and any service where the rigid government specifications for submersion proof testing are to be maintained.

Complete information and a new catalog can be obtained from the manufacturer.

Volume controls with serrated shafts, for quick and exact replacement of controls having the knurl and slot shafts, are announced by *Clarasat Mfg. Co., Inc.*, 285-7 North Sixth St., Brooklyn, N. Y. These Series KS controls are of the popular *Clarasat* midgelet type, and permit replacements without having to replace the slip-on knobs as well. Series KS units are available in all required resistance values, although only six values are required in servicing the bulk of existing radio sets.

RCA Manufacturing Company, Inc., Harrison, New Jersey, are making available through their transmitting-tube distributors the RCA-829—a new, push-pull, beam power amplifier tube having a total maximum plate dissipation of 40 watts. A single 829 tube operated in push-pull class C telegraph service is capable of handling a power input of 120 watts with less than a watt of driv-

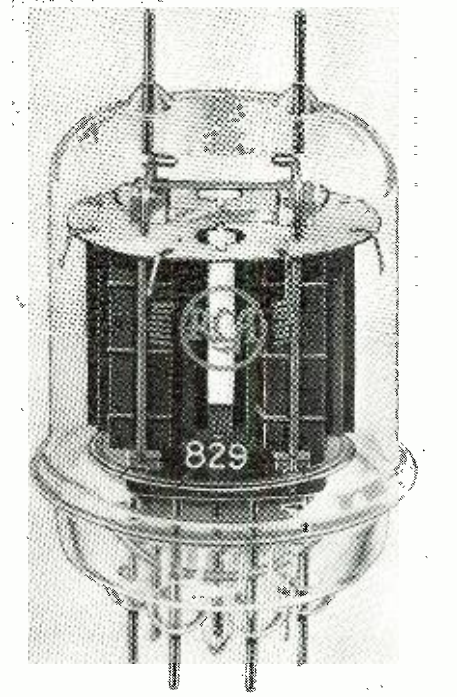

ing power—at frequencies as high as 200 megacycles.

The exceptional efficiency of the 829 at the ultra-high frequencies is made possible by the balanced and compact structure of the two units, excellent internal shielding, and close electrode spacing. The internal leads are short and heavy in order to minimize internal lead inductance. The terminal arrangement provides excellent insulation and is designed to facilitate symmetry of circuit layout.

Marked emphasis on modern styling, more cooling per kilowatt-hour of input, and substantial reductions in physical size feature the trend in self-contained room air conditioners as evidenced by the three new room coolers—one window-type and two con-oles—just announced by the *General Electric Company*. Meeting the past criticisms of interior designers the cabinets are styled in simple, modern lines, with exteriors of finished walnut and antique leather over steel backing. Taking up about 36 per cent less room than previous units of comparable rating, the new models produce up to 16 per cent more cooling effect per unit of electricity used.

The window type, which is one-half horsepower, has a net cooling capacity of 5,000 Btu per hour and is 28 inches wide, 19 inches high and projects into the room 9 inches from the window sill. The one-half horsepower console model is rated at 6,000 Btu per hour net cooling; while the three-quarter horsepower model has a net cooling capacity of 8,000 Btu. Both consoles measure approximately 35 inches high and extend 19 inches from the wall.

Simpson Electric Co. of Chicago, announces that, for the first time, a current transformer and an indicating instrument have been combined in a small A.C. multi-range ammeter that sells at a price almost unbelievably low. Known as "Micro-Tester" Model 280, this instrument provides readings in any of five different ranges, from fractions of an ampere up to 25 amperes. It is housed in a red Bakelite moulded case, with satin-finish steel front panel. Pocket-size, it measures only $2\frac{1}{2}$ " x $5\frac{1}{4}$ " x $1\frac{1}{4}$ ", weighs just 20 ounces.

This Model 280 is the standard bearer of the new line of "Micro-Testers" which Simpson has just placed on the market. These companion testing instruments, all the same size, can be combined in sets of three to measure current, voltage and resistance for almost every requirement. Kept in a sturdy carrying case, which has room for necessary leads, such a set provides measurement on individual meters at a total cost far below that of the usual combination instrument. The separate meters, too, allow a flexibility never before obtainable.

The complete "Micro-Tester" line includes: Model 281 A.C. Voltmeter "Illustrated." Ranges:

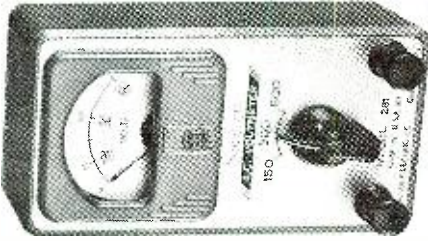

0-150, 0-300, 0-600 Volts. Model 282 D.C. Ohmmeter. Ranges: 0-1000, 0-10,000 and 0-100,000 Ohms; 0-1 and 0-10 Megohms. Model 283 D.C. Milliammeter. Ranges: 0-1, 5, 10, 25, 50, 100, 250, 500, 1000 M.A. Model 284 D.C. Microammeter. Ranges 0-50, 100, 250, 500 and 1000 Micro-amperes. Model 285 D.C. Ammeter. Ranges: 0-1, 0-2.5, 0-5, 0-10, 0-25 Amperes. Model 286 A.C. Voltmeter. (Rectifier Type). Ranges: 0-5, 10, 25, 50, 100, 250, 500 and 1000 Volts. Model 287 D.C. Voltmeter. Ranges 0-1, 2.5, 5, 10, 25, 50, 100, 250, 500, 1000 Volts.

Just announced by *Howard Radio Company* of 1735 Belmont Avenue, Chicago, is the new *Howard Radio Recorder*. This instrument makes it possible to record radio programs on phonograph record blanks. By means of the mixer control provision is made to blend the voice or music from the microphone with the radio program in the background. Music or voice alone



may be recorded as well. This unit will also duplicate standard records or records made by this instrument. An automatic record player is provided for 10" and 12" or mixed sized records. By means of the microphone and radio receiver, a powerful home amplifier system is provided. Two types of radio chassis are available—a 7 tube two band receiver and a 9 tube three band receiver. The cabinet is of authentic Hepplewhite design, available in Mahogany or Walnut. The cabinet dimensions—31 1/2" long, 33 3/4" high and 15 3/4" deep.

American Phenolic Corporation, 1250 Van Buren Street, Chicago, Illinois, announce a new socket for crystal-holders made of transparent ultra-low-loss *Amphenol* "912" pure polysty-

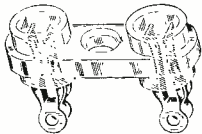

rene), which is non-hygroscopic, won't collect frost, and is tough and strong. Losses are so low as to be negligible, and permit full crystal output to be applied to the grid of the oscillator tube. The phosphor-bronze contacts are silver-plated to reduce contact resistance, and are set in long pockets extending above and below the central rib.

The mounting arrangement is interesting as it can be assembled either on top of a chassis, or from underneath, fastening with a single No. 6 screw.

Leardadio presents the *Tri-Power* Portable that operates on AC-DC and Batteries, featuring choice of AC-DC or battery operation by merely flipping a switch, in response to urgent pilot demand. Pilots asked for a portable receiver they could use indefinitely indoors without the penalty of battery loss. The *Tri-Power* can be used in the

air or out-of-doors on its own batteries—or on any ordinary electrical outlet without the slightest battery wear.

Other important features of this receiver are: radio-range plus commercial broadcast reception



—phone jack for use on aircraft band—external terminal for connection aircraft antenna—battery life of 20 hours or more—weight of only 12 1/2 pounds complete.

Despite the considerable improvement over previous models, the *Tri-Power* is offered at no increase in price.

Model 334 *Utilitester*—all-purpose compact general utility test instrument. 22 ranges. Three inch meter. Resistance 0 to 1 meg. with internal heavy duty dry cell. Volts 0 to 3000 A.C. and D.C. Milliamps 0 to 300. Decibels minus 6 to plus 64. Sensitivity 1000 ohms per volt. All ranges selected by single rotary switch. Specially tapered ohms adjust control. Pre-geared rectifier. Wire wound shunts and all multiplier resistors plus or minus 1% (one percent). Leather carrying handle. Black wrinkle case. Ivory metal panel with black raised designations. Size 5 3/4" x 7 1/2" x 2 3/8". Weight 2 1/2 lbs. *Triumph Mfg. Co.*, 4017-19 W. Lake Street, Chicago, Illinois.

"Multivolt" multi-tap vitreous-enamelled Resistors especially suited for cathode modulation radio telephone circuits are offered by the *Ohmite Manufacturing Co.*, Chicago.

These 50 watt Units (No. 1206 of 10,000 ohms Resistance and No. 1209 of 25,000 ohms Resistance) make it possible to secure the proper im-

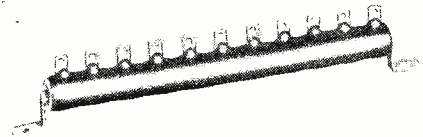

pedance match of the modulator to the filament or cathode circuit of the final radio frequency amplifier. They provide the exact control needed for correct cathode modulation.

Ohmite Multivolt Resistors have ten equal sections. The resistance wire is accurately wound on a porcelain core and permanently protected by *Ohmite* vitreous enamel to assure long dependability.

In addition to their convenience in cathode modulation circuits, the Multivolts are also handy as voltage dividers, etc. They are available in many resistances in 50, 75 and 150 watt sizes.

The *Thordarson Electric Mfg. Co.* announces a new addition to its line, the *Tri-Fidelity* Studio Amplifier.

This new model provides audio amplification with superior tone fidelity... tones so perfect that they actually create an illusion of presence. This is a quality which especially recommends it to broadcast stations, studios, owners of extensive libraries of choice phonograph records, and others who appreciate fine music and speech reproduction.

Noticeable among the many features of this new amplifier is the *Audio Frequency Equalizer*, a refinement of the *Thordarson* pioneered *Dual Tone Control Circuit*. Actually, it provides an unlimited choice of audio frequency ranges.

Although the amplifier is essentially one unit, the low level and voltage amplifier stages are isolated from the power stage and power supply, reducing hum to an absolute minimum.

It is available for rack mounting or in a grey cabinet. A beautiful "Brushed Steel" panel makes this a most attractive instrument in any conspicuous position.

Complete specifications and technical data are available in Bulletin SD-443 by writing the *Thordarson Electric Mfg. Co.*, Chicago, Illinois, or at your local distributor.

The *Turner Co.* of Cedar Rapids, Iowa, is announcing a new low-cost microphone named the "Hand" because it is shaped to fit the hand, and also because it is handy for so many purposes. Available in both crystal and dynamic, this new microphone fits snugly into the hand, has a hook which allows it to be used as a hanging mike for stage work and call systems, and is designed to fit any standard desk or floor stand with 5/8"-27 thread.

This new Hand-D microphone is 4 1/4" long (including the hook), 2 3/4" at widest point and

1 7/8" thick. It is finished in a rich brushed chrome which does not scratch easily or show smudge from handling, yet blends or matches with modern desk and floor stands. It is furnished with an 8 ft. cable set, but a 25 ft. set or longer can be furnished. A removable connector is furnished so that cables can be changed or repaired without opening the mike.

A positive contact slide switch affords easy action on the Hand-D, and permits the off and on switch to be operated without thumb fatigue. The frequency response of both the crystal and dynamic models is engineered to be suitable for both close speaking (voice application) and for voice and music pickup where the performer may operate at a distance. Voice reproduction is crisp and clear without unnecessary sacrifice of bass responses, yet feedback problems are held to a surprising minimum.

As with all *Turner* Microphones, each unit is individually tested in a sound pressure room for level and frequency before it is shipped, assuring purchasers that the microphone is in perfect condition.

According to the manufacturer, the Model 9D Dynamic Hand-D should be chosen when the microphone will be subjected to extreme cold humidity or rough handling, or where extremely long lines are necessary. Model 9D Dynamic is available in high impedance—30-50 ohms, 200, 250 ohms or 500 ohms. Lines of 75 feet may be used with high impedance types. Unlimited lines are possible with other impedances. This Dynamic is particularly recommended when the

mike is to be used in an automobile. Model 9D with 8 foot cable set, high impedance is listed at \$25.00 Level HI-Z-54DB. Range 60-7000 cycles. Reference level 1 volt per bar. It comes packed with chamoisette protector and diagrams.

The Model 9X Crystal is slightly less rugged than the 9D, yet withstands a great amount of abuse, and gives clear cut performance on both voice and music. It also is packed with chamoisette bar and diagrams, and with 8 ft. cable set, lists at \$22.50. Response 60-7000 cycles. Level -50DB, reference level 1 volt per bar.

Complete information on these Hand-D models may be had by writing the *Turner Co.*, Cedar Rapids, Iowa.

Radiotechnic Laboratory, Evanston, Illinois, has announced the Model 120, an innovation in tube testing. The PMT circuit switching is an outstanding feature of this instrument. It is designed to accommodate any possible combination of heater and control elements of all existing sockets, and for all tubes that may be introduced in the future.

In the event of new sockets, space is provided, and wiring would only be made to an adjacent socket.

All tubes, including local, single-end, miniature, Hytron Bantam, Raytheon CK series, 50, 70, 117 volt series, pilot lamps and Christmas tree bulbs can be accurately tested on this new instrument. Gaseous rectifiers are also tested with proper operating voltages.

Patent claims have been filed for the PMT (permutation) switch system. R-T-L states that this PMT method is the only way that a flexible

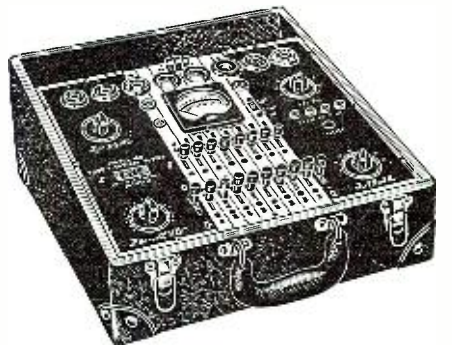

switch system can be incorporated in a tube tester without going to specially built switches. Stock switches are used throughout, thereby keeping the cost at a minimum. Three D.C. ranges 0-10V, 0-100V, and 0-1000V are available for the testing of batteries and D.C. power supplies.

The 120 is available in two models; the counter, which has a sloping metal case with a slide drawer to hold the tube chart; the portable model is mounted in an attractive leatherette case.

For additional information, write *The Radiotechnic Laboratory*, 1328 Sherman Avenue, Evanston, Illinois.

A new innovation in merchandising in the radio
(Continued on page 57)

"REMOTES"

This is the Reader's Page; where he can express his opinions, and where he can find all corrections.

Refer to: High-Fidelity Tuner, RADIO NEWS, Feb., 1940.

An error appears in the schematic diagram as follows; Condenser C1 should be connected on the R1 side of the AVC circuit, instead of on the coil side. The AVC return goes to the coil direct and then to the first grid.

Refer to: Build this modern Oscilloscope, RADIO NEWS, May, 1940.

The diagram on page 33 shows a by-pass condenser C1 at the tube socket. Actually one side of the filament is grounded at the power supply and condenser C1 is mounted right at the tube socket for by-pass purposes in case stray fields are set up. This is required in order to prevent any self-distortion of the pattern on the oscilloscope tube screen and therefore should be included.

Refer to: The 1940 Portable Rig, RADIO NEWS, May, 1940.

Correction for the parts list on page 17. T3 should be a Thordarson T-14R40 transformer-115v. 50-60 cycle or 6 v.d.c. vibrator transformer. The part listed as T4 is the one incorrectly shown for T3. This is a Thordarson T49C91 choke.

Refer to: The Full Floating Tube Tester, RADIO NEWS, April, 1940.

6 Alden sockets, 4-5-6-7 LS, 8 and local
1 wafer socket for 80
8 Yaxley 3215J circuit sw.
1 Yaxley 32117J fil. sw.
9 H & H SPDT push button sw.
1 Triplett O-1 ma meter
1 DPDT toggle sw.
1 SPST toggle sw.
1 No. 465 Yaxley plate No. 1-15
1 270° Gordon dial No. 263
1 Yaxley B control No. 1 taper
1 Yaxley M200P potentiometer
1 pin jack
1 400 v. condenser .25 or .5 mf
1 1/4 watt neon lamp 115v.
1 socket for neon lamp
1 5,000 ohm 1/2 w. resistor
1 400 ohm 1/2 w. resistor
1 Fil. Trans. 1.5 to 115 v. sec.
1 30 v. anode transformer

At the time the tester was constructed (last Oct.) Radio-Wire-Television, Inc. in Chicago was the only nearby jobber able to supply the filament transformer. It is listed in the last catalog. The 270° dial plate may be any make but the writer found it necessary to order direct from the Gordon Specialties, Park Ridge, Ill. Substitution may be made for any of the above

parts, provided the requirements of the tester are met.

Special attention is called to a drafting error in the diagram. F2, the common lead of the filament transformer secondary, should be connected to the *negative* bus.

At the time the tester was built no sockets were available for the new RCA bantam tubes. I understand *Amphenol* has such a socket now, and would include one if building the tester at this time. I have had the instrument in service since last October, and as there has so far been no occasion to test these bantams have not yet made any provision for doing so. During that time have tested in excess of 2,000 tubes with only one exception the 0Z4. Since this tube requires 300 volts for breakdown, no provision was made for it, since it would defeat the primary purpose of the article, i.e., construction from stock parts obtainable by all. However, the 0Z4 either rectifies or does not, and the quickest and surest test is to install a new one. Anyone doing auto work should surely have at least one new 0Z4 on hand.

Refer to: Full Floating the Full Floating Tube Tester, RADIO NEWS, April, 1940.

The sensation caused by the publication of the details of the writer's latest masterpiece, the "Full Floating Tube Tester," was only what might be justly expected in view of the outstanding merits of this challenge to the domination of the mighty tube trust. Letters of congratulation poured in, at the rate of one or two a week; representatives of the larger equipment manufacturers, *Easton*, *Quadruplet*, *Billion* and others bid frantically for rights to the author's future efforts. The pale faces of downtrodden service men brightened for the first time in years, at the realization that here was a tube tester they could use for a *whole week* before it became obsolete. *David Sound-off*, president of the powerful tube trust, *Ar-sylvan-rad*, hurriedly announced their entry into the television field, clearly indicating their withdrawal from the tube industry, since the days of easy profits were over now that anyone could test tubes. Bells rang—whistles blew, and the writer beheld people hurrying from all directions toward his door. Unfortunately a big fire broke out around the corner at this time, which distracted the crowd, and by the time the fire was out it was time for them to go back to work.

In the midst of this general furor of adulation and acclaim, a discordant note appeared, which became audible as a jeering whisper—"Taint full floating, taint full floating." Stung by these taunts, originated no doubt by the low hirelings of the tube manufacturers, the writer withdrew to the seclusion of his workshop, to ponder over this grave charge. His dander rose—his Scotch rose, and was quickly mixed

in a glass of *White Rock*, with two ice cubes floating about as a symbol of his mission. Sleepless minutes passed (from 1:01 to 1:03 p.m.) until the reply to the kibitzers was ready.

Transformers and other components were hurriedly unbolted from the chassis and mounted on one inch rubber washers. The meter was neatly taken care of by a round rubber teething ring as a support. In the right-hand tool compartment, a half dozen cakes of *Ivory Soap*, long the American synonym for floating, were installed. The left hand compartment was quickly lined with zinc, and with the addition of a quart of water, became the happy floating ground of two gold fish named Elmer and Eloise. 1½ inch lengths of coil spring were fastened on each control shaft, and the knobs attached to the springs. The slight nudge is sufficient to cause these knobs to bob about, simulating the effect of stray bits of garbage floating down Long Island Sound. Little more was needed to float everything else. A length of tubing was installed in each corner of the case, and the last necessity was a six-foot length of light chain, with four long coil springs attached to one end.

Arriving at the customer's home, the service man throws back the lid of the instrument, which floats to the floor, landing with a crash which will attract the customer's attention. Throwing a few bits of fish food to Elmer and Eloise, to demonstrate a kindness to dumb animals, the service man slips a small flag into each corner bit of tubing. As most modern houses do not provide a breeze, it will be necessary for the service man to anticipate this, and supply his own breeze with a small electric fan, which may be easily carried around by hooking over either ear. When the fan is turned on the flags will float attractively, adding a gala touch.

Only one more thing remains—floating the whole ensemble. Leaping lightly on the customer's piano, the service man screws a hammock hook in the ceiling, attaches the length of chain; and returning to the floor attaches the four springs to the corners of the case, and behold! everything floats, including the customer's head. When the customer is able to speak she will say "Ooh—what a remarkable whoosit!!!" and the service man can proudly reply:

"Yessir—its the most fullest floatingest full floating tube tester, they is in these here parts."

By R. K. Wheeler,
Indianapolis, Ind.

P. S.: After writing the above opus—I am for some obscure reason reminded of a famous story which you have probably heard before, but here goes:

A man contemplating a trip through the desert was discussing his proposed equipment with a friend, stressing the need for a compass in case he got lost. His friend however insisted he did not need a compass, only a deck of cards, saying:

(Continued on page 58)

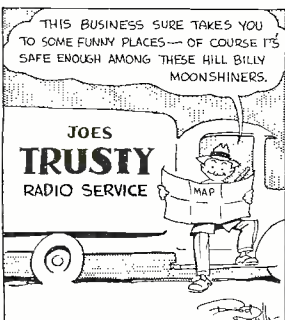

A HOME BUILT 1-10m. RECEIVER

by PAUL POPENOE, Jr.

Altadena, California

For the very ultra short wave reception, this special set should generally do a much better job than the general receiver.



Compact and efficient is this small unit.

▼ TODAY it is possible to purchase but few receivers which go as high as 300 megacycles (1 meter). These receivers are out of the reach of many experimenters, for they are expensive. This expense is incurred in trying to maintain electrical efficiency.

But, the question may be asked, what use is a receiver going up to 300 mc. anyway? The most important use of such a receiver is, of course, in receiving the amateurs operating on the 28 mc. band and bands which are harmonics of this band: 56 mc., 112 mc., and 224 mc. Between 5 and 10 meters there can be heard various commercial services. Some of these are television, u.h.f. broadcasting and two way Police phone. Between 1 and 5 meters the services, which are relatively scarce, are mostly experimental.

In answer to the need for a low cost receiver which would work efficiently between 1 and 10 meters, the author decided to build such a set. What would be the requirements of this receiver? It must be super regenerative, a super-het being too expensive. It must have an r.f. stage which should not show a loss on the ultra high frequencies. The tubes of the receiver

must be made for these frequencies, and the losses throughout the set must be reduced to a minimum. Taking these "must" factors, as well as various factors of less major importance but which nevertheless add to the utility of the set, into consideration, the set here described was built.

In choosing the tubes to be used, the factors both of expense and efficiency were taken into consideration. The first tubes designed for ultra high frequencies were acorn tubes, which are excellent but expensive. In choosing the tubes used in this receiver a saving of nearly five dollars was made over the price of acorn tubes, when figuring the cost of the sockets which must be used with the acorn tubes also. The detector tube is a Hytron HY615, which works efficiently up to 300 mc. An 1851, a tube originally designed for television, works very well in the r.f. stage.

The mechanical construction of the set, which may be seen from the photographs, is not quite conventional. The entire set is built up on a 5x9x2 chassis, using one end of the chassis as the front of the receiver. Mounting on the front end of the chassis is a

(Continued on page 54)



Rear view of the receiver.

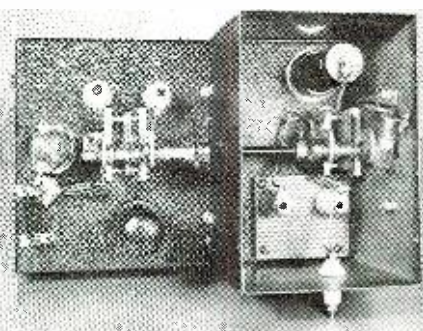

Looking into the baffle-can.

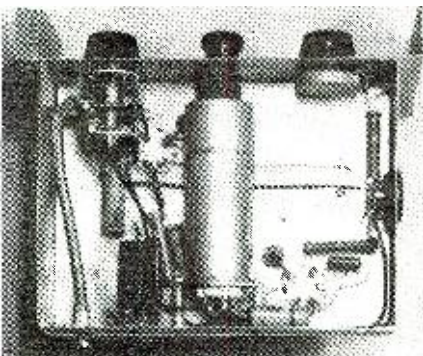

Underchassis connection view.

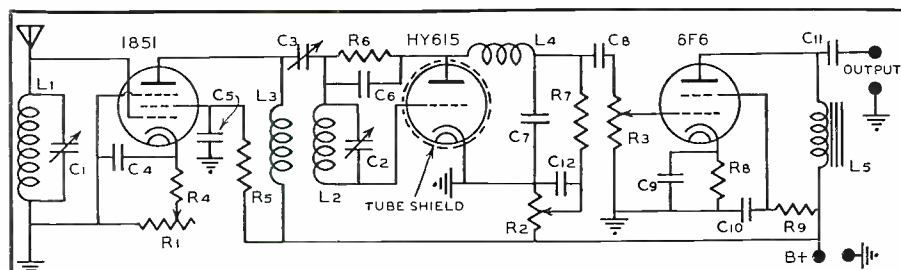

C_1, C_2 —15 mmf. variable condensers, ganged. Hammarlund.
 C_3 —100 mmf. variable air trimmer. Hammarlund.
 $C_4, C_5, C_6, C_7, C_8, C_9, C_{10}, C_{11}, C_{12}$ —0.01 mfd. fixed condensers. Aerovox.
 C_1 —1 mfd. fixed condenser. Aerovox.
 C_2 —0.002 mfd. Aerovox.
 C_3 —0.006 mfd. Aerovox.
 C_4 —10 mfd. Aerovox.
 C_{10}, C_{11}, C_{12} —5 mfd. Aerovox.
 R_1 —10,000 ohm potentiometer. Centralab.

R_2, R_3 —500,000 ohm potentiometers. Centralab.
 R_4 —500 ohm, 1 watt Aerovox.
 R_5 —100,000 ohm, 1 watt Aerovox.
 R_6 —1 megohm, 1/2 watt Aerovox.
 R_7 —250,000 ohm, 1 watt Aerovox.
 R_8 —400 ohm, 1 watt Aerovox.
 $R_9, R_{10}, R_{11}, R_{12}$ —10,000 ohm, 1 watt Aerovox.
 L_1, L_2 —See coil data.
 L_3, L_4, L_5 —5 meter R.F. chokes. Ohmite.
 L_5 —250 henry audio choke. Stancor.

“Cheap and Efficient at the Price!”

by **HORACE E. EDDY, W8MTZ**

Oneonta, New York

A vertical antenna is one of the most efficient types of radiators. They are fine for reception, too. Build this one and see.

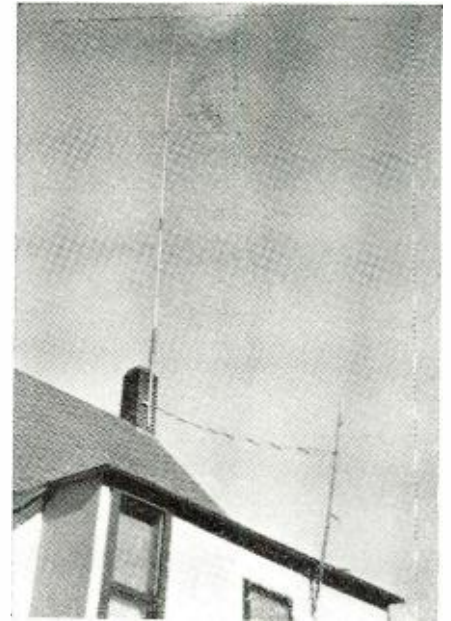

Vertical antennae do not mar houses!

FEELING that there is a need for an inexpensive, easily-erected, unguyed, vertical antenna, I decided to construct one that fully meets these specifications.

For an unguyed pole, 33 feet in length, which can be mounted on a housetop, the use of bamboo is practically dictated. Rugs are shipped wrapped around poles, 8 to 10 feet in length, and of varying diameters. The local furniture store is usually glad to get rid of a few. One pole, 10' by 1 1/4" forms the bottom section, another 10' by 1" the middle section, and a piece of fishpole, 16' by 3/4" as the top section.

The first step in joining, is to saw off the small end of the bottom section just below the first joint, leaving a cavity, the walls of which should be strong and free from cracks. The butt end of the second section should have a cross wall at the very end. The slight protuberance around this joint

can be filed down, insuring a snug fit. These two sections are joined, with a liberal application of casein glue, and the outside wall is securely wrapped with heavy fishcord, and given several coats of lacquer. The top section is added in the same manner, and there results a very sturdy pole which can be supported by one hand.

The bamboo was then joined to a piece of 2x2, five feet long, by means of a pipe fitting consisting of a section 1 1/4" i.d. by 1', a reduction joint, and a section 1 1/4" i.d. by 1'. The larger section of pipe was jammed onto the 2x2, and the butt end of the pole fitted into the 1 1/4" section with casein glue. Finally, the whole structure was given several coats of outside white paint, small standoff insulators were wired on at two feet intervals, and the No. 12 antenna wire was wired to the insulators. The pole was then ready to be erected.

To fasten the pole to the chimney was a problem. Stack wire and strap iron bands were rejected because of inflexibility. Galvanized metal clothesline was the final choice and it has proved its worth. Three galvanized 3" turnbuckles were purchased and an electrical appliance store provided small copper cable clamps for securing the loops which pass through the eyes of the turnbuckles.

Ascending to the roof we cut a piece of clothesline long enough to pass once around a piece of 2x2 and around the chimney, with the ends joined by the turnbuckles. (The point at which the cable crosses should be at the outside of the 2x2 and not against the chimney.) Then on the ground two other cables were cut, one to the length of the model, and one seven inches shorter. This last length is the middle cable, and does not encircle the pole.

The pole went up much more easily than was expected. It proved easy to hold with one hand, while adjusting the middle cable with the other. This held the pole solidly enough to permit the use of both hands in the adjusting of the other cables.

This antenna has been in use for six months, and it is as solid as the day it was erected. Three continents, twenty-five countries, and an average increase of 2 S points per report have been added to the previous DX achievements, due directly to this antenna, and it is for this reason, as well as for that of low cost and ease of construction that I recommend this vertical antenna to the amateur world.

Parts List

One piece bamboo, straight and sturdy, 10'x1 1/4".
One piece bamboo, straight and sturdy, 10'x1".

(Continued on page 49)

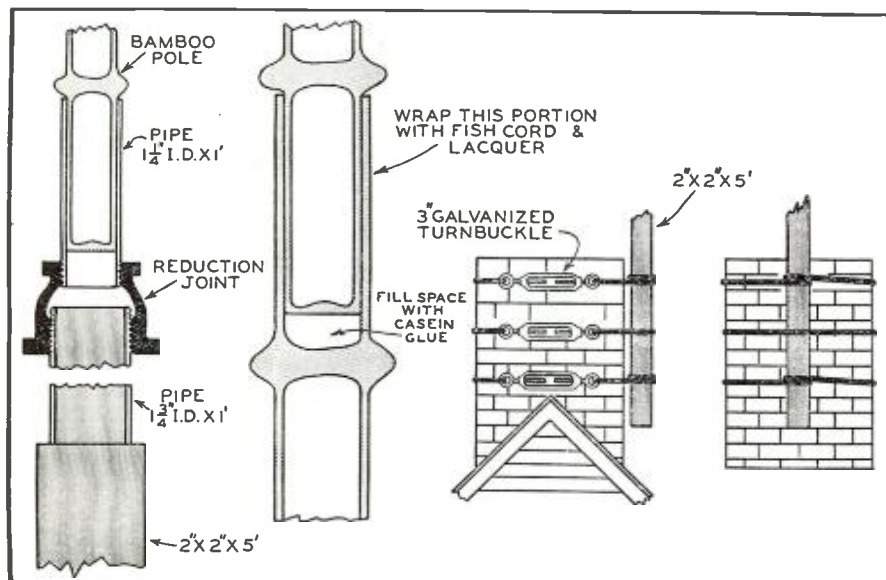

SAME MEANS OLD CABBINETS

by **CLYDE D. KIEBACH**

Reading, Pennsylvania

Those old cabinets which the serviceman takes in trade can be rebuilt for profit to house phonographs and new radio receivers.

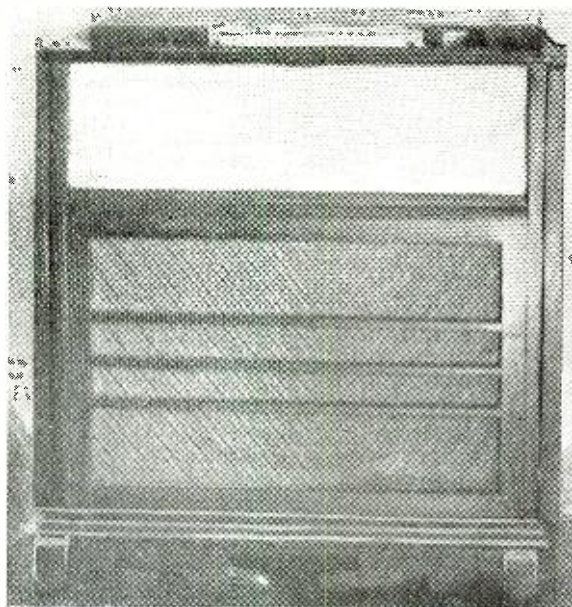

It would be hard to believe that this cabinet looked like the one in the lower right corner.

WHAT to do with the old cabinets the serviceman takes in trade on the new radio receivers is a problem. Some of those in the trade just dispose of them to the junk man, while others let them accumulate dust in the cellar. A better idea would be to put them to some good use, or better still, convert them to source of income. This may be done by making the old cabinets into fine modern "side" phonograph cabinets called "phonotronics."

This phonotronic was constructed from an old Grebe radio receiver, type 428. The legs were sawed off and roller-bearing casters were mounted on the four posts for easy moving. The antique framework in front of the cabinet was eliminated and the inside woodwork was disposed of. A modern front was made from light oak wood. The glass panel (green opaque) was purchased from a local glass store for a sum of fifty-three cents.

One-quarter inch moulding holds the glass panel and the front in place and was obtained at a nearby lumber yard at one cent per foot, using ten feet.

The decorating of the master music maker was done by an expert, who in turn bartered for the repairing of his radio receiver.

The inside of phonotronic which holds the record changer and the unused records (former space for radio) was lined with one yard of good quality felt, purchased at two dollars a yard, and fastened in place with draftsmen's thumb tacks.

On the back of the modernistic front was placed the grille cloth (*Philco* make), using one yard at four dollars and twenty-five cents a yard, which was also fastened with thumb tacks.

To operate the electro mechanism, one must have a key which opens the lock mounted to the right of the illuminator. The key lock is a *Outler-Hammer* brand and certainly is a worthy addition.

The music player is a *General Industries Record Changer*, Model K, playing eight ten-inch records automatically, repeating or rejecting a record at will was built in. The changer is equipped for recordings at 33½ and 78 speeds. The enclosed type motor is used. The unit occupies a space of one hundred and forty-four square inches, and is finished in a highly polished statuary bronze. It retails for forty-seven dollars and fifty cents, complete with volume control and switch.

An *Astatic* crystal pickup is used of the S-type.

Operadio Portable Amplifier Unit, model 414 with power rating of fourteen watts, peak at seventeen watts, was installed. It has provisions for remote control, paging switch and head-phone or meter for monitoring; also three channel input, electronically mixes two microphones and one phonograph, fully protected, recessed, illumination controls, beam power output tube, and cathode degeneration. The amplifier can be purchased for sixty-five dollars, designed for use with P.M. dynamic speaker.

The electro-acoustic transducer selected was a *Jensen*, Model PM12B, standard type. The loud speaker is known for predominating high quality. The diameter of speaker is twelve inches; voice coil has an impedance of eight ohms, and was readily mountable in the space provided.

The baffle board was made of *celotex* and reinforced by roofing laths. Cost of *celotex*, five cents a square foot; cost of laths, one cent a foot; size 16 5/16" in width and 24 13/16" in length and 5/8" thick.

To illuminate the interior of the record playing compartment and to provide additional light for reading purposes without the aid of any other lamp in the room, the light selected

was the same kind as featured in G.E. modern electric kitchen—a long tubular lamp, size 11¼" x 1½". The approximate value of the candle power is 344 lumens with a power rating of forty watts. This lamp is mountable on an aluminum bracket, size 2½" x 13 13/16". It is equipped with rotary switch to operate it independently.

Exact mounting instructions have not been given since a great amount of divergence from this original will have to be made by the serviceman installing the record changer and associated equipment in other and different cabinets. Mostly, the idea is to turn the old cabinet into a money-maker for the man who owns the "old monstrosity." Each and every type of old-time radio cabinet will present a different situation to be dealt with according to the problem presented. The result must be pleasing to the eye, and it is hoped to the purse.

Since most purchasers act on eye-appeal, it will be necessary to make the finished product as good-looking as possible. The fact that after the renovation, the finished "phonotronic" will cost around \$80-\$100 should not be a deterrent.

-30-



This is what the author rebuilt.



While slightly bulky, this cycle radio will make your trips more enjoyable.

***You may put a radio receiver on your motor
or bicycle with comparative ease, and enjoy
all the pleasure of music while you ride.***

THE bicycle radio offers a new and fascinating field for set builders and radio enthusiasts. The demand for a simple bicycle receiver has existed for a long time. The writer has received hundreds of letters on this subject from "bike" owners, asking for circuit designs and outlining their requirements. Practically all the letters called for a radio set of extreme simplicity. They wanted a radio which any amateur or beginner could build out of standard, readily obtainable radio parts. A second important item on the list of specifications called for an all wave receiver which would be able to pick up short wave stations as well as the standard broadcast ones. Other important features demanded by these alert cyclists were low battery drain, efficiency, compactness, light weight and simplicity of operation.

There seemed to be some difference of opinion as regards the use of a loud speaker. Many insisted that this was necessary, while others indicated that earphone reception was more desirable. On one point, however, everyone agreed. The bicycle radio set must be inexpensive in order to meet present-day economic conditions.

The writer has been designing radio sets for home constructors since 1921. In the early days of radio, these receivers were simple affairs. As the radio art progressed, the sets became more and more complicated and recent designs called for 16-tube receivers with automatic volume control, push-button tuning, electron ray tuning indicators and many other improvements. These new sets are beyond the capabilities of the average home set constructor who has certainly been justified in calling for articles telling

MUSIC While You Cycle

by

H. G. CISIN
New York City, N. Y.

him how to build simpler receivers within the scope of his knowledge and attainments.

No one, no matter how limited his radio knowledge, should have any difficulty in building this efficient little set. Although it uses only two tubes and is devoid of any features which might add complications to the assembly, wiring or operation, it does incorporate practically all the items which the bicycle users themselves have specified as desirable in a bicycle receiver.

The "Ranger" can receive short wave as well as broadcast transmissions. Hence, it can be used to pick up police calls, messages from amateurs, code and other interesting short wave signals. If desired, it can be converted in an instant, into a standard broadcast receiver. Although the "Ranger" has been designed primarily for use on a bicycle, it can also be used as a portable, due to its small size, light weight and compactness. During the winter months, it can be installed in the home and under the more favorable circumstances of a more efficient antenna system, combined with better climatic and atmospheric conditions, the set should bring in numerous foreign stations on the short wave bands.

The "Ranger" uses five plug-in coils to cover the wave band range from 18 to 550 meters. These are arranged in suitable overlapping steps, so that the single tuning condenser can be

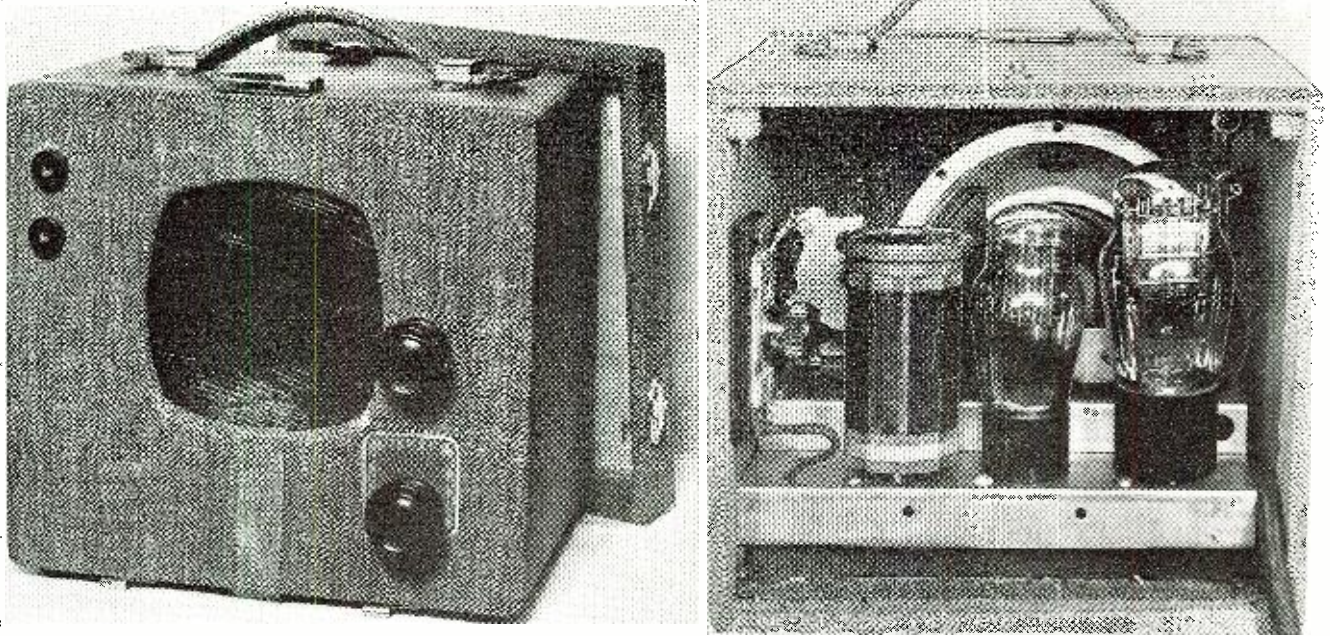

This cycle radio receiver is not only compact, but is wholly portable.

used in covering the entire band. Changing from one coil to another is as simple as inserting a new tube in a socket. To bring in the upper portion of the broadcast band, a coil with many turns is inserted in the coil socket. A coil with fewer turns is substituted to bring in police calls and lower broadcast stations. Other coils, with fewer and fewer turns, are substituted to permit the set to receive the higher frequencies.

The set uses a circuit of simple design, but nevertheless, one which has proved to be sensitive and highly efficient. This consists of a tuned regenerative detector stage and two resistance coupled audio stages. To conserve space and also for increased efficiency, the dual purpose type 19 two-volt tube is employed. One section is used as the detector, the other as the first audio stage. A 33 type tube is used in the output stage. This latter tube is a two-volt power pentode developed especially to afford considerable improvement in battery receiver performance. The use of the 33 tube has made it possible to secure results somewhat comparable with the automobile type tubes.

Regeneration is obtained through the use of a tickler winding on the plug-in coil. It is controlled quite smoothly and effectively by means of a 75,000 ohm potentiometer shunted across the tickler. The "on-off" switch is mounted on back of the potentiometer, thus being controlled by the same knob.

In order to save space, permit a more compact lay-out, shorter leads and hence better results, a new type of variable tuning condenser known as an "ultra midget" is used. This condenser has been designed especially for portable apparatus such as a bicycle radio, and although of very small size,

it has the ability to withstand rough usage.

Antenna control is possible through the use of a variable antenna trimmer, which must be tightened when a short aerial is used and loosened when using a long aerial. The set is provided with a five inch magnetic speaker which gives excellent volume on the stronger local stations. Miniature tip jacks at the front panel permit the use of earphones when set is tuned to the weaker stations or when it is being used under adverse conditions.

The "Ranger" is contained in a carrying case which measures $6\frac{1}{4}$ " by $7\frac{1}{4}$ " by $6\frac{3}{4}$ ". These are overall dimensions. The front cover is $\frac{3}{4}$ " deep and serves, when set is not in use, to protect the front panel containing speaker grille and control knobs. When set is in use, this cover opens on hinges and may be removed if desired. The rear cover opens on hinges at the bottom, permitting ready access to tubes or for changing coils.

The carrying case is made of $\frac{1}{4}$ " wood, over which a fabric of attractive design has been glued. The fabric is of type now being widely used in the popular "airplane" luggage.

The set itself is mounted on a miniature metal chassis of the new "step" type. The chassis is $6\frac{1}{2}$ " wide by 4" deep. The height of the rear step is $\frac{3}{4}$ ", and that of the front step, $1\frac{1}{2}$ ". The
(Continued on page 53)

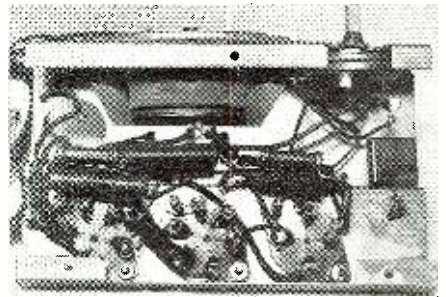

Underchassis view of the cycle set.

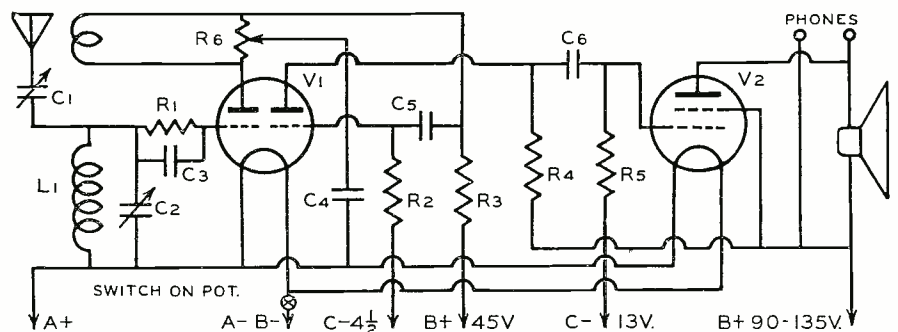

R_1 —1 meg. $\frac{1}{2}$ w., carbon, I.R.C.
 R_2 —1 megohm, 1 w., I.R.C.
 R_3 —200,000 ohms, 1 w., I.R.C.
 R_4 —200,000 ohms, 1 w., I.R.C.
 R_5 —1 megohm, $\frac{1}{2}$ w., I.R.C.
 R_6 —75,000 ohms, pot., Yaxley

C_1 —10-70 mmf. trimmer, Hammarlund
 C_2 —140 mmf. var. cond., Hammarlund
 C_3 —0.001 mf. mica, CD.

C_4 —0.0005 mf. mica, CD.
 C_5 —.01 mf. tubular, CD.
 C_6 —.01 mf. tubular, CD.

L_1 —Set of 4 Hammarlund coils
 17-270 meters. SWK-4

V_1 —RCA type 19
 V_2 —RCA type 33

SPKR—Utah orthovox spkr. and pentode output trans.

TECHNICAL BOOK & BULLETIN REVIEW

DO YOU WANT TO GET INTO RADIO, by Frank A. Arnold, published by *Frederick A. Stokes Co.*, New York. 140 pp. \$1.50. This volume is written for the hundreds of young men and women who would like to get into radio but do not know how to go about it. It is not intended as a text book or a study in psychology; rather as a story of radio broadcasting from the standpoint of its career possibilities, bearing always in mind the training and aptitudes required for success in this field. Says the author: By force of circumstances radio has drawn heavily on workers in other professions—actors, dramatists, directors in the theatre and motion pictures, novelists, journalists, composers, instrumentalists, vocalists—and in short, the entire field of professional entertainment. These people do not consider radio a vocation but simply an opportunity to market their own special accomplishments. The writer has drawn his information from case examples and personal experience, frankly discussing the difficulties and failure as well as the successes which have come as a result of ability and hard work combined with a well defined aptitude for this most exacting profession.

JFD BELT and BALLAST BOOK, published by the *J.F.D. Manufacturing Co.*, Brooklyn, N. Y. 78 pp. plus catalog items. 15 cents per copy. This booklet contains a complete listing of all types of replacement control cables (belts) used in radio receivers. The manufacturer has listed the belts in a manner that will make it easy for the serviceman to find the type required in short order. The second section of the booklet is devoted to a complete listing of all types of Ballasts for use in modern radio receivers. Socket pin layouts are also included so that the serviceman have some accurate means for identifying a certain ballast that might not bear any marks of identification.

IRC VOLUME CONTROL GUIDE and Resistor Catalog, edition No. 2, and the 1940 SUPPLEMENT, published by the *International Resistance Co.*, Philadelphia, Pa., 124 and 46 pp., respectively. Price on application. The supplement includes information on proper replacement controls for practically all 1939 model receivers and for a large number of early 1940 sets. Standard controls, as listed on pages 3-9, are used wherever possible. Special controls that cannot be replaced by Standard types are listed on pages 44 to 47. For older models Volume Control Guide Edition No. 2 should be used.

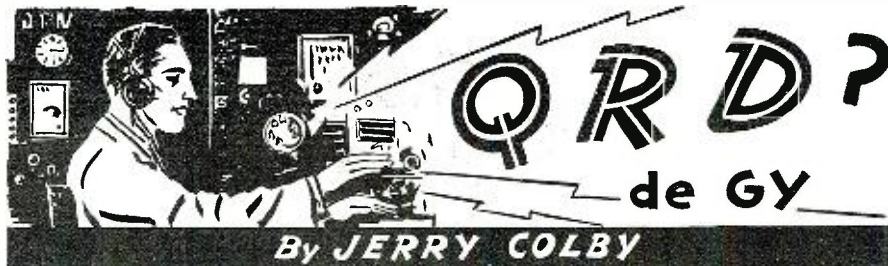

WELL, t'other eve your colyumist was the guest speaker at the *Bell Ham Club* where he spouted wisdom (not bad, eh) words on the Past, Present and Future status and possibilities in the radioping field. Our observations were, of course, our own opinions and, as such, can be salted considerably. But a few of the highlights of the address can bear repeating since many of youse guys and gals weren't there . . . or was you dere? Quote . . . Whilst pay increases have been considerable in the past few years due to the efforts of the unions, there has been a tremendous drop in berths. In 1933 there were 2300 vessels equipped with radio and radiops; in 1939 there were only 1300 vessels radio-equipped and manned. And there are fewer vessels today because of the trend towards selling and chartering to foreign buyers and countries. Furthermore, new inventions have cut down the number of men required to stand a 24 hour watch such as Auto-alarm, 'phone equipment and Facsimile. This latter, although comparatively new, is being used extensively and has proven practical in Uncle Sammy's Navy. Under trying conditions and pressure of large number of radiograms, Facsimile has definitely set itself up in business. Installation of this equipment is cheap, which adds to its features. Therefore, radio-grounded and radio-minded men would do well to seek to study and learn other radio fields where their abilities will have more chance for development and profit. Of course, there are always the Airlines and the Department of Commerce Airways. But we advocate a look-see into the as yet clear Television field. Unquote. Just an opinion, me hearties, gathered from a perusal of the facts for 14 years.

AND the *Bell Ham Club* is nothing to sneaker at. We'll wager there are not many Radio Amateur organizations which can boast of having over 400 paid up members, their own spacious club rooms, their own weekly publication, and the fact that they have never owed a penny for rent or other items. And to have been established for more than eight years! And last, but not least, to have had but one President during this entire period, none other than Charles Fay (W6EJZ). Charlie, as he is affectionately known to the tribe, proudly told us that he has never missed a single meeting in this length of time, not even when he had all his teeth yanked out or when several other mishaps tried to stop him. These are records that will stand for a long time, unless one of you Hams can prove better ones. To close a splendid meeting, a very fine explanation and description of his mobile transceiver was made by Buddy Rothrock, W6MYC, which to our way of thinking is the finest and neatest job we've ever laid these old optics on. He stated that he has worked as far as Hawaii whilst cruising around Pasadena. So here's three cheers for an organization of radio-hams which has aided in earthquake and flood troubles, and in which there is complete harmony.

INCIDENTALLY, another speaker at the *Bell Club* the same evening was William L. Prager, an oldtimer who reminded us of our grey hairs when he reminisced of his old wireless club which was formed way back in 1912. Bill has been connected with the *American Television Laboratories* assisting Dr. Lee DeForest and U. A. Sanabria in furthering the perfection of Television transmitting and receiving. In his own right he has a few patents pending on color television and, from what he said, it will be the last word when it hits the airways. He spoke of

the great strides which had been made in the art but deplored the fact that there were not sufficient capable men available to handle television apparatus. His last words to us were, "I'll be happy to correspond with any one who wishes to learn more about the future of television and what it holds for you." Which is very nice, and we'll be happy to forward any mail to him.

BECAUSE Mates' and Engineers' licenses are renewable with a minimum of three months service and radiops require a service record of three years in the aggregate or the last two years solid for renewal, and because the renewal of radiop licenses will be almost impossible due to the unstable operation of ships under the American flag, it is being requested by the *ARTA* that radiops be given the same privilege of renewal as other licensed officers aboard the *American Merchant Marine* ships. Which is nothing more than fair, especially since the *FCC* recently stated that only six percent of those taking the new examinations have passed them. So either the *FCC* will have to soften the exam questions, or else agree to the *ARTA's* request . . . or else.

JUST wondering what will happen if the *ACA* Chicago convention accepts the new divisional plan of East Coast, Pacific and Gulf offices. What will happen when out of town shippers wire to the divisional office for a man and the local phones by long distance, trying to sell some beached on the idea of taking the vessel which he might not like?

RADIOPS at the head of the assignment list sometimes are particular about a billet offered to them. This happened in *ART-4 Local 7*, San Pedro, when it was impossible to get a man to take out the McCormick boats Brookings and the Charles L. Weever, because of the \$115 salary. The ships finally had to sail for 'Frisco without radiops, thereby incurring fines totalling more than \$1000. So what'll be, what'll be?

BUT there is the case of Ralph Service who took a billet on a Norway-bound boat after every one else had refused it. When they were out a few days he picked up an SOS from a Greek steamer. They followed Service's bearings taken on the doomed boat and finally rescued her, towing her into port. The pleasant end of this story is that after Service had returned to the States, he received a check for approximately \$1100 as his share of the salvage money. Which just goes to prove that Gold is not always where you look for it, or sumpin'.

A UNIQUE agreement was signed by Jordan of the *ARTA*, and *Paramount Pictures*, whereby radiops who work on any of their assignments must be willing to wear any special costumes furnished by them and that they cannot receive any extra pay for being thus photographed in a sequence. The pay will average \$10 per day. Can you imagine a radiop getting paid to kiss Dorothy Lamour . . . or does the hero always do that in the final cut?

WE sadly report the silent key of Brother William Walsh who had been employed by the *Wilmington Transportation Company* for the past 15 years. All those who had known his cheerful smile in the past find it all the more difficult to believe that he shot himself. The msg found beside his body read . . . Quote . . . signed off 6:30 (More QRD? on page 58)

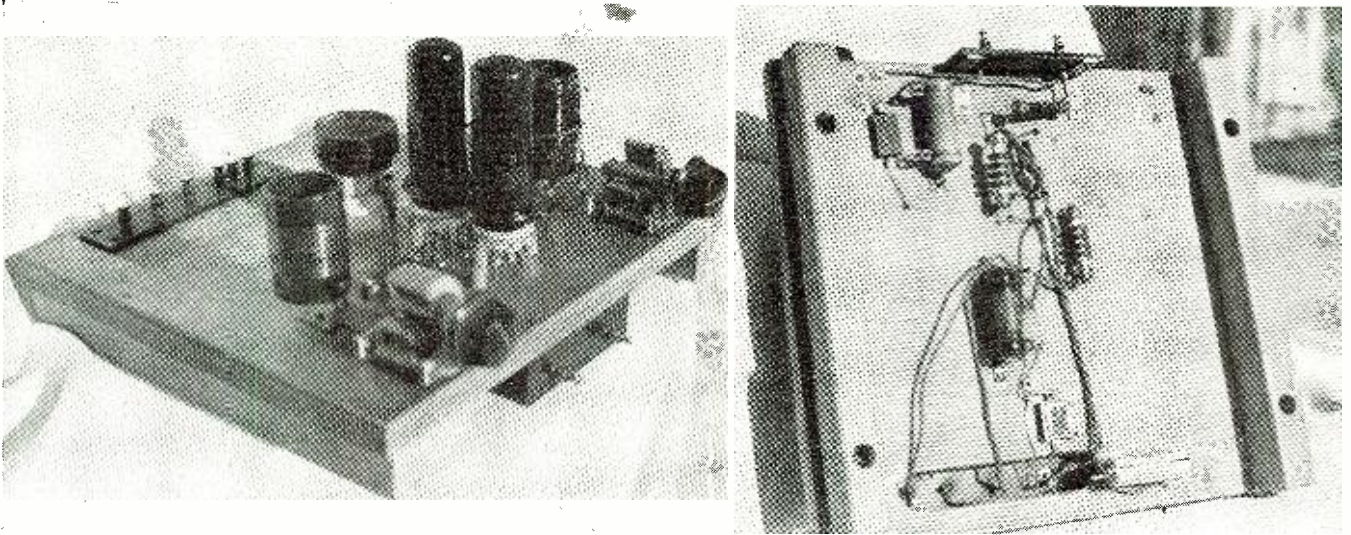

This breadboard layout still has many followers, and works very well.

Doubling in OSCILLATORS

by H. W. KLINE
Schenectady, New York

By using two tubes in parallel, the output of an oscillator may be doubled if the frequency is not too high. Makes a nice QRR rig.

A TRITET oscillator, using two type 6L6 tubes connected in parallel and developing about 60 watts output at the crystal frequency and about 40 watts output at twice the crystal frequency, has been installed at W2DKE, Schenectady, N. Y., to drive two type 203A tubes at full class C rating.

The oscillator, by itself, constitutes an economical, simplified transmitter which keys easily and has no cranky tendencies.

The type 6L6 tube requires a driving power of but 0.3 watt. Two tubes in parallel would double this rating. At approximately 0.6 watt, the average crystal rides very easily. Due to these low driving power requirements, it was decided to try two of these tubes connected in parallel. The results turned out to be so gratifying that it was believed that many would like to use this arrangement.

The circuit is very similar to a single 6L6 tritet oscillator except for the addition of another 6L6 tube, having all its elements connected in parallel with the first tube.

The parts are listed according to the coding of the wiring diagram. The cathode biasing resistor R_1 , and the grid leak R_2 , have been altered, in respect to the conventional circuit, for parallel operation. In parallel operation, the cathode and grid currents are double those of a single tube so the resistors are halved.

Instead of a series screen resistor, a 50,000 ohm divider was used to obtain the 300 volts screen potential. A 500 volt power supply, of good regulating characteristics was used. The actual plate potential, however, is the power supply voltage (500 volts) minus the voltage drop across the cathode resistor R_1 .

Under full load, the total plate and screen currents will be of the order of 200 milliamperes. The voltage drop across the cathode resistor will then be 200 times 0.2 or 40 volts. This voltage, subtracted from 500, leaves 460 volts on the plates.

If a high resistance voltmeter was connected between V_1 (negative terminal) and V_2 (positive terminal) it would indicate, under conditions of full loading, about 460 volts, providing the power supply had good regulating characteristics. With the positive terminal of the instrument on V_2 , the tap on the screen potential dividing resistor R_2 , should be adjusted until the voltmeter reads 300 volts, under full load conditions.

This means of measuring grid bias voltage, applies to all oscillators or amplifiers, whether grid leak, cathode, or combined grid leak and cathode biased amplifiers.

The method of attack, in the case of amplifiers, is to always connect the positive terminal of the voltmeter to a point in the cathode circuit where there is no series d.c. resistance between the voltmeter terminal and the cathode. This point must be at zero r.f. gradient, however.

Connect the negative terminal of the volt-

meter to a point in the circuit where there is no d.c. resistance in series with it and the grid. This point must also be at zero r.f. potential. The voltmeter, therefore, will read the combined voltage drop across both the cathode resistor and the grid leak which combination is the total grid bias.

In the case of an amplifier which dynamically operates class C with ex-

(Continued on page 59)

R_1 —200 ohms, 10 w.
 R_2 —50,000 ohms, 1 w.
 R_3 —50,000 ohms, 25 w.
 C_1 —.002 mfd., 1000 v., mica.
 C_2 —.01 mfd., 500 v., mica.
 C_3 —.01 mfd., 500 v., mica.
 C_4 —.00025 mfd., 1000 v., mica.
 C_5 , C_6 —.0001 mfd., midget type receiving conds.
 L_1 , L_2 —2.5 mh., miniature choke coils.
 L_3 , L_4 —Same as recommended in conventional handbooks for single tube tritet oscillators.

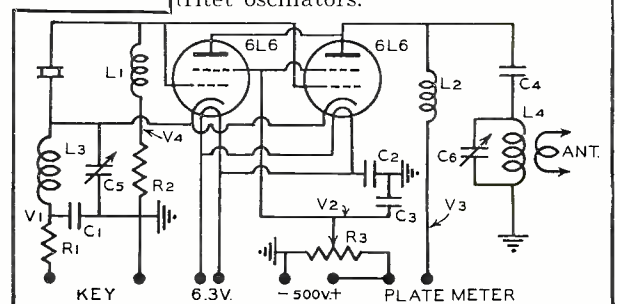



Schoolmarm YL Joanna W9JWJ Barnes.



Married, by gum: W9CHD es W2MBC.

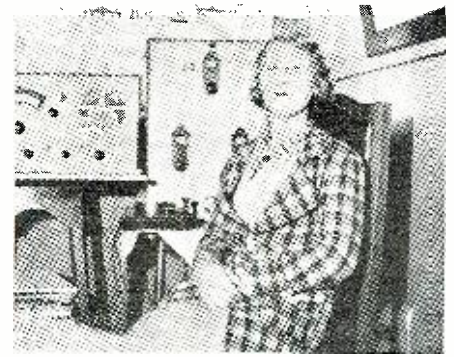

5' tall, wid eyes of blue,—YL ZS1DB.

HAM CHATTER



"Wooden Indian Joe," W9WIJ of Iowa.

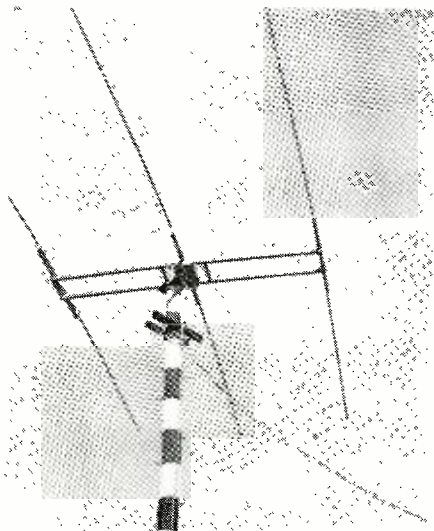

W6FHQ's superswellegant rotobeam.

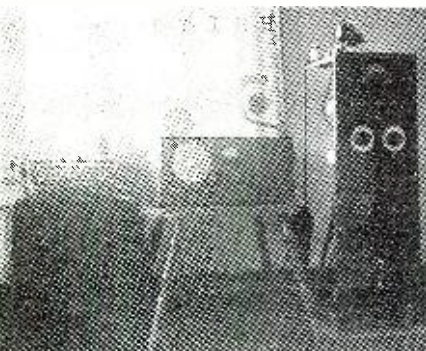

Hamstation of W5IRH.



HI3N visits hamstation W5CIU.



Hamstation of W1MKR.

WE are in receipt of an urgent request for a hamop to be trustee for a hamstation at BOYS TOWN, Nebraska. It would be entirely unnecessary for us to dwell at length on the good that is being done by the famous Father Flanagan for homeless, abandoned boys regardless of race, color or creed. As we all know, Boys Town is non-sectarian and non-proselyting, and a thoroughly American Institution in the fullest sense of the word. We feel that there might be a ham, or a group of hams, in or near Boys Town who would want to undertake this fine work and help put the Boys Town hamstation across. Father Flanagan is being furnished with a complete station, gratis, but needs an op to comply with the F.C.C. regs.

If you want to help, and are in or near Boys Town, Nebraska, drop us a line, c/o Hamchatter Editor, RADIO NEWS, 608 S. Dearborn St., Chicago, and we'll forward your letter to Father Flanagan. Please give your qualifications, age, etc., and the time you can afford to devote to this work.

Here is a chance for those hams who are in the position to prove that a ham is a man with a heart, and that he will lend a helping hand.

Watsa gang? *The Hamchatter Editor.*

AMATEUR BAND AVAILABLE FOR FM TRANSMISSION

THE Federal Communications Commission on April 13, 1940, modified the rules governing amateur radio operators and stations to make available to amateurs the band 58,500 to 60,000 kilocycles for radiotelephone frequency modulation transmission.

Previously amateurs were permitted to use radiotelephone frequency modulation in all amateur bands above 112,000 kilocycles. The change in the rules will make possible wider experimentation in this type of transmission, since equipment is quite generally available for the lower band.

The Commission also took the opportunity to re-arrange, in the interest of clarity, the other rules which specify the use to be made of the amateur bands, although no changes were made therein.

IF course you've heard about the ham who died and went to the nether regions where he beheld a mess of ham equipment. Hams were all around the place crying and wailing and carrying on something fierce. It was obvious that they were not pleased.

The Newly Arrived Ham stopped one and said, "Watsa matter, no dx?"

The other handed him a pair of ear phones. CQ's from all parts of the world were pounding in.

"No antenna?" asked the N.A.H.

The other took him to the window, and there the N.A.H. saw a maze of 5 element beams, plus some long, perfectly shaped rhombics, beautiful to behold in the golden glow of the flames.

"No transmitter?" was the next question.

The other sorrowfully pointed to a solid row of the most beautiful rack-and-panel jobs that ever graced a broadcast station.

"No power?"

He was shown the meters which showed 2000 volts at 500 MA running into every final. All buffers were running at full blast. What could be the trouble. Why were they all so glum?



Hungarian pre-war hamstation HA6Q.

"Well, why don't you work them?" asked our N.A.H.

"We can't tune the rigs, every stage is outta resonance, and no matter what you do to the controls, the stages stay outta resonance, giving us not the tiniest piece of a watt output anywhere."

"Ah, that must be the Hell of it," commented our N.A.H. sadly.

WERE told it's very very old, but we still like the remark heard on the one sissie band the other pecem. "Are you a ticket ham, or just a ham?" Hmminmmmm!

IT has always been our contention that Christmas came too few times during the year, coming only once as it does, and that we ought to have a Christmas every 3 or 4 months to relieve the monotony of not having Christmas more often. While we are not invested with the power of our President who can and has changed dates of holidays to suit the will of the people, we are still able to simulate Christmas whenever we want to, and write a Kris Kringle Story to heighten the illusion. Such a story is about to be perpetrated on you . . . and, as Maurice Chevalier would aptly put it . . . right now!

In the 7th District lived two hams. Unusual, too, was the fact that they were husband and wife. Both had calls, and both used their tiny rigs for whatever pleasure you can get from operating with a tenth watt in the crowded 7mc band. As receivers they had a one tube regenerative set each. One trouble developed and that was that each could pick up the other's receiver far better than they could any sigs. Also, in case I forgot to mention it, they were so poor that the mice in the kitchen were moving back to the Church, and the Cockroaches were bringing in their own lunch.

When Christmas approached the OM thought things over, and decided that there would not be anything quite so nice, quite so welcome to the XYL, as a B receiver. He had one all spotted, second-hand, at the local hamstore where they held a "blind" auction every week end. You were assigned a number and then you wrote your number and the amount you offered for the set on a card on the wall, and other hams who wanted to bid against you wrote their numbers and the amount higher than your bid which they wished to pay for the set. Our Hero started at \$5 which he expected to get as a present from the Simon Legree who employed him as dishwasher in the local hamsginery. The next day he went to the hamstore again during his lunch hour.

Sure enough, another couple of hams had raised the price to \$8. Our Hero added his number and wrote down \$8.50. The next day there were only two other hams left in the auction and our Hero had to go to \$9.75 to top them. The next day only one other ham was left and our Hero reluctantly placed his bid in at \$10. The other ham raised to \$10.50; our Hero raised back to \$10.75. The other ham raised to \$11; and our Hero raised it to \$12 to freeze out the other guy. He got the receiver. He snuk it home, "what a present for the XYL," he thought.

Christmas morning dawned clear, cold and cheerful. On the bare table imposed the heavy package which represented all our Hero's money, his lunches for the next two weeks, and an advance from the Boss.

His XYL opened the package, her face lighted up, then her chin trembled.

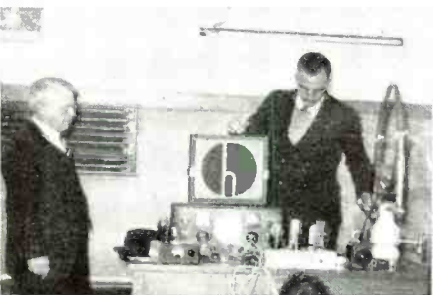

W5HEJ (L) watches W5ADJ show a loop.



This beauty belongs to Ohio's W8MSG.

"Why, Harry," she cried, "You got this from the ZYX Hamstore, didn't you?"

"Yes, dear," Harry replied, "And I would have gotten it lots cheaper except I had to bid against a guy whose number was 65789 and he kept raising me."

The XYL went to the cupboard, took there from her purse and handed the OM a card without a word. It read:

Dear Mrs. Blank:
We have entered you in our weekly blind auction, for the Blahblah FXB-76T Receiver; and you have been assigned number 65789.

Very truly yours,
THE ZYX HAMSTORE.

Now, ain't you glad Christmas comes but once a year?

IS our fare red? Youseedit, boy youseedit! So the British took the PK's offn the air! Hmminmm! We didn't know that we had so many readers who knew that the PK's weren't British. To tell the truth, the map changes so often nowadays, that we have installed a loose-leaf system to keep track of everything. However, our correspondent was in error, and if the PK's are offn the air, taint the fault of the English—or is it? A thousand poddons OMs, a thousand poddons fer our ignorance!

TRANS-PACIFIC dx reached a new low during the past 30 days. *Muz* seems to have joined hands with *Old Sol* and between them they virtually eliminated dx for a short period.

The European war, with its accompanying bans on ham activities throughout the world has wiped many countries off the map so far as amateur reception is concerned. But to make matters even worse, atmospheric conditions have been very poor for the first three weeks of this month. During the last few days a marked improvement has been noted and the few remaining active trans-Pacific hams have again become audible in this country.

All parts of the British Empire, including Australia, New Zealand, India, Malaya, Hongkong, etc. have been silent. A report on VU2FQ has been received again, but is still unconfirmed. An observer in Western Australia reports hearing a VU2SQ (VU2FQ?) on 14.09 meg. twice, but the station gives no location and is obviously a *foney*. So far as we know, with only one or two unconfirmed exceptions, the British ban has been carried out thoroughly in all parts of the Empire, not only with regard to amateur activities, but to a great many experimental and commercial phone stations as well. VK2ME, VK3ME, VK8ME, VU2Q and other AMA stations which have now been off the air for several months.

A few PK (*Ab, there, Gidley*) stations are still being reported from several sources. Although the log shows a severe drop from that of last month, four transmitters in Java and Sumatra have been heard more than once.

PK2AY on 14.09 meg., unreported for two months, was again received with surprising volume. PK1RI (14.03 meg.) was evidently not heard in America, although two listeners in Honolulu report fair reception. PK3VI (14.05 meg.) is still being logged irregularly, although overseas fans state that PK3BD (14.07 meg.) is the only active PK3 at the present time.

PK4KS (14.04 meg.), one of the most regular visitors to America, was the only other East Indian, and the only representative of Sumatra, to be reported last month.

A few new Nipponese transmitters have been



OM es XYL hamstation of K4EZR-FKC.

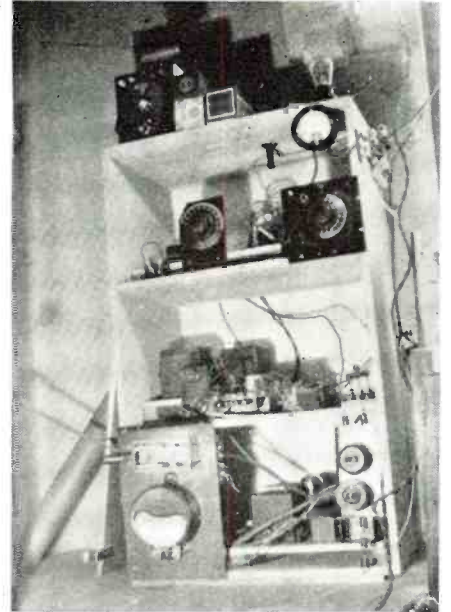

The only active Kwantung rig, J8PG.



World-famous Army hamstation NY2AE.

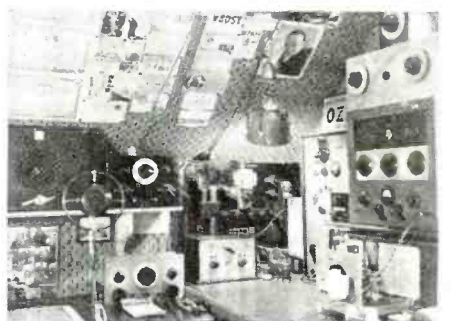

Danish (German?) Layridsen's hamshack.



Camden, N. J.'s, hamstation W3BYK.

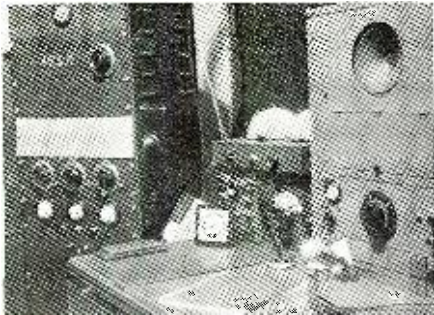

XYL K4ERZ again. Nice shack, isn't it?

added to the log this month. J2NQ, Tokyo, and J2KN, also located in Tokyo make their appearance after being unreported for five or six weeks. J3CX and J8CA (Korea) are also coming through again. All four stations are on the LF side of the 20 meter band.

J7CB (14.08 meg.) needs scarcely be mentioned any more. Mr. Hashimoto's rig has been reported by innumerable fans, and is responsible for an extremely strong signal most of the time. Still no identification of the 40 meter Japanese fones which speak only in the native tongue.

XUSRB (14.09 meg.) and XU1B (14.134 meg.) are still "tops" in the Chinese part of our log. Both are still extremely active and are reported regularly.

A station XUSXI was received once or twice, but seems to have vanished almost as suddenly as it appeared. Walt Sullivan's XUSWS is back again but very irregularly.

A station using the call XUSGK has been reported on 14.14 meg. and a XU7HB on 14.08 meg. Neither of these calls are listed, however, and reception has not as yet been confirmed.

In addition to an almost endless list of 20 meter Philippine stations, a number of 10 meter transmitters have been logged during the past 30 days. Of these by far the strongest are KAILZ and KA1ME, both of which have been reported time and again during the past several months.

KA1GC (ex W6CIN) (14.13 meg.) is now on the air quite frequently, and KA1GX (14.07 meg.), another comparative newcomer, is also being logged by many listeners. KA1EM (14.08 meg.) and KA1CS (14.13 meg.), both 1000 watters, are now giving KAILZ (14.17 meg.) and KA1ME (14.18 meg.) a run for their money, and all four are regular visitors to America between 5 and 8 A. M.

The balance of this month's Philippine log includes KA1AG (14.13 meg.), KA1BB (14.27 meg.), KA1FH (14.18 meg.), KA1PI (14.14 meg.), KA1LS (14.11 meg.), KA1AF (14.16 meg.), KA1HR (14.06 meg.), KA1AK (14.14 meg.), KA3KK (14.28 meg.), KA1MM (14.125 meg.).

Poor reception conditions, coupled with an extreme scarcity of dx stations has caused many fans to shift the major part of their listening activity from 20 to 10 meters, with the result that the 10 meter log for Hawaii has been vastly increased this month. The following calls have been reported on the lower waveband during the past few weeks: K6NZC, K6RVG, K6ROB, K6PCF, K6OXY, K6RDB, K6MVA, K6FIR, K6PRR, K6QMA, K6PUL, K6PAS, K6GLZ, K6NYD, K6OQE, K6QQM, K6PIT, K6REF, K6ROK, K6PCF, K6NEJ, K6MVA, K6OQH, K6BNR.

Twenty meter Hawaiians have become too numerous to list in their entirety, but the following have been reported most frequently: K6NYD, K6RVU, K6BNR, K6MVA, K6PIT, K6KGA, K6PUL, K6OJI, K6OQE, K6PAD, K6NVJ, K6PUL.

K4FKC, located in San Juan, has been extremely active and reported by almost everyone lately. It has been heard on 10 meters, 20 meters and 75 meters.

K4DDE, K4DSE, and K4ENT have also been received quite regularly on the 20 meter band, while K4FOW has been on the air very often using 10 meters.

Es ts it.



OM W9TIO es

LOOKING back over the 12TH ARRL DX Competition just finished, we find that the hams in the midwest were surprised at the dx that they heard. Most of us thought that the dx test would be very dull this year, but it turned out to be a rather exciting contest after all.

On the 14 mc. band phone dx was represented by such outstanding signals as those of PK4JD, KAILB, KA1ME, PK1OG, J2NF, PY2-

'Nuther thing. We are gg to run a beauty contest among the YL's. So enter your YL or XYL. Only specification is tt while the gal may be a YL or an XYL WITH OR WITHOUT a ticket, she MUST be sponsored by a licensed ham. Send the pix along to "YL-XYL Beauty Contest, c/o HAMCHATTER ED. RADIO NEWS." If we get enuff entries, we'll give a swell prize. All pix published will be paid fer at our usual rates. So get gg, es lets show up these movie gals. We can do it.

VA, BK1AF, YS1MF, YV5ABE, PK3KJ, KA1FH, PK3GD, PK1JR, PK4KS, PK1ZM, YN1IP, LU3AN, OQ5AN, CO2WM, TG9BA, and many K6, XE, and K4 stations.

On the 28 mc. band XUSAM, KA1ME, OQ5AB, LU7AZ, HC1JD, NY4AD, CX3CO, CE2BX, LU3AN, YV4ACE and other less consistent phone stations were heard in only a few hours.

Conditions on the high frequency bands during the afternoon and evening of March 24 were very peculiar. At 9:30 P. M. the 14mc. band was completely dead while the 28mc. band was wide open for W1, W2, W3, W8, and W9. On the 7 mc. band there was a great stillness broken by only a few signals from such stations as W6QD, W6GRL, W6WVQ, XPIA and XE1CM.

It seems that the west coast boys had the best dx pickings this year and our money is on W6OCH and W6GRL for national high scores in the phone and c. w. divisions respectively.

We believe that XE1CM and XPIA will have the two highest foreign scores.

Ten meter phone activity has been very pronounced around Kansas City, Mo., during the past few weeks. The following local stations are well known on the ten meter phone band:

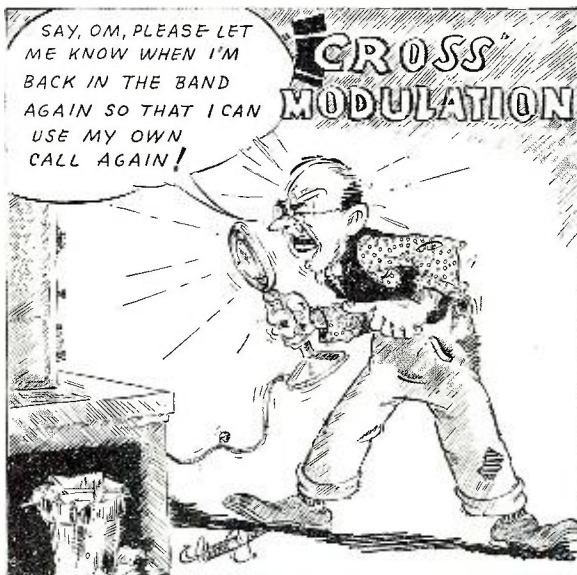

W9CXU, Liberty, Mo., has a beautiful station located on top of a hill just west of Liberty. Sam uses 800 watts input to a pair of T200's modulated by a pair of 822's. The receiver is an SX17 and the antenna is a neat looking 3 element beam setting on a tower which is right on the peak of the hill. All operation is confined to the ten meter phone band.

W5FJY/9 is on 7 mc. in Kansas City, where he is going to a radio school. Glenn runs about 100 watts and has a fine signal on the low end of 40.

W9RMI, Webb City, Mo., has put up a new antenna pole and is active on 80, 40 and 20 meter cw. The transmitter is completely band switching with a 740 in the final. The receiver is an SX27.

W9ASV, Joplin, Mo., is the proud father of a new junior operator. Congratulations, Charles, we hope he makes a fine ham some day.

W9ZAW, Fort Scott, Kans., has become a dyed in the wool 75 meter phone ham. Gene is becoming well known on 75 here in Mo. Gene will finish high school this spring.

W9QXG, Fort Scott, Kans., has a 2 element 20 meter rotary beam. Bob has been working 20, 40 and 80 meter cw. with regularity for several years now.

W5LD who is engineer for KCO.4 has a very fine 75 meter phone signal here in the midwest.

W9RJP, Carthage, Mo., is selling his rig and concentrating on his college work.

W9EPV, North Kansas City, has just finished building a new frequency standard which is a dandy. The standard uses a crystal that will oscillate on 100 kc. or on 1000 kc. The crystal stage is followed by a 10 kc. multivibrator and a 1 kc. multivibrator. To get the reading down to a frog's hair, Ed uses a separate calibrated oscillator of very narrow range which he beats with the signal to be measured and then measures the beat difference between the 1 kc. points and the calibrated oscillator. The crystal is tempera-

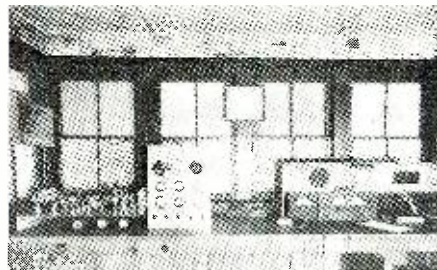

W-k Jersey DXer's hamstation W2AIW.

ture controlled and the accuracy of the readings is about 10 cycles plus or minus on 7 mc. The crystal is kept in step with WHT on a separate receiver when measurements are being made.

As an official observer for the ARRL I would like to remind the phone boys that the FCC requires that every station must include the prefix when calling another station. Lately a good many phone stations have been heard using a procedure something like this: is 9— calling 8—. This saves very little time and is classified by the FCC as the signing of a false call. 73 de W9RSO.

THE postman rang twice and brought from: Charlie W5IRH Palmer—

On February 28th and 29th, the four ham-engineers here at KARK played host to a foreign ham known as Tex Anding or H13N. Tex who flies for a sugar plantation in the Dominican Republic, had left home early on the morning of February 27th bound for Wichita, Kansas in a damaged plane. He maintained contact with his wife (H13N) until he reached the coast of Florida. With only ten minutes gasoline supply left in his planes tank, Tex made a forced landing at Appalachiola, Florida. Mr. Anding spent the night in Appalachiola and took off the next morning for Little Rock, Arkansas. Tex landed at the Little Rock airport around 5:30 P.M. C.S.T., and after registering at his hotel, he telephoned the KARK studio to locate a ham.

Percy Nichols, control operator on duty and W5HUQ, invited Tex up to the studio and also got yours truly on the phone. After a brief gab-fest at the studio, I drove Tex out to the home of Gladman Upchurch—KARK engineer—W5CIU.

Around eleven o'clock H13N was heard on 20, but due to the condition of the band, we were unable to contact her. A QSY was made to 75-fone in an attempt to contact an East Coast station for a relay to H13N. W9DOD, Clinton, Indiana, was contacted but could not relay.

However, upon completion of the c.s.o. we heard W9EWL of West Lafayette, Indiana, frantically calling us. W9EWL turned out to be an old friend of Tex, and so the c.s.o. was not "just another c.s.o." W9EWL promised to contact Tex's wife the next day and notify her that Tex had landed safely in Little Rock. The evening finally ended around 2 A.M. after pictures were taken of H13N at the W5CIU rig. W5IRH took Tex back to his hotel, and the next morning W5HUQ and W5DRZ (Bill Atkinson—another KARK engineer) escorted Tex to the airport to see him off.

Tex took off at 9:10 A.M. C.S.T. for the final jump to Wichita. His transmitter was a 12-watt, W.E. job operated on either of two crystal frequencies and similar to the *Private Flyer's Xntr* in the Feb. 1940 RADIO NEWS.

W5CIU is recovering in the hospital from a sinus operation and is anxious to get back on 20 and 75 meter fone. The rig is a T-40 in the final running at 110 watts input and modulated with a pair of HY-35's. The 20-meter antenna is a half-wave end-fed vertical while the 75-meter antenna is a half-wave end-fed horizontal.

W5HUQ is sporting a new RME-70 and is heard quite frequently on 20 and 75-meter fone running around 70 watts input to a pair of HY-35's.

W5IRH is the peanut-whistle of Little Rock—running 27 watts input to an HY-25 final, modulated with a 6N7 in Class B. In case the parts distributors are interested, W5IRH is C-WHHD, and he doesn't need any more new catalogs. (3 sets received to date!) The operating frequencies are 14.188, 14.304, and 28.608.

W5DRZ is going strong on 40 meter cw. over in North Little Rock. Bill is going on phone when he sets the audio section of the new rig completed, but for the present he is running



his XYL W9ZNU.

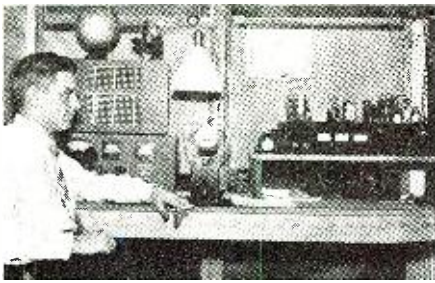

Hamop W5IPX at the controls.

around 250 watts to the HY-40's in the final. W5GGW (A.H.H. engineer) is going strong on 20 meter using cathode modulation. Alex and W5DRZ are roommates and use the same receiver at present. W5GGW has a new *Premar*, 20-meter vertical that is going up within the next few days.

W5FAL is working out on 10 meter fone. W5PWF, one of the A. T. & T. boys, spends his spare time on 20-meter fone using around 60 watts input.

W5GUG operating on 160 fone is being bothered with complaints from the bel's.

DX on the East Coast:

The most outstanding station being heard this month is EK1AF in Tangier, S. Africa, on 14.132. Jose is the only active station at the present time in Tangier. He usually puts in the strongest sigs from 5:00 to 10:30 p.m. & his sigs swing from R6 to R8.

Other African stations heard r the OQ's. OQ5AD on 14.125 in the Congo puts in a PB sig in the early part of the morning, but cw sigs from the KA's do a job on him later on. On ten fone the out-standing OQ is OQ5AB and a new comer on the band OQ5IM. Both operate amid 28,275 & can be wrkd by East coast stations between 10 to 12 noon. Altho they can be heard until late afternoon they can't be wrkd beuz of a change in skip conditions.

THE Far East stations hve bn coming in wid unusually strong sigs. The most consistent Chinese ham is XU1B on 14.162. His sigs peak at R8. XUSAM-14.133, XUSRB-14.100 & XU5GX-14.025 r the only other hams coming thru. They r heard abt 8 in the morn & then start coming in again abt 5pm & reach max strength from 5:30 to 6:00pm. They fade out of the picture abt 7:15pm.

On ten meters the only XU is XUSMC on 29.023. His sigs r vy wk & r usually fading rapidly. He comes thru occasionally at abt 5pm. J2NF-14.1 mc & J5CW r the 2 outstanding Japs hr on the coast. On several occasions they were heard wid vy strong sigs, but on the average they r abt R2 to 5. They r heard abt the same time as the XU's. J2KN can be heard vy wk on the low end of the American ten meter fone band abt 7 in the evening. He is the only Jap station that can be heard on the band. The East coast hams hve vy little chance of wrking him beuz the West coast stations put strong sigs into Japan during the period he is active.

The most active DX country this month is the Philippine Islands. The KA's hve bn coming in hr practically all hours of the day wid lrg sigs & vy little fde. The best time to the East in wrk these fellows is from 4:30 to abt 7:00pm.

The most outstanding KA's during the month hve bn: KA1MR-14.143, KA1PH-14.207, KA1CS-14.172, KA1LB-14.021, & KA1GC on 14.150. Other Philippine stations heard r: KA1CW-14.174, KA1BB-14.264, KA1LH-14.113, KA1ML-14.120, KA7EP-14.163, & KA4LI on 14.113.

KA1GC-28.386 & KA1ER-28.383 r the only Philippine hams on ten meters. Their sigs r fairly ed but due to a rapid fade they r hard to copy. Only time they r heard is around 5pm.

Several other Chinese stations if I forget to mention th hve bn putting ed sigs in r: XU1A, XU5AM-14.1mc, XUSMC-14.1mc, XUSRG-14.065 & XU1HV-14.062.

The PK's, (*what again?*) altho they r supposed to be off the air r still on & hve bn vy active of late on 14mc. Their sig strength however has not bn as gd as usual. PK1OG is by far the most consistent & strongest sig coming from Java. Other E. Indies hams bn on the air r: PK3JK-14.05mc, PK1VM, PK3JK, PK3DD-14.01mc, PK1JR-14.073, PK4DA-14.083, PK3GD-14.072, PK6GC-14.064, PK1AF-14.053, PK1MP-14.092, & PK3WI on 14.060.

SEVERAL VK stations were heard previous to the 1940 DX contest, but no stations were active during or after the contest period. The ban on ham radio has



Hamop W2GFW.

most likely bn enforced.

The Hawaiian stations heard r K6LKM-14.225, K6OCV, K6PLG, K6MNV-29.000, K6OQE-14.242, & K6GLZ on 28.650.

KC1USC has bn coming in occasionally on 14-330 & 14,360 using cw. His sigs r R6 & he has a slow fade dwn to R2. Best time to look for him is 9pm EST.

HK3CC is located in the "Hams Paradise," 1000 ft up in the Andes Mts in Colombia. Any of u fellows th hve wrked him can luk forward to getting a fb QSL card from him. On his card is a beautiful pic of an ornament he found during his wrk of excavating ruins in the Andes. The ornament is made of solid gold & is over 500 yrs old. It was used in Indian worship. The card is one to put among ur prize QSL's. XE1GE-2.890, XE1A1 & XE2FC r the more popular Mexican stations-it can be heard on 75 fone. They come in arnd midnite. By the way, 1GE hails from N.Y. While on a tour of the states a while ago he paid a visit to W1HM & W1AIZ.

THE South American hams hve bn coming in vy well on both 10 & 20 fone. HC1JB has bn the most active on 10 meters. His sigs never go below 5-9 & at times is the only S.A. ham poking a sig thru. He's running abt 600 watts input to a pair of defunkt BC bottles and figures th he's only getting 100 watts output to a rotary antenna. Some of the other active S.A. hams on ten r: CE2BX, LU7AG, LU5AN, O44R, PY5AQ, CX2CO, YV1AQ on 28.353, & HC2CR in the Honduras.

CO2DY—the "Little Palooka" has increased powr & is nw running 400 watts to HK254's. Johnnie was recently visited by a few Chicago y's & he really showed them around the old town. They were expert Rumba dancers by the time they had to go back home. I'm told the girls really cried when they boarded the ship, they were so sorri at having to leave beautiful

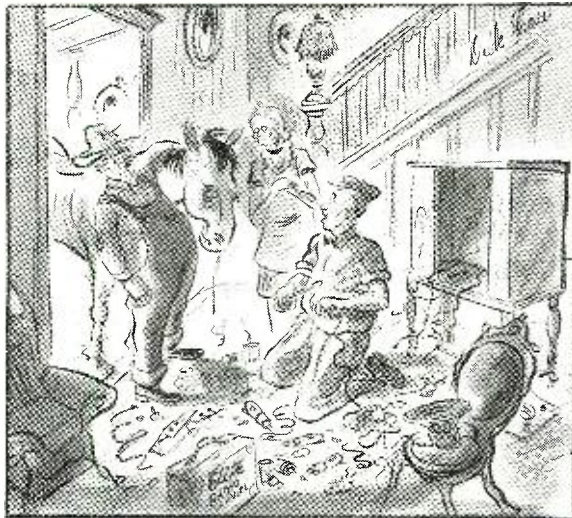

"I ain't got no 115 line plug, the oldest hoss I got on the line is only 103."

Cuba (not to mention Johnnie). In Cuba the y's call him "Valintimbo." Johnnie is planning to be in the states abt. October for a 3 wk business trip. One of his most prized possessions is a pic of W5DEW, the little dewdrop, in Port Arthur. Incidentally, Johnnie is trying to raise a mustache & is having a little trouble in getting it to bloom as he wud like it to. P.S. Send all helpful hints direct to John.

Forty meter DX has bn vy gd lately in the early mornings. Some of the gd catches are X18M1 7055, HK5ED 7095, PY1UR 7030, PY2OE 7060, J2UP 7160, J2KN 7023, J21H 7060, J7CT 7063. The best time to look for the Far East is from 4 to 7 am EST. Also LU7AZ on 6995 who is on daily frm 4 to 7:30 pm EST.

Several ed catches on 20 the past few months: ZP1LB 14.065, ZP3AC 14, AC4YN 14.268, KF6JEG 14.202, YS1NS, KC4USC 14.180 on board of the Snow Cruiser, and MX1A on 14.202 kc.

Since LU7AZ has just gotten in the Century Club he has been having some fb QSO's on the



W8TLI's peewee powerhouse.

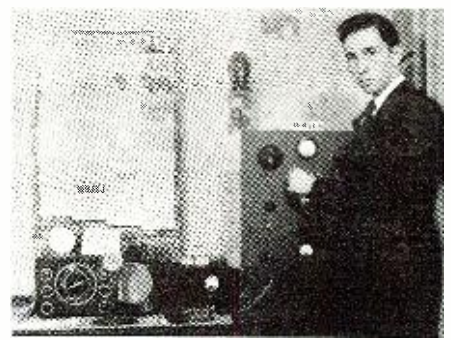

Hamop W9HS at his hamstation.

low frequency end of 7 mc. He says LUSEN put one over on him by having one more country listed in the Century Club.

HH2MC wants some dope on AC4AM. The only stations on the air in Haiti now are HH2MC, HH3L, HH2ES, and HH2PB with HH2B on phone. HH1DOJ is phoney.

Here is a little more of the stuff we're hearing from S. America and vicinity: 20 meters—LU1QP, LU2BJ, 14.048, CX2CO 14.067, YN1IP 14.052, YN1PF, HC2QQ, TG9BA 14.263, HK3CO, HH2B 14.130, HH4AS, YV1AP, YV1AV, YV4AE, 14.173, YV4AB 14.140, YV5ACE 14.120, CE1AS 14.153, CETAC 14.130, CE3EX, 14.350, CE3BE, PY4BK, PY2AB, PY1AB, H1GQ, H13N, NY4AD, COTAS, 10 meters—HA9K, OA5AA (on cw), CE3BW, CE3DW, CO2AM, CO2WM, NY4AD, K4FKC, K4POW, K4AC, K4GIG, K5AT, TI3AB, HR5C, XE2AF, and XE2FL 28.260.

W5ISE is a new YL ham in New Orleans.

W5FJW manages to keep busy with a new Economy 40. Who said YL's only go in for fone.

W5AKJ and W9AKJ finally got together on 10 meters the other day.

W5LVF forgot his own call letters in the excitement of his first QSO.

W51PR is getting started on 40 c. w.

W5HOS has been having QSL trouble. Seems the West Monroe postoffice wants 3c per them since the cards are slightly larger than ordinary. Well "Hoss," how about cutting off the edges!

W5HMY and W5ESP are heard consistently on 160 fone.

W5DRF has a specially printed QSL from G5QY. "Confirming all our FB QSO's on 28 mc, and commemorating our 100th consecutive daily contact." Some record Allen, wonder if anyone can beat it?

ex-W5BFT couldn't stay away from the key any longer. He's recently made a visit to the R. I. Welcome back!

W5EGK is emergency coordinator for 117L in Monroe.

W5LHX was well pleased to learn that Uncle Sam is going to build a new and larger CAA shack in Monroe.

Lewis Slater, although not yet a ham, keeps Ouachita Valley Amateur Radio Club members well posted on radio theory. He is professor of Physics and

Chemistry at Northeast Junior College and at present is teaching CAA students rudiments of radio and navigation in their flying classes.

W5BDJ, W5CRV, and W5CNG hold the only Class A tickets in Monroe. What's the matter with the rest of you fellows?

W5HUZ visited Ouachita Valley Amateur Radio Club several times lately. Best wishes for your new club in Shreveport, J. E.

W5FWD is one of the few hams in this section to have a 5 meter rig.

W5HEJ turned loose on 20 c. w. this week. He already has friends on 160 and 10 meter fone.

W5CRV is building a multi-band rig for use on 20 and 40 c. w. and 75 fone.

W5CNG can copy c. w. at a sustained speed of 65 words per minute for thirty minutes at a time without error. He puts it all on the mill, too. Where's that old world record, anyway.

W5GJH does his share of traffic handling on 160 fone.

W5HXC has a home made R meter on his Sky Champion.

ex-W5EMP (electromotive force) is working for an electric service company in Monroe and hopes to have his ticket in shape again soon.

W5HEJ needs only one more to be H.A.S.

W5CNG took along a portable mobile rig when he visited California last summer and kept the Monroe gang informed of his whereabouts during the entire trip on 10 meter fone. He also

(Over to page 60)



Bill Schuss.

SEEKING THE MAN'S CASE HISTORIES

by **ALFRED A. GHIRARDI, B.S., E.E.**

Author of "The Radio Physics Course," "Modern Radio Servicing": member Radio Servicemen of America, New York Electrical Society, Institute of Radio Engineers.

Reprinted with permission, from **RADIO Trouble Shooters Handbook**, Copyright, 1939, Radio & Technical Publishing Co. Copyright in Canada and Great Britain, and all countries subscribing to the Berne Convention, by Radio & Technical Publishing Co. All rights reserved.

- FRESHMAN G**
- Volume control 1) disconnect the volume control lead from the antenna receiver when adjusted, connect a 0.1-mfd. by-pass condenser from the plate terminal of the second r-f coil to the "ungrounded" terminal of volume control
- Selectivity poor 2) loosen the adjustment of the Equaphase condensers and set for maximum regeneration without instability
- 3) align the tuned stages
- 4) if necessary connect a 0.1-mfd. by-pass condenser from each filament terminal of the r-t socket to ground
- No reception, (low voltage) 1) shorted r-f by-pass condenser
- Weak or no reception 1) defective pigtail resistors
- No reception . . . 1) open-circuited output transformer

- FRESHMAN 2N**
- Fading 1) loose or corroded connection at connecting terminals in the power pack, making intermittent contact. Go over these terminals and tighten each with a large screwdriver
- 2) open-circuited filament winding in power transformer. Re-connect the leads from this winding to any of the other windings of the same voltage. If the r-f and audio tubes are heated from the same winding, replace the 1800-ohm r-f bias resistor with a 500-ohm unit, since there is now more current flowing in this circuit

- FRESHMAN "PRESIDENT"**
- Hum, 1) burned out resistor due to an internally shorted tube. Check all tubes—then check resistors
- No grid voltage 2) centertapped resistor connected across the 1.5-volt filament winding "shorting" to chassis
- Noisy or intermittent operation when tuning 1) broken lead on the tickler coil. This coil is mounted on a can which moves with the tuning condensers. Replace the broken lead with one which is more flexible

- FRESHMAN Q-15**
- See also Case Histories listed for Freshman Q-D-16-18

- FRESHMAN Q-16**
- See also Case Histories listed for Freshman Q-D-16-18

- Intermittent reception, Fading 1) defective type '22 tube biasing resistor. Replace with net unit
- 2) go over all socket connections, contacts and soldered joints for intermittent contacts
- 3) check all flexible pigtail resistors for fraying and breaks

- FRESHMAN Q-D-16-18, 3-Q-15, 3-Q-16**
- Noisy reception, Intermittent reception 1) open-circuiting flexible pigtail resistors
- Hum at resonance . . . 1) poor type '22 tube
- 2) check 0.25-mfd. filament by-pass condenser for "open"
- Broad tuning, Oscillation 1) incorrect adjustment of regeneration control connected from det. plate to antenna

- GABLE 1937 RECEIVERS**
- Inoperative . . . 1) check the wire on low side of filter choke. Insulation breaks down causing "short" to ground. Insulate it with spaghetti

- GALVIN**
- See receivers listed under "Motorola"

- GAMBLE-SKOGMO**
- See receivers listed under "Coronado"

- GEM A.C.-D.C.**
- Inoperative . . . 1) defective speaker coil, usually open-circuited. Since the speaker here cannot be repaired, the unit should be replaced
- Loud crackling noise after 1) poor connection at the lug of the filter choke

being in operation about an hour

GENERAL ELECTRIC (AMERICAN) *RECEIVERS

- GENERAL ELECTRIC 1937 MODELS**
- Colorama pilot lights burn out 1) insert a 150-ohm resistor in the center-tap lead of the high-voltage winding. Also connect a 15-ohm resistor in series with the Colorama bulbs
- 2) if green lights are on constantly, check the rectifier for trouble

- GENERAL ELECTRIC A-52**
- Microphonic howl (at 6 mc.) . . . 1) short-wave trimmers do not have full tension and vibrate at this particular frequency—causing the set to "howl". Remove the trimmer screws. Put the screws back in place, and realign the short-wave band

- GENERAL ELECTRIC A-53**
- See also the Case History listed for G.E. A-52 receiver
- Inoperative . . . 1) open or high-resistance contacts on band switch
- Distortion, "Squawking" noise . . . 1) short-circuited condensers C-16 or C-26. Replace with new units
- Noisy reception . . . 1) defective type '6K7 r-f tube (even though it may test O.K.). Replace with new tube
- Hissing noise, "Birdies" . . .

* For Case Histories of Canadian General Electric Receivers, see the listings in the "General Electric (Canadian)" group. This follows immediately after the General Electric (American) receivers.

† For a cross-index of the Model numbers of American G. E. with those of corresponding American RCA and RCA-Victor, Westinghouse, and Graybar receivers, see the list in Section 3 of this book.

- GENERAL ELECTRIC A-54**
- Oscillation, . . . 1) open-circuit or high-resistance connection at condenser C-27. Resolder connections to this condenser and note the effect
- Distortion (at low-frequency end of broadcast band with tone control at high-frequency setting only) . . . 1) open-circuit or high-resistance connection at condenser C-27. Resolder connections to this condenser and note the effect

- GENERAL ELECTRIC A-55**
- Same Case History as that listed for G. E. A-52 receiver

- GENERAL ELECTRIC A-63**
- Inoperative on short-wave band but O.K. on broadcast band 1) "open" 3600-mmfd. oscillator condenser C-9. Replace

- Inoperative, Weak reception . . . 1) "open" 2,000-ohm plate-dropping resistor
- 2) replace 0.05-mfd. by-pass cond. in grid circuit of 6K7 i-f tube

- Inoperative . . . 1) if the 0.03-mfd. 400-v. tone-control condenser "shorts", replace it with a 1000-volt unit
- Distortion with tone control in "treble" position 2) check the 8,000-ohm 1-watt resistor in series with the condenser. Replace it if necessary

- Intermittent reception (both broadcast and short-wave bands) 1) inspect the lugs of the r-f and oscillator coils. See that they do not "short" to the mounting nuts on the transformers

- High voltage between type '6A7 or '6A8 tube and ground . . . 1) open-circuit between shield pin of type '6K7 tube and socket resulting in an "open" ground contact. This causes the '6K7 to oscillate and draw grid current through R-11, resulting in the appearance of a d-c voltage across it and from the type '6K7 or '6A7 tube to the control-grid ground

- Noisy reception at high volume causing interference in other sets 1) filings in air-gap of speaker

- Noisy 1) field coil breaking down to ground
- High hum level 1) filter the plate circuit of the 6F5 or 6C5 tubes by introducing an additional 50,000-ohm carbon resistor between the plate load resistor and the voltage supply. By-pass the junction point of the two resistors to "ground" with a good 0.1-mfd. condenser

- Distortion . . . 1) if necessary, shield the control-grid wire of the 6F5 tube
- 2) "open", or "partially open" 250,000-ohm resistor (R8) in the plate circuit of the 6F5 tube

- Distortion and low volume 1) "shorted" or "leaky" 0.03-mfd. tone-control condenser
- Howling 1) blow out any dust particles that are lodged between the tuning condenser plates

- 2) see that the oscillator tube prongs all make good contact and that the oscillator and i-f tube grid caps fit snugly
- 3) dress the short-wave oscillator primary lead across and along the r-f short-wave primary bus
- 4) move the r-f broadcast primary lead away from the oscillator short-wave primary lead
- 5) dress the green rubber-covered lead from the band switch to the r-f section of one gang against and around the front gang condenser retaining bolt
- 6) dress the yellow AVC return lead (from the r-f secondary to the i-f secondary) so it does not touch either the twisted filament pair or the oscillator primary common (white, red tracer)

- GENERAL ELECTRIC A-64**
- Severe a-c hum 1) electrostatic shield of the cartridge-type electrolytic by-pass condenser (C23) touching the high a-c voltage terminal of the type '52A rectifier tube socket. Move the condenser away from the terminal, and wind tape or insulating paper over the shield

- Inoperative (no screen voltage) . . . 1) open 8,800-ohm section (R-9) in the voltage divider. A 9,000-ohm replacement may be used

- Intermittent reception, Fluttering signal, Inoperative . . . 1) to determine whether this condition is caused by "open" or high-resistance contacts on the band switch, remove chassis from cabinet and set it so the band switch is accessible. Tune the set to a signal and probe the rotor contacts with a non-conductive rod. It may be found that the springs behind the contacts have lost their tension; this is easily remedied by bending the spring with a pair of long-nose pliers toward the stationary section of the switch

If the relationship of the contact arms is such that both front and rear arms do not make contact at the same time, the following procedure should be used: Loosen clamp nut on front of chassis and twist front section of switch in either direction until both contact arms seat properly. This adjustment is limited due to the stopping lug, and if it is not sufficient to correct the difficulty, the flat shaft may be bent by using two pairs of pliers

All contacts should be cleaned carefully with abrasive paper and wiped off afterwards with cloth. At no time should lubricant of any kind be used on this switch. If the switch should work stiffly, the trouble will probably be found in the external mechanism of the switch assembly. Operating arms of the external mechanism should be examined for straightness, and all moving parts oiled

Better reception on local stations with the type '6H6 tube removed . . . 1) open-circuited secondary in the second i-f transformer

- GENERAL ELECTRIC A-65**
- Same Case Histories as those listed for General Electric A-63 receiver

- GENERAL ELECTRIC A-66**
- Intermittent reception . . . 1) see Case History for this same trouble listed for General Electric A-64 receiver

Increasing Loop Sensitivity

by **CHARLES THOMAN**

Eastover, South Carolina

AFTER reading "Simple Loop Construction" and building one, I find now that it can be made accurate to a degree that will make it a useful gadget to have around.

This is a follow up of the article written and published in the April issue of RADIO NEWS, 1939, by John X. Utley out in Tallkeetna, Alaska, under the title of "Simple Loop Construction." To the present loop was added a balance condenser and a sense antenna and the addition of a ground at the center of the loop.

The balance condenser may be purchased, but after inquiries it is a bit too costly for the average radio experimenter. Therefore, we turned to the junk-box and found a 35 mmfd. which did the trick. Take the rotor out of the condenser and then with a hacksaw equipped with two blades together, cut the stator in half. Incidentally, this condenser is of the straight line capacity type. Since there are many different constructions in this type of condenser we shall only say that it need only be fairly close to being cut in half in order to work properly. If you have one of the old type it will be necessary to cut around the bottom mounting bolt, on both sides as shown.

Add the necessary lugs and insert it into the circuit. Notice that antenna marked "sense" is brought in and connected to the rotor of the balance condenser, through a single pole double throw momentary contact switch similar to the ones used in the present day testing apparatus. The blade of the switch is connected to the antenna and the normally open contact is connected to one side of the loop input or to one side of the balance condenser. The normally closed contact is connected directly to the rotor plates of the balance condenser.

The sense antenna should be about thirty-five feet long. Various lengths should be tried. It was found that the longer sense antenna gave a much sharper nul point. The average is about twenty to forty feet. This sense antenna has two functions. First, it is used to determine the *direction* from which the signal is entering the loop circuit. To do this requires the addition of a pointer on the end of the loop stem. This pointer has one side, or the right side bulged. After things

If a loop antenna is sensitive enough, it can be used as a direction finder. The author tells of certain improvements which will do just this.

are working, definitely locate an incoming signals direction. Now push the switch connecting one side of the loop with the sense antenna. Rotate the loop. On one side of the longitudinal axis of the loop we find the signal strongest. Set the pointer with the bulged side toward the direction of the signal fixing it so the pointer is actually 90° to the left, as we look down on a compass card.

Now release the switch and rotate the loop pointer into the direction of the incoming signal until a nul is heard. Rotating the balance condenser and the loop together we will be able to sharpen the nul to a point of absolute zero. This point will be found to be very sharp. Varying the length of the sense antenna will reduce this sharpness. The use of a variable resistance such as is used in some types of receivers works well, instead of actually rebuilding the sense antenna.

Now for some real accuracy. Directly under the pointer on the loop stem, place a mariner's compass or magnetic compass of fairly good size. Now let's take a bearing on a radio station. What does the pointer say? Check this on a map showing the various locations of radio stations. If you find that the bearing you took and the actual direction found on the map differ than at this point the radio compass is in error. Remember the map is right and we are going to have to calibrate the radio-loop. We can continue to take bearings, recording their exact position as show on the map and the bearings on which we found they were indicated according to the radio loop. The more we can get in all directions the more accurate the finished curve will be for future use.

Now lay out a piece of graph paper for future references. Use a good grade of paper and draw a center line along its longitudinal axis. Divide this

center line into degrees running from 0° to 360°. Draw vertical lines perpendicular to the center line at each degree. Now take the greatest error you found. For example, let us take an extreme case of twenty degrees. Lay out on the paper twenty lines above the horizontal center line and twenty below. These lines run parallel to the center line and are spaced evenly apart. The center line is now called the normal or the true compass. All points taken are located by relating them to the normal compass. If the radio loop bearing reads less than the map or normal compass bearing, then we must add the difference to the horizontal center line.

If the radio loop is greater than the normal compass then we must subtract. Therefore an error point will be located as shown. Radio loop gave a reading of 25°. The correct reading should be 45°. Difference is plus 20°. Another: The radio loop gave a reading of 48°. The true bearing is 35°. The difference is 13°. Suppose from the final curve we were to take a radio loop bearing on a signal and we

(Continued on page 54)

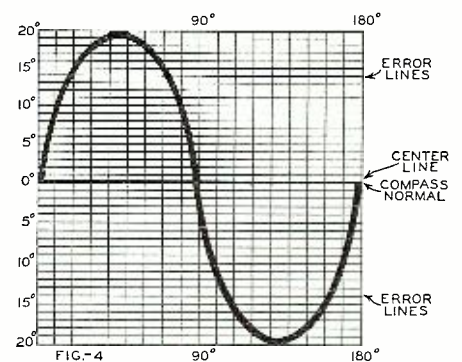

FIG.-4

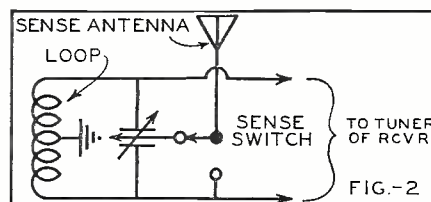
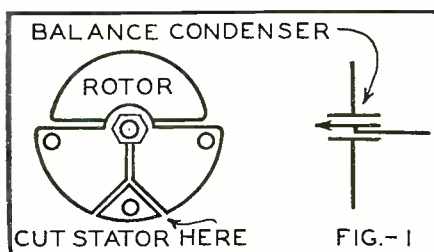
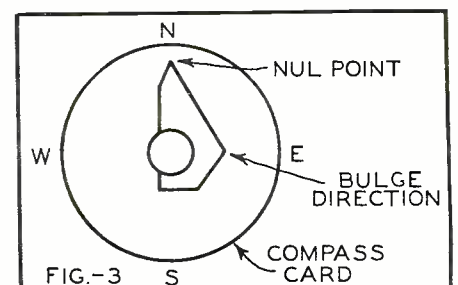

FIG.-2





"Which antenna?", is the problem which faces every dx fan, ham, or professional engineer.

HOW ABOUT WHAT ANTENNA?

NUMERABLE articles have been written concerning antennae; methods of construction, various means of excitation, coupling methods, impedance matching, etc. Almost every conceivable phase of the subject has been approached from the *practical* side, but, with the exception of textbook treatises, publications on antenna *THEORY* have been conspicuous by their absence.

It is the purpose of this article to bridge the gap between theory and practice; to bring it within the scope of the layman, and to demonstrate that theory and practice are by no means so incompatible as is persistently believed.

An analysis of the fundamental theory underlying wave propagation takes us back to basic laws. These are:

1. A moving electric field creates a magnetic field.
2. Conversely, a moving magnetic field creates an electrical field.

As we know from our knowledge of the elementary electric generator, when the conductors of the armature sweep by the magnetic field radiated from the field poles, a difference of potential is induced in the conductor. This difference of potential constitutes an electric strain, or electric field, which is *always* at right angles to the magnetic field direction of movement. Accordingly, this electric field exists whether there is a conductor present or not.

A moving electric field is usually

caused by a movement of countless electrons through a conductor. Referring to our basic laws, such an electric field will create a magnetic field—this field being at right angles to the electric field direction of motion, and having a polarity dependent upon the electric field direction of motion. We can also generate an electric field by the charge and discharge of a condenser. In this case, the electric field will be in *SPACE* instead of through a conductor. If we enlarge the space between the plates of our condenser, we will have a comparatively open field, one which corresponds to that of an antenna. This is illustrated in figure 1.

Lines AB and CD represent the two legs of a center fed antenna and in our analogy are the two plates of the condenser. The a.c. generator at the center is the source of energy and corresponds to the point at which the transmission line would be coupled in a transmitting antenna.

Since the legs of the antenna are in a vertical plane, the electric field is also in a vertical plane and is represented by the dashed lines in figure 1. The magnetic field created by the movement of the electric field, being at right angles to it, is in a horizontal plane, and is represented by the solid lines in figure 1.

We know from our elementary electricity and magnetism that the strength of magnetic field is proportional to the current flow in the con-

ductor. We also know from our knowledge of condenser action that the charging current is greatest at the instant the condenser is totally discharged and is zero when the condenser is fully charged.

Referring then to our condenser in figure 1, we find that when the electric field is zero (*condenser completely discharged*) the current is maximum and the magnetic field is also at maximum and is fully expanded. Since one of our fields is at maximum when the other is at minimum, our electric and magnetic fields are ninety degrees out of time phase, a fact which we shall see presently is of vital importance at radio frequencies.

This combination of electric and magnetic fields in space is called the induction field. We find such a field surrounding every a.c. circuit regardless of frequency. Although theoretically extending to infinity, the induction field at commercial frequencies is very limited, and practically all of the energy is returned to the circuit upon the collapse of the field.

As we increase our frequency however, we find that the element of *TIME* becomes more and more important. We know that electricity, and electric and magnetic fields, travel with the speed of light—300,000,000 meters per second. Therefore as the frequency increases, the electric field has less and less time in which to collapse back into the circuit. At radio frequencies, we find that the electric field actually does not have sufficient time in which to collapse back into the circuit, and we have the phenomenon of a field isolated in space. This can be more easily grasped if we follow the movement of an imaginary point (X, Figure 1) in the electric field as the condenser goes through a cycle of charge and discharge.

As the condenser charges, the field

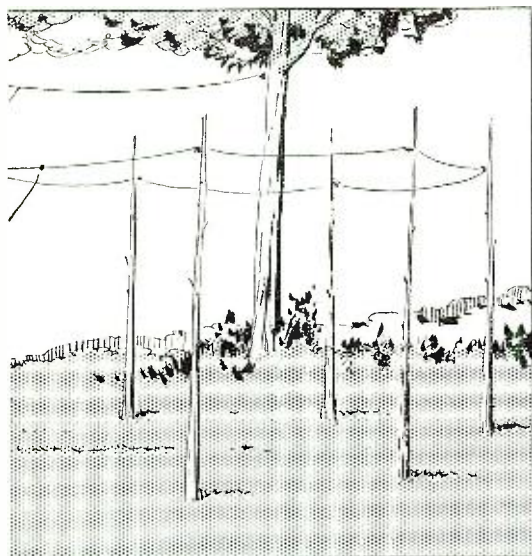

***Antennae are not like Topsy who "Just Grewed."
They require careful planning and engineering if
the set they serve is to function at maximum.***

by

ERNEST J. VOGT

Hialeah, Florida

at point X reaches maximum value at a certain interval of time later than that portion of the field closer to the conductors (Point Y, Figure 1). At the instant the condenser is fully charged, the current has reached zero and the field at point Y is at maximum. Due to the time element involved, however, the field at point X has not yet reached maximum.

As the condenser discharges, the field commences to collapse. The field at point Y collapses almost instantly. The field at point X however, not having reached maximum as quickly as that at point Y, does not begin to collapse until a certain interval of time later. Immediately upon completion of discharge, the condenser begins charging in the opposite direction and an electric field opposite in polarity to the previous collapsing field is built up.

Because of the time interval, all of the energy at point X has not been returned to the circuit and is isolated in space by the expansion of the second field of reversed polarity. Energy in space cannot remain stationary. Since the field at point X is repulsed by the new expanding field of opposite polarity, it travels outward—still with the speed of light.

Since, according to our basic laws, a moving electric field creates a magnetic field, our electric field moving through space at the speed of light will be accompanied by a magnetic field at right angles to it. This combination of electric and magnetic fields isolated in space is known as the *radiation field*. The electric and magnetic components of the radiation field, unlike the induction field, are in time phase with each other. As we know from the study of generator action, a moving electric field of constant velocity produces a magnetic field which varies directly as the strength of the

electric field. Since the components of the radiation field are self-sustaining (a moving magnetic field creating an electric field, and vice versa) they will travel through space theoretically to infinity.

It has been determined that the induction field decreases as the square of the increase of distance. We know, too, that the radiation field decreases directly as the increase of the distance. Therefore, theoretically both fields extend to infinity, it can be seen that the induction field is very weak at a distance of a few wavelengths from its source, while the radiation field falls off much more slowly. Immediately in the vicinity of the antenna the induction field predominates—i.e., the magnetic and electric components will be ninety degrees out of time phase. At a long distance from the antenna however, the radiation field predominates, and since the induction field will be negligible in amplitude, the electric and magnetic components will be in time phase.

If the frequency is kept constant, the original strength of the radiation field will depend directly upon the magnitude of the current flow in the radiators (antenna conductors). In other words, an increase in the power input to the antenna results in an increase in antenna conductor charge and discharge current with consequent increased field strength.

However, since the time element and frequency remain unchanged, the net result is an increase in field energy per unit space, that is to say, the field *density* is greater. The field density can also be increased by increasing the frequency. In this case, although the power input to the antenna is the same, there are a greater number of wavelengths in a given unit of space with a resultant increase in field energy per unit space.

From the foregoing it would appear that maximum radiation could be obtained by merely increasing power input and frequency. Unfortunately however, a number of other factors which impose very definite limitations must be taken into consideration. Only a portion of the power absorbed by the antenna is radiated usefully in the form of an electromagnetic field. The remainder is consumed in various ways, and since it contributes nothing toward radiation, represents a complete loss.

It is customary when dealing with power absorbed in a circuit, to regard this power as being expended in a resistance. The value of this resistance, of course, is such as would consume the actual power in the circuit at the same current flow. In antenna circuits, this fictitious resistance is known as the "effective resistance." Since all the power expended in an antenna is not usefully consumed as radiation, the effective resistance is divided into two components: radiation resistance (or useful resistance) and loss resistance. (*Next page, please*)

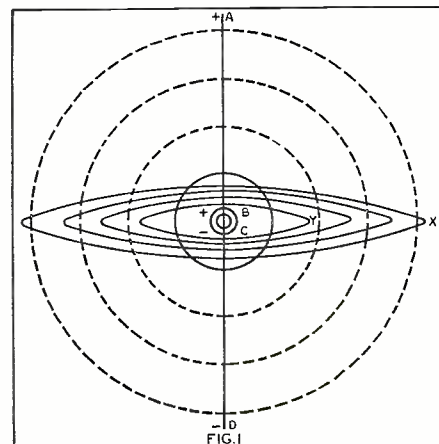
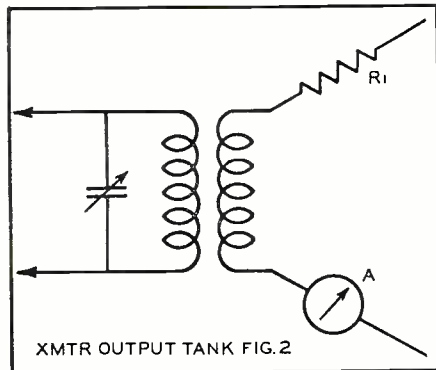

Figure No. 1.



Obviously, for maximum efficiency, the loss resistance must be kept at a minimum. A number of factors contribute to the total loss resistance, and their importance should not be underestimated. These factors, therefore, will be enumerated below and discussed in the order of their importance.

The total loss resistance is composed of: dielectric loss, resistance loss, eddy current loss, leakage loss and corona loss.

Dielectric loss occurs in all dielectrics and varies inversely as the frequency. It is due to the phenomenon of hysteresis and is especially noticeable in poor dielectrics such as damp wood, concrete, masonry, trees, etc., which are in the field of the antenna. Although this loss decreases as the frequency increases and is, therefore, comparatively small on the more popular amateur frequencies, it is still one of the most important occurring in a radiating system and should be kept at a minimum. Special care should be taken to keep poor dielectrics away from the ends of an antenna, since the highest electric gradients usually occur at these points. Much power loss due to this cause also occurs at the point of entry of the antenna feeders into the radio room. If possible, a point of entry should be chosen where the material immediately surrounding the feeders has high dielectric properties.

Resistance loss is the easily understandable loss due to the ohmic resistance of the antenna and feeder conductors themselves. This loss can be kept at a minimum by making use of wire having a large cross-section and good conduction. The largest useful cross-section can be obtained by using a number of small wires, properly interwoven and insulated from each other, thus minimizing the "skin effect" and reducing the R.F. resistance. In choosing the material for the wire, a happy medium must be reached at which good conductivity is combined with tensile strength. Phosphor or silicon bronze is often used.

Eddy current loss is caused by the current induced in surrounding metallic objects. Every effort should be made to eliminate, as far as is practicable, all metallic masses from the vicinity of the antenna field. If the method of construction is such that

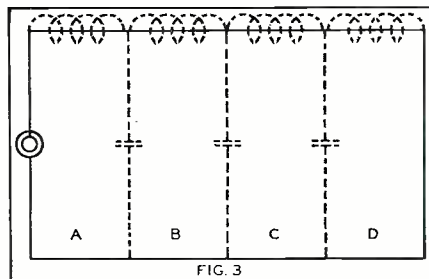

guy wires are necessary for the support of antenna masts, such guy wires should be properly broken up by insulators. Guy insulators should be spaced so that the intervening sections of guy wire will not resonate at any harmonic of the antenna frequency. If other antennae are in the vicinity, the transmitting antenna should be as far removed from them as possible. Failing this, the radiating portion of the antenna should be erected at right angles to them, thus minimizing their pickup. The increase in eddy current loss is directly proportional to the increase in frequency, and can assume serious proportions on many of the amateur bands.

Leakage loss varies directly as the square of the voltage. Since the voltage is inversely proportional to the frequency, it follows that the leakage loss varies inversely as the square of the frequency. Although this loss does not assume Herculean proportions on the amateur bands, in the interests of efficiency, every effort should be made to keep it at a minimum. Leakage losses are caused by the flow of leakage currents from antenna to ground, or between the legs of dipole antennae. The leakage path resistance is naturally greatly diminished in wet weather and the losses, especially on the lower frequency amateur bands, become noticeably large. Care should be taken to make all possible leakage paths as high resistant as possible, by the choice of proper insulators and feeder cables.

Corona loss, which takes place at high voltages, is caused by partial ionization of the air about the antenna wires. The ionization causes the air to become a partial conductor and enables it to carry a current. Because of the bluish glow which accompanies it, corona effect is visible at night. Corona effect begins to take place only at certain definite voltages, the critical voltage varying with the size and shape of the conductors, and being smallest at points and corners in the antenna system. Corona loss varies inversely as the frequency, and in the average low-power amateur installation is practically negligible. However,

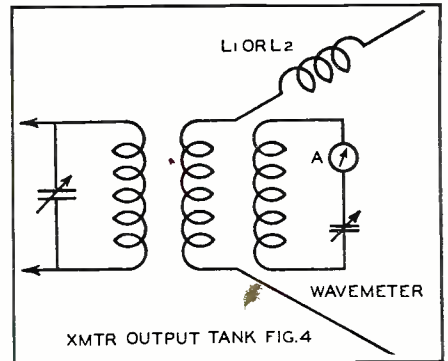
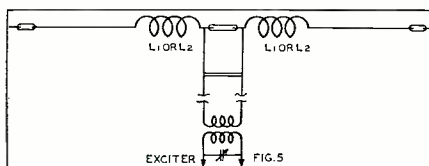

if the power input to the antenna is very high, any precautions taken in avoiding sharp turns and angles in the antenna system will be worth while.

If reasonable precautions are taken, the loss resistance can usually be kept down to 5 percent or less of the effective resistance. If the effective resistance of an antenna system is known, it is sometimes possible to determine the approximate ratio of loss resistance to radiation resistance. For example, let us assume two amateur transmitters, A and B. Both transmitters have the same power input—300 watts, and both antenna systems are current fed and identical physically. Both amateurs are putting two amperes into their antenna systems. From the foregoing, it would appear that both installations are operating at the same efficiency. However, this is not necessarily true. Suppose we were to measure the effective antenna resistances and found that A had an effective resistance of 25 ohms and B one of 37.5 ohms. Then:

$$P = I^2 R$$

$$\begin{aligned} \text{For transmitter A,} \\ P &= 2^2 \times 25 = 4 \times 25 = 100 \text{ watts.} \\ \text{Efficiency} &= \frac{\text{Output}}{\text{Input}} = \frac{100}{300} = \frac{1}{3} \text{ or} \\ &33\% \text{ efficient.} \end{aligned}$$

$$\begin{aligned} \text{For transmitter B,} \\ P &= 2^2 \times 37.5 = 4 \times 37.5 = 150 \text{ watts.} \\ \text{Efficiency} &= \frac{150}{300} = \frac{1}{2} \text{ or } 50\% \text{ efficient.} \end{aligned}$$

Despite the fact that transmitter B above is transferring more energy into its antenna system than transmitter A, does not necessarily indicate that B's signal is "getting out" more efficiently. The greater antenna resistance in B's case may have a larger component of loss resistance, in which case it is possible that A is radiating more actual watts of useful signal.

A rough check on this may be obtained by arranging a schedule with a third amateur—preferably one several hundred miles away—to compare the signal strengths of transmitters A and B. Should it develop that B is putting out a weaker signal than A, despite the greater amount of energy he is transferring to his antenna, this is fairly conclusive evidence that the loss resistance of B's antenna system is overly large. The remedy, obviously,

(Study further on page 47)

SAVE ON CONTROLS.

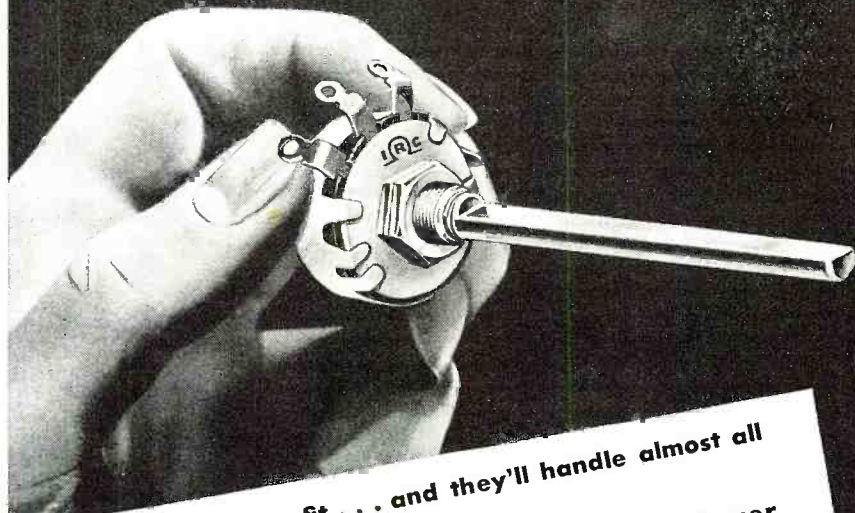

- ★ They always fit . . . and they'll handle almost all replacement jobs.
- ★ Plug-in shafts . . . easier to install . . . fewer "Specials" required.
- ★ One stock does the work of two . . . Use midgets to replace both midgets and the larger, standard-size controls.
- ★ Small in size . . . Designed for real dependability.



by Using

MIDGETS

Universally!

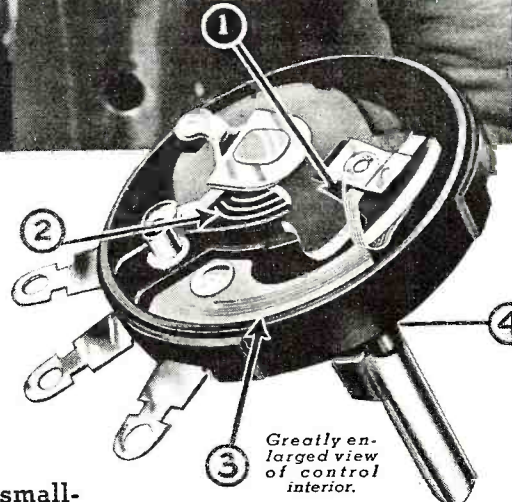

Greatly enlarged view of control interior.

Although IRC Controls are made in every type for every radio need, there is a fast-growing trend on the part of servicemen and jobbers to concentrate on IRC Midget Controls for every replacement need. And it is a logical move! It means stock simplification in that a small supply of IRC Midgets equips you for the big majority of jobs. It means using replacement controls

you are sure will fit—even in the smallest of modern sets. It means easier installations, thanks to the exclusive IRC plug-in shaft features. Above all, it means real dependability, for IRC Midgets have every engineering feature of the larger size "standard type" IRC Controls.

Certainly, it is a trend well worth your while to investigate. A study of their possibilities will quickly convince you that IRC Midgets offer the biggest savings in time, space and stock simplification, *plus* the utmost in true dependability.

The Only Midgets With EVERY STANDARD-SIZE CONTROL FEATURE

When you buy an IRC Midget you get an exact miniature of the famous IRC standard "CS" Control. Nothing has been left out. Not a single important design feature has been changed. Exclusive features include (1) IRC 5-Finger "Knee-Action" Silent Element Contactor; (2) IRC Spiral Spring Connector; (3) IRC Metallized-type Resistance Element; and, (4) Thrust Washer used to avoid end play in shaft.

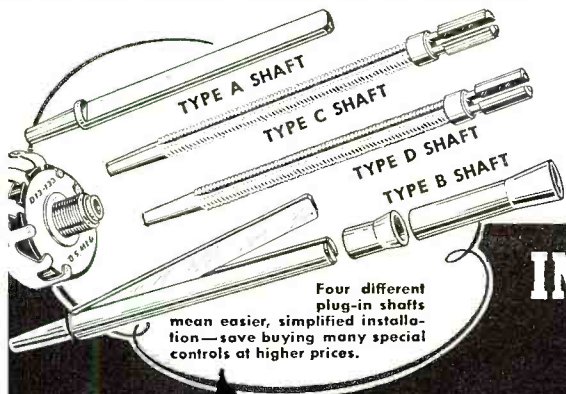

Four different plug-in shafts mean easier, simplified installation—save buying many special controls at higher prices.

INTERNATIONAL RESISTANCE COMPANY

401 N. Broad St., Phila., Pa.

In Canada: 187 Duchess St., Toronto, Ont.

MANUFACTURERS' LITERATURE

RESISTORS and VOLUME CONTROLS, catalog 44, published by the *International Resistance Co.*, 401 North Broad St., Philadelphia, Pa., is now off the press. This very complete line of all types of resistors for use by radio manufacturers and servicemen includes those designed for specific purposes. Among these are a line of Attenuators for broadcast applications or in high-grade sound equipment. The IRC line also includes volume and tone controls, special standard controls, midget controls, auto radio and replacement controls, metallized resistors, wire-wound resistors, insulated resistors, metal cabinets, power wire-wound resistors and adjustable types for all applications. The popular line of precision wire-wound resistors is also included. These offer the radio man accurate units for use in the construction of many test instruments. Free. (RADIO NEWS No. 6-100.)

CINAUDAGRAPH SPEAKERS, a new catalog put out by the *United Teletone Corp.*, 100 Varick St., New York, is now available. Formerly the Cinaudagraph Corp., this catalog represents the first published by the new company. The Linear standard units feature High-Fidelity, Low distortion, Efficiency, Polyfibrous cones, Acim voice coil supports, moisture-proof centering, and Curvilinear cones. The latter are used on their Linear standard speakers to insure maximum fidelity and minimum distortion characteristics. Linear Standard permanent magnet speakers are also being manufactured with the same features. A special series of speakers for public address are completely illustrated and described. These are available in diameters up to 18". Air Column sound projectors are also described. These may be had complete with speakers mounted up to 60 watt capacity. Free. (RADIO NEWS No. 6-101.)

MALLORY-YAXLEY RADIO SERVICE ENCYCLOPEDIA, supplement No. 6 is now ready. This contains information on "Half wave and Doubler Power Supply Systems." The serviceman will find much hard-to-get information covering the servicing of all types of sets that make use of voltage-doubler circuits. The first part is devoted to a discussion of Half Wave rectifier operating characteristics. Typical examples are given for this and the reader may get a complete understanding on the functioning of the power supply in quick manner. The entire supplement follows the very complete explanation of the subject as used by the *Mallory-Yaxley Co.* in all of their previous issues and is recommended as a valuable addition to the serviceman's library. The second portion is devoted to a complete explanation of "The Symmetrical or Full Wave type of Voltage Doubler." Some

of the sub-headings are: Typical Operating Characteristics of the Symmetrical Doubler, Operating Conditions of Capacitors in Symmetrical Doubler Circuits, Considerations of Circuit Returns and Power Line Grounding in the Symmetrical Doubler, Common Line or Series Line Feed Type of Doubler Circuit, Typical Operating Characteristics of the Series Line or Half Wave Doubler. Many other paragraphs are contained. Price on application. (RADIO NEWS No. 6-102.)

JENSEN CATALOG NO. 114. *The Jensen Radio Manufacturing Co.*, 6601 So. Laramie St., Chicago, recently brought out their new catalog on all types of reproducers. These new units are especially designed for applications that require sound projection in large areas or where clean, crisp speech must be delivered without blasting or distortion. This company is specializing in units having the ability to cover large arenas, skating rinks, stadiums, etc. Probably the most outstanding achievement in the new line of *Jensen* products is the new type X Loud Speaker Unit. These new units are of the metal alloy diaphragm, sound chamber type but incorporate entirely new principles of design and construction. They are, therefore not to be confused with the more or less conventional loud speaker of the metal diaphragm type. They employ a small, rugged, narrow annular type diaphragm, much stiffer than the more conventional spherical or dome type diaphragm. The voice coil is 2½" in diameter and the whole unit is ruggedly constructed and designed for maximum life expectancy. Free. (RADIO NEWS, No. 6-107.)

LAFAYETTE 1940 SPRING CATALOG. *Radio Wire Television Inc.* (formerly Wholesale Radio Service Co., Inc.) announces the publication of the Spring edition of its 1940 catalog. Comprising 124 pages, this new catalog of the world's largest radio supply house includes a comprehensive listing of the new line of Lafayette radios and radio-phonograph combinations, featuring for the first time the *Lafayette Radiocorder*. The Lafayette Radiocorder is a sparkling new addition to the Lafayette line which is sure to win great favor with the music loving public. It is a highly practical home recording assembly consisting of an easy-to-operate recorder for acetate records, a fine radio and phonograph combination and a moderate power public-address system all contained in a handsome console cabinet.

The new catalog also contains the first listing of the complete new line of *Lafayette Public Address* equipment featuring several innovations in circuit design as well as new cabinet styling. In addition, the Spring edition lists more than 64 pages of equipment,

parts and tools for the servicemen and more than 10 pages of interest to the "ham," experimenter and television enthusiast.

Copies of the *Lafayette Spring 1940* catalog may be obtained from the above company at 100 Sixth Avenue, New York City, without charge. Copies are also available at any of the following branches: 265 Peachtree St., Atlanta, Ga.; 110 Federal St., Boston, Mass.; 901 W. Jackson Blvd., Chicago, Ill.; 542 E. Fordham Rd., Bronx, N. Y.; 90-08 166th St., Jamaica, L. I.; and 24 Central Ave., Newark, N. J. Free. (RADIO NEWS No. 6-103.)

CLARION SPRING 1940 PUBLIC ADDRESS CATALOGUE. *The Transformer Corporation of America* has just announced a new CLARION P. A. Catalogue for 1940 which they claim contains the most extensive line of Sound Equipment ever offered in a book designed exclusively for the use of the agency who sells P. A. equipment in the field.

Featuring a completely new line of "designed with individuality" sound equipment, this new book contains amplifiers and complete sound systems ranging in power from 7 to 100 watts, mobile systems, recorders, school systems, musicians sound equipment, record changers, transcription players, intercommunication systems, microphones, speakers, speaker baffles and horns, in fact everything in sound.

Copies may be had by writing to the *Clarion Institute of Sound Engineers*, care Transformer Corporation of America, 69 Wooster Street, New York, N. Y. Free. (RADIO NEWS No. 6-104.)

PUBLIC ADDRESS CATALOG released by *Terminal Radio Corp.*, 68 W. 45th St. and 80 Cortlandt St., N. Y. C. The answer to practically every public address and sound amplification requirement will be found in the *Terminal Radio Corporation's* Public Address Catalog, just released. Hundreds of items are listed, including complete P. A. systems, amplifiers, tuners, microphones, speakers, record players and accessories. A free copy may be obtained by writing to the *Terminal Radio Corporation*, 68 West 45th Street, New York City, or by visiting either of the two Terminal Radio Supply stores located in New York City. Free. (RADIO NEWS No. 6-105.)

ALLIED SPRING-SUMMER RADIO CATALOG. Holding to the 17-year tradition of "one purpose—one direction"—Everything in Radio—the new 172-page Spring-Summer Catalog of *Allied Radio Corporation*, Chicago, contains complete listings of all the latest radio equipment. An attractive new 3-color processed cover is attract-
(Continued on page 52)

Mobile on 10*(Continued from page 18)*

To Frank C. Jones must go the credit for this receiver as his article "The 1938 Model 222 Receiver" appeared in the June, 1938, issue of *Radio*. There he introduced, for the first time, the 6J8G hexode converter tube. This tube seemed to have possibilities. So our former experiences somewhat pessimistically, an experimental converter was made up and hooked ahead of our broadcast radio. While getting it lined up the first signal heard was an ultra-high police transmitter 2500 miles away. Then it was tried ahead of our auto radio and it worked far better than our expectations. Finally, we wound up some five meter coils and when we heard signals on this band we knew we had something. It was then built up in its present form as shown in the photographs and our particular receiver problem was solved.

We cannot recommend it too highly as we have nothing but praise for its performance. It has the three primary requisites of any receiver: sensitivity, selectivity and stability. Its gain and conversion ability at the ultra-high frequencies is remarkable. Images, a major problem in many receivers, are the least of our worries. Tuning the auto radio to 1500 kc. makes the combination a "double super-het" with all the inherent advantages. And using the auto radio means that 90% of the receiver—from I.F. to speaker—is already built up. Finally, inasmuch as they have efficient line and hash filters already built in, trying to find the particular combination for your lay-out is eliminated.

The converter is a low *C* (for gain) regenerative first detector and a high *C* (for stability) reversed feed-back oscillator. Regeneration is used in the detector as it greatly increases the sensitivity and helps to eliminate images. This regeneration necessitates the detector trimmer condenser be available from the front panel but this also assures perfect alinement of the front end. Ofttimes when you want that signal that is "away down in the mud" or fading badly it is mighty helpful to tune it in "right on the nose".

The reversed feed-back oscillator seems to give better results on the higher frequencies and is obtained by winding L2 in the opposite direction of L1. Unlike ordinary oscillators the grid is connected to the untuned tickler coil. Both coils of the oscillator are wound in the same direction but be sure that the grid is out one end and the plate out the opposite end of the coil form. The high *C* tank makes the converter very stable and keeps the frequency drift at a minimum. The switch in the antenna circuit is a low capacity double pole double throw one section of which changes the antenna either to the auto radio or to the converter.

The antenna input to the converter

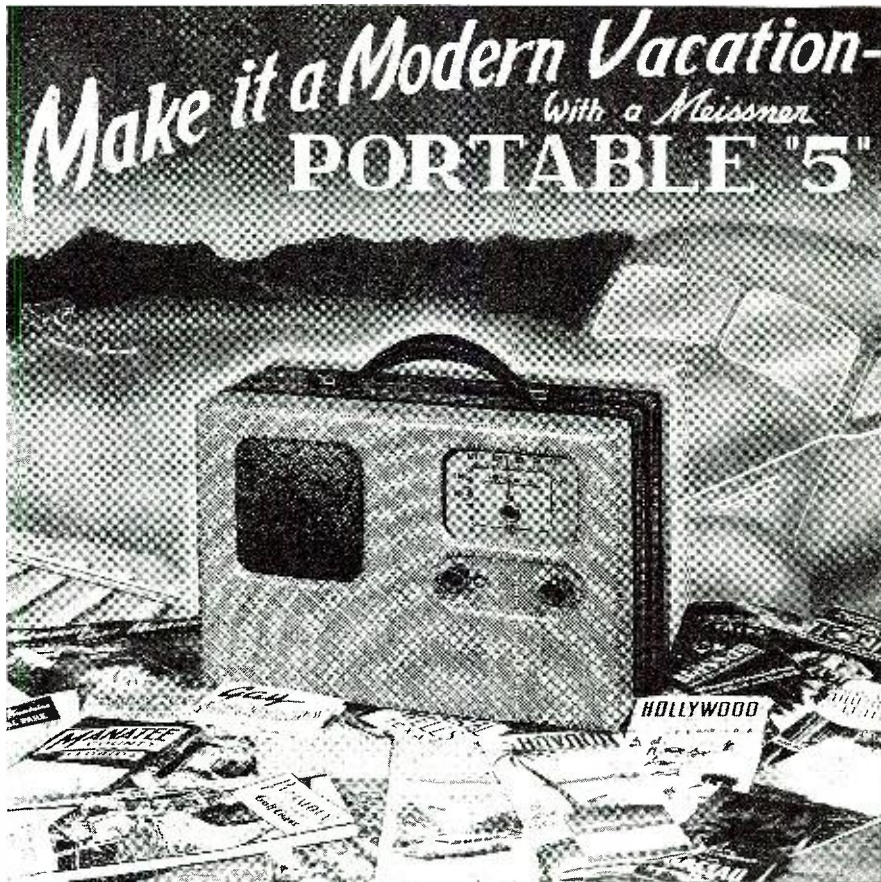
**Where-ever you go—**

Whether you travel by rail—strike out on the open road—or take life easy in a cabin in the pines—you can have radio with you by including a Meissner Portable "5" in your vacation plans.

Keep abreast of the times—the latest news the minute it happens—it's yours with this highly efficient little receiver. It'll take the place of your daily paper. And even if you're one of those who want to forget about the news for awhile—there'll still be evenings when you'll enjoy musical entertainment—you won't have to miss those favorite programs you've been keeping up with.

The Portable "5" is a sensitive, 5-tube super-het, using latest types of 1.4-volt tubes. Completely self-contained, with batteries and built-in loop antenna—just turn it on for reception anywhere! Beautiful brown-tone aviation luggage style case is only 8½" x 6½" x 13" and complete set weighs only 15 pounds.

And—best of all—this remarkable set is furnished as one of the famous Meissner Complete Kits! All parts are supplied (except tubes and batteries), with Meissner super-clear instructions, pictorial and schematic wiring diagrams. So simple a twelve-year-old could have it working in a few hours! No special tools required.

See your Meissner Parts Jobber at once and get acquainted with the possibilities of this receiver. Not "just another battery set" but a full-fledged portable super with dynamic speaker. A ready companion for any adventure under any conditions!

SEND FOR COMPLETE MEISSNER CATALOG

Your copy of the big 48-page general catalog is ready and waiting. Contains complete listings descriptions and illustrations of the entire line of Meissner Kits, ready-built units and radio accessories. A post-card will bring yours at once!

ADDRESS DEPT. N-6

MT. CARMEL
ILLINOIS

Meissner

"A FAMOUS NAME FOR TWO DECADES"

Announcing
A SENSATIONAL NEW SCOTT!
 OFFERS BOTH
Frequency Modulation
AND REGULAR RECEPTION

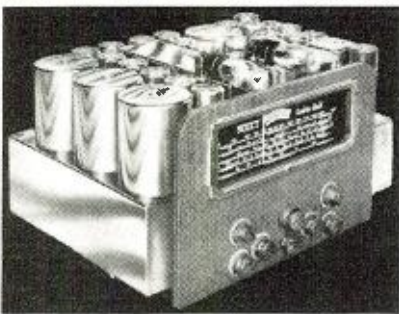

**MOST FAR-REACHING INVENTION
 IN RADIO FOR TWENTY YEARS!**

RADIO science now offers a startling new invention . . . **FREQUENCY MODULATION**. Not just an improvement of our present radio system, but an entirely new system of transmission and reception. Static and "noise" have finally been conquered. Even in the heart of a crashing storm, or with X-Ray or other powerful electrical equipment right alongside, reception from the new Custom Built SCOTT FREQUENCY MODULATION receiver, within the service area of the F.M. Stations, remains undisturbed. Only the serene and changeless beauty of the inimitable Scott tone is revealed.

TONE UNEQUALLED IN RADIO HISTORY

The very peak of high fidelity—up to 15,000 cycles—is now transmitted on direct studio F.M. broadcasts—a tonal range 2 to 3 times greater than that used in present broadcasting. Programs are reproduced by the new Scott F.M. receiver with such amazing perfection—so free of static and noise—you are tempted to pinch yourself to make sure you are not actually present in the studio or concert hall.

5 YEAR GUARANTEE • 30 DAYS TRIAL

New F.M. transmitters are being rapidly installed. Prepare now for this magnificent new reception. The new far advanced Scott offers both F.M. and regular receiver on one chassis, or new F.M. Tuner alone, for easy connection with present receivers in F.M. service areas. Precision custom built to same quality and performance standards that have won for the Scott universal recognition as "World's Finest Radio." 30 days home trial and extended terms in U. S. A. Sold only direct from our Laboratories. Be first. Write for all details now.

GET SPECIAL INTRODUCTORY OFFER!

E. H. SCOTT

RADIO LABORATORIES, INC.

440 Ravenswood Avenue,
 Dept. 5K40, Chicago, Ills.

Send all facts, special offer,
 Scott record review, and order
 blank. No obligation.

Name

Address

STUDIOS: CHICAGO, NEW YORK, BUFFALO, DETROIT, LOS ANGELES



might have been obtained by using a small trimmer condenser coupled to the grid end of the detector coil but in our case we use a loop of Number 12 wire inside of the coil form. This can be moved up or down after the converter is in operation until the best coupling is obtained. In all probability coils for other bands will be wound up and this method assures optimum coupling for each band as the coils are plugged in—instead of readjusting an antenna trimmer. In line with our policy of ruggedness—after the circuits are lined up—the coil turns should be cemented in place with duco cement.

With the coil turns and tuning condensers specified the ten meter phone band is spread over 30 divisions of a O-100 dial. Ultra-high frequency broadcast stations operating in the vicinity of 26,500 kc. can be heard at the high capacity setting of the tuning condensers and are often used as a criterion of conditions on that particular day. Police stations operating around 9 meters can be heard by re-setting the oscillator band set condenser to a slightly lower capacity. Individual requirements as to the amount of bandsread can be obtained by altering the number of turns of L3. Tuning condensers C1 and C3 should be of the straight line frequency type for easiest tuning. When it is desired to "shave" a station, a slight readjustment of the auto radio dial makes a FB vernier.

Other methods of coupling the output of the converter to the auto radio can be used but with a receiver of good sensitivity the parallel feed system shown has proven to be ample. It also has several other features we like—First—simplicity with a minimum of parts and adjustments and a consequent reduction of probable trouble. Second—we like to be able to read CW signals. A very simple method is used in that the auto radio can be tuned to the side of a broadcast station carrier for the necessary heterodyning and CW comes through in fine shape.

If the auto radio does not have sufficient sensitivity one section of an I.F. transformer link coupled to the receiver will help. Or in stubborn cases a separate amplifier made with a pentode and an I.F. transformer tuned to the operating frequency of the auto radio will provide all the gain you can use. Incidentally, the choke in the plate of the first detector is not of the short wave type but one designed to operate at broadcast frequencies.

Constructional details can be seen in the photographs and are self explanatory. The detector coil and trimmer condenser are mounted on the left front of the chassis with the oscillator components on the right rear. The angled shield between sections serves a double purpose in that it also strengthens the front panel and the chassis. The tuning condensers C1 and C3 are ganged but should have a flexible coupling between them to pre-

vent any tendency of the oscillator to "jump" while tuning.

In the front view photograph the upper left knob is the detector trimmer C2 and the upper right knob is the oscillator band set condenser C4. In the view of the bottom of the converter the 6J8G may be seen mounted in rather an unorthodox manner, i.e., horizontally. But this certainly makes for short leads and in the RF wiring, where it is really important, there isn't a lead over 1½" long—with most of them well under this figure. Where a lead passes through the chassis use a large rubber grommet with a short heavy piece of spaghetti slipped over the wire to make a snug fit.

The lips or ears on the front panel may seem a bit unusual but were made in our particular case so as to provide an easy mounting in the glove compartment of the car. We suggest that a model of the converter chassis and panel first be made up out of heavy cardboard. We had the disconcerting experience one time of very carefully measuring the space it was to fit in; the metal chassis was made up and then discovered it wouldn't go in without removing some of the automobile controls.

The output of the converter is fed through a low capacity shielded cable to the antenna connection of the auto radio. Another shielded cable carrying three wires—grounded A and negative B, hot A, and B plus—supplies the converter power. These shielded cables should be grounded but do not rely upon the shield alone for grounded A and negative B. For standby periods while transmitting and at the same time keeping the battery drain at a minimum. The speaker field and the primary side of the power transformer are rewired as shown.

A heavy lead is brought out to the arm of a single pole double throw switch. In one position the auto radio acts perfectly normal while in the other position this lead is connected to the receive side of one of the relays. This method cuts out the vibrator and speaker field current but keeps the receiver filaments hot while transmitting. The lead marked X in the diagram is most important and well worth experimenting with in its termination. In our case 90% of the vibrator hash was eliminated by connecting this lead directly to the battery terminal. On the subject of hash and its removal every installation will require different treatment.

While many amateurs can and will eliminate it, in stubborn cases the help of an experienced serviceman specializing in auto radio installations will be of immeasurable value. However, here are a few suggestions: Adding ordinary filter seems to be of little help; A chokes of heavy wire and pie wound RF chokes usually will prove advantageous; try different sizes of mica and/or paper condensers; try bringing the hot side of the 6J8G filament to different points; instead of the receiver's main power lead going

to somewhere on the dash as is usually done, connecting it to the battery terminal or starter switch instead usually will help.

The problem of a power supply for the transmitter isn't so easy and here are several not so well known fundamentals to keep in mind. The use of another storage battery in addition to the regular car battery is highly recommended if you want to eliminate battery troubles. While it is true that a storage battery will stand momentary overloads—it is also true that a steady drain will usually have disastrous results as you already know if you ever let the headlights burn over night. While transmitting the total drain is a little over 15 amps and on receiving the drain is about 10 amps. If you anticipate any great amount of operating this is too much of a consistent drain for a single battery unless you do a lot of driving. Most of the later model cars are equipped with a device that maintains an automatic charging rate. If you do not have one better put in something that will conveniently adjust the charging rate. A rheostat installed on the dash and connected in the field of the car generator is such a device. Auto supply stores call this item a "charging regulator" and while you are at it, unless your generator is well cooled, better get a "generator ventilator". These two items are very inexpensive but are well worth while.

There are two general types of power supplies available—vibrator and motor generator. Both have their good points as well as their bad. The vibrator type is probably the most tricky and erratic. One major fault is that their regulation isn't so good. We are a staunch believer in class B for portable-mobile operation—simply because it is the most efficient type of modulation. In this respect a motor-generator is ideally suited as the inertia of the armature is such that it carries through the Class B peaks with remarkably good regulation. In fact it is better than most power supplies built for this purpose. In our installation the voltage barely fluctuates even though the motor-generator is being worked at its rated current with the modulators resting.

Most motor-generators are rated so that they can handle a 25 to 30% continuous overload so these temporary speech peaks do not cause any harm. One thing worth noting is that it is our personal observation that the more segments there are on the generator side the less hash there will be. And the integral filter system for the particular supply—be it motor-generator or vibrator—is a cheap investment as the manufacturer knows more about the filter constants required than could be determined in hours of cut and try experimentation.

All primary or low voltage wiring should use the heaviest wire possible. It will help you to remember this point if you realize that a drop of one volt on the primary side can cause as much

as a 50 volt drop on the high side. And as a possible source of drop don't forget the relays. The contacts carrying low voltage should be heavy and adjust them with a thin file so that they seat perfectly. In wiring up the power cable and sockets connecting the filament prong and the adjacent prong together makes a heavier connection and eliminates a common source of grief at this point.

It is a well known axiom that no rig is any better than the antenna used with it. We are fairly well informed today on the subject of ordinary antennas but knowledge on portable-mobile antennas is sadly lacking. The author has had antennas fastened on his car at practically every place

it was possible to mount them. We have carried a collapsible full-wave and even experimented with portable beams. But, undoubtedly you will try operation in high places and the wind velocities and weather encountered usually makes short work of any complicated system. A portable-mobile antenna must have the ability to radiate power without being fussy about it. And there must be no such thing as bulk with unhandy and unwieldy apparatus. And so a quarter-wave *Marcini* working against ground was a logical and highly satisfactory choice.

Early in our experimentation it became apparent that the placement of an antenna on the car affected the directional pattern to a more or less ex-

SOUND TIPS ABOUT THE SOUND THAT'S TOPS

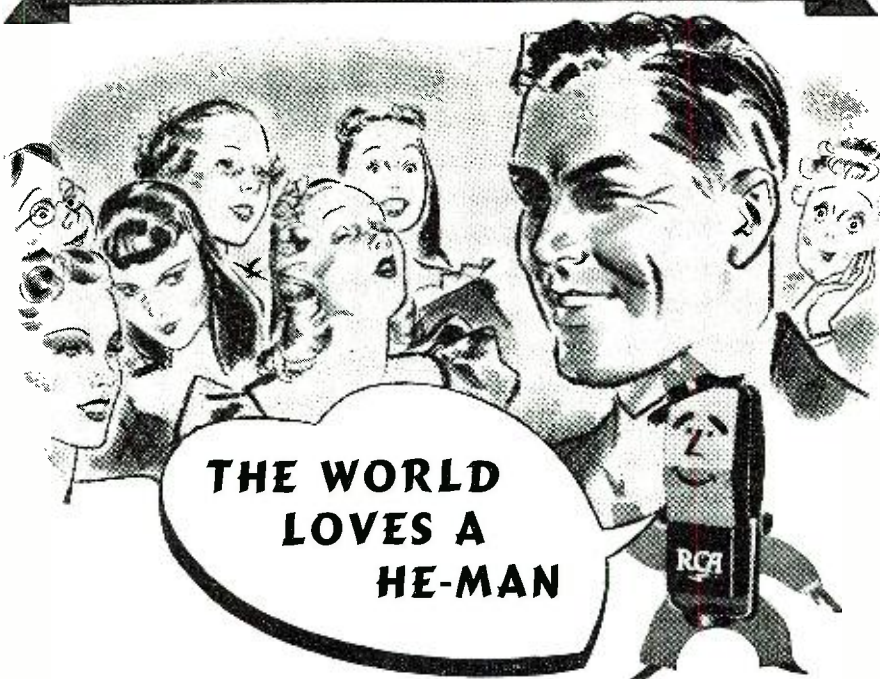

IN THE MOVIES, he-men like the one above mean dollars to exhibitors. They have public acceptance.

RCA offers *you* public acceptance in the sound business. And any man using a product with this vital advantage is well on the way to new business every time he approaches a prospect.

The RCA trademark is known everywhere. In the minds of your prospects and customers it means high grade equipment at reasonable cost. It means research and engineering plus the world's most comprehensive experience in sound. It's another reason why it will pay you to recommend RCA Commercial Sound.



FOR FINER SOUND SYSTEM PERFORMANCE—USE RCA TUBES

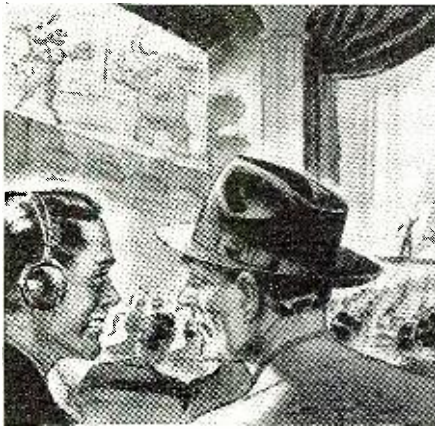

"HE SAYS THEY SHOULD HAVE USED UTAH SPEAKERS"

There are important reasons for this increasing preference for Utah speakers among sound equipment men. They recognize the time proved dependability, uniformity and consistent high quality.

When Utah speakers are used, the benefit of these outstanding features, as well as many others are obtained.

1. Special Utah phenolic resin cement treatment provides an extra sturdy voice coil assuring maximum safety under EXTREME OVERLOADS.
2. Completely dust-proofed.
3. All cementing operations completely cured before final test, assuring perfect centering, made possible THE MODERN METHOD — use of THERMO-PLASTIC cements throughout.
4. Rugged formed-steel cone housing for maximum strength and rigidity—rust-proofed, aluminum finish.
5. All diaphragms are lacquer treated to assure minimum moisture absorption.
6. Cone and spider assembly selected for maximum power handling and tone quality and minimum distortion and break-up.

There is a Utah Speaker for every original equipment or replacement requirement.

Utah speakers are distributed nationally through carefully selected, recognized parts jobbers and dealers. Look for the famous Utah trade mark on the carton. If your supplier can't furnish Utah speakers, write us direct.

UTAH RADIO PRODUCTS CO.
824 Orleans St., Chicago, Illinois. Canadian Sales Office: 560 King Street West, Toronto, Canada. Cable Address: Utaradio—Chicago

Three of the 90 different models of Utah Speakers



SPEAKERS

VIBRATORS • TRANSFORMERS

UTAH-CARTER PARTS

tent. For instance, placing the antenna on the left rear bumper made the rig transmit best in a line through the right front fender. And an antenna mounted on the car's radiator transmitted best in a backward direction. Field strength tests—with distant stations—indicated that a quarter wave Marconi transmitted best in line with the greater bulk or mass of the car. So the antenna was mounted in the middle of the turtle deck between the rear window and luggage compartment hinge line as shown in the photograph. In this position the directional effect is directly straight ahead and has a pattern similar to an ordinary antenna with a reflector behind it.

As an example, if our signal was R8 when pointing directly at another distant station, simply by turning the car around 180 degrees would make the signal drop down to R3-4. The same effect is noted when receiving. Separate antennas for transmitting and receiving were not used for the same reason that most amateurs today use the same antenna for both. The logic being that if you get out best in a certain direction with a certain antenna the same antenna should be used so that you can best hear stations from this direction. And then too another antenna would probably distort the directional pattern and give an erroneous impression.

It is interesting as well as practical upon arriving at an unknown location to tune in a signal and then orient the car for best reception. As to be expected the null point is the sharper and more definite. It is difficult to judge when the received signal is above R6 but by turning the car around in a circle and noting the car's position when the received signal is weakest then the exact opposite of this will be the direction for maximum signal strength when receiving as well as transmitting.

Many persons have asked why I do not use an antenna attached to the rear bumper as is the usual police car installation. If you are only interested in communication where the ground wave does most of the work placement of the antenna is unimportant. But for distant contacts fastening the antenna to a bumper does not work out so good.

Details of the antenna installation are shown. We use a collapsible fish-pole for the radiator because it has the least wind resistance. It's length will be more than half the theoretical half-wave value and should be at least 8 feet long. It is made plug-in by using the giant type of plug and jack. The jack is sweated into the end of the radiator. The plug is insulated from the car body by means of two machined mycalex washers. Due to the fact that the turtle deck is slanting at this point of the car the antenna is bent at the bottom end so as to be vertical when in use. This will cause a tendency for it to turn around with the wind but this can be overcome by hack-sawing a key way in the

jack and fitting a key into the side of the plug.

A concentric line is undoubtedly the efficient form of feeder for this type of installation and can be cheaply constructed from copper tubing and isolantite beads. These beads should be fastened on the wire every 4" but this distance should be shortened to about 2" where bends take place in the line.

The coupling scheme shown worked the most efficient of dozens that were tried. For some reason I cannot explain it seems to "resonate" the entire antenna system and reports average 2 R's better than other types of coupling systems. The coupling condenser, C is a 50-75 mmf. variable and serves a double purpose in that it is also used to adjust the antenna load to any desired degree. Two or three turns of insulated wire are wound around the center of the final tank coil with one end going to ground and the other to the coupling condenser.

Tuning the transmitter is quite conventional. But we like to clip a 100 mill thermo-galvanometer across two inches of the middle portion of the antenna and then go back over all tuning adjustments. Lacking the galvanometer a field strength meter can be substituted. The most critical adjustment is the crystal tuning condenser—and a compromise must be met between maximum output and stability. Tuning on the higher capacity side reduces the output slightly but effects better stability and minimum drift. If tuned carefully a ten meter crystal will have very little more drift than a lower frequency crystal with doubler stages.

If you have been putting off building a portable-mobile station simply because you thought that flea-power didn't have a chance then the results obtained with this 15 watts ought to convince the most skeptical. It has been a source of never ending amazement to us to receive the reports that we have with this power. If anything they are better than the reports gathered with the 260 watt station at the home QTH. Of one thing we are very certain—every bit of RF in the car's antenna goes places and does things. It has made me wish that I had some sort of an X-ray machine so that I could see all the parasites of power around my home. All the wiring and plumbing of my own house, plus my neighbors' houses, plus the various and sundry wires on the street and in the alley certainly must soak up a lot of RF even before it has a chance.

One last thing: While it is perfectly all right to run any input you care to as long as there is a convenient power plug handy it is quite a different thing when you have to carry this power with you. For portable-mobile operation inputs up to about 15 watts to the final are about all that can be run if one wishes to experience any amount of pleasureable operating. Beyond this point past experiences of others as well as myself indicate

that the difficulties and troubles encountered increase all out of proportion to the increase in signal strength at the other end. But what a pleasure and a surprise this 15 watts can be.

73's and see you most any Sunday afternoon.

Typical Operating Conditions	
Voltage	Current
RK34 Plate 280	54 mils.
RK34 Grid	—10 mils. under load.
6J75 Plate 190	27 mils.
79 Plate 290	16 mils. resting, 35-40 peaks.
Total transmitter filament drain—2.3 amps.	
-50-	

How About That Antenna?

(Continued from page 40)

is to go over the various losses which have been enumerated above and take whatever steps are possible to minimize these losses.

It has been seen above that the value of effective resistance of an antenna is a very useful factor to have at hand. A practical method of measuring this resistance is outlined.

Due to the behavior of electricity at high frequencies, measurements of circuit constants are not as easily obtainable as are those at the lower frequencies. Ordinarily, to obtain the resistance of an alternating current circuit, the current and voltage would be measured at resonance, and Ohm's law applied to obtain R. In an antenna system, we find that the current is the only factor which can easily be measured. However, by measuring the antenna current at various resistances of the circuit, several pairs of simple simultaneous equations can be obtained from which the antenna resistance can readily be computed.

If our antenna system is tuned to resonance, according to Ohm's law,

$$I = \frac{E}{R} \tag{1}$$

Rearranging:

$$E = IR \tag{2}$$

If we now add a known value of resistance, R₁, in series with our antenna system, we get a new value of current, I₁, and according to Ohm's law,

$$I_1 = \frac{E}{R + R_1} \tag{3}$$

Rearranging:

$$E = I_1 R + I_1 R_1 \tag{4}$$

Since the value of E is the same in both cases, we may combine (2) and (4) which gives us:

$$IR = I_1 R + I_1 R_1 \tag{5}$$

Then:

$$IR - I_1 R = I_1 R_1 \tag{6}$$

And:

$$R(I - I_1) = I_1 R_1 \tag{7}$$

Dividing by (I - I₁):

$$R = \frac{I_1 R_1}{I - I_1} \tag{8}$$

Or:

$$R = \frac{R_1}{\frac{I}{I_1} - 1} \tag{9}$$

This method of obtaining the antenna resistance, known as the resis-

tance variation method, is based on equation (9), in which:

R unknown antenna resistance,

R₁ value of added resistance.

I current with no resistance added,

I₁ current with added resistance.

Several values of added resistance, R₁, should be used and the results averaged for greater accuracy. Every effort should be made to use resistors which are as far as possible non-inductive. Other than the resistors, no additional apparatus is necessary to perform the measurement. Some provision should be made to facilitate opening of the antenna circuit to provide for the insertion of the resistors. The arrangement of the apparatus is shown in Figure 2.

The experiment is conducted as follows: The antenna circuit is tuned to resonance with the transmitter and the current, I, carefully noted. A known value of resistance, R₁, is then inserted in series as shown in Figure 2, and the current, I₁, again carefully measured. The values obtained, I, I₁, and R₁, are then substituted in equation (9). The experiment is then repeated several times, each time using different values of R₁, and substituting in equation (9). The various values of R obtained should be averaged for the final value.

Care should be taken during the measurements to maintain a constant transmitter power output, since any fluctuation of power transferred to the

Two New Instruments—At Record Breaking Low Prices



**THE NEW MODEL 1230
SIGNAL
GENERATOR
WITH
FIVE STEPS
OF
SINE-WAVE AUDIO**

SPECIFICATIONS

RADIO FREQUENCIES from 100 K. C. to 90 Megacycles in 7 bands by front panel switch manipulation. All direct reading and accurate to within 1% on I.P. and Broadcast bands, 2% on higher frequencies. The R.F. is obtainable separately or modulated by any one of the five Audio Frequencies.
AUDIO FREQUENCIES: 5 steps of SINE-WAVE audio 200, 400, 1000, 5000 and 7500 cycles WITH OUTPUT OF OVER 1 VOLT. Any one of the above frequencies obtainable separately for servicing P.A., hard-of-hearing aids, etc.
ATTENUATOR: Late design, full-range attenuator used for controlling either the pure R.F. or modulated R.F.

CIRCUIT: The Model 1230 employs an improved electron coupled oscillator circuit for the R.F. affording positive protection against frequency drift and a Hartley oscillator circuit for the A.F. section.
DIAL MANIPULATION: Large 3 1/2" dial etched directly on front panel, using a new mechanically perfected drive for perfect vernier control.
APPEARANCE: The front panel is etched by a recently perfected process which results in a life-long attractive finish and the instrument comes housed in a streamlined shielded cabinet.
CURRENT SOURCE: The Model 1230 operates on 90 to 130 Volts A.C. or D.C. any frequency.

The Model 1230 comes complete with tubes, shielded cables, moulded carrying handle and instructions. Size 14" x 6" x 11". Shipping weight 15 pounds. ONLY **\$12⁸⁵**

**THE NEW MODEL 1220
World's Lowest Priced
5,000 OHMS
PER VOLT!!**

Extremely valuable because of its high sensitivity, the Model 1220 is an all-purpose tester that permits resistance measurements up to 3 Megohms, with only a 3 V. self-contained flashlight battery and reads directly down to 0.2 ohm.

SPECIFICATIONS

- ★ 6 D.C. Voltage Ranges: 0-3-10-50-250-500-5,000 volts.
- ★ 3 A.C. Voltage Ranges: 0-15-150-1500 volts.
- ★ 4 Resistance Ranges: 0-3000 ohms, with 15-ohm center, direct reading to 0.2 ohm; foregoing base range multiplied by 10, by 100 and by 1,000, to read up to 3 Meg. with self-contained 3 V. flashlight battery.
- ★ 4 D.C. Current Ranges: 0-200 microamperes; 0-2-20-200 Milliamperes, using wire-wound shunts.
- ★ 3 Output Meter Ranges: Same as A.C. Voltage Ranges.
- ★ 3 Decibel Ranges: From -2 to +58 D.B., based on .036 watt in 500 ohms.
- ★ Uses full-sized 3" square 0-200 microammeter, with 2% accuracy and finely damped movement, contained in a handsomely-designed, square molded Bakelite case.



Model 1220 comes complete with cover, self-contained battery, test leads and instructions. ONLY **\$10⁴⁵**

SUPERIOR INSTRUMENTS CO.

136 Liberty St. Dept. RN6 New York, N. Y.

RAIN or SHINE...

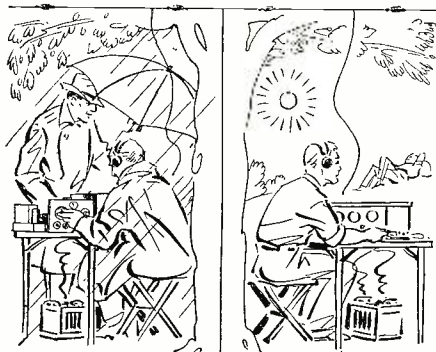

P. R. MALLORY & CO., Inc.
MALLORY
Vibrapacks
(TRADE MARK REG. U. S. PAT. OFFICE)

are always dependable

Every day is Field Day for countless Mallory Vibrapacks. In 24-hour-a-day regular operation, these Vibrapacks provide unflinching service in police squad cars, in forest fire control stations, in airplane communication equipment, in ship-to-shore telephone and in other similar services from fixed stations and in mobile equipment aboard automobiles, boats and airplanes.

The selection of Mallory Vibrapacks for these applications is logical because of their dependability, lower battery drain and economy.

Amateurs want these same advantages for their Field Day and QRR rigs—especially when genuine Mallory Vibrapacks cost no more than other forms of power conversion equipment. Learn the advantages of Mallory Vibrapacks and why they provide "Perfect Portable Power" for receivers, transmitters and P.A. Systems. Ask your distributor for the technical data booklet, form E-555-C, or write—

P. R. MALLORY & CO., Inc.
INDIANAPOLIS INDIANA
 Cable Address—PELMALLO



antenna will introduce serious error in the results. It is best to check plate current and voltage of the last transmitter stage before each antenna current reading and to correct any existing discrepancy. It is advisable to use an R.F. milliammeter to measure the antenna current and to adjust the transmitter output so that the current falls well within the meter scale before beginning the measurements. However, an accurate R.F. ammeter will serve the purpose if care is taken in making the readings.

Another, somewhat simpler, method of measuring the antenna resistance is by means of the so-called "half-deflection" method. This method is based entirely on Ohm's law:

$$E = IR$$

It will be apparent from the above simple equation, that, if the voltage E is kept constant, current I will vary inversely as the resistance R . In other words, if E is kept constant, and R is doubled—then I will be halved.

The apparatus is set up for this measurement exactly as in the case of the resistance variation measurement. The driver, or transmitter, is tuned to resonance with the antenna and an accurate measurement of the antenna current is made. The antenna circuit is then opened and enough resistance is added to cause the antenna current to fall to half its former value. When this condition is obtained, the value of the added resistance will be exactly equal to the antenna, or unknown, resistance. Great care should be taken to maintain a constant power input to the antenna circuit, since any variation in E will destroy the accuracy.

The stability of the power input can be checked by quickly shorting out the added resistance and noting the antenna current. If the current is the same as it was before the resistance was added, it can be assumed that the power remained constant during the measurement.

In performing the above measurement, the resistance used should be of the non-inductive type. However, since no resistance is really perfectly non-inductive at radio frequencies, there will be a small change in circuit values of L and C . It will therefore be necessary to make whatever small change in tuning is necessary to regain the condition of resonance.

In both the above measurements of antenna resistance, it is extremely important to maintain the antenna circuit in exact resonance with the oscillator or transmitter, otherwise the results will be in error. If the antenna is off resonance during any part of a measurement, the antenna impedance will not be equal to the R.F. resistance, but will be the vector sum of the capacitive and inductive reactances plus the resistance. There will also be error due to phase distortion. At resonance, however, the capacitive and inductive reactances will be equal and opposite to each other and will balance out. The impedance will then be equal to the resistance of the circuit.

At low frequencies in general the current at different points of a circuit is the same. If the voltage remains constant, however, the current into a capacitive circuit increases with the frequency. Similarly, if the current remains constant, the voltage across an inductance increases with the frequency. At low frequencies, displacement currents are present only at those points of a circuit where relatively large condensers have been intentionally inserted. In other words, the inductance and capacity are definitely localized or "lumped."

At very high frequencies, however, when the dimensions of the circuit become comparable to the wavelength, the capacities between different parts of a circuit become important and the current varies appreciably in different parts of the circuit. This variation of current through inductances in different parts of the circuit causes their inductive effect to vary similarly. At high frequencies, therefore, the equivalent inductance and capacity of the circuit will depend upon the frequency. The separate condensers and inductances must be considered with regard to their position in the circuit. In other words, one must deal with "distributed" inductance and capacity.

Such a circuit is shown in Figure 3. The circuit represented is composed of two long parallel lines supplied by an alternator at one end and closed at the far end. The inductance and capacity of the circuit is represented by the dashed lines. At low frequencies very little current will flow through the circuit condensers and if ammeters were inserted at points A, B, C and D, the reading of all of them would be essentially the same. As the frequency is increased, however, more and more current will flow through the condensers. Consequently, we would find that our ammeter readings would decrease as we approached the far end of the circuit. The current reading at point A would be highest, point B would be lower, point C still lower, and the current at point D would be lowest of all. As a result of this varying distribution of the current in the circuit, it is evident that the equivalent inductance, capacity and resistance also varies with frequency.

The mathematical treatment of currents in circuits having distributed inductance and capacitance (such as antenna circuits) is generally concerned with the theoretical case wherein these quantities are uniformly distributed. Because of end effects, this condition can not be strictly obtained in antenna circuits, except in circuits of infinite length—such as two parallel wires, a single wire with concentric cylindrical return, or single (or a number of parallel) wires with ground return. It is evident, therefore, that the distributed inductance and capacitance of an antenna system are values which are not easily computed. However, these values can be measured for a particular antenna system. When one value has been found, it is possible to compute the other very

simply. A method of measuring the antenna inductance easily available to the average amateur and experimenter is outlined below.

This measurement is based on the familiar equation:

$$\text{Wavelength} = 1.884 \sqrt{LC} \quad (10)$$

The only extra apparatus necessary to perform the measurement is a few standard inductances of known value. A couple of 2.5 mh and 5 mh R.F. chokes of reliable make would be sufficient. The arrangement of apparatus for a simple current fed system is shown in Figure 4. One of the standard inductances, L_1 , is connected in series with the antenna system. The transmitter is then tuned to resonance with the antenna system, and the wavelength is measured by means of the wavemeter. The wavelength can then be substituted in equation (10) which is modified as follows:

$$\lambda_1 = 1.884 \sqrt{(L_1 + L_n)C} \quad (11)$$

where,

L_1 = known inductance inserted in microhenries,

L_n = unknown antenna inductance in microhenries,

C = antenna capacitance in microfarads.

The experiment is then repeated using a different value of known inductance, L_2 . The wavelength measured this time, λ_2 , is again substituted in equation (10) which gives us:

$$\lambda_2 = 1.884 \sqrt{(L_2 + L_n)C} \quad (12)$$

We now have a pair of simultaneous quadratic equations, (11) and (12) which can be solved for L_n as follows:

$$\lambda_1 = 1.884 \sqrt{(L_1 + L_n)C} \quad (11)$$

$$\lambda_2 = 1.884 \sqrt{(L_2 + L_n)C} \quad (12)$$

Squaring both sides of both equations:

$$\lambda_1^2 = (1.884)^2(L_1 + L_n)C \quad (13)$$

$$\lambda_2^2 = (1.884)^2(L_2 + L_n)C \quad (14)$$

Dividing (13) by $(L_1 + L_n)$:

$$\frac{\lambda_1^2}{L_1 + L_n} = (1.884)^2 C \quad (15)$$

Dividing (14) by $(L_2 + L_n)$:

$$\frac{\lambda_2^2}{L_2 + L_n} = (1.884)^2 C \quad (16)$$

Equating (15) and (16):

$$\frac{\lambda_1^2}{L_1 + L_n} = \frac{\lambda_2^2}{L_2 + L_n} \quad (17)$$

By cross products:

$$\lambda_1^2 L_2 + \lambda_2^2 L_n = \lambda_1^2 L_2 + \lambda_2^2 L_n \quad (18)$$

Rearranging:

$$\lambda_2^2 L_n - \lambda_1^2 L_n = \lambda_1^2 L_2 - \lambda_2^2 L_1 \quad (19)$$

Or:

$$L_n(\lambda_2^2 - \lambda_1^2) = \lambda_1^2 L_2 - \lambda_2^2 L_1 \quad (20)$$

And:

$$L_n = \frac{\lambda_1^2 L_2 - \lambda_2^2 L_1}{\lambda_2^2 - \lambda_1^2} \quad (21)$$

Equation (21) is the ultimate formula upon which the measurement is

based and the values of wavelength and inductance used in the experiment should, for convenience, be substituted in equation (21). The derivation of the formula is given for the benefit of those interested and need not enter into the calculations for determining antenna inductance. All values of L_1 , L_2 and L_n are in microhenries.

It should be understood that in the above measurement, the inductances should be inserted directly in the radiating portion of the antenna itself, and not in the feeder lines if the antenna is fed by some sort of transmission line. Adding inductance to the coupling coil at the station end of a transmission line will result only in lowering the efficiency of coupling to the transmitter output and will not affect the antenna constants in any way whatsoever. If the antenna is coupled to the transmitter by means of a tuned or untuned transmission line, the apparatus for this measurement should be set up as illustrated in Figure 5 with the inductances inserted directly in series with the radiating portion of the antenna.

In this case, it is best to use two inductances of equal value, inserting one in each leg of the antenna, thus preventing serious mismatch to the transmission line. Insertion of these inductances in the antenna causes voltage and current displacements, which, unless, properly counterbalanced by having equal amounts of lumped inductance in each leg of the antenna, would cause enough shift of the voltage nodes and peaks to seriously impair the impedance match to the transmission line.

Once the inductance of the antenna has been ascertained by this measurement, it is a simple matter to compute the capacitance. The value of inductance found from equation (21) is substituted in equation (10). In this case, the wavelength used should be the wavelength of the antenna system without any added inductance at all. In other words, the wavelength of the antenna system as it is normally used, should be the value substituted in equation (10). Equation (10) is rearranged as follows:

$$C = \frac{\lambda^2}{(1.884)^2 L} \quad (22)$$

Where:
 C = antenna capacity in micro-microfarads, and
 L = antenna inductance in microhenries.

"Cheap at Half the Price!"
 (Continued from page 26)

- One piece bamboo, straight and sturdy, 16'x 3/4".
- One piece 2x2 by 5', fir, knot-free.
- One piece iron pipe, 1'x 1 1/2" i.d.
- One piece iron pipe, 1'x 1 1/4" i.d.
- One pipe reduction joint, 1 1/4" to 1 1/2".
- Three 3" galvanized turnbuckles.
- Six Simpson solderless connectors, U-shaped (Cable clamps).



**DEALERS
SERVICEMEN
SOUND MEN
RADIO BUILDERS
AMATEURS**

Get this book of
RADIO VALUES
Now!
SAVE ON EVERYTHING IN RADIO
FREE



60 NEW SETS
 1940 RADIO HITS! New "Camera" and standard Portables—new European reception models—new "Com-pacts"—all types, all sizes, for every purpose. New plastic phono-radios, new Recorder-Radios, new auto radios—all at the very lowest prices—in this new FREE Catalog.



NEW SOUND SYSTEMS
 18 new Public Address Systems—7 to 75 watts—for Electricians, Orchestras, Churches, Schools, Rentals, etc. America's finest P. A. at startling low prices. Easy Time Payment Plan. Complete accessory listing, new recording equipment, etc.—all in this new value-packed book.



15,000 RADIO PARTS
 You'll find everything in Radio in this new Catalog. Servicemen—see the new Test Equipment and full replacement parts listings. Amateurs—get a big surprise and the "low-down" on the new "Ham" receivers. And don't miss the special Bargain section—there's nothing like it!



Dozens of brand-new exciting kits — new diagrams. Depend on ALLIED for information and advice. Send for Free Parts Lists.

See the splendid new Howard Amateur Communications Receivers (Model "435" illustrated). Get the exciting story of the new "Progressive Series"—a brand-new Amateur Receiver idea — there's never been anything like it before.

ALLIED RADIO

833 W. Jackson Blvd., Chicago, Illinois Dept. 1-F-0

Send me your FREE New 172 page Spring Catalog covering Everything in Radio!

Name

Address

City State

SEND COUPON NOW!

It's RCA All the Way in Profitable Service by Signal Tracing

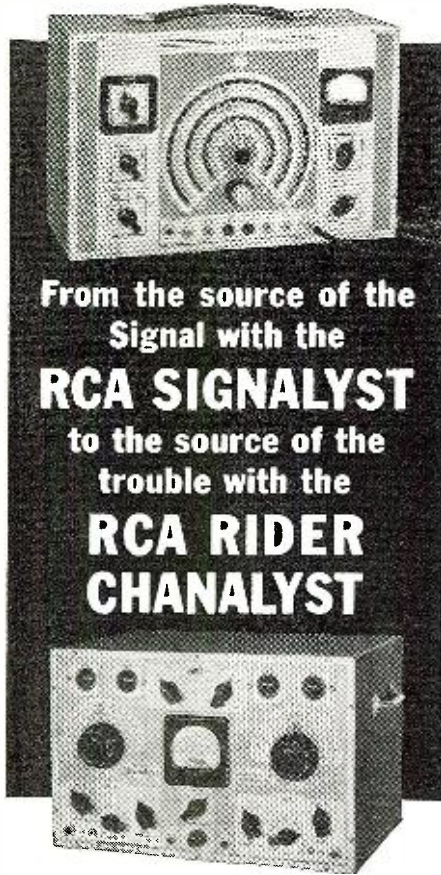

From the source of the
Signal with the
RCA SIGNALYST
to the source of the
trouble with the
**RCA RIDER
CHANALYST**

*Your work is quickly done without
disturbing any circuit constants!*

THE revolutionary time-saving, money-making signal tracing method of servicing radios begins with the source of the signal. Here RCA gives you tomorrow's signal generator today...the RCA Signalyst. Universal in application—all frequencies in fundamentals—the RCA Signalyst sets a new high in dollar value for a signal generator. Its range is greater than any test oscillator...its accuracy and stability are tops.

With the RCA Signalyst providing a metered signal of known value...you can then follow that signal through the radio you are testing with the RCA Rider Chanalyst without disturbing any circuit constants. And in short order, you'll find the source of the trouble. Dollar for dollar, the RCA Rider Chanalyst offers you more utility, greater flexibility and stability, and greater freedom from complicated circuits.

RCA Rider Chanalyst

\$10750 Net
F. O. B.

Camden, New Jersey



RCA Signalyst

\$10750 Net
F. O. B.

Camden, New Jersey

Test Equipment
RCA Manufacturing Company, Inc., Camden, N. J.
A Service of the Radio Corporation of America

Marine Receiver

(Continued from page 7)

Receiver unit layout is quite the expectable thing. The r.f. coil assembly is below chassis, the gang tuning condenser above-chassis and positioned for short stator and rotor leads to the switch mounted coils. The r.f. 6S7G is forward toward the panel, the 6J8G between it and the i.f. input transformer. Positioned between the two i.f. transformers is the second 6S7G, and at the rear of the chassis (top-side) are the 6V6G and the optional speaker matching component. The 6T7G second detector is below chassis. No attempt will be made to point out the positioning of the various smaller components; suffice to say that these are located at or near the tube sockets with which they are associated in circuit position.

Construction

1. It is first and last necessary for the builder to construct, or have constructed for him by some metal parts manufacturer, two special items: the cabinet, which should be approximately 9" wide, 10" high, and 13" deep, with removable front panel; and a chassis to fit the 9x13" dimension and high enough (about 5") to accommodate the specified all-wave coil assembly. It is particularly important that the cabinet be of heavy stock, and it is suggested that it feature no lift cover.

2. The interior of the cabinet might well be coated with marine lacquer (if unpainted) to prevent rust. A ripple finish for the exterior will of course provide additional protection and at the same time give the box professional appearance—slate grey or aluminum grey being the recommended color.

3. The shield box for power supply components may be anything suitable. Like the receiver cabinet it should provide ample protection for all parts, be of rigid construction, and be of reasonably compact dimensions. A box about 5"x9"x6" of the general utility type (such as the Par-Metal UC-596) would be quite suitable and would provide ample room for the *Vibrapack*, relay, fuse, and filter items.

4. Drill and stamp the receiver chassis for installation of the major components—r.f. coil assembly, i.f. transformers, gang condenser, sockets, and output transformer. Drill individual holes for lead wires to *each* condenser stator and rotor lower lug from the coil assembly. (The leads will pass through chassis and the holes for them should be about $\frac{3}{8}$ " in diameter and grommeted.) Make sure, by the way, that with the condenser in position, its shaft will extend forward just enough to provide a proper fit to the dial hub—remembering that the latter will be mounted directly on the front panel, scale face fitting into the panel cutout for it, and that the panel will support the chassis by means of the securing nuts for volume and gain controls, binding post assemblies, cable

receptacle, and selector switch.

5. Mount the coil assembly in position temporarily. Install, on the front chassis drop, the bushing and nut for the extended volume control shaft, then the receptacle and various controls and binding posts. Place the gang condenser in proper place, then mark the front panel for a proper line-up for all shafts and for the dial. In doing this, allow for clearance so that panel and chassis, when secured together, will slide into the cabinet evenly and permit the panel to make a proper cabinet fit. Using a circle-cutter, drill out a hole for the dial. Make holes for the various shafts, remembering that they must be large enough so that the threaded extensions of the receptacle, switch, controls, etc., will protrude. With this job done, assemble together panel and chassis, checking for dial-hub to condenser shaft alignment and making sure that all threads come through.

6. Disassemble panel and chassis, then remove the r.f. coil assembly and gang condenser. Install the sockets, i.f. transformers, and (if one is not built onto the speaker frame) output transformer. Secure the front drop items temporarily in place.

If you use the separate output or speaker transformer (which may be anything matching 7,000 ohms to voice coil but which under any and every circumstance should be well impregnated and, in addition, shielded), the 6T7G socket must go below chassis, preferably placed in such position that the tube will extend along the 9" chassis dimension, grid cap toward the i.f. transformer side. Any method of rigid mounting will be satisfactory. (Shielded tube and socket assembled together, for instance, might be mounted by means of an *Amphenol* magic eye holder somewhat as we have done the job).

If you don't use a separate output component—and there certainly isn't any reason whatsoever for using one where the speaker comes equipped with the transformer and that transformer is especially impregnated for marine service—the 6V6G socket may be placed conveniently in the spot occupied in our own layout by the transformer and the 6T7G socket may logically be moved upstairs. This would simplify the business of both construction and wiring.

7. On the rear chassis wall, positioned so that the volume control (with on-off switch) shaft will line up accurately (when extended), with the bushing at chassis-front, mount the Yaxley RB-249 bracket, 500,000 ohm audio potentiometer, and switch assembly—extending the bracket away from the wall sufficiently far by means of metal washers to provide ample switch clearance. This locates the volume control in the logical place for it and makes unnecessary any long a.f. leads—providing, of course, that the 6T7 assembly's socket has been itself positioned as indicated in the under-chassis photo. (Continued on page 51)

8. Before again installing the r.f. coil assembly and gang condenser, complete as much of the receiver wiring as you possibly can. Mount small parts close to associated sockets, make leads short and direct, bring B minus and A minus leads from the 5-prong receptacle down the depth of the chassis to a common ground point at chassis-rear, and *shield* the other leads from this receptacle—i.e. the B plus, A hot, and relay circuit line. The circuit is quite straightforward and will be familiar to even the less experienced builder. We need not go into details regarding the rest of the wiring; and shall conclude construction data on the receiver with simply a few remarks regarding the r.f. coil assembly and the gang condenser. But as the layout is so unusually compact, it might well be pointed out that unusual care must be exercised toward the end that all connections be proper in the very first place (check them carefully against the circuit diagram as you go along), that these connections be securely soldered, and that the various components be positioned securely. It will not be the easiest business in the world to correct errors in the wiring once it has been completed.

9. Install the gang condenser, using rather long mounting screws and leave this quite loose at first so that leads from the r.f. coils may be brought up short to the lower lugs (both stator and rotor) and soldered. Get the coil leads for stators and rotors, by the way (these leads are of braided copper, uninsulated, and are related to each r.f. assembly stage section) up through the grommets in the chassis before securing the coil layout in position. Otherwise it will be difficult to get these leads through for condenser connection, due to the very little working space.

Now get the coil assembly in place, make the condenser connections for each section, tighten up the condenser (checking for precise dial alignment between shaft and hub), and complete the r.f. wiring. With the securing nuts for the various controls removed, the frame extension of the dial cut away to permit this unit to clear the chassis, and with the dial mounted on the front panel, we can now complete the assembly.

It is only necessary to secure panel and chassis together, by means of the cable receptacle, the binding post units, and the securing nuts for band-switch, potentiometer, volume control bushing, and balancer condenser, to connect antenna and ground leads from the coil assembly to one binding post unit, and to connect shielded output leads from the speaker transformer (or 6V6G plate circuit) to the speaker binding post unit.

10. Alignment might well be effected with the receiver powered by any available a.c. pack supplying 250 and 6.3 volts. The pack, of course, should have at least an 80 ma. high voltage capacity and the center-tap connection to chassis-ground for the power trans-

former 6 volt secondary should be opened (one side of the filament line being grounded at the receiver). The i.f. is aligned at 456 kc., exactly. The coil assembly is aligned only if and when such alignment seems absolutely imperative; proper adjustments have been made at the factory, and in any case don't attempt trimmer re-settings unless a good service oscillator is available.

11. If all's well with the receiver, the next step is to build the power supply and interconnecting cable system. No particular layout for the power components is imperative—though input and output leads should be reasonably well separated and the various parts mounted for fairly short point-to-point connections. Use two receptacles at the power supply can—one for battery input and one for B minus, B plus, and relay circuit connections between power and receiver assemblies. As for the cabling itself, bear in mind these suggestions:

A. Use individual leads. Don't depend upon shield braiding for B minus and A ground, particularly for A ground. Consider each return a part of a separate circuit, calling for a separate wire. The one exception may be the return for the relay circuit.

B. The A HOT leads from power supply to battery and battery to receiver should run *separately* from the A HOT terminal, should be of heavy duty wire (No. 12 or better), and should be as short as convenient cabling will permit. It is advisable to keep both A HOT and A GROUND leads from battery to power supply abbreviated in length, as voltage drop in these leads may affect *Vibrapack* output adversely. It is advisable, though not particularly imperative, that these leads be shielded: A HOT from battery to power unit; A HOT from battery to receiver; B PLUS from power unit to receiver; A HOT relay line from receiver to power unit.

Installation

In marine application, the receiver may be installed in any convenient spot aboard ship but should be used with as long and as high an antenna as may be erected. Where space is limited, the vertical aerial is generally the best bet. The writer has found that, for the average private boat, nothing could be more practical than simply a standard Premax or similar transmitting beam element, pulled out to its maximum length of about 17', self-supported by some sort of suitable deck insulator, and carefully coated with weather-resistant paint. A single beam element isn't very expensive, is rigid enough when extended to full length (requiring very little or no guying), may be dropped down to six foot length when that's necessary, and, last but not least, will be right there ready for use as a radiator when you decide one of these days to install that radio telephone.

In ordinary mobile application, the receiver may be installed under the dash, firmly supported at the firewall.

THERE IS NO PREMIUM FOR

JENSEN

QUALITY

There is no speaker of a higher quality than JENSEN—yet there is no price premium to pay for that quality!

A JENSEN speaker is available for as little as \$2.30 less the usual trade discount.

The use of bucking coils to reduce hum . . . larger wire to give more sensitivity . . . dustproofing to insure trouble-free operation . . . are JENSEN'S contribution to your reputation as a technician.

And then there is a dominant quality, typical of every JENSEN product, inherent by habit and instinct of those who have been designing and building JENSEN products for ten years or more.

JENSEN speakers cost more to make—but they cost you no more because they give satisfaction!

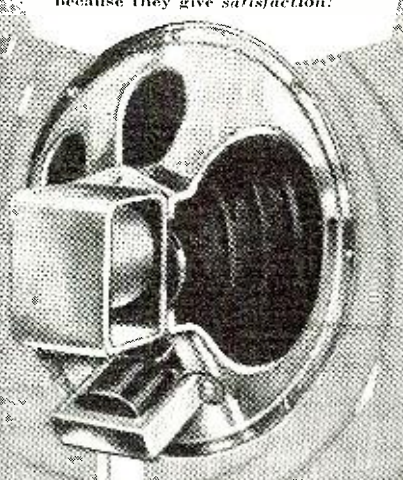

Jensen
Replacement
Speakers

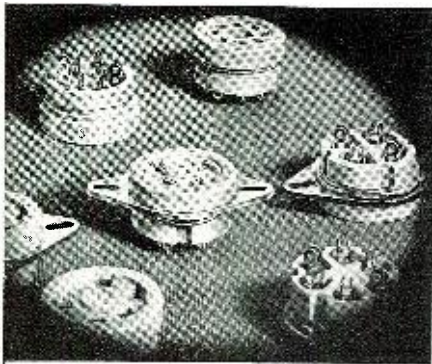

DESIGNED for APPLICATION

MODERN SOCKETS for MODERN TUBES! Long flashover path to chassis permits use with transmitting tubes, 866 rectifiers, etc. Ideal for mounting on rugged thick cast aluminum chassis now being used on much of the better commercial equipment. Long leakage path between contacts. Contacts are type proven by hundreds of millions already in government, commercial and broadcast service, to be extremely dependable. Sockets may be mounted either with or without metal flange. Mount in standard size chassis hole. All types have barrier between contacts and chassis. All but octal also have barriers between individual contacts in addition.

Catalogue Upon Request

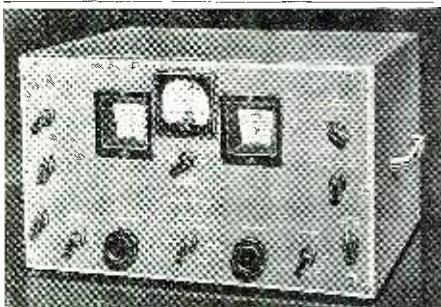

For HIGH Stability!
USE "HQ-120-X"

AUTOMATIC voltage regulation maintains constant oscillator plate voltage despite wide changes in line voltages and a special compensating device automatically corrects frequency drift during temperature changes. These two outstanding features make the "HQ-120-X" exceptionally stable in operation and results in unusual tuning accuracy. And, these are not the only reasons for its top-notch performance. . . . Ask your jobber or write for details.

WRITE FOR "HQ" BOOKLET!

HAMMARLUND MFG. CO., Inc. RN-6
424 W. 33 St., N. Y. City

Please send 16-page "HQ" booklet

Name

Address

City..... State.....



Canadian Office: 41 West Av. No., Hamilton, Ont.
Export Dept.: 100 Varick St., N. Y. City

Set layout and size have been deliberately worked out to facilitate positioning in this manner in the car—the proportions (long depth and relatively short width) being such as to take up as little under-dash space as possible (laterally) and, at the same time, to bring dial and controls well forward for convenient handling.

(It's advisable to remember, incidentally, that your city or state may have some very definite ordinance or law limiting auto-radio frequency coverage. If you contemplate installing the set in your car, whether temporarily or permanently, look into the matter carefully by consulting your local police dept.

Proper *Vibrapack* output is obtained through adjustment of the switch at the side of the pack. (Adjustments should be made with the power turned off and the setting should be such that the measured B plus at the 6V6 screen is approximately 250 volts.) As for hash interference, should it appear in spite of the fact that power supply and receiver are physically separate units, this may usually be eliminated through trial and error by-passing of A HOT and B PLUS leads. Sometimes mica condensers from these leads to ground at the points of entrance to the receiver will eliminate hash where paper types (C17-C18) do no good. Remember, by the way, that hash noise is an r.f. effect set up by the *Vibrapack*—noise which no amount of *a.f.* filtering beyond that necessary to the *smoothing out* of *Vibrapack* high voltage output will attenuate.

Incidentally, some cases will be found where no hash noise at all is evidenced with antenna and lead-in disconnected, such noise immediately appears on one, some, or all bands as the case may be with the aerial tied in. The no-noise condition with no antenna indicates that power leads into the receiver are adequately shielded and by-passed. Appearance of the noise with antenna connected, on the other hand, indicates that the noise is picked up *by* the antenna or its lead-in or *both*. Remedies are to shield the lead-in thoroughly, remove the antenna as far as possible from the power pack, check the power supply for its overall self-shielding, and, if the installation has been made in a car, bond all shields to car-ground carefully and effect a good short connection between the power supply can and ground.

The power supply unit should in any and every installation be located close to the 6 volt storage battery to eliminate long leads. Just as leads of insufficient cross sectional area will effect voltage drop and prevent the realization of full *Vibrapacks* output, so will *long* leads bring about this undesirable condition.

One last word—which we perhaps should have brought into this writing while discussing matters of construction. If you can afford it—use paper

type filter capacitors in the C19 and C20 power supply positions. This move is particularly advisable where extended service at sea is expected of the receiver. Electrolytics are perfectly all right for general application—marine or otherwise—but the paper types will as a rule stand up much longer in humid, salt atmospheres.

-30-

Manufacturers' Literature
(Continued from page 42)

ing much interest. Completeness is combined with many new features. Each radio field is arranged in individual sections for speedy reference. All sections and all items are clearly defined and carefully indexed. The 32-page Radio Set Section introduces sixty new *Knight* models, including a wide choice of portables, farm radios, consoles, table models, phono radios, automatic record changers, "Camera" type portables, with new miniature tubes, Recorder-Radio combinations, and a large selection of phono and recording accessories. The 36-page Public Address section includes 18 new complete systems, ranging from 7 to 75 watts, for Electioneering, Orchestras, Churches, Schools, Rentals, etc. Presented are many new units such as: "The Speechmaster," a one-unit system ideal for speakers; Rental-Type P. A. Systems for Servicemen; low-cost systems for orchestras and musicians; Chime Systems for Churches; and a complete line of P. A. accessories. For builders and experimenters there is an unusually complete section featuring the latest kits, accessories, projects, diagrams, and *Allied's* new Radio Builder's Handbook. The Amateur Section features the latest receivers of the country's leading manufacturers and the complete story of *Allied's* new separate Exclusively Amateur Catalog. Of special interest to the serviceman is the big general section covering 15,000 parts for every radio need. There are sections devoted to photocell equipment; to bargains in brand new merchandise; and to the latest books, manuals and literature covering every radio field. A copy of this 172-page Spring Catalog is available by writing to *Allied Radio Corporation*, 833 West Jackson Blvd., Chicago, Illinois. Free. (RADIO NEWS No. 6-106.) USE COUPON BELOW.

RADIO NEWS, Catalog Dept.
608 S. Dearborn Street, Chicago, Ill.

Please send me the literature I have checked below. If there is any charge I have enclosed the money.

... 6-100 ... 6-103 ... 6-104 ... 6-106
... 6-101 ... 6-103 ... 6-105 ... 6-107

I am the following: (please check)

S'v'cem'n..... Ham..... Exp'm'nt'r.....

Name

P. O. Address.....

City..... State.....

This offer expires July 1, 1940.

Music While You Cycle
(Continued from page 29)

tuning condenser is mounted on a bracket at the right front of the chassis. The regeneration control is mounted directly beneath the condenser, but below the chassis. The five inch magnetic speaker fits into a recess at the front of the chassis and is fastened to the front chassis wall. The coil socket and the two tube sockets are mounted on the rear (lower) step, with the coil socket directly behind the variable tuning condenser and the power output tube at the extreme left.

After the chassis is assembled, the wiring is performed according to the diagram. It is desirable to wire in the filament circuit first. Next wire the grid circuits, then the plates, etc. For best results and most rapid work, the use of solid push-back wire is recommended. All joints should be carefully soldered with rosin core solder.

The completed set should be tested before installing it in the carrying case. It should then be secured permanently within the case, at which time connections to the earphone jacks should be made. The case may then be mounted to the handle bars of the bicycle by means of a leather or metal strap. The batteries, spare coils and earphones are contained in a separate case 11" long by 5½" wide, by 2¾" high. This is fastened to the frame of the bicycle and connected to the receiver by means of a 6 wire cable. Of course, the battery box dimensions may be varied to suit the type and number of batteries employed.

The "Ranger" requires two 1½ volt "A" batteries, two 45-volt "B" batteries and a tapped 22½ volt "C" battery. All of these batteries are available in very compact models, designed especially for portable work. Increased volume can be obtained by using three 45 volt "B" batteries instead of two. In this case, the "C" bias of the 33 tube must be increased to minus 13½ volts.

A few hints on testing the "Ranger" may be useful and may serve to prevent the burning out of the tubes in making the initial battery connections. If flashlight cells are used for the "A" supply, solder small clips to the positive terminals at the centers and to the negative metal casings. The clips provide an easy means for connecting one battery to the other and also for connecting the "A" minus and "A" plus leads. Having connected the "A" batteries, put the tubes in the proper sockets and note whether they light up. Now recheck all the wiring and make sure all connections are correct.

Take out the tubes and connect the "A" batteries. Proceeding with the test, connect all batteries, plug in a broadcast coil in the coil socket, connect antenna, the ground and a single or double earphone, or speaker. When testing, the earphones should be used rather than the speaker. Be abso-

lutely certain that the batteries are connected correctly before inserting tubes in sockets. Do not mishandle or drop the tubes. Remember that they are delicate and if the "B" battery is shorted to the filament circuit, even for a second, the tubes will be burned out and worthless.

The "Ranger" is tuned by means of the variable tuning condenser (station selector). It is adjusted by the regeneration control potentiometer and the antenna trimmer. The antenna trimmer is used to make the set more selective. This is accomplished by loosening the adjustable set screw provided. It is also used to help tune in weak and distant short wave stations. The regeneration control is operated as follows: place one of the short wave coils in the coil socket. Turn the station selector until a whistle is heard. Each whistle indicates a different station. It may be necessary to adjust the antenna trimmer to get the whistles. As the station whistle is tuned in, turn the regeneration control until the set "spills over," or a distinct hissing sound is heard. The station selector is then turned until a continual whistle is heard and should be left at the point where the squeal is loudest. The whistle can now be cleared and the station brought in by turning the regeneration control knob slowly back. A slight further adjustment of the station selector knob may be necessary.

A telescoping vertical antenna of the automobile "whip" type is recommended for an aerial. This may be attached quite readily to the handle bars of the bicycle. The "Ranger" is sensitive enough to bring in the local stations with the whip type antenna. Of course, even better results can be obtained when the bicycle is stopped, by connecting the ground terminal to a convenient wire fence, a pipe or similar grounded metal object.

It may be of interest to the builder of the "Ranger" Bicycle Receiver to know that it is possible to obtain a bicycle generator which develops 2½ volts and produces more than enough current to operate the lights of the bicycle, and also to energize the filaments of the tubes in the "Ranger" Receiver. The use of this generator thus permits elimination of the "A" batteries.

The "Ranger" will furnish its owner with pleasant diversion while on a trip and will be a constant source of pride to him. One point, which has not been sufficiently emphasized, is the fact that this set can be built for very little money, since it uses only a comparatively few tubes and other components.

After the "Ranger" has been completed and in operation for a while, the builder will be able to add various improvements. For example, it is possible to employ a remote control device which will permit the entire outfit to be fastened in back of the saddle and still be controlled and tuned from the handle bars.

SYLVANIA HELPS
To Help You Sell



Display This Electric Edgebrite Clock Sign. Made of sturdy, satin-finish metal, illuminated with two lamp bulbs. Separate switch controls lights so clock operates at all times. Movement is self-starting. Convenient size, 13½" high, 20" wide... complete with YOUR NAME on illuminated glass panel...\$6 Without name but with plain glass panel.....\$5



Put Up This Striking Flange Sign. Sign is weatherproof baked enamel on heavyweight sheet metal. Size, with detachable name plate, 16¼" x 16". Without name plate, 16¼" x 11¾". Flange Sign complete with YOUR NAME on name plate in baked enamel.....\$1.00 Sign, without name plate.....\$2.5c



New Electric Sign Can Increase Your Business. Strong metal frame electric sign trimmed in chrome plate with glass panel. Flat base for standing and adjustable chain for hanging. Size 22½" x 8¾" x 3¾". Complete with imprinted name plate.....\$2.25 Without name plate..... 1.25

USE THIS VALUABLE COUPON

Hygrade Sylvania Corporation
Emporium, Pa.

- Enclosed is..... Please ship the following:
- Electric Edgebrite Sign
- Metal flange sign, without nameplate
- Metal flange sign, with imprinted nameplate hanger
- Electric Sign
- Imprinted nameplate, separate—Can be used either with flange sign or new electric sign.

Name.....
Address.....
City..... State.....
Imprint.....
(Please print)

NEW!



**• MILLION •
NEW DF TUBE CHECKER**

TESTS THE NEW 7 PIN
MINIATURE BATTERY TUBES,
BALLAST TUBES AND OZ4
GAS RECTIFIERS.

New, with wider application range. Tests emission of all tubes. Twelve sockets cover all types from the new Raytheon "hearing aid" tubes and RCA 7-Pin battery types to new Loktals and S series. Filament switch covers 1.4 to 110 volts with spare positions for the future. Gives instant "good-bad" readings on oversize D'Arsonval meter. Makes neon short or leak test with tube hot. Tests by-pass condensers, etc. Literature on request.

MODERN
ACCURATE
DEPENDABLE
ECONOMICAL

\$16⁹⁵
NET

IF YOUR JOBBER CANNOT SUPPLY, WRITE US DIRECT—GIVING THE NAME OF YOUR JOBBER.

MILLION RADIO AND TELEVISION
577 No. Union St. Chicago, Ill.

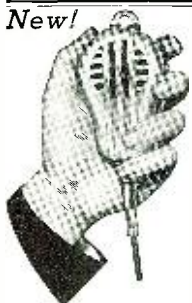

**TURNER
Han-D
MICROPHONE**

Crystal or
Dynamic

- Hold It!
- Hang It!
- Use it on desk or floor stand.

FILLS THE JOB OF SEVERAL MIKES

Whether you want it for voice, music-pick-up or auto use, the Turner Han-D will fill the bill. Positive contact slide switch on both crystals and dynamics permits off-on switch to be operated without thumb fatigue.

Voice reproduction is crisp and clear with out unnecessary sacrifice of bass response, yet feedback problems are held to a surprising minimum. Will not blast from close speaking. Allows one mike to do the work which required two or more before. Each unit individually tested for level and frequency in sound pressure room before shipping. With 8 ft. removable cable set and chamouis ette mike pouch.

9D hi-impedance Dynamic, \$25 List.
9X Crystal, \$22.50 List.

The TURNER CO.

908 17th St. N. E. Cedar Rapids, Iowa

Crystals licensed under patents of The Brush Development Co.

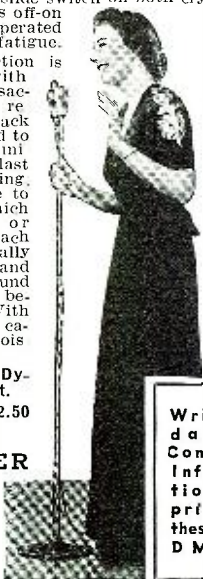

Rich brushed chrome finish matches modern desk and floor stands.

Write to-day for Complete Information and prices on these Han-D Models.

1-10 Meter Receiver

(Continued from page 25)

3x4x5 shield can, which is used for housing the r.f. stage. No panel is used as the dial and condenser assembly is mounted directly on the shield can. Tuning condenser assembly C₁, C₂ is ganged, as the selectivity of the r.f. stage does not warrant separate controls. Condenser C₁ is mounted directly on the shield can with the rotor shaft grounded, while C₂ is mounted on stand-off insulators, as the rotor must not be grounded.

While the r.f. stage provides a relatively large amount of gain, it is not difficult, nor tricky, to build. There is only one thing to make sure of, this being the complete shielding of the plate from the grid. The leads should be short, and the by-pass condensers connected close to the tube contacts. The gain control R₁ in the cathode circuit is useful on local stations. The r.f. and detector coils are both mounted on small banana plugs which plug into a pair of banana-plug jack type cone insulators. This provides a quick and simple means of changing from one band to another.

The detector consists of a grid blocking oscillator using an HY615, which works very efficiently. The r.f. stage is coupled to the detector through C₃, a 100 mmf. variable air trimmer condenser. The tuning assembly of the detector is similar to that of the r.f. stage except that L₂ must be a little larger than L₁, owing to the low interelectrode capacities of the HY615. The grid leak and condenser, R₂, C₆, are critical, and the given values were found to be the best. If a high pitched squeal is heard, the value of the grid leak or grid condenser should be lowered. About all else that may be said about the construction of the detector is that the HY615 has a base shield that must be grounded.

Although it was designed for ear-phone reception, the 6F6 audio stage will give enough volume to operate a magnetic speaker on most signals. Output coupler, L₃ and C₁₁, is necessary in order to get full value from the audio amplifier. In the screen grid circuit there is a filtering arrangement, which reduces a large amount of hum. This filter consists of a 10,000 ohm resistor, R₃, and a .5 mfd. paper condenser, C₁₀. The volume of the set is varied by audio gain control R₂. Potentiometer R₂ is to control the regeneration of the detector.

In wiring up the set there are a few things to remember. In the portions of the set carrying r.f., the condensers and the tube sockets, etc., should all be made of low loss insulation such as isolantite or victron; the fixed condensers should all be mica. It is important that all leads be as short and direct as possible, not straying around through the set. After the set is all hooked up there should be no trouble in getting it to work the first time it

is tried, provided the instructions have been followed and the set hooked up correctly. Being now hooked up the set is ready for alignment procedure and operation.

The first part of the set to get working is the detector and, of course, the audio. Operating the audio stage is common procedure, and so I will not give it here. The detector, however, may require some adjustment. The values given for the parts in the detector are empirical, but were designed for use with this detector. They should be changed only under extraordinary circumstances. In lining up the detector the antenna may be connected and signals received, although, of course, an oscillator is easier to use.

The regeneration control is set to a minimum hiss level and a signal is tuned in. If no signals are received, the receiver may not be hitting the band for which the coils was designed. In this case the inductance of the coil can be changed by changing the number of turns or the spacing. Different arrangements of parts often produce different stray capacities in the set, and these are important where the tube has a low capacity.

After the detector is operating, the antenna may be connected to the r.f. stage, and the r.f. stage to the detector. The gain on the r.f. is opened wide, and the regeneration control on the detector advanced to a fairly loud hiss level. Condenser C₃ is then coupled until the detector just goes into super regeneration. After the receiver is working on one frequency, there should be no trouble in getting it to operate on the other frequencies. Preferably, the receiver should be lined up first on 28 mc. and then on each higher frequency band in succession. Now, when the set is all lined up, there should be no trouble at all in getting it into regular operation. It will be found that it works excellently for this type of receiver.

Coil Data

All coils wound with No. 12 tinned wire, 3/8" inside diameter.

	R. F.	Detector
28mc.	14 turns	17 turns
56mc.	6 turns	9 turns
112mc.	3 turns	4 turns
224mc.	1 turn	2 turns

-30-

Increasing Loop Sensitivity

(Continued from page 37)

did not know its exact location. The radio loop gave a bearing of 10°. Referring to the graph we find that at 10° the correction average is plus 3°. Therefore the true bearing of that station is 13°. Another: The radio loop gave a reading of 100°. Checking we see that 100° the radio loop was in error minus 3°. The correct bearing of this station is 97°.

We may now take bearings on ships at sea or other radio stations and even locate interference accurately. It may also be used as we do here, for the tuning out of interfering stations on the same frequency.

-30-



Within Earshot
(Continued from page 4)

they report that it far surpasses anything that AM can give. Ho, hum . . . gotta think up something new again to scoop the dailies!

* * *

AS a rule we take very little if any exception to what the radio columnists write for the newspapers. We feel that they, too, serve a public, and that that public has its right to demand and know what is going on in the broadcasting field. But once in a great while these same gentlemen of the press stick their necks way out to here, on a subject of which they know very little and generally nothing. Then we ought to, and do lop those collective necks off as short as we can.

A few weeks ago in a big Chicago daily the radio broadcast columnist advised his readers that the hams were an anathema to the industry, and advised all broadcasters who were discommoded by these same hams to report the matter to the FCC. Hams, in his opinion, were of low degree, and not worth the powder to blow them to bits. You are very, very wrong, Mr. Columnist. You would not now be able to write your column without the same hams of whom you write so disparagingly. It was they who developed and pioneered your field of endeavor, and it was they who are mostly responsible for those "scoops," concerning which you write so glibly, which you receive on that Scott Short wave receiver you own. The hams, my friend, are the same persons who furnished your paper with reams and reams of copy during the Ohio Flood; and who are even now furnishing your paper with most of the news of the Byrd Antarctic Expedition; who built up most of NBC, CBS and MBS. You, of all people, should be grateful to the hams. You should bring about a better understanding between the hams and their neighbors, the broadcast listeners. You should realize that hams were using Frequency Modulation way back in 1925, and that their mobile rigs, the forerunners of the Police Radios of today, were operating in 1923. So my fair, fancy friend, consider yourself verbally spanked. Go and be a good boy; before sometime you may find that the hams will no longer be your friends, and you will lack for material for that precious column of yours.

* * *

AROUND a table in a dim serviceman's back shop sat a bunch of the boys. The discussion veered around to what would happen to the business should war finally come to these United States. While it would be futile to record all the opinions which had their airing that evening, the consensus was that the war might come, and men might go to it, but the serviceman would continue to do business anyway.

It was pointed out that air raid precautions, envisioning the necessity for thousands and thousands of loud speaker systems and their associated ills would need the serviceman to install and maintain them.

Not everyone goes to war, and therefore there would be just as many, if not more sales in broadcast and short wave receivers. The interest in radio would increase, and with it an increase of business.

The "farming out" of government schools, already put in effect by the Civil Aeronautics Authority in the matter of training pilots, would probably be followed. Thousands of competent servicemen would

find themselves teaching radio to the men in the Government armed forces.

Since communications have risen to a position of major national prominence, the field of maintenance of the radio end of the tremendous communications network would fall upon the able shoulders of the serviceman.

Research, always given additional impetus by a war, will be conducted to a limited degree by servicemen under the guidance of Army engineers.

Not alone in the radio field will the servicemen find business, but in all the electrical fields as well. He will branch out as electrician, motorman, lineman, repairman, and manufacturer.

No, servicemen, you will need have no qualms about what will happen to you in a war. Of all trades, yours will be one which will boom.—KAK.

-30-

1-Tube Signal Tracer

(Continued from page 9)

The leads to the primary will have to be reversed if the polarity is not correct, for then the tube will not oscillate. Satisfactory evidence of oscillation will be had by removing the grid cap from the 6A7 and, with the dial of the test set turned to about 60 and the volume control turned down low, slowly turning the tuning condenser on the converter. At about the same setting of the converter dial a loud hum should be heard when the finger tip is touched to the control grid of the 6A7. If no such hum is heard and the connections are all right

otherwise, reverse the primary leads.

The method of using the instrument is quite simple. When listening in on the r.f. stages the switch on the tuning condenser is closed, rendering the oscillator inoperative. The set under observation is tuned to the strongest local available and the test set tuned to the same station. Either one wire to the voice coil of the set under observation should be unsoldered or a jumper should be put across the voice coil. Then with the r.f.-i.f. test prod the quality of the signal can be ascertained throughout the r.f. stages. If nothing suspicious is disclosed there, the test set should be tuned to some place on the low-frequency end of the dial where no station whatever can be heard normally, the oscillator switch should be opened, and the oscillator dial set higher than the dial of the test set by an amount equal to the i.f. of the set in question. The test set will then receive the i.f. of this set and, still using the r.f.-i.f. probe, the quality of the signal can be judged up to the grid of the second detector.

Passing to the audio frequency part of the receiver, the audio probe is used and the oscillator dial is set to the same reading as the dial of the test set and the volume of the latter turned down pretty low. The audio frequencies will then modulate the oscillator carrier wave and can be heard through the test set just as if they were being transmitted to it.

-30-

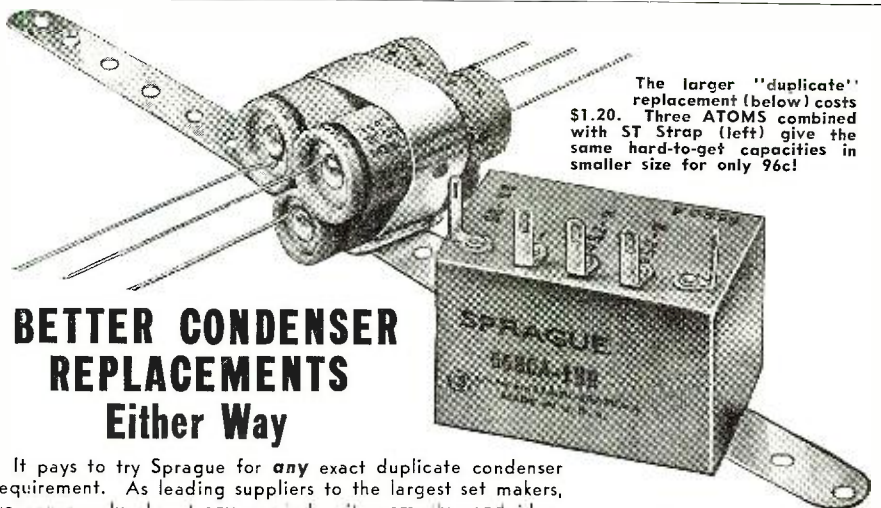

The larger "duplicate" replacement (below) costs \$1.20. Three ATOMS combined with ST Strap (left) give the same hard-to-get capacities in smaller size for only 96c!

BETTER CONDENSER REPLACEMENTS
Either Way

It pays to try Sprague for any exact duplicate condenser requirement. As leading suppliers to the largest set makers, we can supply almost any needed unit promptly—and identical to the original specifications.

But don't forget, you can save on most hard-to-get replacements, simply by combining several Sprague Atom midget dries. Just strap 'em together (see picture) with Sprague ST Mounting Straps—supplied free—and you have a smaller, better unit and actually at less cost than an exact duplicate! Using ST Straps, you can make up almost any combination of capacities and voltages using standard Sprague Atoms stocked by every Sprague jobber. Big catalog of Sprague Condensers and Koolohm Resistors FREE.

New Manual on Radio Interference

Just the book you've been looking for. Complete—fully illustrated—tells what to do, how to do it to eliminate all types of man-made radio noise. 25c net.



SPRAGUE CONDENSERS
KOOLOHM RESISTORS
TEST EQUIPMENT
SPRAGUE PRODUCTS CO. NORTH ADAMS, MASS.



YEARS AHEAD
TRIPL
 1941 Model 1696-A
MODULATION MONITOR

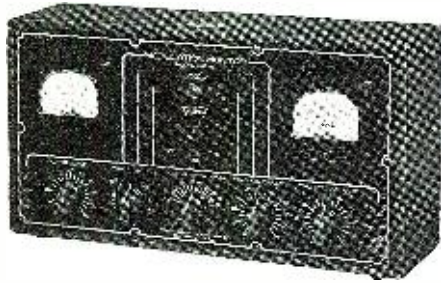

You've solved your problem of getting maximum efficiency from your transmitter when you invest in a Model 1696-A Modulation Monitor. Plug it into your AC line—make simple coupling to the transmitter output and the monitor shows:

- Carrier Reference Level
 - Percent of Modulation
 - Instantaneous Neon Flasher (no inertia) indicates when per cent of modulation has exceeded your predetermined setting. Setting can be from 40 to 120 per cent.
 - Helps comply with FCC regulations. Has two RED•DOT Lifetime Guaranteed Triplett instruments. Modernistic metal case. Model 1696-A—Amateur Net Price.....\$34.84
- Also available as a rack panel mounting unit.

For More Information—Write Section 156, Harmon Drive

TRIPL ELECTRICAL INSTRUMENT CO.
 Bluffton, Ohio

ADJUSTABLE LINK
50 WATT OSC. COILS



for
ACCURATE
COUPLING
ADJUSTMENT
ON EACH
BAND

Excitation or output on each band can be easily and accurately controlled by moving the link in or out of the coil to achieve the desired degree of coupling.

Cat. No.	Capacity	Amateur Net
OLS- 10	21 mmfd.	\$.90
OLS- 20	33 mmfd.	.90
OLS- 40	50 mmfd.	.90
OLS- 80	75 mmfd.	.90
OLS-160	95 mmfd.	.90

Ask for your copy of the latest BUD Catalog at your jobber's.



BUD RADIO, INC.
 CLEVELAND, OHIO

112 MC Transceiver

(Continued from page 15)

The tuning condenser which has isolantite insulation is mounted on a piece of high frequency type insulation and is held off the chassis by two bakelite rods. The condenser is removed from the front of the panel to allow tuning by an insulated shaft to eliminate undesirable body capacity effects.

The coil consists of 4 turns of number 14 enameled wire, 1/2" in diameter and spaced approximately 1/4" between turns. The coil is mounted directly on the condenser. Since your layout will probably be slightly different, it may be necessary to prune the coil to hit the band.

The grid condenser, which is of the small mica type, is connected from the grid prong on the socket to the rotor of the variable condenser.

The r.f. chokes should preferably be of the u.h.f. type but if care is taken to keep leads short and too much capacity is not induced in the circuit from metal chassis, etc., the regular chokes will work fairly well.

One side of the filament and the cathode of the detector should be grounded directly to one of the screws that goes through the angle bracket which holds the tube socket off the chassis.

A plug is provided at the rear of the cabinet for making connection to the power supply, either a.c. or motor-generator. The plug is so wired that the switch on the volume control turns on whatever supply you may be using.

The power supply should deliver about 250 volts under load. It can be an old B eliminator and a 6-volt transformer or a small supply may be built for the transceiver and placed inside the metal cabinet.

When installing the unit in the car, be sure to use at least number 12 wire for the "hot" A lead to the vibrator supply or motor-generator or you will be disappointed at the performance of the rig, both on transmit and receive. With too small an A lead the output from the power source drops quite a bit and as a result the output from the oscillator does the same.

The antenna used in the tests was a 4-foot aluminum rod mounted directly on the standoff insulator on the front panel. It is coupled to the oscillator tank through a two turn coil coupled to the 4 turn coil. To adjust the coupling, turn the send-receive switch to receive position and couple the antenna coil to the tank until the receiver is blocked, or the hiss disappears. Then pull the coil out slightly until the hiss is again heard. It will be found that this is the point of greatest sensitivity. For fixed station use, a half wave doublet placed as high as possible is recommended. It should be fed with an open wire feedline. The feedline is made of number 16 wire, spaced 2" insulated.

The transceiver can be checked on "transmit" by means of a small neon bulb held near or on the coil, or by the use of a flashlight bulb (6.3) connected to a two turn coil. The bulb will increase in brilliancy with modulation.

If the reader wishes he may install a regeneration control to reduce the plate voltage to the detector when used on receive. This will reduce the hiss, increase the sensitivity, and cut down the radiation. It can be connected as shown in Fig. 3.

For Immediate Release

(Continued from page 13)

a "sponsor" who paid for "time on the air." We thought that such operation was in violation of the FCC Rules & Regulations which do not permit unlicensed stations (and WHD is admittedly unlicensed) to operate and specially to have paying "sponsors." The answer of the Commission is repeated below. Whether or not it is the answer to our inquiry, we leave to the reader's interpretation.

Gentlemen:

This is with reference to your letter of March 4, 1940, concerning an article in Time magazine referring to a low power radio frequency device used for broadcasting programs throughout the Russell Sage Dormitory at Dartmouth.

The Commission has established regulations concerning the operation of low power radio frequency devices which rely largely on the induction field for the operation of remote control radio receivers, to eliminate wire connections between record players and receivers for wired radio communication systems and for other similar purposes. A copy of the regulations is enclosed herewith.

The regulations permit operation without a license so long as the field of the device does not exceed 15 microvolts per meter at a predetermined distance fixed by the operating frequency, and no interference is caused to the reception of signals of radio stations.

Very truly yours,
 (Sgd.) T. J. Slowie,
 Secretary.

A MULTI-CHANNEL radio telephone for aircraft, which provides for dial-switch selection of any one of ten pre-tuned frequencies, has been announced by the *Western Electric Company*. The new apparatus was designed primarily for use by airlines and private planes. To meet the need arising out of the long-range operation of modern airliners, the new transmitter develops more than twice the power of conventional equipment.

The equipment is extremely simple to operate. Both the transmitter and receiver are simultaneously controlled from a small switching panel located on the plane's instrument panel. The control is accomplished electrically requiring no mechanical cable or rotating shafts. One dial on this unit gives the pilot a choice of any one of ten pre-tuned frequencies. A second dial converts the equipment for telephone, telegraph, modulated telegraph, or facsimile operation. An "on" "off" switch, and a toggle switch for "send" "receive" when employing telegraph, complete the controls. Although the transmitter and receiver are designed to be used as a two-way system, either may be employed alone. When so used, a separate electrically-operated remote control panel may be supplied for each unit or local control can be employed.

Other features of the transmitter include provision of special condenser combinations to match practically any type of antenna or transmission line; forced draft pressure type ventilation through a spun glass filter; and self-contained MCW oscillator.



Bench Notes

(Continued from page 19)

There was a moment of strained silence. Then Cliff stepped out of character and laughed.

"Ya got me, pal!" he admitted. "The felon is frustrated!"

What did Pete do to prevent the robbery?

Preview

Judging from the answers arriving in response to Repairman's Riddle No. 5, many servicemen forgot their practical experience as soon as they picked up their slide rules. The "Test-it" problem was presented in narrative form, and laid in a radio store—as were previous ones—to bring out the practical considerations repairmen must face under actual conditions.

To have made the problem one for the simple use of the slide rule, or the formula book, would have failed to bring out the practical experience that makes the successful serviceman. There was, therefore, included a small—but nevertheless significant—catch. It was a fair "catch" since your work in the serviceman or radio field would have easily supplied the answer. The condensers could not be electrolytics; only paper or mica.

Electrolytics would have passed current on the five "open" d.c. checks, and would have made the a.c. readings

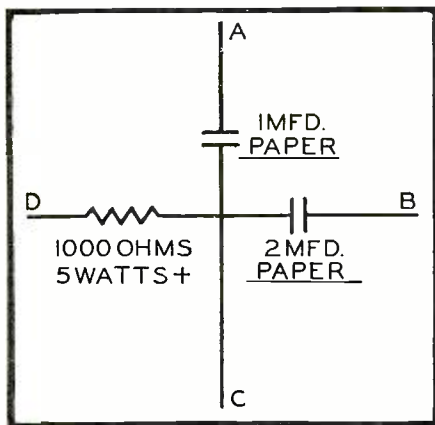

impossible. This distinction is an important one to a serviceman; not many of us would try to connect a dry electrolytic, for instance, across the primary of a power transformer, and we would know instinctively they should not be sealed in pitch.

The resistor in leg D passed 60 mils a.c. during the given test between D and C. In handling 3.6 watts, a one- or two-watt resistor would have been too low; 5 watts is the next higher common size, so it was of that rating, or higher. (Remember that Cliff "wired a heavy 1,000 ohm resistor" into the a.c. test leads?)

Winners will be announced in the next issue. How'd you make out?

YOU are busy in your store on a rainy afternoon, and a neighboring housewife drops in for the first time. She wants

to know the meaning of frequency modulation.

Would you:

(1) Tell her it was too technical for explanation, and describe it by waving your hands?

(2) Explain it was an unusual form of the art which would be adopted when/if it was proved its advantages outweighed its cost?

(3) Tell her not to worry until it became much commoner than it now is?

(4) Drive her home in your car so you could see the set and give an estimate for rewiring it? Or would you

(5) Lend her a text-book and an umbrella?

First, decide what you would do; then turn to page 60 for the correct answer.

-30-

What's New in Radio

(Continued from page 23)

parts industry, will be introduced in a few weeks, by the *Tilton Electric Corp.*, 15 East 26th Street, originators of the famous *Ex-Stat* Condensers, Resistors, Transformers, Antennas, etc.

The sales drive, that will be directed to the consumer, dealer and distributor, will feature "BONUS-BUYING," as part of an unusual 6-point plan. For the first time in this industry, co-operative sales participation will prevail for the buyer and seller, to spur sales.

A host of new products will also be a highlight of this new and unusual campaign. Among the products to be introduced is a patented vertical-rod antenna that is ideal for hotels, homes or offices, particularly, where the noise level is exceedingly high. Because of the unique design and construction of this antenna, it is not only possible to obtain a 95% noise reduction, but a decided increase in signal level. The base of this antenna containing a symmetrically wound transformer is of the rotary type, permitting installation anywhere in any position, without fear of obstruction. A nine-foot collapsible, non-corrosive metal rod is used. Because of its collapsible characteristics, it is entirely possible to use this antenna for ultra high frequencies, as well as standard high and broadcast frequencies.

The promotional campaign will be opened by direct mail with broadsides, letters and folders. This will be followed by co-operative newspaper advertising. Spot broadcasting will also be used. Lantern slides will be sent out and featured at lectures and in local motion picture houses.

Experimenter's Amplifier

(Continued from page 8)

reason a 50 mil. choke is shown in the list of parts.

There are just three precautions that should be kept in mind:

(1) The chassis is connected to one side of the 115 volt line and cannot be grounded. If the amplifier is to be used in the vicinity of grounded objects, it would be a good idea to enclose it in an insulating cabinet. Of course the chassis could be floated (i. e. not connected to one side of the line), but this is rather an inconvenience in construction.

(2) Remember to insulate the key jack from the chassis; a rubber grommet will do the trick.

(3) Remember to have something connected across the output terminals whenever the amplifier is turned on. If the plate circuit is left open, the screen will have rather an unpleasant time of it; and there will soon be a 25L6 reposing in your waste-basket. If you are at all forgetful, it would be advisable to use a closed-circuit jack in place of the output terminal strip.

Aside from these three suggestions the unit is practically fool-proof; it's not a high-fidelity amplifier. -30-

I Train You Quickly in Your Spare Hours . . . Right at Home

You Do Practical Experiments with Real Equipment

I offer you a new and altogether different type of practical training for a money-making career in Radio and Television. I teach you in a simplified, logical, understandable style . . . all about Television, Electronics, Facsimile Radio, Radio Set Repair and Installation. I GIVE YOU PERSONAL COACHING ALL THE WAY.

TRAINING PREPARES YOU FOR GOOD RADIO JOBS . . . at Excellent Pay

No matter if you desire to BE YOUR OWN BOSS in your own business or hold down a good job in Radio, my training will give you the useful information and knowledge to win success. DON'T JUST WISH FOR MORE MONEY—START TRAINING FOR IT RIGHT NOW.

Read What This Student Says:

EARNED \$250 SINCE STARTING COURSE
"I have only completed one-third of the Sprayberry Course and I find it very interesting, which makes it easy to learn."

"By devoting several hours of my spare time daily to studying and servicing, I have made about \$250 gross since starting the Course." Earl W. Hostetler, R. No. 4, Lebanon, Pa.



YOU GET PROFESSIONAL TEST EQUIPMENT PLUS EXPERIMENTAL OUTFITS

Includes 146 RADIO PARTS for building a complete

5-tube Radio Receiver, RADIO TOOLS, ALL-WAVE, ALL-PURPOSE ANALYZER. Besides its invaluable use in experimental work, my Equipment will enable you to make spare time profits while you're learning and can serve you in your own Service business later on. I give you DATA SHEETS on how to build popular Radio circuits. Also you receive BUSINESS BUILDERS which show you how to get and do spare time, neighborhood Radio Service work.

NO PREVIOUS EXPERIENCE NEEDED

My Training starts right at the beginning of Radio . . . covers all essential subjects. It makes no difference what your education has been. I can fit you for an excellent paying job in Radio. Your success is my full responsibility. I know how to get Radio across so that you can understand it . . . and remember it.

SERVICEMEN

I offer Advanced Training for those already in Radio. Get complete details in my FREE 52-page Book.

REMEMBER — THE SPRAYBERRY COURSE IS SOLD UNDER A MONEY-BACK AGREEMENT



RUSH THIS COUPON FREE for BIG FREE BOOK

DON'T DELAY! ACT NOW!

SPRAYBERRY ACADEMY OF RADIO
F. L. Sprayberry, Pres.
325-F University Place, N. W., Washington, D. C.
Please send me FREE copy of "HOW TO MAKE MONEY IN RADIO."

Name Age
Address
City State
Tear off this coupon, mail in envelope or paste on penny postcard. Servicemen—Check here ☐.

FACTORY-TO-YOU SAVES YOU UP TO 50%

EASY TERMS



PUT THIS 1940 14 TUBE CHASSIS IN YOUR PRESENT CABINET \$19.95 COMPLETE

Foreign Reception

Here's our big 20th Anniversary radio special, the 14-tube 1940 Television-Adapted Midwest! Brilliant performance . . . and amazing foreign reception!

30 Days Trial

Absolute satisfaction guaranteed on money-back basis. Catalog also shows 14-tube cabinet console for only \$29.95 complete!

Other models from 5 to 17 Tubes, and up to 5 Wave Bands. Send 1¢ postcard for FREE 1940 catalog, showing complete line. (User-agents make extra money!)

See Midwest's Answer to TRADE-INS!

MIDWEST RADIO CORPORATION
Dept. 11-H Cincinnati, Ohio

RADIO ENGINEERING DEGREE IN 2 YEARS

Complete Radio Engineering Course in 96 weeks. Bachelor of Science Degree. Radio (television, talking pictures and the vast electronic field) offers unusual opportunities for trained radio engineers. Courses also in Civil, Electrical, Mechanical, Chemical, Aeronautical Engineering, Business Administration and Accounting. Tuition, living costs low. World famous for technical two-year courses. Special preparatory department for those who lack required high school work. Students from all parts of the world. Enter June, Sept., Jan., March.

Write for catalog. Burton Handy, Pres.

TRI-STATE COLLEGE
1650 College Ave., Angola, Ind.



YOU CAN BECOME A CODE EXPERT!

Learn the Quick CANDLER WAY!

Candler doesn't care if you're just a beginner or if you've tried to develop your speed without success. If you follow the simple Candler System you will learn code right, with the correct fundamentals. It's a mental process; you must learn sound consciousness, and this Candler will teach you as he has taught thousands upon thousands of others, including such operators as T. R. McElroy, World's Champion and World's Record Holder.

In a short time after you've started Candler training you'll find yourself reading code as easily as you read the printed page, without strain or conscious effort. A few weeks of Candler training are equivalent to months of undirected practice. Write today for FREE 1940 "Book of Facts." Learn how the Candler system works, read what highly paid commercial operators say about the Candler system. Send for your copy today!

CANDLER SYSTEM CO.
Dept. N-5, Asheville, N. Carolina, U. S. A.

QRD? de Gy

(Continued from page 30)

PST. No signals heard. Walsh 32340 . . . Unquote . . . Our sincere regrets to his family and his friends.

In a recent issue we suggested to some of the boys that they try the Airways for jobs. We received a letter in which a reader said he had written, re-written and again wrote airline companies for a billet and so far all he had received was silence. He also said, in effect, that we shouldn't kid our readers. Well, we just received another letter from one of said readers, C. J. Bolvin, who sez . . . quote . . . got tired of riding the car-ferries and decided I wanted a shore job . . . So I sits me down and wrote a lotta letters to the various airlines. Came lots of application forms which were then filled out and returned. Got results so fast that it nearly floored me. This outfit (TWA) wired so that's the reason I'm here. The others—four of them—sent letters which I didn't get until I came back from trying out here in KC. By that time I had this job and had to turn down the other offers. Anyhoo, it was a revelation that there are so many jobs floating around waiting for some guy to come and get 'em . . . Unquote. Now won't the other letter writer's face get red. Incidentally, CJ sez we shouldn't forget the CAA which is expanding by leaps. There is some talk of the CAA taking over the Alaskan communications system which is at present being handled by the army. About 15 radiops will go up yonder this month and that's just the first contingent. So there's a word to the wise. If one radiop can get billets where he wanted it, others can follow suit. And we ain't playing bridge!

AL SEGEN (ex-ham W3BGD) writes that he has changed his tanker job for a yacht berth, the "Elsie Fenimore," to go on an extended cruise around the Caribbean. Johnny Yarns (ham W5HCZ) has moved into the chief's job at WHBB, Selma, Alabama. Bill Tullis, formerly at WUE, Ft. Geo. Wright, Washington, is now with the CAA at Evanston, Wyoming, but will move to Sheridan, Wyoming, soon with the same outfit.

INCIDENTALLY, we are a bit buoyed up by the information of our nose-for-news reporter, CJ, who tells us that there is an association of radiops around TWA known as the Skyline Assn. of Radio Operators. We've always been wondering why some one hadn't tried to unionize these lone wolves of the field and here is a functioning organization which has in its constitution the provision that it can include ops from other airlines as well. Jack Stone, Secretary of SARO, sez he'll be happy to hear from any one interested in 'jinin' up. This should be looked into by ops interested in the airways.

WELL, we've received fan mail from former radiops who are now doing everything else but radio work, but the hat goes off to Jim Caldwell who is now Manager of the Antelope Ranch at Willcox, Arizona. Herding msgs to herding steers is really a stretch of the imagination, even for one like ours. He sez . . . quote . . . Since I used up six tickets your column has afforded me considerable interest as there is little contact with the seagoing fraternity out in these h'ar parts . . . I've often wondered where the old timers have gravitated to. Such as old MacCarty of KSF and KSH (Finland and Koonland), the old Minnekahda, KDKK, Geo. Dill, Johnny Flag, Ernest Hawkins, Goldsmith and the others . . . and Charlie Harn . . . and Charlie Guthrie. Whatever became of Carl Langvin? The present day turmoil reminds me of the time the USSB Conejos struck a mine in the Black Sea and went down in 20 minutes. Fred Selim was op on her and I well remember the rag chewing he carried on until the last second. We were bound for Constantinople at the time and we were still in the Mediterranean. . . . I have tried to locate a good 600 meter receiver such as the Sargent but so far unable to do so. So I use a National SW3 with 600

mtr coils which brings in East coast plenty QSA. WSC and WIM vie with KPH for sig strength. Heard the SS Aztec several nights ago off Sandy Hook with steering gear carried away. Imagine if you can, an ex-seagoing man herding cattle around the scenery by day and listening on 600 by night . . . in spite of the wife and daughter . . . so 73 to the old gang and I'd like to hear from any of 'em.

AND so another log is despatched into that great unknown wherein those with foresight will find that it will pay to study the latest developments in the radio art . . . 73 . . . ge . . . GY.

Remotes

(Continued from page 24)

"When you have lost your bearings, and there is no sign of any help, sit down, take out the cards, and start a game of solitaire—and, it won't be five minutes before some so and so looks over your shoulder, and tells you what card to play next."

R. K. W.

Refer to: Hammer article, RADIO NEWS, April, 1940.

I have been using a similar meter for two years, but with a circuit that is a bit more sensitive and flexible, and adding a small C battery and changing the Diode

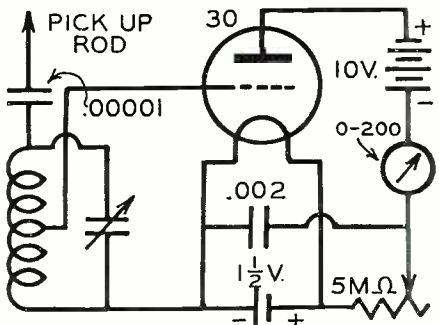

circuit to a Vacuum Tube Voltmeter. I use a 0-200 microammeter but the 0-1 milliammeter will work almost as well.

By EARLE OPPENHEIMER W2IZT,

Refer to: Wireless mike, RADIO NEWS, December, 1939.

One of the elements in the 1A7 tube was omitted. A corrected diagram appears here-

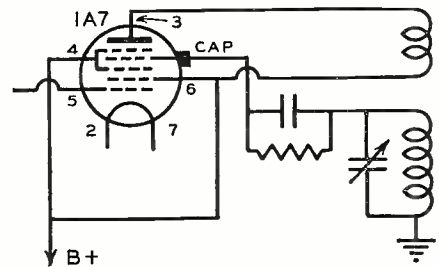

with. All numbers refer to socket pin markings.

Refer to: Cover, April, 1940, issue, RADIO NEWS.

So many of our readers had the necessary technical knowledge to tell us that the scene shown was not the final amplifier of station KNX, that we were at once amazed and pleased. All of you who caught that, were right. The buffer was what was shown. The information which appeared on the cover was furnished us by our correspondent at the West Coast. He was in error, and so were we. A thousand pardons, gentlemen.

Modernizing Old Receivers

(Continued from page 13)

due to this improved circuit and the more efficient tubes.

Provision is made to connect three different aeri-als, one for 5 meters, one for 10 meters and a general aerial, controlled by a three position switch. In the latter position, the converter is disconnected and the general aerial connected directly.

-30-

EXPERIENCED RADIO MEN WILL
Send at once!
FREE New LAFAYETTE CATALOG

Experience has taught men in radio that a new Lafayette catalog means news . . . buys . . . savings! Send for the Lafayette catalog—just published—and see for yourself. Have this guide to the best buys handy—buy everything you need from one source—save valuable time and money! Get your copy today. It's FREE.

LAFAYETTE RADIO
 Dept. 2F—100 Sixth Ave., New York, N. Y.

AMATEUR RADIO LICENSES
 Day and Evening Classes in Code and Theory
HOME STUDY COURSES
 Reasonable, Efficient and Thorough,
 Hundreds of Licensed Students
 Now on the Air
 American Radio Institute, 1123 Broadway,
 New York, N. Y.

TURN YOUR SPARE TIME INTO CASH!

Have you a few spare minutes a day? Then you can very easily earn plenty of extra cash! You could add \$10—\$25— or even \$50 a month to your income. How? Simply by joining the Radio News Booster's Club and discussing RADIO NEWS with your amateur or servicemen friends. Send for subscription supplies and detailed information on how to increase your income! Do it now!

SEND COUPON TODAY!

Booster's Club, RADIO NEWS
 608 S. Dearborn St., Chicago, Ill.

Gentlemen: Please send subscription supplies and detailed information on how to increase my income.

NAME

ADDRESS

CITY & STATE

Serviceman's Experiences

(Continued from page 14)

"So I figured," Al went on, "the best thing to do was to let them keep the cabinet and sell them a new chassis. The new angle got them, and I sold them a new chassis and speaker for fifty bucks, cash. They didn't want the Colonial chassis, so I allowed them a fiver for it. How'd you make out with Ben?"

"Aw, he wouldn't listen to reason," I said. "That will be an easy job on Ken's set—the knobs on the 31 don't come through the front of the cabinet, so there won't be any wood-working involved."

"Surprised that you noticed," Al remarked. "Ben said you left his house in a hurry."

"That reminds me," I laughed, "we are getting Ken and Ben to do something different. Hope it doesn't break up the team!"

"It won't," Al said. "After you left, Ken 'phoned Ben and made him order a duplicate chassis!"

-30-

Doubling in Oscillators

(Continued from page 31)

citation, and using a combination of cathode and grid leak biasing, optimum adjustment can be made by removing the excitation and adjusting the cathode resistor to bias the tube or tubes a little under class A operation. This can be determined by observing the plate current and adjusting it, by means of the cathode resistor, to a little under the recommended value for class A operation.

Additional grid leak may then be inserted, so that when excitation is applied, the total bias voltage, measured by the high resistance voltmeter, is no more nor less than the rated bias for class C operation. A little trimming, between the grid leak and cathode resistor, will give optimum results without imposing too much on either the plate supply voltage or the r.f. excitation.

It is more certain than a grid milliammeter. When a grid current meter is used, one has to stop to figure the i.r. drop across the cathode resistor and that across the grid leak and add these results together in order to determine the actual bias on the grid. The voltmeter method presupposes that the amplifier has been properly neutralized, however.

If for any reason it should be desired to read the total grid bias voltage, connect the positive terminal of the voltmeter to V, and the negative terminal to V_g. The grid bias voltage will be of the order of 60 to 80 volts but in the case of this oscillator, it is not necessary to adjust it further or even to measure it.

The parts are all mounted on a breadboard as shown in the photographs. The board measures 10" long



What's your future in Radio?

You don't need to gaze into a crystal globe — just look around you. Television — radio facsimile — electronics in industry; these and other developments are crystallizing right under your very nose TODAY. Here lies the future of the servicing industry, here lies YOUR future in radio . . . If you are ready to capitalize. Know as much about these developments as you know about a superhet — OR ELSE see the most profitable part of your business go to a competitor. Read carefully the contents of the following books — and Order Today!

SERVICING BY SIGNAL TRACING

By John F. Rider

Use the system of servicing which is proved and endorsed — fastest — most modern — the system you can apply to all receivers regardless of age, type or make. Servicing by Signal Tracing operates independently of every limiting factor heretofore encountered. In this new book you learn how all receivers are brought to a common servicing level. You learn how components receive a functional check while the circuits are in an operative condition. Over 360 pages — hard covers — only \$2.00.

THE OSCILLATOR AT WORK

By John F. Rider

JUST OFF THE PRESS!

Get your money's worth — KNOW! This new book tells all about ALL oscillators. It explains the theory by means of simple illustrations, diagrams and curves. It gives you the practical facts you need to combine theory and practice. Get your copy TODAY! 256 pages — illustrated — \$1.50.

OTHER RIDER BOOKS YOU NEED

The Cathode Ray Tube at Work — 336 pages — 450 illustrations — \$2.50 Hour a Day with Rider Books on subjects you should know — Hard Covers — 60c each. And of course — All Eleven Rider Manuals.

JOHN F. RIDER, Publisher 404 FOURTH AVE. NEW YORK CITY

EASY TO LEARN CODE

It is easy and pleasant to learn the modern way—with an Instructograph Code Teacher. Ideal for the beginner or advanced student. ■ Many tapes available ranging from alphabet for beginners to typical messages on all subjects. Speed range 5 to 40 WPM. ■ Always ready, no QRM, beats having someone send to you.

FOR SALE OR RENT
STANDARD with 10 tapes, book of instructions, A.C. motor \$24.50 with spring-wound motor \$18.50
JUNIOR with 5 tapes and book of instructions (not rented) \$12.00
RENTAL Standard with 10 tapes and book of instructions \$3.00 first month, \$2.25 each additional month. References or \$10 deposit required. All rental payments may be applied on the purchase price should you decide to buy the equipment.
 Write for details today



INSTRUCTOGRAPH COMPANY

Dept. NR, 912 Lakeside Place, Chicago, Illinois
 Representatives for Canada:
 Radio College of Canada, 54 Bloor St., West, Toronto



Training YOUR DOG

properly is essential if you are to get full enjoyment and comfort from him. POPULAR PETS, the sensational new magazine for animal lovers, shows you exactly how to teach your dog to obey your commands or signals. Easy-to-read and easy-to-understand, POPULAR PETS brings complete, authoritative counsel by America's leading trainers and breeders, men and women who are tops in their fields. Treat yourself to this grand magazine today!

POPULAR NOW ON SALE AT Pets ALL NEWSSTANDS

RADIO made EASY

with Ghirardi's BIG 1-Volume Radio Training Course

Fit yourself, at home in spare time, for a good-paying Radio job. Yes, you can do it—with Ghirardi to help you, as he has helped thousands of others, who got their basic training in Radio from his world-famous Radio Physics Course. Because you see he has a genius for making it all vividly clear and easy to understand. You need no "background" to prepare you for this intensive course of technical training—not even a knowledge of math! Ghirardi will "see you through" from elementary Electricity right through Radio, Sound, Television, Cathode-Ray Tubes, etc., etc. It's all explained here—complete—in one big handy \$4 volume.

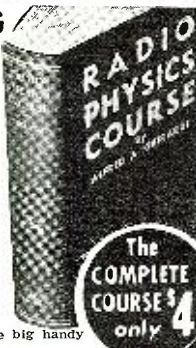

The COMPLETE COURSE 4 only \$4

USED BY U. S. ARMY

Yes, because of its excellence, Radio Physics Course has been given the rare honor of being selected as a training text for radio courses conducted by the U. S. Army and Navy. In fact, it's recommended and praised everywhere as "tops"—it's used by more radio schools and students than any other radio text in the world!

- 36 VOLUMES IN 1—972 PAGES—508 ILLUS.
1. Radio Broadcasting System, 2. Sound, Speech, Music, 3. Electron Theory, Elec. Current, 4. Elec. Units; Ohm's Law; Resistance, 5. Elec. Circuits; Batteries, 6. Magnetism, 7. Electromagnetism, 8. Electromagnetic Induction, 9. Inductance, 10. Capacitance; Condensers, 11. A. C. Circuits, 12. Filters, 13. Measuring Instruments, 14. Radio Waves, 15. Broadcasting, 16. Receiving, 17. Vacuum Tube Principles, 18. Vacuum Tube Characteristics, 19. Vacuum Tube Construction, 20. Vacuum Tube Detector and Amplifier Action, 21. Radio Frequency Amplification, 22. "Superheterodyne," 23. R. F. Amplifiers; Tuning Coils, 24. Audio Amplifiers, 25. Speakers, 26. Battery Operated Receivers, 27. Power-Supply Units, 28. Elec. Receivers, 29. Automobile and Aircraft Radio, 30. Phono Pickups; Sound Systems, 31. Short Wave, 32. Photoelectric Cells; Cathode-Ray Tubes, 33. Television, 34. Antennas and Grounds, 35. Testing; Servicing, 36. Sound Motion Pictures
- ... 856 Self-Review Questions!

Test It 5 Days—OUR Risk!

Send for it—Read it—Use it! If not completely satisfied, you may return the book within 5 days and your money will be promptly refunded. You risk nothing—but you'll lose your great opportunity, unless you at least SEE this book!

MAIL THIS COUPON NOW

RADIO & TECHNICAL PUBLISHING CO., 45 Astor Place, New York, Dept. RN-60. Here is my \$4 (\$4.50 foreign). Send RADIO PHYSICS COURSE postpaid, with your money-back guarantee.

NAME

ADDRESS

CITY..... STATE.....

Send me free descriptive illustrated literature.

and 8" in depth. A sheet of metal, preferably brass, copper or lead, 10" by 6", is attached to the forward surface of the board. All ground connections, shown on the wiring, go directly to the metal plate. The parts are easily recognized in the pictures. The two fixed condensers between the tubes and the tank capacitors, on the top of the board, are: on the left of the tubes, the screen grid's by-pass condenser; and, on the right of the tubes, the plate tank d.c. isolation condenser.

-30-

RADIO PHYSICS COURSE

by Alfred A. Ghirardi

(Continued from May issue)

As long as the filament voltage of a tube is normal and is not raised over 10% above the rated value, the evaporation and replenishing continues at an equilibrium rate, so that a constant layer of thorium is maintained on the surface.

If too high a filament voltage is used, the rate of evaporation of thorium is increased more rapidly than the rate of diffusion of the thorium to the surface, the thorium surface layer is partially or totally destroyed, and the emission drops to that of pure tungsten (which is practically zero at these temperatures) and the tube operation is impaired. If the tubes are operated at very low voltages, the filament temperature is so low that the process of boiling out the thorium from the interior of the filament becomes abnormally retarded, and the layer is slowly used up.

The great majority of thoriated tubes die a natural death, in that their life continues until all of the thorium in the filament is used up. Obviously, nothing further can be done with them. Tubes which decrease in operating efficiency after having suffered some of the abuses mentioned above can usually have their thorium layer and full efficiency restored by the simple process of "reactivation" or "rejuvenation." Reactivation consists of cleaning the surface and reducing some of the thorium oxide in the wire to metallic thorium by heating the filament of the tube (with plate and grid circuit disconnected) to a higher temperature than normal, for a short time, by the application of specified high voltages. This is known as "flashing." Then it is operated for a longer time at a lower temperature. This boils out additional thorium atoms from the interior of the filament and a new active layer is formed on the surface. This is known as "ageing."

(To be continued)

Answer to Problem on page 57

NUMBER two. She'd understand that, if she had sense enough to come in out of the rain, and you could lead up naturally to the fact you stood ready to make any necessary set changes in the future. Present ones too, for that matter!

Hamchatter

(Continued from page 35)

got to work a few stations over W6USA. W5AKT doesn't have a 5 meter rig yet, but he knows what it's all about. He explained a 56 mc. rig from construction to actual operation at a Ouachita Valley Amateur Radio Club meeting recently.

W5ADJ brought a loop antenna to Monroe, and when he finished demonstrating its selective powers several local hams declared they had to build one too.

W5IRO is a new ham in Hodge.

W7GAE, W6MBD, K6NYD, K4FKC, LU3AN, OA4R, OA4K, YV1AQ, CE3CZ, CO2WN, just to mention a few whose signals are consistently heard in Monroe, La.

W5DRP brought an e.c.o. rig to a Ouachita Valley Amateur Radio Club meeting and demonstrated its adaptability to different frequencies.

W5DXL is all set to start working 40 c. w. He won't have any trouble keeping up with the best of them for his speed is about 45 words per minute.

W9ECC and W9RSR are students at the University of Wisconsin.

W7AEP is a new operator at Kewaskum, Wis. (that makes two).

W9PPV works for the Bell Telephone Co. He likes to operate on 75 fone and often used to work crossband wid W9QXI on 160 f.

W9QQL heretofore on CW is now being heard on 160 m. fone.

W9QXI has modernized the old rig and incorporated everything into a relay rack, receiver and all. One night we saw shadowy forms climbing in the night and it turned out to be QXI repairing the skyhook in the middle of the night.

W9SGG who is a doctor at a sanitarium would like to operate on 160, but says that it would cause too much QRM on the patients' sets.

W9WSY the DX hound is now playing on 160 m. fone, he sounds funny though, these CW men all have to learn something about fone. But Lee gets out fine b. Runs 20 watts and puts R9 into Mich., Ohio and Etc. from Wis.

W9OBT had quite a party, while he was on the air, one night. We could hear all the YL's and the XYL's titter and laugh in the background. It wasn't anything funny that OBT said though, then what was it?

W9TPY says that Beaver Dam is the city of 19 manholes wid 18 covers (Don't ever visit TPY) hi hi.

Some time when you all hook up wid W0DDD, ask him to tell you abt the time that he tried to get on ten meters and how he landed in the 13 meter band.

Speaking of off band operation, W9KOL had quite a fine b. sig on 80 meters. Fact was that he got better reports on 80 m. fone than on 160 m. fone where he was operating. It happens to the best of them.

W9ZGK is planning to put up a beam, says that HF stuff is nice. And that he is itching for some DX.

W9JPU is using cathode Modulation in his e.c.o. says that it works all o.k. so far.

W9CQO has just received his class A ticket and is ready to go to town on 20.

THE only radio fraternity of its kind, *Rho Epsilon*, has recently granted a charter to the Newark College of Engineering. This new chapter will be known as the *theta* chapter. One purpose of the organization is to raise the prestige of the radio clubs in our colleges and universities. Founded some years ago at Washington State College, *Rho Epsilon Fraternity* has grown immensely, gone National with chapters in some dozen colleges all over the United States, and continue to prosper. The secretaries of any accredited College Radio Clubs are invited to write the National Secretary for detailed information concerning the grant of a charter at their school. Address—Mr. Nilo E. Koski, W7LD, 5827 E. Green Lake Way, Seattle, Washington.

Chet Warren, EX-3AVX for some years, had a peculiar glint in his eye as he looked over the rig here and as he tuned the receiver over the band. Could it be that he is thinking of starting... No! Couldn't be, hi.

What is the matter with the boys at *City College of New York*? Why not get a transmitter on the air over there? N. Y. U. is on with W2HJ, *Columbia Univ.* with W2ABE, and N. C. E. with W2JPK, so what say about a sked sometime?

I read in *RN* where W1GFW is a champion antenna putter-upper. How about coming down here and giving your namesake W2GFW a hand OM?

15-year-old W2MRZ is getting out FB with his 7-watt rig. A 6L6G xtal oscillator and a 2-tube blooper are all that Bill use to put out a swell sig on 80 and 160.

The most consistent signal from Africa since the ZS's left the air is OQ5AY. He can be found every Sunday on (14,312 kc. TS).

HCLJB is very active on ten meter phone and works his father in the W9 district. He is operator of a new broadcast transmitter there in Quito. The call used is HCJB and the station is for missionary purposes.

From Cuba, the isle of pearl, we find that CO2GY is really full of humor. He claims that he is the Johnny in *Oh Johnny*. When Johnny isn't using tkw, he is making Neon signs. He sent W5DEW a neon sign with her call letters in beautiful color. [The gals get all the breaks!]

W2CZS has a 60-watt fone on 160 meters. Stan is secretary for the forth-coming Hudson Division Convention to be sponsored by the Union County Amateur Radio Association.

W2LGV is still trying to be heard at the Newark College of Engineering. He only lives about 20 miles away but so far none of the skeeds have gone through. Harry is a sophomore.

Besides having a big fone rig on 75 meters. W2GQM has a 20-watt portable rig on 160. Paul recently moved to Roselle Park.

Plan-powered W2LOP can often be heard on 160 fone with a swell signal. Hank tried a RK-34 on five meters in a mobile rig but was unsuccessful. He expects to start at the University of Idaho next year, and will have a little rig with him to try to talk back home.

W2MTI was only a swl when he won an SX-2 receiver at a ham-fest but now Pat has his ticket. His rig uses a 6L6G final and a 6L6G modulator. Sounds plenty loud here.

W2KKO had a thrilling experience recently, when he noticed that his ticket was soon to expire! Phil had to rush to get it renewed in time. It seems that phonograph records occupy a lot of time at W2KKO and he doesn't get on the air so much any more.

W2LSX recently got the flu. He is recuperating now and more active than ever.

W3AAL surprised us by saying his input was 2 watts! He has worked 19 states with the little rig on 40 c. w. His frequency is about 7020 and is trying to work the west coast.

No qsl cards ever get lost in Jersey City. Why? Because W2CFW works in the post office and he keeps an eye out for them. Bill is pounding brass on 80 c. w. again.

W2HXL has his outfit perking on 20, 40, and 80 meters. Bob claims he'd like to try it on 10 also, but doesn't have time. By the sound of ten CW, we could use a few more men down there.

The rig at W2MQP is a 6L6-6L6 with 60 watts input. Receiver a 6-tube super and the antenna is a Marconi. Herb says that altho his street is called Vassar Ave., it is purely a coincidence, and there are no pretty coeds around. Shux.

W2ANW has a new buz and is trying to get used to it. Tom's set uses an RCA 809 with 55 watts input.

Comes spring and W2DYO's fancy turns to traffic handling. Julius says that with no dx and nothing, he's going in for the again. Some of the nets on 80 meters certainly do operate smoothly. The boys sound like commercials with their snappy bk in.

W2HZY tried 10 meter fone and only had one QSO. (With a chap in the same town, at that) George promptly gave that band up as a loss and came back to 80 c. w. His ECO sounds very much like xtal.

Art at W2LVO is using 6 watts input to a 6L6 oscillator with an end-fed hertz antenna. This seems to be the vogue around here, as all the younger fellers are using them.

W3AKV has had such good results with his 25-watt portable rig that he is going to give it a try on 75 fone, too!

W2MUE is another beginner doing big things with his little rig. With thirty watts to a 6L6, Owen has knocked off North Dakota and Oregon. His *Sku-Champion* receiver must help on the pulling-in end.

W2LBG keeps Linden, N. J. on the map by working out on 80 c. w. Dan said the QRM was terrible on us the other night on 3505 kc. We shifted to 3636 kc, but it was still terrible! hi.

W2FNT is dividing time between 80 c. w. and 160 fone. *Oh Johnny, how you can QSO!* Input 200 watts with no dx to report at FNT.

W2CEJ has to keep his wife's rig on the air as well as his own. Both he and Mary (W2JLL) have tickets at their home. Bill's rig works on 40-meter CW and Mary works fone on 160 meters most of the time. Their son is also learning the code!

One of the few 160-meter sigs we've heard comes from W3HXN. Ed has a hundred and thirty watts input to an *Eimac 35 T*.

W2MKN uses about 80 watts input on 80 c. w. and 160 fone. Frank keeps 1918 kc. busy here with his swell sigs. We also worked him from the college radio club.

W2MPQ undoubtedly owes his success to his 40-meter zapp and 60' counterpoise. Chan's outfit uses a 6L6G and a 210 ampier with 35 watts input. Receiver is a *FB-7* and works good.

Another "6L6 fiend" is W2MNA who uses two of 'em. However it won't be long before Bill gets about a 1/4-KW going on 160 fone. It doesn't seem to worth the trouble to put anymore power on the 'er because with a 6L6 you can wrk all the locals.

THE mail bag says:

Well on we want our say in the *RY* from this part of the country so hr goes.

Ten members hr in this club es most of them ex ops of some kind either navy, R. R., or ham there are 3 tickets es one coming up in a few days or wen the fec puts the old ok on it. Rest are wrking fr them.

Seems there is a station wid the call 7HJT by name Shirley who contemplates joining the YL league watch out fer (him) girls, hi.

Also 7HJK who wants to wrk dx but can't stay awake later than 3 Pm. hi! Watsa matter doc, fruid that little 53 osc will go to sleep on u.

WI I beat the boys to a kb hr awhile back on 80 who was calling eq te eqs qsp's fer him es tux to W2MHD got them on the east coast in gd time then they all piled in on K6 frm Pa. to the west coast hi.

Where's EJS th ol 160 fone man.

On lots of qm hr in Mis, this winter but still we wrk the East coast ok but sure wish it boys who owe us cards out hr wud qsl as we want our WAS to so wat sa boys dont be proud even that of penny post card will do it so 73s from the Walowa Mts. W7HJJ.

GOOD ole Keith W4ARX Mathis comes thru, as per usual, wid:

W4FPI at Opp, Ala., comes up with the news that he has been very busy which explains his absence from the air. You had better watch those YLs over at Damascus, Taylor, they are school teachers, you know.

W4EAB at Opp, Ala., reports that he and his father recently suffered from a disastrous fire which destroyed their warehouse and seed store.

W4FDJ reports that he is rebuilding and will operate on ten meters mostly during summer.

W4FDE at Cordele is on ten with a new rig and reports that the band is really open down his way.

W4DSB at Americus has recently put up a new antenna and his 75 meter phone signals are much better.

W4GHU at Albany recently had his picture in the Atlanta Journal in regards to his work there in disaster.

Did youse eys glim the recent remarks of one so called editor of this magazine in regards to our *never failing*. What man I ask do you expect out of a good reporter such as we are. Hi!

W4FOO, Fender, Georgia near Tifton is a new ham on one sixty with a fb sid watt rig. Alvin says that he can really work em with this power.

W4EZL, Selma, Ala., is putting out a swell fone signal on 160. These Ala. hams gets better all the time Hi.

W4FPQ, Dothan, Ala., says that hams there are thick but not many active at one time. He has rebuilt recently and his signal shows nice results. Earl is a grocery store operator and that means plenty of cats hi.

W4FDZ wants to know if W4FJM at Panama City, Florida has jumped in the hay but we didn't know and our idea is that mebbe the XYL there decided that the OM needed some sleep. However, *Ilocus Pocus*, let's hear from you so we can keep up the good word about you.

"Howcome," writes in a well meaning friend, "do you remember all about how buildings looked in the last (wat'dya mean, *last*) World War? Gosh," continued the letter, "we know that you look old but having went to some schooling wid you we don't think that they let romped babies fight that war." All of this referred to our recent dispatch from Albany, Ga., and

Bliley Vari-X



VARIABLE CRYSTAL OSCILLATOR



Provides e. c. o. frequency flexibility with quartz crystal stability

The Vari-X is a full crystal controlled variable frequency exciter for 40 and 80 meters. See your Bliley Distributor at once for complete details.

ASK FOR CIRCULAR D-2

BLILEY ELECTRIC CO., ERIE, PA.

3,313 "CASE HISTORIES"

Compiled by Alfred A. GHIRARDI

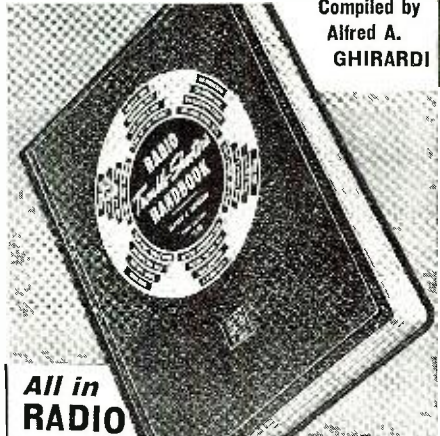

All in RADIO

Trouble-Shooter's HANDBOOK

GET the complete book of Servicemen's "Case Histories"—the world's biggest collection of assembled and classified for you in Ghirardi's handy data book. Now you can "lick" every fault service line job that comes along. For here, in a few seconds, you can see what all the likely trouble sources are for practically any set you will be called on to service today—over 3,313 models in all, representing 177 different manufacturers! What's more, you'll learn how to remedy those troubles—met with a lot of "theory" but according to the most successful experience of the country's leading servicing organizations. "Practical?"—you bet it is!—practical from cover to cover. Think what this book will do for you—the servant **TIME** you will save—the headaches avoided—the customer satisfied—yes, and you'll find yourself doing better work and getting more money for it.

More Time-Saving Data Besides!

That's just one section of this great Ghirardi Trouble Shooting Handbook! But you'll find 50 more of them when you open the book—every one just chock full of valuable data of all kinds which you need in your everyday service work—E. F. Desks (over 15,000 listings); Auto-Radio Data for Installation and Servicing; Interference Elimination; Car Wiring, etc.; Trouble-Shooting Charts, Trade Directories; and over 30 other tables and charts. Get this book—It's a real time saver! (Mail coupon TODAY!)

Special Combination Offer \$3.33 Both Books—\$6.50—if purchased together

MODERN RADIO SERVICING

The complete volume in the Handbook—It gives you a thorough grounding over in the basic theory and fundamentals of modern radio servicing work and provides in 12 months—All made unobscurely clear and easy to understand!—that instruments, Troubleshooting, Servicing, etc. \$10.00 (11.00 foreign)

MODERN RADIO SERVICING \$4. (\$4.50 foreign.)

RADIO & TECHNICAL PUBL. CO., Dept. RN-60 45 Astor Place, New York.

RADIO TROUBLE-SHOOTER'S HANDBOOK \$3.33 (\$3.50 foreign.)

MODERN RADIO SERVICING \$4. (\$4.50 foreign.)

BOTH BOOKS \$6.50. (\$7.00 foreign.)

Name

Address

City

State

Use it 5 days —OUR RISK!

MONEY BACK GUARANTEE

FREE CATALOG

ALL RADIO NEEDS

Here in this one big book you will find everything you need in radio . . . sets, parts and supplies . . . public address systems . . . amateur equipment . . . testers and kits . . . your nationally known favorites at lowest possible prices. Write today for this big valuable catalog and save money.

PROMPT SERVICE

BURSTEIN-APPLEBEE COMPANY

1012-14 McGEE STREET, KANSAS CITY, MISSOURI

Webster Rim Driven Motor

78 R.P.M.

110 V. A. C., 60 Cycle

New Design, self starting, constant speed, compact and shock-proof.

Complete with 9" turntable. Ship. Wt. 6 lbs. List Price \$6.00. Net Price \$2.69 (Plus Postage). 25% Deposit Required with Order. Write for Our Latest Radio Parts Bulletin.

ARROW SALES COMPANY

619 W. Randolph St. Chicago, Illinois

QUALITY ABOVE ALL

SOLAR CAPACITORS

Write for Catalog

SOLAR MFG. CORP.

BAYONNE, N. J.

RADIO COURSES

Start September

RADIO OPERATING—BROADCASTING

RADIO SERVICING—a practical course

RADIO AMATEUR CODE • TELEVISION

ELECTRONICS—1 yr. day course, 2 yrs. eve. Day and Evening Classes. Booklet Upon Request.

New York Y. M. C. A. Schools

7 W. 63rd St. New York City

CRYSTAL TALK

Informative Bulletin No. 1

By **HIPOWER**

"WHAT MAKES A LOW DRIFT CRYSTAL?"

Regardless of whether the cut of a crystal is called A, X, Q or Z, if it is cut at an angle from the optical axis, on the mechanical axis of a piece of quartz, and has a temperature coefficient of 0 to 77 cycles per degree centigrade per megacycle, it is a low drift crystal. The degree of the angle determines the amount of drift with temperature change.

HIPOWER "Rubies" are cut at an angle which allows us to guarantee them to have a drift with temperature change of less than 4 cycles per degree centigrade per megacycle. Mounted in holders, especially designed to dissipate heat, they present an outstanding example of an active low drift crystal unit.

The HIPOWER CRYSTAL COMPANY, one of the oldest and largest manufacturers of crystal units for Broadcast, Commercial, Aviation and Laboratory use, is able to offer the amateur low drift precision crystal unit at a very low price because of their large production and the exclusive HIPOWER grinding process.



<p>"EMERALDS"</p> <p>Guaranteed to have a drift with temperature change of less than 10 CY. per °C. per MC. With holder, 160-80-40 meters... \$3.35</p> <p>Special 20 meter unit... \$5.50</p>	<p>"RUBIES"</p> <p>Finest amateur crystal unit available. Guaranteed to have a drift of less than 4 CY. per °C. per MC. With holder, 160-80-40 meters... \$4.50</p> <p>Special 20 meter unit... \$7.25</p>
---	---

Available at Your Parts Distributor

HIPOWER CRYSTAL COMPANY
1615 CHARLESTON ST. CHICAGO, ILL.

READ SEND CODE LIKE AN EXPERT

Learn Quickly at Home—Get Real Speed

It's easy, fascinating, to become a good op. with the NEW ALL ELECTRIC MASTER TELEPLEX CODE TEACHER to help you. Only instrument ever produced which records your sending in visible dots and dashes—then sends back to you at any speed you desire.



Also sends practice work, recorded by an expert. That is why so many schools teaching code prefer Master Teleplex, why thousands agree this method is surest and quickest.

FREE BOOK

We furnish Complete Course, lend you Master Teleplex, give you personal instruction with a MONEY-BACK GUARANTEE. Low cost. Send today for booklet RN6, no obligation.

TELEPLEX COMPANY 67-69 PARK PLACE NEW YORK
In Canada write: CANADIAN ELECTRONIC INSTITUTE, TORONTO, ONT.

that, my friend, wuz just a figger of speech that all of us better know writers use.

Some day we guys in the fourth are going to wake up and realize that our yankee brethren are using five meters more than we are and then mebbe that band will be used for plenty of hamming.

W4GHY at Anniston, Ala., has a DX record of over 47 countries on contacts on the various CW bands and has recently made his first phone transmitter using it on 160 meters.

W4AJJ who is going to school at Yale recently paid his home state of Georgia a visit. Sid says that the northern boys are very active.

W4FMS, Savannah, has been off the air due to being sick but reports that he now is able to chew the rag once more.

Your scribe hopes to make the hamfest in the fourth this year so if you have one coming up drop us a card so that we can be there. (Heck, don't let my reputation for eating scare you.)

W4BZD, at Fitzgerald, Georgia, is still DXing on twenty and has promised your scribe to get back on a good band.

W4EN A, Macon, Ga., has a fb cathode modulated rig on ten meters.

W4CQR another Macon ham also has a nice rig on ten and is very active with his DX work.

W4FZE at Macon is trying to get the honors away from W4GIA as regards YLs as he has a new one with him on every contact that he makes. Boy—you single guys just won't learn, hi.

W4GOA, Jacksonville, Florida, active on 40 meter CW is a new ham and is brother of W4FFI. Reports that he will get the phone fever soon.

W4FPP, Brunswick, Ga., has again rebuilt his FB phone rig and now says that he can run 200 watts, that is, sometimes, hi.

W4CUS, Orlando, Florida, is very active on 160 meter phone and the signal is worth listening to.

W4FYF at Montgomery has a nice signal on 160 meter phone and is very active on that band.

W4BOL, Cochran, Georgia, another ole time ham after being on various CW bands has built a low powered job for 160. Lamar says that his brother Clyde, a former ham, has the aviation fever at present time.

W4FNY, at Brunswick, Georgia will soon have a xmitter.

W4GHK at Savannah, Georgia, drops in a post-card and says that he is having trouble getting his phone rig to work down to ten meters. Knowles says that his cathode modulator works fb.

W4VFF, Rome, Georgia, has a fine signal on 75 meters. He is one of the gentlemen responsible for the FB hamfest there which is an annual affair looked forward to by all Georgia hams.

W4HET is working portable on 160 at Toccoa Falls, Georgia and says that he likes the south.

W4GHD, W4GLB, Albany, Ga., and W4GHW at Damascus are new recruits in Georgia Army net.

W4FCW, "Doctor Charlie" says that he thinks that we often mention the fact that the *Crisp County Radio Club* is the only one that he knows that meets every day except Saturday in a local cafe in Cordele, Ga. If any others can beat this he wants to see it in RN.

W4GAA at Tallahassee, Florida reports that he has a new Defiant receiver which is the cats-whiskers. Also says that he don't know why we mentioned his DX in a recent column. Well Tommie keep up the good work with ur twenty-five watts.

W7HUJ is a new ham in Anaconda and is on 40 meters with a 47-46 transmitter and a *National Sr.3* receiver.

W7FL purchased a new car last fall and reports it to be very fb, business.

W7CUK has built a new xmttr. using a 616-807 exciter and driving a pair of 809's modulated by a pair of 616's. He has the exciter finished and is getting some very fine reports from the

boys on 40 meters. Rumors have it that "Tom" is going to build a ten meter rotary beam.

W7CRE has built a new exciter using a 616 and a T-20 for use in that kilowatt rig of his. The new exciter is taking the place of a Collins.

W7EQH has a very fine 160 meter phone transmitter and it really gets out.

W7BUG is contemplating building a new rig using a 616 oscillator and an 807 final.

W7AQH is going to take a fling at 160 meter phone one of these days with a super deluxe compact rig.

The other night W7HRP had a very interesting experience. He was pounding the brass on 40 meters and on almost the same frequency as he was operating, he heard a CO by W9FMN. He answered and "low and behold" on exactly the same frequency, W7FMN replied. There was no possibility of an error in reading code because later W9FMN was heard on exactly the same frequency.

W7HVV located at Sidney, Montana is really getting out with his rig built of 616s and 616gs. All of the boys are giving him 599x reports.

W7EIH is really going to town getting new equipment. He is building a Stancor 20P transmitter for use as an exciter, and this is going to drive a rig using a 24 as a final. On top of this, he is building a 10 and 20 meter rotary beam.

Es 73 de W7HUJ.

VIA THE RADIO:

The News of the K5's: AT is still wrestling with that lone xmttr and kinda disgusted with the sky hook. M's OPS now in no man's country, their company having been dissolved in the Canal Dept. shakeup. AC not being heard vly often these days; probably too busy with maintenance work on those army sets on maneuvers! Ham radio came to the rescue when the 2d Field Artillery got bogged down in the jungle during heavy rains here; broadcasting on 3550 kc, the Artillery hams hooked up with AT and got vital info through. JS (formerly WILLE/WIKLW/WA1) will soon be on with 60 watts on 20 fone and e. w. and hopes to come through o. k. W2's and W3's come through here fine. Following are the times when stations are authorized to be on air down here: 10 P.M.—3 P.M. to 5 P.M.; 20 M.—5 P.M. to 8 P.M.; 40 M.—8 P.M. to 11 P.M.

R. F. Gaudreault (K5AS)

KALCS, Frank Spier, of Manila, uses a Spray gun and an acetylene torch, draws copper wire through the acetylene torch, sprays it out over bamboo poles, thus making a bamboo rotary beam. The whole cost came to \$10.50, and certainly puts in a tremendous signal here into the West Coast. Frank says he worked W2ICA, W8CNA, W3's, W6's, and W7DX with his 100% bamboo antenna. The way Frank has it fixed, the three element beam supports itself. It ends three and one-half feet off of his roof, so it just clears the roof. As near as we can figure Frank still feeds it with a twisted pair. Frank's friends will be glad to know that he is now enroute to the States, and will be visiting us all before long.

W6BF, as president of the *Oakland Radio Club* is doing a fine job. It meets twice a month—that is the second and fourth Tuesdays at the Alden Library, 52nd Street and Telegraph Avenue, Oakland, California.

W6KW, Johnny Griggs, is doing a fine job working the *Burd Expedition*. Johnny's super-ham transmitter, and diamond antenna, is working just the way it should.

W6NWG, makes a fine 160 meter stepping stone between Los Angeles, and San Diego, at Oceanside, for daytime relays.

The 1940 *Northwest Division Convention* will be held at Walla Walla, Washington, August 24, and 25. The Convention Committee is as follows:

Wilbur Beale, W7FCG—Chairman
Dick Rose, W7GMC—Program Chairman
Ed Williams, W7HPG—Publicity Chairman

It is sponsored by the *Walla Walla Amateur Radio Club*, and those that were there before remember with a great deal of pleasure the fine times we all had.

W6LPZ will be found down on Cahuenga Boulevard, Hollywood, from now on. His round-the-world relays on 40 meters certainly used to be interesting to listen to during the evening.

We are all wondering if the *Treasure Island Amateur Station* will be opened again. W6USA certainly worked out fine, and undoubtedly the fine equipment had a lot to do with it, because the noise level there from all of the exhibits was tremendous.

W6ITH does not come in as loudly in Southern California at his new location as he did when he was on the eleven-hundred foot hill out there near Berkeley, but Reg does get out in his usual good style. No doubt it is much better for the amateurs in the east bay too, because Reg's signal also skips over them in arriving at the remote places.

W6IXZ, Bob Reimus, although he was married last year, is now an "old-timer" at the marriage game, and has more time to be on the air, again. KALCS is a very helpful chap. By discussing Asia DX with him some of the boys may still work a few countries over there, besides the ones that are coming in regularly, such as the Philippines, Japan, and China.

The *Whitcomb Hotel* S.F. is still a pretty good radio location for Hams visiting San Francisco, although they took down the 200 foot broadcast towers on top of the hotel, which formerly made ideal supports for portable ham rig antennas.

W7BVO, as usual makes his equipment look beautiful, and if we did not know it were an amateur station, we might think it were one of the broadcast stations. (Next page, GM)

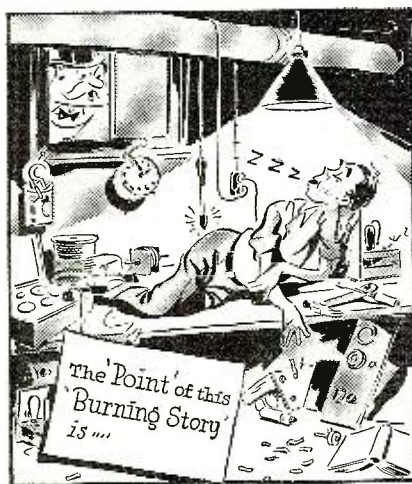

Centralab

Keeps late hours with the Serviceman

With fingers weary and worn the poor lad probes for trouble in the shape of some nice noise, sarcastic shorts, "lousy" leaks and open circuits.

When he finds them . . . Centralab replacement parts end his worries. Hams . . . servicemen . . . or set builders agree on CENTRALAB . . . FIXED RESISTORS . . . VOLUME CONTROLS . . . CERAMIC CAPACITORS . . . SWITCHES.

"always specify CENTRALAB" Div. of Globe Union Inc., Milwaukee

HANDEE

Tool of 1001 Uses

A Whole Tool Shop in your hand

Smooth, steady power at your finger tips. Uses 300 accessories to grind, drill, polish, rout, cut, carve, sand, saw, sharpen, engrave, etc. Plugs in any AC or DC socket.

10 Days' Money-back Trial

Order today. Standard Model (Illustrated) \$8.000 p.m. 16 oz. \$10.75 postpaid with 3 Accessories. De Luxe Model \$18.50 p.m. 12 oz. \$18.50 with 6 Accessories.

Chicago Wheel & Mfg. Co., 1101 W. Monroe St., Dept. RN, Chicago, Ill.



Save Hours of Hand Work

FREE 64-PAGE CATALOG

Complete information on Handee Products and their wide application in crafts work and industry all over the world.

Burroughs

CASH REGISTERS
LOW PRICES-EASY TERMS
COLORS TO HARMONIZE
WITH SURROUNDINGS

For a free demonstration call the nearest Burroughs office or write—

BURROUGHS ADDING MACHINE CO.
DETROIT, MICHIGAN

RADIO ENGINEERING

DEGREE IN 2 YEARS

Intensive, specialized course, including strong basis in mathematics and electrical engineering, advanced Radio Theory and Design. Modern laboratory. Low tuition. Self-help opportunities. Also 2-year courses in Aeronautical, Chemical, Civil, Electrical and Mechanical Engineering. Participation in Civilian Pilot Training Program. Enter June, September, December, March. Catalog.

INDIANA TECHNICAL COLLEGE
760 E. Washington Blvd., Fort Wayne, Ind.

RADIO TECHNOLOGY

RCA Institutes offer an intensive course of high standard embracing all phases of Radio and Television. Practical training with modern equipment at New York and Chicago schools. Also specialized courses and Home Study Courses under "No obligation" plan. Catalog Dept. RN-40.

RCA INSTITUTES, Inc.
A Radio Corporation of America Service
75 Varick St., New York 1154 Merchandise Mart, Chicago

RADIO ENGINEERING,

broadcasting, aviation and police radio, servicing, marine radio telegraphy and telephony, Morse telegraphy and railway accounting taught thoroughly. 48 weeks' Engineering course equivalent to 3 years of college radio work. All expenses low. Catalog free. School established 1874.

Dodge's Institute, Oak St., Valparaiso, Ind.

RADIO plus TELEVISION

mastered by pre-tested Training

No matter where you are or what you do, National has a complete training plan for you—to fit your circumstances. National's plan is for those seeking immediate shop-training as well as for those who cannot give up present employment and income. Mail coupon below. Find out how you can get the finest in radio and television training.

NATIONAL SCHOOLS

NATIONAL SCHOOLS, Dept. RN-6
4000 So. Figueroa St., Los Angeles, Calif.

Please send free Literature and full details.

NAME _____ AGE _____

ADDRESS _____

CITY _____ STATE _____



W7AHX, the original long wire antenna man will no doubt be at the Oregon Amateur Radio Association Convention at Salem, Oregon, during April.

The Cheyenne Hams will be glad to know that Chuck Houge, is well under way with his amateur license again, so may join them on the air soon.

Wally Leeland, W7GCO, is on 20 CW these days. His good old ex-navy fist sounds fine.

"Doc" of W7GGG, and W0ESA have been keeping a daily schedule on 7150 KC, for years and years.

W7FDV was reminiscing the other day, and remembered the night, just before the shut-down, when he worked U3CY, D3FZJ, F8OY, VP7, VP5, and an OZ-4C, all in one evening.

W7CEO, of Cheyenne, certainly rolls in fine down here in Southern California, on 160 meter phone, which is really nice dx.

Some of the other Cheyenne amateurs, W7-BAH, and W7BCL, come in well on the higher frequency bands, 20 and 40.

W7BVV has a large diamond for 10 meters phone, but due to his being on the wrong slope of the hill, his rotary very often beats it. The slope of the hill has been a very satisfactory adjunct to diamonds for some time, and a hill is quite effective when they use them with half-wave antennas, using the side of the hill as a sort of reflector into the sky, both for receiving and transmitting.

W6EJC, has a nice rotary beam now, and we expect him to add to his 73 countries, and 260 foreign contacts.

Now that KA1AW, has resigned as SCM, for Manila, we are wondering who the next SCM will be.

W6GRL is still putting up more diamond antennas. The sky's the limit!

Ernie Brown, W6KNZ, is President of the Marin County Radio Amateur Association, and has helped make a lot of new amateurs, and his code classes are very well handled.

Mars Lusinchi, W6PVC, is editor of the Marin County Amateur "QSA 5," and certainly puts out a fine rag.

Roland Zehr, W6BZF, as Secretary and Treasurer, reminds one of the late Will Rogers.

W6EY, ye good old director, McCargar, never misses an RM Yte nor an RM Meeting.

W6CIS can be counted on to show up during any of the CW Contests.

W7HDO has moved to San Anselmo, and is now on 160 meters.

W6MWK is building his own modulator transformer, and of course by the time this gets to press, will have it completed and operating in fine shape.

Sam Houston (watsina name?) W6ZM is doing extra good work on the American Legion Net, on 1825 KC.

Some of the boys thought the net was to be on 9240 KC, and bought crystals there, and others bought 1826 KC, but now Sam Houston has now settled down on 1825 KC. As yet the American Legion Net does not have the superb organization of the Mission Trail Net, but inasmuch as Sam is an old Mission Trail Man, it will doubtless work out to the satisfaction of all.

W6GPB is going in for beams; W6DIX sounds speedy on his bug; W6OZT is fine on his 20 meter beam.

W6ZL is back on the air after 14 years' absence, and is certainly going strong on 3512 KC. This frequency incidentally is a very fine "rag-chewing" net, and it is a pleasure to join with them once in a while.

W6OKB has a fine location; W6PAZ is active as usual.

W6TL Horace Greer, as usual gets from one to 50 pounds of QSL cards a day, for his QSL Bureau. The rate at which he distributes them is a marvel to all who behold. First he distributes them as "A, B, C, etc." into cubby holes. Then he takes each group and redistributes them as "AA, AB, AC, etc." Horace figures about two hours a day, even with this speedy system based on post office procedure. If envelopes are there, the cards go right back. Those with several No. 10 envelopes get fast service. It is really a tremendous job, and we all owe a vote of thanks to Horace Greer, for the fine work that he is doing there. He now has between ten and fifteen thousand cards on hand some of them going back as far as 1931 and 1932.

W6PAZ is nearly ready; W6OEI has a very active XVI. (Active, now, is it?)

The Associated Radio Technicians of British Columbia, although made up of about half amateurs, shun the idea of mentioning amateur activities in their meetings. The little groups get off on the side, however, because "once a Ham, always a Ham," and even though they try to keep it out of their meetings and out of their literature, they know their hearts and souls are in amateur radio as usual.

W6BJN likes 40 meters best; W6JTP is 160 meter phone; W6AOF is working both 160 and 80 meters; W6GFPB is trying to increase his power; W6FVK likes the high end of the 14 mc. band.

W7FXM is quite an editor and does quite a lot of writing for the Northern Publications.

We all hope that the ARRL will have another board meeting in San Francisco. It is the first time that the board ever met out on the West Coast, and it certainly gave the boys a good viewpoint of the directors in Hartford. Many of them feel that they know the directors and officers of the League personally, and are very enthusiastic about them. I guess the board members will remember for a long time the reception put on by W6EY.

It seems like the Marin County Radio Amateurs can get about 70 hams out about every meeting. More power to them!

KA1QL, now W6QL, is traveling six states, attends Ham meetings everywhere, and visits all

Read How These Men Got Good Pay Jobs in RADIO



HAS OWN' RADIO BUSINESS EXTRA SPARE TIME PROFITS'

I HAVE BEEN IN BUSINESS FOR MYSELF FOR TWO YEARS, MAKING BETWEEN \$200 AND \$300 A MONTH BUSINESS HAS STEADILY INCREASED.

ARLIE V. FROEHNER
306 W. TEXAS AVE.
GOOSE CREEK, TEX.

I EARN \$10 TO \$25 A WEEK IN SPARE TIME AND ALWAYS HAVE PLENTY TO DO. ONLY TRAINED MEN CAN FIX RADIO SETS NOWADAYS. I OWE MY SUCCESS TO N.R.I.

WILLIAM F. RUPP
61 GREEN ST.
BRIDGEPORT PA.

GOOD RADIO STORE JOB

I WAS WORKING IN A GARAGE WHEN I ENROLLED WITH N.R.I. I AM NOW RADIO SERVICE MANAGER FOR M. FURNITURE CO. FOR THE CITY OF 4 STORES

JAMES E. RYAN
119 PEBBLE ST.
FALL RIVER, MASS.

AVIATION RADIO OPERATOR

N.R.I. TRAINING HELPED ME GET AND HOLD MY JOB. I AM NOW IN CHARGE OF THE RADIO DEPARTMENT FOR THE AMERICAN AIRLINES AT CLEVELAND.

WALTER B. MURRAY
AMERICAN AIRLINES, NATIONAL AIRPORT, CLEVELAND, OHIO.

BROADCAST STATION OPERATOR

AFTER COMPLETING 20 LESSONS I OBTAINED MY BROADCAST OPERATOR'S LICENCE AND JOINED STATION WMPC WHERE I AM NOW CHIEF OPERATOR.

HOLLIS F. HAYES
322 MADISON ST.
LAFAYETTE, MISS.

LOUD SPEAKER SYSTEM

MY LOUDSPEAKER SYSTEM PAYS ME ABOUT \$35 A WEEK IF IT HAD NOT BEEN FOR YOUR COURSE I WOULD STILL BE MAKING COMMON WAGES.

MILTON L. LEIBY, JR.
TORONTO, PA.

Be a Radio Technician

Learn at Home—Make Good Money

Do you want to make more money to be successful like the man above? Then find out how you can train at home nights to be a Radio Technician.

Many Radio Technicians Make \$30, \$40, \$50 a Week

Radio Broadcasting Stations employ engineers, operators, technicians. Radio manufacturers employ testers, inspectors, foremen, servicemen in good-pay jobs. Radio jobbers and dealers employ installation and service men. Many Radio technicians open their own full-time Radio businesses and make \$30, \$40, \$50 a week. Some hold jobs in other lines and make \$5 to \$10 a week fixing Radios in spare time. Others make extra money fixing radios while learning. Automobile, Police, Aviation, Commercial Radio, Public Address Systems, Electronic Devices are other fields offering opportunities for Radio Technicians.

Get Sample Lesson and 64-Page Book Free—Mail Coupon

Act today. Mail the coupon now for Sample Lesson and 64-Page Book Free. They point out Radio's spare time and full time opportunities and those coming in Television; tell about my Course in Radio and Television; show more than 100 letters from men I have trained, telling what they are doing and earning. Fine out What Radio offers YOU! MAIL COUPON in an envelope or paste on a postcard—NOW!

J. E. Smith, President
Dept. OFR National Radio Institute
Washington, D. C.

Mail this Now FREE
Get 64-page Book

RICH REWARDS IN RADIO

J. E. Smith, President
Dept. OFR
National Radio Institute
Washington, D. C.

Mail me sample lesson and 64-page book "Rich Rewards in Radio" FREE. (No salesman will call. Write Plainly.)

AGE.....

NAME.....

ADDRESS.....

CITY.....





AIR-MINDED YOUTH GET A 'BREAK'

"If flying is so interesting to me, it ought to interest others. Young men should have a career in it . . . learn to fly properly." Realizing how much easier his boyhood would have been had someone lent him a helping hand, millionaire G. Allan Hancock founded the Santa Maria College of Aeronautics in 1928. During the past twelve years he has helped scores of able and deserving young men who lacked sufficient funds to acquire a thorough aeronautical education. Here's an intensely interesting biographical sketch about one of California's most prominent and colorful aviation figures.

AVIATION'S PATRON SAINT by Edward Churchill



"SOUP'S ON!"

A few years ago airline passengers were lucky to get a thermos jug of coffee! Today they are served delicious six-course dinners second to none. The type of meals served . . . how menus are determined . . . effect of air travel on passengers' appetites . . . these are just a few of the many interesting phases of airline food problems discussed in this unique article

by DE WITT WENDELL

"THE PERFECT" AIRPLANE WING

David R. Davis, "just a little fellow trying to get along," has profoundly affected the study of aerodynamics. This modest genius solved an aviation riddle which defied the most brilliant aeronautical minds since that event at Kitty Hawk! Don't fail to read how this "nut on aviation" combated flight's greatest enemy, air resistance, and shocked the aviation world with his "perfect" wing. You'll find this great article, MYSTERY AIRFOIL by Harold Keen, on page 36 of your P. A.



Get Your Copy of the JUNE ISSUE

Follow the march of modern aviation toward greater goals . . . read the World's Leading Aviation Magazine every month. The June issue is now AT ALL NEWSSTANDS

POPULAR AVIATION

the parts jobbers, as a sort of noon hour occupation.

W6LMD is running for *SCM*, and presumably got it, because W6SG resigned.

W6DWR took his beam down, and is now putting it up again after cleaning it, and eliminating considerable corrosion.

W6DGE has a new *Mimis* Rotary Antenna, which is surely a "peach." It is on top of an eighty foot telephone pole, on a little rise of ground at the East end of Long Beach, just before the strip-off into Belmont Shore, with its salty subsoil.

Jim Larsen, W7DZL, can now be found at Ninth and Burnside, Portland. We all remember the snappy little portable he had up at Mount Rainier.

Temp Ehmsen, W7VS, certainly is making the instantaneously operating 60 watt mobile transmitters these days.

Frank C. Jones, W6AJF, is on the air whenever he builds a new transmitter. Hi!

"XULD is coming in quite consistently," says W6RRE; W6FJX is working portable; W6DEP has a new *Mimis* Rotary Antenna, he is planning to put up.

W7VS, W7DNP, and W7FU had a busy time on ten meters. Their gear shift lever came out while they were on a trip throughout the city of Portland, so they kept on describing the trouble and talking while being towed in (we were wondering if the *FCC* has a ruling about amateur stations being towed).

W7AXR has worked 41 states on his 10 meter mobile. The cards are plastered all over the inside of the car.

W7FDU has a swell "gasoline buggy" wheel chair. We were trying to get him to put a mobile rig right on it. He is a member of the *Chattanooga Club*.

Some of the Long Beach amateurs are very interested in television, and are watching the programs which come nightly from Don Lee in Los Angeles. They use a variety of beams. Roger Howell, an ex-W7 has a three element beam in his home, and a six element down town. The six element (two layers of three element beams a half-wave apart) practically eliminates QRM as the beam itself works against itself, thus forms an effective shield against street noise.

W6PFA is a good convention Ham. He handled sixteen hundred *Wanderbird* messages while the *Wanderbird* was down at the South Pole last year, and plans on doing it again this year. This will be the fourth year.

INTERESTING commentary on the stages to which the belligerent dictatorships will go to disseminate their propaganda is to be found in the columns of Quesstee which faithfully reports that certain German hamstations will be relicensed to operate during the present war. Most significant of all, is the statement attributed to D4BU. Please notify all interested.

In view of the well-taken program promulgated by the *ARRL* for the benefit of the American Ham, and in further view of the fact that the newspapers have been full of the German "White Paper" alleging that we, of all people, started this war, we wonder who might be the persons who are "interested." The policy laid down by the *ARRL* not to communicate with the belligerents, and agreed to by many of the remaining hams on the air today, whether here or elsewhere, cannot allow that by the mere permission of the German Government to sanction the "D's" being on the air, we should thereby drop our ideas that belligerents are to be watched from the sidelines and not "spoken."

Then, too, there is always the risk that the "D's" might at some future date print their own "White Paper" accusing the American Ham with starting the war. Hi.

While we sympathize with the German Hams, ever mindful of the fact that they, too, had little to do with the rupture in the general good-fellowship which had prevailed among the hams, prior to this war, we feel that the *ARRL* edict should stand and that we should continue to mind our own business and refrain from QSO'ing the "D's"—at least until the end of the hostilities. Let us remember that by doing this we will best serve our country in maintaining its neutrality.

TEN meters won't be completely outdone, and for the first time in many months there is enough 28MC DX to devote a separate paragraph to it. With everyone using ECU's it is tough giving frequencies, so you will have to dig 'em out yourself. Active during the past month were: CX1FB; LU9AX; LU2FC; LU2DH; HC1VT K6; AYD; K6SCH; K6PAH; PY2AC; K6QZL; K6-SBU/K6; K4DTH; XELAM; ZP1AA; LU7AZ; PY1HQ; K4FKC; K6FFL; CO2AM; CE1AO; K6-JLV; CO2IM; NY4AD; K6PLZ; K6BNR; LU1DA; TL3AV; HP1A; and KA1GC. While it isn't DX one of those unusual things came though on 28-MC. CW during the DX contest. In order to make public their achievement here is a partial list of stations active on 28MC. CW during the DX contest. W1TS; BPN; 2BDK; IRI; APT; HHP; WC; EEN; UK; CJM; AIW; 3EMM; 4BZ; CDE; ECI; FJS; 10; 5AVF; FGB; DWO; 6QQI; QD; POZ; 7EZX; GBW; UQ; FES; EHL; DRF; SOXG; ERA; ZY; 9FYV; WTW. Of course there were numerous others active who are not listed, but this at least proves there is something rarer than a ten meter CW signal—no it's not a 160 meter CW signal.

W4FVR is ex-W2AAL and is now engineering at WBT. John out at W9CSI really works out using a 250 watt final with an HF200. Antenna is a Johnson Q. Incidentally, W9CSI has 97 countries on CW, but is not on 20 phone.

W6HSV/2 is none other than Fritz of NY2AE.

etc. Now stationed at the Brooklyn Navy Yard in New York he'll be signing a W2 call real soon. Newcomer W2MUCO makes himself heard with 60 watts on 20 meters. Frank didn't waste any time getting on the air. First contact for W2MUCO outside of the U. S. was HH2MC.

W2HP is the local supply for Long Island pole masts. John is with the local power company if that means anything to you.

Almost overlooked, but not quite is a DX list for the first two days of the month, logged on the East coast. Phone: XU1B; PK1OG; KC4USC; EK1AF; K7HCX; LU1BA; and a slow of K6's CW: X17AL; A7JN; TA1AR; KC4USC; X66-MK; X17AL; D8HU; HA4P; K63ID; PY2NO; K16BRWZ; CE3BG; LU95Z; J2OC; J2KG; K6-SCB; CE3CB; J2KN; HK5BD; XU6K; HH3DN; HH2MC; OQ5BF; OQ5AV; U9ML; UR1B; HA4H; LY1S; all on 14MC on 40 there were ample Hawaiians, HA4H; several K6's; and HH2PB. 80 was good also, but no DX was heard except four Spanish speaking phones in un-identified countries. Add on HP1G; CM2BF; CM2PW; CM2JC; CO7CX and you have the DX story for the month.

W9MSX runs 150 watts into an S52 using an indoor antenna and a NC101X receiver. Burt's first qso with the setup was 11R. W9FS, the contest DX'er, is trying to snag AC1YN for zone number you-know-what. AC1YN-K6BRWZ-W5-EGA-W21OP supply a fast route to Tibet if you have any traffic to friends or relatives there. W5DG is running a kilowatt on 40. HH3DN says to QSL to Gabriel Dorce; Quarters General; Haiti. CM2JC asks you to ship his pastebored to Julio Martinez; Oquendo 204; Havana, Cuba.

W7HNY over Portland way runs 100 watts into his VFO 809. KC4USC won't work anyone on his frequency—which is the latest way to get rid of QRM. Too bad for the boys who have their only crystal on his frequency, but that's DX. WSTZ in Cincinnati, Ohio pounds through using a 30 watt portable rig. Nothing startling until we learn it's on 14MC phone! The line up is a 6L6 into an 807, modulated by a 6J7 into a 6C5 driving a pair of 6N7's. The complete rig is on one small chassis and according to George runs his HK254 PA plenty of competition.

WH1CA hit the 110 mark in the DX CC and is

Classified
Rate 15c per word. Minimum, 10 words.

CORRESPONDENCE COURSES

USED Correspondence Courses and Educational Books sold or rented. Inexpensive. Money-back guarantee. Write for Free Catalog listing 4000 bargains. (Courses Bought.) Lee Mountain, Pisgah, Alabama.

CORRESPONDENCE courses and educational books, slightly used. Sold, Rented, Exchanged. All subjects. Satisfaction guaranteed. Cash paid for used courses. Complete details and bargain catalog free. Send name. Nelson Company, F-237 Manhattan Bldg., Chicago.

INSTRUCTION

AMATEUR Radio Licenses, complete training in code and theory. Hundreds of licensed students on the air. American Radio Institute, 1123 Broadway, New York.

PATENT ATTORNEYS

INVENTORS—Before disclosing your invention to any one send for Form "Evidence of Conception"; "Schedule of Government and Attorneys' Fees" and instructions. Sent free. Lancaster, Allwine & Rommel, 414 Bowen Building, Washington, D. C.

PATENTS—Advice and booklet free. Highest references. Best results. Promptness assured. Watson E. Coleman, Patent Lawyer, 724 9th Street, Washington, D. C.

PATENTS Secured. Two valuable booklets sent free. Write immediately. Victor J. Evans & Co., 583-G Victor Building, Washington, D. C.

RADIO ENGINEERING

RADIO Engineering, broadcasting, aviation and police radio, servicing, marine and Morse telegraphy taught thoroughly. All expenses low. Catalog free. Dodge's Institute, Elm St., Valparaiso, Ind.

RADIO

WE buy and sell used radio testing equipment. Harold Davis, Inc., Jackson, Miss.

HAM STUFF

MUST sell all transmitting and receiving equipment. Write for list. Carl A. Kowalski, 1239 Kinsmoor Ave., Ft. Wayne, Ind.

SELL: McMurdo Silver "15-17" receiver with Clifton console, \$110. Gay Morrison, Jr., Box 123, Conway, Ark.

BARGAINS. Used sets, equipment, tubes. J. C. Thimblan, Lake City, Minn.

MISCELLANEOUS

SONGWRITERS. Authors, Inventors! Protect your ideas. Total cost \$2.00. Request free booklet. Evidence Bureau, F1501 Broadway, N. Y. C. PHONOGRAPH Records—twelve, \$1.00. Paramount, FA-358 East Market, Wilkes-Barre, Pa.

now sitting back to enjoy life. W6QQL is back at Boulder City, Nevada, to make the boys happy. W21OP is rebuilding completely again. Remember the little piece about old timers and young ones in the Frankford Radio Club? W3KT got mad that we said the reason it is such a club is the young live wires keep it at top. Jessie went out and won the club WAS contest producing the 48 cards early in February.

W2FOA/W2HXQ are selling out. Why? W2JDG/W2JZX will soon be back on the air with their highpower on 20 meter phone. W2GT, DX'er de-luxe, lost his rotary during the freak ice storm which hit the East recently.

WIHSA and WIMPC are co-operating at MIT with some of their projects. W2EWH/4 manages to enjoy some real Florida sun while working down there. W9UUA/7 is operating at Rock Springs, Wyoming.

DX men have been working overtime to produce a list that looks like old times. The DX contest brought out a few new ones, but generally it was just good "digging." You'll notice numerous European stations listed, but best done on hand indicates that the FCC does not approve of contacts with Europe.

The 20 meter phone band outshone everything to give us: LY1J; BA7BA; EK1AF; KC4USC; CO2RA; ITAK; K7BUB; XUSAM; XU1A; XU1B; YN1P; YN1FF; YN1OP; XU1AA; LY1S; HAQO; HA9Q; HA6T; LZ1ID; LX1RB; ES5D; ES5G; K4FKC; KA1ME; KA1AF; HK2CC; KA1SM; K6OJI; K7HUZ; K6BNR; K6MGA; CO2BA; PA5F; YV5AA; CO2AM; CO6OM; YV1AQ; YV5ACE; CO2JG; XE2IY; TI5JAS; HK1PA; T16HP; XE1FF; and YV4AE.

20 meter CW isn't too bad, but mainly because of AC1YN. W2GTZ and W2A1W are two recent workers of Fox. W9HLE skeds AC1YN daily, as does K6BRWZ on the Tibet-New York traffic line. The following DX may be found from 14300 KC to 14400 J2IX, J2NE, J2KN, HA9U, K4KD, K4JPH, K4FCV, LU7AZ, K6BRWZ, PY2NO, XE1AM; H13C; PY2AL; PY1G; HH2MC; LU4NB; CM2AP; PY5OG; K5AB; KA1FG; KA1HR; PY2GS; OA4U; PY1HO; LU2AG; LU4AG; LY1SS; CP1 XA; HC1VT; PY2AG; LU5FB; HE2F; CM2AO; CX2BK; PY2KT; HK2BD; PY1DS; PY1HC; PY1DW; and D4BIU; OK3ID; OQ5IM; OQ5AV.

W2KWP has recently slipped down from 29690 kc to 29060 kc, so that he doesn't have to yell so long per QSO. Bill is with the Newark Police Radio.

W2FGJ has an SX-17 receiver. Hank has one of the best-sounding cathode-modulated outfits around town, and runs 140 watts.

W2EDJ isn't being heard so much of late because Jack is having trouble with his modulator. XE2FI, is XE2FC's brother. Our last QSO of 1939 was with XE2FC in Tampico, and climaxed another year full of many swell QSOs.

In the Newark's only evening paper) Kay Caldwell writes a column for the adolescents called "Youth Talks It Over." Her advice to young girls who despair of their less-amorous swains sure is disheartening. She says that when the lad prefers to talk about his Short-wave radio all the time, it isn't due to the girls' failing charms but is just a sign of his (the ham's) immaturity! Oh well . . . we've been accused of everything else.

Say E1, don't forget that Lighthouse! hi. W2BFL has a 3-element beam that is a joy to behold, and with a hundred in. Tony's working out fine.

W2KRA has been on for some time working DX on 10 and 20 meters. Barry has a near rack & panel job which is responsible for a good sig.

W2LDX who is sophomoring at Rutgers University reports little ham activity because of studies. Al claims they have a swell gang at the radio club, and that he will have his own junk going soon after the marking period. (Better not before.)

W2GPF is beginning to feel the ham-itch again. After ten years off Roy is setting up a new layout, and with the help of his pal ZAG, will be working out on ten fone. Something on the roof wud work better than that indoor antenna, Roy.

We in Northern Jersey welcome W2MTJ to our midst. Ken who is ex-9LNO has just moved in from points west. He has a dandy layout using a grid-modulated T200 with 225 watts input.

With a "Couple O' Kilowatts" W2COK is banging out on ten-meter phone. Bill is up on the high-freq end of the band where he finds the QRM situation less acute. Gnd! Wotta vocabulary.

Even the much-scooped at town of Weehawken, N. J., boasts of an amateur. He's W2KXS, works on ten fone, and also in the post office. Howdy Ray!

Another confirmed CW man gone "phony" is W2FTL. Johnny has a new cathode-modulated outfit using a 7Z-40 final and a pair of 45's as modulators. He's still using the same 40-meter zapp, but a *Haiti* after's recvr has supplanted the 81Z.

W2LUJ who is still portable-two, built Johnny's rig, and is working out swell with his own flea-powered ECO outfit. How about a call sometime, Art?

W6MUM's QSL card gave us quite a surprise. But Mum's the word, Baird.

The Newark College of Engineering Radio Club has a new National NC-100X receiver. This job has full range coverage and it was decided that it would be an asset to have something to do a lil listenin' to expeditions, commercials, etc.

Conspicuous by his absence on 160-meter phone is W2IBX. How's about getting the heap going again Paul? (Pse QST next page, O.M.)



Put Your Valuable Radio Experience to Work for You!

Your experience is a valuable asset in preparing for a career in the professional field. Many top engineers and others in radio today turned their "hobby into a career" and now enjoy good technical jobs. You have the same opportunity, by applying your inherent love for radio to a planned, proven course of training. C.R.E.I. courses are selected by men in the industry who realize that technical training is the difference between "just a job" and a real future in radio! Among our students are many amateurs who are now heading into good engineering jobs . . . hundreds of men in more than 300 broadcasting stations . . . more than 700 radiomen in the Navy . . . scores of airways men. C.R.E.I. training must bring results. May we show you why?

Write for Free Book, "A Tested Plan"

To enable us to send you complete information, please state briefly your background, education and present position—and whether you are interested in home-study or residence training.



CAPITOL RADIO Engineering Institute
Dept. RN-6, 3224 16th St., N. W., WASH., D. C.

Correspondence Courses in **RADIO and ELECTRICAL ENGINEERING**
ELECTRICAL ENGINEERING Get good electrical field. Prepare yourself at Low Cost, for secure future. Modern course. So simplified anyone can understand quickly.
RADIO ENGINEERING Extra fine course in radio, public address, photo-electric work. Training you to be super-service man, real vacuum-tube technician. Experimental kits furnished. Diploma on completion.
Either course, only \$25. Deferred payment plan available. Write for free copies of school catalog, student magazines, full details. SEND NOW!
LINCOLN ENGINEERING SCHOOL, Box 931-R 18, LINCOLN Nebr.

FREE! VERY LATEST PROFIT GUIDE
Everything in RADIO!
At Lowest Prices!
COMPLETE SELECTIONS GUARANTEED QUALITY Faster Delivery
Most complete stocks of Universal and Exact Duplicate Replacement and Repair Parts. Tubes, Aerials, Cabinets, Radio Sets, and Amateur Equipment.
P. A. EQUIPMENT
Separate amplifiers or complete systems with any desired assortment of speakers, horns, baffles and microphones. Everything from 5 to 100 watts. Prices that save money for you.
ELECTRICAL APPLIANCES
Extra profits for you! Standard Brand Electric Irons, Grills, Toasters, Percolators, Waffle Irons, Vacuum Cleaners, Clocks, Mixers, etc., at lowest prices.
MAIL THIS COUPON TODAY
The RADOLEK Co., 601 W. Randolph St., Chicago, Dept. R-42
Send the latest Radio Profit Guide FREE.
Name _____
Address _____ Dealer? _____
Experimenter? _____ Serviceman? _____ Amateur? _____



- ★ As radio marches on to a still more critical technique, there are new and more precise requirements to be met by mica condensers. Which accounts for several new items in the AEROVOX mica line.



- ★ Push-button tuning and other critical applications are taken care of by the AEROVOX Silver Mica Condensers now generally available. These units have long been used by set manufacturers. Pure silver is deposited and firmly bonded on mica sheets. A remarkably low temperature coefficient is attained—only plus .0022 per degree F. These condensers have excellent retrace characteristics. Practically no capacity drift with time. Exceptionally high "Q." Tolerance limits can be held to as close as 1% if required. Available in usual brown bakelite, or the yellow XM low-loss bakelite. .000005 to .005 mfd. 500 v. D.C. Test.



- ★ The dozen and a half bakelite molded receiving and transmitting types of AEROVOX mica condensers are now available in yellow XM low-loss bakelite at only 25 cents added to list. Meter-mounting-bracket units are also available for r.f. shunting of meters. And when it comes to handling considerable power at elevated frequencies, there are the porcelain-case units.



★ Ask Your Jobber . . .

He can show you any mica condensers you may require, from the extensive AEROVOX line. Ask to see them. Ask for new 1940 catalog and free subscription to monthly RESEARCH WORKER. Or write us direct.



W2KGZ has joined the gang around town who are trying to get a little activity stirring on 2 1/2 meters. What with work and night school, Mike doesn't get too much time for ham radio.

It seems to us that the W-hams would get an awful kick out of getting "calls heard" reports from some of the DX boys who are off right now. So make 'em voluminous boys, and include all those S2 sigs like mine. (Conceded eh? All right then, S1.)

Another of the 160-meter phone boys, W2HFB, seems to be in the doldrums at this time. Watsa Bill? That YL can't be taking up all your spare time.

That guy on the cover of Mar. '40 RN has a peachy final tank.

W2MPQ went over to neighbor W2IDU's house for a visit, and succeeded in talking George out of his bug. By the by, IDU has a new Pontiac convertible coupe.

[Tx to W2GPW for the above. Ed.]

W2EFI and W2IFX both are now working for the American Airlines at North Beach Airport.

W2MWK new ham located in Ozone Park intends to install ten and two es one half gear in his gas buggy for this summer.

W2JWE has pair of 809s in final on twenty and forty cw and is thinking of cranking the rig up an eighty cw.

W1IN/2 that tall feller working in local ham house in NYC hails from Boston, Mass.

W2KIK piled up a nice score in the 1940 ARRL DX contest.

W2CKQ is waiting for the New York World's Fair to open so he can handle tlc at W2USA. Wat sa. WZHXQ?

W2KPE is the Voice of Canarsie on 160 fone. W2KYV active on twenty, forty, eighty cw with 125 watts.

W2LUX can't seem to work out so good on ten fone so is trying his luck on two es a half.

W2LGS doing nicely on two es a half working into N.J.

W2MQA on 160 fone in Flatbush "Yowzah." W2GGN using a single 801 osc on two es a half.

W2KXG not active due to nite school work. [Tx to W2HBO for the above.—Ed]

AN East Providence, R. I., 2 1/2 meter SWL reports:

The following is a list of 2 1/2 meter stations heard operating more or less consistently in and around Providence, R. I., during the last several months.

W. BOM. CDI. CNJ. DBA. EBA. GUD. GWL. HJB. HQR. HKV. INM. JP. JAA. JUN. KKE. KOA. KUX. KVB. LKH. LNK. LPY. LQE. MHB. MKL. MLA. MLL. MOT. MXA. MXB. MXO. OAD. OEX. OJF. RAD. RAG. RUS.

One of the local 112 mc. hams is off the air temporarily due to a new kind of interference problem. A bellicose neighbor, who plays an electric guitar, complained that instead of *Aloha Oe* all he could bring forth was "*W one Blub Blub Blub calling See Cee*." Hi!

While visiting the other day ran across a ham who was using a temperature gauge. From an extinct auto instrument panel for a plate milliammeter. He was running a type 10 long line oscillator with 500 volts at 185° F. input. Hi!

Most of the receivers are of the self-quenched type. (56 or 76) with one of two stages of audio, while the Xmters vary from 45's to HK24's in all the usual circuits.

FROM W3EEW.

W3FZI, opping portable while on a job in Baltimore, plans to keep in touch with Phila. friends via 80 and 40 cw, using the popular 6L6G xtal osc.

Two of his buddies down there with him, W3GBQ and W3EJF, are talking up some high-class 2 1/2 meter plans.

W3RR heard on 7 mc. enjoying his weekly ragchew skeds with W2JDC and W1BDU.

A well know Phila. contest man is having fun chuckling over his "no-handed" contest setup. Rigging up a small speech amplifier, he dit dit dit dahs into the mike and operates a relay which keys the rig. Doggone if it doesn't work, leaving hands free for receiver and log! What next!

Another veteran c. w. man planning on a 2 1/2 meter vacation is W3DPU, Phila.'s emergency coordinator.

With a fb eco and good fist, W3GKO is dragging in plenty of traffic on 80 and 40 these days.

Being an active station in a trancon traffic net means work, discovers W3HRS. Over 100 messages direct from Calif. in one night is no picnic, hi!

W3QV's new rhombic, backed by his powerful transmitter, is to be relied on for lots of work with the Byrd Expedition.

A certain 80 meter ARS man is getting quite expert at playing "America" on his eco. Super-patriot?

Three of Phila.'s bc stations are reported readying for new frequencies this summer, and what pleases us is the fact that they are moving to even hundred kc. spots, making it fb for those using 100 kc. freq. standards.

W3EEW builds eco's for others but spent two months trouble-shooting in his own, hi!

W3AGY and W3EBS heard boasting about excellent results in the Jan. ORS Party. They usually have good reason to.

WSTNA/S. now doing oil research work at VPI. says the ym/yl ratio is too high down there! Has to go after "dx yls!"

June is a long way off but lots of Field Day plans are being carried on already. Preparedness counts a lot, it seems.

W3FFL, besides fooling with his 10 meter

fone rig, is experimenting with a high-fidelity amplifier for his symphonic records.

VIA W4EVX:

Since spring is here at last the whole gang of W4's are brushing up their rigs, putting up new antennas and getting ready for newer activities.

A new club has been formed in Nashville, Tennessee and under the club call of W4GN. About five different bands are covered including five meters with a maximum of 500 watts on the lower frequency bands. All of the Tennessee hams can participate by making schedules, reporting activities and by showing operating procedure that will help in time of emergency. This club is expected to be the center of traffic handling for Tennessee. Some of the organizers are W4AYE, W4BAF and W4DDF. Listen for W4GN every Monday night on 3550 kc. at 8:00 p.m.

W4DRZ of Fort Lauderdale, Fla. has become acquainted enough with PK10G to receive a pack of cards from him to forward to the boys throughout the fourth district who have worked PK10G.

W4FNS, the "freckle-faced" Kid of S. C. (age 15) is doing FB. He has W4C. W4S. W4BE, and has worked 60 countries with confirmations of 45.

Reaching out into spots where such glamorous activities are unheard of we find that W1BLO can't seem to get it is for him to receive R9 from YU7LX on c. w. while W1BLO is on phone with only a kw.

W3FJU is back on 20 meter phone again after being on 75 this winter. So conditions must be getting better for DX. He already wants to know the Qth of EA7AV.

W7AYO is giving W1AW some competition in transmitting official ARRL messages. You might think so when he does it for the benefit of the South Americans besides the whole W gang. Stan is a real pal to any of the well known hams down there.

Since W6PH of Salinas, Calif. received a card from Tennessee, he only needs Mississippi and S. D. for W4S now.

W3CRA, the old Century Club man who has more countries than any other station in several W districts is on regular now with a CQ with XUPZ at the other end.

We find W5CTW rotating a *mins* beam. Yes, with one shout at K4USC that ATSC came back so quick giving 5CTW, 589X that it kinda scared him, but since 5CTW gets R9 from that those DX honeys he didn't take it so serious at that.

W3HTF says he thought this best DX was a VK3 on 40 meters, but since Herm worked HC1FG and HC1VT in one night on 20 he is going to stick to 20.

ROLL out the DX and we'll have a band full of fun. Who said DX was a minimum nowadays? Even if it is falling off a bit, fellas, the fever is as strong as ever and the way cards are coming through lately it shows that some of the best Q5ers for W4C are ZS6BJ, ZS6EU, ZS1AC, ZS1DB, ZS2G, ZS5CQ, ZS4AA, XU8MI, LZ1ID, LU8DJ, and VK5AJ.

To the editor: Your dope telling some of the South Carolina stations to wake up and listen for the CE's in the April issue of RN really brought results. Listen to this:

CE3AG and CE3BF have been active trying to work W4S lately. Both have had cards from 47 different states years ago, but for three years they have been calling CQ S. C. every night. At the same time the other day two letters were received from Chile, one from 3AG and the other from 3BF. CE3AG said, "Ah! at last I worked W4CQ in S. C. on ten meter phone!"

CE3BF says "I worked W4EMT in S. C. and got his card." Congrats boys and FBI! CE3BF is now on board the *Santa Clara* taking a voyage to Antafagasta (CE1) where he is making negotiations for the *DX Century Club*. He says that he has an album which contains the cards of the countries that he has worked and all the Chilean amateurs look at it because he is nearest to the *DX C.C.* He hopes to be the first South American Member of the *DX C.C.* He will be back in Santiago in a month and start posting the brass again.

CE3CB is Chile's best ragchewer. He QSL's 100% and sends a separate card for each QSO.

AND tt abt winds up another colym fer this mnth. Sure hs bn a lot of info being passed around here. HMCHTR continues to top them all fer gossip es such. But it cn be made much bigger. So long as the publisher of RN will give us the space why not use it? Need lots of dope fm the following places: Maine, Vermont, Upper New York, Kentucky, South es North Carolina, Missouri, Texas, Arizona, New Mexico, Utah, Idaho, The Dakotas, Oregon, Washington, Nebraska, West Virginia, Washington, D. C., and Kansas.

Watsa youse guys? Don't you want your state represented? We pay fer the info, es the pix. Es if the pix is one of your shack you can have it free, after publication, for the asking. Cuts dwn the cost of personalized QSL's like no-body's biz. Es hw abt your vacation trips? Wat, no rdio? We don't believe it! Send along all the dope.

BCNU es sk fer nw. Ye Ed.

Printed in

\$5,000.
**PICTURE
 CONTEST**

**CLOSING DATE
 SEPT. 1, 1940**

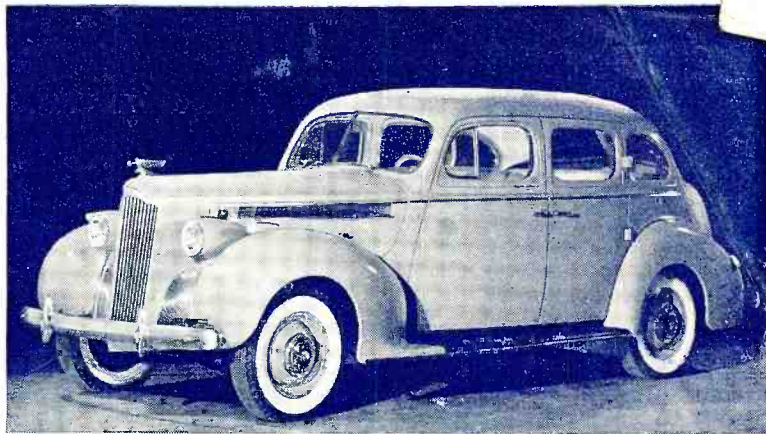

**FIRST PRIZE: this 1940
 Packard touring sedan**

**271 OTHER!
 PRIZES!**

Camera fans—here's the most *spectacular* photo contest ever held by any photographic magazine! Whether you are an amateur or professional photographer, you can't afford to pass it up. *Just imagine*, \$5,000 in prizes! Yes, *your picture* may win that 1940 4-door Packard touring sedan or any one of the other 271 *big* cash or merchandise awards!

You'll find the complete list of prizes together with the official contest rules and entry blank on page 52 of your June POPULAR PHOTOGRAPHY! If you haven't a copy of this important issue, go to your nearest newsstand or camera store *immediately*—but don't delay! Enter this giant photo contest now and make your camera pay dividends!

COMPLETE DETAILS IN THE JUNE

**Popular
 Photography**

NOW ON SALE

At All Newsstands and Camera Stores — 25c

THE NEW CHANNEL-ANALYZER

Follows the SIGNAL from Antenna to Speaker

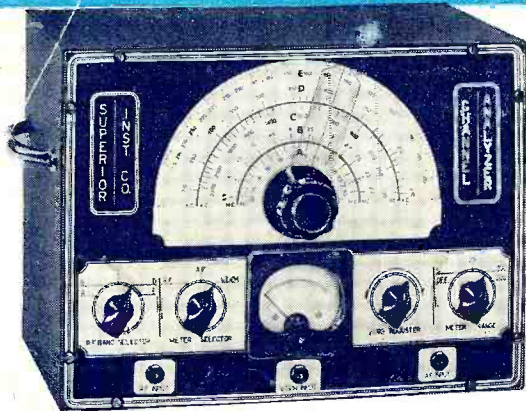

The well-established and authentic SIGNAL TRACING METHOD of locating the very circuit in which there is trouble, and the very component that causes the trouble, is now for the first time available at a price any radio serviceman can afford.

THE CHANNEL-ANALYZER will

- ★ Follow signal from antenna to speaker through all stages of any receiver ever made.
 - ★ Instantly track down exact cause of intermittent operation.
 - ★ Measure both Automatic-Voltage-Control and Automatic-Frequency-Control voltages and circuits without appreciably loading the circuit, using built-in highly sensitive Vacuum-Tube Voltmeter.
 - ★ Check exact gain of every individual stage in receiver.
 - ★ Track down and locate cause of distortion in R.F., I.F., and A.F. amplifier.
 - ★ Check exact operating voltage of each tube.
 - ★ Locate leaky condensers and all high-resistance shorts, also show opens.
 - ★ Measure exact frequencies, amount of drift and comparative output of oscillators in superhets.
 - ★ Track down exact cause of noise.
- The Superior Channel-Analyzer comes housed in shielded cabinet and features an attractive etched aluminum panel. Supplied complete with tubes, three specially engineered shielded input cables, each identified as to its purpose. Also full operating instructions. Size 13"x10"x6". Shipping weight 19 pounds. Only

\$19.75

THE NEW MODEL 1280 SET-TESTER

Combines Models 1240 and 1250

A complete testing laboratory in one unit, the Model 1280 combines the Models 1250 Multitester and 1240 Tube Tester. (See specifications of each below.)

- ★ Instantaneous Snap Switches Reduce Actual Testing Time to Absolute Minimum.
- ★ Spare Socket and Filament Voltages Up to 120 Volts, Make the Model 1280 Obsolescence Proof.
- ★ Latest Design 4 1/2" D'Arsonval Type Meter.
- ★ Works on 90 to 125 Volts 60 Cycles A.C.

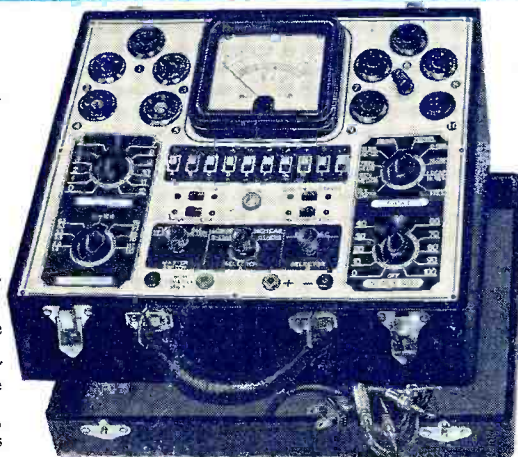

Even those servicemen who through past purchases know they can always get SUPER-VALUES from Superior, will be amazed and delighted when they read the specifications of this all-purpose instrument and then note the unbelievably low price. The Model 1280 features a 4 1/2" D'Arsonval type meter for easy reading of the various scales, and in line with our new policy of stressing appearance as well as serviceability in our new 1200 line of test equipment, our Model 1280 utilizes an aluminum etched panel, designed for beauty as well as ruggedness. The primary function of an instrument is, of course, to make measurements accurately and when designing test equipment this is our first thought. However, we also appreciate the important part the appearance of an instrument plays in the impression a serviceman makes on his customers, especially on home calls. We have, therefore, paid special attention to the outward design of all of our new instruments. For instance, the panel of this Model 1280 is made of heavy-gauge aluminum and etched by a radically new process which results in a beautiful, confidence-inspiring appearance.

Model 1280 comes complete with test leads, tabular data and instructions. Shipping weight 18 pounds. Size 13"x11"x6 1/2". Our net price

\$19.95

Portable cover \$1.00 additional

THE NEW MODEL 1250 MULTITESTER



SLOPING PANEL FOR PRECISE RAPID SERVICING

Etched Aluminum Panel

Specially Designed Electronic Rectifier Enables Linear A.C. Scale, High Stability and Little or no Temperature Drift.

Here is an opportunity to acquire a Multi-Service, Precision Engineered Instrument, for less than you would have to pay for an ordinary Volt-Ohm-Milliammeter. Besides making the usual volt, resistance and current measurements (both A.C. and D.C.) this unit accurately measures the CAPACITIES of mica, paper and electrolytic condensers, INDUCTANCE of coils, chokes and transformers, DECIBEL gain or loss, of power amplifiers and public address systems, WATTS output of amplifiers, receivers, etc.

SPECIFICATIONS

Complete A.C. and D.C. Voltage and Current Ranges	High and Low Capacity Scales .0005 to 1 mfd. and .05 to 50 mfd.
D.C. Voltage: — 0-15, 0-150, 0-750 volts	3 Decibel Ranges
A.C. Voltage: — 0-15, 0-150, 0-750 volts	—10 to +19, —10 to +38, —10 to +53
D.C. Current: — 0.1, 0-15, 0-150, 0-750 ma.	Inductance: 1 to 700 Henries
A.C. Current: — 0-15, 0-150, 0-750 ma.	Watts: Based on 6 mw. at 0 D.B. in 500 ohms .006000 to 600 Watts
2 Resistance Ranges 0-500 ohms., 500-5 megohms	

Model 1250 works on 90-120 volts 60 cycles A.C. Comes complete with test leads, tabular charts and instructions. Shipping weight 9 lbs. Size 9 1/2"x11"x6 1/2". Our net price.....

\$11.85

Portable Cover \$1.00 Additional

THE NEW MODEL 1240 TUBE TESTER

Instantaneous Snap Switches Reduce Actual Testing Time to Absolute Minimum

Tests All Tubes 1.4 to 117 Volts

Sockets for All Tubes—No Adapters

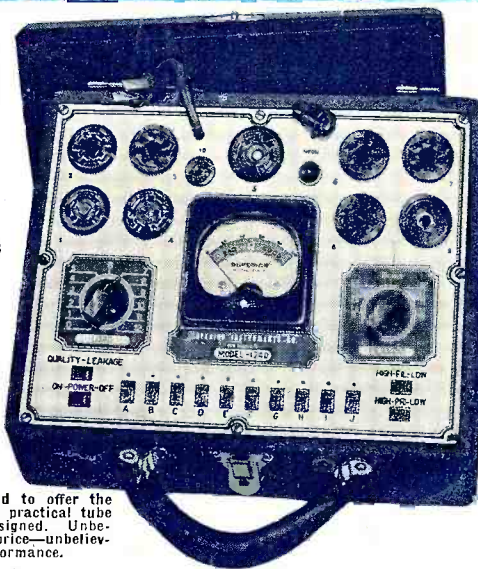

Superior is proud to offer the newest and most practical tube tester ever designed. Unbelievably low in price—unbelievably high in performance.

- ★ Tests all tubes, 1.4 to 117 Volts, including 4, 5, 6, 7, 7L, octals, loctals, Bantam Jr., Peanut, single ended, floating filament, Mercury Vapor Rectifiers, the new S series, in fact, every tube designed to date.
- ★ Spare socket included on front panel for any future tubes.
- ★ Tests by the well-established emission method for tube quality directly read on the GOOD ? BAD scale of the meter.
- ★ Jewel protected neon.
- ★ Tests shorts and leakages up to 2 megohms in all tubes.
- ★ Tests leakages and shorts in all elements AGAINST all elements in all tubes.
- ★ Tests BOTH plates in rectifiers.
- ★ Tests individual sections such as diodes, triodes, pentodes, etc., in multi-purpose tubes.
- ★ Latest type voltage regulator.
- ★ Features an attractive etched aluminum panel.
- ★ Works on 90 to 125 volts 60 cycles A.C.

Model 1240 comes complete with instructions and tabular data for every known type of receiving tube. Shipping weight 12 pounds. Size 6"x7 1/2"x10 1/2". Our Net Price.....

\$11.85

Portable Cover \$1.00 Additional

SUPERIOR INSTRUMENTS CO.

136 LIBERTY ST., DEPT. RNS
NEW YORK, N. Y.