

RADIO'S FOREMOST MAGAZINE



34

# RADIO NEWS and The SHORT-WAVE

25¢

MARCH

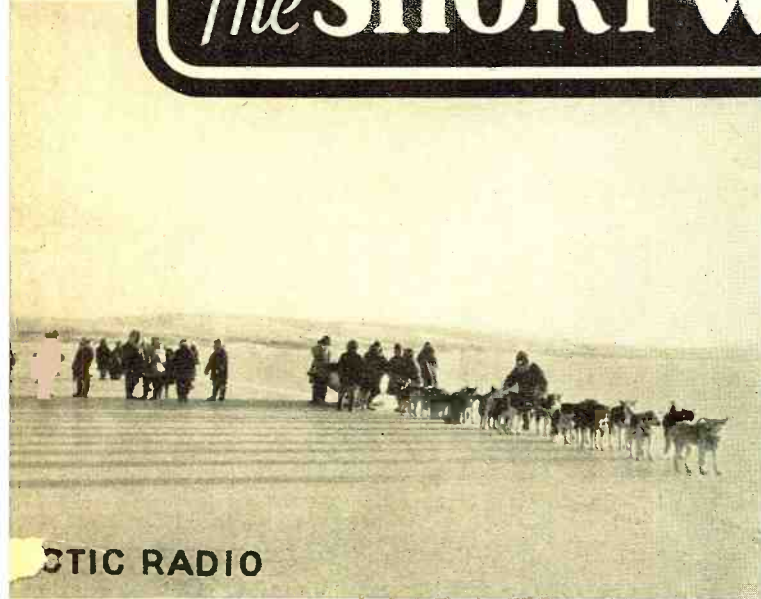

ACOUSTIC RADIO

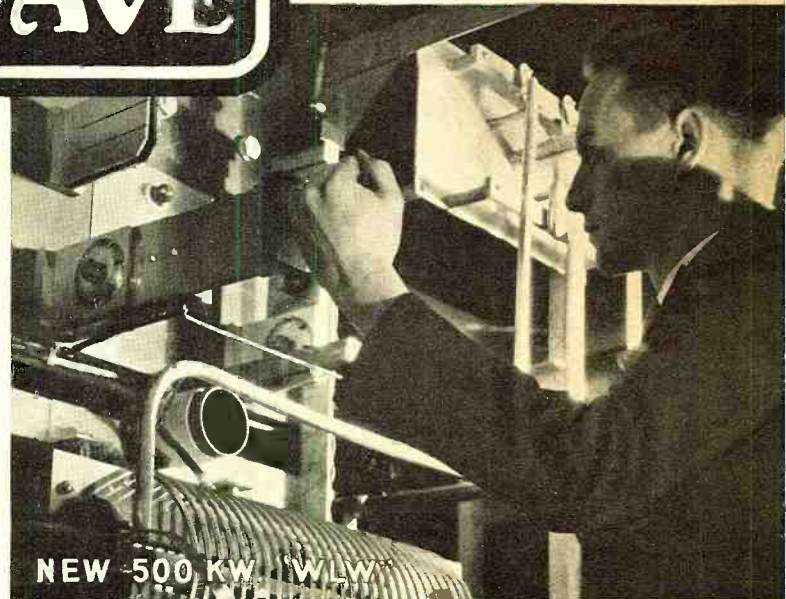

NEW 500 KW "WLW"



RADIO "TICKER"

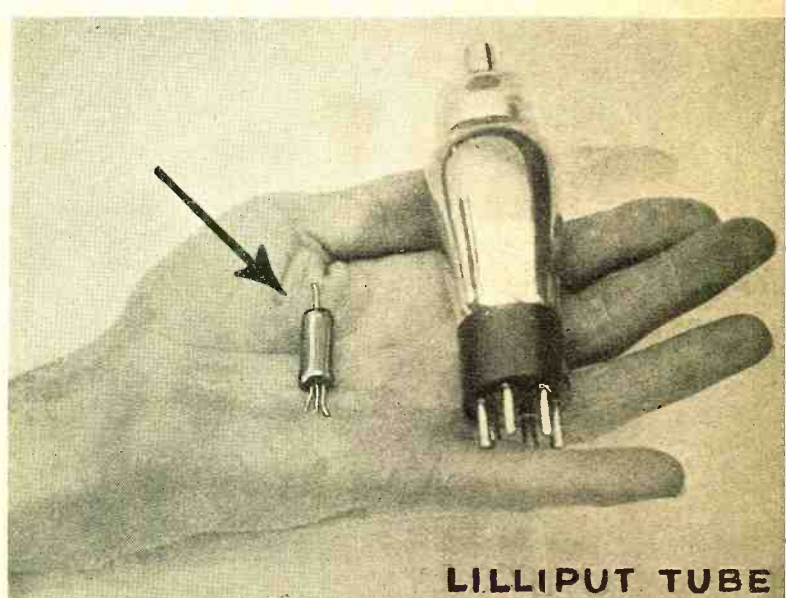

LILLIPUT TUBE

## MODERN BATTERY SETS

A Publication Devoted to Progress and Development in Radio

Service Work  
Engineering  
Industrial Application  
Experimental Research

Short Waves  
Broadcasting  
Television  
Electronics

DX Reception  
Set Building  
Amateur Activity  
Electrical Measurements



# All-Wave Radio

## ENTERTAINMENT FROM THE WHOLE WORLD!

**PERFORMANCE** the best ever! Efficiency in design and operation! Painsstaking manufacture of chassis and cabinets.

These are only some of the features that qualify the new RCA Victor "All-Wave" models as leaders in their field. For example, did you ever hear of an all-wave set before with complete coil-systems for *each* wave-band? This is but one feature of the RCA Victor models which indicates their superiority in design and operation. Also, the new airplane type dial for easy, accurate tuning is an additional advantage.

Through experience, you have come to know you can rely on the RCA Victor trademark as the emblem of radio quality. And it represents outstanding performance. These models are the last word for the "All-Wave" fan . . . you'll be thrilled everytime you turn the switch.

Become acquainted with the RCA Victor line of "All-Wave" models. See your RCA Victor dealer today or write us for detailed information.

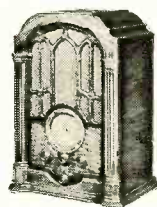

**Model 140 "All-Wave"**

—An all-wave radio receiver identical in quality and performance with the Model 240, housed in an exceptionally beautiful cabinet. For homes where space is at a premium, this high-quality instrument is the perfect solution to the problem of getting world-wide entertainment from a small but efficient set. Complete with RCA Radiotrons \$92.50.



**Model 240 "All-Wave"**

An eight-tube all-wave Super-heterodyne with a frequency range from 16 to 555 meters. Full-vision airplane dial, 50 to 1 vernier tuning, automatic volume control, continuously variable tone control, full size 10-inch dynamic speaker. Extremely low background noise and complete set of individual coils for each wave band. Complete with RCA Radiotrons, \$128.75.

*All Prices F. O. B. Camden, N. J.*



# RCA VICTOR

*A Radio Corporation of America Subsidiary*

RCA Victor Co., Inc., "Radio Headquarters," Camden, N. J., U. S. A.

# Learn at Home to Make More Money



**Here's Proof**

I'll train You Quickly for Radio's **GOOD** spare time and full time Jobs . . .

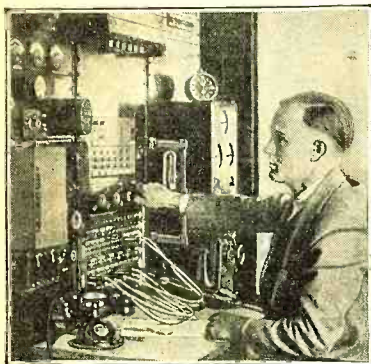

Broadcasting Stations employ managers, engineers, operators, installation and maintenance men for jobs paying up to \$5,000 a year.



Set servicing has paid many N. R. I. men \$200 to \$1,000 a year for their spare time. Full-time men make as much as \$40, \$60, \$75 a week.

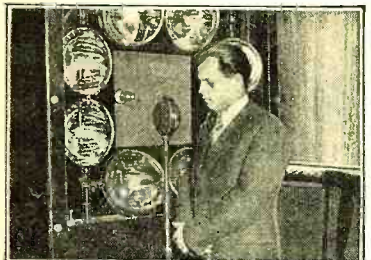

Television, the coming field of great opportunities, is covered in my Course.

## Some Other Jobs N.R.I. Trains Men For

- Broadcast Engineer.
- Operator in Broadcast Station.
- Aircraft Radio Operator.
- Operator of Airway Beacons.
- Government Radio Operator.
- Ship Operator.
- Service man on Loud Speaker Systems.
- Installation Engineer on Loud Speaker Systems.
- Sales Manager for Retail Stores.
- Service Manager for Retail Stores.
- Auto Radio Installation and Service man.
- Television Broadcast Operator.
- Television Engineer.
- Set Servicing Expert.

**Mail Coupon for FREE Information**

Why slave your life away in a no-future job? Why skimp, why scrape, trying to pay your bills? I'll train you quickly for the live-wire field—the field with a future—**RADIO**. \$40, \$60, \$75 a week—that's what many Radio Experts make. \$5, \$10, \$15 a week extra money—that's what many of my students make in their spare time shortly after enrolling.

My free book tells you about Radio's spare-time and full-time opportunities—about my tested training—about my students and graduates—what they are doing and making. Get this book. Be a Radio Expert. The Radio field is big enough to absorb many more properly trained men.

### Many Radio Experts Make \$40, \$60, \$75 a Week

Spare-time and full-time Radio Servicing, Operating Broadcast, Aircraft Radio, Commercial Land, Ship and Television stations, a Radio service business of your own. I'll train you for these and other good jobs in the manufacture, sale and service of Radio and Television apparatus. My **FREE** book tells you about the many money-making opportunities in Radio.

### Save—Learn at home in your spare time

You don't have to leave home and spend \$500 to \$1,000 to study Radio. I'll train you quickly and inexpensively right in your own home and in your spare time for a good Radio job. You don't need a high school or college education. Many of my successful graduates didn't even finish grade school. My amazingly practical 50-50 method of training—half with lessons, half with Radio equipment—gives you broad practical experience—makes learning at home easy, fascinating, practical and rapid.

### Many make \$5, \$10, \$15 a week extra in spare time almost at once

My book shows how my special training, instruction material, plans, ideas, and my nineteen years' experience training men for Radio careers have helped many students make \$200 to \$1,000 a year quickly in their spare time. My Course is famous as "the one that pays for itself."

### Your money back if not satisfied

I'm so sure you will be satisfied with my training that I agree in writing to refund every penny of your money if you are not entirely satisfied with my Lessons and Instruction Service when you finish.

### Find out what Radio offers you

Act today. Mail the coupon. My 64-page book will be sent free to any ambitious fellow over 15 years of age. It tells about Radio's opportunities—explains the eighteen star features of my Course—shows letters of what others are doing and making. There is no obligation. Mail the coupon.

**J. E. SMITH, President, National Radio Institute, Department 4CR, Washington, D. C.**

### FREE Radio Servicing Tips



Let me **PROVE** that my course is clear, easy to understand and fascinating to study. Send the coupon for a free lesson, "Trouble Shooting in D.C., A.C., and Battery Sets." This interesting lesson gives 132 ways to correct common Radio troubles. I am willing to send this book to prove that you too can master Radio—just as thousands of other fellows have done. Many of them, without even a grammar school education, and no Radio or technical experience, have become Radio experts and now earn two or three times their former pay. Mail the coupon now.

### "Made \$6,000 in 2 Years"

"Soon after the depression started, I found myself without a job, but I was well protected with N. R. I. training. I swung right to full-time Radio servicing and I have made over \$6,000 in a little over two years."  
—W.M. SPARTIVENT, Sparty Radio Service, 93 Broadway, Newark, N. J.



### "Made \$17 In One Night!"

"Who says there's a depression? I have made more money in Radio than ever before. I am busy day and night. Last night I made \$17. Last week \$45. I had a tough struggle at first but you fellows helped me back in the race and kept me going."  
WILLIAM J. MAKI, Creighton Mine, Ont., Canada.



### "\$500 a Year in Spare Time"

"Although doing spare-time Radio work only, I have averaged about \$500 a year extra in addition to my regular income. Full-time Radio work would net me many times that amount."  
—EDW. H. FAWCETT, Slough Rd., Ladner, B. C., Canada.



### "Good Position, Good Pay"

"I am Chief Operator at Radio Station WSMK. This is a good position with good pay. I have advanced in Radio right along. I recommend N. R. I. to anyone who wants to be successful in Radio."  
—JOHN HAJDUK, JR., 3 Broxey Apts., Southern Hills, Dayton, Ohio.



**ACT TODAY**

Special Offer. Send me your two books, "Trouble Shooting in D.C., A.C., and Battery Sets," and "Rich Rewards in Radio." I understand this does not obligate me. (Please print plainly.)

I want to take advantage of your

NAME.....

ADDRESS.....

CITY.....

STATE.....

MAIL

**MAIL THIS for FREE 64 page book**

Vol. XI  
No. 9

# RADIO NEWS

March, 1934

Edited by LAURENCE M. COCKADAY

S. GORDON TAYLOR  
Managing Editor

WILLIAM C. DORF  
Associate Tech. Editor

JOHN M. BORST  
Technical Editor

SAMUEL KAUFMAN  
Broadcast Editor

HOWARD S. PEARSE  
Associate Editor

JOSEPH F. ODENBACH  
Art Editor

## THIS MONTH—

•  
*Short Waves*

•  
*Servicing*

•  
*Electronics*

•  
*Amateur Radio*

•  
*Television*

## NEXT MONTH—

SPECIAL SHORT-WAVE AND DX NUMBER, including world map, time chart, constructional articles, world short-wave timetable, and in addition articles for servicemen, home constructors, experimenters, broadcast listeners, etc.

Automatic Radio Doors.....	519
<i>Editorial</i>	
New Midget Tubes.....	520
<i>By Laurence M. Cockaday</i>	
Micro-wave Miniature Tubes.....	521
<i>By John M. Borst</i>	
Filming "Eskimo".....	522
<i>By Michael Jackson</i>	
Getting Acquainted with Short Waves.....	524
<i>By James Millen</i>	
New All-wave Receiver.....	526
<i>By the Staff</i>	
The DX Corner for Short Waves.....	527
<i>By the Staff</i>	
World Short-Wave Time-Table.....	528
<i>By the Staff</i>	
13-2000 Meter Receiver.....	530
<i>By H. L. Shortt</i>	
Mobile Radio Ticker.....	531
<i>By W. G. H. Finch</i>	
Remedies for Poor Notes and Key Clicks.....	532
<i>By Christ Kardas</i>	
Modern Service Benches.....	534
<i>By the Staff</i>	
Modern Battery Receivers.....	536
<i>By the Staff</i>	
Cathode-Ray Television Applications.....	538
<i>By J. M. Hollywood and M. P. Wilder</i>	
A. V. C. Applications and Limitations, Part One.....	540
<i>By Edgar Messing</i>	
A.C. Vacuum-tube Voltmeter.....	542
<i>By C. K. Krause</i>	
Phenomena Underlying Radio, Part Seven.....	544
<i>By E. B. Kirk</i>	
The DX Corner for Broadcast Waves.....	545
<i>By the Staff</i>	
New 500,000-Watt Super Station.....	546
<i>By Joseph A. Chambers</i>	
Station List—U. S. Broadcast Stations.....	548
<i>By the Staff</i>	
Backstage in Broadcasting.....	549
<i>By Samuel Kaufman</i>	
The Technical Review.....	550
The Service Bench.....	552
With the Experimenters.....	554
Radio Physics Course.....	556
Latest Radio Patents.....	560
QRD.....	562
What's New in Radio.....	564

Published Monthly by Teck Publications, Inc., Washington and South Avenues, Dunellen, N. J.  
EDITORIAL AND EXECUTIVE OFFICES

### OFFICERS

Lee Ellmaker, *President and Treas.*  
Warren P. Jeffery } *Vice Presidents*  
Huston D. Crippen }  
Abner Germann, *Secretary*

222 WEST 39th STREET, NEW YORK CITY, N. Y.

Entered as second class matter at the Post Office at Dunellen, N. J., under the act of March 3, 1879. Copyright, 1934, by Teck Publications, Inc., in U. S. and Canada. All rights reserved. Registration of title of this publication as a trade mark applied for in United States Patent Office. Printed in the United States of America. The contents of this magazine must not be reproduced without permission. We cannot be responsible for lost manuscripts, although every care is taken for their safety.

25c a Copy, \$2.50 a year,  
\$3.00 in Canada, \$3.50 in  
Foreign Countries. Sub-  
scribers are notified that  
change of address must reach  
us five weeks in advance of  
the next date of issue.



**NOW** *Another* **NAVY MAN SELECTS**

**MASTERPIECE, II**

**FOR A 'ROUND THE WORLD CRUISE**



**Lt. Fred L. Schoenwolf, U.S.N.C.R. follows example of Admiral Byrd and selects Masterpiece II for trans-oceanic work.**

Never before has a radio receiver been the subject of so much official interest. Read what this well known radio engineer says about it:

"At the completion of exhaustive analyses for selectivity, sensitivity, fidelity and other very important characteristics of radio receivers of the leading makes of 'All-Wave' radio receivers, I have finally decided to take with me, on a "Around the World" cruise, the MASTERPIECE II. After making this decision, I was very much impressed by the fact that another Naval officer, Rear-Admiral Richard E. Byrd had decided to take the same type receiver on his second Antarctic Expedition to "Little America."

It has been my intention to obtain a radio receiver capable of receiving important information, from both my home and office, by high-frequency radio, as well as to investigate short-wave radio transmission phenomena throughout the entire cruise. It was necessary, therefore, that I place my reliance on a receiver of maximum efficiency so that, when installed in my stateroom aboard the S. S. President Van Buren, it will assure the most consistent possible performance.

The tests indicate that your MASTERPIECE II should unquestionably fulfill my requirements and am therefore attaching hereto my order for one of these receivers.

Respectfully,  
 Fred L. Schoenwolf  
 Lieutenant (ig)  
 U. S. Naval Communication Reserve.

**With Byrd aboard the ship Jacob Ruppert**

Four Masterpiece IIs are serving the Byrd Antarctic Expedition on 10 to 570 meter work. They were selected at the instance of



Admiral Byrd's radio advisor, a great eastern university. The picture at the right shows one of the MASTERPIECE IIs installed in the radio room of the Jacob Ruppert, with Clay Bailey and Guy Hutchenson in attendance. Wouldn't YOU like a radio exactly like those being used by Admiral Byrd?

**McMURDO SILVER, Inc.**  
 1733 Belmont Avenue, Chicago, Illinois

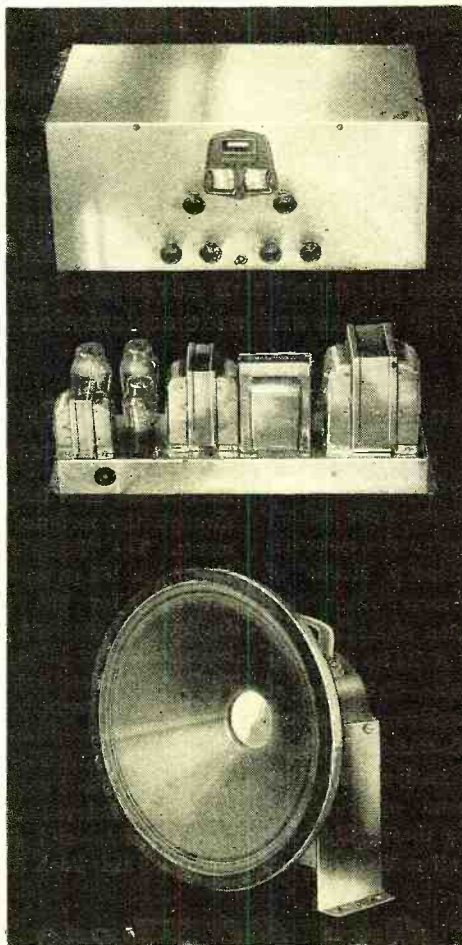

**BRIEF SPECIFICATIONS**

Wave length Range 10 to 570 meters or 520 to 30,000 kc. Four position wave change switch. (External unit extends range from 700 to 2000 meters.)

Tuned R. F. stage on both Broadcast and entire Short Wave range yet single dial tunes the receiver. Greatly improves signal-noise ratio on 12,000 mile reception.

Band-spread tuning on short waves. Makes short wave tuning actually easier than broadcast tuning.

3-air-tuned intermediate stages. Most accurate intermediate amplification ever developed.

Sensitivity better than 1/4 micro-volt absolute average. Inter-station noise suppressor adjustable to exact location requirement.

Automatic volume control holds all stations 20 microvolts and up at constant volume to the ear.

Selectivity absolute 9 Kc. for Europe, better than U. S. needs (21 Kc. wide 10,000 times down).

Fidelity perfect over 30 to 4,000 cycle audio range. Undistorted power output, 15 watts. Automatic and manual tone controls.

Special impregnation for tropical climates.

Built-in beat oscillator for easy finding of S. W. and weak broadcast stations.

Chromium plated steel shielding case eliminates need for cabinet.

**ACTUAL 10 DAY TRIAL**

**Money Back Guarantee**

You are entitled to the same quality of radio performance that Admiral Byrd, Lt. Schoenwolf and others insist upon. I guarantee that my Masterpiece II will give you that kind of performance . . . but I let you be the sole judge. Either you get what you want out of my Masterpiece II or you get your money back instantly, without question or argument. It's just as simple as that. My new book tells all about this offer and gives full technical details of Masterpiece II. The coupon will bring it.

McMurdo Silver, Inc., 1733 Belmont Ave., Chicago, U.S.A.

Send me full technical information on Masterpiece II.

Name .....

Street .....

Town ..... State .....



# 30,000 Copies Distributed — And Orders Are Still Pouring In!

Why are these three books in such popular demand? Because our subscribers know that the editors of *Radio News* have gathered pertinent information from the four corners of the radio world—weeding out superfluous information—testing every practical idea—boiling down the facts into simple, clear language—and cramming them into these popular pocket-size handbooks. Each book was carefully prepared and edited for months in advance of publication—and the result has been 30,000 orders and wide acclamation from radio men all over the world!

### 23 Lessons in Radio

Those just beginning radio training— young men needing a reference book containing radio fundamentals—more experienced men wanting dope on the essentials—all will find “23 Lessons in Radio” of special value. It covers: Elementary Radio Theory—The Action of Radio Components—How-To-Build A Radio Receiver and Short-Wave Converter—Principles of Transmitting and Receiving—Standard Radio Symbols—How-To-Build a Simple Transmitter—How to Analyze Receiver Circuits—and a thousand other things which make this book a thoroughly comprehensive training for all radio men!

### Radio

#### Experimenters' Handbook

Many radio men find pleasure and profit through the medium of practical experiments. The “*Radio Experimenters' Handbook*” has 136 pages crammed full of useful data for the radio experimenter. Included in the long list of contents are: Laboratory and Shop Notes—Antenna Experiments—Miscellaneous Radio Experiments—Experimental Circuits in Radio and Electronics—Principles of Short-Wave Reception—Ultra-Short-Wave Essentials—Equipment for Photo-Electric Work—Experimental Television Data—Miscellaneous Measurements—and Circuit Design Data. You need this book at your workbench!

### Short-Wave Handbook

The growing importance of short-wave communication has resulted in the publication of the “*Short-Wave Handbook*.” Here, in one handy volume, is presented the information needed by every short-wave enthusiast. It contains: Principles Underlying Short-Wave Communication—Helpful Short-Wave Data—Short-Wave Receiver Construction—Popular Commercial Apparatus—Short-Wave Antenna and Noise-Control Systems—Station Lists—Best Bets for DX—How to Learn the Code—How-To-Build Amateur Transmitters—and Ultra-Short Waves. All s-w fans need this book!

## Any One Of These Books Given Free! With 5 Issues of Radio News At \$1

These three books were published solely for the use of RADIO NEWS subscribers. They have never been offered for sale—at any price! Each one of them contains information of tremendous value to the radio enthusiast! Get a copy of the book most suited to your needs now! And, get it absolutely free—with a 5-month subscription for America's foremost radio magazine, RADIO NEWS. Mail the convenient coupon below with your remittance of \$1 today! (Canada and Foreign \$1.50.)

**Radio News**  
222 W. 39th St. New York, N. Y.

RADIO NEWS, Dept. 343,  
222 W. 39th St., New York, N. Y.

Enclosed find \$1 for which kindly send me a copy of.....  
.....and enter my subscription for the next  
5 issues of RADIO NEWS. (Canada and Foreign \$1.50.)

Name .....

Address .....

City ..... State .....

# You Fellows Who Want BIG PAY —

*get into*

# RADIO

*Hundreds of men  
I have trained*

# EARN

**\$35 to \$75**

# A WEEK



"R-T-I Training pays its own way. I have only completed 30 lessons, but have already made \$250 doing spare time Radio work. Did my first job two weeks after I started your Course."

L. M. Christensen  
Deveeville, Utah

Why stick on a small-pay, no-future job—when hundreds of men, just ordinary fellows—are drawing down \$35 to \$75 every Saturday as R-T-I Trained Radio Experts? Fit yourself for a real job. Get into Radio. My big, FREE Book tells you how—explains how I train men at home for full-time or part-time Radio work.

### Radio—The Big Pay Field

Radio factories employ engineers, service men, testers, inspectors, managers and foremen for jobs paying up to \$5,000 a year. Broadcasting stations employ trained men for jobs paying up to \$5,000 a year. Talking Pictures, Aircraft Radio, Photo-Electric Cell equipment, Public Address systems have made, and will continue to make, thousands of good-pay jobs. But it's the *trained* man—the Radio Expert—who makes the really big money.

### I'll Train You At Home

I'll train you at home—in your spare time. You work just as you are working now. My famous R-T-I method of Home Training—*endorsed by more than 30 leading Radio manufacturers*—gives you simplified, practical training along workshop lines. In a few short months many R-T-I Trained men step out of poor-pay, no-future jobs into big-future Radio work paying \$35 to \$75 a week and up.

### Many Make \$5 to \$20 A Week, Extra— While Learning

To learn Radio my way you don't have to be a College man, or even a High School graduate. You can read. You can write. That's enough. My Training is practical *Shop Training* for the home. You learn by doing—with 4 big Working Outfits I give you without extra cost.

### Money Back If Not Satisfied

That's what I agree to do. And back of me in this agreement stands the resources of Radio and Television Institute. There's nothing like R-T-I Training anywhere. It's the training that more than 30 leading Radio manufacturers endorse. *It's the training for you!*

### Get My FREE BOOK—Now!

Learn WHY these big Radio manufacturers recommend R-T-I Training. Read the names of the famous engineers—Radio's Top-Notchers—who direct R-T-I Training. See 4 big Working Outfits I give you without extra charge. See the hundreds of pictures, the proofs, the Big-Pay letters of R-T-I Trained men. Don't wait a minute. Clip, sign and mail coupon RIGHT NOW!

Ray D. Smith, President  
RADIO AND TELEVISION INSTITUTE  
Chicago, Illinois



**SEND FOR FREE BOOK**

Ray D. Smith, President  
Radio and Television Institute (R-T-I)  
2130 Lawrence Ave., Dept. 43, Chicago, Ill.

Without obligating me, send your free book, "Radio's Future and Yours"—telling about spare time and full time Radio opportunities and how I can train for them at home in my spare time.

Name.....Age.....  
Address.....  
City.....State.....



"Before taking R-T-I Training I was a garage mechanic. After finishing a few lessons I secured more Radio work than I could do in spare time. Now I have my own Radio Shop. With the money I have made in Radio I bought a home, new furniture and \$500 worth of shop equipment."

D. E. Patton  
519 Wilson Ave.  
Lebanon, Tenn.

## 4 BIG Working Outfits

Make R-T-I Real Shop Training for the home. You work out with your own hands many of the things you read in my lessons. Makes learning at home easy, interesting, practical. You can use R-T-I equipment in your service work.



YOU LEARN  
BY DOING



# News About NATIONAL UNION Profit!

*Sold by More Service Men Than Any Other Make*

NATIONAL UNION RADIO CORPORATION OF NEW YORK 400 MADISON AVE. NEW YORK CITY, N. Y.

## NATIONAL UNION MEANS MORE THAN RADIO TUBES

National Union policies are of vital concern to you as an alert serviceman. The objectives of National Union, in addition to producing the finest radio tubes that science can devise are to aid and assist the serviceman in building a better and more profitable business for himself. This page will give you a brief idea of the way National Union is assisting its authorized service dealers. Many more ways to help you are in course of preparation. Read this page carefully and keep in touch with future National Union developments.

### SERVICE AIDS

For more than three years National Union has specialized in service aids. Charts, data and information which would be of most practical value to experts in the service business. A few of the many items are: Peak Frequency Charts, Tube Base Connection Finders and Voltage Divider Charts. These valuable aids, available to National Union authorized dealers at no cost cannot be duplicated from any other single source. Every National Union service outlet can testify to what this has meant to him in better service work and more profit.

### PROFIT

The 10¢ higher list prices of National Union tubes were made to enable the serviceman to make the highest margin of profit on his tube sales. National Union servicemen have enthusiastically supported this full profit program with resultant benefits which are self evident.

### SUPERIOR QUALITY

Strict adherence to closer manufacturing limits is responsible for the consistent superiority of National Union tubes. Recognized leaders in the fields of science involved in radio tube manufacture watch every step in National Union tube production. This outstanding scientific force is headed by Dr. Ralph E. Myers for twenty-one years responsible for the production of lamps and radio tubes at Westinghouse Lamp Works. National Union tubes are fully guaranteed. Continued customer satisfaction is assured.

National Union jobber stocks are complete.

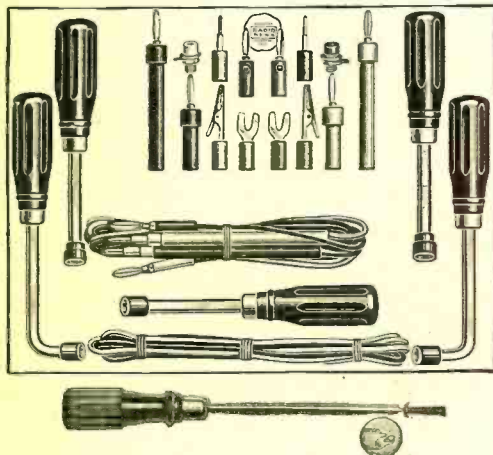

NEW! Screw Holding Screw Driver. Note Special End of Blade Which Holds Screws



### SAYS W. L. HOLLENBACK ABOUT NATIONAL UNION

"If more dealers and servicemen knew how National Union plays ball with them there would be a lot more free equipment and service helps hatted out and when more of the public realize how National Union tubes bat out their favorite programs there will be a lot more National Union users in the grand-stand".

(Mr. Hollenback submitted the photograph above showing a National Union tube sale in action).

### FULL LIST PRICES AND GOOD WILL

National Union tubes are sold everywhere at full list price. This means that the serviceman has no need to fear the ill will of his customers who might otherwise see the tubes in "cut price" stores. National Union stands for full price, fair profit and good will!

### FREE SHOP EQUIPMENT

One of the principal objectives of National Union has been to supply the serviceman with modern shop equipment and data so that he would be in a position to do better service work and more of it at a profit. Testers, analyzers, service manuals and service tools are given with the purchase of National Union tubes. The wide awake dealer realizes the advantage of obtaining his equipment in this way as he has both the guarantee of the manufacturer and the backing of National Union.

The Servicing Tool Kit illustrated at the left is one of National Union's newest free offers. Note that with this kit is included a patented screw holding screwdriver. It's new! It grips screws and holds them! An invaluable asset to service experts.

- Other National Union offers are:
- Supreme No. 333 Analyzer
  - Service Manuals—Auto Manual
  - Triplet Oscillator and Output Meter
  - Triplet Tube Tester
  - Hickok Tube Tester
  - Supreme Model 85 Tube Tester

All offers, subject to withdrawal without notice. Small deposit. What do you need? Get details!

### A FEW NATIONAL UNION ENGINEERING ACHIEVEMENTS

An inductively wound heater coil and special insulating spray to banish hum in quick heater tubes... a rotary cathode spray machine to assure uniform emission... non-paralyzing tube Types 199... super tube Type 201AA... an automatic volume control circuit... a special hydrogen-electric furnace for degassing metal parts... perfection of automotive radio tubes, such as 6F7 and 84... National Union engineers accept only one standard and that "Perfection."

### LEDERER ULTRA VIOLET LAMPS

Here's a new money-maker for the serviceman. These new lamps are safe, economical and produce a range of vital ultra violet equal to lamps costing over \$300.00. Complete lamp kit only \$23.50. (\$26.50 West of Rockies). Investigate! Dealer discount 40%.

### A FINE SALES AID



Among National Union's sales helps and good will builders is this outstanding Radio Log. Twenty-two large pages crammed with broadcast, short wave, police and foreign station listings, radio star photos and biographies. An ideal good will builder. Hand one out on every service job. Available at 2c per copy through National Union distributors. Sample copy sent on receipt of 15c in stamps to cover postage and handling. You will like this splendid Log and it will delight your customers.

National Union Radio Corporation of N. Y.

400 Madison Avenue, New York City.



Send me details about:

Name .....

Street .....

City .....

State .....

**Write or Send COUPON Now!**



# Radio News

March, 1934

## The RADIO DOOR

*The Editor—To You*

Doors that open when you approach! Spooky, but entirely practical. No more bumped heads. Photo-electric devices cause them to function automatically. A photo-cell sees you come, opens the door and closes it after you have passed through. Would you like one on your garage doors?

**M**AGICAL radio doors, which open and close automatically as you approach and leave them, mark a new mile-post along the path of radio's application in adding to the safety and comfort of modern life. These doors operate through the medium of electronic control of pneumatic apparatus functioning through a radio amplifier. Two sets of these doors were recently installed in the Pennsylvania Terminal, in New York City, and eight more are to be installed. They are found invaluable where many persons pass through a doorway with bundles or packages in their hands, and where swinging doors constitute a hazard in slamming and injuring persons passing to and fro. The actual control is through the agency of photo-electric cells concealed in guide posts supporting the railing on each side of the door. Light sources throw a beam of light from one post across to the photo-electric cells on another post. These posts are situated six feet from the doors themselves. The controls are duplicated on both sides of the doors. Anyone passing toward the door passes the control posts and interrupts the light beam which causes a minute change in current flowing from the photoelectric cell. These currents flow in wires down through the posts and under the floor to an amplifier which operates a solenoid relay controlling an air valve allowing compressed air to force a plunger into a cylinder to open the doors. The doors are also pneumatically buffered so that their movements are smooth and quiet in opening and closing. In watching the installation at the Pennsylvania

station one could see hundreds pass through the doors without a moment's hesitation or effort and as soon as they passed by, the doors closed smoothly and quietly. Installations such as these are now being used in restaurants to accommodate hurrying waiters passing to and fro, in main doorways of buildings, pantry doors, service and garage doors, as shown in the illustrations below.

The pneumatic door opening mechanism is ingeniously hidden from view and mounted directly over the doors so that only the small arms and brackets can be seen.

Here is another exposition of radio application in a commercial field other than strictly radio. Radio dealers and servicemen would do well to investigate the possibilities of this ingenious system for installation in their communities. The Editor believes that thousands of similar installations can be sold, on merit alone, throughout the various metropolitan communities in this country. The idea itself is a practical one and the advertising value, alone, of such a doorway in a commercial or public building should more than compensate for the cost of the installation within a short time. Even in the home, the convenience of such a device on the garage doors would prove a definite blessing.

Owners of buildings, engineers in charge of maintenance, individual home owners, radio dealers and servicemen who are interested in the possibilities of this novel application of electronics are hereby invited to write to the editor for complete information regarding these installations and the manufacturer of the equipment used.

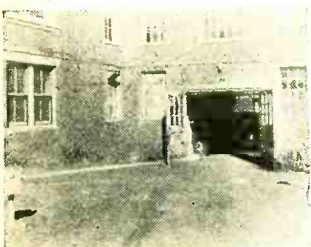

# LILLIPUT

*How Will They Affect the*

Eliminating the glass bulb and the tube base from vacuum tubes is a radical step that may improve radio importantly. The tiny tube invention described on this page appears to be entirely practical

L. M. Cockaday

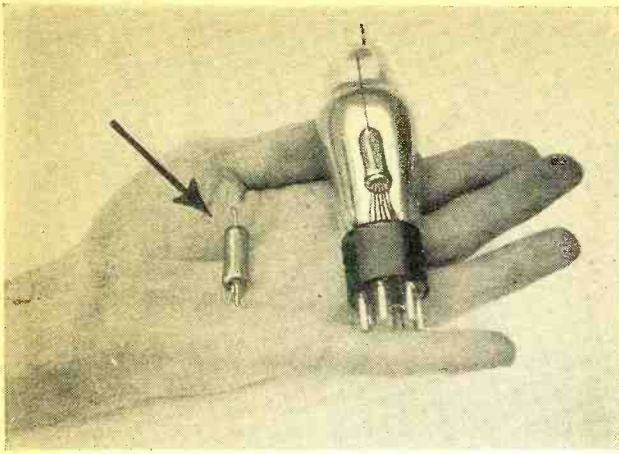

**IT'S ALL IN THE PLATE!**

Arrow points to the new tube, the metal plate forming the outside of the tube with the ends plugged up containing a vacuum

**A**N interesting and quite possibly a far-reaching development in radio receiving apparatus is the new "Lilliput" metal tube developed by Frederick S. McCullough and first shown in the accompanying illustrations in this article. The inventor may be remembered as the originator of the a.c. tube as described first by the author in an article in 1927. By referring to Figure 1, this new metal tube is seen in comparison to a man's hand (arrow points to it) while at the right is seen a conventional a.c. tube.

If we examine an ordinary a.c. tube, we will find that it consists of a plate, one or more grids, and a filament; the plate usually surrounding the grids and the filament. This assembly is surrounded by a vacuum, maintained by a glass bulb, with the leads to the central elements brought out at terminals at the top and bottom of the tube. But the *actual working mechanism is encompassed in the area that lies within the plate!* The rest of the space taken up is just—"mere space." In McCullough's new tube, the plate, which is cylindrical, forms the main support for the vacuum that is necessary for operation. In general, his invention may be summed up in the following words: "He has eliminated the tube base and the glass bulb. He uses the cylindrical plate as the vacuum container and

mounts the filament and grids *inside the plate*, plugging up the two ends and sealing off the vacuum with a ceramic material." The result appears to be a very satisfactory tube, similar in operating characteristics to the modern tubes except that it has a lower operating inter-electrode capacity and it takes up but a small part of the original size associated with the vacuum tube, the tubes being 5/16 inch in diameter and 1 1/8 inches long. Some of the more complicated pentodes are 3/4 inch in diameter and 1 1/4 inches long. The tubes can be made in all contemporary types, including power tubes and rectifiers, the latter tubes being slightly longer to obtain a greater dissipating plate surface. The general arrangement of a tube of this "Lilliput" type corresponding to a -27 tube is shown in Figure 2. This is a heater tube with one grid and a single plate. The cathode lead is brought out at one end while the grid and filament leads are brought out at the other end of the tube. The plate connection can be made by soldering directly to the external cylinder.

These tubes have been manufactured in two ways, one of which is that shown in Figure 2, where a ceramic plug (shown at 5) is used to seal off the vacuum. This tube contains *no glass* in prong by (Continued on page 572)

**A LEADING TUBE EXPERT**

Frederick S. McCullough, inventor of this new Lilliput tube, has also the a.c. type of tube to his credit, as well as many types of transmitting tubes

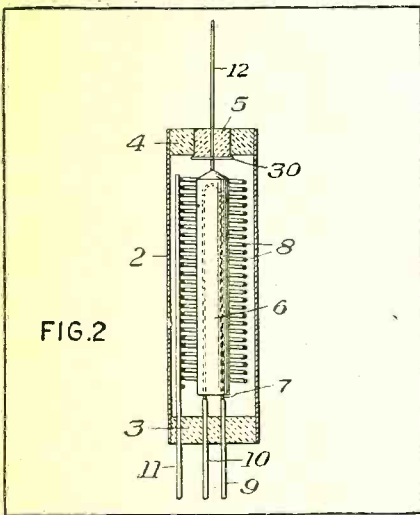

FIG. 2

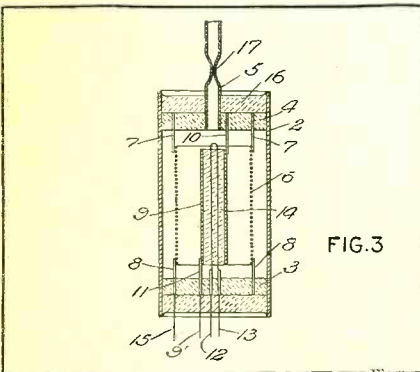

FIG. 3

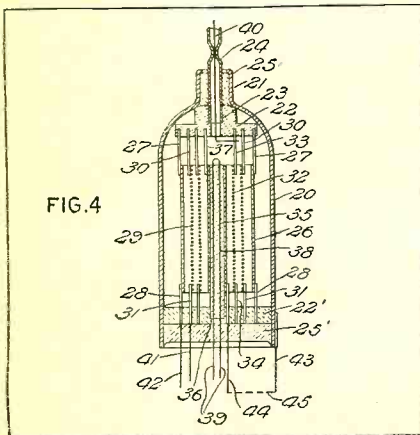

FIG. 4

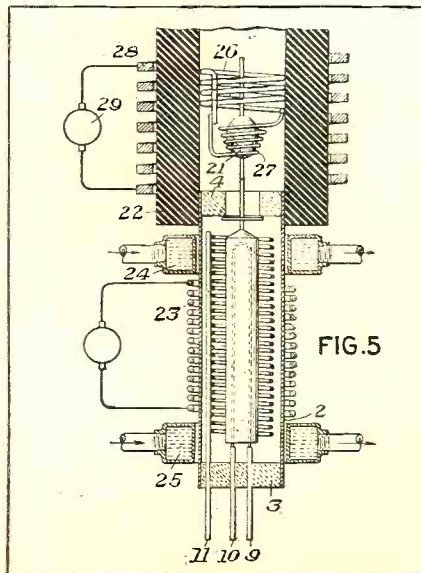

FIG. 5



# TUBES !!!

## Radio Sets of the Future?

Greater efficiency in ultra-high-frequency receivers demands the reduction of all parts to minimum physical size. The tiny tube described here is definitely a step in the right direction

John M. Borst

**T**UBES no larger than a button on your coat were recently demonstrated at the Institute of Radio Engineers. One of the tubes was employed as an oscillator on a wavelength, measured by means of Lecher wires, of 40 cm. Another tube, oscillating at a frequency of approximately 300 megacycles, was modulated by a program picked from the air. The 300 mc. signal traveled across the room to a receiver, employing two tuned r.f. stages and detector—three tuned stages in all. The oscillators employed regular inductive feedback.

These small micro-wave tubes were developed by B. J. Thompson and G. M. Rose, Jr., engineers of RCA Radiotron.

While the usefulness of shorter and shorter radio waves has become known, it is very difficult to generate and amplify them by means of the conventional tubes and circuits. The reasons lie in the mechanical construction of the tube. Interelectrode capacitance, the length of the leads inside the tube and the path of the electrons are all of too large dimensions for the extremely short waves involved. There is a practical limit to the frequency which can be reached with the normal triode. Special circuits have been designed to over-

come these difficulties, such as the Barkhausen-Kurz oscillator, but these have many drawbacks.

It was reasoned that shorter waves could be reached if a tube could be made which had considerably shorter leads, smaller internal capacity, etc. This has been accomplished in the tube shown in the illustration at three times normal size.

Experimental tubes were made in two types, a triode and a screen-grid tube. The size of the tube can be appreciated from one of the illustrations. The little box in the other hand is a receiver containing a t.r.f. stage and detector—exclusive of the power supply. These very small tubes equal larger tubes in efficiency, chiefly because the spacing between the electrodes and the size of the electrodes have been reduced in proportion.

The triode, shown in one of the photographs, has an amplification factor of 14.7, a transconductance of 1550 micromhos and a plate resistance of 9500 ohms. It requires 3 volts to heat the filament. When the plate potential is 67.5 volts and the grid bias —2 volts, the plate current is 4 ma. Interelectrode capacitances (Continued on page 571)

### THE TRIODE

*A detailed view of the triode tube. This tube is indirectly heated, with the cathode connected to one side of the filament*

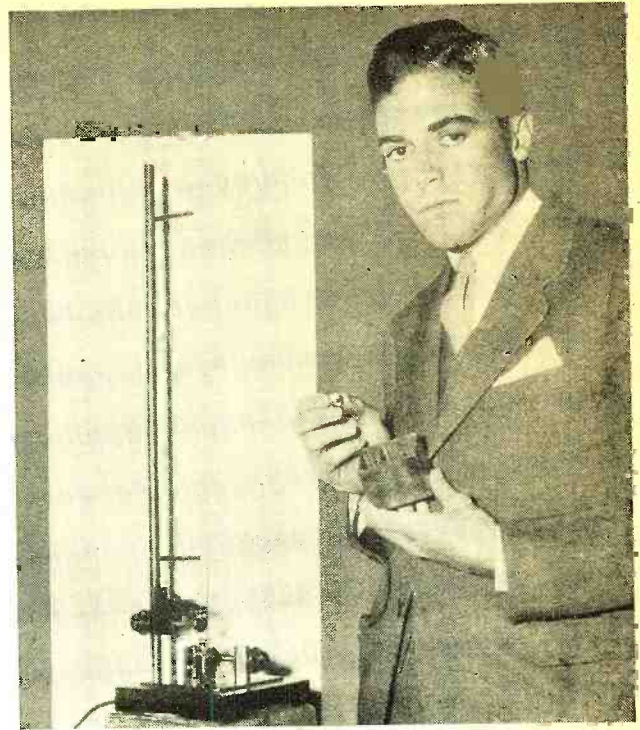
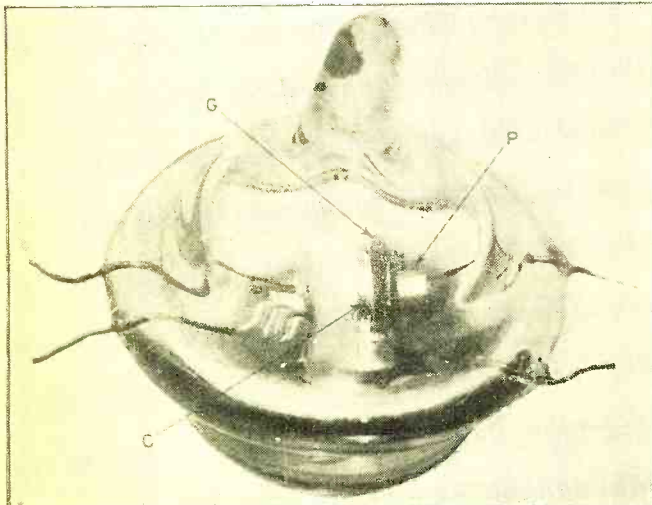

### COMPLETE ULTRA S.W. SYSTEM

Here is shown a complete communication system. Mr. B. J. Thompson, of the RCA Radiotron research laboratory, is holding one of the new tubes in his right hand and a receiver in the left. In front of him is the transmitter

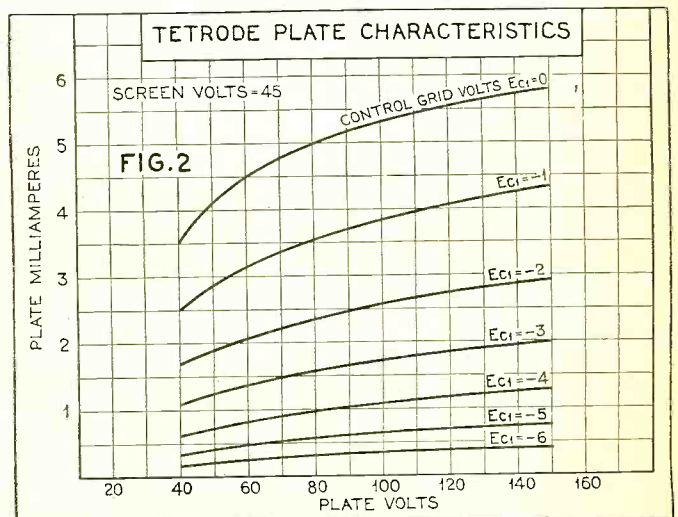
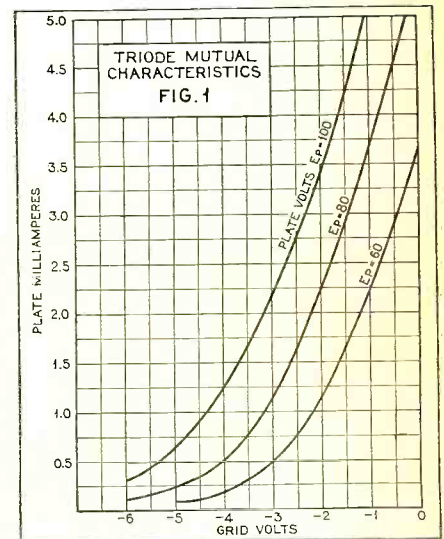

## RADIO'S PART AS A MEANS OF "FILMING"

In the vast space of the Arctic vital, and when the producers of being shown on the nation's silver them an experienced short-wave How well radio worked in Arctic to New Zealand and back told in this

Michael



RADIO OPERATOR AND CAMERAMAN

*This is Clyde De Vinna pounding a "mill" on the Schooner "Nanuk" while he receives a message via short-wave radio*

NINE thousand miles through the air a radio message flickered. And a radio operator, receiving it, knew something was wrong. From Chatham Island, near New Zealand, he then relayed the message, via Honolulu to the Arctic, and saved a life. The whole incident took place in ten amazing minutes. The man whose life was saved in this astounding radio adventure was Clyde De Vinna, cameraman with the M.G.M. polar expedition, filming "Eskimo" in the Far North. He, with Col. W. S. Van Dyke, the director, and a crew of thirty-five, were frozen in, aboard the whaling schooner *Nanuk*, in the northernmost regions inhabited

### STUCK IN THE ICE

*The expedition's Schooner caught in an ice jam near "location"*



by mankind. They have been there six months. It would not be until early Spring that the ice-floes would break up, when the ship could start southward.

De Vinna earlier was a radio man in the army. Wherever he goes, he takes with him his portable low-wave set. He carried it

through the jungles of Africa when they filmed "Trader Horn." He carried it to the South Seas when they filmed "White Shadows in the South Seas." From the varied wilderness to which he accompanies Van Dyke's expeditions he always keeps in touch with the outside world via radio.

The other man in this strange rescue story is James M. Laughlin, who operates amateur radio station ZL2HO, on Chatham Island, a rock-bound spot in the Pacific, east of New Zealand.

Every night De Vinna, his radio installed in a tiny igloo (ice house) on

the floes near the ship, sent out his contact messages. Sometimes they got through. Sometimes crashes of static, caused by the fantastic electrical display known as the Northern Lights or Aurora Borealis, interfered. His igloo was located at a spot where static was less severe than around the masts of the ship. But nevertheless the static often makes it uncertain whether his messages will be picked up or not. So he casts about until some low-wave amateur operator answers, sends his messages, and they are relayed to whomever he addresses, through the Amateur Relay League, an international association of short-wave enthusiasts.

Laughlin's station is approximately nine thousand miles southwest of the *Nanuk*, and just a few miles from the line that marks the change in days in the navigation system (the International Date Line). For some reason this station has been receiving De Vinna's messages more readily than others. McLaughlin usually relays them to the station operated by Col. Clare Foster, millionaire radio experimenter at Carmel, California, and thence they

### A TYPICAL IGLOO INTERIOR



# ARCTIC COMMUNICATION IN "ESKIMO"

quick communication often is this famous motion picture, now screens, left they took along with radio operator for this purpose. spanning the Pacific from the again to save a man's life is interesting story

## Jackson

come to the studio at Culver City. Anyway, on the night of the rescue, De Vinna was sending Laughlin the news of the day. Suddenly his wording grew incoherent, his hand seemed to be faltering on his key—then there was silence. Laughlin decided that something was wrong. He radioed a Honolulu amateur who was in touch with an experimenter at Teller Island, not far from the ship. In a few minutes the Teller operator was pushing his dog sled, headed for De Vinna's igloo. He found De Vinna unconscious. A small coke stove, used to warm the igloo, had generated considerable quantities of carbon-monoxide gas. De Vinna had been breathing the odorless, deadly stuff. Hurried to the ship, De Vinna was revived and soon was able to send his nightly radio bulletins home. But he believes in oil stoves now!

This radio adventure is one of many amazing experiences the handful of white men, filming a picture with an Eskimo cast, experienced. They have had narrow escapes hunting walrus and polar bear. They have had hairbreadth escapes in Arctic hurricanes that are as

vicious as the American cyclone. They have seen cloudbursts that fall, freeze into crusts of ice on the frozen earth, and spread devastation in the Eskimo villages.

About their frozen in ship grew a little village of skin huts and igloos, where the Eskimos settled. Sometimes, at night—which is most of the twenty-four hours, they erected their portable projection machine, and showed motion pictures for the amazed natives. Van Dyke says that the strangest experience he ever had was when he showed "Trader Horn" with its African natives and animals, to these Arctic dwellers who had never before seen a motion picture.

Their ship was stocked with supplies for a year, but at the same time the expedition had to rely largely on the native hunters for caribou and other meat. They also had to rely on the



**DIRECTOR OF THE EXPEDITION**  
*W. S. Van Dyke not only directed the Arctic picture, but played the part of an inspector of mounted police, in which costume he is shown*

Eskimos for the heavy fur clothes that ward off the "bite" of the Arctic. Fire is one of the most feared dangers of the Arctic. It is more dangerous than ice. For fire destroys shelter, and that means almost instant freezing in a temperature of sixty below zero. Another peril of the Arctic, and a serious one, is the frequently-encountered pack of hunger-crazed dogs. These animals, desperate, can attack and kill the largest polar bear. These same dogs are what the Eskimo depends on for his life. Without sled dogs, the natives cannot hunt and accumulate food supplies for the winter. Hence rabies, which takes a virulent form. (Continued on page 563)

## SHOOTING A "SUMMER" SHOT



## AUTHOR-ADVENTURER

*Capt. Peter Freuchen, author of "Eskimo," famous book from which the picture was taken*

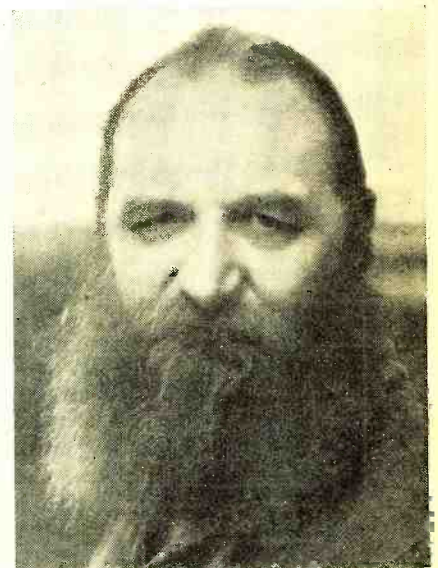

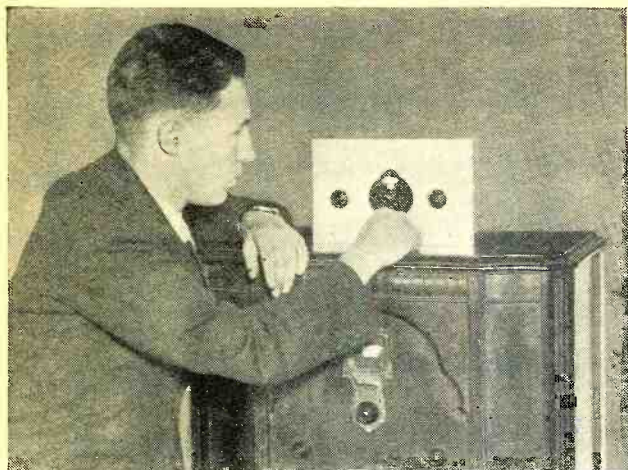

# GETTING ACQUAINTED *with* SHORT WAVES

Methods of short-wave reception and how to build a simple single-tube short-wave adapter

James Millen

**I**N the second article of this series we discussed the quality of short-wave fare—what to expect in the way of programs below two hundred meters and, briefly, three methods of reception. These were: by means of an adapter, the short-wave receiver and the short-wave converter, considered in the order of their essential simplicity from the beginner's point of view.

The short-wave adapter is, in reality, nothing more than a minor modification of the short-wave receiver, but due to the fact that it obtains its power from the broadcast receiver, and utilizes part of the broadcast receiver circuit, it necessarily has less parts and is more simple than a short-wave receiver of similar reception efficiency. The adapter may consist of one or more tubes, and is usually connected to the broadcast receiver by removing the detector tube and inserting a plug in its place. Occasionally, the detector tube is placed in the adapter, making it unnecessary to purchase an additional tube. The wires from the plug to the adapter carry current to the adapter and also connect the adapter output to the input of the audio amplifier in the receiver, thus making possible loudspeaker reception of short waves from the broadcast set. The tubes ahead of the detector (or rather the plug), generally known as the radio-frequency tubes, are not utilized, although they are lighted when the short-wave adapter is in operation.

The short-wave receiver, in its highest development, is the most efficient

method of receiving short waves. This is because every component can be especially designed for its particular short-wave purpose, rather than depending on parts and circuits, the short-wave efficiency of which may be impaired by the fact that they are not intended for this use. It does not follow, however, that a good converter, employed in conjunction with an efficient broadcast receiver, will not give better short-wave results than only a fairly good short-wave receiver.

The short-wave converter, like the adapter, is used in connection with the broadcast-band receiver. However, unlike the adapter, it utilizes all tubes and circuits of the set. What the converter actually does is to change the short wave into a long wave, within the tuning range of the receiver, which then amplifies it throughout the various circuits just as if it were a broadcast-band signal.

Operation of all three systems of short-wave reception—the adapter, the receiver and the converter—is very simple, and with correctly designed apparatus is no more complicated than that of a broadcast receiver. As a matter of fact, there exists next to no difference at all, and the slight matter of technique may be acquired with a few minutes' practice. Short-wave equipment can be made single-control, exactly as the sets with which most of us are more familiar. They can be enclosed in attractive cabinets—and have definitely emerged from the laboratory into the "living room" of the broadcast enthusiast.

The single-tube short-wave adapter provides a very simple method of short-wave reception. Such an adapter can be made by almost any fan—and those who are not mechanically inclined have recourse to the local radio serviceman, who will build it for a very small cost.

The circuit of such an adapter is shown in Figures 1 and 2. Figure 1 is the schematic diagram, as preferred by those having some experience in radio construction. Figure 2 is a picture diagram in which the parts and the manner of their interconnection will be more apparent to the beginner. In both diagrams, the labels and letters refer to the same parts, which can be identified on the following parts list.

### List of Parts

- 2 National 6-prong sockets
- 4 National radio-frequency choke coils

FIGURE 8

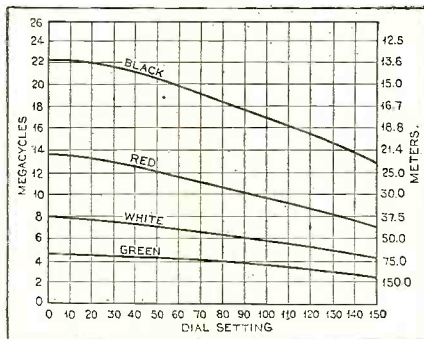

FIGURE 1. SCHEMATIC WIRING DIAGRAM

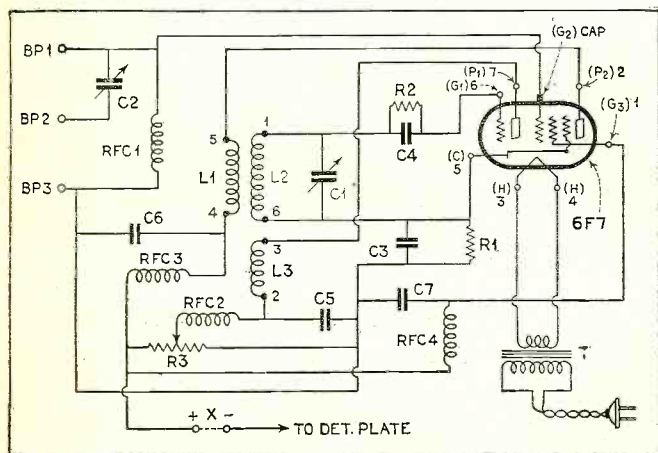
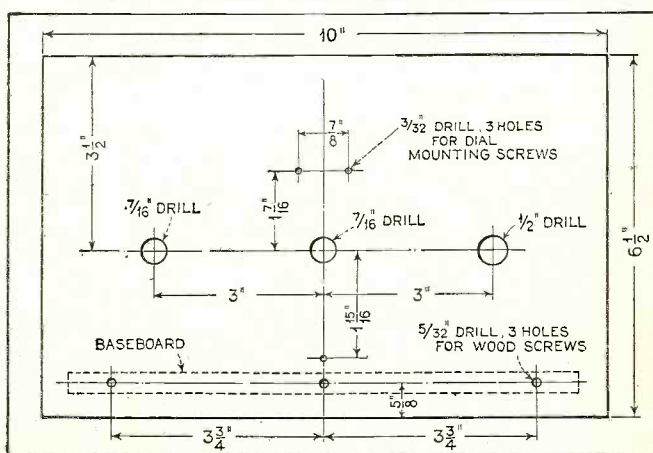

FIGURE 3. PANEL DRILLING SPECIFICATIONS



- (RFC1, RFC2, RFC3 and RFC4), type 100
- 1 Lynch 1-watt resistor, 350 ohms (R1)
- 1 Lynch 5-megohm grid leak (R2)
- 1 variable potentiometer, 0 to 50,000 ohms (R3)
- 1 National 100 mmfd. variable condenser (C1), type SE100
- 1 National dial, type BM-C
- 1 National 50 mmfd. variable condenser (C2), type ST50
- 4 by-pass condensers, .1 mfd. (C3, C5, C6 and C7)
- 1 grid condenser, .0001 mfd. (C4)
- 1 5- to 6-volt filament-lighting transformer (T)
- 1 National grid-grip, type 24
- 4 binding posts
- 15 feet hook-up wire
- Bus-bar wire, 20 feet
- Miscellaneous hardware, screws, washers, etc.
- 1 aluminum panel, 6½" by 10" (or 7" by 10")
- 1 baseboard, 6" by 9"
- 1 tube base
- Small piece of bakelite strip for binding posts
- National plug-in coils for bands desired, type R-39, series 10 (L1, L2 and L3)

The first step in construction, after all the parts are secured and at hand, is to drill the panel in accordance with the plan of Figure 3. It does not matter if the panel is slightly larger than indicated in the dimensions. For instance, if a standard 7" x 10" panel is available, it need not be cut down. The baseboard may be prepared from any good solid piece of wood. Three-ply wood with two cross braces on the under side is excellent. The baseboard should be given a coat of shellac (orange looks better than the white variety). In fastening the baseboard to the panel, be careful to use small screws so as not to split the wood—particularly when plywood is used. These screws are not subjected to much strain, the main panel support being supplied by the condenser C1 mounting. This condenser should be the first instrument mounted, in accordance with the detailed drawing of Figure 4, page 567.

Next, study the general layout as shown in the picture wiring diagram, Figure 2, the layout, Figure 5, page 567, and the top view photograph, Figure 6.

It is important that all parts be laid out exactly as shown. After the main tuning condenser, C1, the parts are best mounted in the following order: binding-post strip; sockets; filament transformer, T, condenser, C2, and the volume control, R3.

Start with the wiring before mounting additional parts, and connect condenser C2 across binding-posts BP1 and BP2. Now mount and connect condenser C3 and C4. Use bus-bar wire here in order to make these parts self-supporting. (The top view photo, Figure 6, will show where it is desirable to use the bus-bar rather than the flexible hook-up wire). Solder a 7-inch lead to BP1 for the grid cap. Resistors R1 and R2 are next connected by means of their semi-flexible pigtailed which also hold them rigidly in place. The socket connections should now be completed, and chokes RFC1 and RFC2 mounted and connected by means of their pigtailed. Mount and wire the remaining connections.

For the sake of habit, it will be desirable to connect the volume control, R3, so that volume increases as it is turned to the right—or clockwise. With the volume control in place, and looking at it from the back of the panel, the wire from the right-hand lug should lead to BP3. The center lug is connected to RFC2, and the remaining lug as shown on the diagrams.

All joints must be soldered—and soldered cleanly. If possible, use rosin-core solder—and nothing else. This will not be difficult if the joints are

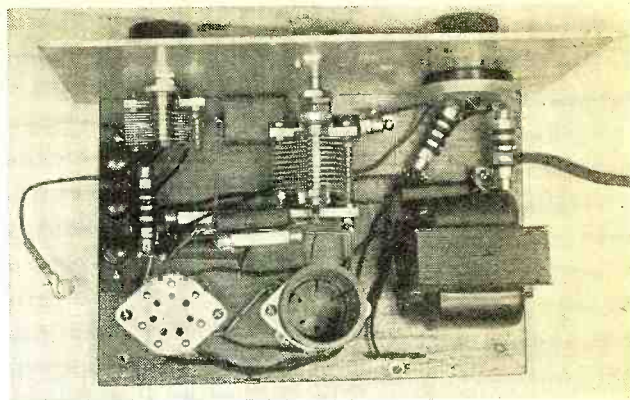

FIGURE 6. TOP VIEW OF ADAPTOR

good and clean. If you must use a paste—such as Nokorode—clean the joints, after soldering, with denatured alcohol, being sure to wipe off all surplus paste. Have your iron clean, well tinned and sufficiently hot.

The wiring should be checked and double-checked against Figures 1 and 2.

To mount the dial, pry off the hub cap with a small screw-driver. Loosen the screw in the hub so that the dial will slip over the condenser shaft. Secure dial to the panel by means of the three small screws from the back of the panel. Turn the condenser plates on C1 all the way out, and adjust the dial to zero. Now tighten the set-screw against the shaft and replace the hub cap. While the dial has 200 divisions, only 150 divisions will be used over a 270-degree rotation.

It will be necessary to provide some means of connecting the adaptor to the receiver. The most convenient way of doing this is by a plug which can be substituted for the detector tube. Secure a base from a burned-out detector tube or any other tube having the same kind of base. Break the bulb, and clean out the base. Locate the plate prong by (Continued on page 573)

FIGURE 2. PICTURE WIRING DIAGRAM

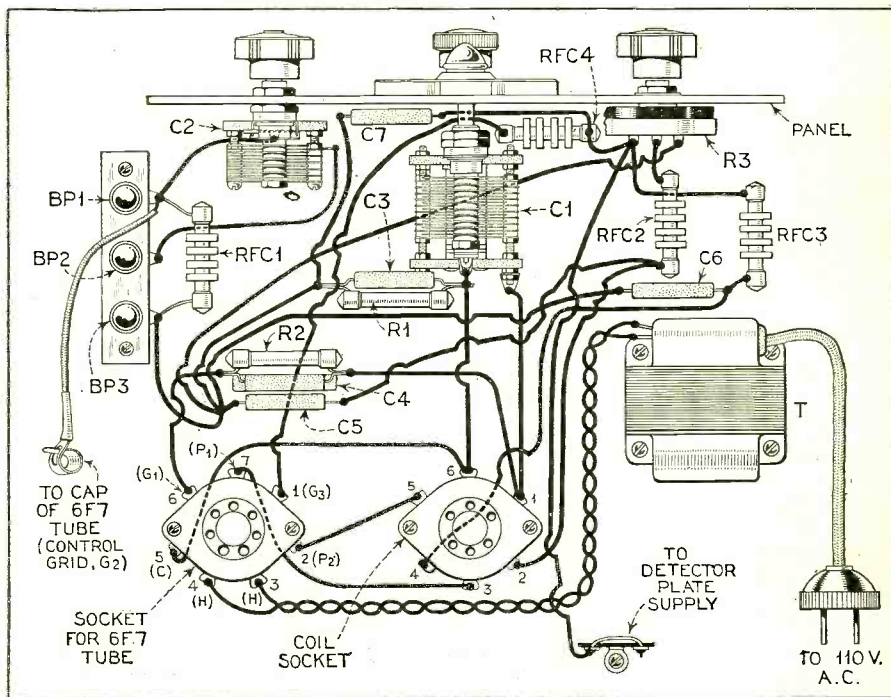
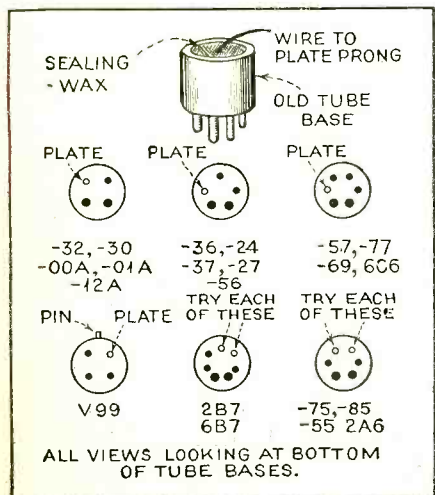

FIGURE 7



*New*

# ALL-WAVE RECEIVER

(R. C. A.—Victor Model 240)



**T**HE extra measure of entertainment value provided by an all-wave receiver, as compared with one which operates on the 200-550 meter broadcast band only, does not require further "selling" to RADIO NEWS readers inasmuch as we have been stressing this advantage continuously for years. It is interesting to know, however, that the larger radio companies have now very definitely entered the all-wave field—a field which has heretofore been of interest primarily to small manufacturers or those who specialize in "laboratory-built" equipment.

The advent of the larger manufacturers into this field will result in a wider variety of equipment available to all-wave fans, in further popularization of short-wave broadcast reception and then, in response to the increasing de-

mand there will be more broadcasters opening up on the short waves to provide an ever wider variety of programs than is now found there. Thus manufacturers, the broadcasters and the public will all profit.

An example of one of the new receivers is found in the RCA-Victor Model 240 All-Wave receiver pictured herewith. A table type, Model 140, which employs the same chassis as the 240, has been under test in the RADIO NEWS laboratory and one of our listening posts for the past few weeks, and shows some features which will interest readers.

The chassis of Models 240 and 140 is available in two types, one having four wave bands from 16-555 meters and one with a fifth band for European use, covering from 732 to 2000 meters. The diagram on this page shows the circuit of the latter type.

Individual ranges are identified by letters. Range X covers from 732-2000 meters, 150-400 kc.; range A is the American broadcast band, 540-1500 kc. or 555-200 meters; range B covers from 1500-3900 kc. or 200-77 meters; range C includes the 50-meter broadcast band and the 31 meter band, it covers 3900-10000 kc. 77-30 meters. Range C covers the shortest waves from 8000-18000 kc. or 37.5-18.7 meters.

Eight tubes are employed, of the following types: First r.f., -58; second r.f., -58; detector and oscillator combined, 2A7; i.f., -58; second detector and a.v.c., 2B7; audio driver, -56; output stage, -53; rectifier, -80.

The design of this circuit includes

several novel features. Instead of using two i.f. stages and one or no r.f. stage, it employs only one stage in the i.f. amplifier and one r.f. stage on three of the four bands with an extra r.f. stage on the shortest waves.

On these short waves the designers found the signal-to-noise ratio less favorable than on the other bands and that this condition could be improved by providing this extra r.f. gain ahead of the first detector. The result is that this receiver makes an especially good showing on the 16-, 19- and 25-meter bands, as borne out by the tests. Another advantage of the extra r.f. stage is less trouble from image frequencies and increased sensitivity.

The next point of interest is the combined second detector and automatic volume control tube. The two diodes, in parallel, are employed as a half-wave detector. A voltage, depending on the strength of the incoming signal, will be developed across the two upper resistors in the diode grids circuit. The top one is a part of the r.f. filter and the drop across the lower one is available for amplification in the pentode section of the 2B7. At the same time, this voltage drop is applied to the grids of the r.f. stage and of the i.f. stage. Note that the lower resistor is tapped and that different voltages are applied to these tubes. This type of control proved highly effective.

The audio circuit for this system is one of the first to make use of the -53 Class B tube. The type -53 is a single tube including two triodes which are employed as both (Continued on page 567)

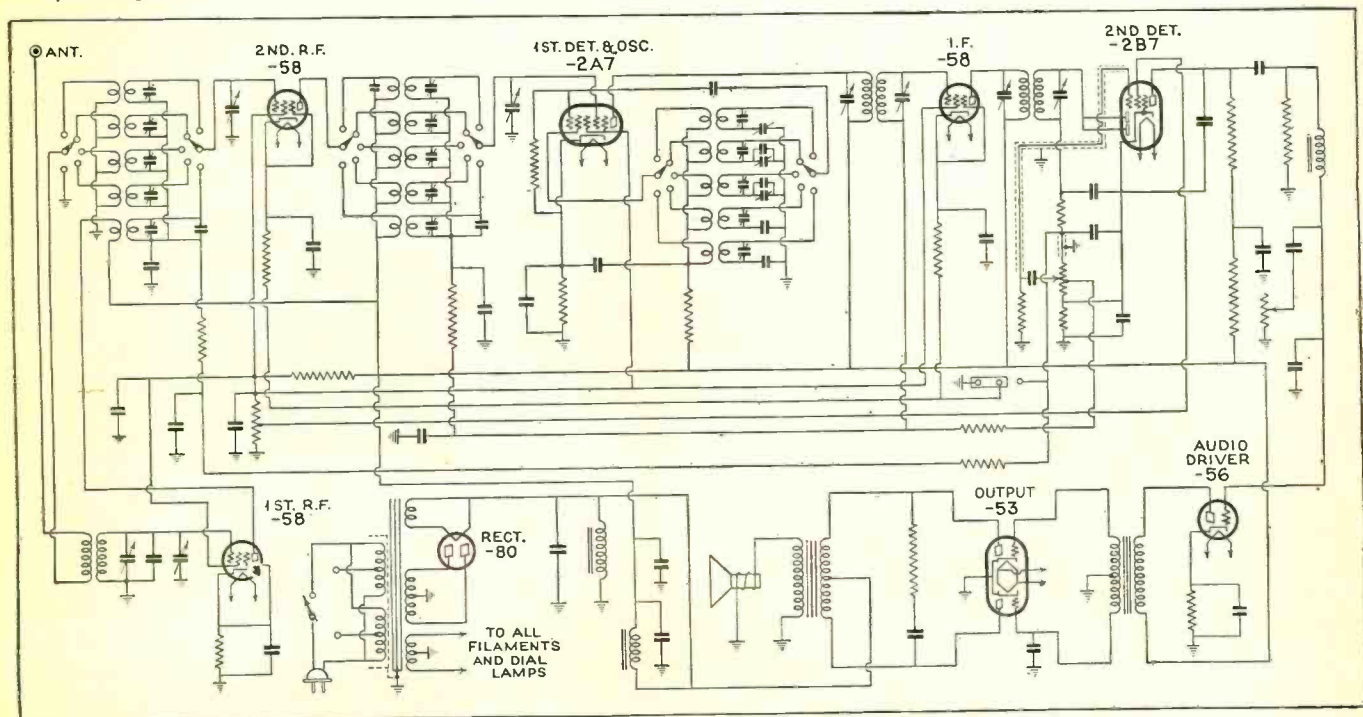





## S. W. TIME SCHEDULE

RECEPTION REPORTS

**I**N this twelfth installment of the DX Corner, we look back over a year of expansion of our activities in bringing before the public all the available worthwhile short-wave data. A leading feature of this department has been *Short-Wave Best Bets*, which this month we find in a new and enlarged form on the following page, under the title *World Short-Wave Time Table*. This Time Table contains a list of world short-wave stations logged during the past month at the RADIO NEWS Short-Wave Listening Post in Westchester County, New York, and at other Official RADIO NEWS Listening Posts throughout the world (listed in a box on this page). The schedule includes the best received stations, hourly, from 5 o'clock in the morning until 12 midnight, G.M.T. and E.S.T. Space has been left for filling in local time. Space has also been left opposite the call letters for your own dial settings for each station. Unless otherwise noted, stations are heard daily.

### Reception Conditions This Month

During the past month the 49-meter band has again improved in signal strength and freedom from static. During the early morning hours the 31-meter transmission from Australia have been excellent as is also true of the 19-meter band. During the early afternoon the 31-meter band has again become favorable. But by far the best reception has been on the 49-meter band. During the following months we expect the 31- and 25-meter bands to improve again with the 49-meter band remaining about the same high standard.

### Outstanding S.W. Reception Features of the Past Few Months

Probably the greatest international transmission feat, at the end of the year 1933, were the British Empire Christmas Greetings, linking the whole of the Empire by short waves. Many beam transmitters could be heard in this link-up as well as the regular "G" stations. Our readers reported hearing this remarkable broadcast, including immediate responses between political leaders in Australia, New Zealand, Canada, Bombay, South Africa, and many other British possessions over Station GSA and in some cases direct from the commercial beam stations.

Another feature broadcast was the Japanese celebration program following the birth and naming of the heir to the throne of the Mikados. Some queer oriental music was heard including a trio of Kotos

written according to the classical themes of old Japanese music. It was played on Japanese instruments and formed a very interesting part of the ceremonial. We are hoping for more such program material from Japan as short-wave activities across the Pacific are on the increase.

And last but not least, are Byrd's interesting and informal broadcasts from the Antarctic which have been reported as heard direct as well as through LSK and the station from Kokohead, Hawaii. Another relay post is the station at Bolinas, California. Can you add to these?

### Moscow Transmission

An official communication from radio station RV59 states that they will be on the air on 50 meters, from 4 to 5 p.m., E. S. T., everyday except Thursdays and Saturdays. They also have a program on 25 meters but the time was illegible in the communication. (We think the time was from 9 to 11 a.m., E. S. T.)

### German, Italian, Canadian and South American Transmissions

An official communication received by Listening Post Observer Johnson, of Texas, from the Reichs-Rundfunk-Gesellschaft states that station DJB will transmit on 19.73 meters from 7:55 a.m. to 4:30 p.m. Station DJD will transmit on 25.51 meters from 10 a.m. to 6 p.m. DJA will transmit on 31.38 meters from 5 p.m. to 9:15 p.m. DJC will transmit on a wavelength of 49.83 meters from 7 to 9:15 p.m.

Another official communication received by Mr. Johnson from radio station I2RO states that they will be on the air on a wavelength of 25.4 meters from 11 a.m. to 12:30 p.m. and from 2:30 p.m. to 5:30 p.m.

A third official communication received by Mr. Johnson from radio station VE9GW states that they will be on the air on 49.2 meters Thursday from 8 a.m. to 5 p.m.; on Friday and Saturday from 4 p.m. to midnight; on Sunday from 11 a.m. to 9 p.m.

Mr. Johnson's fourth official communication is from station HC2RL which will transmit on a wavelength of 45 meters twice a week on Sundays from 5:45 to 7:45 p.m., E.S.T. and on Tuesday from 9:15 to 11:15 p.m., E.S.T. The power is 150 watts.

The fifth official communication is from station CP5 of La Paz, Bolivia. CP5 will be on the air on a wavelength of 49.3 meters on Mondays, Wednesdays and Fridays from 6:30 to 7:30 p.m. and from 9 to 11:30 p.m.; Tuesdays, Thursdays and Saturdays from 6:30 to 8 p.m. and from

### Official RADIO NEWS Listening Post Observers

**L**ISTED below by States and countries are the Official RADIO NEWS Short-Wave Listening Post Observers who are serving conscientiously all over the World in logging stations for the DX Corner.

In the United States of America:

Alabama, J. E. Brooks; California, C. H. Canning; Florida, E. M. Law, James F. Dechert; Georgia, C. H. Armstrong; Illinois, R. L. Weber; Indiana, F. C. Balph, J. R. Flannigan; Maine, R. I. Keeler; Maryland, H. Adams, Jr., J. W. Smith; Massachusetts, E. F. Orne, A. Hamilton, Roy Sanders; Mississippi, Dr. J. P. Watson; Missouri, C. H. Long; Nebraska, Harold Hansen; New Jersey, William Dixon, R. H. Schiller, W. F. Buhl; New York, I. H. Kattell, Donald E. Bame; North Carolina, H. O. Murdock Jr., W. C. Couch; Ohio, R. W. Evans, C. H. Skatzes; Pennsylvania, K. A. Staats, C. T. Sheaks, George Lilley, J. A. Leininger, F. L. Stützing; Tennessee, A. Smith; Texas, Heinie Johnson; Virginia, D. W. Parsons; Washington, G. E. Dubbe, Chas. G. Payne; Wisconsin, W. M. Harrell, W. A. Jasiorkowski.

British Guineya, E. S. Christiani, Jr.

Canada, J. Bews, A. G. Taggart, W. H. Fraser, D. Wood.

Cuba, F. H. Kydd.

England, J. J. Maling, Alan Barber, D. Burns.

South Africa, C. McCormick, Mike Kruger.

Switzerland, E. J. de Lopez.

New Zealand, Dr. G. Campbell.

Applications for Official Observers in the remaining States and Countries should be sent in immediately to the DX Corner. Listeners outside of the United States who feel that they would like to serve in this capacity are also requested to file their applications as soon as possible before final appointments are made.

9 to 11:30 p.m.; on Sundays from 9 to 11:30 p.m., all E.S.T.

### PLV Transmissions

Listening Post Observer Parsons of Virginia sends in an official communication from radio station PLV at Bandoeng, Java, stating that this station is on the air on 9415 kc., 31.86 meters, occasionally relaying broadcasts from Holland with also an occasional original broadcast. The station is normally used, however, for commercial telegraphy and telephony.

### The British Empire Transmissions

An official communication from the British Broadcasting Company states that the Empire transmission will be as shown in Best Bets with the following possible alternatives: GSE may be substituted for GSD; GSD may be substituted for GSB. When three stations are listed during the same hour, the middle station (in wavelength) will continue through the whole hour with a switch from one to the other of the two other stations listed.

(Continued on page 558)

# WORLD SHORT WAVE TIME-TABLE

The schedule of short-wave broadcasting stations listed below includes only those that are received best in RADIO NEWS LISTENING POSTS. The schedule is from 10 G. M. T. to 05 G. M. T. Both wavelength and frequency, in kilocycles, are noted for each station under STATION LOCATIONS. Unless otherwise noted these stations are heard daily.

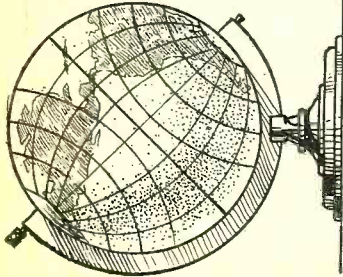
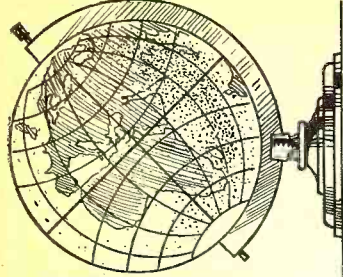

### Short-Wave 'Best Bets'

Wavelengths in Meters	Call Letters	Dial Settings	Local Time	Station	Wave Length	Call Letters	Frequency	Location
10 G.M.T. 5 A.M. E.S.T.	HVJ	30.5	19.7	W8XK	31.4 +	W2XAF	1405	Pittsburgh, Pa.
	JAA	31.2 + Sun.	19.7	DJB	40.5 +	HC2RL	7370	Boud Brook, N. J.
	VK2ME	31.5 Wed., Sat.	25.2	HJ1ABB	45.0 + Tues.	PRADO	17790	Daventry, England
	VK3ME		25.2	FVA	45.3 Thurs.	W3XL	15330	Schenectady, N. Y.
	LCL		25.4	I2RO	46.6 + Fri.	H11A	15243	Poitouise, France
	RV15		25.5	DID	47.8	TCGW	15270	New York, N. Y.
			25.6	VE9JR	48.5	W8XK	15200	Zeesen, Germany
			31.2 + Sun.	VK2ME	49.0	W2XE	15123	Vatican City
			31.5 + Sun.	VK3ME	49.0 + Sat., Sun.	VE9HX	12830	Rabat, Morocco
			40.5 Ex. Sun.	LCL	49.1 + Sat.	W3XAL	11900	Poitouise, France
11 G.M.T. 6 A.M. E.S.T.	DJB	19.7	47.8	H11A	49.1 + Except Sat.	VV1BC	11870	Pittsburgh, Pa.
	DID	19.7	49.0 + Ex. Sat., Sun.	HBL	49.1 + Except Sat.	W9XFR	11865	Daventry, England
	JAA	30.5	49.2 Fri., Sat., Sun.	DJA	49.2 Except Sun.	CP5	11810	Rome, Italy
	VK2ME	31.2 + Sun.	49.3 + Sun.	GRBA	49.3	W8XAL	11750	Daventry, England
	VK3ME	31.5 Wed., Sat.	49.3 + Sun.	PRAG	49.4 +	W3XAU	11705	Zeesen, Germany
	LCL		49.6	GSA	49.4 + Sat.	HIX	11730	Poitouise, France
	RV15		49.6		50.6 Mon., Wed., Fri.	G6XR	11720	Winnipeg, Canada
12 G.M.T. 7 A.M. E.S.T.	W8XK	16.9 +	15.9 +	W8XK	04 G.M.T. 11 P.M. E.S.T.			
	GSG	16.9	16.8	W3XAL				
	FVA	19.7	19.7	W8XK				
	DJB	19.6	19.7	W3XL				
	GSE	19.7	19.7	VV3BC				
	PHI	23.3 + Sun.	23.2	W8XK				
	PRAG	23.3 + Sun.	23.2	FVA				
	VK2ME	25.3	25.5	W2XE				
	LCL	25.5	25.5	DID				
	PHI	25.5 + Ex. Tues., Wed	25.5	VV1BC				
	VK2ME	31.2 + Sun.	31.2 +	W9XFR				
	LCL	42.9 +	42.9	VE9GW				
	W8XAL	49.4 +	49.4	CP5				
	RV15	70.2	70.2	W9XAA				
13 G.M.T. 8 A.M. E.S.T.	W8XK	16.9 +	16.8	H11A				
	GSG	16.9	16.8	GSA				
	FVA	19.7	19.7	OXV				
	DJB	19.6	19.7	DJC				
	GSE	19.7	19.7	HJ4ABE				
	PHI	23.3 + Sun.	23.2	W8XK				
	PRAG	23.3 + Sun.	23.2	VE9JR				
	VK2ME	25.3 +	25.2	FVA				
	LCL	25.5 +	25.2	EQO				
	PHI	25.5 +	25.3	DJA				
	VK2ME	31.2 + Sun.	31.3 +	W2XAL				
	LCL	42.9 +	42.9	W9XAL				
	W8XAL	49.4 +	49.3	GRBA				
	RV15	70.2	70.2	PRAG				
14 G.M.T. 9 A.M. E.S.T.	W8XK	16.8 +	16.8	PSK				
	GSG	16.8 +	16.8	HJ3ABD				
	FVA	19.7	19.7	VJ2AM				
	DJB	19.6	19.6	HC2RL				
	GSE	19.7	19.7	HJ1ABB				
	PHI	23.3 +	23.2	W3XL				
	PRAG	23.3 +	23.2	TGW				
	VK2ME	25.3 +	25.3	VV3BC				
	LCL	25.5 +	25.5	W8XK				
	PHI	25.5 +	25.5	W2XE				
	VK2ME	31.2 +	31.2	W8XK				
	LCL	42.9 +	42.9	GSD				
	W8XAL	49.4 +	49.4	EAQ				
	RV15	70.2	70.2	W3XAU				



# A New MOBILE RADIO TICKER

W. G. H. Finch



**PRINTS MESSAGE ON TAPE**

*The author and inventor holding mechanism which is installed in back of dashboard, with the tape message projected through a window on the dash*

ONE effective way of securing secrecy in radio communication is by the application of the telegraph printer, a device which operates by radio, somewhat in the manner of the news "ticker," operating on telegraph lines. The telegraph printers now available, however, are too bulky and weighty and usually require a high degree of synchronism between transmitter and receiver units. This, generally, makes them impractical for application in mobile uses such as police signaling, aircraft communication, etc. A printer for mobile use must be light in weight, having as few moving parts as possible; it must be rugged in construction and should operate on a 6-volt storage battery. With these ideas in mind, I have developed the printer shown in the accompanying illustrations. It weighs only eight pounds and will print, automatically, from radio signals at a rate of 30 words a minute. In a recent test I have shown that it could receive transmitter communications from a transmitter W2KBF, located in the Bronx, when it was installed in a car proceeding from the Bronx to Pelham. A variation in transmission speeds of as much as 50 percent was noted but not affecting the accuracy of the received printed messages.

In order to insure further secrecy in operation the alphabet and numerals have been divided into seven parts and the characteristics have been embossed on 7 code discs, which are interchangeable at any time thereby giving many combinations which may be employed. I believe the unit will be found applicable to mobile police units and other land vehicles as well as for planes and ships—anywhere where mobile radio reception is necessary. And aside from such uses there is a definite demand today for the application of mobile radio "tickers" by business houses in the dispatch of fleets of trucks, buses, and the like.

Referring to the reproduction of the patent drawing, we can see the system

of printing diagrammatically illustrated. The code transmitted from the transmitter 10 comprises a synchronized impulse voltage by a 2-unit code combination. In response to the synchronizing impulse, the relay 12 which is an extra slow acting relay, is energized. Normally relay 12', whose winding is of a lower resistance than the series winding of magnet 48 and relay 100, provides a bypass circuit for the current from battery 111 over contact 23' and brush 20 to ground at 121. Relay 12', however, upon being energized over this circuit, opens the circuit at its armature 13' which disengages its back contact. Thereafter upon receipt of the first signal impulse, the circuit completed extends over conductor 113, since relay 12', being slow to release, is not deenergized during the no-impulse period. If, therefore, the synchronizing impulse is received while brush 20 is on contact 23', normal operations proceed. If, on the other hand, no synchronizing impulse is received when brush 20 is on synchronizing contact 23', no operation can occur. Brush 20 will remain on contact 23' until the synchronizing impulse, showing that the transmitter and receiver are in synchronism, is received.

The synchronizing impulse is much longer than even the long impulse of the code in order to energize extra slow relay 12'. As soon as relay 12' is energized, stepping magnet 48 is energized. Brush 20 is moved from contact 23'. At the end of the synchronizing impulse, magnet 48 is deenergized stepping the brush a further distance and the apparatus is ready for the first signalling impulse. In response to the first signal impulse energizing relay 12, an energization circuit is completed from the battery 111 front contact and armature 110 and conductor 113 through the magnet 48, conductor 114

and relay 100 to ground, at 115. Magnet 48 is a stepping magnet controlling the operation of the distributor device 13, which controls the switching of the oncoming impulse to mechanisms, responsive to the two-unit code and controlling the final printing and restoration of the printer.

This switching is effected by the brush or contact arm 20 which is mounted on, and locked by a key to one end of a rotatable shaft 21, the other end of which carries a friction plate 22. Shaft 21 is driven by a motor through a worm 41, mounted on a shaft of the motor and meshing with a worm wheel 42, secured to and driving shaft 43. Secured to, for rotation with shaft 43, is the fraction disc 44 including plates 22 and 45. As the motor rotates, shaft 21 carrying distributor arm 20, tends to rotate with it, but is normally prevented from rotating by the pawl 47 in engagement with one tooth of the ratchet 46, secured to the shaft 21. One end of the pawl 47 consists of an armature controlled by a magnet 48 to which the armature is attracted when that magnet is energized. Normally, however, the pawl 47 is held against its backstop by a spring 49, one end of which is secured to the pawl 47 and the other to the framework.

When magnet 48 is energized in the manner described above, it attracts pawl 47 which rocks about its pivot, withdrawing the lower tooth of pawl 47 from the ratchet wheel 46 and moving its upper tooth in the path of the ratchet wheel, permitting a rotation of the shaft 21 (Continued on page 575)

**DETAILS OF DEVICE**

*Figure 1 shows the operating circuit, while Figure 2 indicates the method of installation behind the dashboard*

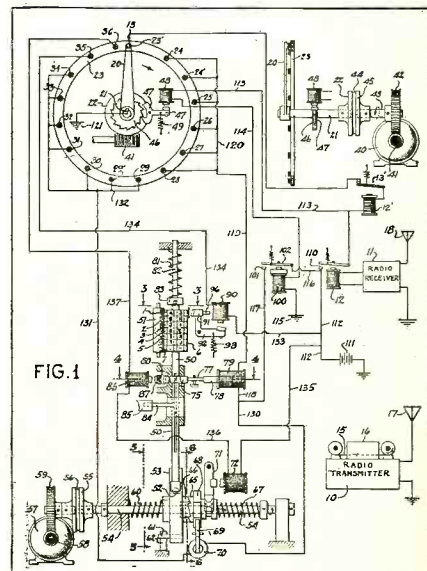
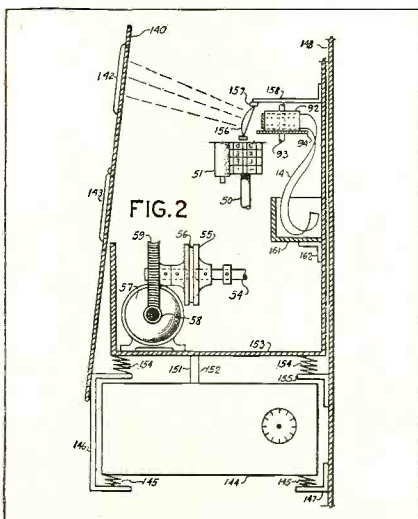

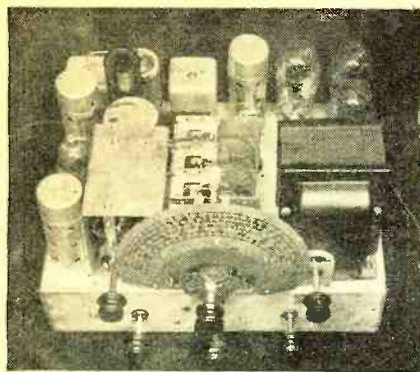

TOP VIEW OF CHASSIS

The dial is calibrated in kilocycles and megacycles on all bands

# A FIVE-RANGE 13-2000 METER SUPERHET

Is this receiver typical of the receiver of a few years hence? Many authorities predict the future adoption of channels up to 2000 meters for broadcast purposes in North America, as in Europe

Hubert L. Shortt

THE average radio receiver in the American home of the near future will be a combination, long broadcast and short wave set—so we believe. In the European home, this range, which includes the 850-2000 meter band, is now in use. It was to meet this expected demand in America that the Lafayette Trio-wave superheterodyne was developed in our laboratory. It is expected to fill the need for an all-wave receiver at a moderate price.

The Trio-wave receiver covers the wave bands from 13 to 555 meters or 550-24500 kc. continuously in four steps, and an additional long wave range (850 to 2000 meters). It incorporates automatic gain control (a.v.c.), manual volume control, manual sensitivity control, and is supplied with the latest tubes in the output stage, delivering 10 watts of undistorted power to the dynamic speaker. Another model, called the Dual-wave Superhet, does not include the long-wave range but is otherwise identical with the Trio-wave receiver.

Ten tubes are employed in this super-

heterodyne circuit. The first detector is a 58 type, while the oscillator is a 57. Separate tubes are employed in preference to the multi-purpose tube because greater sensitivity can be attained that way, particularly in an all-wave receiver. A preselector circuit is employed ahead of the first detector on the broadcast and long wave bands.

The intermediate frequency amplifier consists of two stages employing 58 type tubes. A 56, connected as a diode serves as second detector and automatic volume control combined. Then follow two resistance coupled audio stages with two 56 tubes which feed the output stage consisting of two 2A3 tubes in push-pull.

The rectifier employed is the 5Z3 which can deliver a higher current than the customary -80.

The intermediate frequency is 115 kc.; it was chosen as the most logical one in view of the range of the receiver which tunes as low as 150 kc. The image frequency will thus be 230 kc.

higher than the desired signal. A special image-frequency bucking coil is used on the broadcast and long wave bands which eliminates all trouble with repeat points on these bands.

There seems to be some controversy on the theory of action of this bucking coil. We advance the following explanation: The hum-bucking coil feeds a small part of the signal to the detector grid circuit and it arrives there 180 degrees out of phase with the signal arriving by the normal route. The desired signal and the image-frequency signal are present in the coils L2 or L7 and will consequently induce a voltage in the bucking coil at both of these frequencies. The normal signal voltage is also induced in the coil L7 or L8 because of their electromagnetic coupling with L2 and L3. Since the grid circuit of the detector is tuned, the image-frequency signal will be very much decreased before it reaches the grid, while the desired signal is only slightly decreased. The (Continued on page 573)

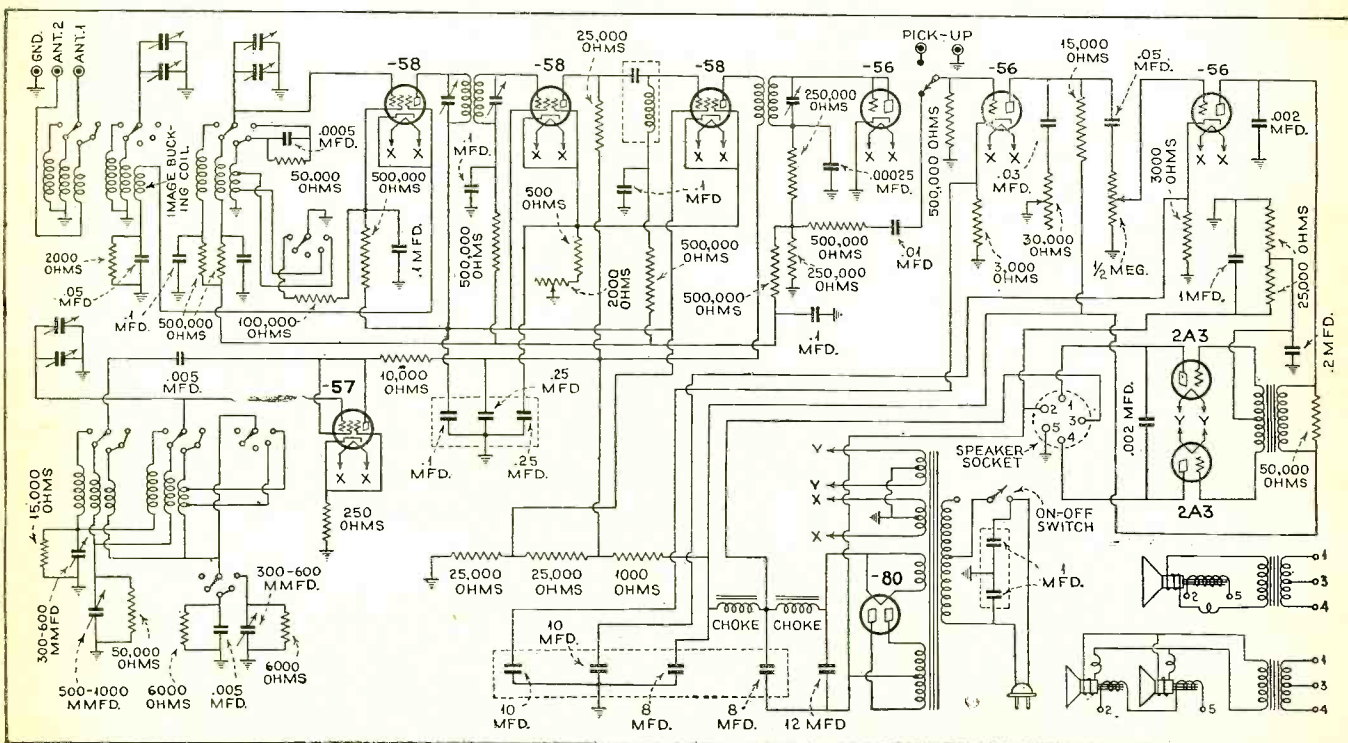

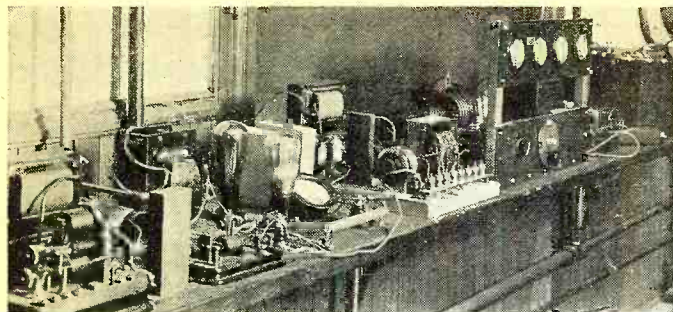

THE EXPERIMENTAL TRANSMITTER

Located 500 feet from the receiving and measuring equipment was the remote controlled transmitter shown here. As alterations were made in the transmitter supply, its wave form was duly checked and photographed

# Remedies for POOR NOTES and KEY CLICKS

Christ Kardas\*

Part One

THIS analytical study of poor notes and key click interference should interest all "Hams" operating c.w. transmitters, because it shows in detail the causes for these common troubles and how to prevent them.

MUCH has already been written concerning interference produced by radio transmitters on account of improper design of power supply systems and faulty keying circuits. This article, however, is not another treatise on design in the strict sense of the word, but is an oscillographic study of a transmitter's signals whose rectified plate supply filter, plate supply, and plate voltage regulation were changed so as to actually see the resulting effects.

In telegraphic transmitters of the non-modulatory type, it is necessary to prevent the carrier frequency current from being modulated. It is also necessary, for good transmissions, to avoid key clicks and thumps when manipulating the telegraph key. Therefore, if these two important considerations are fulfilled, sharp, clean-cut signals will be produced. Steady signals of "pure" d.c. quality are desired, and not the rough, wobbly, and "swinging" frequency kind which are unreliable for better communication under adverse conditions.

Poor voltage regulation on the plate of the oscillator will cause the frequency to swing. This variable frequency causes the signals to become broad and introduces interference with other stations.

Voltage regulation of a generator, transformer, rectifier or rectifier filter may be defined as the variation in voltage the device delivers with variations in the load. Voltage regulation is accordingly an important consideration when designing the transmitter. If the latter is of modern design, namely, of the high-capacity type oscillator, or still better, high-capacity and piezo-crystal controlled oscillator, we see from the formula of oscillation given below that voltage regulation affects the frequency. For, although this formula does not involve voltage terms, it is affected by them. Rapid changes in plate voltage cause an unstable condition, known as the "dynamic" instability, which is due to the low ratio of load impedance to

the plate impedance of the tube used.

The equation for frequency of oscillation is,

$$(2\pi f)^2 = \frac{1}{CL} \left( 1 + \frac{R}{r_p} \right)$$

In this equation,  $r_p$ , the plate resistance of the tube, is the dynamic variable, and  $R$  is the load resistance. The latter should be made small in comparison with  $r_p$ , then  $R/r_p$  is small and the effectiveness of variation in the tube's plate impedance is greatly reduced, as far as frequency variation is concerned. Therefore, it is seen how voltage regulation affects the "dynamic" stability of the circuit.

If rectified alternating current is not properly filtered, then the transmitter's emitted wave will have a 60-cycle modulation if a half-wave rectifier is employed or a 120 cycle modulation if full wave rectification is provided. In order to show just what a filter circuit does, we shall briefly review the theory of the rectifier in order to have a basis for discussion. A good half-wave rectifier is not as desirable as a poor full-wave rectifier and the reason for this will be easily seen a little later.

When a half-wave rectifier is employed, only every other current loop is effective. Figure 1 (A) represents an alternating current wave and (B) represents the wave as it leaves the rectifier. If full-wave rectification is used, the out-put wave of the device is as illustrated in the loops of (C). The current rises from zero to a maximum

value, drops to zero, and again repeats. This form of d.c. is not desirable for plate supply and should be changed to approach the "pure" d.c. as represented by the heavy curve of (C). By introducing inductance coils in the load circuit, the current waves may be made to overlap as shown in (D), curves  $a$  and  $b$ . This change or overlapping of the waves makes it possible for the d.c. to reach a distance of  $x$  from the base line where, previous to the overlapping, it dipped to the base line. Thus the inductances (chokes) somewhat reduce the pulsating quality. By adding sufficient chokes and condensers, the current is made to follow the dotted lines shown in this figure. The choke coils give the time "lag" effect to the current and cause it to slowly rise as  $s$  indicates and the condensers produce the  $s'$  effect.

If  $e_2$  is the voltage across the load and  $i$  is the load current, then  $Ri = e_2$ , where  $R$  is the total resistance of the load circuit, and

$$\frac{\delta e_2}{e_2} = \frac{8\pi}{Rp^2 L \left( C + \frac{1}{p^2 L} \right)^2}$$

which is the equation derived in the theoretical treatment of a single-phase rectifier. This equation represents the ratio of change of voltage to the voltage  $e_2$ . By this formula, it can be seen that as the frequency increases, the capacity for the filter circuit must be decreased to avoid an increase in the

RECTIFIED A.C.

Wave forms are shown for a.c. (A), half-wave rectification (B), full-wave rectification (C) and full-wave rectification with filter (D)

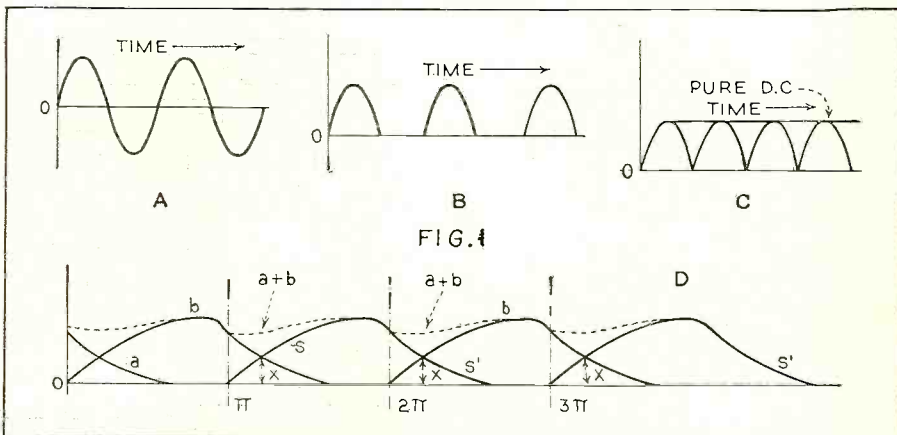

\* Owner and operator of short-wave amateur station W9FOK.

percentage fluctuation. Oscillograms of waves, using different filter circuits, will be shown later.

Besides voltage regulation and filtration, we still have to consider the keying circuit. This subject, however, will be treated in a later article.

The apparatus employed in obtaining experimental data for these articles consisted of a short-wave radio receiver, an audio-frequency amplifier, a Duddell oscillograph, an experimental transmitter, a full-wave power rectifier, and a number of choke coils, resistances and condensers for the power supply and key filter circuits. Two views of the experimental set-up, located in the electrical laboratory, Science Hall, Northwestern University, are shown in the accompanying photographs.

In order to photograph the radio signals, a short-wave receiver was necessary. The output from the latter was passed into the oscillograph through a special impedance-matching transformer. The receiver was a regenerative detector type. In order to have suitable deflections, a three-stage distortionless amplifier was used. A loudspeaker was used to listen to the signals to be photographed.

In order to allow current to flow through the oscillograph circuit, which has a resistance of about 10 ohms, its impedance (practically composed of all pure resistance) was matched to the impedance of the output circuit of the amplifier by means of a suitable transformer.

There was no choice as to the type of oscillograph to use for this work. The Physics Department of the University had available for our purpose one of the earliest instruments of the Duddell electromagnetic type. An arc light provided the necessary illumination for its two vibrating mirrors. The heart of the oscillograph is, of course, the delicate suspended element. Its principle of operation is described in many textbooks. Briefly, the vibrating system consists of a phosphor-bronze wire suspended from top of loop and held in

DETAILS OF DUDELL OSCILLOGRAPH

*The oscillograph used in these experiments had three mirrors, two of which were attached to vibrating elements and the third stationary. This third mirror traces a reference line on the photographic filament*

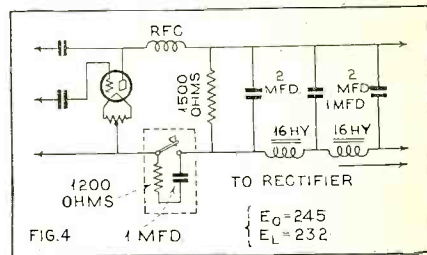
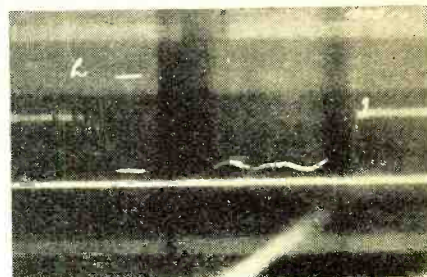
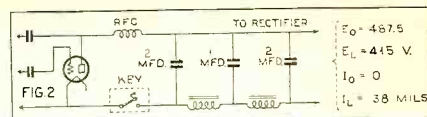
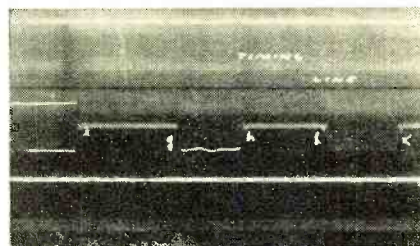
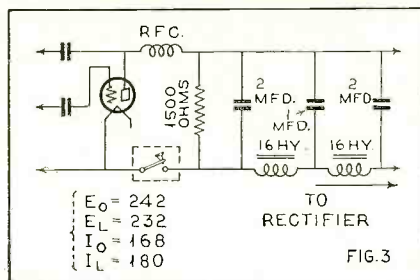
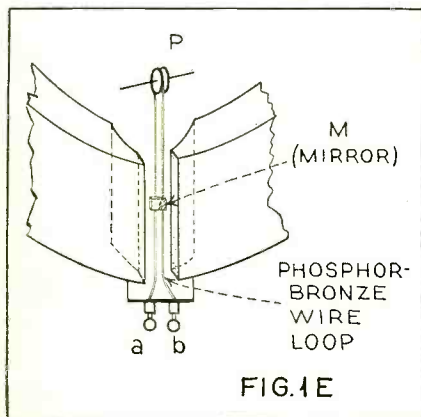

tension by a spring. See Figure 1 (E). In this diagrammatic view, *N* and *S* represent the poles of a strong electromagnet, *M* is a very small mirror and *P* is a pulley over which the element is stretched. When an alternating current is applied to the element's terminals, *a* and *b*, one of the legs of the inverted "U" is caused to advance while the other recedes, and the mirror is thus turned about a vertical axis. Just as long as the field coils are excited and an alternating current is applied to the element, there will be a continuous vibration. This particular element's natural period is 1/10,000 of a second.

The oscillograph had two vibrating elements, one of which was actuated by radio signal currents and the other by current from a 1000-cycle tuning fork used for a timing line. The oscillograph had also wave-viewing facilities so as to view the waves before photographing.

The experimental transmitter was located in the old mineralogical laboratory, about 500 feet from Science Hall. It consisted of a simple Hartley oscillator employing one type -10 tube in a self-excited circuit.

Among the many types of circuits, the Hartley was preferred on account of its simplicity. Its oscillatory circuit was of the high-capacity small-inductance type, since this has the advantages of better frequency stability. This circuit is also more easily adjusted than the tuned-plate, tuned-grid type, or the more complicated power amplifier circuit. The power supply was shunt-fed, since it did away with the split-coil affair which is necessary in series-fed power supply.

The rectifier was of the full-wave type, employing two type -81 tubes.

To photograph signals and at the same time be able to vary the wave's amplitude without making changes in the receiver and amplifier circuits was accomplished by increasing or decreasing the coupling of the matching impedance transformer windings.

The experimental transmitter was operated by remote control from the receiving and recording station. When making adjustments of this transmitter, a telephone line between the sending end and the receiving end was utilized for (Continued on page 575)

THE RECEIVER AND OSCILLOGRAPH

*This is the equipment employed in the experiments described in this article. It is located in the Electrical Laboratory of Northwestern University, Evanston, Illinois*

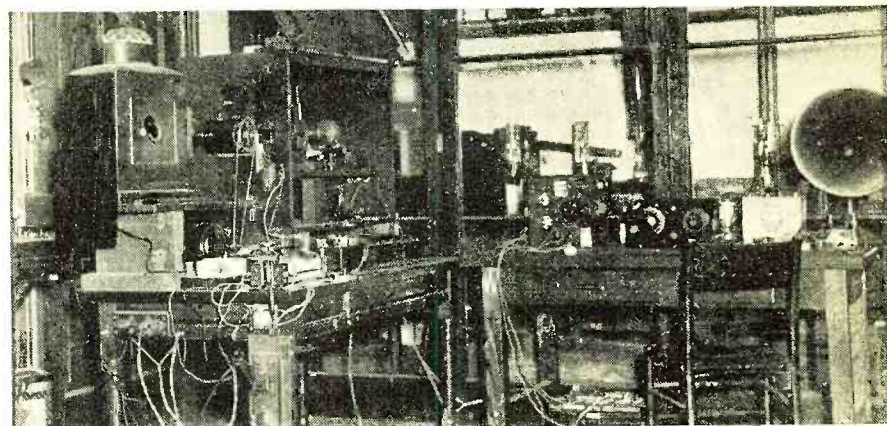

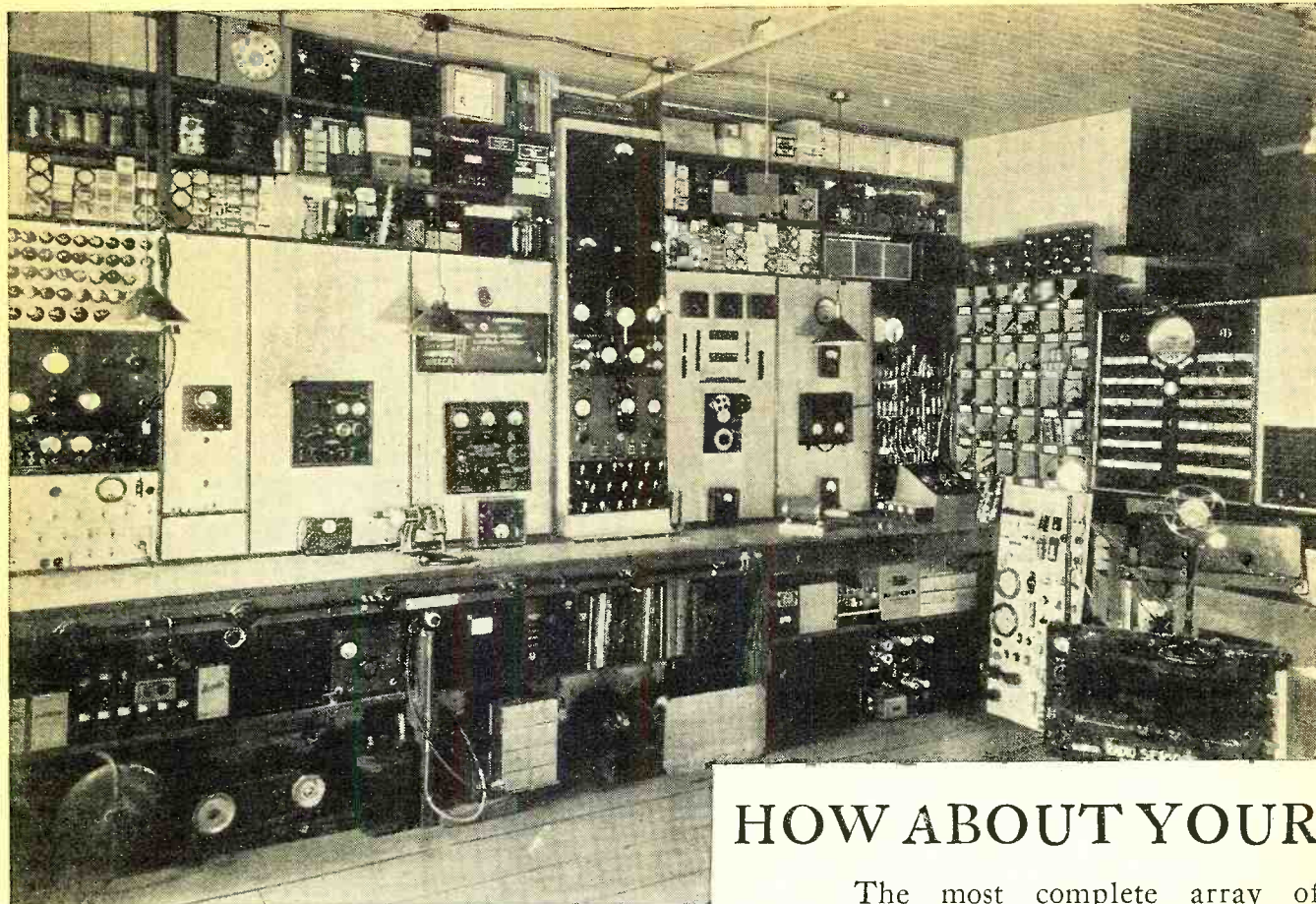

WINNER OF THE FIRST PRIZE FOR SERVICE BENCH  
*Above: Service bench installation of the Dakota Radio Service Co., 304 Broadway, Yankton, So. Dak. Below: Second prize winner, Edwards Radio Service, Mass. Ave., at 9th, N. E., Washington, D. C.*

## HOW ABOUT YOUR

The most complete array of equipment in the world will not it is so arranged as to insure speed

THE radio service field has developed to a point where profits depend on volume of work. For the most part servicemen have adopted a fixed scale of charges—and these fixed prices must be low enough to be reasonable from the customer's standpoint, which means that work must be handled with a high degree of efficiency if enough is to be accomplished to show a profit. Then, too, jobs must be quickly done even when work is slack, in order to avoid the dissatisfaction which results if the owner must do without his receiver for an unduly long time.

The National Union Radio Company, while not directly interested in service equipment, has been conducting an extensive campaign to aid the serviceman in improving the efficiency of his operations. As one step in the campaign this company recently sponsored

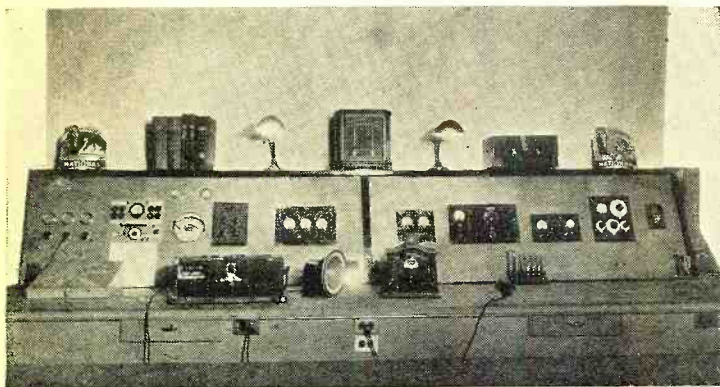

*Below: Service bench of the Radio Specialty Co., 422 N. W. Broadway, Portland, Oregon*

*Another view of the Stitely's Radio Shop service bench at Oskaloosa, Iowa*

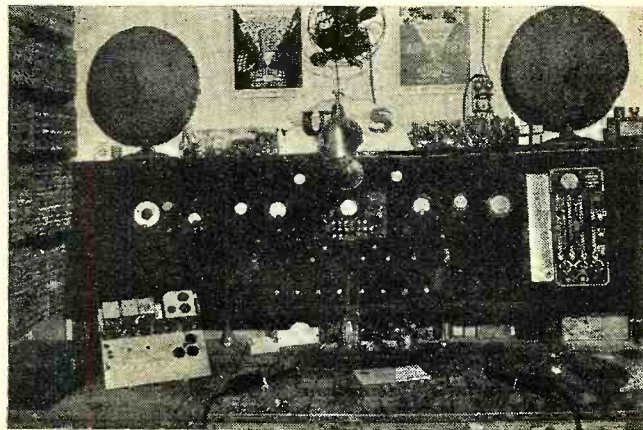
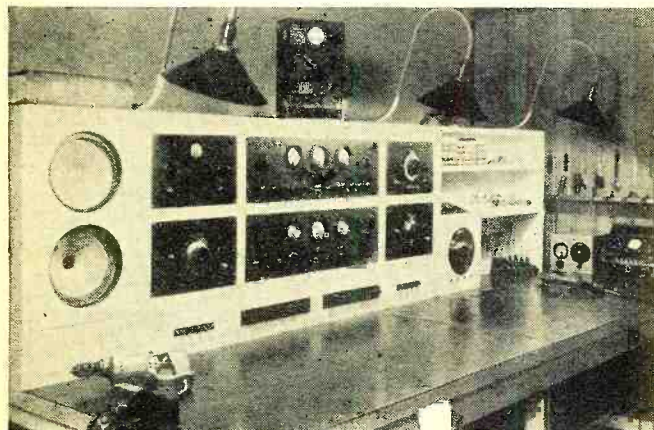



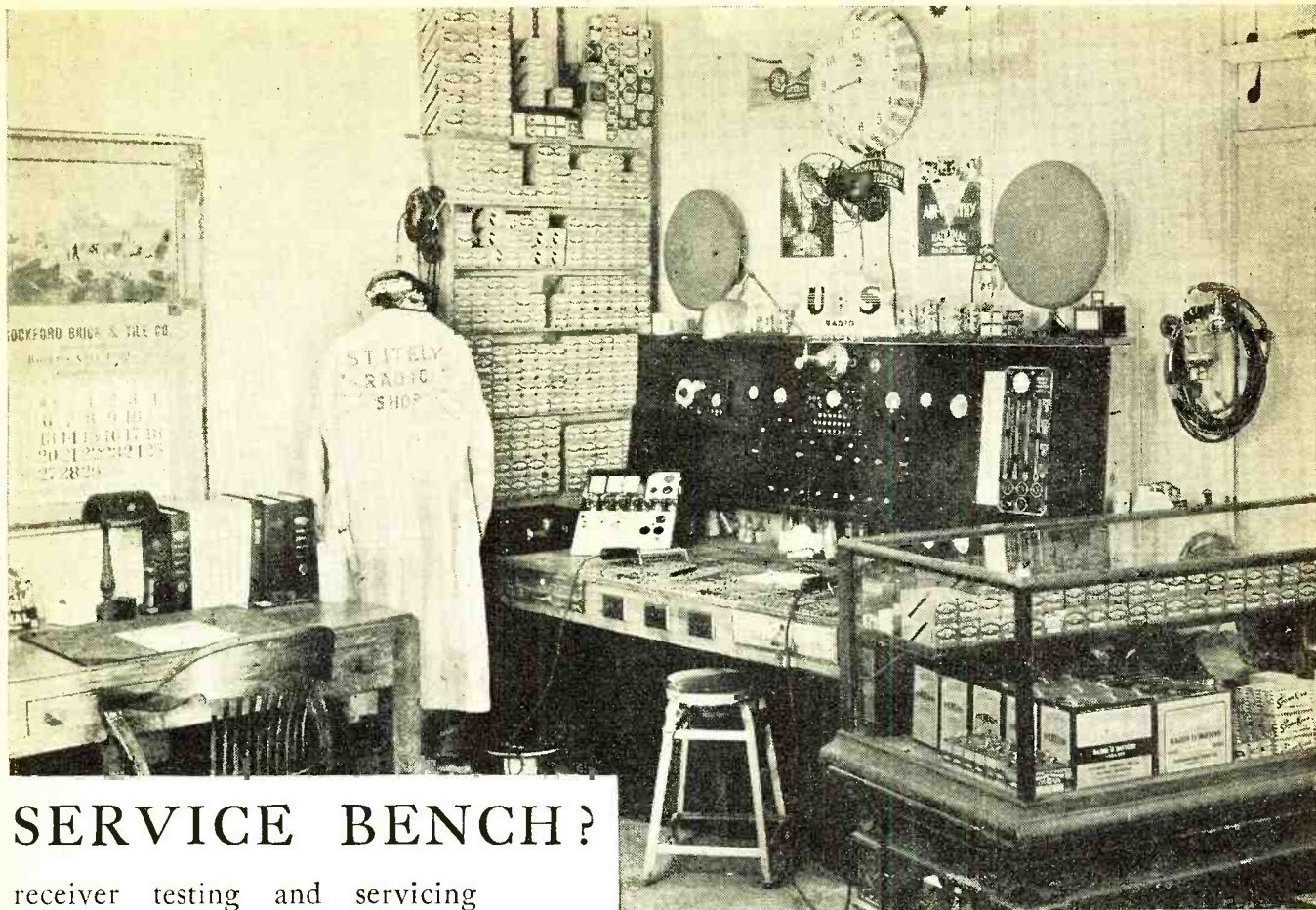

# SERVICE BENCH?

receiver testing and servicing result in efficient servicing unless and convenience of operations

A COMPACT, WELL-EQUIPPED SERVICE SHOP  
*Above: General view of the Stitely Radio Shop, Oskaloosa, Iowa.  
Below: Third prize winner, Lyon Radio Service, 584 Delaware St., Syracuse, N. Y.*

a competition, offering prizes to the 28 servicemen whose service benches were selected by the judges as the best of those entered in the contest. Judgment was based on photographs submitted and other available data.

The prizes awarded consisted of a set of 25 autographed National Union tubes to each of the 28 prize winners, with cash prizes of \$100, \$50 and \$25 to the three entries adjudged the best of the 28.

The entries were surprising both in point of number (considering that all had to be accompanied by photographs of the service benches) and in the completeness and arrangement of service equipment employed by the entrants.

Herewith are shown the photographs submitted by the first, second and third (Continued on page 571)

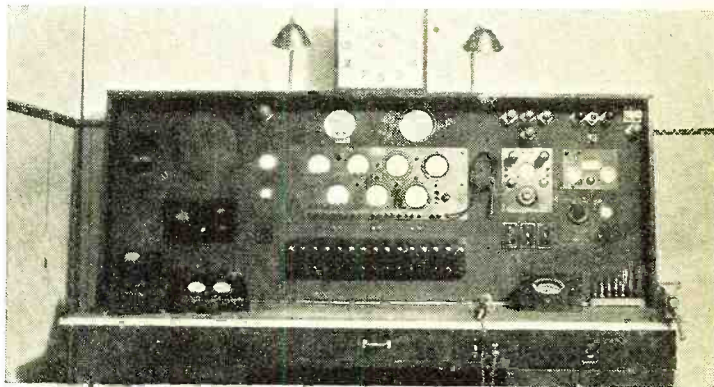

*Thirty-five-foot service bench of the Ace Radio Service, 621 York St., Newport, Kentucky*

*Well-equipped bench of G. W. Roper, Public Market Bldg., Sacramento, California*

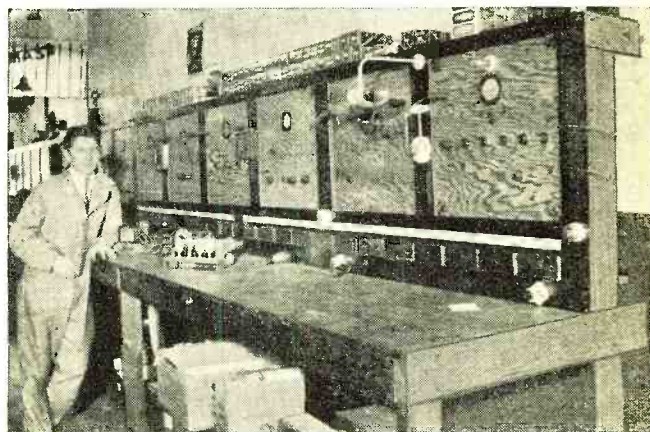
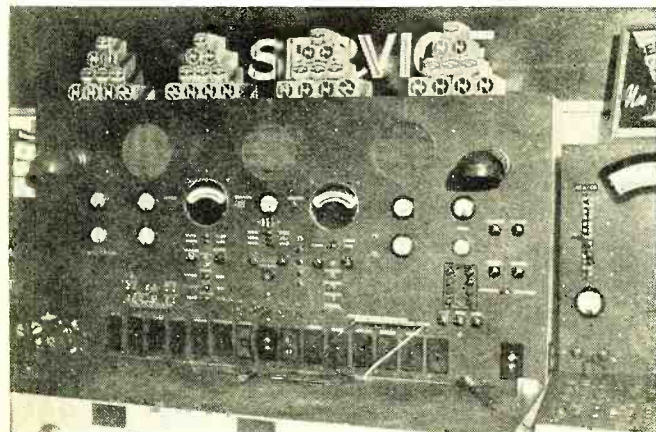

GENERAL INFORMATION AND SERVICE DATA ON

# MODERN BATTERY RECEIVERS

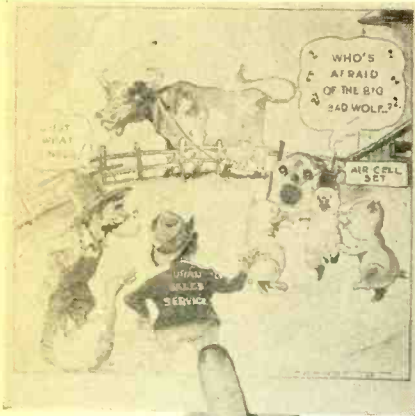

WHEN YOU SEE THIS CARTOON You will know that the article it accompanies is one of a series on air-cell receivers for rural listeners



With the following general information on new rural radio receivers is included advance service data which will prove a useful addition to the files of rural radio servicemen and dealers

**R**URAL dealers and servicemen are writing us hundreds of letters regarding the new battery-operated receivers for use by broadcast listeners who reside in locations where there are no power lines. They have requested information as to what manufacturers are making this type of equipment and also the full technical details on these sets. In this, the third article of the series, we are including this information on three of the sets mentioned in the preceding article, giving the required service and operating data as furnished direct from the engineering departments of the manufacturers. The rural serviceman is finding that this type of equipment is solving the problem of rural radio, in providing modern high-quality reception comparable with that

of line-operated receivers. The diagrams and tables accompanying these descriptions give the values of the component parts as well as the correct tube potentials.

The Sparton Model 82 Air-Cell receiver has a wavelength range from 120 to 360 meters, providing police, aeronautical and amateur signals in addition to reception on the regular broadcast wavelengths. The manufacturer points out the following features which have been provided in this new battery-operated set: permanent-magnet dynamic speaker, adjustable A battery voltage control which permits use of an air cell, 2-volt storage or 3-volt dry-cell battery, illuminated full-vision dial, antenna-equalizing condenser and Class B power amplification using the new

POINT-TO-POINT ANALYSIS, SPARTON MODEL 82

Measurements are made with batteries in good condition, volume control full on, antenna disconnected and wave-band switch set for broadcast-band operation. Resistance measurements, made with all battery leads connected together, are accurate within plus or minus 15 percent

TUBE	LOCATION	PLATE		SCREEN GRID VOLTS	CONTROL GRID VOLTS	GRID RES. TO PRECEDING PLATE (OHMS)	RESISTANCE TO GROUND (OHMS)			
		VOLTS	MA.				PLATE	SCREEN	C.GRID	CATHODE
1A6	1ST. DET. OSC.	135	1.3	67.5	-3.	—	12.5	0	750,000	0
-32	I.F. STAGE	135	1.7	67.5	-3.	500,000	12.5	0	500,000	0
-32	2ND. DET.	135	.6	50.	-3.	500,000	350,000	500,000	500,000	0
-30	1ST. AUDIO	135	3.0	—	-7.5	85,000	80	—	500,000	0
-19	POWER	135	4.0	—	-3.	300	75	—	220	0

ALL FILAMENT VOLTAGES = 2.0 VOLTS A BATTERY DRAIN .6 AMPERE, B' BATTERY DRAIN 25 TO 35 MILLIAMPERES.

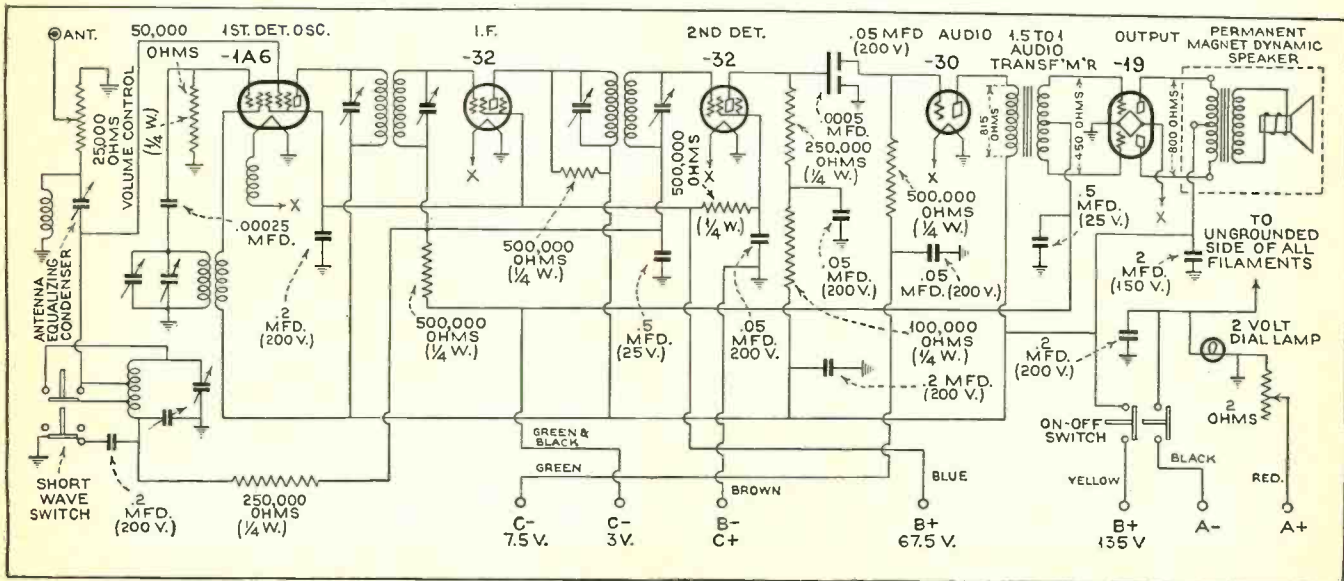

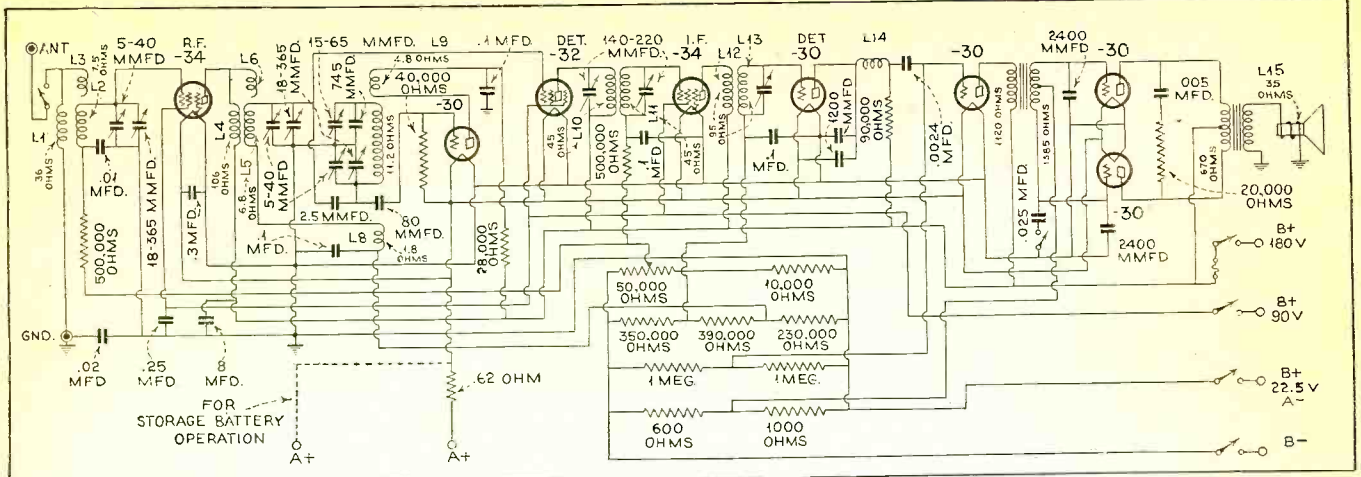

TUBE	LOCATION	CONTROL GRID TO FILAMENT VOLTS	SCREEN GRID TO FILAMENT VOLTS	PLATE TO FILAMENT VOLTS	PLATE CURRENT MA.	FILAMENT VOLTS
-34	R.F.	*3.0	65	155	2.5	2.0
-30	OSCILLATOR	—	—	55	4.0	2.0
-32	1ST. DET.	*4.0	65	155	0.5	2.0
-34	1. F.	*3.0	65	155	2.5	2.0
-30	2ND. DET.	*10.0	—	*130	0.25	2.0
-30	A. F.	*7.0	—	150	2.5	2.0
-30	POWER	*14.0	—	155	2.0 TOTAL	2.0
-30	POWER	*14.0	—	155		2.0

\*VOLTAGES ARE OBTAINED BY MEANS OF HIGH RESISTANCE DIVIDERS AND IT IS NOT POSSIBLE TO ACCURATELY MEASURE THEM WITH ORDINARY EQUIPMENT.

type -19, 2-volt tube in the output stage. This receiver employs a superheterodyne circuit using an intermediate frequency of 456 kc. It employs one type 1A6 tube as first detector and oscillator, -32's for the i.f. amplifier and second detector, a -30 type tube in the first audio stage and a -19 in the Class B

**CONDITIONS OF MEASUREMENT, RCA-VICTOR MODEL 241-B**

*Voltage and currents shown are obtained with new batteries, volume control set at maximum and no signal tuned in*

power stage. The set is designed for use with the Eveready Air-Cell battery, 2-volt storage battery or the Rayovac 3-volt dry-cell A battery. The remaining batteries required for its operation are three 45-volt heavy-duty B batteries and one 7-volt C battery. The A battery current drain is .6 ampere and the B battery consumption 25 to 35 ma.

The control knob at the extreme left is the off-on power switch, the lower middle knob is the range selector. The

**VOLTAGE MEASUREMENTS, A-K MODEL 387**

*At time of measurement B voltage had dropped to 120 v. Tube voltages measured from F minus of each tube, using 250-volt scale of a 1000-ohm-per-volt meter*

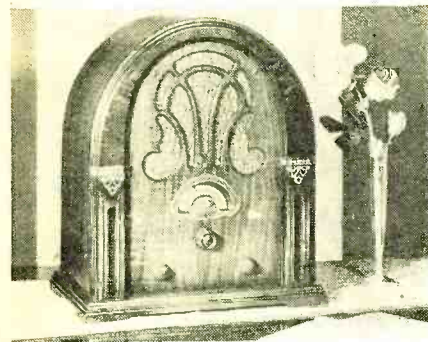
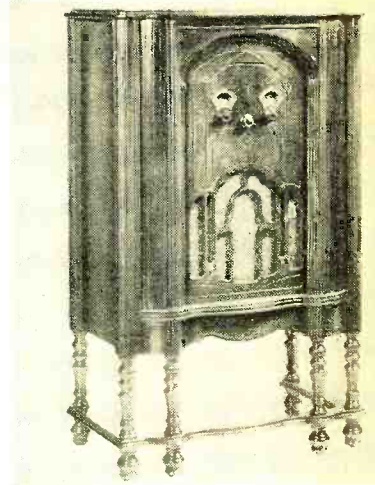

top middle knob is the station selector, the dial of which is calibrated in kilocycles for the broadcast band and in megacycles for the short wavelengths. The knob on the extreme right is the volume control.

The antenna-equalizing condenser is located at the top of the chassis near the front and close to the dial assembly. The A voltage control knob is accessible from the rear of the receiver chassis.

The Sparton table model 81 air-cell receiver is (Continued on page 568)

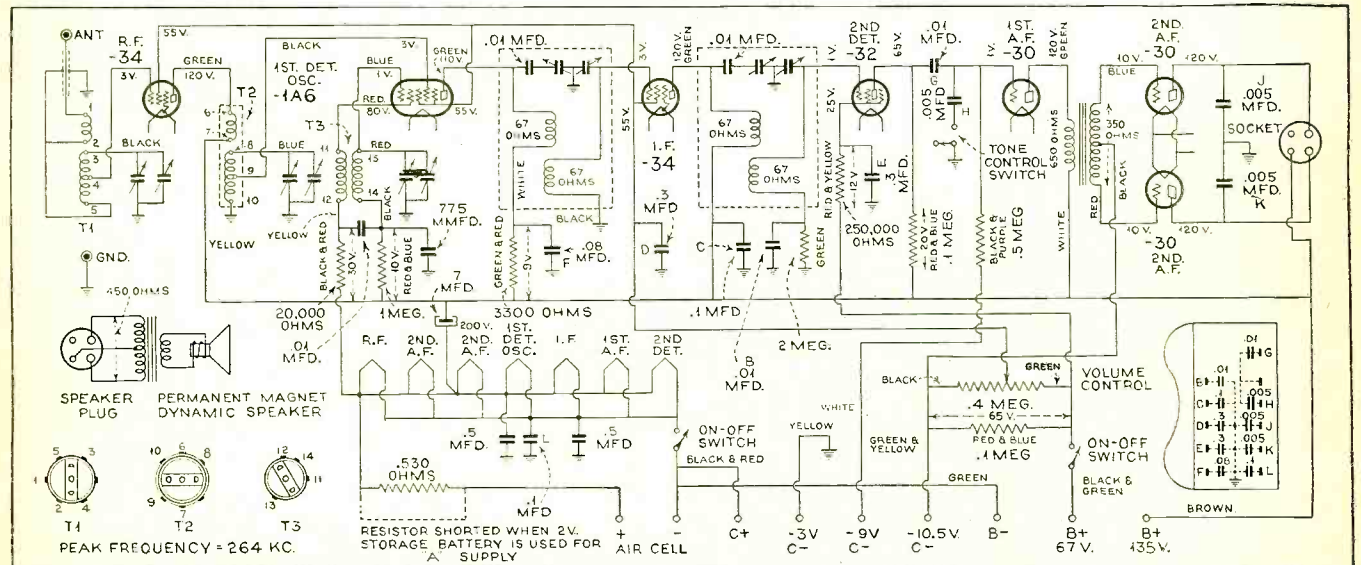

# TELEVISION APPLICATIONS OF CATHODE RAY TUBES

In this, the fifth, article the authors describe an amplifier with an unusually flat frequency characteristic ranging from 1/4 cycle to 250 kc.

J. M. Hollywood, M. P. Wilder

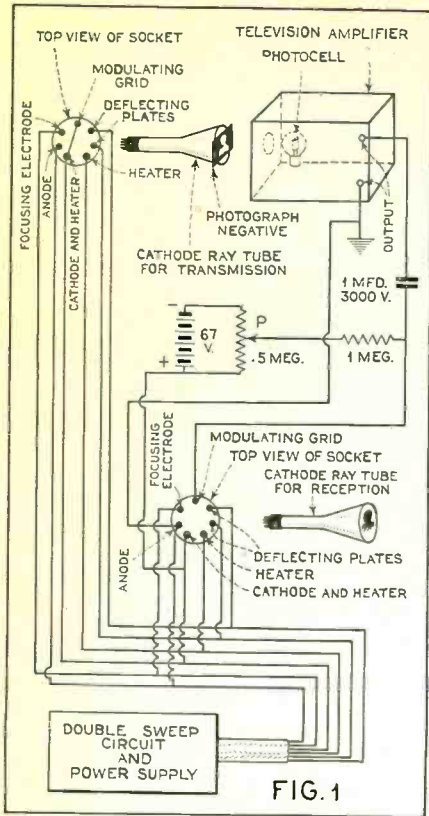

It is probable that cathode-ray tube reception of television pictures will become important in the future, because they can be made suitable for pictures of any number of lines and degree of definition, up to 400 lines at least. It would be difficult to make mechanical scanners to handle such high scanning speeds, but there are no moving parts in the cathode-ray tube and no limit as to its scanning speed. The degree of detail in pictures than can be obtained depends upon the size of the spot of light produced on the screen as compared to the size of the screen. Apart from this, picture detail in cathode-ray television is limited more by the apparatus associated with the tube than by the tube itself.

Accordingly, it may be of interest to describe an amplifier which can handle a sufficiently wide frequency range to permit pictures of 120 lines, recurring 20 times a second. This amplifier has a calculated gain of over 100 db. and is shown in the accompanying photographs, its circuit being given in Figure 2. This amplifier was used in sending television pictures over a short wire line. This experiment can be duplicated by anyone sufficiently interested, without too great expense. The arrangement is shown in Figure 1.

Two cathode-ray tubes are used. The deflecting plates of both tubes are connected together and to a common sweep circuit. In this way, the spots of light on both screens are automatically moved in synchronism while scanning the screen area. The tube at the sending end is used to scan a photographic negative with the moving spot of light, the negative being held tightly against the screen. The light is then passed on to the photo-cell and amplifier, where changes in voltage occur in accordance with changes in light as the spot passes over darker and brighter parts of the negative. These voltage changes are amplified and applied to the modulating grid of the cathode-ray tube used for reception. The amplifier, photo-cell and cathode-ray tube are connected so that a decrease of light on the photo-cell causes an increase of brightness of the

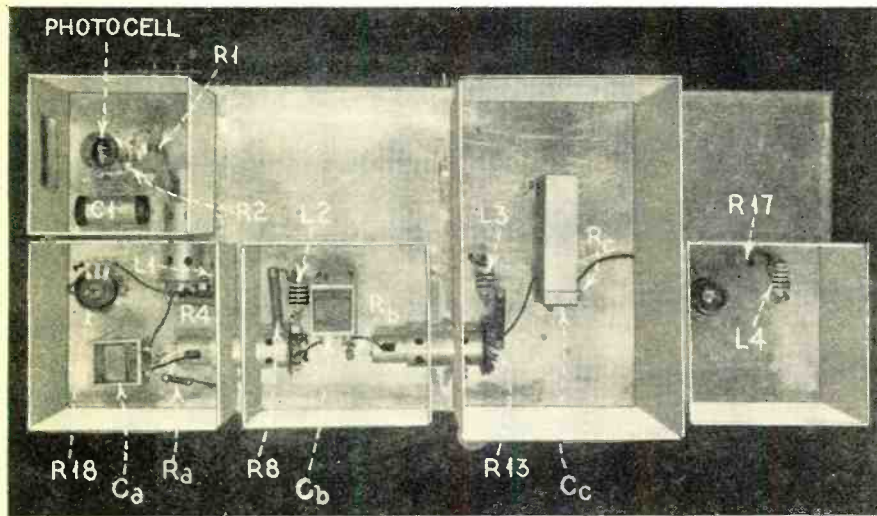

INSIDE VIEW OF AMPLIFIER  
Extraordinary thorough shielding is employed. Note the horizontal mounting of the tubes. The resistance-capacity filters are under the chassis

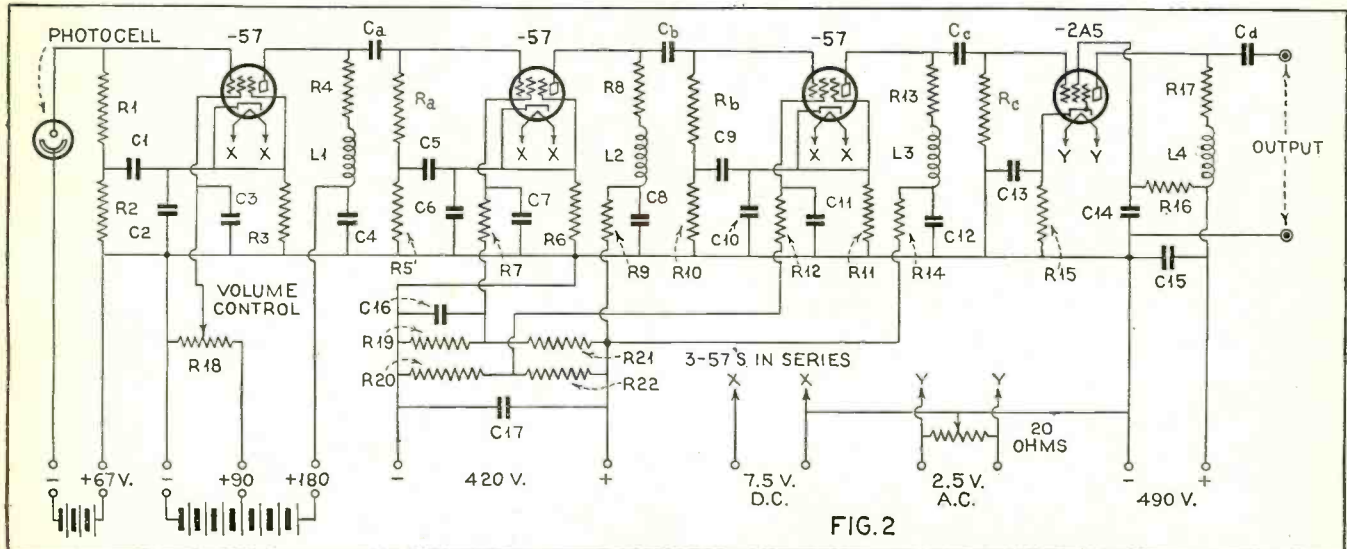

spot on the screen of the cathode-ray tube. Consequently, a positive picture is traced out on the end of the receiving tube as the negative is scanned at the sending end.

The power supply and sweep circuit can be similar to that shown in the second article of this series, in the December issue of RADIO NEWS. Instead of one sweep circuit, however, two must be used, one for deflecting the spot of light horizontally across the screen about 2400 times a second, and the other for deflecting the spot vertically about 20 times a second. The combination of the two linear deflections causes the spot to trace out scanning patterns of about 120 lines. The pattern will be repeated 20 times a second, which will not give much flicker.

It is to be understood that the socket connections shown are only for a particular make of cathode-ray tube. However, any cathode-ray tubes can be used if the socket connections are changed so that the proper wires go to the proper electrodes in the tubes. The power supply voltage for the focusing electrode may have to be changed by altering the resistance values in the voltage divider in that unit; and the heater voltage may have to be changed by means of a rheostat or a different transformer voltage. This applies to the power supply described in the December issue. Data given by tube manufacturers should indicate what changes, if any, will have to be made in the power supply.

The general light intensity level of the picture can be regulated by varying the grid bias voltage with potentiometer P of Figure 1. This should have an insulating shaft, and it and other apparatus connected to the grid should not be touched, because such points are at high d.c. potential with respect to ground. The degree of contrast in the picture can then be regulated by varying the volume control of the amplifier. If the largest possible output is small, the light intensity will have to be reduced by potentiometer P to obtain good contrast. In any case, the average light intensity should not be made over half the maximum possible value, so that it can increase when a positive voltage is applied to the grid from the television signal.

The amplifier itself is rather interesting. A wide frequency range must be amplified in order to reproduce fine details. For example, if the picture is a checkerboard with 120 squares to a side, when the light spot sweeps over the picture it will be interrupted 60 times per line, 7200 times per picture, and 144,000 times per second. Frequencies at least as high as 144,000 cycles would have to be handled to obtain even a poor reproduction of such a picture. On the other hand, if the top half of the picture is black and the lower half white, the light will be interrupted 20 times a second, requiring frequencies lower than 20 cycles to be passed. When such a picture is shown, the voltage input to the amplifier jumps suddenly to a constant value lasting for a fortieth of a second, then jumps down to another constant value. The output voltage will not follow this action faithfully unless the

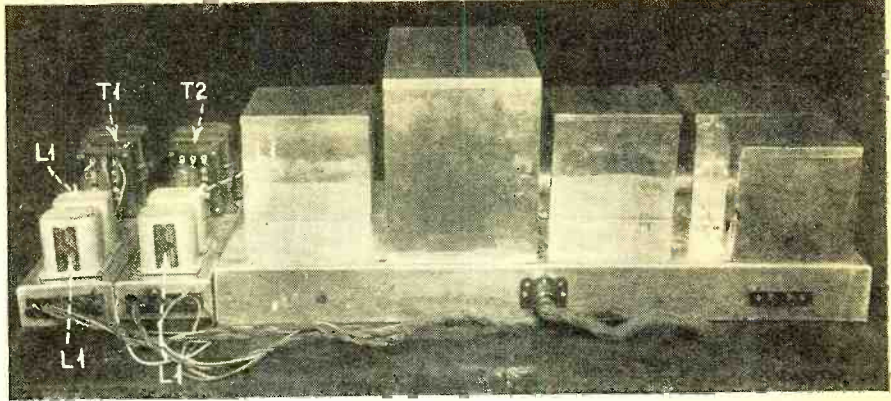

coupling condensers Ca, Cb, Cc, discharge slowly through resistors Ra, Rb, Rc, as compared to the time the input voltage remains at one level. A condenser of C mfd. discharging through a resistance of R megohms starts discharging at a rate that would discharge it completely in (CR) seconds. In order to have each condenser discharge only 2.5% while the input remains constant for one fortieth of a second, (CR) was made equal to 1 second in each case. This would make the amplification drop 16% in each stage at one-quarter of a cycle per second; i.e., 50% drop for the entire amplifier and its coupling system to the cathode-ray tube at 1/4 cycle.

At high frequencies the amplification is limited by the interelectrode capacities between cathode and grid and between cathode and plate of the tubes, and other stray capacities by-passing the coupling resistors. The coupling condensers are mounted as far from the shielding as possible, but even so the total by-passing capacity is about 20 mmfd. In order to make this by-passing action relatively small, low-resistance coupling must be used. With resistors of 30,000 ohms, the amplification per stage would drop 16% at a frequency of 250 kc., making total drop in amplification about 50%. By using small inductances in series with the coupling resistors as shown, the amplification tends to increase at high frequencies, counteracting to some extent the by-passing action of stray capacitants. Thus it is seen that the amplifier loses 50% of its gain or 6 db. at 1/4 cycle and at over 250 kc. Its calculated gain is 110 db. or 300,000 times. With such high gain and such a frequency range, very good shielding is necessary, so all parts are completely enclosed in aluminum shield cans except the photo-cell, for which an opening is cut, protected by a copper screen.

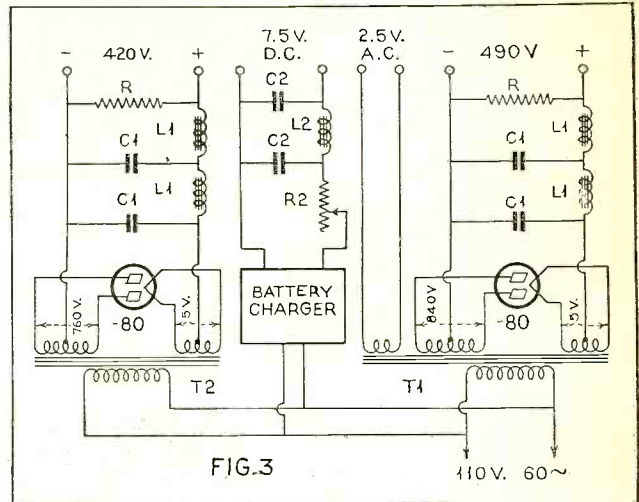

FIG. 3

POWER SUPPLY

Two independent power-supplies are used to insure stability. Any good battery charger which can deliver one ampere is suitable for the filament supply

Magnetic shielding is unnecessary, since the only inductances used are very small.

The fact that the amplifier passes very low frequencies means that trouble may be encountered from slow oscillation or "motorboating," and to prevent this, simple filter circuits are placed in individual grid and plate leads; also the screen-grid leads cannot be connected to a common voltage divider, but must have individual dividers or series resistors. Trouble may also be encountered from fluctuations of the a.c. line voltage; if this is serious, some automatic line voltage or B voltage regulating device may be necessary, or B batteries can be used instead of an a.c.-operated supply from the first stages.

In a receiver for television by radio, much less low-frequency amplification is used, and many of the difficulties encountered in the amplifier become negligible. The fact that such a high-gain amplifier suitable for television can be made shows that the problem of making a receiver that will give sufficient picture detail is by no means insoluble.

Incidentally, the output of the amplifier shown in Figure 1 could be used to modulate a small amateur transmitter for transmission of photographs, pictures of call letters, etc., by radio at small expense, on the proper wavelengths and with the proper license. It would be necessary to provide for synchronization (Continued on page 566)

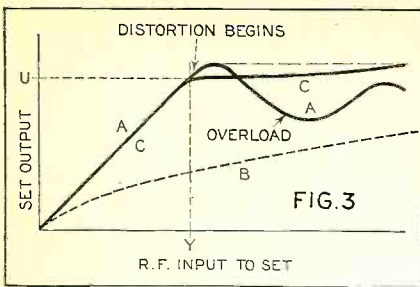

# “AY-VEE-SEE”

*(Its Purpose, Applications and Limitations)*

The author, a consulting design-engineer, presents an unusually comprehensive discussion on a subject which has received too little attention in radio publications

**Edgar Messing**

*Part One*

**T**HE function of automatic volume-control circuits is to present a practically constant signal to the audio detector so that a more or less constant sound output, save for program variation, is heard even though the signal in the antenna may vary widely. To discuss the “why” of a.v.c. we must distinguish between two classes of receivers—home receivers and automobile sets. Under the first we list all those sets intended for use in the home in locations within fifty miles of desirable stations. Under automobile receivers we may class sets designed for operation in cars, motor boats, etc., and also highly sensitive receivers.

The major functions of a.v.c. for each type are different. In auto sets the function is primarily to prevent fading. In home sets the basic purpose is to prevent overloading of the set; the elimination of fading is of secondary importance.

The auto set, due to the low antenna pick-up, is operated by relatively weak signals whose strength may fluctuate very rapidly over great extremes. The set must be able to accommodate these wide fluctuations and still produce an output signal that is substantially constant.

The home receiver with a normal antenna is expected to reproduce signals from local stations with good field strengths. The one great obvious fault of the home receiver without a.v.c. becomes glaringly apparent when the operator turns the volume control fully on and tunes through the broadcast band. In any large city where local stations have good strength such operation will bring in one or two stations satisfactorily and that is all. The strong local stations will blurr in and then out, in again and then out again. As the operator tunes in a strong local station the output from the set grows in volume and then dies down abruptly and sounds “choked up” when the station is exactly tuned in. As the operator continues tuning, the output suddenly jumps up again to maximum and then dies down as the station is tuned out.

This double-spot tuning is all the

worse because the operator complains not only that he gets stations in two places but also that in each of the two places the quality is poor. The quality is poor, of course, because the signal is heard when the station is off resonance and side bands are being cut. At resonance the signal is so strong that the audio detector is overloaded, rendered practically inoperative, and the “choked up” effect results.

Incidentally, the terms “automatic volume control” and “a.v.c.” are really not correct. “Automatic sensitivity control” would be the right words. Engineers know this but they talk about “a.v.c.” just the same. Because of their popular acceptance, the first two terms are employed in this article.

Figure 1 shows a typical a.v.c. circuit. V1, V2 and V3 are either i.f. or r.f. amplifier tubes. V4 is the a.v.c. tube, shown here as a separate diode tube for the sake of simplicity. The diode plate goes to some r.f. or i.f. signal source such as the plate of the last amplifier tube. The value of the signal thus presented to the diode plate is governed by the gain of the amplifier tubes. And in turn, since the gain of these tubes is determined by the signal the diode plate receives, automatic control is achieved. The signal going to the a.v.c. diode is the controlling voltage.

The signal on the diode plate causes various currents to flow in the direction indicated by the arrows. The voltages across “r,” due to these currents, are: a d.c. voltage proportional to the signal carrier, an a.c. voltage proportional to the modulation of the carrier and an a.c. voltage proportional to the carrier itself. Other voltages we may neglect as not pertinent to our discussion.

The direction of the d.c. is such that the ground end of “r” is positive with respect to point “A.” Neglecting the a.c. voltages, we see that the grids of the amplifier tubes are at the same d.c. potential as point A with respect to

ground. The resistors in series with the grid returns do not affect this voltage equality because no current flows through them (since the condensers C1, C2 and C3 prevent any current from passing along R from A).

Point A, and therefore the tube grids, will become more negative with respect to ground as the signal applied to the diode increases. Since ground is already negative with respect to cathode, due to the drop in the cathode resistors, the bias is increased and the amplifying efficiency of the tubes is decreased.

The above may be somewhat tedious to the reader, but a clear understanding of just what happens makes the more interesting phases easier to comprehend.

In Figure 1, or the equivalent circuit, Figure 2, it will be noted that a number of resistors and several condensers are used. Not all of these units may be necessary, but we will not discard any until we learn their use. Resistor “r,” it was said, had several voltages developed across it. The d.c. voltage is distributed through R and R1 to V1 and similarly to the other tubes. The a.c. voltages, audio and r.f., that are across “r” are nuisances and trouble makers. If we let the r.f. voltage, for example, reach the grids of the amplifier tubes, the whole amplifying system would go into oscillation. If we let the audio voltage reach the grids, then the gain of the tubes might be varied at an audio rate and we would have audio modulation of the signal, resulting in distortion.

It is the function of the resistors, other than “r,” and the condensers to filter out these two a.c. voltages. R and C are the first sections of the filter and are so proportioned that the voltage across C, r.f. or a.f., is a small fraction of the initial voltage across “r.” In series with each tube’s grid there is a separate additional filter, as R1 and C1, for V1. The final voltage that reaches the grid of V1 would be that across C1, which is a very small fraction of the

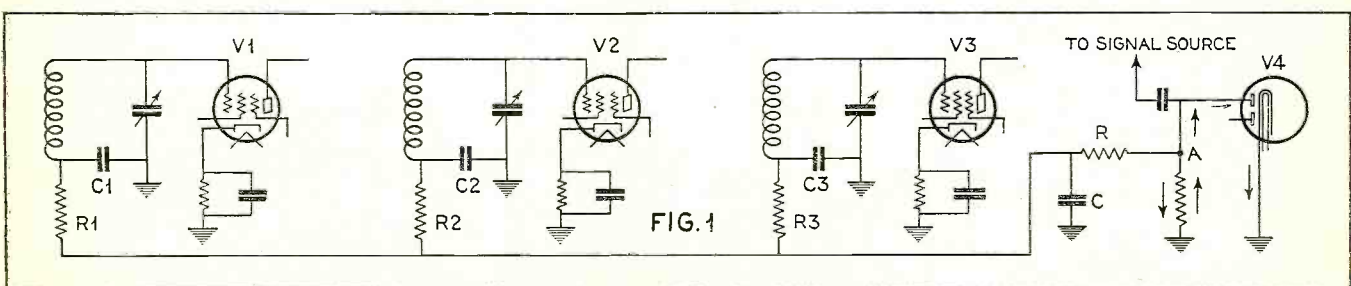

original and can be made negligible by proper choice of constants.

Sometimes the filter system shown may not be adequate to prevent oscillation or distortion, in which case additional filtering is necessary. A condenser across "r" may be needed or perhaps another resistor and condenser filter similar to R and C must be put in. With a proper choice of values, however, the filter system shown will be sufficient.

A tendency toward oscillation in the amplifier is due to the fact that the grid returns of all tubes are connected to a common point through R1, R2 and R3. If condensers C1, C2 and C3 are not large enough, there will be a small voltage drop across them due to a.c. currents in the tuned circuits. This voltage will be fed back to all of the grid returns because they are all connected to the same point. Resistors R1, R2 and R3 have the added purpose, then, of isolating the grid returns.

It is often possible to remove all or some of the resistors R1, R2 and R3. If, for instance, V1 is an r.f. amplifier, V2 a first detector and V3 an i.f. amplifier in a superheterodyne, R1 and R3 may not be needed. Since V3 is an i.f. amplifier, any voltage across C3 will be at the i.f. and can therefore be allowed to feed back to V1—which is an r.f. amplifier—without causing oscillation. The first detector, however, is both an i.f. and r.f. amplifier and therefore is sensitive to voltage variations from either V1 or V3. Therefore, R1 and R3 often can be eliminated while R2 can more rarely.

We have discussed the filter system qualitatively so far and have mentioned that the elements must be large enough to prevent oscillation or distortion though we haven't given practical values. It is easy enough to make all of the filter elements large—but what is the limitation on their size? And this is a question that brings up our next topic—a.v.c. time constant.

Not only has little been said about a.v.c. time constant but until recently little has been done about it. One of the largest radio companies as recently as last November put a big console set on the market in which so little attention has been paid to time constants that many engineers wondered at the nerve of the designers. Fortunately, as always the public is relatively ignorant of how good a set should be.

"Time constant" sounds deep—as though it concerns things in abstruse physics books. It concerns very simple phenomena here, however.

Most of us know from experience that if we put a condenser across a d.c. voltage the condenser becomes charged

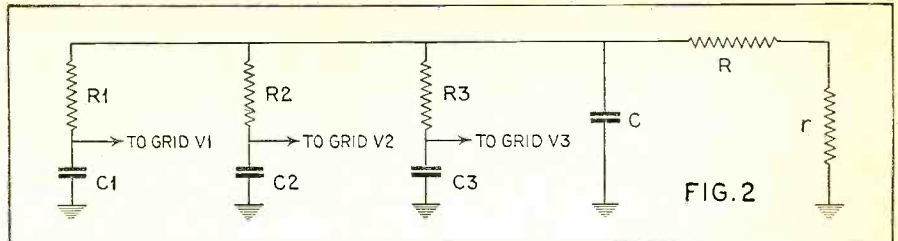

r	R	R1, R2, R3	C	C1, C2, C3
1.0 MEGOHM	0.5 MEGOHM	.25 MEGOHM	.03 MFD.	.03 MFD.
.5 "	0.5 "	.1 "	.05 "	.05 "
1.0 "	0.5 "	.1 "	.04 "	.04 "

TABLE I

and after it has been removed from the source it is possible to draw a spark from across its terminals. A high resistance voltmeter will show that the condenser voltage is equal to that of the charging source. If the voltmeter is left connected to the condenser it will be noted that the voltage reading gradually dies down to zero. For any given voltage, the time required for the voltage to decrease from maximum to zero is determined by the capacity of the condenser and the resistance, in this case the voltmeter resistance through which it discharges. The "time constant" value of a circuit is the product of the capacity in farads and the resistance in ohms and is therefore related to the time it takes the condenser to discharge.

Refer to Figure 2. When a signal produces a d.c. voltage across r condensers C, C1, C2 and C3 are charged to the voltage across r. The effect of the other resistors is to prevent the condensers from charging immediately. So long as the signal applied is constant and the condensers remain charged. When the input signal is withdrawn, however, the voltage across r disappears and the condensers begin to discharge. Since as indicated in Figure 1, the ground sides of the condensers are positive, current, in the usual terminology, from C will go to ground and then through r and R back to C; currents from the other condensers will go to ground and then through r, R and the respective resistor R1 or R2 or R3 back to the condenser.

It will be noted that C1, C2 and C3 must discharge through the path with the most resistance. If all the condensers are equal they will therefore take longer to discharge. The presence of the resistors and condensers means that the voltage on condensers C1, C2 and C3 and therefore the bias on the amplifier tubes will not change as rapidly as the voltage across r.

Practically, this means that when a

fading station is being received and a voltage is built up across r the rapidity of fading may be such that it will not be compensated for by automatic volume control action. Even more important than fading is the effect of large time constants on accurate tuning. The lag of a.v.c. action means that the operator will tune just off the station when the tuning meter shows maximum response. The set can be tuned accurately only if the operator tunes very slowly and painstakingly. Without a tuning meter it is even harder to tune exactly.

The check on whether the a.v.c. time constant is too large is to tune in a strong local station so that the a.v.c. is operating strongly, turn up the volume control and then quickly tune just off the station. The time required for the noise background to build up to full volume is a measure of the time constant. The time should not be noticeable.

Experience has shown that .05 second is a good time constant value and that it should not exceed .06 second; that is, the product of the condenser having the largest resistor to discharge through, expressed in mfd. and the resistance through which it discharges expressed in megohms should not exceed .06. In Figure 2 for example if r and R are 1/2 megohm R1-2-3, 1/4 meg., and all the condensers are .05 mfd. the time constant for the controlling condenser circuits is .05 times (R1 plus R plus r) or .05 times 1.25 or .625 second which would just exceed the limit we fixed.

Practical values that various manufacturers use are given in Table I.

Consideration of another factor greatly limits the choice of constants. For the type of circuit of Figure 1 which is the simplest and is commonly used in good sets, the a.v.c. diode plate usually takes its exciting signal voltage from the plate circuit of an amplifier tube. This means that resistor r and whatever is across it is placed in

(Continued on page 561)

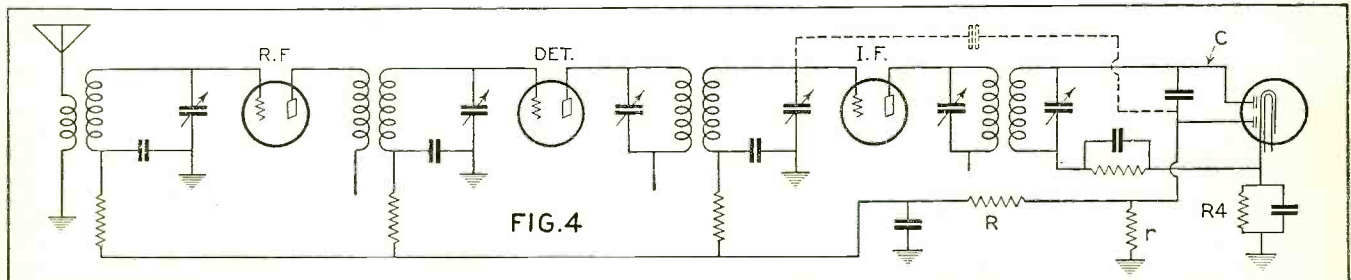

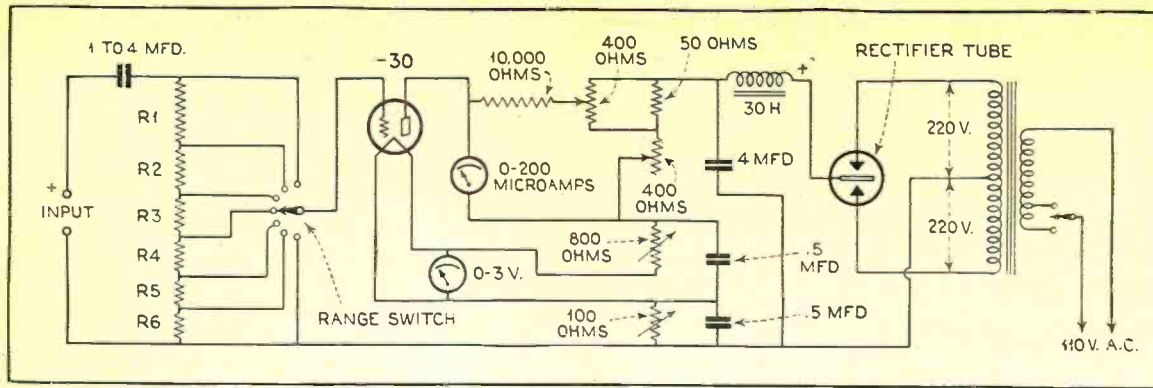

## MAKING AN ALL-PURPOSE A.C. OPERATED V. T. VOLTMETER

FOR the man who is experimentally inclined, a vacuum-tube voltmeter is a highly desired if not most essential piece of measuring equipment in a well-appointed radio laboratory.

On the other hand, the radio serviceman who is in the game to repair and test commercial radio equipment, usually as means of livelihood, customarily considers the vacuum-tube voltmeter as being something that is too expensive, elaborate, and not adapted to his particular needs. However, when it is considered that this form of voltmeter is the best and simplest form of output meter than can measure accurately a.c. voltages from .1 volt up to any desirable values, some consideration is deserved. Among other uses to which the meter is adapted, because of its high input-impedance, is the measurement of overall gain of an audio-frequency amplifier, from the detector to the output or by individual stages; obtaining the selectivity and gain performance of the radio-frequency stages; measurement of hum in receivers, etc.

As for the general theory of "why and how" a vacuum tube can be made to function as an a.c. voltmeter, the reader is referred to the bibliography of references which is given at the conclusion of this article. Suffice to say that the fundamental action is identical to that of the familiar grid-bias or power detector. The impedance on the input is extremely high and the a.c. voltages that can be measured may be as low as a small fraction of a volt.

One of the greatest handicaps which has prevented a more general acceptance of a thermionic voltmeter is the fact that it has usually been necessary to use batteries, which are an item of expense to keep up. Also, with the change of battery voltages, a frequent calibration of the meter has been essential in past procedure.

To overcome this difficulty, the meter to be described was designed primarily from the standpoint that it should be operated from the usual 110-volt a.c. lighting circuit, with no batteries of any nature whatsoever. Also, in order to design as ideal an instrument as possible and one that would be universal in application, the following points were carefully studied and worked out:

C. K. Krause

1. The meter should be portable.
2. Entirely self-contained.
3. Simple in construction and operation.
4. Measure accurately small increments of voltage.
5. Wide range of voltage.
6. High input resistance.
7. Unaffected by frequency or wave-form.
8. Low cost.

A circuit to be a.c.-operated must utilize some form of rectifying system such as an ordinary power supply of a commercial radio receiver to supply d.c. for plate and grid. The filament may be directly operated by a.c., such as the -26 type or the cathode type tubes. An alternate method is to use the direct current of the power pack to operate one of the d.c., low-current tubes such as the -30, -99, -32, or -22 types.

The design of the meter was attacked from all of the above angles and it was finally found advisable to use one of the low-filament-current d.c. tubes.

The type -30 tube probably offers the best all-around characteristics for a universal-type meter. The -32 is very desirable but is too sensitive to increment voltage changes, with the result that in order to cover a wide range of voltages a rather elaborate

and expensive voltage-dividing network would have to be used on the input of the meter. Furthermore, this latter type tube will introduce appreciable frequency errors.

Using the type -30 tube as the basis for design, the voltmeter circuit was evolved as shown in the schematic diagram. It will be noticed that the tube filament is in series and an integral part of the power supply voltage divider, the electrical position being such that the plate and grid voltage may be readily obtained.

In order to maintain the proper voltage on the circuit, a 3-volt meter is placed in shunt across the tube filament. With this method of indication, a constant current can be maintained in the divider resistors, with the result that identical voltages are always applied to the tube when in operation.

It is well to bear in mind that the tube selected for the meter might well be one that has been used for a period of 40 or 50 hours. In this way, certain irregularities will be eliminated

	VALUE IN OHMS	MULTIPLYING FACTOR
R TOTAL	1,000,000	1
R1	500,000	2
R2	300,000	5
R3	100,000	10
R4	80,000	50
R5	10,000	100
R6	10,000	-

TABLE 1

### REAR VIEW OF VOLTMETER

*This shows the arrangement of the various parts, sockets and tubes placed in position and wired up*





which are due to change of the characteristics with use. In order to facilitate the final design of the power supply, tests were conducted on eight type -30 tubes in order to determine the proper operating voltages for the average tube. These final operating potentials are indicated on the calibration curve. Generally speaking, a slightly used tube of the -30 type will operate most satisfactorily at these potentials, thus making it unnecessary for the builder to work out new values.

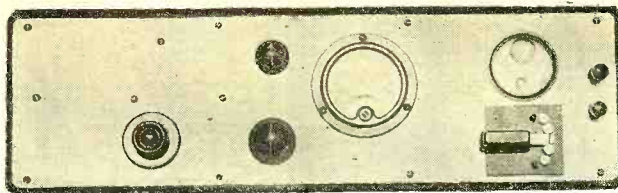

PANEL VIEW OF THE METER

*Arrangement of meters, switches, adjustment knobs and binding posts on the front of the panel, which is cut to fit an old Atwater Kent cabinet*

The power pack is conventional, with the exception that, due to the fact that a relatively low d.c. voltage is to be delivered, the input condenser has been eliminated. The rectifier, which can be either an -80, -82 or BH tube, is fed into a filter consisting of a 30-henry choke and a single 4 or 8-microfarad condenser in the output or voltage-divider side. This type of filter has been found sufficient for the purpose, gives fine regulation, minimum ripple and is economical.

### Building the Voltage Divider

In building the voltage-divider network, it will be wise to invest in the best wire-wound resistors. All of these resistors used are stock sizes, and their place in the circuit should be clear from the diagram. The 800-ohm plate-voltage resistor and the 100-ohm grid-voltage resistor are shown with an arrow through them to indicate that they might well be semi-variable. In this way, the builder can secure different operating potentials, if he so desires, and the resistor can be set and clamped in suitable manner to maintain a fixed voltage.

In the voltage divider, two 400-ohm, wire-wound potentiometers are used. The first one is connected in shunt with a 50-ohm resistor and placed just ahead of the 800-ohm plate-voltage resistor. This provides a small "bucking" voltage which feeds current through a 10,000-ohm protective resistor to the plate side of the microammeter. By adjusting this 400-ohm potentiometer, the residual plate current taken by the vacuum tube can be done away with, giving the full scale of the meter over to measuring purposes. The second 400-ohm potentiometer is in the divider circuit proper and is connected as a rheostat just ahead of the previously mentioned 50-ohm fixed resistor. The function of this variable resistor is to control the setting of the filament voltmeter in order to maintain the same value of current through the divider at all times.

The 0.5 mfd. condensers, shown on the diagram, are purely for by-pass purposes. Under no conditions should the builder place a by-pass condenser from the plate side of the microammeter to the negative side of the filament unless some means is provided to prevent the charging current of the condenser from passing through the meter.

The input to the vacuum-tube voltmeter (grid-to-filament) is shunted with a series combination of precision resistors, which serve the purpose of a voltage-

divider network, in order to secure various ranges of the meter. This network must be reasonably high in value so that the power consumed by the instrument shall be of negligible quantity. For economic purposes this network was made to have a total of 1,000,000 ohms. The network is made of six individual precision resistors, each of such a value as to give a suitable multiplying factor to increase the

voltage range of the instrument; the value of these resistors is given in Table 1.

It will be noticed that the sizes listed are carried in stock by several of the good precision resistor manufacturers. It is advisable to pay a slight premium and secure the resistors that are rated to an accuracy of 0.5 percent of their rated value.

This voltage divider provides a permanent path for the bias voltage, and the a.c. voltages to be measured are applied to the divider through a 2 or 4 mfd. condenser. Smaller values of condensers should not be used, and it is well to be sure that the condenser is a high-quality paper condenser. One other point that should receive careful consideration is the selection of a suitable switch to change the range of the instrument. The General Radio low-contact-resistance switch is very good. It is known as model 202-A.

The layout used by the author is self-explanatory from the photographs and any deviation that is desired can be made. However, in our first point, mentioned at the beginning of this article, it was stated that the instrument should be portable.

and condition two was that it should be self-contained. These two requisites were satisfied by using one of the neat cabinets which were used by A. K. on their battery sets. There is adequate space and the cabinets can be picked up very cheaply.

### Simple Operation

The third imposed condition was that it should be simple in construction and operation. From the foregoing it is clear that there is no complication in design outside of a reasonable amount of care on the part of the builder. From an operating standpoint, the adjustment of the filament voltmeter is all that is necessary to maintain proper operating conditions and automatically fixes all operating potentials. Furthermore, this adjustment is independent of the a.c. voltage fluctuations and aging of the rectifier tube. Also there is only one curve for all ranges of the meter.

The fourth point is covered in that with the operating potentials and the tube selected, the voltmeter is accurate to 5 percent at the extreme lower portion of the scale, with a sensitivity of less than 0.1 volt. On the upper portion of the scale, the accuracy and sensitivity is increased to 0.5 percent and 0.01 of a volt, respectively.

The next requirement is satisfied by using a resistance-network voltage divider in order to increase the range of the instrument, which is more than necessary for normal use.

Next, the input resistance is kept sufficiently high for average (Continued on page 568)

### CALIBRATION CURVE

*In this curve a plate current in ma. has been plotted against the input a.c. voltage applied to the voltmeter described. If the same tubes are used and the same resistances, this curve will be a reasonably accurate calibration curve for any meter of this type*

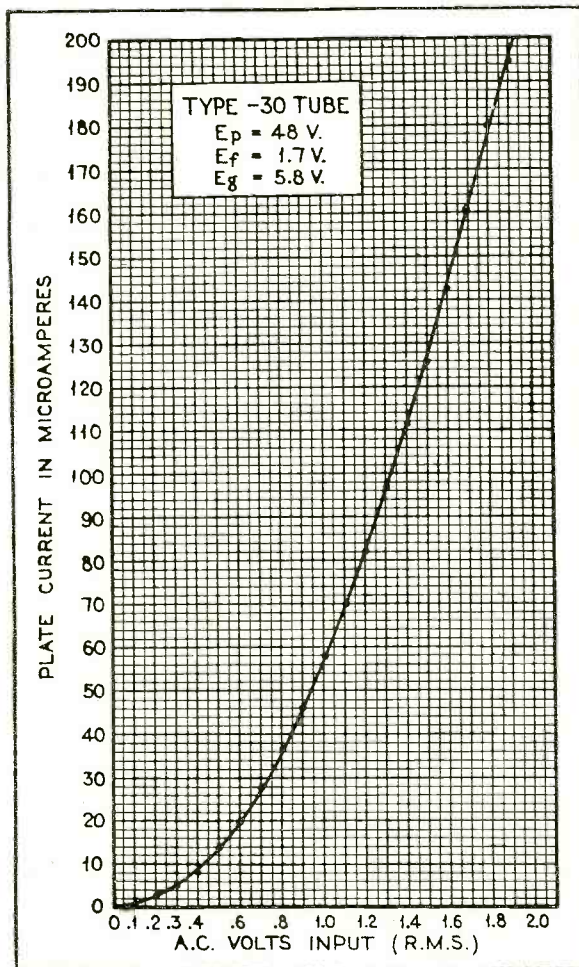

# PHENOMENA UNDERLYING RADIO

(Piezo-Electric Effects)

E. B. Kirk

Part Seven

WHEN we turn to examine the behavior of non-conductors under the action of heat and mechanical force we find some interesting and useful phenomena. Of this group the piezo-electric (piezo in Greek meaning "I press") and its converse effect have been used widely in radio. There is no sharp line of demarcation between conductors and non-conductors; one class grades imperceptibly into the other. The characteristic behavior distinguishing conductors from non-conductors is thought to be due to difference in the freedom of the electrons of the two classes of materials. In a good conductor there is a relatively great number of free electrons, giving a high electron pressure, whereas in a good insulator all but a few electrons are bound to the atomic nuclei, resulting in a low electron pressure. The bound electrons (those revolving in orbits around the nuclei) can only be temporarily shifted by external forces of ordinary magnitude; under the influence of an external force the fields of force of the atoms may be disturbed or distorted by shifting the shape and directions of the axes of the electron orbits, but when the external action is removed the atomic fields mutually pull themselves back to their original arrangement. This helps to explain why certain crystal non-conductors for example, quartz, Rochelle salts and tourmaline, when cut into thin plates and subjected to pressure, develop charges on the faces in line with the pressure.

Piezo crystal plates must be cut with special reference to the optic and the electric axes of the crystals, and they must be ground with accurately parallel faces if consistent results are to be obtained. The amount of the charges developed, which are equal and opposite on the two faces, is proportional to the pressure and for a given total force is independent of the dimensions of the plate.

If compression along the electric axis be replaced by an elongation along the third axis and the force-per-unit-area be the same, the charges developed will be the same, both in sign and in magnitude. Pressure along the optic axis produces no charge. Temperature has an important influence on the action, since thermal expansion or contraction changes the dimensions and therefore the periods of vibration of the plate. The quantitative relation between applied force and charge developed is given in footnote 1.

P. R. Coursey in a lecture before the Wireless Society of London in 1921 stated: "Theophrastus about 300 B. C.,

referred to piezo-electricity; and I have a date of 1703 when some Dutch chemists described the piezo phenomena, etc. Anyway, we are safe in describing it as 200 or 300 years old, and probably a great deal more." Be that as it may J. and P. Curie are usually credited with the discovery of this phenomena in 1880, since they certainly were the first to examine the action in a systematic manner. Shortly afterward Lippmann, on theoretical grounds, pointed out that there should be a converse effect. That is, there should be changes in the dimensions of the quartz when a potential difference is applied in the place of mechanical pressure. This was found to be the case by the Curies who devised several ingenious measuring devices for its investigation. (See footnote 2). By an apparatus in which the direct effect

was balanced by the converse they were able to measure displacements as small as 1/10,000,000 of a centimeter (this displacement is about 40 times that caused by the least audible sound. The diameter of a hydrogen molecule is about 1/4 of this value).

Another application of the converse effect is the measurements of high potentials using what is called a piezo-electric voltmeter. With this device for example it is possible to measure 50,000 volts with an accuracy of 200 volts. However the piezo-electric effect did not receive much attention until 1918 when Langevin used a quartz oscillator for the production of super-sonic waves in water. Its real usefulness began in 1922 when Cady applied it to the production of frequency standards and as a means of producing electric oscillations at very constant frequencies. Since then it has gained a very important place in radio as a means of maintaining, within very narrow limits, the frequencies of transmitting stations. By the use of a crystal oscillating at a constant temperature it is possible to control the frequency of a station to within an accuracy of 1 in 10,000,000. A somewhat closer examination of what takes place within a crystal may be worth our while.

A crystal when subjected to external forces suffers internal strains which

(Continued on page 572)

## PREPARATION OF PIEZO-ELECTRIC PLATES

A quartz plate, for experimental purposes, can be made as follows: First cut a hexagonal prism by cutting through the crystal at A and at B perpendicularly to the optic axis. This can readily be done with a rapidly rotating disc of steel or brass (1/2 mm. thick and 20 or so mm. in diameter). The prism is supported without undue pressure, the disc being supplied with water containing carborundum powder and some glycerine. (Any portions of a prism which exhibits twinning when examined under polarized light must be removed.) A plate is then cut from the prism in a direction perpendicular to any of the parallel faces of the hexagon (or as shown in the figure). This can be done with a steel wire stretched in a hack-saw frame and moistened with water carrying carborundum powder. A good piezo-electric plate must be of uniform thickness. This necessitates careful grinding and polishing. Preliminary grinding can be done on a polishing plate with moist carborundum powder. Hinderlich gives the following directions for the final polishing. He recommends putty powder and advises the use of rouge and water only for very small changes. "Upon a sheet of clean, flat glass is placed some thin paste of abrasive with water. The finger-tips are firmly placed upon the polished side of the quartz, so as not to scratch it with loose abrasive, and the quartz is swept over at least 30 square inches of glass, with a gentle pressure, to allow a supply of abrasive to come underneath, alternating with heavy pressure to perform the actual grinding. The finger-tips should be placed on the quartz surface, not on the edges. After a few moments the fingers are lifted, the quartz rotated through 45 degrees and the fingers are put down again, in order that all parts of the quartz may receive equal amounts of grinding. This method is quite successful for crystals above 1 mm. in thickness, but the thinner ones are sufficiently flexible for trouble to occur unless great care is taken."

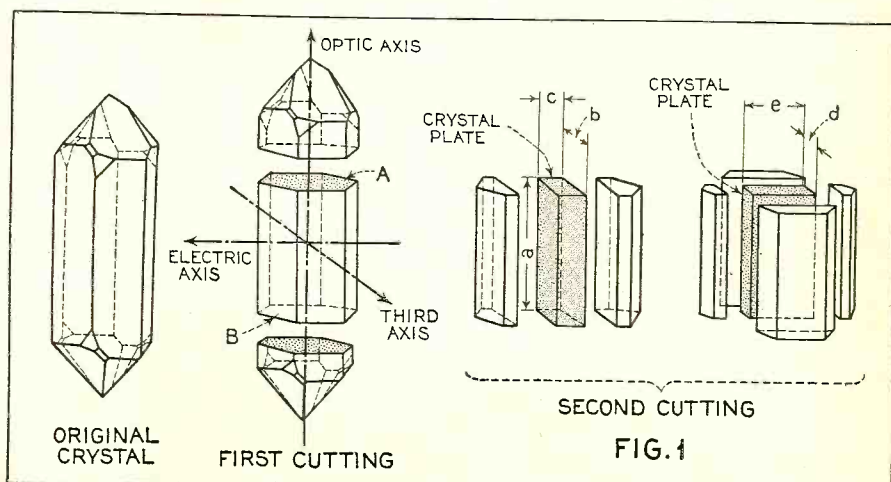

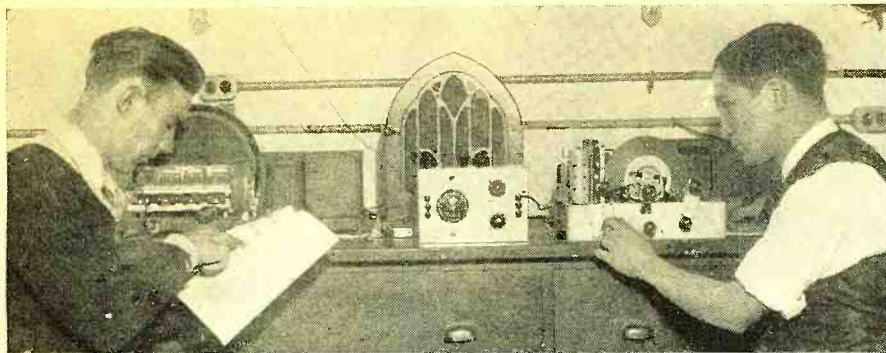

## THE DX CORNER

FOR BROADCAST WAVES

**T**HIS month the DX Corner for the Broadcast Band is presented for the fourth consecutive time. Whether it will be adopted as a permanent feature rests entirely with our readers. If you want it, write and say so, because its continuance will depend entirely upon your response. If enough readers evidence interest in this department, it will not only be continued permanently, but will be enlarged beyond the space now allotted to it. Address your letters to the DX Editor, RADIO NEWS.

### Ho! Hum! Only 30 Japs

Claire Calavan of Jefferson, Oregon, complains that the season thus far is noisy and that DX reception is nothing to brag about—and then goes on to say that “the usual run of about 30 Japanese stations have been coming through, but only the 10,000-watters are good. XGOA (China) comes through good at times. XGOD (China) with the same program also comes in after 6 a.m., P.S.T., but much weaker. A few other Chinese stations come in, but are too weak to identify. KZRM (Manila) comes through with fine signal strength about 6 a.m. Australians are generally weak, only the more powerful ones being intelligible. On several different occasions I have heard a news broadcast in English from about 25 Japanese stations, including the greater part of the more powerful ones, shortly after 2 a.m., P.S.T.”

Wonder just what Mr. Calavan could accomplish, given half-way decent DX weather? Most of us here in the East would run up the flag and consider we had something to write home about if we were lucky enough to bag even a single Japanese or Chinese station. Seriously, however, this situation is quite understandable, when it is realized that the lucky DX'ers of the Pacific Northwest have a direct, all-water route for the signals from the Orient, whereas these signals, to reach the eastern portion of the United States, must travel over Alaska, Canada and part of the U. S.

### DX Grounded Antenna

Mr. Calavan credits his antenna system at least partially for his success in DX'ing, and provides the following description for the benefit of other fans who may desire to try it out:

The counterpoise or “grounded antenna” is highly directional and consists of a single wire, 10 or 15 feet above ground and 50 to 250 feet in length (preferably not less than 100 feet), depending on the space available. This wire is pointed toward the direction from which reception is desired and is grounded at the end away from the receiver.

When using this “grounded antenna” the receiver should not be grounded. The usual antenna is connected to the antenna terminal of the receiver and the “grounded antenna” to the ground terminal of the receiver. However, better results are sometimes obtained by reversing these connections; that is, by connecting the regular antenna to the ground post of the set, and the “grounded antenna” to the antenna post. When used with an a.c. receiver, the primary of the antenna coil must be disconnected from the chassis, otherwise it will be effectively grounded through the power lines and the effectiveness of the “grounded antenna” system will be reduced, if not entirely lost.

This system results in an improvement in the strength of signals coming from the direction in which it points, and a decided reduction in the strength of signals coming from other directions. Where the space is available it is advisable to install from four to eight of these wires, running in different directions, using a switch to connect in the proper wire for the direction from which reception is desired. One point on the switch may be connected to a regular ground, for general reception. So effective is this system that the writer, situated midway between Portland and Eugene, Oregon, both of which operate on 1420 kc., is able to hear either one practically without interference from the other, by using a “grounded antenna” pointing to the north for one and to the south for the other.

The writer would appreciate hearing what results other fans have with this system.

### WLW Testing with 500 KW.

Many readers have by this time undoubtedly heard the test programs being transmitted after midnight, C.S.T., by the new Crosley station which is described elsewhere in this issue. Here in New York this station was heard during the latter part of December. The field strength was appreciably higher than the present 50 kw. transmitter now regularly used by WLW, but field strength measurements made at the Radio News listening post did not show the improvement expected. It is quite probable that the full 500 kw. power was not employed, and if this is the case it would explain the relatively small improvement noted. It would be interesting to have comments from readers concerning the reception of the test programs in different parts of the world. The test programs occur between 1 a.m. and 6 a.m., C.S.T., and the station operates on 700 kc.

### A “Hopped Up” Neutrodyne

Fred Kehret of Nashua, Iowa, submits

a remarkable log of daytime reception. Included in the list are 29 stations over 500 miles distant from Nashua, all of which were heard between 9 a.m. and 3 p.m. The list of these stations is given here to serve as a mark for other daylight fans to shoot at:

Miles	Call	Location	Freq. kc.	Power Kw.
1800	WGY	Schenectady, N. Y.	790	50
1500	WHAM	Rochester, N. Y.	1150	50
1300	CFRB	Toronto, Ont., Can.	690	10
1100	WTAM	Cleveland, O.	1070	50
1100	WADC	Akron, O.	1320	1
1100	WSM	Nashville, Tenn.	650	50
1000	WLW	Cincinnati, O.	700	50
900	WJR	Detroit, Mich.	750	10
800	WOWO	Ft. Wayne, Ind.	1160	10
650	KMMJ	Clay Center, Neb.	740	1
650	WBW	Topeka, Kans.	580	1
650	KMOX	St. Louis, Mo.	1090	50
600	KGBZ	York, Nebr.	930	5
600	WIND	Gary, Ill.	560	1.
600	WHB	Kansas City, Mo.	860	1.
600	WDAF	Kansas City, Mo.	610	1.
525	KFAB	Lincoln, Nebr.	770	5.
525	KFRU	Columbus, Mo.	630	5
525	KFEQ	St. Joseph, Mo.	680	2.5
500	WNAX	Yankton, S. D.	570	1.
500	WMAO	Chicago, Ill.	670	5.
500	WBBM	Chicago, Ill.	770	25
500	WGM	Chicago, Ill.	720	50
500	WAFF	Chicago, Ill.	920	5
500	KYW	Chicago, Ill.	1020	10
500	WMBI	Chicago, Ill.	1080	5.
500	WJJD	Chicago, Ill.	1130	20
500	WLS	Chicago, Ill.	870	50
500	WENR	Chicago, Ill.	870	50

The principal factor in this record is disclosed in the fact that the nearest power line is five miles away and the location is generally good. Presumably “man-made static” is unknown to Mr. Kehret—a condition which the great majority of us cannot even imagine. The reception was accomplished with a 7-tube neutrodyne receiver which had been doctored up to provide extreme sensitivity by adjusting the neutralizing condensers so that the set just goes into oscillation with the rheostat turned on full. In addition a 195-foot antenna is employed, and this is tuned by means of a tapped spider-web coil of 60 turns, No. 24 d.c.c. wire and a 250 mmfd. variable series condenser. The principle is the same as that employed in the RADIO NEWS “Tenatuner” described last month. Another refinement employed by Mr. Kehret is variable coupling between the primary and secondary of the antenna coil in the receiver. All of these are features which tend to deliver the maximum signal voltage to the grid of the first tube, a practice which has many times been stressed in the past because of the distinct advantage it offers in the way of an improved signal-to-noise ratio.

### European Frequency Changes

A reallocation of frequencies used by the majority of European broadcast band transmitters became effective January 15, 1934. This means that all 1933 lists of European stations are now obsolete. The following list includes all the more powerful stations as well as others which are heard in North America. The frequencies given are the new ones. In many cases changes were also made in power on January 15th. Complete information on these changes is not available, but where known the new power rating is given in this list:

Kilocycles	Location	Power Kw.
546	Budapest, Hungary	18.5
556	Bernunster, Switzerland	60
565	Athlone, Ireland	60
574	Muhlacker, Stuttgart, Germany	60
592	Vienna, Austria	100
620	Brussels, Belgium	15
638	Prague, Czechoslovakia	120
658	Langenberg, Germany	60
668	Gr. Britain, North Regional	50
677	Sottens, Switzerland	25
686	Belgrade, Yugoslavia	2.5
704	Stockholm, Sweden	75
713	Rome, Italy	50
722	Kiev, Russia	36
740	Munich, Germany	60

(Continued on page 566)



THE CONTROL CONSOLE

*J. E. Whitehouse, Chief Transmitter Engineer, at the console which provides complete control, not only of the 500 kw. transmitter of WLW but the transmitters of the other Crosley stations, WSAI and W8XAL as well, W8XAL being a short-wave transmitter*

**B**Y the time this article reaches the eyes of readers it is probable that many of them will have heard the new 500 kw. transmitter of WLW, the Crosley station at Harrison, Ohio. At the time of writing this, the installation is nearing completion so that tests, to be carried on between the hours of 1 a.m. and 6 a.m., will start within the next few weeks.

This new transmitter will be by far the most powerful broadcast transmitter in America. In fact, there is no transmitter in the world employing such high power at the present time. It is expected that the area over which the new transmitter can be heard will be ten times that covered by WLW's present 50 kw. transmitter. It is felt that innumerable rural communities not now satisfactorily served by local stations will thus be provided with excellent radio programs at a signal level high enough in most cases to largely override local noise and static conditions.

We have been working toward this 500,000-watt transmitter for the past five years, and our own technical staff worked up complete plans for such a unit. About a year ago we submitted our plans and predictions to the Federal Radio Commission and received permission to construct such a transmitter. Then came a series of meetings with many of the country's leading radio engineers. R.C.A. was given the contract to supply the material and install the entire 500,000-watt amplifier and modulator. Since it was an experimental transmitter of an entirely new design, it rapidly developed into an engineers' picnic. It was decided to incorporate as many new ideas as possible. It was necessary to design many new pieces of equipment. I am sure it is going to be the last word in broadcast transmitter design and will incorporate many features never before attempted.

Briefly, the new equipment is a radio-frequency amplifier capable of 2,000,000 watts peak output, an audio-frequency amplifier of sufficient size to modulate the radio-frequency amplifier and the necessary power supplies and control circuits.

## And A 500,000 WATT

The tremendously rapid advance of the progress of WLW from a 20 watt successive power increases to 50, 500, 500,000 watt station described in this

Joseph A.

The radio amplifier contains twelve RCA 100 kw., type 862 tubes. These are divided into three units of four tubes each. In each unit the tubes are operated push-push parallel. Each unit

has its own grid tank and plate tank circuits. This arrangement, along with unusual mechanical design, results in a very stable amplifier. Each unit is individually neutralized. The tubes are operated as Class C amplifiers. The final audio stage or modulator contains eight of the 100 kw. tubes. These are divided into two units of four tubes each. They are also operated push-push parallel as Class B audio amplifiers. The output audio transformer is divided into two sections. There is one section for each of the modulator units. Secondaries of the two sections are connected in series and the output modulates the plate voltage of the final

r.f. amplifier. Direct current is blocked out of the modulation transformer secondaries and a 500-microfarad audio coupling condenser is used. This amplifier is capable of delivering over 400 kw. of undistorted audio power.

Three 1500-ampere generators connected in parallel provide 4300 amperes at 33 volts for the filaments. They are driven by three 75-horsepower, 2300-volt motors. These motor generators can be controlled individually or as a unit. Normally, they are controlled as a unit from the console on the transmitter floor, and a single control adjusts the voltage from all three generators. Naturally, the generators are of special design to have minimum ripple and other desirable characteristics.

The main plate supply rectifier will deliver 100 amperes at 12,000 volts. This is the normal voltage applied to

### MODULATION TRANSFORMERS

*To handle the tremendous audio power of 500,000 watts it was necessary to design and construct this pair of modulation transformers which weigh close to 50 tons and are submerged in 1400 gallons of oil*



TRANSMITTER PLANT AND ANTENNA

*This 831 foot tower is not an antenna support it is the antenna itself and is mounted on an insulating base capable of withstanding the load of 450 tons resulting from the weight of the tower plus the down pull of the insulated guy wires*

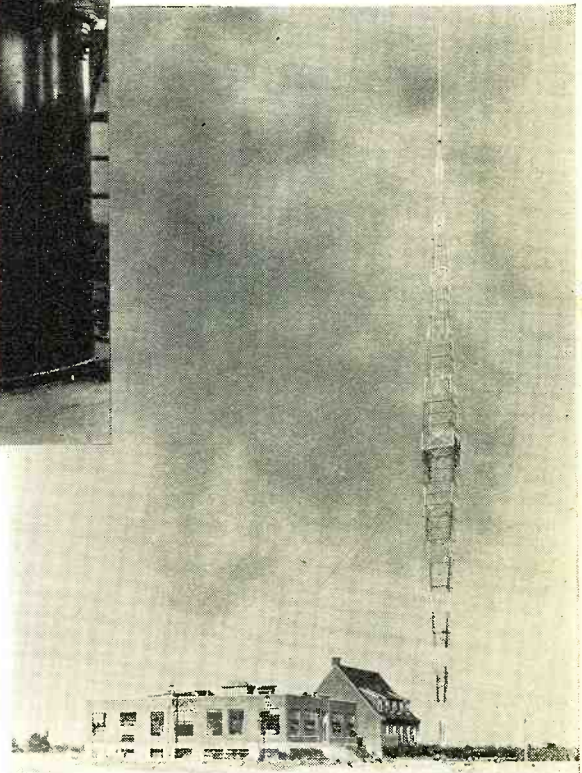

# Now:— SUPER STATION

radio broadcasting is exemplified in transmitter employed in 1922 through 1000, 5000, 50,000 watts, and finally the article and soon to be in operation

## Chambers

all the tubes. At 100 percent modulation the peak voltage applied to the radio-frequency stages will be 24,000 volts. A three-phase, full-wave rectifier circuit is used, employing six special hot-cathode, mercury-vapor rectifier tubes, developed by the G. E. Company specially for this installation. This tube will be known as the RCA 870. A system of oil switches controlled from the control console on the transmitter floor permits the rectifier transformers primaries to be connected either Delta or Y. This permits two voltages, namely, 8000 and 12,000, as normal operating voltages. Automatic step starting is also afforded whereby the voltage is applied gradually.

High-level modulation is used and Class B audio amplifiers deliver the required audio power. This has various advantages, particularly in that it is more economical in power. All radio-frequency stages are operated Class C, which is the most stable and efficient arrangement. The audio amplifiers consuming large amounts of power are operated Class B for efficiency. Fortunately, the RCA 100 kw. tube is excellent as a Class B audio amplifier.

### ONE OF THE R.F. UNITS

*This view shows one of the three 180 kw. r.f. units. Each of these units employs four 100 kw. tubes. This view shows only about one-fifth of the main transmitter panel which is 54 feet long and 16 feet high*

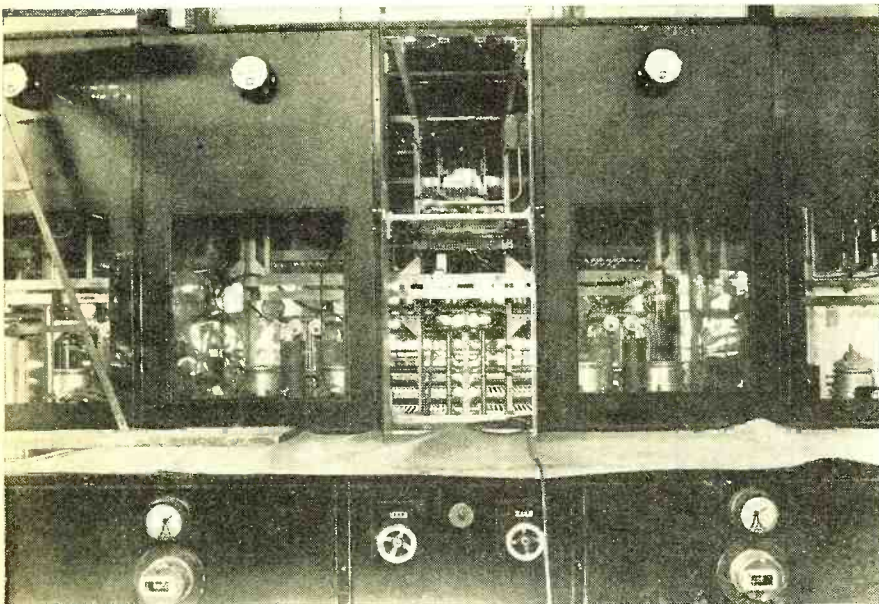

High-quality audio amplification is obtained. The biggest single problem was the design and construction of the tremendous audio transformers used as modulation transformers. These weigh close to 50 tons and are shown in one of the accompanying illustrations.

Some interesting problems resulted from this high-power Class B amplification. Constantly varying power is drawn by the modulators; very low power in between words and high power at peaks of modulation. In order to maintain constant voltage under this highly variable load, the entire power supply system had to offer very low reactance. A condenser of 260 microfarads is used in the main rectifier filter. The rectifier transformers were special low-reactance units. In co-operation with the engineers of the Union Gas & Electric Company, a power supply substation was planned with low-reactance equipment throughout. Special lines were installed to our transmitter to meet our load conditions.

In view of the fact that all the power equipment has low reactance, this reactance cannot be counted upon for protection in case of short circuits or rectifier tube flashbacks. Almost unlimited power would be fed into any fault. To supply the necessary protec-

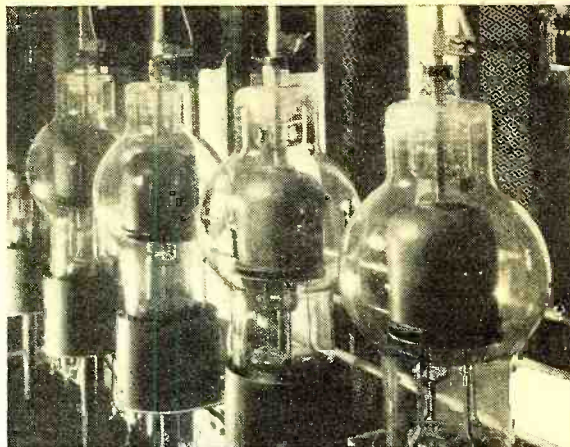

THE RECTIFIERS

*The transmitter requires 1200 amperes at 12,000 volts for the plate supply. Six of these mercury vapor rectifier tubes, rated at 450 amperes each, are employed in the 3-phase, full-wave rectifier system*

tion under these conditions and also to meet various other control requirements, the G. E. Company developed a special high-speed circuit breaker as rectifier primary control. This breaker is rated at 100,000 amperes interrupting capacity and is so fixed that the time from the energizing of the trip coil till the arc is extinguished is only 1/12 of one second. It closes just as fast and the transmitter control circuits are so arranged that under certain conditions this breaker may open three times under short-circuit conditions in less than a second.

The output of the radio-frequency amplifier is transmitted to the antenna proper by a concentric type transmission line. This type transmission line, particularly at 500 kw., involved quite a few problems. It was designed after the tower had been completed and measured and was made to match the tower impedance without the necessity of any coupling system whatsoever. This eliminated quite a bit of equipment with its corresponding losses and harmonic radiation. The particular advantage of the concentric type of transmission line is the reduction of harmonic radiation, which represented quite a problem with 500,000 watts power.

The tower itself serves as the antenna and was quite an engineering accomplishment. It stands 830 feet above the surface of the ground and its foundation extends 70 feet beneath the ground. The steel itself weighs 136 tons. This weight, combined with the down pull of the eight guy wires, makes a total load on the base insulator of about 450 tons. The base insulator is made up of two porcelain cones so connected in the middle that swaying of the tower will not put any twisting forces in the porcelain. As long as most of the load is direct compression, this insulator will stand up to about 1500 tons load. Fifty-six guy wire insulators were used in the guy wires to insulate the tower from ground and to break up the guy wires so that they could not distort the pattern. All eight guy wires fasten to the tower near the center.

By actual measurement the use of this antenna (Continued on page 565)

# BROADCAST STATIONS IN THE U. S.

*By Frequency, Wavelength and Call Letters*

- 550 KC., 545.1 Meters  
KFDY, KFUO, KFYR, KOAC, KSD, WDEV,  
WGR, WKRC.
- 560 KC., 535.4 Meters  
KFDM, KGIZ, KLZ, KTAB, WFI, WIND,  
WLLT, WNOX, WQAM.
- 570 KC., 526.0 Meters  
KGKO, KMTR, KVI, WKBN, WMCA,  
WNAK, WOSU, WSYR, WVNC.
- 580 KC., 516.9 Meters—*Canadian shared*  
KMI, KSAC, WDBO, WIBW, WOBW,  
WTAG.
- 590 KC., 508.2 Meters  
KHQ, WEEI, WKZO, WOW.
- 600 KC., 497.7 Meters—*Canadian shared*  
KFOD, KFSO, WCAC, WCAO, WICC,  
WMT, WREC.
- 610 KC., 491.5 Meters  
KERC, KZRM, WDAF, WIP, WJAY.
- 620 KC., 483.6 Meters  
KGW, KTAR, WFLA, WLBZ, WSUN,  
WTMJ.
- 630 KC., 475.9 Meters—*Canadian shared*  
KFRU, KGFX, WGBF, WMAL, WOS.
- 640 KC., 468.5 Meters  
KFI, WAIU, WOI.
- 650 KC., 461.3 Meters  
KPCB, WSM.
- 660 KC., 454.3 Meters  
WAAW, WEAF.
- 670 KC., 447.5 Meters  
WMAQ.
- 680 KC., 440.9 Meters  
KFEQ, KPO, WPTF.
- 690 KC., 434.5 Meters—*Canadian exclusive*
- 700 KC., 428.3 Meters  
WLW.
- 710 KC., 422.3 Meters  
KMPC, WOR.
- 720 KC., 416.4 Meters  
WGN.
- 730 KC., 410.7 Meters—*Canadian exclusive*
- 740 KC., 405.2 Meters  
KNMJ, WHEB, WSB.
- 750 KC., 399.8 Meters  
KGU, WJR.
- 760 KC., 394.5 Meters  
KXA, WBAL, WEW, WJZ.
- 770 KC., 389.4 Meters  
KFAB, WBBM.
- 780 KC., 384.4 Meters—*Canadian shared*  
KELW, KTM, WEAN, WMC, WTAR.
- 790 KC., 379.5 Meters  
KGO, WGY.
- 800 KC., 374.8 Meters  
WBAP, WFAA.
- 810 KC., 370.2 Meters  
WCCO, WNYC.
- 820 KC., 365.6 Meters  
WHAS.
- 830 KC., 361.2 Meters  
KOA, WEEU, WHDH, WRUF.
- 840 KC., 356.9 Meters—*Canadian exclusive*
- 850 KC., 352.7 Meters  
KIEV, KWKH, WWL.
- 860 KC., 348.6 Meters  
WABC, WHB.
- 870 KC., 344.6 Meters  
WENR, WLS.
- 880 KC., 340.7 Meters—*Canadian shared*  
KFKA, KLX, KPOF, WCOG, WGBI,  
WQAN, WSUI.
- 890 KC., 336.9 Meters—*Canadian shared*  
KARK, KFNE, KSEI, KUSD, WGST, WILL,  
WJAR, WAIMN.
- 900 KC., 333.1 Meters  
KGBU, KHJ, WBEN, WJAX, WKY, WLBL.
- 910 KC., 329.5 Meters—*Canadian exclusive*
- 920 KC., 325.9 Meters  
KFEL, KFNF, KOMO, KPRC, WAAF,  
WBSE, WWJ.
- 930 KC., 322.4 Meters—*Canadian shared*  
KFWI, KGBZ, KMA, KROW, WBRC,  
WDBJ.
- 940 KC., 319.0 Meters  
KOIN, WAAT, WAVE, WCSH, WDAY,  
WHA.
- 950 KC., 315.6 Meters  
KFWB, KGHL, KMBC, WRC.
- 960 KC., 312.3 Meters—*Canadian exclusive*
- 970 KC., 309.1 Meters  
KJR, WCFL, WIBG.
- 980 KC., 303.9 Meters  
KDKA.
- 990 KC., 302.8 Meters  
WBZ, WBZA, WJEM.
- 1000 KC., 299.8 Meters  
KFVD, WHO, WOC, WORK.
- 1010 KC., 296.9 Meters—*Canadian shared*  
KGGF, KQW, WHN, WIS, WNAD, WPAP,  
WQAO, WRNY.
- 1020 KC., 293.9 Meters  
KYW, WRAX.
- 1030 KC., 291.1 Meters—*Canadian exclu.*
- 1040 KC., 288.3 Meters  
KRLD, KTHS, WESG, WKAR.
- 1050 KC., 285.5 Meters  
KFBI, KNX.
- 1060 KC., 282.8 Meters  
KWJJ, WBAL, WJAG, WTIC.
- 1070 KC., 280.2 Meters  
KJBS, WCAZ, WDZ, WTAM.
- 1080 KC., 277.6 Meters  
WBT, WCBD, WMBL.
- 1090 KC., 275.1 Meters  
KMOX.
- 1100 KC., 272.6 Meters  
KGDH, WLWL, WPG.
- 1110 KC., 270.1 Meters  
KSOO, WRVA.
- 1120 KC., 267.7 Meters—*Canadian shared*  
KFIO, KFSG, KRKD, KRSC, KTRH, WDEL,  
WHAD, WISN, WTAW.
- 1130 KC., 265.3 Meters  
KSL, WJJD, WOV.
- 1140 KC., 263.0 Meters  
KVOO, WAPI.
- 1150 KC., 260.7 Meters  
WHAM.
- 1160 KC., 258.5 Meters  
WOWO, WVVV.
- 1170 KC., 256.3 Meters  
WCAU.
- 1180 KC., 254.1 Meters  
KEX, KOB, WDG, WINS, WMAZ.
- 1190 KC., 252.0 Meters  
WOAL, WSAZ.
- 1200 KC., 249.9 Meters  
KBTM, KERN, KFJB, KFSD, KFNJ, KGDE,  
KGEK, KGFI, KGH, KGVO, KMLB,  
KSUN, KVOS, KWG, WABI, WBBX,  
WBBZ, WBHS, WCAT, WCAK, WCLO,  
WPAI, WFB, WFB, WHBC, WHBY,  
WIBX, WIL, WIBC, WJBL, WIBW,  
WKBQ, WKIC, WLA, WNBO, WNBW,  
WPHR, WRBL, WVAE.
- 1210 KC., 247.8 Meters—*Canadian shared*  
KASA, KDLR, KFJL, KFOR, KFPW, KFVS,  
KFXM, KGCR, KGY, KIEM, KPPC,  
KWEA, KWFV, WALR, WBAX, WBBL,  
WCB, WCRM, WEDO, WEDC, WFAS,  
WGB, WGCW, WGN, WHBF, WHBU,  
WHET, WIBU, WJBI, WJBY, WJEF,  
WJW, WKFI, WKOK, WMBG, WOCL,  
WOMT, WPRO, WQDX, WSBC, WSEN,  
WSIX, WSO, WTAX.
- 1220 KC., 245.8 Meters  
KFKU, KTW, KWSC, WCAD, WCAE,  
WDAE, WREN.
- 1230 KC., 243.8 Meters  
KGGM, KYA, WFBM, WNAC, WSBT.
- 1240 KC., 241.8 Meters  
KGCU, KLP, KTAT, KTFI, WKAQ,  
WNYZ.
- 1250 KC., 239.9 Meters  
KFOX, WAAM, WCAL, WDSU, WGCP,  
WLB, WODA, WRHM.
- 1260 KC., 238.0 Meters  
KOIL, KRGV, KUOA, KVOA, KWVG,  
WLBW, WNBX, WTOC.
- 1270 KC., 236.1 Meters  
KGCA, KOL, KVOR, KWLC, WASH,  
WFBR, WJDX, WOOD.
- 1280 KC., 234.2 Meters  
KFBB, WCAM, WCAP, WDOD, WIBA,  
WORC, WRR, WTNJ.
- 1290 KC., 232.4 Meters  
KDYL, KLCN, K TSA, WEBC, WJAS,  
WNBZ.
- 1300 KC., 230.6 Meters  
KALE, KFAC, KFH, KFJR, WBBR, WEVD,  
WFAB, WHAZ, WIOD, WOQ.
- 1310 KC., 228.9 Meters  
KCRJ, KFBK, KFG, KFPL, KFPM, KFNR,  
KFYO, KGBX, KGCX, KGEZ, KGFV,  
KIFH, KIT, KMED, KRMD, KTSN,  
KNRO, WAML, WBEO, WBOV, WBRB,  
WCLS, WDAH, WEBR, WEXL, WFBG,  
WDFD, WGA, WGH, WHAT, WIAS,  
WJAC, WKBC, WLCB, WMBQ, WNBH,  
WOL, WRAW, WROL, WSAJ, WSJS,  
WTEL, WTJS, WTRC.
- 1320 KC., 227.1 Meters  
KGHF, KGMB, KID, WADC, WSNB.
- 1330 KC., 225.4 Meters  
KGB, KMO, KSCJ, WDRC, WSAI, WTAQ.
- 1340 KC., 223.7 Meters  
KFPY, KGDY, KGNO, WCOA, WLEC,  
WSPD.
- 1350 KC., 222.1 Meters  
KIDO, KWK, WAWZ, WBNX, WEHC.
- 1360 KC., 220.4 Meters  
KGER, KGIR, WCSC, WFBL, WGES,  
WQBC.
- 1370 KC., 218.8 Meters  
KCR, KFBL, KFJM, KFJZ, KGAR, KGGF,  
KGFL, KGKL, KICA, KIUF, KMAC,  
KONO, KOOS, KRE, KSO, KUJ, KVL,  
KWKC, WBTM, WCBM, WDA, WGL,  
WGLC, WHBD, WHBO, WHDF, WIBM,  
WIBK, WITL, WLEY, WLVA, WMBR,  
WPF, WQDM, WRAK, WRAM, WRDO,  
WRJN, WSVS.
- 1380 KC., 217.3 Meters  
KOH, KQV, WKBH, WSMK.
- 1390 KC., 215.7 Meters  
KLRA, KOY, WHK.
- 1400 KC., 214.2 Meters  
KLO, KTUL, WARD, WBAA, WBBC,  
WKBF, WLTH, WVFW.
- 1410 KC., 212.6 Meters  
KFLV, KGRS, WAAB, WBCM, WDAG,  
WHBL, WHIS, WODX, WRBX, WSFA.
- 1420 KC., 211.1 Meters  
KABC, KBPS, KCMC, KFIZ, KGGF, KGGC,  
KGIW, KGIX, KICK, KIDW, KORE,  
KUMA, KWCR, KNL, WACO, WAGM,  
WANC, WAZL, WEED, WEHS, WELL,  
WENC, WHDL, WHFC, WILM, WJBO,  
WJMS, WKHI, WLB, WMA, WMBQ,  
WMBH, WNRA, WPA, WSPA, WTBO.
- 1430 KC., 209.7 Meters  
KECA, KGNE, WBAK, WCAH, WFEA,  
WHEC, WHP, WNR, WOKO.
- 1440 KC., 208.2 Meters  
KDFN, KLS, KXYZ, WBIG, WCBA,  
WMBD, WSAN, WTAD.
- 1450 KC., 206.8 Meters  
KTBS, WGAR, WHOM, WSAR, WTEL.
- 1460 KC., 205.4 Meters  
KSTP, WJSV.
- 1470 KC., 204.0 Meters  
KGA, WLAC.
- 1480 KC., 202.6 Meters  
KOMA, WKBW.
- 1490 KC., 201.2 Meters  
WCKY.
- 1500 KC., 199.9 Meters  
KDB, KGFI, KGFK, KGKB, KGKY, KNOW,  
KPI, KPO, KREG, KXO, WCNW,  
WFDY, WHE, WKB, WKBZ, WKBZ,  
WKEU, WMBQ, WMCB, WNB, WOP,  
WPE, WRDW, WSYB, WWRL, WWSV.



EDITH MURRAY



RICHARD CROOKS



RUDY VALLEE



SHIRLEY HOWARD

# BACKSTAGE in BROADCASTING

**E**DITH MURRAY, one of the newest additions to the vocal ranks of CBS sustaining artists, had varied theatrical experience before launching her radio career. She is a native of Chicago and starred in vaudeville and talking picture shorts. Chicago, London and Australian musical comedy audiences saw her in the leading rôle of "Good News."

**S**OMETIME in February, Fred Waring's Pennsylvanians will switch their allegiance from cigarettes to automobiles. The orchestra, one of the past year's broadcasting sensations on the Old Gold series, will be heard on a CBS Sunday schedule sponsored by Ford Motor Company dealers—the same sponsors of the Lum and Abner series on NBC. It is expected that prominent guest artists will be added to each Waring broadcast.

**A**N array of orchestral and vocal novelties is presented on each of the new Camel Caravan half-hours presented Tuesdays and Thursdays over the CBS. Glen Gray's Casa Loma Orchestra supplies the instrumental background while vocal specialties are offered by Irene Taylor, blues singer formerly heard on NBC, and the Do Re Mi Girls Trio. The series is sponsored by the R. J. Reynolds Tobacco Company, which not long ago presented the Morton Downey-Jacques Renard-Tony Wons daily broadcasts.

**F**OR the fifth season, the Firestone Tire & Rubber Company has resumed sponsorship of the popular "Voice of Firestone" programs Monday nights over NBC. Richard Crooks, tenor, and Law-

## Samuel Kaufman

rence Tibbett, baritone, are this season's featured vocalists, appearing on alternate weeks. Both Tibbett and Crooks appeared on the previous year's Firestone programs and won much favorable comment. Both vocalists are members of the Metropolitan Opera Company. William Merrigan Daly again wields the baton for the series.

**L**IKE many other radio stars before him, Rudy Vallee recently hied Westward for a talking picture assignment. To radio listeners, his change of locale made no difference, inasmuch as his network programs were still available each Thursday night at the customary hour. Rudy retained the variety type of program that he was so successful with in New York, and, while in Hollywood, recruited guest artists from the movie colony. Rudy's screen appearance will be in George White's "Scandals," and many of the crooner's ardent fans hope that he'll score better than he did in "The Vagabond Lover" film of several seasons ago.

**T**HE comedy team of Ole Olsen and Chic Johnson, which somehow failed to click in a recent NBC series, is now scoring favorably on the CBS Swift Revue,

presented Fridays. Their nonsensical microphone capers have won them choice ratings amongst the premier funny men of the air. Like the majority of radio comics, they were recruited from the theater. The series originates in the Chicago CBS studios. Harry Sosnik, formerly an arranger for many of the air's best-known dance orchestras, conducts the ensemble supplying the musical background for the Olsen and Johnson humor.

**S**HIRLEY HOWARD, who not long ago was a reporter on a Philadelphia newspaper, is the new star of the Mollie Show presented over NBC stations Mondays, Wednesdays and Fridays. Featured on the same series is the trio once known as the Tastyest Jesters, consisting of Dwight (Red) Latham, Guy Bonham and Wamp Carlson. Rudy Vallee is accredited with discovering Miss Howard. He heard her sing at a social affair and arranged for her NBC debut.

**T**ED WEEMS'S Orchestra has succeeded the Vincent Lopez unit as the stellar attraction of the NBC Sunday night Real Silk Program. Guest stars of various types are included on each broadcast. The Weems unit is one of the best-known dance orchestras in radio. Ted took up music as a profession in 1923, when he tired of engineering studies at the University of Pennsylvania.

**O**NE night several weeks ago we journeyed 200 miles to witness the first fifteen-minute broadcast by the Philadelphia Orchestra conducted by Leopold Stokowski. (Continued on page 557)

OLSEN AND JOHNSON

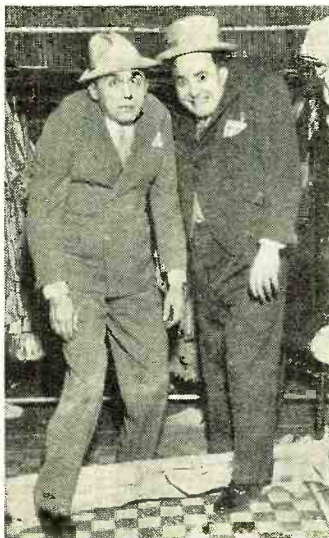

RIGHT:  
GLEN GRAY



FRED  
WARING



LEFT:  
TED WEEMS



LEOPOLD  
STOKOWSKI





# THE TECHNICAL REVIEW

JOSEPH CALCATERRA

*Electrons at Work*, by C. R. Underhill. McGraw-Hill Book Co., 1933. Few engineers who are not specialists on the subject realize the possibilities of the use of electronic devices for industrial control. This book was written as a guide to those who desire a general knowledge of electronics. Workers in the radio field, and also manufacturers and engineers in other lines, will find in it suggestions for applications of electron tubes.

The book discusses all the fundamental principles involved regarding radio tubes, rectifiers, thyratrons, photo-cells, X-ray tubes, cathode-ray tubes and the circuits that go with them. It is *not* a highly mathematical treatise; in fact, mathematics is very little used and the text should be easy to follow for most readers. The introductory chapters deal with the construction of matter, potential, capacity electrons and ions. The principles of electricity are reviewed in the next chapters. In Chapter IX several types of electronic tubes and their properties are explained; this includes the screen-grid tube and a pentode. Following this the reader learns about elements of electronic tube circuits, electronic lamps, gaseous discharge tubes. Photoelectric effects with applications are next in line. Cathode-ray tubes, invisible light, X-rays, etc., are the subject of later chapters. Application of all types are mentioned and many more suggested. The book is written in such a way that it is not necessary to read all previous chapters in order to understand a later one.

*Radiotrons, Amateur Transmitting Types*; published by RCA Radiotron Co. This is a booklet on transmitting tubes similar to their other book on receiving tubes. Only the smaller types of tubes, such as the amateur uses, are included. The information on each tube consists of curves and characteristics with some text explaining the use of this tube as modulator, oscillator or amplifier, as the case may be.

*Notes on a Photoelectric Glow-Discharge Oscillator*, by Melchor Centeno. A pamphlet describing some little-known uses of the photoelectrically controlled neon oscillator. The pitch of a neon oscillator can be controlled by varying either a resistor or condenser in the circuit. Employing a photo-cell as the resistor makes it possible to translate light values into variously pitched sounds. Several applications are discussed; for instance, the "omnaphone," an instrument to enable the blind to read printed characters. Another device which can be made is a novel musical instrument.

*Cathode-Ray Oscillographs and Their Applications*. The General Radio Experimenter, November, 1933. A discussion on the use of the oscillograph, to check modu-

lation percentage and distortion. Several pictures of images show how various defects show up on the translucent screen.

## Review of Articles in the December, 1933, Issue of the Proceedings of the Institute of Radio Engineers

*Television Image Characteristics*, by E. W. Engstrom. Quantitative information on the various characteristics of television images, particularly those relating to image detail. The results are of value in establishing operating standards, determining satisfactory performance and guiding development work. The data is given in such form as to be readily applicable to practical conditions.

*Experimental Television System and the Kinescope*, by V. K. Zworykin. An experimental television system using a cathode-ray tube (kinescope) as the image-reproducing element in the receiver. The fundamental considerations underlying the design and use of the kinescope for television are outlined. A description of the circuits associated with the kinescope and an explanation of the application to an experimental receiver are included.

*Experimental Television Transmitting Apparatus*, by R. D. Kell. An experimental television transmitter installed in the Empire State Building and used in experimental television system tests. The installation included facilities for radiating sound and picture signals from studio and from motion picture film. The general considerations underlying the design and performance of television terminal and transmitting apparatus for this experimental system are reviewed.

*Experimental Television Receivers*, by G. L. Beers. The major considerations involved in the design of a number of television and sound receivers constructed for use with an experimental television system. Curves showing the performance characteristics of the receivers and a brief discussion of the observations made during the field tests of the receivers are included.

*Vacuum Tubes of Small Dimensions for Use at Extremely High Frequencies*, by B. J. Thompson and G. M. Rose, Jr. Construction and operation of very small triodes and screen-grid tubes, of the order of one-tenth the size of conventional receiving tubes, designed for use on wavelengths down to 60 centimeters with conventional circuits.

*Tube Oscillators on a Common Load*, by S. I. Model. The problem of obtaining high power by means of a great number of tube oscillators operated in parallel. The principal disadvantages of conventional

parallel circuits are listed, and the advantages of subdivision of tubes into groups (units) with their tank circuits coupled to a common load circuit are shown.

## Review of Contemporary Literature

*A 100-Kilowatt Vacuum Tube*, by H. E. Mendenhall. Bell Laboratories Record, December, 1933. The development and the features which have made possible the construction and use of a tube capable of providing an anode dissipation of 100 kilowatts.

*Equalizers in Open-Wire Carrier Circuits*, by A. L. Stillwell. Bell Laboratories Record, December, 1933. The effect of unequal attenuation of different frequencies in producing distortion and decreasing intelligibility in telephone circuits. The method of providing attenuation equalizers to overcome this defect is explained in detail.

*Minimizing Modulation in Transformers*, by E. T. Hoch. Bell Laboratories Record, December, 1933. Methods employed to minimize distortion and cross-talk in telephone lines, especially in carrier current systems.

*Circle Diagrams of Valve Input Admittance and Amplification Factor*, by F. M. Colebrook. The Wireless Engineer and Experimental Wireless, December, 1933. The variation of input admittance and voltage amplifications can be shown simply by the use of circle diagrams, permitting clear physical interpretation and enabling the most important features to be formulated without elaborate calculation.

*Theoretical and Experimental Data on Class C Operation of Radio-Frequency Amplifiers*, by R. J. Davis and W. J. Cahill. Proceedings of the Radio Club of America, November, 1933. The important factors of tube and circuit efficiency which affect the operation of transmitters using Class C amplification.

*Resolved: That the United States Should Adopt the Essential Features of the British System of Radio Control and Operation*. The affirmative and negative sides of a debate on the question of whether the British system of radio control and operation should be adopted in the United States.

*Note on Multi-frequency Automatic Recorder of Ionosphere Heights*, by T. R. Gilliland. Bureau of Standards Research Paper RP608. A system which gives a curve of the virtual height of the ionosphere against frequency. Records are presented which show the characteristics for different times of the day and night. The system described offers a more convenient method than the manual methods previously employed and greater economy in both time and personnel.

*A Method of Providing Course and Quadrant Identification with the Radio Range-Beacon System*, by F. W. Dunmore. Bureau of Standards Research Paper RP593. A method of obviating the difficulties experienced by pilots, especially when near the radio beacon, when passing from one course or quadrant to another.

*Pre-selection and Image Rejection in Short-Wave Superhets*, by J. J. Lamb and F. E. Handy. QST, December, 1933. Circuits and construction data of wave-trap and pre-selector units designed for image rejection use.

*Controlling Receivers from the Broadcast Transmitter*. Electronics, December, 1933. This article points out the desirability of utilizing some means of controlling the receiver from the broadcast transmitter, so as to ring a bell or turn on the



set when features of particular interest to the owner of the set are on the air. It also describes the principles of operation of various methods which can be or are being used to accomplish this result.

*Learning the Code.* QST, December, 1933. A schedule of the A.R.R.L. Code practice programs which are transmitted regularly by a number of stations to help amateurs to learn the code and increase their speed is given in this issue of QST.

*The Automatic Noise Gate.* Service, December, 1933. The circuit and description of the principle of operation of the "noise gate" circuit for suppressing inter-channel noise when tuning from one station to another are given in this article.

*Tube Checker Design,* by O. J. Morelock, Jr. Radio Retailing, December, 1933. Circuits, circuit data and operating information in the design and use of tube checkers, including the location of shorts, measuring cathode leakage, gas content, noise and interpretation of rectifier, diode and double Class B readings.

**How to Get Copies of Articles Abstracted in This Department**

The abstracts of articles featured in this department are intended to serve as a guide to the most interesting and instructive material appearing in contemporary magazines and reports. These publications may be consulted at most of the larger public libraries or copies may be ordered direct from the publishers of the magazines mentioned.

RADIO NEWS cannot undertake to supply copies of these articles. They are not included in the RADIO NEWS Free Technical Booklet Service.

**Free Technical Booklet Service**

THROUGH the courtesy of a group of manufacturers, RADIO NEWS offers to its readers this Free Technical Booklet Service. By means of this service, readers of RADIO NEWS are able to obtain quickly and absolutely free of charge many interesting, instructive and valuable booklets and other literature which formerly required considerable time, effort and postage to collect. To obtain any of the booklets listed in the following section, simply write the numbers of the books you desire on the coupon appearing at the end of this department. Be sure to print your name and address plainly, in pencil, and mail the coupon to the RADIO NEWS Free Technical Booklet Service. Stocks of these booklets are kept on hand and will be sent to you promptly as long as the supply lasts. To avoid delay, please use the coupon provided for the purpose and inclose it in an envelope, by itself, or paste it on the back of a penny postcard. The use of a letter asking for other information will delay the filling of your request for booklets and catalogs.

**Technical Booklets Available**

2. 1934 R.F. Parts Catalog. Complete specifications on the entire line of Hammarlund variable and adjustable condensers, r.f. transformers, sockets, shields and miscellaneous parts for broadcast and short-wave receivers, complete short-wave receivers and transmitting variable condensers.

(Continued on page 569)

*Now*  
**The "PRO"**  
*Will Grace*  
**Your**  
**LIVING**  
**ROOM**

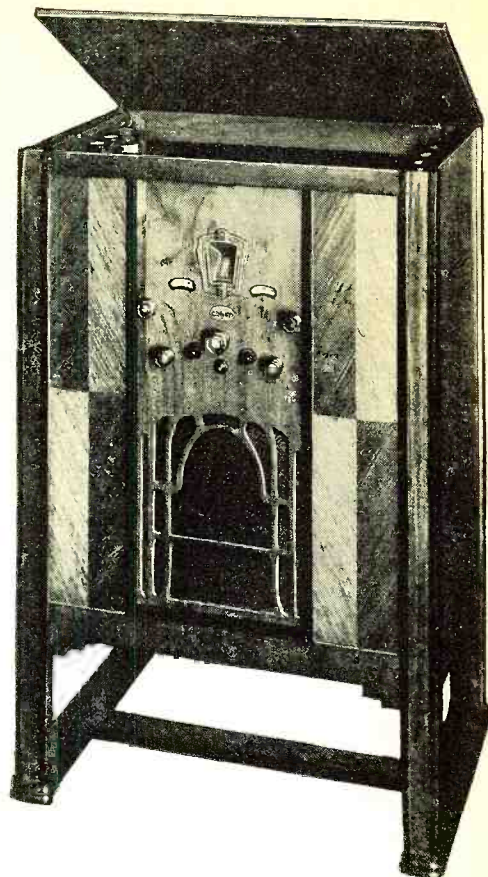

Modified modern lines harmonize with other room furnishings. Complete with speaker and power supply. Hinged top provides easy access to chassis and storage rack for coils.

**COMET "PRO"**  
**RECEIVER**

CHOOSE for your COMET "PRO" the handsome new "Moderne" Console, the table model in shielded metal cabinet or the chassis only—each will give you world-wide reception on all wave lengths from 8 to 550 meters.

The "PRO" is now supplied in four complete models: Standard; Standard plus A. V. C.; Crystal; and Crystal plus A. V. C.—Battery, D.C. or A.C.—all voltages; all frequencies.

Hammarlund's 33 years of engineering leadership guarantees thrilling performance of this receiver in your home.



**CRYSTAL FILTER and AUTOMATIC VOLUME CONTROL may be added at moderate cost to the STANDARD MODEL "PRO"**

Mail coupon for information about the COMET "PRO" Receiver, and free copy of Catalog "34" of precision equipment for transmitting and receiving on all waves.



**HAMMARLUND MFG. CO. N.R.A.**  
**424 W. 33rd Street**  
**New York, N. Y.**

... Check here for new booklet describing the COMET "PRO" Receiver and adding Crystal Filter or Automatic Volume Control to the Standard Model "PRO".... Check here for General Catalog "34".

Name.....  
Address.....

RN3

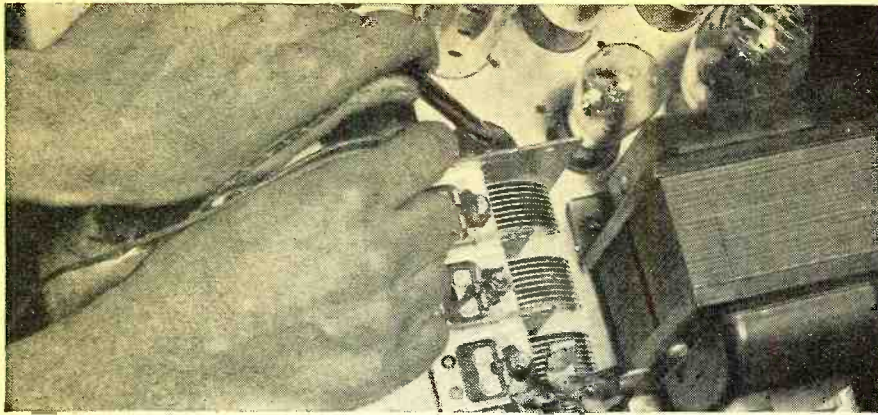

## THE SERVICE BENCH

ZEH BOUCK

### THE AIR-CELL AND RURAL RADIO



ALTHOUGH the expansion of power line facilities into previously isolated rural areas has increased the field for a.c. operated receivers, the sales possibilities for modern high quality battery sets has only just started in volume. As a matter of fact, recent personal investigations by your *Service Editor* have shown a decidedly more active market for such receivers than the trade has enjoyed up to this time. As has been intimated, prospects for this new type receiver are usually located up over the hills and far from the winding ribbons of concrete road. Today, the back-hill farmer has at last conceded the utility of radio. He appreciates its entertainment value, acknowledges the usefulness of many special broadcasts dedicated to the cause of agriculture, and for the first time he is in the market for a set!

Battery receivers of past vintage presented a serious power problem. Reasonably good reception postulated the use of a storage battery for filament lighting, necessitating fortnightly visits to the nearest garage for recharging. Reception was often interrupted for weeks at a time by snow-bound roads during winter, when the radio would have been most appreciated. Battery reception also suffered by com-

parison with an a.c. operated receiver. The tone quality and volume output were definitely inferior, while the radio-frequency efficiency of the former suffered from the use of relatively antiquated circuits.

The advent of the air-cell battery, with specialized tubes and sets, has completely altered the rural radio picture, and invites the serviceman to take full advantage of the farmer's ripened acceptance of radio broadcasting.

The Eveready Air-Cell battery is of the primary type. That is, it cannot be recharged. It differs from other batteries in this category, however, in its ability to depolarize itself. Polarization is the phenomenon which gradually paralyzes a battery—such as one made up of dry cells—causing a continuous drop in voltage. With automatic depolarization, there is practically no drop, and the battery can be used until the chemical elements are consumed.

The Air-Cell will deliver over 600 ampere-hours at a maximum drain of .65 ampere, with no more than a negligible variation of the normal potential which is approximately 2 volts. Currents in excess of 650 milliamperes will polarize the battery more quickly than the polarization process can take place. Special 2-volt tubes, having low filament consumption, have been designed for operation with this battery, and highly efficient receivers, employing the most modern circuits have been developed about the combination. A typical 7-tube receiver requires one type 30 tube, four type 32 tubes and two type 31 power amplifying tubes (in push-pull). The types 30 and 32 draw .06 ampere, and the 31s, .13 ampere. The total filament consumption is therefore 560 milliamperes—well below the safe limit of the air-cell battery. Considering its rated ampere-hours, it is easy to compute that the battery, with the receiver described above, will give more than 1000 hours reception—which is equivalent to one year of average service.

The 2-volt series of tubes is manufactured in all popular types—triodes, screen grid, pentode, etc.—and practically any receiver can be modified for their use—always providing the number and types of tubes are not such as to impose an excessive filament drain on the air-cell battery.

The rural serviceman should have on hand, for sale, several factory-made receivers. He will find his prospective customers divided into two general classes. About half the farmers in isolated districts are anything but prosperous. They suf-

fered from an agricultural depression long before the other kind came along, and, for the greater part, purchased farms in inaccessible districts as a matter of economy. They sell next to no farm products—with an occasional exception of a hog or calf—consuming, themselves, practically everything they raise. Such a farmer will be more interested in buying a small set. The larger jobs will go to the other class of farmer, who has availed himself of cheap acreage to acquire a huge and productive farm. Dirt roads are no impediment to his milk and produce laden trucks.

The serviceman's sales talk should consider the slightly divergent interests of these two classes of prospects. The entertainment value of radio—news and musical broadcasts—should be stressed in selling the former. The market price for farm products will be of little interest to him—he has none to sell—but announcements of feed and grain costs will be of benefit, as will weather reports predicting rain, frost and snow. The large scale farmer will be definitely interested in the prices he may expect to receive for his wares.

### Care of Battery

Full instructions for the care and maintenance of the battery should be part of the installation procedure. Warn the customer not to neglect the recommended monthly inspection, and to keep the level of the electrolyte just over the indicator wires. The terminals should be maintained free from corrosion, and should be wiped off occasionally with vinegar.

The Air-Cell should never be placed where the temperature of the battery is below 40 degrees F. Low temperatures, however, will have no effect whatever so long as no attempt is made to draw current.

Operation of an air-cell receiver with any other type of battery should be advised against. Even when the proper resistances or rheostats are employed, it will be easy to damage the tubes, and reception will never be as satisfactory or economical as with air-cell operation. Elsewhere in this issue is an article describing three new Air Cell receivers with complete service data.

### ALL IN THE DAY'S WORK

It occasionally happens that the primary of a push-pull transformer burns out, and an emergency repair is in order. Frank E. Martin, of the Supreme Radio Service, Crowley, La., contributes the diagram of Figure 1. The wires are broken where in-

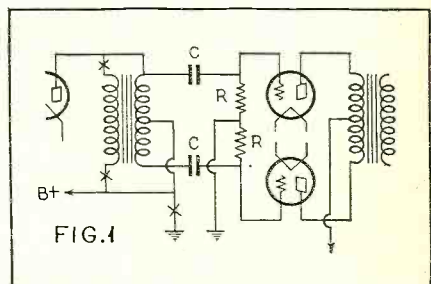

dictated with an "X" and reconnected as shown on the diagram. Condensers C are .1's and the resistors R should be about 500,000 ohms each.

The secondary now functions as an autotransformer with a step-up ratio of two to one.

### A Home-Made P. A. Horn

An easily made horn for public-address work is sketched in Figure 2. This should

appeal particularly to the rural serviceman, who must keep the costs of sideline equipment as low as possible. This horn was built by Norman H. Speight of Toronto, Canada, who specializes in auto radio service. The sides are made of beaver-board, bolted to 1 1/4" by 1 1/4" basswood frames. After soaking in hot water for ten to fifteen minutes, the basswood is readily bent into the desired flare. The sides are bolted

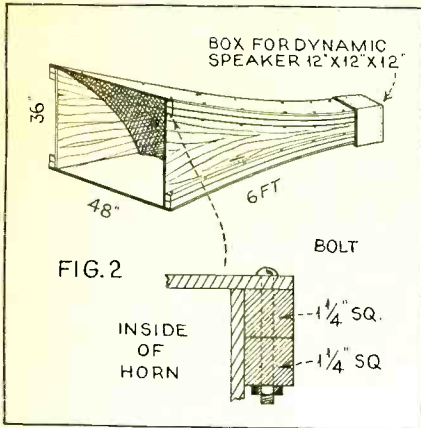

together as shown in the detail drawing. It should be noted that the frames are on the outside of the beaver-board panels, leaving a clean, unobstructed sound passage.

All dimensions are given in Figure 2. The horn should be given several coats of water-proof paint. The finished product is easily collapsible for transportation.

### SERVICE NOTES

An ingenious radio tube base connection finder has been designed by W. M. Perkins, chief of the radio application laboratory of National Union, in an effort to thread his way through the maze of some eighty different pin connections. As will



be seen in Figure 3, the device takes the form of a disk—three concentric disks, to be accurate, which may be turned after the manner of a circular slide-rule. As the middle disk is revolved, the numbers of different tubes appear in the right-hand slot, simultaneously with the base and cap designations on another part of the disk. This pin indicator will be sent free of charge to servicemen writing to RADIO NEWS, Dept. U, on their business letter-heads.

The combined identification tag and repair record shown in Figure 4, goes a long way toward establishing customer confidence and gaining repeat calls for the efficient serviceman.

An excellent example of baited advertising is illustrated in Figure 5. The city

(Continued on page 576)

# RUBINOFF gives a Tip— that brings new joy to radio listeners



## New Radio Tubes

Improved 5 ways by  
**RCA**

Have your dealer test your tubes today. Insist on the only tubes guaranteed by RCA Radiotron Co., Inc., to have these improvements:

- 1 Quicker start
- 2 Quieter operation
- 3 Uniform volume
- 4 Uniform performance
- 5 Every tube is matched

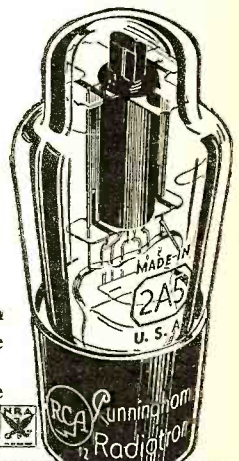

# Cunningham Radiotron





## WITH THE EXPERIMENTERS

S. GORDON TAYLOR

### Home-Made Shock-Proof Mounting for Tubes

The physical vibration of a receiving set caused by jarring, will often cause certain tubes to set up a microphonic howl, loud enough at times to be uncomfortable. The -99 type of tube particularly is more prone to this singing condition if it is jarred, than are the larger tubes.

In the illustration is shown simple shock-proof mounting that will eliminate any tendency for the tubes to hum. The material consists of 2 metal brackets, two pieces of live rubber, and a bakelite strip for mounting the tube sockets. The two brackets are alike, and are made of a strip of 1/16-inch thick brass, 1/2-inch wide and 6 3/4 inches long, bent as shown in the drawing. Two pieces of metal a half-inch square, are cut from the same metal. Holes are drilled through these square

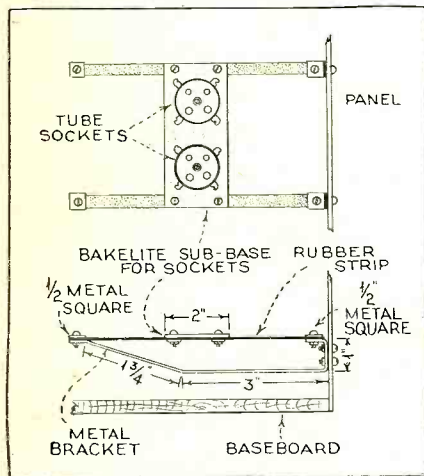

pieces and through the turned-up ends of the metal brackets with a No. 27 drill, in order to pass 1/16 machine screws, 3/8 inch long. Two other holes should be drilled for the same size screw through the part of each bracket that rests against the panel. A half-inch wide strip of rubber, either a piece of wide rubber band or a section cut from an old inner tube, with holes cut in it near the ends, is stretched between the ends of the bracket and fastened in place by clamping it between the half-inch square pieces of metal and the bracket. The rubber should be drawn tight enough so that it does not sag.

All of the tube sockets in the set should be mounted in a row on a two-inch-wide piece of bakelite, and the ends of this bakelite piece drilled and fastened to the rubber strips by machine screws, as shown. Do not use bus-bar wire for making the connections, as it will undo the purpose

for which the brackets were constructed. Having the metal brackets project so far back of the panel without support from the baseboard is done purposely; for the metal in the brackets is springy and helps to take up vibration.

The bakelite strip that supports the tube sockets can be weighted by fastening a piece of sheet lead to the underside of it. We have then both a high- and low-pass mechanical filter. The rubber strip part of the mounting forms the low-pass section of the filter, and stops all of the high-frequency vibrations of the set from reaching the tube sockets. Correspondingly, the weight of the lead constitutes the high-pass part of this mechanical filter, and does not transmit any of the low-frequency mechanical vibrations. It is the inertia introduced by the lead weight that causes the high-pass filtering action.

CHARLES FELSTEAD,  
Los Angeles, Cal.

### Variable Resistor Without Contacts

In your kit of automobile supplies you have all the parts necessary for assembling

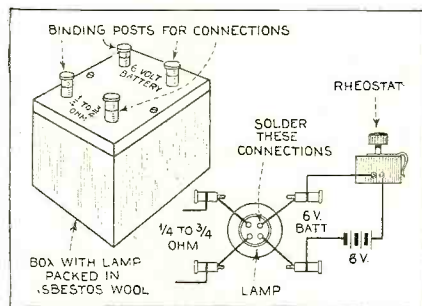

a resistance which can be varied from about 1/4 ohm to 3/4 ohm in steps of .0001 ohm or less. The circuit will be free of all varying contacts and the fluctuations due to

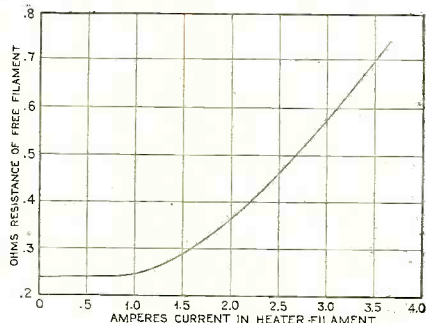

them. The principal part of this apparatus is a 32-candlepower, 6-volt, double-filament automobile lamp. You will also

need a battery to supply current for one of the filaments and a rheostat for varying this current. The other filament will be the variable resistance. The filament has a high temperature coefficient of resistance, and when you heat both filaments by passing a current through one, the resistance of the free filament will increase as you increase the current in the other. The amount of variation is indicated in the accompanying curve. As much as one ampere of current can be passed through the variable resistor (the free filament) before any extra heating will be noticed. When you are making a large change in resistance, that is of .1 ohm or more, the new value will slowly change for about 10 minutes, but for smaller variations in resistance the new value will become stable in about one minute.

Cover the lamp with a small box or can which is filled with asbestos wool to prevent variations due to room temperature. Solder all connections and use heavy wire and large binding posts for making connections to the external circuits. A good arrangement is shown in the accompanying drawing. The leads from the binding posts support the lamp, which hangs under the top of the box. The latter is fastened to the top plate by means of two wood screws.

W. E. STEWART,  
Sewaren, N. J.

### Building Electrolytic Condensers

The experimenter usually has a number of old variable condensers with aluminum plates, which may be used for making home-made electrolytic condensers.

First dismantle the condenser by remov-

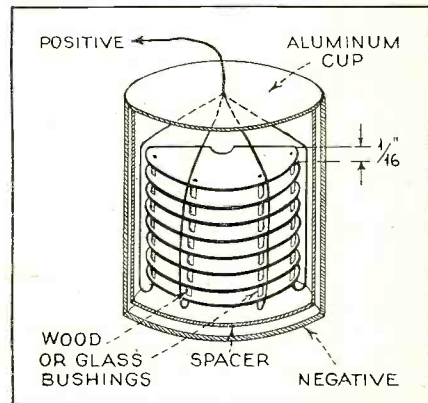

ing all of the plates, the entire condenser could be used if it were of aluminum, but usually the spacers, binding rods, mounting bolts, etc., are made of other metal. Both fixed and rotor plates may be used if they can be arranged to stack well, or one condenser could use the rotor plates and another the fixed plates. Identical sets of holes should be drilled through the corners of the plates. After drilling, the plates should be stacked with small wooden bushings (glass beads are excellent) between them, so that they are separated 1/16 inch or so. Then pass aluminum wire through the holes and up the outside of the plates. Twist the four wires together to form a bridge to support the whole group of plates. The whole assembly should then be supported in an aluminum cup, wooden or fiber spacers being used to insure that the plates do not touch the cup. The cup may be a drinking or measuring can which can be obtained from any hardware or tent-cent store.

The condenser should then be filled with a solution of the following proportions:

- 100 g. glycerine
- 62 g. boric acid
- 50 c.c. or 26% ammonia water

The condenser may then be formed by

connecting it to a source of direct current. The leakage current will be very high at first and a current-limiting resistor of a couple thousand ohms should be placed in series with the condenser so that it will not draw excessive current and so that the device furnishing the voltage will not be injured. After the condenser is formed, the resistor may be gradually reduced until completely removed. The condenser should be formed at the voltage at which it is to be used, maximum being about 400 volts. The lower the voltage used, the higher will be the capacitance. The can is negative, of course.

F. C. EVERETT,  
Delta, Ohio.

**Humless Headphone Connection**

To eliminate any objectionable hum that may be present in the earphones where

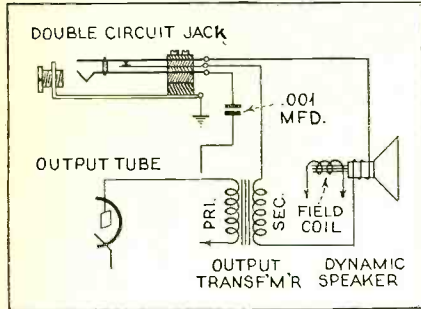

they are connected in the plate circuit of the output tube in an a.c. receiver, I connect a low-capacity coupling condenser of .001 mfd. in series with the 'phones, thereby filtering out the lower frequencies. Quality is impaired somewhat and there is an appreciable reduction of volume. However, there is more than sufficient signal left for average headphone reception. By using a double-circuit jack as shown, the speaker is automatically cut in, when the 'phone plug is withdrawn.

PAUL KUEHN,  
Detroit, Mich.

**Home-made Meter Rectifier**

A low-range milliammeter of the D'Arsonval type can readily be converted to

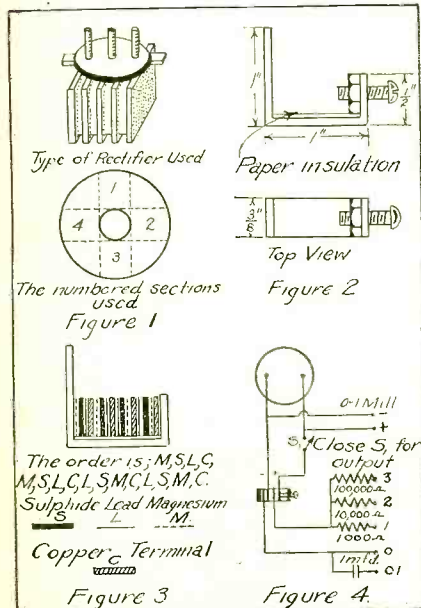

use as an output meter by the addition of the reconstructed rectifier described here. This unit is one made from an Elkon type rectifier.

The original rectifier unit is dissembled and the various parts inspected. The thick  
(Continued on page 576)

# NEW-

## Servicemen and Radio Dealers

Get a **FREE** Copy of This New Book  
"The Inside Story of "A" Batteries  
for Air Cell Radio"

Right off the press — A direct Efficiency and Cost comparison of the Storage Battery; Dry "A" Battery and the new and improved Eveready Air Cell "A" Battery as used on the new 2-volt sets.

Send  
the  
Coupon

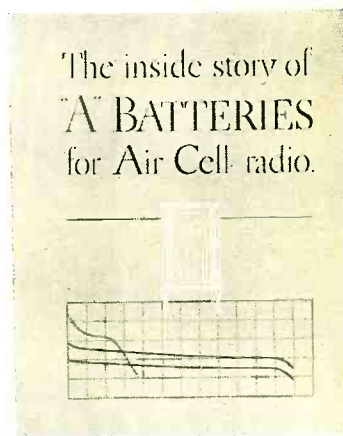

**NATIONAL CARBON CO., INC.**  
30 East 42nd Street, New York, Dept. RN-3

Please send me a Free copy of your new Book

---



---



---

# Ghirardi's Radio Physics Course



has everything!  
sound  
electricity  
radio  
talkies  
television

COMPLETE IN ONE VOLUME—392 PAGES

Send for FREE Booklet Describing in Detail Contents of the 36 Illustrated Chapters of this famous book.

See it yourself!

DEPT R-3, RADIO & TECHNICAL PUB. CO.  
45 Astor Place, New York

**STOP** Don't buy an all-wave receiver! Wait for the new **hallicrafter's DE LUXE**

... another great forward step in selectivity, sensitivity, and ease of tuning. Write for advance announcement and special introductory price.

**SILVER-MARSHALL MFG. CO.**  
417 N. State St., Dept. B, Chicago, U.S.A.

2ND EDITION **OFFICIAL PUBLIC ADDRESS AMPLIFIER MANUAL** JUST RELEASED  
AND SOUND SYSTEM TREATISE THE ONLY BOOK AVAILABLE OF ITS KIND!

A Vital Necessity to Everyone Connected in Any Way With Sound System—Public Address Work—or Amplifiers and Associated Equipment!

Filled from cover to cover with real "meats"—no complicated mathematical formulas—no theories that are over your head—but full of practical "dope"—adequately illustrated and carefully, simply and clearly explained. An intensely practical book—edited for men who take their Public Address Work seriously. It not only tells you WHY but shows you HOW to correctly install, test, measure, operate, and maintain P. A. Systems. And it provides abundant information for all—the Beginner—the Serviceman—the Dealer—as well as for the Professional Sound Engineer.

**1.00** POST PAID

**RADIO-AMP PUBLISHING CO.**  
123-N WEST 17th ST. NEW YORK 22

# RADIO PHYSICS COURSE

ALFRED A. GHIRARDI\*

## Lesson 27 Transformers

THE ordinary type of transformer has its primary and secondary windings distinct and insulated from each other. It is not necessary to have the two windings distinct, however. In the *auto-transformer* shown in Figure 1 the secondary winding is connected to the primary winding. This type of transformer may be built either to step up the voltage as in (A), in which case the primary winding is a portion of the secondary, or it may be built to step down the voltage as at (B), in which case the secondary winding is a portion of the primary. The position of

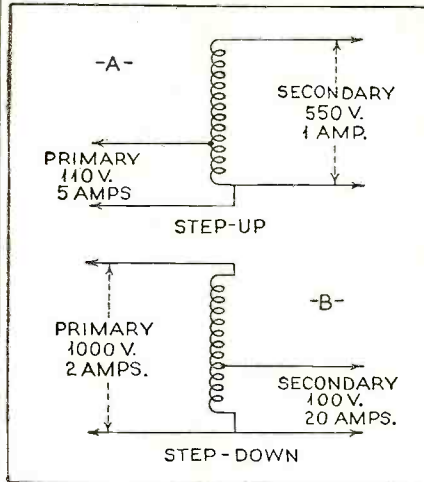

Figure 1. (A) A step-up auto-transformer. (B) A step-down auto-transformer

the tap on the winding determines the voltage and current ratios of the primary and secondary. The voltage across the secondary winding bears the same relation to that across the primary part as though there were two separate windings, and the ratio of the voltages is the ratio of the number of turns included between the secondary and primary terminals, just as in the case of the ordinary transformer. The voltages and currents for a particular case are also shown in Figure 1.

Iron-core auto-transformers are used for power work in low-voltage circuits such as in the battery charger. They are also used in motion-picture work for efficiently reducing the 110 volts of the line to 40 to 60 volts for the electric arc. They are usually called "economizers" in this case. They are also employed for audio-frequency amplifier couplings in some forms of impedance or modified choke coupling, to provide a moderate voltage step-up. The transformation of the energy from the primary to the secondary circuit in an auto-transformer is partly by *transformer action* and partly by *straight electrical conduction* from one circuit to the other. For moderate ratios of transformation, the auto-transformer is much more economical in the use of materials, and has a much higher efficiency, than a transformer which *transforms* all the power. With the higher ratios of transformation, more and more of the power is transformed by regular transformer action and less by conduction. The auto-transformer is therefore econom-

\* Radio Technical Pub. Co. Publishers, Radio Physics Course.

ical only for small ratios. Also, as the low- and high-voltage sides are connected together, conductively, in commercial power systems the low side should be grounded at the proper point for reasons of safety, if the high-side voltage is sufficiently high to be dangerous.

Air-core auto-transformers are often employed as couplings for the antenna circuit and first tuned circuit in radio receivers, and are sometimes used as interstage coupling transformers between radio-frequency amplifying tubes, as we shall see later.

The secondary winding of a transformer is usually placed outside, and the primary winding is between the core and the secondary.

The cores in practically all the iron-core transformers are made up of a number of thin sheets of transformer iron or steel. These thin sheets are called *laminations*, and the core is said to be *laminated*. The purpose of the laminated construction is to greatly reduce the loss due to eddy currents, as we shall now see.

In a closed-core transformer with a *solid steel core*, the core can be considered as a single turn secondary which would have a low voltage induced in it by the rapidly varying magnetic field through it. This would produce circular currents flowing as shown at the left of Figure 2, in a plane at right angles to the direction of the main field, and in such a direction as always to be opposed to the main magnetic field through the core. These currents would be very large, even though the in-

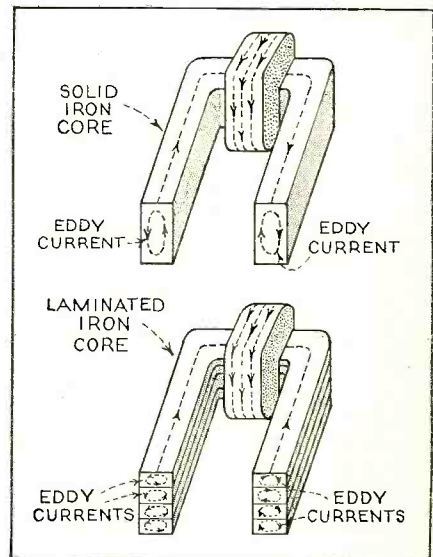

Figure 2. The effect of laminating a magnetic core to reduce eddy currents

duced voltage were low, since the resistance of the path in the core would be very low due to the large solid cross-section area. Of course these currents flowing around the closed ring core as shown (eddy currents always flow in planes perpendicular to the flux), would cause a considerable amount of heat which would quickly heat up both the core and windings, and also result in a decrease in efficiency since this current is not useful but is wasted. These currents are called "*eddy currents*."

By constructing the core of thin laminations of steel, each one electrically insulated from the next by a specially formed film of oxide, a thin sheet of paper, or a coat of insulating varnish or enamel, the

eddy currents are confined to the single laminations, and therefore they are weak, since the resistance of these paths is very much greater than the resistance of the paths in a solid chunk of steel, due to the fact that the length of each path is longer and the cross-section area is less, as shown at the right of Figure 2. The iron is thus left continuous in the direction of the magnetization, but discontinuous in the direction of the flow of the eddy currents. Because of the low efficiency of small transformers, the primary current is ordinarily 10 to 20 percent greater than a consideration of the secondary current and turns ratio would indicate. Large transformers used in power work may have high efficiencies, of 95 percent and over. Because of the space taken up by the oxide or varnish on the core laminations, the value of the true effective cross-section area of the core may be 5 or 10 percent less than the outside physical dimensions would indicate.

In order to further reduce the strength of the eddy currents, the steel used in most alternating magnetic circuits has from 2 to 4 percent of silicon added to it. This is called *silicon steel* or *electrical sheet steel*. The 2 to 3 percent of silicon added to the medium silicon steel used for most transformer cores increases the electrical resistance of the steel from about 10 microhms per cubic centimeter to 45, an increase of 4.5 times. The eddy-current loss is proportional to the square of the frequency of the varying flux through the core.

Unless the laminations are effectively insulated from each other, by the iron-oxide layer or other means, the eddy-current losses may be much greater than would otherwise be the case, since the eddy currents would be able to flow across from one lamination to the next. By decreasing the thickness of the laminations, the eddy current losses can be reduced to any desired value, but there is a limit, since if the material is made too thin, the space occupied by the insulating layers becomes excessive, thus producing higher net inductions in the steel and resulting larger losses and magnetizing current. Also, thin sheets cost more to manufacture than thick ones, and more to punch and assemble. Also they have higher hysteresis loss per unit weight, since the material has a finer grain and hence more internal friction due to the repeated rolling than thicker sheets. It has been learned that the best balance between these various factors is to use sheets having a thickness of from 12 to 18 mils (1 mil = .001 inch) for the cores of apparatus to be operated on 60 cycles. The steel is usually operated at a flux density of about 60,000 lines per square inch; 14-mil sheet is perhaps the most commonly used in America for this purpose. For special iron-core radio-frequency apparatus, sheet from 1 to 3 mils thick is used. The laminations should be clamped tightly to prevent their tendency to vibrate at a frequency equal to that of the primary current, due to the changing magnetic field.

Power transformers are heavily constructed, with large cores and heavy windings, since relatively large currents flow through them. They are usually enclosed in metal cases with either air or other cooling facilities provided to carry away the heat developed by the hysteresis and eddy-current losses in the core material and the I<sup>2</sup>R losses in the primary and secondary conductors. They are used for boosting and then lowering the voltages on long power transmission lines. By using high voltages of from 30,000 to 250,000 volts, the line losses are reduced, since only small currents are required to transmit a given amount of power at these high voltages ( $W = E \times I$ ), so it is possible to use

smaller and cheaper conductors and supporting towers.

The electric lighting companies all distribute electrical power for home lighting, at rather high voltages to neighborhoods. It is then stepped down to 120 volts by transformers and supplied at this voltage to the consumers. Transformers are also used in a.c. electric welding work, for a.c. bells, etc. Small audio transformers and power transformers used in radio equipment are usually sealed in paraffin wax or pitch to "damp" any vibration of the laminations, since the noise produced by loose laminations is sometimes very objectionable. The metal containers around such transformers act as partial magnetic shields for the windings, provided they are thick enough and the stray fields of the transformers are not too excessive. In the shell type of transformer there is a minimum of leakage flux, and the iron of the core itself forms a partial magnetic shield.

Small power transformers used in radio receiving equipment usually have several secondary windings to provide the various voltages required. When the cores are built up of individual lamination strips stacked one over the other with their ends interleaved, the joints between the ends must be kept very tight to prevent any air gaps which would decrease the magnetic flux and so decrease the output voltages. Audio transformers have a large number of primary and secondary turns of fine wire. The step-up voltage ratio is usually 3 or 4 to 1. Loudspeaker coupling transformers are also used to keep the plate current of the last audio tube in a receiver out of the loudspeaker winding. Transformers are also used to match impedances in radio and telephone circuits as we shall see later.

## Backstage in Broadcasting

What's Going On in the Studios

(Continued from page 549)

kowski. The symphonic group has long been known to network listeners, but never before did it try so radical an idea as presenting quarter-hour daily broadcasts. This limited time, of course, necessitates the frequent presentation of excerpts rather than complete symphonic works, but Stokowski believes that the small but continuous doses of good music may serve to further public interest in the more serious type of composition. The series is presented every day, excepting Sunday, under the sponsorship of the Liggett & Myers Tobacco Company, from the studios of WCAU, Philadelphia. Stokowski takes full technical charge of the studios during his broadcasts. He has his own ideas of microphone placement and everything he says goes. The control men are musicians of his own selection. No visitors are permitted to his broadcasts and all usual studio formalities are discarded. The conductor doffs his coat before the broadcast, turns in his shirt neckband and climbs up a tall stool on the conductor's rostrum. Using no baton, but merely waving his hands, Stokowski is perched atop the stool, which he himself designed, throughout the program. At times he stands precariously on the stool, managing to maintain this position by locking his heels behind a rung encircling the stool's legs. He terms radio "a great adventure" and likes the studio better than the concert hall for the reason that it eliminates the coughing, sneezing and applauding of visible audiences.

*Now*  
**SIMPLIFIED**  
 and **IMPROVED**

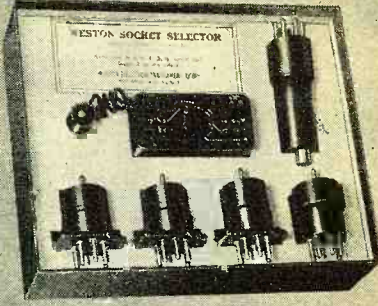

**WESTON**  
**SOCKET**  
**SELECTOR**  
 MODEL 666, TYPE 1A

The method of Selective Analysis, introduced by Weston, has been further improved and simplified. *Now* . . . only one socket selector cord and plug is necessary — colored special adapter combinations provide for 6, 5, 4 and large 7-prong tubes.

Model 666 makes any analyzer truly universal in its capacity to analyze radio receivers. Combined with the Weston Model 665 Volt-Ohm-Milliammeter it provides a method of analysis which banishes obsolescence. You will want full data on Model 666, type 1A. Return the coupon today . . . Weston Electrical Instrument Corporation, 615 Frelinghuysen Ave., Newark, N. J.

**WESTON**   
*Radio Instruments*

Weston Electrical Instrument Corporation  
 615 Frelinghuysen Ave., Newark, N. J.

Send *Name*.....  
 Bulletin *Address*.....  
 on Weston *City and State*.....  
 Radio In-  
 struments.



## The New Centralab RADIOHM

### available for Replacements

Servicemen everywhere are mighty glad that these new 1 3/8 in. Radiohms are now available for replacements. Smaller—for the new type sets—they are the last word in efficiency.

Employ the famous Centralab rocking contact for smooth, quiet, noiseless performance. At your jobber.



Resistor B of annular shape, has long been the standard type. Current concentrates around the INNER edge, i. e.; the shortest path.



Resistor A used in the new Radiohm, has the same length path across its entire width, giving greater effective area for good volume control.

Your Jobber has the new 1934 Volume Control Guide.

Ask for it!

CENTRAL RADIO LABORATORIES

**Centralab**  
MILWAUKEE, WISCONSIN

FREE



## NEW 1934 RADIO and SHORT-WAVE TREATISE

108 Pages  
100 Hook-Ups  
1500 Illustrations

### Not Just Another Catalog

Every time a new edition of our Radio and Short Wave Treatise comes off the press it is an important event. Completely revised and enlarged, this new 1934 edition contains 108 solid pages of useful radio information, diagrams, illustrations, radio kinks and real live radio treatise. It contains more valuable radio information—more real live "meat"—than many text books on the subject. PARTIAL LIST OF CONTENTS. Fundamental Principles of Radio for the Beginner. Chapter 2—Fundamental Circuits and Uses of New Tubes—Revamping Six Volt Battery Sets for Two Volt Tubes—Public Address Systems—How to Build Short Wave Transmitters and Receivers—Up to Date Tube Chart and Socket Connections, etc., etc. WHITE TODAY—Enclose four cents for postage Treatise sent by return mail.

RADIO TRADING COMPANY  
92 PARK PLACE NEW YORK

LEARN IN LOS ANGELES  
**Radio-Television**  
ELECTRICITY—TALKING PICTURE  
BROADCASTING—Special Limited Offer  
GOOD JOBS WON BY TRAINED MEN. Each one allowed to L. A. Earn living while learning. 30,000 graduates. Latest facilities. No dummy equipment. Free employment service. Est. 29 yrs. Send for FREE Illustrated Catalog. Tells how to earn good pay and win a steady job.  
NATIONAL RADIO & ELECTRICAL SCHOOL  
Dept. RN-3 6004 S. Figueroa Los Angeles, Calif.

# The DX Corner for Short Waves

(Continued from page 527)

## W2XAF and W2XAD Transmissions

An official communication from Schenectady, New York, states that station W2XAF will transmit on a wavelength of 31.48 meters daily from 7:45 to 11 p.m. W2XAD will transmit on a wavelength of 19.56 meters on Mondays, Wednesdays and Fridays from 2:30 to 3:30 p.m., on Sundays from 2 to 4 p.m., all E.S.T.

## A Report from Los Angeles

Mr. W. O. Howard, who requested that we get the information published in the article in the January 1934 issue under the title "The South Pole Calling," sends us in the following. He states: "I find I just cannot be without RADIO NEWS for authentic short-wave material. I sometimes walk to the newsstand several times a day until RADIO NEWS is in my hand. In regard to the Byrd broadcasts, I find that K6XO, Hawaii, comes in every night on about 40 meters. They rebroadcast KJTY. I am not getting FYA, GSD, DJD, GSE very strongly. W3XAU and W2XAD are my strongest Americans. I get RV15 here at about 11 p.m. J1AA on 7880 kc. is also very good after 1 a.m., P.S.T. EAQ is always steady. I am using a Midwest 16-tube set with a Lynch transposed antenna lead-in."

## A Report from Washington

Mr. A. D. Golden reports the following DX Best Bets received on an FB7 with a doublet antenna: KJTY, GSE, GSD, GSC, FYA, EAQ, DJD, I2RO, PRADO, XETE, VK2ME, VK3ME, HJ4ABE, HJ3ABD, HC2RL, KKH, W8XK and all the rest of the Canadian and American stations. RV15 comes in strong and clear on 70 meters. I also heard an experimental broadcast to American listeners from a Moscow station (I believe the letters were RND) on 12,000 kc.

## Report from Minnesota

A. E. Koivisto reports that on his Midwest 16-tube receiver the following are his Best Bets in his location: FYA, I2RO, DJB, DJC, EAQ, GSB, GSG, GSD, GSE, GSF, PRJO.

## A Report from New Jersey

Mr. Cornelius Bakker of Passaic, New Jersey, sends in Best Bets received in his location on a home-built superheterodyne: HIX, RV59, PHI, I2RO, W8XK, CP5, W2XK. He reports hearing W8XAR on 73 meters which he says is a new experimental station of KDKA. He also reports hearing W2XK at Schenectady, New York, on 61,000 kc.

## Oklahoma Listens In

W. H. Boatman of Atoka, Oklahoma, reports the following Best Bets on a home-built converter ahead of a ten tube Ozarka Viking receiver: GSA, DJC, HJ1ABB, RV59, FYA, VE9JR, VK2ME, VK3ME, XETE, HJ3ABD, HBL, I2RO, YV3BC, XAM, J1AA, GSC, CT3AQ, EAQ, X26A, VS1AB, OXY, EAJ25, CT1AA, HVJ, LSN, LSY, OCJ, FZS, HJB.

## A Report from Yankton, S. D.

Using a tiny Radio News Junk Box receiver which I built-up quickly the other day from an old issue of RADIO NEWS, I immediately began to receive the experimental station KEE at Bolinas, California,

with good volume on 38.86 meters. W8XK, W3XAL, W2XAD, W9XF, W3XAU, W2XE and XETE are coming in very well. Will send you a more complete log later.

## A Report from Omaha, Neb.

Mr. Harold Hansen reports the following stations: HJ4ABB at Manizales, Colombia, Friday evenings, 41 meters, 8 to 9 p.m.; C.S.T. PSK every evening from about 5:45 to 6:45 p.m., C.S.T. on 36.65 meters. HC2RL starts at 5:45 p.m. and ends at 7:45 p.m. E.S.T. (He is only using 150 watts).

## Report from Massachusetts

Ernest G. Fairbank of Wilton, Massachusetts reports the following Best Bets on a National d.c. SW3: GSB, GSC, GSD, BSE, FYA, W8XK, I2RO, DJA, DJD, VE9GW, VE9DR, VE9JR, EAQ, VK2ME, VK3ME, HBL, HBP.

## A Report from British Columbia

Mr. Jack Bews of Revelstoke, B. C., reports the following Best Bets in his location: W8XK, W3XAL, Y2XAD, W2XAF, W9XF, W2XE, W3XAU, KEQ, J1AA, RV15.

## Report from British Guiana

Mr. J. A. V. Bourne reports hearing RV59, Moscow, on 50 meters. He says that English is spoken on these transmissions from about 5:30 to 6:30 p.m. twice a week. He says that RKK and RNE in Soviet Russia, interfere with W8XK and with GSA and DJD respectively.

## Short-Wave Report from Florida

Mr. E. M. Law of Miami, Florida, reports the following Best Bets: On the 49-meter band DJC, GSA, VE9GW, W8XK, W9XF, W3XAU, YV3BC, YV1BC, CP5 and W8XL were the best. On the 31-meter band, VK2ME and VK3ME are features. On the 19-meter band FYA and DJD are worth listening to. On the 45-meter band he mentions HC2RL and PRADO. On the 30-meter band EAQ, LSX at Buenos Aires he reports as relaying programs to the Columbia Broadcasting System and the National Broadcasting Company after 7 p.m. on 28.8 meters. He reports W6XI and KKW (Hawaii) are heard testing with W2XBJ relaying programs from the Byrd expedition, also from 10 to 10:30 p.m., E.S.T. Saturdays on 39 meters. He states that in the past month the 31-meter band fades out soon after the Australia transmissions.

## A Report from England

John J. Maling of Norfolk reports the following Best Bets in England: LCL, RV59, WKW, W2XE, HVJ, VUC, VK2ME, CNR, CN8MC, VE9GW, W3XAL, YV1BC. He says that LCL is used to rebroadcast the Oslo long-wave programs on a wavelength of 42.9 meters. He also hears HAS2 (Budapest) relaying the program of the new 120 kw. Budapest station on about 43 meters. Announcements are made in Hungarian, French, German, English and Italian.

## Report from the Dominican Republic

Senor Jose Roca Castaner of San Pedro de Macoris reports the following Best Bets picked up in his location on a Scott all-wave deluxe receiver. During the day:



W3XAL, W2XAD, FYA, W8XK, DJB, GSF. During the evening: DJD, FYA, W3XAU, GSC, DJA, W2XAS, YV3BC, GSB, YV1BC and Radio Manizales.

**Another Official Observer Report from England**

Mr. A. Barber of Blackpool states that the European stations have been received fairly well during the last month. He gets W3XAL very well. He reports the new Norwegian station LCL at Jeloy on 42.9 meters with a power of 1kw. He also reports the German and Russian stations come through with good signals as well as is true of CT1AA and FYA.

**Readers Who Helped Log Stations for This Month's Report**

We are indebted to the following readers of RADIO NEWS who sent in reports of reception this month: A. B. Coover, Union City, Ind.; Clarence Disch, Cleveland, O.; G. E. McJunkin, Kansas City, Kans.; Roy Sanders, Worcester, Mass.; R. W. Evans, Lima, O.; H. O. Nelson, Hutchinson, Kans.; H. G. Taylor, Beckley, W. Va.; K. R. Boord, Smithfield, W. Va.; W. G. Wey, Mannette, Wis.; J. E. Brooks, Montgomery, Ala.; G. W. Renish, Jr., Omaha, Neb.; E. F. Orne, Cambridge, Mass.; B. Starr, Buhl, Idaho; H. Adams, Jr., Baltimore, Md.; D. Smith, Woburn, Mass.; W. Howald, Los Angeles, Cal.; E. C. Webber, Roanoke, Va.; J. W. Smith, Baltimore, Md.; Dr. J. P. Watson, Hazlehurst, Miss.; E. Brummer, Chicago, Ill.; H. F. Drake, Clinton Corners, N. Y.; A. A. Hansen, Fort Benning, Va.; O. Beyerjuss, Chicago, Ill.; A. Foster, New Castle, Pa.; R. Cardoso, Rio de Janeiro, Brazil; Heinie Johnson, Big Spring, Tex.; W. A. McAllister, Hopkinsville, Ky.; D. H. Townsend, Jr., Fallon, Nev.; M. L. Thrum, Winona, Minn.; F. C. Balph, Indianapolis, Ind.; W. F. Daboil, Providence, R. I.; C. Horton, Saginaw, Mich.; H. K. Miller, Northampton, Mass.; C. H. Armstrong, Atlanta, Ga.; C. H. Skatzev, Delaware, O.; F. W. Kutzner, Jersey City, N. J.; G. Moraldi, Rome, Italy; W. Dixon, Plainfield, N. J.; E. H. Kydd, Ceballos, Cuba; W. F. Buhl, Newark, N. J.; W. C. Couch, Asheville, N. C.; W. L. Weber, West McHenry, Ill.; A. G. Taggart, Manitoba, Can.; W. A. Jasiorkowski, Milwaukee, Wis.; K. A. Staats, Aliquippa, Pa.; A. Barber, Blackpool, Eng.; J. R. Castaner, San Pedro de Macoris; J. J. Maling, Norfolk, Eng.; E. M. Lav, Miami, Fla.; J. A. V. Bourne, British Guinea, S. Amer.; J. Bews, Revelstoke, B. C., Can.; E. G. Fairbank, Wilton, Mass.; H. Hansen, South Omaha, Neb.; F. I. Brackenberry, Yankton, S. D.; W. H. Boatman, Atoka, Okla.; C. Bakker, Passaic, N. J.; A. E. Koivisto, Hibbing, Minn.; A. D. Golden, Seattle, Wash.; A. Hamilton, Somerville, Mass.; D. W. Parsons, Cape Henry, Va.

**Send in Your Reports**

The Editors acknowledge with thanks the assistance of public-spirited readers who have thus cooperated to make these columns so successful and helpful. Let us urge our readers, one and all, to continue, in even a larger way, to send in these reports. We would be grateful if every reader who hears even a single station would send it in to us with just the data as to its wavelength, the time which it was heard, etc. Of course, we would prefer to get more information, including the Best Bets in each listener's locality, as well as definite logs of stations, their wavelengths and times of transmission. Readers will also help by stating what type of receiver they use in logging these stations.

# Lafayette

## 10 tube superhet

### TRIO-WAVE

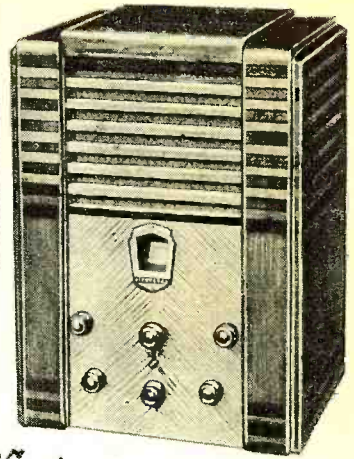

## SPANS the WORLD

15-550 Meters 15-2000 Meters!

Every turn of the dial brings a new thrill when you tune in this custom built 10 tube All Wave Receiver. London, Paris, Moscow, Sydney, Tokio, Singapore, Buenos Aires come in startlingly clear! Listen to transatlantic phone conversations, airplane messages, amateur calls, etc! The whole world is right at your finger tips! For discriminating people who seek a modern radio plus luxurious performance, the Lafayette Trio Wave is the answer!

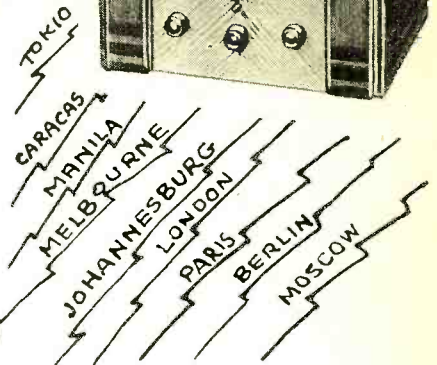

## 2 SETS IN ONE! A CUSTOM BUILT MARVEL!

The Lafayette 10-tube All Wave Receiver is the last word in Radiol. It is truly two sets in one. Not only does it insure marvelous reception on the regular broadcast band, but it insures real distance and perfect reception of foreign broadcasts on wave

lengths up to 2000 meters. More than that this receiver is available in a model which tunes in the wave lengths from 15 to 200 meters thus making code signals, transatlantic phone conversations, police calls, available to you.

### EVERY LATEST DEVELOPMENT

Every latest development has been incorporated such as improved superhet circuit; newest tubes; automatic volume control; remarkable sensitivity; perfect tone quality, etc. The cabinet is a masterpiece combining American Walnut, Claro Walnut and Fine Burl Maple.

If you are looking for that rare combination—perfection in engineering and construction, plus genuine beauty, plus luxurious performance—this 10 Tube Lafayette All Wave Receiver is the one set to buy!

### TWO SETS FOR THE PRICE OF ONE

Why be content with ONE receiver when you may have two sets combined in one—for the price of one? The unsurpassed performance of this custom-built receiver, its rare beauty and its perfection of construction and engineering make this the outstanding sensation of the year! The Lafayette 10 Tube All Wave Receiver, and cabinet with matched dynamic speaker comes complete with tubes for 110-220-240 volts. Tunes 200 to 2000 meters. Also available in special model tuning 15 to 2000 meters. Write today for complete details and prices, etc.

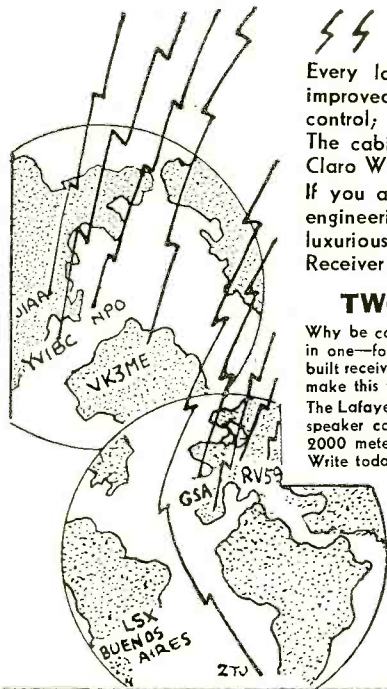

**WHOLESALE RADIO SERVICE CO., Dept. N-34**  
100 Sixth Avenue, New York, N. Y.

Gentlemen—Please send me additional information, prices, etc., on the Lafayette 10 tube All Wave Receiver.

Name .....  
Address .....  
City ..... State .....

**WHOLESALE RADIO SERVICE CO. INC.**  
100 Sixth Avenue, New York, N.Y.  
New Branch  
219 Central Avenue, Newark, N.J.

# WHEN SEEKING A RADIO SCHOOL

RCA Institutes, with its reputation firmly established by 24 years service is an institution recognized as an important factor in the radio industry.

Experienced radio men come to RCA Institutes . . . or take RCA Institutes Home Study Courses, because these men know the reputation and standing of the school.

The beginner who seeks instruction in any branch of radio will find courses designed for him . . . and this beginner, in looking for a radio school, might well follow the example of the experienced men.

Resident Schools in New York and Chicago — Fully Equipped — Conveniently Located — Low Weekly Tuition Rates.

## Features of Home Study

Extension courses for home study on convenient "no obligation" plan. Examination and technical advisory services. Free post-graduate practical training at resident school with modern equipment under instructing engineers.

Write for Catalog

**RCA INSTITUTES, Inc.**  
Dept. RN-3  
75 Varick Street, New York  
1154 Merchandise Mart, Chicago



# AMERTRAN DE LUXE TRANSFORMERS

AmerTran De Luxe Parts represent the highest quality audio equipment available for public address, custom-built sets, broadcasting and recording. The line includes audio transformers, audio and filter reactors, and power transformers of revised designs for use with latest tubes in modern circuits. New mountings are of similar appearance for all sizes and types of standard units, and the customer may specify whether terminals are taken out at the top or base as illustrated. Also, list prices on many items are lower than in previous years.



Write to-day for bulletin No. 1001 giving complete engineering information, characteristic curves, and impedance ratings. It fully explains AmerTran's extra value.



**AMERICAN TRANSFORMER CO.**  
177 Emmet St., NEWARK, N. J.



# LATEST RADIO PATENTS

BEN J. CHROMY\*

- 1,903,075. ELECTRICAL TRANSFORMER. PETER WILLIAM WILLIAMS, Towcester, and MARK WARD, London, England, assignors to Radio Corporation of America, a Corporation of Delaware. Filed Nov. 11, 1924, Serial No. 749,128, and in Great Britain Dec. 17, 1923. 4 Claims.
2. The combination of a pair of valves and a low-frequency coupling therebetween,

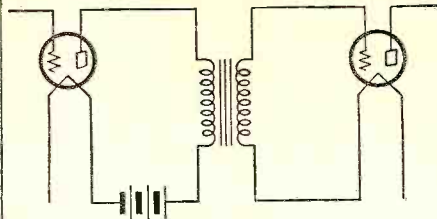

said low-frequency coupling comprising a winding in the output circuit of one of said valves that has an impedance which is large compared to the impedance of that valve whereby substantially uniform amplification is obtained over the audio-frequency range and a winding in the input circuit of the other one of said valve that has an impedance which is large compared to the impedance of the first-mentioned winding when said first-mentioned winding is open-circuited whereby a substantial step-up of voltage is possible and which is small compared to the impedance of the first-mentioned winding when said first-mentioned winding is short-circuited whereby tight coupling is attained.

- 1,902,086. MEANS FOR ENERGIZING ANTENNAE. NILS E. LINDENBLAD, Port Jefferson, N. Y., assignor to Radio Corporation of America, a Corporation of Delaware. Filed May 22, 1929. Serial No. 365,024. 6 Claims.
1. In combination, a pair of radiators,

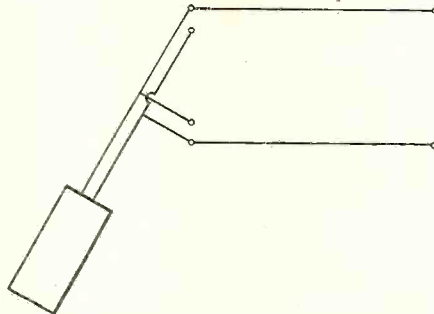

a pair of diverging feeders for supplying energy thereto, and leads run from each feeder close to and parallel to the other feeder.

- 1,905,946. AUTOMATIC GAIN CONTROL. GASTON ADELIN MATHIEU, London, and GERALD ARTHUR ISTEAD, Essex, England, assignors to Radio Corporation of America, a Corporation of Delaware. Filed Apr. 1, 1932, Serial No. 602,524, and in Great Britain Mar. 28, 1931. 2 Claims.
1. An automatic gain control arrangement for a superheterodyne receiver which includes a radio-frequency amplifier, first detector, intermediate-frequency amplifier and a second detector, said arrangement comprising a diode control tube having a cold electrode connected to an input electrode

of said second detector for the impression of signal currents on said diode electrode, a control bias source connected in the circuit of said diode cold electrode, and a plurality of independent direct-current connections from a plurality of points of increasing negative potential on said source to the gain control electrodes of said second detector, intermediate-frequency amplifier and said radio-frequency amplifier respectively, said points being so chosen that as the received signals vary from weak to strong the biases of said gain control electrodes are successively altered in the aforesaid order.

- 1,904,772. RADIO SIGNALING SYSTEM. ALBERT H. TAYLOR, Washington, D. C., assignor to Wired Radio, Inc., New York, N. Y., a Corporation of Delaware. Filed Oct. 23, 1930. Serial No. 490,729. 6 Claims.
1. In a signal receiving system, a radio-frequency energy collecting system comprising a pair of longitudinally extending conductors, a plurality of laterally extending conductors connected to each of said longitudinal conductors at spaced intervals

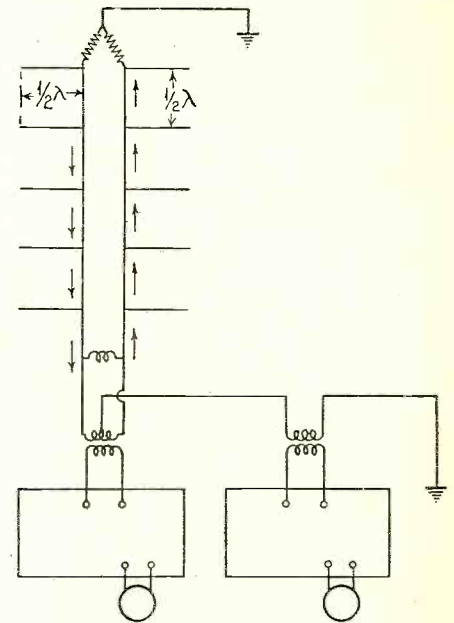

along the length thereof and projecting normally thereto, said laterally projecting conductors being spaced a distance apart equal to substantially one-half of the received wavelength, a primary inductance disposed in series with said longitudinally extending conductors, a receiving circuit coupled with said primary inductance, a connection between a nodal point in said primary inductance and through an independent primary inductance to ground, a separate receiving circuit coupled with said independent primary inductance, and means connected with each of said receiving circuits for integrating the effects of the received signaling energy of said conductors in shifting planes of polarization.

- 1,905,332. CAPACITY CONTROLLED RELAY. CONSTANTIN D. BARBULESCO, Dayton, Ohio, assignor to Paul S. Edwards, Dayton, Ohio. Filed Sept. 13, 1928. Serial No. 305,754. 19 Claims.
1. In combination, a self-modulated high-frequency oscillator of the electron tube type comprising a vacuum tube hav-

\* Patent Attorney, Washington, D. C.

ing a filament, grid and plate, a tank circuit comprising a low inductance, large capacitance and low losses connected across the grid and plate, a coil between the fila-

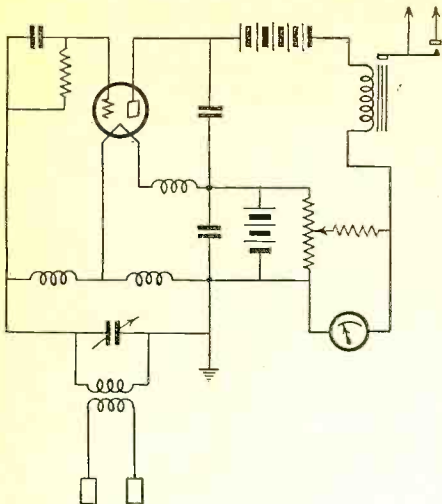

ment and the grid and a second coil between the filament and plate of the tube.

### "Ay-Vee-See"

(Continued from page 541)

parallel with the i.f. transformer in the plate circuit. If "r" is made too low the gain of the amplifier tube is destroyed. Practically, "r" should be about 1 megohm to prevent such shunting effects. R and C are in parallel with "r" and therefore are also in parallel with the transformer; R is usually about .5 megohms.

Consider Figure 3. Curve A shows the response curve of a receiver without a.v.c.; B the curve with a.v.c., and C the characteristic of the set with delayed a.v.c. and a nearly perfect a.v.c. system. These curves tell the whole story; without a.v.c. we get distortion, overload, and double spot tuning. With a.v.c. we lose sensitivity and may never get full output, with delayed a.v.c. we maintain sensitivity, get maximum power output and do not experience distortion or overload.

By delayed a.v.c. we mean the prevention of any control action until a certain value of input signal is achieved. This value is called the threshold value. In the range of signal inputs between O and Y there will be no a.v.c. action and carrier fading will not be corrected. In a home receiver this is not so important because local stations usually do not fade and are the stations relied upon for entertainment; auto sets will be dealt with subsequently.

The next questions are—how to delay and how much to delay. A study of Figure 1 gives the clue to the answer to the first question. The current through "r" that produces the a.v.c. voltage is caused by the r.f. signal put on the diode plate. During the half cycles when the plate is positive with respect to the cathode current flows in the direction indicated by the arrows.

Suppose, however, that the diode is biased—the plate made negative with respect to cathode. Under that condition current cannot flow through "r" until the r.f. signal to the diode is made large enough to overcome the bias. This biasing can be accomplished as shown in Figure 4 where a bleeder circuit resistor R4 is introduced between cathode and ground. The amount of drop across R4 forms the diode bias and therefore governs the delay.

# ELECTRAD for QUALITY

**Y**OU hire a lawyer for legal advice—a doctor for health. Why not rely on the specialized experience of ELECTRAD for RESISTORS and VOLUME CONTROLS?

Since the birth of radio, the name "ELECTRAD" has stood for QUALITY of design, workmanship and performance. And Electrad's moderate prices make it unnecessary for you ever to accept inferior substitute products. Mail Coupon for new FREE Catalog.

## TRUVOLT—Master RESISTOR

Exclusive in design—superior in performance. No other resistor has these features: (1) Patented design permits larger wire and open-air cooling. (2) Double-spiral winding insures perfect electrical contacts. (3) Sliding clips provide adjustments to exact voltages required. (4) 1,000 volt insulation. (5) Full-length protective fibre guard. All Standard Sizes.

## Replacement VOLUME CONTROLS

Consider these time and labor-saving advantages: (1) Interchangeable end covers instantly convertible to use power-switch. Just snap one out and the other in without disturbing control connections. (2) Long ALUMINUM shafts, easily cut to desired length. (3) Only five types required to service 799 standard receiver models.

**RESISTOR SPECIALISTS**  
Since the Birth of Radio

**FREE**  
Vest-Pocket Volume Control Guide

**ELECTRAD, INC., Dept. RN-3**  
175 Varick St., New York

Check here for FREE 1934 Catalog.  
 Check here for FREE Vest-Pocket Volume Control Guide.

Name.....  
Address.....

## Short Wave Sets

The Best Values . . Dollar for Dollar . . on the Market

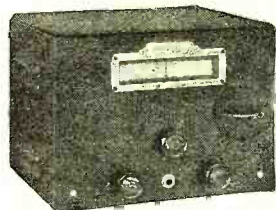

**ALAN ACE**  
110v. A.C.-D.C. S.W. (15 to 200 Meters) 3 Tubes—6F7—43—2525  
Absolutely quiet Built in Power Supply  
Front panel plug-in coils, speaker outlet and field supply, phone jack on front panel; completely shielded in black crackle, hinged cover metal cabinet.  
Complete, incl. 4 coils (15-200 m.)  
less tubes..... \$16.95  
Set, Arcatrus Tubes..... 3.95  
Complete Kit with Blue prints..... 13.95  
Broadcast Coil..... 1.49



**ALAN PRIZEWINNER**  
A.C.-D.C. S.W. (15 to 200 Meters)  
Completely self powered latest type 77-43 and 2525 Tubes. Provision for Head Phones and Speaker.  
Complete, less tubes, in rich crackle-finish cabinet. Assembled, wired, tested, ready to plug in with four coils..... \$12.95  
Kit of RCA or Arcatrus Tubes to match..... 3.75  
Complete Kit of parts, including 4 coils..... 10.55  
Broadcast coil for covering 200 to 300 meters..... .90  
220 V. A.C. or D.C. Adaptor..... 1.75

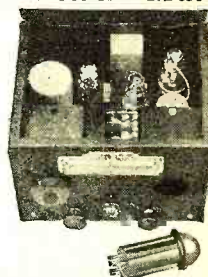

**ALAN INTERNATIONAL**  
Tuned Radio Frequency  
110v. A.C.-D.C. S.W. 15-200 meters.  
4 tubes: 2-28's, 1-43 and 1-2525. Built-in power supply; para of plug-in coil. Other specifications same as Alan Ace.  
Complete including 4 pairs of coils, 15-200 m..... \$24.95  
Set, Arcatrus Tubes..... 4.95  
Complete Kit with Blueprints..... 21.25  
Pair Broadcast Coils..... 2.75

**New!** THE BYRD 2-tube Kit, complete parts nothing extra to buy. 34 Detector, 33 Pentode Output, Micro-Vernier dial, Black cracked finish hinged top cabinet. Set 3 coils, 15-200 m. Complete specifications, blueprints, hardware, wire..... \$5.75  
Set of matched and guaranteed tubes..... 1.95

ACE and INTERNATIONAL also available for straight 110 or 220 A.C. or D.C., and for 2v. and 6v. battery operation.  
Write Today for Full Particulars

**ALAN RADIO CORP. SPECIALISTS IN SHORT WAVE RECEIVERS**  
83 Cortlandt St. Dept. 3 AN. New York City

# BOOKS

for Every Radio Man!

## Short Waves by Leutz

This book by Chas. R. Leutz and Robt. B. Gable contains 384 pages with innumerable illustrations, and covers: Short-Wave Propagation; Commercial Radio Telephony; Ship-to-Shore Radio Telephony; Directional Antennae; Television; Aircraft Radio Equipment; Short-Wave Broadcast Receivers; Ultra-Short Waves (Medical and Surgical Applications); Amateur Short-Wave Equipment; a Historical Review of Radio; and a barrel of other valuable information. **Price \$1.** (Canada and Foreign \$1.50.)

## 101 Radio Hook-Ups

62 pages of circuits for experimenters; hook-ups of s-w receivers and transmitters; circuits of auxiliary devices; amplifiers, power supply units and serviceman's test equipment; and a large number of circuits of standard manufactured receivers. **Price 25c.**

## How To Make Money In Servicing

130 pages of practical suggestions by Zeh Bouck for servicing profits including: Equipment; Contacts; Advertising; Circularization; Service Procedure; The Service Salesman; Off-Season Business; Service Sidelines; How To Buy; and Keeping Up-to-Date. **Price 25c.**

## 1001 Questions And Answers

This 96-page, 9 in. by 12 in. book answers your questions on: Power Supply; How to Kill Vagrant Noises; The How and Why of Radio Filters; Short Waves; Tubes; Audio-Frequencies; Popular Circuits; Radio Symbols; etc. **Price 25c.**

## How To Make It

Gives full details for making furniture, fireplaces, lamps, telescopes, model tug-boats, blow-torches, small lathes, telegraphones, enlarging machines and many other useful articles, together with plenty of handy wrinkles, kinks and formulas. **Price 25c.**

## Amateurs' Handbook

96 pages containing many How-to-Build articles on receivers and transmitters, and chapters on Electric Phonograph Pick-Ups; Broadcast Station Harmonics; Radio Wrinkles; The Serviceman; DX Instructions; Tube Data; Experiments; and Volume Control Methods. **Price 25c.**

## Teck Publications, Inc.

222 W. 39th St. New York, N. Y.

Teck Publications, Inc., Dept 3c  
222 W. 39th St., New York, N. Y.

Enclosed find \$..... for which  
please send me the following books:.....

Name.....

Address.....

City..... State.....

# QRD? QRD? QRD?

CONDUCTED BY GY

THE Air Transport Code which was signed by the President carried the following stipulations, which are of real interest to the operating personnel in this industry: . . . hours of not more than 48 in one week . . . a rate of time and one-third to be paid for overtime . . . the rates of pay of all employees included in Article 3 whose hours of employment have been reduced by the provisions of this code but whose wages have not been increased by the foregoing section of this article shall be increased by readjustments so that equitable differentials in earnings shall be maintained. . . . The ARTA, the only organization representing the operators in connection with this code, were unable to have their stipulations written into the code because they did not have the proper percentage of ops on their rolls but, still, they were able to insist that the operators be kept out of the code in connection with a definite minimum wage of \$80.00 per month which permits for further arbitration on this point. The answer for success is 100% cooperation in the future.

Fate was standing behind Arthur Morris, W2AJH, when he was about to sign on the S.S. *Black Arrow* a short time ago. Something or other happened which caused him to take out the S.S. *Hinckley* of the Oriental Lines. 'Cause while they were en route from Rio to Europe riding a terrific storm, he picked up an SOS from the *Black Arrow* which had run aground somewhere off the Canary Islands. Brown, the operator on the *Black Arrow*, has not been heard from since. Just one of those things or perhaps Artie has been saved for a hanging.

On board the S.S. *American Legion* a news reporter tried to save some money by abbreviating Secretary of State as "S. O. S.," in a wireless despatch to his paper. The msg never got off the ship that way! What with other ships hearing the distress call and continually asking the *Legion* for her position and everyone breaking in just when she would open up, it didn't have a chance. After some time was lost trying to break through the continual interruptions, the error was cleared and peace resumed, but it went out as secretary of state!

Santa Claus, in the person of the ARTA signally honored Ye Ed, (Jerry Goldby) and Lowell Thomas, the broadcasting newsman, by tendering them an Honorary Membership in the organization. Lowell was instrumental in getting a raise for the boys on one of the freighters recently. Ray Meyers, the operator on said vessel and a good friend of his, wrote a letter to him stating that the outfit had promised the gang a raise if and when, and also, that the ship was at that time proceeding through the Panama Canal with a load of dynamite for West Coast ports. Lowell, on his 18:45 EST, broadcast, said that perhaps if the dynamite went up, it was the raise the company facetiously intended to give them. P. S., the boys got their raise in American iron men.

From the S.S. *Watertown*, off the Florida coast, Brother Reinhardt Foegen was rushed to the Marine Hospital at Key West by the Coast Guard plane service, where he died shortly after from a severe attack of typhoid fever. Stricken with the fever, Foegen would not give in until he had barely enough strength left to wireless the authorities for assistance. We mourn his

loss and take our hats off to an able operator who lived up to the traditions by sticking to his post 'til the last. Adios, Brother Foegen. . . .

The Broadcast Code has been OK'd by the President for a 90-day period so as to allow for adjustments. Of interest to ops are the following: . . . Hours shall be not more than 48 in one week. . . . Those stations which now operate on a basis of a lesser number of hours per week are limited to those hours and may not increase their working week for broadcast technicians to 48. . . . Overtime is not permitted within the industry except in the case of an emergency worker . . . wages guaranteed according to classification of station by FRC.

a. Clear channel or high-power regional stations not less than \$40.00 per week.

b. Clear channel part time or low-power regional stations not less than \$30.00 per week.

c. Low-power part-time or low-power regional stations not less local unlimited or local part time stations not less than \$20.00 week.

Working conditions in any broadcasting station or network shall not be changed to frustrate the intent and purpose of this code. Where on November first any broadcaster paid technician's wages in excess of the minimum herein contained or worked such employees a lesser number of hours per week than herein permitted, such higher wages and such less number of hours shall be deemed to be and are hereby declared to be the minimum scale of wages and maximum hours with respect to such station. The ARTA is desirous of receiving immediate notice of any violations of this law so that such may be brought to the attention of the proper authorities. So stick to it boys and give all cooperation until the puck is driven through the goal.

The TRT log at New Orleans carried the following entry: Recd nrl from . . . and on rpt operator on her sed "pse send slowly can't copy more 10 wpm."

S'funny but a passenger with palpitation of the heart wanted to send his sweetie one of those heavy mushy msgs and inquired from the operator on duty if he read all the radiograms that were transmitted.

DAN trying to get a ship on short wave to lower his freq told him "QRM pse go deeper."

GPU was asked to relay a svc to FFP replied "sorry OM but FFP barred."

Brother Golden from up Boston way reports that the government monitor station at Hingham is being exceptionally official with the citing of those operators who cannot seem to quit superfluous transmission. Again this warning must be instilled in those craniums who continue blasting the air with a lot of hooey and plenty QRN. If they must pound brass we suggest rigging up a small oscillator for their own personal use which will not interfere with regular traffic moving thru the atmospheric. Three citations by the monitor station mean the suspension of the op's ticket and the boys sure wouldn't like that. So watch the old step and, incidentally watch the clock for those silent periods because they are also checking up on that. Yousah, they are getting plenty regulation in their old age. Whether it's liver or lumbago if it helps to clear up the air so that legitimate traffic will have

smooth sailing, then we are all for it, what?

We wish to thank the gang for their replies on that Telefunken argument which was started by Bliss and Kerchoff, and especially H. H. Parker who also sent a diagram along to illustrate fully why Kerchoff was right. And speaking of the gang, we hear that Eddie Russek has caught onto the taffrail of *S.S. Coastwise*, a collier, from out of Boston. . . . Brother Flaherty got himself another assignment. It's sure something trying to hang an anchor on that boy. He remained long enough in town to give President Haddock of the ARTA some cooperation down in Washington. . . . Biscak has taken unto himself a freighter and given up, for the time being, that idea of playing the guitar to those moon-filled heavens of Bogota. . . . Joe Lukas went out on the *Saturn* for some fresh air and the shekels. Now some would like to hear from that yokel boy from the big town, Joe Whiteley. So speak up and let's hear from you.

And so it seems all the gang are going and coming and few remain put in the static rooms of the RMCA. From New York to Boston and Frisco to New Orleans it is all the same. The New Deal has given a greater impetus to exporting than anything else could have done in the short space in which it is operating. But now with the passing of repeal of the Volstead Law a great deal more shipping is in prospect for the gang and we believe that the only men who will be on the beach will be those who don't want to leave and not as in the past. Life is dull . . . no one around . . . but do we mind that when we know that the gang is happy, occupied with jobs, the codes bringing them better living wages and conditions? So things should continue this-away and bring joy and happiness to all . . . with cheerio and bon voyage . . . 73 . . . ge . . . GY

### Filming "Eskimo"

(Continued from page 523)

in the North, is a dire calamity. At Prince of Wales Island practically every dog died of the malady last year, and the natives faced starvation until the American government managed to get supplies in to them.

The picture expedition remained "frozen-in" on their ship until the Spring thaw, when it returned to Nome, and headed for California again. Captain Peter Freuchen, author of the story of "Eskimo" and an Arctic explorer of thirty years' experience, accompanied the party. Jerry Jones, an air pilot from Nome, managed a few times to reach the frozen-in expedition, with medical supplies and such necessities. When one of the party was ill, he rigged a litter in his fuselage and flew the patient back to Nome through a blizzard.

It is probable that only a few of the people who are now seeing the motion picture "Eskimo" would ever come to think of radio as being an important part of the expedition that filmed the picture. But the actual fact is that if De Vinna's radio had not been working more than a few lives would have been lost, including that of De Vinna himself.

BUCHAREST—The radio station here requests applicants for announcers, male or female, to report at the station. The requirements are freedom from accent, knowledge of breathing technique, clear pronunciation and a pleasant voice. The last point will be decided by the listeners.

## 1/2 Per Cent. Accuracy in New Bernard Oscillator

A NEW model test oscillator, a new accuracy at low cost, a new economy, are achieved in the Bernard 1A6. The oscillator circuit is an amplitude-stabilized harmonic generator, with electron coupling to the output, which is equipped with a practically constant impedance attenuator.

The Model 1A6 has a frequency-calibrated scale, 135 to 1,500 kc, and the coincidence of the generated frequency with the scale is 1/2 per cent. or better and is not disturbed by tube replacement. The constancy of the generated frequency itself is better than 0.1 per cent. under all conditions. The Test Oscillator is battery operated, so works anywhere, and draws less current than any other Test Oscillator, so that battery upkeep, average use, costs only 3 cents a week. Standard batteries, readily renewable, last for months. Plate current is less than 0.2 milliamperes.

Optional modulation (30 per cent.) is provided, zero beats are attainable at all settings, and coupling is confined to the shielded output lead. (No stray radiation coupling.)

This is the most accurate of all the low-priced Test Oscillators. Moreover, Bernard Test Oscillators are the only low-priced ones that carry any frequency guarantee.

Construction is sturdy, in a crinkle-finish black shield cabinet; bakelite top panel with copper foil backing grounded to cabinet.

Model 1A6 Bernard Test Oscillator, completely self-contained, ready to operate; in 4x6x6-inch cabinet, including 1A6 electron-coupled tube and 30 modulator; batteries tube and shielded 6-ft. output cable (shipping weight 5 lbs.). Sent express collect on receipt of . . . .

**\$1200**

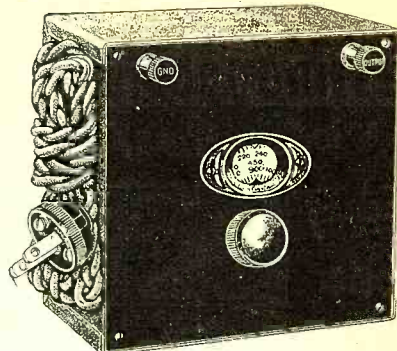

The two models of Bernard Test Oscillators have the same general appearance as illustrated. Model 1A6 differs from the illustration by having a battery switch, a modulation switch and an output attenuator.

We also have a universal type oscillator, same general appearance, same frequency coverage, constantly modulated 100%, works from 90-120 volts, a.c. (any frequency), d.c. or B batteries. No output attenuation, no prevention of stray radiation coupling. Not electron-coupled. Accuracy, 1 per cent. Model 30-N, complete, with 30 tube, ready to operate (shipping weight 3 lbs.). Sent express collect on receipt of . . . . .

**\$750**

**HERMAN BERNARD**

**135-N Liberty Street**

**New York, N. Y.**

## "THIS CREI DIPLOMA IS YOUR BEST REFERENCE"

CREI training will thoroughly prepare you for the big radio jobs and the big salaries that go with them. This is not an ordinary school, but an institute offering advanced radio engineering to ambitious men. A graduate of CREI is recognized throughout the industry as an expertly trained man.

### 3 Convenient Forms of Study—

Home study and residence courses, or a combination of them both, to meet the needs of all. Our one year Residence Course is recognized as the most comprehensive in the entire country.



WRITE NOW . . . FOR

**New 40-page Catalog**

Just Off the Press!

## CAPITOL RADIO ENGINEERING INSTITUTE

E. H. RIETZKE, President

14th and Park Road, N. W.

DEPT. RN-3

WASHINGTON, D. C.



## NEW 1934 AUTOCRAT RADIO



6-Tube Super-Heterodyne 30-Day Trial Offer  
Special wholesale price offer. Latest circuit, Dynamic Speaker. Costs to cost reception. Wonderful tone. Tremendous volume. Hand finished walnut cabinet. Biggest radio value out. Wholesale price and 30-day trial offer good for short time only. Act quick.

**\$1755**  
COMPLETE WITH TUBES

Points Wanted—Big money placing sets on 30 days trial. Get details. AUTOCRAT RADIO CO., 3855 N. Hamilton Ave., Chicago, Ill.



### TRIMM FEATHERWEIGHT PHONES

Prove their Superiority

Actual testings made by technical experts show conclusively that TRIMM FEATHERWEIGHT phones have superior tone quality, extreme sensitivity, exacting uniformity, and rugged durability. Our engineers will co-operate with you in solving your phone problems.

TRIMM RADIO MFG. CO. Earphone Specialists

1528 Armitage Ave., Chicago, U.S.A.

# WHAT'S NEW IN RADIO

WILLIAM C. DORF



*Complete*  
**TESTING Laboratory**  
*in One Case!*

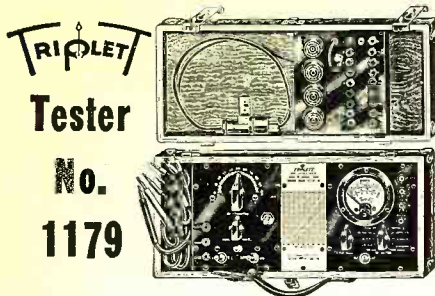

**N**OW you can carry a complete and compact laboratory with you and solve any testing problem . . . without having to guess what the trouble may be. This new Triplet portable laboratory, No. 1179, consists of three units: 1150 Oscillator, 1125 Volt-Ohm-Milliammeter, and 1166 Free Point Set Tester. No. 1150 is a well designed, completely shielded oscillator. A switch permits generating either a stabilized modulated or unmodulated signal of constant level. Extremely accurate scale divisions cover fractional frequencies from 110 to 1600 K.C., on the individually hand-made chart.

No. 1125 contains a direct reading Ohmmeter, Output meter, A. C.—D. C. Voltmeter and Milliammeter. Complete with 16 different scale readings. All readings are controlled by a selector switch. It lends itself admirably to point to point continuity testing for set analysis and general testing.

The Free-Point Set Tester, No. 1166, is universal, flexible and is designed to overcome obsolescence. Four sockets take care of all present day tubes.

**YOUR JOBBER CAN SUPPLY YOU**

at the dealer's net price of \$34.67  
*See Him Today*

**THE TRIPLET ELECTRICAL INSTRUMENT CO.**

39 Main Street Bluffton, Ohio



**Send Coupon For Facts**

Triplet Electrical Instrument Co.  
39 Main Street  
Bluffton, Ohio

Gentlemen:

Send me catalog on Triplet Tester 1179 . . . and complete line of radio servicing instruments.

Name.....

Street Address.....

City..... State.....

**Universal Receiver**

*Description*—The introduction of this Emerson Mickey Mouse, model 411 universal a.c.-d.c. receiver capitalizes the popularity of the Walt Disney world-famous Mickey Mouse sound creations.

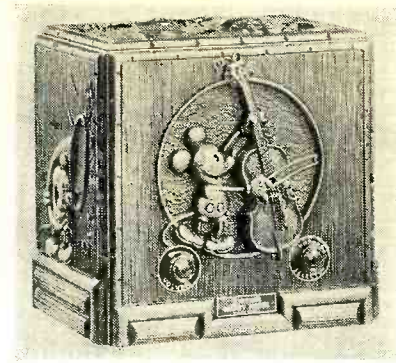

The receiver employs a four-tube tuned r.f. circuit using the new dual type 6F7, one type -78, one type -38 and one type 1V tubes. The cabinet measures 6½ inches by 6½ inches by 4¾ inches.

*Maker*—Emerson Radio & Phonograph Corp., 641 Sixth Ave., New York City.

**Remote Control Receiver**

*Description*—Announcement was recently made of the new Motorola Model S-10 Lazy Boy portable remote control eight-tube superheterodyne receiver for the home. The control cabinet, which meas-

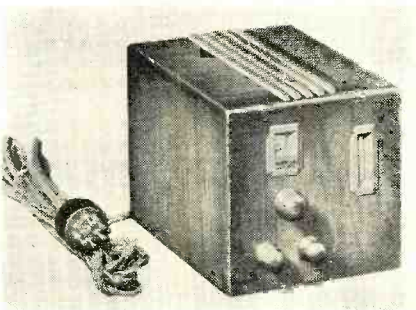

ures 6 inches high by 6 inches wide by 8¾ inches deep, utilizes four tubes and incorporates "Tunalite" silent tuning and tone control. Twenty feet of connecting cable

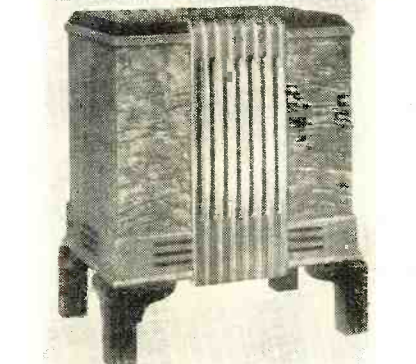

is used for coupling the control unit to the amplifier speaker cabinet. The manufacturer advises that there are no live wires in this connecting cable. The attractive burl walnut speaker cabinet measures 22 inches high by 15 inches wide by 12 inches deep. The remaining four tubes are em-

ployed in the amplifier-speaker unit. This company also announces the model J-8 Lazy Boy, a six-tube remote-control receiver designed to operate from either alternating or direct current.

*Maker*—Galvin Manufacturing Corp., 847 W. Harrison St., Chicago, Ill.

**Display Light**

*Description*—To utilize color and light in displaying merchandise the Display-Light Mfg. Company offers this attractive and practical display device which consists of a glow tube mounted on a sturdy bakelite moulded base. The tubes are available in a wide variety of colors and can be employed in effectively presenting

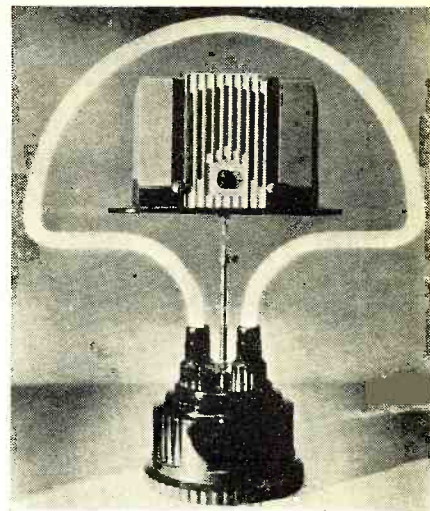

all types of merchandise, as for instance, the universal radio receiver illustrated.

*Maker*—Display-Light Mfg. Co., Bridgeport, Conn.

**Standoff Insulators**

*Description*—Announcement is made of Birnbach's new line of small porcelain standoff insulators. They are available in several sizes ranging from ⅝ths of an inch to 1¼ inches high. The ⅞ and 1¼ inch sizes are supplied with jacks making them especially suitable for mounting

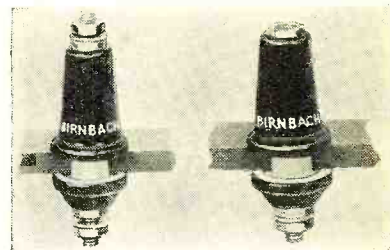

plug-in coils, chokes and all types of high voltage apparatus. These insulators will find many uses in receiving, transmitting and testing work.

*Maker*—Birnbach Radio Co., Inc., 145 Hudson St., New York City.

**Line Voltage Control**

*Description*—The General Radio Variac adjustable line voltage transformer provides a continuously variable a.c. voltage control from 0 to 130 volts when operated from any 110 volt 60 cycle a.c. line. Besides its numerous laboratory applications, this voltage control has any number of industrial uses, such, for instance, as a

speed control for small motors, over voltage and under voltage testing on electrical household appliances, brilliancy control for sign lighting installations, etc. The Variac is made in two models: Type 200-CM has



a protecting case, an attachment cord, and an outlet receptacle and is intended for laboratory and experimental use. The other model is supplied without the case and is available for those who wish to build the control into other equipment. The maximum current rating of this voltage control is 5 amperes. Models for larger and for smaller currents are under development.

**Maker**—General Radio Co., Cambridge, Mass.

**Test Oscillator**

**Description**—This new portable Dayrad series 31 test oscillator is designed to produce frequencies from 105 to 1650 kc. The instrument is sturdily constructed and is fully shielded and by-passed. It is equipped with an attenuator, separately shielded, to vary the intensity of the signal

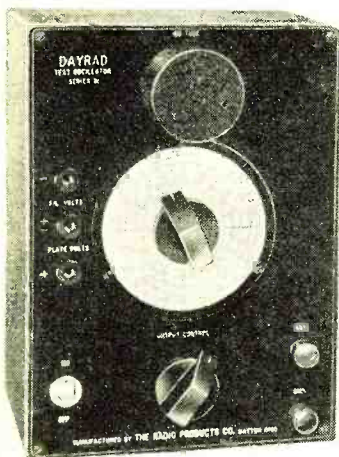

for properly aligning and neutralizing radio receivers.

**Maker**—The Radio Products Co., Dayton, Ohio.

**Recording Unit**

**Description**—The photograph illustrates the new Universal feed screw phonograph recording device. This unit is simple to

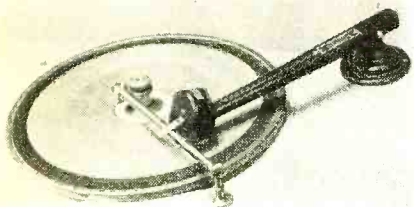

operate, easily installed and is designed for use with any standard recording cutting head. The device grooves its own record

and is capable of cutting 80 grooves an inch. It can accommodate records up to 12 inches in diameter. This new recording mechanism is especially adapted for use in home recording, transcription studios and broadcasting stations who make their own recordings and transcriptions.

**Maker**—Universal Microphone Co. Ltd., Centenela at Warren Lane, Inglewood, Calif.

**A 50 KW. Station**

(Continued from page 547)

this antenna with the 50 kw. transmitter resulted in an average of 40 percent improvement in signal strength over an antenna of normal design and in most cases eliminated distortion fading as well as moving our primary fading zone out about 50 percent.

To summarize some of the outstanding features of the transmitter, I want to point out:

**First:** The normal carrier delivered to the antenna is 500,000 watts.

**Second:** 100 percent modulation of this 500,000 watts is obtained.

**Third:** This means that 2,000,000 watts is radiated at peaks of modulation.

**Fourth:** An average of 1800 kva. of power is required.

**Fifth:** The frequency characteristic of the entire transmitter is flat (within 2 db.) from 30 to 10,000 cycles.

**Sixth:** The total audio-frequency harmonics do not exceed ten percent up to ninety-five percent modulation.

**Seventh:** The radio harmonic radiation is so low that at any point the harmonics will not be greater than 1/100 of one percent of the fundamental.

**Eighth:** Rectifier filaments which required 30 minutes to heat up are turned on by a time clock; a spare tube is kept hot at all times.

**Ninth:** The starting control system will start the entire transmitter automatically in proper sequence and with proper time delays, if desired, or individual control of any part of the sequence is obtained by switches on the control console.

**Tenth:** In case of momentary failures, such as arc-overs or tube flash which can be cleared by removal of power, the transmitter is automatically restarted in about 1/5 of a second.

**Eleventh:** In cases of failure requiring attention, the unit containing the failure is automatically isolated and the transmitter automatically restarted in about one second and continues operating at slightly reduced power.

**Twelfth:** 22,500 cubic feet of air per minute is circulated for cooling various parts of the transmitter.

**Thirteenth:** 500 gallons of distilled water and 700 gallons of city water are circulated each minute for tube cooling. A spray pond 75 feet square is used for cooling the city water.

**Fourteenth:** A .58 wave vertical radiator, 830 feet high, is used as an antenna.

To those who may be alarmed about local blanketing, may I point out that the increased signal over what we now have is the same as the increase when we went to 50 kw. from 5 kw. There was considerable alarm at that time over the blanketing, and it was not at all serious. In the meantime, receiver selectivity is very much improved and we expect even fewer complaints when we go from 50 kw. to 500 kw. than when we went from 5 kw. to 50 kw. **Joseph A. Chambers**, Technical Supervisor, Broadcasting Division, Crosley Radio Corp.

**How To MAKE even the small jobs**

**PAY!**



**Send for SYLVANIA'S FREE Book, SERVICE HINTS. Learn new quick ways to spot and repair radio troubles!**

There's a world of valuable information other service men have found useful in Sylvania's 64-page book, "Service Hints." Things that will save you time and trouble, too!

"Service Hints" contains definite solutions of the special service problems of 43 popular makes of radios . . . more than 200 models in all!

It gives formulas for calculating electrical quantities . . . practical hints on amplifiers, auto radios, condensers, etc. . . and a complete Interchangeable Tube Chart!

Don't be without this useful handbook. Mail the coupon today! We'll send "Service Hints" FREE, and put your name on the mailing list for Sylvania's FREE monthly "Service Bulletin" that gives additional helps in every issue!



**Sylvania**

**HYGRADE SYLVANIA CORPORATION**  
 MAKERS OF  
 Sylvania Tubes, Hygrade Lamps, Electronic  
 Devices  
 FACTORIES  
 Emporium, Pa., St. Mary's, Pa., Salem, Mass.,  
 Clifton, N. J.

**HYGRADE SYLVANIA CORP., A-8**  
 Emporium, Penna.  
 Please send me your free booklet "Service Hints" and your free monthly Service Bulletin.  
 NAME .....  
 ADDRESS .....  
 CITY ..... STATE .....

# NEVER OBSOLETE

## Shallcross Number 611 Universal Tester

will be as modern next year as it is today



- TESTS**  
any radio receiver electrical circuit
- CONDENSERS**  
paper or electrolytic
- RESISTORS**  
fixed or variable
- TRANSFORMERS**  
**CHOKES**

**Maximum Ranges**

- 1000 volts A.C.—D.C.
- 1000 ohms per volt
- 1000 M.A.—D.C.

- 5,000,000 ohms D.C. Resistance
- 3,000,000 ohms A.C. Resistance

Capacitance .001-10 Mfd.

Inductance 100-10,000 Henrys

Send 3c in stamps for Bulletin No. 611-D describing this instrument.

**SHALLCROSS MFG. COMPANY**

*Electrical Measuring Instruments and Accurate Resistors*

700 MAC DAVE BOULEVARD  
COLLINGDALE, PA.

# FORDSON CATALOG

Deal Direct AND SAVE **FREE** 1/3 TO 1/2

Enjoy the performance of ANY FORDSON MODEL in YOUR OWN HOME FREE for 30 DAYS. Thousands sold around the world. An owner writes: *You are doing for Radio what Henry Ford did for Auto industry—You have cheap but how Good!* Many models: AC-DC; battery; long and short wave; all-wave supers; 6 and 32 volt; consoles; all-electric auto radio. Sets for home, car, camp, farm and export. **GUARANTEED 30-DAY FREE TRIAL in YOUR HOME.** A postcard or the coupon brings the REMARKABLE NEW CATALOG \$9.45 FREE. Send today! Prices will amaze you, from

**MAKE MONEY** as our agent. No experience needed. 2-color literature and cards (with your name) all FREE. Agent's sample sets FREE. Write! Send card or coupon now!

**FORDSON RADIO MFG. CO.**  
Dept. 3, 4181 Oakman Boulevard, Detroit, Mich.

Send me FREE catalog and agents proposition (this is not an order.)

NAME.....

ADDRESS.....



**UNIVERSAL BATTERY CONVERTERS**  
110 Volt Alternating Current from 6 Volt Storage Batteries

Maximum efficiency for amplifier and public address work or most any device requiring 110 A.C. (ex. radio rec'rs). Send for descriptive Circular, 60 watt-battery drain 6v. at 15 amps. List \$36.00, 150 watt-battery drain 6v. at 18 amps. List \$60.00 (Standard Discount)

**UNIVERSAL MICROPHONE CO., LTD.**, 424 Warren Lane, Inglewood, Calif., U.S.A.

## The DX Corner (Broadcast)

(Continued from page 545)

767	Gr. Britain, Midland Regional	30
776	Toulouse, France	60
785	Leipzig, Germany	120
804	Gr. Britain, Scottish Regional	50
814	Milan, Italy	50
832	Moscow, Russia	100
839	Strasbourg, France	11.5
877	Gr. Britain, London Regional	50
886	Graz, Austria	7.
922	Brno, Czechoslovakia	36
932	Brussels, Belgium	15
950	Breslau, Germany	60
977	Gr. Britain, West Regional	50
1013	Gr. Britain, North National	50
1031	Heilsberg, Germany	60
1040	Rennes, France	1.3
1050	Gr. Britain, Scottish National	50
1077	Bordeaux, France	13
1131	Horby, Sweden	10
1149	Gr. Britain, London National	50
1195	Frankfort, Germany	17
1222	Trieste, Italy	10
1249	Luxemburg	10
1258	Rome, Italy	50
1411	Bucharest, Roumania	12

### New Zealand Changes

Following is a list of New Zealand stations which started operating on new frequencies in December. The old and new frequencies are both given, for convenience:

Call	Location	Old Freq.	New Freq.
1YA	Auckland	820	650
1YX	Auckland*		880
1ZB	Auckland	1420	1190
1ZH	Hamilton	630	770
1ZJ	Auckland	1320	1310
2YA	Wellington	720	570
2YB	New Plymouth	1230	750
2YC	Wellington	1010	840
2ZD	Masterton	1180	1170
2ZF	Palmerston N.	1050	960
2ZH	Napier	1370	820
2ZJ	Gisborne	1150	980
2ZL	Hastings	1400	1240
2ZO	Palmerston N.]	1050	1400
2ZR	Nelson	130	1110
2ZW	Wellington	1120	1060
3YZ	Christchurch	980	720
3ZR	Gr. ymouth	1300	940
4YA	Dunedin	650	790
4ZB	Dunedin	1080	1050
4ZM	Dunedin	1080	1050
4ZO	Dunedin	1080	1050
4ZP	Invercargil	1160	620
4ZW	Dunedin	1080	1470

\*New Station

### Canadian Changes and Additions

The Canadian Radio Commission has announced changes in frequency, power or call letters of several Canadian stations. Following are the new listings for these stations:

Call	Location	Freq.	Power Kc. Watts
CFAC	Calgary, Alta.	930	100
CFCO	Chatham, Ont.	600	50
CFRC	Kingston, Ont.	1510	100
CFCT	Victoria, B. C.	1450	50
CHCK	Charlottetown, P. E. I.	1310	50
CHGS	Summerside, P. E. I.	1120	50
CHPR1	St. John, N. B.	1370	100
CJAT2	Trail, B. C.	1200	100
CJCA	Edmonton, Alta.	730	1000
CJCI	Calgary, Alta.	690	100
CKLJ1	Kirkland Lake, Ont.	1310	100
CJLS2	Yarmouth, N. S.	1310	100
CJOR	Vancouver, B. C.	600	500
CJRC1	Middlechurch, Man.	1390	100
CJRM	Moose Jaw, Sask.	540	1000
CKB13	Prince Albert, Sask.	1200	100
CKCR	Kitchener, Ont.	1510	100
CKG1	Timmins, Ont.	1420	100
CKMC	Cobalt, Ont.	1210	50
CKOC	Hamilton, Ont.	1120	50
CKPC4	Brantford, Ont.	930	5
CKPR	Fort Williams, Ont.	780	50
CRCV	Vancouver, B. C.	1100	1000

1New stations. 2CJAT, formerly 10-AT, 1155 kc., 25 watts. 3CKB1, formerly 10-B1, 1200 kc., 25 watts. 4CKPC, formerly 10-BQ, 1200 kc., 5 watts.

### Special Program from France

The New England Radio Club *DX News*, the bulletin sent out periodically to members of the New England DX Club (135 Highland Street, Worcester, Mass.), contains a note that should be of particular interest to DX fans, especially those along the east coast. It states that the

French station, Poste Parisien, announced during a recent broadcast that a special program would be put on, in English, each Sunday from 6 to 6:30 p.m., E.S.T., on 776 kc. This station has a power rating of 60 kw. and on the frequency it employed prior to January 15 was well received in the eastern part of the U. S. and Canada. The proximity of its new frequency to those of WJZ and WBAL may offer complications for listeners in several of the coast states. The DX Corner will be glad to receive reports from readers who hear these programs.

## Cathode Tubes in Television

(Continued from page 539)

of scanning at the transmitter and receiver, for instance, by using sweep circuits at the two ends with the frequencies "locked" by means of the same a.c. power system.

The last article of this series will show the results of some tests on this amplifier, and will give some further comments on cathode-ray tubes as applied to television by radio, including a suitable double sweep circuit.

### Parts Used in Amplifier of Figure 2

- Ca, Cb—Aerovox bakelite case or filter condensers, 1 mfd., 400 volts
- Cc, Cd—Aerovox filter condensers, 4 mfd., 400 volts
- C1, C2, C3, C5, C6, C9, C10—Aerovox electrolytic condensers, 25 mfd., 100 volts
- C4, C7, C8, C11, C12, C13, C14, C15, C16, C17—Five Aerovox double electrolytic condensers, 8-8 mfd., 500 volts
- L1, L2, L3—Hammarlund r.f. chokes, 8 millihenries
- L4—National r.f. choke, 2.5 millihenries
- Ra, Rb—IRC metallized resistors, 1 megohm, 1 watt
- Rc—IRC metallized resistor, .25 megohm, 2 watts
- R1—Aerovox wire-wound resistor, 50,000 ohms, 10 watts
- R2—IRC metallized resistor, 50,000 ohms, 2 watts
- R3—Aerovox wire-wound resistor, 900 ohms, 5 watts
- R4—IRC metallized resistor, 30,000 ohms, 3 watts
- R5—IRC metallized resistor, .1 megohm, 2 watts
- R6—Aerovox wire-wound resistor, 1,000 ohms, 10 watts
- R7—Aerovox wire-wound resistor, 100,000 ohms, 15 watts
- R8—IRC metallized resistor, 30,000 ohms, 3 watts
- R9—IRC metallized resistor, 85,000 ohms, 3 watts
- R10—IRC metallized resistor, .1 megohm, 2 watts
- R11—Aerovox wire-wound resistor, 1,000 ohms, 10 watts
- R12—Aerovox wire-wound resistor, 100,000 ohms, 15 watts
- R13—IRC metallized resistor, 30,000 ohms, 3 watts
- R14—IRC metallized resistor, 85,000 ohms, 3 watts
- R15—Aerovox wire-wound resistor, 410 ohms, 5 watts
- R16—IRC metallized resistor, 37,000 ohms, 3 watts
- R17—Aerovox wire-wound resistor, 7000 ohms, 15 watts
- R18—Electrad potentiometer, 50,000 ohms
- R19, R20, R21, R22—IRC metallized resistors, 50,000 ohms, 2 watts



- 1 Yaxley type 612, 12-conductor cable, plug and receptacle
- Eby "Junior" binding posts, plain
- 1 Eby No. 13A Isolantite socket, 4-prong
- 4 Eby wafer sockets, 6-prong

- R2—Rheostat, 6 ohms
- T1, T2—Amertran plate-filament transformers, Type W-311, 800 volts, 120 ma.
- 2 Eby wafer sockets, 4-prong
- Eby "Junior" binding posts, plain

**Parts Used in Power Supply of Figure 3**

- C1, C1, C1, C1—Two Aerovox double electrolytic condensers, 8-8 mfd., 500 volts
- C2, C2—Aerox electrolytic "A" condensers, 6000 mfd.
- L1, L1, L1, L1—Amertran chokes, 40-henry, 40 ma., type L-217
- L2—Amertran A supply choke, 2.5 amperes, .15 henry, Type L-211
- R, R—IRC metallized resistors, 1 megohm, 2 watts

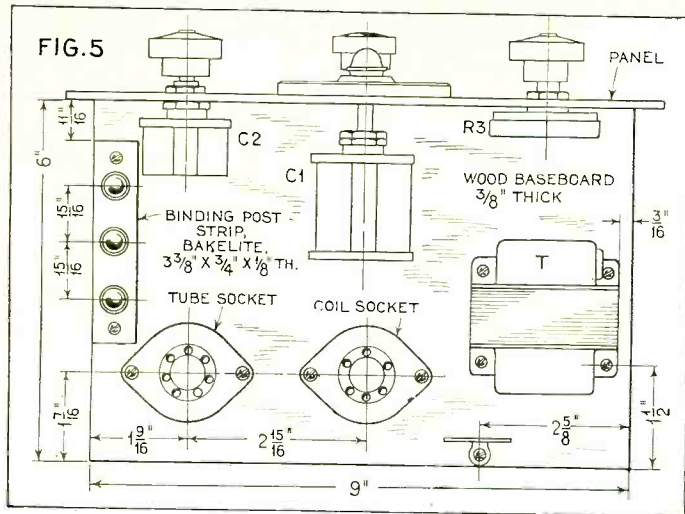
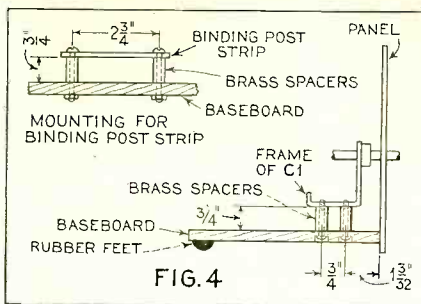

**All-Wave Set**

*(Continued from page 526)*

sides of the "push-pull" circuit. Its maximum output is approximately 6 watts. A -56 is used as a driver, which is coupled to the output stage by means of a special transformer with a low resistance secondary. During the tests the 6 watts proved ample to wake the neighbors, and the low notes as well as the high were well represented.

An especially interesting and practical feature is the new "airplane" type dial. It provides a compact, yet accurately calibrated dial with a separate scale for each wave band. The short-wave broadcast bands and the police band are indicated on it, which should enable the inexperienced listener to tune in these interesting stations readily. The dial knob has a reduction gear ratio of 50 to 1, with a little handle on the knob to help spin it fast when making large jumps on the dial.

Below the main dial knob is the tone control knob which also controls the "off-on" switch. The volume control is at the right while the left-hand knob controls the wave switch. Letters corresponding to those on the dial are marked on the switch.

At the back of the receiver two wires will be found. The black one is to be connected to the aerial and the yellow one to ground—connect the latter to the cold water pipe if you can. Provision for a phonograph is made at the back.

The receiver was first tried out in the RADIO NEWS laboratory and then taken to one of the listening posts. The aerial used was just an ordinary inverted "L" with a total length of about 65 feet. The time was December and included Christmas week. During the test period, short-wave

reception conditions were relatively poor, a fact which checked with results obtained with other receivers operated at the same location and time. Yet it proved possible, for instance, to tune in Pontoise on 19.6 meters and hold it for several hours of enjoyable reception. The usual European stations on 25 meters, such as GSD, DJD, I2RO, and FYA were received repeatedly and on 31 meters several stations were heard regularly. In addition to these innumerable amateur 'phones on all bands. The advantages of the extra r.f. stage were quite obvious when tuning in the shortest waves of 16-20 meters. Commercial 'phone stations, sometimes scrambled and sometimes straight, and plenty of code stations were tuned in.

On the broadcast band one evening a quick run was made of all frequencies between 660 and 880 kc. at 7:00 p.m., a range which includes the powerful locals. There were stations coming in at every 10 kc. except at 780 and 870 kc.; understandable enough to get announcements on all but 830 and 850 kc. Remembering that 850 and 870 kc. are right next to WABC, our powerful local, this record is favorable. Not all of these stations came in well enough to be rated as entertainment but most of them did, including three Canadians.

One more word about the dial calibration. In the broadcast band the error never exceeded 1 percent and at most places it was less than .5 percent. The error on the short waves was mostly very small, .95 percent at 95000 kc.; approximately .5 percent in the 25 meter band and negligible at 16 meters. The worst variation was at approximately 50 meters where the error was 5 percent. On the 77-200 meter band the error was .7 percent at 1500 kc. and no errors at 2000.

**NEW SENSATIONAL OFFER**  
*Learn* **RADIO**  
**PAY FOR TRAINING AFTER YOU GRADUATE**

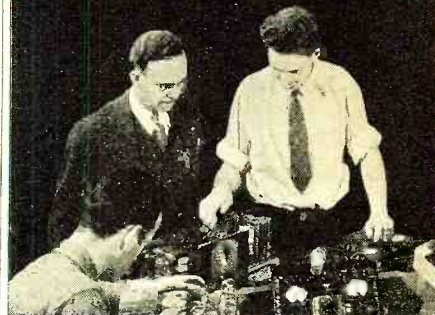

To a few honest fellows I am offering an opportunity to get a training and pay for it after they graduate in easy monthly payments. You get Free Employment Service for life. And if you need part-time work while at school to help pay expenses, we'll help you get it. Coyne is 33 years old. Coyne Training is tested—You can find out everything absolutely free. Just mail the Coupon for My Big Free Book.

**Jobs Leading to Salaries of \$50 a Week and Up**

Jobs as Designer, Inspector and Tester—as Radio Salesman and in Service and Installation—as Operator or Manager of a Broadcasting Station—as Wireless Operator on a Ship or Airplane, as a Talking Picture or Sound Expert—Hundreds of Opportunities for fascinating Big Pay Jobs!

**10 Weeks' Shop Training AT COYNE IN CHICAGO**

We don't teach you from books. We teach you by Actual Work on a great outlay of Radio, Broadcasting, Television, Talking Picture and Code equipment. And because we cut out useless theory, you get a practical training in 10 weeks.

**TELEVISION Is Now Here!**

And Television is already here! Soon there will be a demand for Television Experts! The man who gets in on the ground floor of Television can have dozens of opportunities in this new field! Learn Television at Coyne on the very latest Television equipment.

**Talking Pictures A Big Field**

Talking Pictures, and Public Address Systems offer golden opportunities to the Trained Radio Man. Learn at Coyne on actual Talking Picture and Sound Reproduction equipment.

**Get the Facts**

Don't spend your life slaving away in some dull, hopeless job! Don't be satisfied to work for a mere \$20 or \$30 a week. Let me show you how to make Real Money in Radio—the fastest-growing, biggest money-making game on earth! Get my Big Free book and all details of my pay after graduation offer. Mail the coupon today.

H. C. LEWIS, President  
**Radio Division, Coyne Electrical School**  
500 S. Paulina St., Dept. 34-3K, Chicago, Ill.

Dear Mr. Lewis:  
Send me your big Free Book; details of your Free Employment Service; and tell me all about your special offer of allowing me to pay for training on easy monthly terms after graduation.

Name .....  
Address .....  
City..... State.....

# MATHEMATICS

the key to all technical success

made plain in these books

Help your advancement in technical or scientific work. Learn mathematics. Palmer's course makes it easy to master the essentials. Shows how to use them in your daily work. Over 216,000 copies sold.

Palmer's famous home study course available on easy terms



Covers: ARITHMETIC ALGEBRA GEOMETRY TRIGONOMETRY CALCULUS with practical applications

Sent for Examination No Money Down Small Monthly Payments

## A Self-Instruction Course for Practical Men

Palmer's simple, step-by-step treatment carries you from first essentials to working knowledge of all mathematical methods. Even makes clear the practical use of calculus. Course based on Palmer's years of trade school teaching; gives thousands of exercises and problems with answers based on every-day questions practical men brought to him for solution.

### Study at Home; Pay As You Go

A few minutes a day will give you practical command of this important subject. See entire course without sending a cent in advance. Pay only \$1.00 in 10 days and \$2.00 monthly for three months if you keep the books. If you have ever felt the lack of a working knowledge of practical mathematics, send the coupon at once and look over the Palmer Course.

### McGraw-Hill ON-APPROVAL COUPON

McGraw-Hill Book Co., Inc., 330 W. 42nd St., N. Y. C.

Send me the Palmer Practical Mathematics and Calculus Home Study Course (2 volumes) for 10 days' examination on approval. In 10 days I will send \$1.00, plus few cents postage and delivery, and \$2.00 monthly for 3 months, or return books postage free (no postage on orders accompanied by remittance of first installment.)

Name.....  
 Address..... Position.....  
 City and State..... Company..... RN-3-34

# WANTED!!



**Short Wave Fans. Amateurs and Commercial Operators** who can appreciate the necessity of the T. R. F. pre-selector stage, the efficient draw-coil system of wave-changing and band spreading, the well-balanced superheterodyne circuit and the many other developments so essential to really efficient local and foreign reception. Found only in the new, 1934 Custom-built POSTAL INTERNATIONAL. This tube superheterodyne covers a wavelength range of 14 to 340 meters. The year's outstanding receiver—the POSTAL INTERNATIONAL, is sold directly from our laboratory on a 10-day trial in your home. Foreign reception on the dynamic reproducer is guaranteed or your money refunded. Send 3c stamp immediately for special price offer, circuit diagram, completely illustrated folder, and proof of consistent distant loudspeaker reception.

## POSTAL RADIO

135 J. Liberty Street, N. Y., N. Y.



# RADIO ENGINEERING,

broadcasting, aviation and police radio, servicing, marine radio telegraphy and telephony, Morse telegraphy and railway accounting taught thoroughly. Engineering course of nine months' duration equivalent to three years of college radio work. School established 1871. All expenses low. Catalog free. Dodge's Institute, Oak St., Valparaiso, Indiana

**NEW Wholesale Catalog**  
 For Dealers, Servicemen, Amateurs and Set Builders  
 RADIO—ELECTRICAL—HARDWARE—  
 SAVE 50%  
 Send for FREE copy  
**WHOLESALE MERCHANTS, INC.**  
 5626 Broadway, New York, N. Y.

# A V.T. Voltmeter

(Continued from page 543)

purposes so that the amount of power consumed is practically nil.

The seventh point was satisfied by taking a set of aged tubes and by curves and associated data, average operating potentials were selected so as to operate the tube on the quadratic portion of the characteristic curve. This resulted in an instrument reasonably free of frequency and wave-form error.

Last, but not least, the cost of the instrument has been kept as low as possible consistent with good workmanship. In an instrument of this type, quality should be paramount, but it is not necessary to be extravagant. The meters and resistors are the principal cost. The power-supply equipment is good, but with replacement parts at the price they are, this is a small item. The instrument made by the author, excluding workmanship, cost approximately \$40.00.

It is quite unnecessary to go into details as to the methods of calibration, as this has been covered completely by the material outlined in the bibliography. With precision resistors used in the network, calibration may be carried on at any voltage within range of the instrument. If a precision voltmeter with 0-2 volts range is available, it is slightly more accurate to calibrate at this range in order to reduce the personal error.

Calibration is facilitated if magnifying lenses are used to read the two meters. From the photograph, a lens can be seen on the filament voltmeter and covers the portion of the scale which is always used. This is a small lens, plano on one side, with a focal length of about 1½ inches. A drop of water will cement the lens to the glass on the meter.

The instrument should be calibrated at least three times and the average results used. At least a dozen points should be taken at each calibration. It is well to perform the calibrations at intervals of at least several hours or better and still take three days and calibrated once on each of the days, or have some other person run a calibration. The calibration curve is self-explanatory and the same curve is used for all ranges, the only essential being to multiply the voltage by the proper factor similar to reading various ranges on an ordinary voltmeter. It will be found that if the potentials indicated are used, the lowest range will be in the vicinity of 2 volts, a.c. In other words, approximately 2 volts, a.c., applied to the grid of the tube will give full-scale deflection of the microammeter.

In conclusion, then, the particular instrument constructed by the author has been in actual operation better than 400 hours and there has been no necessity for recalibration. Unless the tube characteristics should change suddenly, the meter, with the operating potentials selected, ought to go from 800 to

1000 before an appreciable error would be noticeable. It is wise, however, to check the calibration at several points, say after every 40 or 50 hours of use. It will be noticed that the last switch contact is used to short out the voltage divider used across the tube input (grid to filament); in this way the bucking-out voltage, used to bring the plate-current meter reading to zero, can be checked without removing the a.c. that is being measured.

To place the instrument in operation, the plug is inserted in the customary 110-volt, 60-cycle a.c. socket and the rectifier circuit is then energized. The 400-ohm rheostat should then be adjusted until the voltmeter, which is across the filament of the type -30 tube reads 1.7 volts; this reading should be maintained at all times and should be adjusted if necessary when the vacuum-tube voltmeter is in use. With 1.7 volts potential on the filament, the 0-200 microampere meter in the plate circuit should register between 20 and 50 microamperes, if there is no bucking current flowing. This residual plate current can be done away with by adjusting the 400-ohm potentiometer until the microammeter shows zero. When this adjustment is made, the 0-3 voltmeter should be carefully set at 1.7 volts.

With these adjustments made, the a.c. voltage to be measured can be applied to the input binding posts, with the high-potential side attached to the positive end of the input voltage-divider circuit. It is good judgment, when measuring an unknown voltage, to have the switch arm on the contact which is connected to lower end of R5 and the upper end of R6; this gives a multiplying of 100. If the applied voltage is insufficient to give any or suitable deflection of the microammeter, the switch arm should be moved to one of the other contacts until the desired amount of deflection is obtained. The value of voltage measured can then be taken from the calibration curve, remembering to multiply by the proper factor.

### Bibliography

- (1) A Two-Range Vacuum-Tube Voltmeter, by C. M. Jansky, Jr., and C. B. Feldman. A. I. E. E. Journal; Feb., 1928; page 126.
- (2) Compensated Vacuum-Tube Voltmeter with Balanced-Bridge Output, by W. G. Hayman. Exp. Wireless; Oct., 1930; page 556.
- (3) Some Developments of the Thermionic Voltmeter, by E. B. Moullier. Inst. E. E. J.; Aug., 1930.; page 1039.
- (4) Vacuum-Tube Voltmeter of High Sensitivity, by H. J. Reich, G. S. Manin and K. A. Stoll. Electronics; Sept., 1931; page 109.
- (5) The Thermionic Vacuum Tube, by H. F. VanDer Byl.
- (6) A New Vacuum-Tube Voltmeter, by J. I. Heller, Radio News; Dec., 1930; page 491.
- (7) The vacuum-tube voltmeter, RADIO NEWS; Jan., 1931; page 625.

# Modern Battery Receivers

(Continued from page 537)

also a dual wave set with a wavelength range from 120 to 560 meters and the following type tubes are used; one 1A6 for the first detector and oscillator, -32's for the i.f. and second detector, a -30 type for the first audio and a -33 type in the power output stage. The battery requirements are one Air-Cell battery, three 45-volt B blocks and one 22½ C battery. In this table model as in the console there is sufficient space for all the batteries.

An attractive six-legged console houses

the new RCA-Victor Model 241B eight-tube superheterodyne receiver which is especially designed for the 2-volt type tubes in combination with the Air-Cell battery.

This model features such modern refinements as class B amplification, two-point tone control, a permanent-magnet type dynamic speaker and a local-distance switch. The various tubes and their functions are indicated on the schematic circuit diagram. Two transformers comprising three tuned circuits and one untuned circuit are employed in the i.f. amplifier which is tuned to 175 kilocycles. The i.f. adjusting capacitors are conveniently accessible from the rear of the chassis. The r.f. and oscillator trimmer condensers are

accessible from beneath the receiver chassis. It will be noted by inspecting the diagram that the bias voltages for the tuner are obtained from voltage divider network connected across a 22½ volt section of the B battery, thus dispensing with the C battery.

The local distance switch disconnects the antenna from the set when receiving strong local stations. The volume control varies the control grid bias on the r.f. and i.f. tube. The tone control comprises a condenser which is connected across one half of the secondary winding of the input audio transformer for the maximum low position. For the maximum high position this condenser is disconnected by the switch S2. While the set is especially made for Air-Cell operation, it is also adaptable to 2 volt storage battery operation. The A battery current drain is .48 ampere and the average B battery current is 15 ma. The wavelength range is 540 to 1500 kilocycles (555 to 200 meters) and the receiver is designed to provide a maximum undistorted power output of 1 watt. For convenience of the serviceman, the plate, screen and bias voltages as well as the plate current readings for all tubes are given herewith.

In addition to the Air-Cell battery, the set requires four 45 volt dry batteries to supply the plate and bias voltages. The receiver is shipped with tested tubes in the sockets and the set is ready to operate when the antenna and ground leads are connected and connections made to the batteries as described in the instructions accompanying the set.

This company also makes a table model No. 142B Air Cell receiver, which employs the same chassis described above.

The Atwater-Kent model 387 is a seven-tube mantle type Air-Cell receiver, especially made for use on unelectrified farms and in the thousands of other homes without central station service. This receiver employing the new Air-Cell battery combined with the 2 volt tubes, enables the rural dweller to enjoy to the fullest extent the benefits of modern radio.

The set is equipped with tone control, permanent magnet dynamic speaker and a push-pull Class A power stage using type 30 tubes. The tubes and their functions are shown on the schematic circuit diagram. The diagram also shows drawings of the various coils with terminals marked to correspond with numbers in the schematic circuit.

The volume control is a 400,000 ohm potentiometer which varies the screen-grid voltages on the r.f., combined first detector and oscillator and i.f. tubes. The tone control comprises a .0005 mfd. condenser and an off-on switch connected across the grid to ground circuit of the first a.f. tube.

This company also produces a console, model 427Q Air-Cell receiver which employs the same tubes as used in the midget set.

## Technical Review

(Continued from page 551)

4. *A 15- to 200-Meter Superheterodyne.* The outstanding features of the Hammarlund-Roberts high-frequency superheterodyne designed especially for commercial operators for laboratory, newspaper, police, airport and steamship use.

5. *A 1934 Volume Control and Resistor Catalog.* Complete data on Electrad standard and special replacement volume controls, Truvolt adjustable resistors, vitreous wire-wound fixed resistors, voltage

# Let Your Customer Sell Himself!

## In 3 Simple Steps

1. Adjust Line and Select Filament.
2. Insert Tube and Set Tube Selector.
3. Press Button and Read the Verdict.

### ONLY 4 SOCKETS

—tube cannot be inserted in wrong socket—Tester cannot be harmed by incorrect operation.

In addition to its amazing simplicity and ruggedness, this new tester is provided with a new neon glow test which reveals 21 possible combinations of "shorts" and LEAKAGES up to 90,000 ohms; namely Cathode-Heater leakages, G5-CG, Plate-Cathode, CG-Cathode, G3-Plate, Heater-Plate, G4-Plate, G4-G5, CG-Heater, G4-CG, G3-G5, Plate-G5, Cathode-G5, CG-Plate, G3-Heater, G3-G4, G4-Heater, Cathode-G4, CG-G3, Cathode-G3, and G5-Heater.

Ordinary testers provide only two or three short tests and practically no leakage tests. The neon glow lamp is faster than a meter needle—faster than the heating of the pilot lamp short indicator of ordinary testers—it catches intermittent LEAKAGES and "shorts" with the speed of Light! Watch others follow the Leader with neon glow leakage tests. The new Supreme Model 85 is THE tester of 1934, at a price that every Service Man can pay!

**Now in Stock at Your Jobbers**



## Supreme Model 85 Tube Tester

Dealers' Net Cash Wholesale Price **\$39.95**

### SEND THIS COUPON

Supreme Instrument Corporation,  
485 Supreme Building, Greenwood, Miss.

Gentlemen:

Send me, without obligation, full information on the new Supreme Model 85 Tube Tester.

Name .....

Address .....

City .....

State .....

Jobber Preference .....



## PERFECT VISION for SPORTS LOVERS

### New Triumph of Optical Science

**S**PORTOCULARS, the powerful new binoculars that you wear like spectacles, make a 25c seat at the ball game as good as a \$5.00 box in the grandstand.

Sportoculars are sturdily built, yet light in weight to insure maximum comfort. New improved features allow instant adjustment to any head size, man, woman, or child. Slip them on like a pair of spectacles—adjust the powerful lenses to the proper focus—then sit back and enjoy the show, the game or the race. Wear them indoors or out, wherever perfect vision is desired.



**SAVE HALF with Introductory \$7.50 Offer Only**

Sportoculars sell everywhere at \$15.00. While offer lasts we will send you a brand new pair, complete with solid leather case, postpaid for only \$7.50. Money back if not satisfied. Address—

**R. M. OPPENHEIM**  
226 West 39th Street  
New York, N. Y.

## The Famous RCA-Photophone Oil-Damped Pickup

Two Speed  
33 1/3-78RPM  
Plays 10-12  
-16 inch records  
Low Impedance -  
20 ohms.

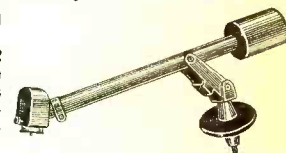

We have purchased what we believe is the last available supply of these fine quality pickups. It will be worth good money to you to stock up one or two for future requirement. Our supply won't last long at this low price.

This is the original and genuine RCA-Photophone Oil-Damped Pickup. Used wherever the finest quality of reproduction is essential. Has a perfectly balanced tone arm mounted on a double adjustable balancing frame, together with a counterbalance for minute adjustment of pressure—insuring beautiful fidelity of tonal quality. Has a special scratch filter.

A special matching transformer is available to match this 20 ohm pickup to any standard 200 or 400 ohm input.



Cat. No. 7745 . Net Price. **\$11.45**

Special Matching Transformer  
Cat. No. 8145 . Net Price. **1.75**

### Federated Purchaser, Inc.

New York City  
25 Park Place

Atlanta, Ga.  
546 Spring St. N.W.

Newark, N. J.  
273 Central Ave.

Bronx, N. Y.  
534 E. Fordham Rd.

Chicago, Ill.  
1331 S. Michigan Ave.

Pittsburgh, Pa.  
343 Blvd. of the Allies

Jamaica, L. I.  
92-26 Merrick Rd.

Philadelphia, Pa.  
2909 N. Broad St.

# RCA VICTOR Portable Public Address System

## Type PG-62-B



22 in. x 15 1/2 in. x 11 1/8 in. (closed). PG-62-B Carrying Case (open) containing Two Loudspeakers and Coils

Type PG-62-B complete portable public address system, including the famous *Velocity Microphone*, a high grade Class B 20 watt amplifier and two modern dynamic loudspeakers with extension cords—all self-contained in two carrying cases. Operates on 110 volts AC, and is designed to reinforce speech and music. Provision for electrical phonograph input.

Type PG-63 is a less expensive model, employing one loudspeaker and carbon tube microphone, and is self-contained in one carrying case.

Write for descriptive folders. Portable electric phonograph units of single and double turn-table types available for either of the above equipments.



23 in. x 15 1/4 in. x 9 in. (closed). PG-62-B Amplifier Carrying Case, opened



Velocity Microphone and Stand



Centralized Sound Section

**RCA VICTOR CO., INC.**

CAMDEN, N. J.

"RADIO HEADQUARTERS"



# Accuracy Wins



... whether in bowling, shooting, or in making Resistors



Dec. 19, 1933

Mr. Arthur H. Lynch  
Lynch Mfg. Co., Inc.  
51 Vesey St., New York, N. Y.

Dear Mr. Lynch:

I have made precise tests of 33 one watt Lynch Resistors. Some were more than a year old. I used a Leeds and Northrop Wheatstone Bridge and new batteries.

The units measured were from our regular stock and ranged from 750 to 750,000 ohms.

The most accurate unit was .001% off rating; the least accurate was 6.0% off rating; the average was 3.87%.

Yours very truly,

Sun Radio Co.,

JG-MS

(Signed) Jack Grand

Write **LYNCH MFG. CO., Inc.**  
51 Vesey St., New York, N. Y.

(Makers of Lynch Resistors and Noise-Reducing Antenna Systems)

for Free Descriptive Folder

dividers and other resistor specialties and public-address amplifiers (using new tubes).

7. *Rich Awards in Radio.* Interesting information on the growth of radio and the opportunities existing in the field of radio manufacturing, radio servicing, broadcasting, talking pictures, television, public-address systems and commercial-station operation on land and sea, for men who are trained to fill the many jobs created by the radio and allied industries. The book also contains detailed information on the home-study courses in radio and allied subjects offered by the National Radio Institute. This book is available only to RADIO NEWS readers who are over 16 years of age and who are residents of the United States or Canada.

9. *Catalog of Resistors.* Specifications of the International Resistance Co. 1934 line of metallized, wire-wound and precision wire-wound resistors, motor-radio suppressors, handy servicemen's kits, valuable technical data and list of free bulletins available on the building of servicemen's test equipment.

16. *R.M.A. Standard Resistor Color-Code Chart.* A handy postcard-size color-code chart designed by the Lynch Mfg. Co. to simplify the job of identifying the resistance values of resistors used in most of the standard receivers. Also a list of the most commonly used values of resistors with their corresponding color designations. A catalog of Lynch products is included.

25. *Noise-Reducing Antenna Systems.* Two types of noise-reducing systems perfected by the Lynch Mfg. Co. for both broadcast and short-wave reception.

34. *Serviceman's Replacement Volume-Control Guide.* A revised list, in alphabetical order, of old and new receivers showing model number, value of control in ohms and a recommended Electrad control for replacement purposes. Contains specifications and volume-control circuits for over 2000 different receiver models.

41. *How to Build the "Economy Eight."* A folder prepared by Wholesale Radio Service Co. giving constructional information, diagrams, list of parts, etc., of an efficient 8-tube receiver.

42. *How to Build Useful Servicing and Testing Instruments with Simple, Standard Meters.* Complete data, with diagrams, showing how any meter—preferably a low-range milliammeter—can be used to measure amperes, volts and ohms over any desired range through the use of proper shunt and series resistors. The bulletin was prepared by the Lynch Mfg. Co. and gives both the theoretical and practical data required to make all the calculations to convert or change the range or function of a given meter.

44. *How to Add a Remote-Control and Station-Selector Unit to Any Receiver.* A folder published by Wholesale Radio Service which shows how any single tuning control receiver can be converted into a remote-control and station-selector set at a total cost of only \$12.50.

52. *The Servicer.* Helpful information gathered by the International Resistance Co., designed to help the serviceman do better work and make more money doing it.

53. *Practical Training for Radio Servicemen.* The Radio Training Association of America gives an outline of their course of instruction for radio servicemen—a course that is endorsed and recommended by more than thirty leading radio manufacturers and trade associations. Some of the greatest authorities predict the next three years will show a greater growth in the radio industry than has the past twelve years, with many opportunities for thousands of ambitious, technically trained servicemen.

56. *Servicing and Testing Instruments.* Description of a new line of Supreme low-priced analyzers, set testers, tube testers, ohmmeters, capacity testers, oscillators and universal meters. Complete information is also given on the new Supreme model 55 tube tester and the new Supreme Master diagnometer which employs the "free reference point system of analysis."

57. *How to Build a High-Quality Condenser or Ribbon Microphone.* This circular describes the Superior microphone kit and instruction sheets with which it is possible to build, quickly and easily, a high-quality condenser or ribbon microphone. The kit is made by the Bruno Division of the Amperite Corporation.

59. *The I.R.C. Volt-Ohmmeter.* The characteristics and uses of the International Resistance Co. volt-ohmmeter, a combination voltmeter and ohmmeter specially designed for the point-to-point method of trouble-shooting.

60. *Audio, Power Transformers, Choke Coils for Use in Public-Address Amplifiers and Radio Receivers.* Information on the characteristics of a wide variety of Amer-Tran de luxe and Silcor (popular-priced line) audio and power transformers and chokes.

61. *Replacement Parts for Dealers and Servicemen.* A pocket-size book, prepared by Wholesale Radio Service Co., listing manufacturer's name and model number of a large number of current-model and old-type receivers, with the recommended replacement power transformers, condenser blocks, volume controls, voltage dividers and audio transformers required for such sets. This catalog is a list price catalog which servicemen can show their customers when quoting prices for replacement parts.

MARCH, 1934

RADIO NEWS Free Technical Booklet Service

222 West 39th Street  
New York, N. Y.

Gentlemen: Please send me, without charge, the booklets or folders I have filled in below:

Numbers.....  
.....

My occupation or connection in radio is checked off below.

- Serviceman Operating Own Business
- Serviceman Employed By:
  - Manufacturer
  - Jobber
  - Dealer
  - Servicing Organization
- Dealer
- Jobber
- Radio Engineer
- Experimenter
- Laboratory Technician
- Professional or Amateur Set Builder
- Licensed Amateur
- Station Operator
- Public Address Work

I am a  subscriber  newsstand reader.

I buy approximately \$..... of radio material a month. (Please answer this question without exaggeration or not at all.)

Name.....

Address.....

City.....State.....

PLEASE USE PENCIL AND PRINT, IN FILLING IN COUPON

**RADIO OPERATING  
RADIO SERVICING—**



Prepare for the new Government Radio Operating license examinations; Radio Operator, Marine and Broadcasting. Also Radio Amateur Telegraph and Telephone. Resident courses. Write for booklet

**"Opportunities  
in Radio"**

West Side YMCA Trade & Technical Schools  
17 West 63rd Street New York City

**STOP** Don't buy an all-wave receiver! Wait for the new **hallicrafters DE LUXE**

... another great forward step in selectivity, sensitivity, and ease of tuning. Write for advance announcement and special introductory price.

**SILVER-MARSHALL MFG. CO.**  
417 N. State St., Dept. B, Chicago, U. S. A.

**JUST OFF THE PRESS!**  
**Free** MAKE US YOUR HEADQUARTERS for PUBLIC ADDRESS AMPLIFIERS Deal DIRECT with Manufacturers and **SAVE BIG MONEY.**  
**COAST TO COAST RADIO CORP.**  
123-N WEST 17th ST., NEW YORK, N.Y.

THE HOME **BARTENDER'S GUIDE AND SONG BOOK**



After trying a few recipes in this book you will want to get right up and sing—loud and long! The "Home Bartender's Guide and Song Book" gives precise instructions for mixing over 200 cocktails, fizzes, rickey and highballs including: Old-Fashioned, Orange Blossom, Dry Martini, Manhattan, Mint Julep, Tom Collins, Horse's Neck and Golden Fizz!

Many famous old songs including "Frankie and Johnnie"—lavish illustrations from bygone days—humorous descriptions of every drink that will prove the life of many a party—all are included in this 9 x 12 in., 96-page recipe book! Send 75c (plus 10c for postage) for your copy and taste all the joys of repeal! (Foreign and Canada \$1.)

**TECK PUBLICATIONS, Inc.**  
Dept. 3A, 222 W. 39th St., New York, N. Y.

**Lilliput Tubes**

(Continued from page 521)

are: grid-athode, 7 mmfd.; plate-cathode, .07 mmfd.; grid-plate, .8 mmfd. Curves of the triode are shown in Figure 1.

The screen-grid tube requires a filament voltage of 3 volts, screen voltage of 67.5 volts; plate voltage of 135 volts, and grid bias of -.5 volt. Under these conditions the plate current is 4 ma.; transconductance, 1100 micromhos; plate resistance, 360,000 ohms and amplification factor 400. The interelectrode capacitances are: input, 2.5 mmfd.; output, .5 mmfd.; plate-grid, .015 mmfd. Curves of the screen-grid tube are shown in Figure 2.

The tubes are of parallel plane construction; in the case of the triode, the plate and grid are supported by their leads, which are very short. Consequently, there is no stem and the various leads come out through the glass seal. The elements can be seen in the enlarged photograph.

The screen-grid tube is a little different in construction. Here the elements are assembled upon a small ceramic disc. The grid and plate leads come out on opposite sides of the bulb, while the other leads pass through the seal. The tubes can therefore be mounted in a hole in a shield in such a way that the external shield is in the same plane as the screen, while the plate and grid leads come out on opposite sides of the shield. This construction makes for effective shielding and very short leads.

The spacing between elements is very close; some are separated only a few thousandths of an inch. Experimental receivers and transmitters were built in order to investigate their action on ultra-short waves. One receiver, consisting of two r.f. stages, a detector and one audio stage, was seven inches long, three inches wide and three inches high. On the inside, it consisted of three shielded sections, one for each tuned circuit, and another section for the detector and audio stage. The screen-grid tubes were mounted in holes in the shield partitions between stages, thus taking advantage of the shielding possibilities mentioned above.

The other receiver, the one shown in a picture in this article, had one r.f. stage and a grid-leak detector. This tuned around 75 centimeters. It is claimed that the gain per r.f. stage is approximately four.

These ultra-short-wave tubes are an experimental development only and are not available on the market. Illustrations and data for this article were supplied by the RCA Radiotron Company.

**Service Benches**

(Continued from page 535)

prize winners, and also those of four which were awarded honorable mention. These views will enable servicemen readers to compare their own service benches with these seven and perhaps to find some ideas for improved equipment or arrangement which will aid them in meeting the increasingly rigid requirements of efficiency imposed on the modern service business.

**1200 Kw. Station in Russia**

**LENINGRAD, U. S. S. R.**—The Soviet Government intends to erect a super-broadcast station with a rating of 1200 kw. With the operation of such a station one hopes to cover entire Europe.

**YOU CERTAINLY  
FOUND THE TROUBLE  
IN A HURRY."**

**YOU BET! IT'S EASY  
WITH THIS NEW READRITE  
419-711 TESTER "**

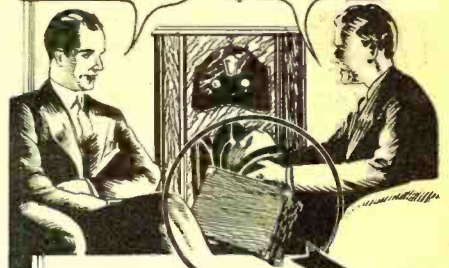

**SINCE** 1904, Readrite engineers have pioneered many important developments in electrical measuring instruments. The new 419-711 tester is regarded as a milestone in Readrite progress.

No longer is it necessary to take more than one instrument out on a service call. This practical and flexible unit permits you to make every necessary radio set analysis, to quickly check both good and bad tubes.

Furnished with a practical selector switch, this instrument enables you to test voltages and resistances at set sockets. In addition, voltage, resistance and capacity tests are available through the meter jacks. Equipped with the new Triplett Darsonval Voltmeter, which has 1000 ohms per volt resistance.

The No. 419-711 tester makes testing of new and old tubes a simple, easy, quick operation. The shaded two-color scale is an exclusive Readrite feature—making it possible to read tube values in plain English... in language your customers can understand. The position of the needle immediately indicates to what degree a tube is either good or bad.

**Your Jobber Can Supply You**

... at the dealer's net price of \$48.75. See him today.

**READRITE METER WORKS**  
101 College Avenue, Bluffton, Ohio

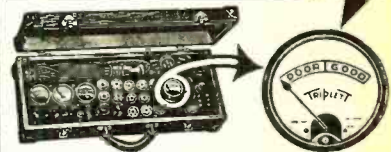

**MAIL TODAY FOR DETAILS**

**READRITE METER WORKS,**  
101 College Ave., Bluffton, Ohio

Gentleman:  
Send me catalogue on Readrite Tester No. 419-711 and complete line of servicing instruments.

Name.....

Street Address.....

City..... State.....

**NOW... a Radio  
GUARANTEEING  
WORLD-WIDE  
RECEPTION**

*New*  
**15-550 METER  
SCOTT  
ALL-WAVE  
Deluxe**

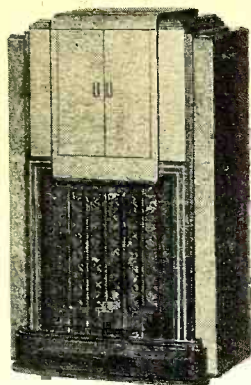

RECEIVE broadcasts from Europe, the Orient, Australia—'most anywhere on the globe you choose—direct! This new, laboratory-built instrument of precision engineering is guaranteed to tune in foreign stations 10,000 miles or more away, with full loud speaker volume and natural tone fidelity, at all seasons. What a way to broaden your world-culture! Hear press dispatches from England's stations . . . typical national music from Spain—symphonic music from Germany . . . opera from Rome . . . other fascinating programs from the ends of the earth. Recalls travel-thrills for those who have been . . . and adds to the pleasant anticipation of those who are going. Superb on domestic broadcasts, too! Costs no more than many less efficient models of ordinary receivers. Send coupon for all details, technical specifications and performance proofs.

**USE THIS PROOF COUPON**

E. H. SCOTT RADIO LABORATORIES, INC.  
4450 Ravenswood Ave., Dept. N34, Chicago, Ill.

Send me full particulars regarding the SCOTT ALL-WAVE DELUXE, 15-550 Meter Super-heterodyne Radio Receiver.

Name.....  
Street.....  
City..... State.....

**SERVICEMEN!**  
You may not be a "Coupon Clipper" . . . BUT HERE'S ONE YOU CAN'T AFFORD TO MISS

**F. L. SPRAYBERRY,** 132 Bryant St. N. W. Washington, D. C.

Please rush—FREE—complete details of PRACTICAL MECHANICS OF RADIO SERVICE—your new ADVANCED TRAINING system for servicemen.

Name..... RN-3  
Address.....  
City..... State.....

If a recognized authority told you he could save you time, money and help you build a better, more profitable service business, you'd surely spend the price of a stamp to learn the facts. And that is exactly what F. L. Sprayberry is telling you now. His ADVANCED TRAINING system covers EVERY TYPE of servicing. It explains the easiest way of doing hard jobs—testing parts—modernizing all kinds of Set Analyzers. It covers super-het circuits, auto radio, A.V.C., public address, latest tubes—EVERYTHING met with in your daily work. At the introductory price of only \$10, it will more than pay for itself in short order. **INVESTIGATE!**

**THE INSTRUCTOGRAPH**  
(Code Teacher)  
The Scientific, easy and quick way to learn the code. Send a post card today for literature. Machines, tapes and complete instructions for sale or rent. Terms as low as \$2.00 per month. Rental may be applied on purchase price if desired. Rent for a month. If the Instructograph meets every requirement, buy it. If not, send it back.  
INSTRUCTOGRAPH CO. 912 LAKESIDE PLACE, CHICAGO

**Lilliput Tubes**

(Continued from page 520)

The other type of tube is shown in Figures 3 and 4, utilizing a glass exhaust pinch as is standard with regular modern vacuum tubes. Figure 3 shows this construction comparable with the modern -27 tube, while Figure 4 shows a construction similar to the modern screen-grid tube. In this latter tube the outer shell is a separate metal shield, not being connected to the plate.

The inventor claims that this new development not only makes a tube that eliminates the cost of manufacture connected with present-day glass-blowing and fusing machinery, but it also eliminates the cost of the tube base and terminals, which he regards as a limiting factor on the operation of the tubes at short wavelengths, anyway. He claims that his tubes can be soldered directly into the set by their leads, while the set is being manufactured, and that this very act will make future radio sets more foolproof than ever before. He also claims that this construction will eliminate the owners taking the tubes out of their sets and switching them around—in many cases doing harm not only to the set but to the tubes. He states that this job belongs in the realm of radio servicemen, anyway, and a radio set, like an automobile, should be serviced at regular intervals by a competent serviceman.

In Figure 5 is shown the ingenious manner in which the tube is evacuated, flashed and sealed off with a ceramic plug. All of these diagrams have been reproduced from the inventor's patent papers. A plug, 3, of ceramic materials has first been fused into the lower opening of the plate cylinder. The filament and grid elements also have been inserted during this fusing process and are supported in the proper positions. Another ceramic ring, 4, has been used at the top end of the cylinder, with the cathode attached to a disc and rod projecting through the upper ring. The rubber tube, 22, running to the vacuum pump, is then attached and the pumping process started. A radio-frequency heating coil, 23, then heats up the plate and the internal elements to drive out gas, while the pumping is in process. The two cooling rings, 24 and 25, prevent a remelting of the ceramic end-plug materials. Fused to the cathode wire lead is a plug of ceramic material, 27. Around this plug there is arranged a heating coil for melting this plug down into the circular hole in the top end-plug, 4. When the exhausting process has proceeded to a sufficient degree, a radio-frequency current is sent through the coil, 28, outside of the rubber tube, 22. This induces the heating current of the inner coil, 26, and melts the plug, 27, thus sealing off the tube.

With tubes of this type developed to an efficient operating standpoint, the mind can visualize many developments in future amplifiers, where a multiple number of stages may be encompassed in but a small space. Tubes such as these may make possible much smaller but much more powerful receivers in the future.

which takes place under the influence of an external force will be characterized by a correspondingly unsymmetric shifting of the atoms and electrons. This internal shifting of the electric forces involves the bound electrons which, since they are held by the attraction of their nuclei, each to its own relatively small area, are not able to redistribute themselves freely throughout the crystal. The result is a shift in which a displacement of the orbits of the bound electrons is predominately in one direction with of course, a relative displacement of the nuclei in the opposite direction which gives, in effect, a separation of a negative electrostatic field of the electrons, from a positive electrostatic field of the nuclei. As soon as the external force is removed, as for example the pressure in the case of a crystal plate, the particles and their fields of force assume their former arrangement.

In the case of quartz (SiO<sub>2</sub>) the silicon and the oxygen atoms are not equally spaced (although in a constant relation to each other) throughout the mass of the crystal. The resulting field of force therefore does not have spherical symmetry and if modeled would be represented by a peculiarly shaped solid. A quartz crystal is built of these queer-shaped molecular arrangements, fitting together in an orderly manner so that their fields of force, attraction and repulsion, are mutually satisfied. The differing arrangements of the atoms along the three axes (see Fig. 1) of the quartz crystal is called on to explain the electric and optical properties of the crystal in these directions.

The converse effect which is observable when a potential difference is applied to the faces of a crystal in the place of external pressure or force is explainable in a similar manner. A potential difference by its influence on the normally distorted fields of force of the unsymmetrical molecules sets up strains within the plate (related to dielectric strains) which have to be met by a shifting of the molecules, a shift of the electrons toward the positively charged face and a shift of the nuclei toward the negatively charged face. These internal movements although infinitesimal, in the case of the individual molecules, are sufficient to add up to a detectable change in the dimensions of the crystal. In other words, when a potential is applied, two things happen; first, charges are induced on the faces (similar to the process of electrostatic induction); second,

**Phenomena**

(Continued from page 544)

must be met by a shifting of the electronic, atomic and molecular fields of force. Since a crystal has a definite atomic arrangement ("space-lattice" as it is called) and the spacing of the atoms along any axis is in general different from that along any other, any internal rearrangement

**MARCH, 1934**

Technical Information Coupon  
RADIO NEWS Laboratory  
222 W. 39th Street  
New York, N. Y.

Gentlemen:

Kindly supply me with complete information on the attached question:

- I am a regular subscriber to RADIO NEWS, and I understand this information will be sent me free of charge.
- I am not yet a subscriber to RADIO NEWS.
- I wish to become a subscriber to RADIO NEWS, and enclose \$2.50 to receive the magazine regularly for one year, and to receive this valuable technical information service free of charge.

Name.....  
Address.....

the dimensions of the plate are changed.

<sup>1</sup> The piezo-electric constant  $H$ , the ratio of the developed charge to the applied force along the electric axis is  $6.32 \times 10^{-8}$ , the force being measured in dynes and the charge in C.G.S. electrostatic units. Since the total charge  $Q$  developed by a force  $F_b$  along the electric axis equals  $HF_b$ , even very large forces liberate relatively small charges.

<sup>2</sup> A potential difference of  $V$  electrostatic units between the surfaces of a plate should give an elongation  $\Delta e = HV$  where  $H$ , is the piezo-electric constant. If the dimensions of the crystal plate be  $a$ ,  $c$ ,  $b$  millimeters along the optic, electric, and third axis respectively (see Fig. 1) the charge,  $Q$ , and the elongation,  $\Delta b$ , along the third axis are

$$Q = -H \frac{b}{c} F_b$$

$$\Delta b = -H \frac{b}{c} V$$

where  $F_b$  = force along third axis.

## 13-2000 Meter Super

(Continued from page 531)

image-bucking coil is in the cathode circuit of the first detector and therefore also in the grid circuit. It can therefore be connected and coupled in such a way as to balance out the image-frequency signal. This will of course attenuate the desired signal somewhat, but very slightly, because the coupling of the bucking coil is very loose so only a very minute portion of the desired signal is fed into the grid circuit out of phase.

The changeover from one wave band to the other is accomplished by means of a multiple switch of five positions and four sections. Each section carries two rotating arms making contact with two semi-circular segments on one side and with one of five contacts on the other. Each section thus comprises a double-pole five-way switch and the whole switch is an eight-gang five-position switch. The short-wave coils and the long-wave coil are above the base under the shield; the coil for the broadcast band is under the base.

On the short waves a novel kind of trimmer is employed. A copper disc, movably supported on a threaded shaft, can be moved back and forth within the coil by means of a rotary knob on the panel, thereby changing its inductance and bringing the circuit into resonance. The user will find that a slight readjustment of this trimmer will sometimes greatly improve the signal strength.

The individual ranges of the five bands are: 150-370 kc., 540-1500 kc., 1500-3800 kc., 3800-10,000 kc., and 10,000-24,500 kc. It will be noticed that the coverage is continuous except for a gap from 540-370 kc. It is considered that these frequencies are of little interest because there is nothing but code stations on them.

### Automatic Volume Control

The diode has proved its worth as a high-quality detector and needs no further discussion. The same tube serves as an automatic volume control, feeding back to the two i.f. tubes and the first detector a negative bias proportional to the received signal. It should be noted, however, that this happens only on the broadcast and long-wave bands. On the short waves, the first detector has a fixed bias and the i.f. tubes alone are controlled automatically.

There is provision for a phonograph pick-up to be connected in the second detector stage. The switch is on the tone control. The pick-up used should have a high impedance or a matching transformer

should be employed. The volume control in the set is employed to control the volume of the phonograph and the tone control can be used normally. The radio-frequency portion is disconnected and it does not matter how the dial is set.

No so-called "squelch" circuit is employed because the designers feel that it introduces some distortion. Instead a manual sensitivity control has been added which can be set so as to lower sensitivity and thus minimize the background noise. The background noise between stations can in this way be adjusted to suit the desire of the listeners.

The output stage with its 2A3 stage is connected in a fixed bias circuit. It will deliver enough power for two speakers, if desired. The diagram shows connections for either one or two speakers. There is 12 watts of power available for field excitation, so if two speakers are used, each can be supplied with 6 watts.

### Installation

The receiver is equipped with two antenna posts and a ground post. The second antenna binding post is for use with a doublet antenna or "di-pole" with a double lead-in. If a simple inverted L-type antenna is used, this second binding post should be connected to the ground terminal and both should then be connected to a good ground by the shortest possible route. Hard-and-fast rules regarding the most efficient length of the antenna cannot be given. In general, it should be attempted to suspend the antenna wires as high as possible and away from electrical conductors. Another point to keep in mind is to find a location for the antenna where the electrical interference is minimum.

### Controls

The dial is so well displayed in the picture that we need hardly call attention to it. A two-speed reduction gear is employed, instantly changeable by a small lever. The scale is calibrated in kilocycles or megacycles on all five wave bands. Parallax has been avoided by the use of a fixed wire behind the translucent scale which casts a shadow.

The front of the receiver has six control knobs. The upper center one is the tuning dial with combination sensitivity control and phono-radio switch below it. The lower right-hand knob is at the same time an on-off switch and volume control; the knob above it is a tone control. This should be turned to the right for brilliance and to the left for emphasis on low notes with elimination of the highs. The lower left-hand knob is the range selector switch and the short-wave trimmer is located at the upper left.

The Dual Wave Super, in chassis form with an 8-inch speaker and tubes, can be purchased for less than fifty dollars, while the Trio Wave receiver is available for a few dollars extra.

## Short Waves

(Continued from page 525)

reference to the drawing, Figure 7—looking at the bottom of the base (prongs toward you). Hold a hot soldering iron against this prong until the solder melts, remove the old lead, and force through, from the top, a short length of bare wire. Clip off the portion that sticks through the bottom of the prong and cover with a drop of solder. Clean the prong with a nail file, being careful to remove any trace of solder that might prevent insertion into the socket. Now solder a flexible lead to the bare wire—as far down in the base as you can get. This lead should be long

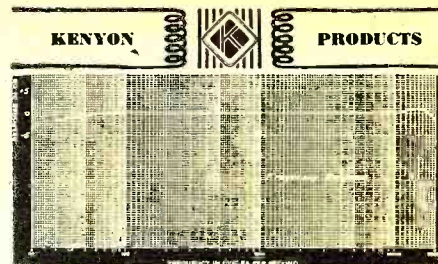

## KENYON Performance

Here's a frequency characteristic curve of a triple push-pull 2A3 amplifier unit. It's typical of KENYON Laboratory Standard Component assemblies. There can be no better frequency response in actual practice. And KENYON ruggedness completes the performance with long life, trouble-proof operation, and lasting satisfaction.

### Laboratory Standards Audio

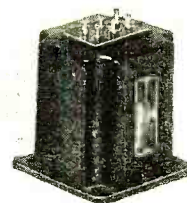

KENYON Laboratory Standard Components are the choice of men who know tone quality. Sturdy units encased in high permeability cast iron. Handsome appearance. Top or bottom terminal arrangement. Positively flat line characteristic. Negligible wave form distortion and phase shift. Vacuum impregnated. Moisture-proof sealed.

### Quality—At a Price

For radio receivers and public address systems where quality is sought at a competitive price, KENYON audio components are most popular. Attractive silver finished cases. Careful design. Liberal proportions. Unapproachable for overall quality in this price range.



### Transmitting Equipment

In broadcasting, amateur, government and commercial radio transmitters, KENYON transformers and chokes are included for reliable performance. Advanced design, properly engineered application, finest workmanship and materials—all contribute to better transmitter practice.

Remember KENYON—not only for superior iron-core devices in terms of performance and lasting satisfaction but also for transformer engineering co-operation.



Write for your copy of the new KENYON catalog. It contains vast fund of information on transformers, characteristics, latest type tube circuits, etc., etc.

Kenyon Transformer Co., Inc.



122-124 Cypress Ave.  
New York City

# RADIO for 1934

## NO SERVICEMAN DEALER OR SET BUILDER CAN AFFORD TO BE WITHOUT THIS BOOK

Send for the most valuable book in Radio. Packed with quality and value. Lists the most complete line of radio replacement parts for any service requirement.



Features latest type set-building kits, test instruments, Long and Short Wave Radios, Socketed Systems,

Write for this Catalog today!

# FREE

### ALLIED RADIO CORP.,

Dept. A, 833 W. Jackson Blvd.  
Chicago, Illinois.

Please send me FREE your New 1934 Radio Book.

Name.....  
Address.....  
City.....State.....

# Allied Radio

## TRI-STATE COLLEGE

### Radio Engineering Degree in 2 Years

Complete Radio Engineering course in 96 weeks. Bachelor of Science Degree Radio (television, talking pictures and the vast electronic field) offers unusual opportunities for trained radio engineers. Courses also in Civil, Electrical, Mechanical, Chemical, Aeronautical Engineering; Business Administration and Accounting. Low tuition, low living costs. World famous for technical two-year courses. Those who lack high school may make up work. Students from all parts of the world. Located in picturesque hill and lake region of northern Indiana. Enter March, June, September, January. Write for catalog.

1634 COLLEGE AVE. ANGOLA, IND.

**STOP** Don't buy an all-wave receiver! Wait for the new **hallicrafters DE LUXE**

... another great forward step in selectivity, sensitivity, and ease of tuning. Write for advance announcement and special introductory price.

SILVER-MARSHALL MFG. CO.  
417 N. State St., Dept. B, Chicago, U.S.A.

**METAL - WORKING LATHE..**

Precision equipment for the small shop. New designs and manufacturing processes make this amazing bargain possible. Complete metal working lathe with compound slide-rest, combination toolpost and independent chuck and tail center; 6" swing; 24" length; 20 lbs. Send \$1.00. Balance plus postage C. O. D. Lathe for wood-turning alone, \$4. Attachments for milling, grinding, sanding, saw-table, etc., available at low prices. Order from ad at once and have a complete machine shop.

**\$7.50 COMPLETE**

AMERICAN MACHINE & TOOL CO., Dept. N-8, 200 BROADWAY New York

enough to reach from the adapter to the radio broadcast receiver. Fill the tube base with sealing wax.

The free end of this lead is connected to the post on the adapter marked "to detector plate."

The adapter is now ready for operation. Place a type 6F7 tube in the corner socket of the adapter. In the remaining socket, plug in a coil covering the wave range desired. This can be determined by referring to the tuning curves in Figure 8. For instance, if you want to receive a station transmitting on say 39 meters—10 megacycles—you will receive this on the coil having the red identification line on the upper rim—with the condenser tuned close to 95.

Remove the detector tube from the broadcast receiver and substitute the adapter plug. Disconnect the antenna from the receiver and connect it to either BP1 or BP2 on the adapter. If you have a long aerial—over seventy-five feet—the adapter will probably work best when the lead-in is connected to BP2. If it is connected to BP1, condenser C2 will not be used. Now run a wire from the ground post on the receiver to BP3. Be sure and leave the ground connected to the receiver also. Turn on the receiver and plug in the power line on the adapter (or switch on the battery if this source is employed for lighting the 6F7 tube).

Turn the volume control, R3, slowly to the right. At a point fairly close to full "on," a click should be heard, and a hiss will be audible in the loudspeaker from then on. The adapter is now oscillating. Radio telephone stations will always be received loudest just before (to the left of) the "click." When the adapter is oscillating, reception will be accompanied by a whistle, which will change in pitch as the adapter is tuned. Satisfactory reception cannot be had in this condition, but it is often very helpful in locating weak stations. As the volume control is backed down from the point of oscillation, it will be necessary to retune slightly. When using a long antenna, reception can occasionally be improved by discovering an optimum adjustment on the antenna condenser, C2. Aside from these points, tuning is effected

# Get the finest

## RESISTORS SUPPRESSORS CONDENSERS

Serviceman, experimenter and manufacturer alike, throughout the world, rely upon Continental for quality and service unsurpassed. New catalogs show complete lines of resistors, auto-radio suppressors, and condensers.

Ask Your Jobber or Write

**CONTINENTAL CARBON Inc.**

13908 LORAIN AVE CLEVELAND, OHIO

## NEW AMAZING AERO INTERNATIONAL

11 Tube Super DeLuxe All-Wave...\$29.75  
Aero World-Wide 1 Tube Short Wave 5.95

Complete line of radio sets and transmitting apparatus

Write for FREE CATALOGUE

CHAS. HOODWIN CO., 4242 Lincoln Ave., Dept. J-30, Chicago, Ill.

## NOW READY

### HANDY SERVICEMEN'S MANUAL

Full of Hookups—Data—Charts, etc.—Reg. \$1.00

**25c**

TRY-MO RADIO CO. Inc. 85 Cortlandt St., Dept. R, N. Y. City

Send for 1934 Catalog

## Tricks With Electricity

Make things spin, jump, kick, buzz, shoot, shock, flash, mystify—all by electricity. Make lights obey voice, window novelties, trick lights, floating rings, spirit rapping—all kinds amusing, practical devices. Book tells how to do 200 stunts with 110 volts A.C. Postpaid \$1.

CUTTING & SONS, 34 B St. CAMPBELL, CALIF.

## SERVICEMEN!

THE MOST COMPLETE LINE OF CONDENSERS AND RESISTORS FOR EVERY RADIO USE

Write for our new 10-page Catalog holder free of charge.

# AEROVOX CORPORATION

78 Washington Street Brooklyn, N. Y.

### INDEX TO ADVERTISERS

Aerovox Corp.	574	McGraw-Hill Book Co., Inc.	568
Alan Radio Corp.	561	Midwest Radio Corp.	Fourth Cover
Allied Engineering Inst.	576	National Carbon Co., Inc.	555
Allied Radio Corp.	574	National Company, Inc.	Third Cover
American Machine & Tool Co.	574	National Radio & Electrical School	558
American Transformer Co.	560	National Radio Institute	513
Atlas Press Co.	576	National Union Radio Corp.	518
Autocrat Radio Co.	563	Postal Radio Corp.	568
Automote Mfg. Co.	575	RCA Institutes, Inc.	560
Automator Laboratories, Inc.	576	RCA Radiotron, Inc.	553
Bernard, Herman	563	RCA Victor Co., Inc. (Engineering Div.)	570
Bud Speaker Co.	556	RCA Victor Co., Inc.	Second Cover
Candler System Co., The	576	Radio & Technical Publishing Co.	556
Capitol Radio Engineering Inst.	563	Radio & Television Inst.	517
Central Radio Laboratories	558	Radio-Amp. Pub. Co.	556
Classified Advertisements	575	Radio Trading Co.	558
Coast-to-Coast Radio Corp.	571	Radolek Co.	576
Continental Carbon, Inc.	574	Readrite Meter Works	571
Coyne Electrical School	567	Rider, Publisher, John F.	575
Cutting & Sons	574	Scott Radio Labs., Inc., E. H.	572
Dodges Institute	568	Shallcross Mfg. Co.	566
Electrad, Inc.	561	Silver, Inc., McMurdo	515
Federated Purchaser, Inc.	569	Silver-Marshall Mfg. Co.	556, 571, 574
Fordson Radio Mfg. Corp.	566	Sprayberry, F. L.	572
Gibbons School of Broadcasting, Floyd	576	Supreme Instruments Corp.	569
Hammarlund Mfg. Co.	551	Teleplex Co.	575
Harrison Radio Co.	575	Trimmo Radio Mfg. Co.	563
Hoodwin Co., Chas.	574	Triplett Electrical Instrument Co.	564
Hygrade-Sylvania Corp.	565	Tri-State College	574
Instructograph Co.	572	Try-Mo Radio Co., Inc.	574
Instructional Correspondence Schools	576	Universal Microphone Co., Ltd.	566
Kenyon Transformer Co., Inc.	573	Weston Electrical Instruments Corp.	557
Lynch Mfg. Co., Inc.	570	West Side Y.M.C.A. Trade & Tech. School	571
		Wholesale Merchandisers, Inc.	568
		Wholesale Radio Service Co.	559



# READ AND SEND CODE

Learn Easily At Home This Quicker Way

No experience needed. Beginners read code quickly, copy accurately. If already an op, speed up your wpm with this approved amazing New Master Teleplex. Only instrument ever produced which records your sending in visible dots and dashes—then sends back to you audibly through headphones. Fascinating, fool-proof gets results because you learn by HEARING as well as seeing. Teleplex has taught the code to more students in past few years than all other systems combined. Used by U. S. Army and Navy, R. C. A., A. T. & T., and others. We furnish Complete Course, lend you the New Master Teleplex, and give you personal instruction with a **MONEY-BACK GUARANTEE**. Low cost, easy terms. Write today for folder R.N.-3; no obligation.

**TELEPLEX COMPANY**  
76 Cortlandt St.  
New York, N.Y.

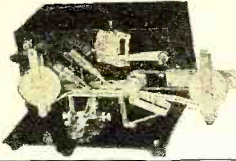

## WORLD-WIDE TWO TUBE SHORT WAVE RECEIVER

12,500 Mite reception, record established! Tunes from 15 to 200 meters. Gets foreign broadcasts, police calls, airwaves, amateur, etc. **COMPLETE KIT** (no drilling) with four instructions to build this remarkable 2 tube receiver. Dry cell or AC Model. Send \$10.00 Balance C.O.D. Satisfaction Guaranteed! Not a toy! Not an attachment! A real, complete All-Wave Receiver!

Harrison Radio Co., Dept. N-3, 142 Liberty St., N. Y. C.

**Brand New \$3.95**  
Vohi-Ohm-Milliameter  
Basic 0-1 Milliammeter 50 M.V.—1000 ohms per volt. 3/4 in. case. **GUARANTEED. BUILD YOUR OWN TESTER.** Complete plans with each instrument.

**UNIVERSAL METERS \$6.95**  
A.C. D.C. Rectifier Type  
COMPLETE WITH RECTIFIER  
Special prices on wire wound 1% accurate resistors. Send for bulletin.

PRINTED DIALS on brass back plates for UNIVERSAL and OMMETERS ALL TYPES. 45 cents each.  
**AUTOMOTE MFG. CO.** 88 West Van Buren St. Chicago

### Read Classified Advertising — It Pays

Advertisements in this section twenty-three cents a word for each insertion. Name and address must be included at the above rate. Cash should accompany all classified advertisements unless placed by an accredited advertising agency. No advertisements for less than 10 words accepted. Objectionable or misleading advertisements not accepted. Advertisements for these columns should reach us not later than 1st of 2nd month preceding issue.

**TECK PUBLICATIONS, INC.**  
222 West 39th St. New York, N. Y.

### Books

**FREE**—246-page Catalogue of more than 1000 McGraw-Hill books covering every phase of automobile work, aviation, chemical engineering, building construction, highway engineering, surveying, sanitary engineering, practical electricity, radio, power plant engineering, machine shop practice, welding, etc. Some of these pay-raising books can help you. Write for the free Catalogue to Frank B. Dickman, McGraw-Hill Book Co., 330 West 42nd Street, New York.

### Correspondence Courses

**USED** Correspondence Courses and Educational Books sold or rented. Inexpensive. Money-back agreement. Catalog listing 3000 bargains—**FREE** (Courses bought). Lee Mountain, Pisgah, Alabama.

### Inventions

**INVENTIONS, COMMERCIALIZED.** Patented or unpatented. Write, Adam Fisher Mfg. Co., 278 Enright, St. Louis, Mo.

**INVENTORS**—Time counts in applying for patents. Send sketch or model for instructions or write for free book, "How to Obtain a Patent and Record of Invention" form. No charge for information on how to proceed. Clarence A. O'Brien, Registered Patent Attorney, 309-J Adams Building, Washington, D. C.

### Patent Attorneys

**PATENTS.** Instructions "How to Establish Your Rights" and form, "Evidence of Conception"—sent Free! Lancaster, Allwine & Rommel, 414 Bowen Building, Washington, D. C.

**PATENTS**—Advice and booklet free. Highest references. Best results. Promptness assured. Watson E. Coleman, Patent Lawyer, 724 9th Street, Washington, D. C.

### Radio

**RADIO ENGINEERING**, broadcasting, aviation and police radio, servicing, marine and Morse telegraphy taught thoroughly. All expenses low. Catalog free. Dodge's Institute, Elm St., Valparaiso, Ind.

**Dealers, Service Men and Agents.** Latest Crusader Midget Radios \$5.85. Write for full particulars. Chicago Radio Distributors, 1325 S. Michigan, Dept. 33, Chicago.

exactly as it is on the broadcast receiver. If the adapter will not oscillate, and you are satisfied that it is correctly constructed and wired, it is probably because insufficient voltage is being supplied through the detector plug. This will usually happen when the detector tube in the broadcast receiver is coupled to the audio amplifier through a resistance, or a diode is used as a detector. In such instances, a 45- to 90-volt B battery should be inserted in the adapter plug lead at X in Figure 1. Be sure the plus and minus terminals (positive and negative, respectively) are connected as shown.—James Millen, the National Co.

## Poor Notes

(Continued from page 533)

for communication purposes. An omnigraph was used at the receiving end to operate the remote controlled keying circuit of the transmitter.

The oscillogram of Figure 2 shows such spurious oscillations appearing at *a* and at *c*, the beginning and end, respectively, of the particular dot. Waves having characteristics of this sort produce a "chirpy" note. The duration of the interference at *a* is 0.02 second, then for 0.075 second the signal holds its steady amplitude. At *c* the spurious oscillations again occur for .008 second.

In the diagrams of Figures 2, 3 and 4, *E<sub>o</sub>* represents the voltage at the output terminals of the filter with the key open; *E<sub>i</sub>* represents the voltage at the same place with the key closed. *I<sub>o</sub>* is the current flowing when key is open, *I<sub>i</sub>* is the total current under load.

The oscillogram of Figure 3 shows a slight improvement over Figure 1 so far as voltage regulation is concerned.

In the oscillogram of Figure 4, the voltage regulation is good, but a slight modulation in the wave seems to be present. The introduction of the key filter has checked the spurious oscillations at the beginnings and ends of the signals; but the key filter needs to be improved, because the waves still rise quickly to their maximum values, and, when the key is opened, fall rapidly to zero.

## Radio Ticker

(Continued from page 530)

with arm 20 through an angle equal to one-half the pitch of the teeth of ratchet wheel 46.

As shown in Figure 2 the radio receiving circuit is mounted in a metal container for protecting it from outside disturbances, particularly such as are found in a moving vehicle. The container is mounted through a spring cushioning device 145 on the brackets 146 secured to the lower edge of the dash board 140.

As the characters are printed on the tape 14, the tape is fed inwardly in the arrangement so that the characters sweep from right to left along the lens 156 mounted by means of the supports 157 on the bracket 158. The simple amplifying arrangement is provided by lens 156 for projecting the characters through a slot at 142 cut in the dash board and through which the characters are made visible to the driver sitting in the car. The arrangement is such that the characters are projected and made visible instantaneously so that the driver sees the message as soon as it has been received.

# Announcing VOLUME IV OF Rider's Perpetual Trouble Shooter's Manual

Volume IV of Rider's Manual will be off the presses during the month of February. It will contain more than 1000 pages.

- Volume IV, as in the case of previous volumes will contain schematic wiring diagrams, chassis wiring diagrams, voltage data, socket layout, electrical values, peak frequencies, alignment notes, resistance data, etc., etc.
- Volume IV picks up where Volume III left off and does not duplicate any of the contents of Volumes I, II and III of Rider's Manuals or the contents of National Union Service Manuals, Volumes I, II or III.
- Volume IV also carries on from where the RCA Radiotron—E. T. Cunningham "Complete Rider's Manual" left off.
- The index in Volume IV is cumulative and covers all of the volumes listed above, so that Volume IV can be used with all of these manuals—with reference to only one index—namely that in Volume IV.
- Particular attention has been paid to see that the cigarbox type receivers announced during 1933 have proper representation. . . . Also the numerous smaller manufacturers whose names are not well known.
- Volume IV is right up to the minute and offers coverage of practically every radio receiver announced during the 1933-1934 season. Every major manufacturer's line is to be found completed in Volume IV.
- Volume IV contains the products of smaller manufacturers whose schematics have never before appeared in print.
- Volume IV maintains the standards set forth by Volumes I, II and III printed thus far.
- Volume IV is loose leaf bound in an "instant-removal" type of binder covered with genuine Dupont Fabricoid.
- Special effort has been made in Volume IV to furnish all possible information about alignment of combination short wave and broadcast receivers. . . . As a matter of fact a special section is devoted to "Short Wave—Broadcast Wave Receiver Alignment."

Volume IV Price \$7.50 Postpaid  
Sold with a Money Back Guarantee

## Special Price Notice

Because of the unsettled financial condition of the nation—with respect to future prices—degree of inflation, etc. it is impossible to sign long term contracts with printers and paper manufacturers and others who contribute to the production of Rider's Manuals. Consequently, we cannot guarantee that the price quoted in this advertisement will be binding for a period in excess of the next month. It is of course possible that future printings of these manuals will be available at today's prices. It is our suggestion that you protect yourself against price increases by **BUYING NOW!** We can guarantee that the prices will NOT BE LOWER.

- Volume I (1000 pages) is still available at \$7.50 postpaid.
- Volume II (800 pages) is still available at \$6.50 postpaid.
- Volume III (1185 pages) is still available at \$7.50 postpaid.

DON'T DELAY.. BUY NOW!.. TODAY!!

**JOHN F. RIDER**  
1440 Broadway  New York City

## Make Your Own Radio Parts \$79 On ATLAS 9" LATHE

Wind coils, make coil forms, shafts, dials, knobs, cut threads, etc. Do a thousand-and-one constructional and service jobs. 9" swing, 18" between centers. Does all regular lathe work. The essential tool in any complete workshop. Complete less motor \$79 cash, or Easy Terms, 10 months to pay.

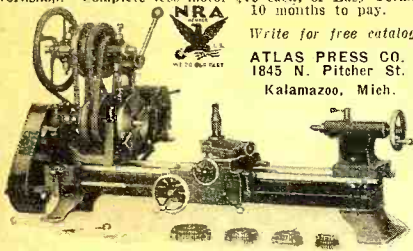

Write for free catalog.  
ATLAS PRESS CO.  
1845 N. Pitcher St.  
Kalamazoo, Mich.



# WANTED:

## radio service experts!

THE popularity of radio increases by leaps and bounds. In the period of four-teen short years it has become a great American industry. And its possibilities have been barely scratched!

Today there is a wide need for radio experts. In order that this need may be adequately filled, International Correspondence Schools offer a modern course in Radio Servicing. Prepared by experts and furnishing the solution to 1934 radio problems, in 28 concise lessons this course will equip you to become a radio service expert. In addition, automobile service men, installers of public address and centralized radio systems, radio salesmen, dealers, and all interested in broadcast and short wave receiving systems will find this course of great value.

Complete information will be sent upon request—just mail the coupon!

### INTERNATIONAL CORRESPONDENCE SCHOOLS

BOX 8264-N, SCRANTON, PENNA.

Without cost or obligation, please tell me about the NEW RADIO COURSE.

Name.....Age.....

Street Address.....

City.....State.....

If you reside in Canada, send this coupon to the International Correspondence Schools Canadian, Ltd., Montreal, Canada.

## With the Experimenters

(Continued from page 555)

blue-black discs are composed of copper sulphide. The pliable washers are lead, while the stiff ones are magnesium. If any of these pieces have a whitish appearance, they should be polished with fine emery cloth. A copper sulphide, a lead and a magnesium disc are taken and cut as shown in Figure 1. The sulphide disc is easily cut with a hacksaw.

Four terminals 1 inch by 1/4 inch are cut from sheet copper. A small angle of heavy copper or brass is bent as in Figure 2 and a hole is bored in the side for the set-screw. The unit is reassembled as shown in Figure 3 with a heavy piece of paper on the bottom for insulation. The outer terminal is positive, the center one negative, while the other two are the a.c. terminals. The set-screw must be very tight.

The circuit used is shown in Figure 4. The meter has 3 ranges, as shown, with the terminal .01 being used for measurements from plate to ground. The meter can be calibrated by comparison with an a.c. meter, but this is not necessary for use as an output meter. The unit is boxed, with connection posts so that the meter can be used for other than output measurements.

CHRISTIAN RICK,  
Kansas City, Mo.

## The Service Bench

(Continued from page 553)

of Schenectady, N. Y., has next to no suburban environs, and is surrounded almost immediately with rolling farm lands.

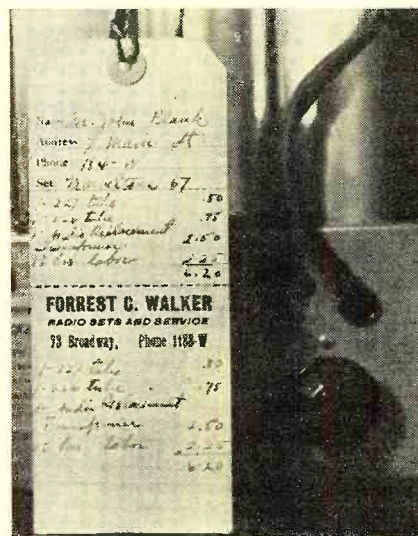

FIGURE 4

### RADIO SERVICE

BY TRAINED AND EXPERIENCED SPECIALISTS  
Christmas Special Standard 30-Day  
Complete Repairs \$2.95 RMA Guarantee

To demonstrate our unqualified service, complete repairs on your radio (including all parts except tubes) regardless of how expensive a trouble for only \$2.95 and guarantee the set to work the way the MANUFACTURER intended it to. This offer is only to advertise our service. Take advantage of this opportunity.

C. F. ROLF SERVICE LAB.

Graduates of Cincinnati, National Radio Institute  
511-513 PAIGE ST. PHONE 2-1910-R

FIGURE 5

This advertisement is worded so as to have a combined appeal both to rural and urban radio fans.

## ALL-WAVE AIR SCOUT

ONLY SET OF ITS KIND IN THE WORLD

Designed by  
H. G. CLAY,  
Inventor of the  
Universal A.C.-D.C.  
Circuit

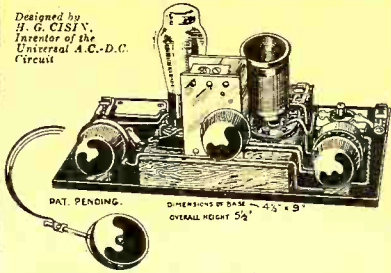

THIS powerful little set brings in all standard broadcast stations and also police calls, amateur calls, foreign stations, code and trans-Atlantic phone conversations. Powered by inexpensive batteries. Available in Kit form. Patented terminal color coding feature eliminates need for wiring diagrams. Red is connected to red, black to black, etc., and set is ready to operate. Used by thousands of Boy Scouts. Scout John Stott of Sanford, Me. brought in England, Holland, Germany and South America on this set. Complete Kit with Tube, Earphone, Two Coils nothing else to buy except batteries.....only postpaid \$5.00

Assembled, wired and ready to use—\$5.95 postpaid  
SPECIAL OFFER: Valuable data on All-Wave Set sent free upon receipt of 10c to cover handling costs.

ALLIED ENGINEERING INSTITUTE  
98 Park Place, Dept. R.N., New York, N. Y.

## ARE YOU "STUCK?"

You Can Become a Fast, Capable  
RADIO OPERATOR at Home

The CANDLER SYSTEM Makes it Easy for you! BYRD Antarctic Ships are manned by CANDLER trained ops. Whether Beginner, Amateur or Com'l op. tell us what ticket you're going up for and we'll show you how EASY it is to get.

CANDLER SYSTEM gives you Speed, Accuracy and ability to Copy Behind—shows you how to use "mill" in copying, fast stuff. All questions answered. Save time and money by sending for FREE BOOK today!

CANDLER SYSTEM CO., Dept. N-3  
6343 So. Kedzie Ave., Chicago, Ill.

World's Only Code Specialist

## WANT TO BROADCAST?

If you have talent here's your chance to get into Broadcasting. New Floyd Gibbons method trains you at home in spare time. Fascinating course fully explained in Free Booklet, "How to Find Your Place in Broadcasting." Send for your copy today. Give age. Floyd Gibbons School of Broadcasting, 2000-14th St., N. W., Dept. 4C9, Washington, D. C.

### NEW! SENSATIONAL!

## 110 VOLTS AC FOR AUTOS

The new AUTONATOR generates 110 Volt A.C. Current in motor cars, aeroplanes and from all types of engines and motors, direct from fan belt. Costs nothing to operate. No service—no brushes, collector rings, commutator or wire wound armature. Ideal for operating PORTABLE Sound Equipment, A.C. Radio Sets, Neon Signs, Electric Lights, Searchlights. Send for complete details.

AUTONATOR LABORATORIES, Inc.  
8440 South Chicago Avenue Chicago, Illinois



RADOLEK CO., 215 Canal Station, Chicago

I am a Dealer [ ] Serviceman [ ]  
I operate from Shop or Store [ ] from Home [ ]  
I own the following Test Equipment.....  
My training and experience is.....  
Name.....  
Address.....  
City.....State.....

RADOLEK · CHICAGO

# NATIONAL RADIO PRODUCTS



Shown below are a few representative examples of National Radio Products. The list prices given are subject to 40% discount when purchased through an authorized NATIONAL CO. distributor. National Velvet Vernier Dials, Transmitting and Variable Condensers, R. F. Chokes, Amateur Receivers (SW-3, SW-58 and 34, FB-7A, FBX-A, AGS and AGSX), Short Wave Power Units, and Short Wave Accessories are built to strictly maintained standards of precision and workmanship, and are universally used in Short Wave and Amateur Radio. The full line is described and priced in our new and complete Bulletin No. 220. Write for your copy today, enclosing 6c to cover mailing costs.



**STD Midget Condenser**  
Double condenser, 180° SLW plates, 50 mmf. per section. Air gap, .026. Isolantite insulation. Constant impedance rotor connection, insulated front-bearing. List price \$3.50.



**Type "N" Dial**  
Solid German silver 4" precision dial with original and matchless Velvet Vernier mechanism. Machine divided scale and vernier read to 1/10th division. Ratio 5-1. List price \$6.75.



**Air-Dielectric Condenser-Tuned IF Transformer**  
Standard in National FB-7A and FBX-A Amateur Receivers. 450 to 550 kc. tuning range. Also made in 175 kc. model. List price ea. \$5.

**STN Midget Condensers**

For neutralizing 245, 247, 210 and similar tubes in amplifier, buffer or doubler stages. Isolantite insulation. Max. cap. 18 mmf. 3000 v. breakdown. List price \$2.00.



**SEH Midget Condenser**

Like half of 2SE Condenser but with more plates and air gap of .0175. Caps. 200, 250, 300 and 335 mmf. List prices (respectively) \$3.75, \$4., \$4., \$4.25.



**2-SE Midget Condenser**  
Isolated rotors, electrically independent, prevent interstage coupling through common rotor and frame circuits. Isolantite insulation. 270° SFL plates. 100 mmf. per sect. Air gap .026. List price \$5.00.



**Air-Dielectric Padding Condenser**  
Shielded air-dielectric padding-condenser on Isolantite base. In 75 and 100mmf. max. capacities. Extremely compact. List price (respectively), \$2 and \$2.25.



**NATIONAL Sockets**  
National Isolantite Sockets reduce socket losses to a minimum. Made in either 4, 5, 6 or 7-prong styles and also special 6-prong for National coils. Ea. \$ .60.



**Type B Dial Velvet-Vernier**  
The smooth, National Velvet-Vernier Drive is positive and free from back-lash. Variable ratio 6-1 to 20-1. Horizontal diameter 4". List price (without illuminator) \$2.75.



**Stand-off Insulator**  
Isolantite insulator with 3-point mount and 6/32 screw on top. For carrying high tension leads, mounting transmitter inductances, etc. List price, ea. \$ .25.



**Low Frequency Oscillator Coils**  
Contains two separate inductances closely coupled within a shield, as used in the National Type SRR 56 MC Super-regenerative Receiver. List price OSR \$1.50.

**FB-7A Coil Form**

Made of R-39, special low-loss dielectric. Complete with grounded metal end handle, air-dielectric padding-condensers, and protective sleeve. List price each \$3.65.



**SEU Midget Condenser**

Heavy, double-spaced, polished, round edge, 270° SFL plates. Air gap .055. Isolantite insulation. 15, 20 and 25 mmf. capacities. List prices (respectively) \$2.50, \$2.75, \$2.75.

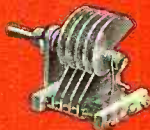

**Standard R-39 Coil Forms**  
Made of R-39 ultra low loss form material, for National SW-5, SW-45, SW-34, SW-3, and SW-58 Receivers. In 4, 5 or 6-prong bases, list price each \$ .75.



**Midget R-39 Coil Forms**  
For ultra HF use. Have best form factor and lowest RF resistance. 1" diam. 1 1/2" long, 1/16" wall. Unwound and ungrooved. List price ea. \$ .50.



**ET Equitune Condenser**  
The original National "girder frame" condenser. Modified 180° plates. 150 to 500 mmf. Air gap, .023. List prices \$4.25 to \$5.



**EMP Condenser**  
Split-stator condenser for receivers and low power push-pull transmitters. 1200 v. breakdown. Air-gap, .023. Standard size 100 mmf. per section. List price \$5.00.



**NATIONAL Coil Cabinet**  
For storage and protection of coils. Heavy gauge brown moiré finished steel in two sections, closing to form a cabinet 9" x 8" x 5". List price \$3.75.



**Frequency Meter Condenser**  
For Amateur Frequency Meters and Monitors. Special circular rotor plates permit use of High C Circuit. Min. cap. 40 mmf. Max. cap. 75 mmf. List price, \$5.50.



**Type 90 RF Choke**  
For by-passing work on screen grid or plate circuits of screen grid tubes or between detector and first audio. DC res. 350 ohms. Ind. 90 m.h. List price without mount, \$1.25.



**EM Equimeter Condensers**  
For low powered transmitters and oscillators 1000 v. and under. 180° SLW plates. Isolantite insulation. Air gap, .023. Caps. 50 to 1000 mmf. List prices (without dials) \$2.50 to \$5.50.



**Type R-152. RF Choke**  
Continuous universal winding in 5 sections on 10,000 v. Isolantite insulation. Ind. 4 m.h. Distrib. cap. 1 mmf. DC Res. 10 ohms; continuous rating 0.6, intermittent 0.8 amps. List price \$2.25.



**NATIONAL GridGrip**  
For attaching a wire to the screen grid terminal of AC or DC tubes. Never works loose, permanent contact. For broadcast set tubes, list price, ea. \$ .05; for large tubes like 872, list price ea. \$ .10.



**Type 100 RF Choke**  
Isolantite mounting, continuous universal winding in 4 sections. Ind. 2 1/2 m.h. Distrib. cap. 1 mmf. DC res. 50 ohms. 125 ma. List price each \$ .75.



NATIONAL COMPANY, INC., MALDEN, MASSACHUSETTS



# AMERICA TURNS TO MIDWEST!

AMAZING NEW SUPER-DELUXE

# 16-TUBE ALL-WAVE Radio

(9 TO 2000 METERS - 5 WAVE BANDS)

Is First Choice of Thousands of Radio Fans!

**Big FREE Catalog Shows Sensational Radio Values**

**B**EFORE you buy any radio, write for this big new FREE Midwest catalog... printed in four colors. It has helped thousands of satisfied customers save from 1/3 to 1/2 on their radios... by buying direct from the Midwest Laboratories. You, too, can make a positive saving of 30% to 50% by buying a Midwest 16-tube de luxe ALL-WAVE radio at sensationally low direct-from-laboratory prices. You'll be amazed and delighted with its super performance! Broadcasts from stations 10,000 miles and more away are brought in... "clear as locals." You get complete wave length coverage of 9 to 2,000 meters (33 megacycles to 150 KC.) Now, you can enjoy the new DX-ing hobby... and secure verifications from world's most distant radio stations.

**WRITE FOR NEW FREE CATALOG**



TODAY'S MOST POWERFUL LONG DISTANCE RECEIVER!

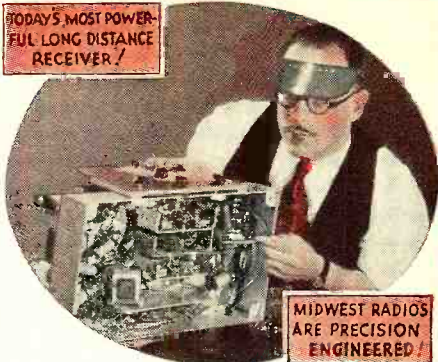

MIDWEST RADIOS ARE PRECISION ENGINEERED!

**30-DAY FREE TRIAL PLAN STARTLES RADIO WORLD!**

Try the Midwest radio you select from the free catalog... in your own home... for 30 days before you decide. Midwest can afford to make this sensational offer because, when you see and hear this bigger, better, more powerful, clearer toned, super selective radio you will want to own it—as so many thousands of men and women have done.

**"40 NEW 1934 FEATURES"**

See for yourself the 40 new 1934 features that insure amazing performance. Here are a few of these features: Automatic Select-O-Band, Amplified Automatic Volume Control, 16 New Type Tubes, Balanced Unit, Superheterodyne Circuit, Super-Power Class A Amplifier, 29 Tuned Circuits, New Duplex-Diode-High Mu Pentode Tubes, Full Rubber Floated Chassis, Centralized Tuning, 7 KC. Selectivity, New Thermionic Rectifier, Automatic Tone Compensation, Auditorium Type Speaker, etc. These features are usually found only in sets selling from \$100 to \$150.

This Midwest ALL-WAVE Radio has FIVE distinct wave bands: ultra-short, short, medium, broadcast and long... putting the whole world of radio at your finger tips. Now listen in on all U. S. programs... Canadian, police, amateur, commercial, airplane and ship broadcasts... and programs from the four corners of the earth. Thrill to the chimes of Big Ben from GSB, at Daventry, England—tune in on the "Marseillaise" from FYA, Pontoise, France—hear sparkling music from EAQ, Madrid, Spain—enjoy opera from 12RO, Rome—listen to the call of the Kookaburra bird from VK2ME, Sydney, Australia. Listen to Admiral Byrd's broadcasts from "Little America." Taylor, of Ocean Beach, California, wrote: "Heard KJTY, U. S. S. 'Bear', Byrd

Expedition... near New Zealand, broadcasting phone conversation to U. S. A." etc. **Never before so much radio for so little money! Write for FREE catalog.**

**FOREIGN STATIONS COME IN LIKE LOCALS**  
Crawfordsville, Ind. — I have heard HVJ.  
Vatican City, Italy; DJB, Zeelen, Germany; and YVIBC, Venezuela. They came in with the volume and clearness of any local station. I logged stations from Canada to Cuba, from coast to coast.  
JESSE BALLINGER, 207 Bluff St.



WORLD'S GREATEST RADIO VALUE

**\$49.50** with New **Deluxe Auditorium Type SPEAKER**



**MAINTAINING CONTACT WITH W9XZ (STRATOSPHERE BALLOON)**

Recently, the Official Radio News Observer for Pennsylvania reported that his Midwest Super De Luxe 16-tube ALL-WAVE radio maintained contact with W9XZ (Stratosphere Balloon) when other sets lost signals.

**NEW STYLE CONSOLES**

Write quickly for your FREE copy of the new Midwest catalog. It pictures a complete line of beautiful, artistic de luxe consoles and chassis... in four colors! Sensational low prices save you 30% to 50%. You can order your Midwest radio from this catalog with as much certainty of satisfaction as if you were to select it personally at our great radio laboratories. Write TODAY!

TERMS AS LOW AS \$5.00 DOWN

DEAL DIRECT WITH LABORATORIES

**SAVE UP TO 50%**

Increasing costs are sure to result in higher radio prices soon. Buy before the big advance... NOW, while you can take advantage of Midwest's amazingly low prices. No middlemen's profits to pay! You save from 30% to 50% when you buy direct from the Midwest Laboratories... you get 30 days FREE trial—as little as \$5.00 down puts a Midwest radio in your home. Satisfaction guaranteed or your money back. Our FREE catalog shows sensational radio values. Write for it TODAY!

**MAIL COUPON TODAY! FOR AMAZING 30-DAY FREE TRIAL OFFER AND NEW 1934 CATALOG**

MIDWEST RADIO CORP., Dept. 465 Cincinnati, Ohio.

Without obligation on my part send me your new FREE 1934 catalog, and complete details of your liberal 30-day FREE trial offer. This is NOT an order.

AGENTS! Make Easy Extra Money Check Here for Details

Name.....  
Address.....  
City..... State.....

**MIDWEST RADIO CORP.**  
DEPT. 465 - CINCINNATI, OHIO, U. S. A.  
Established 1920 Cable Address: Miraco. ABC 5th Edition