

**HOW TO ELIMINATE STATIC**

**RADIO  
NEWS**

**OCTOBER  
25 Cents**

**Make Your Own  
Dynamic Microphone**

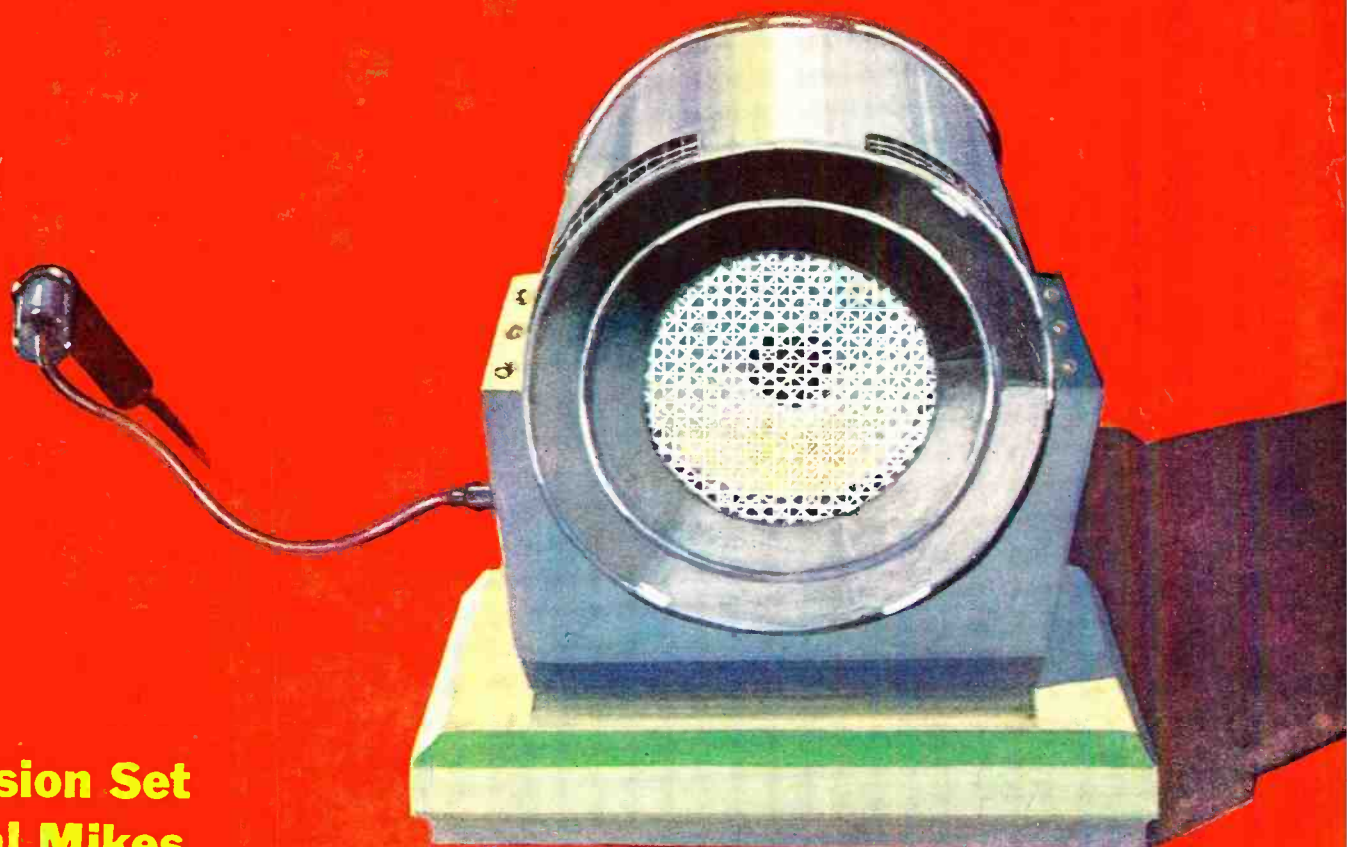

**Television Set  
Crystal Mikes  
and Speakers  
Home-made Photocells**

LEWIS & CLAY 32

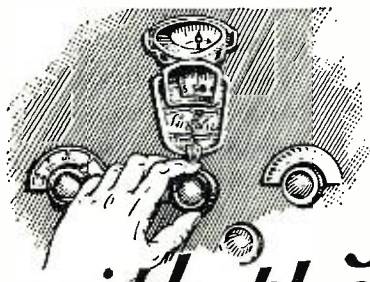

# Tune the NEW way for World-Wide Reception with the LINCOLN DE·LUXE·SW·33

## SILENT TUNING...

The weakest carrier wave is registered on the signal indicator and can be tuned with precision and perfect silence without disturbing atmospheric noises.

## SIGNAL INDICATOR

A meter directly above the dial indicates, not only the weakest signal, but allows the operator to tune into a signal perfectly. Guess work is entirely eliminated. Comparative signal strength is indicated.

## UNDISTORTED HIGH AMPLIFICATION

Three stages of push pull with new system of twin-grid detection allows tremendous undistorted amplification of the high gain I. F. amplifier. The handling power of this system seems to be unlimited and tremendous volume on weak signals can be had if desired.

## AUTOMATIC VOLUME CONTROL.....

There are two paramount advantages in good automatic volume level. First, in tuning from weak to strong signals; and secondly, in holding a steady volume level on fading stations which is so common in short wave reception. The effect of this new Lincoln feature is so efficient that a near-by stroke of lightning registers only a muffled sound in the speaker; it has the same effect on all sharp electrical interference.

## NEW FIDELITY

Twin-grid detection preceded by push pull input I. F. transformers and followed by two stages of transformer coupled push pull stages, produces an undistorted register of a wide band of frequencies, giving a perfectly balanced output with realism hard to associate with radio.

All of the new reactions in the SW-33 model are what we all have wanted for years,—they are here for you today—thanks to Lincoln's foresight in radio possibilities.

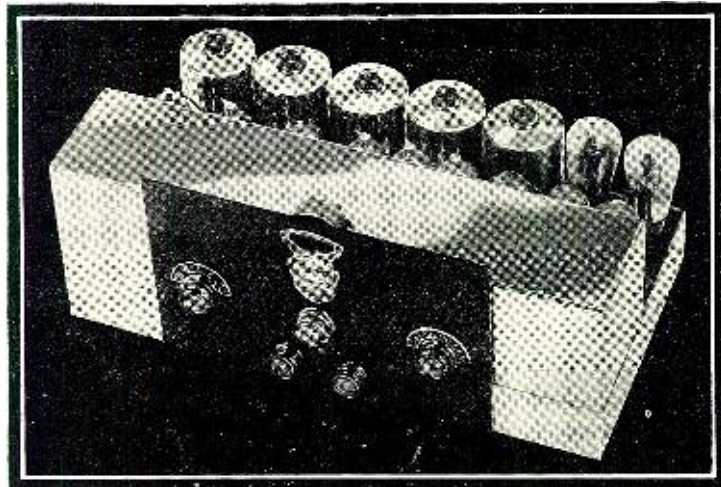

## THE NEW DEVELOPMENTS

have made the new DeLuxe SW-33 just about as ideal a receiver as one could hope to own. The use of five variable mu tubes controlled by the new twin grid second detector and followed by two transformer coupled push pull stages has opened the gates to new ideas of enjoyable distant reception.

The signal indicator locates carrier waves which are difficult to hear; many times the carrier is not being used or modulated as is the case in transatlantic phone. The signal indicator registers these silent carriers and enables you to be accurately tuned, ready for the voice to be heard.

WHEN THIS CARRIER IS TUNED, ATMOSPHERIC NOISES ARE REDUCED TO A MINIMUM, AUTOMATICALLY.

Distant stations can be tuned silently, and volume then brought up to desired strength (volume control does not affect sensitivity). Perfect volume level on short wave stations is another great asset in the new Lincoln. If you have ever tuned in a foreign short wave station, or even many of our short wave stations in the U.S.A., you will appreciate the great value of uniform volume level.

The performance of Lincoln equipment has been known the world over for years. Its use by Polar Expeditions, broadcasting stations, both domestic and abroad, U. S. Naval Station operators, and hundreds of super critical DX fans, has proved Lincoln's exceptional merit.

Complete equipment consists of chassis, power equipment, auditorium type speaker and complete set of laboratory tested tubes. Chassis is finished in highly polished nickel over copper and presents a handsome appearance. Precision laboratory construction is employed throughout, and every receiver is tested on distance before shipment.

Write for description of new developments and new sales plan which overcome the present defects in the present custom built radio merchandising.

LINCOLN RADIO CORPORATION  
Dept. N-10, 329 S. Wood St., Chicago, I. I.

Please send information on  A.C.  D.C. receivers.

Name .....

Address .....

City ..... State.....

Print name and address plainly

**LINCOLN**  
*DeLuxe Receivers*



# Train *with* R.T.A. *for* Radio Service Work

Important and far-reaching developments in Radio create sudden demand for specially equipped and specially trained Radio Service Men.



*This excellent  
set analyzer  
and trouble  
shooter included  
with our course  
of training*

**M**ANY skilled Radio Service Men are needed now to service all-electric sets. By becoming a certified R. T. A. Service Man, you can make big money, full time or spare time, and fit yourself for the big-pay opportunities that Radio offers.

We will quickly give you the training you need to qualify as a Radio service man . . . certify you . . . furnish you with a marvelous Radio Set Analyzer. This wonder instrument, together with our training, will enable you to compete successfully with experts who have been in the radio business for years. With its help you can quickly diagnose any ailing Radio set. The training we give you will enable you to make necessary analyses and repairs.

Serving as a "radio doctor" with this Radio Set Analyzer is but one of the many easy ways by which we help you make money out of Radio. Wiring rooms for Radio, installing and servicing sets for dealers, building and installing automobile Radio sets, constructing and installing short wave receivers . . . those are a few of the other ways in which our members are cashing in on Radio.

As a member of the Radio Training Association, you receive personal instruction from skilled Radio Engineers. Upon completion of the training, they will advise you personally on any problems which arise in your work. The Association will help you make money in your spare time, increase your pay, or start you in business. The easiest, quickest, best-paying way for you to get into Radio is by joining the Radio Training Association.

This amazing Radio Set Analyzer plus the instructions given you by the Association will transform you into an expert quickly. With it, you can locate troubles in all types of sets, test circuits, measure resistance and condenser capacities, detect defective tubes. Knowing how to make repairs is easy; knowing what the trouble is requires expert knowledge and a Radio Set Analyzer. With this Radio Set Analyzer, you will be able to give expert service and make big money. Possessing this set analyzer and knowing how to use it will be but one of the benefits that will be yours as a member of the R. T. A.

## Write for No-Cost Membership Plan

We have worked out a plan whereby a membership enrollment need not cost you a cent. Our thorough training and the valuable Radio set analyzer can be yours. Write at once and find out how easily both of these can be earned.

Now is the time to prepare to be a Radio Service Man. Greater opportunities are opening up right along. For the sake of extra money in your spare time, bigger pay, a business of your own, a position with a future, get in touch with the Radio Training Association of America now.

Send for this No-Cost Membership Plan and Free Radio Handbook that will open your eyes as to what Radio has in store for the ambitious man. Don't wait. Do it now.

RADIO TRAINING ASSOCIATION OF AMERICA  
Dept. RNA-10 4513 Ravenswood Ave. Chicago, Ill.

Fill Out and Mail Today!

RADIO TRAINING ASSOCIATION OF AMERICA  
Dept. RNA-10, 4513 Ravenswood Ave., Chicago, Ill.  
Gentlemen: Send me details of your No-Cost Membership Enrollment Plan and information on how to learn to make real money in radio quick.

Name.....

Address.....

City..... State.....

S. GORDON TAYLOR  
*Technical Editor*  
 WILLIAM C. DORF  
*Associate Editor*  
 JOHN M. BORST  
*Ass't Tech. Editor*



HOWARD S. PEARSE  
*Associate Editor*  
 SAMUEL KAUFMAN  
*Broadcast Editor*  
 JOS. F. ODENBACH  
*Art Editor*

*Edited by* LAURENCE M. COCKADAY

VOLUME XIV

October, 1932

NUMBER 4

## CONTENTS

*(Cover Design by Morey)*

From 'Frisco to Paree By <i>Fred V. Griffin</i> .....	PAGE 203	Future of Radio Servicing By <i>E. H. Rietzke</i> .....	PAGE 222
A Crystal Control Transmitter By <i>James Millen</i> .....	PAGE 206	Latest All-Wave Super (Part 3) By <i>S. Gordon Taylor</i> .....	PAGE 224
Photoelectric Progress By <i>Irving J. Saxl</i> .....	PAGE 209	U. S. Station Call List By <i>The Staff</i> .....	PAGE 226
Eliminating Interference By <i>Thomas C. McClary</i> .....	PAGE 212	A DX Super (Part 2) By <i>Wm. C. Dorf</i> .....	PAGE 228
Crystal "Mikes" and Speakers By <i>C. B. Scott</i> .....	PAGE 214	Rural Radio Service By <i>Zeh Bouck</i> .....	PAGE 230
"Between-Station" Noise By <i>W. A. Smith</i> .....	PAGE 216	A British Televisor By <i>J. Foster Cooper</i> .....	PAGE 236
A Dynamic Microphone (Part 2) By <i>P. S. Zolnier and J. E. Selliken</i> ....	PAGE 218	A Pickle-bottle Photocell By <i>M. L. Wendel</i> .....	PAGE 238
Low-Cost Receiver Design By <i>McMurdo Silver</i> .....	PAGE 220	Backstage in Broadcasting By <i>Samuel Kaufman</i> .....	PAGE 240

## DEPARTMENTS

The Service Bench.....	PAGE 230
Radio Science Abstracts.....	PAGE 232
Free Booklet Service.....	PAGE 233
With the Experimenters.....	PAGE 236
What's New in Radio.....	PAGE 242
Latest Radio Patents.....	PAGE 248
QRD .....	PAGE 251

*Published Monthly by* Teck Publications, Inc., *Washington and South Avenues, Dunellen, N. J.*

### OFFICERS

Lee Ellmaker, *President*  
 Warren P. Jeffery } *Vice Presidents*  
 Huston D. Crippen }  
 Paul Diffenderfer, *Treasurer*  
 Abner Germann, *Secretary*

### EDITORIAL AND EXECUTIVE OFFICES

222 WEST 39th STREET, NEW YORK CITY, N. Y.

Entered as second class matter at the Post Office at Dunellen, N. J., under the act of March 3, 1879. Copyright, 1932, by Teck Publications, Inc. All rights reserved. Title Registered at the U. S. Patent Office. Printed in the United States of America. The contents of this magazine must not be reproduced without permission. We cannot be responsible for lost manuscripts, although every care is taken for their safety.

25c a Copy, \$2.50 a year,  
 \$3.50 in Canada, \$3.50 in  
 Foreign Countries. Sub-  
 scribers are notified that  
 change of address must reach  
 us five weeks in advance of  
 the next day of issue.



The **ONLY** receiver  
 positively **GUARANTEED**  
 to give **ACTUAL**  
 world-wide reception

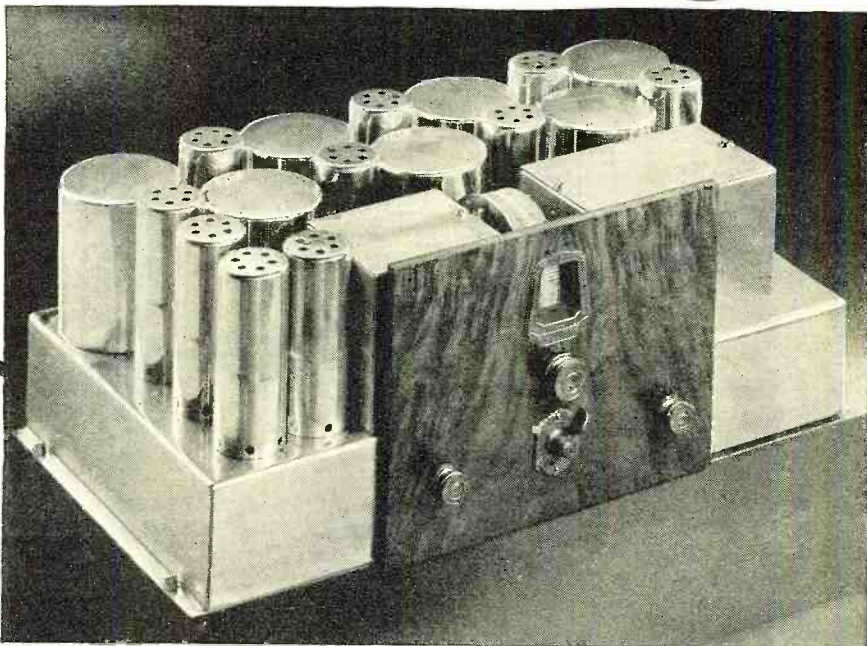
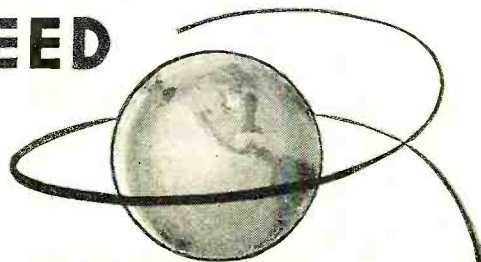

**Features of the Scott Allwave Deluxe**

**15-550 Meters**

Includes major European, Asiatic, Australian, African, South American and Domestic voice stations.

**Single Dial**

Tunes both R. F. and Oscillator circuits in perfect alignment automatically from 15 to 550 meters—without trimmers.

**No Plug In Coils**

Coils are not tapped. Entirely new system—actually MORE efficient than plug in coils.

**New Class A Linear Amplifier**

Gives perfectly uniform response to all frequencies from 30 to 8000 cycles at low as well as at high volume.

**Twin Speakers**

Give actual reproduction to the perfect, linear output of the amplifier.

**Non Oscillating**

100 per cent shielding enables use of maximum sensitivity without annoyance of oscillation.

There is no question—no doubt—no gamble in the purchase of a Scott Allwave Deluxe. No mere hope, to be followed by bitter disappointment. You KNOW—before you spend your money for a Scott Allwave Deluxe—exactly what you are going to get in performance. You KNOW you will hear England, France, Germany, Spain, Australia, South America and many more of the 300 intensely interesting foreign stations regularly received by owners of Scott Allwave Deluxe receivers. You know these things, before you buy because this receiver is positively guaranteed to give you actual world-wide reception... every day... regardless of which state you live in!

possible an absolute guarantee of actual world-wide reception. Only the Scott Allwave Deluxe has a sensitivity of 4-1000ths microvolt per meter at 1400 K. C.! That's one reason. The second is that the Scott Allwave Deluxe is the ONLY receiver having such a low natural noise level that the 4-1000ths microvolt per meter sensitivity can be used to yield loud, clear reception over distances up to 10,000 miles!

**Send for PROOF!**

A great independent laboratory has charted the sensitivity, selectivity and tone of the Scott Allwave Deluxe. These charts PROVE, beyond any question of doubt that the Scott Allwave Deluxe will POSITIVELY give you the foreign reception you want... the 90 channel broadcast selectivity you want, and the tone you want. Send today for this convincing PROOF... then, you will understand fully why the Scott Allwave Deluxe is the only receiver that CAN be sold with a definite, unconditional guarantee of actual, world wide reception. Clip the coupon. Mail it at once.

**Why This Amazing Guarantee Is Possible**

It might seem strange that no one else can offer the purchaser such absolute certainty of satisfaction on the subject of foreign reception. Yet it is not strange when all the facts are understood, because... only the Scott Allwave Deluxe has the electrical characteristics that make

THE E. H. SCOTT RADIO LABORATORIES, INC.  
 4450 Ravenswood Avenue • Dept. RN10 • Chicago, Illinois

The **SCOTT ALLWAVE DE LUXE**

15-550 meter Superheterodyne

E. H. SCOTT RADIO LABORATORIES, INC.  
 4450 Ravenswood Ave., Dept. RN10 Chicago, Ill.

Send me fully detailed technical description of the new Scott Allwave Deluxe.

NAME.....  
 STREET.....  
 TOWN..... STATE.....



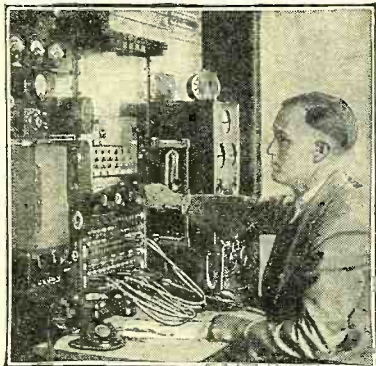

Broadcasting Stations employ trained men continually for jobs paying up to \$5,000 a year.

# I WILL TRAIN YOU AT HOME

## Many Make \$50 to \$100 a Week in Radio -- *the Field With a Future*

My book, "Rich Rewards in Radio," gives you full information on the opportunities in Radio and explains how I can train you quickly to become a Radio Expert through my practical Home Study training. It is free. Clip and mail the coupon NOW. Radio's amazing growth has made hundreds of fine jobs which pay \$50, \$60, \$75, and \$100 a week. Many of these jobs may quickly lead to salaries as high as \$125, \$150, and \$200 a week.

### Radio—the Field With a Future

Ever so often a new business is started in this country. You have seen how the men and young men who got into the automobile, motion picture, and other industries when they were started had the first chance at the big jobs—the \$5,000, \$10,000, and \$15,000 a year jobs. Radio offers the same chance that made men rich in those businesses. It has already made many men independent and will make many more wealthy in the future. You will be kicking yourself if you pass up this once-in-a-lifetime opportunity for financial independence.

### Many Radio Experts Make \$50 to \$100 a Week

In the short space of a few years 300,000 Radio jobs have been created, and thousands more will be made by its future development. Men with the right training—the kind of training I will give you in the N.R.I. Course—have stepped into Radio at 2 and 3 times their former salaries. Experienced service men as well as beginners praise N.R.I. training for what it has done for them.

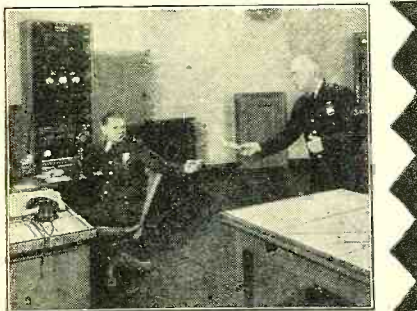

Police Departments are finding Radio a great aid in their work. Many good jobs have been made in this new field.

### Many Make \$5, \$10, \$15 a Week Extra in Spare Time Almost At Once

My Course is world-famous as the one "that pays for itself." The day you enroll I send you material, which you should master quickly; for doing 28 Radio jobs common in most every neighborhood. Throughout your Course I will show you how to do other repair and service jobs on the side for extra money. I will not only show you how to do the jobs but how to get them. I'll give you the plans and ideas that have made \$200 to \$1,000 a year for N.R.I. men in their spare time. G. W. Page, 110 Raleigh Apts., Nashville, Tenn., writes: "I made \$935 in my spare time while taking your Course." My book, "Rich Rewards in Radio," gives many letters from students who earned four, five, and six times their tuition fees before they graduated.

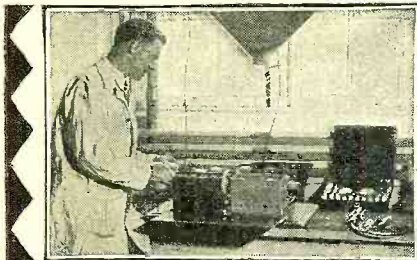

Spare time set servicing pays many N.R.I. men \$200 to \$1,000 a year. Full time men make as much as \$65, \$75, \$100 a week.

### Get Ready Now for Jobs Like These

Broadcasting stations use engineers, operators, station managers and pay up to \$5,000 a year. Radio manufacturers employ testers, inspectors, foremen, engineers, service men, buyers, and managers for jobs paying up to \$6,000 a year. Radio dealers and jobbers (there are over 35,000) employ service men, salesmen, buyers, managers and pay up to \$100 a week. Talking pictures pay as much as \$75 to \$200 a week to men with Radio training. There are hundreds of opportunities for you to have a spare time or full time Radio business of your own—to be your own boss. I'll show you how to start your own business with practically no capital—how to do it on money made in spare time while learning. My book tells you of other opportunities. Be sure to get in at once. Just clip and mail the coupon.

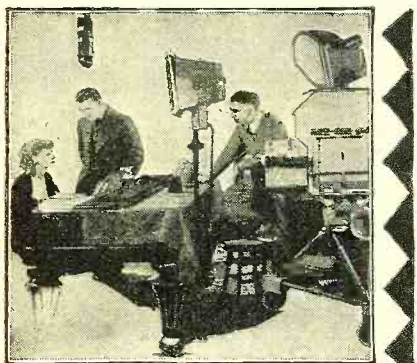

Talking Movies—an invention made possible by Radio—employs many well trained radio men for jobs paying \$75 to \$200 a week.

## I HAVE STARTED MANY IN RADIO AT 2 AND 3 TIMES



**\$400  
Each  
Month**



**\$800  
In Spare  
Time**



**Chief Engineer  
Station  
WOS**

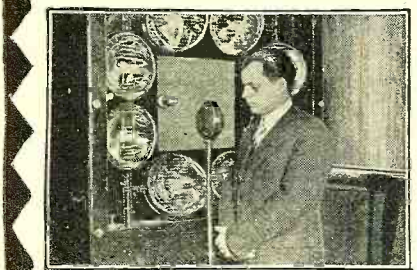

Television—the coming field of many great opportunities—is covered by my course.

"I spent fifteen years as traveling salesman and was making good money but could see the opportunities in Radio. Believe me I am not sorry, for I have made more money than ever before. I have made more than \$400 each month and it really was your course that brought me to this. I can't say too much for N.R.I." J. G. Dahlstead, Radio Station KYA, San Francisco, Cal.

"Money could not pay for what I got out of your course. I did not know a single thing about Radio before I enrolled, but I have made \$800 in my spare time although my work keeps me away from home from 6:00 A.M. to 7:00 P.M. Every word I ever read about your course I have found true." Milton I. Leiby, Jr., Top-ton, Pa.

"I have a nice position and am getting a good salary as Chief Engineer of Radio Station WOS. Before entering Radio, my salary was barely \$1,000.00 a year. It is now \$2,400.00 a year. Before entering Radio, my work was, more or less, a drudgery—it is now a pleasure. All of this is the result of the N.R.I. training and study. Your course is by far the simplest, clearest I have yet seen. You got me my first important position. After I accepted this position a number of others were offered to me as the result of the efforts of your Employment Service." H. H. Lancee, Radio Station WOS, Jefferson City, Mo.



# TO BE A RADIO EXPERT

**Act Now --- Mail Coupon Below for Free Book of Facts and Proof**

**You Learn at Home in your Spare Time to be a Radio Expert**

Hold your job. There is no need for you to leave home. I will train you quickly and inexpensively during your spare time. You don't have to be a high school or college graduate. My Course is written in a clear, interesting style that most anyone can grasp. I give you practical experience under my 50-50 method of training—one-half from lesson books and one-half from practical experiments with equipment given without extra charge. This unique and unequalled method has been called one of the greatest developments in correspondence Radio training. N.R.I. pioneered and developed it. It makes learning at home easy, fascinating, practical.

**Learn the Secrets of Short Wave, Television, Talking Pictures, Set Servicing, Broadcasting, Etc.**

I'll give you more training than you need to get a job—I'll give you your choice, and not charge you extra either, of my Advanced Courses on these subjects—(1) Television, (2) Set Servicing and Merchandising, (3) Sound Pictures and Public Address Systems, (4) Broadcasting, Commercial and Ship Radio Stations, (5) Aircraft Radio. Advanced specialized training like this gives you a decided advantage.

**Your Money Back If You are Not Satisfied**

I will give you an agreement in writing, legal and binding upon this Institute, to refund every penny of your money upon completing my Course if you are not satisfied with my Lessons and Instruction Service. The resources of the National Radio Institute, Pioneer and World's Largest Home-Study Radio School stands behind this agreement.

**Find out what Radio offers. Get my Book**

One copy of my valuable 64-page book, "Rich Rewards in Radio," is free to any resident of the U. S. and Canada over 15 years old. It has started hundreds of men and young men on the road to better jobs and a bright future. It has shown hundreds of men who were in blind alley jobs, how to get into easier, more fascinating, better paying work. It tells you where the good Radio jobs are, what they pay, how you can quickly and easily fit yourself to be a Radio Expert. The Coupon will bring you a copy free. Send it at once. Your request does not obligate you in any way. ACT NOW.

**J. E. SMITH, President**

**Dept. 2KR, National Radio Institute  
WASHINGTON, D. C.**

**FORMER PAY**



**Experienced  
Radio Man Praises  
N. R. I. Course**

"Before taking your course, I had worked at Radio for over seven years, doing quite a bit of servicing, but I realized that I was in need of better training. From the first lesson on I began to understand points that had had me wondering. I would not take many times the price it has cost me, for the knowledge I have gained. In a period of nine months, I have made at least \$3,500." C. J. Stegner, 28 So. Sandusky St., Delaware, Ohio.

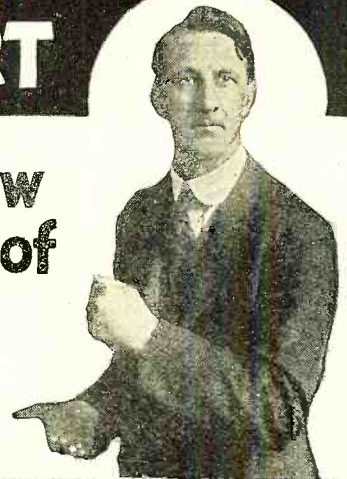

## Special FREE Offer

Act now and receive in addition to my big free book, "Rich Rewards in Radio," this Service Manual on D.C., A.C., and Battery operated sets. Only my students could have this book in the past. Now readers of this magazine who mail the coupon will receive it free. Overcoming hum, noises of all kinds, fading signals, broad tuning, howls and oscillations, poor distance reception, distorted or muffled signals, poor Audio and Radio Frequency amplification and other vital information is contained in it. Get a free copy by mailing the coupon below.

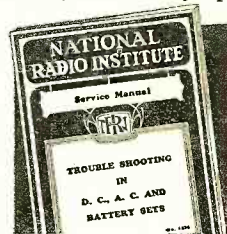

## SPECIAL Radio Equipment for Broad Practical Experience Given Without Extra Charge

My Course is not all theory. I'll show you how to use my special Radio equipment for conducting experiments and building circuits which illustrate important principles used in such well-known sets as Westinghouse, General Electric, Philco, R. C. A., Victor, Magnacord, and others. You work out with your own hands many of the things you read in our lesson books. This 50-50 method of training makes learning at home easy, interesting, fascinating, intensely practical. You learn how sets work, why they work, how to make them work when they are out of order. Training like this shows up in your pay envelope—when you graduate you have had training and experience—you're not simply looking for a job where you can get experience.

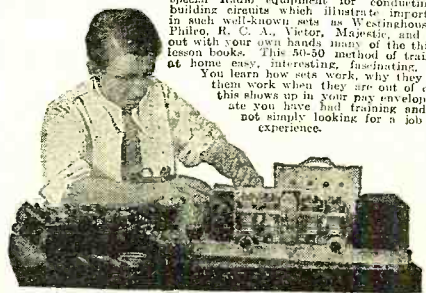

With N. R. I. equipment you learn to build and thoroughly understand set testing equipment—you can use N. R. I. equipment in your spare time service work for extra money.

## Clip and mail NOW for FREE INFORMATION

**J. E. SMITH, President  
National Radio Institute, Dept. 2KR,  
Washington, D. C.**

Dear Mr. Smith: I want to take advantage of your Special Offer. Send me your Service Manual "Trouble Shooting in D.C., A.C. & Battery Sets" and your book "Rich Rewards in Radio," which explains Radio's Opportunities for bigger pay and your method of training men at home in spare time. I understand this request does not obligate me.

Name.....  
Address.....  
City..... State.....

"M"



# The Editor—to You

NEVER before during the present editor's regime has a RADIO NEWS feature service been accepted with as great an acclaim by technical men, engineers in general, servicemen and experimenters both amateur and professional, as the Technical Booklet Service inaugurated with the August, 1932, issue. As a result of the first month's activities there have been requested by readers and mailed by our staff well over 10,000 technical booklets containing valuable information on radio practice in design, experimental work, service work and replacement. A considerable percentage of readers subscribing to this free service have written in to the editor commenting on the speedy and valuable service rendered to them. Here are a few of the letters:

\* \* \*

"I RECEIVED the copies of the literature requested through your Free Technical Booklet Service. I take this opportunity to thank you for the prompt mailing of this literature, which I greatly appreciate for its technical information and all around value. It is my utmost desire that you keep this service as one of the features of RADIO NEWS. I am sure it will prove one of the best aids to those interested in radio."—Wilbur M. Kerner, Erie, Pa.

\* \* \*

"I AM in receipt of the mailing of the RADIO NEWS Free Technical Booklet Service and wish to express my great appreciation of this service. I surely hope it will be continued and feel sure it will mean increased business to manufacturers who have their data mailed through this service. Data of this type is always filed by us and referred to a great deal, and often our orders for various items are placed solely on data received in this way."—Edward A. Turnier, Jr., Certified Factory Radio Service Station, Hoboken, New Jersey.

\* \* \*

"THANKS for your Free Booklet mailing. Sure glad to see this service in RADIO NEWS and hope it stays in each issue. Have been reading this magazine since 1923 and still heads the list here of the many radio magazines I read. Also want to thank your magazine for its wonderful radio amateur articles."—Shelby Ott, Amateur Radio Stations W9DJK and W9CVF, North LaCrosse, Wisconsin.

\* \* \*

"RECEIVED your Free Booklets and wish to thank you for them and for your letter. I will say that this service certainly promises to be very welcome help to the serviceman and experimenter."—B. Haberland, Jr., Jackson Heights, N. Y. C.

\* \* \*

"I WOULD like to see the Free Book-

let Service continued and expanded. It helps the radio serviceman and experimenter by the useful information contained in them and also helps us to get better acquainted with the radio and parts manufacturer."—L. A. Richardson, Radiotrician, Crane, Texas.

\* \* \*

It is interesting to note how the national police of countries other than our own are using radio as a means of communication in insuring public safety for their citizens.

\* \* \*

THE illustrations below are representative of the finest of these types of police installations. The upper photograph shows the interior of one of the main "listening posts" of the Bureau of Public Safety in Paris, through which messages are received from all over the world regarding police matters of importance. The lower photograph shows the extensive antenna systems for both transmitting and receiving, of this same Bureau. With such installations, even international criminals may find it difficult to escape in the future the jurisdiction of the countries they have unlawfully operated in.

\* \* \*

NOT infrequently do younger members of the radio fraternity write to our editors regarding opportunities in the commercial radio operators' field, and they often ask in their letters whether the life was interesting and adventurous as well as being just purely radio.

\* \* \*

OUR lead article in this issue might be



called a "page out of a notebook" of an old-time radio operator, sailing the high seas on a commercial vessel close to the end of the World War. We think it may prove encouraging and an inspiration to those intending to study to become a radio operator in commercial fields.

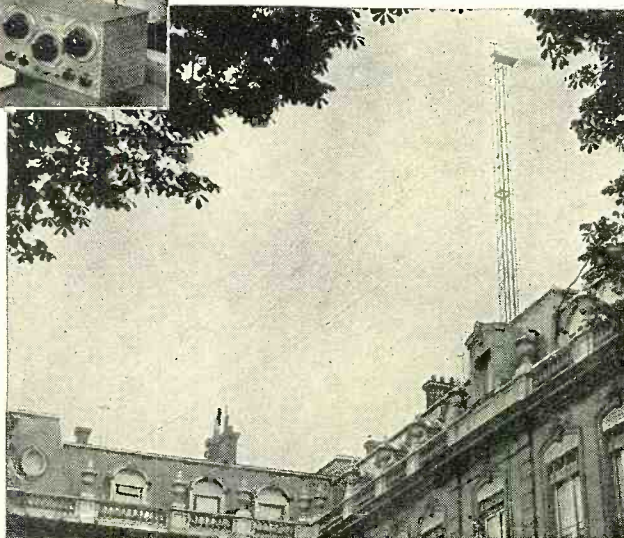

OUR Service Editor, Zeh Bouck, has been making a considerable study of rural service conditions throughout the East and presents, this month in the "Service Bench," some of his findings along this line. It is believed the information he has presented in his department will be of more than passing interest and help to the servicemen located in the smaller villages and outlying districts throughout the United States.

\* \* \*

COMING over the Editor's desk this month are a number of letters from readers, regarding RADIO NEWS, extracts from a few of which follow:

\* \* \*

"I HAVE never taken a radio magazine from which I derived so much knowledge and usefulness as out of RADIO NEWS. It is good all the way through. I would like to see more articles describing different makes of receivers."—Edward B. Worthen, Elgin, Ill.

\* \* \*

THE Editors feel that this issue anticipates Mr. Worthen's requests.

\* \* \*

"MAY I take this opportunity to state that I look forward eagerly to every issue of RADIO NEWS. I would add also that never before has RADIO NEWS been more interesting or of more value than during the last year."—Kenneth Springer, Radio Service Department, The Gift Shop, Mayville, N. D.

\* \* \*

THE Editors appreciate the constructive criticisms, friendly views and notes of readers the world over.

*Stewart M. Lockaday*



# They Wanted WORLD-WIDE PERFORMANCE and **THEY GOT IT!**

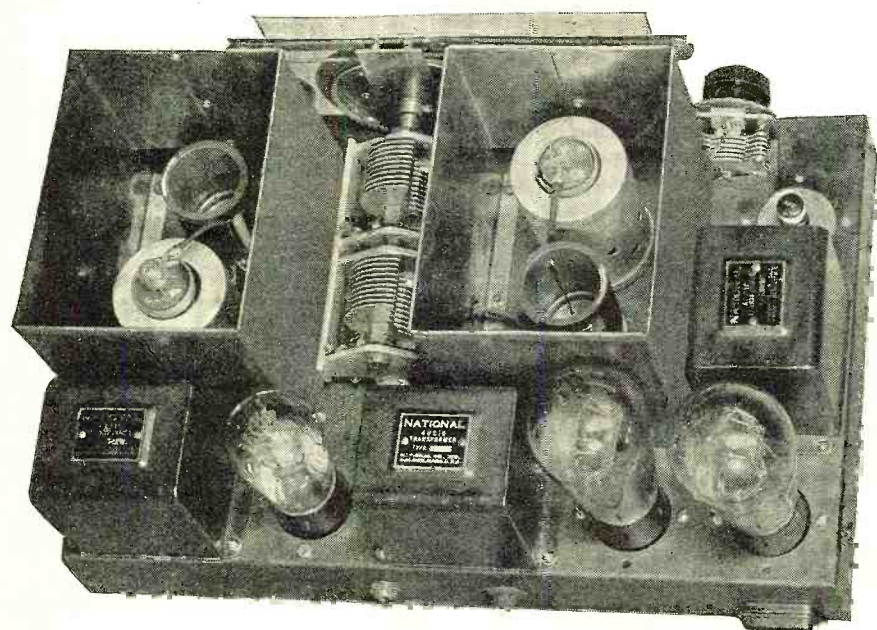

When They Bought  
**NATIONAL**  
Short-Wave Receivers

**You Can Get THRILLS** from reliable reception of short-wave broadcasts **THE WORLD OVER**, with the NATIONAL SW-58 THRILL-BOX. Thousands have bought the NATIONAL SW-58 and SW-45 Short-Wave THRILL-BOXES. Thousands of satisfied short-wave enthusiasts can't be wrong. . . . These THRILL-BOX buyers wanted short-wave performance, and they got it, with NATIONAL SHORT-WAVE RECEIVERS. . . . They got a short-wave set with the lowest background noise and the best signal-to-noise ratio of any commercially available SW receiver. . . . They got tremendous sensitivity and extreme ease of tuning and control. . . . In short, they got everything one could wish for in performance. And you can get it, too, with the SW-58.

### Plus "Controlled Selectivity"

An entirely new feature, found only in the SW-58, which allows the set ALWAYS to be operated at the best selectivity consistent with signal strength and reception conditions.

### Loud Speaker Performance

A Push Pull Stage with 245 tubes for best tone-quality gives fine loud-speaker volume. There is also a jack for headphones.

### Full AC or DC

The AC set operates with the NATIONAL 5880 Special SW Power Supply with extra shielding and filter sections for humless operation. RCA Licensed. Battery model also available for use where there is no AC current.

### New 16-Page Catalogue and Full Particulars Without Obligation

Mail the coupon below today for your copy of our new 16-page catalogue and full details of the new NATIONAL SW-58 THRILL BOX.

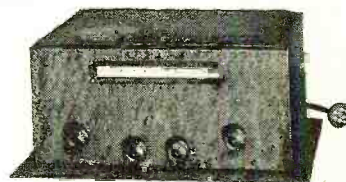

### "They don't make SW-Receivers better than the NATIONAL . . ."

So writes one admirer of the NATIONAL SHORT-WAVE THRILL-BOX. Others say:  
"We tuned in a program from Rome—and it was an Italian Symphony Orchestra which was playing *The Emperor* concerto by Beethoven. This came through so loud that . . . sat down at his piano and accompanied this orchestra at a distance of several thousand miles. Tie this one if you can!" (Boston.)  
"It is a peach of a Receiver. The best I have ever heard in 3 years experience." (N. Y. State.)  
"To date I have heard 24 different short-wave broadcasting stations—among them Australia, Indo-China, and Germany and most all the South American points." (Texas.)  
"I have logged over 50 stations off and on, mostly on the loud-speaker." (India.)

(Names on Request)

### Unsolicited Testimonials of Outstanding Performance

Ever since NATIONAL Co. began to make and sell the Short-Wave THRILL BOX, a constant flow of enthusiastic, unsolicited testimonials have come in to us. All praise the performance of the THRILL BOX. Many tell of remarkable instances of long-distance reception. These files are open to anyone at our office, for inspection. We have never paid one cent for these testimonials.

### The New SW-58 Is Better Still

Range: 9-850 meters . . . Standard range transformers give range of 13.5 to 115 meters, other transformers available at low extra cost . . . New 58 tubes increase RF gain and selectivity . . . New isolated rotor gang condenser isolates RF and Detector circuits . . . New tube and stage-shielding eliminates stray coupling between coils. New full-vision Velvet Vernier Dials, latest design:—exact tuning can be seen at a glance.

### PLUG-IN COILS GIVE SW-58 BEST PERFORMANCE

For reliable round-the-world SW Reception, there is no substitute for plug-in coils. No other arrangement gives equal flexibility and reliability in a set designed exclusively to give the utmost in SW Reception, like the SW-58.

**NATIONAL**  
A. C. SW-58  
THRILL-BOX



### REGULAR USERS of NATIONAL Short-Wave Equipment

NATIONAL Short-Wave Equipment and Short-Wave Receivers are used by thousands of Short-Wave listeners and amateurs all over the world, and by every large commercial company in the communications field, including:

- |  |  |
|--|--|
| General Electric Co.                               | Signal Corps, U. S. Army                     |
| Westinghouse Electric & Mfg. Co.                   | U. S. Dept. of Commerce (Lighthouse Service) |
| R.C.A. Communications                              | Pan American Airways                         |
| Tropical Radio (United Fruit Co.)                  | Boeing Air Lines                             |
| Federal Tel. & Tel. Co.                            | Western Air Express                          |
| Western Electric Co.                               | Transcontinental and Western Air Express     |
| Press-Wireless                                     | Radio-Marine                                 |
| Maekay Radio (Postal)                              | United Air Lines                             |
| American Airways                                   | Eastern Air Transport                        |
| American Tel. & Tel. Co.                           | Canadian Airways, Ltd.                       |
| Canadian Marconi U. S. Naval Research Laboratories | Southern Air Transport                       |
| U. S. Navy   |  |

## Mail Coupon Today

### National Co. Inc.

61 Sherman Street, Malden, Mass.

Please send me your new 16-page catalogue and full information on the NATIONAL AC SW-58 THRILL BOX.

Name .....

Address .....



# Again Midwest Offers the Season's Greatest Radio Sensation!

## World-Wide Reception

Just a few excerpts from letters written by delighted Midwest owners. We have thousands of them on file. Mail coupon or write for new catalog and we'll send you ample PROOF of Midwest World-Wide reception.

### Clarity! Selectivity Volume! Distance!

"To try and express our joy over the set we purchased from you would be a problem, but with the deepest sincerity we will defy anyone to pry it away from us.

"Clarity! Selectivity! Volume! Distance! Anything and everything one would care for in a radio. It surely is a beauty! Having visited your plant, I am at liberty to say I found it just like the radio, 'Ship-Share'.

"May you enjoy many more years of success as I know you will with your 'direct from factory' prices."

P. G. Kurth, 2211 N. Booth Ave.,  
Milwaukee, Wis.

### France, England, Spain, Cuba, Hawaii

"We have always thought that our nine-tube radio was quite superior to most, but now that we have tried out the Midwest All-World, All-Wave, we are all for your set. There is nothing to equal its clear, fire-like tone, selectivity and power to bring in distant stations as clearly as locals.

"Regarding the Short Wave, it comes way above our expectations. Police stations, testing stations, airports and amateur operators come in clearly at almost any time. We also get stations in France, England, Spain, Cuba and Hawaii."

D. M. Fish, R. F. D. No. 4, Ithaca, N. Y.

### Germany, Italy, South America

"Have received the set and so far am very pleased with it. On broadcast it is exceptionally sharp. I live in the heart of the city with 42 broadcasting stations within 10 miles and the Midwest is surely giving results. KMOX comes in like a local."

"As for short waves, received Germany last Sunday afternoon. Italy has also been heard and several South American Stations."

E. Joyce, 756 Home St.,  
Bronx, New York City.

### Likes Midwest Automatic Tone Control

"Reception on the regular broadcast set, in my opinion, is very hard to equal and I dare say impossible to beat on any set costing twice the amount of the Midwest. It is very sensitive and so selective that barely a touch of the dial knob and you have another station coming in clear and without interference. The automatic tone control is great. I am now able to hold many stations which before would fade out right in the best part of the program. I have not done very much 'fishing' with the short wave as yet, although I have listened to Bound Brook, N. J., Schenectady and Australia and a few others."

Archie J. Goss, 6th South 3rd West,  
Brigham City, Utah.

W8XK—W3XAL—W1XAZ  
—W2XAF

"I am very much satisfied in every way with my Midwest radio. I heard Sydney, Sunday 3:00 A. M. Also W8XK, W3XAL, W1XAZ, W2XAF, in the evening. On the regular band have some 55 stations so far."

Aug. Balbi, 1427 Myra Ave.,  
Los Angeles, Calif.

# All-Wave

Regular Broadcasts--  
Foreign Broadcasts--Police--Amateur--  
Ships at Sea--All With One Dial!  
**15 to 550 METERS**

**W**HAT a radio! One complete 16-tube chassis with one DUAL-RATIO DIAL—new Super-Heterodyne circuit with a range of 15 to 550 METERS. . . . No plug-in coils—No Trimmers . . . and with the new STAT-OMIT tuning silencer you get in-between-station silence and perfect tuning without Neon lights, meters or buttons which were formerly necessary without this latest tuning system. . . . Large acoustically matched DUAL SPEAKERS. . . . New CLASS "B" PUSH-PUSH Super Power Amplifier with six times the power of ordinary tubes. . . . Full band AUTOMATIC VOLUME CONTROL. . . . COLORLITE Multi-Wave Band Selector giving instant choice of four distinct wave bands, regular broadcasts, foreign broadcasts, police and amateur. . . . FULL-FLOATING VARIABLE CONDENSER. . . . Complete Scientific Shielding. . . . Absolute tone fidelity. . . . Image Frequency Suppressor. . . . Fractional Microvolt Sensitivity. . . . 18 TUNED CIRCUITS. . . . NEW TYPE TUBES, 55, 56, 57, 58, 42, 46 and 82 tubes. . . . DUPLEX DUO DIODES, DUAL AND TRIPLE GRIDS, Two Full Wave Rectifiers including the new Mercury type. DUAL POWERED, two separate power transformers. A bigger, better, more powerful, more selective, finer toned radio than you've ever seen before . . . offered at an amazingly low price direct from the big Midwest factory. Midwest engineers have far outdistanced all past performances in perfecting this new set.

**DEAL DIRECT with FACTORY!**  
**Save the Middlemen's Profits**

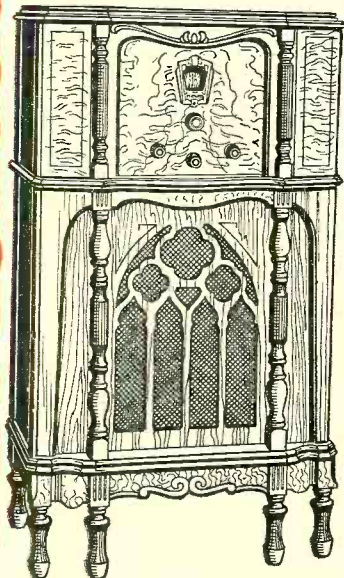

### Complete Line of Beautiful New Consoles

The big new Midwest catalog shows gorgeous line of artistic consoles in the new six-leg designs. Mail the coupon or write us a postal. Get all the facts. Learn how you can save 30 percent to 50 percent on a big powerful radio by ordering direct from factory.

Midwest methods of production effect large economies and give radio fans bigger and better radios for less money. And when you get this big, powerful Midwest 16-TUBE set you get ALL that the radio world can offer you—great range, perfect tone, amazing selectivity, tremendous reserve power, sensationally low cost of operation. Don't be satisfied with less than a Midwest 16-tube all-electric set. Broadcast listeners are coming to realize that a receiver covering only the regular broadcast waves is *only half a set*. This amazing new Midwest gives you regular, foreign, police and amateur broadcasts in one single dial set. No converter or any extra units required. Improvements in short-wave receivers and programs have made ordinary broadcast sets obsolete. In selecting a set, choose one that is not only good today but will be in step with tomorrow.

### PAY As You PLAY!

Remember, you buy DIRECT FROM THE MAKERS. No middlemen's profits to pay. You get an absolute guarantee of satisfaction or money back. You try any Midwest 30 DAYS before you decide to keep it. Then, if you wish, you can pay for your set in easy monthly amounts that you'll scarcely miss. Besides, you can make easy EXTRA money as our USER AGENT. Coupon brings full details—mail it NOW!

**TERMS**  
as low as  
**\$5.00**  
**DOWN**

### Mail the Coupon!

Investigate! Mail the coupon. Get the Midwest catalog. Learn the facts about Midwest 9, 12 and 16-tube ALL-WAVE sets. Learn about our sensationally low factory prices, easy payment plan and positive guarantee of satisfaction or money back. Save up to 50 percent on your new radio!

# MIDWEST RADIO CORP.



# 16-Tube <sup>Only</sup> \$39.95

Completely Assembled with Large DUAL SPEAKERS

Save UP TO 50%



## New 1933 Features

New Class "B" Push-Push Power Amplifier. . . . Stat-Omit Tuning Silencer. . . . Color-Lite Tuning. . . . Full band automatic Volume Control. . . . Duplex Duo-Diode Detection. . . . Dual-Ratio Single Dial. . . . No Trimmers, No Plug-in Coils, No tuning meter or Neon light required. . . . Fractional Microvolt Sensitivity. . . . Dual Powered (2 separate Power Transformers). . . . Absolute Tone (30 to 5200 cycles). . . . 18 Tuned Circuits. . . . New Mercury Rectifier. . . . Full-Floating Variable Condenser. . . . Low Operating Cost. The new Midwest 16-tube set actually uses less current than previous sets of 8 and 10 tubes. . . . Uses the new type tubes, 55, 56, 57, 58, 42, 46, 82. . . .

**30 DAYS FREE TRIAL**

Remember, every Midwest set is backed by a positive guarantee of satisfaction or your money back. 30 DAYS' FREE TRIAL in your own home makes you the sole Judge. Midwest, now in its twelfth successful year, offers bigger, better, more powerful, more sensitive radios at lower prices than ever before. The coupon or a postal card brings you big new catalog and complete information. Mail it NOW!

## Every Improvement That Makes for Better Reception

**BATTERY RADIOS**

**Using the New AIR CELL BATTERY**

Two sensational values: a 6-tube super-het for standard-wave reception and a 9-tube ALL-WAVE, both using the new AIR CELL "A" battery that never needs recharging. Low factory prices. Coupon brings details. Mail it NOW!

Nothing has been overlooked and nothing important omitted in the new Midwest 9, 12 and 16-tube ALL-WAVE A.C. sets. You'll be amazed and delighted with the volume, the ease of control, the amazing clarity of reproduction and the absence of frying and cracking noises. Such radio reception has never before been known. Don't buy a set of any kind until you get the big new Midwest catalog. Mail the coupon now. Learn how you can save 30 percent to 50 percent direct from the factory—and buy on easy terms to suit your convenience.

**Get All the Facts NOW**

**RUSH THIS COUPON FOR AMAZING FREE TRIAL OFFER AND BIG BEAUTIFUL CATALOG**

Midwest Radio Corp., Dept. 118, Cincinnati, Ohio. Gentlemen: Please rush my copy of your big, beautiful, new catalog and complete details about the powerful, new 9, 12, and 16-Tube ALL-WAVE super-heterodyne outfits. I am not obligated.

**USER AGENTS**  
Big money in spare time. Check here for details.

This is not an order, and

Dept. 118, CINCINNATI, OHIO

Name \_\_\_\_\_ Street \_\_\_\_\_ Town \_\_\_\_\_ State \_\_\_\_\_



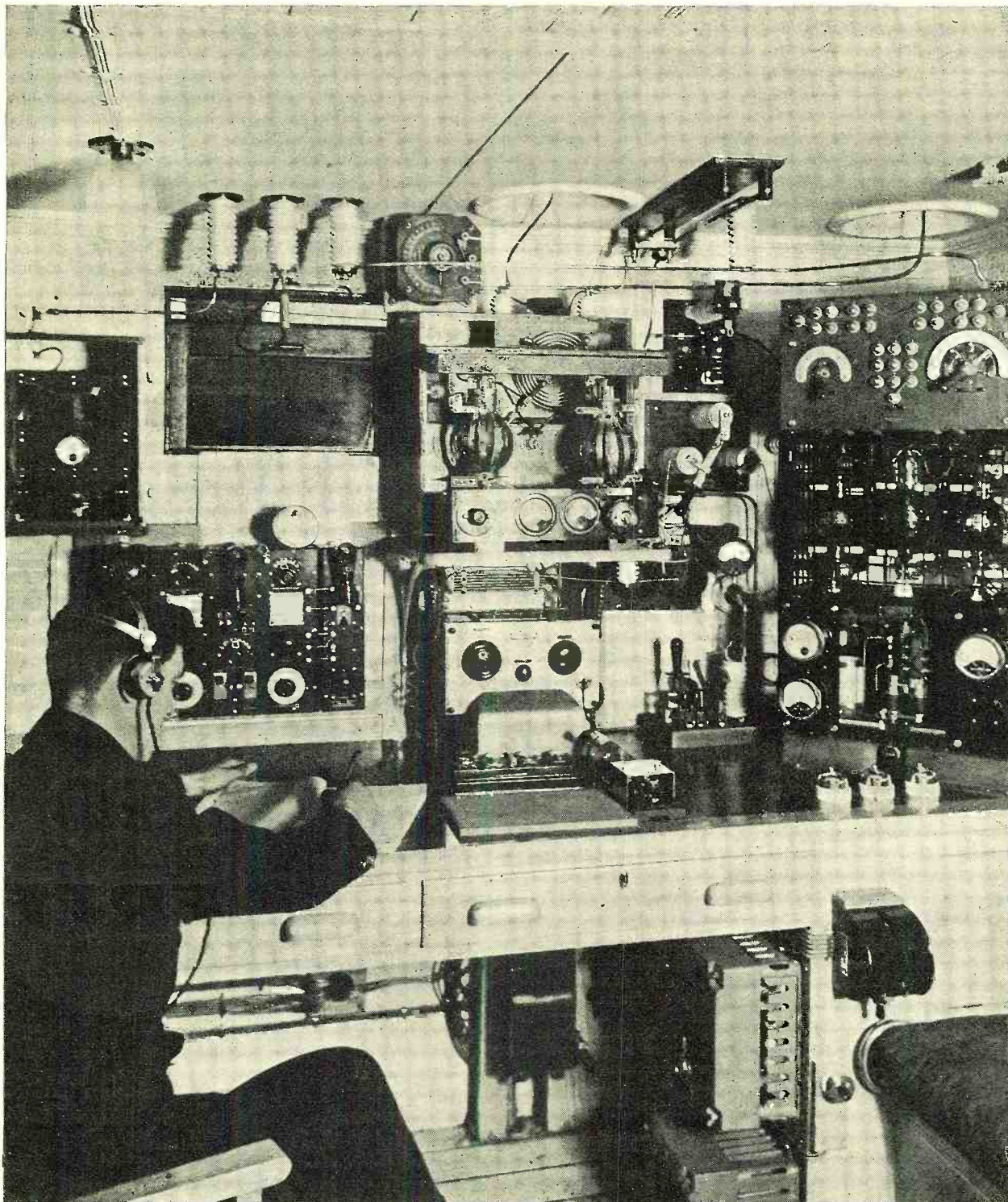

### Master of His Domain

*"On board" the radio operator is recognized as an officer of his ship with almost as much responsibility for his passengers as the captain. In his cabin, surrounded by complicated radio apparatus of all varieties, he is supreme. Every soul aboard relies on him for contact with the outside world, for weather reports, storm warnings, news and emergency messages. This is the radio cabin of the Discovery II, showing the long and short-wave transmitters and receivers of types easily recognizable at once by the well-informed operator*



# Radio News

VOLUME XIV

October, 1932

NUMBER 4

## FROM 'FRISCO TO PAREE'

*Presenting a page out of the experiences of an old-time radio operator on a, to him, memorable trip during the last year of the war. It is packed full of adventure and romance of an operator's life and should be both an encouragement and an inspiration to those who intend to get into the radio game as commercial operators*

By Fred V. Griffin

I KNEW those sloping shoulders, that cocky set of the head, that rolling gait—"Hey, Bill, what in Sam Hill are you doing here?" I was on the Trans-Pacific wharf along that avenue of telegraph poles known as the Embarcadero in San Francisco.

It was Bill. He turned around at the hail and recognized me with, "Just came in from Hong Kong on the *Persia*. Beating it up to the office to get these reports made out. You coming along?"

"All right," says I, falling in line with him and starting officewards.

We had only taken a few steps when our attention was arrested by a bunch of workmen on the side of another large trans-Pacific liner. Said Bill, "What's going on here with the old *Yokohama*? Ain't she on the trans-Pacific run any more?" In reply to which I informed Bill that the vessel in question was being prepared for transfer to the Atlantic and was going to London for war duties.

"Let 'er goldarned well go. Let 'em all get blown ter Davy Jones' Locker, but me for the peaceful Pacific. Look at all the 'colors' on deck. Surely that ain't the crew, is it? What a bunch! What a mixture—Japs, Swedes, Chinks, Mexicans, Lime-juicers, and all the bums for fair. It's sure a human rainbow for 'colors,' anyhow."

With a grunt and a "Gaw blimey" from Bill, for he was 100% Australian, we started off again. Entering the sanctum of our "Mal," the name of our chief of the wireless tribe at GHQ, we noticed a cloud of trouble settle over his face. But "Mal" recovered the shock of our arrival, breathed heavily and blurted out, "For the love of Pete, I guess the only way to keep you fellows apart (we were known as the "Heavenly Twins") is to shoot one of you. Here is Bill, been to the Orient and you to Mexico, and you turn up here together again. You are the queerest couple of radio 'ops' going. Give me your reports and let's get you out of here."

Both of our business reports having been completed, conversation then turned to the S.S. *Yokohama*. "Mal" said, "I want one of you chaps to take it out on that trip to England. Maybe you can get across the Channel and see something of Paris." We both laughed, but Bill said to me, "Come on, Buddy; let's get out of here before he gets us into trouble," and with this remark the conversation turned to me.

After talking the matter over for a while, it was finally decided that I was to take out the *Yokohama* as chief operator, with an "op," whom we shall call Shorty, as my assistant.

Once again the "Heavenly Twins," a name we had gained for our various escapades together around 'Frisco, were parted, much to the relief of dear old "Mal."

I hooked up with Shorty and we took a room in a palatial "Pay when you can" suite in which to wait for the eventful sailing date. We were awakened one morning by a regular cannonade on the door of our room. On opening the door, after much grunting and getting out of bed, we admitted a distinctly overexcited company official, and his first words were: "Ship's sailing at noon and it is 11 o'clock now. Move your lazy stumps and pack for your lives. There is hell to pay at the office and the skipper is raising a regular fog down at the wharf."

With the assistance of the hotel clerk and a few interested visitors, we were packed off in great shape in the panting Ford the official had brought to rush us down to the good ship *Yokohama*.

Later we remembered the old saying, "Too many cooks spoil the broth," but in this case it was "too many packers spoil the wardrobe." We found a hotel mat, a soap dish, several empty bottles and many other lines of rubbish our jocular friends had wished upon us.

The whistle heaved a sigh of relief, I nearly heaved a fit, Shorty heaved a suitcase at my head and we were off, bound for London, Gay Paree or Davy Jones' Locker, according to whether we met Kaiser Bill's undergraduates on the way or not.

ON THE BRIDGE  
*The author and Shorty on the trip through the Straits*





"Full astern" went the ship's telegraph repeatedly. Well, we went astern, with a big query on the "full," and with the tide running as it does in San Francisco Bay, we scarcely cleared the wharf, but managed to make it with no more damage than a few piles snapped off. Small and unimportant as this little incident appeared at the time, it showed its greatest meaning when we started full ahead up the bay, for our "crew of many colors" were apparently used to anything but coal heaving and work in general, with the result that for the greater part of the whole trip "full ahead" varied from four to ten knots on engines which had been regularly doing eighteen knots on the China run. Our Chink fireman had quit with the parting words, "Me likee plenty Hong Kong—Atlantic no plover placee. Cathem tin fishee. Bang! Bang!"

We were now heading the tide through the Golden Gate, and being somewhat late on account of our low speed, it was almost at turning point, and we cleared the channel with considerable difficulty after many a deep breath by those on the bridge, at the proximity of seal rocks, around which the tide swirls with terrific force. We were clear, and once again all faces looked pleasant on the bridge and the course was set for Point Arguello on our way to Panama, which was to be our first stop, as we were to go via the Canal.

### Panama Bound

Our speed was terrible. We were scarcely making five knots, but we kept plugging along until we got off San Diego, when we stopped for lack of steam. And it was about eight or ten hours before we got started again, for our firemen were not firemen at all and had practically laid down on the job. There had been several free fights in the engine room, a mixing of colors which didn't blend, and the poor old chief engineer was half frantic after a night of putting men in irons and sorting out the useful and the useless. With a little gentle persuasion of a "bunch of fives" and a spare Colt, work was resumed and again we sailed peacefully towards Panama.

Another couple of days brought us off Magdalena Bay on the coast of Lower California, where two of the Japanese dreadnaughts had apparently tried to take the overland route and rested peacefully on the sandy shores away from the German Pacific Fleet which they were scouting, but which afterwards came to grief in their contact with a few little old dreadnaughts under the British flag.

Fortunately, the weather favored us and we were able to do very well—almost eight knots—until we got to Panama and the capt'n had handed me his arrival report, which had already been transmitted, leaving me quietly seated on watch, peacefully smoking a fat cigar. I was startled from my day dreams by the purring of Balboa station rotary spark. He desired my presence on the key, so after placing aside the remainder of the cigar which had not been swallowed in the excitement of my rude awakening, I gave a G.A. (go ahead) and hoped for

### CONVICT SHIP

*The H. M. S. "Success," oldest sailing vessel, was the first sailing ship to install radio. It is said Marconi installed the set with his own hands*

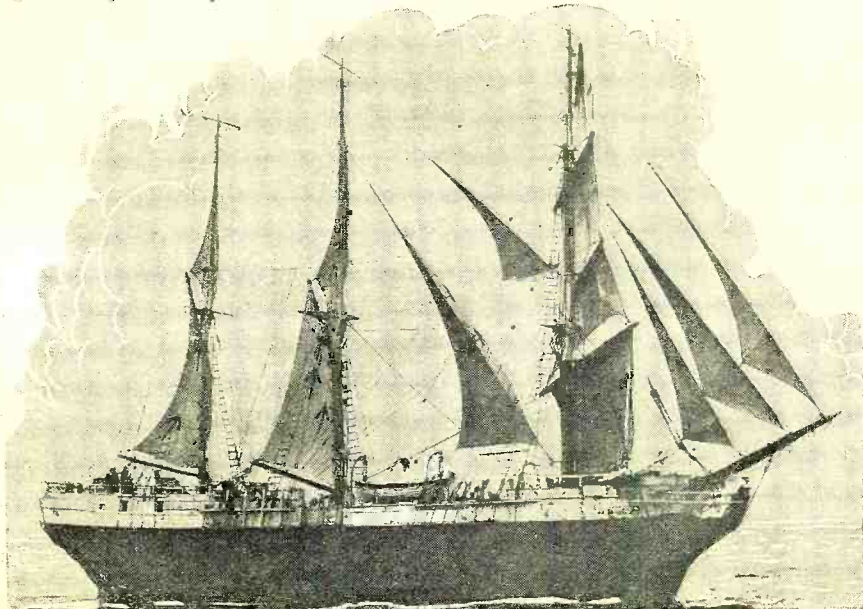

### Mutiny!

*With a colt and a "bunch of fives" the chief officer soon has the crew where he wanted them and had weeded out the good from the bad*

the best. The message buzzed through: "Balboa Port authorities to Captain S.S. Yokohama—Landslide in Culebra. Canal closed for three days." "Our luck's sure in," I thought as I handed the message to the skipper. He looked with eyes like saucers, said nothing, but from his expression, thought a whole book full.

We dropped the hook off Balboa and waited calmly for three days. The boys were getting thirsty and uncomfortable. Once again I got on the key and was informed that it would be another week at least before ships could pass through the Canal. Similar cheering news emanated on several occasions from the wireless cabin until there was much murmuring amongst our "zoological" pets in the "black gang" regarding the slight matter of "murdering dem vireless oberaters," which naturally had no cheering effect on either Shorty or myself, who also looked with longing eyes on the shore, "so near yet so far." We had spent our time playing poker, finishing off the remainder of the bar's contents, lazing around deck, being a nuisance everywhere, and were now reduced to lying in hammocks watching the lights of Toboga, that glorious little island resort of all Balboa, and heaving the fury of our wearied souls in a tremendous upheaval of cuss words at one another, the like of which could almost do credit to a "square-rigged mate."

But our day was to come; the skipper had been ashore, and as he approached in the launch, all necks were stretching and ears flapping in the breeze for words of hope, and shortly after he set foot aboard the flapping ears were rewarded with gentle music of the turning windlass, for we were heaving anchor, ready to dock for coal and supplies, for the canal slide was worse than at first figured and the delay was indefinite, with the result that our owners had cabled for us to proceed via Magellan Straits.

We docked, no steam aboard but sufficient in the towboats alongside. The black gang had ceased to work at the shovel, the little word "ashore" had



### STREET IN LAS PALMAS

*The last land before starting for the submarine zone was the Canary Islands. We visited Las Palmas*



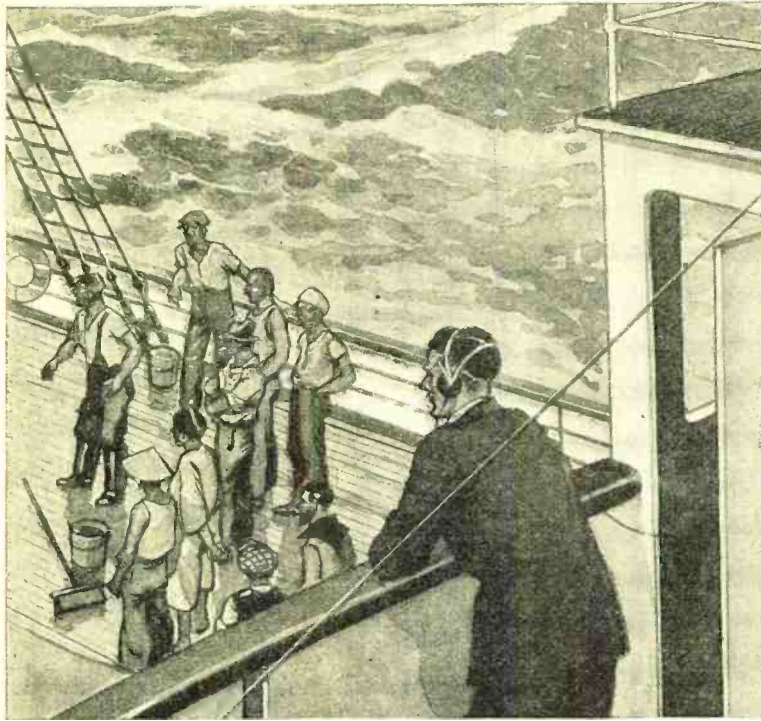

vibrated throughout the eardrums and had turned its usefulness to clothes, for the heaving line had scarcely gone over before there was a mad rush for shore. I thought for the moment a new free lunch counter had been opened, but it was merely that the "black gang" could not wait any longer and had dressed ready for shore whilst the towboats had done the work of the now extinct ship's fires. Next day the coaling and matter of supplies was attended to by a gang of "British subjects" from Jamaica, as they termed themselves, who were the first pests to be imported into the Canal Zone after the mosquitoes had had their day.

Our period of watchful waiting at anchor had been just three weeks, so now that the boys had got loose there was plenty of trouble. The skipper had not been made any allowance for giving the crew an advance of pay, so they quit the ship "cold" in a bunch and went about tapping people for cash for a glorious drunk. Our agents finally decided to get on the right side of the crew by giving them a small advance and allowing them official leave in order to give them a chance to relax after their strenuous efforts at steam manufacturing. But the desired effect was not brought about, and once again the boys got playful and resorted to their former tactics, with the result that when the ship was ready for sailing the crew were all in jail.

Shorty, Yapski (the Russian-American second mate with the countenance of a Siberian wolfhound, who had earned his nickname through yapping at everything and everyone) and myself were seated peacefully in comfortable cane chairs outside the corner café of one of Panama City's pleasing little plazas, sipping the cooling elixir of life and resting our eyes on the soulful sights of Spanish maidens driving past, well guarded by their austere parents.

"Come on, you fellers; snap out of your dreams." We turned as would the recipients of the order "Eyes right" to behold the mate. "We've got to get out of this hole. The old man's gone after a bunch of Marines, and we've all got to get the crew separated from the local jails, and we can't afford no more time, so better get busy."

Half an hour later I was pushing and cursing my way through Panama's lowest quarters, where the world's dullest characters and brightest colors held their debauches. It is peculiar that the City Hospital is right in the center of this district. I suppose it must be for convenience.

*The Equator—and Overcoats*

A huddled heap lay in the gutter, muttering guttural oaths. It was Heinie, the Dutch fireman. I found a wagon, gathered him up and proceeded on my scouting trip, and later found Tony the Dago rolling along with Sam Yoo, the only Chink aboard, and enticed them along with another drink. Next stop, the jail, where I was greeted by two mosquito-like Panamanian guards who stepped nobly forward with fixed bayonets. I hesitated, wondering whether or not to rub them out, but the hesitation was short, I kicked the shins of the nearest one, who lost his balance and fell off his perch, and whilst the other was getting over the surprise I entered the guard house, where, after presenting my papers to the Chief, one further member of our dilapidated crew was recovered and I passed out once again, receiving, on the way, many strange remarks from the guards, who had by this time recovered their dignity and who had also apparently decided that my reception by their Chief was sufficient warning for them to refrain from further interference. I know very little Spanish, but if looks are anything to go by, their words were far from complimentary.

Finally our work was done, the crew was once again mustered, and we proceeded to sea, bound for Coronel, Chile, for our next coaling.

Things, generally, went very smoothly. The first place of importance sighted was Callao, Peru's seaport, and we were soon across the Equator, the passing of which, strangely enough, was accompanied by wearing of overcoats, for a stiff breeze was blowing. Ere long we sauntered up the narrow channel to Coronel, and precautions having been taken against the crew getting ashore again on another bust, our next coaling

was accomplished with distinctly more satisfaction and less delay than the last. We were hooked up to buoys fore and aft, but still three members of the crew got away and were left in Coronel, being replaced by Chilanos. There is very little to be said about this town, for there is little of it and is of no particular interest, excepting as a replenishing point for the German (Continued on page 244)

A BEAUTIFUL VIEW

*This is one of the many scenes greeting the eye when we pulled into Rio de Janeiro*



"OUR VOYAGE SHIP"

*This is the steamer that took us on this trip from one side of the world to the other and which, for a number of reasons, must remain nameless in this article*

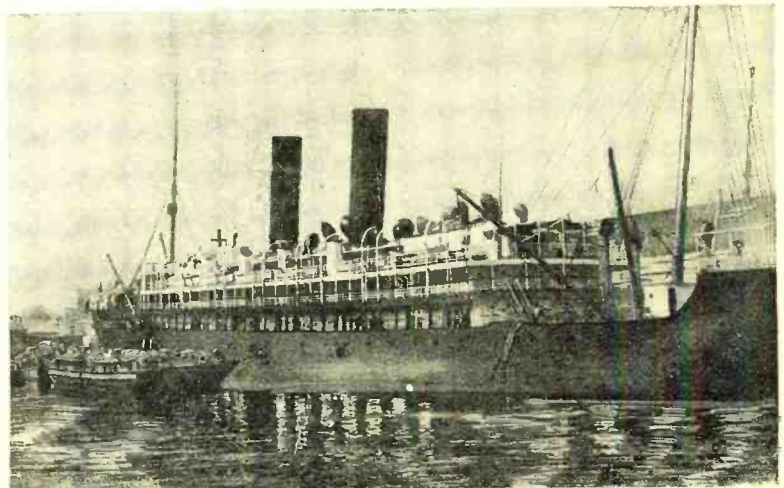



# THE FUNDAMENTAL CIRCUIT DETAILS AND CRYSTAL 56 MEGACYCLE

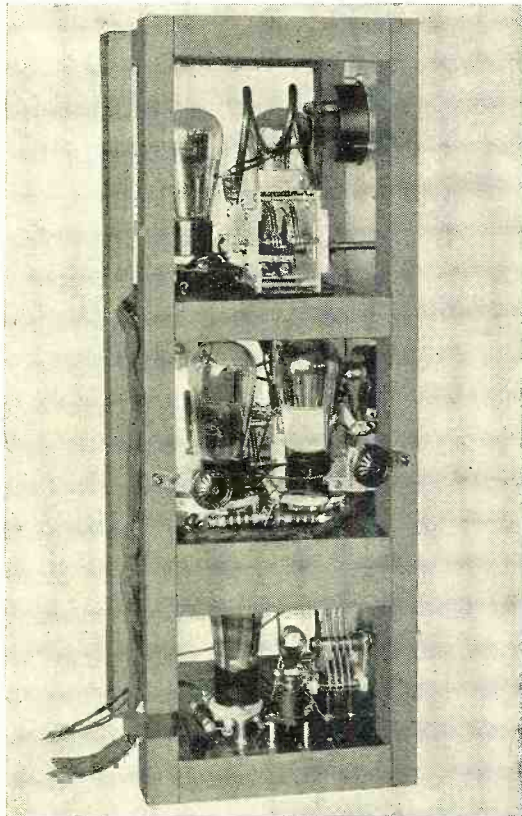

RIGHT SIDE VIEW

Figure 6. This illustration shows the recommended construction for the new transmitter

*Engineering considerations involved in end of the radio wavelength spectrum. The amateur and experimenter are tions to the radio science have been directed to the intriguing possibilities through the use of crystal*

tional high-frequency receivers are impossibly long in ultra-high-frequency design. Circuit capacities which were believed at an absolute minimum, two years ago, would place definite tuning limitations in the ultra-short-wave transmitter or receiver. A slight turn in a lead will so boost the inductance as to render the apparatus inoperable at the desired frequency.

Obviously the least vibration in the wiring or parts of the equipment will cause momentary frequency shifts, or modulation, to an intolerable degree.

Similar consideration of other factors influencing frequency, such as slight plate-voltage variations and electronic peculiarities, which are hardly of vital import on longer waves, disclose another fundamental source of frequency instability and modulation, which, unless definitely circumvented, severely limits the possibilities of the quasi-optical waves for communication purposes. Indeed, the outstanding characteristic of the popular ultra-high-frequency transmitters operating in the amateur 5-meter band is the extreme degree of frequency modulation. The use of a self-excited oscillator with Heising modulation (the conventional arrangement) results in a frequency shift, over the complete audio cycle, which is often as high as 200 kc.

The "wobulation" of such a transmitter is not noticeable when reception is effected on a super-regenerator, due to the fact that the receiver itself is continuously sweeping over a wide frequency range in variations caused by the action of the interruption frequency on the detector circuit. In other words, the frequency stability of the receiver is of the same order as that of the transmitter, with the net result that the deficiencies of the latter are not noticeable. As a matter of fact, even a sharp transmitter, confining its signal to a band 10 kc. wide, would seem equally broad on the super-regenerator! However, on better receivers, such as the ultra-short-wave superheterodyne described in RADIO NEWS for August, the modulated-oscillator type of transmitter is immediately shown up in its true colors and is, in many instances, incapable of transmitting intelligible speech to such a receiver.

By some, this may be construed as an argument in favor of the super-regenerator—but such an argument, at the same time, is an admission of experimental defeat. The super-

\* The National Co., Inc.

**M**UCH of the necessary engineering procedure in the design of ultra-short-wave transmitters and receivers is implied in the fundamental equation which states that the frequency of a tuned circuit is equal to the reciprocal of 2 pi times the square root of LC. Inspection of this equation will show that, as the frequency is raised, the quantity under the radical sign must become smaller and smaller. In the higher region of megacycles the LC constant is in the magnitude of a single unit times 10<sup>-18</sup>! It immediately becomes evident that even an infinitesimal variation in capacity or inductance may represent an appreciable fraction of the whole and may result in a considerable frequency shift. In a typical broadcast receiver, tuned to the center of the broadcast band, the variation of 1 micromicrofarad in tuning capacity will effect a frequency change in the order of 1.5 kc. A similar capacity variation at 56 megacycles will cause a frequency shift *one thousand times as great!*

Connection leads which were considered short in conven-

### THE CRYSTAL CONTROL APPARATUS

Figure 1, at right, contains the fundamental crystal circuit. The constants are arranged so that it will just oscillate off the crystal frequency. Figure 4, at left, gives the layout of the tourmaline crystal unit, which comprises the lower panel in the transmitter, shown in Figures 6 and 7

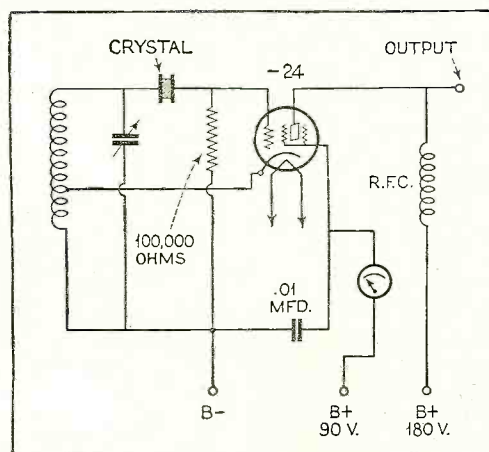
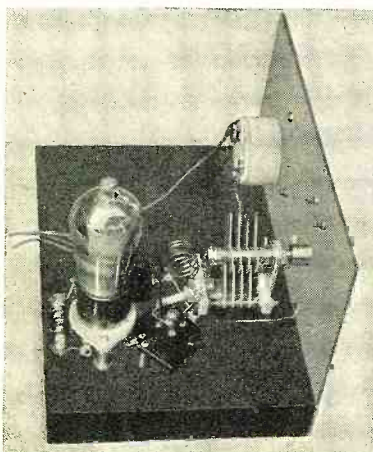



# CONSTRUCTIONAL DATA FOR A PRACTICAL CONTROL TRANSMITTER

*the development of the high-frequency require unusual ingenuity and technique. instinctive pioneers and their contributions considerable. Their attention is now of the ultra-high-frequency channels control transmitter circuits*

regenerator is, in effect, a "pound of" cure. As was pointed out in the article referred to above, full advantage of the ultra-short-wave field can be taken only with sharply tuned and highly sensitive receivers. The problem therefore resolves itself into the design of stable ultra-high-frequency transmitters.

The possibilities of the magnetron offer one solution of the problem, and a thoroughly practical transmitter of this type was described in the preceding article of this series. To the experimenter, undeterred by the field power requirements and its unconventionality, the magnetron, as was demonstrated, provides a fertile field for research. How-

## Millen\*

ever, to amateurs intimately acquainted with crystal-controlled transmitters on lower frequencies, the possibilities of this more familiar method of frequency stabilization will immediately present themselves—as well as the associated problems.

As radio developments go, quartz crystals have been long used for frequency stabilization in virtue of their piezo-electric or mechanical-electric effect. Placed in a suitable circuit, they limit the oscillations of that circuit to a definite single frequency. Quartz crystals are cut parallel to the optical axis and are capable of vibration along any one of three electrical axes. (An axis is a convenient way of referring to the most efficient path, through a crystal, traversed by a vibratory phenomenon. The optical axis, for instance, refers to the line through which light will be passed without causing double images, or other aberrative phenomena, depending upon the characteristic of the crystal.) The dimensions of the crystal determine the frequencies at which it will oscillate, and for the highest frequencies the thickness of the plate (the smallest dimension) is the deciding factor. The resonating wavelength of a quartz crystal is generally about 110 meters for each millimeter thickness. This consideration logically imposes a limitation upon the lowest wavelength which it is practical to attain. A 5-meter crystal, for instance, would be only 1/22nd millimeter thick—about 1.8 thousandths of an inch! A quartz crystal of this thickness would be quite incapable of standing the gaff. Much thicker crystals disintegrate explosively under the electrical and mechanical stresses of operation. Also, even when operated inefficiently at low powers, ultra-high-frequency quartz crystals give rise to spurious frequencies neighboring the predominant resonance point, resulting in a form of instability quite similar to and as iniquitous as that they are designed to eliminate.

VIEW FROM THE LEFT

Figure 7. This shows the details of construction of the buffer stage and r.f. amplifier

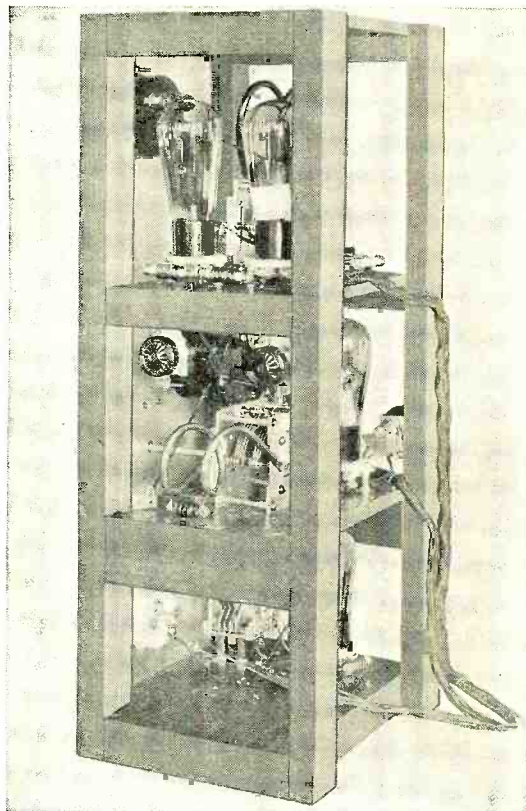

An obvious but theoretical solution to ultra-short-wave, quartz-crystal stabilization is by means of repeated frequency doubling. This is cumbersome and expensive, however, due to the fact that the harmonics are excessively weak, requiring amplification following each doubling stage—resulting in an impractically elaborate set-up.

A real solution to the problem exists in the use of tourmaline (in place of quartz), which permits the operation of the ultra-short-wave transmitter at the fundamental crystal frequency. While the tourmaline piezo-electric constant is about 10% less than quartz, it is altogether adequate for oscillating purposes without use of excessive powers, and even when ground to quasi-optical frequencies, exhibits none of the instability characteristics of quartz. A great deal of the preliminary experimental work on tourmaline crystals has already been done in the American Radio Relay League laboratory at Hartford under the direction of James J. Lamb and reported in the amateur periodical, *QST*. It is also considerably more rugged, suffering no serious consequences even under ultra-high-frequency

## THE COMPLETE SET-UP IN OPERATION

Figure 8. The transmitter being operated by Lloyd Green, radio editor of the Boston Globe. It is used in conjunction with a class B modulator shown in the center. The receiver is the ultra-short-wave super described in the August issue

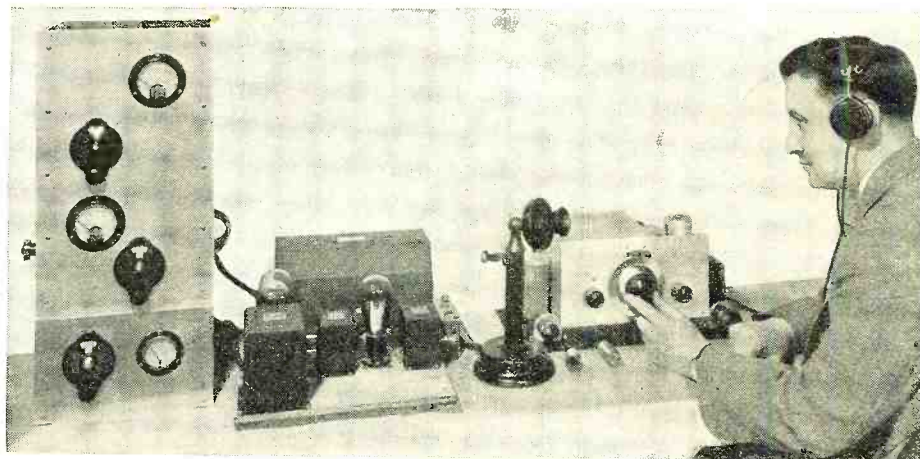



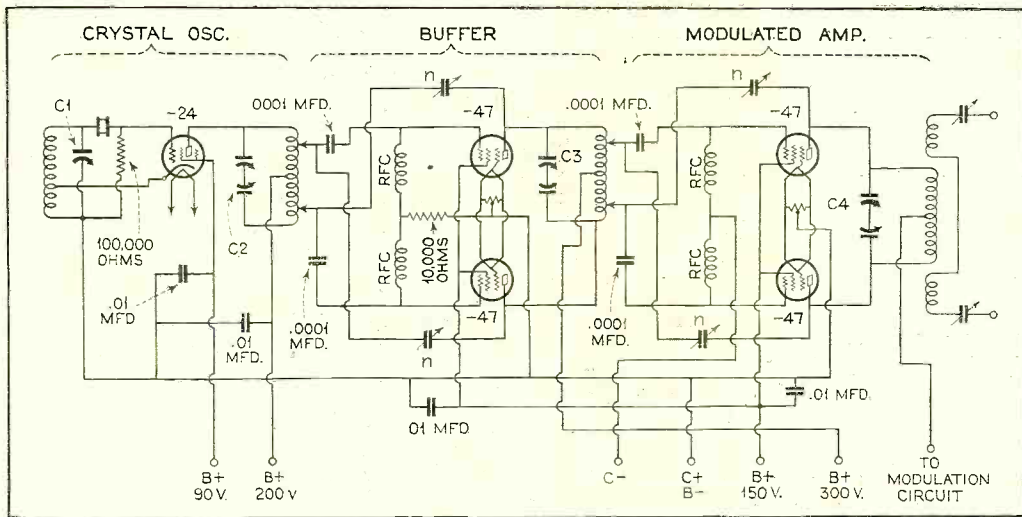

SCHEMATIC DIAGRAM OF THE COMPLETE SYSTEM

Figure 2. This is the scheme of connections for the 56-megacycle crystal-control transmitter. The crystal is ground to the transmitter frequency—no doubling being required

overload, and, as its electrical-mechanical ratio is approximately 80 meters for each millimeter thickness, the plates are approximately 35% thicker than quartz for a given frequency. Circular tourmaline plates also have a smaller diameter than corresponding quartz plates, resulting in an additional strength. A 5-meter tourmaline plate is about 2.5 thousands of an inch thick and about 3/8 inch in diameter. As a matter of incidental interest, the optical axis of tourmaline coincides with an electrical axis, and the plates are therefore cut perpendicular to the optical axis.

**The Crystal Oscillator**

The fundamental crystal circuit is shown in Figure 1, and while it varies slightly from several conventional arrangements, the departures represent the result of considerable engineering and experimentation. The constants of this circuit are such that sufficient regeneration exists to sustain oscillations when the crystal is replaced by a grid condenser. When the crystal is substituted for the grid condenser, the circuit will still function as a self-excited oscillator until the crystal frequency is approached, at which time the crystal will snap into control and maintain it over a considerable range of tank-condenser settings. The milliammeter connected in the screen circuit will show an increase in current as the crystal resonance point is approached, followed by the familiar decrease in current as crystal-controlled oscillations commence. This circuit will be recognized as of the electron-coupled family (accorded detailed description in preceding articles of this series), which still further tends to insure the independent oscillating action of the crystal circuit. One of the many advantages of this arrangement is the fact that it will operate efficiently with low voltages. In fact, it is not necessary to exceed the voltage rating of the type -24 tube—a truly unusual condition in an experimental circuit.

Referring to the complete schematic diagram, Figure 2, it will be observed that the wiring of the buffer stage and final amplifier follows standard practice and is self-explanatory. The use of high-mu tubes is desirable, since difficulty is generally experienced in obtaining sufficient r.f. excitation to insure efficient operation of a low-mu tube, such as the type -45. The type -47 pentodes are ad-

mirably suited for this type of work. They are exceptionally easy to excite and deliver a satisfactory output with a reasonably low-impedance plate load. In operating these tubes it is important to keep the accelerator grid potential below 200 volts, or excessive heating is almost certain to ensue. The plate voltage may be as high as 400 with apparently no ill effects. The circuit in Figure 2 may be effectively modulated by a Class B amplifier, such as that shown in Figure 3. The connections between the modulator and power amplifier are evident. The inductor in the crystal circuit consists of 5 turns of No. 14 bare wire, wound on a 1-inch-diameter form and spaced about 1/4 inch. The position of the tap should be determined experimentally, and the optimum will be found between the first and second turn from the low-potential terminal. The circuit should "just oscillate" when detuned from the crystal frequency. The tuning condenser has a maximum capacity of 18 mmfd. The complete crystal unit is shown in photograph, Figure 4.

**Data on Parts Used**

The center-tapped inductors in the buffer and amplifier circuits are wound with 2 turns of 1/4-inch copper tubing, 2 inches in diameter. These coils are tuned by C2, C3 and C4, National double stator condensers with 100 mmfd. capacity per section. The radio-frequency choke coils are the special ultra-short-wave, type 100, of the same make. The neutralizing condensers, N, have a maximum capacity of 5 mmfd. Voltages and other values are indicated on the diagrams, Figures 1, 2 and 3. It is essential, of course, that low-loss ultra-short-wave parts be consistently employed in all radio-frequency portions of the circuit.

The crystal holder is shown in Figure 5, which drawing, in conjunction with the rear-view photographs, gives an adequate idea of the construction of this unit. Considerable care must be observed in grinding the plates, which must be flat within a few wavelengths of light.

It will be well to emphasize a few general constructional precautions. The layout of the transmitter must be such as to minimize the length of all r.f. leads. The skyscraper construction suggested in the photographs of the experimental transmitter, Figures 6 and 7, is recommended. (Cont'd on page 239)

**THE CRYSTAL HOLDER AND THE MODULATOR CIRCUITS**

Figure 5, at left, shows the mechanical constructional data for the crystal holder given with approximate dimensions of the parts. Figure 3, at right, indicates the proper circuit for the class B amplifier—modulator used in this outfit

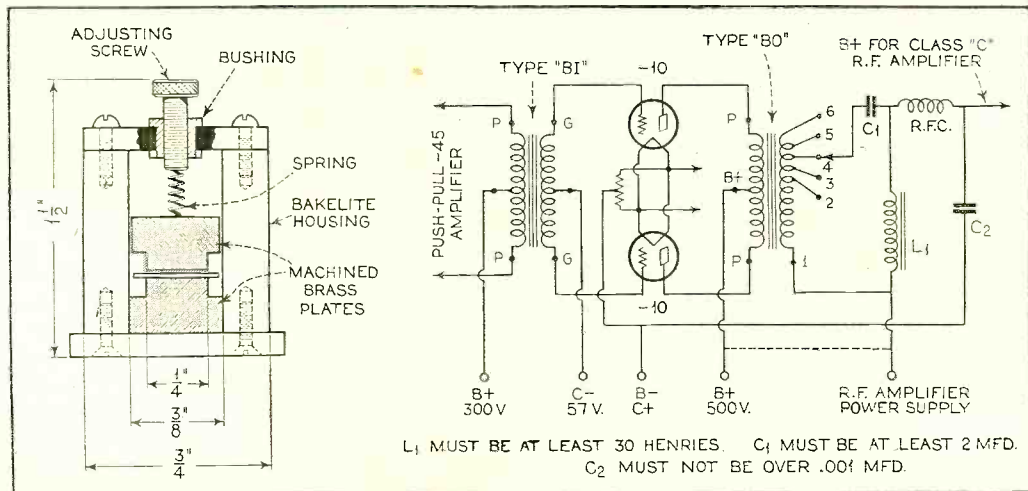



# RELATING SOME HIGH POINTS IN PHOTOCELL PROGRESS

*More and more experimenters and technicians are turning their efforts toward experimentation with light-sensitive apparatus for the control of machinery for detecting bodies, for counting and sorting manufactured products and for work in color matching, etc. The author in this article points out some of the fundamental principles upon which photo-electric devices operate. He also devised them into classes and relates some of the outstanding developmental achievements to date*

By Irving J. Saxl, Ph.D.

**T**HE wide technical application of light-sensitive devices in the fields of radio, television, sound film, for controlling industrial processes and chemical actions; finally the creation of electric energy directly from light have brought about the development of many forms of photo-sensitive apparatus. When Heinrich Hertz, as early as 1887, discovered that the length of electrical discharges as produced by an electrical inductor could be increased when the electrodes between which the spark passed were illuminated by the light of a mercury interrupter, he probably did not dream of the wide industrial and scientific possibilities opened by his discovery and the modern light-sensitive cells which are several hundred times more efficient than the crude device in which he recognized the physical fundamentals of the photo-electric effect.

### Photo-electric Effect

What does this wonder tool of the electronic magician of today consist of? The theory of all types of light-sensitive devices—and there are today quite a number of widely different types—goes back to the common source: the photo-electric effect. Under the influence of electromagnetic radiation, preferably of a frequency which can be seen with the human eye, certain reactions take place in the irradiated material. This law, however, is more general than just for the range of human visibility.

Light and other electromagnetic waves beyond the range of light have an effect upon almost everything in the universe. Light colors the leaves of the trees green by developing chlorophyll particles in them; it influences the halogenides of silver in the emulsions of our photographic films; it sets up a voltage difference in biological material which is irradiated; it acts, with a mechanical force of attraction or repulsion, upon the tails of comets being driven away by the sun's radiation.

Mechanical and chemical reactions are inaugurated under the electromagnetic radiations of certain wavebands, a part of which are of this dimension we humans call color. What physical data do we have about these reactions?

It was William Hallwachs' who took the essential parts of Hertz's

arrangements and simplified his experimental set-up so far that he was able, in 1888, to clarify the problem of photo-electric reaction. This was the thought of Hallwachs: if the light of the mercury interrupter, shining upon the electrodes, could seemingly effect the distance between the electrodes, then probably something was going out from the electrodes which reduced the resistance of the space between them. From where could this something originate, if not from the electrodes themselves?

Electrodes, at that time, were made of zinc. So, for isolating this phenomenon, Hallwachs put a polished zinc sphere upon a sensitive gold-leaf electroscope which he charged negatively. The leaves, ordinarily showing a wide divergence, under these circumstances touched each other almost instantly when the electroscope was irradiated with an arc-light. The negative charge had disappeared, or a positive charge had been acquired, thus neutralizing the system. See Figure 1.

### EARLY PHOTO-ELECTRIC EFFECTS

Figure 1, below, shows the photo effect of light on a charged sphere connected to an electrometer. At the left is the sphere before radiation, showing the gold-leaf repel, and at the right a sphere acted upon by light from an arc with the gold-leaf at rest alongside the electrode. Figure 2, at bottom of page, illustrates Stoletow's experiment, showing that a zinc plate will give off electric particles when illuminated, the particles passing from the zinc plate to the grid and measured by a galvanometer

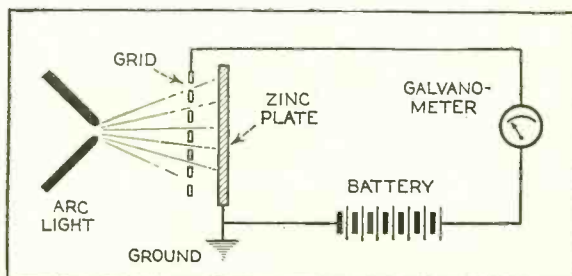
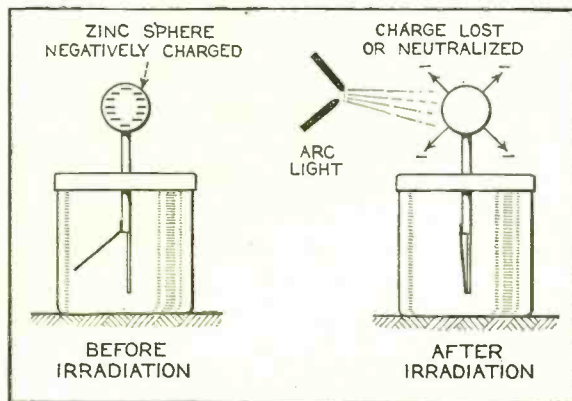

In further investigations, using a sensitive quadrant-electrometer instead of an electroscope, he and other investigators—especially Righi and Stoletow—were able to show that under the influence of electromagnetic waves physically similar to radio waves but of a considerably higher frequency, a negatively charged body loses its charge, whereby such charge outgoing from the body follows practically the lines of electrostatic force!

### Early Experiments

In Stoletow's experiment a polished zinc plate Z (see Figure 2) was exposed to an intensive light source which included the shorter wavelengths. Outgoing negative charges were collected upon a grid G, thus diminishing the space resistance between Z and G and allowing a small current to pass through the sensitive galvanometer G under the influence of the electromotive force delivered by the battery.

This circuit of Stoletow<sup>2</sup> actually disclosed the principles used in many modern photo-electric circuits. However, the energy output of his polished zinc plate, with relation to the light falling upon it, was a small one and inconstant.

For increasing the photo-electric sensitivity, several methods were later followed. First, it was realized



that only a *polished* plate acted satisfactorily. As soon as this plate dulled, mainly by covering itself with a layer of zinc oxide, the photo-electric effect ceased.

Elster and Geitel<sup>3</sup> used, instead of the pure zinc, an amalgamation of zinc and alkaline compounds. Their sodium amalgam, which was enclosed in a glass vessel to prevent oxidation, may be considered as the first photo-cell in use, although it tarnished badly and had to be cleaned by a magnetic scraper. Finally, by discovering that colloidal suspension of the cathode increased the sensitivity by two decimal points, they were able to build a cell which, in many ways, has not been changed considerably in its fundamentals until recently. The increase of sensitivity was produced mainly by passing a glow discharge in a photo-cell filled with hydrogen gas, to evacuate the cell after the sensibilization and to fill it with an inert gas as argon or helium of low pressure.<sup>4</sup>

There are today widely different types of light-sensitive devices which, though they go back to the same fundamental principles, are widely different in their action and appearance. From the various developments along the lines of light-sensitive cells, the following are of practical interest:

1. *Photo-electronic Cells.* These are the cells most widely used, although for many purposes other types of cells seem to be promising.
2. *Wet Photo-voltaic Cells,* using the Becquerel effect, who discovered (in 1839) that a potential difference is created between two electrodes in an electrolyte from which one was irradiated and the other kept in the dark for a period of time.
3. *Dry Photo-voltaic Cells* ("Light batteries," disc cells with copper oxide, silver selenide, etc.)
4. *Photo-conductive Cells* (Selenium bridges, for instance). These have been neglected for some time, but their improved types are now most promising.
5. *Crystal Photo-cells* (effects between minerals, as, for instance, argentite, and their metal contacts).

In this article special attention is given to the newer types of dry and wet photo-voltaic cells.

**How to Make Photo-Voltaic Cells**

Photo-voltaic cells are found in nature. Every leaf, if irradiated, indicates minute voltage changes. These, however, are too low to be measured without special amplification. But certain chemical compounds have been developed with which it is possible to make a photo-voltaic cell (Becquerel cell) for a few cents.

Figure 3 shows a diagrammatic sketch of such a *light-battery*. A beaker of clear glass is filled with a solution of lead nitrate. In this lead solution is immersed a copper plate which has been uniformly coated with

cuprous oxide. At the front of the beaker a lead plate is hung into the solution. The lead plate has a hole in the middle through which the light can enter the cell. The outside of the cell is covered with black paper or coated with a dark lacquer with the exception of a hole at the same place where the hole in the lead plate is. The cell is protected at all sides from light with the exception of that one opening.

If the copper disc is irradiated through this hole, a voltage difference is produced between the lead and the copper electrode. If the two poles are connected in an electric circuit, currents as high as several milliamperes can be produced when the cell is exposed to daylight or sufficient artificial illumination is brought into the cell, for instance, by concentrating the light of an incandescent lamp by a lens before the hole. The amount of current output for a given intensity of light depends to a large extent upon the electrode surface, larger surfaces giving stronger currents.

Besides cuprous oxide, it is possible to use silver halides and many more substances. Even two plates of the same material, one of which is exposed to the light and the other kept in the dark, show the photo-voltaic effect, although not quite so intensively. Investigations made by Garrison<sup>5</sup> indicated that the current produced between the electrodes reverses its direction shortly after the illumination of one plate and flows thereafter in the opposite direction, finally reaching equilibrium.

It is also possible to produce this voltage difference without the aid of an electrolyte. With the aid of discs covered with thin layers of material it is possible (similar to the wet photo-voltaic cells based upon the Becquerel effect) to develop currents directly from sunlight. Considerable research has been done on this idea in the last year. Dr. Lange of Berlin experimented with copper-oxide discs and increased the output of his cells considerably by using silver selenide. His cells delivered *enough current from daylight to drive a small electric motor* similar to the type used in kilowatt-hour meters.

Disc cells have also been developed in the Westinghouse laboratories. They use a copper-oxide disc about the size of a silver dollar. Another disc cell is produced by the Weston Company. Figure 4 shows a picture of this latter cell, called the phototronic cell.

Its output is sufficient to operate a highly sensitive relay of the contact-galvanometer type, as shown in Figure 5, or to read on a microammeter. By calibrating this ammeter in light intensity, it is possible to read illumination (in foot candles) directly. For this latter purpose two cells are used together, as shown in Figure 6.

The current output of the cell

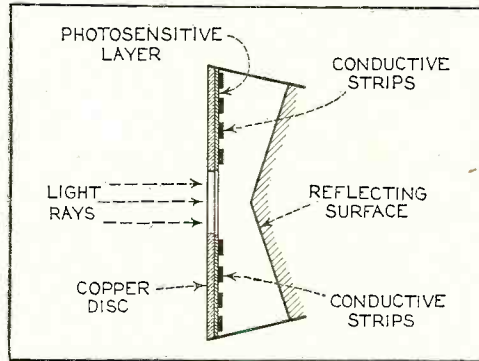

THE DISC CELL

Figure 10. Schematic cross-section view of the disc cell illuminated through a circular opening at the back

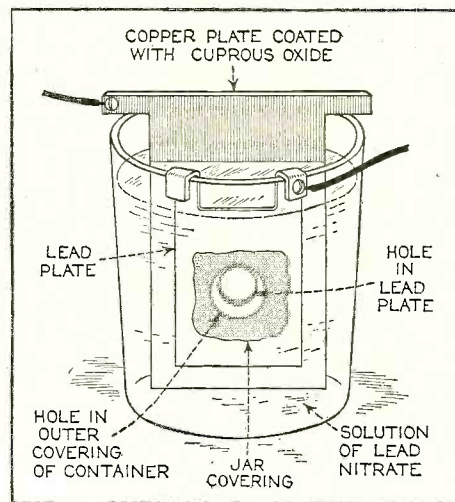
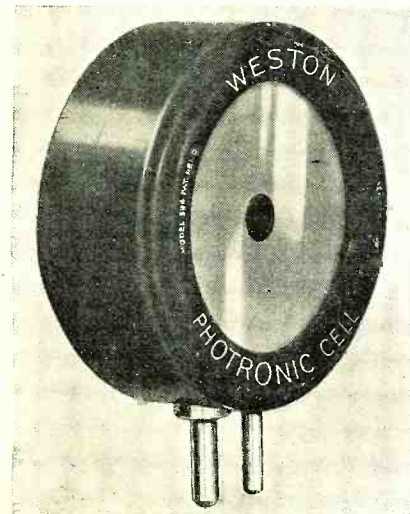

LIGHT-SENSITIVE ARRANGEMENT

Figure 3 is a drawing of the photo-voltaic (Becquerel) cell. Figure 4, at the left, is the new Weston phototronic cell. Figure 9, at the right, is a view of a disc cell showing conductive stripes across the light-sensitive surface

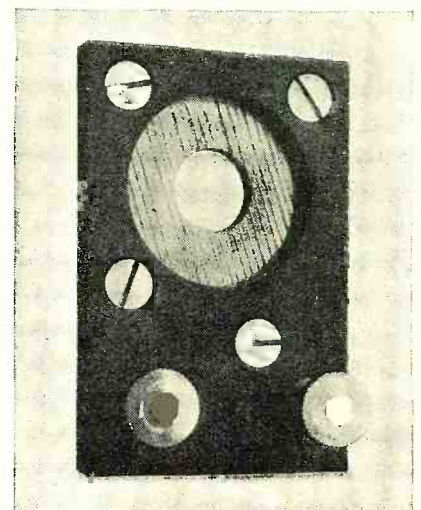



depends upon the light intensity and also the color of the light (its wavelength). The sensitivity maximum for this type cell is somewhat higher in the yellow part of the spectrum, the human eye having maximum sensitivity in the green-yellow part of the spectrum. In photo-cells, however, this increased sensitivity towards the longer light waves can be of advantage if they are operated from artificial light sources (as, for instance, incandescent lamps), the maximum light output of which is also moved towards the red end of the spectrum. In Figure 7 a spectral response curve of the disc cell is given.

There is one more important factor which influences the current output of these cells. This is the external resistance of the circuit in which the cell operates. Like a vacuum tube or a battery, the best performance of any generator of electromotive force can be expected if its internal resistance is approximately equal to the resistance of the circuit. How this looks in the case of the photonic cell is shown in chart in Figure 8. The average sensitivity is about 1.4 microamperes per foot candle.

How is a disc cell actually constructed and how does it work? In Figure 9 is shown a photograph of a device of this type, a cross-section of which is given in Figure 10. The light-sensitive element is a copper plate which has been covered with a specially prepared layer of cuprous oxide. The outer surface of this sensitive layer of minor electric conductivity is covered with a net or stripes (as clearly visible in picture No. 9) which act as the second electrode. Instead of the stripes, other constructions have been used, for instance, conductive clamps attached to the outer circle and to the center of the disc.

**Transparent Metal Used as Second Electrode**

One of the most interesting constructions involved in the manufacture of these cells is the use of a continuous film of metal which covers the entire front surface exposed to the light. This conductive skin is so thin that the light is allowed to pass through the metal. On these so-called "front cells" the photo-electric effect takes place not at the main layer of the metal, but between the metal skin and the semi-conductor! The electrons liberated in this semi-conductive layer do not have to travel a considerable distance through relatively high electric resistance. It can be therefore

understood that losses occurring from the high electrical resistance within the cell can be reduced considerably by construction of this type, and therefore the output of this type front cells is a better one.

In the construction shown in Figures 9 and 10 this outer metallic cover is the positive part of the photo-cell. The second and negative terminal is the solid copper plate upon which the light-sensitive layer had been deposited.

The interior resistance of this photo-cell, measured in the direction of the photo current, is about 350 ohms. Its electric capacity is about 150 centimeters. If the light of an incandescent lamp of about 35 watts is concentrated upon the cell, a photo voltage of about 4 to 5 millivolts is created.

Various theories exist about the working of these generators of electric current which are able to transform light directly into electric energy. One hypothesis, which has been accepted today by investigators, is in principle as follows:

**Theory of the Disc Cell**

The dry cell is in its basic construction similar to the copper-oxide rectifiers. Many laws valid for the latter can be applied readily in the construction of the photo-cells.

The photo current is supposed to be generated by light quanta which fall upon a semi-conductive, light-sensitive layer and generate in it free electronic oscillations. These semi-conductors have a negative coefficient of temperature in their electric resistance characteristics.

The photo-electrons create an electric current by being moved through the blocking layer between the copper oxide and the main copper. This blocking layer has to be extremely thin and, at the same time, of an electrical resistance which is considerably high. It is probably this layer of a few atoms thickness that makes possible not only the creation of a voltage difference (the photo-electric effect), but also the detector effect, the rectifier effect as used in the Grondahl cells<sup>6</sup> and the reactions between minerals and metallic contacts upon them,<sup>7, 8</sup> as, for instance, argentite (Ag<sub>2</sub>S) and metal.

This type of cell is dependent in its action on changes in temperature. If subjected to overheating, the sensitivity of the cell goes down. For precision measurements the temperature should be kept constant.

In Figure 11 the frequency response characteristic (Continued on page 247)

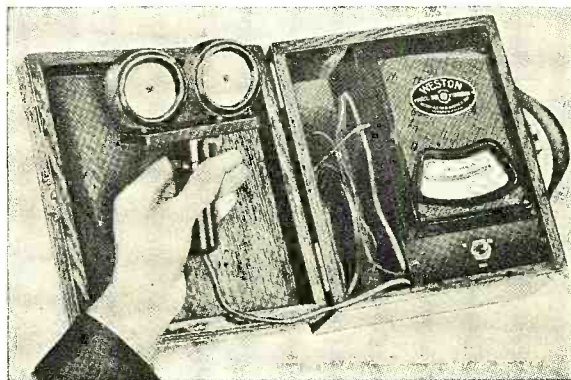

A DISC CELL ILLUMINOMETER

Figure 6. View of a commercial illuminometer that operates without batteries. The device uses two disc cells and is calibrated directly in foot candles

**CURRENT OUTPUT CURVES**

Figure 8. This chart shows the current output curves of the photonic type of photo-electric cell and shows its interdependence with external resistance. The curve is calibrated in illumination foot candles and current in microamperes

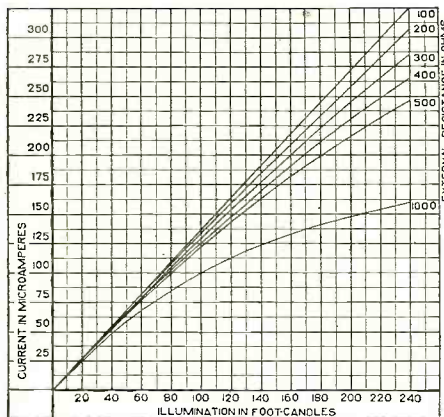

**FREQUENCY RESPONSE CURVE**

Figure 7. Response curve of the photonic cell using a quartz window up to 4000 Angstrom units and a glass window for the longer wavelengths

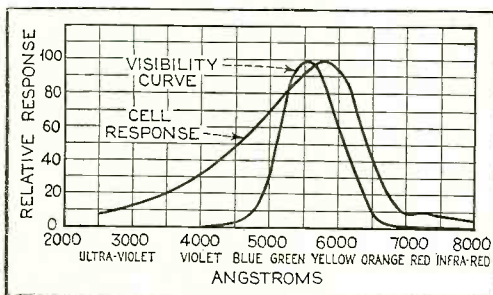

SENSITIVE RELAY

Figure 5. A contact galvanometer of a type which operates directly from a disc cell

**AUDIO-FREQUENCY RESPONSE**

Figure 11. Curve showing audio-frequency response of a disc cell operating a light source interrupted at different audio frequencies

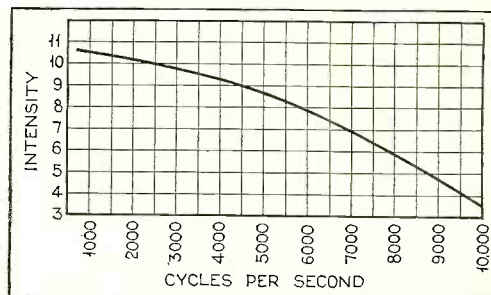



# USING A BALANCED AERIAL SYSTEM TO *Eliminate Interference*

**T**HERE is no doubt that even with the increased power of broadcasting stations today, radio interference still spoils reception in many localities. Part of this interference is due to natural causes such as static, but part of it is also due to inductive interference sometimes called "man-made" static, and still in part some is caused by trouble developed in sets, loose connections, worn out batteries and tubes, etc. A further source is that set up by poorly constructed antennas running in the wrong direction or with improperly erected lead-ins.

However, even with the most carefully constructed antenna, with thoroughly protected lead-ins, properly checked tubes and latest hook-ups, noises often make for poor reception in some instances. Particularly is this true in metropolitan centers where man-made static has come to have a special meaning of its own to listeners-in. These noises in radio reception are due to the filtering into the receiver circuits and inductive impulses coming from elevators, household electrical machinery and sometimes commercial manufacturing plants near by.

Up until recently, engineers have shrugged their shoulders at thoughts of further eliminating these man-made static noises. "The noises are there. If the set, the antenna and the tubes are in proper condition, if the proper filters are installed, what more can be done?" This has been their attitude. Some laymen answered by shutting off their sets entirely. But the technically minded research men have gotten busy with new circuits and antenna systems to try to eliminate trouble. Engineers of the General Motors Radio Corp. have been at work on this problem and have set about to study the causes first and to try to develop means for overcoming interference. At the present time, with many thousands of the installations described in this article in service, they feel they can pronounce their solution generally successfully.

Their analyses show that between 60% and 90% of man-made static interference in radio reception is picked up by the lead-in and ground connections and that only a small percentage is picked up on the flat-top antenna proper. Interference noises from refrigerators, door bells, elevators, telephones, etc., are constantly struggling to get in, therefore, on the lead-in wires.

The new system is a simple affair involving nothing more complicated than a double antenna installation, with a twisted-pair lead-in feeder connected to suitable balancing transformers at the set. In other words, by balancing out all of the noises picked up on the lead-in and ground system equally, the interference is practically eliminated; the balanced transmission line offering a guarded path through the noise field for the radio signals that are picked up, high in the air above local interference. Local "strays" and inductive noises from

the general run of household machinery are thus immediately ejected from the feeder circuit and passed to ground, allowing only the radio signals to operate the sensitive receiver amplifiers.

The question, "How can the radio signal, itself, get through this transmission line," may present itself. The answer lies in the difference in potential between the top antenna wire and the low counterpoise wire on the roof, as seen in Figure 1. This potential difference results in an unbalance which permits the fields surrounding the antenna wires to produce an electric potential which will pass the system to the receiver. Fields, however, that are immediately adjacent and surrounding the lead-in wires will cancel each other out.

**[ By Thomas C. McClary ]**

When the engineers started their investigation the most pressing relief was needed by apartment houses and business buildings where the length of the lead-in could not be governed. The difficulty was overcome by using inductive coupling so that the length of the lead-in with this type of aerial did not matter.

The author investigated one of the apartment building systems in operation in Dayton, Ohio. High over the building, above the noise field, is the antenna on tubular masts. Two wires are used, one directly above the other, about 10 feet apart and 50 feet in length, as shown in Figure 1. The engineer explained that the distance separating these wires must be at least 10 feet, and that the lower wire must be at least 3 feet above the roof—5 feet is preferable. The higher the set of wires are, above any surrounding wires, the better.

The antenna wires should be stranded, enameled copper of at least seven strands of number twenty-two for the best results. They should be at least thirty-five feet in length, longer if possible. One hundred foot is the best length, if space is available. Here the important part of the system begins. The wires must be of exactly the same length, otherwise the counter-balance of outside noises is not accomplished. If guy wires are used for the support of the masts, glass insulators should be used at the ends nearest the mast to break any collected energy from being passed on to the antenna. The antenna should, of course, be placed as far from the noise field as possible.

A twisted-pair lead-in of number nineteen "outside" weather-proofed wire is used, connected to the antenna wires at the ends farthest from the noise field. Mechanically twisted wire is essential as hand-twisted wire is not sufficiently accurate and a loss of sensitivity and noise elimination results. The lead-in wires are anchored to the mast at a point midway between the two antenna wires so that the length of each lead-in, from anchor to antenna, is exactly even. A porcelain cleat attached to a piece of wood serves as an anchor.

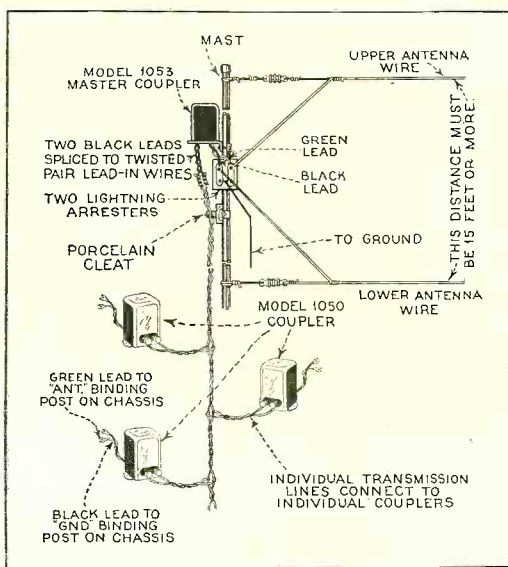

### DATA FOR THE SYSTEM

Figure 2, above, shows the system installed from a diagrammatic viewpoint. Figure 4A, left, shows the transformer connected to receiver while Figure 4B, right, shows the transformer to be connected on the aerial mast

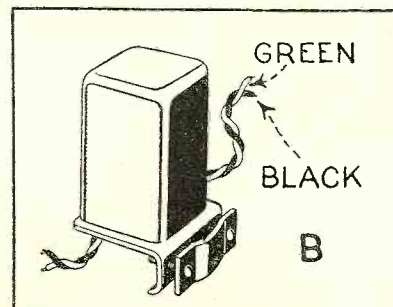
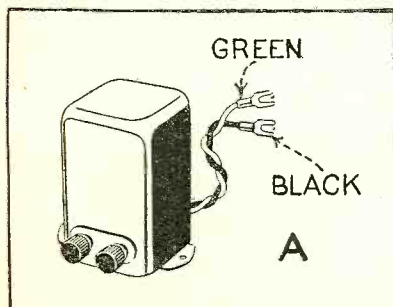



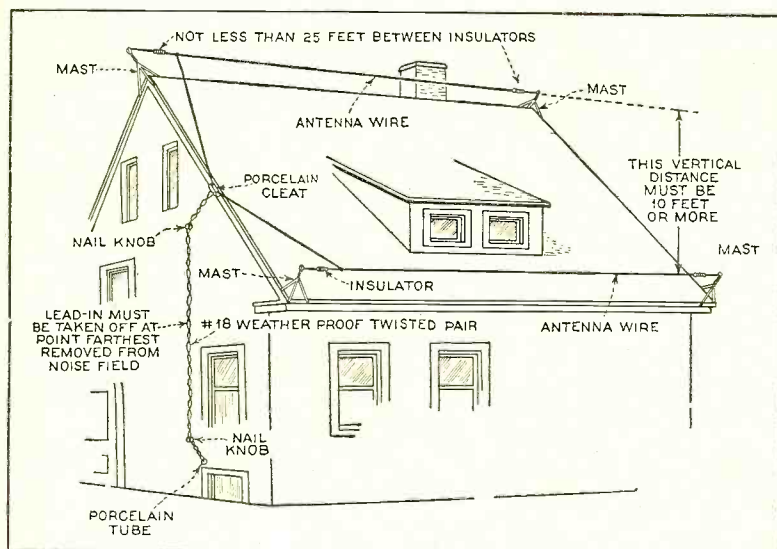

INSTALLATION ON A PRIVATE DWELLING

Figure 3. This drawing shows the main details for constructing the new double antenna system and placing it on a home

However, as two lightning arresters will be used, the better plan is to mount them on a solid block of wood anchored to the mast, and use the binding posts of the arresters for the lead-in, being careful to see that the length of the lead-in from its anchor is exactly even. One post of each arrester is used as a terminal for the lead-in wires, while the ground terminals of the arresters are joined together by a jumper wire and grounded preferably on a cold water pipe.

The twisted-pair lead-in is carried on to the receiver and connected to an antenna coupler which should be mounted as near the receiver chassis binding-posts as possible. The lead-in wires are attached to the coupler, which in turn is joined to the receiver's "ground" and "antenna" binding posts by means of twisted-pair wires.

This same system may be used for any number of receivers up to twenty-five, the only difference being that for a multiple installation a master-coupler should be used between the antennas and the leads-in. In a multi-installation job, the antenna wires should be as long as possible, never less than fifty feet. They should be spaced not less than fifteen feet apart and the lower wire should be not less than from six to ten foot above the roof instead of three to five as is all that is necessary for a single installation. Where a master-coupler is used it is installed on the mast, midway between the two antenna wires—see Figure 2. The lead-in wires are taken from the lightning arrester into the coupler. The two black leads of the master-coupler are then spliced to the main twisted-pair, lead-in wires which connect with the master trunk line.

**Multiple Installations**

To establish the proper polarity, make tests with the first receiver attached to the trunk line of the system. Reverse the green and black leads from the individual coupler to the chassis binding-posts. If there is no difference in volume, the polarity of the master-coupler is reversed where it connects with the two antenna wires. If the polarity of the master-coupler is correct, there should be a decided difference in the volume when the leads from the individual coupler to the receiver are reversed. To change the polarity of a master-coupler it is only necessary to reverse the connections to the antenna wire.

For houses with a sloping roof, or any other location where the tall mast type

of aerial is impractical, the system described is merely laid on its side, see Figure 3. Two wires are used as in the other system, the upper antenna being ten feet or more higher above the ground than the lower one. This is particularly important to remember when installing the antenna on a broad roof with only a slight slope. The lower wire is laid parallel to the upper along the lower edge of the roof.

**Single System for Homes**

Four masts should be used, set so as to keep both antenna wires at least three feet above the roof at all times. The greater the height of both of the antenna wires and the greater the vertical distance between them, the better the results. The twisted-pair lead-in should be anchored midway between the antenna wires so that both wires are the same length from the point of anchorage to the far insulators. Both antenna wires must be exactly the same length, exactly parallel, and connected with the lead-in wires at the point farthest from the noise field. No master-coupler is needed for this single installation; only the type 1050 coupler at the set.

Once the antenna is completed, continuity tests of the antenna and all lead-in wires should be made.

It is important that there be no grounds on either of the two antenna or lead-in wires or between the wires of the twisted-pair lead-in wires, and that the lightning arresters are not short-circuited or grounded. It is also advisable to run a common ground wire to the frames of all metal signs, cornices, etc., on the roof of the building and that conduit or "BX" cables in the building are grounded properly.

Both types of couplers are illustrated in Figure 4a and in Figure 4b.

It is important to remember that such a system as this is not necessarily a cure-all for all radio interference. Its purpose is to eliminate man-made static or interference originating in the house or in the immediate vicinity where it would be picked up by an ordinary lead-in wire. Also—and what is particularly important—it avoids the transfer, to the antenna system, of interference brought into the house over the light lines. Such interference usually is not picked up by the antenna proper but is picked up readily by the ordinary lead-in wire. By eliminating the possibility of pick-up by the lead-in, noises of these types are effectively eliminated.

**DOUBLE ANTENNA ON AN APARTMENT HOUSE**

Figure 1. The essential details for setting up the new interference eliminating balanced antenna system on a flat topped apartment

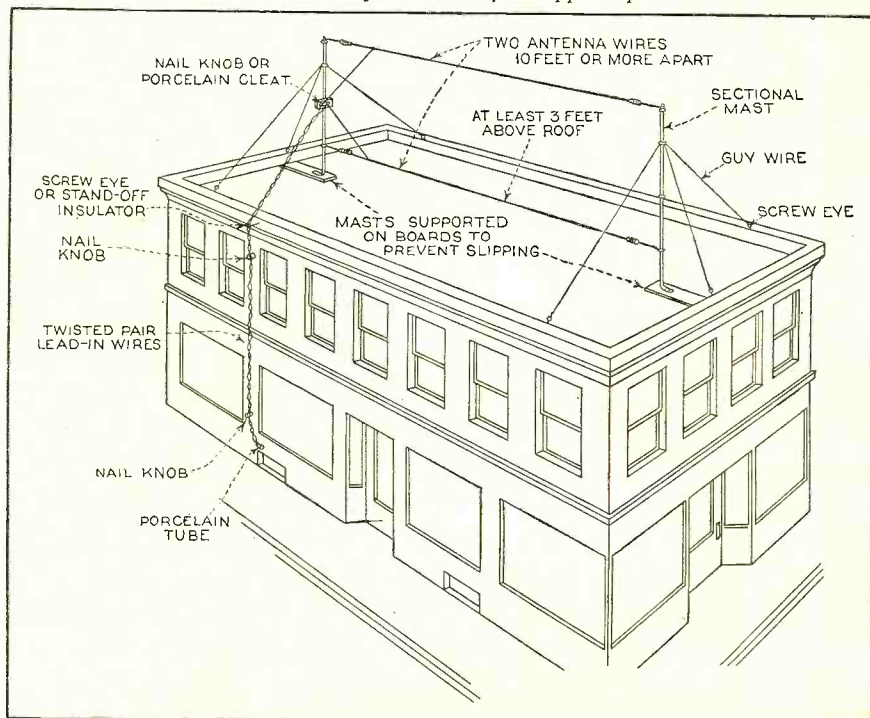



# CRYSTAL MICROPHONES

*and*

# LOUDSPEAKERS

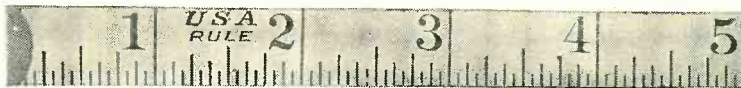

*The use of Rochelle salt crystals for converting electricity into sound and vice versa has been known in the art for some time. But these new devices described here incorporate principles of construction and operation, eliminating some of the faults while at the same time producing new and truly remarkable results*

By C. B. Scott\*

THE piezo-electric characteristics of Rochelle salt crystals give them an inherent ability to convert directly mechanical energy into electrical energy and vice versa. This so-called piezo-electric effect has been known for many years and if homogeneous crystals of large enough size can be grown, it is possible to adapt them for use in energizing radio loudspeakers and also for use as a microphone or phonograph pickup.

As the result of a number of years of research, Dr. C. Baldwin Sawyer and his associates of the Brush Laboratories have developed improved methods for growing and machining these Rochelle salt crystals and also have made a number of practical applications of the crystals to various uses in radio.

One of the main problems in this line of research was the fact that production methods had to be arrived at to get standard crystals in large numbers. Previous experimentation along this line had produced crystals that were either too small, too expensive or too variable and subject to deterioration through the inclusion of "mother" liquor. The method used by Dr. Sawyer produces almost unlimited quantities of homogeneous crystals of standard characteristics.

It was also necessary to learn how to cut and shape suitable crystal slabs. The former method of cutting had consisted of wearing through the crystal by the use of a wet string. This

was unsatisfactory for two reasons; it was very slow and inaccurate. It was finally found, however, that not only saws, but also milling machines, etc., could be used, provided special blades and critical speeds of cutting were used.

It is well known that the properties of the Rochelle Salt Crystal vary with reference to the crystalline axes. Taking as an example a plate cut so that its major surfaces are perpendicular to the electric or "a"-axis, it must of necessity lie in the plane of "b-c" axes, with sides parallel to the "b" or "c" axis (Figure 1). If a plate is so cut and foiled on surfaces perpendicular to the "a"-axis and is then electrified with a 60-cycle, alternating current while corners "x" and "y" are held rigid, all points in edge "q-r" will move synchronously back and forth parallel to the "b"-axis.

If, then, a slab is cut from the plate at 45° to the "b" and "c" axes the shear sensitivity is resolved into compression or extension sensitivity. In other words it is possible to produce single slabs of Rochelle crystal which will expand and con-

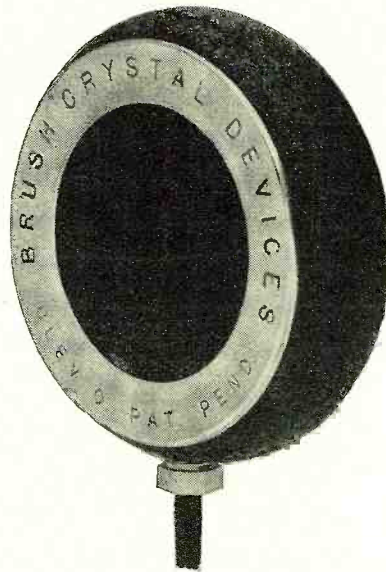

TINY BUT POWERFUL

*This microphone shown with scale illustrates the size of the new crystal device for transmitting sound waves into powerful electric waves with great fidelity*

\* Brush Development Company

### THE PIEZO-LOUDSPEAKER; ITS ELEMENT AND FIDELITY

*The crystal loudspeaker is shown at left. Figure 1 shows the method of cutting used in preparing crystals for piezo-electric application. In Figure 2, at right, is a fidelity curve taken of an installation using one dynamic and one crystal speaker in combination as shown in the output circuit diagram*

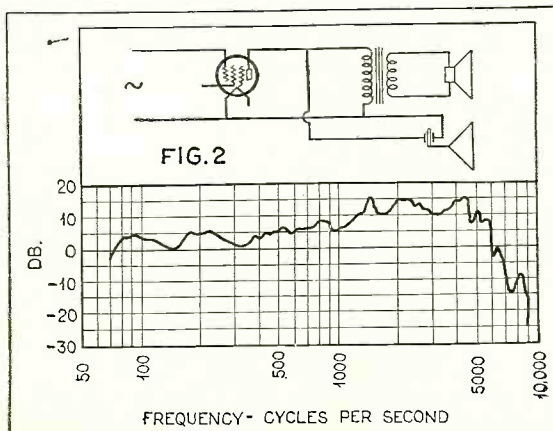
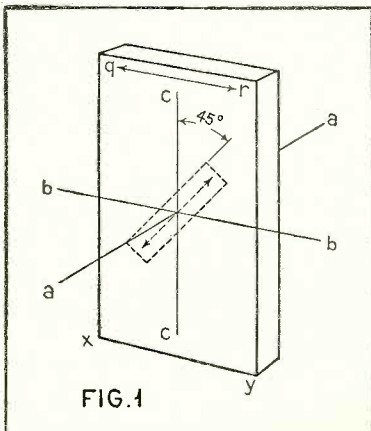
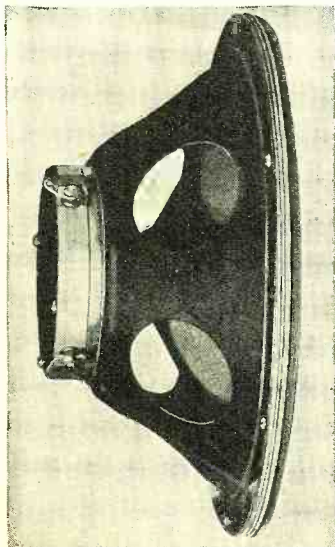



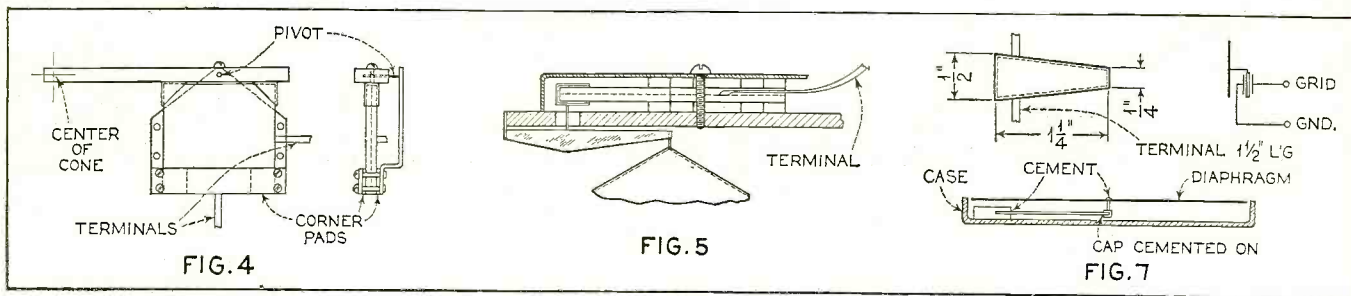

HOW THE AMATEUR EXPERIMENTER MAY USE THESE CRYSTALS

Figure 4 illustrates method of mounting crystal at one side of the center of the cone in a loudspeaker. Figure 5 arranges the parts to mount cone in center of crystal. Figure 7 shows the small crystal element to be used in conjunction with a diaphragm in constructing a microphone

tract or which will vibrate, in shear, in response to an alternating-potential difference. Such slabs, either shear or compression, may be combined as single elements with a sound-reproducing diaphragm and will function as a loudspeaker. In reverse fashion they may function as a microphone.

When two plates are cemented together in mechanical opposition, great magnification of movement is obtained and simultaneously disproportion, such as of saturation, is overcome. Elements employing this plan of differentiation may be constructed either to bend or to twist on the application of electric potential. Either of such elements may act as receivers or emitters of acoustic impulses. Such elements as those described immediately above are known as bi-morphs. Their development comprises the third forward step toward commercial application of Rochelle salt crystals.

Practical Application

At the present time, primary radio interest is in the crystal microphones and loudspeakers. Both of these devices are remarkable for their extreme simplicity. This characteristic is largely due to the lack of necessity for anything analogous to permanent magnets, magnetizing coils, or polarizing fields.

The Brush crystal speaker, type R-95 uses a bi-morph element 2 1/2 inches square and 1/4 inch thick, overall. It consists of two foiled plates, cemented together and provided with positive and negative electrodes. This plate is firmly held in the "motor" housing, with three corners clamped between rubber pads. The fourth corner, which is left free to vibrate, is connected by means of a metal corner piece and linked to an amplifying tone arm, the length of which may be varied depending upon the amplitude of motion desired, but which in the type R-95 speaker gives an amplifying ratio of approximately 2 1/2 to 1. The free end of the tone arm is connected to a conventional speaker cone. As the crystal reacts through a frequency range from 0-500,000 cycles, the

limit of speaker sound reproduction is only that imposed by materials used in tone arm and cone. The cone is held rigid by a riveted gasket around the circumference of the frame. The finished speaker, with a 9 1/2-inch cone, is 3 3/4 inches deep overall and weighs only two pounds.

Advantages of Crystal Speakers

From the electrical point of view, the crystal speaker has several advantages. It is voltage-operated and the current consumption is very low. As has already been said, it requires neither field current nor polarizing voltage. On account of these features, it has been recognized as being valuable in multi-speaker installations for schools, hospitals, hotels, etc. Due to its superior efficiency, several may be operated at equal volume, on the same amount of power ordinarily required to operate one of the present types of speakers!

For purpose of transformer design, this speaker is considered to have a negative impedance of about 25,000 ohms at 1000 cycles (it has similar characteristics to a .03 microfarad condenser). When taking the output of type 47 pentode tubes, it operates extremely satisfactorily across an output choke. The speaker has astonishing volume across a pair of -30 tubes in push-pull and for battery-operated sets should be ideal when operated by a pair of these little tubes. The accompanying diagrams in Figure 8 suggest several types of output circuits.

For some time radio manufac- (Continued on page 246)

ADDITIONAL TECHNICAL DATA

Figure 3 shows the circuit for using two crystal speakers and a dynamic for theatre work and gives curves showing flat load characteristics. Figure 6 contains an output curve of a crystal microphone. Figure 8, at A, B, C and D are shown four methods for connecting crystal speakers to set having different output tubes

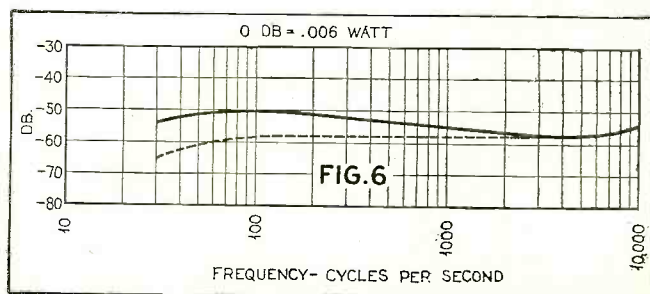
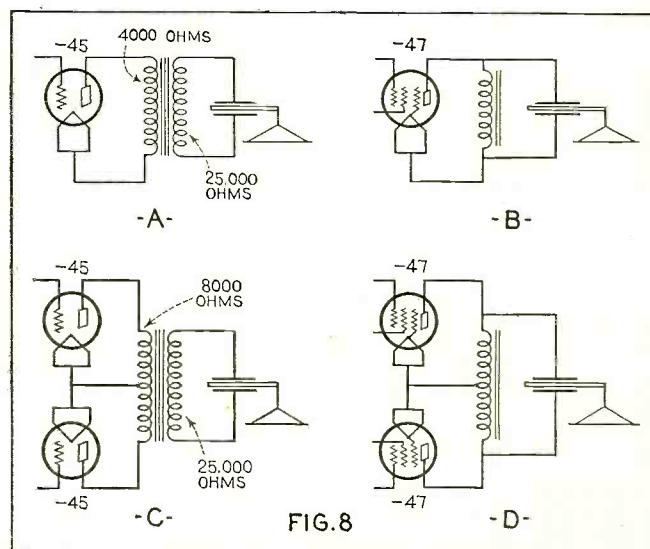
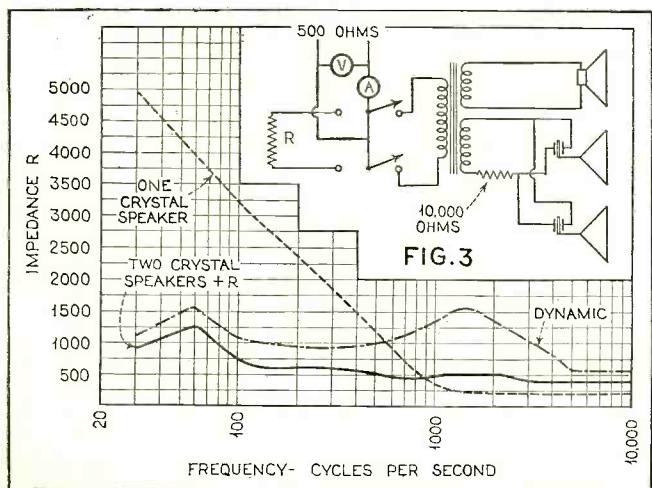



# Eliminating “Between-Station Noise” in Tuning A.V.C. Receivers

*One drawback encountered in receivers which include automatic volume control has been the high noise level when tuning between stations. One of radio's newest developments offers a practical method of overcoming this obstacle—automatically*

**H**AVE you ever noticed in tuning a radio set that static is most noticeable between stations and that when you tune in a good strong signal the static disappears almost entirely? Wouldn't it be nice if we could go from one station to another without having any static between stations? Wouldn't it be even better if one could omit all of those signals which are chopped up with static and bring in only those signals which are strong enough to override and blanket out the static, leaving only undefiled, enjoyable music? This is exactly what is accomplished by the “Statomit” circuit to be described in this article.

The amount of energy contained in crashes of static is really very small. The duration is so short that the forces acting do not have time to accumulate any measurable energy. This may seem strange, considering the terrific crashing noises in the loudspeaker, but it is true, nevertheless.

The energy in a radio wave being continuous, even though appearing less, actually contains more energy than the intermittent bursts of static. This fact is the basis of the modern radio that omits static between stations.

### The Basic System

The energy in the radio wave is amplified through the radio-frequency end of the set and impressed upon the detector. At the time that it is stripped of its audio-frequency component, the radio-frequency component or carrier is rectified and used to provide an automatic volume-control bias voltage. This voltage is applied to the radio-frequency amplifier so as to maintain a constant volume. This same voltage is utilized in the system described here to operate a relay to silence the set between stations by controlling the audio amplifier in such a way that it is blocked except when a signal is tuned in.

A mechanical relay might be operated in the plate circuit of a tube controlled by this automatic volume-control bias voltage by causing it to short circuit some portion of the audio-frequency amplifier, but such a relay would necessarily be delicate and subject to mechanical troubles such as bad contact, chattering, sluggish action during cold weather, and would also cost much more than the scheme finally adopted.

In general, the outline of the scheme is such that this automatic volume-control bias voltage is amplified and applied to the grid return of one of the audio tubes in such a way as to completely block passage of any current. Further,

the action is such that the effect is cumulative; that is, the energizing voltage applied to the amplifier tube is aided by the effect it causes. This insures that the action once started will carry through to completion without any possibility of lag or motorboating. The effect is one of complete and instantaneous cut-off.

The simplified circuit is shown in Figure 1. The automatic volume-control bias voltage is represented by a battery and potentiometer between ground and grid of T1, the tube employed to provide the “Statomit” action. When this voltage is zero and no signal is coming in, the grid is at such a voltage as to permit considerable current to flow from the plate of this tube through  $R_x$ , producing a voltage across  $R_x$ . This voltage is applied to the grid of the first audio tube (T2) and is sufficient to completely block this tube so that no static can come through.

### Carrier Wave Unblocks Audio Tube

If a signal is tuned in and a negative voltage generated by the rectifier, this negative voltage is applied to the grid of T1, completely blocking it, and the voltage across  $R_x$  falls to zero, unblocking the audio tube and permitting it to amplify and pass the signal through to the loudspeaker.

This action is cumulative and self-locking in such a way that when once started it carries itself through. This is accomplished in the following manner:

The voltage  $E_t$  on the grid of T1 is composed of the drop across  $R_y$  plus the automatic volume-control bias voltage. These voltages are in series aiding. The voltage across  $R_y$  is produced by total current composed of several constant currents plus the variable currents  $I_s$  and  $I_a$ . When the set is blocked,  $I_s$  is at a maximum and  $I_a$  is zero; therefore, only  $I_s$  is effective in helping to produce the voltage across  $R_y$ . When the set is operative,  $I_s$  is zero and  $I_a$  is at a maximum. Because maximum  $I_a$  is greater than maximum  $I_s$ , the voltage

across  $R_y$  will be greater when the set is operative than when the set is blocked. Now the voltage across  $R_y$  is aiding the voltage from the automatic volume-control tube, therefore when this automatic volume-control bias voltage builds up to the point where it operates to unblock the audio system, it is locked in this position by this aiding voltage.

This locking action is illustrated in the curve shown in Figure 2. Assume that the automatic volume-control bias voltage is zero and the set is operative. When the automatic volume-control bias increases until

[ By W. A. Smith\* ]

### A RECEIVER WHICH EMPLOYS THE “STATOMIT”

*The new 16-tube Midwest all-wave receiver, in addition to many other features, includes the Statomit system of noise reduction and the complete shielding called for by this system*

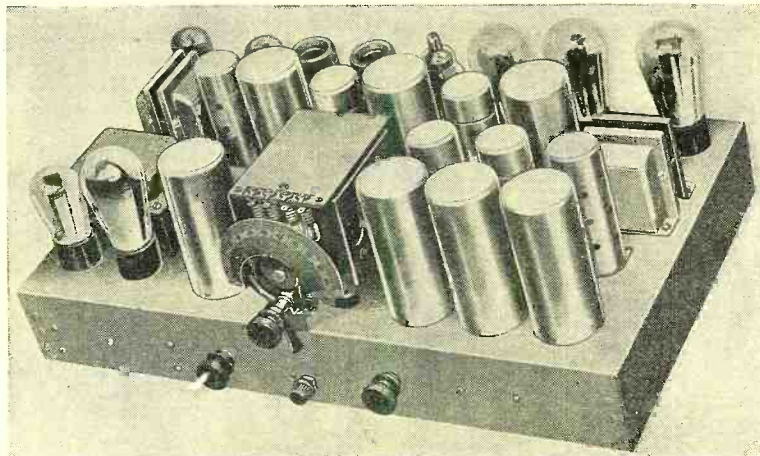

\* Chief Engineer,  
Midwest Radio Corp.



it reaches the point marked L, its effect is to produce a drop in voltage across  $R_x$ , permitting passage of small current to the audio tube so that  $I_s$  is decreasing and  $I_a$  is increasing. As soon as  $I_a$  becomes greater than  $I_s$ , the locking action takes place and instantly the curve shifts to point N. This action is controllable by condensers to prevent clicks and surges, but without such condensers the action is quite violent. Any further increase in the automatic volume-control bias can produce no further effect on  $I_a$  because  $I_s$  is already zero.

**Under Full Control**

If the automatic volume-control bias is decreased because of lower signal voltage, it is necessary that it decrease to the point P before any effect is noted on  $I_a$ . It is necessary that  $I_s$  increase above  $I_a$  before the decrease in the voltage across  $R_y$  is effective. Instantly that point is noted, the current in  $I_a$  drops to zero and the set is completely blocked.

The distance between N and P may be adjusted by means of resistors  $R_x$ ,  $R_y$  and  $R_z$ . It is adjusted to the point where fading of signals does not produce blocking of the set unless the fading is sufficient to produce the signal below the static level. This insures that when a signal is once tuned in it will remain until such times as it is useless for entertainment purposes.

**Actual Circuit**

The circuit actually used is shown in Figure 3. The tubes selected, as shown in this circuit, were more positive in their action than the triodes shown in Figure 1. The cut-off points are very definite in the -57 type tube and the screen-grid currents further aid in the action described previously.

The area L M N P L (Figure 2) may be shifted along the abscissae by adjusting  $R_y$ . With a larger  $R_y$  aiding the automatic volume-control bias voltage, the operative point of the set is lowered to a more sensitive point so that fainter signals may be heard. The value of  $R_y$  may be increased to a point where the set is never blocked, even with the antenna shorted. This insures that even the faintest signals may be tuned in. The value of  $R_y$  may be decreased to the point where exceedingly strong signals

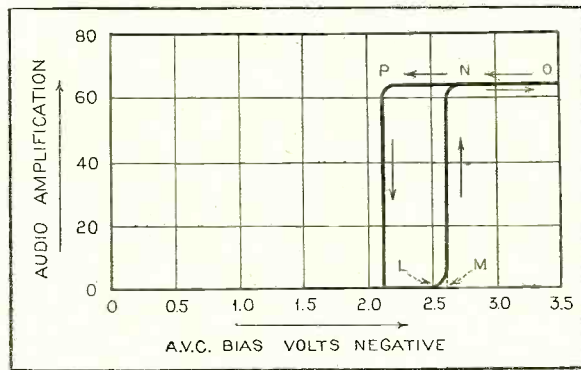

THE "STATOMIT" OPERATING CURVE

Figure 2. Shows how the audio amplifier is inoperative until a signal providing an input above a certain predetermined level is tuned in

are required to produce sufficient automatic volume-control bias to unblock the set. This enables the operator to set the level in such a manner that none but strong local stations can be heard.

This resistance  $R_y$ , in the form of a simple rheostat, is placed on the panel of the set, available to the operator's control. For ordinary home use it may be set in such a way that the receiver is absolutely quiet except to local stations, and these may be tuned in without hearing a sound on any part of the dial except where the local stations occur. If DX reception is desired, on the other hand, the listener can set this control for full sensitivity of the receiver so that the faintest signals may be heard at any part of the dial. In other words, the sensitivity of the set may be set at any point to suit the tastes of anyone.

Such a device, intended to render the set inoperative on static, requires that every precaution be taken to eliminate static by careful shielding. Shielding must not only be maintained to prevent pick-up of static but must extend between coils and stages to prevent hiss, superaudible oscillation, and any self-modulation that would generate voltages in the automatic volume-control bias generator. No voltages should be permitted to reach the statomit tube except carrier voltages. An example of this complete and individual shielding is shown in the photographs of the new Midwest receiver, which makes use of the "Statomit" system.

**A Step Forward**

It is not difficult to appreciate the advantages that this new development will provide in receivers in which it is incorporated. It easily satisfies those who object to the crashes of static which occur

between stations on sets containing the usual automatic volume control, and it also satisfies those pioneers of the air who like to search out stations from the far corners of the United States and, on the short-wave bands, from the opposite sides of the earth. Such receivers are truly individualistic in that they can be set for the exact degree of sensitivity required by any listener or permitted by the noise level in any particular location.

ONE after another, new radio developments appear. Some stand the test of practical application, while others fall by the wayside. Occasionally we find one which represents a distinct and outstanding improvement; among these we might number single control, complete shielding, pentode and certain other of the modern tubes, meter tuning, and automatic volume control. Now we have another type of automatic control as described in this article, which is more than likely to be adopted universally in the year to come.

THE FUNDAMENTAL CIRCUIT

Figure 1. This shows the basic circuit, T1 being the tube which functions as the automatic noise eliminator

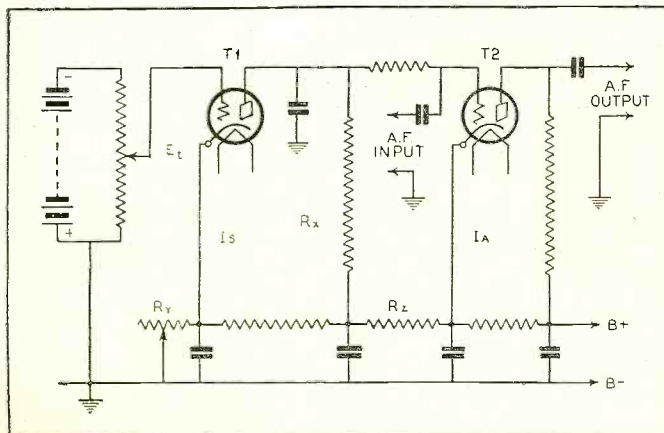

THE COMPLETE "STATOMIT" CIRCUIT

Figure 3. This is the circuit of Figure 1 as actually applied in the Midwest receiver and discussed in the text

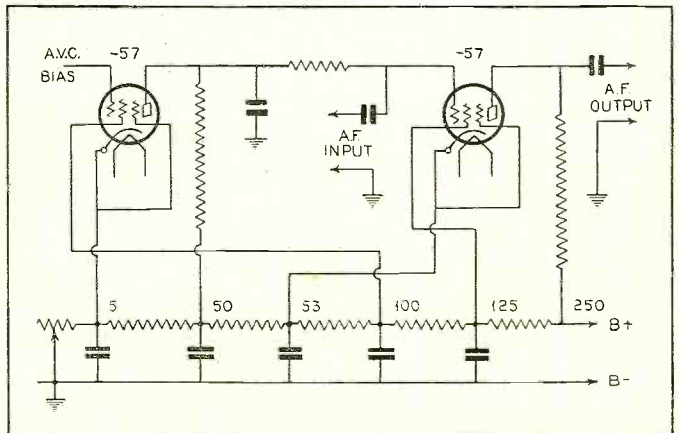



## PARTS READY FOR ASSEMBLY

*A is the "pot" from an old Magnavox horn speaker; B, the diaphragm and voice coil and their ring mountings; C, top plate with supporting ring attached; D and E, housing and mounting stand; F, sponge rubber cushion*

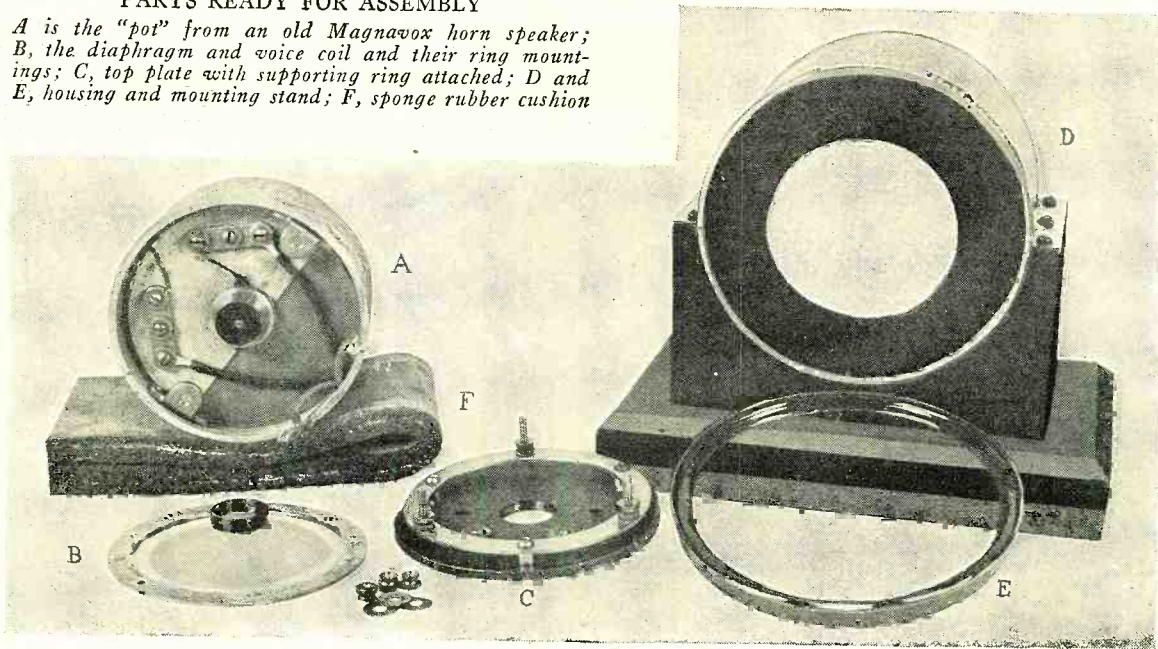

## COMPLETE CONSTRUCTIONAL DETAILS ON A Dynamic Microphone

*Last month the authors gave detailed instructions for making and mounting the diaphragm and voice coil. This month they conclude the description with instructions on assembling the completed unit*

By Paul S. Zolnier and Julius E. Selliken

**W**ITH the voice coil and diaphragm assembly completed, as described last month, the work of assembling the complete unit can be undertaken.

Slip the diaphragm ring over the upright screws in the supporting ring, at the same time passing the leads from the voice coil through the hole in the top plate. Turn the adjusting nuts until the lower edge of the voice coil comes even with the under side of the top plate. Tighten the locking nuts, when the voice coil has been centered in the top plate by moving the entire clamping ring assembly. Solder the two wires from the voice coil to the terminal block on the underside of the top plate. From the same terminals bring out two leads through the hole in the side of the case to the terminal strip to be later fastened on the back of the microphone case.

With precision, carefully lower the top plate with completed diaphragm assembly onto the field case and tighten the top plate screws with a pair of flat-nose pliers. No further centering adjustments should now be necessary. But, if upon depressing the cone it is found to be off center, a slight re-adjustment should be made by loosening the locking nuts and shifting the entire ring assembly until the coil is centered. Retighten the locking nuts.

The terminal strip is of hard rubber  $2\frac{3}{8}$  inches by 1 inch with corners rounded to a  $\frac{1}{4}$ -inch radius and holes drilled in accordance

### Part Two

with the photograph of the rear of the unit (shown last month). This strip is fastened to the back of the case with  $8/32$  machine screws in holes formerly used for holding the pot to the base. Small pillars are used to support the strip. Connect the voice coil leads to the upper two terminals and the field leads to the lower two. These terminals should be plainly marked to avoid the possibility of connecting the field supply voltage to the voice coil.

### Mounting the Microphone

The ordinary spring suspension used for carbon microphones is not applicable to dynamic microphones due to the greater weight to be suspended. A good mounting is illustrated in the photographs and Figure 4. The base is 5 inches by 8 inches, with the top edge beveled. The two pieces which form a cradle for the microphone case are 6 inches by 3 inches by  $\frac{3}{4}$ -inch blocks. Cut from each piece a semi-circular segment with a 5-inch diameter. Smooth off any irregularities with a rasp. Now cut two blocks 3 inches by  $1\frac{1}{2}$  inches by  $\frac{1}{2}$  inch to be attached between the cradle blocks. Sandpaper the completed base preparatory to painting.

The microphone case has its humble origin in a one-pound "Beechnut" coffee can, 5 inches in diameter. In the center of the bottom of the can (which becomes the front of the case) cut a 3-inch hole. The same

### SIDE VIEW OF DIAPHRAGM ASSEMBLY

*The relative positions of diaphragm, top plate and rings are shown. This model varies slightly from the one described in the text, inasmuch as it does not include a clamping ring*

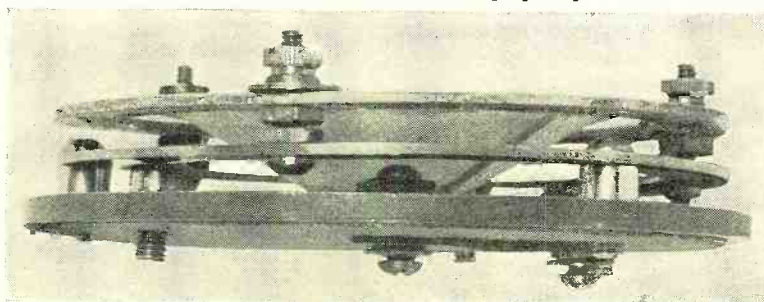



procedure is followed with the can cover, except that the cutout is made on the largest indented circle. Using a knife, make two cut-outs in the side of the can,  $3\frac{3}{4}$  inches by  $\frac{1}{2}$  inch, following along the rolled bottom edge of the can. There will be a  $1\frac{1}{2}$ -inch space on top of the case between these cut-outs.

**Housing**

To protect the microphone diaphragm, cut out a  $3\frac{3}{4}$ -inch circle of  $\frac{1}{8}$ -inch mesh hardware cloth and solder it in place inside the can to cover the opening. Likewise, cut strips of the same material and solder under the long cut-outs on the side of the can.

The can is then set in the cradle blocks and soldered fast to two strips of tin 3 inches by  $1\frac{1}{2}$  inches which previously have been drilled for wood screws, bent and fastened to the tops of the cradle blocks. The entire microphone mounting is cushioned by two strips of sponge rubber (cut from a kneeling-pad, obtainable in the 5 and 10-cent store) and fastened in the bottom of the base with collodion. Can and stand may now be given one or two coats of lacquer or enamel. When this has dried, wrap the microphone in a 12-inch by 3-inch strip of the sponge rubber and slide the microphone into the case, making sure that the microphone does not remain in direct contact with any part of the case. Put on the ring made from the can cover, and the microphone is ready for service.

In using this microphone with an amplifier it is very important to secure a good impedance match between the input transformer (of the amplifier) and the microphone; otherwise the results will not come up to expectations. A transformer having a primary impedance of 50 to 100 ohms and secondary matching the tube input impedance will be suitable. The microphone field supply is obtained from a six-volt storage battery. In order to obtain good volume and quality from a push-pull -45 output stage, it is desirable to utilize an amplifier with a high gain -24 first stage, resistance-coupled to a -27 feeding the output stage. With a parallel -50 stage instead of the -45 push-pull, the output will be suitable for use in modulating a 15-watt transmitter amplifier stage.

**Suggestions on Use**

Run the voice-coil leads in a grounded shield to avoid instability. For the same reason keep the microphone away from the loudspeaker. Do not have the microphone far distant from the amplifier, because the small energy output of the microphone is easily dissipated by the resistance of long output leads. If a considerable separation is necessary, it is better to employ a one-stage head amplifier near the microphone, in which case the main amplifier usually need be only a two-stage affair.

Any extra care taken in constructing and adjusting this dynamic microphone will repay the builder, because when it is properly made the results ob-

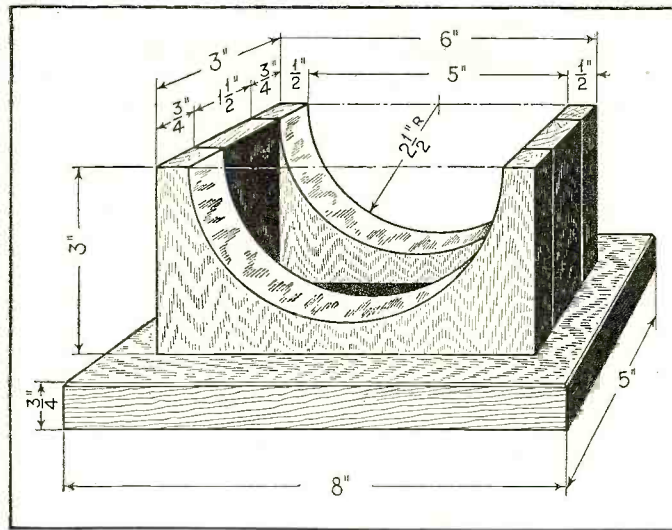

THE MOUNTING BASE

Figure 4. Specifications for the wood base and cradle

tained when used in conjunction with a good amplifier are more than gratifying.

It is quite probable that many readers who may wish to construct this microphone will find it impossible to obtain the field coil assembly from an old Magnavox speaker. These speakers are no longer manufactured and are not carried in stock by dealers. Many readers will of course have one on hand from the old days when this type of speaker was considered a close approach to the ideal, but for readers who are not so fortunate and cannot buy, beg or borrow one from somebody else, the best source of supply will be found in the second-hand dealer.

The inability to obtain the Magnavox speaker will not, however, prevent the reader from constructing a dynamic microphone along the lines described here. The field coil from any moving-coil type of dynamic speaker can be used, and where this is done it will simply be necessary to change the dimensions of the field coil and possibly the diaphragm, as given in the article last month. The same constructional principles may be employed, although it may be desirable to experiment with the number of turns on the voice coil.

**Another Dynamic "Mike" Coming**

*In the near future another article is planned, giving complete constructional details on a dynamic microphone which employs the field coil from a standard type of inexpensive dynamic speaker. The necessary experimental work is being carried on at the present time and it is hoped that the material will be ready for publication in either the November or December issues.—THE EDITORS.*

**READY FOR USE**

*A "professional" looking instrument—and its operating qualities are even better than its appearance*

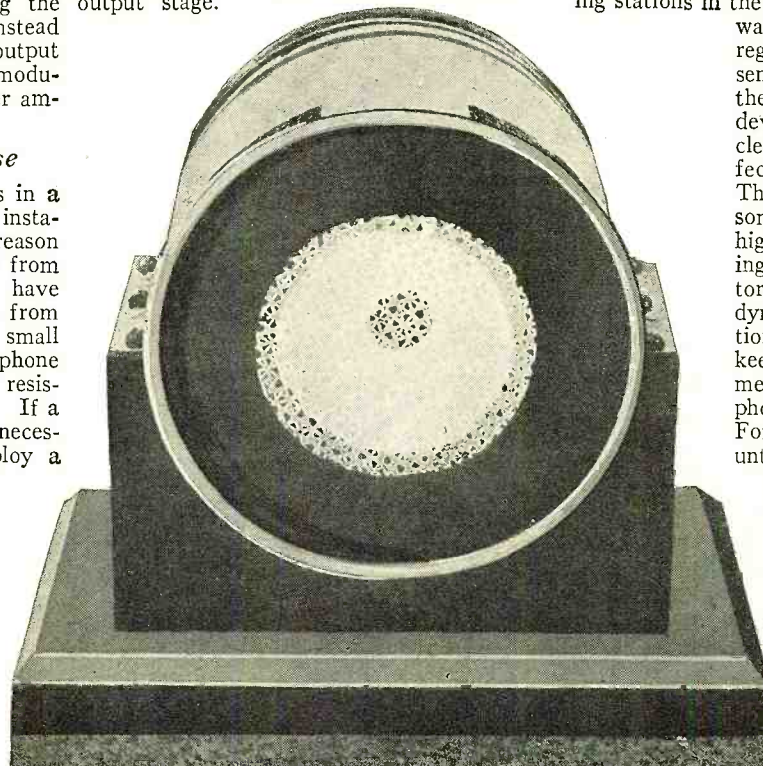

An interesting and impressive illustration of the unusually fine quality of reproduction afforded by the dynamic type of microphone is found in a story brought to the editors' attention recently. In one of the popular broadcasting stations in the East a series of sound effects

was provided for certain of the regular feature programs presented over this station. Among the other contrivances was one device employing a vacuum cleaner to provide the sound effect of an airplane in flight. This device had been used for some time and was considered a highly satisfactory and convincing imitation of an airplane motor. With the introduction of dynamic microphones this station, in line with its policy of keeping up to date in its equipment, replaced the older microphones with this newer type. For a few days all went well—until the time arrived for a program which featured the airplane. The vacuum cleaner was called into play as usual—and then the fun began. So truthful was the reproduction of the new microphone that the entire range of sound produced by the cleaner was reproduced and it sounded exactly like a

(Cont'd on page 245)



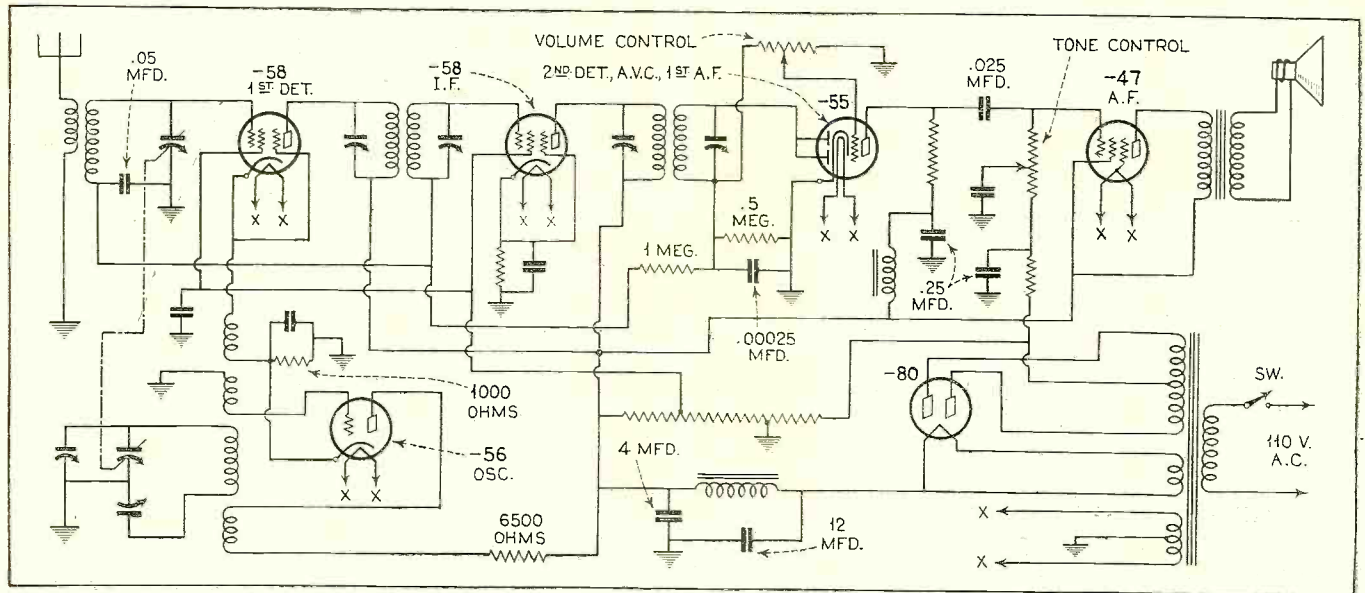

Figure 3. The Schematic Circuit Diagram

# NEW DEVELOPMENTS IN DESIGN RESULT IN Low-Cost Receiver

*New tubes and circuit arrangements make it possible to produce a receiver which includes some of the ultra-modern refinements for a fraction of the cost of the mediocre receivers of a few years ago*

**R**EALLY fine radios can now be bought for prices that a few years ago were considered rock-bottom

for even the cheapest of sets, but despite this fact there are still many homes without radios, simply because the family exchequer cannot stand the drain of seventy-five dollars or more for even the finest of radios. It was as much this condition as any other that brought the midget receiver into being.

We find today really good midgets, or personal radios, selling at thirty to fifty dollars, and they fit a definite niche in the market. Of course, their sensitivity, selectivity and fidelity are not comparable to sets selling at two to three times their prices, but they do represent very satisfactory sets for what they are intended to be. The receiver to be described herewith has been developed in the month following the annual R.M.A. Trade Show, after an examination of all competitive sets there exhibited, and incorporates a number of new technical features found in no other sets today, since they, too, were developed after the Trade Show.

The complete chassis and speaker assembly is seen in Figure 1, in which it will be noted that the eight-inch electro-dynamic speaker is an integral part of the chassis. This allows the entire set to be placed in a simple table cabinet. It is quite possible, however, to separate the speaker and chassis so they can be mounted in a console if preferred.

The set itself employs six tubes in a superheterodyne circuit with automatic con-

By **McMurdo Silver\***

trol obtained through the use of the new -55 duo-diode-triode tube. These tubes are a -58 vari-mu r.f. pentode first detector, -56 oscillator, -58 i.f. amplifier (465 kc.), -55 second or audio power detector, first audio stage and a.v.c. combined, -47 pentode output tube and an -80 rectifier. At this point some question may arise in the minds of those who have read the writer's article in the July, 1932, issue of RADIO NEWS, as to why a pentode instead of a -45, and the answer is that this set is built to sell for about thirty dollars retail, and is expected to provide the very finest possible tone quality, hence the high power sensitivity and power output of the pentode must be taken advantage of. If the set is not called on to deliver over 3 watts of audio power, its tone quality will be quite acceptable for the purposes for which it is intended—as an inexpensive temporary "first" set, or as a "second" or "personal" set in an already radio equipped home.

Likewise, the question will arise as to why the type -80 rectifier instead of the newer -82 mercury vapor type. Here again the answer is economy. The -80 is cheaper to filter, since it generates far less r.f. noise than does the -82, and for a six-tube set its output and power regulation are more than ample for all requirements. Hence economy and efficiency dictate the use of an -80.

The receiver is interesting because it demonstrates just how, with raw material and labor costs at their present low levels, a sensitivity of 12 to 25 microvolts absolute, selectivity which will be absolute two channel if not one, and fidelity flat to 6db. from 30 to 4000 cycles

### UNDER THE CHASSIS

Figure 2. In spite of its compact construction, the parts are readily accessible for inspection, test or repair

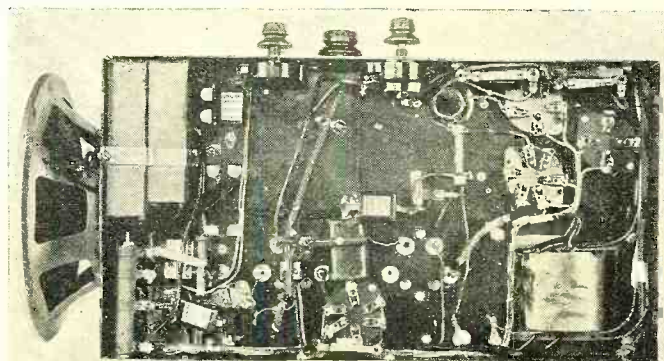

\* President, Silver-Marshall, Inc.



with an undistorted output of three watts, can all be built into a set to sell complete at around the thirty dollar price mark. Yet just four years ago all this could not be had at any price!

The chassis, just 18 inches long and 8 1/4 inches square, including its 8 1/4 inch electro-dynamic speaker, is illustrated in Figures 1 and 2, with its circuit in Figure 3 and its sensitivity, selectivity and fidelity curves in Figures 4, 5 and 6.

**The Receiver**

Looking at Figure 1, the dial is seen in the center, with the volume control and on-off switch at the left and the tone control at the right. The large square shield houses the gang condenser and the individually shielded antenna and oscillator coils, as well, of course, as the antenna and oscillator alignment trimmers. At the right are the -56 oscillator, -80 rectifier and -58 vario-mu r.f. pentode first detector, while at the rear, left to right, are the power transformer, first i.f. transformer, -53 i.f. amplifier tube, second i.f. transformer, -55 second detector, a.v.c. and first audio tube and the -47 pentode output tube. Figure 2 indicates the simplicity of the assembly, all parts beneath the chassis being quite accessible, as are the four i.f. trimmers.

Looking at Figure 3, the antenna circuit is seen to be single-tuned, which results in a two to one improvement in signal-to-noise ratio as against a siamese or dual selector input. The use of a -58 first detector obviates any possibility of cross modulation, while the possibility of image frequency interference is eliminated by the use of a 465 kc. i.f. amplifier. This means that the image point, or the second signal that a single setting of the oscillator will heterodyne to the i.f. of 465 kc., will be 930 kc. (twice the i.f.) away from the lowest signal frequency to be received. This being 550 kc. it will be seen that the first image point will be at 550 + 930 kc. or 1480 kc. Thus, image interference is possible on 1480, 1490 and 1500 kc. only. While it is possible, it is very improbable, since there is the rejectivity of the quite selective antenna circuit to be considered. In practice over some months, no image interference whatsoever has been reported in service with systems of this type, and none is to be anticipated with good re-

**THE SENSITIVITY CURVE**

Figure 4. Sensitivity is shown here in terms of microvolts absolute for standard 50 milliwatt audio-frequency output

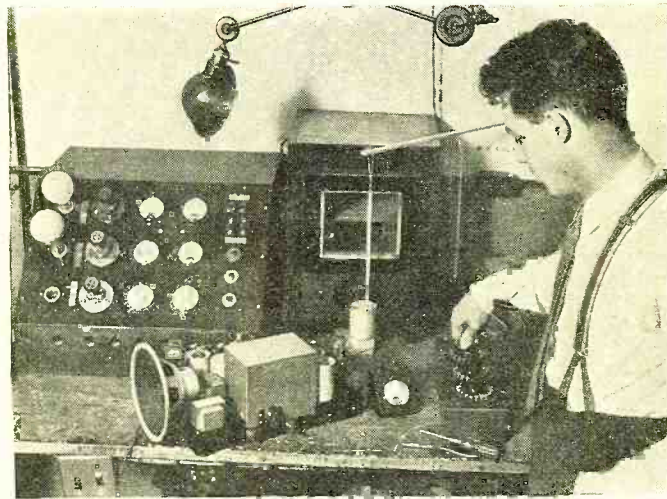
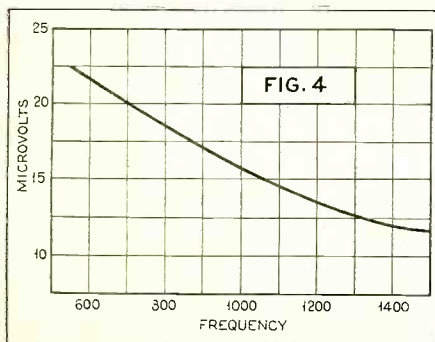

**ON THE TEST BENCH**

Figure 1. The chassis, including the built-in speaker, measures only 18 inches in overall length and is 8 1/4 inches square. The three knobs control tuning, volume and tone

has a minimum fixed bias provided automatically by a resistance and bypass condenser, that for the first detector also serving to bias the oscillator.

The combined second or audio detector, a.v.c., and first audio tube is quite interesting. It is the new -55, introduced in June, and is really two diodes and a triode in one tube. It has a common cathode, two separate anodes, and a grid and a plate. There are several ways of using it, but the one shown in Figure 3 is felt to be the most efficient by the S-M engineering staff. This involves connecting the two diode anodes together to form one Fleming valve rectifier, which is placed in series with a one-half megohm resistor across the secondary of the last i.f. transformer. The rectified signal voltage appears across this resistor as pulsating d.c. which is utilized in two manners. It is fed to the grid of this same tube through a potentiometer which acts as the volume control, and from the -55 plate feeds through resistance and capacity coupling to the grid of the output pentode. Thus the grid, plate and cathode of the -55 act as an a.f. amplifier for the signal rectified by the tied-together anodes and the cathode. It will be noticed that there is no fixed negative bias on the -55 grid, it being biased automatically by the signal, and in proportion to signal volume, by the voltage drop across the half megohm resistor, which is bypassed by a 250 mmf. condenser.

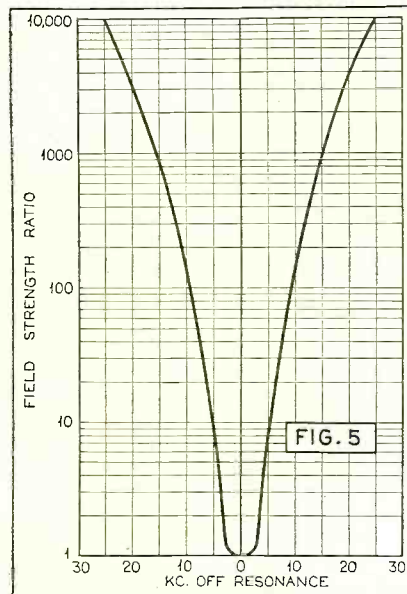

**MEASURED SELECTIVITY**

Figure 5. While the selectivity does not, of course, equal that of high-priced receivers, still it is more than adequate for all ordinary purposes

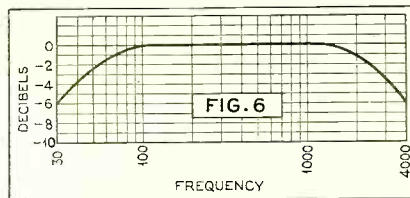

**ELECTRICAL FIDELITY**

Figure 6. Flat within 2 db. from 55 cycles to 2400 cycles, this receiver is shown to have tone quality comparable with many much more costly receivers

ceiver designs involving high intermediate frequencies.

The first detector and oscillator circuits are quite conventional on the whole, the oscillator using the usual S-M tank-tuned and padded circuit for frequency stability, with a series plate resistor of 6500 ohms, which serves to drop the total plate voltage to a reasonable value, and being in the r.f. circuit, to at the same time even up its output over the entire frequency range.

The i.f. amplifier has only one stage, but gives a voltage gain of over 200 times. It uses two dual tuned Litz wound i.f. transformers tuned to 465 kc. Both the first detector and i.f. amplifier are variably biased by the a.v.c. tube, but each

has a minimum fixed bias provided automatically by a resistance and bypass condenser, that for the first detector also serving to bias the oscillator. The combined second or audio detector, a.v.c., and first audio tube is quite interesting. It is the new -55, introduced in June, and is really two diodes and a triode in one tube. It has a common cathode, two separate anodes, and a grid and a plate. There are several ways of using it, but the one shown in Figure 3 is felt to be the most efficient by the S-M engineering staff. This involves connecting the two diode anodes together to form one Fleming valve rectifier, which is placed in series with a one-half megohm resistor across the secondary of the last i.f. transformer. The rectified signal voltage appears across this resistor as pulsating d.c. which is utilized in two manners. It is fed to the grid of this same tube through a potentiometer which acts as the volume control, and from the -55 plate feeds through resistance and capacity coupling to the grid of the output pentode. Thus the grid, plate and cathode of the -55 act as an a.f. amplifier for the signal rectified by the tied-together anodes and the cathode. It will be noticed that there is no fixed negative bias on the -55 grid, it being biased automatically by the signal, and in proportion to signal volume, by the voltage drop across the half megohm resistor, which is bypassed by a 250 mmf. condenser.

(Continued on page 235)

**A.V.C. EFFECTIVENESS**

Figure 7. Taking advantage of the characteristics of the new -55 tube, automatic control maintains constant output volume (within 2 db.) for all signals of 200 microvolts or more

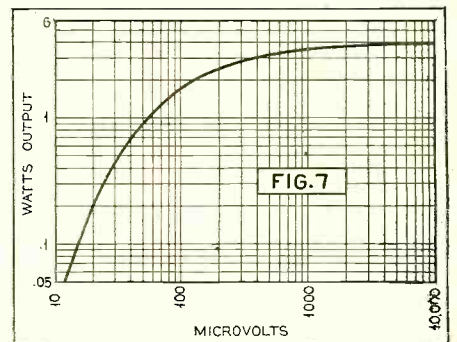



# The Future of RADIO SERVICING

*The serviceman today is already a powerful influence in radio, in sales as well as in service. What is he doing and what must he do to carve out the kind of future for himself that will make him the backbone of the radio industry?*

**R**ADIO servicing, in order to progress, must be placed on a professional basis. It must function as a unit entirely divorced from affiliation or allegiance to any other group, cooperating fully with all other branches of the industry.

It is unfortunate for the radio industry and for set owners that servicemen are assumed to belong to the laboring class, and that they should be classed as mechanics. On the other hand, however, those who realize that radio servicing is a profession and who are doing everything within their power to elevate it to that plane, are slowly but surely forcing out the laborers so that it is only a matter of time until the work of maintenance will be in the hands of men who are capable and whose income is based on *what they know*, not on the time they spend on a specific job or what they claim to do.

There are too many misfits in the radio service field today; too many men who do not realize the extent or importance of the work in which they are engaged; too many who are not adapted to radio; too many who do not have the fundamental training that is necessary to be successful; too many who do not appreciate that the requirements imposed upon a radio serviceman today are far more rigid than those of a few years ago.

## Profession or Trade?

"Profession," "trade," and "mechanic" are three words that are often confused, particularly by radio servicemen. Until recently every one referred to radio servicing as a "trade," and servicemen themselves were classed as "mechanics." Hence, they came to be considered in the same category as mechanics in the various trades (electricians, for example).

Definitions of the terms will clarify the situation:

Profession—A vocation, especially one that requires an education.

Trade—An occupation; dealing by way of buying and selling. (No reference to education.)

Mechanic—A skilled workman. (No reference to education.)

There is, therefore, a vast difference between a professional man and a mechanic. A mechanic (according to common usage of the word) is a laborer and it is not essential that he be conversant with the principles involved in his work, nor the devices upon which he is working. The main point is that he know what tools to use at the proper time and how to handle them in order to do the work that is laid out for him. The professional man, on the other hand, combines his ability as a mechanic with *fundamental training*. He exerts every effort to keep himself fully informed concerning the developments of the art with which he has allied himself.

The mechanic type of serviceman may claim that he is

keeping abreast of development, but unless he has grounded himself in the fundamentals he is not in a position to fully understand the meaning of the new devices, nor to analyze them. His lack of ability in this respect results in his getting deeper and deeper into the realm of the unknown and his ability as a serviceman becomes less with each successive development that is introduced.

The professional type of serviceman, on the other hand, versed in the fundamental principles of radio, recognizes the necessity for keeping in close touch with what is going on in the industry. His contact is not restricted to engineering developments, but he follows the news also, although, undoubtedly, the technical angles are the most important to him. He knows that he is adapted to the work which he has chosen as is evidenced by his contentment. He has applied himself to the task of securing a full and complete training in fundamentals. He has a complete assortment of testing equipment that will enable him to perform his work with ease and dispatch. He goes about his duties in a business-like manner that cannot fail to impress his clients. He is courteous. He does not make disparaging remarks about other servicemen, about the product upon which he is performing service, nor about the programs of the broadcasting stations. He knows that when he knocks the work of another man, he lowers himself and his profession in the estimation of the customer. He realizes that his comments about broadcast programs are merely the opinion of an individual, so, instead of berating the broadcasters for their failure to provide the type of program that he likes, he explains to the client that the broadcasters welcome suggestions for programs in order that they might be better informed concerning the desires of the listeners.



By E. H. Rietzke\*

## The Garden Variety of Servicing

Take the laborer type of serviceman in contrast. In more cases than not, this type of serviceman is egotistical and holds the opinion that his knowledge of radio is ample. He reasons with himself that as he handled all his service calls last week or last month he will have no trouble in the future. His charges for service are usually based upon the amount of time spent on the job at so much per hour, with no consideration for overhead. He applies the "rule of thumb" method in diagnosing trouble and repairing it. His lack of fundamental training makes it impossible for him to grasp new ideas quickly. He "alibis" his failure in specific instances by shifting the blame for inefficient service upon the broadcasting stations. He belittles other servicemen and products that do not strike his fancy. He condemns merchandise because of prejudice and then reverses his opinion if one who handles the product flatters him. His test equipment is sadly deficient and he usually expresses the opinion that there is no need for high-grade test apparatus. If one would stop to consider this last point, however, it is evident that his reasoning is based

\* President, Capitol Radio Engineering Institute.



upon the fact that he would not be capable of handling modern apparatus of good quality even *if he had it!*

The professional man is distinctive in another respect. He will cooperate with fellow servicemen. He recognizes the necessity for organization in order that cooperation will be simplified. He appreciates the value of association with other men engaged in the same field of endeavor in order that ideas might be exchanged. He keeps himself informed on radio development by study and by careful reading of the proper books and selected technical periodicals. He sees the folly of each individual attempting to carry on alone. He considers that although he may be putting forth his best efforts there are certain things that he will overlook and which will be brought to his attention by those with whom he associates or with whom he has a reading acquaintance.

The laborer type is a direct opposite. He refuses to associate with other servicemen on the ground that he will divulge valuable information. He holds the opinion that his knowledge of radio is superior to that of others and that no one can tell him anything about which he has not already learned. He finds no uses for study courses, books or magazines dealing wholly on the subject of his endeavors. Such a man is doing nothing but kidding himself and will be eliminated in short order. If he were truthful he would admit that his refusal to cooperate with the field and to learn something from it is due to his lack of knowledge of the work in which he is engaged, and that he would be constantly fearful lest someone "put him on the spot" by asking a question he could not answer.

There is no question concerning which, of the two classes of serviceman, will survive. The public is not asleep. They are learning rapidly that it is safer and more economical to secure the services of a man who is of the professional type even though those in the mechanic or laborer classification may bait them with ridiculously low service-charge offers.

*Progress in Service Work*

Radio servicing is making unprecedented strides today. The quality of the personnel is improving and there are many men with university and college degrees who have taken up the work because they are interested in it and because they recognize its potentialities. However, it cannot be truthfully said that all servicemen who are in the labor class, today, are unsuited. Many of them, in fact a large percentage of them, will develop into high-grade men under the proper guidance.

Attention is directed toward the work that is being done to put radio servicing on a professional plane by the Institute of Radio Service Men, a technical organization that was formed last fall and which has its general headquarters in Chicago. The founders of the Institute have concluded that radio servicing was above the plane of common labor; that the only solution to the problem was to rid the field of untrained and unsuited men and to fill their places with men who are educated, efficient, courteous, fair, reliable, and willing to cooperate with fellow members of the profession in order that all

might advance. Its activities are not confined to local areas, but extend to all parts of the world—wherever radio is used. It is strictly a non-commercial society whose members pledge themselves to aid in raising their activities to the status of a profession and maintaining it as such.

Radio servicing is an industry within itself, and a highly important one. The conduct of those engaged in it will determine the success of the entire radio industry. The radio serviceman is virtually the representative of the manufacturer and the merchandiser when he enters the home of a customer to service the radio receiver, and it is imperative that he be of the highest type. In order to attain that type of personnel

the laborers must be eliminated and professional men, cooperating with all other members of their profession, shall take their places.

The radio serviceman now in the field should examine himself impartially. He should clearly determine his present status, his technical ability, his opportunities, the possibilities for improvement of his status through further education and through closer cooperation with the better types of servicemen

in his community—and then do everything within his power to raise the general standard of his profession and his own individual standing in his chosen field.

This is the time of year when servicemen, or those who aspire to be servicemen, can well give serious thought to what the various training schools have to offer. The day is past when all a man needs is the ability to put up an aerial or insert new tubes in a receiver. He must know the common types of troubles encountered on service calls and, what is perhaps more important, he must be able to diagnose the various troubles encountered only occasionally. Then he must, of course, know how to overcome all of these ailments, but any experienced physician will admit that the correct diagnosis of physical ailments represents the most complicated and difficult part of his work. This applies equally well to the servicing of radio receivers. One with a mere smattering of knowledge can eventually eliminate the cause for a pronounced hum in a receiver, for instance, provided he is given time. He can try one thing after another until the correct remedy is found. But a profitable service business is not built upon any such hit-and-miss basis as this. The patience to cut-and-try until the solution of a problem is found may be admirable in some things, but radio servicing is not one of them. A solid bedrock of knowledge is the only sure foundation upon which to build. Not only does such knowledge provide its direct benefit but it gives the serviceman confidence in himself and engenders the confidence of others.

True, it takes time and stick-to-itiveness to acquire this

knowledge but it is certainly worth the effort because it lifts the worker into the professional class where he is paid for his knowledge and what he accomplishes rather than on the basis of "so much per hour." Acquiring such knowledge haphazardly through experience is possible—but it is a tedious process. Taking advantage of the recognized training courses offers a short-cut which any man who wants to forge ahead in the game cannot afford to overlook.

*"There are too many misfits in the radio service field today . . . The laborer type must give way to the trained professional business man"*

WELL-EQUIPPED SERVICE BENCH IN A SERVICE LABORATORY

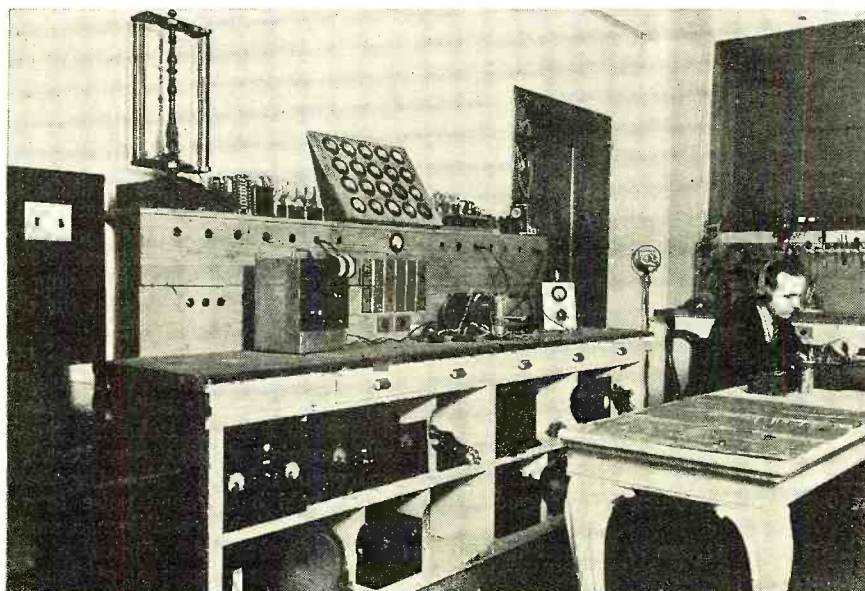

Capitol Photo



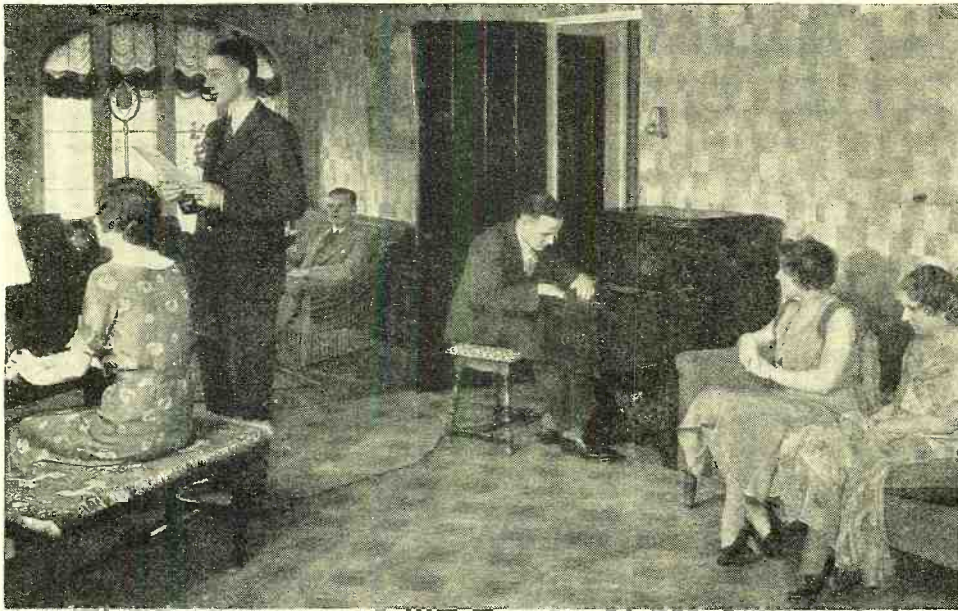

## COMPLETE HOME ENTERTAINMENT

*The three-stage audio amplifier suits the receiver admirably for phonograph or microphone reproduction, and for home recording. In the model shown here the phonograph and recording equipment are housed in a deep drawer in the console*

## MORE INFORMATION ON THE Latest All-Wave Super

*Reception tests with this receiver were discussed in detail in the two preceding articles of this series. This month two interesting incidents of the tests are described and more information is given on the receiver itself*

**I**N two preceding articles (August and September issues) the results of reception tests covering both the short-wave and broadcast-band reception were described. These tests demonstrated the sensitivity and the selectivity of the new Scott DeLuxe all-wave receiver and provided an ample check on the characteristics as shown by means of curves in the August article.

Since writing the first two articles there have been two interesting experiences with this receiver which may well go on the record. The first one is not particularly unusual but is cited to show one of the "stunts" which add to the pleasure of possessing a good all-wave receiver. The second is unusual—so much so that the reader cannot be blamed if he takes it with a grain of salt. No one who had not actually witnessed the feat could be blamed for being skeptical, but it was actually demonstrated and was witnessed by two members of the RADIO NEWS staff, who can vouch for its authenticity.

The first experience occurred on the Fourth of July, or on the Saturday following (the log is not clear as to the date). About 6:50 p.m., while idly tuning in the short-wave range, a phone station which signed itself WEF (a commercial 'phone station) was heard calling LSX of Buenos Aires. Contact was established and WEF explained that it was calling to arrange test details, preparatory to an American rebroadcast of the LSX program. Tuning the receiver then to LSX, this South American station was picked up, and thereafter both sides of the conversation and tests were brought in by shifting back and forth between the dial settings of the two stations. This continued until about 7:10 p.m., after which LSX stayed on the air continuously.

It developed that the rebroadcasting was to be done by the Columbia chain, beginning at 7:15 p.m. Switching the receiver

*Part Three*

to WABC'S setting on the broadcast band, the rebroadcast was heard to start shortly after this hour, and thereafter, switching the receiver back and forth between 349 meters (WABC) and 30 meters (LSX), a comparison was made possible.

The quality of reception direct from LSX was a surprisingly close approach to that of the rebroadcast from WABC—surprising because here we were using a Scott receiver with a mediocre antenna and only an average location (Fairfield, Connecticut), while the commercial station which was picking up and relaying the program via land wire to WABC had the advantage of receiving equipment costing many times as much

**By S. Gordon Taylor**

as our receiver, plus probably an ideal directional antenna, in an excellent location. Actually, the only substantial difference between the original and the rebroadcast was found in the occasional interference caused by the ignition systems of automobiles passing on a road about 30 feet from the receiving antenna. The program as received direct was strong and clear, free from background noise (except the automobile ignition interference, and this was only slight), with fading so slight as to be almost imperceptible. In every respect the direct reception was such as to be thoroughly enjoyable.

It is not intended to convey the idea that the comparison between direct and rebroadcast reception is always so favorable. When fading is bad, for instance, the special antenna equipment and almost unlimited facilities of the commercial phone receiving stations may permit volume to be held at more constant levels. Also, the use of directional antennas helps to hold background noise to a minimum. But, given reasonably favorable conditions, a really good all-wave receiver such as the one under discussion can provide the thrill of enjoyable direct reception of important foreign programs,



eliminating dependence on local broadcast stations which may or may not be rebroadcasting the desired programs.

The second experience referred to above occurred one evening in the middle of July. About 8:15 p.m., EAQ of Madrid, Spain, was tuned in and was found to be somewhat stronger than usual.

### Europe Without an Antenna

After listening to the program for a few minutes, the outside antenna was disconnected and a short indoor antenna connected in its place. This worked very well, so it in turn was replaced with a 6-foot wire, then a 1-foot wire, and finally the antenna was eliminated entirely and still signals came in with sufficient strength to be heard by a member of the family sitting on the porch about 12 feet from the speaker.

With such a completely shielded receiver (even the tubes are shielded, except for the vent holes in the caps), it appeared that the pick-up must come either through the ground lead or through the metal body of the antenna binding post itself. The next step was to disconnect the ground lead from the receiver, and—believe it or not—the station was not only audible, but understandable (announcements are made in both Spanish and English) out on the porch. This meant that, with nothing connected to either the antenna or ground binding posts, the program from several thousand miles away was still being heard!

On Monday, July 25, shortly before 6 p.m., the same thing was tried on 12RO, Rome, and the same results obtained as previously with EAQ. Then it was repeated on the Eiffel Tower station in Paris, proving that antennaless reception was not just a freak of the 30.4-meter wavelength on which EAQ transmits.

It might be well to add that to eliminate the possibility that pick-up was being transferred from the nearby antenna lead which had been disconnected from the receiver, this lead was first grounded and later removed entirely from the vicinity of the receiver, without any noticeable decrease in the received signals.

### Single-Control Tuning

In the first article of this series the outstanding features of this receiver were mentioned. Since that time the author has had considerable experience with the receiver, operating on all wavelengths, and more detailed first-hand information can now be given on some of these points.

The true single-control tuning has proven during these reception tests to be all that was claimed for it. It is no great trick to provide a single control for a broadcast superheterodyne, but to extend single-control operation, with no auxiliary verniers of any type, throughout the entire wave-band from 550 meters down to 15 meters, is a real accomplishment. That it has been accomplished effectively in this receiver is quite evident from the sensitivity and selectivity demonstrated on all wave-bands. The success of this system is due to a feature of the electrical design of the receiver which makes tracking of the circuits mostly automatic. It would be impossible to apply the ordinary methods of

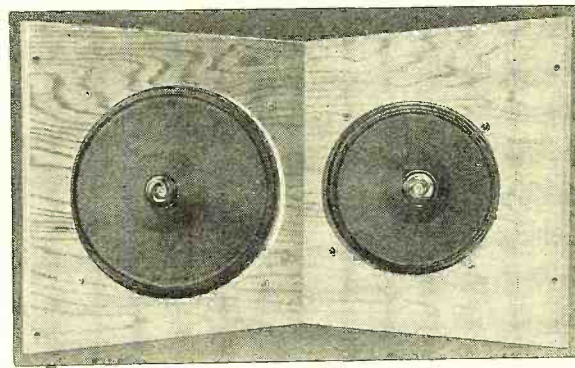

THE DUAL-SPEAKER ASSEMBLY

*Two speakers are employed for the purpose of extending the audio-frequency range to include the higher frequencies which lend realism to the reproduction of music and speech*

this circuit is partially tuned. The first detector input and the oscillator circuits are both tuned when operating on the short-wave bands, the same as on the broadcast waves.

The band-switching system has proven itself flawless in operation. A simple throw of this switch to any one of its four positions selects the desired wave-band. An interesting illustration of the simplicity of this arrangement is found in tuning from W8XK, the Pittsburgh short-wave station that operates on 48.86 meters, to WEAF. It so happens that W8XK comes in at exactly the same point on the dial as does WEAF. Thus with the band switch set for the 23-61 meter band and with W8XK tuned in, a turn of the band selector switch to the broadcast range is all that is necessary to bring in WEAF.

Another interesting point disclosed in tests was the accuracy of the frequency calibration on the broadcast band from 550 kc. to approximately 1000 kc. Every channel below 1000 kc. may be tuned in right on the dot as indicated by the frequency scale. From 1000 kc. up, the calibration is slightly off, but the maximum variation is less than one channel (10 kc.). The advantage of this degree of accuracy is seen when a station is tuned in and one can tell at a glance the frequency upon which it is operated. For the DX enthusiast this feature is invaluable. Even to those who are not particularly interested in DX reception, it is most decidedly an advantage to be able to set the receiver for the frequency of any desired station with the assurance that that station will be heard.

### Balancing the R.F. and I.F. Circuits

With the large number of circuits and the single-dial control, one might suspect that the lining up of the ganged circuits of the intermediate-frequency stages would be a difficult task. To determine whether or not this is the case it was decided to completely upset the line-up by detuning all of the trimmer condensers—some up and some down—and then to try to reline the entire system. This was accomplished satisfactorily

without resorting to the use of either an oscillator or an output meter. Simply by setting the dial at the frequency of a local broadcast station and turning the sensitivity control fairly high, the various trimmers were adjusted, one after another, until the station could be heard with maximum strength. Then a distant station was tuned in and the trimmers were gone over again with greater precision. After this was accomplished, the tuning control was run through its entire range. All stations (Cont'd on page 234)

THE MULTI-WAVE COIL ASSEMBLY

*Some idea of the precision construction of the receiver is gained from this bottom view of the chassis with shield plate removed*

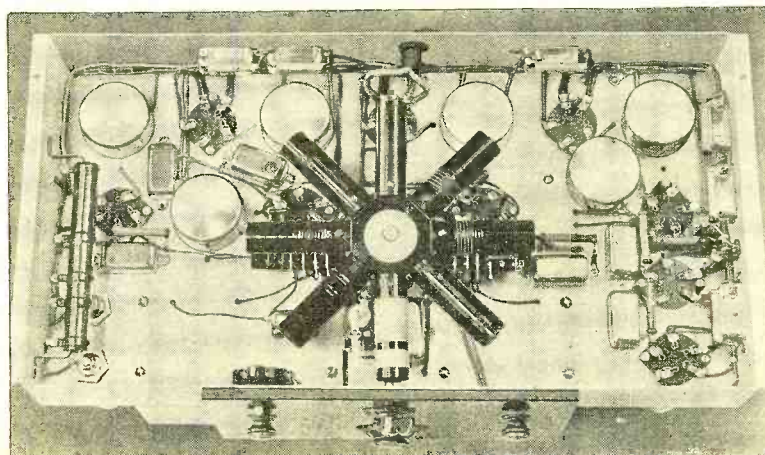



# Broadcasting Stations in the U. S.

*Alphabetically by Call Letters, Location, Frequency and Power*

Call	Location	Kilocycles	Watts	Call	Location	Kilocycles	Watts	Call	Location	Kilocycles	Watts
KABC	San Antonio, Tex	1,420	100	KGFG	Oklahoma City, Okla.	1370	100	KSL	Salt Lake City, Utah	1130	5,000
KARK	Little Rock, Arkansas	890	250	KGFI	Corpus Christi, Texas	1500	100	KSO	Clarinda, Iowa	1380	500
KBPS	Portland, Oregon	1420	100	KGFI	Los Angeles, California	1200	100	KSOO	Sioux Falls, Dakota	1110	2,500
KBTM	Paragould, Arkansas	1200	100	KGFK	Moorhead, Minnesota	1500	50	KSTP	St. Paul, Minnesota	1460	10,000
KCMC	Tupelo, Mississippi	1420	100	KGFL	Raton, New Mexico	1370	50	KTAB	Oakland, California	560	1,000
KCRC	Enid, Oklahoma	1370	100	KGFW	Kearney, Nebraska	1310	100	KTAR	Phoenix, Arizona	620	500
KCRJ	Jerome, Arizona	1310	100	KGFX	Pierre, South Dakota	580	200	KTAT	Fort Worth, Texas	1240	1,000
KDB	Santa Barbara, California	1500	100	KGGC	San Francisco, Calif.	1420	100	KTBR	Portland, Oregon	1300	500
KDFN	Casper, Wyoming	1210	100	KGGF	South Coffeyville, Okla.	1010	500	KTBS	Shreveport, Louisiana	1450	1,000
KDKA	Pittsburgh, Pennsylvania	980	50,000	KGGM	Albuquerque, N. Mexico	1230	250	KTFI	Twin Falls, Idaho	1320	250
KDLR	Devils Lake, N. Dakota	1210	100	KGHI	Pueblo, Colorado	1320	250	KTHS	Hot Springs National Park, Arkansas	1040	10,000
KDYL	Salt Lake City, Utah	1290	1,000	KGHL	Little Rock, Arkansas	1200	100	KTLC	Houston, Texas	1310	100
KECA	Los Angeles, California	1430	1,000	KGIR	Billings, Montana	950	1,000	KTM	Los Angeles, California	780	500
KEW	Burbank, California	780	500	KGIR	Butte, Montana	1360	500	KTRH	Houston, Texas	1120	500
KERN	Santa Maria, California	1200	100	KGIV	Trinidad, Colorado	1420	100	KTSA	San Antonio, Texas	1290	1,000
KEX	Portland, Oregon	1180	5,000	KGIX	Las Vegas, Nevada	1420	100	KTSL	Shreveport, Louisiana	1310	100
KFAC	Lincoln, Nebraska	770	5,000	KGIZ	Grant City, Missouri	1500	100	KTSM	El Paso, Texas	1310	100
KFAB	Los Angeles, California	1300	1,000	KGKB	Tyler, Texas	1500	100	KTW	Seattle, Washington	1220	1,000
KFBF	Great Falls, Montana	1280	1,000	KGKL	San Angelo, Texas	1370	100	KUJ	Walla-Walla, Wash.	1370	100
KFB	Milford, Kansas	1050	5,000	KGKO	Wichita Falls, Texas	570	250	KUOA	Fayetteville, Arkansas	1390	1,000
KFBK	Sacramento, California	1310	100	KGKX	Sandpoint, Idaho	1420	100	KUSD	Wremillion, S. Dakota	890	500
KFBL	Everett, Washington	1370	50	KGKY	Scottsbluff, Nebraska	1500	100	KUT	Austin, Texas	1500	100
KFDM	Beaumont, Texas	560	500	KGMB	Honolulu, Hawaii	1320	250	KVI	Tacoma, Washington	760	1,000
KFDY	Brookings, S. Dakota	550	500	KGMP	Elk City, Oklahoma	1210	100	KVL	Seattle, Washington	1370	100
KFEL	Denver, Colorado	920	500	KGNO	North Platte, Nebraska	1430	500	KVOA	Tucson, Arizona	1260	500
KFEQ	St. Joseph, Missouri	680	2,500	KGNF	Dodge City, Kansas	1210	100	KVOO	Tulsa, Oklahoma	1140	5,000
KFGQ	Boone, Iowa	1310	100	KGO	San Francisco, Calif.	790	7,500	KVOR	Colorado Springs, Colo.	1270	1,000
KFH	Wichita, Kansas	1300	1,000	KGRS	Amarillo, Texas	1410	1,000	KVOS	Bellingham, Washington	1200	100
KFI	Los Angeles, California	640	50,000	KGU	Honolulu, Hawaii	940	1,000	KWCR	Cedar Rapids, Iowa	1310	100
KFIO	Spokane, Washington	1120	100	KGVO	Missoula, Montana	1420	100	KWEA	Shreveport, Louisiana	1210	100
KFIU	Juneau, Alaska	1310	10	KGW	Portland, Oregon	620	1,000	KWG	Stockton, California	1200	100
KFIZ	Fond du Lac, Wisconsin	1420	100	KGW	Lacey, Washington	1200	100	KWJJ	Portland, Oregon	1060	500
KFJB	Marshalltown, Iowa	1200	100	KHJ	Los Angeles, California	900	1,000	KWK	St. Louis, Missouri	1350	1,000
KFJF	Oklahoma City, Okla.	1480	5,000	KHQ	Spokane, Washington	590	1,000	KWK	Kansas City, Missouri	1370	100
KFJ	Astoria, Oregon	1370	100	KICA	Clovis, New Mexico	1370	100	KWKH	Shreveport, Louisiana	850	10,000
KFJM	Grand Forks, N. Dakota	1370	100	KICK	Red Oak, Iowa	1420	100	KWLC	Decorah, Iowa	1270	100
KFJR	Portland, Oregon	1300	500	KID	Idaho Falls, Idaho	1320	250	KWSC	Pullman, Washington	1220	1,000
KFJY	Fort Dodge, Iowa	1310	100	KIDO	Boise, Idaho	1350	1,000	KWWG	Brownsville, Texas	1260	500
KFJZ	Fort Worth, Texas	1370	100	KIT	Yakima, Washington	1310	100	KXA	Seattle, Washington	570	500
KFKA	Greeley, Colorado	880	500	KJBS	San Francisco, Calif.	1070	100	KXL	Portland, Oregon	1420	100
KFKB	Milford, Kansas	1050	5,000	KJR	Seattle, Washington	970	5,000	KXO	El Centro, California	1500	100
KFKU	Lawrence, Kansas	1220	500	KJCN	Blytheville, Arkansas	1290	50	KXRO	Aberdeen, Washington	1310	100
KFKX	See KYW			KLO	Ogden, Utah	1400	500	KXYZ	Houston, Texas	1420	100
KFLV	Rockford, Illinois	1410	500	KLPM	Minot, North Dakota	1240	250	KYA	San Francisco, Calif.	1230	1,000
KFLX	Galveston, Texas	1370	100	KLRA	Little Rock, Arkansas	1390	1,000	KYW	Chicago, Illinois	1020	10,000
KFMX	Northfield, Minnesota	1250	1,000	KLS	Oakland, California	1440	250	NAA	Washington, D. C.	690	1,000
KFNF	Shenandoah, Iowa	890	500	KLX	Oakland, California	880	500	WAAB	Boston, Massachusetts	1410	500
KFOR	Lincoln, Nebraska	1210	100	KLZ	Denver, Colorado	560	1,000	WAAC	Chicago, Illinois	920	500
KFOX	Long Beach, California	1250	1,000	KMA	Shenandoah, Iowa	930	500	WAAM	Newark, New Jersey	1000	1,000
KFPL	Dublin, Texas	1310	100	KMAC	San Antonio, Texas	1370	100	WAAT	Jersey City, New Jersey	940	300
KFPV	Greenville, Texas	1310	15	KMCS	Kansas City, Missouri	950	1,000	WAAB	Omaha, Nebraska	660	500
KFPY	Fort Smith, Arkansas	1340	50	KMED	Inglewood, California	1120	500	WABC	New York, New York	860	50,000
KFQD	Spokane, Washington	1340	1,000	KMJ	Medford, Oregon	1310	100	WABI	Bangor, Maine	1200	100
KFQV	Anchorage, Alaska	1230	100	KMLB	Fresno, California	1210	100	WABO	see WHEC		
KFQW	Holy City, California	1420	100	KMMJ	Monroe, Louisiana	1200	100	WABZ	New Orleans, Louisiana	1200	100
KFRG	Seattle, Washington	1420	100	KMO	Clay Center, Nebraska	740	1,000	WACO	Waco, Texas	1240	1,000
KFRU	San Francisco, California	610	1,000	KMOX	Tacoma, Washington	800	500	WAGC	Tallmadge, Ohio	1320	1,000
KFSF	Columbia, Missouri	630	500	KMPR	St. Louis, Missouri	1090	50,000	WAGM	Presque Isle, Maine	1420	100
KFSG	San Diego, California	600	500	KNOW	Beverly Hills, California	710	500	WAIU	Columbus, Ohio	640	500
KFUL	Los Angeles, California	1120	500	KNX	Los Angeles, California	570	500	WALR	Zanesville, Ohio	1210	100
KFUO	Galveston, Texas	1290	500	KOA	Austin, Texas	1500	500	WAPI	Birmingham, Alabama	1140	5,000
KFUP	Clayton, Missouri	550	500	KOAC	Hollywood, California	1050	5,000	WASH	Grand Rapids, Michigan	1270	500
KFVJ	Denver, Colorado	1310	100	KOB	Denver, Colorado	830	12,500	WAWZ	Zarapath, New Jersey	1350	250
KFVY	Culver City, California	1000	250	KOCW	Corvallis, Oregon	550	1,000	WBAA	West Lafayette, Indiana	1400	500
KFVZ	Cape Girardeau, Mo.	1210	100	KOH	State College, N. Mexico	1180	20,000	WBAK	Harrisburg, Pennsylvania	1430	500
KFWB	Hollywood, California	950	1,000	KOIL	Chickasha, Oklahoma	1400	250	WBAL	Baltimore, Maryland	1060	10,000
KFWF	St. Louis, Missouri	1200	100	KOIN	Reno, Nevada	1380	500	WBAP	Fort Worth, Texas	800	10,000
KRWI	San Francisco, Calif.	930	500	KOL	Council Bluffs, Iowa	1260	1,000	WBAX	Wilkes-Barre, Penn.	1210	100
KFXD	Nampa, Idaho	1420	100	KONO	Portland, Oregon	940	1,000	WBBC	Brooklyn, New York	1400	500
KFXF	Denver, Colorado	920	500	KOPC	Seattle, Washington	1270	1,000	WBBL	Richmond, Virginia	1210	100
KFXJ	Grand Junction, Colo.	1310	100	KOPF	Seattle, Washington	920	1,000	WBBS	Chicago, Illinois	770	25,000
KFXM	San Bernardino, Calif.	1210	100	KPPC	San Antonio, Texas	1370	100	WBBS	Brooklyn, New York	1300	1,000
KFXR	Oklahoma City, Okla.	1310	100	KPPC	Marshallfield, Oregon	1370	100	WBBZ	Ponca City, Oklahoma	1200	100
KFXZ	Flagstaff, Arizona	1420	100	KPRC	Eugene, Oregon	1420	100	WBCM	Bay City, Michigan	1410	500
KFYV	Abilene, Texas	1420	100	KQV	Phoenix, Arizona	1390	500	WBCN	see WENR		
KFYR	Bismarck, N. Dakota	550	1,000	KQW	Seattle, Washington	650	100	WBEN	Buffalo, New York	900	1,000
KGA	Spokane, Washington	1470	5,000	KQW	Prescott, Arizona	1500	100	WBEO	Marquette, Michigan	1310	100
KGAR	Tucson, Arizona	1370	100	KRE	San Francisco, California	680	5,000	WBGF	Glens Falls, New York	1370	50
KGCB	San Diego, California	1330	500	KREG	Denver, Colorado	880	500	WBHS	Huntsville, Alabama	1200	50
KGBU	Ketchikan, Alaska	900	500	KRGV	Pasadena, California	1210	50	WBIG	Greensboro, N. Carolina	1440	500
KGDX	St. Joseph, Missouri	1310	100	KRKD	Wenatchee, Washington	1500	50	WBIS	see WNAC		
KGEB	York, Nebraska	930	500	KRLD	Houston, Texas	920	1,000	WBMS	Hackensack, New Jersey	1450	250
KGCA	Decorah, Iowa	1270	50	KRMD	Pittsburgh, Pennsylvania	1380	500	WBNX	New York, New York	1350	250
KGCR	Watertown, S. Dakota	1240	250	KRMP	San Jose, California	1010	500	see WABC			
KGCU	Mandan, North Dakota	1200	100	KRND	Berkeley, California	1370	100	WBOW	Terre Haute, Indiana	1310	100
KGCV	Wolf Point, Montana	1310	100	KRNL	Santa Ana, California	1500	100	WBRE	Birmingham, Alabama	930	500
KGDA	Mitchell, South Dakota	1370	100	KRNL	Harlingen, Texas	1260	500	WBSC	Wilkes-Barre, Penn.	1310	100
KGDE	Fergus Falls, Minnesota	1200	100	KRNL	Inglewood, California	1120	100	WBST	Needham, Massachusetts	920	500
KGDM	Stockton, California	1100	250	KRNL	Dallas, Texas	1040	10,000	WBTT	Charlotte, N. Carolina	1080	5,000
KGDV	Huron, South Dakota	1200	100	KRNL	Shreveport, Louisiana	1310	50	WBVM	Danville, Virginia	1370	100
KGDF	Los Angeles, California	1300	1,000	KRNL	Oakland, California	930	500	WBZ	Boston, Massachusetts	990	15,000
KGEG	Yuma, Colorado	1200	100	KRNL	Seattle, Washington	1120	50	WBZA	Boston, Massachusetts	990	1,000
KGEB	Long Beach, California	1360	1,000	KRNL	Manhattan, Kansas	580	500	WCAC	Storrs, Connecticut	600	250
KGEW	Fort Morgan, Colorado	1200	100	KRNL	Sioux City, Iowa	1330	1,000	WCAD	Canton, New York	1220	500
KGEX	Kalispell, Montana	1310	100	KRNL	St. Louis, Missouri	550	500	WCAE	Pittsburgh, Pennsylvania	1220	1,000
KGFF	Shawnee, Oklahoma	1420	100	KRNL	Pocatello, Idaho	900	250				



Call	Location	Kilocycles	Watts	Call	Location	Kilocycles	Watts	Call	Location	Kilocycles	Watts
WCAH	Columbus, Ohio	1430	500	WHDI	Minneapolis, Minnesota	1180	500	WNAX	Yankton, South Dakota	570	1,000
WCAJ	Lincoln, Nebraska	590	500	WHDL	Tupper Lake, New York	1420	100	WNBK	Binghamton, New York	1500	100
WCAK	Northfield, Minnesota	1250	1,000	WHDC	Rochester, New York	1440	500	WNBH	New Bedford, Mass.	1310	100
WCAL	Camden, New Jersey	1280	500	WHDE	Cicero, Illinois	1420	100	WNBQ	Silver Haven, Penn.	1200	100
WCAP	Baltimore, Maryland	600	250	WHDF	Bluefield, West Virginia	1410	250	WNBW	Memphis, Tennessee	1430	500
WCAT	Asbury Park, New Jersey	1280	500	WHDG	Cleveland, Ohio	1390	1,000	WNBX	Carbondale, Pennsylvania	1200	10
WCAX	Rapid City, S. Dakota	1200	100	WHDH	New York, New York	1010	250	WNBZ	Springfield, Vermont	1200	10
WCAY	Philadelphia, Penna.	1170	50,000	WHDI	Des Moines, Iowa	1000	5,000	WNCJ	Saranac Lake, New York	1290	50
WCBA	Burlington, Vermont	1200	100	WHDJ	Jersey City, New Jersey	1450	250	WNCN	Newark, New Jersey	1450	250
WCBB	Carthage, Illinois	1070	50	WHDK	Harrisburg, Penna.	1430	500	WNCN	Knoxville, Tennessee	560	1,000
WCBC	Allentown, Pennsylvania	1440	250	WHDL	Ottumwa, Iowa	1420	100	WNCN	New York, New York	570	500
WCBD	Zion, Illinois	1080	5,000	WHDM	Madison, Wisconsin	1280	500	WNCN	San Antonio, Texas	1190	50,000
WCBE	Baltimore, Maryland	1370	100	WHDN	Elkins Park, Penna.	930	25	WNCN	See WREC		
WCBF	Springfield, Illinois	1210	100	WHDO	Jackson, Michigan	1370	100	WNCN	Trenton, New Jersey	1280	500
WCBO	Minneapolis, Minnesota	810	5,000	WHDP	Chicago, Illinois	560	1,000	WNCN	Charleston, West Virginia	580	250
WCDA	New York, New York	1350	250	WHDQ	Poynette, Wisconsin	1210	100	WNCN	Davenport, Iowa	1600	5,000
WCDF	Chicago, Illinois	970	1,500	WHDR	Topeka, Kansas	580	1,000	WNCN	Jamestown, New York	1210	50
WCDE	Brooklyn, New York	1400	500	WHDS	Utica, New York	1200	100	WNCN	Paterson, New Jersey	1250	1,000
WCDE	Chicago, Illinois	1490	5,000	WHDT	Bridgeport, Connecticut	600	250	WNCN	Mobile, Alabama	1410	500
WCDE	Covington, Kentucky	1490	5,000	WHDU	St. Louis, Missouri	1200	100	WNCN	Ames, Iowa	640	3,500
WCDE	Long Beach, New York	1500	100	WHDV	Urbana, Illinois	890	250	WNCN	Albany, New York	1440	500
WCDE	Janesville, Wisconsin	1200	100	WHDW	Wilmington, Delaware	1420	100	WNCN	Washington, D. C.	1310	100
WCDE	Joliet, Illinois	1310	100	WHDX	New York, New York	1180	500	WNCN	Manitowoc, Wisconsin	1210	100
WCDE	Culver, Indiana	1400	500	WHDY	Miami, Florida	1300	1,000	WNCN	Grand Rapids, Michigan	1270	500
WCDE	Pensacola, Florida	1340	500	WHDE	Philadelphia, Penna.	610	500	WNCN	Bristol, Tennessee	1300	100
WCDE	Meridian, Mississippi	880	500	WHDF	Columbia, S. Carolina	1010	500	WNCN	Kansas City, Missouri	1500	1,000
WCDE	Harrisburg, Pennsylvania	1200	100	WHDE	See WIBA			WNCN	Newark, New Jersey	710	50,000
WCDE	Yonkers, New York	1210	100	WHDF	Milwaukee, Wisconsin	1120	250	WNCN	Worcester, Massachusetts	1200	500
WCDE	Chicago, Illinois	1210	100	WHDF	Johnstown, Pennsylvania	1310	100	WNCN	Jefferson City, Missouri	630	500
WCDE	Charleston, S. Carolina	1360	500	WHDF	Norfolk, Nebraska	1060	1,000	WNCN	New York, New York	1130	1,000
WCDE	Portland, Maine	940	1,000	WHDF	Elkhart, Indiana	1310	50	WNCN	Omaha, Nebraska	590	1,000
WCDE	Tampa, Florida	1220	1,000	WHDF	Providence, Rhode Island	890	250	WNCN	Fort Wayne, Indiana	1160	10,000
WCDE	Kansas City, Missouri	610	1,000	WHDF	Pittsburgh, Penna.	1290	1,000	WNCN	Paducah, Kentucky	1420	100
WCDE	Amarillo, Texas	1410	1,000	WHDF	Jacksonville, Florida	900	1,000	WNCN	See WQAO		
WCDE	El Paso, Texas	1310	100	WHDF	Cleveland, Ohio	610	500	WNCN	Pawtucket, Rhode Island	1210	100
WCDE	Philadelphia, Penna.	1370	100	WHDF	La Salle, Illinois	1200	100	WNCN	Chicago, Illinois	560	500
WCDE	Fargo, North Dakota	940	1,000	WHDF	Red Bank, New Jersey	1210	100	WNCN	New York, New York	810	500
WCDE	Roanoke, Virginia	930	250	WHDF	Detroit, Michigan	1370	50	WNCN	Philadelphia, Penna.	1500	100
WCDE	Orlando, Florida	1120	500	WHDF	Decatur, Illinois	1200	100	WNCN	Hattiesburg, Mississippi	1370	100
WCDE	Wilmington, Delaware	1120	250	WHDF	New Orleans, Louisiana	1420	100	WNCN	Atlantic City, N. J.	1100	5,000
WCDE	Waterbury, Vermont	1420	50	WHDF	See WBBM			WNCN	See WTR		
WCDE	Minneapolis, Minnesota	1180	1,000	WHDF	Lewisburg, Pennsylvania	1210	100	WNCN	Providence, Rhode Island	1210	100
WCDE	Texasarkana, Arkansas	1420	100	WHDF	New Orleans, Louisiana	1200	100	WNCN	State College, Penna.	1230	500
WCDE	Chattanooga, Tennessee	1280	1,000	WHDF	Gadsden, Alabama	1210	100	WNCN	Raleigh, North Carolina	680	1,000
WCDE	Hartford, Connecticut	1330	500	WHDF	Jackson, Mississippi	1270	1,000	WNCN	Miami, Florida	880	250
WCDE	New Orleans, Louisiana	1250	1,000	WHDF	Mooseheart, Illinois	1130	20,000	WNCN	Scranton, Pennsylvania	880	250
WCDE	Ruscola, Illinois	1070	100	WHDF	Gary, Indiana	1360	1,000	WNCN	New York, New York	1010	250
WCDE	New York, New York	660	50,000	WHDF	Ironwood, Michigan	1420	100	WNCN	Vicksburg, Mississippi	1360	500
WCDE	Ithaca, New York	1270	1,000	WHDF	Detroit, Michigan	750	10,000	WNCN	St. Albans, Vermont	1370	100
WCDE	Providence, Rhode Island	780	250	WHDF	Alexandria, Virginia	1460	10,000	WNCN	Thomasville, Georgia	1210	100
WCDE	Columbus, Ohio	570	750	WHDF	Oglethorpe Univ., Ga.	1370	100	WNCN	Williamsport, Penna.	1370	100
WCDE	Superior, Wisconsin	1290	1,000	WHDF	Mansfield, Ohio	1210	100	WNCN	Wilmington, N. Carolina	1370	100
WCDE	Harrisburg, Illinois	1210	100	WHDF	New York, New York	760	30,000	WNCN	Reading, Pennsylvania	1310	100
WCDE	Buffalo, New York	1310	100	WHDF	San Juan, Porto Rico	890	250	WNCN	Philadelphia, Penna.	1020	250
WCDE	Chicago, Illinois	1210	100	WHDF	East Lansing, Michigan	1040	1,000	WNCN	Columbus, Georgia	1200	50
WCDE	Eric, Pennsylvania	1420	100	WHDF	Laconia, New Hampshire	1310	100	WNCN	Greenville, Mississippi	1210	100
WCDE	Boston, Massachusetts	590	1,000	WHDF	Joliet, Illinois	1310	100	WNCN	Roanoke, Virginia	1410	250
WCDE	Reading, Pennsylvania	830	1,000	WHDF	Birmingham, Alabama	1310	100	WNCN	Washington, D. C.	950	500
WCDE	Emory, Virginia	1350	500	WHDF	Indianapolis, Indiana	1400	500	WNCN	Augusta, Maine	1370	100
WCDE	Evanston, Illinois	1420	100	WHDF	La Crosse, Wisconsin	1380	1,000	WNCN	Augusta, Georgia	1500	100
WCDE	Battle Creek, Michigan	1420	50	WHDF	Cicero, Illinois	1420	100	WNCN	Memphis, Tennessee	600	500
WCDE	Chicago, Illinois	870	50,000	WHDF	Youngstown, Ohio	570	500	WNCN	Lawrence, Kansas	1220	1,000
WCDE	see WORC			WHDF	Jersey City, New Jersey	1450	250	WNCN	Minneapolis, Minnesota	1250	1,000
WCDE	Eric, Pennsylvania	1420	30	WHDF	Galesburg, Illinois	1310	100	WNCN	Racine, Wisconsin	1370	100
WCDE	New York, New York	1300	500	WHDF	Connersville, Indiana	1500	100	WNCN	New York, New York	1010	250
WCDE	St. Louis, Missouri	760	1,000	WHDF	Buffalo, New York	1480	5,000	WNCN	Knoxville, Tennessee	1310	100
WCDE	Royal Oak, Michigan	1310	50	WHDF	Ludington, Michigan	1500	50	WNCN	Dallas, Texas	1280	500
WCDE	Dallas, Texas	800	50,000	WHDF	Lancaster, Pennsylvania	1200	100	WNCN	Gainesville, Florida	830	5,000
WCDE	South Bend, Indiana	1200	100	WHDF	Cincinnati, Ohio	550	500	WNCN	Richmond, Virginia	1110	5,000
WCDE	Philadelphia, Penna.	610	500	WHDF	Oklahoma City, Okla.	900	1,000	WNCN	Cincinnati, Ohio	1330	500
WCDE	Knoxville, Tennessee	1200	50	WHDF	Kalamazoo, Michigan	590	1,000	WNCN	Grove City, Penna.	1310	100
WCDE	Cincinnati, Ohio	1200	100	WHDF	Nashville, Tennessee	1470	5,000	WNCN	Allentown, Pennsylvania	1440	250
WCDE	Altoona, Pennsylvania	1310	100	WHDF	Louisville, Kentucky	1200	100	WNCN	Pall River, Massachusetts	1450	250
WCDE	Syracuse, New York	1360	1,000	WHDF	Minneapolis, Minnesota	1250	100	WNCN	Huntington, W. Virginia	580	250
WCDE	Indianapolis, Indiana	1230	1,000	WHDF	Muncie, Indiana	1310	50	WNCN	Atlanta, Georgia	740	5,000
WCDE	Baltimore, Maryland	1270	500	WHDF	Kansas City, Kansas	1420	100	WNCN	Chicago, Illinois	1210	100
WCDE	Flint, Michigan	1310	100	WHDF	Petersburg, Virginia	1200	100	WNCN	South Bend, Indiana	1230	500
WCDE	Rome, Georgia	1310	100	WHDF	Stevens Point, Wisconsin	900	2,000	WNCN	Columbus, Ohio	1210	100
WCDE	Anniston, Alabama	1420	100	WHDF	Oil City, Pennsylvania	1260	500	WNCN	Montgomery, Alabama	1410	500
WCDE	Manchester, N. H.	1430	500	WHDF	Long Island City, N. Y.	1500	100	WNCN	Springfield, Tennessee	1210	100
WCDE	Philadelphia, Penna.	560	500	WHDF	Bangor, Maine	620	500	WNCN	Winston-Salem, N. C.	1310	100
WCDE	Hopkinsville, Kentucky	940	1,000	WHDF	Ithaca, New York	1210	50	WNCN	Nashville, Tennessee	650	5,000
WCDE	Clearwater, Florida	620	250	WHDF	Lexington, Mass.	1370	100	WNCN	New Orleans, Louisiana	1320	500
WCDE	Brooklyn, New York	1400	500	WHDF	See WGN			WNCN	Dayton, Ohio	1380	200
WCDE	Lancaster, Pennsylvania	1310	100	WHDF	Philadelphia, Penna.	560	500	WNCN	Gastonia, North Carolina	1210	100
WCDE	Cleveland, Ohio	1450	500	WHDF	Boston, Massachusetts	1500	100	WNCN	Spartanburg, S. Carolina	1420	100
WCDE	Freeport, New York	1210	100	WHDF	Chicago, Illinois	870	50,000	WNCN	Toledo, Ohio	1340	1,000
WCDE	see WNBK			WHDF	See WPRO			WNCN	Iowa City, Iowa	880	500
WCDE	Evansville, Indiana	630	500	WHDF	Lynchburg, New York	1400	500	WNCN	See WFLA		
WCDE	Scranton, Pennsylvania	880	250	WHDF	Lynchburg, Virginia	1370	100	WNCN	Buffalo, New York	1370	50
WCDE	Gulfport, Mississippi	1210	100	WHDF	Cincinnati, Ohio	700	50,000	WNCN	Rutland, Vermont	1500	100
WCDE	Newark, New Jersey	1250	250	WHDF	New York, New York	1100	5,000	WNCN	Syracuse, New York	570	250
WCDE	York, Pennsylvania	1000	1,000	WHDF	See WSYR			WNCN	Quincy, Illinois	1440	500
WCDE	Chicago, Illinois	1360	500	WHDF	Buffalo, New York	1040	1,000	WNCN	Worcester, Massachusetts	580	250
WCDE	Newport News, Virginia	1310	100	WHDF	Washington, D. C.	630	1,000	WNCN	Cleveland, Ohio	1070	50,000
WCDE	Fort Wayne, Indiana	1370	100	WHDF	Chicago, Illinois	670	5,000	WNCN	Eau Claire, Wisconsin	1330	1,000
WCDE	See WLB			WHDF	Macon, Georgia	1180	500	WNCN	Norfolk, Virginia	780	500
WCDE	Chicago, Illinois	720	25,000	WHDF	Newport, Rhode Island	1500	100	WNCN	College Station, Texas	1120	500
WCDE	Buffalo, New York	550	1,000	WHDF	Detroit, Michigan	1420	100	WNCN	Springfield, Illinois	1210	100
WCDE	Atlanta, Georgia	890	250	WHDF	Peoria, Illinois	1440	500	WNCN	Cumberland, Maryland	1420	100
WCDE	Schenectady, New York	790	50,000	WHDF	See WIOD			WNCN	Philadelphia, Penna.	1310	100
WCDE	Madison, Wisconsin	1940	750	WHDF	Richmond, Virginia	1210	100	WNCN	Athens, Georgia	1450	500
WCDE	Milwaukee, Wisconsin	1120	250	WHDF	Joplin, Missouri	1420	100	WNCN	Hartford, Connecticut	1060	50,000
WCDE	Rochester, New York	1150	5,000	WHDF	Chicago, Illinois	1080	5,000	WNCN	Jackson, Tennessee	1310	100
WCDE	New York, New York	1300	1,000	WHDF	Wilkesburg, Penna.	1500	100	WNCN	Milwaukee, Wisconsin	620	1,000
WCDE	Louisville, Kentucky	820	10,000	WHDF	Auburn, New York	1310	100	WNCN	Nashville, Tennessee	1470	5,000
WCDE	Philadelphia, Penna.	1310	100	WHDF	Brooklyn, New York	1500	100	WNCN	Savannah, Georgia	1260	500
WCDE	Troy, New York	1300	500	WHDF	Tampa, Florida	1370	100	WNCN	Laurel, Mississippi	1310	100
WCDE	Kansas City, Missouri	860	500	WHDF	Memphis, Tennessee	780	500	WNCN	Hammond, Indiana	1200	100
WCDE	Canton, Ohio	1200	10	WHDF	New York, New York	570	500	WNCN	Detroit, Michigan	920	1,000
WCDE	Mount Orab, Ohio	1370	100	WHDF	Brooklyn, New York	1500	100	WNCN	New Orleans, Louisiana	850	5,000
WCDE	Rock Island, Illinois	1210	100	WHDF	Fairmont, West Virginia	890	250	WNCN	Asheville, N. Carolina	570	1,000
WCDE	Sheboygan, Wisconsin	1410	500	WHDF	Lapeer, Michigan	1500	100	WNCN	Woodside, New York	1500	100
WCDE	Memphis, Tennessee	1370	100	WHDF	Jamaica, New York	1210	100	WNCN	Pittsburgh, Pennsylvania	1500	100
WCDE	Anderson, Indiana	1210	100	WHDF	New York, New York	1350	250	WNCN	Wheeling, West Virginia	1160	5,000
WCDE	Green Bay, Wisconsin	1200	100								



## A PRELIMINARY TRY-OUT

The author is shown here making early tests in the R. N. Laboratory. Subsequent reception tests are described in this article which is a continuation from last month

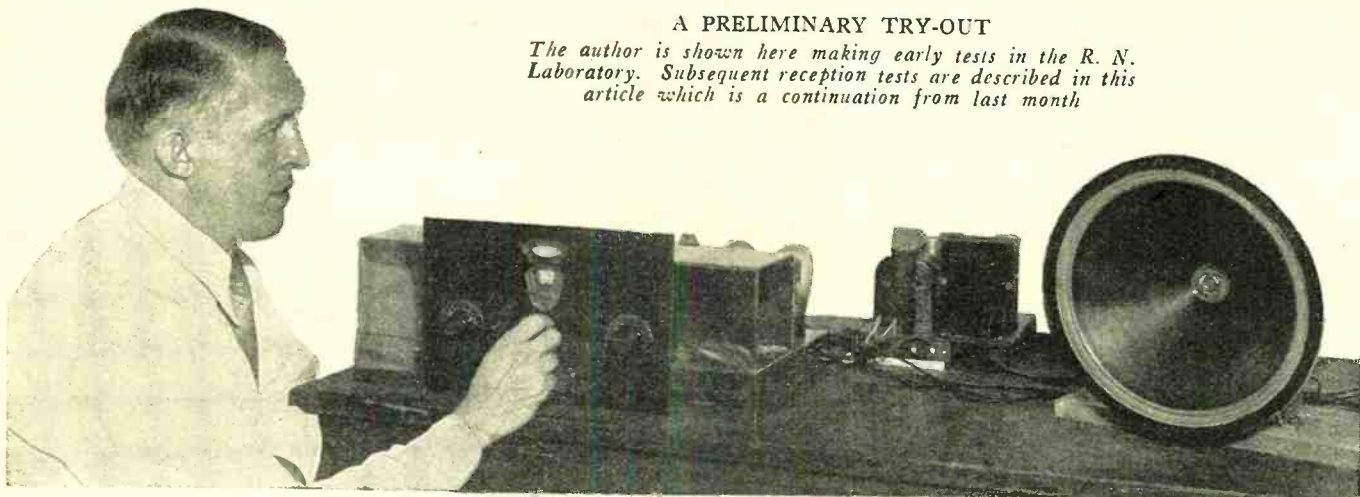

## An Outstanding DX SUPER for Long and Short Waves

**T**HE first article on the new Lincoln DeLuxe SW-33 all-wave receiver, which appeared in last month's issue, treated with considerable detail the modern features and developments as employed in this receiver, including a band switching arrangement which is controlled from a single knob mounted on the front panel, automatic volume control, the reduction of background noise, and visual meter tuning. The present article will discuss the reception results obtained in tests on both the broadcast and short wavelengths and will also include data on installation and notes on operation of the set. The reception tests to which this receiver has been subjected in the past two weeks bear out all the indications of the preliminary tests described last month.

In the beginning, the tests were conducted without the employment of a baffle for the speaker, but even under these conditions the quality of reproduction was impressive and the presence of both high and low notes, with neither over-emphasized, was obvious. Tests were made thereafter with a 4-foot baffleboard and it is needless to say the quality of reproduction was strikingly realistic.

The design of the circuit, complete shielding and the push-pull arrangement of tubes in both the first and second audio stages, all contribute to this naturalness of reproduction.

The receiver was tested at the author's apartment in New York City and in two suburban locations, Bayonne, New Jersey, and Blauvelt, New York. The selection of the latter places was made without previous knowledge or reports that they were better than the average location. The choice was made due to the gracious extension of home and facilities of friends, for these tests.

The approximate distance of Bayonne from New York City is ten miles and of Blauvelt

## Part Two

about thirty-five miles. The operating tests and records of reception referred to in the following paragraphs will indicate wherever possible the date, time and location of test.

Running through the tuning dial from zero to 100 degrees for a check of daytime reception on the broadcast band at the author's apartment in the city, signals were received for over half the assigned channels. Due to the infrequent announcement of station calls, no attempt was made to log a complete list of stations received, but it is interesting from a standpoint of a sensitivity test for daylight reception to say that WIP, Philadelphia, and WICC, Bridgeport, Conn., were received with volume

equal to the local stations.

The antenna utilized for the city tests was a single wire of fifty feet with lead-in measuring ten feet and the ground lead about five feet. The apartment house is situated close to cross trolley lines and is a busy thoroughfare for automobile traffic.

The evening reception test, also for the broadcast wavelengths, took place in New York City on June 6th. The first part of the evening there was a great deal of static present which completely interfered with reception. Toward 10 p.m.,

however, the storm responsible for this condition was over and the distant stations were coming in with great volume.

Generally, without the use of laboratory measuring instruments, the ability of a receiver as regards the selectivity and sensitivity is determined by a comparison of the distant stations received; their strength and freedom from interference from the locals operating on adjacent channels.

The author decided a good comparison would be obtained by attempting to log all the stations between the

[ By William C. Dorf ]

## UNDER THE CHASSIS

The all-wave coils may be seen at the lower right. Note the straight line arrangement of tubes and the resulting simplicity of the wiring

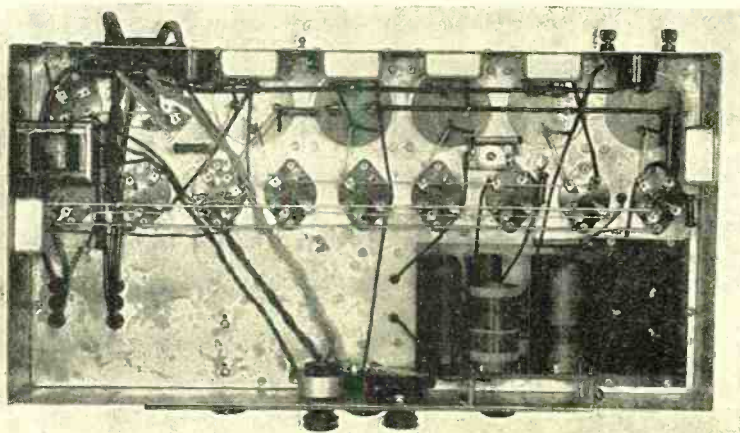



channels of 660 to 760 kilocycles, which include WEAJ, WOR and WJZ, three of the powerful local stations. The log is shown in Table 1, and it is to be noted that reception with the station announcement was obtained on ten channels to include the above three local stations. The channel of 680 kilocycles was the only exception. This is occupied by KPO, a station rarely heard at this time of the year in New York.

**Reception Tests**

There was slight fading on the distant stations, excepting WLW and WMAQ, which were both received with sufficient volume to be classed with the locals.

Naturally, after the excellent broadcasting results, the author was anxious to see what the receiver could do on the short wavelengths. This is an appropriate time to state that the outstanding features of the receiver, such as meter tuning, the low noise level and the vernier adjustment control were of decided advantage for reception on these low wavelengths.

The reception on the short waves for the New York City location included signals from the principal European and South American stations, as well as numerous Canadian and American short-wave broadcasters. The operating test also included the police and aeronautical calls, several international phone stations and the amateur stations on all their assigned wavelengths.

A check of the three principal European short-wave stations, 12RO, Rome, 25.40 meters; G5SW, Chelmsford, 25.53 meters, and Paris, 25.63 meters, was made for a period of six days between the hours of 5.30 and 7 p.m. Daylight Saving Time. The signals for these stations were easily received during these hours each evening, but, of course, with variations in intensity, noise level and fading for the different days.

For the second test the receiver was installed at Bayonne, New Jersey, about 5 p.m. the day of July 8th. The house in this location is situated on a knoll and faces New York Bay. After checking through the broadcast band and finding the reception to be entirely satisfactory, the band-shifting arrangement was rotated to the 15 to 30 band with disappointment.

**On Later Tests**

Interference was found to be present over the entire band from 15 to 200 meters. An investigation of the antenna installation and the grounds were made but disclosed no faults, therefore a high-power line running parallel to the rear of the house was judged the most likely cause for this annoying interference.

Fortunately, the interference was present for only an hour and one-half, up to 6.30 p.m., time enough to receive England and Paris with good results. About 8 p.m. that evening the dial was rotated to the setting where station EAQ of Madrid, Spain, should be heard. Sure enough, EAQ was present and with volume heretofore unheard from a European broadcast.



**THE POWER SUPPLY UNIT**  
*This unit, connected to the receiver and speaker field coil, supplies all operating power*

The announcement is made in both English and Spanish and at a distance of 75 feet from the house the English announcement was easily discernible.

**Final Test**

The station LSX, Buenos Aires, Argentina, was received with about the same volume, but the fading periods were longer and the noise level higher. The antenna used in this location was a single wire of 70 feet, the lead-in about 30 feet and the ground connection about 5 feet.

The third test was conducted in Blauvelt, New York, on July 16th, and provided the most interesting and really exceptional short-wave results. This is a rural district and the house was situated in a clearing which made it possible to erect an antenna of 100 feet in length by approximately 25 feet in height. The lead-in was 20 feet and the ground connection 15 feet. The first test was made about 4.30

p.m., with the signals of Paris and Rome coming in with very little fading or noise and with sufficient volume to be heard 150 feet from the house. The owner of the house remarked that the reception of Rome was equal to a good many low-power local stations—discounting the fading, of course.

The Canadian short-wave stations of VE9GW on 49.22 meters and VE9DR on 25.46 meters were easily received with plenty of volume and good quality.

There are several Canadian stations present every evening on the 30 to 50-meter waveband. These stations were always easily tuned in and are to be found between 69 and 80 degrees on the dial. Table 2 gives a log of the short-wave stations referred to in the above paragraphs, with their dial settings, call letters and locations.

The operating test on both broadcast and short wavelengths were made with an improvised antenna installation and ground connections. Therefore, the radio enthusiast with a radio antenna especially installed for his conditions could in all likelihood better these reception results.

**Installation and Operation**

The installation of the receiver is simplicity itself, cables leading from the receiver chassis and the loudspeaker for attachment to the power unit consist of color-coded wires and their proper connections are plainly indicated.

Three insulated tip-jacks on the rear wall of the receiver chassis take their respective colored leads from the speaker to complete the circuit to the output transformer, which is mounted on the speaker.

There is a single six-prong type socket provided for the Wunderlich type second detector tube. All the remaining sockets are plainly marked to accommodate the various other type tubes.

After the antenna and ground leads are connected to their terminals as marked on the receiver chassis, and the a.c. line plug has been inserted in the wall (*Continued on page 245*)

TABLE 1			
MAIN DIAL	WAVELENGTH IN KILOCYCLES	CALL	PLACE
61	760	WJZ	NEW YORK CITY
63	750	WJR	DETROIT
64.5	740	WSB	ATLANTA
66	730	XEM	TAMPICO, MEXICO
67.5	720	WGN	CHICAGO
69	710	WOR	NEWARK, N.J.
71	700	WLW	CINCINNATI
72	690	(CHAIN)	CANADA
75	670	WMAQ	CHICAGO
77.5	660	WEAF	NEW YORK CITY

TABLE 2			
MAIN DIAL	WAVELENGTH IN METERS	CALL	PLACE
15 TO 30 METER WAVEBAND			
70	25.25	W8XK	PITTSBURGH, PA.
71.5	25.40	12RO	ROME, ITALY
72	25.53	G5SW	CHELMSFORD, ENGLAND
73	25.63	FYA	PARIS, FRANCE
81.5	28.98	LSX	BUENOS AIRES, ARGENTINA
92.5	30.40	EAQ	MADRID, SPAIN
30 TO 50 METER WAVEBAND			
47	31.48	W2XAF	SCHENECTADY, N.Y.
27	34.5	W2XAC	"
74.8	-	VE8DR	MONTREAL, CANADA
77.5	49.22	VE9GW	"
85.5	-	-	COLUMBIA, S.A.



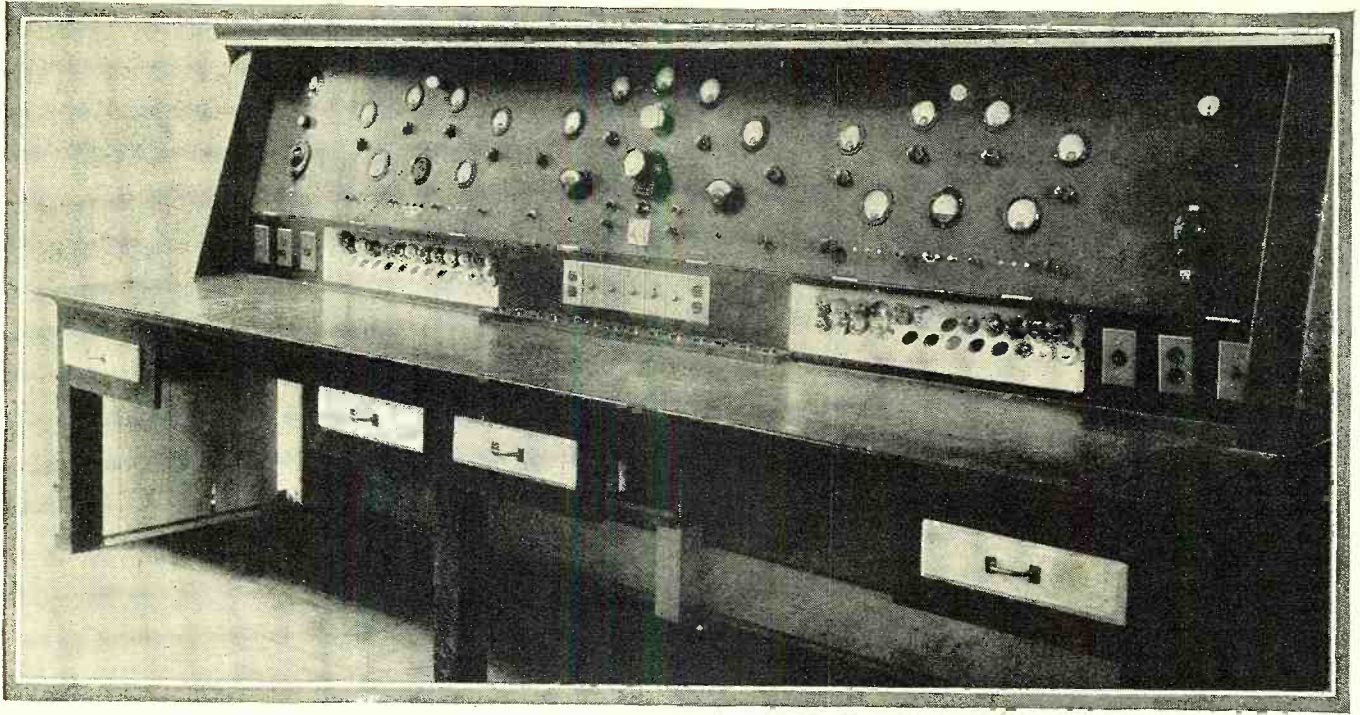

# The Service Bench

*Rural Radio Sales and Service, The Importance of the Sideline, Electric Refrigerators, Rural P. A. Possibilities, Analyzing the Inventory, Service Equipment, A Vacation Sales Idea, Pepping Up the Rural Tube Business, Service Notes, etc.*

**T**HE tendency toward dissatisfaction with one's present condition is a fundamental trait of human nature. By no means a few of the many letters recently arrived at the desk of the Editor have been from radio technicians in small communities who have inquired as to the possibilities of urban service, expressing a definite desire to ignore the general countryward tide of things and to seek fortune, if not fame, in tending the radio service wants of New York and Chicago! The best answers to these letters are the many instances, known to the writer, of city servicemen who (without even bothering to write for advice and packing what equipment had escaped the pawnbroker) have migrated to the country with hopes of making a *better* living.

The rural expert often looks enviously at the distant city spires, makes a rapid calculation on a "per capita" basis, and rightly concludes that there are many more receivers to be serviced in the congested urban area. But his arithmetic is woefully one-sided if he forgets that *there are proportionately many more servicemen to service them!* On the other hand, his brother in the city looks to the rolling hills of the countryside and realizes that though there are fewer radios per square mile, the servicemen also are probably few and far between. So far a balance has been struck and nothing adduced to the advantage of rural or urban servicing. However, the scale immediately tips in favor of the country when it is considered that overhead and living expenses are definitely reduced and that list prices may be exacted for parts and complete receivers, in contrast with the profitless price-cutting of the city trade. Also, in the rural districts it is almost invariably possible to select profitable sidelines in which no immediate competition exists.

*Conducted by  
Zeh Bouck*

## *The Major Sideline*

In the majority of instances investigated, the major sideline has been *Electrical Wiring*. The qualifications of an expert and licensed electrician are no mean recommendation for the urban as well as rural radio expert. A working knowledge of the under-

**R**URAL communities represent a portion of our population of vast economic and social importance. In a state of relative isolation, radio, as an entertainment and a cultural education, assumes a status of first importance. But radio, without adequate service, fails to fulfill its mission. This month's "Service Bench" is dedicated to the rural serviceman—the technicalities of his job and the problem of making a comfortable living, commensurate with the vital service he renders.

writers laws and general wiring is a guarantee of an expert and safe installation. It is of particular importance in connection with public-address work, where set-ups, even though temporary, must pass rigid fire and underwriters requirements, and time permits no variations of the original installation. And in the case of rural establishments, it is evident that such talents may provide a considerable source of income.

It may appear somewhat illogical to consider an activity which represents so large a

portion of the total income as a "sideline." However, as we are looking at the entire set-up from a radio point of view, and as, in many instances, general electrical wiring and contracting grew as a by-product from an originally exclusive radio business, the idea is not untenably inconsistent.

Other endeavors, less correctly classified as major sidelines, are the garage and automobile accessory business, plumbing and the maintenance of a general store.

## *The Importance of the Sideline*

While it is possible to build up a successful and exclusively service business, this department has always emphasized the profits in a relevant sideline. As a matter of fact, an intensive research on the part of RADIO NEWS into the economics of rural radio has demonstrated that the sidelines of what may be nominally a radio business contribute over 50 percent of the entire profits! An analysis of conditions existing in a typically rural county in New York State, computed from figures supplied by five local service organizations, sums up the situation as follows:

TYPE OF SALES	PERCENTAGE OF TOTAL INCOME
Major sideline .....	50%
Minor sidelines.....	20%
Radio sets .....	15%
Public address sales and rentals .....	10%
Radio servicing .....	5%
Total income .....	100%

A detailed and specific analysis of the above tabulation will give an excellent idea as to the possibilities of the rural radio business—technique, equipment and general procedure.





FIGURE 1

**Minor Sidelines**

The minor sidelines consist of the usual electrical appliances, such as refrigerators, toasters, fans and washing machines. The sale of refrigerators alone represents 15% of the 20% attributed to minor sidelines.

The electrical refrigerator provides an excellent summer business as the winter radio trade falls off. Also, several radio companies are making refrigerators, and a rural dealer in such units can readily secure a franchise and credit (if credit has been established for radio receivers) for that particular refrigerator. The rural communities, catching up with the times, are just turning to electrical refrigeration, making such devices attractively profitable for the next three or four years.

**Radio Sets**

The set line chosen should, primarily, be one that has demonstrated popularity in a neighboring community. It should, of course, be rather extensive and include battery-operated as well as a.c. receivers. The quickest turn-over seems to be made on sets listing in the neighborhood of \$80.00. The feeling of the farmer is that the cheaper models are not good enough, and that he hasn't enough money for the most expensive. The indicated compromise results.

Regardless of his dependence on the mail-order catalog for a goodly portion of his yearly expenditures, the farmer shows a definite preference for the local expert when it comes to buying a radio set. This is probably due to the fact that here is an item which he feels justifies consultation and upon which he wishes advice.

About 20% of the receivers covered in any rural service area are of the battery type. However, many of these were purchased prior to the general extension of electric service coincident with the opening up of a vast rural network of concrete roads, and this figure by no means gives an accurate idea of the present-day sale of such receivers. Probably not more than five to seven percent of the receivers sold today are of the battery-operated type.

All receivers are sold for strictly list prices,

FIGURE 3

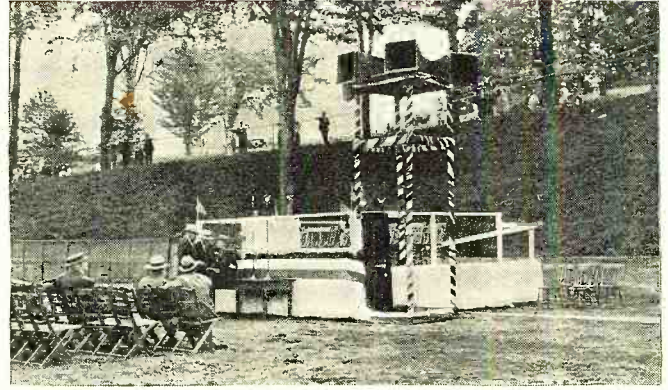
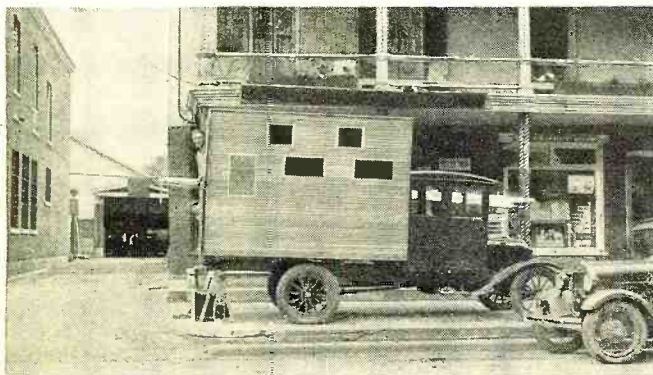

FIGURE 2

which includes tubes, installation and 6 months' free service or guarantee. Allowances are made on old sets only when salable. *A thoroughly healthy condition!*

**Public Address Work**

The *Service Bench* has for some time stressed the profits existing in the sale and

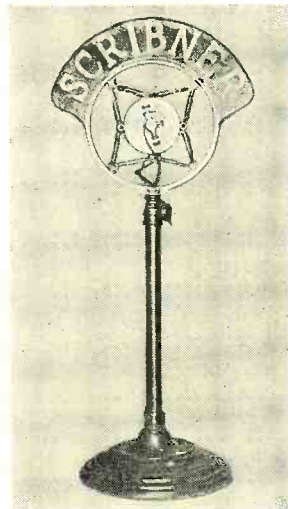

FIGURE 5

rental of public-address apparatus. In the cities these profits generally accrue to the manufacturer of such apparatus or to organizations specializing in sound installations. In the country it is the job of the rural serviceman, and if he knows amplifiers and speakers he can usually count on an exclusive territory, embracing several dozen villages and towns.

The sound installations shown in the accompanying photographs were all made by the Scribner Brothers of Schoharie, N. Y. They are typical of what can be done and illustrate the diversity of events in which public-address systems can be advantageously employed. Figure 1 shows the installation at the county fair grounds on the Fourth of July. The distance from Schoharie is 15 miles. Figure 2 shows the set-up at Delhi,

N. Y. (about 60 miles from headquarters) on the occasion of an address by Franklin D. Roosevelt, governor of the state and Democratic presidential nominee.

Figures 3 and 4 illustrate a novel variation from the usual form of P.A. work, and show the set-up for open-air motion pictures presented every Thursday evening in Schoharie. Two projectors are mounted in the Ford truck (Figure 3), which is driven on the sidewalk directly facing the County Courthouse across the street (Figure 4), where the two loudspeakers will be observed. The screen is dropped between the loudspeakers. The truck equipment also includes an electric turn-table which provides musical entertainment, through the projection amplifiers and loudspeakers, prior to the pictures. The enterprise is supported by the town in the highly successful endeavor to attract large crowds, one night a week, who return the compliment by patronizing the local establishments during their evening's sojourn. The village owns the projectors and rents the amplifiers and horns from Scribner Brothers.

The rental charge for P.A. equipment averages \$50.00 for half a day and \$75.00 for 12 hours—the amount varying somewhat with the distance from Schoharie. Wright DeCoster loudspeakers are used in the installation described.

Included in the general income from P.A. work are the profits of sound-head installations on silent or record type projectors representing a net profit of \$60.00 per sound-head, plus an installation fee depending upon time required and the distance traveled. Syncrofilm sound-heads are used with either Radiart or Powerizer amplifiers. Where a record-type projector is being converted it is occasionally possible to employ the original amplifier and loudspeaker system.

The features outlined above are regularly supplemented with the conventional P.A. installations described at length in "How to Make Money in Radio Servicing."

**Radio Servicing**

While radio servicing contributes directly only 5% of the total profits in a typical rural radio-electrical establishment, it per-

*(Continued on page 253)*

FIGURE 4

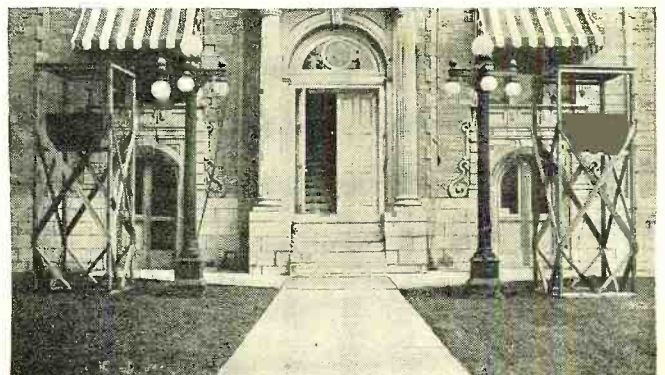





# Radio Science Abstracts

*Radio engineers, laboratory and research workers will find this department helpful in reviewing important current radio literature, books, Institute and Club proceedings and free technical booklets*

*Photo Electric Phenomena*, by A. L. Hughes and L. A. DuBridge. McGraw-Hill Book Company, Inc., 1932. A textbook, covering the complete field of photoelectricity, has been needed for a long time. Up to the present time, the information contained in this book could only be obtained by consulting a well-stocked scientific library.

The book has been written in the way of all scientific textbooks and is addressed chiefly to those who have had some college training in physics and mathematics. Practical applications and laboratory methods are treated briefly in the last two chapters.

The man who expects to advance in the field of television, sound-motion-pictures or other photo-cell applications, would do well to study this text carefully. The Fundamental Laws of photo-emission, which should be familiar to him, are discussed in detail. The experiments which led to the formulation of these laws are also indicated, together with the original source of the information. There is hardly any Law stated without indicating also the experimental or mathematical proof and who contributed it.

The first six chapters deal with the fundamental principles of the emission of electrons under the influence of light. In chapter 7 ionization of gases is discussed. Then follows a treatise of photo-conductivity and photo-voltaic effects, the photo-electric effects in non-metallic substances and the photo-electric effect of X-rays and  $\gamma$ -rays.

A final chapter gives much miscellaneous information; the appendix lists the values of constants and the definitions of units. A separate index is provided for the names mentioned in the text.

## *A Fundamental Home-Study Radio Course—National Radio Institute*

Listed below are the various lessons of the course:

Reference book—Definitions of Radio terms and symbols.

Lesson 1FR—A bird's-eye view of radio.

Lesson 2FR—The language of radio-tricians.

## *Conducted by* **Joseph Calcaterra**

Lesson 3FR—How the receiver is supplied with power.

Lesson 4FR—Practical radio circuits.

Lesson 5FR-1—How resistors are used in radio to control current flow.

Lesson 6FR-1—Radio coils—how and why they work.

Lesson 7FR—Radio condensers, their function and operation.

Lesson 8FR-1—How a vacuum tube works; types of tubes in use.

Lesson 9FR-1—Radio transformers and the principles of tuning.

Lesson 10FR-1—How a 3-element tube amplifies.

Lesson 11FR—Iron core a.f. and power transformers.

Lesson 12FR—How a 2-element tube rectifies a.c. in power-pack operation.

Lesson 13FR—Various voltage-supply methods for radio equipment.

Lesson 14FR—Changing sound into electricity and electricity into sound.

Lesson 15FR—The vacuum tube in audio-frequency stages.

Lesson 16FR—The vacuum tube in radio-frequency stages.

Lesson 17FR—How a vacuum tube acts as a detector.

Lesson 18FR—Screen-grid, variable  $\mu$  and pentode tubes.

Lesson 19FR-1—Practical r.f. circuits and methods of controlling volume.

Lesson 20FR-1—The radio-frequency amplifier and how it works.

Lesson 21FR—The vacuum tube as a generator in radio circuits.

Lesson 22FR—Tuners and wave filters.

Lesson 23FR—The modern superheterodyne receiver.

Lesson 24FR—How to select a good radio receiver.

Lesson 25FR1—Photocells and glow lamps.

Lesson 26FR—Loudspeakers and how they operate.

Lesson 27FR—Loudspeakers, tone and output devices.

Lesson 28FRx-1—Current measuring devices and their uses.

Lesson 29FR-1—Voltage-measuring devices and their use.

Lesson 30FR—Resistance, capacity, inductance and frequency measurements.

Lesson 31FR—Receiver refinements.

Lesson 32FR1—Short-wave receivers and transmitters.

Lesson 33FR1—Transmitting antennas and their radiation characteristics.

Lesson 34FR—Power audio amplifiers.

Lesson 35FR—A typical broadcast station.

Lesson 2SB—Radio servicemen's tools and their use.

Lesson 3SB—Commercial radio condensers.

Lesson 4SB—How to build a broadcasting station.

Lesson 5SB—Antennas for broadcast reception. Book 1.

Lesson 6SB—Antennas for broadcast reception. Book 2.

Lesson 7SB—Set analyzers.

Lesson 8SB—Decibels; audio amplification.

Lesson 1SM—Trouble shooting in d.c., a.c. and battery sets.

Lesson 1JS—28 Tested methods for making extra money.

Lessons 1SS—6SS Circuit-diagrams of commercial receivers.

Lesson 1SSC—Service manual. 14 circuit diagrams each with testing information (Canadian sets).

This list is that of the contents of the "Fundamental radio course" sent to students of the National Radio Institute.

Each lesson consists of a booklet of about 30 pages. The text is clearly written and illustrated with many drawings and photographs. The last page of each lesson contains questions whereby the student can test his progress.

The fundamental concepts of radio theory are carefully explained; especially the lesson 9FR which goes into more detail concerning the theory of tuned circuits and resonance than is usual.

From the list of subjects it is easily seen that the latest improvements have been included in the course. In the lessons are



many practical hints and instructions intended to enable the student to make his own equipment.

The ambitious booklet 4SB—"How to build a broadcasting station," is an account of the work done by a graduate student while constructing a 500-watt transmitter.

### Extract of Two Articles in Bell Laboratories Record for June, 1932

*Transmission Instruments for the New Audiophone*, by W. C. Jones. In order to make the hearing device as small and light as possible, the vacuum tube is not employed but the required amplification is provided by a mechanical amplifier, described in this article.

*Motion Pictures in Relief* (unsigned). An account of the experimental work of Dr. H. E. Ives on three-dimensional motion pictures. The effect is obtained by dividing the pictures into elemental lines and superimposing different views of the picture on the film. Each group of lines is projected on a celluloid rod. For every possible position of the observer a different picture is seen.

### One Paper from Proceedings of the Radio Club of America for May-June, 1932

*Notes on the Design of Radio Receivers*, by Lincoln Walsh. This paper discusses the design of tuned circuits with especial attention to the circuit resistance, how it is affected by the shielding and how it is measured. The rating of sensitivity in decibels instead of in microvolts is proposed.

### Review of Articles in the July, 1932, Issue of the Proceedings of the Institute of Radio Engineers

*Application of the Class B Audio Amplifier to A.C. Operated Receivers*, by Loy E. Barton. This paper discusses the reasons for the trend towards Class B amplifiers as a means of obtaining greater output for a given cost, and points out the important factors of circuit design, and power supply requirements necessary to obtain satisfactory results with this type of amplifier.

*Design of Resistors for Precise High-frequency Measurements*, by L. Behr and R. E. Tarpley. A very complete description of shielded and unshielded resistance boxes and fixed standards of resistance for use in precise high-frequency measurements is given in this article. It also explains the construction of a new type of resistance unit and two new types of decades. In one of the boxes described, only one coil of each decade is connected in the circuit at a time, the rest of the resistance coils being completely disconnected while the configuration of the circuit inside the box remains constant for all settings of the dial.

*Triple-Twin Tubes*, by Charles F. Stromeier. This paper gives complete information on the triple-twin tube and compares the operation of this type of tube with the type -45 and -47 tubes from the standpoints of efficiency and sensitivity. It points out that while all of these tubes have the same plate voltage rating, the triple-twin tube delivers nearly twice as much power as

### Review of Technical Booklets Available

1. *1932 Condenser Catalog*. A 12-page booklet giving complete details, specifications and list prices on Micamold dry electrolytic, paper, mica and replacement condensers, automobile ignition suppressors and carbon resistors.

the -47 and three times as much as the -45.

*A Theoretical Comparison of Coupled Amplifiers with Staggered Circuits*, by J. R. Nelson. In this paper, detuned or staggered circuits are compared theoretically with the so-called "band-pass," or coupled circuits, from the standpoint of amplification and selectivity result. Resonance curves have been calculated for each case which show that approximately the same results are obtained up to optimum coupling by either method.

### Review of Contemporary Periodical Literature

*Dynamic Speaker Design*, by A. R. Barfield. *Electronics*, June, 1932. This article discusses mathematically, the factors which determine the frequency-response and the sensitivity characteristics of dynamic speakers and the manner in which maximum efficiency can be obtained with minimum expenditure.

*Determining Field Distribution by Electronic Methods*, by E. D. McArthur. *Electronics*, June, 1932. This paper describes a method whereby the distribution of the electrical field about an object or set of objects such as cables, insulators, etc., may be determined experimentally instead of by using the solution of a partial differential equation, ordinarily required in that type of work.

*Measurement of Class B Amplifier Distortion*, by Clyde L. Farrar. *Electronics*, June, 1932. A discussion of the factors which cause distortion in Class B amplifiers, and how the conditions for minimum distortion may be obtained, are discussed in this article, together with the method used to measure the per cent. distortion in this type of amplifier.

*Modern Production Sensitivity Measurement*, by Richard F. Shea. *Radio Engineer-*

## Free Technical Booklet Service

Through the courtesy of a group of radio manufacturers, RADIO NEWS now offers its readers this new Technical Booklet Service. By means of this service readers of RADIO NEWS will be able to obtain quickly and absolutely free of charge many interesting, instructive and valuable booklets and other literature which formerly required considerable time, effort and postage to collect.

To obtain any of the booklets listed in the following section, simply write the numbers of the books you desire on the coupon appearing at the end of this department. Be sure to print your name and address plainly and mail coupon to the Radio News Technical Booklet Service. Stocks of these booklets and catalogs are kept on hand and will be sent you promptly as long as the supply lasts. Do not send for any material in which you are not actually interested in order to avoid waste of needless postage

2. *1933 Condenser and Parts Catalog*. An 8-page folder which gives complete specifications and list prices on the new Hammarlund line of broadcast, short-wave, ultra-high frequency, band-spread, transmitting, midget and dual midget variable condensers,

ing, July, 1932. This article contains a rather complete discussion of the various methods used in production testing and a description of a flexible and comparatively simple test system which can be used effectively by both small and large set manufacturers.

*Electrolytic Condensers for the Transmitter*, by William Mason Bailey. *Radio Engineering*, July, 1932. The advantages of electrolytic condensers in making possible the use of high capacities at comparatively low cost in transmitter filter-circuits are discussed and the precautions which must be observed to prevent damage to condensers in such circuits are given in this article.

*Production Testing of Small Power Transformers*, by R. M. Hukle. *Radio Engineering*, July, 1932. This article describes a simple, flexible production system for testing power transformers for radio receivers, with information on the construction of the test circuits and testing procedure.

*Insulator Developments Point to Noiseless A-C Tubes*, by Henry L. Crowley. *Radio Engineering*, July, 1932. A discussion of the importance of the insulators, used in tubes on the characteristics of the tube, is given, and a new type of insulator designed to eliminate difficulties heretofore experienced is described in this article.

*Ten Million Volts*. *Radio Engineering*, July, 1932. Some interesting facts on the voltage and current characteristics of lightning and the nearest approach to it which has been attained by man are given in this article which describes a laboratory demonstration of a 10,000,000-volt artificial lightning bolt.

*Building a Low-Cost 1750-kc. Phone-C.W. Transmitter*, by George Crammer, QST, July, 1932. A description of an up-to-the-minute transmitter which includes such features as Class B audio, 100% modulation, buffer amplifiers, etc., and can be built for less than \$100.00. The transmitter has a rated carrier output of 25 watts on both c.w. and phone.

*Radio Law Bulletin of the School of Law*. The Catholic University of America announcements, August, 1931. A series of lectures on radio law covering such subjects as "Who Owns the Ether?," "Federal and State Regulation of Radio Communication," "Interpretation of Public Interest, Convenience or Necessity," "Procedure Before the Federal Radio Commission," "International Radio Regulation," "Religious and Educational Broadcasting and Some of Its Problems" and "The Piracy of Broadcast Programs."

*Recording of Modulation Level of a Broadcast System*, by H. L. Kirke. *The Wireless Engineer and Experimental Wireless*, July, 1932. This article describes apparatus which has been developed for indicating and recording the modulation level of a broadcast system to ensure the maintenance of high quality in a program broadcast by a station or group of stations. The apparatus can also serve to check the programs of other or interfering stations and furnish definite proof or evidence of interference.

equalizing, trimming and padding adjustable condensers, sockets, coils, 465 kc. intermediate-frequency transformers, shields for all types of tubes, including the new -56, -57 and -58 tubes, broadcast receiver and transmitting chokes and flexible couplings.

4. *14 to 200-Meter "Pro" Comet Superheterodyne*. A custom-built high-frequency



superheterodyne receiver, designed especially for professional operators and advanced amateurs, is described in this folder. The receiver is designed for the reception of both code and voice signals and is especially suited for laboratory, newspaper, police, airport and steamship use. Hammarlund.

5. 1932 Radio Catalog. Complete specifications and list prices on the entire line of volume controls, voltage dividers, vitreous resistors, Truvalt adjustable resistors, public-address equipment, amplifiers, replacement controls and resistors are contained in this 10-page book. It also contains a chart of replacement controls and circuits and an important announcement on the Resistor Replacement Handbook. Electrad.

6. Line Voltage Control Folder. This folder gives complete description of the characteristics and uses of the automatic regulator and explains why all leading radio manufacturers recommend its use to prevent radio trouble. A chart showing the proper unit for all the popular receivers now in use is also given. Amperite.

9. Resistance Catalog. A handy folder giving complete specifications and list prices of metallized and precision wire-wound resistors, motor radio suppressor kits, handy servicemen's resistor kits, etc., of the International Resistance Co.

10. Information on the Suppression of Motor Radio Noises. This interesting and useful folder, published by the International Resistance Company, shows how to overcome motor-generator, ignition, coil, interrupter and spark-plug noises in automobile radio installations.

11. 1932 Condenser Catalog. This 4-page folder gives complete specifications and list prices on the line of both high and low-voltage paper condensers for by-pass and filter use in transmitting and receiving equipment. Units for both original and replacement use are listed. Flechtheim.

12. Certified Tube Plan Booklet for Servicemen and Dealers. This booklet explains in detail a special plan of the Triad Mfg. Co. which makes it possible for servicemen and dealers who maintain a service department to obtain certified Triad tubes direct from the factory at discounts which enable them to make tube replacements at attractive profits. Distribution of this folder is restricted exclusively to servicemen and dealers who maintain a service department.

14. Descriptive Folder for No. 120 and No. 160 Phonovox. Contains complete operating notes on both of the popular-priced electric phonograph reproducers. Patent.

15. Booklet for the No. 171 Recordovox and Control Box. Detailed description, specifications, installation and operating notes on a versatile combination instrument for both making and reproducing records electrically through standard radio receivers.

16. The RMA Standard Resistor Color-Code Chart. This handy postcard-size resistor color-code chart can be carried in pocket, notebook or kit of tools. It has been designed to simplify the job of identifying the resistance values of resistors used in most of the standard receivers. Lynch.

17. 1932 Radio Instrument Catalogue WJ. A 20-page book on radio measuring and testing instruments, containing specifications on the complete lines of both the Weston and Jewell organizations that is without doubt the most complete of its kind. A copy should be in the hands of every engineer, serviceman, purchasing agent, teacher or anyone in the industry who uses or specifies measuring and testing instruments.

18. A Baptism of Fire. This interesting 16-page illustrated booklet describes, in non-technical language, the materials and processes used in making Centralab fixed resistors. It gives many useful and little-known facts on the research work, facilities and skill required to manufacture these small but highly important members of the resistor family.

19. Making Auto Radio Sets All-Electric with the Genemotor. This circular gives complete specifications and description on the Carter genemotor which is designed to eliminate "B" batteries in connection with automobile, aviation, farm and other similar sets. A dynamotor unit operating from the storage battery, and consuming less current than a parking light is employed.

20. Resistor Booklet No. 110. This useful folder gives circuits which show how resistance units can be used to make multi-range voltmeters and ohmmeters, wheatstone bridges and capacity bridges. A chart indicates the proper resistance required with milliammeters of different ranges to convert them into voltmeters of any required range. A table listing standard values of Shallcross Super Akra-Ohm resistors is also included.

21. Exact Duplicate Replacement Transformers. This 6-page folder gives complete information, with receiver name and model numbers, on a complete line of Stancor replacement power transformers, chokes, audio transformers and output transformers made by the Standard Transformer Corp. The units listed are exact duplicates, electrically and mechanically, of the originally-installed transformers used in the many popular sets now in use.

22. Resistor Stock List No. 8. A 6-page folder giving complete specifications and listing the complete line of fixed, semi-variable, meter-multiplier, transmitting, voltage-divider and power-pack resistors, non-inductive resistors, slide-wire, rheostat-potentiometers and power rheostats which are carried in stock at all times by the Ohmite Mfg. Co. All resistors are of the vitreous enamelled type.

23. Replacement Resistor Bulletin No. 10. This 2-page folder gives a complete list of Ohmite "Red Devil" replacement resistor units designed to withstand high tempera-

tures and also gives complete listings and data on a new type of vitreous-enamel, semi-variable resistors that are ideally suited for use as replacement voltage dividers.

24. Service Kit Booklet. This piece of literature explains how it is possible for any serviceman or dealer to obtain, without charge, a Sylvania service kit, 17 inches long, 7 inches wide and 10 inches deep, built of 3-ply veneer, covered with black leatherette and provided with decorative brass fittings, lock, key, kit for small parts, tool tray, literature rack and space for 20 assorted tubes.

25. Noise-Reducing Antenna System. A detailed description of a new antenna system, perfected by the Lynch Mfg. Co., which is equally effective on both broadcast and short waves in eliminating the great majority of electrical noise interference. It is especially suited for application on all-wave receivers which have heretofore given unsatisfactory results because of objectionable interference on the shorter waves. This system can be applied to existing installations and offers a big field for jobs for the serviceman. Its use on amateur receivers makes possible more and better QSO's.

26. The Basic Training a Serviceman Needs. This is an outline of a course of instruction used by the National Radio Institute to prepare the beginner or established serviceman to meet the rigorous demands of modern radio servicing. It lists the information and training required by the serviceman to read and understand current literature so necessary to keep abreast of the times. The outline covers the fundamental subjects of radio and the special subjects of service technique such as the construction, theory and testing of vacuum tubes, r.f. and a.f. amplifiers, superheterodynes, detectors, oscillators, service procedure, location and elimination of all radio troubles, automobile radio installations, meters, testing equipment and circuits.

### All-Wave Super

(Continued from page 225)

came in as before, indicating that the line-up was accurate.

The next step was to connect in an oscillator and an output meter to determine whether or not this would provide a more accurate method of lining up the receiver. It was found that slightly better accuracy could be obtained in this manner, but that for all practical purposes an extremely close approach to accuracy had been obtained without the oscillator and output meter.

Normally, of course, it is not necessary for the owner of one of these receivers to balance his own set, because they are accurately lined up and adjusted before leaving the factory. However, it is well to know that the balancing process is a simple one, should occasion ever arise to perform the operation.

The receiver employs two stages of audio amplification feeding into a push-pull stage, using a pair of type -45 tubes, a total of three stages in all. This unusually large amount of audio amplification makes the audio system excellent for phonograph or microphone reproduction. A pair of binding posts for connection of these devices is provided on the back of the chassis. Likewise plenty of amplification and power are available for home recording.

### Antenna Requirements

Naturally, the antenna requirements are an important consideration in the case of a modern receiver. In the tests conducted by RADIO NEWS, various antennas have been tried with the set. The one used in most of the tests is approximately sixty feet long,

October, 1932  
**RADIO NEWS Free Technical Booklet Service**  
 222 West 39th Street  
 New York, N. Y.

Gentlemen: Please send me, without charge, the booklets or folders I have filled in below:

Numbers.....

Radio Engineer  
 Serviceman  
 Experimenter  
 Laboratory Technician  
 Dealer  
 Jobber  
 Manufacturer's Executive  
 Professional or Amateur Set Builder  
 Licensed Amateur  
 Station Operator

I am a  subscriber  newstand reader.

Name.....  
 Address.....  
 City.....State.....



and with this the all-around results on both the short-wave and broadcast bands are excellent. On the other hand, an antenna approximately 200-feet long and with an unobstructed elevation of 100 feet has been tried. Naturally the signal strength from distant stations was greatly increased by this tremendous antenna. As for selectivity, WEAf, the strongest "local" station, just barely reached over into the adjacent channel occupied by WMAK of Chicago. Other New York stations, about fifty or sixty miles distant from this antenna and using up to 50 kw. power, were confined strictly to their own channels, permitting out-of-town stations to be tuned in on the adjacent channels on either side. From this it would appear that in the average location there is almost no limit to the size of the antenna that may be employed. With a short antenna, such as is usually used with a high-powered receiver, the results will be excellent and the selectivity almost unbelievable, whereas with a very large antenna the signal strength will be greater and the selectivity still good enough for all practical purposes.

On the whole, this receiver seems to be one which will meet the demands of every type of radio listener. Its operation is so simple that even a novice will not have the least difficulty in using it. On the other hand, its performance is such as to satisfy the requirements of the most rabid DX fan, and not the least of advantages is the fact that maximum performance is easily obtained, even by one who knows nothing about the technical side of radio.

### Low Cost Set

(Continued from page 221)

The signal voltage developed across this resistor is also used to vary the bias of the first detector and i.f. amplifier to obtain a.v.c., or more properly, automatic sensitivity control. Since the signal voltage across the half-megohm resistor is essentially pulsating d.c., it is necessary to smooth it out before it can be used for grid bias for a.v.c., and this is done by the one-megohm resistor and the .05 mfd. condenser seen in the first detector grid return. The constants of the whole circuit are so proportioned that antenna inputs from 200 microvolts absolute and on up will result in the maximum power output of the a.f. pentode, or about 3 watts, which can be cut down by the volume control. The volume control is in the first audio grid circuit. Tone control is effected by moving a condenser up and down the grid coupling resistor of the a.f. pentode, this being the usual form of progressive high-frequency attenuator.

The balance of the circuit is convenient. The output pentode has an a.f. filter in its grid return, the rectifier and filter is usual in all respects, the speaker field serving as a choke with one 12 mfd. dry electrolytic input condenser and a 4 mfd. output filter condenser. Additional filtration for the first audio stage (part of the -55 tube) is provided by a high-inductance a.f. choke and .25 mfd. condenser in the first a.f. plate circuit.

The sensitivity, selectivity, fidelity and a.v.c. curves of figures 4, 5, 6 and 7 speak for themselves. It can only be added that during the month of July, 1932, in Chicago, it is quite easy to bring in Cincinnati just 20 kc. away from a powerful Chicago local, as well as Davenport, Milwaukee and a few other out-of-town stations in daylight on a sixty-foot antenna, while at night east and west coast stations can be heard with fair regularity. Such, then, is what can be done for about thirty dollars in these depression times, from which it may be concluded that it really is an ill wind that blows nobody good.

Made to order for  
the Service Man—

We've put ourselves in your place and brought out everything you need . . .

FIRST-AID KIT



### FIRST-AID RESISTOR KIT

Handy pocket size kit furnished in two different types —1-watt kit containing 20 Ohiohm resistors, ranging from 250 ohms to 2 megs.; 2-watt kit containing 10 Ohiohm resistors, ranging from 500 to 50,000 ohms.

### Value stamped on each unit

Each Ohiohm resistor, in addition to being color coded according to R.M.A. standard, has the actual value stamped on each piece.

## FREE

The following three items are given free with initial order of First-Aid Kit:—

**OHM DIAL** Instantly tells the resistance value in ohms of any resistor in the sets you service, when the resistors are color coded according to R.M.A. standards. Regular price, 50c each.

**GUIDE** A simplified and ready means for determining the correct model, resistance value and number of resistors to be used in most popular sets.

**LABELS** to help get you further service. Each First-Aid Kit contains a supply of labels to place in the back of the set, which, in addition to recording the work done, secures further service because your name and address appears on the label.

**OTHER ADVERTISING HELPS FREE**

### SPARK SUPPRESSOR SETS ... for eliminating ignition interference on AUTOMOBILE RADIOS

Are you going after this new, rich field of business? Ohiohm Suppressor Sets supply you with the condensers and spark suppressors to meet all usually encountered conditions of automobile radio installations.

• Write for prices and details •

**THE OHIOHM COMPANY**  
12508 BEREA ROAD CLEVELAND, OHIO

OHIOHM RESISTORS are made in Canada by  
C. C. Meredith & Co., Ltd., Toronto

OHM-DIAL

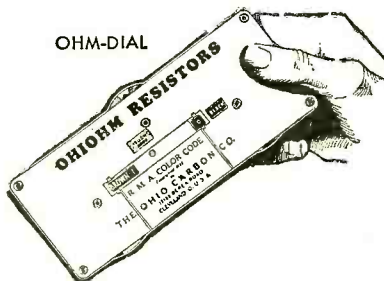

LABELS

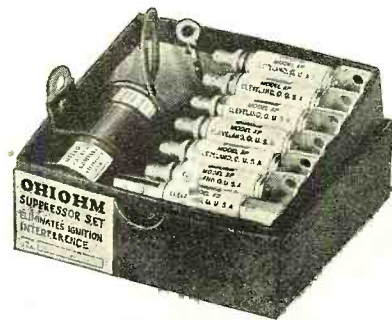

SPARK SUPPRESSOR SET





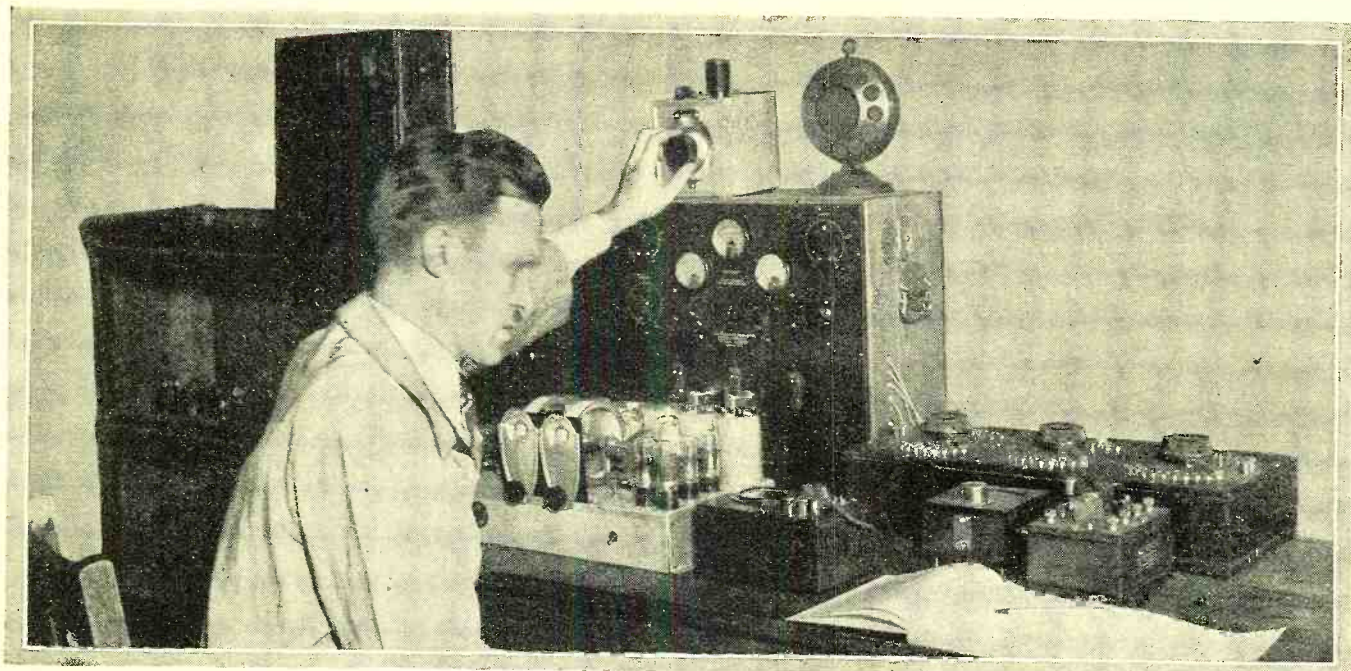

# With the Experimenters

*Television in England, DX Antenna Combinations, Drill Holder, Field Supply from Receiver for Separate Dynamic Speaker, Receiving Ground System, Stand for Argabrite Condenser Microphone, Modulated Test Oscillator, Supports for Temporary Wiring, Home-Made Cable Plug*

## *Experimental Television in England*

THE following extract from a letter received from J. Foster Cooper of Toll Bar, Barton Road, Cambridge, England, will be of interest to American television experimenters inasmuch as it conveys some idea of television transmission and reception as carried on in England:

"The only system used here, at least publicly speaking, is the Baird. We have transmissions every day from the London regional station (356 meters, 70 kw.), together with synchronized sound on the London National program (260 meters, 68 kw.).

"30 line vertical scanning is employed, and the picture ratio is 7:3.

"I also receive television and tele-movie films broadcast from the two Berlin stations, Königswusterhausen and Witzleben. In this case the same system is used, but with horizontal scanning and a 3:4 picture ratio.

"That is why you see two viewing tunnels on my televisor, each with its separate neon tube.

"This system employs magnetic synchronization, broadcast on the same wavelength with the image, which permits any source of supply to be used for the disc motor. Baird synchronizers may be seen mounted behind the motor, together with a knob for 'framing' the picture.

"On the whole, I prefer vertical scanning to horizontal scanning, as the slight picture 'float' common to all televisors, is not so trying on the eyes when it is in a vertical direction.

"The neon circuit, is, of course, known to all television enthusiasts.

"The motor speed for both types of transmission is 750 r.p.m. which equals 12½ pictures per second.

## *Conducted by*

**S. Gordon Taylor**

"I hope these few details may prove of some interest to those readers of your maga-

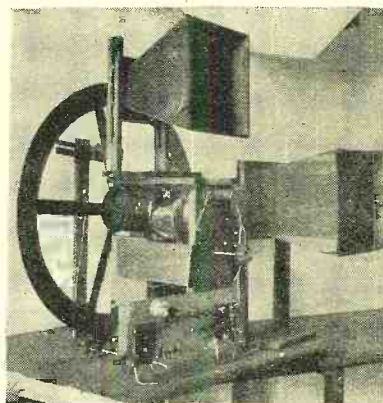

zine who have bought, or made, apparatus for receiving television."

## *DX Combination Antenna*

I use a "filtered aerial" for my DX work and in experimenting with it have come across some stunts which may be helpful to other DX listeners who use this type of antenna.

(The Insuline "filtered aerial" to which Mr. Stokes refers is a special type of aerial designed to work on the transformer principle. It consists of a 60-foot insulated solid wire which constitutes the core. Around

this insulation is tightly wound approximately 300 feet of relatively small enameled wire which constitutes the aerial proper. The turns of enamel wire are evenly spaced. This type of antenna is shown in schematic form in the accompanying illustration installed as normally recommended by the manufacturer. It will be noted that the wire core is grounded at both ends while one end of the helical winding is connected to the antenna post of the receiver and the other end left open.

The transformer principle is based on the core wire serving as a primary and the helical wire as the secondary. The theoretical operation principle set forth by the manufacturer is based on the core wire and the ground serving as a large loop, the voltage across this loop being transferred to the helical winding by induction. The helical winding, in addition to this transferred energy, naturally picks up some signal voltage direct with the result that the total pick-up, inductive and direct, is presumably considerably greater than that of an ordinary aerial.—Ed.)

Until very recently I grounded both ends of the insulated core wire as per the manufacturer's instructions. One day, however, I disconnected the ground from the end of the core wire nearest the set and left the far end grounded. Boy!—the volume jumped 50 to 75%.

I use a Silver No. 30 receiver and, with this new antenna arrangement, pull in WFAA, WENR, WABC, WBBM, WLW, WGN, WEAF, WWJ, WJZ, WJR, WHAS, WGY, WGAR and practically all the other stations of 2500 watts and over, this side of the Mississippi, with the volume control turned all the way off. I have had KOA and KFI twice in this same manner and can average thirty to forty stations during day-



light hours, from Boston to Chicago and Gainsville to Toronto.

Users of a "filtered aerial" might try this idea. Another thing; my best DX is done using no ground wire although this would not apply to all receivers inasmuch as some specifically require a grounded connection.

It might be of interest to readers to know that my log includes 886 stations on the broadcast band, distributed in 17 countries, with TJW a 7.5 watt station in Bermuda as my best catch. Next season I hope to

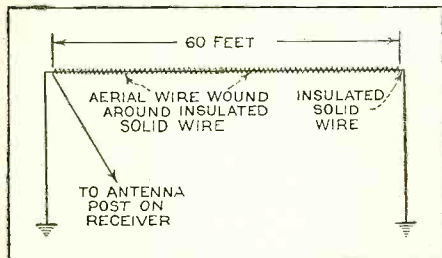

hear the Japanese and Australian stations (broadcast band) quite often using this antenna system.

A peculiarity I have noticed is the adaptability of this "filtered aerial" as a ground system. Using a copper screen about 20 inches long and 10 inches wide as an aerial and the "filtered aerial" as a ground very good results are obtained. The fact is I switch around my aerial and ground connections and get considerably different results with different combinations. Five of the combinations I have tried are as follows:

1. Aerial on aerial post; ground on ground post.
2. Wire screen on aerial post; ground on ground post.
3. Ground on aerial post; aerial on ground post.
4. Aerial on aerial post; ground post open.
5. Ground on aerial post; ground post open.

Switching around in this manner, I can determine which of these methods of connection is best for each station. Using No. 3 for instance, some of the local stations come in very strong while others are only fair. Using No. 5, this combination is reversed on the local stations, that is, the local stations which were only fair on combination No. 3 become very strong on combination No. 5 and vice versa. On the higher frequencies from 1100 kc. to 1500 kc., No. 1 offers the best combination. From 550 kc. to 1100 kc., No. 4 is the best. No. 2 is used mainly for quiet reception of locals.

These particular combinations will, of course, not produce the same results in all locations and with all receivers. However, they are given here to suggest ways and means for fans who wish to experiment.

JOSEPH STOKES,  
Swissvale, Pa.

### Holder for Small Drills

Many of the smaller types of hand drills have a hollow handle to hold and contain

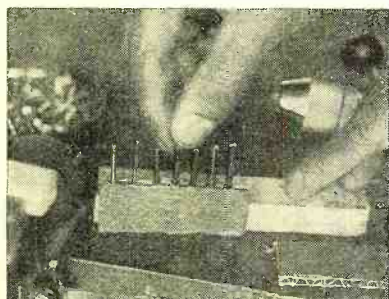

the drills. Not so handy when using them, and it is necessary to frequently sort and

change drills on a bench job. Take a small piece of corrugated cardboard and tack it to a light stick or block as shown. Put the drills you are using in the holes made by the padding. Easy to put them in and take out to use. Always in plain sight and not rolling all over the bench and into cracks.

FRANK W. BENTLEY, JR.,  
Missouri Valley, Iowa.

### Novel Field Supply for Dynamic Speaker

I recently acquired an RCA 106 dynamic speaker for use with a receiver that had been primarily designed for magnetic speaker operation. I was puzzled at first as to how to suitably connect the speaker field into the receiver circuit since the voltage drop across it when used as a choke might have been large enough to appreciably lower the output of the B supply.

The circuit shown in the accompanying diagram seemed to offer the best solution to the problem and when actually tried, fulfilled the requirements very well.

The current maintaining the magnetic flux

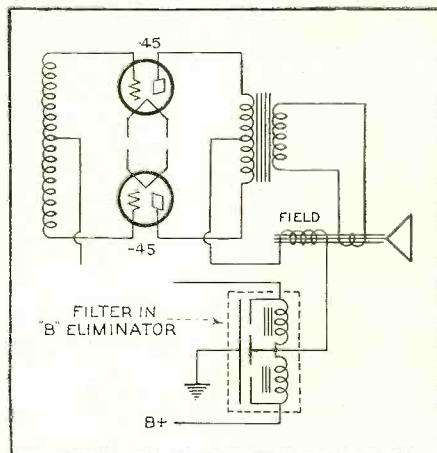

is that which supplies the push pull tubes and it was found that after introducing the field into the circuit, the two -45 tubes drew a total of 71 ma. The resistance of the field is 1000 ohms and by using Ohm's Law the resulting voltage drop was found to be  $1000 \times .071 = 71$  volts. This value of voltage drop was not great enough to impair the operation of the tubes, but was sufficient to satisfactorily magnetize the field.

The use of this circuit would not yield good results with a high resistance field. However, I am submitting it to readers of the RADO NEWS believing that it might be of aid to someone with a similar problem.

PAUL R. FLANCHER,  
Cincinnati, Ohio.

### A Better Ground System

A network or fan of buried copper wires is probably the best form of ground connection that can be used for a radio receiving set. Bare wire, number ten to sixteen in size and in twenty-five to one-hundred foot lengths, can be buried a few inches below the grass in the front or back yard and as nearly directly under the aerial as possible. The wires can radiate out fanwise from the station; they can run parallel like the tines of a fork; or they can be made into a network, taking care that all joints where the wires cross are soldered. The wires can be buried easily by making a cut several inches deep in the sod with the end of a spade, and pressing the wire down into it. The earth should be tamped back into place then. The grass soon grows over the cut; so the appearance of the lawn is not in any way marred. Every time the lawn is watered the earth around this ground connection is dampened, which makes for a very efficient

(Continued on page 250)

# SENSATIONAL NEW ITEM FOR RADIO DEALERS



\$29.50

The  
**ROYAL  
SIGNET**

MONO-FACE TYPE • NO SHIFT KEY

Here is a 3-fold sales opportunity for Radio Dealers . . . (1) A new product, (2) a waiting market, (3) a sensational low price. • Millions have already bought portables at double the price of the new Royal Signet. • Now being promoted by one of the greatest advertising campaigns ever developed for a typewriter. It includes "Opportunity Awards" —163 Cash Prizes—total, \$5,000. This feature will appeal to everyone, bringing customers into your store twice. • The Royal Signet is certain to outsell almost every item you now handle. Its market is practically the same homes into which you have sold radios and electrical appliances. And beyond this developed market, there is a vast untouched field. • Be first to handle the new Royal Signet! Everyone who can read and write is a logical prospect for this handiest of small typewriters.

**ROYAL TYPEWRITER COMPANY, Inc.**  
2 PARK AVENUE, NEW YORK CITY

**FILL OUT—MAIL TODAY**

Please send me full information concerning the special Royal Signet proposition for Radio Dealers.

Name \_\_\_\_\_

Address \_\_\_\_\_

R. N. 10

**NEW PRODUCT • NEW MARKET**



# How to Make a Pickle-Bottle PHOTO-CELL

*The cell described here can be made by anyone at a cost of only a few cents and will prove to be interesting to those experimenting with photo-electricity*

## Part One

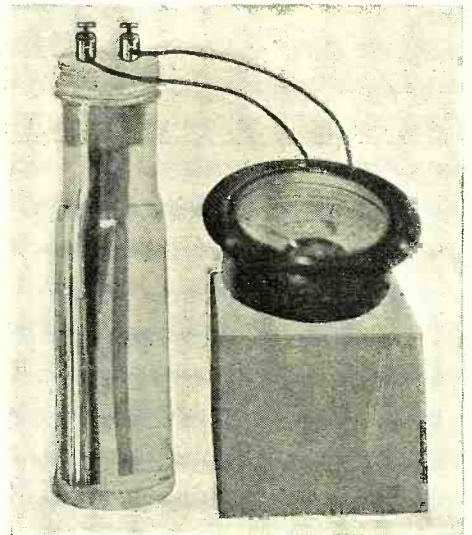

**M**ANY electrical experimenters have been denied the fun of playing with photo-electricity because they have for some reason or other decided that the marvels of this fascinating new science were either beyond their pocketbooks or beyond their technical resources. Neither one of these facts should be true, for, as far as constructional material goes, I cannot think of any that could be put together much more cheaply—a pickle bottle, a couple of binding posts and little chemical with two very simple electrodes. And practically no technical skill is needed; even the rankest tinker can rest assured that he can master the construction and operation of the simple cells that the present article describes in complete detail.

[ By M. L. Wendel ]

The results obtained with these photo-cells are surprising. Friends may be amazed with all sorts of tricks, such as doors that are opened by beams of light or motors operated by merely waving the hand. Truly, the photo-cell is the magic wand of science today.

The bill of materials follows:

- 1 small pickle bottle
- ¼ pound lead nitrate
- 1 piece of sheet copper 1 inch by 4 inches
- 2 binding posts
- 1 lead electrode ½ inch by 4 inches

To this modest list of needed materials we might add a little tar or asphaltum and a few bits of metal too unimportant to mention in a bill of materials.

copper will become gradually black through the formation of cupric oxide, which has a chemical formula expressed by CuO. In the construction of photo-voltaic cells, the builder is not interested in the formation of cupric oxide as such, but he must tolerate it, because it must be formed during the formation of cuprous oxide, which is the light-sensitive coating that is desired on the surface of the copper plate or electrode. Underneath this surface of cupric oxide there is a surface of cuprous oxide.

This upper surface of cupric oxide is disposed of by rubbing it off with emery paper or by dissolving it off chemically with nitric, sulphuric or hydrochloric acids. Ammonia may also be used to dissolve this film. This film of oxide will have a rather golden color and has been removed, the copper electrode with its photo-sensitive surface should be given a thorough rinsing with water.

After the copper electrode has been so treated, its back is coated with asphaltum and the terminal is added in the manner shown in Figure 1. To do this properly and to form a good electrical connection, it will be necessary to solder. Naturally, the cuprous oxide film will have to be removed at the point the soldering is done. The lead electrode is held in place by simply drilling a hole in one end and running the machine screw of the binding post through the cork.

To prevent corrosion and leakage of the electrolyte, it will be necessary to immerse the whole top of the unit in hot tar or asphaltum. Then, after the cork has been driven in place, hot tar is poured over the top to form a perfect seal. If the binding posts have become clogged with tar during this operation, it may be removed with a little gasoline so that a good electrical contact will be formed.

With this done (the photo-voltaic cell, which is the real technical name of the device that we have been building and which is to respond to what has been called the Becquerel effect), the device is ready for testing and, if the tests turn out satisfactorily, is ready for general use. To test the cell it will be necessary to have a fairly powerful electric light, ranging in rating anywhere between 60 and 100 watts. It will also be necessary to have a good milliammeter reading about 1 to 5 milliamperes. The testing light (Continued on page 239)

It will first be necessary to so treat the copper that a layer of cuprous oxide will be formed on the surface. If the sheet copper (after having been carefully cleaned with emery cloth) is placed in a hot flame such as that provided by a bunsen burner, or even a coal fire, the surface of the

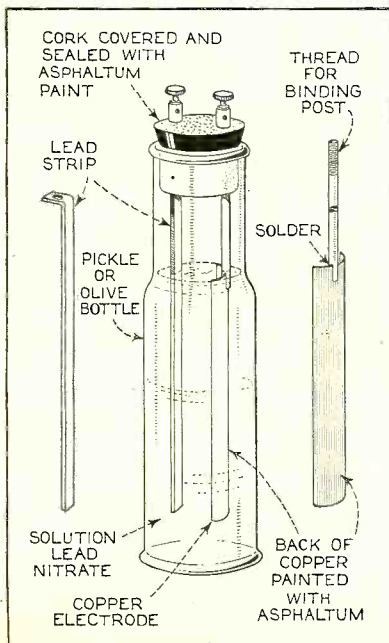

### DETAILS OF PARTS

Figure 1, left. The finished cell is shown, together with drawings of the two electrodes. The preparation of these is described in the text

### PHOTO-CELL CIRCUIT

Figure 2, at right. The meter (or a relay) is connected across the photo-cell terminals. As the photo-cell becomes conductive it acts as a shunt across the meter, causing a change in current flow

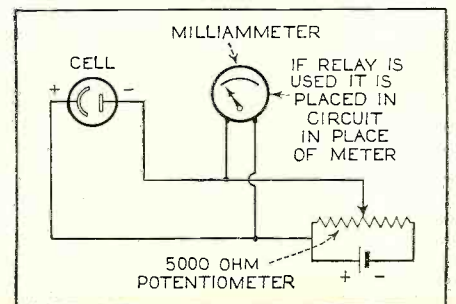



# Crystal Control Transmitter

(Continued from page 208)

Any leads carrying r.f., such as excitation leads between stages, must be straight, since a wire, even when only 5 inches long, will offer considerable impedance at 56 megacycles when it is curved or bent. All wiring should be rigid and supported or dampened in such a manner that it will not vibrate. The circuit may be severely detuned, or neutralizing rendered ineffective, by a small displacement of a plate or grid lead.

Perhaps one of the most difficult things to obtain is a sufficiently high impedance in the various tank circuits. Here low-loss and low-capacity technique is of especial importance. The various tank circuits should be characterized by a high L/C ratio.

In experimenting with crystals and holders, considerable time and trouble will be saved by connecting the crystal holder to a simple oscillating detector operating in the desired band. It is only necessary to connect one side of the holder to the grid of the tube. As the oscillator frequency passes the resonance point of the crystal, a distinct click will be heard in the output circuit. An imperfect crystal, or a holder that is improperly ground, will usually result in a series of clicks of varying intensities. Before the crystal and holder can be made to function properly in the transmitter, it is necessary that they be further polished or adjusted until only one loud click is present. Two or three weak clicks on either side of the definite response does not indicate serious trouble, as the crystal will oscillate at the frequency of the loud click. Jarring the crystal and holder slightly will often change the intensity and number of the clicks, this condition being indicative of poor construction in the holder.

While the general procedure in neutralizing the buffer and amplifier is the same as with similar systems operating on longer wavelengths, it will be found that the adjustment is very much more critical. This of course is due to the low impedance which even a very small capacity offers to ultra-high-frequency oscillations. In other words, unless the neutralizers are adjusted with precise care, coupling between the successive tank circuits may be bothersome. While the circuit as a whole may not go into oscillation, interlocking of controls will make the proper alignment of the different circuits next to impossible. It will be found advisable to connect the grid sides of the neutralizing condensers to the excitation taps, rather than directly to the grids of the tubes. This is probably another way of say-

ing that the paths of the neutralizing circuits and of the tube capacity circuits should be equal.

No trouble was experienced in tuning the various circuits when properly neutralized. Detuning caused by changes in the circuit constants, as the tubes cool or heat with load variations, is negligible.

In order to minimize harmonic distortion, the Class B plate supply should have a voltage regulation of 10% or less, and the C bias should be constant. The output transformer secondary should not be used to carry the r.f. amplifier plate current if best tone quality is desired. If, however, some distortion can be tolerated, the secondary can be used for this purpose, with the consequent elimination of the coupling condenser and choke.

It is not advisable to operate the Class B stage without load, as extremely high voltages may be built up in the output circuit, with the possibility of breaking down the coupling or by-pass condensers.

As a general rule, the use of type -10 tubes, having oxide-coated ribbon filaments, is not recommended, as the characteristics are usually different from the standard type for which the transformers are designed.

Figure 8 shows the 56 mc. tourmaline-crystal-controlled transmitter being operated, in conjunction with the Class B amplifier-modulator, by Lloyd Greene, radio editor of the Boston *Globe*. Reception is on the ultra-short-wave superheterodyne, previously described.

This combination results in an effective and practical ultra-high-frequency installation, as well as an excellent nucleus for further experimental work. It is probable that additional progress can be made in the design of ultra-high-frequency inductors, and the author recommends the attention of experimenters to the possibilities of different wire sizes and form factors. It is still an open question whether or not a push-pull circuit is preferable to the single-sided arrangements. In the transmitter shown, no shielding was required. However, with the possible attainment of higher efficiencies, it is probable that the individual stages will require complete isolation.

Also, the limit of the tourmaline crystal for direct oscillation stabilization is considerably above 56 megacycles, and the attention of the pioneer is directed to the duplication or even betterment of satisfactorily stable 1.2-meter transmission which has been accomplished with this remarkable crystal.

## Pickle Bottle Cell

(Continued from page 238)

should also be arranged in a reflector, which may be a dishpan if nothing else is available.

The cell is connected directly across the meter as shown in Figure 2. Inasmuch as the cell is polarized, it will be necessary to connect the meter as shown. The lights should then be turned out and the testing lamp lighted. As the testing light is brought near the photo-cell, the meter should start to register. At a distance of six or seven feet a faint current should be noted, and by the time the light has reached a distance of three to four feet from the cell the current generated by the light should have reached at least one milliampere. When the cell has been brought to within a few inches of the light, the registration should reach about three to four milliamperes if the cell has been correctly made and the solution of lead

nitrate, which should be made up of one ounce of crystals to one gill of water, is of the correct proportion.

To use this cell, as will be described in the next article, it will be necessary to obtain or build a small relay which will be sensitive to a change of a milliampere or two in the output of the cell. Such a relay may be made from the parts or magnets of an old 1000-ohm telephone receiver, equipped with an armature and contacts. This relay must be used to operate a second and heavier relay if a heavy current is to be controlled by a light beam. It would be a little unreasonable to expect a relay small enough to come from the parts of a telephone receiver to be able to handle the 250-watt current of a one-quarter horsepower motor. It will be found that a second relay, which is really an automatic switch, might be made from an old telegraph sander provided with a couple of heavy contacts that may be used in connection with 110-volt lighting circuits.

# Look this service over Let I.R.C. Supply All your Resistor Needs

Come to resistor headquarters no matter what your problem. Test for yourself the money-saving devices the International Resistance Company provides for Service men.

### Metallized Resistors for Replacement



### Wire-Wound Resistors for Meter Conversion



### Handy Certified Kits



- Kit No. 1 containing 20 1-Watt Metallized Units.
- Kit No. 2 " 20 2-Watt Metallized Units.
- Grid Bias Kit " 10 assorted Metallized and Wire Wound Units.

Motor Suppressor Kits—for 4, 6 and 8-cylinder cars.

### I R C Resistor Replacement Guide

—a loose-leaf manual which gives full resistor data about any popular receiver. An order for 20 Metallized units or Kit No. 1 or No. 2, brings you the Guide free. Or it may be bought singly for \$1.

### I R C Color Code Chart

In R M A colors—tells instantly the resistance value of any resistor R M A color coded. Free.

### I R C Meter Conversion Charts

They show how to build your own test equipment at astonishingly small cost. Free for the asking.

### Make Your Own Set Analyzer

Keep your equipment up to date with the new tubes. A complete instruction folder on the Sprayberry Set Analyzer will be sent without cost.

Feel free to write us at any time. Get on our service list and have the new I R C service helps as soon as issued.

INTERNATIONAL RESISTANCE CO.  
Philadelphia, Pa. Toronto, Ontario

**I R C Metallized**  
and Precision Wire Wound  
**RESISTORS**



**Come to Los Angeles!**  
**4 full courses**  
**at price of single**  
**course**

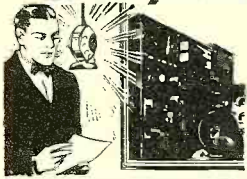

Save money by enrolling in National Now. For single tuition fee, we now offer the four complete radio, electrical, television, talking picture and broadcasting courses. Four courses for price of one.

**LEARN**  
**RADIO-ELECTRICITY**  
**TELEVISION-TALKING PICTURES**  
**and BROADCASTING**

No longer is it necessary to pay several tuitions. Now, for the first time in history, National offers complete training in Radio, Electricity, Television, Talking Pictures and Broadcasting all at a single tuition fee. When you enroll at National, these four full and unlimited courses of training will be given, enabling you to qualify for good jobs. We train you in four big pay trades; award you a life scholarship and help assist you to get a job that will start you on the road to big pay and independence for the rest of your life. Individual, practical instruction. Right NOW, while jobs are almost impossible to "land" by the untrained man, you can get TRAINING for the lowest tuition fee ever offered. This is a limited offer, but you must act NOW!



Electricity

Become an electrical expert. Complete electrical machinery and equipment for you to work on at National.



Television

The newest trade, with a tremendous future. Latest scanning disc equipment. National pioneers in this interesting work.

Come to Los Angeles, the center of radio and electricity—and where the great American television laboratories are located—where hundreds of trained sound engineers and mechanics are employed in talking picture studios. Thousands of dollars invested in new training equipment, by National for you to work on.

**Largest and Oldest Trade**  
**School in West**

For 27 years National has successfully trained men by practical shop methods. Previous education unnecessary. More than 25,000 graduates.

**Railroad Fare Allowed to L. A.**

For a limited time we will allow coach railroad fare to Los Angeles from any point in the United States. This is deducted from the tuition, so the trip costs you nothing.



Talking Pictures

10,000 theatres equipped for sound. Good pay. National-trained men preferred in studios and theatres.

**Free Employment**  
**Service**

Spare time jobs while at school. We help you get a job to pay living expenses while learning. Our unlimited employment service will help you get a JOB after you graduate. A few delightful months of training and you are qualified.

**NATIONAL**  
**RADIO & ELECTRICAL SCHOOL**

Radio, Electricity, Television, Talking Pictures and Broadcasting

Dept. 1011E, 4006 S. Figueroa, Los Angeles, Calif.

**MAIL THIS COUPON FOR FREE DETAILS**

This coupon will bring you our big, free training book if you are interested. It gives full details of the 4 big courses—radio, electrical, television, talking pictures and broadcasting; also details about railroad fare offer.

Name.....  
 Address.....  
 Town..... State.....

**Backstage in**

*Personal interviews*  
*with broadcast artists*  
*and executives*

By  
**Samuel Kaufman**

THE Eno Crime Club thrillers which have been heard over the CBS on Tuesday and Wednesday nights will, under a new contract, continue to be heard on the CBS for another year. The dramatizations are adapted from English and American mystery novels. The mystery of each plot is presented on Tuesday night and the solution on the following night. When the World Association of Detectives held its annual international convention in New York recently, a group of its officers made a trip to the CBS studios to witness the broadcasting of an Edgar Wallace thriller. They

Reese, who is usually featured in the role of the detective in the broadcasts, a badge of honorary membership in the association. Reese was born in Baltimore of English parents and was educated at John Hopkins University. He has traveled widely and spent much time in England. He has appeared in numerous legitimate productions on Broadway and was featured in numerous dramatic roles on the CBS prior to his present series.



P. WHITEMAN

PAUL WHITEMAN, dean of American jazz orchestra conductors, recently returned to New York to win additional microphone plaudits for his NBC broadcasts from the Hotel Biltmore. Previous to this assignment, Whiteman gained much attention as chief orchestra director at the NBC Chicago studios. Whiteman's orchestra is accredited with being the first musical organization of its type to face a microphone. The premiere performance took place over old Station WJZ in Newark. Paul's father was supervisor of music in the Denver public schools for half a century. At the age of seventeen, Paul was chief viola player in the Denver Symphony Orchestra. Between numerous musical engagements that followed, Paul took time out to participate in automobile racing as well as to sell automobiles. He conducted a Navy band during the war and subsequently went to San Francisco to organize his own orchestra. An engagement in an Atlantic City hotel followed. While playing at a New York cabaret, Whiteman was signed for a number in the Ziegfeld Follies.

VIRGINIA REA, the soprano who won a tremendous following on the old Palmolive Hour under the name of Olive Palmer, has returned to the NBC. Miss Rea is now being featured under her real



F. M. ANDREWS AND E. REESE

name in varied programs of concert, classical and semi-classical selections. Miss Rea, after four consecutive years on the Palmolive Hour, took a much-needed rest from the microphone. A native of Louisville, she decided, upon her graduation from Drake University, that she would pursue a musical career. She heard that a prominent producer planned a revival of twenty operas in New York. She telephoned him from her Kentucky home. When he gave her a discouraging answer, she determined not to miss her opportunity and sang into the telephone. This bold effort won her recognition. She made numerous concert tours here and abroad but radio offered her greater rewards. Miss Rea was among the first radio artists to sign an exclusive contract limiting her radio performances to a single sponsor's programs. Her return to the air was widely heralded.

THE "Witch's Tale" on WOR, Newark, has been running for over a year and is one of the best-known thriller-type programs in the East. The program heard each Monday night features Alonzo Deen Cole who is also the author of the script. Marie O'Flynn is the heroine and Adelaide Fitzallen plays the part of the witch. Cole hails from St. Paul, Minnesota, and has been featured in numerous theatrical ventures in various parts of the United States before his radio debut. Marie O'Flynn was born in Toronto and she, too, was engaged in stage roles before her radio debut. Miss Fitzallen is said to be one of the oldest actresses on the air. She is a descendant of a family of thespians and has been accorded much attention for her character roles.



VIRGINIA REA



# Broadcasting



THE WITCHES HOUR

There seems to be a big demand for humorists on the air, with sponsors striving to sign all of the prominent funny men. The comic team of Ole Olsen and Chic Johnson are among the recent radio acquisitions. They are co-featured with Rudy Vallee on the Fleischmann Hour, heard Thursday evenings over the NBC. The same type of clowning which marked their stage and screen work is featured in their radio dialogues and songs. Olsen and Johnson met while they were both working their way through college. Olsen sang in a movie theatre and Johnson was a waiter. After rehearsing a vaudeville act, they went to a Chicago restaurant one evening and astonished the manager by suddenly jumping to their feet and presenting the act. The manager hired them and vaudeville and film engagements followed. Olsen plays the violin and Johnson is adept at the piano. They have composed several popular songs.

OLSEN AND JOHNSON



*Chatty bits of news on what is happening before the microphone*

NBC. His return to New York radio circles was hailed as one of his most important steps and network officials predict great success for him. Novis was born in England, the son of a singer in a village choir. At the age of two, he migrated with his family to a small Ontario mining and lumber town. A clergyman from Pasadena, California, was a guest at the Novis home one night and after hearing the elder Novis sing, offered him a salary to sing in his church. The family soon arrived at Pasadena. During Donald's school days in California, he took especial interest in athletic activities but frowned at singing. It was at the continued requests of his father that he agreed to study music. While attending Whittier College, he sang in the glee clubs as featured soloist. He was engaged as a church soloist and was engaged for prominent California concert engagements. He won the state Atwater Kent auditions in 1927. The following year, he again won the state auditions but also obtained the greater honor of winning the finals in New York. He married a soprano in the church choir two years ago and they now live in an apartment overlooking Central Park.



DONALD NOVIS

tering broadcasting, Neeley served as a newspaperman, novelist, aviator, sailor and wireless operator. On this new series, the Rollickers present novel instrumental effects by vocal methods. The only instrumentalist on the program is Clifford Lang, the pianist and arranger. The Rollickers include: Clark Brewer, first tenor; Victor Hall, second tenor; William Scholtz, baritone, and James Davies, basso. Like Neeley, the Rollickers are radio veterans.

HENRY M. NEELEY, well known to radio audiences over a long period as "The Old Stager," recently returned to the air as master-of-ceremonies for the Rollickers Quartet on a Wednesday night NBC period sponsored by the Shumilk Corporation. Prior to entering broadcasting, Neeley served as a newspaperman, novelist, aviator, sailor and wireless operator. On this new series, the Rollickers present novel instrumental effects by vocal methods. The only instrumentalist on the program is Clifford Lang, the pianist and arranger. The Rollickers include: Clark Brewer, first tenor; Victor Hall, second tenor; William Scholtz, baritone, and James Davies, basso. Like Neeley, the Rollickers are radio veterans.

GEORGIE PRICE, well-known to theatre-goers as "What Price Georgie?" is now scoring as the featured artist of the Chase & Sanborn Tea program each Tuesday and Thursday evening over the CBS. He is only thirty-two but has already spent twenty-seven years on the (Cont'd on p. 243)

**DEALERS! SERVICE MEN!**  
**Equip Your SERVICE SHOP!**

Take these **5 FREE OFFERS**

... National Union, maker of National Union radio tubes, continues this amazing offer a few weeks longer

Radio men! Here is equipment every up-to-date service man must have. You can have absolutely free any one or all of the equipment featured in this advertisement... with a small purchase of National Union radio tubes. So take advantage of this opportunity at once! Read the details about this equipment, then mail the coupon below at once!

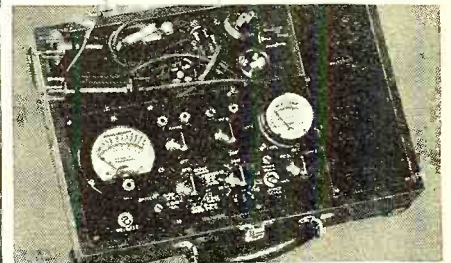

Latest method of servicing! This is the new Readrite continuity, capacity and resistance tester! No more chassis pulling! With the new Readrite resistance tester you can make every test... without taking the set apart! Free with small purchase of tubes.



Readrite Tube Tester—(left)—has illuminated dial for dark corner reading! Oscillator and output meter—(right)—only way to really test superhets. Both, are yours free with small purchase of tubes.

Vol. 1. Over 2000 diagrams—color codings, etc. Vol. 2. Over 700 pages, possible operation of resistance data, making tester above. Free with small purchase of tubes.

**NATIONAL UNION RADIO CORP.**  
400 MADISON AVENUE NEW YORK

Sirs: I am interested in following equipment:  
Readrite Tube Tester  Oscillator & Output Meter  Readrite Resistance Tester  Volume I  Volume II

NAME \_\_\_\_\_  
ADDRESS \_\_\_\_\_  
CITY \_\_\_\_\_ STATE \_\_\_\_\_

MAIL COUPON TODAY!



# Service Men TAKE NOTICE

J. R. Williams, E.E.,\* originator and designer of such service instruments as the Supreme Diagonometer, Confidence English Reading Tube Tester, etc., etc., is preparing complete and minute details on the construction and use of all types of service equipment—mostly new inventions. Nothing left out. Measurement drawings and detailed construction.

Within the next few months there will be such releases as Condenser Dielectric Leakage Tester, English Reading Tube Tester, "Resonator," a new method for peaking and aligning, etc.

You get this for \$2.00 a year.

Many months of research and design are behind each release and you will save over \$2.00 on each and every construction.

You will receive detailed construction data on complete large Central Service Station Test Boards. In fact, you will receive one release after another in such complete and concise detail you will be equipped with all necessary knowledge and drawings to build the latest and finest of all radio test equipment.

All of this for \$2.00 a year.

You will know the problems of each device. Nothing to guess about. The first release is ready for distribution.

Send your \$2.00 now to

**J. R. WILLIAMS AND SONS**  
519 Palm Street  
Little Rock Arkansas

\* Chief Engineer, Apparatus Design Company.

# What's New in Radio

A department devoted to the description of the latest developments in radio equipment. Radio servicemen, experimenters, dealers and set builders will find these items of service in conducting their work

By The Technical Staff

## A New Type Horn

*Description*—A radial designed public address horn to project sound over a complete circumference of 360 degrees and with even intensity of distribution. This horn is equipped with a cast aluminum throat, cold-rolled steel suspension brackets and has a

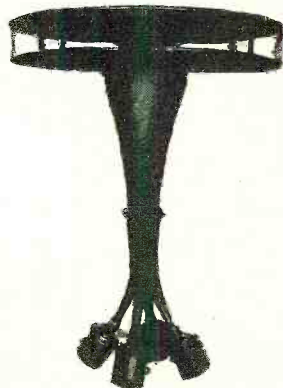

reinforced edge. It is demonstrable, of stormproof construction, and is especially adapted to sound-amplifying systems for churches, tower equipment and for use on sound trucks.

*Maker*—Racon Electric Co., Inc., 52 E. 19th Street, New York City.

## Automobile Radio Receiver

*Description*—A compact motor-car radio receiver with remote control, a dynamic type loudspeaker requiring only a single hole for mounting, and semi-automatic volume control. This receiver, termed the "Auto Dial

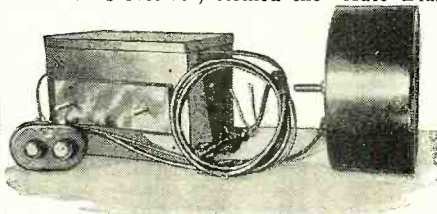

Radio," employs a.c. tubes of the following types: two -24, one -35, one -27 and a -47 pentode tube. All power connections to the receiver and speaker are made by connecting cables, terminating in two plugs which are easily attached or disconnected. The receiver and associated parts are sturdily constructed to withstand constant vibration. The receiver cabinet is made from heavy-gauge, rust-proof steel. The set is designed to operate from 180 volts of "B" supply, and for this purpose either "B" battery blocks or an automobile "B" power eliminator can be used.

*Maker*—J-M-P Manufacturing Co., 3429 Fond du Lac Ave., Milwaukee, Wis.

## A Permanent Magnet Dynamic Type Microphone

*Description*—The Tomlab dynamic type microphone, measuring 3½ inches in diameter by 3½ inches deep, employs a highly tempered cobalt steel permanent magnet, which eliminates the necessity of any external battery supply for the microphone. The life of this permanent magnet is indefinite. Frequency tests have shown a close ap-

proach to a flat-line response for the audio-frequency band. It is constructed and designed to be waterproof and shockproof. The diaphragm is unaffected by temperature or humidity conditions. The impedance of the voice coil is 30 ohms, and this same manufacturer offers transformers for matching this value to the grid impedance of a vacuum tube, to a 200-ohm line or to a 500-ohm line. A two-stage pre-amplifier is required with this microphone to bring its



output up to an audio level slightly greater than the average carbon microphone. The microphone is available with desk type stand having an overall height of five inches, or with a swivel type suspension arm as shown in the illustration.

*Maker*—Thomaston Laboratories, Inc., 135 Liberty St., New York City.

## Mantel Type Receiver

*Description*—This compact nine-tube superheterodyne midget receiver features automatic volume control, noise suppression, meter tuning and a double-tuned, image-suppressor pre-selector circuit. The follow-

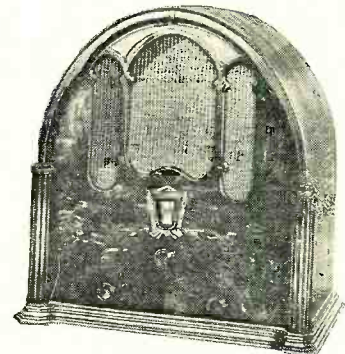

ing vacuum tubes are employed: three -58's, one -57, two -56's, two -42's and one -80. The front panel of the cabinet is attractively finished in stump walnut veneer and the cabinet measures 17½ inches high by 16¾ inches wide by 9¾ inches deep.

## Strange Invention SAVES UP TO 50% on Gas Bills

New, amazing rings fit around gas range burners. Give full heating power in half the time. Keeps utensils clean. Thousands now in use, saving money to consumers.

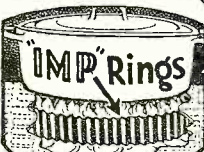

**AGENTS • 200% PROFIT**  
Every home buys. No competition. Saves its cost on first month's gas bill. Agents needed at once. Exclusive territory. Earn up to \$20 a day showing people how to save money by cutting their gas bills up to 50%. Write at once for complete details, exclusive territory proposition and free demonstrator offer. ECONOMY APPLIANCES, 1213 Van Buren, Dept. 2870, Chicago



Maker—Crosley Radio Corp., Cincinnati, Ohio.

**Midget Receiver with Rejctostatic System**

Description—A superheterodyne receiver so constructed and designed as to be practically free from all types of man-made static. This Model K-110 set employs 8 tubes in all; type -58 tubes for the first r.f. stage, first detector and first intermediate-frequency stage;

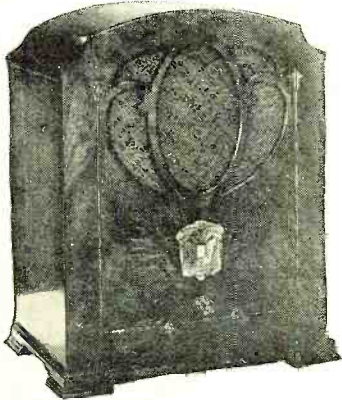

-56's for the second detector, first audio-frequency stage and oscillator, and the -47 pentode tube in the power output stage. An -80 type tube is used for rectification. The receiver is equipped with automatic volume control, tone control, phonograph connections and an outlet for utilizing the Kolster short-wave converter.

Maker—Kolster Radio, Inc., 360 Thomas St., Newark, N. J.

**Automobile Reproducer**

Description—A new reproducer termed the Infant Vehicle Speaker, sturdily constructed to provide long service and to



stand up under the severe usage of automobile radio installation. The speaker cabinet has a black crinkly baked finish and is modernistic in design. The dimensions of the cabinet are 9½ inches high by 9¾ inches wide by 5 inches deep.

Maker—Wright-DeCoster, Inc., St. Paul, Minn.

**Backstage**

(Continued from page 241)

stage. He considers the microphone an excellent medium for his singing and impersonations. He is one of the numerous "finds" of Gus Edwards. After Gus Edwards heard him sing, he immediately placed him in his noted "School Days" production. At five, Georgie was the support of his family. He continued to play the vaudeville circuits until he reached the age of sixteen when he was engaged for the Ziegfeld Midnight Frolic. Since then he has alternated between successful vaudeville and musical comedy appearances. He claims that his radio impersonations are improved by the placing of a photograph of his subject on a music-stand. The photograph, he claims, enables him to better visualize the person. He writes his own dialogue and verses.

Chart indicates the decided financial benefits of advanced training

**TRAINED MEN ARE WORTH MORE MONEY!**

Today it's the man with an education who advances . . . this is exceptionally true in Radio . . . our advanced course will give you a better understanding of RADIO and TELEVISION ENGINEERING . . . it's the "college course" of Radio . . . and the way for you to make more money. Higher technical knowledge is your assurance of success!

Write for our FREE BOOKLET, "Practical Radio Engineering," for information regarding our advanced home study course in Radio Engineering . . . remember this course is for EXPERIENCED RADIO MEN ONLY who are anxious to "make good!"

**CAPITOL RADIO ENGINEERING INSTITUTE**  
14th and Park Rd., N. W. Dept. RN-10 Washington, D. C.

**Positive Dependability!**

**Bud Loud Speakers**

the only dynamic units sold today on a FREE FIVE-DAY TRIAL PLAN! There's a reason. BUD ALUMINUM TRUMPETS AND BUD LOUD SPEAKERS make a combination that outdemonstrates them all.

Write for particulars

**BUD SPEAKER CO.**  
DEPT. 10 1156 DORR ST.  
TOLEDO OHIO-U.S.A.

Mr. C. M. Fox, Technical Engineer

**Get Into the Toy Business**

As Our Manufacturer

Earn Money casting our new hollow Toy Soldiers, Indians, 5c and 10c Automobiles, Airstrays, etc., for a firm of many years standing. NO EXPERIENCE required as we furnish full instructions with moulds and buy finished goods. A rare opportunity for these times, so if you mean strictly business write at once for full details as CHRISTMAS RUSH is Now Starting.

**Metal Cast Products Co.** Dept. 12  
1696 Boston Road New York

◆ CONDENSER MICROPHONES ◆  
CONDENSER MICROPHONE AMPLIFIERS

**Chrissell-Acoustic Laboratories Announce a New, Better, Completely Redesigned Microphone**

Public-Address Men, Amateurs, Experimenters were quick to appreciate the true value of the original Chrissell-Acoustic Microphones and bought hundreds of them in the last two months. The new microphone is far superior mechanically, is more sensitive, and has a wider frequency response range, with still finer reproduction of voice and music. And the new complete kit of parts is very simple to assemble. All the hard work has been done for you. Precision throughout. Write for literature describing the new microphone, the new microphone, kit, A.C.-operated amplifier power supply.

—Parts for DYNAMIC MICROPHONE (Sept. Radio News)—

**CHRISSELL-ACOUSTIC LABORATORIES**  
175-68th Street Brooklyn, N. Y.

**\$5,000 WILL BE PAID TO ANYONE WHO PROVES THAT THIS**

is not the actual photo of myself showing my superb physique and how the Ross System has increased my own height 6 to 6 ft. 3-3-4 inches.

Hundreds of Testimonials.  
Clients up to 45 years old gain from 1 to 6 inches in a few weeks!!

No Appliances—No Drugs—No Dieting **FIRST IN 1907**  
**ROSS SYSTEM NEVER FAILS. Fee Ten Dollars Complete**  
Convincing Testimony and Particulars 6 cents stamp.  
Allow time for return mail across the Atlantic.  
**G. MALCOLM ROSS, Height Specialist**  
Scarborough, England. (P. O. Box 15)

**SERVICEMEN-DEALERS**

Complete Stock of NEW Radio Replacement Parts  
Write for our Catalogue

Hard to Get Parts—We have them. Send us your repair work for estimate.

**Grant Radio Laboratories**  
6521-N South Halsted St., Chicago, Ill.

Aero Short Wave Receiver . . . \$ 6.45  
Aero Auto Radio, Complete . . . 39.50  
Aero Short Wave Converter . . . 12.50

Send for Complete Catalog  
**CHAS. HOODWIN CO.**  
Dept. X-3  
4240 Lincoln Ave. Chicago, Ill.

**NA-ALD** Get the latest dope on

the new 6-prong analyzer plugs, adaptors and sockets for all the new tubes including the 7-prong.

Send stamp for chart showing the adaptor to use for testing new tubes with your present analyzer or checker.

**ALDEN PRODUCTS CO.** Dept. N. Brockton, Mass.



# From 'Frisco to Paree'

(Continued from page 205)



No radio service department or experimenter's bench is complete without this valuable 104-page book, listing over 3000 bargains. Is yours for the asking. It features up-to-date radio receivers and replacement parts, also

**COMPLETE PUBLIC ADDRESS SYSTEMS FOR MOTOR TRUCKS AND PASSENGER CARS**

**1932 RECEIVERS WITH EXCLUSIVE "GHOST TUNING" FEATURE**

Write to headquarters or drop in to our nearest branch and ask for your copy.

**Federated Purchaser inc.**

Main Office: 25 Park Place, Dept. A, New York, N. Y.

169 Washington St., New York, N. Y.  
 92-26 Merrick Road, Jamaica, L. I.  
 51 East 3rd St., Mt. Vernon, N. Y.  
 2909 No. Broad St., Philadelphia, Pa.  
 631 Spring St., N. W., Atlanta, Ga.  
 273 Central Ave., Newark, N. J.

## Get Started in RADIO



Write for free booklet telling about this growing and most promising industry. The radio operator is an officer aboard ship. His work is light, pleasant and interesting. He has many opportunities

to travel to all parts of the world.

A new course in TELEVISION now under way. Full information on request.

EDUCATIONAL DEPARTMENT

WEST SIDE Y M C A 17 W. 63d St. New York

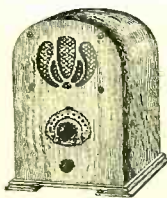

### NEW AUTOCRAT JR. \$11.95

NEW TRIPLE SCREEN GRID PENTODE TUBES We pay post-175 to 550 Meters age in U.S.A. Built-up Kit, 110 Volt. A.C. 100 to 750 miles. Size 12 1/2" x 7 1/4" x 9 1/2"—weights 12 lbs. Easily assembled—Full instructions. 4 R.C.A. (Lic'd) Tubes. Hand-rubbed solid walnut cabinet. Full vision dial. Dynamic Speaker, etc. COMPLETE WITH ALL PARTS — EVERYTHING. Send \$2 Deposit. Bal. \$9.95, C.O.D. Completely assembled. \$13.95. AUTOCRAT RADIO CO., Dept. RN 3855 N. Hamilton Ave., Chicago, Ill.

### VAN

#### SHUNTS-DIALS RESISTORS

For small 1 Milliampere Meters,

D.C. or A.C. Rectifier Type

ORDER THROUGH YOUR DEALERS

If they cannot supply, send for folder

D. L. VAN LEUVEN—Laboratory

410 East 15th St. New York City

fleet and later for their bombardment practice. The foothills of the great Andes range are here, but mountain climbing held no charms for me.

We pulled out calmly and peacefully, and a day or so after leaving here we passed the island of San Juan Fernandez, not far off the Chilean coast, where the much-talked-of "Robinson Crusoe" was supposed to have originated. It is said that he was the sole surviving member of a "square rigger" crew which was wrecked here on her way for the Horn.

We next reached the entrance to Magellan Straits, and a more weird, rugged and stormy sight I have never seen; towering mountains on each side and to the south, a long trail of jagged rocks, lashed by the fury of the gale which was then raging, darkened by heavy storm clouds and torrential rains. My impression can only be summed up as "the entrance to the gates of hell," but perhaps I struck a bad time, for I guess it is much more interesting in fine weather.

We passed along the Straits toward Punta Arenas, the most southerly point of the American Continent, passing on the way, in the distance, several canoes of the man-eating tribes of southern Chile, who are housed in the hills there. The anchor again took hold in the Bay of Punta Arenas, whilst we awaited the turning of the tide, but we were soon away again at the greatest speed of the whole trip, for there is a twenty-knot tide from Punta Arenas to the Atlantic. We speeded along at twenty-four knots, by adding our own four knots to that of the tide. Our course then took us up the sailing-ship route, through the center of the Atlantic, and we communicated with the Falkland Islands and passed on our way. This is the course on which the phantom ship *Flying Dutchman* is supposed to have been seen, but I'm afraid old sailors saw many queer things. However, there is no doubt about the peculiarity of the atmosphere and its possibilities of reflection and refraction of light which has resulted many times in showing a ship far away from its actual position and course. Also along this line of sailing ships there have been many islands spring up or disappear overnight on account of volcanic action taking place under the sea.

Later we arrived in the magnificent natural harbor of Rio de Janeiro, and, on passing through the very narrow entrance through the mountainous coastline, a wonderful sight was revealed to us, with the glorious sunset playing on the brightly be-decked minarets and domes of Brazil's capital and showing up to advantage the Naval Academy on its small peninsular, surrounded by the fleet with its numerous bright green national flags floating in the breeze. Much pomp and show was going on here at the time, for two Argentine battleships were visiting, and there were continued gun salutes most of the time we were in Rio.

We spent about three days in Rio de Janeiro, and, having put the worst members of our crew in irons, we spent quite a peaceful sojourn. Shorty and I spent most our time ashore, around the stores of the Avenida, Rio's main thoroughfare, and it goes almost without saying that we also found a couple of convenient cafés under the palms from whence we could view the passersby and make a study of them. I was somewhat disappointed in Rio when I got ashore, for the city looks such a beautiful place from the harbor, whilst two blocks or less from the main street were filthy side lanes full of disease. This city is a much unformed one, and numerous swaggering officers are continually parading the streets.

Also queer little fellows in nice wedgewood-blue uniforms, supporting rifles and bayonets much larger than themselves, pose in front of many of the main buildings. But I am inclined to doubt the amount of protection afforded by them.

Our next jump on the journey was to Las Palmas in the Canary Islands, off the north-west coast of Africa. We dropped anchor in the harbor of Santa Cruz one glorious morning, and the hills presented a beautiful sight. Las Palmas is the winter resort for many wealthy Europeans. We were soon ashore to take in the sights and grabbed off a carriage and drove into the city itself. Santa Cruz is just a port and full of the squalid type of old Spanish settlements. So we passed on, and soon the road opened out into the city's first plaza. The city is a fair size and of the usual Spanish type. Once you've seen one Spanish town, you've seen them all, whatever part of the world they happen to be in. We stayed here but three days, during which time I visited many of the tourist hotels up in the hills, and they surely made me feel that the sea was no place for a respectable human being. There are many places of historical interest in and around Las Palmas, but space will not permit of detail.

Sailing day arrived once again, but not without the usual little troubles, for no money had been handed out to the crew, with the result that they had signed many fictitious names to chits for various articles purchased from bumboats, the purchases including monkeys, dogs, parrots, firewater and an ample supply of cigars. The chits had been signed against the purser, so you can imagine the rumpus when they were presented for payment.

The crew had to be kept in their quarters and the bumboatmen were promised payment when the propeller turned over, which they seemed, with their scant knowledge of English, to think was O.K. They returned to their boats and waited. The propeller turned all right, the anchor came up with a jerk and they were paid, but satisfaction did not seem to appear, according to their shouts and gestures as the ship slid out of port.

Then came a sad day. The skipper made general inspection, for the authorities figure it unhealthy for England to receive pets from the Canary Islands, and before entering the port of London all parrots, dogs, canaries, monkeys and other germ-breeding nuisances had to be given the "deep six"—in other words, were confined to "Davy Jones' Locker"—to the tune of much wailing and gnashing of teeth.

We were now in the zone of submarine activities and our wireless cabin was the source of much interesting news; our noble crew of tough-muscled and soft-hearted humanity took sudden interest in their lifebelts and could not be parted from them day or night with a team of sixteen horses.

We were inspected in the Downs, a bay on the southeastern English Coast, the anchorage for picking up pilots during the war, where we had another mishap in the shape of smashing into another vessel which had to be beached to save her from sinking. Later the pilot tied us up safely alongside Tilbury dock, part of the Port of London. The first night here started the usual shindy again and several heads were smashed, so that a special police force was stationed aboard during the time of our sojourn there.

I had not been in London for seven years, so I hiked towards that town and was soon receiving a welcome from the old "places."



I had promised Shorty that I would show him around London, so I met him in Piccadilly and soon noticed disappointment written on his face, for it was November and a real London fog was enveloping the city.

We adjourned to the Regent Palace and cheered our foggy souls, and I was soon kidding Shorty about the two-guinea "coat" which he had bought for eight guineas, (a guinea is about five dollars). Also about a haircut which cost him another guinea in a society barber's shop.

We spent much time looking around all the sights of London and with the improvement of the weather Shorty found it very interesting after all, and especially after I had looked up many of my old friends and spent several pleasant evenings at parties in some old English country homes and managed to "ring in" on an admiralty dinner at the Savoy Hotel. By pulling wires I managed to get over the Channel with Shorty and on to Paris for two hilarious days, but no more about that.

Back in London. Our orders later came from our Leadenhall Street office saying that we were to run trans-Atlantic and later we left for New York, which trip was accomplished after encountering three days' terrific storm off the southwest of Ireland, during which time were merely kept "head on" to the mountainous seas but did not move. But we finally pulled through, with the loss of our hospital (which was swept clean off the deck), all our lifeboats and most of the deckwork.

It was sure one of the liveliest trips I have ever known in all my long travel experiences as a wireless "op," and when we arrived in New York harbor I was all packed and ready for shore and, offering up a prayer of thanks that I was back, put on a merry and bright smile once again, wondering what was next in line for me.

## DX Super

(Continued from page 229)

socket, turn the selector switch to the desired wavelength range. Then advance the lower right-hand knob until the on-off switch is turned on, lighting up all the tubes and the pilot lamp in the tuning dial window. In a few seconds the visual-tuning meter hand will advance from right to left, indicating that the tubes are heating up normally and the set is now ready for operation.

Now advance the lower left-hand control knob, which is the sensitivity adjustment, to the right, almost to its maximum setting. The right-hand knob (audio volume control) is to be retarded to a midway position. Proceed next to rotate the main tuning control, and as a station is reached, the meter needle will be seen to advance to the right. Next adjust the vernier for greatest swing of meter hand and readjust the volume control.

The upper right-hand knob is an auxiliary tuning control, and it is essential that this knob be adjusted for maximum meter swing, which indicates that the receiver is tuned to the exact center of the carrier wave. The right-hand volume control is advanced to the desired volume and left at this point. Thereafter all stations tuned in will be limited to this same volume by the action of the automatic volume control.

## Dynamic "Mike"

(Continued from page 219)

vacuum cleaner and nothing else! The listening public easily detected the difference and letters poured in to the studio to that effect. For weeks the engineers were the butt of their friends' jokes, with the result that their unofficial opinions of the new microphones, as verbally expressed, took on a decidedly bluish hue.

# You Must Know MATHEMATICS To Succeed in Radio Today



The man equipped with *practical* training is the safe man today and the key man tomorrow. There are jobs and contracts only for trained men—the men who have the basic knowledge that enables them to master the practical technique of their jobs. In radio, as in all mechanical, scientific, or technical work, *mathematics* training is essential to success for without mathematics a man can work only with his hands—and today he must work with his head as well if he is to secure his job.

### Now—Mathematics Self Taught—Easily, Quickly, Inexpensively

You can now master mathematics, without going back to school or taking an expensive correspondence course. An expert who has been instructing practical men all his life has prepared an extremely interesting group of books which at last removes the mystery of mathematics and makes it possible for you to apply it profitably to your own work.

## MATHEMATICS For Self Study

By J. E. Thompson, B.S. in E.E., A.M., Dept. of Mathematics, Pratt Institute, Brooklyn.

These books start right from the beginning with a review of arithmetic that gives you many short-cuts and "trick" methods of calculation that clip many hours from your working time. Then they go right into higher mathematics and you see how clear it is when an expert explains it for you. In a short time you will be tackling successfully the most difficult problems.

### An Expert Gives You These Simplified Methods

Mr. Thompson, the author of these books, has had many years' experience in mathematical training. He presents each practical method and problem in the clearest, simplest way. He gets right down to the kind of information that you need in your daily work.

## Send No Money

Examine These Books for 10 Days Free  
Mail This Coupon

D. VAN NOSTRAND CO., INC.  
250 Fourth Ave., New York.

Send me MATHEMATICS FOR SELF STUDY in 4 volumes. Within 10 days I will either return the books or send you \$1.65 as first payment and \$2.00 per month for 3 months—total \$7.65 (5% discount for cash). (R.N. 10-32)

Name.....  
Address.....  
City and State.....  
Business Connection.....  
Reference.....

### A Complete Course and Reference Work on Mathematics in These Four Inexpensive Books

Each step is clearly explained and is followed directly by sample problems and answers. There are, in addition, interesting practice problems with answers.

- Arithmetic for the Practical Man
- Algebra for the Practical Man
- Trigonometry for the Practical Man
- Calculus for the Practical Man

4 Volumes - 1240 Pages - Illustrated

## A Little Fellow with a Big Wallop

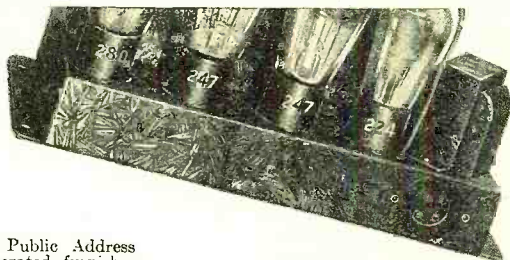

The WEBSTER-CHICAGO Public Address Amplifier M-463, all A. C. operated, furnishes volume for audiences up to 500 persons. You cannot obtain a better amplifier for medium size P. A. or music systems.

We offer this 5-tube Amplifier at a remarkably low price, which includes an 8" dynamic speaker. Modern circuit uses pentode tubes—output 7 watts. Power supply, including mike current—built in. Unusually pure tone.

SEND FOR THE WEBSTER CATALOG which describes the M-463, also a full line of sound equipment for every purpose. There are good profits for Service Men and Sound Contractors who take advantage of our generous trade discounts. Write today.



## THE WEBSTER COMPANY

850 Blackhawk St. Chicago, U. S. A.

## 23 Lessons in Radio 124-Page Red Cloth Bound Book—FREE

With 5 issues of RADIO NEWS for \$1.00

A Few of the Subjects Covered:

Elementary Radio Theory—The Detector Tube—Construction of a two-stage audio-frequency amplifier—How the Radio-Frequency Amplifier Works—A Short-Wave receiver—Principles of transmitting and receiving—Complete Chart of Standard Radio Symbols—How to Build R F Tuner—A 3-stage resistance coupled audio-frequency amplifier—The How and Why of B-Power Units—Breaking into the Amateur Game—A code test outfit—Circuit, constructional and operating details of a Low-Power Transmitter—How the Vacuum Tube Works—Battery construction details—How to Analyze Receiver Circuits. Send order to Radio News, Dept. 10, 222 W. 39th St., New York, N. Y.

## You Can Become a Fast, Capable RADIO OPERATOR at Home

### CANDLER

E. J. Yarris, Chicago, copied 8 wpm in 11 hours' study. C. Lane, Portland, Ore., does 20 words on third lesson.

### Scientific System

In less than half the usual time. Amazing results. Thousands of fast Radio operators taught by CANDLER. FREE advice if you're "stuck." All questions answered personally. No obligation. If beginner, get facts on Junior Course. If Radio operator, ask about ADVANCED COURSE for SPEED and Copying Behind and "MILL" Course. FREE illustrated book will save you time and money. Write now! CANDLER SYSTEM CO., Dept. 17 6343 So. Kedzie Ave., Chicago, Ill.



World's Only Code Specialist



# A NEW SHALLCROSS

**Combination Multi-Range**

**A.C.  
and  
D.C.  
Meter**



using Type 610 Shallcross Resistor Kit and the Weston Model 301 Universal Meter.

**This Combination Meter measures**

- 4 D.C. Voltage Ranges
- 4 A.C. Voltage Ranges
- 4 D.C. Current Ranges
- 3 Resistance Ranges
- 3 Impedance Ranges

including Capacity, Inductance and a High Resistance Range.

Send 6c in stamps for Bulletin 152-D which contains a diagram of this circuit and information on its construction.

ALWAYS Super ACCURATE

**Shallcross Mfg. Company**  
ELECTRICAL SPECIALTIES  
700 PARKER AVENUE  
Collingdale, Pa.

ACCURATE NON-INDUCTIVE WIRE WOUND RESISTORS

# THE MICROMIKE



In a small precision microphone which fastens to the clothing. It is a substitute for the large microphone and marks a new day in broadcasting and public address work. Its size—less than a half dollar and its weight less than 1½ ounces. Allows the speaker complete freedom of expression. This Micromike with Powerizer Portable is the last word in portable low priced P. A. Systems. It is ideal for home recording.

- Enclosed please find remittance for units checked below at the introductory price and send to me prepaid.
- 1 Micromike.....\$10.00
  - 1 Mikontrol.....\$3.00
- Bulletin on Powerizer Portables and Micromike.

Name.....  
Address.....

**RADIO RECEPTOR CO. INC.**  
108 - 7th Avenue N. Y. C.

## AUTOCRAT AUTO RADIO \$17.45

**6 TUBE  
175 to 550 Meters**

Complete less \$1.00 Batteries But Plus Tax

Complete accessories include mounting brackets, illuminated dial, lock switch, remote control, dynamic speaker, 6 RCA (Lisc.) Tubes, spark suppressors, and antenna. Everything except "B" Batteries. Small and compact 5¼" x 6½" x 8¼". Distance range 100 to 1000 miles.

Send \$2.00 deposit. Balance C. O. D.  
AUTOCRAT RADIO CO., Dept. R. N.  
3855 N. Hamilton Ave. Chicago, Ill.

Just Off the Press

**Our NEW 64-page CATALOG  
A REAL BUYING GUIDE FOR  
DEALERS AND SERVICEMEN**

Send for Your Free Copy

**WORLD WIDE RADIO CORP.**

47 Murray St. New York, N. Y.

# Crystal "Mikes" and Speakers

(Continued from page 215)

turers have recognized the fact that there are certain advantages in using two types of speakers operating from the same source. This has become known as the dual-speaker system. In this connection, the crystal, or capacitive-type speaker, when used with a dynamic or inductive type, has proven such a combination far superior to a pair of either kind. The fidelity of musical reproduction is tremendously improved, as is shown by the output-frequency curve in Figure 2, taken from an installation using one dynamic and one crystal speaker. When used as a dual speaker, it is only necessary to connect the crystal speaker across the primary of the dynamic transformer. It is important to note that in this type of installation, the power factor is greatly improved, which of course means increased sensitivity.

Inasmuch as the dynamic speaker is inductive and the crystal speaker is capacitive, a phase displacement automatically takes place between the two speakers. This has been found to improve the quality of reproduction considerably. It does make a difference, however, in which way the crystal and dynamic are phased. A trial switching terminals will quickly indicate when the two are in proper phase relation. When it is desirable to alter the frequency characteristics of the crystal speaker, the use of a small condenser in series or parallel can accomplish this purpose. The condenser can be used in series to cut the low-frequency response or in parallel to cut the high-frequency response.

It has been found that the use of two crystal speakers and a dynamic as indicated in Figure 3 gives excellent results in theatre work. This combination results in strong reproduction of frequencies even above 10,000 cycles and the usual dip customary with dynamics between one and two thousand cycles is absent.

It is a well-known fact that pentode tubes have a high percentage of second and third harmonics, unless worked at a constant output load. A further inspection of the curve in Figure 3 indicates the flat load characteristic obtainable through the use of the combination with virtual elimination of these objectionable harmonics.

It should be pointed out that crystal speakers have run continuously for years under a wide range of temperature change, without deterioration either in tone or output and have, during that time, required no servicing or other attention.

Two sketches are shown here suggesting possible methods for the amateur construction of crystal speakers. Both methods produce excellent results. The conception shown in Figure 4 shows the crystal mounted at one side of the center line of the cone and the design in Figure 5 arranges the parts in such manner as to permit the mounting of the cone directly in the center of the crystal.

In both cases, mechanical amplification through a tone arm is necessary, and in general the larger the cone diameter, the smaller the step-up ratio necessary. Care should be taken when gluing parts to the crystal to select an adhesive which does not evaporate rapidly to produce a rapid local cooling which may damage the crystal.

Figure 4, however, is the preferred mounting. In using this method, three corners of the crystal are firmly and evenly clamped between rubber pads, and the power is taken from the fourth corner.

## The Crystal Microphone

Crystal microphones may be developed us-

ing a separate diaphragm or using the crystal itself as the diaphragm. In the latter case, a great variation of design is possible and microphones may be built round, square, or any shape to comply with special requirements. Crystal microphones also have many advantages over existing types, since such crystal mikes require no current supply or polarizing voltage, cannot be overloaded, are inherently silent having no carbon hiss, and may be situated a long distance from the amplifier. In this type of microphone, the voltage generated is proportional to pressure on the crystal; in fact, a direct pressure applied to a crystal microphone causes a proportionate voltage to be generated, which remains until the pressure is removed or the electric charge leaks away.

In the Brush crystal microphone, type Q202, which has been developed for the highest class of broadcasting and recording work, a bimorph crystal diaphragm is used. This diaphragm is a disc, two inches in diameter and .025 inch thick, overall. It is foiled in four sections and with proper electrodes attached, is mounted in a machined bakelite ring, electrodes being connected in series parallel. After proper damping has been provided, the back of the housing is entirely sealed except for a small vent to provide for equalization of atmospheric pressure. This unit is then housed in a brass case, finished in black and chromium, and is fitted with ten feet of shielded cord. The microphone is 3½ inches in diameter, 1½ inches thick and the total weight is 1½ lbs.

From the foregoing description it can be seen that the microphone has no mechanical moving parts, is extremely rugged, and can be used in any desired position. The microphone may be used to replace the usual condenser head, care being taken to disconnect the polarizing voltage supply in the head amplifier. If it is not convenient to disconnect this voltage, a high-grade mica condenser about .1 mfd. may be used in series to eliminate the voltage. The microphone may be matched to a 200- or 500-ohm line by means of a step-down transformer, the primary side of which is wound for 25,000 ohms. This transformer may be placed from ten to thirty feet from the microphone. The microphone may also be connected straight across the grid of the first tube of the amplifier; if the amplifier is situated within thirty feet, a grid leak or volume control of at least 500,000 ohms being used.

The output curve shown in Figure 6 is characteristic of these microphones and was taken by comparing one with a calibrated condenser microphone. It includes a transformer to balance to a 500-ohm line. It will be noted on this curve that the output varies, when the bass is reduced by the customary use of resistance in parallel, only 2 decibels from approximately 100 cycles to 6,000 cycles and increases from there on.

It is possible for the amateur to construct a crystal microphone having an output comparable to a good two-button carbon microphone and requiring only three stages of amplification. In this case, a small crystal element can be used in conjunction with the diaphragm. The sketch (Figure 7) suggests how this can be done. The result is a microphone having a high output, good quality for musical reproduction and excellent for voice.

In conclusion, it may be said that there are other devices in which Rochelle salt crystal may be used to advantage, such as phonograph, pickups, relays, oscillographs, oscilloscopes, etc. These devices have already been developed and there are other applications yet to be worked out by the research physicist in other fields.



## Photocell Progress

(Continued from page 211)

of a cell of the type shown in Figure 9 is illustrated. We have, for instance, at 2000 cycles per second, an intensity of the output of the numeric value of 10. At about 9000 cycles this is reduced to about 50% of the amount at 2000 cycles.

Will we ever get from photo-electric cells of these types a part of the electric power we need in our civilization of today? It is stated that certain laboratory types of cells are now able to deliver as much as one watt energy per square yard, in direct sunlight. Imagine desert areas, now a nuisance and a danger, covered with photo-electric power plants! Solar electric generators turning vast areas into sources of energy—without rotating machines and without considerable cost of maintenance. . . .

This is a question of further development—a development which sprouts from the needs of radio to obtain better photo-cells.

- <sup>1</sup> Hallwachs, Ann.d.Phys., 33,301, 1888.
- <sup>2</sup> Stoletow, Journal de Physique, 9,486, 1890.
- <sup>3</sup> Elster and Geitel, Ann.d.Phys. 38,497 and by the same authors, 41,161, 1890.
- <sup>4</sup> An exact description for the manufacturing of this type of photo-cell is given in Elster and Geitel, Phys. Zs. 1911, 609 and 1913, 714.
- <sup>5</sup> Garrison, Journ. Phys. Chem. 28,334, 1924.
- <sup>6</sup> L. O. Grondahl, USA Pat 1640335 v.T. 1.25.
- <sup>7</sup> H. H. Sheldon and P. H. Geiger, Proc. Nat. Acad. Amer. 8, 161, 1922.
- <sup>8</sup> P. H. Geiger, Brit. Pat. 277610, 1927.

### Requirements Fixed for New Aero Radio License

WASHINGTON, D. C.—The Radio Division of the Department of Commerce is now conducting examinations for a new class of radio operator—the radio-telephone aeronautical class, qualifying license holders to operate aeronautical ground radio stations. To qualify, the applicant must show knowledge of airplane dispatching, meteorology, international air regulations, aids to air navigation and operation of teletype apparatus in addition to the regular federal radio-telephone requirements. Examinations will be given in New York, Boston, Baltimore, Philadelphia, Norfolk, Atlanta, Portland, Ore., Seattle, Miami, New Orleans, Los Angeles, San Francisco, Chicago, St. Paul, Kansas City, Denver, Dallas, Detroit and Buffalo.

### C. F. Burgess Laboratories Now in Electronic Field

NEW YORK—Announcement is made that C. F. Burgess Laboratories, Inc., of 202 East 44th Street, New York City, have taken over the activities of the Burgess Battery Company in the sale of Burgess Radio-visor Bridges (light-sensitive cells).

### Resistor Sales Reflect Radio Servicing Activities

PHILADELPHIA, PA.—Radio sets must last longer. Whether this be due to the curtailed family pocketbook or again to the stabilized radio engineering of the past few years which grants a longer span of life to the radio set, the fact remains that radio servicing activities are on the upgrade. Furthermore, the servicemen are showing a preference for the highest grade replacement parts, bearing out the idea that radio sets must provide the longest service life.

The best barometer of the present servicing situation is the sale of resistors. Within the past year, the sale of resistors through the jobbing channels has increased steadily.

## THE MARVEL OF TELEVISION

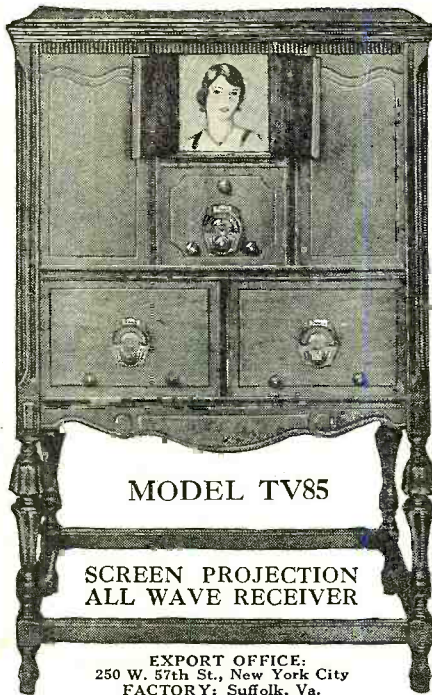

# Rawls

TELEVISION with Synchronized Sound **\$295.00**  
LIST PRICE

The Ultimate in Television  
Produced by Rawls Engineers!

### A Message to Money makers

And by moneymakers we mean dealers who are alive to new developments—dealers who are quick to appreciate the tremendous selling possibilities to the public of a Television set that provides real home entertainment. If you are interested drop us a line on your firm letterhead and we will be glad to send you full details.

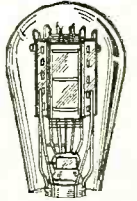

Originators of "Rawls Yellow Base Tubes"

W. C. RAWLS & CO., RN Bankers Trust Bldg., NORFOLK, VA.

## ANNOUNCING

### New Brush Crystal Devices for Public Address

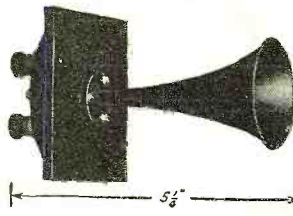

The P.A.-4 exponential horn unit, using the same power, is used with ten-foot horns.

Two types of microphones are now available; the Q-202 for high-class radio broadcasting and professional recording; and the B-303 for public address work.

Write for literature describing the complete line of Brush Crystal Speakers and Microphones. Manufacturers' inquiries invited.

**THE BRUSH DEVELOPMENT COMPANY**  
3715 EUCLID AVENUE CLEVELAND OHIO,

The type H. F. horn (illustrated) is the latest development in Piezo-Electric devices. It is indispensable for theatres and public address systems for reproducing high frequencies unobtainable with present equipment. Range 3,000 to 15,000 cycles.

The P-12 speaker (illustrated) is designed for use with horn baffle. Its four-motor drive gives it a remarkable range and quality.

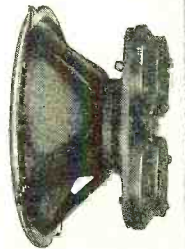

### C. F. Burgess Laboratories Now in Electronic Field

NEW YORK—Announcement is made that C. F. Burgess Laboratories, Inc., of 202 East 44th Street, New York City, have taken over the activities of the Burgess Battery Company in the sale of Burgess Radio-visor Bridges (light-sensitive cells).

### Resistor Sales Reflect Radio Servicing Activities

PHILADELPHIA, PA.—Radio sets must last longer. Whether this be due to the curtailed family pocketbook or again to the stabilized radio engineering of the past few years which grants a longer span of life to the radio set, the fact remains that radio servicing activities are on the upgrade. Furthermore, the servicemen are showing a preference for the highest grade replacement parts, bearing out the idea that radio sets must provide the longest service life.

The best barometer of the present servicing situation is the sale of resistors. Within the past year, the sale of resistors through the jobbing channels has increased steadily.

**SUPPRESSED KNOWLEDGE OF THE AGES**  
Hidden, denied, but not lost, is the miraculous wisdom of the ancients. Their methods of mental power in achieving SUCCESS and MASTERY IN LIFE are available TO YOU. Write for a FREE copy of the "Wisdom of the Sages" and learn how to receive this rare knowledge. MAKE YOUR LIFE ANEW.  
SCRIBE PKM  
**ROSICRUCIAN BROTHERHOOD**  
SAN JOSE CALIFORNIA

**TRICKS WITH ELECTRICITY**

Make electric lights obey voice, make things spin, jump, kick, run, vibrate, buzz, shoot, shock, flash, mystify—all by electricity. Make window novelties, floating rings, spirit rapping, all kinds amusing and practical devices. Book tells how to do 200 stunts with 110 volts A. C. Postpaid \$1.00.  
**CUTTING & SONS, 102-B St., Campbell, Calif.**

THE MOST COMPLETE LINE OF CONDENSERS AND RESISTORS FOR EVERY RADIO USE

## AEROVOX

Write for Complete Catalog free of charge  
**AEROVOX CORPORATION**  
78 Washington Street Brooklyn, N. Y.

**1933 Edition UNIVERSAL CATALOG**

Keep posted on the new Universal products. Universal makes Tomorrow's New Developments Available Today! Get your copy from your dealer.  
**UNIVERSAL MICROPHONE CO., Ltd.**  
424 Warren Lane, Inglewood, Calif., U.S.A.

**JOBBER-DEALERS**  
There's profit for you selling TRIMM Quality Earphones. More stations are in your Short Wave receiver when you use the 4000 ohm Featherweight. Amateurs are asking for it. Money back if not satisfied. Liberal discounts.  
**TRIMM RADIO MFG. CO.**  
"Earphone Specialist"  
1528-38 Armitage Ave. Chicago, Ill.

**KEEP UP WITH RADIO**

NEW General course at New York Resident School. Includes all NEW branches of radio, as well as Broadcasting, Sound Pictures, Servicing, Aviation and Marine Operating. Also specialized courses at New York and Chicago schools and Extension Courses on "no obligation" plan. Catalog.

**RCA INSTITUTES, Inc.**  
Dept. RN-10, 75 Varick St., New York



The New Way  
TO ANALYZE SETS

*Readrite*

No. 1000

RESISTANCE  
CONTINUITY and  
CAPACITY TESTER

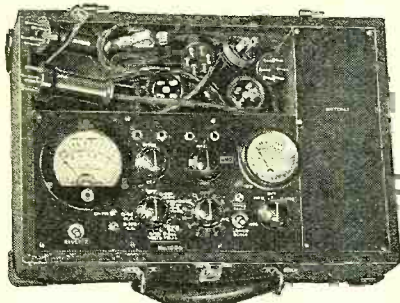

\$33 NET TO DEALER

Send for catalog describing this point-to-point exclusive Readrite method of set testing.

Send for Catalog

Readrite Meter Works, Estab. 1904  
20 College Ave., Bluffton, Ohio

JUST OFF THE PRESS

A NEW CATALOG

One of the most complete radio catalogs ever published listing such nationally known lines as Weston, Amertran, Universal Microphone, National, Lynch, Electrad, Aerovox, Clarostat, Cornell, De Jur and many others. Write for your copy now it's—

FREE — FREE

WRITE FOR YOUR COPY NOW

BALTIMORE  
RADIO CORPORATION

725 BROADWAY NEW YORK, N. Y.

PATENTS

Write for Free Information, HOW TO OBTAIN A PATENT and RECORD OF INVENTION—or send drawing or model for examination.

MILLER & MILLER, Patent Attorneys  
FORMER MEMBERS EXAMINING CORPS U. S. PATENT OFFICE  
1006 Woolworth Bldg., Dept. H, New York  
206 Earle Building, Washington, D. C.

PATENTS TRADE MARKS  
COPYRIGHTS

"Little Ideas May Have Big Commercial Possibilities"  
PROTECT THEM BY PATENTS  
Send for our Free book, "HOW TO OBTAIN A PATENT"  
and "Record of Invention" blank.  
Prompt Service—Reasonable Charges—Deferred Payments.  
HIGHEST REFERENCES

VICTOR J. EVANS & CO.

Registered Patent Attorneys—Established 1898  
622-K Victor Building, Washington, D. C.

PATENTS

Time counts in applying for patents. Don't risk delay in protecting your ideas. Send sketch or model for instructions or write for FREE book, "How to Obtain a Patent" and "Record of Invention" form. No charge for information on how to proceed. Communications strictly confidential. Prompt, careful, efficient service. Clarence A. O'Brien, Registered Patent Attorney, 3097 Adams Building, Washington, D. C.

# Some Latest

A description of the outstanding acoustics and electronics as they are Office. This information will be found engineers, set designers and production as well as describing the

By Ben J.

1,853,021. MEANS FOR ELIMINATING FADING. ERNST F. W. ALEXANDERSON, Schenectady, N. Y., assignor to General Electric Company, a Corporation of New York. Filed Nov. 15, 1927. Serial No. 233,508. 6 Claims.

1. In combination, an antenna having a plurality of alternately arranged members disposed in different planes, a second an-

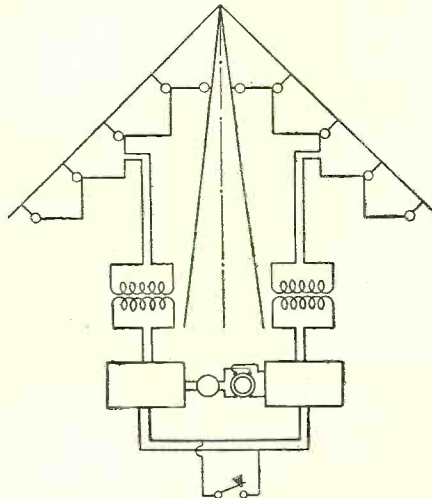

tenna having a plurality of members similarly arranged in planes parallel to said first mentioned planes, means including high frequency apparatus associated with both of said antenna whereby certain members of both of said antennæ cooperate in a certain plane and means whereby certain other members of both of said antennæ cooperate in a different plane.

1,854,274. TELEVISION SYSTEM. DIETRICH PRINZ, Berlin, Germany, assignor to Telefunken Gesellschaft für Drahtlose Telegraphie m. b. H., Berlin, Germany, a Corporation of Germany. Filed Apr. 4, 1931, Serial No. 527,669, and in Germany Apr. 3, 1930. 1 Claim.

In a television system, a cathode ray image recreating device, means for controlling the intensity of said cathode ray for image reproduction in accordance with received signalling impulses, a local source of alternating current of a frequency substantially identical with a corresponding local source at the point of transmission, a glow discharge frequency reducing means energized from said local source for producing alternating current impulses of a frequency less than the source frequency to control the projection path of said ray in one direction for synchronizing the movement thereon, and frequency multiplying means also energized from said local source for producing alternating current impulses of a frequency greater than the source frequency to control the projection path of said cathode ray in a second direction for synchronizing the movement thereof along a path transverse to the first path of synchronized movement.

1,855,149. METHOD AND MEANS FOR THE VENTRILOQUIAL PRODUCTION OF SOUND. W. BARTLETT JONES, Chi-

cago, Ill. Filed Apr. 13, 1927. Serial No. 183,414. 12 Claims.

1. In combination, two sound pick-up devices positioned with respect to the origin of a sound wave so that each device receives and picks up the same wave at a different time, the differential time being comparable to the difference in time between impacts of a sound wave on the two ears of a human

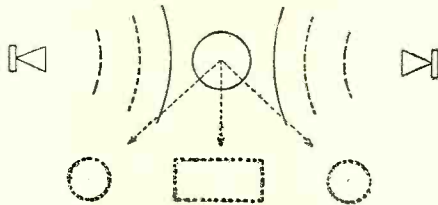

being, and means to vary the ratio of intensities of action of the same wave on the two devices in accordance with the difference in distance between them, the relation being predetermined by the desired angularity of the virtual origin and the desired distance of the virtual origin from the listener.

1,857,359. RADIO SIGNALING. LOUIS COHEN, Washington, D. C. Filed Aug. 13, 1928. Serial No. 299,386. 8 Claims. (Granted under the act of Mar. 3, 1883, as amended Apr. 30, 1928; 370 O. G. 757.)

1. In a system for multiplex reception of radio signals comprising an antenna which is grounded through an impedance, a plural-

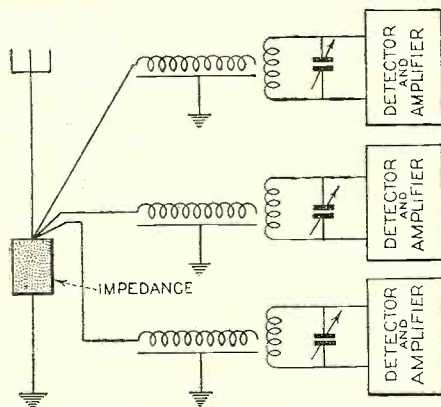

ity of wave conductors connected at the junction point of connection of said antenna to said impedance, each of said wave conductors being separately adjustable to respond to the wave length of one of the signals desired to be received, a separate receiving circuit system coupled to each of said wave conductors, and each of said receiving circuit systems being provided with means for detecting and amplifying said signals.

1,858,339. PIEZO ELECTRIC OSCILLATOR. RUSSELL S. OHL, New York, N. Y., assignor to American Telephone and Telegraph Company, a Corporation of New



# Radio Patents

*patented inventions on radio, television, granted by the United States Patent a handy radio reference for inventors, men in establishing the dates of record, important radio inventions*

## Chromy\*

York. Filed June 24, 1926. Serial No. 118,350. 3 Claims.

1. The method of producing oscillations of predetermined frequency with a piezo-electric crystal capable of being set into vibration in a plurality of modes, which consists in selecting the desired mode of vibration and changing the effective reactive value of the crystal to a capacitance of definite

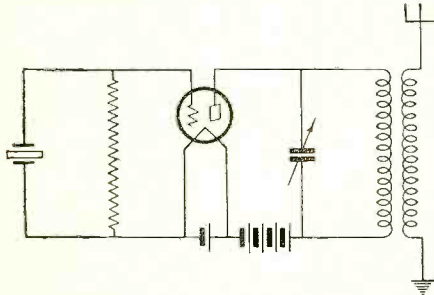

magnitude to correspond to the predetermined frequency.

1,859,103. TRANSMISSION SYSTEM. BYRON B. MINNIUM, Chicago, Ill., assignor to Stewart Warner Corporation, Richmond, Va., a Corporation of Virginia. Filed Nov. 26, 1929. Serial No. 409,792. 3 Claims.

1. In an amplifier system employing multi-electrode electron discharge devices, means for suppressing undesirable oscillations

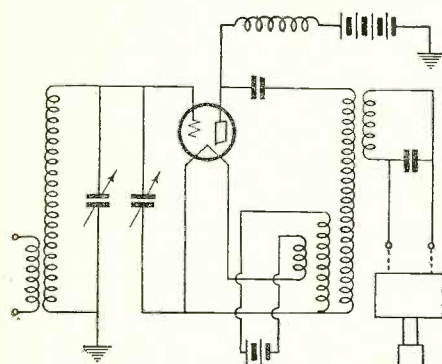

due to inter-electrode capacities including an input inductance connected to the grid of said device, a filamentary cathode for said device, an output inductance having one end connected to the anode of said device, the opposite end of said output inductance being directly connected to said cathode, a pair of balancing coils inductively related to said pair being connected to a leg of said filament, and a source of filament heating current connected in parallel with said coils.

1,859,565. APPARATUS FOR REDUCING CROSSTALK CURRENTS. CLYDE R. KEITH, East Orange, N. J., assignor to Bell Telephone Laboratories, Incorporated, New York, N. Y., a Corporation of New York. Filed Dec. 4, 1928. Serial No. 323,724. 7 Claims.

2. The combination in a transmission system of a line for the transmission of signals, and means for the suppression of disturbing currents therein comprising an amplifier therein for amplifying substantially without distortion waves of normal signal amplitude impressed on said amplifier from said line, said amplifier being normally opaque to currents of crosstalk amplitude

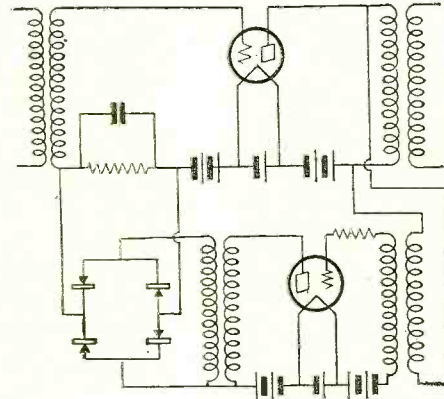

but having means dependent upon the current transmitted through said amplifier for rendering the gain thereof as a distortionless amplifier high for currents of normal signal amplitude.

1,856,709. COUPLING ARRANGEMENT FOR COMPENSATED HIGH FREQUENCY AMPLIFIERS. EDUARD KAPPLUS, Berlin-Tempelhof, Germany. Filed Jan. 9, 1928, Serial No. 245,616, and in Germany Jan. 11, 1927. 3 Claims.

1. In combination with a neutralized high frequency amplifying system, a vacuum tube having anode, cathode and control electrodes, a primary inductance coil for receiving oscillating currents to be amplified by said tube, said inductance having its mid point tapped and connected to the zero reference point of said system, whereby equal high frequency potential occurs at the ends of said inductance, a secondary inductance arranged symmetrically within said first inductance coil and also having its mid point tapped and connected with the zero potential reference point of said system for producing controlling potential and compensating potential for said vacuum tube, and the capacitive couplings of said inductances varying uniformly with changes in frequency and degree of coupling.

1,856,922. PHONOGRAPH ELECTRICAL REPRODUCER. ARNO MERKEL, New York, N. Y., and RICHARD R. HALPENNY, Bridgeport, Conn., assignors to Ray G. MacPherson and James E. MacPherson, New York, N. Y. Filed Apr. 28, 1928. Serial No. 273,539. 1 Claim.

An electrical reproducer for phonographs comprising an electromagnetic pick-up device having a plurality of electromagnetic pick-up coils, reproducing means having a corresponding number of energizing coils, and an audio amplifier connecting each pick-up coil with an energizing coil and having its input circuit including said pick-up coil, the pri-



## In the Great Shops of COYNE

Don't spend your life slaving away in some dull, hopeless job! Don't be satisfied to work for a mere \$20 or \$30 a week. Let me show you how to make REAL MONEY in RADIO—THE FASTEST-GROWING, BIGGEST MONEY-MAKING GAME ON EARTH!

### Jobs Leading to Salaries of \$50 a Week and Up

Jobs as Designer, Inspector and Tester,—as Radio Salesman and in Service and Installation—as Operator or Manager of a Broadcasting Station—as Wireless Operator on a Ship or Airplane, as a Talking Picture or Sound Expert—HUNDREDS of Opportunities for fascinating, BIG Pay Jobs!

### 10 Weeks' Shop Training AT COYNE IN CHICAGO

We don't teach you from books. We teach you by ACTUAL WORK on a great outlay of Radio, Broadcasting, Television, Talking Picture and Code equipment. And because we cut out useless theory, you get a practical training in 10 weeks.

## TELEVIS ON Is Now Here!

And TELEVISION is already here! Soon there'll be a demand for TELEVISION EXPERTS! The man who gets in on the ground-floor of Television can have dozens of opportunities in this new field! Learn Television at COYNE on the very latest Television equipment.

### Talking Pictures A Big Field

Talking Pictures, and Public Address Systems offer golden opportunities to the Trained Radio Man. Learn at COYNE on actual Talking Picture and Sound Reproduction equipment.

### Earn As You Learn

You get Free Employment Service for Life. And if you need part-time work while at school to help pay expenses, we'll help you get it. Coyne is 32 years old. Coyne Training is tested—You can find out everything absolutely free. JUST MAIL the Coupon for My BIG FREE BOOK.

H. C. LEWIS, President  
Radio Division, Coyne Electrical School  
500 S. Paulina St., Dept. 72-5C, Chicago, Ill.

Send me your Big Free Radio Book and all details of your Special Introductory Offer. This does not obligate me in any way.

Name .....

Address .....

City ..... State .....



# LEARN RADIO

this easy, practical way

WRITTEN by two widely known radio engineers, these three books cover every phase of building, repairing and "trouble-shooting" on modern receiving sets.

## Radio Construction Library

Including Television and Short-Wave Receivers

This fundamental library includes: PRACTICAL RADIO—the fundamental principles of radio, presented in an understandable manner. Illustrated with working diagrams. PRACTICAL RADIO CONSTRUCTION AND REPAIR—Methods of locating trouble and reception faults and making workmanlike repairs. Discusses modern Short Wave Receivers fully. RADIO RECEIVING TUBES—Principles underlying the operation of all vacuum tubes and their use in reception, remote control and precision measurements.

The Library is up-to-the-minute in every respect and is based on the very latest developments in the design and manufacture of equipment.

Three Volumes,  
6 x 9—993 pages,  
561 illustrations.

See this  
Library  
FREE!

No  
Money  
Down

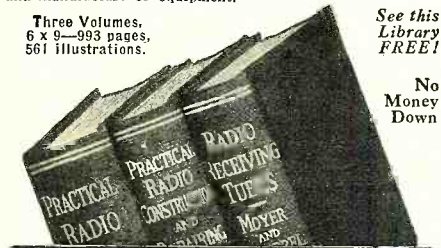

### FREE EXAMINATION COUPON

McGraw-Hill Book Company, Inc.  
330 West 42nd Street, New York

Send me the new RADIO CONSTRUCTION LIBRARY, three volumes, for 10 days' free examination. If satisfactory I will send \$1.50 in ten days, and \$2.00 a month until \$7.50 has been paid. If not wanted I will return the books.

Name .....

Home Address .....

City and State .....

Position .....

Name of Company..... RN-10-32

## RACON Always Leads

AND NOW . . . A radically new type Horn, having a complete circumferential coverage of 360 degrees with even intensity of distribution.



Send for Complete New Catalog on Horns and Units

### RADIAL HORN

Stormproof, demountable, and is perfectly adapted for use on trucks, lower equipment, churches, and general public address use where a complete circumferential coverage is desired.

Again the pioneer manufacturers of acoustic sound reproducers prove their leadership with this New Radial Horn. You must also remember . . . there is a Racoon Horn for every purpose and nothing is finer than Racoon.

RACON HORNS and UNITS ARE COVERED BY U.S. PATENTS NOS. 1,507,711; 1,501,032; 1,377,270; 73,217; 73,218; 1,732,448; 1,711,514; 1,781,489; 1,832,008; 1,834,327; 1,835,739.

Address Dept. R.N.-10

**RACON ELECTRIC CO., Inc.**  
52 E. 19th STREET NEW YORK  
LONDON, ENGLAND TORONTO, CANADA

## RADIO'S REWARDS



are rich for those who are prepared. Study all branches of practical radio at RCA Institutes America's oldest radio school. Hundreds of in New York and Chicago. Also extension courses for home study on new "no obligation" enrollment plan. Catalog upon request.

**RCA INSTITUTES, Inc.**  
Home Office, Dept. RN-101  
75 Varick St. New York

## FREE Amateur and Servicemen's Wholesale Guide

—Hot off the press! Chock full of latest of everything for the Radio Serviceman, Amateur, Experimenter. Detailed illustrations; vital and interesting facts. Hundreds of "Hot Shot" bargains! Astonishing wholesale prices that challenge all America. WRITE TODAY for your free copy!

**BURSTEIN-APPLEBE COMPANY**  
1405-C McGee St., Kansas City, Missouri



mary of an audio transformer, a condenser for tuning said circuit to resonance at a determined frequency in the audio frequency range, and a resonance broadening resistance for varying the potentials generated in the

primary coil responsive to varying amplitudes of motion of the armature of the pick-up device, the said input circuits of the audio amplifiers being tuned to resonance at different frequencies in the audio range.

## With the Experimenters

(Continued from page 237)

condition. This is really more of an unisolated counterpoise than a ground. If only from the standpoint of ease of installation, this ground is one of the best for the average person to construct.

CHARLES FELSTEAD,  
Los Angeles, Calif.

### A Stand for the Condenser Microphone

The following is a suggestion I have to offer to the readers of RADIO NEWS concerning a stand for the condenser "raike" described in the April issue of RADIO NEWS. I had a Western Electric cone speaker and

most part self explanatory. The writer has tried this circuit and can vouch for its performance. The oscillator is of the conventional type but the form of modulation is somewhat out of the ordinary. If not more than ninety volts is placed on the plate of the tube, the quality of music obtainable will be more than pleasing to anyone that desires to try out this circuit. The high resistance in the grid has a tendency to match the input so that proper oscillation and modulation can be obtained.

M. H. BERRY,  
Columbia, Tenn.

### Golf Tees as Wiring Supports

Holding and placing light battery wires temporarily around the bench or on dis-

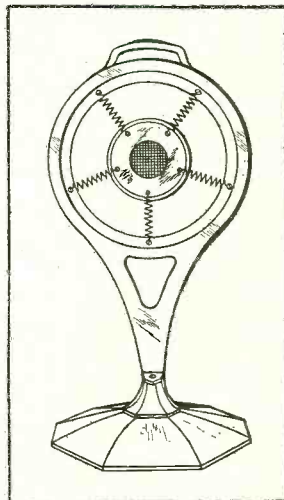

tributing blocks is often an aggravating incident when hurriedly hooking up for an experiment. Inexpensive hardwood golf tees of the type shown here are a very handy thing for the purpose. The long sharp ends can be firmly stuck in any small hole or opening, while the upper end due to its spool-like head is an excellent temporary fastening for the wire. Some thirty or forty of these little pieces can be procured for a dime or less and are quite handy and convenient for this purpose.

EDWIN T. RILEY,  
Chelsea, Mass.

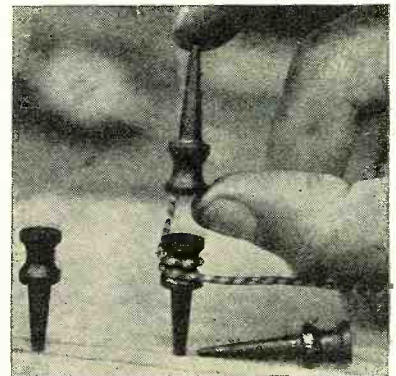

### Modulated Test Oscillator

Servicemen and experimenters often have use for an oscillator that can be used in connection with an electric pick-up without the

FRANK W. BENTLEY, JR.,  
Missouri Valley, Iowa.

### Home-Made Cable Plug

A neat method of making the battery or power pack connections to a home-built radio set is shown in the sketch. The cable wires are soldered to the tube-base prongs,

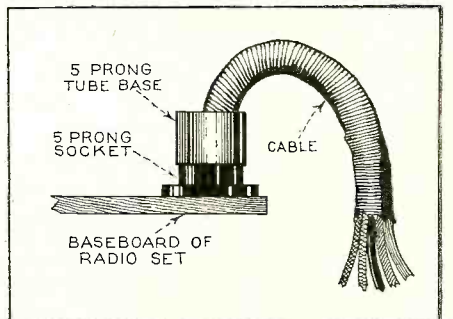
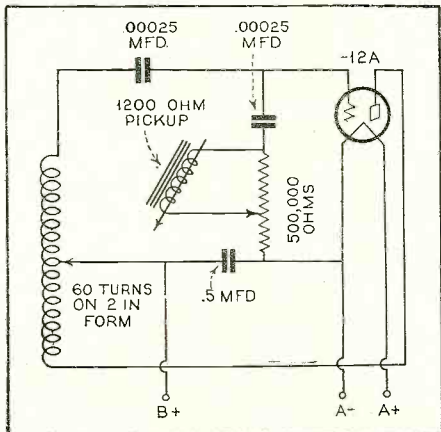

and the socket is mounted at the rear of the set.

HORACE B. GOSS,  
Essex, Conn.



# ?QRD?

*A column devoted to the commercial operator and his activities*

*Conducted by GY*

HELLO, gang—friends, radio gadgets and brass pounders—lend me thine ears. The boss was just over here telling me it's about time I let you fellows get wise to who I am—not that I'm such a secretive guy—because I think most of the old bunch would know me if you bunked into me walking down the street. So get close gang, keep the old ears open and sit tight.

Years back I found out the difference between a spark gap and a secondary coil and decided to give the world a break and be the hero in all future disasters at sea—yeh. I also read those books on going down to the sea in ships. Boy, I'll never forget those

of the time I was tryin' to find the stuff that I had checked in. Whoopee, what a bookkeeper I made! One trip on her and I decided, or rather it was decided for me, by the skipper, that I ought to try my hand at dancing, and so I found myself pounding the pavements in li'l ol' N'York. So sez I to myself, sez I, we'll try a little bit of broadcasting. Gathering an armful of references and a couple of letters from Congress (a letter from a Bishop is also necessary nowadays) I ambled into one of the stations where, as luck would have it, they had an empty chair.

Now the time comes to the present where I'm sittin' back "shootin' the breeze" again, givin' you guys that what's this and the who's who on the fellows that have been, are being and will be. 'GY' is the sign and there's many an old tale that carried it. Remember—Yeah? But as Horatio Schnitzelberger used to crack, "It ain't where you start from, it's the finish that counts"—so don't worry, gang, ten years from now it'll all be different—even though the finish is like this, huh.

And so the pot gets passed and here's a laugh. Eh, eh, I'm laughing already. A young feller who just found out the difference between an electric bulb and a tube was asked to explain what was meant by the International Silence Period. Very brightly he comes back, "The International Silence Period means that all radio stations

## In the Ring!



**It didn't need improving  
—but WE DID IT!**

**THE COMET "PRO" Superheterodyne was already the peer of short-wave receivers, but recent tube developments permitted important improvements.**

**So, we made them.**

The "PRO" now contains four "58" tubes, two "57's", one "80" rectifier, and a 2½ volt heater-type Pentode output tube.

It is even more selective. Delivers full loud-speaker volume. The oscillator is more stable, due to electron coupling. Intermediate amplification is increased, with greater stability. Smoother operation on the 10 to 20 megacycle band. More effective shielding. Simple band-spread tuning, of course. New metal cabinet removes all stray influences. Wood cabinet optional. A really GREAT receiver!

### ONE OF MANY PROOFS:

"We tested several short-wave receivers to find one with the sensitivity to maintain international schedules, and sufficient selectivity for the severe interference now prevailing, there being about 1,000 amateur stations in Los Angeles County alone. The answer was the "Comet Pro." We work all continents with loudspeaker volume, including England, France, Austria, Czechoslovakia, South Africa, Japan, India, China, Ecuador, Peru and many others. Any operator at W6USA will tell you that the "Comet Pro" is the finest high-frequency receiver he ever handled. Congratulations on a splendid piece of engineering."

NORMAN L. MADSEN,  
Operator, W6USA,  
Official Station of the Olympic Games

For police, ships, airports, broadcasting stations and other professional use, the COMET "PRO" is the most reliable and efficient receiving instrument ever devised.

The

Mail Coupon TODAY for 16-page illustrated folder giving all details.

**COMET**  
Custom-Built "PRO"  
by  
**HAMMARLUND**

HAMMARLUND-ROBERTS, INC.,  
424 W. 33rd St., New York

Please send me 16-page illustrated folder, describing the COMET "PRO" Short-Wave Superheterodyne.

Name .....

.....

..... RN-10

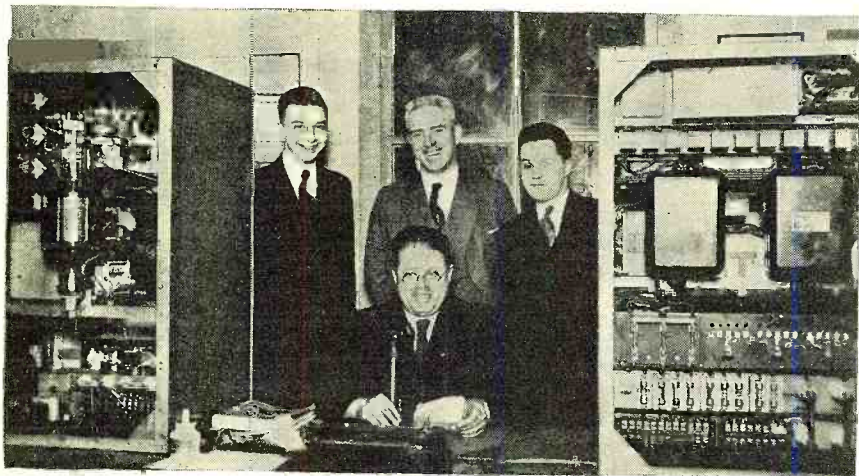

### SOMERVILLE POLICE RADIO

*This is the first short-wave police transmitter to be erected in the north-eastern part of the United States. It is operated by Harry R. Cheatham shown at the microphone surrounded by his staff.*

dit-dit-dits and da-da-das that kept hammering in my head as I pounded on that little buzzer and key outfit. Well, as they say in the movies, time went on and I found myself on the overgrown tug boat *Niemaha*. In those days getting a license was a "cinch" compared to what it is today. Well, billets came and billets went and after floatin' up and down the East and the West Coast and a couple of trips over, I decided I wasn't gettin' enough excitement and so I signed up in Uncle Sammy's Navy—learning "Chinese hash" in the Asiatics.

Operatin' wasn't much different, except for the regulations where there was no "shootin' the breeze" and no "poundin' brass" unless it was official. That, of course, broke my heart and when I came out of that and looked around for a billet on "shore side" hooking up with the Federal bunch on the West Coast. I could say now "Do you remember so-and-so and so-and-so," but we'll go into that later.

But the tootsies got itchy again and I stretched out the carcass on the old Mary Nan. Boy, oh boy, oh boy, if that wasn't a billet! Half the time I was runnin' around looking for bills o' ladin' and the other half

must remain quiet for two minutes at 11 o'clock on November 11th!"

While on the trail for the latest "info" Yours Truly plopped into Mr. Arthur S. Fish, Examiner for Licenses, up there on the second floor of the Federal Reserve Building. Yes, he's the guy who asks for the diagram of a tube transmitter plus power-supply unit complete after you had studied the spark outfit as though nothing else ever existed. He sez there's a new license out known as the Aeronautical Class Radio Operator's license. The "exam" consists of the regular second-class questions plus a knowledge of meteorology. No code test goes with this except where the station is licensed for telegraph and telephone equipment and then the "op" must have his commercial license in addition. There's a great future in this field, fellows, as the ground work has barely been scraped with regards to its future possibilities. There are numerous government stations already up and lots more in erection and also private air fields where such "ops" will be at a premium. For any further information on this just drop this

(Continued on page 252)





**Insure YOUR WORK**  
with  
**CLAROSTAT Replacement VOLUME CONTROLS**

CLAROSTAT Replacement Volume Controls are "Custom-made" to exactly suit the receivers for which they are offered. Not a makeshift job lot idea. The resistance, taper, shape and shaft are made according to the proper specifications. There is no delay in installing them. There are no comebacks when you use CLAROSTAT products.

**CLAROSTAT Mfg. Co.**  
285-287 N. 6TH ST. B'KLYN. N.Y.

**LYNCH**

**Noise-Reducing Antenna Products Solve the Interference Problem!**

Practically noise-free results on all waves, long and short alike. For the broadest listener, the short wave and television experimenter and the "amateur." No serviceman should be without these LYNCH Antenna Products which have proved their ability, by test, to eliminate background racket. Ideal for suburbs as well as the most congested city areas. Very simple to "hook-up" to any receiver. Better performance assured.

**LYNCH Transposition Blocks**  
Extremely durable. Made of "Lynchite," a new material, recognized for its great resistance and natural freedom from electrical losses.  
Handy Complete Kit of 10 Blocks --- \$2.50

**LYNCH Cage-Aerial Spreaders**  
Great pick-up qualities and freedom from directional effect. Also made of "Lynchite."  
Handy Complete Kit of 10 --- \$2.50

**LYNCH "U. S. Navy Standard" Antenna Insulators**  
Prevent electrical loss or leakage across the antenna insulators.  
Kit of 8 --- \$3.00

**LYNCH Commercial Antenna Insulators**  
Patterned after the "U. S." but for use where the tensile strength of the "U. S." is not required.  
Kit of 8 --- \$1.50

**LYNCH "All-wave" Antenna Coupler**  
Secures best possible results with any of the noise reducing antenna systems recommended by us.  
--- \$1.50

**SERVICEMEN**—Discount of 40% from above List Prices

Send order TODAY or write for new, illustrated and descriptive folder.

**LYNCH MFG. CO. Inc., 1775N Broadway, N. Y.**

**101 Radio Hook-ups! Free!**  
With 5 issues of RADIO NEWS for \$1  
Send Order to Dept. 10, Radio News, 222 W. 39th St., New York, N. Y.

**LEARN BY LISTENING** **Telegraphy**  
*Morse or Continental*

Become a trained, highly paid operator in Morse or Radio Code, easily, quickly, at home, with TELEPLEX, the Master Teacher. Used by the U. S. Government and leading schools. Not just a machine, but a new, scientific code course in 12 rolls of tape. During last ten years TELEPLEX has trained more operators than all other methods combined.

Write for Folder RG-10  
**TELEPLEX CO.**  
76 Cortlandt St., New York, N. Y.

Learn AT HOME With  
**teleplex**



?QRD?

(Continued from page 251)

column a line as soon as possible.

And whilst the mill is still working here's a se-erut. Chief Engineer Windham of WHN broadcast station has just completed a new H. F. transmitter with a few new innovations which sure will interest you "Heavy Hammers." He has promised to give me the details for a later issue—so stand by, me hearties.

With realization of the great help radio-equipped police cars are in the apprehension of criminals, Somerville, Massachusetts, has commissioned Brother H. R. Cheetham to design the transmitter and receiver equipment. For his home town's "finest" the best is none too good so you can bet Harry's strutting his stuff—and how.

Which reminds me of getting marooned up the Yangtze after the river dropped where, even if there was a war going on it didn't make any difference to us. We still had to go out and hunt for our "chow."

Then came the dawn and Mr. Fred Muller, the guiding light of the Veteran Wireless Operators' Association. What a man—what a man! There is no doubt but with him at the helm the "ship" is going to ride through this depression and tough breaks like a charm. His enthusiasm for the organization, coupled with the cooperation he is getting from the members, should make this a banner year, so come to the forefront, all ye faithful, and sign the John Hancock on the dotted line. Every one is eligible who has pounded brass and this includes you Navy gadgets, Coast-guarders, Airways and Army signalers. There's a lot in common amongst us all, the dog watches, the day watches, the static and the breakdowns. So don't forget—come one, come all—but come early.

The fan mail received the other day was amazing — stupendous — unbelievable — remarkable. So after we got through reading the 'steenth inquiry it was decided to throw the magazine away and publish this column. What's on your mind, if any? Let us hear from the old crowd who were on the Utah back in '24. From the bunch on the Jason. Anything that won't burn paper. Do you want to hear from your old buddy? He gets this RADIO NEWS. Do you want to get the latest "info" on laws and conditions? We'll let you know. Would you like something you read in RADIO NEWS explained further? Write us, we won't fail you. That's the idea, gang. This is your column—get going—send in the latest happenings and anecdotes—your old shipmates will want to hear about it, too. And now that we "savvy" each other, how's to take out that ink and make some Joe, what is. That stuff reminds me about the one JT (Jack Allen, RM1/c USN) wheezed, "I take me one sip and then the fountain pen gets the rest."

Be seein' you, bunch, and 73's. . . .

**DX Club in New England Formed to Scout Static**

HARTFORD, CONN.—Gathering data on static and its different manifestations by means of a series of observations extending over a period of weeks is a work recently undertaken by the Radio Listeners Club of Central New England. Fifty members of this organization have been furnished with data sheets which will enable them to record their observations.

**Read Classified Advertising—It Pays**

Advertisements in this section twenty-six cents a word for each insertion. Name and address must be included at the above rate. Cash should accompany all classified advertisements unless placed by an accredited advertising agency. No advertisements for less than 10 words accepted. Objectionable or misleading advertisements not accepted. Advertisements for these columns should reach us not later than 1st of 2nd month preceding issue.

**TECK PUBLICATIONS, INC.**  
222 West 39th St. New York, N. Y.

**Agents Wanted**

**SHOE MANUFACTURER** wants salesmen. Big pay every day. Guaranteed quality. Low direct prices. No experience necessary. Sales outfit sent free. Write Consolidated Shoe System, Dept. A-32, Eau Claire, Wis.

**Correspondence Courses**

Used correspondence school courses and educational books sold, rented and exchanged. Money-back guarantee. Catalog free. (Courses bought.) Lee Mountain, Pisgah, Alabama.

**Electric Refrigeration**

**MEN**—Learn to service Electric Refrigerators. Jobs open. Big opportunity. Write for booklet. National Tech., 4307 Euclid Ave., Cleveland, O.

**For Inventors**

**INVENTORS**—Sell your inventions before patenting. Use our legal form for recording proof of invention. Write W. T. Greene, 956 Barrister Building, Washington, D. C.

**INVENTORS**: Sell your invention, show it to manufacturers and patent buyers, win \$500.00 in awards and a certificate for distinguished accomplishment by exhibiting your invention at the Exposition of American Inventions to be held at Broadway Auditorium, Buffalo, October 12 to 19th, 1932, under auspices of the American Society of Inventors, Inc. If your invention has been sold, leased, has patent pending, or is unpatented, it is eligible to compete for an award and merit certificate. Selection of winners by a committee appointed by the Buffalo Engineering Society. Exposition sponsored by leading industrialists. Write for complete details to Exposition of American Inventions, 609 Crosby Building, Buffalo.

**Inventions**

**INVENTIONS COMMERCIALIZED**. Patented or unpatented. Write Adam Fisher Mfg. Co., 278 Enright, St. Louis, Mo.

**Microphone Repairs**

Guaranteed Microphone Repairs. Any make or Model. 24 hour service. Stretched diaphragm double-button repairs, \$7.50. Others \$3.00. Single-button repairs \$1.50. Write for 1932 catalog with diagrams. Universal Microphone Co., Ltd., Inglewood, Calif.

**Patent Attorneys**

**PATENTS, TRADE MARKS**—All cases submitted given personal attention by a member of the firm. Information and booklet free. Lancaster, Allwine & Rommel, Suite 414, 815 15th St., N. W., Washington, D. C.

**PATENTS**—Advice and booklet free. Highest references. Best results. Promptness assured. Watson E. Coleman, Patent Lawyer, 724 9th Street, Washington, D. C.

**Photography**

**HAVE YOU A CAMERA?** Write for free sample of our big magazine showing how to make better pictures and earn money. American Photography, 3105 Camera House, Boston, Mass.

**Radio**

**RADIO SERVICEMEN AND DEALERS**: Free subscription to PHILCO SERVICEMAN (Monthly) and PHILCO Parts Catalog sent on request. We specialize in genuine Philco Parts. Complete stock for all models, service manuals, etc. Write today. Radio Parts Co., 800 S. Adams St., Peoria, Ill.

**MATHEMATICS IN RADIO**

During 1931 there has been published in Radio News a series of articles describing the use and application of mathematics in radio, written authoritatively by Mr. J. E. Smith, President of the National Radio Institute, of Washington, D. C. These articles begin with simple rules of Arithmetic, and extend through Algebra, Geometry, and Trigonometry. Each subject is treated carefully; and in simple terms, clearly illustrated with easy-to-read diagrams and charts.

We have received so many requests for reprints of these lessons from our subscribers, that we have arranged to secure a limited supply reprinted in booklet form, one booklet for each subject.

**How To Get These Four Booklets—FREE**

While our supply lasts, we will include a complete set of these instructive booklets with each eleven month subscription for Radio News at \$2. Sign the order from below and return to us today!

Radio News, Dept. 10, 222 W. 39th St., N. Y. C. Enclosed is \$2. Enter my subscription for eleven months of Radio News and send me without charge, the four Mathematics Booklets.

Name.....  
Address.....



# The Service Bench

(Continued from page 231)

forms a vital function in effecting contacts which provide outlets for sidelines; in promoting confidence and good will in the enterprise as a whole. A summation of rural radio troubles tabulates in the following order of maintenance difficulties:

1. Resistor breakdown.
2. Condenser breakdown.
3. Transformer trouble, splitting 50-50 between power and audio transformers.
4. General adjustment and realignment.
5. Tube trouble.

The above table also gives a good idea of the requirement of replacement parts and the logical shop inventory. Tubes represent the largest financial outlay, and average 80 percent a.c. tubes—the usual -80's, -45's, -24's, -35's, -27's and -47's—and 20 percent battery tubes. Battery tubes are divided between the old -01-A and -71-A types and

the new 2-volt tubes. Tube stocks rarely fall below six of each type.

Permanent shop equipment is missing in many rural service set-ups, portable equipment serving double duty. This results in a reduction of original investment and overhead; and seems justified in view of the fact that at least 50 percent of rural radio repairs are effected on the premises of the owner. Portable equipment of a typical country serviceman consists of a Hickok tube tester, a homemade modulated oscillator covering the broadcast and intermediate frequencies, a set tester, also a product of the shop, the usual tools, radio periodicals, general service manuals, and service bulletins on the air-cell "A" battery.

Average radio inventories of five rural radio stores and service stations indicate the following investment:

## RADIO NEWS Export Service

AS a service to our readers in locations outside the United States of America, either commercial, professional or private individuals, RADIO NEWS will arrange to provide contact with leading American manufacturers of radio supplies and receiving equipment.

To utilize this service, clip and fill out coupon below and send it attached to your letter on which you list the types of apparatus you are interested in.

Our Export Service Department will refer your inquiries direct to the proper manufacturers, asking them to send you full particulars, catalogues, prices, etc.

\* \* \*

ALS einen Dienst für unsere Leser, entweder Kaufleute oder Privatpersonen ausserhalb der Vereinigten Staaten von Amerika, kann RADIO NEWS mit den führenden Amerikanischen Fabrikanten von Radio Apparaten Kontakt herstellen.

Für den Gebrauch dieses Dienstes schneide man den Kupon aus und sende denselben mit einer Liste von Apparaten die für Sie von Interesse sind.

Unsere Export Abteilung wird Ihr Schreiben umgehend an die betreffenden Fabrikanten weiter befördern, mit der Bitte Ihnen Auskünfte, Preise und Kataloge zu senden.

\* \* \*

POUR rendre service à nos lecteurs demeurant hors des Etats-Unis d'Amérique (commerçants, professionnels ou particuliers), RADIO NEWS vous fera entrer en relation avec les principaux fabricants d'appareils de T. S. F. en Amérique.

Pour profiter de cette organisation, il vous suffira de remplir et de découper le coupon ci-joint, et de l'envoyer attaché à votre lettre, en énumérant les types d'appareils qui vous intéressent.

Notre service d'Exportation fera suivre directement vos demandes aux fabricants intéressés en le priant de vous adresser tous renseignements, catalogues, prix, etc. . . .

\* \* \*

COMO un servicio especial a nuestros lectores que se encuentran fuera de los Estados Unidos de America, ya sean comerciantes, profesionales o personas privadas, RADIO NEWS tendra a bien ponerlas en contacto con los principales centros manufactureros de radio, de aparatos receptores y accesorios.

Para beneficiarse de tal servicio, sirvase recortar el coupón de esta página, enumerar los tipos de aparatos que le interesen, y envíenlosla con su carta.

Nuestro Departamento de Exportación se encargará de ponerse en contacto directo con dichos centros, pidiendo le envíen información completa. catalogos, precios, etc.

\* \* \*

RADIO NEWS Export Service Department

Kindly put me in contact with American firms manufacturing the class of radio apparatus noted on attached sheets.

Name .....

Address .....

Business .....

HERE'S THE

## SMALLEST PHOTO CELL



**LOW VOLTAGE**  
**LOW DARK CURRENT**  
**HIGH OUTPUT NO LAG**  
**NO FATIGUE**

Only 3/4" diameter by 1 1/8" overall length. Easily concealed. Active surface 5/16" square.

Maximum of six volts. An ordinary small "C" battery will last over a year in continual use.

Only .05 Milliamps Dark Current at 6 Volts, to

3 Milliamps at one foot from a 40 Watt Frosted lamp. Direct hookup to a relay for burglar alarms, indicators, counters, etc.

These cells have been used in commercial installations for over two years, without any replacements.

The exceedingly high frequency response makes it possible to use this cell in sound reproduction.

In ordering specify if for relay or sound use.

**FREE!**  
Valuable folder describing some of the many uses of this famous cell, and various types, sent on request. DEALERS: Write for our proposition.

PRICE ONLY **\$7.50** POST PAID

Send \$2 with order, balance C.O.D.

**INTELLECT-A-RAY CORPORATION**

221 SINGER BLDG. PASADENA, CALIF.

## for INVENTORS, EXPERIMENTERS

HOW TO USE CATHODE RAY TUBES

for NEW DEVICES, MEASUREMENTS, MACHINES, TESTS, and TELEVISION



**Cathode Ray Tubes open way to**

a tremendous field of invention, discovery and investigation. The key to Television, these tubes also have unlimited commercial applications. These tubes, now available at nominal cost, make electric currents, sound waves, and secret movements visible to the eye, introduce new means for microscopic measurements, new methods for mechanical and electrical tests.

This Handbook written by Henry M. Lane, former instructor at Mass. Institute of Technology, is intended for students, inventors, experimenters. Gives full data on sweep circuits, power packs, and also information on Thyatron tubes.

**Price 50¢ postpaid**

Send cash, stamps, or money order

**GLOBE TELEVISION AND PHONE CORPORATION**

36 Haven Street, Reading, Mass.



# F. & H. CAPACITY AERIAL



Price \$1.00 Complete postpaid

Every Instrument Tested on Actual 1127 Mile Reception  
**A LARGE NUMBER ARE IN USE BY GOVERNMENT, IN NAVY HOSPITAL**

The F. & H. Capacity Aerial Eliminator has the capacity of the average 75-foot aerial. 50 feet high. It increases selectivity and full reception on both local and long distance stations; is absolutely guaranteed. It eliminates the outdoor aerial along with the unsightly poles, guy wires, mutilation of woodwork, lightning hazards, etc. It does not connect to the light socket and requires no current for operation. Installed by anyone in a minute's time and is fully concealed within the set. Enables the radio to be moved into different rooms, or houses, as easily as a piece of furniture.

8,000 dealers handle our line. Dealers! Over 80 leading jobbers carry our line or order sample direct. Write for proposition.

— SEND COUPON, IT PROTECTS YOU —

Name.....

Address.....

City.....State.....

Send one F. & H. Capacity Aerial with privilege of returning after 3-day trial if not satisfactory, for which enclosed find  check  M. O. or dollar bill, or send  C. O. D.  Send Literature.  Dealer's proposition.

F. & H. RADIO LABORATORIES

Fargo, N. Dak. Dept. 19

## ANNOUNCING

The U-9-Portable Public Address System, a quality product designed for many uses. Operates on 110 volts A.C. Includes double button microphone, desk stand, screen grid pushpull pentode amplifier, controls, loudspeaker, carrying case, cords and plugs. Connections are handy for auxiliary equipment.

U-9-PORTABLE COMPLETE (LESS TUBES) **\$79.00** LIST PRICE

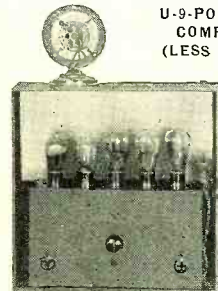

Control Section of the U-9-Portable

And here's something! The U-10-Car system for the political campaigns. Uses car battery as sole source of power, and is a complete public address system including a Wright-DeCoster dynamic loudspeaker and horn (connections for three more speakers). U-10-Car System Complete (less tubes) List Price \$147.50

UNITED SOUND ENGINEERING CO. Manufacturers of Specialized Sound Equipment 2233 University Ave. St. Paul, Minn.

### Atwater Kent

Electrical values are to be found in Volume 2 of John F. Rider's "Perpetual Trouble Shooter's Manual"

Both Volume 1 and Volume 2 of this manual are now available for distribution. When you make up your mind to buy a manual—compare Rider's "Perpetual Trouble Shooter's Manual" with all others and you will find it far more complete—accurate and detailed. It is the "standard" manual among all established service organizations. No duplication between Volume 1 and Volume 2. 1900 pages in the two volumes.

If your dealer does not have the manuals order direct from us. Volume 1 is \$5.00 and Volume 2 is \$5.00 postpaid.

RADIO TREATISE CO., INC.

1440 Broadway New York, N. Y.

## RADIO SCHOOL

Instruction for Radio, Telegraph and Radio Telephone

LICENSES

ALSO RADIO SERVICING

Catalog Given Established 1899

MASS. RADIO SCHOOL

18 Boylston Street, Boston, Mass.

Tubes (wholesale price).....	\$135.00
Miscellaneous parts.....	150.00
Sets.....	250.00
Equipment (cost).....	250.00

Net value total inventory.....\$785.00

All of these stores have been established for over two years, and the above figures represent an average, year-round inventory.

Service charges approximate those current in the cities, but the profits are considerably greater as list prices are charged for tubes and all replacement parts. As a rule, there is no inspection or "couvert charge" on receivers brought to the shop. Outside calls are charged for, in addition to parts and time, by amounts varying from \$1.00 for a local call to \$5.00 for an out-of-town journey over rough dirt roads.

### Advertising and Publicity

The rural serviceman is wide awake to the possibilities of advertising and publicity. He covers his territory by advertising in two or three weekly papers, and calls editorial attention to every unusual sound installation and radio event. The Scribner brothers have taken a tip from the broadcasting companies and the microphone stand they supply with their rental public-address installations (Figure 5) carries a reminder of where expert radio service can be secured—not to mention refrigerators, radio sets and general house wiring!

## ALL IN A DAY'S WORK

In apropos with this month's dedication to the rural serviceman, Mr. J. M. Hansen, of Nunn, Colo., presents the following idea for pepping up tube sales.

"I believe that the rural serviceman can increase his profits from tube sales by changing over the older type of battery sets for use with the new 2-volt tubes. A conversion charge provides an additional profit. I make this a specialty in my territory, which includes a large proportion of battery sets. Your customer is usually willing to replace his -01-A's or -99's with type -30's and his -71-A's or -12's with -31's when you explain to him that his old tubes draw 12 times the power in watts from his storage battery. This is easily demonstrated by Ohm's Law. You can further explain to him that, in addition to the lowered filament current, a 6-volt storage battery provides three batteries for the 2-volt tubes. Of course, the storage battery will not light the new tubes 12 times as long as it would the old tubes, due to the usual loss in charge over several months, but the period of reliable service will be multiplied many fold.

"Vastly improved results can be obtained by merely substituting the -30's for -99's and operating from one dry cell in place of three! Where adapters are necessary (on the very old sets) they are readily made, from sockets and bases, in the service shop."

## A SERVICE-SALES IDEA

James Allen of Lynbrook, N. Y., and Wells, Me., gets the better of the summer slump by following his customers in their migration campward. As the one and only serviceman in a summer colony of some 500 families, he keeps himself profitably busy while at the same time enjoying the recreations of the multitude. In addition to servicing, he augments his income by selling amateur recordings at a popular pavilion for 25 cents a throw. Writes Mr. Allen:

"The evening crowds are generally in a

## INDEX TO ADVERTISERS

<b>A</b>	
Aerovox Corporation.....	247
Alden Products Co.....	243
Autocrat Radio Co.....	244, 246
<b>B</b>	
Baltimore Radio Corp.....	248
Bud Speaker Co.....	243
Brush Development Co.....	247
Burstein-Applebee Co.....	250
<b>C</b>	
Candler System Co., The.....	245
Capitol Radio Engineering Inst.....	243
Central Radio Laboratories.....	255
Chicago Radio Apparatus Co.....	256
Chrisell-Acoustic Labs.....	243
Clarostat Mfg. Co., Inc.....	252
Coast to Coast Radio Corp.....	256
Coyne Electrical School.....	249
Cutting & Sons.....	247
Classified Advertising.....	252
<b>E</b>	
Eastern Rabbitry.....	256
Economy Appliance Co.....	242
Evans & Co., Victor J.....	248
<b>F</b>	
F & H Radio Laboratories.....	254
Federated Purchaser, Inc.....	244
<b>G</b>	
Globe Television & Phone Corp.....	253
Grant Radio Labs.....	243
<b>H</b>	
Hammarlund-Roberts Mfg. Co., Inc.....	251
Hoodwin Co., Chas.....	243
<b>I</b>	
Intellect-A-Ray Corp.....	253
International Correspondence Schools.....	256
International Resistance Co.....	239
<b>J</b>	
J-M-P Mfg. Co.....	255
<b>L</b>	
Lincoln Radio Corp.....	Second Cover
Lynch Mfg. Co., Inc.....	252
<b>Mc</b>	
McGraw-Hill Book Co., Inc.....	250
<b>M</b>	
Massachusetts Radio & Telegraph School.....	254
Metal Cast Products Co.....	243
Mid-West Radio Corp.....	200, 201
Miller & Miller.....	248
<b>N</b>	
National Co., Inc.....	199
National Radio & Electrical School.....	240
National Radio Institute.....	196, 197
National Union Radio Corp.....	241
<b>O</b>	
O'Brien, Clarence A.....	248
Ohio Carbon Co., The.....	235
<b>P</b>	
Poik & Co., R. L.....	256
<b>R</b>	
RCA Institutes, Inc.....	247, 250
Racon Electric Co., Inc.....	250
Radio Receptor Co., Inc.....	246
Radio Trading Co.....	255
Radio Training Ass'n of America.....	193
Radio Treatise Co., Inc.....	254
Rawls & Co., W. C.....	247
Readrite Meter Works.....	248
Rhamstine, J. Thomas.....	256
Rosicrucian Brotherhood.....	247
Ross, Malcolm G.....	243
Royal Typewriter Co., Inc.....	237
Scott Radio Labs., Inc., E. H.....	195
Shalleross Mfg. Co.....	246
Silver-Marshall, Inc.....	Fourth Cover
<b>T</b>	
Teleplex Co.....	252
Trimm Radio Mfg. Co.....	247
<b>U</b>	
United Sound Engineering Co.....	254
Universal Microphone Co.....	247
<b>V</b>	
Van Leuven, D. L.....	244
Van Nostrand Co., D.....	245
<b>W</b>	
Webster Co., The.....	245
West Side Y.M.C.A. Radio Inst.....	244
Williams & Sons, J. R.....	242
World-Wide Radio Corp.....	246



joyful mood, and appear to get quite a kick from making records of their own voices and sending them home instead of postcards. A mailin envelope and protective cardboard are provided free of charge. A mandolin and a "uke" are available for the more talented customers, and, as the recording is carefully monitored, really good records are secured. A loudspeaker in front of the recording booth broadcasts the records as they are being made and played over. As may be imagined, the recordings are of such a nature as to collect and arouse a creditable audience, thus advertising the stunt to prospective customers.

When obviously an excellent vacation stunt, there is no reason why this idea should not be incorporated in many service shops as a permanent feature.

**"Find the Bias"**

The fact that grid-bias trouble is at the bottom of many service calls is appreciated by H. Melchior Bishop, Baltimore, Md., who writes in a paraphrase of "cherchez la femme

"To every service bench comes a goodly number of sets accompanied with complaints of poor or scratchy tone, overloading, low volume and motor-boating. On testing the receiver with an analyzer, everything appears okay except for slightly decreased voltages until the power tube test is made. Here, in spite of a greatly reduced plate voltage, the plate current is exceedingly high—indicating no grid bias.

"This is usually due to a shorted or open grid-bias resistor, a short-circuited bias resistor, by-pass condenser, an open in the bias circuit other than the resistor, or a grounded filament terminal. Occasionally it is due to none of these things, and then it becomes a case of searching for the nigger in the wood pile.

"In such instances you will often save time and trouble by casting a suspicious eye on the dial lamp and its support. In nearly all modern circuits the dial lamp is connected across the filament line to the power tubes. Thus, if one terminal, or the socket shell, grounds on the chassis, the bias resistor is short-circuited. Yet the tube filaments and the dial light will burn merrily on with no

**Order a set of the NEW CENTRALAB Motor Radio Suppressors today**

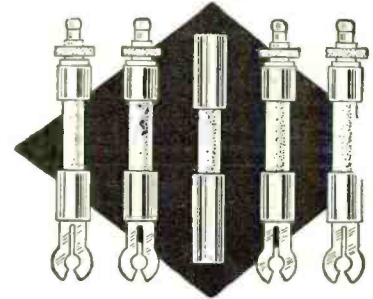

for the NEW Centralab Suppressors are actually 50% to 500% more efficient in reducing spark noise than the average suppressor.

The generous 1 1/2" of resistance material is baked at a temperature of 2700 degrees with its ceramic jacket, both together forming a solid granite-like unit. Simplicity itself!

And this very simplicity makes possible an unusually LOW price. Order a set today... one for each spark plug plus one for the distributor.

	RETAIL PRICE	YOUR PRICE
set of 5 for 4 cyl. car	\$2.00	\$1.10 net
set of 7 for 6 cyl. car	\$2.75	\$1.50 net
set of 9 for 8 cyl. car	\$3.50	\$1.90 net

**Centralab**  
CENTRAL RADIO LABORATORIES  
MILWAUKEE, WIS.

**Radio News Technical Information Service**

The Technical Information Service has been carried on for many years by the technical staff of RADIO NEWS. Its primary purpose is to give helpful information to those readers who run across technical problems in their work or hobby which they are not able to solve without assistance. The service has grown to such large proportions that it is now available to outline and regulate activities so that information desired may come to our readers accurately, adequately and promptly.

Long, rambling letters containing requests that are vague or on a subject that is unanswerable, take up so large a portion of the staff's working time that legitimate questions may pile up in such quantities as to cause a delay that seriously hinders the promptness of reply. To eliminate this waste of time and the period of waiting, that sometimes occurs to our readers as a consequence, the following list of simple rules must be observed in making requests for information. Readers will help themselves by abiding by these rules.

**Preparation of Requests**

Limit each request for information to a single subject.

In a request for information, include any data that will aid us in assisting in answering. If the request relates to apparatus described in RADIO NEWS, state the issue, page number, title of article and the name of the device or apparatus.

- Write only on one side of your paper.
- Pin the coupon to your request.

The service is directed specifically at the problems of the radio serviceman, engineer, mechanic, experimenter, set builder, student and amateur, but is open to all classes of readers as well.

All questions from subscribers to RADIO NEWS will be answered free of charge, provided they comply with the regulations here set forth. All questions will be answered by mail and not through the editorial columns of the magazine, or by telephone. When possible, requests for information will be answered by referring to articles in past issues of

the magazine that contain the desired information. For this reason it is advisable to keep RADIO NEWS as a radio reference.

Complete information about sets described in other publications cannot be given, although readers will be referred to other sources of information whenever possible. The staff cannot undertake to design special circuits, receivers, equipment or installations. The staff cannot service receivers or test any radio apparatus. Wiring diagrams of commercial receivers cannot be supplied, but where we have published them in RADIO NEWS, a reference will be given to past issues. Comparisons between various kinds of receivers or manufactured apparatus cannot be made.

Only those requests will be given consideration that are accompanied by the current month's coupon below, accurately filled out.

OCTOBER, 1932

Technical Information Coupon  
RADIO NEWS Laboratory  
222 W. 39th Street  
New York, N. Y.

Gentlemen:

Kindly supply me with complete information on the attached question:

- I am a regular subscriber to RADIO NEWS, and I understand this information will be sent me free of charge.
- I am not yet a subscriber to RADIO NEWS.
- I wish to become a subscriber to RADIO NEWS, and enclose \$2.50 to receive the magazine regularly for one year, and to receive this valuable technical information service free of charge.

Name.....

Address.....

**FREE GET THIS QUICK**



New and enlarged Summer edition of our Radio and Short Wave Treatise, No. 25, just off the press—100 pages—check full of useful information, radio items, diagrams and illustrations. Positively the greatest book in print—NOT JUST ANOTHER CATALOG. Contains a large editorial section with valuable information not found anywhere else. Considerable space is devoted to a 1000 Illustrations. for both beginners and regular "hams." Among the new technical information listed are the following: Modernizing old radio sets—repairing speakers and headsets—making superhets out of old sets—data on constructing two-volt battery and automobile receivers—circuit of the famous Gernsback Megadyne One-Tube Loudspeaker Set—short wave coil winding data—discussion on S.W. adapters, converters and receivers, etc.; etc. GREATEST BOOK IN PRINT

100 New Hook-Ups, Treatise on SHORT WAVES  
WRITE TODAY. Enclose 4 cents for postage. Treatise sent by return mail.  
RADIO TRADING CO.  
27 West Broadway New York City

**AUTO-DIAL RADIO**

Installs easily in any automobile or motor boat. Set, Remote Control, Suppressor kit, tubes and dynamic speaker complete, \$39.20. Set only, \$17.65. Write today for full details of this SENSATIONAL AUTO RADIO.

J.-M.-P. MFG. CO.  
3430 Fond du Lac Ave., Milwaukee, Wis.



Write for this book

**FREE!**

You cannot possibly afford to be without this valuable book! It is not just another CATALOG—it is indeed a VERIFIABLE ENCYCLOPEDIA of the RADIO INDUSTRY.

**WHOLESALE PRICES**

JUST ISSUED  
FALL 1932—100-Page Catalog  
Send For Your Free Copy Today!  
We Specialize in PUBLIC ADDRESS AMPLIFIER INSTALLATIONS

COAST TO COAST RADIO CORP.  
123 N. West 17th St., New York, N. Y.

# WHAT YOU NEED TO SUCCEED IN RADIO

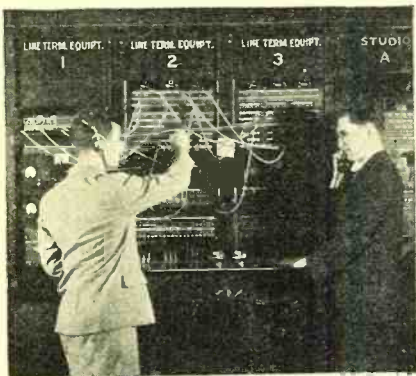

Courtesy of the National Broadcasting Company

RADIO is a highly specialized business. As it develops it is becoming more exacting in its demands. But radio is the modern field of opportunity for those who keep step with its progress!

There is a great demand for *trained* men in the radio industry. There is no place for *untrained* men. Experience must be accompanied by technical knowledge.

A pioneer in radio instruction, the International Correspondence Schools have kept pace with the times and offer courses which give practical instruction in fundamentals and latest developments alike. The courses were prepared and are constantly revised by the Who's Who of Radio!

Composed of 24 basic divisions, the Complete Radio Course covers the whole field of radio. The I. C. S. Radio Servicing Course was prepared specially for men who wish to become service experts, and win over competition. The I. C. S. Radio Operating Course is vital to mastery of operating and transmitting.

We will be pleased to send you details of any or all of these subjects. Just mark and mail the coupon—the information will be forwarded at once. Do it today—*now!*

INTERNATIONAL CORRESPONDENCE SCHOOLS  
Box 8283-L, Scranton, Pa.

Without cost or obligation, please tell me all about the NEW RADIO COURSE

Name \_\_\_\_\_ Age \_\_\_\_\_

Street Address \_\_\_\_\_

City \_\_\_\_\_ State \_\_\_\_\_

If you reside in Canada, send this coupon to the International Correspondence Schools Canadian, Ltd., Montreal, Canada

indication of trouble in the resistor itself. "Such short-circuiting sometimes occurs when the dial lamp is mounted by inserting the lamp socket in a soft rubber "grommet" held in a slot in the bracket. If the grommet is carelessly forced into the slot, it may be pierced or cut, causing a swinging or even a solid short between the socket and the chassis. This condition may also occur in the clip-held type of pilot light because of a bent clip touching the shell or poor insulation on the leads.

"The writer experienced a case of the broken grommet on a Kennedy Coronet, while a Clarion Junior Model 60, which has a rigidly mounted dial lamp, developed the same trouble due to the lamp terminal twisting on the assembly rivet and shorting against the lamp bracket. Since it was impractical with the tools on hand to rivet the assembly more tightly, and a new lamp socket was not immediately available, a bit of friction tape judiciously applied permanently cured the latter case, while a new grommet, carefully inserted, effectively repaired the former.

"A stubborn case of lost grid bias on one power tube of the push-pull -50's in a Silver-Marshall 692 power amplifier was finally traced to a defective insulating washer. This amplifier, as nearly fool-proof as any the writer has seen, provides controls to vary the bias on each individual power tube. One of these controls proved its undoing. Due possibly to an accidental blow when mounting the amplifier in its rack, the shaft of the control resistor forced the insulating washer out of place, and grounded against the chassis. The trouble was remedied by centering the shaft in a new washer and clamping tightly with the mounting nut."

### Increasing Sensitivity

"The sensitivity of the Victor R-32 and R-45 may be increased, after neutralizing, by turning the last neutralizing screw clockwise until the set oscillates and then slowly backing the screw until just below the point at which oscillations occur.

"The sensitivity of most receivers using grid suppressors may be increased by unwinding about ten turns of the resistor wire from each suppressor. The correct number of turns should be determined by experiment."

George H. Nakao, Honolulu, Hawaii.  
Increase in sensitivity is secured in both instances by bringing up regeneration.

### A Microphonic A-K-60

In reference to this receiver, William A. Roberts of New York City, writes:

"This d.c. receiver was badly microphonic after a short operation. There is a metal silencing cap on one of the audio tubes, with felt pads inside. The heat of the tube had shrunk the felt, permitting the cap to vibrate."

### "Fading" in a Zenith 39

And just to show that he is methodical in servicing as well as filing, Mr. Schmidt sends along the following dope on the Zenith 39. The complaint was bad fading.

"The usual analyzer test showed the tubes and circuit okay. After a thorough examination the trouble was finally located in the second and third r.f. grid resistors and in the C bias resistor for the first audio-frequency tube. Ohmmeter test of the grid resistors showed fluctuating values between 1200 and 25,000 ohms! These resistors are of the flexible wire-wound type, and should have a value of 1200 ohms. The C bias resistor had a high resistance contact between the resistance wire and the contact. When this was tightened in a vise it was okay. The correct value of the bias resistor is 2000 ohms."

**New National AC or DC 58**  
9 1/2 to 200 Meters

Greatly improved in selectivity and sensitivity over the type ACSW5. We quote very favorable prices.

**NEW HAMMARLUND COMET "PRO"**  
15 to 200 Meters

Very selective and sensitive superheterodyne. Endorsed by Olympic Games Station W6USA and other amateurs. Special low price on request.

**DETROLA AUTO-RADIO**  
Five Tubes  
2-230's, 1-36, 1-37, 1-41.

Complete with tubes, "B" Batteries, Suppressors, Dynamic Loud Speaker and Battery Box. Very easy to install—Net \$26.50.

We stock a complete line of amplifiers, sound units, trumpet horns and P.A. Supplies.

Cameras and Photographic Supplies. Tell us your needs.

Send 10c for 110-page catalog of short-wave supplies, replacement parts, electric clocks, etc.

**CHICAGO RADIO APPARATUS CO.**  
417 S. Dearborn St. Dept. RN-10 Chicago, Ill.

# MAILING LISTS

Pave the way to more sales with actual names and addresses of Live prospects. Get them from the original compilers of basic list information—up to date—accurate—guaranteed. Tell us about your business. We'll help you find the prospects. No obligation for consultation service.

**FREE** 60 page Reference Book and Mailing LIST CATALOG

Gives counts and prices on 8,000 lines of business. Shows you how to get special lists by territories and line of business. Auto lists of all kinds. Shows you how to use the mails to sell your products and services. Write today.

**R. L. POLK & CO.**  
Polk Bldg.—Detroit, Mich.  
Branches in Principal Cities  
World's Largest City Directory Publishers  
Mailing List Compilers. Business Statistics. Producers of Direct Mail Advertising.

**REX RABBITS** Raise them for us. We pay you **MAKE GOOD MONEY!** to \$12 each for all you raise. Send 25c for full information and contract. Everything explained. Send at once and find out about this big proposition. Make this a profitable year.

**THE EASTERN RABBITRY**  
Route 1, Box 236 New Freedom, Pa.

**PHOTO CELL**  
**BIG BARGAIN!** \$2.00

for experimental work, relay operation, hundreds of interesting uses. Special offer, order NOW, only EACH NET

J. Thos. Rhamstine,\* 500 E. Woodbridge, Detroit

# RADIO MEN—Increase Income!

"How To Make Money In Radio Servicing" written by Zeh Bouek especially for Radio News, is the answer to the burning question of the hour! Prepared after months of effort and at great expense, it tells the radio service man how to make his business show a profit. And, what is more important in times such as the present?

Not only for the active service man, but also for the amateur and experimenter who desires to turn his knowledge and experience into practical money-making channels this book will prove indispensable. It tells you how, and when, and why to do things. It is practical—up to the minute—and complete.

For a limited time, Radio News is offering this money-making book absolutely FREE with a subscription for seven months for only \$1.00. This is a saving of 75c over the newsstand cost. Send order to Radio News, Dept. 10, 222 West 39th St., New York, N. Y.



# FIRST CHANCE

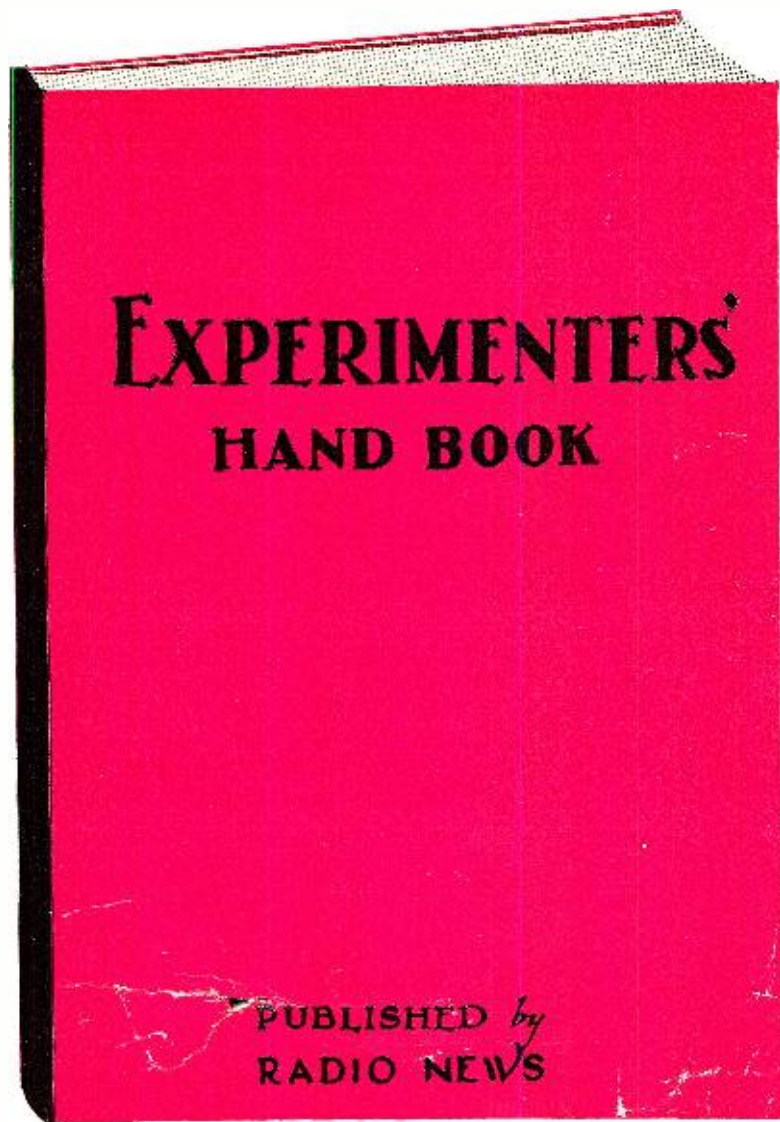

## Resumé of Contents

Part of the Experimenters' Hand Book is devoted to Laboratory Procedure with plenty of "Hints" and "Kinks" and actual experiments for the home work-bench. The service man and technician, as well as the experimenter will be interested in the chapters devoted to "Electrical Measurements of Radio Circuits" which include full descriptions and instructions for making, calibrating, and using electrical meters and test equipment.

In addition, you will find full information regarding Receiver and Parts Design—Transformers, Condensers, Resistances, Volume Controls, Filters, together with comprehensive Charts, Graphs, and other technical Circuit and Tube data.

Photo-Electric Cells—Television—New Hook-Ups—all are covered completely.

Radio News, edited by Laurence M. Cockaday, needs no introduction to you. From the very beginning, it has led every publication in the radio field. It gives you all the radio news—while it is still news. Hot from the laboratories—just out of the experimental stations—all the newest happenings in radio—come direct to you in Radio News. Radio today is the fastest-growing, fastest-moving industry in the world. Greater expansion is just around the corner. Television—short-wave developments—electronics. Astounding new things are happening—you will want to know about them in detail. And you can—by reading Radio News.

to Get

## Your **FREE** Copy of the **EXPERIMENTERS'** **HAND BOOK**

Radio News is broadcasting the *Pre-Publication* announcement of its newest book for experimenters. Thousands of communications have been received requesting our Reader's Service Bureau to publish the information contained in this volume in convenient book form. After months of work, and at great expense, we now are ready to announce that this great book will soon be off the presses.

Experimenters, Servicemen, Amateurs, Technicians, Engineers, in fact, all radio men will find this book wonderfully interesting and instructive.

For a limited time, Radio News is offering this book absolutely **FREE** with a subscription for eleven issues, for \$2.

**SAVE \$.75**

And that is not all—in addition to securing the book **FREE**, you save 75c on your subscription, as these eleven issues purchased on the newsstands would cost you \$2.75.

## All the Latest Developments in Every Branch of Radio

**THIS COUPON IS YOUR "FIRST CHANCE" TO GET THE "EXPERIMENTERS' HAND BOOK" FREE!  
IN THE NOVEMBER ISSUE**

RADIO NEWS, Dept. 10,  
222 W. 39th St., New York, N. Y.

Enclosed is \$2. Send me the "Experimenters' Hand Book" as soon as it is printed, and enter my subscription at once for the next 11 issues of Radio News. If renewal subscription check here ( ).

Name.....

Address.....

City..... State.....

Canadian Price \$2.50

Foreign Price \$3.00

You will find a feature article describing the influence of radio in the coming Presidential Campaign. Probably never before has radio played such an important part as it will this Fall. Don't fail to read the November issue.



**SM**

No other manufacturer claiming  
"record breaking performance"  
**DARES** to place his receiver in  
your home for a ten day trial on a  
money back guarantee.

*Mrs. Murdo Silver*  
Mc Murdo Silver

## The All-Wave 728SW Chassis Has:

*Not only*

No Plug-In Coils

Single Dial Covering BOTH Long  
and Short Wave

1/20th Microvolt Sensitivity

Hair-line Selectivity

New Design of Audio Amplifier

Single or Twin Speakers

New Type Tubes

Noise Suppressor

100% Shielding

New High Ratio Drum Dial

Real Round the World Reception

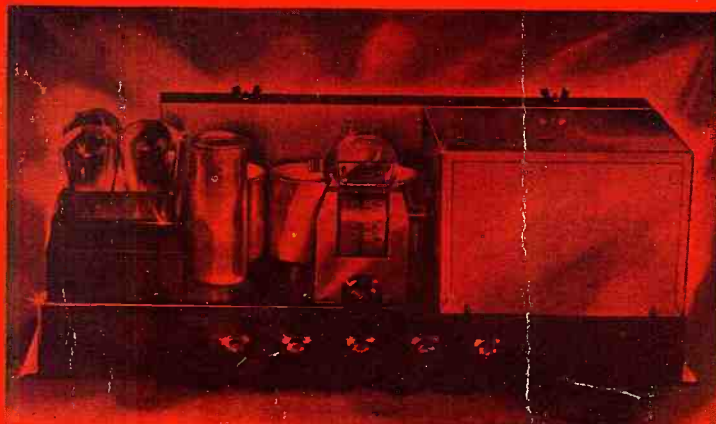

*But also*

The ONLY set having a dial cali-  
brated from 550 to 23,000 kc.

The HIGHEST ratio of noise level to signal  
strength.

EXCLUSIVE new "Class A-Prime" audio  
amplifier.

TRUE Automatic Volume Control.

SILENT Meter Tuning.

The cost of the 728SW is ridiculously low. It is only 1/3 the price  
of so-called competitive sets—yet it is GUARANTEED to do  
everything that any other receiver will—and more. And we back  
that statement up not by idle boasts and challenges, but by offer-  
ing YOU a ten day free trial in YOUR home with a money back  
guarantee!

Write for folder giving curves, log of foreign stations, prices, etc.

# SILVER-MARSHALL, Inc.

6401-6451 West 65th Street Chicago, U.S.A.