

**LATEST RADIO INVENTIONS**

**RADIO  
NEWS**

**February  
25 Cents**

**Automobile  
and Aviation  
Radio**

**Theatre television  
Air-coupled superheterodyne  
Pentode oscillator**



# The COMET

All-Wave

## SUPER-HETERODYNE

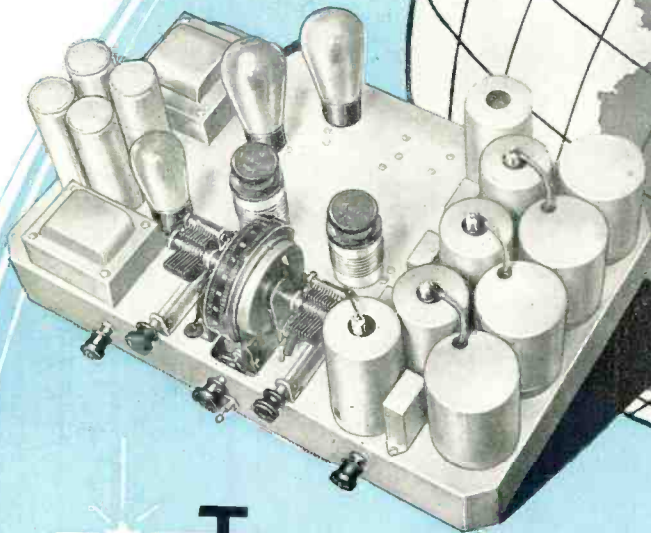

**T**UNE in the entire world of radio, between 15 and 550 meters, with this new Hammarlund "Comet" All-Wave Super-Heterodyne.

Regular broadcasting, short-wave broadcasting, amateur phone and code communications, police, ship and airplane calls—all are yours with this newly-perfected all-wave super-heterodyne receiver.

Uses the newest Variable Mu and Pentode Tubes. Extremely sensitive, highly selective and has marvelous tone quality. A. C. operated.

Beautifully compact and efficient. Engineered by specialists in precision radio equipment since the beginning of broadcasting.

Chassis, complete with RCA tubes, \$130.00. Chassis installed in rich Oriental burl walnut console cabinet, including specially-designed Hammarlund Dynamic Speaker, complete with RCA tubes, \$175.00. Write for descriptive folder, listing world's short-wave stations.

HAMMARLUND-ROBERTS, INC., Dept. RN-2, 424 W. 33rd Street, New York. Export Office: 15 Lighthouse Street, New York, U. S. A.

*Beautifully finished Oriental burl walnut console cabinet, with hinged top for easy access to the chassis.*



**CUSTOM  
BUILT**

by **HAMMARLUND**



# Train *with* R.T.A. *for* Radio Service Work

Important and far-reaching developments in Radiocreates sudden demand for specially equipped and specially trained Radio Service Men.



*This excellent set analyzer and trouble shooter included with our course of training*

**M**ANY skilled Radio Service Men are needed now to service all-electric sets. By becoming a certified R. T. A. Service Man, you can make big money, full time or spare time, and fit yourself for the big-pay opportunities that Radio offers.

We will quickly give you the training you need to qualify as a Radio service man . . . certify you . . . furnish you with a marvelous Radio Set Analyzer. This wonder instrument, together with our training, will enable you to compete successfully with experts who have been in the radio business for years. With its help you can quickly diagnose any ailing Radio set. The training we give you will enable you to make necessary analyses and repairs.

Serving as a "radio doctor" with this Radio Set Analyzer is but one of the many easy ways by which we help you make money out of Radio. Wiring rooms for Radio, installing and servicing sets for dealers, building and installing automobile Radio sets, constructing and installing short wave receivers . . . those are a few of the other ways in which our members are cashing in on Radio.

As a member of the Radio Training Association, you receive personal instruction from skilled Radio Engineers. Upon completion of the training, they will advise you personally on any problems which arise in your work. The Association will help you make money in your spare time, increase your pay, or start you in business. The easiest, quickest, best-paying way for you to get into Radio is by joining the Radio Training Association.

This amazing Radio Set Analyzer plus the instructions given you by the Association will transform you into an expert quickly. With it, you can locate troubles in all types of sets, test circuits, measure resistance and condenser capacities, detect defective tubes. Knowing how to make repairs is easy; knowing what the trouble is requires expert knowledge and a Radio Set Analyzer. With this Radio Set Analyzer, you will be able to give expert service and make big money. Possessing this set analyzer and knowing how to use it will be but one of the benefits that will be yours as a member of the R. T. A.

## Write for No-Cost Membership Plan

We have worked out a plan whereby a membership enrollment need not cost you a cent. Our thorough training and the valuable Radio set analyzer can be yours. Write at once and find out how easily both of these can be earned.

Now is the time to prepare to be a Radio Service Man. Greater opportunities are opening up right along. For the sake of extra money in your spare time, bigger pay, a business of your own, a position with a future, get in touch with the Radio Training Association of America now.

Send for this No-Cost Membership Plan and Free Radio Handbook that will open your eyes as to what Radio has in store for the ambitious man. Don't wait. Do it now.

**RADIO TRAINING ASSOCIATION OF AMERICA**  
Dept. RNA-2      4513 Ravenswood Ave.      Chicago, Ill.

Fill Out and Mail Today!

**RADIO TRAINING ASSOCIATION OF AMERICA**  
Dept. RNA-2, 4513 Ravenswood Ave., Chicago, Ill.  
Gentlemen: Send me details of your No-Cost Membership Enrollment Plan and information on how to learn to make real money in radio quick.

Name.....

Address.....

City..... State.....

S. GORDON TAYLOR  
*Technical Editor*  
 WILLIAM C. DORF  
*Associate Editor*



RAYMOND J. KELLY  
*Associate Editor*  
 JOS. F. ODENBACH  
*Art Editor*

Edited by LAURENCE M. COCKADAY

VOLUME XIII

February, 1932

NUMBER 8

## CONTENTS

(Cover Design by Morey)

Radio's Rôle in the Air Corps Maneuvers By <i>Lieut. Charles H. Howard</i> .....	PAGE 651	Electric Filter Design By <i>C. A. Johnson</i> .....	PAGE 672
Television Hits Broadway By <i>Robert Hertzberg</i> .....	PAGE 654	"Super" Design Featuring 2-Volt Tubes By <i>McMurdo Silver</i> .....	PAGE 674
Electrostatic Loudspeakers By <i>Hans Vogt</i> .....	PAGE 656	Using Graphs and Charts in Modern Radio By <i>John M. Borst</i> .....	PAGE 676
The New KFI By <i>I. R. Baker</i> .....	PAGE 658	A New "Super" for Circuit Experimenters By <i>Chesley H. Johnson</i> .....	PAGE 678
The Radioman's Timepiece By <i>S. Reid Warren</i> .....	PAGE 660	The Pentode Oscillator By <i>Gerard J. Kelley</i> .....	PAGE 680
Filming Radio Programs By <i>Irving J. Saxl</i> .....	PAGE 662	Relays for the Experimenter By <i>C. Bradner Brown</i> .....	PAGE 682
New All-Wave Super Features High-Gain By <i>Lewis W. Martin</i> .....	PAGE 665	New Television Receiver of Novel Design By <i>H. G. Cisin</i> .....	PAGE 683
New Motor Radio Design By <i>Justus W. Berge</i> .....	PAGE 667	CQ CQ CQ de WDDE MacMillan Calls from Baffin Land By <i>Ralph Brooks</i> .....	PAGE 685
Do Meteors Cause Static? By <i>John Cage</i> .....	PAGE 669	Mathematics in Radio By <i>J. E. Smith</i> .....	PAGE 687
The Radio News Telephone Booster By <i>S. Gordon Taylor</i> .....	PAGE 670		

## DEPARTMENTS

With the Experimenters.....	PAGE 688
Backstage in Broadcasting.....	PAGE 691
The Service Bench.....	PAGE 692
Service Data for Servicemen.....	PAGE 695
Radio Physics Course.....	PAGE 696
Radio Science Abstracts.....	PAGE 699
Latest Radio Patents.....	PAGE 701
What's New in Radio.....	PAGE 704
News and Comments.....	PAGE 706

Published Monthly by Teck Publishing Corporation, Washington and South Avenues, Dunellen, N. J.

### OFFICERS

Lee Ellmaker, *President*  
 Warren P. Jeffery } *Vice Presidents*  
 Huston D. Crippen }  
 William Thompson, *Treasurer*  
 Wesley F. Pape, *Secretary*

### EDITORIAL AND EXECUTIVE OFFICES

350 HUDSON STREET, NEW YORK CITY, N. Y.

Entered as second class matter at the Post Office at Dunellen, N. J., under the act of March 3, 1879. Copyright, 1932, by Teck Publishing Corporation. All rights reserved. Title Registered at the U. S. Patent Office. Printed in the United States of America. The contents of this magazine must not be reproduced without permission. We cannot be responsible for lost manuscripts, although every care is taken for their safety.

25c a Copy, \$2.50 a year,  
 \$3.50 in Canada, \$3.50 in  
 Foreign Countries. Sub-  
 scribers are notified that  
 change of address must reach  
 us five weeks in advance of  
 the next day of issue.





J. E. Smith, President, National Radio Institute, the man who has directed the Home Study training of more men for the Radio Industry than any other man in America.

# YOU'RE WANTED for a Big Pay Radio Job

*I'll Train You at Home in Your Spare Time*  
for **RADIO · TELEVISION · TALKING MOVIES**

	<p><b>Set Servicing</b></p> <p>Spare-time set servicing is paying N. R. I. men \$200 to \$1,000 a year. Full-time men are making as much as \$65, \$75 and \$100 a week.</p>		<p><b>Broadcasting Stations</b></p> <p>Need trained men continually for jobs paying \$1,200 to \$5,000 a year.</p>		<p><b>Ship Operating</b></p> <p>Radio operators on ships see the world free and get good pay plus expenses.</p>
--	--	--	--	--	---

**Aircraft Radio**

Aviation is needing more and more trained Radio men. Operators employed through Civil Service Commission earn \$1,620 to \$2,800 a year.



**Talking Movies**

An invention made possible by Radio. Offers many fine jobs to well-trained Radio men, paying \$75 to \$200 a week.

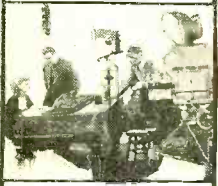

**Television**

The coming field of many great opportunities is covered by my course.



**IF YOU** are earning a penny less than \$50 a week, send for my book of information on the opportunities in Radio. It is free. Clip the coupon NOW. Why be satisfied with \$25, \$30 or \$40 a week for longer than the short time it takes to get ready for Radio?

**Radio's Growth Opening Hundreds of \$50, \$75, \$100 a Week Jobs Every Year**

In about ten years Radio has grown from a \$2,000,000 to a \$1,000,000,000 industry. Over 800,000 jobs have been created. Hundreds more are being opened every year by its continued growth. Men and young men with the right training—the kind of training I give you—are stepping into Radio at two and three times their former salaries. J. A. Vaughn, Grand Radio & Appliance Co., 3107 S. Grand Boulevard, St. Louis, Mo., writes: "Before I entered Radio I was making \$35 a week. Last week I earned \$110 selling and servicing sets. I owe my success to N. R. I."

**You Have Many Jobs To Choose From**

Broadcasting stations use engineers, operators, station managers and pay \$1,200 to \$5,000 a year. Manufacturers continually need testers, inspectors, foremen, engineers, service men, buyers, for jobs paying up to \$7,500 a year. Radio Operators on Ships enjoy life, see the world, with board and lodging free, and get good pay besides. Dealers and jobbers employ service men, salesmen, buyers, managers, and pay \$30 to \$100 a week. There are many other opportunities too.

**So Many Opportunities Many N. R. I. Men Make \$200 to \$1000 While Learning**

The day you enroll with me I'll show you how to do 28 jobs, common in most every neighborhood, for spare-time money. Throughout your course I send you infor-

mation on servicing popular makes of sets; I give you the plans and ideas that are making \$200 to \$1,000 for hundreds of N. R. I. students in their spare time while studying. My course is famous as the one that pays for itself. G. W. Page, 2210 Eighth Ave., S., Nashville, Tenn., writes: "I picked up \$935 in my spare time while taking your course."

**Talking Movies, Television and Aircraft Radio are Also Included**

Special training in Talking Movies, Television and home Television experiments, Radio's use in Aviation, Servicing and Merchandising Sets, Broadcasting, Commercial and Ship Operating are included. I am so sure that I can train you satisfactorily that I will agree in writing to refund every penny of your tuition if you are not satisfied with my Lessons and Instruction Service upon completing.

**64-page Book of Information Free**

Get your copy today. It tells you where Radio's good jobs are, what they pay, tells you about my course, what others who have taken it are doing and making. Find out what Radio offers you, without the slightest obligation. **ACT NOW!**

J. E. SMITH, President  
National Radio Institute  
Dept. 2BR  
Washington, D. C.



**THIS COUPON IS GOOD for**  
**One FREE COPY OF MY BOOK** *mail it now*

J. E. SMITH, President  
National Radio Institute, Dept. 2BR  
Washington, D. C.

Dear Mr. Smith:  
I want to take advantage of your Special Offer. Send me your two books "28 Tested Methods in Making Extra Money" and "Rich Rewards in Radio." I understand this does not obligate me and that no salesman will call.

Name.....  
Address.....  
City..... State.....

**Special Free Offer**

**"28 Tested Methods for Making Extra Money"**

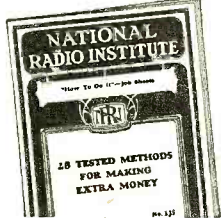

In addition to my big free book "Rich Rewards in Radio," I'll send you my valuable manual "28 Tested Methods for Making Extra Money." Never before available except to students. Now, for a limited time, it is free to readers of this magazine. How to make a good buffer for cone speakers, how to reduce hum in externally fed dynamic speakers, how to operate 25 cycle apparatus on 60 cycle current, how to operate 110 V. A. C. receivers on D. C., how to shield sets from local interference are five of the subjects covered. There are 28 others. Get this valuable book by mailing the coupon now.



# The Editor—to You

## What about television?

The public has already indicated that it wants television, but it wants "acceptable" television. This has been shown by the remarkable interest of the crowds attending demonstrations at radio shows and in the recent television demonstrations in the nation's theatres.

Commercial interests have indicated that they will support television broadcasts that are "acceptable" to the public. Large companies have investigated and made bids for sponsored programs for the first "acceptable" television channels.

The wave-bands used for television broadcasts are unsatisfactory. Sky-wave signals at these frequencies "bounce" down on receivers and produce fading and multiple images that spoil reception.

Present television apparatus in the hands of amateurs does not give "acceptable" definition. The received pictures are too hazy and irregular in outline and do not have a sufficient number of picture units to give clear details.

The first steamboats with their paddle-wheel equipment were also laughed at. But today we have modern transatlantic liners.

\* \* \*

Would it not be common sense to approach a satisfactory solution of television through the same channel? Accept the fact that we need more picture units to get an "acceptable" picture. That it will cost more to do this. That we shall need special short-wave bands for television where a number of channels can be used to produce sufficient detail for a given broadcast. That we need silent operating receivers (probably working on the principle of the cathode ray and screen). That a large, brilliant screen and one visible in ordinary home illumination is required. That suitable apparatus may be complicated and expensive. That television apparatus, cheap enough for the average pocket-book, may give inadequate reception and that poor television would be worse than no television.

\* \* \*

WHAT would be "acceptable" television?

\* \* \*

On this page are shown four photographs of television images of a football player

It would seem to us that an adequate approach to the solution of television broadcasting through "acceptability" might come in this way, but the public should not be misled into thinking they will have "acceptable" television without the necessary expense.

\* \* \*

A few pointers along the path to a solution might be found in the following:

1. Utilization of the broadcast bands between four and six meters for local transmission. Many hundreds of channels could be used here and an area of 30 to 35 miles covered without fading and without sky-wave interference. Signals of this frequency probably would not interfere with other services at a distance, utilizing the same channels.

2. The development of cathode-ray transmitting and receiving apparatus that would give "acceptable" television; fine enough detail, adequate lighting and noiseless operation.

3. It might be possible to utilize the telephone lines for television transmission. The telephone company is increasing its wire services, including the teletype, and if the plan



Bell Lab. Record



The pictures are not large enough to be generally "acceptable." Only a few can "look in." The subjects for television are kept simple, mostly head and shoulders of a performer.

Reproduction is not brilliant enough. The pictures received on home equipment do not show up bright enough so that reception can be had in a lighted room.

Most of the present experimental home television apparatus of the scanning-disc variety is noisy in operation. Gears, motor and disc bearings make so much noise that the accompanying sound broadcast is interfered with.

Present 10-kilocycle broadcast bands do not permit wide-enough side-bands for transmission of sufficient picture units to give good detail.

\* \* \*

The technical limitations and problems confronting television science today *must be recognized and accepted.*

\* \* \*

MANY people in the early days of the automobile said that it would never become popular. Skeptics thought it too complicated and costly.

running, as they would be received on various receivers with different grades of detail. Which one would the public call "acceptable"? The first one shows a television image where approximately 625 picture units are transmitted over an ordinary broadcast band. The second, giving clearer detail but perhaps still inadequate, would necessitate 1250 picture units on two ordinary broadcast channels. The third would require 6250 picture units and could be broadcast over 10 ordinary channels. The fourth would require over 12,000 picture units and 20 broadcast channels.

\* \* \*

In a test with about 300 university students, a detail as fine as the one shown in picture three has been picked out as being "acceptable." In making a decision for yourself while looking at this page, you should remember that a moving image requires less detail for acceptable results than a still picture. You can make the test yourself with the still pictures on this page, if you hold the magazine in your two hands and move it up and down so that you get a movement of the eyes. You will find little difference in pictures three and four under these conditions, and even picture number two is not so bad.

proved feasible, it might rent television receivers for accompanying the local sound broadcasting.

4. In the light of some privately made tests it would seem advisable to go immediately to 120 to 150-line scanning in television.

\* \* \*

At any rate, we feel sure that television will not prove popular until reception is improved so that it will be "acceptable" by the public at large.

\* \* \*

Now is the time for the television interests to get busy, make this fundamental decision, obtain an adequate transmission medium and produce the apparatus the public is rather impatiently waiting for. From watching certain large-scale experiments now in progress, we suspect that the solution may not be so far away. Certainly we do not want to be catalogued along with the early scoffers of the automobile, steamboat, airplane, phonograph and even radio broadcasting. We think practical television is on the way, but we ask, "Who is going to do it and how soon?"

*Stewart M. Lockaday*



# SAY FELLOWS GET INTO RADIO-TELEVISION AND TALKING PICTURES

Let me tell you how I can quickly train you, NOT by book study, but by actual shop training on real Radio, Television and Talking Pictures equipment in 10 WEEKS in the great shops of COYNE in Chicago.

Here at Coyne you don't need advanced education or experience and many of my students earn while learning. After graduation I give them lifetime employment service. Here at Coyne too you get individual instruction and you can start anytime.

Radio offers jobs as Designer, inspector and tester, salesman, and in installation work, operator of a broadcasting station, wireless operator on a ship, with Talking Pictures theatres - with Television Laboratories and studios. Television alone will soon be calling for thousands of trained men.

Come to Coyne here in Chicago and prepare for one of

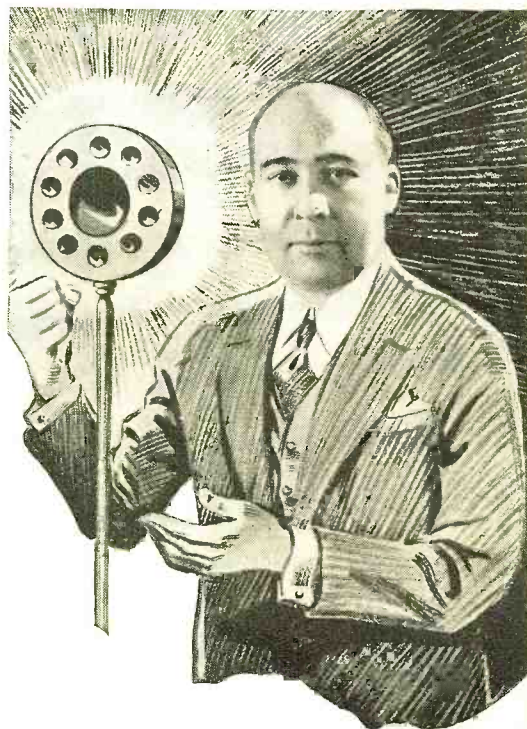

these jobs the quick and practical way - BY ACTUAL SHOP WORK.

It's a shame for any fellow to go thru life as an untrained man working at small pay, and never even run of a steady job, and when he does work working at any old price they want to pay him.

You can avoid this. you can be a trained man and have a real future. mail the coupon today and I'll send you my big Free book and tell you how you can be a success just as hundreds of my graduates are achieving.

**H. C. LEWIS, President**  
**Radio Division, COYNE ELECTRICAL SCHOOL**  
**500 S. Paulina St., Dept. 22-8C, Chicago, Ill.**

Send me your Big Free Radio and Television Book, and tell me how I too can make a success in Radio.

Name .....

Address .....

City ..... State .....



# just out!

## MIDWEST SUPER-HET SHORT-WAVE CONVERTER!

Model Z-4



4 tubes

### Amazing Direct-From-Factory Offer to Introduce Latest Midwest Sensation

Again Midwest demonstrates its leadership by offering you radio's newest and most sensational development—WORLD-WIDE reception with an all-wave converter. This sensational new Midwest converter virtually converts any A. C. or battery set of adequate sensitivity into a short-wave receiver for reception of police calls, airmail and passenger plane conversation, ships at sea, etc., and under favorable radio conditions, even broadcasts direct from many foreign stations located throughout the world.

#### World-Wide Short Wave Reception

Have you ever listened to a program direct from Paris, France?—Berlin, Germany?—Havana, Cuba?—Genoa, Italy?—South America? etc. If not, you're missing the fascinating thrill of a lifetime. It seems like a dream to be able to pick up the flowing strains of a quaint old folk song or the fascinating rhythm of the latest Spanish dance direct from some far off country. Yet, this new, different kind of entertainment is now within your reach.

#### Easy, Simple Application to the Set You Now Have

Quickly and easily attached to the set you now have. (The more sensitive the set, the better the results.) No interchanging of coils and tubes. Only one dial. If you desire, we can furnish an attractive walnut finish cabinet at very little extra cost. Or, you can quickly build the converter into any ordinary radio console.

**TOTAL of 15 TUBES**  
When Used With A C-11  
15-550 Meters

This amazing, new short-wave converter employs 4 tubes, has self-contained power unit using one 280, one 227, and two 224, and when used with the very latest model Midwest 11-tube super-heterodyne radio, shown on the opposite page, gives you a total of 15 powerful tubes, and ALL-WAVE reception unbecatable even in receivers costing several times as much.

### NO PLUG-IN COILS Every Important Feature

1. Ball-bearing variable condenser floated in rubber.
2. Accurately peaked I. F. at 560 K. C.
3. No changes required in set.
4. Complete power unit fil. and B supply (80 rectifier).
5. Three self-healing electrolytics.
6. Scientifically shielded.
7. Unique low-loss switching device, eliminates plug-in coils.
8. Ample overlap between points on switch.
9. Thoroughly filtered (2 choke coils).
10. No hum even on headset.
11. Headset operation for difficult DX, if desired.
12. Non-regenerative detector.
13. Vernier 6-1 slow motion dial (illuminated).
14. No troublesome body capacity.
15. Proven circuit.
16. Shielded output cable.
17. Extremely simple to connect.

#### Rush Coupon For All the Facts

No matter what kind of radio you now have, you need this amazing new Short-Wave Converter to get real ALL-WAVE performance. Get a Midwest Converter and enjoy the whole world's best radio programs. Rush coupon at once for full details and sensationally low direct-from-factory price.

only  
**\$16<sup>75</sup>**  
COMPLETELY ASSEMBLED—

Mail this coupon for amazing details!

**Midwest Radio Corp.,  
Dept. 41-C, Cincinnati, O.**

Gentlemen: Without obligation on my part, please send me complete details of the amazing new Midwest Short Wave Converter. This is NOT an order.

Name .....

Address .....

Town..... State.....

I own a..... Model.... Radio. (State make).

**MIDWEST RADIO CORP.**

Dept. 41-C

Cincinnati, Ohio



# 11 TUBE Super-Heterodyne

**With Pentode  
Variable - Mu  
Tubes and Real  
Automatic  
Volume  
Control**

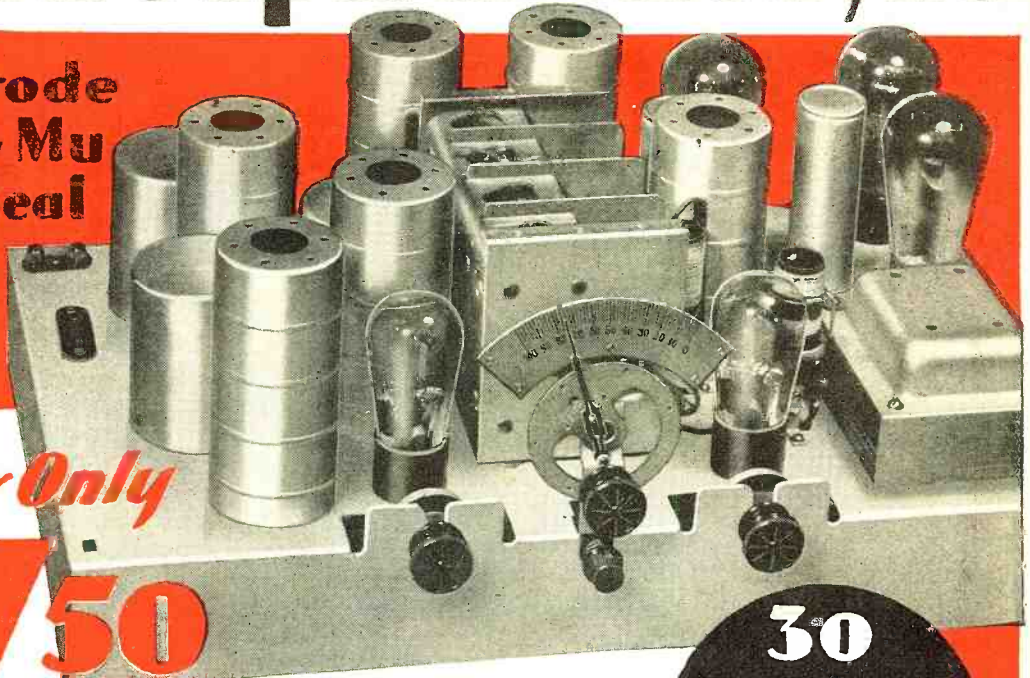

*For Only*

**\$37.50**

**COMPLETELY  
ASSEMBLED**

**With Specially Matched  
Large Dynamic Speaker**

**RADIO FANS!** Just what you've been looking for! A powerful new 11-tube radio at an unbelievably low price. And what a radio! *Two Push-pull Pentode* power output tubes with twice the power and four times the sensitivity of ordinary 45's—*Multi-Mu* tubes, together with a -24 first detector, gives

you **SIX SCREEN GRIDS**. These six screen grids, together with the -80 tubes—gives a total of **ELEVEN TUBES**, with reception equal to fifteen ordinary tubes—in a perfectly balanced, non-oscillating, non-radiating, super-heterodyne **TEN-TUNED** circuit with real automatic volume control that holds those powerful locals down to the same volume as the distant stations and counteracts that annoying fading on weak stations. The use of a band-pass or pre-selector stage, together with *Multi-Mu* full range tubes, makes this radio actually surpass 10 K.C. selectivity. Absolutely eliminates those noisy singing "birdies" and annoying cross talk. You'll be positively amazed and delighted when you see this sensational new set—hear the beautiful mellow, cathedral tone—know what it means to have that pin-dot selectivity and unequalled sensitivity.

Be convinced—**TRY IT 30 DAYS BEFORE YOU BUY**. Don't send a penny. Mail coupon right now for amazing **FREE** trial offer and complete details. You'll be surprised.

**30  
DAYS  
FREE  
TRIAL**

**Terms as  
Low as  
\$5.00  
DOWN**

Try a Midwest 30 days **FREE** in your own home before you decide. Then pay as you play. Easy monthly payments as low as \$5.00 down.

## Read What Enthusiastic Users Say!

### New Zealand User Hears New York and Other Stations Eight Thousand Miles Distant!

I would stack my Midwest up against any other make of set on the market. I have a log of 141 stations. "Midwest" gets 'em all over the world. 36 stations in New Zealand, 34 Australian, 10 in Japan, 1 in China, 2 in India, 1 in Czechoslovakia and Bratislava, 2 in Honolulu, and a total of 56 stations in the U. S. A., including New York, Cincinnati and Los Angeles. I have received WTIC on two different frequencies. Siam "Radio Bankok". This is a log which would be hard to eclipse by any other set of my power. Fred W. Morley, 1000 Fitzroy Ave., Hastings, Hawke's Bay, New Zealand.

### Gets Japan Direct

I received my eleven tube in A-1 condition. Tone quality cannot be beat. We have 13 local stations and can tune in on WABC, New York, at 8 o'clock in the evening when our locals are the busiest. I have had stations from all over the U. S. and JOAK, Japan, loud and clear. One of my friends paid \$250.00 for his radio for chassis alone from factory and my eleven-tube outclasses it in every respect. I'll say my "Midwest" can't be beat. I. B. Eslerick, 9838 Bonita Drive, Beverly Hills, Calif.

## Deal Direct with Factory

**SAVE 50%**

Never before in the history of radio has such a powerful set been offered at Midwest's amazing low price. Deal direct with the big **MIDWEST** factory. Save the jobber's profit. Your outfit will reach you splendidly packed, rigidly tested with everything in place ready to plug in. No assembling. Entertain yourself for 30 days absolutely **FREE**—then decide. Save up to 50 per cent in buying direct from factory—insure satisfaction—deal direct with the world's veteran radio builders—**MIDWEST**. And don't forget—every **MIDWEST** outfit is backed by an absolute guarantee of satisfaction. You take no risk.

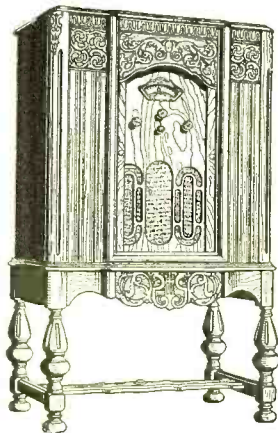

**Complete Line of Consoles**

Rush the coupon for the beautiful catalog that illustrates the complete line of **MIDWEST** console cabinets. All new. All different. You'll gasp with admiration when you see the vast selection of beauty, style and grace that is created into every **MIDWEST** Console. The catalog is **FREE**—it doesn't cost you a penny! Rush the coupon—**NOW!**

**MIDWEST RADIO CORP.**

Dept. 41

Cincinnati, Ohio

## MAIL FOR BIG FREE CATALOG AND LIBERAL TRIAL OFFER

**Midwest Radio Corp.**

**Dept. 41,  
Cincinnati, Ohio**

Without obligation on my part send me your new 1932 catalog and complete details of your liberal 30-day free trial offer. This is **NOT** an order.

Name .....

Address .....

Town..... State.....

Send me **SPECIAL USER AGENTS PROPOSITION**

### USER AGENTS

We pay you **BIG MONEY** just for showing your radio to friends and neighbors. Easy **EXTRA MONEY!** Check coupon for details!





YOU WANT TO EARN MORE MONEY — YOU WANT TO BE SURE OF STEADY EMPLOYMENT— YOU WANT TO BE CERTAIN OF YOUR FUTURE —HERE THEN IS THE OPPORTUNITY YOU HAVE WAITED FOR.

# Start Now-Learn RADIO at Home

—and get into the world's fastest growing and best paying industry.

**I**F you are earning a penny less than \$50 a week, send for the Radio Opportunity Book. Clip the coupon below and find out what tremendous opportunities are awaiting you in this amazing new industry. It's time to put an end to the worry about being out of a job, or struggling along on a mere \$20 to \$30 a week. Honestly, this is the chance of a lifetime for ambitious men, and you owe it to yourself to get all the details, which will be sent to you free.

## Trained Men Needed in Every Branch of Radio

In just a few years Radio has grown from nothing to a billion dollar industry, which has created over 300,000 jobs. Still it grows, and now includes Television, Talking Pictures, Sound Distributing Systems and Industrial Radio, which makes use of the photo-electric cell. These are all branches or offshoots of Radio, and they have created thousands of additional jobs and good pay opportunities for men who are trained.

## Many Jobs to Choose From

In Radio broadcasting, manufacturing, distributing and merchandising, many thousands of men are used as engineers, operators, managers, testers, service experts and salesmen. Salaries range from \$1800 to \$7500 a year, and more. Naturally, the higher salaries go to the men who are trained or who have unusual ability. Television is on the verge of practical use and will demand many more men who know something about it. Sound pictures, a Radio development, pays exceptionally good salaries to an army of men who are required constantly for installation and maintenance work. Men familiar with sound distributing systems and photo-electric cells and grid glow tubes for machine control and other industrial uses, are being paid from \$50 to \$200 a week. R. T. I. Training will prepare you for the opportunities in every one of these fields, including also the installation and operation of Police Radio and Radio in Aviation, fast coming into general use.

# RADIO at Home

TELEVISION  
TALKING PICTURES  
SOUND SYSTEM  
PHOTO CELL WORK

## Great Radio Concerns Co-operate With R. T. I.

Because there is a vast need for more and better trained men, many large concerns, including those listed to the right, are co-operating with the Radio and Television Institute in a great training programme. The endorsement of R. T. I. Training by these well known firms is your guide—your assurance—that here you can get the training you need to enter this rich, new field of opportunity and future. Already hundreds of R. T. I. graduates are making from two to three times their former salaries; others are in business for themselves, happy and contented. Many now preparing for good positions in this field, make several times the cost of their training in spare time work while studying.

## Interesting Gold and Black Opportunity Book Free

Send for your copy now. This beautiful book tells in facts and pictures, all about Radio and its wonderful opportunities. It shows you what jobs there are—where they are—and how you must go about getting them—as well as what other fellows are doing who have taken this training. The book is free. Send for it without obligation.

**16**  
**RADIO MANUFACTURERS**

Endorse and Recommend R. T. I. Training to You. They Are

BOSCH—United American Bosch Co.  
BRUNSWICK—Brunswick Radio Corporation  
BALKEIT—Balkeit Radio Corporation  
CROSLEY—Crosley Radio Corporation  
CLARION—Transformer Corporation of America  
DeFOREST—DeForest Radio Co.  
FADA—F. A. D. Andrea, Inc.  
GREBE—A. H. Grebe & Co.  
HOWARD—Howard Radio Co.  
KENNEDY—Colin B. Kennedy Co.  
MAJESTIC—Grigsby-Grunow Co.  
PHILCO—Philadelphia Storage Battery Co.  
SILVER-MARSHALL—Silver-Marshal, Inc.  
STROMBERG-CARLSON—Stromberg-Carlson Telephone Mfg. Co.  
SENTINEL—United Air Cleaner Corporation  
ZENITH—Zenith Radio Corporation and these Associations—  
RADIO TRADES ASSOCIATION—St. Louis, Mo.  
RADIO SERVICE MANAGERS' ASSOCIATION—New York  
MUSIC AND RADIO TRADES ASSOCIATIONS—Salt Lake City, Utah

## FREE OPPORTUNITY BOOK COUPON

RADIO AND TELEVISION INSTITUTE  
Dept. 842, 2130 Lawrence Ave., Chicago

Please send me a copy of your Opportunity Book and full particulars of your plan for helping men into good pay positions in the Radio field.

Name.....  
Address.....  
City..... State.....





### A Publication of Great Value to Engineers and Experimenters

*The transmission of a program from one continent to another where it is rebroadcast over local stations is carried on almost exclusively by means of what are termed "short waves." When we first began to experiment with these waves we quickly became aware of the fact that a reasonable amount of power would frequently get through to great distances, but we also found that they behaved in an erratic manner. The waves had a peculiar fading of their own, and seemed to be more influenced by whatever it was that affected radio waves. As is natural under such conditions, the engineer and scientist took up the challenge and set about the task of investigating the causes. The work along this line was rather haphazard until the leading engineers on both sides of the Atlantic planned a cooperative series of tests from which a great deal of data has already been accumulated. These investigations are still being carried on and the effects of magnetic variations, sunspot activity and other influences are being charted. Gradually devices were perfected which improved the quality, until today we can depend, fairly well, on these circuits and are enabled to bring over many programs. The original circuits were between the United States and England, Holland and Germany. This has been extended until we now include many of the countries of Europe, South America, Australia and Asia. We have reached the point where we can feel reasonably certain of transmitting a program of an important event, rebroadcasting it for the benefit of our American listeners. This has been accomplished by such devices as diversity antennas, automatic selective devices, automatic level-maintaining devices, and highly developed receiving sets.*

*The radio experimenter and the engineer have been kept well advised of these developments through such excellent publications as the RADIO NEWS. As our present knowledge of radio is but a stepping-stone for future developments, this publication is therefore of great value to those who desire to follow these developments.*

General Engineer, National Broadcasting Company.



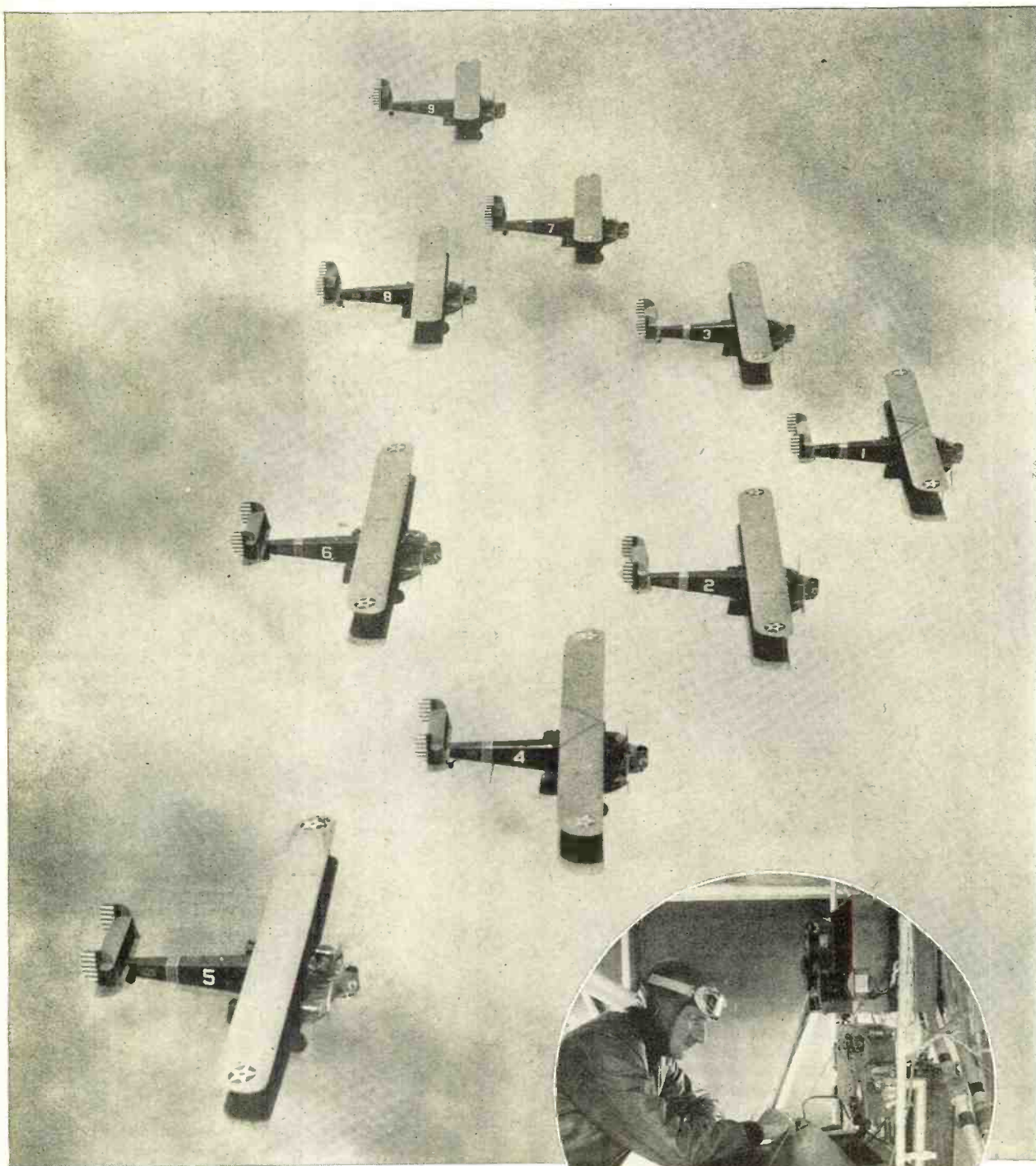

The Flying Unit—  
Under Radio Control

*Radio telephone and telegraph plays its part in maintaining instant communication between the individual ships of a flight of Curtiss Condors belonging to the 11th Bombardment Squadron as they speed above the clouds in their journey eastward. The insert shows Major Carl S. Spatz, commanding officer of the Bombardment Group, transmitting a tactical message from the headquarters ship*



# Radio News

VOLUME XIII

February, 1932

NUMBER 8

## RADIO'S RÔLE IN THE *Annual Air Corps Maneuvers*

*The part that radio played on the recent 6,000-mile flight of a squadron of Army planes across the United States and return, and a description of the apparatus used and the radio contacts made along the route*

**T**HE important part that radio is playing in aviation, both from a safety and an efficiency standpoint, cannot be overestimated. In peace, as in war, the future of aviation is to be inseparably linked with certain phases of radio development. In direction finding, the transmission and reception of weather data and storm warnings, in calling for aid in case of accident or trouble, in changing destinations en route, in commercial communications from ground to aircraft or between aircraft, both telegraphic and telephonic, radio is now looked upon as an essential part of aircraft equipment.

Always outstanding in the advocacy and use of aircraft radio, it was only natural that when the Air Corps planned the recent annual aerial maneuvers across the United States, in which 672 huge planes took part, that the 7th Bombardment Group should look forward to an extensive use of the ether during the exercises.

With this in mind, the 11th Bombardment Squadron, a unit of the 7th Bombardment Group, spent considerable time in installing and testing its equipment. Although each plane was already fully equipped with a radio transmitter and a receiver, the receipt of some articles of new equipment necessitated revised installations.

The new equipment received consisted of three new Stromberg-Carlson aircraft receivers, one for each of the flight leaders' planes; six remodeled standard regenerative receivers of the BC-152 type reworked to use a commercial tube of better performance than the "peanut" tube, and lastly a service test model of a "homing" loop designed by the General Electric Company.

By Lieut. Charles H. Howard\*

In more detail the Stromberg-Carlson receiver is of a modern design from the Radio Frequency Laboratory at Boonton, N. J. It is a tuned-radio-frequency set with three stages of radio, using a.c. tubes of the -24 type with a -24 type detector and a -27 type tube in the output stage. A unique feature is the use of four coils mounted as a "gang" so they may be quickly plugged in or out for frequency band changes. The antenna used with this set is either a six-foot metal mast or a short fixed wire. Tuning is by remote control through a flexible shaft, it being possible to locate the set in any convenient place, the only controls in the cockpit being the tuning dial, the volume control and an "on-and-off" switch.

The most interesting of the new radio devices installed is the "homing" loop. This includes a loop antenna in the wing so arranged that the flat side of the loop faces the direction the plane is going. As is well known, a loop turned with this axis to a station will theoretically pick up no signal, and this is exactly what it is supposed to do in the plane. However, if the plane is turned ever so slightly to the right or left the signal comes in and is indicated by an increased reading on a sensitive meter on the dash. In this particular instrument the deflection of the needle is to the right, regardless of which way the plane turned. However, the pilot quickly corrects for this by noting whether his new intentional change of direction increases the deflection or restores the needle to zero. His action in either case is obvious.

Besides the loop, there is the tuning device in a small, compact box with the necessary switching arrangement to go from the normal trailing antenna, upon which the original signal is picked up, over to the loop. Several flights with



ARMY RADIO PIONEER

*A recent photograph of the author, formerly instructor Air Corps Communication School, Chanute Field, Rantoul, Illinois, who is credited with developing the first successful use of radio in pursuit planes and with the first long range radio contact between bomber and pursuit planes*

\*Commanding Officer, 11th Bombardment Squadron.





#### THE WEATHER MAN GOES ALOFT

*Mr. Dean Blake, meteorologist of the United States Department of Commerce, is probably the only weather man who has accompanied an aerial unit in the Air Corps maneuvers. He is shown in his aerial office in a Curtiss Bomber and took charge of the weather survey, making forecasts and advising the Commanding Officer of the best aerial route to be followed due to weather conditions*

this instrument have indicated its value in enabling the pilot to fly toward a given transmitter without worrying over his exact location. Further developments are going on at present tending to improve this piece of apparatus. The idea of being able to tune in a known broadcast station and to fly to it with certainty will immediately appeal to anyone as an excellent aid to aerial navigation, especially in conditions of low ceiling and bad visibility.

Aside from the regular radio installations the squadron commander's ship was fitted with a compartment and desk for a weather "prophet." After some period of negotiation authority was obtained from the War Department and the Weather Bureau for Mr. Dean Blake of the San Diego weather office to accompany the flight. Among the purposes to be accomplished by this arrangement were: the determination of the value of instantaneous weather forecasts in the handling of large numbers of planes under bad weather conditions; the value of expert advice as to local prevailing conditions; the value to the fliers of the present Department of Commerce weather broadcasts, and last but not least, first-hand information on the part of a Weather Bureau representative of the weather problems of the pilots and their best solution by the bureau. After some 10,000 miles of flying in which we encountered good weather, rain, fogs and winds varying in direction at varying altitudes, it is believed that a clearer picture than ever of weather problems may be presented to the meteorologists operating on radioed weather data.

#### Continuous Weather Service

The reference to our flying weather man is made particularly since the getting of weather data to the pilot is essentially a function of radio. From the time the 11th Squadron started east from Rockwell Field, San Diego, California, until its return, the pilots were in constant touch with either the Department of Commerce stations or the army stations, which relayed weather and field conditions.

In addition to the excellent service rendered by the above agencies there was an added feature of some public interest in the radio contacts established with broadcasting stations throughout the country.

It is far from our thought to convey any idea of originality in these rebroadcasts from the plane, the author having participated in several of these some eight years ago; but for simplicity of arrangements and variety of conditions it was quite an accomplishment.

The method of effecting two-way communication and rebroadcast on the squadron flight across the United States was essentially as follows:

#### Radio Contacts Made

Lt. Maxwell of March Field, California, acting as advance agent for the flight of the 7th Bombardment Group, was given a mimeographed procedure form which he in turn gave to the station with which the contact was desired. This gave the frequency range of the airplane set, the power of the set, the probable range at which communication could be established and a few notes based on previous experience, for the local broadcaster. The station then wired the 11th Squadron, the morning of the broadcast, the frequency desired of the plane, and the station frequency. This telegram was answered by one giving the expected time of arrival and commencement of broadcast.

The first rebroadcast was over station KVOA at Tucson, Arizona. Successful two-way communication was established over a distance of some 60 miles. The rebroadcast began as the planes were some 20 miles away and continued on to the landing.

Going into El Paso, Texas, radio contact was made with the army radio station there and the information exchanged included arrangements on gas, oil and ground transportation.

During the trip, thus far, excellent contact had been maintained with the other squadrons of the 7th Group, which, due to their having a different type plane of about 30 miles per hour superior speed, flew apart from the 11th. The contact was of value to the group commander, Major McNarney, in planning rendezvous points and adjusting speed so as to arrive at proper times.

The next use of radio came as more or less of an emergency measure. One of the planes was forced to land due to a minor defect. This occurred far out in the plains of Texas, where even telephone communication was not available. Just as soon



#### READY TO COMMAND THE TAKE-OFF

*Lieut. Howard, seated at the control of the huge bomber, accompanied by the flying weather man, Mr. Dean Blake, about to take off from Rockwell Field on what was probably the largest and longest flight of a group of Army planes ever assembled*



as the ship was down the crew chief changed his set to transmit and immediately the squadron commander was informed fully of the situation and knew that the ship could soon rejoin the squadron.

In order to avoid tiring the pilots by hours of close formation flying it was customary after the take-off to separate the three flights and let them fly independently. This also had the added value of giving flight leaders opportunity for independent navigation. At 15-minute intervals each flight reported for instructions.

*Other Contacts*

Approaching Memphis, station WNBR, under charge of the Chamberlain brothers, was called and two-way communication and rebroadcast began about 20 miles out. This was continued up to the time of landing. Mr. Chamberlain was enthusiastic about the results, met us at the airport and later that evening the studio was visited. At that time the Village Rhymester, one of WNBR's features, was being broadcast.

The following morning the broadcast was continued, only to be interrupted suddenly when one of our planes encountered trouble and turned back, and our radio facilities had to be directed to some of the more serious things of flying. Fortunately the trouble was soon remedied and the ship soon proceeded on.

Approaching Louisville, station WHAS of the Courier-Journal was called, and long before our signals were sufficiently audible for rebroadcasting we could hear the station telling of our approach. Upon establishing communication we were pleased to learn that our announcer was Mr. Skeets Miller of NBC, who was in Louisville to broadcast the famous Kentucky Derby. However, it was not until New York was reached that we met Mr. Miller in person and discussed the trip. WHAS officials were also much interested in our work. On approaching the field for a landing, our trailing antenna with its formidable lead weights dangled dangerously near the

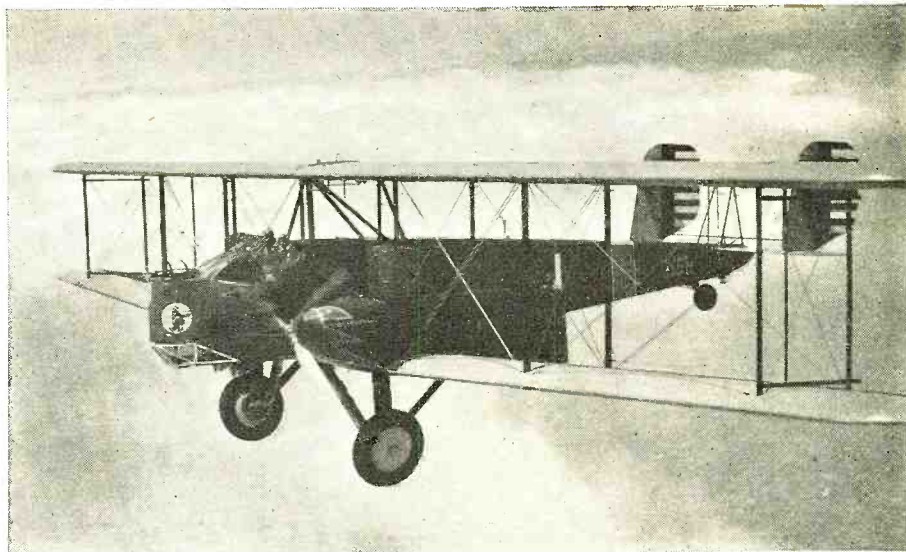

**HEADQUARTERS SHIP OF THE AIR**

*Command ship of the 11th Bombardment Squadron flying above the clouds of Rockwell Field, San Diego, Cal., on a test flight preparatory to the trip across the United States*

ground. On reporting that we would soon have to cease broadcasting and "reel in" we were requested to continue as long as possible. So a quick switch was made to the field wing antenna and Lt. Scott in the lead ship accurately described the landing of the whole squadron at Bauman Field; possibly the first time that such a description has come from the landing plane itself.

Our next hop was to Dayton, and as here we became a part of the 672-plane battle group, our radio activities were limited, as the problem of radio interference became a serious one and the use of radio was controlled by orders from high command and our radio free-lancing was at an end. However, radio within the 2nd Bombardment Group to Langley Field, to which we were now attached, was continued on an assigned frequency. Major Herbert A. Dargue, in command, acted as radio net control station and all transmissions were made only after permission was received from his command plane.

The value of good communication in handling a bombardment group of four complete squadrons was repeatedly demonstrated.

As the First Air Division came into the New York area broadcasting became a national problem, in that both the CBS and NBC networks planned large chain hook-ups for the aerial maneuvers over New York.

*A Flying Studio*

For this purpose General Foulou assigned two three-motor ships as flying studios and the engineers of both chains were given *carte blanche* in installing special equipment designed to give studio quality to the broadcast from the air, even to the suppression of the engine roar, which was an unavoidable part of our contacts.

The success of this national hook-up by the two major broadcasters is well known. Conditions of visibility made observation difficult especially to eyes untrained to look for ships in the air, but as a beautiful example of technical perfection of quality, radio control and switching it was superb.

Upon completion of the maneuvers over Philadelphia, Atlantic City and the final maneuvers over Washington the work of disbanding the First Air Division began. For the 11th, 9th and 31st squadrons this meant another 3,000-mile cross-country trip (Continued on page 720)

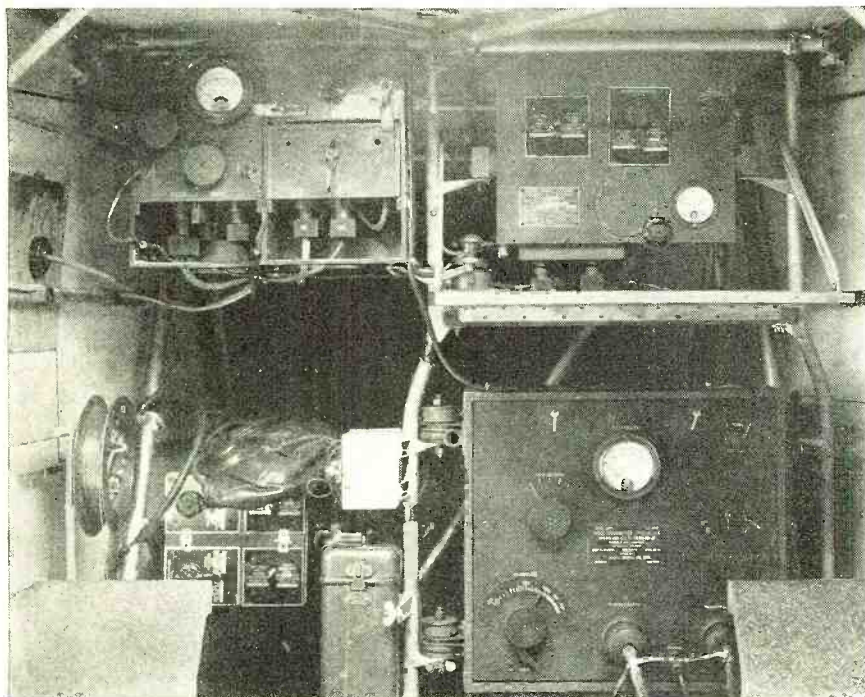

**RADIO INSTALLATION IN A BOMBARDMENT PLANE**

*In the upper right-hand corner is seen the special Signal Corps receiving set and directly below is the type BC-114 transmitter. Upper left is the radio control box and wave changer, lower left shows the reel for the trailing antenna, the operator's head set and auxiliary apparatus*



# TELEVISION

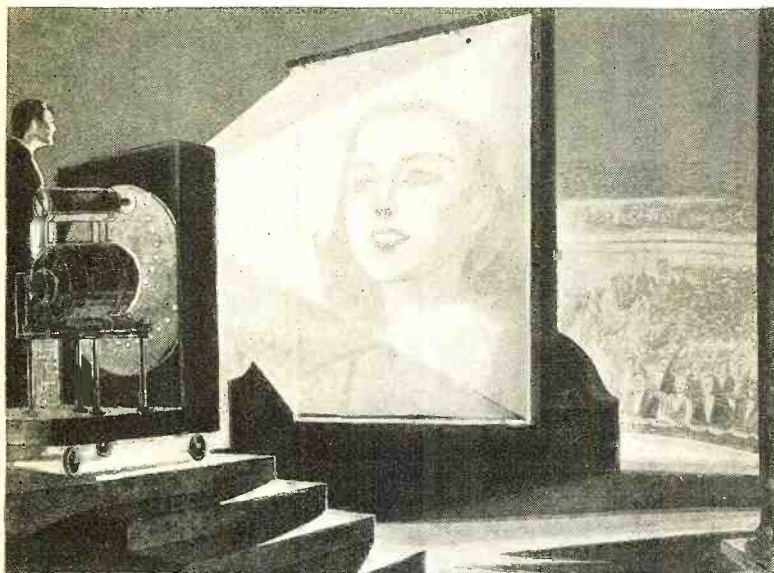

THE PROJECTOR EQUIPMENT

*The television projector was mounted on the stage, behind a ten-foot translucent screen. Loudspeakers, for the reproduction of the sound portion of the program, were located at the base of the screen*

**T**HE prediction has often been made that the public will get its first sight of television in the theatre. This is one prediction in a terribly over-predicted field that has finally been fulfilled. On October 24, 1931, the Sanabria apparatus went on the stage of the B. S. Moss Broadway Theatre, New York, and took its place on a typical Broadway variety bill of girls, comedians, dancers and movies. Television was easily the feature attraction and packed the house from noon to midnight.

The television act as it was presented in New York has been booked for a regular vaudeville tour. According to a representative of the booking agency, several identical units will be built and sent out on the "road." If the act reaches your city, by all means go and see it, not for its entertainment value, which is negligible, but for its technical features. The equipment used in the stage demonstrations is worth examination from the mechanical standpoint alone, for it certainly is the largest and most ambitious disc machinery produced so far. Regardless of whether the disc idea survives or not, the Sanabria system represents one important school of television thought, and is exceedingly interesting from a number of angles.

## "Ballyhoo" Announcing

The theatrical people, having discovered a ace drawing card in this television stuff, are ballyhooing it extravagantly. Unfortunately, they are leaving many things unsaid, and they are only compounding the confusion that now plagues the potential radio-television market. If the press-agents and spotlight seekers would keep off the stage and allow Sanabria himself or some competent lecturer to deliver a sane and simple explanation of the works, the effect on the audience would be better and the whole stunt would look more like the genuine scientific exhibition it is supposed to be.

When the hired blurb-spouter points to a ten-foot screen and a ton of machinery, and makes the remark that television will soon be in the home, he is certainly misleading his listeners. He is also making things unpleas-

*Television made its initial demonstration, using a ten-foot of the regular program in a*

**By Robert**

ant for the local radio dealers, for those same people, after witnessing the rather impressive demonstration, visit the radio stores and inquire about "television attachments" and "television receivers," and delay the purchase of new radio sets with the intention of waiting for the arrival of the promised miracle.

## The Sanabria Set-up

The set-up on the stage is simple. The transmitting apparatus, which comprises an arc light, a scanning disc, photo-electric cells and audio amplifiers, occupies one end of a glass-enclosed studio, with a small piano, a microphone stand and some chairs at the other end. Two men attend the equipment, one at the scanner and the other at the amplifiers. The studio is about fifteen feet long, seven high and seven wide, and is of the usual soundproof construction. Its entire contents are visible to the audience.

After a preliminary spiel, the announcer and two or three entertainers enter the studio, the theatre is darkened, and the scanner turned on. A dim light that does not affect the photo-electric cells is left shining in the studio, just to show the audience that everything is on the level.

At the Broadway Theatre the studio was lowered a few feet into the stage by a disappearing elevator. Then a ten-foot square glass screen just behind the studio was uncovered, and the image of the announcer appeared in a bluish green light, filling the entire screen. Voice accompaniment came through an ordinary theatre sound system.

Now the writer has seen every open television demonstration of importance during the past five years, and he is in a position

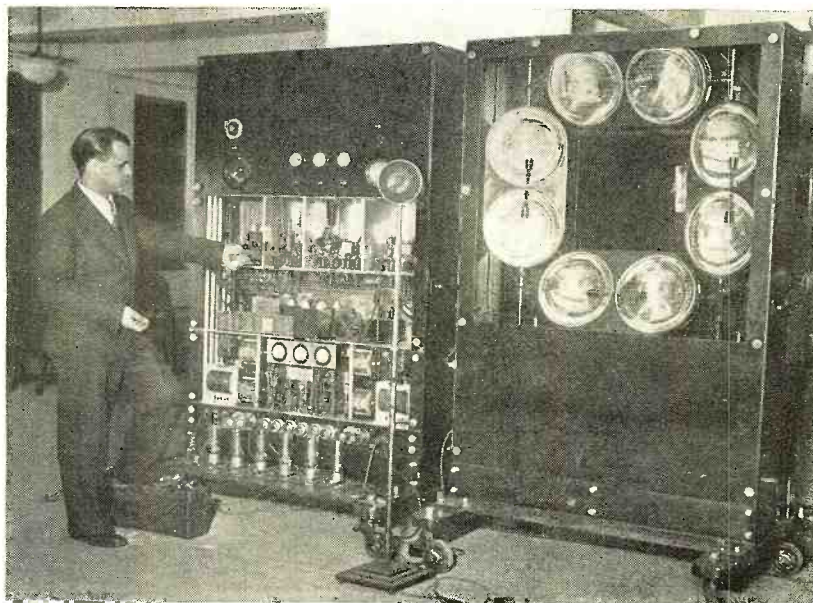

PARTS OF THE TRANSMITTER EQUIPMENT

*Ulysses A. Sanabria, designer of the equipment, is shown in front of the immense eight-stage audio amplifier used to step-up the tiny output of the photo-cells. At the right is the photo-cell frame with its reflector equipment*



# Hits Broadway

appearance in the theatre when screen, was put on as a feature New York vaudeville house

## Hertzberg

to make comparisons. He would rate the Sanabria images, projected on

a large screen with a 45-aperture disc, as "pretty good." They were clearly recognizable throughout a 2000-seat theatre, and thus they probably fulfilled their purpose, although their illumination was not particularly bright. They are neither the best nor the worst large screen images exhibited to date; they are highly creditable.

The Sanabria system is unique in its method of scanning. The disc has only 45 holes, but these are arranged in three spirals of 15 each, each spiral covering 120 degrees of the disc, as shown in Figure 1. The first hole of spiral 1 sweeps across the very top of the subject, and the fifteenth sweeps across the bottom, not the very bottom, but a distance above it equal to the height of two holes. The concentric scanning sweeps do not overlap exactly, as in ordinary disc scanning, but are separated a distance again equal to the height of two scanning holes. Thus one-third of the entire surface of the subject is scanned in one-third of a revolution of the disc, which rotates at 900 r.p.m.

### Scanning System

As the disc continues to rotate, the first hole of spiral 2 travels across the subject, starting directly under the arc traversed by the first hole of spiral 1. The second hole of spiral 2 starts just under the second hole of spiral 1, and so on down the surface of the subject until the fifteenth hole of spiral 2 has passed under the path cut by the fifteenth hole of spiral 1. Two-thirds of the subject's area has now been covered.

The first hole of spiral 3 then scans the remaining space left blank between the first and second holes of spiral 1. Progressively down the subject the holes of spiral 3 scan the last third of the surface,

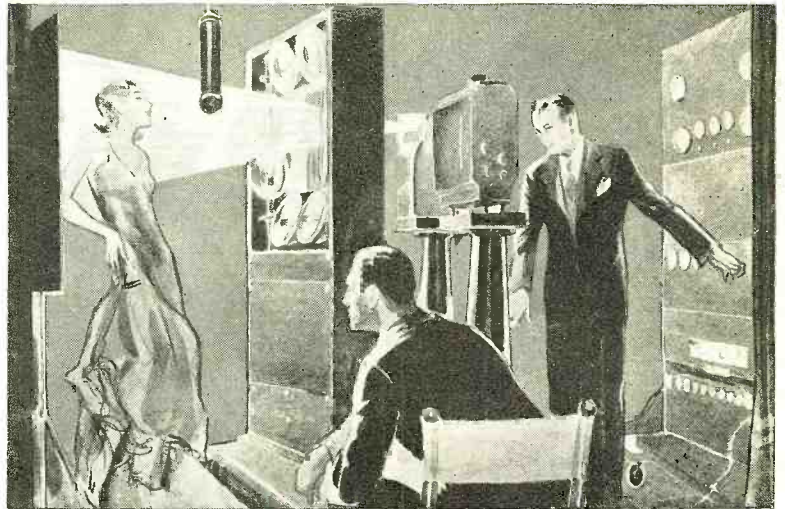

THE TELEVISION STUDIO

An artist's conception of the television transmitter in operation. This equipment was located in a glass enclosed studio, in full view of the audience. The transmitter output was carried to the projector equipment over wires

**BROADWAY THEATRE**  
GEORGE D. TELLING, General Manager

PROGRAM SYNOPSIS BY THE AMERICAN THEATRE PROGRAM CORPORATION

FIVE NIGHTS—Last night 200 and closed last night 300 in New York. In view of the fact that the Broadway Theatre has the largest and finest theatre in the city.

JOHN J. DORRAN, Fire Commissioner

WEEK COMMENCING SATURDAY, OCTOBER 24th, 1931

B. S. MOSS  
(By arrangement with Willoughby Moss)

HAS THE HONOR OF PRESENTING FOR THE FIRST TIME IN ANY THEATRE

**SANABRIA  
GIANT  
TELEVISION**

In a Series of Unique Demonstrations of Sight and Sound Entertainment. Simultaneously transmitted from the stage and broadcast to the Mammoth Screen.

Mr. Carew H. Wells, F.R.G.S., noted English Explorer and Author, as Master of Ceremonies.

Musical Specialties by Miss Ruth Burns, Television's Favorite, and Miss Emily Price, late of National Opera Company, Madison City, and direct from Central Africa

JOHN TIO  
Chaperoned by FRANCIS ABELLA  
Miss Ruth Burns, at the Piano.  
Program Continued Page Seven

### HOW TELEVISION WAS FEATURED IN THE THEATRE PROGRAM

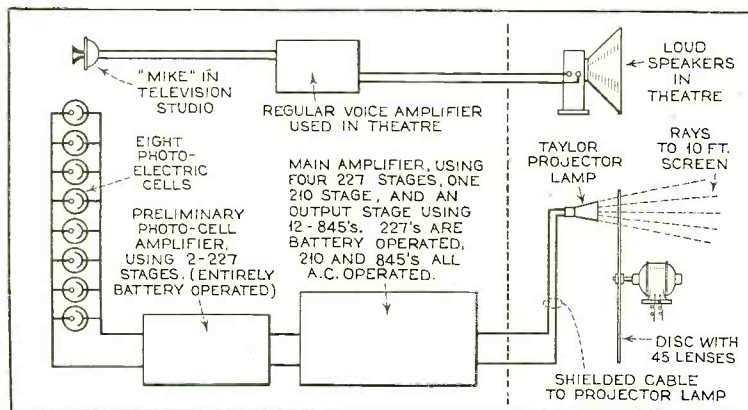

DIAGRAM OF THE THEATRE EQUIPMENT

Figure 2. The transmitter equipment for both image and sound are shown to the left of the broken line. To the right are the loud-speaker and the television projector equipment

until the fifteenth hole sweeps across the very bottom limit.

At the receiving or reproducing end the process is the same, the scanning disc recreating the image in the same manner that it was broken down.

Since all three scanings take place in the total time of 1/15 of a second, they impress the eye as a single composite action. The eye's well-known characteristic of persistence of vision makes this possible.

### Mechanical Precision

The successful operation of the Sanabria system as it is being demonstrated on the stage seems to be due to the precision of the mechanical members, and also to the sensitivity and power, respectively, of the photo-electric cells and the projector lamp. The arc light and disc mechanism of the transmitter are set up on a massive cast-iron stand about four feet high. The base is fitted with leveling and locking screws so that the whole unit will stay put in any desired position. The transmitting disc is small, being only about sixteen inches in diameter.

The rays of scanning light that come through it are not thrown directly on the subject, but are reflected by a 45-degree mirror through a square opening in a seven-foot-high frame holding eight photo-electric cells. This arrangement is very convenient for the operator, as it allows him to see the subject at all times and to make any necessary focusing adjustments on the scanning rays.

The side of the disc facing the reflecting mirror is fitted with a revolving turret carrying four different lenses. The operator selects the best lens for the particular subject being televised.

The photo-electric cells are about the same size as ordinary receiving tubes, but they are given a formidable appearance by the highly polished reflectors in which they are mounted. The active sides of the cells do not face the subject, as most people seem to think, but are turned inward and are placed at the exact foci of the reflectors. Thus the scanning rays from the arc and the disc fall upon the subject, are reflected in varying degrees (Continued on page 712)



# RECENT DEVELOPMENTS IN THE DESIGN OF *Electrostatic Loudspeakers*

*A number of ingenious new principles are incorporated in a new type of differential loudspeaker operating on the forces of attraction and repulsion of electrostatic fields are disclosed in this interesting article. The author discusses constructional and operational data, together with methods that insure quality reproduction*

By Hans Vogt  
Part One

**M**OST present-day loudspeakers are based for their operation on variations of the special electro-magnetic field. The oscillating parts in this field (diaphragms, armatures, coils) must be connected with horns, paper cones and the like, in order to obtain a good coupling with the air to be set in motion. The results of this are often certain acoustic disadvantages (resonance ranges, on-and-off oscillating processes, and bad reproduction of the high frequencies) which influence sound reproduction in respect to amplitude and frequency.

In comparison with the electro-magnetic field the electrostatic field offers essentially better qualities as regards its suitability for sound reproduction:

1. It can be largely extended in area.
2. The oscillating electrode may directly serve for the reproduction of sound.
3. The oscillating electrode can be made very thin and light.

Unfortunately, these properties, which are considered ideal for the reproduction of sound by means of oscillating areas, are made less satisfactory because of the following conditions:

4. Considerable electrode movements are only to be obtained by the use of high voltages impressed across comparatively small distances. The production and insulation of high voltages cause, however, considerable technical difficulties.

5. The density of the field changes with the square of the distance between the electrodes. As the alteration of the distance is the prime requisite for sound reproduction, a considerable distortion of the amplitude

must, of course, necessarily result.

These difficulties are probably the reason why prominent research institutes have neglected to investigate this problem and limited themselves mostly to concentrating their entire attention on the examination of the suitability of the electromagnetic field for the sound reproduction, especially in the form of the controllable moving-coil drive, which is easy in theory. On the other hand, the positive qualities of the electrostatic field appeared to me to be very promising and I hoped to overcome the negative qualities by constructive technical measures in regard to circuit.

The arrangement on which I have finally decided consists of a three-electrode differential system (Figure 1). The radially tensioned diaphragm *m* is firmly clamped at equal distances between two fixed electrodes, *p*<sup>1</sup> and *p*<sup>2</sup>, which are perforated for the admission of air. A wattless direct voltage *E* is impressed on the diaphragm on the one side and on the electrodes on the other side, in order to avoid a doubling of the frequency, to decrease amplitude distortion and in order to increase the electro-acoustic effect. The forces of this field engaging the diaphragm compensate each other in the condition of rest; the diaphragm remains free in the center. If the field between the diaphragm *m* and the two electrodes *p*<sup>1</sup> and *p*<sup>2</sup> are changed in opposite direction, for example, by an alternating voltage from a transformer *tr* which is superposed on the direct voltage, the diaphragm then responds and moves to the side of the stronger field. In comparison with the partially excited older types and arrangements, shown in

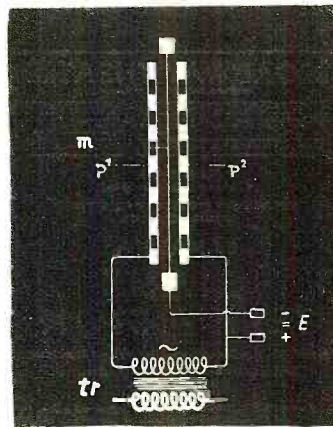

GENERAL PRINCIPLE

*Figure 1. Method of employing exciter voltage between the diaphragm and the two outer electrodes, while the alternating E.M.F. is applied through the transformer*

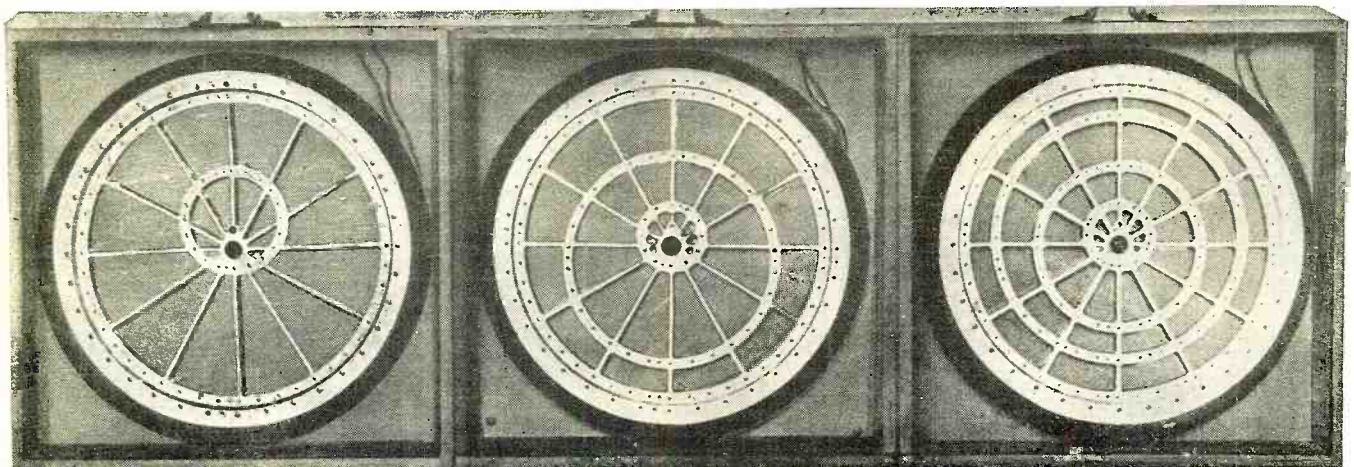

SOME EARLIER TYPES OF PARTIALLY EXCITED ELECTROSTATIC UNITS

*Figure 2. Shows three different ways for arranging the fixed electrode in juxtaposition to the vibrating diaphragm. The eccentric rings are to partially overcome harmonic difficulties*



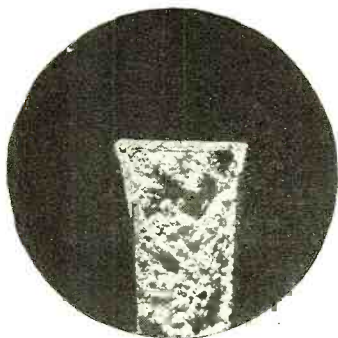
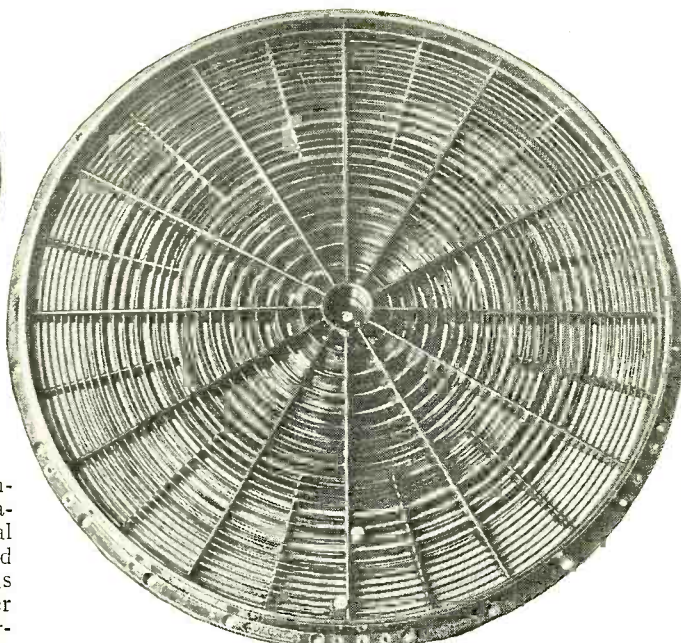

Figure 8. Special coating method produces an insulating covering which is thicker on the corners



THE ELECTRODE STRUCTURE  
Figure 5. Photograph of one of the outer electrodes made of Bakelite for the new unit. The construction is somewhat similar in geometric detail to a spider's web

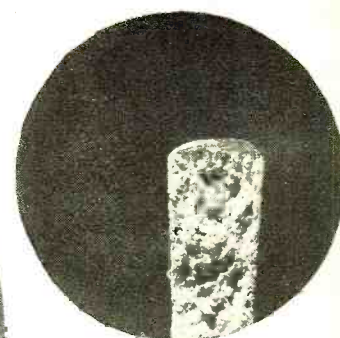

Figure 7. Shows insulating compound under ordinary application, thin toward the corners of the electrode

Figure 2, made possible by conductively covered mica diaphragms and perforated metal plates, with which the first sound films were reproduced here as well as by graphited rubber membranes<sup>2</sup> tensioned over perforated sheet metal and the like, this arrangement possesses considerable advantages.

The technical realization of this new arrangement depends on the solution of certain problems regarding material for the diaphragm. A very thin, firm and light foil, showing no appearance of wear, had to be produced. A material had to be chosen for the fixed electrodes which allowed the same to be given a maximum admission of air with the greatest possible strength and the best insulating capacity.

The material from which the diaphragm is produced is an aluminum alloy (Al, 96.8%; Mg, 2.2%; Si, 0.4%; Fe, 0.5%; Cu, 0.1%). This material can be rolled out in widths from 450 mm. to 0.010-0.015 mm. At the finish it possesses, with very little ductility (about 0.6%), a tensile strength nearly the same as that of ingot steel. These qualities of strength are necessary in order that a sufficiently elastic resistance opposes the engaging forces of the electrical field and thereby improves the power capacity as well as the proportionality of the amplitude. The exact ductility and tensile strength of this alloy is shown in Figure 3 (curve a). For the purpose of comparison, the value of a few other materials with insufficient qualities of strength are given in this diagram. The durability, i.e., the quality as to how far the radially engaged foil maintains its mechanical tension, is shown in Figure 4 (curve Fol. 1/15) In this diagram the same electric voltage is shown as equivalent for the mechanical voltage which had to be employed in order to bend the tensioned diaphragm, which is positioned at a certain

distance over a fixed electrode, to effect a certain contact (see drawing of the experimental arrangement in Figure 4). By constantly maintaining all other conditions, the electrical voltage at which the contact circuit is closed is then suitable as a measure for the mechanical tension of the diaphragm and for the control of the latter. It can be seen from the diaphragm that the above-mentioned alloy at the same thickness, compared with a foil made of an alloy which is rather firm and can be rolled (Al, 94%; Cu, 4%; Si, 2%), admits a stronger mechanical tension and thus the employment of more powerful electrostatic fields. It is further to be seen from the course of the curve that the mechanical tension of the new foil, after clamping, decreases only a little during the first few days, but thereafter maintains its value. The linear temperature-coefficient of the above-mentioned alloy has been determined by means of the differential dilatometer according to Chevenard, within a temperature interval of C—250° C to 0.000024.

For the fixed electrodes a material was chosen consisting of condensed products of phenol and formaldehyde mixed with sawdust in the so-called C condition, under the name "bakelite." From this material it is possible to produce, in the heating press process applying high pressures in the known way, pressed articles of various kinds with excellent insulation qualities. Figure 5 shows this electrode, from the back, provided with peripherally arranged apertures. The suitability of bakelite for precision parts was, however, not known and consequently thorough investigations of the material were necessary. I succeeded in explaining certain instabilities and abnormalities of the bakelite which had previously prevented its use for precision parts and which were observed on measuring the (Continued on page 727)

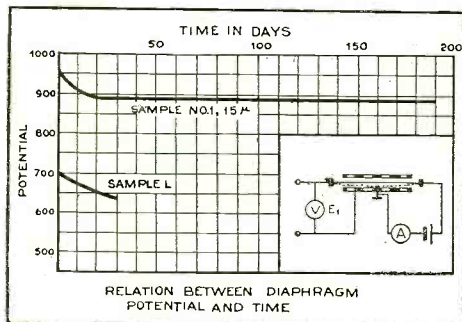

DURABILITY CURVE

Figure 4. Shows the curve obtained in tests on a tension diaphragm. Notice that although it stretches slightly at the beginning, it then maintains a definite tension during the rest of its life

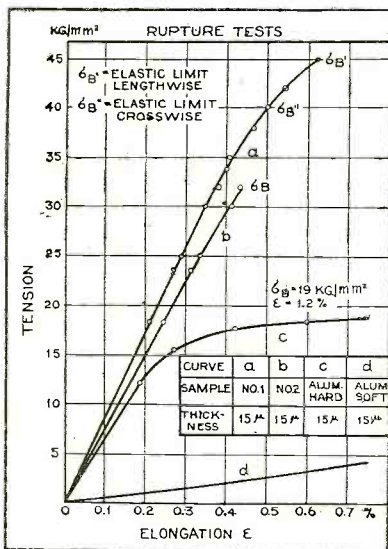

PHYSICAL CURVES

Figure 3. This series of curves shows the ductility and tensile strength of the new alloy for the diaphragm in curve "a" against other material

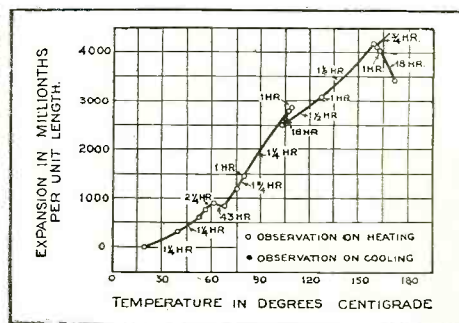

EXPANSION OF BAKELITE

Figure 6. This curve shows up a number of flaws at critical temperature points, depending on temperature and time of application. This can be cured by means of a special thermal after-treatment



# The New KFI

*KFI is now in the super-power class, having recently increased power to 50 kilowatts—the first station west of Texas to use this power. This article provides a detailed description of the new transmitter*

**N**EW and improved radio service is available to listeners along the Pacific Coast and DX fans in other parts of the country have a new mark to shoot at with the opening of KFI's new 50 kw. transmitter near Los Angeles, California. KFI, which is owned and operated by Earl C. Anthony, Inc., has operated for many years, and until recently had a power output of 5000 watts. With the installation of the new equipment, it is expected that listeners will be able to hear this station over a much wider range.

The transmitter is located on a thirty-acre tract near Buena Park, Los Angeles County, approximately twenty miles from the city of Los Angeles. The location was selected after extensive field strength tests by engineers of the RCA-Victor Company, who furnished and installed the transmitter. The location, of course, was chosen so that a very nearly "circular pattern" was obtained, assuring equal radiation in all directions.

## Station Design

The new station is housed in a brick, steel and concrete building of two-story construction. The lower floor houses the power plant and the upper story contains the transmitter proper. The equipment is so arranged that an operator can readily observe the entire operation from one point.

The towers are 400 feet high, located 700 feet apart, and so placed that they form, with the building, almost an equilateral triangle—the building being 475 feet from the middle point between the towers.

The transmitter is one of the standard RCA 50-B units. Figure 1 shows the block diagram of the r.f. and power circuits. Figure 2 shows the schematic of the transmitter.

For the purpose of description, the transmitter can be divided as follows:

By I. R. Baker

(a) Low-power rectifiers and control panel  
(b) Exciter modulator unit

(c) 5 kw. amplifier  
(d) 50 kw. amplifier  
(e) Main control panel  
(f) Main rectifier  
(g) Basement apparatus  
(h) Antenna tuning equipment

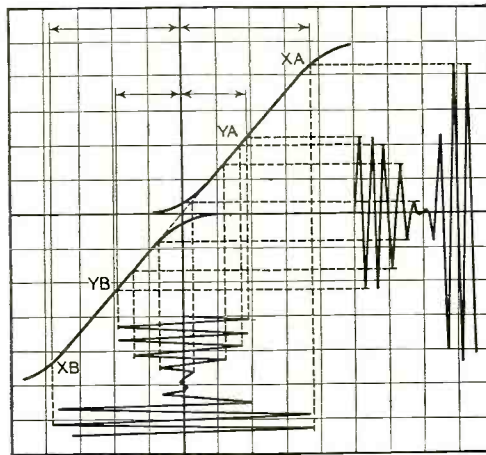

AMPLIFIER CHARACTERISTIC

Figure 3. This curve shows the dynamic characteristic of the power stage, used as a class B amplifier

One of the illustrations shows the entire radio-frequency unit. On the extreme left is the low-power rectifier and automatic control unit. This panel contains three individual mercury vapor rectifiers, various contactors and relays associated with the control circuits, and condensers and reactors associated with the oscillator-modulator amplifier panel. There are a total of ten UX-866's in this panel which supply power to the various radio-frequency stages located in the first three panels.

## The Modulator Unit

The next panel shown in the same illustration is the exciter modulator unit. This panel performs the following functions: (1) produces a constant frequency by means of a crystal control oscillator, (2) amplifies the carrier frequency to a power level to excite the succeeding 5 kw. amplifier, and (3) receives low-level audio energy from the incoming audio line and amplifies this to the level sufficient to modulate the radio-frequency system 100%.

The two complete crystal oscillator units are mounted side by side in this unit behind glass-front doors. The connections are so arranged that either of the crystal units can be used at will, depending upon the position of the crystal unit transfer switch.

The crystal oscillator stage employs one UX-210 tube, connected in the circuit with a quartz crystal accurately ground

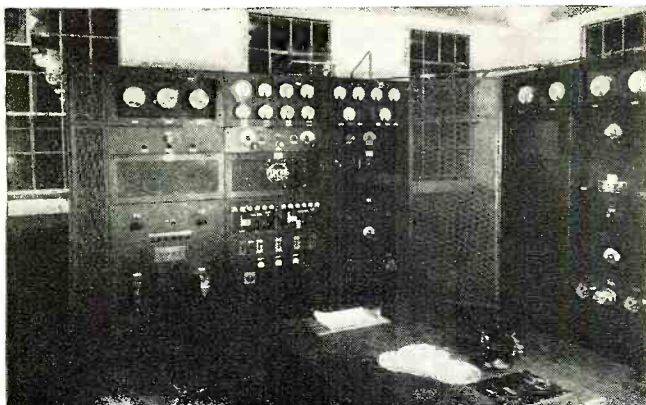

THE R.F. PORTION OF THE TRANSMITTER EQUIPMENT

The three panels at the left contain, respectively, the low-voltage rectifier and automatic controls, the exciter and modulator equipment, and the 5-kw. intermediate amplifier. To the right of the gate are two of the panels on which the 50-kw. amplifier equipment is mounted



to a frequency of 640 kc. at a specified temperature. In order to insure the highest degree of frequency stability, the crystal is mounted in a specially designed holder and is kept in place by quartz spacers. These spacers are ground from the same block as the crystal and therefore have the same temperature coefficient, thus keeping the air gap constant with changes in temperature. The crystal holder is mounted inside a specially designed heated compartment with thermostatic control so that the constant temperature is maintained at the crystal. The heater unit is known as an attenuated heater.

**Crystal Temperature Control**

A sensitive thermostat is located in the vicinity of the source of heat so that it operates on a very small temperature change of the heater element itself. Due to the great thermal capacity of the conducting layer, the resultant change in temperature around the crystal is but a small fraction of the change in temperature which causes the thermostat to operate. In this manner the frequency variations of the temperature changes are kept within very narrow limits. In order to maintain accurate temperature at the crystal itself, a thermometer projects from the oven and accurately indicates any changes which may take place therein.

The power required for the heater is obtained from the 110-volt station lighting circuit instead of from the control circuit used in other parts of the transmitter. Thus the unit can be kept at the proper temperature whether the transmitter or the crystal unit is in regular service or not.

The crystal stage is followed by two buffer amplifier stages, all located in the same cabinet. As stated before, the cabinet is in duplicate, including power supply. The two buffer amplifier stages have identical circuits and use UX-865 screen-grid tubes. The screen-grid feature, of course, eliminates the need of neutralizing. Any reactions from the tuning and buffer amplifier stage are not reflected back to the crystal oscillator. Individual shielding is used to further reduce induction between stages. Each stage has its individual plate current meter; the plate voltage on the amplifier and oscillator is measured by means of a voltmeter.

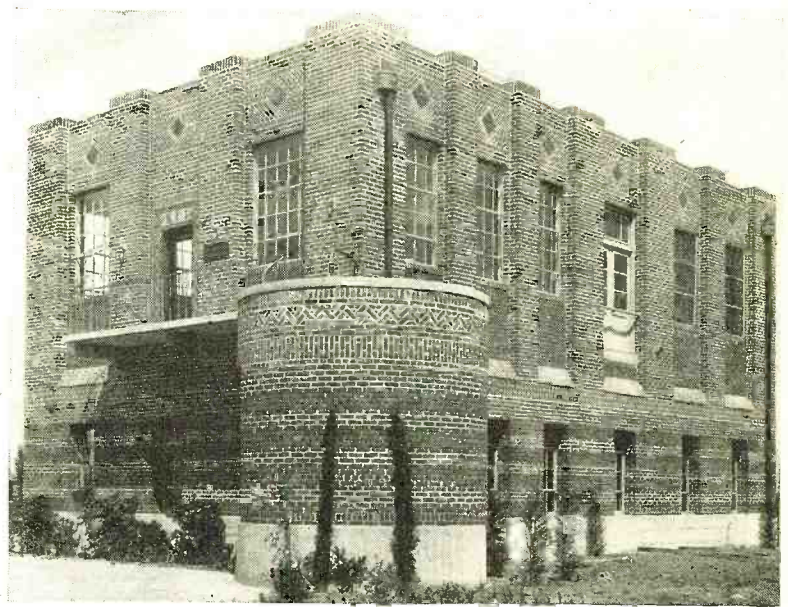

**THE TRANSMITTER BUILDING**

*Houses the new 50-kw. transmitter and power supply units*

There is still a third unit in the spare parts kit of the transmitter which can be pressed into service in the event one of these two units in the transmitter should be removed, thus always giving a large factor of safety in operation.

Referring again to the block diagram, Figure 1, it will be noted that following the crystal control units is the first r.f. amplifier, which utilizes another screen-grid tube, type UX-860, of 75 watts capacity. This is the third buffer amplifier stage between the crystal and modulated stage. It can be readily seen that so many stages are not necessary for providing the necessary power to excite the modulated stage. It is generally conceded, however, to be good engineering practice to have as many buffer amplifier stages as economics will permit between the modulated stage and the crystal stage to prevent any reaction which might occur due (Continued on page 714)

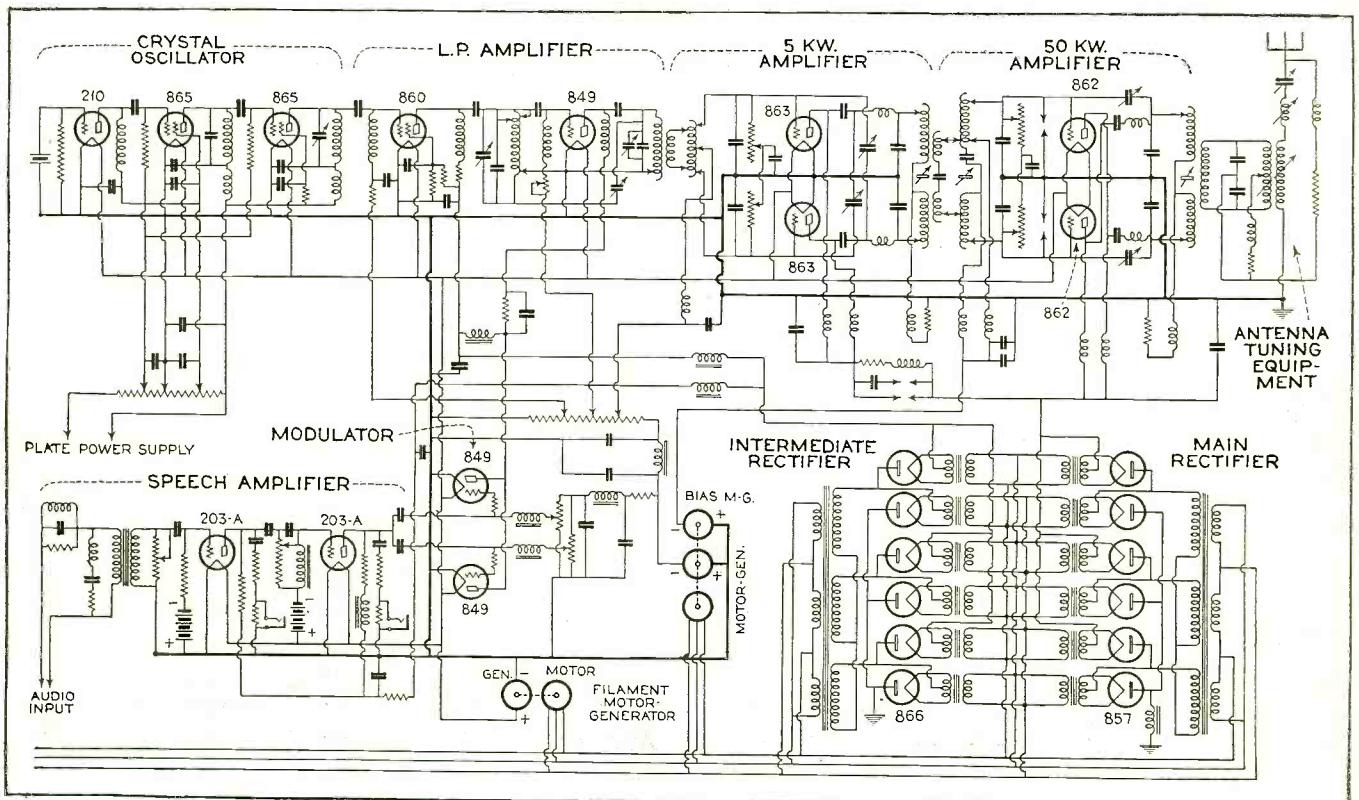

**THE SCHEMATIC WIRING DIAGRAM**

Figure 2. For those interested in the details of the circuit, the complete diagram is given here



# The Radioman's Timepiece

*The necessity for accurate timing—in the broadcast studio, radio shop and laboratory—makes this discussion of recent developments in the watch-maker's art a subject of practical interest to those engaged in radio work*

As one stands before the microphone and projects his thoughts toward the destination of words he is about to send over the air, the idea of time and time measurement forces itself to the forefront of the imagination. Trying to visualize the travel of the broadcast message . . . speeding at 186,000 miles a second . . . out over the vast expanses . . . perhaps to worlds beyond ours . . . at every angle of direction . . . in every plane of projection . . . one cannot exclude thought of the eternal passage of time as well as the incomprehensible boundlessness of space. The two ideas are inseparable elements of an apprehension of the universe.

From the more realistic standpoints, also, of every radio engineering, research, broadcasting, manufacturing, servicing and use—Time thrusts itself into the picture as one of the essentials in the successful application of radio science to the service of mankind.

## Accurate Time Measurement

Many of those concerned in the use of this modern marvel, radio, must depend on precise time indication and time measurement. *Minutely* accurate is hardly exact enough an expression to define the essential precision of time measurement in radio work. For "minutely" connotes a measurement by minutes; whereas even seconds are not the smallest measuring units necessary to exact synchronization and timing in radio.

The radio production man or announcer, who are literally

By S. Reid Warren\*

slaves to their watches, must perfectly time announcements or they will hear from listeners in paragraphs that convey no praise. The opening, continuity and completion of the program must be "on the nose," to use studio slang for a perfectly synchronized broadcast.

Back of all this, the radio research worker, striving daily to uncover better ways to serve the radio public, needs a watch that will unfailingly tell him the time of day under conditions that are sometimes hazardous to watch accuracy.

Not only must he, in the pursuit of his technical duties, tune in on programs at long distances, effect communication and carefully plan tests with the greatest facility, but he is constantly working with electromagnetic equipment.

## Watches and Magnetic Fields

Watches, as is well known, are often guilty of misbehavior when brought into proximity with magnetic fields. This unfortunate fact is thrust before the attention not alone of radio workers and those in various electrical industries, but often of any one who travels in electric cars or gets near a dynamo or some piece of electrical apparatus in home, office or shop.

This is of course due to the fact that numerous parts of a watch are made of steel, which readily becomes magnetized. Chiefly the disarrangement centers in what is called the vibrating assembly. This comprises the hairspring and the balance—that little, rapidly oscillating wheel which instantly catches your attention when you look into the "works" of your watch.

The balance wheel rim is normally made of steel and brass, and its cross arm is of steel. When the steel parts of the balance wheel become magnetized, the arm, acting as a magnet, draws the little hairspring to it and stops the watch; or if not fully magnetized, it may attract the hairspring intermittently, while in certain positions, thus causing erratic timing.

\*Hamilton Watch Co.

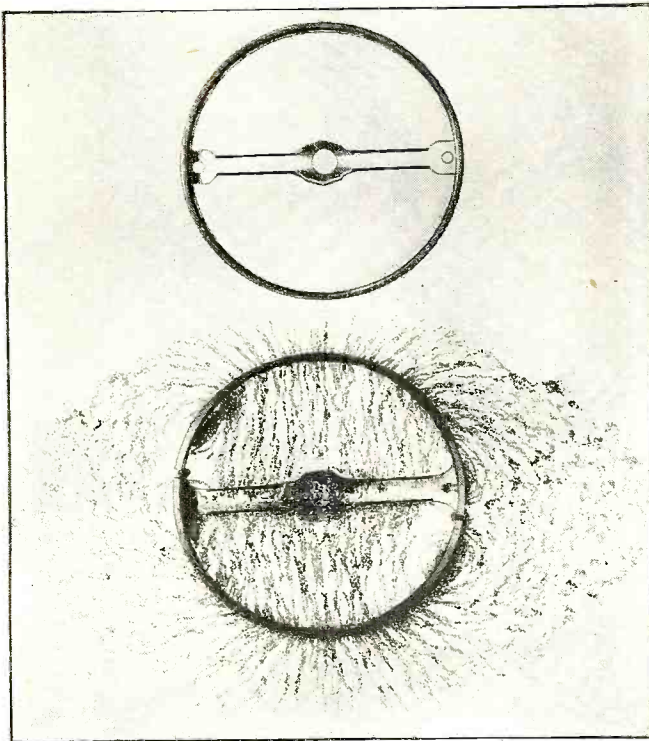

NON-MAGNETIC BALANCE WHEELS

When hairsprings of the new material are used compensating balance wheels are no longer required, thus simplifying balance wheel design and permitting the use of non-magnetic metal in their construction. Here is shown the contrast between the old and new types of balance wheels after subjection to a magnetic field

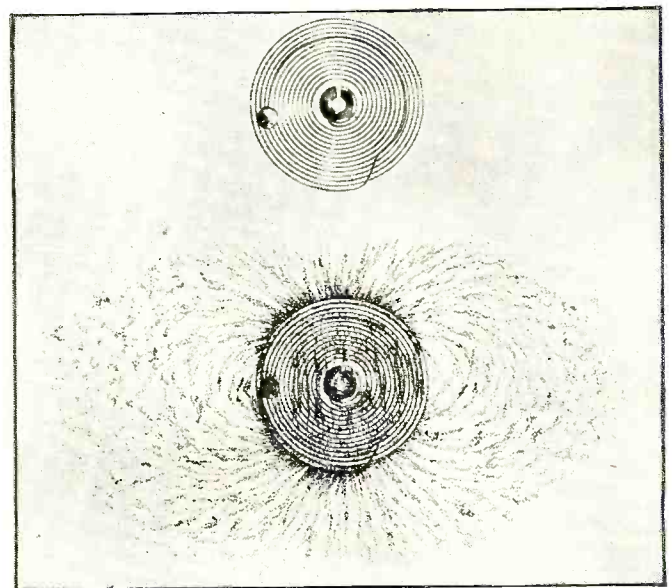

EFFECT OF MAGNETIC FIELDS

These two hairsprings were placed in a strong magnetic field, then removed and tested for magnetization. The upper one—made of elinvar—showed no magnetization, while the ordinary steel spring below was highly magnetized, as shown by the formation of the iron filings around it.

This is an actual photograph



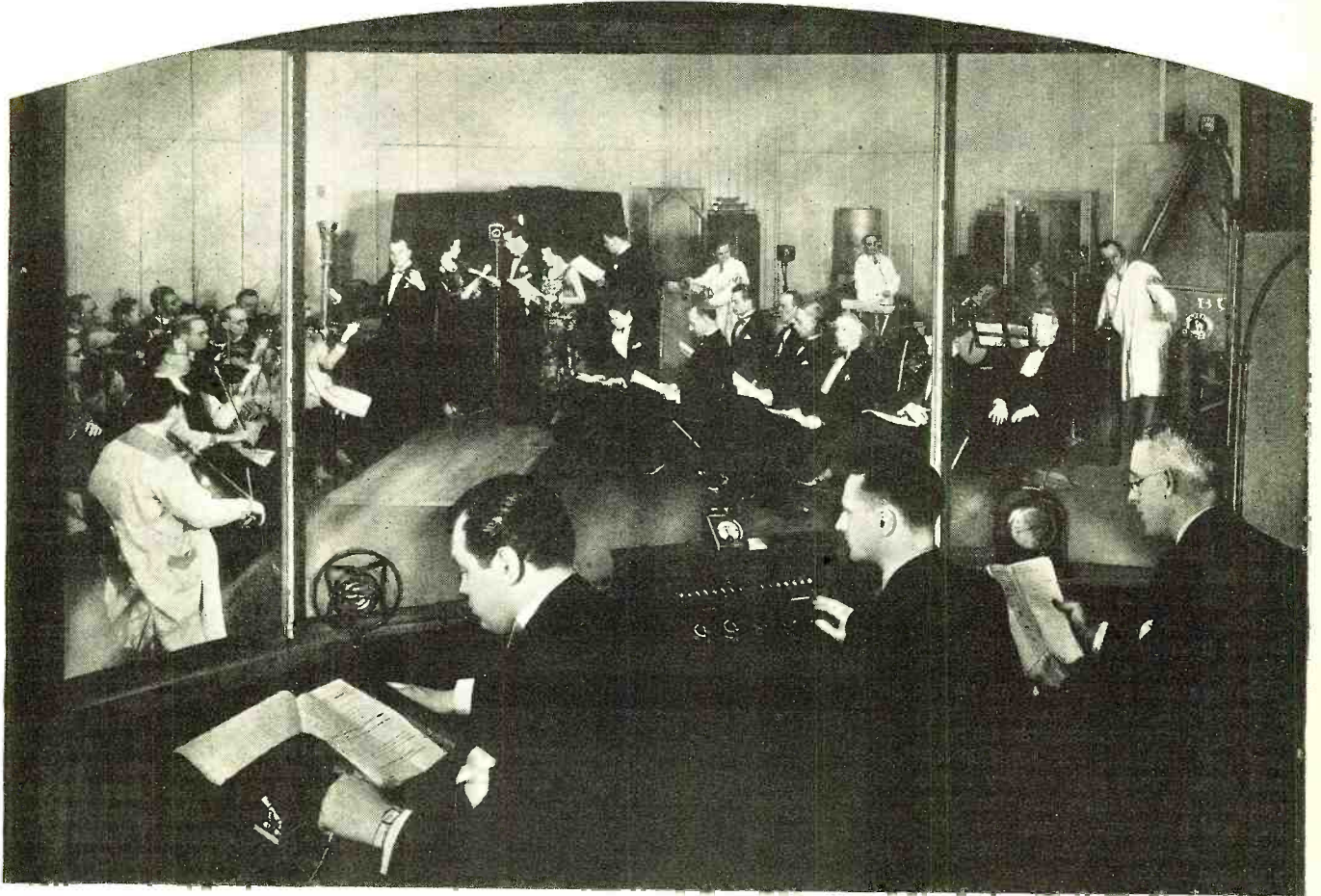

**TIMING THE BROADCAST PROGRAM**

*Few radio listeners appreciate the exactness employed in putting radio programs "on the air." Not only are all sounds carefully monitored and regulated, but every bit of sound and action is timed almost to the second*

An eminent physicist, Dr. Charles Edouard Guillaume, through the invention of a special alloy for hairsprings, has made it possible to use a non-magnetic balance-wheel in watches. This hairspring alloy, called elinvar, and other ferro-nickel developments, won for Dr. Guillaume the rare distinction of being numbered among the recipients of the Nobel Award in Physics, an honor which he shares with such scientists as Einstein, Millikan, Michelson, Curé and Lord Rayleigh.

***Elinvar, the New Alloy***

Elinvar cannot be permanently magnetized; hence a watch equipped with an elinvar hairspring and a non-magnetic balance-wheel retains no harmful after effect even if exposed to a very strong magnetic field.

Numerous tests of a most severe nature have shown that an elinvar-equipped watch will resume running as soon as withdrawn from a magnetic field strong enough to put out of commission watches with conventional carbon steel hairsprings and brass-steel balance-wheels.

These facts are of important concern to anyone engaged in the radio industry or in radio engineering and to the radio user or even those who never go near a radio set. Everyone in these days of electrical transportation and the widespread use of electrical apparatus is likely to come near to magnetic fields of sufficient intensity to affect the running of a watch.

In walking through the cab of an electric locomotive, one might come

within a few inches of cables carrying 2000 amperes direct current. At this point the magnetic field might be as great as 360 lines per square inch. In such a field an ordinary watch can be permanently magnetized and rendered incapable of running again until it has been demagnetized.

Curiously enough, the elimination of magnetism as a serious enemy of watch accuracy was achieved by seeking to overcome another difficulty. Changes in temperature affect the elasticity of the customary carbon steel hairspring. In a high temperature the ordinary hairspring weakens. In a low temperature, it has greater strength; its elasticity increases.

***The Compensating Balance***

Prior to 1766 this fact stood in the way of constructing a watch that could be relied upon. A rise in temperature would make it lose time; a drop in temperature would speed it up, make it gain time.

Had this irregularity not been offset by the invention of what is known as the "compensating" balance, watches would lose 5 to 7 seconds a day for each degree increase in temperature; or gain correspondingly in a falling temperature.

To counteract this possibility, watches are fitted with balance-wheels made of brass and steel and with two cuts in the rim. These two cuts leave the rim segments free to bend inwardly or outwardly when expanded or contracted by a rise or drop (Continued on page 710)

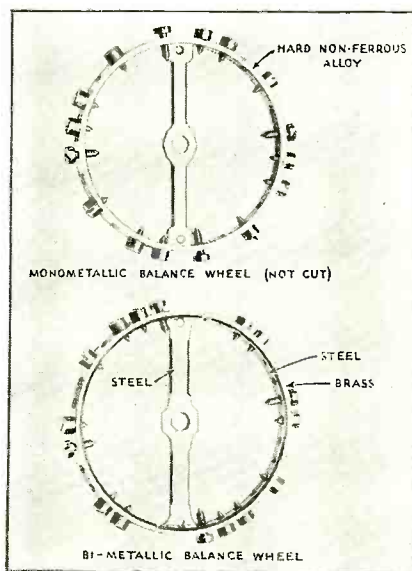

**BALANCE WHEELS**

*A conventional bi-metallic, cut-rim balance wheel and, above, the new type solid rim non-magnetic balance wheel. The latter in conjunction with an elinvar hairspring renders a watch immune against permanent magnetism of these parts*



# Filming Radio Programs

*A description of a new method of producing sound records of news and broadcasting events on standard film that gives promise of higher quality of reproduction. The new film records can carry as many as eight programs on a single strip of standard film. This method is that used at the League of Nations for recording speeches of diplomats*

**H**IGH quality recording of programs, including opera performances, concerts of famous artists, testimony of witnesses, confessions at trials, lectures of great scientists and politicians, important business conferences, records of news events and sports, and important events in the history of the nations, is now possible through the invention of a well-known physicist of the University of Vienna, Dr. Hans Thirring. By Dr. Thirring's new system, known as the Selenophone, sound records lasting as long as forty minutes can be made that are suitable for broadcasting and permit such high quality reproduction that listeners are unable to distinguish between it and the original. The new system records on standard motion picture film.

One of the great difficulties confronting the broadcaster of international events, or even cross country events, is the time difference in the various localities reached by the broadcaster. Another difficulty for large area coverage lies in the fact that it is difficult to determine in advance the exact hour or minute of the event and this necessarily ties up, at present, hundreds or thousands of miles of long-distance telephone lines and often causes halts in programs.

Who knows, for instance, the exact time of arrival of the transatlantic airplane, or who can always be sure of listening in at the correct time to hear an important political session.

By Irving J. Saxl, Ph.D.

Consider an important sporting event which might go on the boards in Madison Square Garden at nine or ten o'clock in the evening in New York City. A San Francisco listener who is interested in this event would have to tune in in the late afternoon, probably just while he ordinarily is traveling home from work on the train. A European radio fan would have to stay up to between two and four o'clock in the morning, depending on the exact location, an hour which is inconvenient even for the modern radio enthusiast.

Until now it was usual to make such transmissions with a microphone and an announcer who was at the place of the event. Now the use of the new sound-film apparatus (without a picture camera) makes possible an entirely new technique for the broadcasting of actual events!

It has been tried before to conserve parts of important programs on record discs. This method, however, had the disadvantage of being limited by the relatively short amount of speech which can be engraved on a record. Furthermore, corrections and selections of the dramatic parts of the event could not easily be made. Last but not least, the quality of the sound is much better with the film method and it is possible to play it over and over again more often and with a greater clearness than a record disc.

With the new sound-recording device the action is fixed on narrow

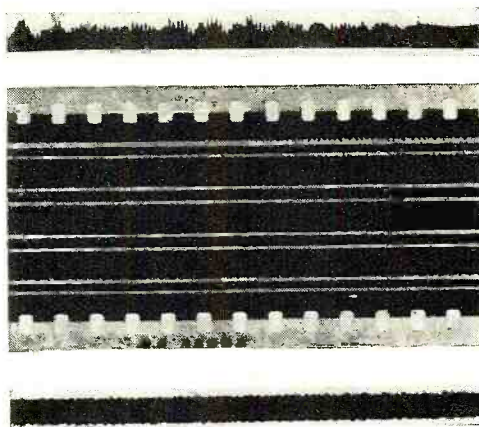

MULTIPLE FILM RECORDS

Figure 6. Top. A reproduction of a single sound track recorded by the Selenophone which operates on the variable-area method. Figure 5. Center. This is a copy of a standard Kodak film upon which eight sound tracks have been placed. Each sound track may be reproduced individually. Figure 7. Bottom. This tiny film carries two programs along the upper and lower edges of the film. Either can be played separately

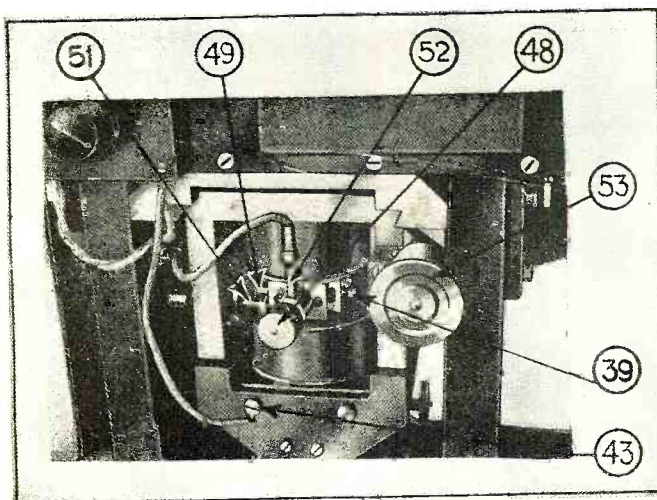

THE VIBRATOR SET-UP

Figure 2. Here is the vibrator mounting inserted between the poles of the electro-magnet with the adjusting screws in place

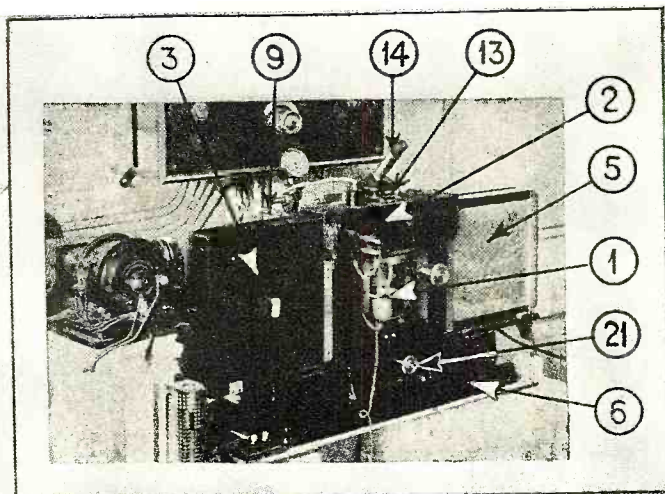

VIEW OF THE RECORDING DEVICE

Figure 8. Here are shown the film holders and the recording compartment with the observer's microscope at the top and the operating motors in the rear



film. From this film a copy is made, the important parts are put together and the *selected* parts of the entire event are reproduced at the predetermined hour which has been announced previously in the radio programs.

**Film Editing**

In addition, the sound-film recording makes possible taking the essential events of the performance and, together with the dramatic interludes of the announcer, to rebroadcast them at a desirable hour and within the time when the listener is available. Radio reporting by this new sound-film method also makes it possible to make use of the art of the dramatic director. By this method unimportant details may be eliminated, the action is concentrated upon the really vital moments of the event and explanations are so injected that the main action may be clearly understood by the listeners. By clever editing it can be arranged that the sound-film record will be much more effective, clearer acoustically and brought within the understanding of the average listener better than in the case of the spontaneous broadcast.

Naturally a speech reproduced by this method will come out much clearer than the sound which strikes the ear of the listener in an average place in the hall where the speech is being made. The special microphone is placed directly before the speaker or carried to the actual event, thus eliminating unimportant sound impressions which have no direct connection with the speech itself.

On one occasion, the rebroadcast of a recent speech by the Roumanian minister Titulescu before the League of Nations, where this "Selenophon" method had been introduced for the first time by the Austrian Broadcasting Company, was understood far better during its rebroadcast in the evening after the meeting, than during the session itself. Those who had not fully understood the minister during the session became acquainted with the exact content of his speech during the "canned" rebroadcast.

**Duplicates Easily Made**

The sound-film method has an additional advantage: It is possible to make *authentic copies of important events* and to mail them to a great number of independent broadcasting stations, who can reproduce them at different times of the program and just at the point where they fit in best.

At the present time most chain transmissions are made possible through special telephone line connections between the separate broadcast stations. This method, however, makes the uses of an expensive line which is capable of transmitting the higher frequencies of speech necessary. This, naturally, in-

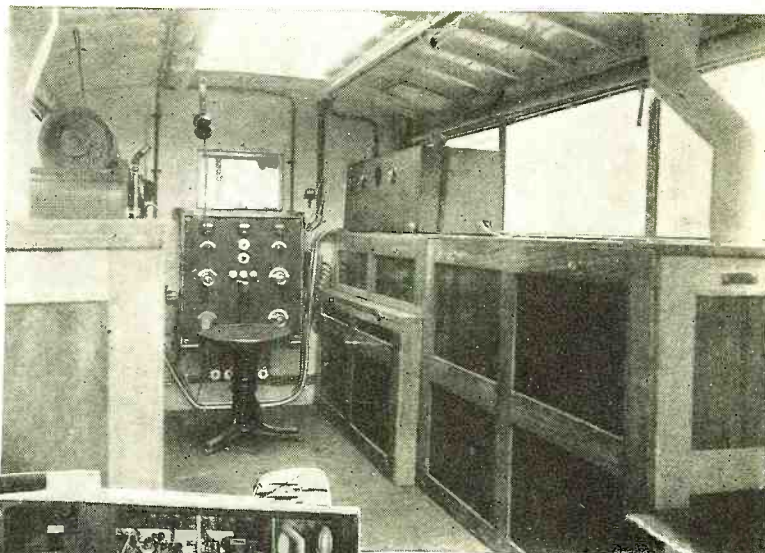

INTERIOR OF THE CAR

The recorder is on a shelf at the left. At center is the switchboard for controlling a number of microphones. At right, the tanks for developing the film immediately after the event on the way to the post office or broadcasting station



COMPLETE OUTFIT IN A BUS

This car travels to the location of the event and records all sounds upon the original tiny film. The apparatus is ready for use the instant the bus arrives on location

creases the cost of transmission considerably. Besides, the programs of different transmitting companies have to be arranged in advance, setting a predetermined hour when these events are to take place. The Selenophon eliminates this cost in chain transmission.

Also the repetition of important speeches can be eliminated. A political candidate can be heard at any time at any place with absolute clearness and without expenditure of undue time and energy. In addition, his speech can be perfected before reaching the public. . . . The time difference between San Francisco and New York can be eliminated in that way.

In the event of international sessions where speeches are

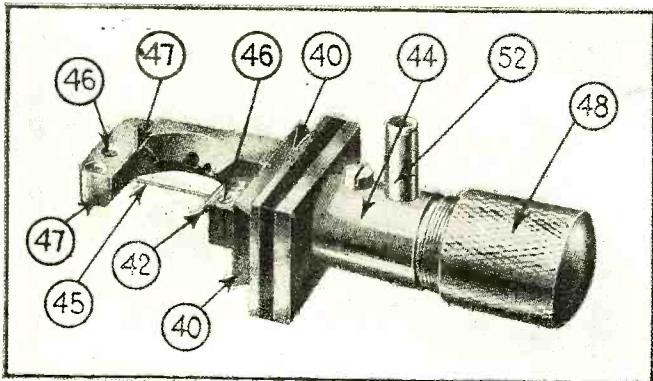

HEART OF THE SYSTEM

Figure 1. Shows the mounting of the string vibrator, one-tenth of a millimeter in thickness

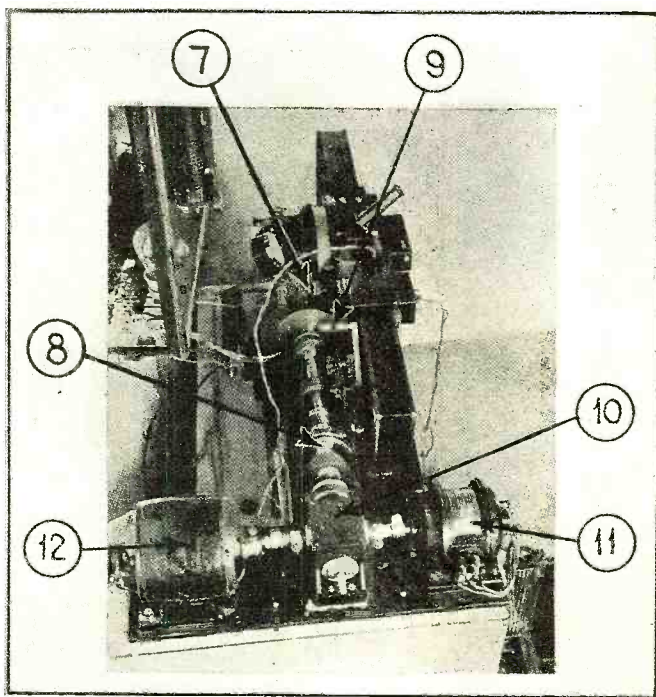

SIDE VIEW OF THE DEVICE

Figure 9. This photograph illustrates the method of coupling the motor drive to the recording apparatus



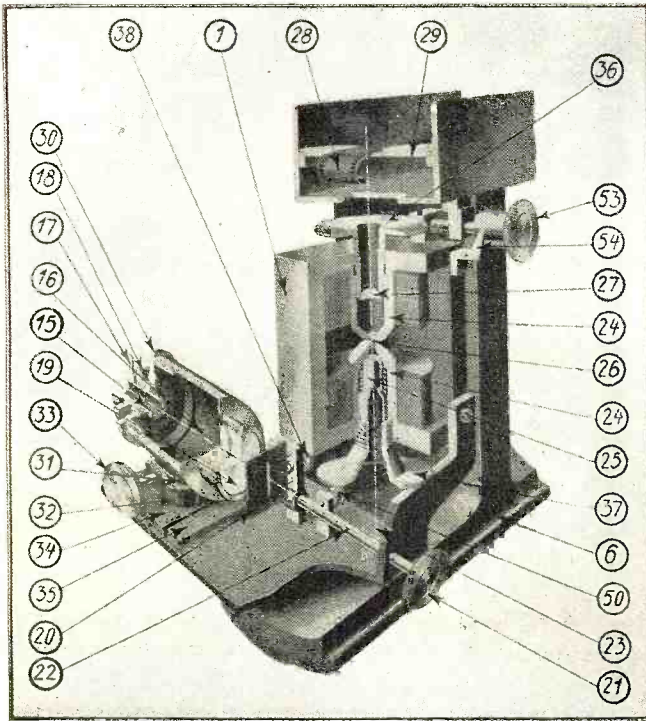

**CUT-AWAY VIEW OF COMPLETE RECORDER**

Figure 4. The various parts encountered along the recording beam of light as it is modulated by the microphone and passes through the film

made and translated in several languages, the time which is necessary to listen to the important parts can be reduced considerably. The speech is recorded on film and only that part of the film with the language of the particular country to which the record is sent, is transmitted. This phase of the problem, though perhaps of little concern to America where English is the only language, is of particular importance in the rest of the world where narrow boundaries separate countries with different languages; and where a French public, for instance, naturally is not interested in the Italian translation of a political speech.

Some excellent recording on film for broadcasting has been done with this new apparatus. This device can be used also for the purpose of general sound recording in the studio. However, the apparatus has been adopted especially for the purposes of broadcasting by its simplicity and easy transportability and especially by its high quality of speech and sound reproduction. A picture shows the complete outfit assembled in a car which was used at the League of Nations in Geneva. In spite of three days of rough traveling from Vienna to Geneva over the minor European roads it was immediately ready for use as it arrived before the house of the League of Nations. This is an important feature for the recording of news events. A sound film or a picture made in the studio can be retaken a number of times till everything is perfect. News events, however, have to be caught at "first sight."

**String Oscillograph Used**

The Selenophone recorder uses as a light-relay a sensitive string oscillograph. The string oscillograph differs from the well-known string galvanometer primarily in that the frequency of the string lies far above 9000 cycles per second; high enough to follow easily every detail of speech and sound and high above the sensitivity of an average needle record upon a disc. The technical perfection of this oscillograph has been due to Mr. Hans Bucek, electrical engineer.

Figure 1 shows the way this string (45) is stretched in a holder similar to a micrometer screw. With a bakelite plate this holder is insulated at one side, so that the electric current can pass through the length (about one inch) of the string. This current is of the order of a maximum of about one ampere, the impedance of the vibration being about .5 ohm or less. The maximum power transferred to the vibrator reaches, therefore, values of the dimension of about .5 watt. The current passing through the string naturally is the microphone

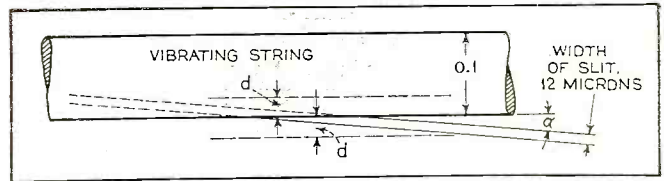

**HOW THE SYSTEM OPERATES**

Figure 3. A tiny line of light is concentrated by the objective lens of a microscope to a thickness of twelve microns. The vibrating string successfully blocks and clears this line of light during its motion

current which has been amplified in the usual way to reach the necessary power. This vibrator is connected to the amplifier by means of a transformer, matched to the impedance of the last amplifier tube. The other windings must be well adapted to carry the relatively strong currents of this step-down transformer, the average ratio of which is about 60:1.

The plug 52 serves to connect the string with the output of the microphone amplifier, the second connection being made by the metallic body of the device.

The metallic string, about one-tenth of a millimeter in diameter, is stretched by means of the screw 48. In case a replacement of the string should become necessary, it can be exchanged easily by removing the screw 46 which holds it in proper position during insertion by the centering holes in the plates 47. Number 40 are the two guides by means of which the string holder is slipped into the magnetic field of the oscillograph.

**Physical Operation**

Figure 2 gives a detailed view of this part of the apparatus. From the string holder which is now inserted in the oscillograph the micrometer screw 48 and the connecting plug 52 are seen protruding. They are lying between the pole shoes of a strong electromagnet, the windings of which are clearly visible. The strong magnetic field is traversed by the amplified microphone currents which correspond to the sound vibrations. The vibrator, therefore, will be displaced laterally by the electro-dynamic forces, according to the amplitudes and frequencies of the alternating microphone current. As the natural frequency of the vibrator is higher than any frequency which could be recorded mechanically by a needle and higher than the highest frequency to be recorded, the record will exactly follow the original. On the other hand, as the vibrator oscillates in a homogeneous magnetic field with relatively small amplitudes of the string, there is practically a perfect proportion between the characteristic of the alternating microphone current and the oscillation of the (Continued on page 719)

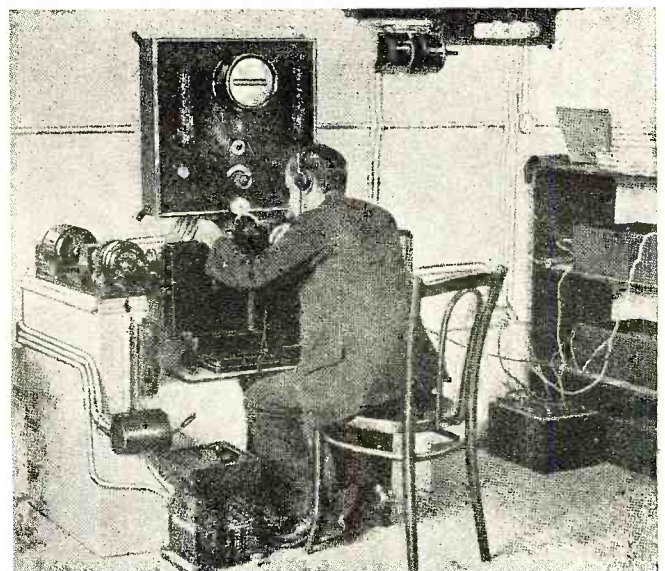

**OPERATOR CONTROLLING A RECORDER**

Making a record on film with the Thirring apparatus. The operator wears headphones in monitoring the sound as it is being recorded



# New All-Wave Super Features High-Gain Design



THE AUTHOR TESTING THE NEW RECEIVER

As will be noted from this view, the receiver is compact in size and neat in appearance. Tuning is substantially single control, but verniers are provided for high precision tuning

Six tuned i.f. circuits and "low-loss" design in both the r.f. and i.f. circuits provide unusual selectivity and high gain. The second oscillator, a unique feature, permits c.w. reception and simplifies tuning of distant broadcast stations by the heterodyne beat method

**D**ISTANCE work has always bristled with intrigue. With short waves and their attendant globe-circling characteristics, the fascination becomes even greater, especially so when suitable receiving equipment is at hand.

The new all-wave superheterodyne receiver, the "Comet," certainly seems to fill the precision requirements for real short-wave work, and for broadcast work as well. The result of a year and a half of intensive laboratory research and experimentation, the "Comet" is truly representative of outstanding design. The following paragraphs set forth the marked engineering advances which have been incorporated in this new receiver. And by the way, it is a custom-built

By Lewis W. Martin\*

project, a Hammarlund-Roberts characteristic which has now become a by-word in radio.

An eight-tube model, it uses two -27's as oscillators, two -24's as detectors, two -35's (variable- $\mu$ ) as intermediate-frequency amplifiers, a -47 (pentode) in the resistance-coupled audio amplifier, and a type -80 as rectifier.

The intermediate-frequency stages use a newly developed band-pass tuning method, to afford extreme sensitivity and selectivity with real fidelity of reproduction.

A feature of the receiver is the variable tone control. This clever device also aids in the elimination of noise. Another unique and interesting feature is the second oscillator, which serves a dual purpose. By putting this

\*Hammarlund-Roberts, Inc.

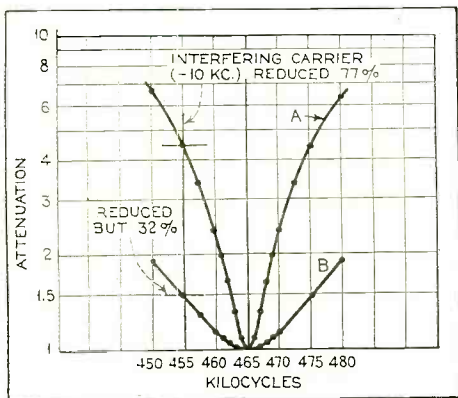

EFFECT OF COIL EFFICIENCY

Figure 2. Curve A, selectivity of i.f. circuit using a "Litz" wound coil. B, an ordinary coil of equal inductance, but four times the resistance

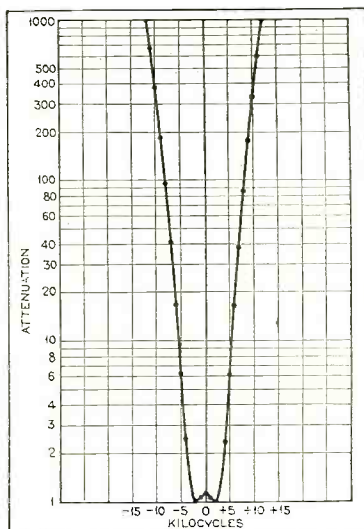

OVERALL SELECTIVITY

Figure 4. This curve represents the calculated overall selectivity of the three i.f. stages employed

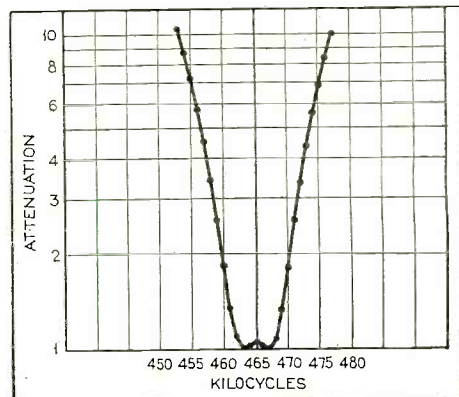

SINGLE-STAGE I.F. SELECTIVITY

Figure 3. Actual selectivity of single intermediate frequency transformer as used in the receiver described in this article



tube into play, distant stations on both broadcast and short waves can be located with utmost simplicity by the heterodyne beat method. Also, it permits reception of c.w. signals (code).

The major tuning control is supplemented by two fool-proof mechanical verniers, one for each condenser for precision tuning and located on each side of the control knob. Incidentally, the projection scale method, which affords magnification of the scale indications, is used. This, of course, provides easy selection of stations.

**Special Coil Forms**

For maximum efficiency, special Isolantite-form, plug-in coils are used. These permit full coverage of all the bands, including broadcast. There are five sets of coils, two coils to a set, having the following ranges: 15 to 30, 28.5 to 62.5, 58.8 to 130; 120 to 273, and 240 to 550 meters.

A new Hammarlund speaker has been designed for use with this all-wave receiver. It derives all the necessary power for energizing its field coil from the set. The speaker is so engineered as to afford truly rich reproduction throughout the entire audible frequency range.

A special cabinet of Oriental burl walnut is provided for this receiver. A hinged lid is a feature of the cabinet. This permits easy access for changing of the plug-in coils. Incidentally, pockets are provided for the housing of each coil.

The chassis is 19 inches long and 11 3/4 inches deep. The receiver operates on 110 volts, 50 to 60 cycles.

The superheterodyne has often been referred to as the "king" of radio receivers, chiefly because its circuit simplifies the problem of obtaining uniform radio-frequency amplification of almost any desired amount and at the same time a high order of selectivity which is also substantially uniform over a wide band of signal frequencies. In the early days, the first-named advantage was the most im-

portant, because radio-frequency amplification at signal frequencies of 500 kc. or over was practically unknown and almost impossible with the tubes and equipment available at that time. Since the advent of screen-grid tubes, gang condensers and elaborate shielding, however, r.f. amplification at frequencies within the broadcast band is easily accomplished. Therefore, the outstanding advantage of the superheterodyne at present is in the matter of selectivity. While this advantage is not negligible at the comparatively low frequencies of the broadcast band, its effect at the high frequencies involved in short-wave reception is truly remarkable. This follows from the fact that the ability of a tuned circuit (or series of tuned circuits) to discriminate between a desired signal and an interfering signal depends entirely on the percentage difference between their two frequencies, not the actual difference in kilocycles. However, the international frequency allocations are not separated by a percentage difference but rather by a specific number of kilocycles (usually ten) even at frequencies as high as 20,000 kc. (15 meters). It can be shown that a series of tuned circuits possessing good discrimination between two signals on adjacent channels (say 1000 kc. and 990 kc.) must be of very high quality, as the percentage difference is only 1%. Assuming it to be possible to build a series of circuits of the same efficiency to operate say in the 10,000 to 20,000 kc. band, it would be practically impossible to separate two stations operating at 15,000 kc. and 14,990 kc., since the percentage difference is but 1/15 of 1%.

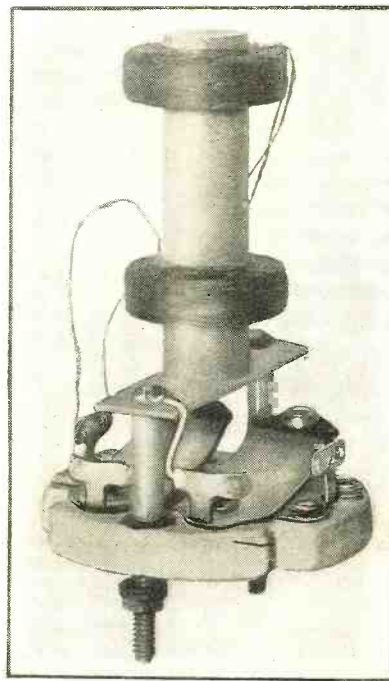

ONE OF THE I.F. COILS  
Both the primaries and secondaries of all i.f. coils are tuned, making a sharply tuned amplifier of high gain

This principle is clearly illustrated in Figure 1. Curves A, B and C represent the tuning characteristics of single tuned circuits resonant at 1000 kc., 5000 kc. and 15,000 kc., respectively. The power factor of all three circuits is assumed to be .01 (Q 100), which is reasonably good (Continued on page 708)

The tuning characteristics of single tuned circuits resonant at 1000 kc., 5000 kc. and 15,000 kc., respectively.

The power factor of all three circuits is assumed to be .01 (Q 100), which is reasonably good (Continued on page 708)

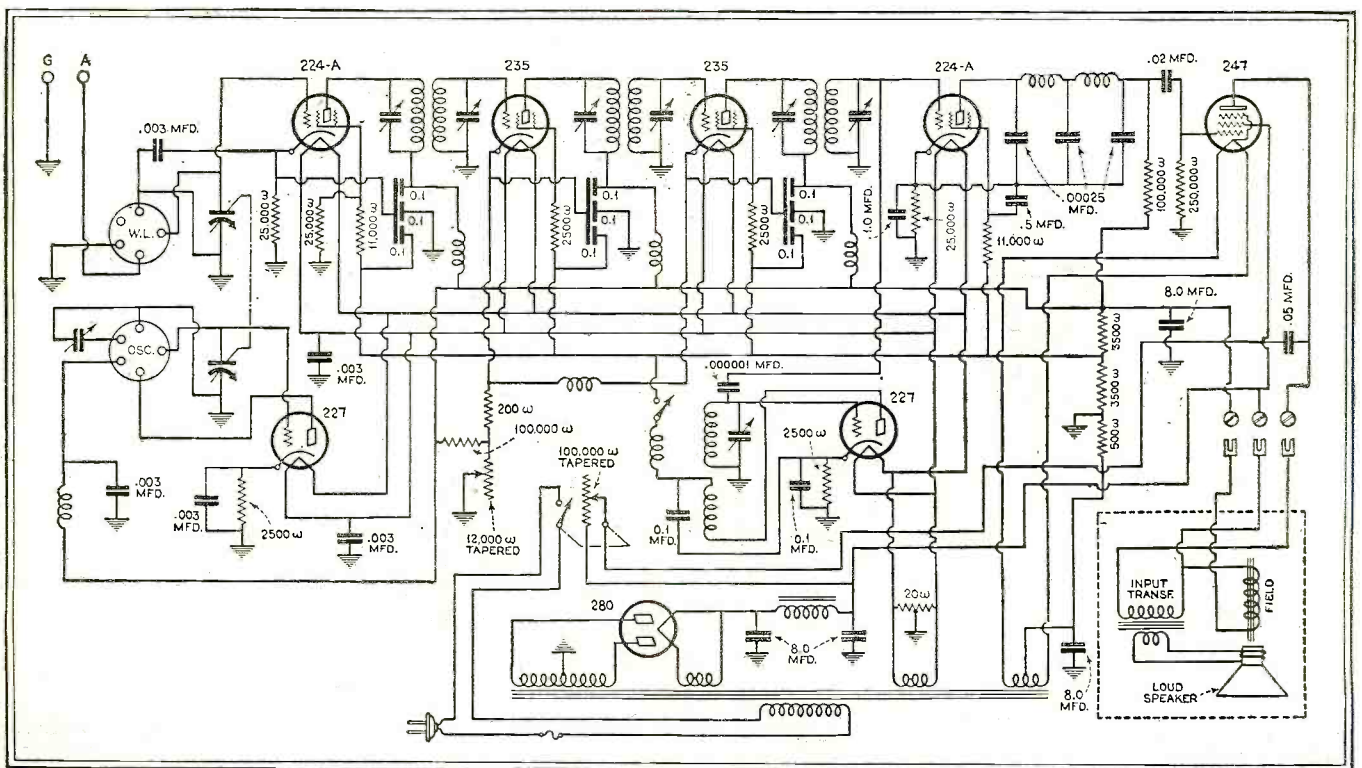

THE SCHEMATIC DIAGRAM

The second oscillator circuit, which includes the -27 tube in the center of the diagram, is coupled in to the last i.f. grid circuit, to beat with the intermediate frequency for heterodyne beat and c.w. reception



# SIMPLICITY OF INSTALLATION A FEATURE OF New Motor Radio Design



*New 6-tube receiver mounts on steering column by means of clamps and utilizes a condenser type antenna mounted under either running board*

AN UNUSUALLY COMPACT RECEIVER  
*The author demonstrates the operation of the remote control*

**I**T is the purpose in this article to give a technical description of one of the newest auto radios, a receiver which is so designed as to be unusually simple in installation and practical in operation.

**By Justus W. Berge**

*Part One*

The complete outfit, which is known as the Marquette Motor Radio, consists of the completely assembled and wired receiver, measuring ten inches in length, seven inches in width and having a total depth of five and a half inches; a one-hole mounting dynamic speaker; a two-hole mounting antenna, which is placed under a running board, and a set of suppressor resistors and condensers.

any radical departures from the conventional tuned r.f. circuit. It uses three -36 type screen-grid tubes, one -37 type general purpose tube and two -38 type

pentodes. These tubes are designed especially for use in automobile receivers and their filaments are made to operate on a voltage of 6.2 with a drain of .3 ampere for each tube.

The total drain on the storage battery of the car is 2.8 amperes, including the dynamic speaker field drain of 1 ampere. Using 180 volts of B supply, the six tubes have a drain of 30 milliamperes. At 135 volts B the drain is 20 milliamperes.

The entire installation can be made in approximately one hour and, in view of the time and labor needed in the installation of other auto receivers, this is indeed a decided advance step in auto-radio equipment design. The feature of this set is that the receiver proper is mounted on the steering post, underneath the dashboard and above the brake and clutch pedals.

A three-gang tuning condenser is employed, each section having a compensator which is accessible from the outside of the receiver after installation. The radio-frequency coils are wound in forms one inch in diameter and two inches high and are enclosed in aluminum cans having a diameter of two inches. The leads come out of the bottom of these cans for sub-base wiring.

With but a few variations from the standard in obtaining cathode and screen-grid voltages, the circuit does not contain

The physical layout of the parts on the chassis is such as to reduce wiring to a minimum. Short leads are stressed throughout. Wiring is greatly facilitated by the fact that the

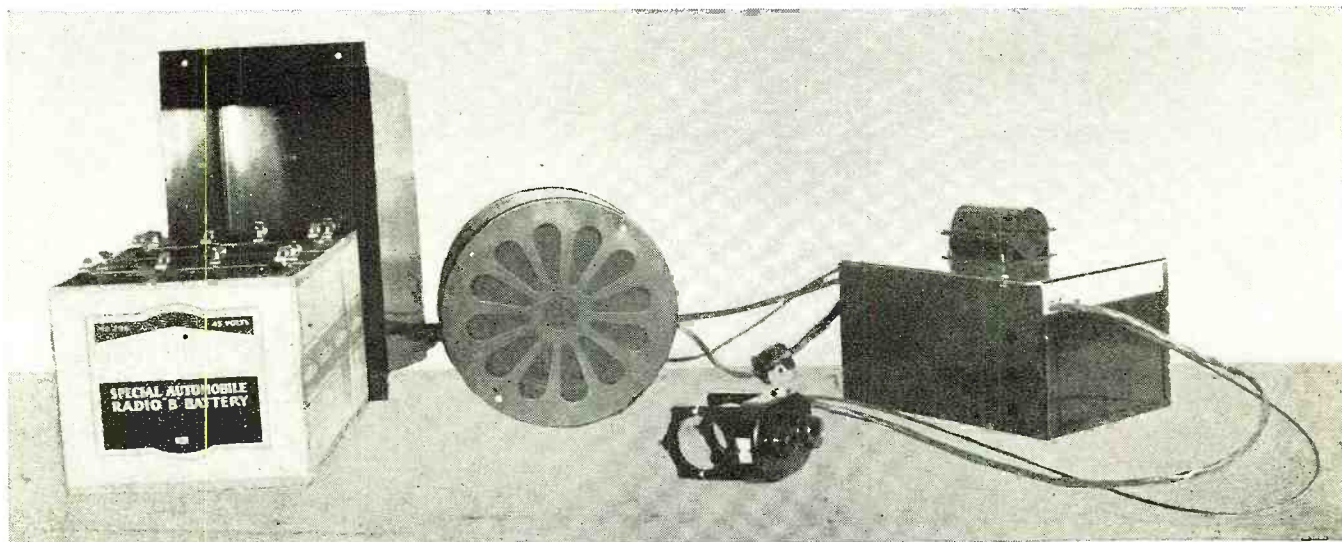

THE EQUIPMENT READY FOR INSTALLATION

*The receiver is shown with the steering post clamp attached. In the foreground is the remote control unit. The B batteries are the new type, especially designed to withstand the rigors of automobile use*



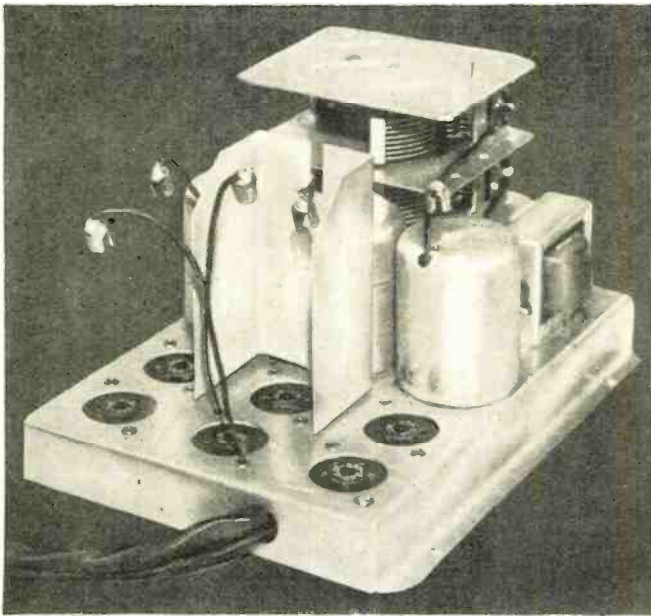

**CLOSE-UP OF THE CHASSIS**

The receiver employs six tubes, including two pentodes in the push-pull output stage

chassis of the receivers is grounded to the negative side of the B battery. Twenty-one leads from various parts are grounded directly to the chassis as they emerge from their own housings.

For signal pick-up a metal plate is used under a runningboard of the car. A capacity effect is thereby produced. Theoretically, the aerial system is an antenna-counterpoise type, with the body of the car acting as the counterpoise. This system, although in many quarters considered to be inferior to an antenna arrangement where wire mesh is placed in the roof of the car, has been found to produce ample radio-frequency pick-up to give the desired results when used with this receiver.

The antenna circuit is tightly coupled to the closed circuit of the first radio-frequency stage. This, in effect, produces a signal which is somewhat broader than the one received on a se-

designed for the home. This feature is considered an asset to a motor radio, where extreme sharpness would lessen the intensity of the incoming signal and might make it difficult to keep a station tuned in while the car is in motion.

Both of the tubes used in the radio-frequency end use the full B voltage on their plates. Screen-grid voltage is obtained through a 50,000-ohm resistor (R1). This circuit is by-passed to the ground through a .1 mfd. condenser (C8).

Cathode voltage is obtained through two resistors having a total ohmage of 20,300 (R5, R6). The variation of R6 is used to regulate the volume of the receiver. Contained in the remote control, this resistor bank is composed of a fixed value of 300 ohms (R5) and a variable one of 20,000 ohms (R6). A .1 mfd. condenser (C7) which is used as a by-pass to ground completes the circuit.

**Resistance Coupling**

The signals pass into the screen-grid detector tube, whose plate operates at a potential of 90 volts. The voltage drop is obtained through a 500,000-ohm resistor (R3). An r.f. choke in the plate lead lessens the oscillation tendencies of the tube by keeping r.f. currents out of the audio end. The conventional r.f. by-pass to ground condenser is used (C11). It has a capacity of 250 mmfds. An unusual feature is the voltage applied to the screen of the tube. It is obtained from the A positive side of the filament voltage and is therefore 6 volts. The cathode voltage is obtained through a resistance of 25,000 ohms (R2) which is shunted by a fixed capacity of .1 mfd. (C9).

Both for compactness in eliminating an additional audio-frequency transformer and for the sake of quality, resistance-coupled amplification is used in the first audio stage. Its component parts are the fixed capacity of .006 mfd. (C12) and a 500,000-ohm resistor (R4). In this tube the cathode is connected to the positive side of the A supply, thereby establishing the effect of a negative bias of 6 volts on the grid.

The final audio stage utilizes two power pentodes in push-pull with the full B voltage applied to both their plates and screens. The regulation C bias is obtained through a 500-ohm resistor (R7) connected between the cathodes of the tubes and ground.

The speaker cable, which is shielded and grounded to the car chassis, contains five wires and connects to the chassis through a five-prong plug and socket. Two leads carry the output of the pentodes to the primary of the (Continued on page 734)

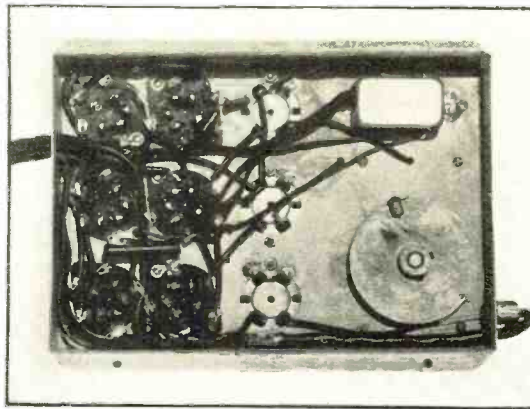

**THE UNDER SIDE OF THE CHASSIS**

In the lower right-hand corner is the spring-counter-balanced pulley used in the remote control tuning system

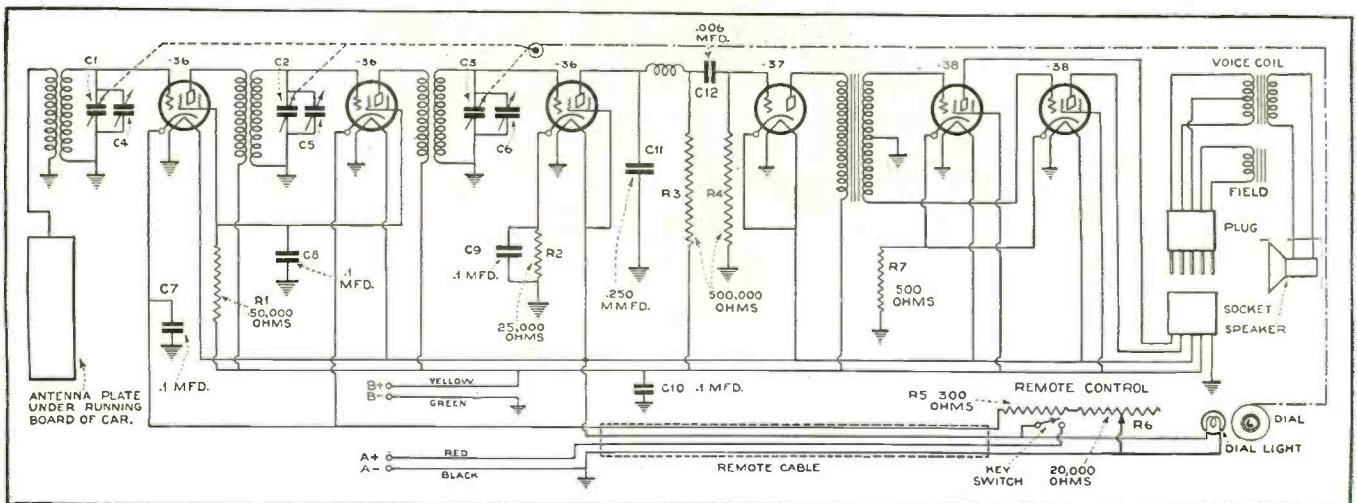

**THE SCHEMATIC CIRCUIT DIAGRAM**

Figure 1. The tuning condensers are operated by a mechanical remote control unit, mounted on the steering post, just below the wheel. This unit also includes a key-operated on-off switch and the volume control



“To my surprise each time a meteor flashed . . . . . there came through the receiver a sound like the crash of static”



# Do Meteors Cause Static?

*An interesting account of the experience of a California engineer that seems to indicate an electrical relation between meteors, thought to be fragments of comets, and the radio disturbances familiar to all listeners-in*

By John Cage

**Q**UITE by accident I have discovered what seems to be an affiliation between meteors (and meteorites entering the earth's atmosphere) and static. This affiliation seems to me so definite, so convincing, that it may influence radio experts and scientists in their quest for the sources of annoying receiver disturbances.

Although the connection between meteors and static was established accidentally, a number of scientific men with whom I have since discussed the phenomenon believe with me that the discovery is likely to lift the veil from a mystery that has perpetually involved the attention of radio engineers. Since another clue to the nature of static disturbance is now indicated, it may provide the nucleus for further investigations.

I was seated in my home at Pacific Palisades, on the ocean's edge near Los Angeles, listening in on general programs with a standard 9-tube superheterodyne. If you will associate your calendar with astronomy you will find that during the middle of August, 1931, the time was most propitious for viewing the bombardment of Perseid meteors through which the earth was at that time passing. The Perseids are a swarm of shooting stars appearing annually during August. They are thought to be fragments from Swift's comet.

At frequent intervals a series of crackling noises came from the set that indicated a loose connection. I went thoroughly over the "super" and found nothing that should cause the disturbance. Yet the crashes continued to be emitted.

Suddenly I remembered a newspaper article that told of the Perseid meteor flock through which the earth is passing in mid-August. Could the noises come from that source?

There was only one thing to do, and that was to try and find out. So I quickly got several lengths of wire and made an extension so the set could be placed on the front lawn with an

unobstructed view of the heavens. I put the receiver on a table and sat myself down in a wicker chair and waited, gazing intently into the night sky.

To my surprise, each time a meteor flashed through the skies there came a sound like a crash of static through the receiver. Not seconds later, as in the case of a cannon being fired at a distance, but simultaneously with the streak of light in the heavens. This would apparently indicate the electrical nature of the meteor's friction with the atmospheric envelope of the earth. Had the noise been merely due to friction alone without any electrical content, the noise would have followed later, and even then it would not have come through the set.

Meteors are supposed to gain visibility at an average height of about 50 to 75 miles above the earth's surface, according to present scientific theory.

Rarification of the air at 50 miles is about 20 inches of mercury, and probably much nearer an absolute vacuum. The temperature 10 miles above the earth as determined by the German balloonists was 148 degrees Fahrenheit below zero. It is probably not too much to expect a temperature of minus 200 degrees at 50 miles.

According to my theory, formed as a result of my discovery, meteors may become luminous not because they

are red-hot, but because in passing through or coming in contact with the rare upper gases about the earth, they illuminate this gas by ionization.

Meteors have been found that were covered with ice, soon after they reached the earth. This may be taken as exploding the theory that they are hot. The big meteor that fell some years ago in India is the classic example of a meteor that came to earth with a covering of several inches of solid ice, attesting to the terrific cold of interstellar space.

It is true that a number of meteors (*Continued on page 734*)





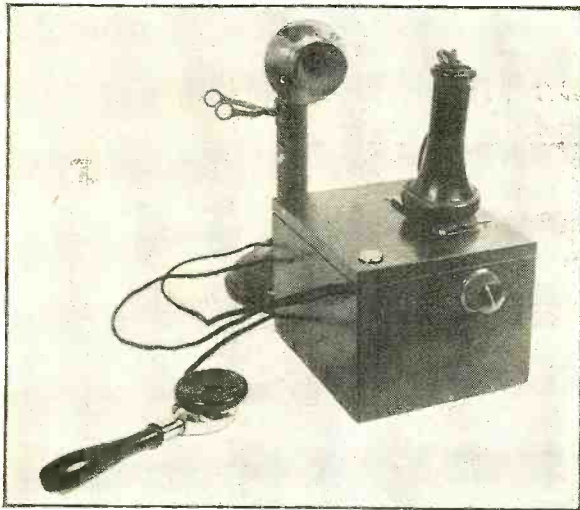

#### THE BOOSTER COMPLETED

To use the Booster, remove the telephone receiver from its hook and place it on the metal-plate switch. This turns on the Booster and the amplified conversation is heard through the Booster headphone. When finished talking the receiver is lifted off the switch and replaced on the hook, thus automatically turning off the Booster battery supply

# The Radio News TELEPHONE BOOSTER

*This, the second of the constructional articles on vacuum-tube aids for the partially deaf, provides complete instructions for building a simple amplifier which can be readily attached to any telephone*

**T**HE inability to hear distinctly over a telephone is one of the hardships imposed upon many of those who are afflicted with various degrees of deafness. Fortunately, many persons who are so deaf that they can take part in ordinary conversation only with the greatest difficulty, find that they can "get by" when listening to conversations over a telephone. But even required to hear such conversations involves such a strain that they are inclined to shun the telephone except in cases of absolute necessity.

Probably every hard-of-hearing person who owns an electrical hearing aid has at one time or another attempted to use it in conjunction with a telephone by holding the hearing-aid microphone against the telephone receiver in order to take advantage of the additional amplification provided by the hearing aid. In practically every case this attempt has proved futile. True, the hearing aid used thus increases the volume of sound, but the voice coming through the combination of the telephone and hearing aid is so distorted as to make it all but impossible to understand. The explanation of this distortion lies, of course, in microphonic and resonance effects and in the dissimilar tone-frequency characteristics of the telephone and the hearing device.

#### Commercial Types of Telephone Aids

There are non-electrical devices on the market which are expressly intended for use with the telephone and for the most part base their usefulness on their ability to carry the sound directly into the ears by means of a pair of tubes similar to those of a physician's stethoscope. Some of these devices offer practical help—particularly to those who can hear quite well over the 'phone without assistance.

A simple vacuum-tube amplifier offers a most practical type of device for use with the telephone. If the component parts for the amplifier are properly selected, the telephone conversation is brought to the ear of the listener in its full, natural tone, or perhaps with slight emphasis of the higher sound frequencies, such as those which make up the sound of the letter

By S. Gordon Taylor

"s," which the average deaf person is likely to miss entirely. The vacuum tube serves to increase the volume of sound to several times its original intensity.

It was after a careful study of the requirements for equipment for such service that the author set about designing a simple amplifier which would enable even very deaf persons to hear distinctly over any telephone. The outcome of this study

is presented here in the form of a descriptive article from which anyone with any experience in radio construction can readily duplicate the RADIO NEWS Telephone Booster. For those who may need such a device, but hesitate to undertake the actual construction, the job can be turned over to any local radio serviceman or dealer.

The Booster consists fundamentally of a single vacuum tube, an input transformer to match the impedance of the telephone instrument to the input of this

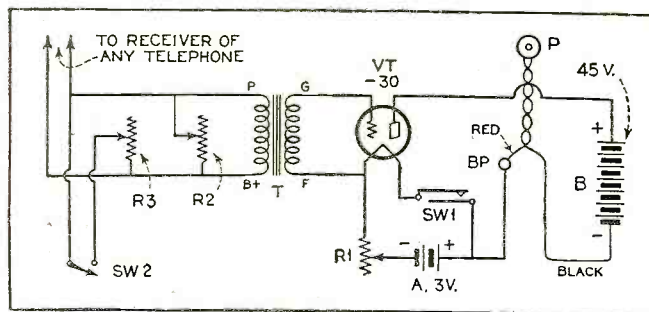

THE CIRCUIT DIAGRAM

Figure 1. The Booster consists of a simple one-stage amplifier, the input of which is connected in series with the regular telephone receiver

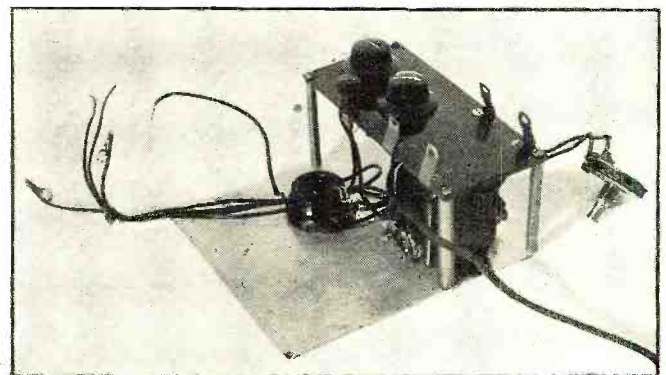

THE FINISHED CHASSIS

Figure 2. This picture gives a good idea of the extreme simplicity of construction. The fittings, including the metal base, shelf, supports and battery clips, may be purchased all cut and drilled ready for use



vacuum tube, and a headphone. The transformer input (the input circuit of the Booster) is connected in series with the telephone receiver, the connection being made inside of the receiver shell as shown in Figure 3. The Booster may be left permanently connected in this manner without in any way interfering with the ordinary use of the telephone. That is, any conversation will be heard the same as before when the regular telephone receiver is placed to the ear. But when greater volume of sound is required, the headphone in the output of the booster is placed to the ear.

*Design Details*

The foregoing is the basic description, but the Booster includes many refinements of design detail intended to provide the utmost in convenience, utility and comfort. For this reason a more detailed description will be of interest.

Inasmuch as the unit will be left permanently attached to a telephone, there is no pressing need for portability. On the other hand, it was considered only logical to make it as compact as it could be made without sacrificing any important features. Whether it is to be used on a telephone table or on a desk, small size is unquestionably an advantage. It was considered likewise important to enclose the entire amplifier equipment and batteries in one case. This immediately indicated the desirability of using a vacuum tube which would permit the use of dry cells for the filament supply voltage and a moderately low B battery voltage. The type -30 tube was decided upon to fit this requirement and it offered the additional advantages of relatively small size and high amplification.

The next consideration was the input transformer. The one selected is especially intended for coupling a microphone to the grid circuit of a vacuum tube. The telephone receiver circuit into which

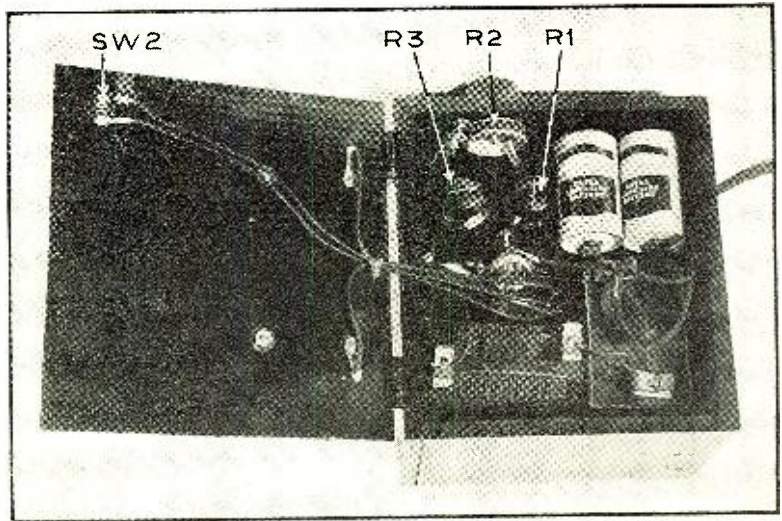

INSIDE VIEW OF THE BOOSTER

*The rheostats R2 and R3 rarely need readjustment and are therefore mounted inside the case. When the flashlight cells wear out they are slipped out of the clips and replaced with new ones—being sure that the brass caps are toward the front wall (on which R2 is mounted)*

## Helping the Deaf to Hear

**T**HERE has been little information available concerning design details of hearing aid equipment, other than that contained in the literature of individual manufacturers. It is because of this scarcity of information that RADIO NEWS presents the series of articles, of which this is the fourth. The first two, published in the November and December issues, covered commercial types of equipment. The third, in the January issue, provided complete constructional details on the RADIO NEWS Ear Aid, a vacuum-tube hearing aid that a deaf person with only a slight knowledge of radio construction can easily build at home. The present article provides data on a telephone amplifier that will prove helpful to many who are so deaf that ordinary telephone conversation is difficult.

It is hoped that these articles will inspire many to investigate the possibilities offered by hearing aids, to the end that they may overcome the distressing handicap of deafness.

—The Editors.

the Booster is connected has approximately the same impedance as a standard microphone circuit and the transformer selected is therefore well adapted for this service. It is also moderately small in size—as small as could be obtained without too great a sacrifice in sound frequency characteristics.

The batteries employed in the Booster consist of two of the midget type 22½-volt B blocks. The plate current drain of the type -30 tube used under the conditions obtaining in this equipment is less than 1 milliamper. These

midget type B batteries will, therefore, have a life of a year or more.

For the filament supply, it was at first intended to use a pair of standard No. 6 dry cells, but on second consideration it was decided that a pair of flashlight batteries would serve admirably. Ordinarily a person does not actually talk over the telephone more than a few minutes a day, and the flashlight cells should therefore provide several months' service before replacement becomes necessary.

### The Headphone

The headphone used was selected because of its combined sensitivity and the clear quality of its voice reproduction. It is adaptable for use either with a headband or with a handle—or it may be used without either.

In the tube filament circuit a 50-ohm rheostat has been included. Once this rheostat has been set it requires readjustment only at long intervals and for this reason has been placed inside the case. The volume control rheostat, on the other hand, will require more frequent adjustment and is therefore placed on the outside, where it is always accessible. This volume control is connected across the input of the Booster, as shown at R2 in the diagram, and will provide complete control of volume from zero to full output.

It will be noted that no (Continued on page 731)

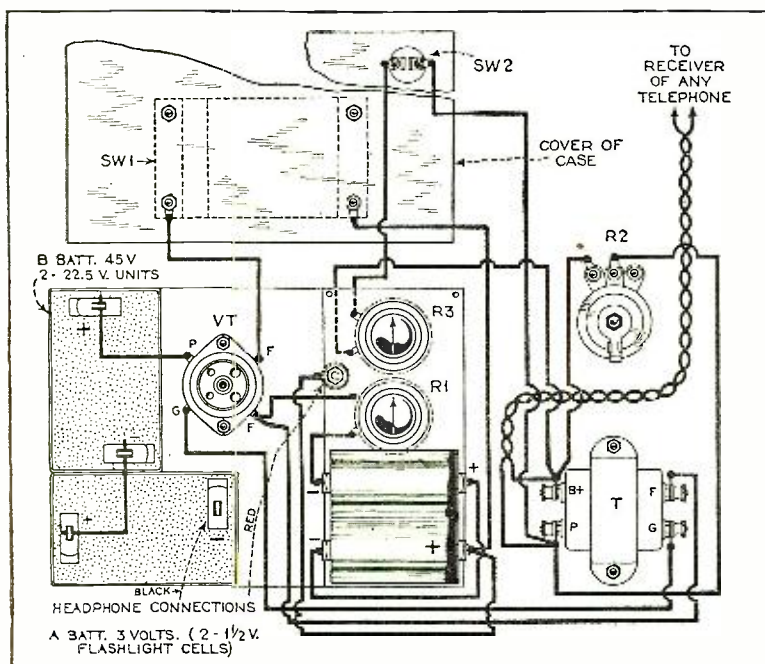

THE PICTURE-WIRING DIAGRAM

Figure 6. From this diagram even the novice can wire the Booster without difficulty



# Electric Filter Design

*The importance of electric wave filters in radio communication both in transmitter and receiver design cannot be overestimated. The following article, second of a comprehensive series, deals with the consideration of image impedances, attenuation characteristics, and transfer loss or gain in inserting filters into a line*

By C. A. Johnson\*

Part Two

It can be shown that if two filters are equivalent when connected between any two impedances they are also equivalent when connected between any other two impedances.<sup>1</sup> This provides an easy way to find the image impedances of a filter. To do this it is only necessary to measure the impedance looking into one end of the filter with the terminals on the other end "open" and then to measure the impedance looking into the same terminals with the terminals on the other end "closed." The image impedance of a filter is then the square root of the product of these impedances. To find the mid-series image impedance  $Z_I$  of the half-section filter shown in Figure 4 (C) in Part I, December issue, measure the impedance looking into the 1-2 terminals with the 3-4 terminals open and then again with the 3-4 terminals shorted. Although the derivation is beyond the scope of this paper, it is readily shown<sup>1</sup> that the mid-series image impedance is

$$Z_I = \sqrt{Z_{OC} \times Z_{SC}} \quad (1)$$

where  $Z_{OC}$  and  $Z_{SC}$  are impedances looking into the 1-2 terminals when the 3-4 terminals are open-circuited and short-circuited, respectively.

Similarly, it is true that the mid-shunt image impedance of Figure 4 (C) (December issue) is:

$$Z_I' = \sqrt{Z'_{OC} \times Z'_{SC}} \quad (2)$$

where  $Z'_{OC}$  and  $Z'_{SC}$  are the image impedances looking into the 3-4 terminals when the 1-2 terminals are open-circuited and short-circuited, re-

spectively, while the symbols used in the above equations refer to the Figures 3 and 4 (December issue), it should be understood that any network of unknown configuration has image impedances and they may be found by making the open and short-circuit measurements and applying equations (1) and (2). These formulæ are useful to the engineer, especially in determining the reflection losses occurring at a junction point.

In speaking of the attenuation characteristics of filters, it is very convenient to use a logarithmic unit. Also, we are not usually as concerned, in radio work, with the absolute value of currents and voltages as we are with their relative values. So telephone engineers have agreed to use the term "decibel"<sup>2</sup> to state how much larger one voltage (current or power) is than some other voltage (current or power). The number of decibels one voltage  $V_1$  (or current  $I_1$ ) is greater than another voltage  $V_2$  (or current  $I_2$ ) is stated by the equation

$$N_{db} = 20 \log_{10} \frac{V_1}{V_2}$$

$$\text{or } \frac{V_1}{V_2} = 10^{\frac{N_{db}}{20}} \quad (4a)$$

and

$$N_{db} = 20 \log_{10} \frac{I_1}{I_2}$$

$$\text{or } \frac{I_1}{I_2} = 10^{\frac{N_{db}}{20}} \quad (4b)$$

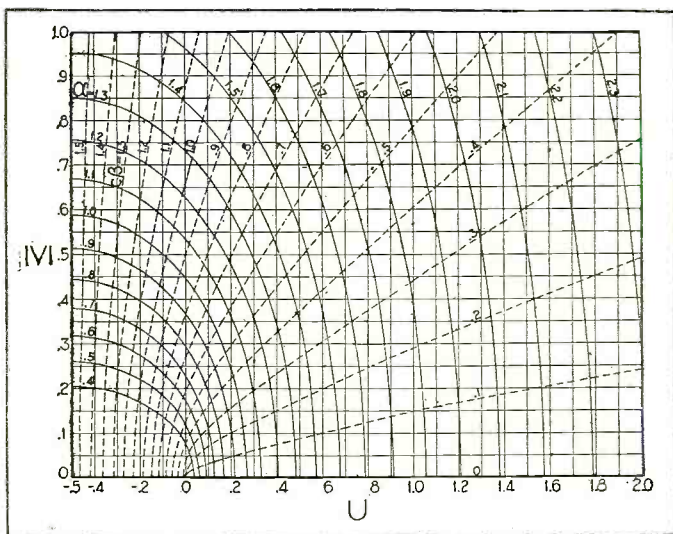
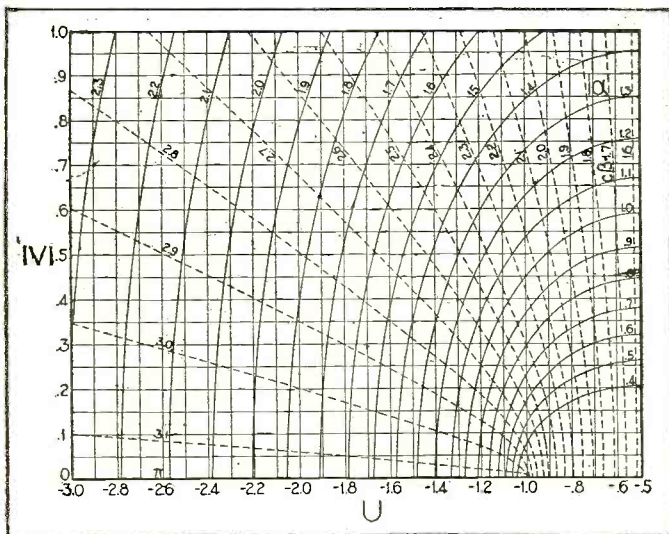
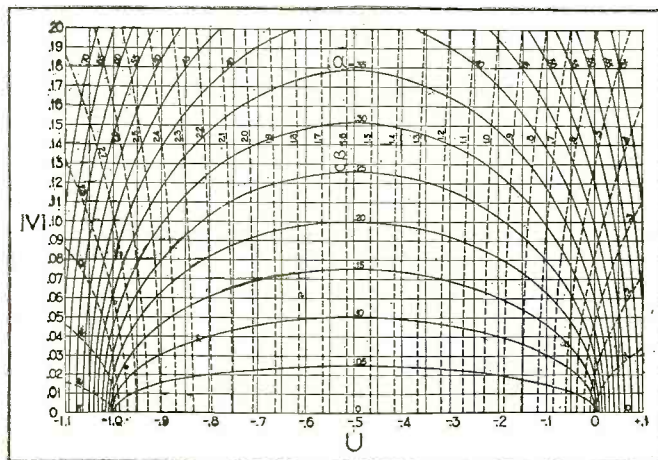

ATTENUATION AND PHASE

Figures 5, 6 and 7. Curves showing relation between the attenuation  $\alpha$  and phase  $c\beta$  and  $\frac{Z_1}{Z_2} = U + jV$ .

$c = \pm 1$  has the sign of  $V$ .



Decibels	$\frac{I_1}{I_2}$ or $\frac{V_1}{V_2}$	$\frac{P_1}{P_2}$	$\frac{I_2}{I_1}$ or $\frac{V_2}{V_1}$	$\frac{P_2}{P_1}$	Decibels	$\frac{I_1}{I_2}$ or $\frac{V_1}{V_2}$	$\frac{P_1}{P_2}$	$\frac{I_2}{I_1}$ or $\frac{V_2}{V_1}$	$\frac{P_2}{P_1}$	Decibels	$\frac{I_1}{I_2}$ or $\frac{V_1}{V_2}$	$\frac{P_1}{P_2}$	$\frac{I_2}{I_1}$ or $\frac{V_2}{V_1}$	$\frac{P_2}{P_1}$	Decibels	$\frac{I_1}{I_2}$ or $\frac{V_1}{V_2}$	$\frac{P_1}{P_2}$	$\frac{I_2}{I_1}$ or $\frac{V_2}{V_1}$	$\frac{P_2}{P_1}$
.1	1.012	1.023	.9886	.9772	5.1	1.799	3.236	.5559	.3090	10.1	3.199	10.23	.3126	.09772	15.1	5.689	32.36	.1758	.03090
.2	1.023	1.047	.9772	.9550	5.2	1.820	3.311	.5495	.3020	10.2	3.236	10.47	.3090	.09550	15.2	5.754	33.11	.1738	.03020
.3	1.035	1.072	.9661	.9333	5.3	1.841	3.388	.5433	.2951	10.3	3.273	10.72	.3055	.09333	15.3	5.821	33.88	.1718	.02951
.4	1.047	1.096	.9550	.9120	5.4	1.862	3.467	.5370	.2884	10.4	3.311	10.96	.3020	.09120	15.4	5.888	34.67	.1698	.02884
.5	1.059	1.122	.9441	.8913	5.5	1.884	3.548	.5309	.2818	10.5	3.350	11.22	.2985	.08913	15.5	5.957	35.48	.1679	.02818
.6	1.072	1.148	.9333	.8710	5.6	1.906	3.631	.5248	.2754	10.6	3.388	11.48	.2951	.08710	15.6	6.026	36.31	.1660	.02754
.7	1.084	1.175	.9226	.8511	5.7	1.928	3.715	.5188	.2692	10.7	3.428	11.75	.2917	.08511	15.7	6.095	37.15	.1641	.02692
.8	1.096	1.202	.9120	.8318	5.8	1.950	3.802	.5128	.2630	10.8	3.467	12.02	.2884	.08318	15.8	6.166	38.02	.1622	.02630
.9	1.109	1.230	.9016	.8128	5.9	1.972	3.891	.5070	.2570	10.9	3.508	12.30	.2851	.08128	15.9	6.237	38.90	.1603	.02570
1.0	1.122	1.259	.8913	.7943	6.0	1.995	3.981	.5012	.2512	11.0	3.548	12.59	.2818	.07943	16.0	6.310	39.81	.1585	.02512
1.1	1.135	1.288	.8811	.7763	6.1	2.018	4.074	.4955	.2455	11.1	3.589	12.88	.2786	.07763	16.1	6.383	40.74	.1567	.02455
1.2	1.148	1.318	.8710	.7586	6.2	2.042	4.169	.4898	.2399	11.2	3.631	13.18	.2754	.07586	16.2	6.457	41.69	.1549	.02399
1.3	1.162	1.349	.8610	.7413	6.3	2.065	4.266	.4842	.2344	11.3	3.673	13.49	.2723	.07413	16.3	6.531	42.66	.1531	.02344
1.4	1.175	1.380	.8511	.7244	6.4	2.089	4.365	.4786	.2291	11.4	3.715	13.80	.2692	.07244	16.4	6.607	43.65	.1514	.02291
1.5	1.189	1.412	.8414	.7080	6.5	2.114	4.467	.4732	.2239	11.5	3.758	14.13	.2661	.07080	16.5	6.683	44.67	.1496	.02239
1.6	1.202	1.445	.8318	.6918	6.6	2.138	4.571	.4677	.2188	11.6	3.802	14.45	.2630	.06918	16.6	6.761	45.71	.1479	.02188
1.7	1.216	1.479	.8222	.6761	6.7	2.163	4.677	.4624	.2138	11.7	3.846	14.79	.2600	.06761	16.7	6.839	46.77	.1462	.02138
1.8	1.230	1.514	.8128	.6607	6.8	2.188	4.786	.4571	.2089	11.8	3.891	15.14	.2570	.06607	16.8	6.918	47.86	.1445	.02089
1.9	1.245	1.549	.8035	.6457	6.9	2.213	4.898	.4519	.2042	11.9	3.936	15.49	.2541	.06457	16.9	6.998	48.98	.1429	.02042
2.0	1.259	1.585	.7943	.6310	7.0	2.239	5.012	.4467	.1995	12.0	3.981	15.85	.2512	.06310	17.0	7.080	50.12	.1412	.01995
2.1	1.274	1.622	.7852	.6166	7.1	2.265	5.128	.4416	.1950	12.1	4.027	16.22	.2483	.06166	17.1	7.161	51.29	.1396	.01950
2.2	1.288	1.660	.7763	.6026	7.2	2.291	5.248	.4365	.1906	12.2	4.074	16.60	.2455	.06026	17.2	7.244	52.48	.1380	.01906
2.3	1.303	1.698	.7674	.5888	7.3	2.317	5.370	.4315	.1862	12.3	4.121	16.98	.2427	.05888	17.3	7.328	53.70	.1365	.01862
2.4	1.318	1.738	.7586	.5754	7.4	2.344	5.495	.4266	.1820	12.4	4.169	17.38	.2399	.05754	17.4	7.413	54.95	.1349	.01820
2.5	1.334	1.778	.7499	.5623	7.5	2.371	5.623	.4217	.1778	12.5	4.217	17.78	.2371	.05623	17.5	7.499	56.23	.1334	.01778
2.6	1.349	1.820	.7413	.5495	7.6	2.399	5.754	.4169	.1738	12.6	4.266	18.20	.2344	.05495	17.6	7.586	57.54	.1318	.01738
2.7	1.365	1.862	.7328	.5370	7.7	2.427	5.888	.4121	.1698	12.7	4.315	18.62	.2317	.05370	17.7	7.674	58.88	.1303	.01698
2.8	1.380	1.906	.7244	.5248	7.8	2.455	6.026	.4074	.1660	12.8	4.365	19.05	.2291	.05248	17.8	7.763	60.26	.1288	.01660
2.9	1.396	1.950	.7161	.5128	7.9	2.483	6.166	.4027	.1622	12.9	4.416	19.50	.2265	.05128	17.9	7.852	61.66	.1274	.01622
3.0	1.412	1.995	.7080	.5012	8.0	2.512	6.310	.3981	.1585	13.0	4.467	19.95	.2239	.05012	18.0	7.943	63.10	.1259	.01585
3.1	1.429	2.042	.6998	.4898	8.1	2.541	6.457	.3936	.1549	13.1	4.519	20.42	.2213	.04898	18.1	8.035	64.57	.1245	.01549
3.2	1.445	2.089	.6918	.4786	8.2	2.570	6.607	.3891	.1514	13.2	4.571	20.89	.2188	.04786	18.2	8.128	66.07	.1230	.01514
3.3	1.462	2.138	.6839	.4677	8.3	2.600	6.761	.3846	.1479	13.3	4.624	21.38	.2163	.04677	18.3	8.222	67.61	.1216	.01479
3.4	1.479	2.188	.6761	.4571	8.4	2.630	6.918	.3802	.1445	13.4	4.677	21.88	.2138	.04571	18.4	8.318	69.18	.1202	.01445
3.5	1.496	2.239	.6683	.4467	8.5	2.661	7.080	.3758	.1412	13.5	4.732	22.39	.2114	.04467	18.5	8.414	70.79	.1189	.01412
3.6	1.514	2.291	.6607	.4365	8.6	2.692	7.244	.3715	.1380	13.6	4.786	22.91	.2089	.04365	18.6	8.511	72.44	.1175	.01380
3.7	1.531	2.344	.6531	.4266	8.7	2.723	7.413	.3673	.1349	13.7	4.842	23.44	.2065	.04266	18.7	8.610	74.13	.1161	.01349
3.8	1.549	2.399	.6457	.4169	8.8	2.754	7.586	.3631	.1318	13.8	4.898	23.99	.2042	.04169	18.8	8.710	75.86	.1148	.01318
3.9	1.567	2.455	.6383	.4074	8.9	2.786	7.763	.3589	.1288	13.9	4.955	24.55	.2018	.04074	18.9	8.811	77.62	.1135	.01288
4.0	1.585	2.512	.6310	.3981	9.0	2.818	7.943	.3548	.1259	14.0	5.012	25.12	.1995	.03981	19.0	8.913	79.43	.1122	.01259
4.1	1.603	2.570	.6237	.3891	9.1	2.851	8.128	.3508	.1230	14.1	5.070	25.70	.1972	.03891	19.1	9.016	81.28	.1109	.01230
4.2	1.622	2.630	.6166	.3802	9.2	2.884	8.318	.3467	.1202	14.2	5.128	26.30	.1950	.03802	19.2	9.120	83.18	.1096	.01202
4.3	1.641	2.692	.6095	.3715	9.3	2.917	8.511	.3428	.1175	14.3	5.188	26.92	.1928	.03715	19.3	9.226	85.11	.1084	.01175
4.4	1.660	2.754	.6026	.3631	9.4	2.951	8.710	.3388	.1148	14.4	5.248	27.54	.1906	.03631	19.4	9.333	87.10	.1072	.01148
4.5	1.679	2.818	.5957	.3548	9.5	2.985	8.913	.3350	.1122	14.5	5.309	28.18	.1884	.03548	19.5	9.441	89.13	.1059	.01122
4.6	1.698	2.884	.5888	.3467	9.6	3.020	9.120	.3311	.1096	14.6	5.370	28.84	.1862	.03467	19.6	9.550	91.20	.1047	.01096
4.7	1.718	2.951	.5821	.3388	9.7	3.055	9.333	.3273	.1072	14.7	5.433	29.51	.1841	.03388	19.7	9.661	93.33	.1035	.01072
4.8	1.738	3.020	.5754	.3311	9.8	3.090	9.550	.3236	.1047	14.8	5.495	30.20	.1820	.03311	19.8	9.772	95.50	.1023	.01047
4.9	1.758	3.090	.5689	.3236	9.9	3.126	9.772	.3199	.1023	14.9	5.559	30.90	.1799	.03236	19.9	9.886	97.72	.1012	.01023
5.0	1.778	3.162	.5623	.3162	10.0	3.162	10.000	.3162	.1000	15.0	5.623	31.62	.1778	.03162	20.0	10.000	100.00	.1000	.01000

TABLE I. RELATIONS BETWEEN DECIBELS AND CURRENT (I), VOLTAGE (V), OR POWER (P) RATIOS FROM 0 TO 20.0 DECIBELS

1. If  $\frac{I_1}{I_2}$  is less than 1, find the number of db for the reciprocal of  $\frac{I_1}{I_2}$  and prefix a negative sign.

Example: The number of db corresponding to a ratio of  $\frac{I_1}{I_2} = .625$  is  $-4.1$ , because the  $N_{db}$  corresponding to

$$\frac{1}{.625} = 1.6 \text{ is } 4.1 \text{ db.}$$

2. If  $\frac{I_1}{I_2}$  is more than 10, divide  $\frac{I_1}{I_2}$  by 10 enough times so that the result is less than 10, find the number of db for the result, and add 20 db for each time the number was divided by 10.

Example: To find  $N_{db}$  for  $\frac{I_1}{I_2} = 631$  divide by 10 twice, the  $N_{db}$  for 6.31 is 16, now add  $2 \times 20$  db and the result is 56 db.

3. To find  $\frac{I_1}{I_2}$  corresponding to more than 20 db, subtract 20 db enough times so that the remainder is less than 20 db, find  $N_{db}$  for the remainder and multiply the result by 10 raised to a power equal to the number of times 20 db was subtracted.

Example: Find  $\frac{I_1}{I_2}$  for 56 db. Subtract 20 db twice,  $\frac{I_1}{I_2}$  for 16 db is 6.31, multiply this by  $10^2$  which gives  $\frac{I_1}{I_2} = 631$ .

From equation (4a) it is easily seen that if one voltage is 100 times another voltage, the small voltage is 40 db. down on the larger voltage. Also we may say that if a certain current is 209 db. down on another current that their ratio is 10 to 1.9. If we are talking about power then the number of decibels that

one power  $P_1$  is larger than another power  $P_2$ , is given by

$$N_{db} = 10 \log_{10} \frac{P_1}{P_2} \text{ or } \frac{N_{db}}{10} = \log_{10} \frac{P_1}{P_2} \quad (4c)$$

(Cont'd on page 736)



# New Superheterodyne Design

## Featuring 2-Volt Tubes

*A receiver especially adapted for use where line current is not available. It employs the new Air-cell A battery, thus providing battery operation without the fuss and bother of storage batteries*

**M**ILLIONS of American homes are not wired for electricity, yet despite this large market radio manufacturers in the years since the advent of the a.c. set have neglected this unwired home radio market almost entirely. From the manufacturers' point of view, the possible battery-radio market was only about one-third that of the possible a.c. market, and in addition represented a low average purchasing power, as was indicated by the very fact that the homes were unwired either because of poverty or distant farm locations—today about the same thing as poverty—yet there is something more to be said in justification of the radio manufacturers' neglect of this market.

Up until 1930 battery-operated sets required either dry A batteries, of short life and uncertain effect on the receiver tubes due to the probable inexperience or carelessness of the user; or they required storage batteries, initially fairly expensive, at most rather messy to the lay public, and requiring charging which frequently resulted in periodic inability to use the radio for a day or more, plus charging costs.

### The New Battery

It remained for the National Carbon Company to eliminate this serious obstacle, which it did in a beautifully effective and complete manner with the development of its air-cell battery in 1930. This battery, having no acids to spill, and requiring no recharging, provides an operating life of about 1000 hours, or nearly a year's service when used with the tubes which the tube manufacturers have produced for this service.

Silver-Marshall in the fall of 1930 introduced the 724-DC air-cell-operated superheterodyne, which evidently met a public need, for many of them have been sold since then. The extent of their sales and the wide interest aroused in them is felt more than sufficient justification for the description herewith of an air-cell-operated superheterodyne which has just been placed on the market, and which incorporates several new and, to the battery users, valuable improvements.

The new 726-DC is illustrated in Figures 1 and 2, and its circuit is shown in Figure 3. It uses nine two-volt tubes, yet its filament drain is only .54 ampere and its B drain but 12 milliamperes. It will provide one watt of undistorted power output without the use of a single power tube! Its sensitivity averages 5 microvolts absolute or  $1\frac{1}{4}$

By McMurdo Silver\*

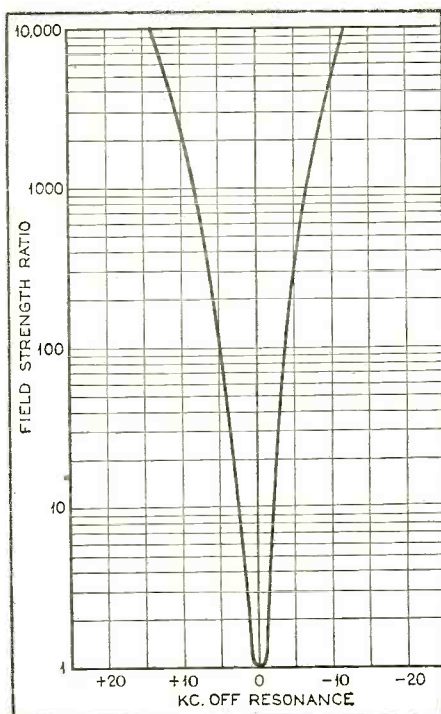

### THE MEASURED SELECTIVITY

*Figure 5. Absolute 10 kc. separation is provided to 100 times down, meaning that an interfering signal on an adjacent channel would have to be 100 times as strong as the desired signal in order to cause interference*

microvolts per meter, and it offers 10 kc. selectivity. The fidelity curve, when used with its proper speaker, is substantially flat from 50 to 4000 cycles!

All of this may sound impossible, and a year ago it was, but not so today—the proof of the pudding is always in the eating—and here's the set itself.

### Low Filament Drain

The circuit employs nine tubes—four type -32 screen-grid and five type -30 general-purpose tubes—not a power tube or pentode in it, but more of that later. As all of the tube filaments draw .06 amperes at 2 volts, the total A drain is obviously .54 ampere plus the dial light drain of .075 ampere (this is a new, low-power lamp produced for use in air-cell receivers. The ordinary dial light cannot be safely used in sets using air-cell batteries because of the excessive filament current requirements), or a total drain of .615 ampere. In terms of air-cell A battery life, this means about 1000 hours of service before the battery fails, or on a basis of three hours average use per day, from eleven to twelve months of battery life—all without recharging or bother of any kind. At this point it is well to mention that the maximum permissible drain of the air-cell battery is .65 ampere. The air-cell will fail very rapidly at drains even slightly in excess of .65 ampere. Hence one reason for the use of type -30 general-purpose tubes as output tubes. If two type -31 power tubes—or two type -33 pentodes—were used in the output

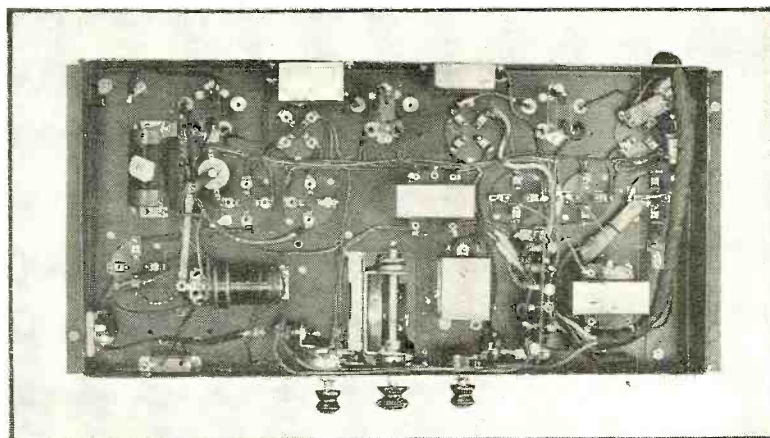

VIEWED FROM BENEATH

*Figure 2. The bottom shield plate has been removed to show the sub-base*

\*President, Silver-Marshall, Inc.



stage, the A drain would go up to .755 ampere, resulting in shortened air-cell life. To avoid this, two of the -30 or -32 tubes would have to be omitted, with corresponding loss of sensitivity—one of the main requirements in rural locations in which battery sets are today used.

**Low B Battery Drain**

From a B battery standpoint, the 12-ma. drain of the 726-DC is so low that in normal operation heavy-duty B batteries will last as long as their normal shelf life of a year. But this is not a true picture of the B drain, for 12 ma. with the push-pull output tubes draining only .4 ma. is the B drain only when no signal or only a very weak one is being received. When the full output of 1 watt is being developed, the total B drain will vary between 12 and 26 ma., and will average around 18 ma., but is still low enough so that the B battery life will be from 9 to 12 months. In any case, this B drain is unusually low for any form of battery set—let alone a nine-tube superheterodyne, which would ordinarily draw from 35 to 50 ma. with a conventional output stage. As 1 watt is rather excessive power for home entertainment, the usual average B drain will be found to run about 14 to 15 ma.

This extremely low A and B drain, and the use of general-purpose tubes in the push-pull output stage, is probably entirely new to most readers, and is accounted for by a recent power amplifier development which is known as Class B amplification. In a normal, or Class A, audio amplifier, the grid bias is so adjusted that the impressed signal voltage will cause the grid voltage and plate current to alternatively rise and fall. In a push-pull amplifier exactly the same thing happens, except that as the grid of one tube goes negative, that of the other goes positive, and the plate current of the two tubes rises and falls in opposite relation. In a Class B amplifier the grid of each tube, instead of being biased to the center of the straight negative portion of its grid voltage plate current curve, is biased to almost the cut-off point, or well down to the negative end of its  $E_g-I_p$  curve—thus when

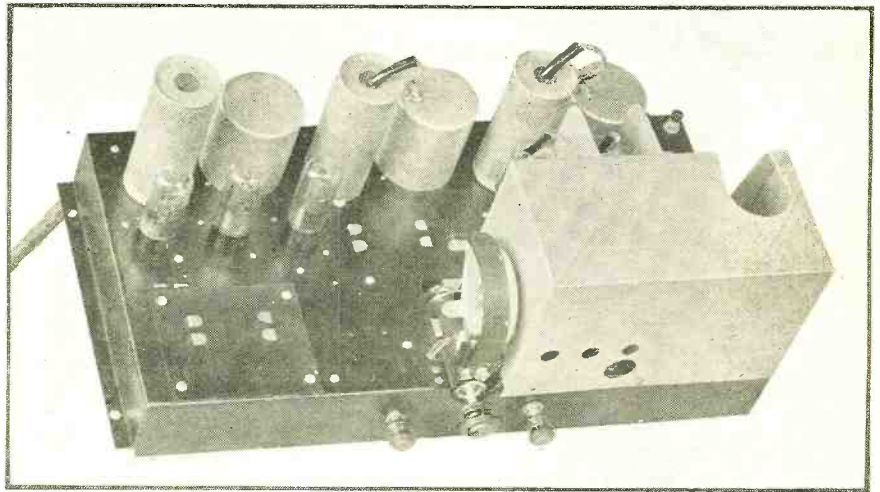

THE NEW RECEIVER

Figure 1. Shows the top view of the receiver which uses two-volt tubes and provides adequate power output without resorting to the use of power tubes.

a signal pushes the grid further negative, the tube cuts off, and substantially no change in plate current occurs, but when the grid goes positive it can handle twice the grid voltage excursion of the same tube normally biased.

In the Class B amplifier, two tubes are connected in push-pull so that as one cuts off a negative signal peak the other takes up the positive grid excursion. In effect, this is as though the length of the straight portion of the  $E_g-I_p$  curve of one tube were doubled, or as though the curves of two tubes were connected end to end—and this is just what is done. But this alone does not account for the fact that two type -30 tubes, which ordinarily will turn out only .055 watt each, or .11 watt together, will in the 726-DC turn out a full watt, or nine times their ordinary power output! This is accounted for by the fact that their grids are allowed to run positive some of the time. Ordinarily this is impossible, for in an ordinary amplifier if this occurs the grids draw current and load the input circuit, which is a pure voltage transfer circuit, and will not (Continued on page 726)

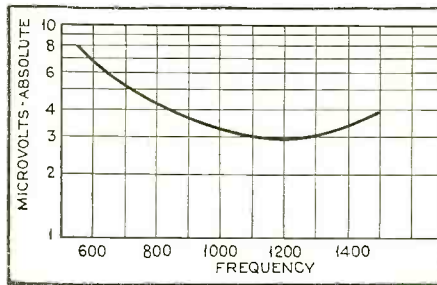

THE SENSITIVITY CURVE

Figure 4. Shows, in terms of microvolts absolute, an average of well below five, ranging between three and four down to 820 kc.

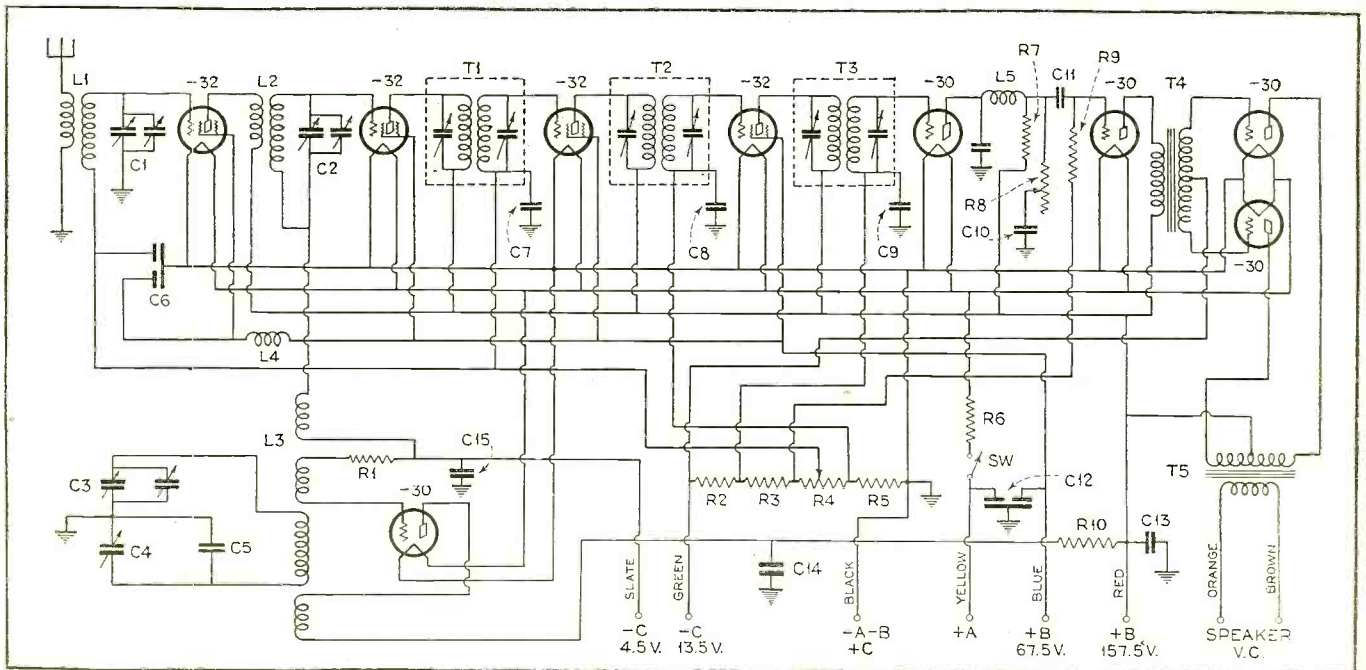

FIGURE 3. THE SCHEMATIC CIRCUIT DIAGRAM



# Using Graphs *and* Charts in Modern Radio Practice

*Alignment charts are one of the engineer's most useful tools. The author explains here not only how to use them, but how to make charts to fit a wide variety of requirements*

**M**OST calculations can be performed without effort by the use of the proper alignment charts.

By John M. Borst  
Part Two

Their principles and preparation are explained in this article. In the forthcoming issues of RADIO NEWS charts are to be printed for the solution of the most frequently occurring equations in present-day radio design.

In the previous instalment was described how a curve illustrates the relation of two variables. If one of them is unknown, a curve may serve as an aid in calculation. When, however, three variables are involved, one curve would not be sufficient.

The alignment chart, however, allows us to find the value of an unknown quantity, dependent on two variables.

Such charts consist of three or more graduated lines, each representing variable quantities which depend on each other. They are drawn and divided in such a way that any straight line intersecting all three cuts off values of the variables which satisfy the equation.

As an example see Figure 1. Let the three lines be parallel and suppose  $x$  to be midway between  $a$  and  $b$ . If we draw any line  $CYD$  crossing these three lines, then we know from plane geometry that  $XY = \frac{1}{2}(AC + BD)$ . It does not matter how this intersecting line is drawn, that relation is always true. At first sight this might not seem such a useful form of equation, but if we drag in our old friends the logarithms, a very familiar form appears.

### The Logarithmic Scale

Let us measure off along  $a$ , inductance in henries and along  $b$ , capacity in farads, both on a logarithmic scale. Then, having a logarithmic scale of the same units along  $x$ , this chart would help us solve the equation:

$$\log x = \frac{1}{2}(\log L + \log C) \text{ or } x = \sqrt{LC}$$

As you see, this form is a part of the famous Thomson formula:  $\lambda = 2\pi \sqrt{LC}$ .

The three graduated lines, then, are not yet quite right for finding the wavelength. It takes, however, only a small change to make it apply to this equation. Taking logarithms on both sides:

$$\log \lambda = \log 2\pi + \frac{1}{2}(\log L + \log C)$$

In other words, to the value of  $x$  found in Figure 1, we only have to add the  $\log$  of  $2\pi$  in order to obtain the correct value for the wavelength sought. This may be taken care of in the graduating of the scale along  $x$ . It amounts to lowering the entire scale of  $x$  until  $2\pi$  hits the point where 1 was before.

We have now multiplied all values along  $x$  with  $2\pi$ .

The above equation, but worked out for the frequency is shown in the large chart in this article. By connecting the frequency wanted with the capacity of the condenser used, one will find the inductance in henries needed for the coil. Whichever of the three quantities is unknown may be found by connecting the proper points on the scales of the known variables. In order to avoid having to clutter up the drawing with many lines when using the chart, it is recommended that a transparent ruler is used which has a line drawn on it.

Returning again to the theory of these charts, in order to draw lines which will help us solve other equations they may be drawn at different distances apart, or at angles—they do not even have to be straight lines. The equation expressing the relation of the quantities measured along them becomes then much more involved. This is of advantage if we can make them so that they will have the complicated relation we want to solve.

Examples of such relations are shown in the Figures 2, 3 and 4.

In Figure 2 there are three parallel lines, irregularly spaced. The interrelation between the lengths of the segments  $a$ ,  $b$  and  $x$  cut off by any straight line can be found in the following way.

In Figure 2, the slope of  $AX$  is  $(x-a)/p$  and the slope of  $XB$  is  $(b-x)/q$ . As these three points lay on a straight line, these two slopes are equal; hence

$$\frac{x-a}{p} = \frac{b-x}{q}$$

$$\text{or } q(x-a) = p(b-x)$$

$$qx - qa = pb - px$$

solving for  $x$ ,

$$(p+q)x = pb + qa \quad x = \frac{pb + qa}{p+q}$$

This is the general formula for this case. It is, for instance, useful in the formula  $W = I^2R$ . Taking logarithms:  $\log W = 2 \log I + \log R$ . Make  $q = 2p$  then, substituting  $p$  and  $q$  in Equation 2.

$$x = \frac{1}{3}b + \frac{2}{3}a$$

Graduate both  $a$  and  $b$  on a logarithmic scale with the same size units and graduate the scale of (*Continued on page 718*)

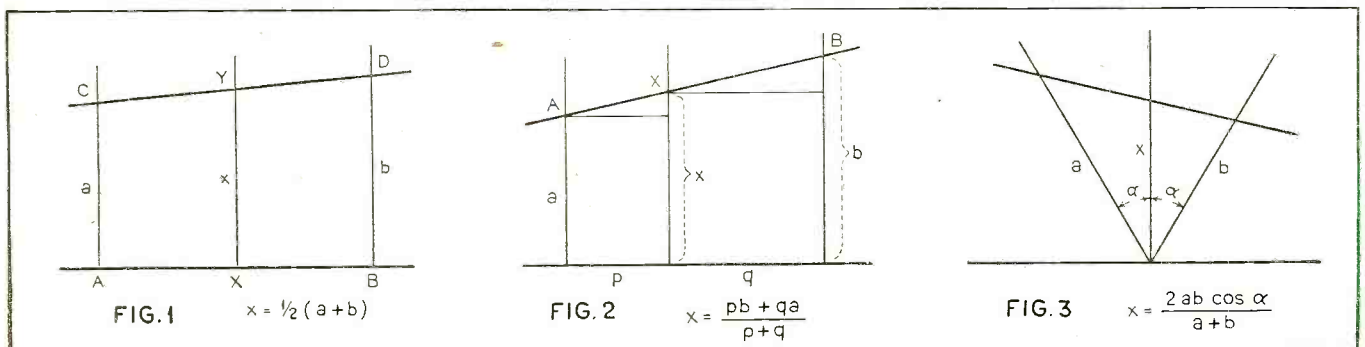



# Relation Between Frequency, Inductance and Capacity

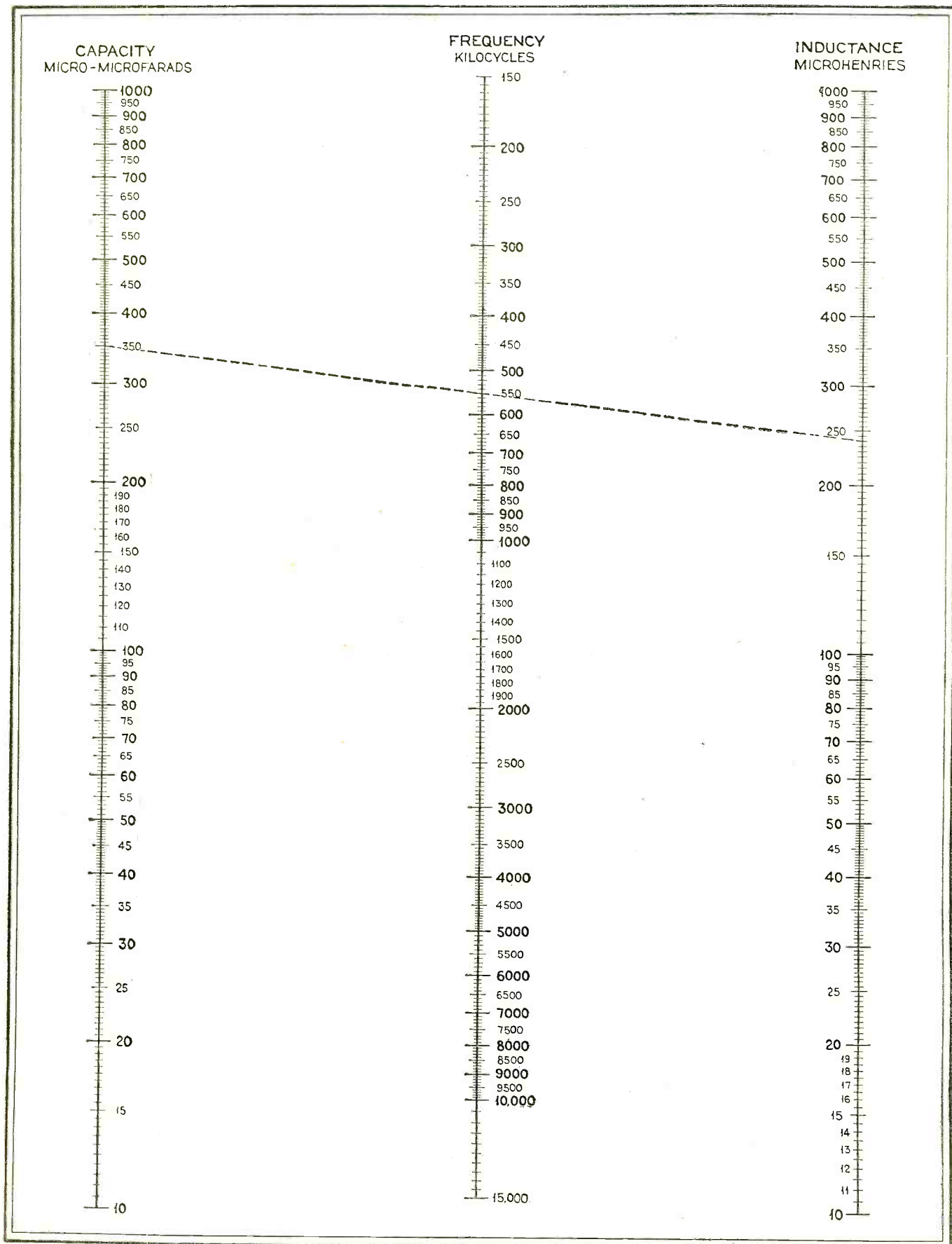

THIS CHART WILL SIMPLIFY YOUR CALCULATIONS

Figure 5. A straight line connecting the values of capacity and inductance intersects the middle scale at their resonating frequency. Example: A condenser of 350 mmfd. with a 240 microhenry inductance tunes to 550 kc. If any two of the three quantities are given the third one can be found



# A New "SUPER" for Circuit Experimenters

*The author this month continues the constructional description of his home-built superheterodyne, outstanding features of which were covered in his first article last month. He also offers an alternate circuit providing for the use of variable-mu tubes in place of the r.f. pentode and the -24's, used in the original receiver*

**T**HE audio amplifier is standard in design and needs no comment. An open-circuit jack or binding posts had better be included in the wiring, although it is not shown. This may be connected directly across the primary of the first or second audio transformer. It is useful for phone reception. The audio amplifier should be wired after completing the i.f. amplifier.

At this point in construction it is well to check the operation of the two amplifiers. Wire up the power pack and determine if this part is correct by listening for any noises that may come through. A finger placed on the cap of the first i.f. stage control grid should produce a humming sound. The

**By Chesley H. Johnson**  
*Part Two*

With the foregoing circuits in operation, the set may be completed by wiring the oscillator and r.f. amplifier. Especial care should be exer-

cised to avoid undesirable coupling and all connections should be tight and rigid to avoid noises that are so easily set up on the shorter waves.

It is suggested that the broadcast band coils, L1, L2, L3 and L4, be the first of the plug-in coils to be constructed. With these coils plugged into the five-prong tube sockets, signals should be heard if the power pack and all auxiliary equipment is properly connected.

When signals are heard, it is advisable to adjust the oscillator for best operation. Vary R3 and notice if set squeals or

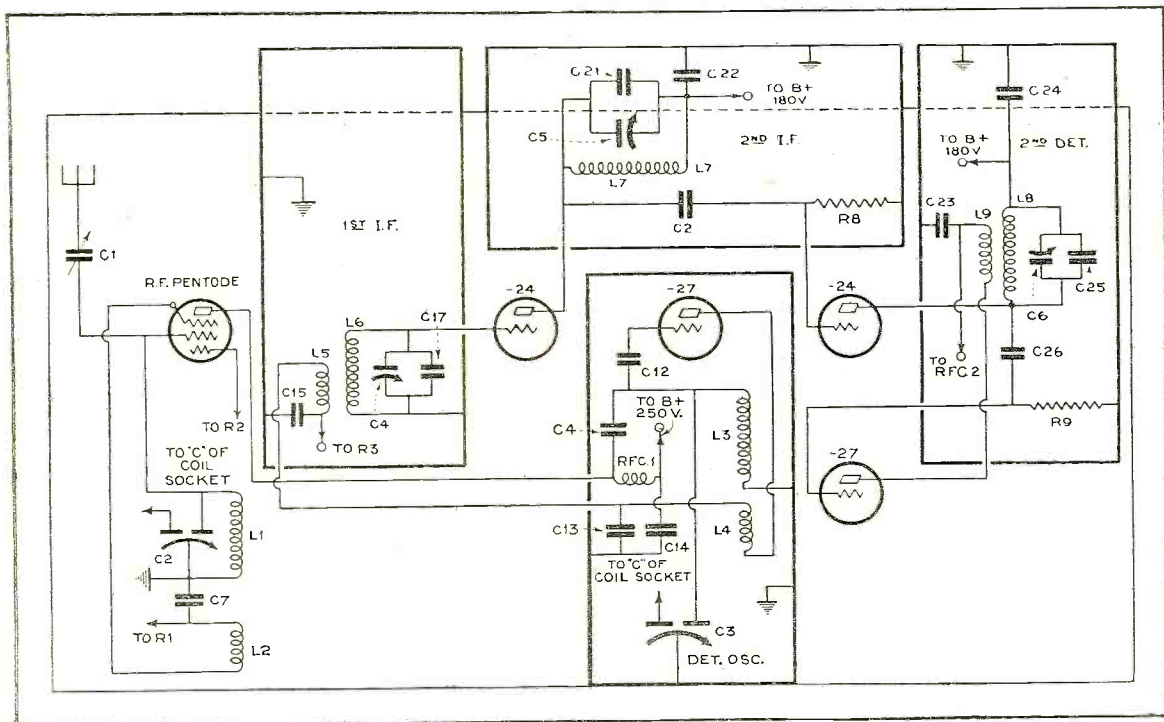

WIRING LAYOUT

Figure 6. Shows, in schematic form, all parts which appear above the base in the finished receiver

body may act as an aerial and cause loud noises from such as vacuum cleaner motors (any commutator type motors) to be heard in the speaker. If such sounds are heard it is well to adjust the midget variable condensers, C8, for maximum response. The condenser in the second detector circuit will probably be the most sensitive. Do not fail to adjust R4, as this will have, presumably, quite a bearing on any signals to be heard.

goes dead if the resistor is turned all out. Signals should come through clearly with R3 turned not more than a quarter way around. Vary C4 and note whether set is properly selective. Stations should not take up over four or five points and weak ones but a point on the usual form of dial. Vary C2 and note whether this dial exerts any decided influence on selectivity. Vary C1, which should exert a decided influence on both volume and selectivity unless too long an aerial is being used.



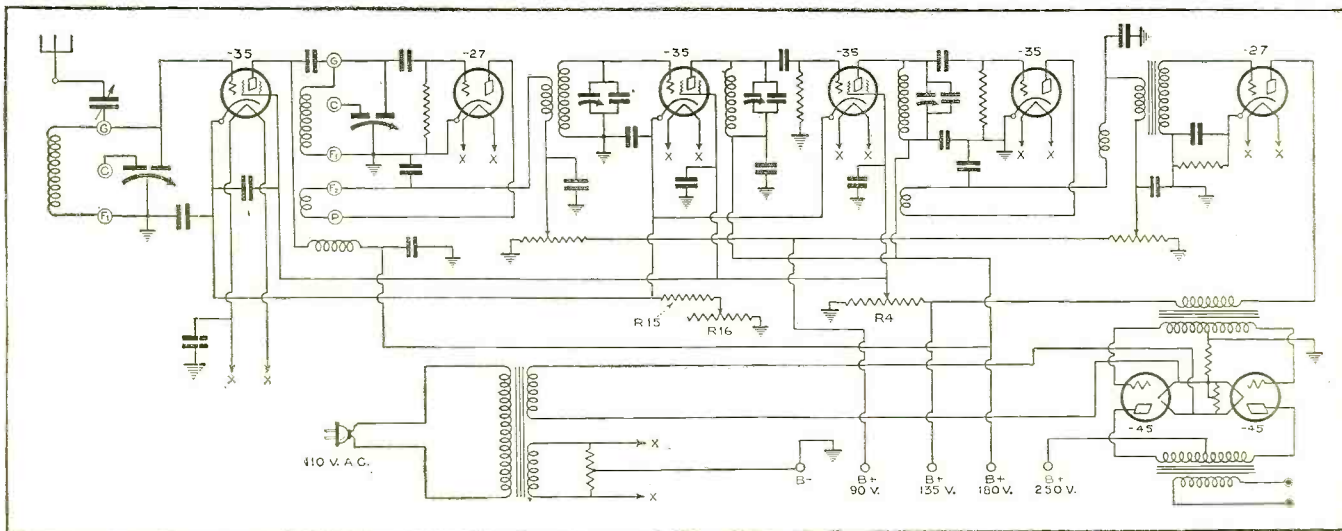

CIRCUIT ADAPTED FOR -35 TUBES

Figure 7. For constructors who may prefer to use variable-mu tubes in place of the r.f. pentode and type -27 tubes used in Mr. Johnson's original model, he has provided this circuit. It will be noted that the antenna coil L and the plate coil L2, as well as the variable resistor R1, of the original circuit, have been eliminated. The resistors R15 and R16 have been added, these are a 100 fixed and a 5,000-ohm variable resistor, respectively. R4 of the original circuit has been changed from 25,000 to 100,000 ohms. These changes do not alter the original panel or base layout. R16 is mounted in the hole provided for the discarded R1

Both C1 and C2 are very important controls on the very short waves but of not much importance on the broadcast band except on weak signals. Vary the regenerative control R11 and listen carefully for the whistle or strong breathing sound. If turning the knob for R4 completely in—cutting out all resistance—fails to make the set whistle, try reversing the tickler coil, L9. Try altering its position, which should be at the filament end of the coil L8. Move it in or out just a trifle. Add a few turns to L9 and repeat the preceding operations until it is possible to make the set regenerate properly. If too many turns are put on the tickler coil L9, the set will fail to function at all. The adjustment of this coil is quite a problem and must be done with care. Once adjusted, it should be fastened in place with a proper glue or shellac. The size of the various grid leaks has considerable influence on this adjustment.

Vary the volume control R4, which is in the screen-grid circuit of the i.f. amplifier. If the shielding is not very good or stray couplings exist, the amplifier may be unsteady and go into oscillation as the resistor is turned to the position of all out. Under such conditions the set becomes inoperative. Signals should come through with a tremendous rush as the knob is turned slightly away from the zero position. The amplifier may be said to be working properly if the set becomes unstable only when the knob is turned all around, putting full voltage on the screen grids of the i.f. amplifier.

In the event that the set fails to function, the fault or faults may be located by a systematic procedure of "trouble shooting." Test each part for grounds or shorts. A better procedure would have been to have tested each particular part of the circuit as the wiring proceeded, in which event the trouble would have been remedied immediately and further fault eliminated in the final assembly. Failing to locate the fault, run a jumper from the first i.f. grid post to the second detector grid condenser, C26, and then remove the tubes in the i.f. amplifier. Local signals should now come through on plugging in the broadcast

coils. Provided such is the case, investigate for some fault in the i.f. amplifier. However, for continued failure to receive signals, try placing a pair of headphones in series with the plate circuit of the pentode tube, just ahead of the large bypass condenser C14. Weak signals should be heard on turning the condenser C2, if the aerial be connected. With this circuit operating, remove the phones and replace the wiring. Next, insert the phones in the plate circuit of the autodyne detector, just ahead of the large by-pass condenser C15, if the set still refuses to operate as a whole. Signals should be heard in the phones as the condensers C2 and C4 are turned. If the signals are very squeally a few turns may be removed from the feedback coil L4. If no signals are heard, add a few turns or try reversing the terminals of the coil. With the detector operating, the phones should be removed, the wiring replaced and signals should pass through the set.

*On the Short Waves*

With the set operating properly on the broadcast waves, the various short-wave coils may be constructed with confidence in their ability to operate the set for the purpose for which it has been designed. Each coil as finished should be checked for proper connection and continuity of circuit.

On the shorter waves burnt-out UY tube bases are satisfactory—especially for the r.f. amplifier. The specifications are given in the tables for these forms.

Plugging in the coils, tune with C4 and C2. Follow up C4 with C2 by listening for the background noises. If C2 is much off tune a steady roar will be heard; also

when the oscillator has spilled over completely. The antenna condenser C1 is not very critical and for the shorter waves is turned toward a minimum amount of capacity. The coil L is to be used only on the broadcast or nearby bands and may be omitted entirely with not much loss.

With signals received, readjust all resistors for best results. Turn R3 only far enough to receive clear signals. Vary R2 and R4 for volume. Faint signals (Continued on page 728)

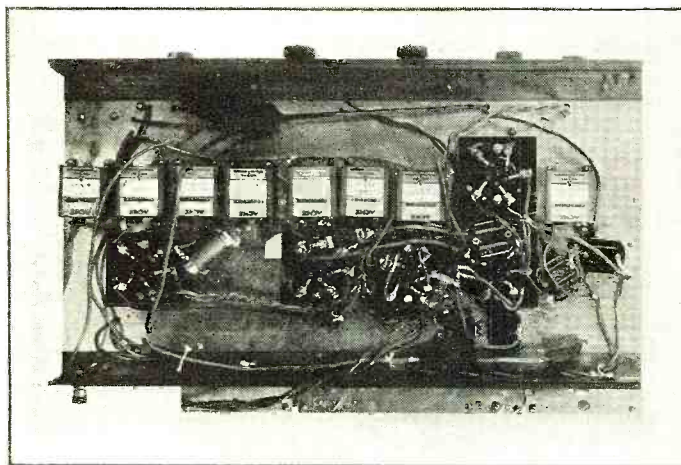

THE BOTTOM VIEW

The space beneath the base provides room for tube sockets and the numerous bypass condensers, as well as for low-potential and low-frequency wiring



# The Pentode Oscillator

*It is not generally realized that the pentodes are excellent oscillators at both radio and audio frequencies. A single pentode, used in an extremely simple circuit, makes a sure-fire modulated r.f. oscillator*

By Gerard J. Kelley

**O**UR tube circuits have become so standardized that they are taken for granted by most people and very few think of the possibility of improving or simplifying them.

It required a long time after the introduction of the screen-grid tube before any new circuits came into general use. Even now full advantage has not yet been taken of all its possibilities.

Finally the pentode became available to the public, and so far it has been hooked up in conventional circuits resembling the triode as much as possible. The introduction of the new grid must have made the tube suitable, perhaps for the performance of new tasks, and it seems that too few experimenters have tried to discover these possible applications.

## Three Grids

Since the pentode contains three grids, the most logical conclusion to make is that it will probably be able to do the work of more than one tube. This would not be the same as reflexing; different combinations of the elements of the tube would be used for each individual function.

The pentode oscillator herein described needs for its operation only the space charge grid and the plate. The control grid does not take any part in the action and it is therefore available for another function, making the same tube serve also as a modulator, a second oscillator or perhaps an amplifier or detector. These combinations are also possible with the plio-dynatron, but the screen-grid tubes on the market are not all good dynatron oscillators, they are critical in their required voltages and coupling and after all only very little power can be delivered.

The pentode does away with all these drawbacks. Also, because of the center tap there is very little component of the oscillation frequency in the B supply lead.

super-regenerative circuit? A variation frequency in the audible range would still be inaudible when using a pentode oscillator.

The oscillator described here needs only one tuned circuit, which means that there is no coupling effect to change the tuning and there are no critical adjustments required to obtain maximum power output. The pentode will oscillate at radio frequencies and at audio frequencies without any trouble. Frequencies from 3 cycles per second to 10 megacycles have been obtained. To go below thirty meters it will be necessary to use some kind of push-pull arrangements for the internal capacities of the tube become too high.

## Easy Oscillators

The tube is not particular what anode voltages are put on it and every tube will oscillate. There is no necessity for selection of tubes as with the dynatron.

As we stated before, the tube while oscillating will do another task at the same time and can, for instance, be made to oscillate at another frequency, thus modulating itself. Or it can be modulated by impressing a signal on the control grid, which makes it a small transmitter.

It is interesting to speculate what would happen when the second frequency is made the same as the first, or when the tube is made to amplify at a certain frequency when the oscillating circuit is adjusted for a harmonic of this frequency. There are so many possible combinations that this tube offers a fertile field for investigation and experiment.

The fundamental principle of the pentode oscillator is illustrated in Figure 1. An oscillatory circuit is connected between the space charge, or second grid, and the plate. The coil is center-tapped and this

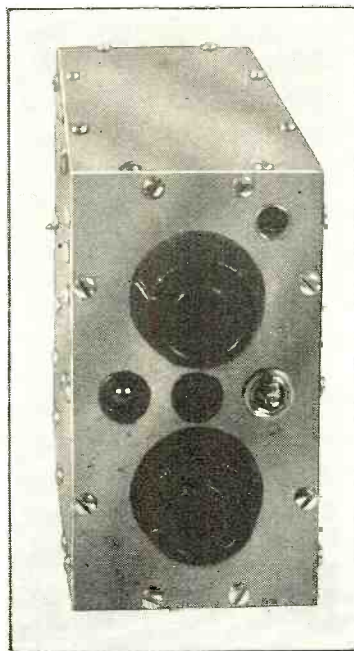

FRONT VIEW

*Upper knob is the output volume control; lower knob regulates the frequency; the right-hand toggle switch cuts in the modulator circuit when desired, and the one at the left is the on-off switch*

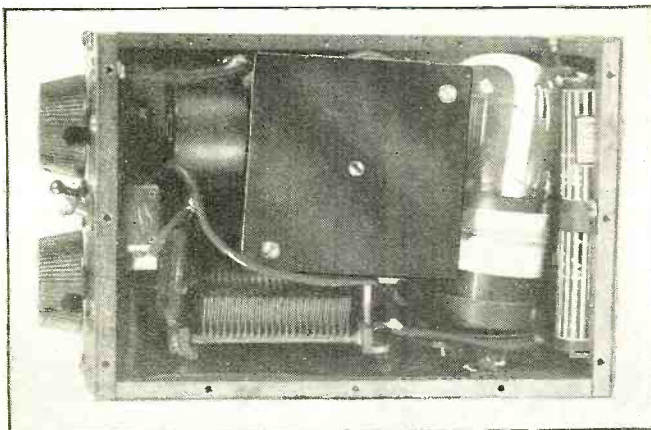

VIEW WITH SIDE OF CASE REMOVED  
*Shows coil mounted around the pentode tube*

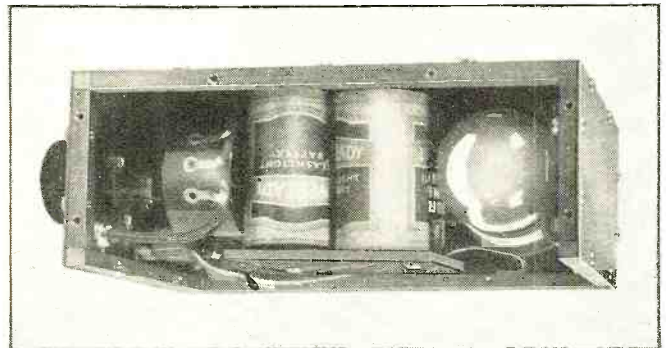

LOOKING INSIDE FROM ABOVE

*Three flashlight cells supply the filament of the type -33 pentode, and the pilot light in series with it. Two 3-volt flashlight batteries of the "pencil" type serve as the B battery. Note the extreme compactness of the design and the rigid construction employed throughout*



center tap connects to the positive terminal of the B battery. The second grid and the plate therefore have the same applied voltage. The control grid is connected to the cathode of a type -38 pentode or the filament in the cases of a -47 or -33. It is often preferable to connect a resistance of from 1/4 to 3 megohms in the grid circuit. This resistance causes the control grid to change its bias, due to the current through it and the resulting potential drop across it. The grid bias in turn lowers the space current; thus conserving the anode battery.

The tube apparently oscillates because of a feedback effect similar to the ultra-audion of De Forest. The exact theory of the causes for oscillation is still a matter of controversy.

So far we have spoken of the simple oscillator. The space-charge grid can now be coupled back again to the control grid, adding another ultra-audion oscillator. This is shown in Figure 2. It seems that the second oscillation modulates the first and this effect has been made use of to obtain a modulated oscillator using but a single tube and an extremely simple circuit.

The frequency of the oscillator in Figure 1 is controlled, of course, by the frequency of the oscillatory circuit. The brilliancy of the filament, the anode voltages and the grid leak also affect it to some extent, but when these are kept constant the frequency can be kept within limits as close or closer than the dynatron.

**The Modulator Frequency**

The modulating frequency depends on the size of the condenser and the size of the grid leak. It is also affected, although very slightly, by the frequency of the other oscillatory circuit. A condenser of .001 mfd. will give a note of about 1000 cycles.

The oscillator needs only about 6 volts on the plate and second grid to make it oscillate at radio frequencies. This and the fact that it can so easily be self-modulated make it an ideal, compact portable unit for the serviceman. For this purpose the basic hookup of Figure 2 should be used but with provision for the coupling of the unit to the receiver. There are two methods of coupling available.

In Figure 3(a) the radio-frequency energy is fed to the receiver by inductive coupling; in Figure 3(b) capacitive coupling is employed. In both cases it is best to use a volume control in the form of a tapered potentiometer of 400 ohms as shown in the figures referred to.

Further, the entire unit should be shielded and the coupling leads should consist of shielded wire so as to be sure that the receiver picks up the energy at the antenna and not somewhere else.

For most service work this modulated oscillator will be satisfactory, but if it is necessary to calibrate the tuned circuit, precautions have to be taken that all factors which influence the frequency are kept the same. We could then go one step

*The pentode oscillator is an excellent service unit. Coupled to the input of a receiver the oscillator provides a dependable modulated signal for use in lining up r.f. and i.f. stages*

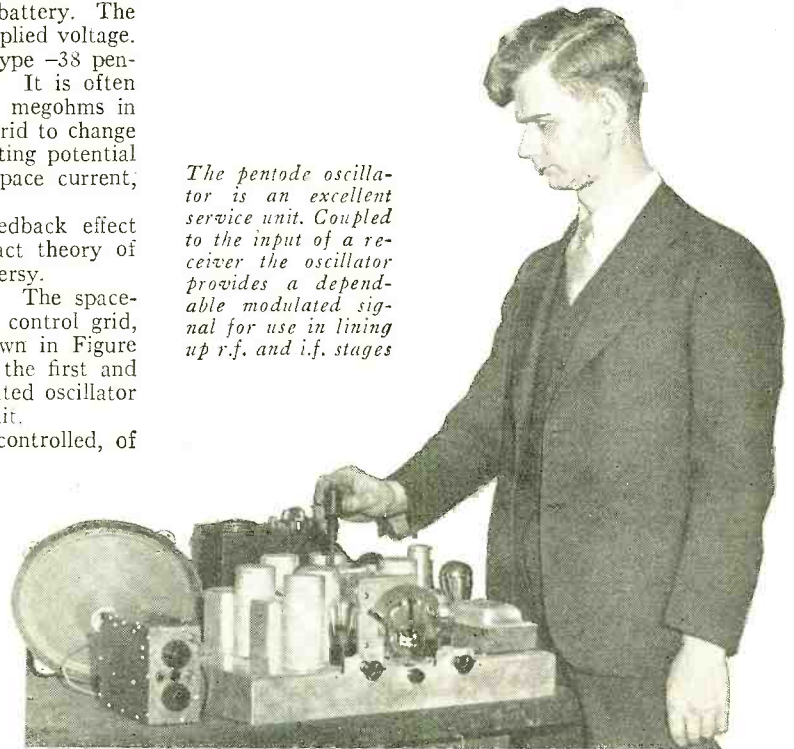

AN EXCELLENT SERVICE UNIT

further and calibrate the volume control in microvolts. Such an instrument should be of great use in the service shop, as it now becomes possible to make exact measurements of the sensitivity of receivers and also of the selectivity.

Apart from the use as a circuit driver, the unit, employing the circuits of Figures 2 or 3, can be made to serve as a modulated oscillator in the laboratory.

In Figure 2 it was shown how we can modulate the carrier frequency with a steady note. However, it is very easy to make a small transmitter by impressing voice frequencies upon the grid either from a microphone or a phonograph pick-up. Figure 4 shows how the oscillator may be modulated by a phonograph which is a very good way of testing the performance of a receiver. It is necessary to connect a radio-frequency choke in the grid circuit to prevent any possible feedback of r.f. energy from the oscillator circuit.

The volume of the oscillator is shown regulated by a 10,000-ohm potentiometer. We found this method more convenient than (Continued on page 722)

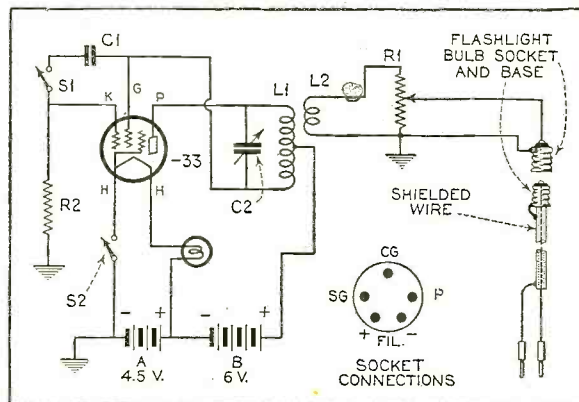

CIRCUIT OF THE OSCILLATOR

Figure 5. The oscillator, as shown here, may be used as an r.f. oscillator covering the broadcast range and may be modulated at approximately 1,000 cycles by closing switch S1

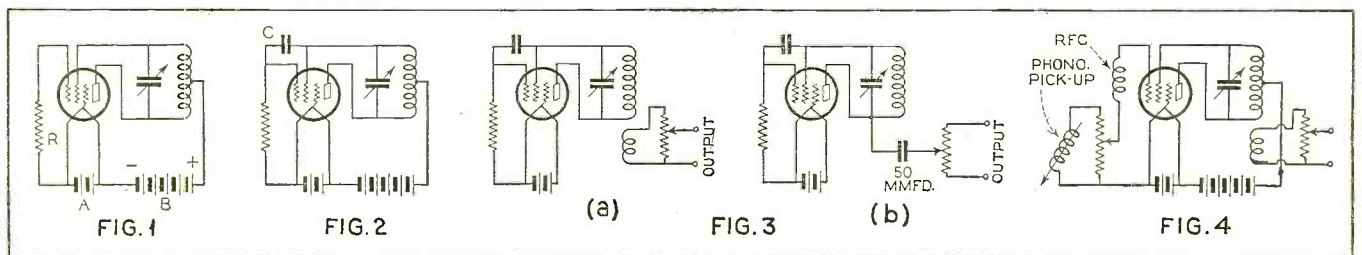

THE PENTODE OSCILLATOR CIRCUITS

Figure 1—the basic circuit for use as an r.f. oscillator. Figure 2—same as Figure 1, but with fixed condenser, C, added for self-modulation at audio frequencies. Figure 3—output coupling and output volume control circuits added; (a) inductive coupling and (b) capacity coupling. Figure 4—circuit for use with external modulation. A microphone may be substituted for the phonograph pick-up if desired



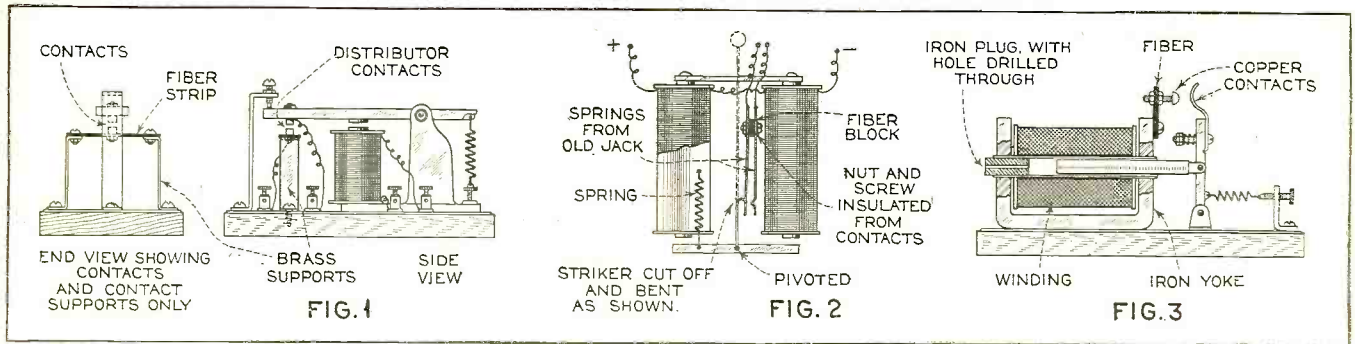

ARMATURE AND SOLENOID TYPES OF RELAYS

Figure 1. A 30-ohm telegraph sounder and a pair of distributor contacts off an old Ford constitute the parts needed. The finished relay will operate on .2 ampere and safely break up to 7 amperes. Figure 2. An old 500-ohm telephone ringer and an old 'phone jack provide the "makings" for this one. It will operate on from 20 to 30 ma. Figure 3. Operates on either a.c. or d.c. and will break up to 20 amperes. This type is used most commonly for power switching

# Relays for the Experimenter

*Frequently the experimenter, especially if he is engaged in photo-cell work, finds a pressing need for relays of various types. The author explains several varieties to be made mostly from the junk box*

RELAYS may be divided into three classes: the armature type, the solenoid type and the induction type. All three of these types have their own especial uses for which they are best suited.

By C. Bradner Brown

### Armature Type

This is the type most commonly used and covers the average purposes very nicely. A 30-ohm telegraph sounder can be reconstructed to form a relay of this sort with a minimum of work. Contacts may be secured at a nominal price from any garage or auto sales store. The contacts used in the model A Ford distributor are ideal for this sort of work. These contacts come mounted on a screw and are furnished with a nut. It is a simple matter to drill a hole through the sounder arm and put a contact in place. The other contact can be mounted below on a fiber strip and arranged in place with two brass strips as shown in Figure 1.

We now have a relay which can be operated on either direct or alternating current. It is advisable, however, to use direct current if possible, as the best operation can be secured in this manner. When used on a direct current, the relay will operate on 0.2 ampere and over, and the contacts will break from 4 to 7 amperes. It is best to shunt these contacts with a condenser of about 1 mfd. capacity, to prevent arcing, especially with large currents. This relay is exceptionally sturdy and costs very little, as most experimenters have an old sounder in the junk box.

If a more sensitive relay is required, it can be produced by revamping an old telephone ringer. Be sure and get one of the type that has a freely pivoted armature held in position by a small spring. The striker (or hammer) should be removed and bent over as shown in Figure 2. A very good set

of contacts may be had by fixing a piece of spring brass and an old radio jack spring in place as shown in Figure 2. This type of relay is far more sensitive than the sounder type previously described, and has the advantage that it is polarized and will operate on very small direct currents. It will not, however, operate on alternating current and was not intended for this use. If the ringer is of the common 500-ohm type it can be expected to operate on about 20 to 30 milliamperes. This figure depends somewhat on the stiffness of the contacts, but the figures given above constitute a reasonable estimate of what a relay of this sort can be expected to do. The current-carrying ability of the contacts is necessarily low and should not run over 200 to 300 milliamperes.

Fortunately, this comes well within the range of the sounder type relay, and these two can be operated in series or cascade to control currents up to 5 or 6 amperes from a 20 ma. input to the first relay. The action is not as fast as could be asked, but it is rapid enough for the average purpose around an experimental laboratory.

### Solenoid Type

This type of relay generally takes on the form of a power-operated switch rather than a relay. However, the relay described below can be used on alternating current and will handle exceptionally large currents, and for these reasons is an addition to our

set of relays. The constructional details are shown in Figure 3. The windings consisted of 500 turns of No. 20 copper wire. However, this merely determines the current and voltage at which the device operates. With the windings given above, the coil operates on 1/2 amp at about 30 to 40 volts of alternating current. The contacts are copper, and will handle upward of 20 amps without serious arcing. (Cont'd on page 720)

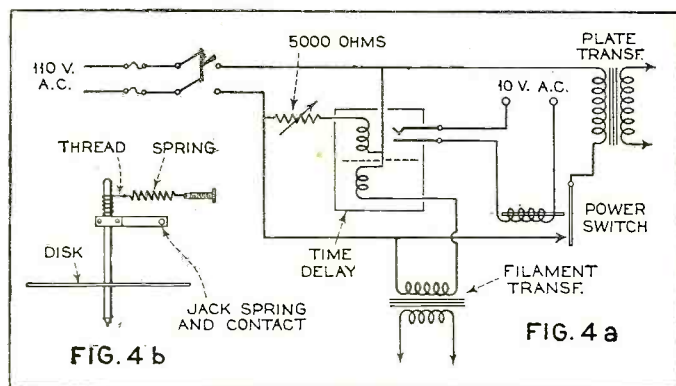

### AN INDUCTION TYPE RELAY

Figure 4. Made up from parts of a discarded watt-hour meter, this type of relay makes a convenient automatic time-delay switch, closing two circuits with a predetermined interval of time between



# New Television Receiver Offers Novel Design Features

*The small size of the visible images has been one drawback in earlier televisior equipment. The equipment described here, for home construction, provides images five inches square, marking a real forward step in television progress*

**I**T begins to look as though public demand, rather than necessity, is the mother of invention. The public demanded better and larger television pictures for the home, and now these are at hand. Fans and experimenters demanded less expensive television receivers and kits, and finally these also have been produced.

These seeming miracles have not been created full-fledged in a single day or even in a single month. They have become possible through the unstinted utilization of brains, money, time and material, backed up by the necessary years of experience in television experimentation.

To attain the desired results it has been necessary to create precedent, rather than to follow it. New ideas have been subjected to long and severe laboratory tests until perfected. New methods have been evolved. Wherever older usages have been retained, they have been refined and improved upon.

### New Televisor Kit

All of which serves to introduce the home television equipment just announced by the Insuline Corporation of America. This equipment is now available not only in kit form, but also as completely assembled, ready-to-use apparatus.

Since the kits are of particular interest to television fans, these will be discussed here. The televisor, called a "Visionette," was developed by A. G. Heller, chief engineer of the Insuline Corporation of America, and is of such improved design that the entire family can view the television images simultaneously, instead of one at a time as in former home devices. The transition from a "peep-hole" to a "screen" effect is of far-reaching importance. The 5-inch square reproduced pictures are bright and clear and can be seen from almost any angle.

By H. G. Cisin, M.E.

The Visionette kit consists of the following essential parts: a special motor, a neon lamp, a 60-line scanning disc, a shadow box or visor, an adjustable "mirror screen," a magnifying lens system, a convenient, compact metal housing.

Perhaps the most startling innovation is that contained in the motor design. The conventional synchronous motor has been supplanted by a specially developed television-type motor of extremely unique and efficient design. This motor contains a wound stator (for providing the rotating field) and two rotors on the same shaft. (See Figure 1.) The lower rotor is of the squirrel-cage induction type, while the upper one is of the synchronous type, with notches or teeth. Neither rotor utilizes any windings.

### Synchronizing System

The induction motor, with its high starting torque, is used for starting and to bring the scanning disc up to speed. By pressing a lever at one side of the housing, the synchronous motor is brought into the rotating field furnished by the stationary windings. Thereafter, the motor is automatically kept in synchronism. If for any reason it should happen to get out of step (resulting in a picture out of frame), a touch of the lever brings the induction motor into play, speeds the motor up to synchronism and hence frames the picture without fuss or delay.

This motor is the last word in simplicity, ease of operation and efficiency, and it does away with speed control rheostats and other similar obsolete methods of framing. The motor is 8½ inches in diameter and 3 inches in width.

The shaft is vertical, driving the scanning disc in a horizontal plane. The motor fastens to the underside of the housing deck, and the scanning disc is also below the deck. It is thus pro-

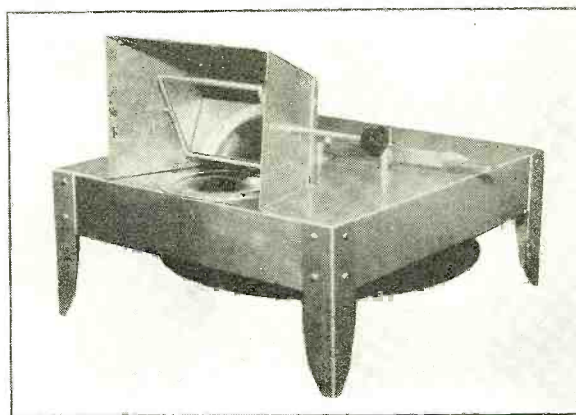

THE TELEVISOR

*The horizontal scanning disc and wafer-shaped motor result in a compact unit. The television receiver may be mounted on the rear of this frame*

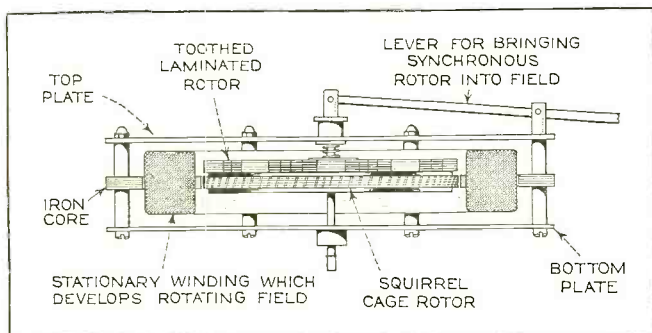

UNIQUE MOTOR DESIGN

*Figure 1. This sketch illustrates the two-rotor arrangement employed in the motor which drives the scanning disc*

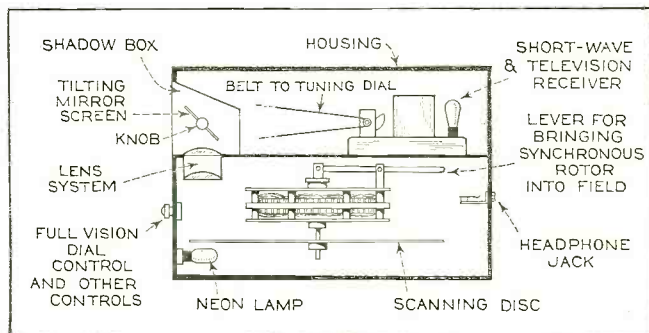

THE GENERAL LAYOUT PLAN

*Figure 2. The receiver and televisor are combined. Note that the tuning controls are on the front of the housing*



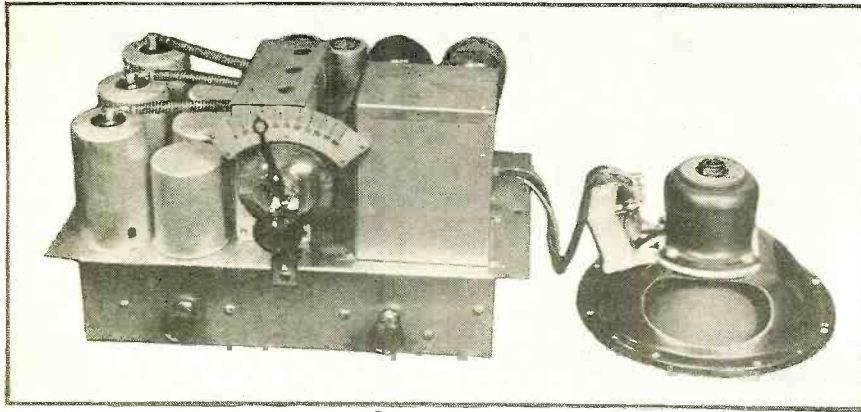

THE TELEVISION AND SHORT-WAVE RECEIVER

The receiver is unusually compact and may be used for both television and short-wave broadcast reception

time increasing its apparent brightness. The metal housing is of rectangular shape and is very compact. It is approximately 14 inches high by 16½ inches wide by 18 inches deep overall, and ordinarily is supported on four metal legs. It has a shrivel bronze finish and presents a neat, harmonious appearance. The housing is so conveniently designed that it can be put on top of a radio console or underneath a standard radio midget, thus permitting the reception of combined sight and sound programs from the single unit.

The special Insuline short-wave television receiver is mounted at the rear of the Visionette housing, behind the shadow box. The receiver kit may be obtained as a separate unit or in conjunction with the Visionette kit.

tected from injury and dust. The arrangement of the various parts is shown in Figure 2. The scanning disc is a standard 60-hole, 16-inch disc, allowing passage of the maximum amount of light. Just below the disc, at the front of the housing, is the neon lamp. This is of a special type, working at low current. It modulates readily, giving splendid light and dark contrasts.

The magnifying lens system employed in the Visionette consists of a combination of lenses telescopically arranged for maximum enlargement. There is no distortion, due to accurate correction for spherical aberration. The television image is not viewed directly in the lens, but is observed in an adjustable mirror screen. By tilting this screen forward or backward about its horizontal axis, it is possible to focus the picture to suit the level of the observers' eyes. Thus a group of people standing would require the mirror at one angle, whereas the same group seated would be able to see the images better with the mirror screen tilted at a different angle.

The effect of the mirror screen is to widen the angle of vision considerably, permitting more people to view the television reception from a number of varying angles. The shadow box or visor excludes extraneous light, thus bringing out the fine details of the image being received and at the same



SCANNING DISC MOTOR

An actual picture of the two-rotor motor, details of which are shown in Figure 1

The circuit employed in the receiver has been developed after extensive research and is the last word in simplicity, requiring only four tubes and rectifier. Two variable-mu tubes are used in the two tuned r.f. stages, with a type -24 screen-grid tube in the tuned power-detector stage and a pentode tube in the single audio output stage. A type -80 full-wave rectifier is employed.

Combination Receiver

The receiver is arranged with built-in r.f. coils of special design covering a wavelength of from 75 to 200 meters. By means of a toggle switch it is possible to change over instantaneously from television signal reception to short-wave voice reception. This doubles the value of the receiver.

There is no need to change coils. A turn of the knob and short-wave broadcast stations come in. A flip of the switch and the receiver is back in position to receive the television signals. A special switch is provided so that the loudspeaker is connected to the output to tune in the television signals, and then by turning the switch in the other direction the neon lamp is substituted in its place. This greatly facilitates tuning. The loudspeaker, however, need not be purchased as a part of the equipment. In order to reduce the expense to the experimenter, a jack is provided connected in the detector circuit, so that a head set may be plugged (Continued on page 729)

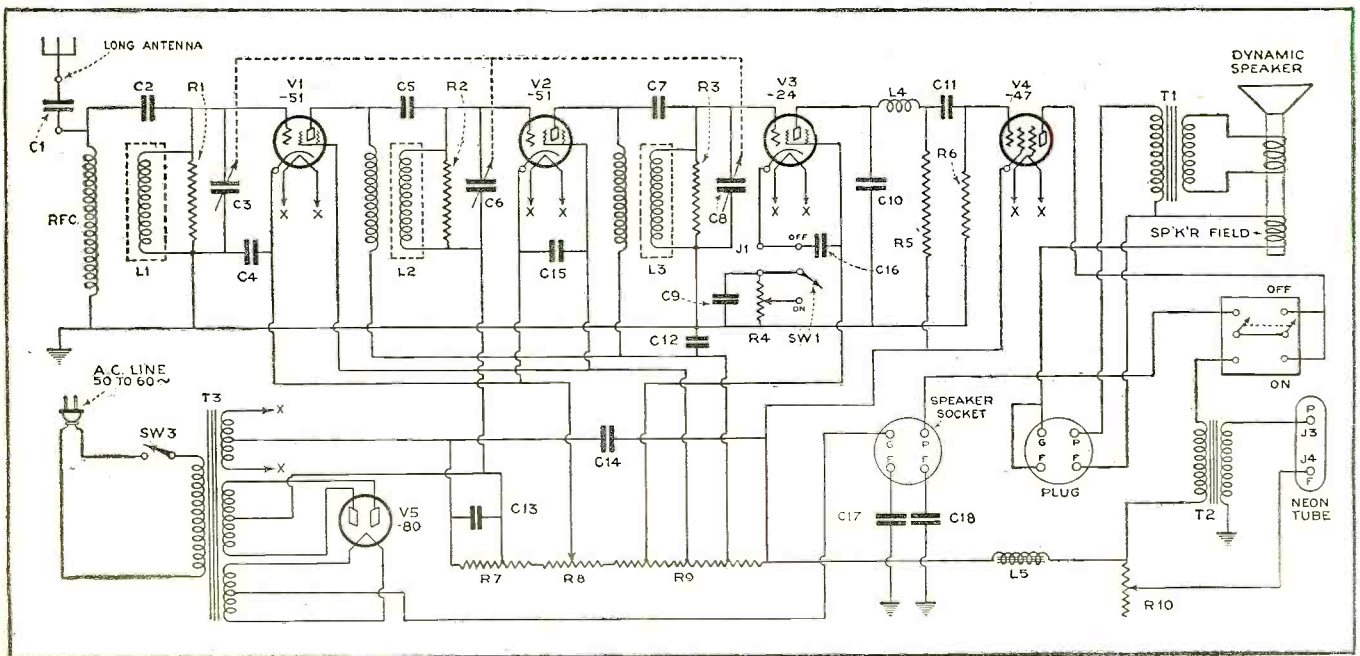

FIGURE 3. SCHEMATIC DIAGRAM OF THE RECEIVER



CQ CQ CQ de WDDDE WDDDE WDDDE

# MacMillan Calls from BAFFIN LAND



CAP'N AND GUEST

The cheerful individual at the helm is Captain Crowell, of the Schooner Bowdoin. On his left is a friendly Eskimo, a visitor on part of the trip

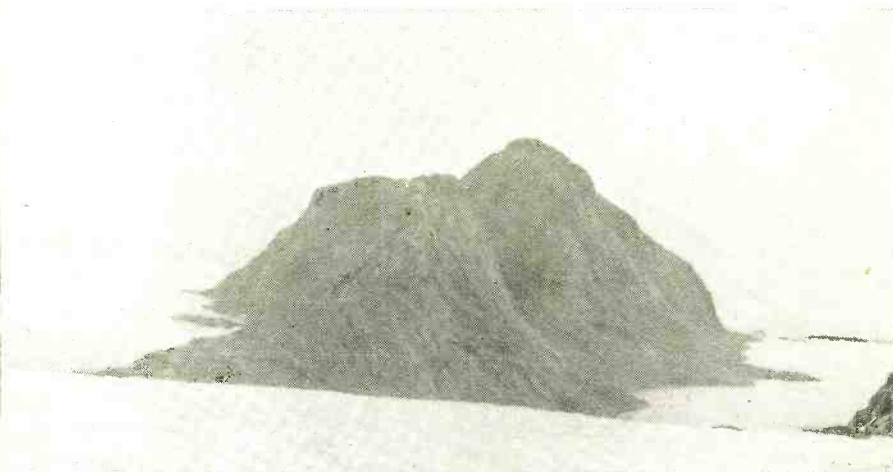

GRIM MOUND OF GLACIER-WORN ROCK

Cape Hollister as viewed from the great Grinnell Glacier; a point to break the monotony of the coast line surveyed by the MacMillan expedition

*An account of the experiences of the radio operator on an Arctic expedition relating the effects of the Aurora Borealis and hidden ore fields on superheterodyne reception of signals between the Schooner Bowdoin and American amateurs who contacted the expedition*

**A**FTER fifteen eventful trips into the Arctic, Commander Donald MacMillan, well-known among the American roster of intrepid explorers, is a firm believer in radio as a means of communication, as a news medium and as a safety measure. He believes that amongst all the scientific apparatus carried by expeditions into the great North, the radio apparatus ranks second to none. Coming as it does from the man who was the first to use radio successfully in the Arctic, the first to reach Finlay Island, the first to reach and explore the western shores of North Cornwall, the first to use aircraft in the western portions of the Arctic, this is high praise indeed. Commander MacMillan made his first trip into the North with Commander Peary in 1908. In 1925 he conveyed Commander Byrd and Floyd Bennett on the expedition of the National Geographic and Field Museum.

### Radio Mystifies Eskimos

In my capacity as radio operator of MacMillan's Arctic schooner *Bowdoin* (call letters WDDDE), I have had many interesting experiences in difficult radio reception. The Eskimos cannot understand radio at all. They cannot seem to get it through their heads that music coming out of a "tiny box" really is an instantaneous reproduction of music actually played by humans far away. They seem to think that a person's speech coming out of the radio set is the voice of some spirit within the box itself. When we'd pick up a musical program from the States they'd look on in wonder and inspect the box

By Ralph Brooks\*

closely, trying to see inside, half expecting to find some kind of dwarf doing the talking.

On our expedition to Baffin Land last summer with Commander MacMillan we took with us, instead of several receivers of various types, a Lincoln ten-tube superheterodyne, using the new type -30, type -31 and type -32 tubes as standard equipment. On previous trips we had depended upon three-tube regenerative receivers, using the -99 type of tubes to be used with headphones. The superheterodyne on the last trip had a tuning range from 10 to 600 meters, being of the all-wave type and using a loudspeaker instead of the wearying headphones. During this trip, the radio, both on the short waves and on the broadcast bands, was a big improvement over earlier outfits. We listened during our spare waiting moments to transatlantic telephones, United States amateurs talking to England, Holland and Germany. South American amateurs whiling away languid moments with Californian "hams." Programs on the broadcast waves were gotten with great clarity from KOA, Denver; KDKA, Pittsburgh; WEA, New York; WJZ, New York; WEEI, Boston; WGY, Schenectady; and WTAM, Cleveland, among others. Code signals were received from virtually all foreign countries, including Russia, England, Germany, Spain and Italy. Our transmissions to the United States were carried on at 13,240 kilocycles, which is close to the 20-meter band, and we usually used this same frequency in communicating with foreign lands. The transmitter, which was my personal contribution to the equipment for contacting "back home" and for use with the expedition plane, was of the push-pull tuned-plate, tuned-grid type, using -204-A type tubes.

\*Radio operator, MacMillan Expedition.



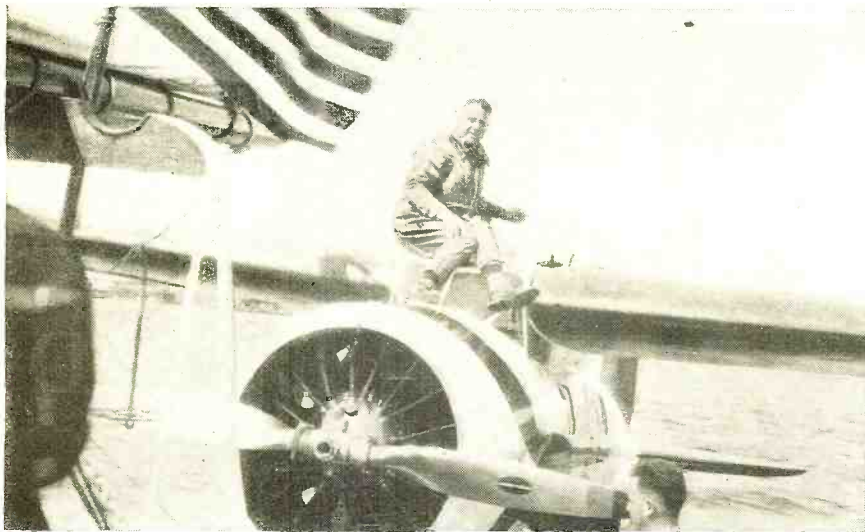

#### START OF A MAPPING FLIGHT

*The pilot of the MacMillan plane "Viking," Charles Rocheville, climbing into position for a final inspection of the plane before taking off for a flight over the icy wastes*

We made some rather interesting observations in regard to fading and the effect of the magnetic North and the Aurora Borealis upon both our transmission and reception on this trip. As stated before, nearly all of our transmission was on or near the 20-meter band. In talking to American amateur stations, we found that this was often drowned entirely as a result of the Northern Lights display, while, at the same time, the incoming broadcast waves between 500 and 1500 kilocycles were remarkably increased in intensity, making reception stronger than usual. At other times, exactly the reverse would be true, so that getting a signal through regularly was often an elusive effort and keeping it at its original strength was truly little less than magic. Another factor affecting radio transmission and reception was the extremely large iron-ore content of the country. At one time our schooner was anchored in a small bay sheltered by huge cliffs and, while there, radio proved of little use due to the absorption effect of the iron fields near by.

We found the best time, during the 24-hour day, in which DX work could be done was from 7 to 10 p.m. and from 3 to 6 a.m. C.S.T. The hours just after sunset, therefore, and just before dawn seemed to bring in the clearest signals and allowed us to work the greatest distance. Of course, during our stay in Baffin Land it was never entirely dark, for the sun would just "duck" under the horizon. Hence there was always light enough for the exploring party to find its way around.

#### Icy Pastimes

Climbing the ice cap with which this land is covered was one of the principal sports of the crew. This vestige of the great ice sheet, which has been the subject of study by MacMillan for many years, contains huge fissures and queer-shaped crevasses which intrigue adventurous spirits. Many hours were spent in plodding over these barren wastes and we believe that our party penetrated farther into the interior than any other white man. The principal accomplishment of our summer's work was in aerial mapping, in infinite detail, the Labrador coastline between Battle Harbor and Cape Clidley. Our motion-picture cameraman accompanied the group and exposed approximately 12,000 feet of film.

All expedition communication was carried on through radio with the help of American amateur radio stations. Two of them are worthy of special mention in

this work. They include Roscoe H. Johnson, who carried on almost the entire traffic with us, who owns and operates station W9ABD, in Chicago. And another amateur in Cincinnati, WSDLD, handled a large amount of traffic by radio telephone.

W9ABD, it may be remembered, was the same chap who, when Colonel and Mrs. Lindbergh were flying way up through northwestern Canada and no word had been received from them, picked up the Lindbergh signals. A note from his log reads, "While cruising the dials on our Lincoln super for our regular schedule with Ralph Brooks, radio operator aboard the schooner *Bowdoin*, we heard, my wife and I, KHCAL (Lindbergh plane) calling WOA (Pan-American Airways, New York). Following the usual preliminaries, Mrs. Lindbergh pounded out in clear, perfect Morse, 'Left Bakers Lake 23.35 G.C.T. Signed Lindbergh.'" He supplied the press with the only news received from the plane at this time.

Through Mr. Johnson's persistent endeavor, nightly contacts with our expedition were maintained under very trying conditions. One evening in July, for instance, while our thermometer registered 18 degrees below zero, while John M. Larson was spelling Johnson at the key and headphones at W9ABD in Chicago, Larson wired "Make it snappy; it's terribly hot here—106 degrees." I came back, "Don't get excited, old boy; it's 18 degrees below up here. My hands are frozen, although I am working with gloves on."

#### Contact with "Home"

We also established contact almost nightly with WSDLD, and many messages were exchanged by members of the crew and their families by means of this medium. It so happened that the father of one of the young boatmen MacMillan took along arrived in Cincinnati one night and, hearing about station WSDLD and its contact with the expedition, called up the operator to see if any news had been heard recently. "Got him on the air now," came the reply over the telephone. "Hurry over and you can say hello to your son."

The schedule for the expedition was as follows: We left Boston, June 15th and proceeded north to Wiscasset, Maine, where final preparations were made for the long trip into the ice. After this point the *Bowdoin* was in nightly contact with Chicago, via radio. After leaving Wiscasset in a heavy fog, the crew was entertained by a (Continued on page 721)

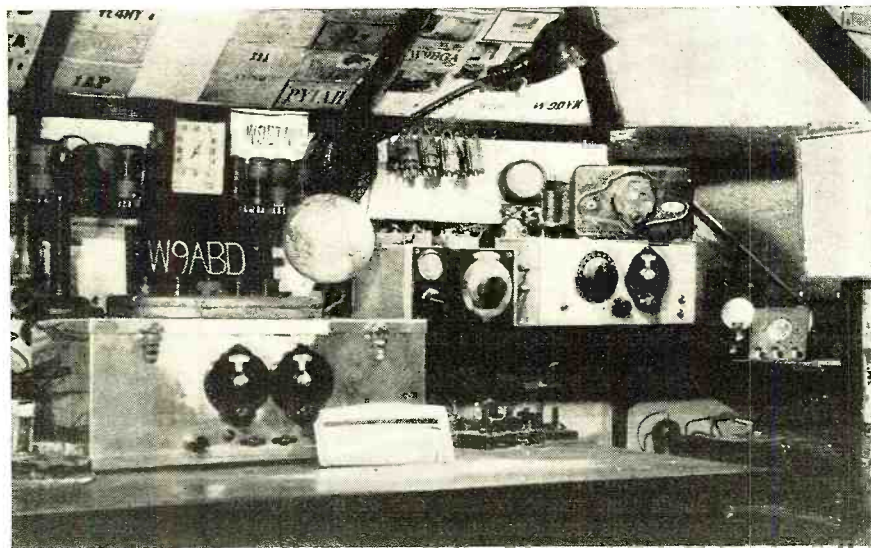

#### RECEIVING SET USED AT CHICAGO

*In talking to the MacMillan expedition, Mr. Johnson, owner and operator of amateur station W9ABD, employed a standard Lincoln d.c. superheterodyne with special shielded case and dials*



# Mathematics in Radio

## Calculus and Its Application in Radio

By J. E. Smith\*  
Part Fourteen

IT is recognized that calculus enters the realm of higher mathematics, but we notice its use so many times in the technical journals and textbooks covering the principles of radio engineering that it becomes advantageous to understand to some extent its underlying principles.

Calculus is not necessarily difficult to understand, although many of the textbooks dealing with this subject appear to be rather involved to the beginner, who has the desire and enthusiasm to know a little more about this subject. It is the purpose of these articles to outline the fundamental principles of calculus as used in radio in such a way that it can be thoroughly understood by those students who have the secret ambition of understanding mathematics just a little better.

Let us emphasize that calculus is not difficult to comprehend and there is a tremendous satisfaction in the outcome of a solution of a problem which can be obtained more easily by the use of calculus than by other methods.

The subject of calculus is divided into two parts—the differential calculus and the integral calculus, one of which is the inverse of the other. Each one is very important and both have their necessary application in the theory of radio circuits.

### Differential Calculus

Let us investigate some of the elementary considerations involved in the study of differential calculus. Let Figure 1 represent a generator, G, which supplies power to a load. Current, therefore, flows through the conductors, A and B, and as a result of this current a magnetic field is set up in the space surrounding the conductors.

In a single conductor, A, the magnetic field is represented in Figure 2 by continuous lines shown in concentric circles around the conductor. This magnetic field is strongest near the conductor and rapidly decreases as the distance increases from the center.

If a number of turns of wire are wound on a spool, the magnetic lines of force generated by the individual turns will unite, and a larger magnetic field will exist across the coil. When an electric

current flows in a circuit similar to Figure 3, the magnetic lines of force set up around the primary coil cut the secondary coil. If the current remains constant, the magnetic flux is constant, but when the current varies the flux varies proportionally. This is shown by a simple experiment, for if, in the circuit of Figure 3, the primary circuit is closed through a battery, then at the moment of closing the circuit the lines of force are set up around the primary, cut the secondary coil and a momentary deflection occurs on the galvanometer. If the current is left on there is no further indication of the galvanometer.

Thus currents will be induced in the secondary coil if the magnetic flux passes in and out of it, and a voltage or electromotive force (e.m.f.) is generated which is proportional to the rate at which the magnetic field cuts the conductor.

It is the rate at which the various elements occur in relation to other factors that become important in the fundamental conception of the differential calculus.

Now, let us consider the circuit of Figure 3 and suppose that the primary and secondary coils are wound over an iron core but, of course, insulated from each other. When an alternating e.m.f. is impressed across the primary circuit, an alternating current flows which magnetizes the iron circuit first in one direction and then in the other. It is important to note here that we have a changing magnetic flux. An alternating magnetic flux means then that these lines of force will cut both the primary and secondary turns of wires and as a result it produces an e.m.f. in both the primary and secondary windings. Note that in the primary winding this induced e.m.f. is opposite in direction to the e.m.f. impressed on the primary coil.

We have here one of the fundamental laws of electromagnetism, that is:

$$e = - \frac{d\theta}{dt}$$

This is interpreted as meaning that the instantaneous value of the e.m.f. "e," induced in each turn (Continued on page 723)

HEREWITH is presented the fourteenth of a series of instruction articles on mathematics, emphasizing especially its application to radio. The articles which have appeared thus far are:

### WHAT HAS GONE BEFORE

Arithmetic.....	Page	542	Dec., '30
The Slide Rule.....		630	Jan., '31
Algebra in Radio.....		722	Feb., '31
Algebra in Radio.....		826	Mar., '31
Algebra in Radio.....		920	Apr., '31
Algebra in Radio.....		1004	May, '31
Geometry in Radio...		1088	June, '31
Geometry in Radio...		63	July, '31
Geometry in Radio...		230	Sept., '31
Trigonometry in Radio		288	Oct., '31
Trigonometry in Radio		292	Nov., '31
Trigonometry in Radio		491	Dec., '31
Trigonometry in Radio		589	Jan., '32

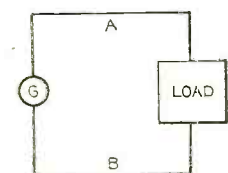

FIG. 1

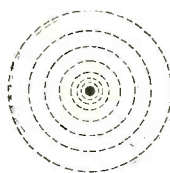

FIG. 2

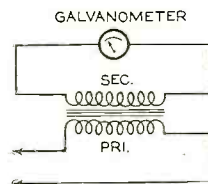

FIG. 3

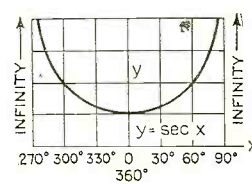

FIG. 4

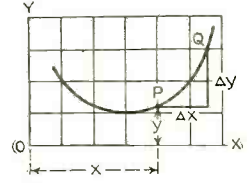

FIG. 5

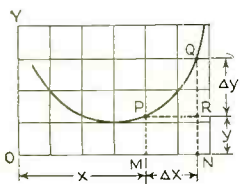

FIG. 6

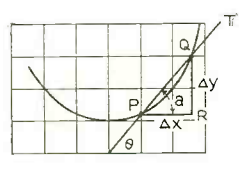

FIG. 7

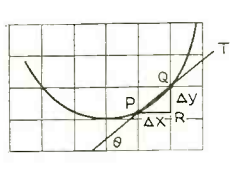

FIG. 8

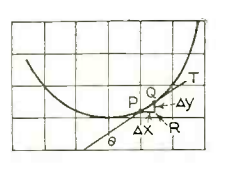

FIG. 9

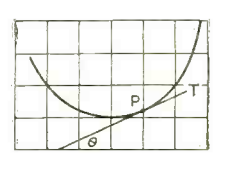

FIG. 10

\*President National Radio Institute.





# With the Experimenters

*Radio Time Switch; Hint for Antenna Erection; Constant Frequency Without a Crystal; Locating Interference with an Auto-radio; Handy Small-part Tray; Tube Trouble; Code Practice Set; Noiseless Microphone Stand; Home-made Welding Device*

## Improved Radio Time Switch

I have just been reading the article by Mr. Vernon W. Palen (RADIO NEWS for December, page 493) on "A Simple Radio Time Switch," using an old alarm clock. About a year ago I made a device, using the same principle but capable of turning the radio *either off or on* at any predetermined time, automatically.

Conducted by  
**S. Gordon Taylor**

the two springs A and B. The alarm is then set for whatever hour it is desired to have the radio turned off. When this time arrives the alarm will be released, the winding key will start to turn and the arm will break contact. The key will continue to turn until the attached arm

pole, double-throw switch and replacing the wood stop with one of metal. These changes are shown in Figure 2.

With this revised arrangement the operation will be the same as in Mr. Palen's device, when the switch-arm G is set on point E. By setting the switch-arm on point F the action is just the reverse in that when the alarm goes off the arm C will come in contact with the metal block D, thus closing the a.c. circuit and turning the radio set on.

Thus in setting the clock to turn the radio either on or off the arm C is turned to make contact with springs A and B. To turn the set on the switch-arm G is set on point F. To turn it off G is set on point E.

The drawing shows only the simplest layout. Refinements may be added, such as using an insulated switch (SW), insulating the arm C to avoid receiving a shock when handling it, etc.

RONALD LAVIOLETTE, B.A., E.E.D.,  
Montreal, Canada.

## Hint for Antenna Erection

It is frequently necessary to weight the end of a rope or wire to throw it over places where a ladder or long stick cannot be made use of. Seems like nothing is ever handy or available when you want it. Knot the end of the rope, or secure the end of the wire in an old and tightly rolled magazine. Tie the magazine in the center or at both ends to keep it solid. You can quite accurately toss or throw

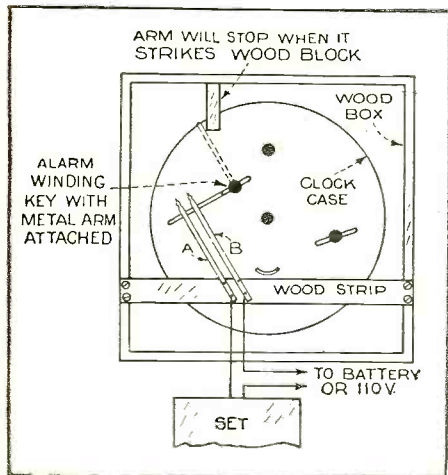

FIGURE 1

The scheme used by Mr. Palen is shown in Figure 1. This arrangement makes provision only for turning the radio off. This is accomplished by turning the alarm winding key of the clock until the metal arm attached to it makes contact with

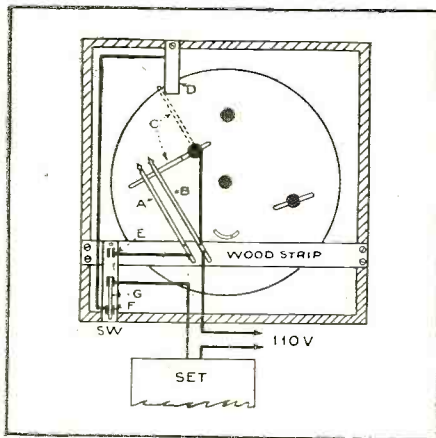

FIGURE 2

strikes the stop, which takes the form of a wood block.

My idea can easily be applied to Mr. Palen's arrangement by adding a single-



this, and if someone above has to catch it, it is very easy to "connect" with. Many odd handy metal things used in a pinch for this purpose are not only hard to throw and catch, but are dangerous when they fall and often break things they happen to hit. This simple scheme can always be used, and is very handy, safe and practical.

FRANK BENTLEY,  
Missouri Valley, Iowa.

**Using an Auto-Radio to Run Down "Man-Made" Static**

A novel and highly practical method of locating outdoor sources of radio interference is suggested by P. E. Current, interference investigator of the East Bay District, Oakland, California. In his work he uses a standard (Transitone) auto receiver. The idea should be applicable using other types of sensitive auto-radio sets also. Mr. Current writes: "Conditions in this work made it necessary to make a slight change in the wiring of the Transitone set in order to eliminate the automatic volume control feature, or to cut it in at will. This was done with a single-pole, double-throw jack switch and a 100,000-ohm resistor.

"The resistor between the grid of the volume control tube and the bias resistors of the radio-frequency tubes was unsoldered at the point where the three are joined together. This left two resistors in series to ground in those stages. The

**Constant Frequency Without a Crystal**

On page 310 of the October issue there was an item contributed by L. H. Stanz of Brooklyn, N. Y., showing a circuit which he has been using in his amateur transmitter to obtain a high degree of constancy in frequency output without resorting to the use of a quartz crystal. Several readers of this department have since called attention to the fact that this

"In addition to the regular dynamic speaker, I use a small horn type speaker and an output meter. The additional speaker is used because it acoustically amplifies the higher frequencies which are prevalent in radio interference. The output meter with a control potentiometer is used to indicate the proximity of the set to the source of interference. These speakers and the meter are all controlled by a switch and jack arrangement so that the speakers or meter or both may be cut in or out of circuit at will.

"In addition an extra set of pin jacks is wired in on this panel so that a pair of headphones may be plugged in.

"This equipment, plus an eight-pound sledge hammer, is all that is necessary to locate leaks in high-voltage circuits which cause radio interference. These leaks are usually in the nature of loose bond wires, line fuses or line switches.

system would not function properly without grid-leaks, although no grid-leaks were shown in the circuit diagram in the October issue.

Word has been received from Mr. Stanz that the grid leaks were omitted through an oversight and that one should have been shown in the grid of each of the two tubes. The leaks he uses have a value of three megohms each, and one is connected from grid to ground in each tube circuit.

We are glad to pass this word along to those who may be interested.

**Handy Small-part Tray for Bench**

Some kind of a small part tray is very handy around the bench, but it is hard to take small screws and pieces out of a



round tray. A simple and very handy little arrangement can be quickly made as shown above. Take a fairly heavy block of 1-inch wood about 3½ by 5 inches. Gouge out a small area of one side and set in one of the light metal sugar scoops sold in any ten-cent store for 5 cents. Tack it down with one or two round-head tacks. This is very easy to move around and handle, and the fingers can readily pull out any part by drawing it up along the tapered end. Very handy when taking to pieces any of the parts which are 90 percent screws or other light metal attachments.

FRANK BENTLEY,  
Missouri Valley, Iowa.

**Tube Trouble**

I have found many tubes that will not test okay and appear burned out are good tubes. The trouble is in the tube prongs. The wire at the tip of the prongs sometimes has not been properly soldered and becomes loose or corrodes and does not make contact with the prong. Resolder and the tube will light.

I have found this to be true in several instances. Noises in many cases will also disappear if the tube prongs are resoldered.

ANDREW P. PLATCO,  
Brockway, Pa.

**Code Practice Set**

A novel code practice set can be constructed in the base of a table lamp. For the person who is aiming to further his knowledge in radio telegraphy, this should be of special interest. The construction of the outfit is as follows:

First, secure a lamp with a hollow base six or seven inches in diameter. The



Mr. P. E. Current, interference investigator, is seen at his very interesting occupation of locating undesirable "man-made" static

end thus unsoldered was connected to the blade of the switch. One switch contact was connected to the point where this resistor was disconnected and the other contact was grounded through a 100,000-ohm resistor.

"When the switch was thrown so that this resistor was cut in, there was no change in quality or volume of reception, the only difference being that there was noticeable fading, which is a feature desired in radio interference investigation.

"When the meter reads maximum we are reasonably sure that we are at the correct place, and as a final check the phones are plugged in and we strike the pole with the sledge hammer as high as it is convenient to swing. This jars the pole so that any loose connections are shown by a decided rattle in the phones. From then on it is a job for the public utility company concerned. It might be added that in the bay area, one hundred percent cooperation is received."



transformer is mounted in the most suitable place in the base. If it is at all possible—use a transformer with a ratio of 3 to 1. Opposite this mount the tube socket. Drill two holes in the side of the lamp base to receive the key and phone jacks. Care must be taken that these holes are insulated with fiber or bakelite washers. The next step is to wire the outfit. Cut one of the leads from the lamp cord, inside the base. Solder the ends to the filament lugs on the tube socket, or, in other words, the filament of the -01A is connected in series with the filament of the bulb in the lamp. Now complete the necessary wiring as

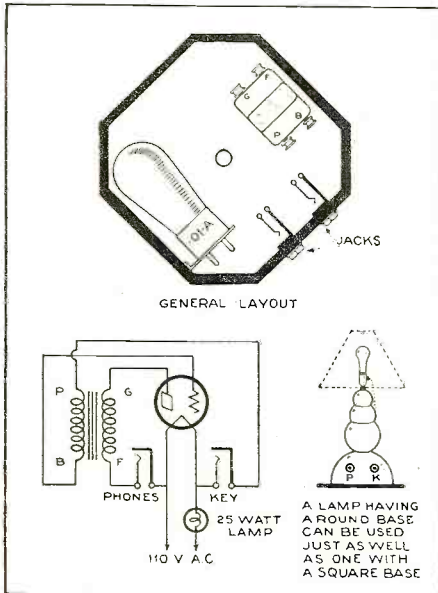

shown in the above drawing and the code practice outfit is ready for use. In performance this set generates signals as clean cut as any that could be received over the air, coming from the best transmitter. This set, too, has many advantages over the battery-type code set, a few of which I shall stress: First, it can remain in a living room without detection of its real use. Second, it offers a real source of amusement when other radio fans call. Third, you never have to worry about new batteries, because it uses none. Last but not least, it might be possible to buy up from second-hand dealers a supply of gas lamps and electrify them and build the code practice set into them, then in turn sell them to your friends for a reasonable price, allowing a handsome profit for yourself.

THOMAS A. BLANCHARD,  
Reading, Pa.

### Noiseless Microphone Stand for the Amateur

One of the greatest annoyances in amateur radiophone work is the background noise caused by the microphone picking up vibrations. There are devices on the market which eliminate this noise, but few amateurs have sufficient funds for their purchase.

The illustrated stand can be made in a short time from an old telephone desk stand, a piece of 1/4-inch square brass rod, a few screw-eyes and a box of rubber bands; most of which are in the average amateur's junk-box.

Saw off the desk stand just below the

receiver-hook hole, and the transmitter crotch 1/4 inch above where it forks. Bend the 1/4-inch square rod into a circle of the desired diameter and braze or solder the ends together. Solder the ring to the transmitter crotch. It makes a better looking job if the ring is first let into the slot and then soldered.

Mount the screw eyes around the ring and in the mike as illustrated. Drill two holes for leads either in the back of the transmitter crotch or through the ring to connect with the hole already in the

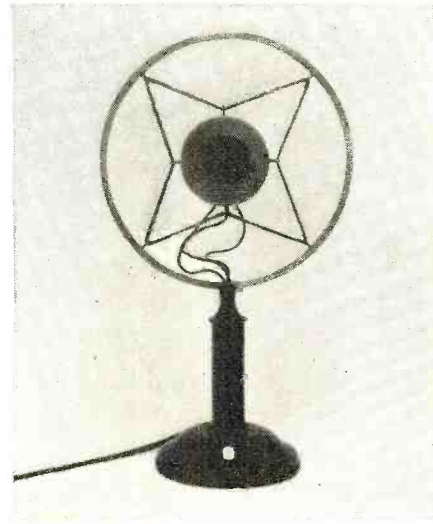

crotch. String the rubber bands, connect the leads and the micropone and talk.

This type of mounting is considerably cheaper and quieter than the commercial type using metallic springs. It can be made in a short time and has given very satisfactory service.

RONALD L. IVES,  
Upper Montclair, N. J.

### Home-made Welding Device

To many people arc-welding calls to the mind an image of bulky, complicated and expensive apparatus. True, such elaborate machines are necessary to meet the demands of industry, but much simpler and cheaper outfits can be constructed for use around the workshop by any experimenter whose home is supplied with 110-volt a.c. or d.c. In fact, the welding outfit described below may be constructed with parts from the junk box which every experimenter has.

Many uses will be found for this simple tool, for welding thin plates or wires made of iron, steel, copper, etc.

The simplicity of the welding outfit may be seen by inspecting Figure 3. The baseboard may be of bakelite, rubber or other insulating material. A half-pint or one-pint glass or earthenware vessel may be used to hold the solution, which will be described later. Earthenware is better, as quite a bit of heat is developed by the passage through the solution of the heavy current required for welding.

The two metal plates that are immersed in the solution may be of brass, copper, lead or aluminum, about one inch wide and two inches high. The simplest way of supporting these plates is to use heavy connecting wires, such as No. 12, with provision to allow one or both plates to be lowered or raised in the solution.

The holder for the carbon rod with

which the welding is done may be as elaborate or as simple as one wishes to make it. All that is necessary is a brass bushing through which the carbon rod slips, a setscrew to hold the carbon in place, provision for fastening the wire from one side of the mains to the brass bushing.

The carbon rod may be obtained by breaking open an old dry or flashlight cell and removing the carbon rod from its center. One end of this rod should be tapered to about one-sixteenth of an inch and the welding done with this point.

The outfit should be wired with No. 14 copper wire. Flexible wire of this gauge is used for connecting the carbon rod, the metal clip, and also for connecting the outfit to the mains. If flexible wire of No. 14 gauge is not available, twist together several lengths of lamp cord and use that.

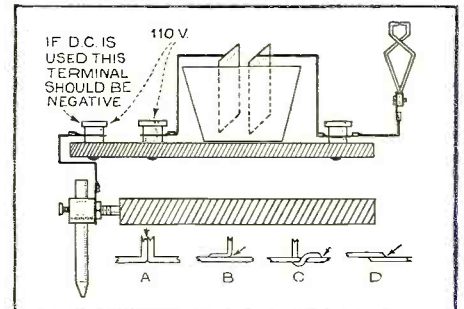

FIGURE 3

The solution contained in the vessel is water with ordinary table salt dissolved in it. The proper proportion of salt is one-half level teaspoonful to one-half pint of water. This salt solution acts like the resistance element of a rheostat, and the two plates serve as the terminals. The resistance is varied by partially withdrawing one or both plates from the solution. Partially withdrawing the plates from the solution causes a corresponding decrease in the current available for welding. This makes it possible to obtain correct values of current for welding wires or plates of various sizes.

To determine which is the positive side of the mains, where the supply is direct current, place the bared ends of two wires, connected to the mains, in a glass of water having a pinch or two of table salt dissolved in it. Arrange the immersed ends of the wires so that they are about an inch apart. The wire at which the greater amount of bubbles form is negative. By marking the positive wire and the wall outlet or socket, and always inserting the connecting plug the same way, it is possible to always obtain the same polarity. The reason for this precaution is that if the welding carbon were made positive, the heat would consume the carbon more rapidly, with less effective welding.

After constructing and wiring the outfit, the experimenter should procure a pair of dark seaside spectacles. Never attempt to weld without the spectacles, as the glare of the electric arc is harmful to the eyes.

Next adjust the two metal plates so that they are about an inch apart and fully immersed in the solution. This completes the welding outfit.

(Continued on page 727)



# Backstage in Broadcasting

*Chatty bits of news on what is happening before the microphone. Personal interviews with broadcast artists and executives. Trends and developments in studio technique*

**W**HILE radio listeners were expecting to see the 1931 radio diction medal of the American Academy of Arts and Letters awarded to some veteran microphone spokesman, much surprise was caused by awarding the coveted trophy to John Wesley Holbrook, twenty-five-year-old NBC announcer who joined the network's staff only a few months before. Hamlin Garland, noted author who made the award, said Holbrook's voice combined the best of "English English" and "American English," and commended his taste, pronunciation, grace and authority in the use of speech. Honorable mention was awarded to David Ross of the CBS and William Abernathy



John Holbrook

and Sen Kaney, both of NBC. Garland said that, in making the third annual award, the committee found a decision more difficult than in the past for the reason that the general level of announcers has risen. Holbrook was born in Boston and recently served on the staff of Station WBZ in that city. He joined the NBC last May, after winning network recognition during his announcements of nation-wide programs originating in Boston. With Holbrook's success, all three of the academy's annual diction awards have gone to the NBC. Milton J. Cross and Alwyn Bach were the previous winners.

**T**HE studio construction experts of Radio City recently returned from Europe prepared to complete final plans for some twenty-seven NBC studios in the gigantic entertainment development now under construction. The party, consisting of O. B. Hanson, Gerard Chatfield and Wallace K. Harrison, visited broadcasting centers in England, France, Germany and Russia. Hanson, NBC manager of plant operation and engineering, surveyed foreign engineering development. Chatfield, NBC technical art director, studied studio finishing. Harrison, one of the Radio



By  
**Samuel Kaufman**

City architects, will adapt building plans to suit studio needs. They announced upon their return that they were prepared to create the last word in studios both from the standpoint of utility and artistry. One studio may have a seating capacity of 1000 and all will be built to accommodate visitors. Following their survey, Hanson and Chatfield listed the following problems of studio planning: (1) The studios must be arranged so as to enable thousands of persons to pass back and forth daily with the least amount of confusion. (2) The studios must be thoroughly sound-proofed, one from another, and each from outside noises. (3) There must be acoustical treatment to meet varying broadcasting conditions. (4) Because each studio will be almost hermetically sealed, an elaborate ventilating system must be perfected, with special emphasis on the elimination of reverberation in the ventilating ducts. (5) The illumination must be suitable

without introducing an abundance of heat. (6) The studios must be attractively decorated without destroying any of the foregoing properties.

Leases were recently signed by David Sarnoff, president of the Radio Corporation of America and RCA-Photophone, Inc.; Merlin H. Aylesworth, president of the NBC, and Colonel Hiram S. Brown, president of the Radio-Keith-Orpheum Corporation, for approximately 1,000,000 square feet of office, studio and theatre space in the huge Rockefeller development. This is believed to be the largest single group lease ever put into effect. The principal tenants will move into Radio City in 1932 and 1933.

**J**OHAN PHILIP SOUSA and Arthur

Pryor, veteran bandmasters, are conducting their respective musical organizations on two series of programs sponsored by the Goodyear Tire and Rubber Company over the NBC. Sousa and his band are presented Tuesdays, while the Pryor Band is heard Saturdays. Sousa was honored by radio folk on the occasion of his seventy-seventh birthday recently by the presentation of a broadcast testimonial from the Times Square NBC studios. Walter Damrosch, Erno Rapee, Arthur Pryor, Edward Franko Goldman and Harold Sanford participated in the event by conducting an orchestra featuring the best-known compositions of the march king. Pryor's former Crema feature on the CBS is now starring Bing Crosby, the songster who was the subject of an item in this department two months ago.



John Philip Sousa



SIGNING RADIO CITY LEASE

**M**UCH attention has been given to the new series of symphonic concerts presented Sunday afternoons by Walter Damrosch and a new orchestral group from the Times Square studios of the NBC. The latest type of parabolic microphones are used to give radio listeners "the best seats in the house" to hear the symphonies of the  
*(Continued on page 725)*



# The Service Bench

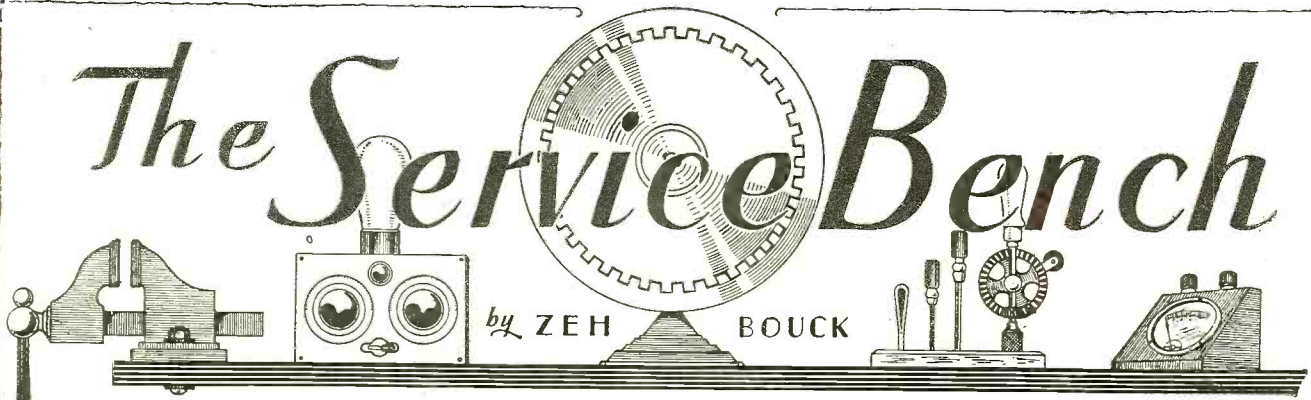

Merchandising Service—Service Sidelines—P. A. Systems, Talkies, Aids to Hearing—Victor—Crosley—Westinghouse

## Sales Aids in Servicing

**R**ADIO servicing today is a highly competitive business. Receivers are becoming more and more fool-proof. Longer and longer life is being built into tubes. At the same time the number of available servicemen is increasing—the ranks being augmented by the constant outpouring of correspondence school graduates and recruits from amateur experts. In the face of this competition, it is not sufficient that the serviceman knows enough to remove the wire with the red tracer from lug number five and insert a nine-hundred-ohm resistor to reduce squealing in the Bloopadyne Model 16A. He must know all this, to be sure, but he must be equally familiar with the science of merchandising and its tools, publicity and advertising.

We illustrate below several pieces of literature which two service organizations consider quite as essential as a test kit or soldering iron. In reference to the mailing card prepared by the R. D. Clerk Company, it will be observed that the approach is humorous and the message concise. There is little doubt that every recipient will read this card. It will be one hundred percent successful in carrying its message.

An equally interesting bit of sales literature is prepared in the form of a multi-graphed letter by Hertel's Radio Store, in Clay Center, Nebraska, who are also responsible for the inspection and sales tags shown on this page. It reads:

"Did it ever happen to you?  
"The score is 6 to 6; the ball is on the 4-yard line; just 3 minutes to play; the whistle blows—the ball is snapped—

and then—'br-r—crack—squawk, squawk'—and the radio has gone haywire. And so the day is utterly ruined.

"The next few weeks will be the best of the year for the radio listener. World Series starts October 1st; big football games are near; the big fall features of the chains and local stations are coming up.

"Are you ready? Is your radio working one hundred percent? Does it need new batteries, tubes or adjustment? Is it likely to go haywire at the critical moment in a big game? **BETTER BE SAFE THAN SORRY!**

"Let us make a complete physical examination of your radio. We'll test its heart and lungs and liver and everything. If it's in perfect condition we'll be glad

to tell you so. If it needs tubes or batteries, or anything in the way of adjustment and repair, we will consult you before going ahead.

"If you live in Clay Center, an examination in your home will not cost you a cent, and will place you under no obligation. There is a small mileage charge for a home examination if you live in the country, but we will gladly examine your set free if you will bring it into our shop.

"Radio is our business. We devote our entire time to it, and we have the most complete service and testing equipment in the country. We have received our sixth annual authorized dealer appointment from Atwater Kent—the best radio in the world.

"Just say the word—and we'll check up your radio, put it in perfect condition for perfect fall operation, or better yet—

"We'll be glad to make a free home demonstration of the new 1932 AT-WATER KENT—the golden value with the golden voice.

"Write or 'phone today, or bring your receiver to our store for testing.

"Sincerely,

"HERTEL'S RADIO STORE.

"By Roger H. Hertel."

While due to its length the above letter will be read through only by perhaps seventy-five percent of those who receive it, it presents a better and more complete sales argument or story than the more abbreviated card circulated by Mr. Clerk. It may therefore have the same sales value per capitem circulation. However, a combination of the two—or two similar

<b>HERTEL'S RADIO STORE</b> Clay Center, Nebraska	
Date Sold	.....
Customer	.....
Test	.....
Checked	.....

FIGURE 1



**DON'T BURY A  
Dead Radio.**

**We can revive it!**

Over 20 years experience  
in Wireless and Radio.

**R.D. CLERK & CO.**  
20 Grenville Ave., Westmount

Telephone  
**WEStmount 9123**

FIGURE 3

FREE RADIO INSPECTION	
Name	.....
Address	..... Phone .....
Make of Radio	.....
AC	..... DC .....
Model No.	.....
Tubes	..... Speaker .....
Aerial	..... Batteries .....
Other Remarks	.....
<small>HERTEL'S RADIO STORE Clay Center, Nebraska</small>	

FIGURE 2

A FEW SUGGESTIONS FOR THE PROGRESSIVE SERVICEMAN



circulars—would probably prove an efficacious effort, using the letter as a follow-up on the card.

The Service Bench continues to be interested in receiving samples of such advertising and publicity material, and will gladly pay for what we publish.

## Service Sidelines

### Profits in New Fields That the Serviceman Can Best Handle

We have already observed in this issue of the Service Bench that the service business is becoming more and more highly competitive, and that only the serviceman alert to the merchandising possibilities of his profession can expect to make the most of it financially. We have heretofore stressed the effect on the cash register of legitimate sidelines ambitiously pushed. By legitimate sidelines we refer to the by-products of radio development, principal among which are public address systems, talking motion pictures and aids for hearing.

The possible profits on P. A. systems are threefold—rental, sale and service—and require a financial expenditure within the ability of the average serviceman. Sound picture projectors offer similar profits, with a slightly reduced market for rentals. Profits on installation and sales are more attractive, but the original outlay often runs into the neighborhood of a thousand dollars or more. The money-making possibilities of hearing-aid devices are almost altogether limited to sales, but the percentage profits are large—for

the apparatus is readily made by the serviceman—and the required capital is small.

The possible markets for public address systems have been considered in past issues of the Service Bench. Several different makes of equipment are now available to the serviceman, covering the various requirements of the field.

The PAM Midget, shown in Figure 5, is the latest addition to the portable jobs and weighs less than thirty pounds complete. It consists of a dynamic speaker built into the carrying case, the side of which acts as the baffle, integral power supply and voice amplifier, microphone and fifty feet of cable. The tubes required are one -80, two -45's (in push-pull) and one -24. The average speaking voice is amplified and reproduced without overloading with sufficient intensity to cover an audience of five hundred persons. The hand microphone is of the two-button type and is said to have excellent frequency characteristics. The volume control is mounted on the mike handle, and may be instantly adjusted by the speaker.

The uses for which the manufacturer recommends the PAM Midget provide an excellent outline of the sales and rental possibilities of P. A. systems in general:

**DEPARTMENT STORES**—For style shows, beauty lectures, special sales demonstrations and employees' training courses.

**BUSINESS HOUSES**—For sales meetings, special demonstrations, employees' gatherings.

**TRADE SHOWS**—For sales demonstrations at industrial exhibitions, trade shows, etc.

**OUTDOOR SALES DEMONSTRATIONS**—For traveling sales demonstrations, etc.



EASILY CARRIED

Figure 4. This outfit is really portable—even though it handles the power output of push-pull pentodes

**CHURCHES AND PARISH HOUSES**—For social gatherings, entertainments, and the meetings of the various church organizations.

**HOTELS**—For banquets, convention gatherings, lectures, bridge parties, etc.

**CLUBS**—For smokers, business meetings, lectures, entertainments, etc.

The PAM Midget is manufactured by the Samson Electric Company of Canton, Mass., and the list price is \$115. We have, as yet, no data on discounts.

A higher power portable unit is made by Silver-Marshall, and is illustrated in Figure 4, packed for carrying. Set up for use, it was shown on page 395 of the November issue. Here again the side of the carrying case is utilized as the speaker baffle. Push-pull pentodes are used in the output, and the power is sufficient for an audience of one thousand. The list price on the S-M portable public address system is \$199.50 and is subject to a serviceman's discount of forty percent. The circuit is shown in Figure 6 and may be used as the basis for a similar arrangement built by the serviceman preferring to construct his own apparatus. The individual parts, as listed in Figure 7, can be obtained from the maker.

Still higher-priced equipment is manufactured by the Gates Radio and Supply Company for both portable and permanent installations. The portable equipment is mounted in a trunk, and, naturally, is not so readily transported as the Samson



ANOTHER MIDGET P. A. SYSTEM IN ACTION

Figure 5. This portable public address system weighs less than 30 pounds, and is capable of carrying the ordinary speaking voice to an audience of 500 persons



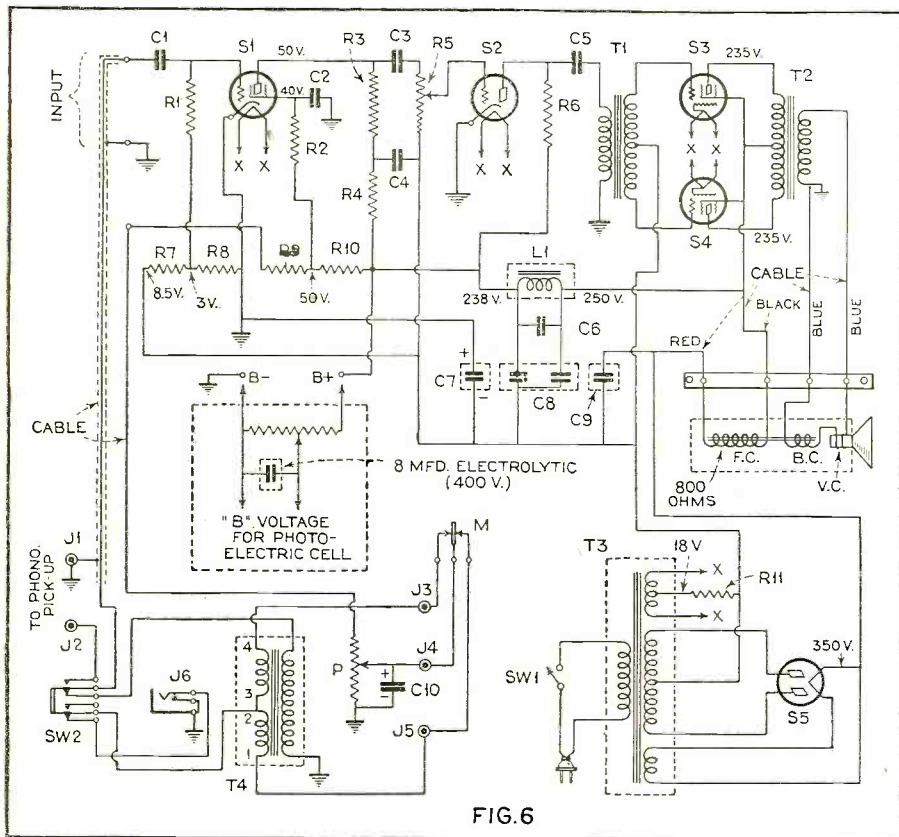

FIG. 6

PARTS LIST

- |                                       |                                      |
|---------------------------------------|--------------------------------------|
| C1 .05 MFD. SPRAGUE (400 V.)          | R4 30,000 OHMS 1 WATT                |
| C2 1.0 MFD. (150 V.)                  | R5 1 MEG. TAPERED VARIABLE RESISTOR  |
| C3 .01 MFD. (MICA)                    | R6 30,000 OHMS 1 WATT                |
| C4 1.0 MFD. (200 V.)                  | R7 250 OHMS                          |
| C5 0.25 MFD. SPRAGUE (750 V.)         | R8 125 OHMS                          |
| C6 0.1 MFD. "                         | R9 2300 OHMS } 5 WATT                |
| C7 10 MFD. DRY ELECTROLYTIC (25 V.)   | R10 11,300 OHMS                      |
| C8 2 MFD. PAPER (400 V.) EACH SECTION | R11 220 OHMS 2 WATT                  |
| C9 8 MFD. DRY ELECTROLYTIC (450 V.)   | S1 -24                               |
| C10 10 MFD. " (25 V.)                 | S2 -27                               |
| L1 10145 CHOKE                        | S3, S4 -47                           |
| J1, J4 TIP JACK (BLACK) TYPE #420     | S5 -80                               |
| J2, J3, J5 TIP JACK (RED) "           | SW1 ON-OFF A.C. SWITCH               |
| J6 MIDGET JACK                        | SW2 SWITCH (MICROPHONE TO PICK-UP)   |
| M UNIVERSAL MICROPHONE                | T1 10176 INPUT TRANSFORMER           |
| P 200 OHM POTENTIOMETER               | T2 10143 OUTPUT "                    |
| R1 2 MEG. }                           | T3 360-V POWER "                     |
| R2 60,000 OHMS } 1 WATT               | T4 10154-M MICROPHONE-PHONO. TRANSF. |
| R3 .5 MEG.                            |                                      |

FIG. 7

CIRCUIT DIAGRAM AND PARTS LIST OF SILVER-MARSHALL EQUIPMENT

Figures 6 and 7. This can be used as the basis of home-made equipment, and the parts indicated can be obtained from the manufacturer

and S-M jobs. The tubes required in the Gates system are: one type -30, one -27, one -26, two -50's and two -81's. The filament of the type -30 tube is lighted from the plate supply to the power tube. The amplifying system combines transformer and impedance coupling in a circuit that is said to provide humless reproduction even at maximum gain. Provision is made for phonograph, radio and microphone amplification. The list price on the Gates portable equipment, with a high-grade broadcast microphone, f.o.b. Quincy, Ill., is \$475. This price is probably subject to a trade discount.

The systems above considered are all designed for operation from the usual 60-cycle, 110-volt supply.

Second-hand public address apparatus can be purchased from the Service on Sound Corporation at 1600 Broadway, New York City, making many excellent bargains available to the serviceman. This same organization also sells sound movie projectors, sound-heads, turntables,

speakers of all types, sound screens, acoustical felt, theatrical burlap, motor-generator sets for arc supply, film speed indicators, ticket choppers, seats and complete theatre equipment, both new and used.

An excellent source of profit to the rural serviceman exists in the changing over of local projectors from silent to sound reproduction. It is possible to buy complete sound-on-film equipment, comprising sound head and mechanism, amplifier and speaker for as little as \$355.50. A reasonable charge for such a conversion would be \$500, netting a comfortable profit for a day's work.

A discount of twenty percent is allowed servicemen on the prices quoted by the Service on Sound Corporation.

Money in Hearing Aids

The profit-making possibilities of hearing aids have already been indicated by S. Gordon Taylor in his various articles

on the subject appearing in RADIO NEWS. The first step in realizing them is to determine the extent of the market in your community. A list of persons suffering from impaired hearing may be readily compiled from tactful inquiries at the local shops, school principals, ministers and doctors. Following the purchase or construction of a demonstration model, the next step is to obtain entrée. Where the prospective customer is a member of a family for whom you have serviced radios, the manner of approach is obvious and facilitated. In other cases, an introduction from a local medical practitioner is desirable and generally easily secured. An excellent move is to demonstrate to the doctor the efficiency and economy of the system recommended.

The demonstration to the customer is best made in his own home, for several reasons. In the first place, the prospect can judge the effectiveness of the device under the conditions which will prevail during the greater part of its use. Moreover, members of the prospect's family can judge the efficacy of the arrangement more definitely and quickly than the prospect himself, because they can gauge the effort required to make him hear and understand, while the subject has no means of knowing whether those to whom he is listening are speaking in a normal conversational tone.

The radio serviceman will also find that those hard of hearing are most amenable to suggestion that a special headphone hook-up be incorporated in the family radio. The most simple of the possible circuits is shown in Figure 8. The telephone receivers are isolated from the high voltage, are provided with an independent volume control, and the hook-up has no effect whatever on reproduction from the speaker. In the case of a push-pull amplifier, wires A and B are connected to the plates of the push-pull tubes. When a single power tube is employed, wires A and B are connected between the plate and ground. Neat and

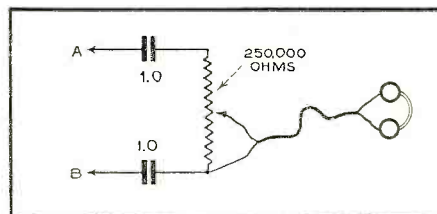

FIGURE 8

convenient equipment for this type of service was shown and described on pages 492-3 of the December issue of RADIO NEWS.

All in a Day's Work

Correction

The resistor values shown in Figure 3 of the Service Bench for December are wrong in three instances. The two 400-ohm resistors and the single 800-ohm resistor should be, respectively, 40 ohms, 40 ohms and 80 ohms. The values indicated in the parts list are correct.

An error also appeared in the diagram (Continued on page 735)



# Service Data for Servicemen

Compiled by Nat. Feiner\*

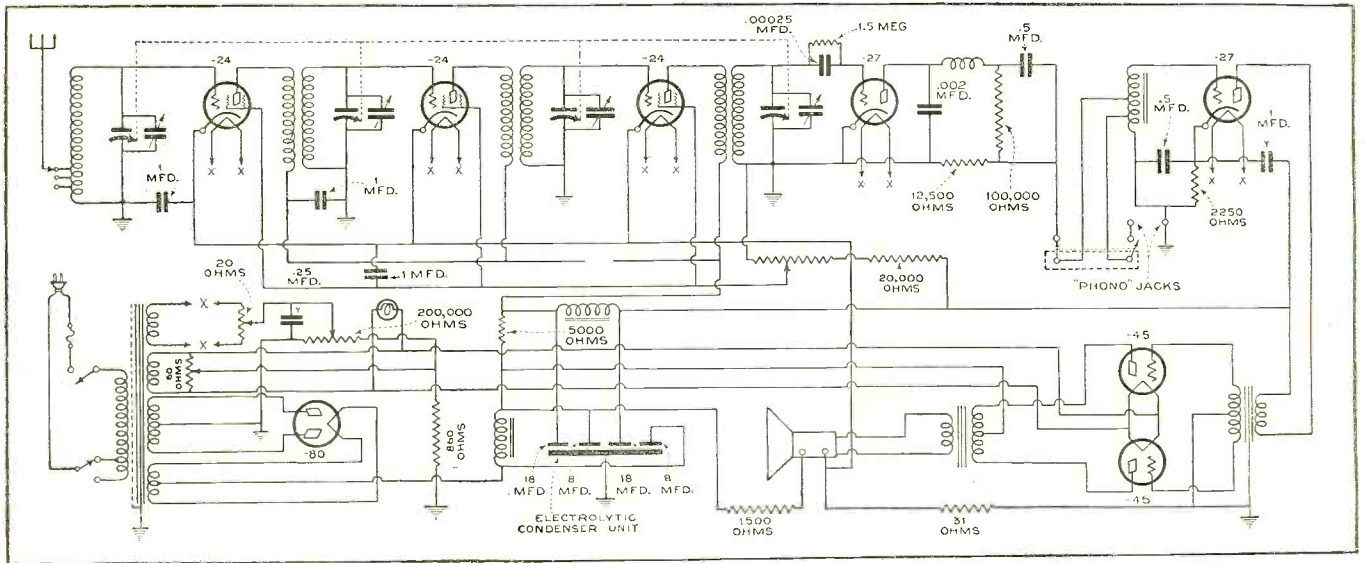

AMRAD, MODEL 81

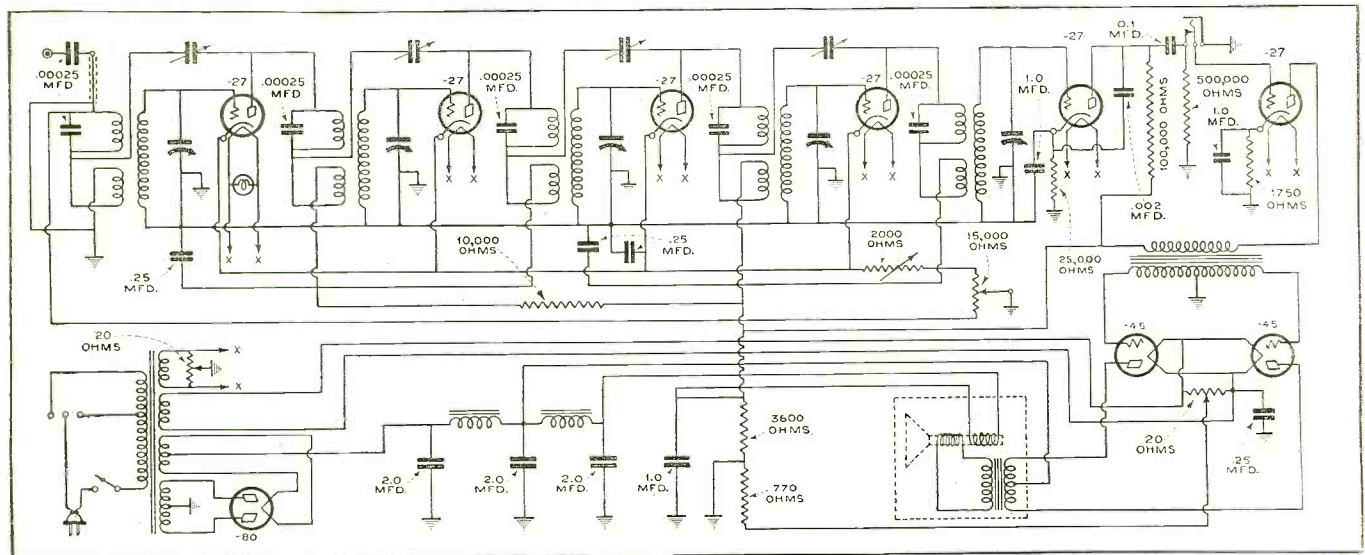

BALKITE, MODEL C

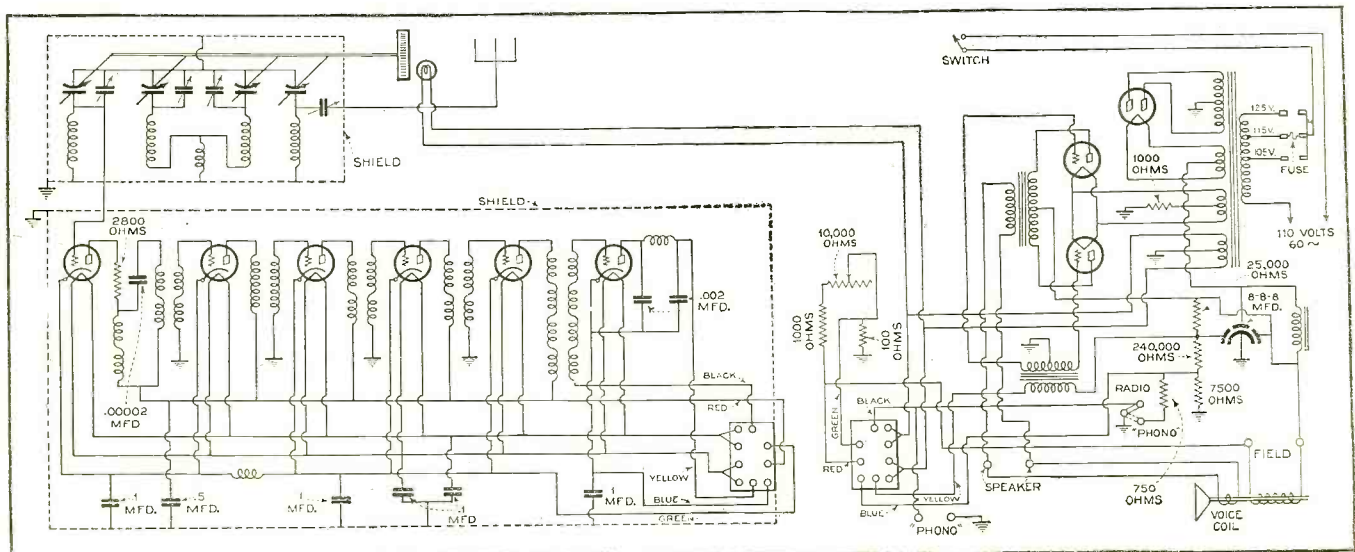

A.C. DAYTON NAVIGATOR

\*Chief Engineer, Federated Purchaser.



# Radio Physics Course

*This series deals with the study of the physical aspects of radio phenomena. It contains information of particular value to physics teachers and students in high schools and colleges. The Question Box aids teachers in laying out current class assignments*

**W**E have now reached a point in our study of electricity where it is necessary to establish definite units and relations to express electric current flow, e.m.f. and resistance quantitatively. In our everyday lives we are accustomed to using common units and their subdivision to express lengths, time, forces, etc. Thus the foot, meter, etc., are employed to measure and express lengths or distances; the second, minute, hour, etc., are used to express intervals of time. In electrical work also, certain units of current, voltage (e.m.f.) and resistance are in common use. Furthermore, these units have been adopted, as standard, by the many countries of the world so that an ampere, for instance, in the United States is supposed to represent the same rate of current flow as an ampere in Australia, England, Germany, etc. Also the units used by the electrical worker or electrician are the same as those employed in radio work. This standardization of units is, of course, essential to a simplified electrical practice. In the early days of the electrical art, before the electron theory was known, several systems of units were proposed and used in different countries. This led to confusion. At the present time the International Units have become standard in all of the civilized countries of the world.

## Quantity of Current (Coulomb)

It was explained that an electric current flowing through a conducting circuit really consists of a large number of tiny electrons moving rapidly in complex paths from atom to atom, but at the same time flowing or drifting through the conductor. Since these electrons are tiny negative charges, it follows that an electric current really consists of the motion of a large number of tiny electric charges, through the circuit, so that a measure of the *quantity* of current really resolves itself into a measurement of the quantity of electric charges. We cannot feel, see, smell, or hear these tiny electric charges and therefore cannot count or measure them by any of our senses. Also we cannot measure an electric charge by any of our common standards of measurement such as length, weight, etc. We can, however, determine a charge by measuring the force of attraction or repulsion which will always exist between it and some other charge. Since the force of attraction or repulsion depends not only on the strengths of the charges themselves, but also on the material and the distance

By Alfred A. Ghirardi\*

between them, these factors must also be considered when defining our units.

A very natural method of procedure in establishing a unit of electric charge would be to specify a standard medium and distance between the charges and the force acting between two unit charges under these conditions. Thus the original *Electrostatic* unit of quantity of electricity was defined as "that

quantity with which a very small body must be charged so that when placed in a standard medium at a distance of one centimeter (2.54 centimeters equal one inch) from a similar body charged with an equal quantity, a force of repulsion of one dyne (1 db. = 444,827 dynes, approximately) will exist between the two. This was the unit of quantity in the *electrostatic system of units*, evacuated space (a vacuum) being selected as the standard medium. The condition is represented simply in Figure 1. However, this unit

and the associated units for voltage and resistance were later found to be entirely too small for conveniently measuring and expressing the quantities of electricity, e.m.f., and resistance dealt with in the applications of practical batteries and generators and in practical electrical devices. For instance, the quantity of electricity flowing through a 100-watt, 110-volt incandescent lamp, every second, is about 2,700,000,000 electrostatic units.

As it was found inconvenient and unwieldy to use the large numbers necessary to express, in this system of units, the

values of quantities of electricity dealt with in practice, the so-called *practical units* were defined to be certain multiples of these original units. The practical units are those in common use today. The fundamental unit of quantity of electricity in the practical system is the *Coulomb* (named after Charles A. Coulomb, the celebrated French physicist). The Coulomb is approximately 3,000,000,000 ( $3 \times 10^9$ ) times as large as the electrostatic unit, defined above.

We may define the Coulomb as that quantity of electrical charge with which a very small body must be charged so that, when placed in a vacuum at a distance of one centimeter from a similar body charged with an equal quantity, it will repel that

body, with a force of approximately  $(3 \times 10^9)^2$  dynes (since the force is proportional to the square of the strength of the charges).

The coulomb represents a definite *quantity* or *amount* of electrical charge just as a gallon of water represents a definite quantity of water as represented in (A) of Figure 2. It is independent of all other units. Since the electron theory has

## Lesson Seven

# Electrical Units of Current, Voltage and Resistance. Ohm's Law

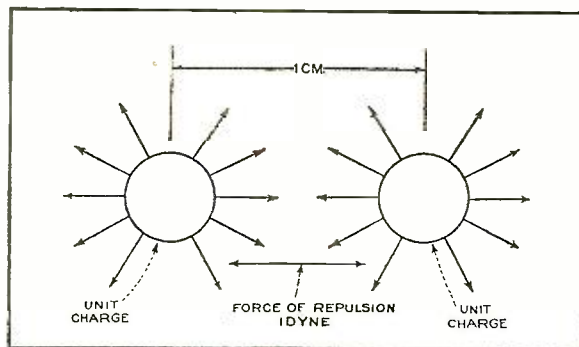

ELECTROSTATIC SYSTEM

Figure 1. Conditions specified for unit quantity of electricity in the original electrostatic system of units

\*Radio Technical Pub. Co., Publishers, Radio Physics Course.



come into use it has been estimated that since each electron contains a definite quantity of electricity, a coulomb is the total amount of charge contained by  $6.28 \times 10^{18}$  electrons (6,280,000,000,000,000 electrons).

### Rate of Current Flow (Ampere)

In the cases of storage of electric charges as in the charging of condensers, or charges at rest as in static electricity, we are interested in the bulk or quantity of electricity or charge stored. The coulomb is useful in expressing this. In the case of current flow through wires and other conductors we are not usually much interested in the total quantity of electricity flowing through the circuit (coulombs), for this does not take into account the time during which the electricity flows. All of the effects of electric current (heating, chemical, magnetic, etc.) with which we commonly deal depend for their intensity on the rate at which current flows through the conductor. For instance, 100 coulombs of current might flow through a wire in one hour. This would produce a certain total quantity of heat in the wire during that time. During the hour the wire would have plenty of time to lose this heat by radiation, etc. If the 100 coulombs were sent through the wire quickly, say in one second, the same total quantity of heat would be produced, but since it is now all produced in one second it heats the wire up to a higher temperature. Thus the intensity of heating effect in the wire depends on the rate of current flow rather than the total quantity of current flowing through it. It is more important then for us to know the rate of current flow.

Instead of expressing the rate of current flow as so many coulombs per second, it is convenient to use a separate short term. The name *ampere* has been adopted in honor of the famous French scientist, André Marie Ampere, to represent the practical unit of rate of flow of electricity. The current flowing past any given point in a circuit is one "ampere" (commonly abbreviated "amp.") when electricity passes through at the net rate of one coulomb per second. (This is analogous to the term gallons per second when expressing the rate of flow of water as shown in (B) of Figure 2.)

Since one coulomb equals  $6.28 \times 10^{18}$  electrons, when a current of 1 ampere is flowing through a circuit of  $6.28 \times 10^{18}$  electrons are drifting past any given point in the circuit every second. It can be seen from this that in our common electrical circuits carrying tens, hundreds, and thousands of amperes of current, billions and billions of electrons are circulating through the conductor every second.

### Milliampere, Microampere

For measuring very small electric currents (for instance, the plate current in a vacuum tube), it is convenient to use a smaller unit than the ampere. In this case the milliampere is employed. Milli is French for  $\frac{1}{1000}$ , or .001 ampere; conversely, one ampere equals 1000 milliamperes.

A still smaller unit sometimes used is the *microampere*. This is  $\frac{1}{1,000,000}$  ampere; or 1,000,000 microamperes equal one ampere.

The student may perhaps gain some idea of just how much an ampere of current is by studying Figure 3. Here several common electrical devices are represented together with the rate of current flow in amperes required for their proper operation. Some devices take currents considerably less than one ampere, some take currents of many amperes. In radio receiving equipment most of the parts are carrying rather weak currents. Meters have been developed for measuring the rate of flow of electric current. They are called ammeters, milliammeters or microammeters, depending upon the strength of the currents they are designed to measure. Their construction and operation will be studied later.

## Question Box

PHYSICS and science instructors will find these review questions and the "quiz" questions below useful as reading assignments for their classes. For other readers the questions provide an interesting pastime and permit a check on the reader's grasp of the material presented in the various articles in this issue.

The "Review Questions" cover material in this month's installment of the Radio Physics Course. The "General Quiz" questions are based on other articles in this issue as follows: Television Hits Broadway; Recent Improvements in the Design of Electro-static Loudspeakers; Filming Radio Programs; New All-Wave Super Features High-Gain Design; The RADIO NEWS Telephone Booster; New Superheterodyne Design Featuring Two-Volt Tubes; The Pentode Oscillator.

### Review Questions

1. Why are standard electrical units of e. m. f., resistance and current necessary in electrical and radio work?
2. Name and define the practical units of current, resistance and e. m. f.
3. The plate current of a certain vacuum tube is 7 milliamperes. Express this current in (a) amperes; (b) microamperes.
4. The signal voltage applied to the grid circuit of an amplifying tube in a radio receiver is 15 microvolts. Express this in (a) millivolts; (b) volts.
5. The grid leak resistor used with a detector tube has a resistance of 5 megohms. Express this in ohms. What is the conductance of this resistor?
6. It is desired to produce a fall of potential of 90 volts in a circuit through which 45 milliamperes of current are flowing. This is to be accomplished by connecting a resistance in the circuit. (a) What must be the value of the resistor in ohms? (b) What must be the maximum watts dissipation rating of the resistor, assuming that it is to be operated at 50% of its maximum rated value?
7. The field coil of a dynamic speaker is connected across a B eliminator having an output voltage of 300 volts. The resistance of the field coil is 1500 ohms. Calculate the electric power in watts supplied to the field coil.
8. State ohm's law. Write the formula for it.
9. Write the three formulas for electrical power in watts. (a) in terms of e. m. f. and current. (b) in terms of e. m. f. and resistance. (c) in terms of current and resistance.

### General Quiz on This Issue

1. Why does distortion result when an attempt is made to relay a telephone message through two telephone lines, by placing the receiver of the first against the microphone of the second?
2. What is a more desirable method of relaying or amplifying telephone conversations?
3. What is the maximum recommended current drain when using one air-cell A battery?
4. What are two special features of the scanning disc used in projecting television images on a ten-foot screen?
5. Explain the principle of a class B power amplifier.
6. What are its advantages over the ordinary power amplifier circuit?
7. What constitutes the oscillatory circuits when using a single pentode tube as a dual oscillator?
8. What are the advantages of the film system of sound recording over the disc method?
9. State and describe one of the shortcomings of loudspeakers. Explain the cause of this.
10. What basic theory of selectivity favors the superheterodyne circuit for short-wave reception?
11. In what fundamental principle does the electro-static loudspeaker differ from ordinary reproducers.
12. Why was 465 kc. selected as the intermediate frequency in the new "Comet" superheterodyne receiver?



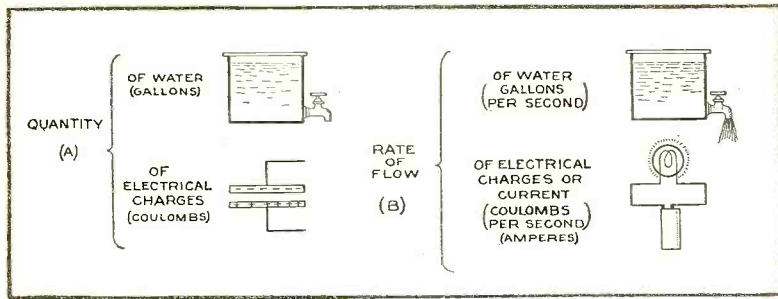

FLUID ANALOGY

Figure 2. Analogous units of quantity and rate of flow for water and electrical charges

**E.M.F. (the Volt)**

During our study of the electron theory we found that the free electrons could be made to drift in a definite direction along a conductor by applying an external electric force which we call "electromotive force" (abbreviated to e.m.f.). This electrical force or pressure exists between any two bodies that have a different intensity of charge or a different polarity of charge. It is sometimes called "potential difference."

Electromotive force may be developed or generated in several ways in practice. Common sources of e.m.f. are primary cells or batteries, storage batteries on discharge and electric dynamos. These devices produce a continuous difference of electric potential or pressure between their terminals. If a complete conducting path is provided, this difference of electric potential will cause a flow of electrons, or electric current. The practical unit of electromotive force is the *volt*, named after the famous Count Alessandro Volta.

When a coulomb of electricity is transferred between two points by an expenditure of one joule of energy ( $10^7$  ergs) the points are said to differ in electrical potential by one volt.

Because of the term *volt* the e.m.f. as sources of electric potential is often referred to as "voltage."

The e.m.f. developed by a single dry cell is  $1\frac{1}{2}$  volts. That developed by the three cells of a lead-acid storage battery on discharge is slightly over 6 volts. Incandescent lamps are usually operated from 110-volt sources of e.m.f. The filaments in the 201A, 171A, and 112A tubes are designed to operate on 5 volts. Those of the 224 and 227 tubes require 2.5 volts. The plate voltages employed on radio receiving tubes varies from 45 to 450 volts, depending on the type of tube. The e.m.f. of a standard B battery is 45 volts. Voltages as high as 2000 are employed on electrical transmission lines. Thus it is seen that a large range of voltages is employed for various devices.

**Kilovolt, Millivolt**

Sometimes it is more convenient to use larger or smaller units of electric potential than the volt. In such cases the kilovolt (equal to 1000 volts), the millivolt (equal to  $\frac{1}{1000}$  volt); and the microvolt (equal to  $\frac{1}{1,000,000}$  volt) are used. For

NOTE: Authorities differ in their use of the symbols  $\omega$  and  $\Omega$ . The American Institute of Electrical Engineers, in their March, 1928, Proceedings, propose a complete group of electrical symbols in which the ohm is shown as  $\Omega$ , and the megohm as  $\omega$ . Prominent electrical corporations such as the Bell System and allied organizations use the letter  $\omega$  exclusively for ohms, and of the various diagrams in a large number of publications which have been scrutinized, about half of them use  $\omega$  as the symbol for ohms, and the other half use the letter  $\Omega$ . To prevent confusion, we are identifying all resistances in this book with the word "ohms" spelled out. In the diagrams the letter  $\Omega$  is used for ohms and M $\Omega$  for megohms.

instance, 5000 volts = 5 kilovolts; .003 volts = 3 millivolts; .00005 volts = 50 microvolts.

Measuring instruments called *voltmeters* have been devised for indicating directly in volts the values of e.m.f. Where the e.m.f. is small (few thousandths of a volt) a *millivoltmeter* is used. This will be studied later.

**Resistance (the Ohm)**

All conductors of electricity oppose the flow of current through them, that is, they have electrical *resistance*. The unit of resistance is called the *ohm* in honor of George Simon Ohm, a German mathematician.

A conductor has a resistance of one ohm if the ratio of the applied e.m.f. in volts to the current flowing through it in amperes is unity. That is, an ohm is the resistance through which an e.m.f. of one volt will send a current of one ampere ( $6.28 \times 10^{18}$  electrons per second). The common symbol for resistance is "R." "OHM" is sometimes represented by the sign " $\omega$ " (the Greek letter Omega). Thus 5 ohms may be written  $5\omega$ . This representation has been standardized by the Radio Manufacturers Association (R.M.A.) for use in radio work. (See note below.)

The resistance of a body varies with its length, sectional area and material. Further consideration of the laws of resistance will be studied later.

**Microhm, Megohm**

The resistance in a conducting path is usually kept as low as possible. Resistors, however, are often employed to control the amount of current flowing in a circuit, to produce heat, etc. It often happens that very small resistances are to be considered, for which the ohm is an inconveniently large unit. Therefore, to facilitate calculations and recording, a smaller unit, the *microhm* is often used. A microhm is equal to one

millionth  $\frac{1}{1,000,000}$  of an ohm. For example, .00031 ohms equals  $.00031 \times 1,000,000 = 310$  microhms. Also, 4500 microhms equals  $4500 \div 1,000,000 = .0045$  ohms.

Where large resistances are dealt with, the megohm is employed (often abbreviated Meg. or represented by the symbol M $\Omega$ ). One megohm means a resistance of 1,000,000 ohms. Thus a 5-megohm grid leak has a resistance of  $5 \times 1,000,000 = 5,000,000$  ohms. Also, 30,000 ohms equals  $30,000 \div 1,000,000 = .03$  megohms or  $.03\omega$ .

**Conductance (the Mho)**

In some calculations and considerations of electric circuits it is convenient to consider not the resistance of a circuit, but its *conductance*. The conductance of a circuit is numerically expressed by taking the reciprocal of its resistance  $\frac{1}{R}$  and expressing it in *mhos*. (Mho is *ohm* spelled backward.) Thus if the resistance of the filament of a vacuum tube is 20 ohms its conductance is  $\frac{1}{20}$  or .05 mhos.

(Continued on page 724)

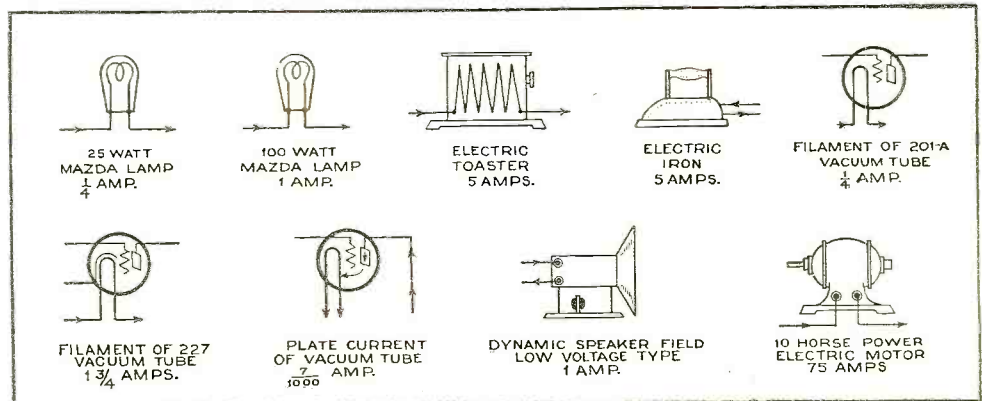

EXAMPLES OF CURRENT ELECTRICITY

Figure 3. Rates of current flows through common electrical devices



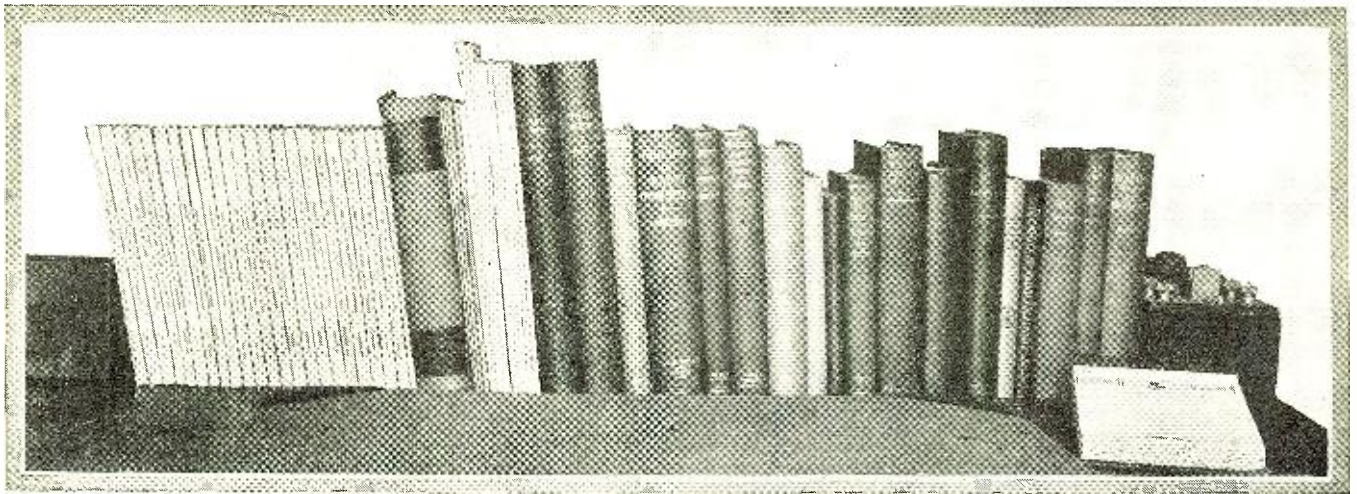

# Radio Science Abstracts

*Radio engineers, laboratory and research workers will find this department helpful in reviewing important current radio literature, technical books and Institute and Club proceedings*

*Radio Physics Course*, by Alfred A. Ghirardi. Second edition. Published by Radio Technical Publishing Company. This is a complete elementary text on radio. It includes not only up-to-date material on modern receivers but information as well on public address amplifiers, photo-electric cells and associated equipment, television and sound motion pictures. The author has made every effort to make the book especially useful as a text for technical high schools and trade schools and also to arrange it so that it is entirely adaptable to home study. The initial chapters of the book consider the fundamental principles that underlie radio and describe the characteristics of speech and music as they relate to broadcasting, the fundamentals of magnetism, a.c. and d.c. circuits.

Except for the chapters on allied sciences such as television, sound motion pictures, etc., the remaining chapters of the book are devoted to radio phenomena and explanations of such things as detection, oscillation, amplification, etc., and some of these chapters are unusually well organized and complete. Take, for example, the subject of electric filters covered in Chapter 12. Filter design is a subject usually treated casually in many texts, although it plays a very important part in the design of radio receivers and similar apparatus. In this book the various types of filters are completely described and design equations for the various types are given and clearly illustrated by means of examples. The chapter covers band-pass filters, low, and high-pass filters of various kinds, band-suppression filters and information on the application of filter circuits.

This book was written as an elementary text on radio and we feel it fulfills its purpose exceedingly well. It will prove instructive and interesting to those intending to take (or already taking) courses in radio and to others who, by home study, wish to understand more of the subject.

*A Manual of the Slide Rule*, by J. E. Thompson. Published by D. Van Nostrand Company, Inc. This small book, written by the author of that excellent series of books, "Mathematics for Self Study," describes in

## Conducted by Howard Rhodes

complete detail the theory, operation and use of the slide rule. The book also contains many problems to serve as examples of how useful the slide rule can be. To the engineer, the slide rule is an indispensable tool which makes it possible to calculate problems quickly and accurately. It is unfortunate that the simpler forms of the slide rule are not more generally used by experimenters and others who have a technical slant on things and who could undoubtedly use the slide rule to advantage.

The slide rule is not difficult to use and with the aid of this text an understanding of how it can be applied is readily obtained. If you don't think the slide rule is a useful tool, just ask the man who habitually uses one and find how much he has come to depend upon it to save time and minimize the possibility of error.

## Review of Articles appearing in the December, 1931, issue of the Proceedings of the Institute of Radio Engineers

*Constant-Frequency Oscillators*, by F. B. Llewellyn. The paper discusses the manner in which the frequency of a vacuum-tube oscillator depends upon the operating voltage. The theory is derived and is shown to indicate methods to permit making the frequency independent of the operating voltages. These methods are applied to the more common oscillator circuits. Experimental data is given to show the stability which may be expected from actual circuits. It is found that, with a properly built and adjusted oscillator, the variations in frequency resulting from changed operating potentials are negligible in comparison with the changes due to temperature variation.

*Amplitude, Phase and Frequency Modulation*, by Hans Roder. The mathematical expressions for the three different types of modulation are derived in the first part of

this paper. They are expressed in three different forms: as amplitude equations, side-band equations and modulation vector equations. The main results derived from a discussion of these equations are:

In phase and frequency modulation an infinite number of sidebands are produced. Amplitude modulation produces but one pair of sidebands.

In amplitude modulation, the modulation vector is in phase with the carrier. In phase and frequency modulation it is 90 degrees out of phase with the carrier.

Frequency modulation is equivalent to phase modulation in which the phase shift is inversely proportional to frequency.

*A Recent Development in Vacuum Tube Oscillator Circuits*, by J. B. Dow. This paper describes a constant-frequency oscillator which depends, for its operation, upon the use of electron coupling between the oscillation-generating portion of the circuit and the work circuit. This form of coupling is used to isolate the work circuit from the frequency-determining portion of the circuit. The oscillator is of the two-anode type (UX-865) and it is shown that by suitable choice of anode voltages, compensating effects may be obtained whereby changes in generator voltage will have a small influence upon the frequency of oscillation.

*A New Treatment of Electron-Tube Oscillators with Feedback Coupling*, by C. K. Jen. The author considers the various well-known types of oscillators and the conditions which must obtain for maintenance of oscillation and optimum intensity of oscillation. Experimental check of the theory has been found quite satisfactory in most cases.

*Henley's Twentieth Century Formulas, Recipes and Processes*, edited by Gardner D. Hiscox. Published by The Norman W. Henley Publishing Company. Here is a book that tells you how to concoct almost anything that you would ever be interested in. It tells you how to make glass, gunpowder, ink, how to develop photographs, plate metals, temper steel, finish woods, and so on. It really is a remarkable book and gives



formulas and processes in connection with the manufacture of many materials together with their treatment or fabrication. The formulas and processes described are so varied that the book can hardly be considered to have been prepared for any particular group. It would certainly be useful to most manufacturing executives and to chemical, mechanical and electrical engineers. The formulas on how to make cold cream or take ink stains out of silk are but two of many examples which might be quoted to prove that the book also has a place in the home.

### Review of Contemporary Periodical Literature

*Problems That Face the Radio Engineer*, by Virgil M. Graham. *Electronics*, November, 1931. A general and not very exciting summary of problems affecting receiver design. The author considers the question of how we can best measure overall fidelity, what degree of selectivity, fidelity and sensitivity are desirable and whether or not practical limits can be set to any of these characteristics. We are afraid that economics and the desires of the public influence many of these things much as the engineer prays that it might be otherwise.

A "Cold" Filamentless Radio Tube, by Clinton W. Hough. *Electronics*, November, 1931. It is an announcement that a new type of tube has been developed by the Engineers of Wired Radio, Incorporated, which has a cold filament, i.e., no filament-heating voltage is required. No really technical data is given, but the author states that the tube has been found satisfactory for use as an amplifier, detector, oscillator or modulator, and that there appears to be no limit to the size to which the tube can be made. That the tube is not a figment of someone's imagination seems certain, since the work has been carried on by Dr. August Hund, who is well known for his excellent work at the Bureau of Standards. Engineers will certainly wait with interest further data on this unusual tube.

*Improvements in Cathode-ray Tube Design*, by Dr. V. K. Zworykin. *Electronics*, November, 1931. This tube was developed with the idea of producing an oscillograph of the cathode-ray type which would give an image sufficiently bright to permit observation of high-frequency phenomena and direct photographic recording. It is of the hot-cathode type and the tube is pumped to a high vacuum. Focusing of the spot on the fluorescent screen is accomplished electrostatically by means of a double anode structure and an additional electrode gives accurate control of the intensity of the spot. The effectiveness with which the intensity can be controlled makes this tube especially adaptable to television, although the article does not specifically state that the tube was developed with this idea in mind.

*Universal Tube-Test Equipment*, by O. H. Brewster and Karl F. Mayers. *Electronics*, November, 1931. This tube-testing unit, designed especially to meet the requirements of the tube manufacturers, was arranged with the idea of producing an extremely flexible unit which would meet all present requirements and conceivable future requirements. The unit contains its own power supply and all of the meters are protected by relays; various selector switches serve to connect the meters in the proper arrangement to make any desired test.

*Moving-Coil Telephone Receivers and Microphones*, by E. C. Wentz and A. L. Thurs. *Bell System Technical Journal*, October, 1931. A description is given of a moving-coil head receiver and a microphone designed particularly for high-quality transmission. The instruments have a substan-

tially uniform response from 40 to 10,000 cycles per second. This uniformity of response has been obtained by the use of very light moving parts and by the association of special types of acoustic networks with the diaphragm. The microphone has a sensitivity about 10 db. higher than that of the W. E. type 394 condenser microphone.

*Some Developments in Common Frequency Broadcasting*, by G. D. Gillett. *Bell System Technical Journal*, October, 1931. This paper describes the results of simultaneous operation of stations WHO and WOC, broadcasting the same program on a common frequency, using independent crystal-control oscillators. Even with crystal control, slight adjustments were necessary to maintain the exact frequency and the control was accomplished by establishing a monitor station midway between the two stations and the signals from the monitor station were sent to WOC to provide an indication for readjusting its frequency to exact isochronism with WHO. A marked increase in the service rendered by these stations was obtained through their operation on a common frequency and common-frequency broadcasting now appears to offer definite means by which improved broadcast coverage can be provided to a number of non-contiguous communities.

*Developments in Short-Wave Directive Antennas*, by E. Bruce. *Bell System Technical Journal*, October, 1931. The more important factors which limit the intelligibility of short-wave radio-telephone communication are: inherent set noise, external noise and signal fading. This article discusses the possibility of counteracting these limitations by means of directed antennas. The latter part of the paper describes an antenna system which maintains a desirable degree of directivity throughout a broad, continuous range of carrier frequencies.

*Acoustics and Its Relation to Seating in Auditoriums* (unsigned). *Projection Engineering*, November, 1931. This article contains some excellent data on acoustic calculations as they apply to auditoriums. Several tables are included which give absorption coefficients for various types of chairs such as are used in theatres. Other tables give absorption coefficients for various types of walls, carpets, drapes, stage openings, etc. In the article several problems are worked out, showing how these absorption coefficients can be used in practical problems.

*The Class B Push-Pull Modulator*, by Loy E. Barton. *QST*, November, 1931. A description of how two tubes can be used in a class "B" circuit which makes possible obtaining high percentage modulation (up to 100 percent). The two tubes used in the circuit described were type -03A and in operation they may be used to take the place of ten type 845 tubes. The two -03A tubes are normally biased in the circuit so that the plate current, without signal, is reduced to about 30 ma. per tube. During one-half the cycle, one tube carries the load and during the other half of the cycle the other tube carries the load. The tubes are arranged in a push-pull circuit, the secondary of the output transformer supplies the modulating voltage to the plate of the oscillator.

*The Electric Condenser*, by R. A. Lane. *Radio Engineering*, November, 1931. A general description of fixed paper condensers, containing considerable interesting information on the construction of condensers, dielectric properties and life tests. The figures given in the article are useful in indicating the specifications to which the modern paper condenser must be manufactured.

*Counteracting Acoustic Feedback Through the Tuning Condenser*, by Zeh Bouck. *Radio*

*Engineering*, November, 1931. A consideration of the manner in which vibration of the plates in a variable condenser may result in acoustic feedback through a receiver. The author reaches the conclusion that acoustic feedback can be reduced by more perfect paralleling of the plates and the centering of the plates by mechanical rather than visual inspection.

*Grid-Circuit Linear Detection*, by James R. Nelson. *Radio Engineering*, November, 1931. The author considers the possibility of using a grid-circuit detector to work directly into the power output stage. Such an arrangement is of course quite sensitive, due to the fact that the detector tube is really functioning as an audio-frequency amplifier and high gain is therefore possible. The problem is to obtain linear detection in the grid circuit so that the distortion can be held to a low value. The article includes several curves, showing the characteristics with r.f. input voltages up to 2 volts.

*Ein Neues Elektrodynamisches Bandmikrophon* (A New Electrodynamic Band Microphone), by C. A. Hartman. *E. N. T.*, July, 1931. A new type band microphone is described, which equals in efficiency a high-quality carbon microphone. In the past the band microphone has not been used because of its low efficiency.

*Engineering Acoustics*. *Electrician*, 1930-1931, Nos. 2740-2761. A series of articles on acoustics covering such subjects as articulation and reproduction in the auditorium, reproducers, loudspeaker efficiency, etc.

*Long-Wave Radio-Receiving Measurements at the Bureau of Standards in 1930*, by L. W. Austin. *Proceedings of the Institute of Radio Engineers*, October, 1931. This report from the Bureau of Standards gives tables of the monthly average field of intensities of various long-wave stations and the corresponding atmospheric disturbances, both groups of measurements having been made in Washington, D. C. Measurements are reported on stations in France, Germany, England, Italy and various stations along the seaboard of the United States. One table gives transmission data on the various sending stations, i.e., effective height of antenna, antenna current, frequency, etc.

*Microphone Technique in Radio Broadcasting*, by O. B. Hanson. *The Journal of the Acoustical Society of America*, July, 1931. An excellent article covering microphone technique as it applies to present-day broadcasting. The author deals at considerable length with the condenser microphone suspended in front of a parabolic reflector. Using ordinary microphones, 5000-cycle tones arriving from a source of 90 degrees displaced from the axis of the microphone are down about 11 db. from low-frequency tones originating at the same source. When the microphone is suspended in a parabolic reflector an opposite condition is obtained, the high frequencies normally producing greater response than the low frequencies; by slightly varying the position of the microphone, however, this response characteristic can be varied in almost any desired manner. The use of a parabolic reflector greatly increases the sensitivity of the microphone and the same output can be obtained therefore, with the microphone located much further away from the source of the sound. This greatly simplifies the problem of placement of the various instruments and it also makes the output of the microphone largely independent of the acoustic characteristics of the room.

*Electron Tubes in Traffic-Actuated Control Systems*. *Electronics*, September, 1931. A review of the various electrical systems being  
(Continued on page 713)



# Latest Radio Patents

*A description of the outstanding patented inventions on radio, television, acoustics and electronics as they are granted by the United States Patent Office. This information will be found a handy radio reference for inventors, engineers, set designers and production men in establishing the dates of record, as well as describing the important radio inventions*

1,825,781. TELEVISION SCANNING DEVICE. LEO H. DAWSON, Washington, D. C. Filed July 30, 1929. Serial No. 382,162. 19 Claims.

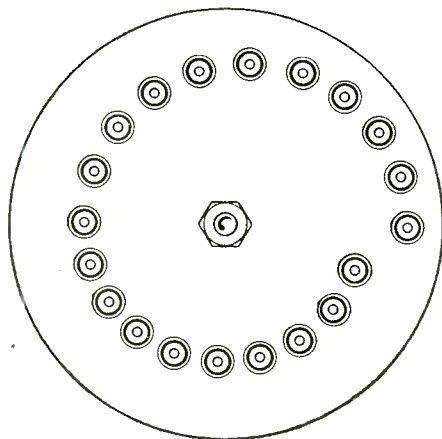

1. A scanning device for television systems comprising in combination an opaque member adapted to be moved in a path of light, said member having a plurality of light-conducting and concentrating members and said last mentioned members comprising individual conical-shaped sections of materials having a relatively high refractive index.

1,827,196. PIEZO ELECTRIC OSCILLATOR. RAYMOND A. HEISING, Millburn, N. J., assignor to Bell Telephone Laboratories, Incorporated, New York, N. Y., a Corporation of New York. Filed May 1, 1929. Serial No. 359,571. 16 Claims.

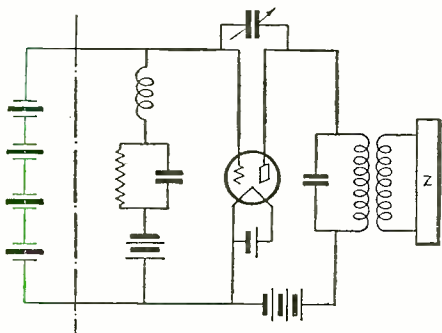

7. An oscillating system comprising an oscillator having input and output circuits, and a plurality of piezo-electric crystals of opposite temperature coefficients connected in series in said input circuit for compensating the effect of temperature variations.

1,826,845. REMOTE-CONTROL RADIO RECEIVING SYSTEM. ARTHUR M. TROGNER, East Orange, N. J., assignor to Wired Radio, Inc., New York, N. Y., a Corporation of Delaware. Filed Mar. 26, 1929. Serial No. 350,096. 5 Claims.

\*Patent Attorney, National Press Building, Washington, D. C.

Conducted by  
**Ben J. Chromy\***

1. A remote-control radio receiving system comprising in combination a plurality of radio receivers having individual frequency adjusting means actuated by individual electric motors, individual audio-frequency oscillators having frequency adjusting means actuated in common with the frequency adjusting means of said receivers respectively, a remote-control unit adapted to selectively energize said motors, individual frequency indicating means at said remote-control unit and a single control circuit extending between said receivers and said control unit and carrying control currents and audio-frequency currents whereby the adjustments of said receivers may be ascertained in terms of the frequency adjustments of said oscillators.

1,826,642. INDUCTANCE COIL. HORACE WILLIAM ADEY, London, England. Filed Oct. 3, 1929, Serial No. 397,091, and in Great Britain Nov. 3, 1928. 3 Claims.

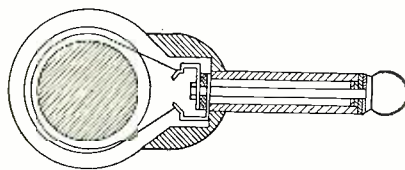

1. An inductance coil for use with radio receiving and transmitting apparatus, comprising a coil holder of insulating material, a metal tubular member secured to said coil holder, a metal rod arranged coaxially with said tubular member, means for insulating said rod from the tubular member, metal strips arranged within the coil holder and respectively secured to the tubular member and the metal rod, and a coil having its terminals respectively connected to the tubular member and to the said metal rod through said metal strips.

1,829,019. PHOTO-ELECTRIC TUBE. GILBERT T. SCHMIDLING, Chicago, Ill., assignor to Alva J. Carter, Chicago, Ill. Filed July 26, 1929. Serial No. 381,226. 4 Claims.

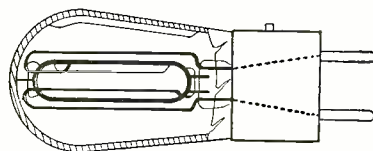

1. A photo-electric tube construction comprising an inner sealed envelope having therein a light-sensitive cathode and an anode and having a translucent wall portion through which light may pass from the exterior to said cathode, an outer sealed evacuated envelope in which said inner envelope is supported in spaced relation to the walls of said outer envelope, and lead-in wires extending from said cathode and anode to the exterior of said outer envelope.

1,825,833. ACOUSTIC DIAPHRAGM. HANS TENNESSE and FREDERICK BASSE, New York, N. Y. Filed June 21, 1929. Serial No. 372,759. 4 Claims.

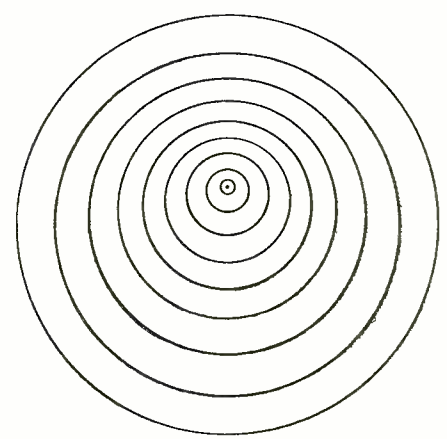

1. An acoustic diaphragm, comprising a main body portion formed to provide a plurality of circumferentially extending vibrating areas, each increasing in width and decreasing in thickness from a minimum dimension to a maximum dimension.

1,829,706. DAMPING CONTROL. NEW-SOME HENRY CLOUGH, Hanwell, London, England, assignor to Radio Corporation of America, a Corporation of Delaware. Filed July 24, 1926, Serial No. 124,763, and in Great Britain July 31, 1925. 4 Claims.

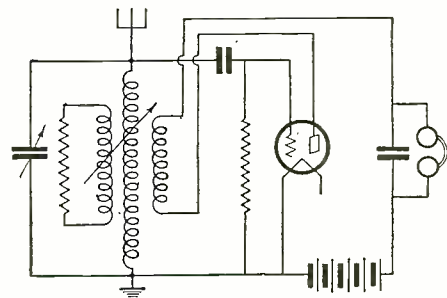

1. Means for controlling damping in an oscillatory circuit without altering the resonant frequency thereof including an untuned closed damping circuit composed of an inductive coil of high resistance wire coupled to said oscillatory circuit.

1,829,419. FREQUENCY MULTIPLICATION. MENDEL OSNOS, Berlin, Germany, assignor to Gesellschaft für Drahtlose Telegraphie m. b. H., Berlin, Germany, a Corporation of Germany. Filed Sept. 21, 1926, Serial No. 136,770, and in Germany Oct. 20, 1925. 8 Claims.

1. In combination, a direct-current magnetized generator of harmonics, a source of energy at a fundamental frequency connected thereto through a circuit tuned to the fundamental frequency, an output circuit coupled thereto tuned to a harmonic of the funda-



mental, and a utilization circuit coupled to the output circuit and tuned in combination with said coupling circuit to a harmonic of the aforesaid harmonic of the fundamental.

**1,829,523. MEANS FOR PREVENTING INTERFERENCE.** FRED H. KROGER, Ridgewood, N. J., assignor to Radio Corporation of America, a Corporation of Delaware. Filed Jan. 18, 1929. Serial No. 333,481. 3 Claims.

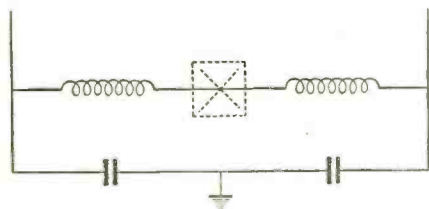

2. A method of preventing energy originating in apparatus, including an inherent source of transient energy, from setting up undesirable oscillations in adjacent radio apparatus which consists in confining said oscillations to a circuit tuned to a frequency which will not affect the adjacent radio apparatus.

**1,829,204. INTERFERENCE ELIMINATION.** GEORG VON ARCO, Berlin, Germany, assignor to Gesellschaft für Drahtlose Telegraphie m. b. H., Berlin, Germany, a Corporation of Germany. Filed July 28, 1925, Serial No. 46,535, and in Germany Aug. 29, 1924. 7 Claims.

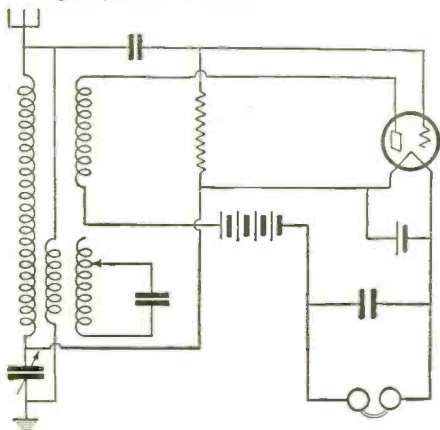

1. In combination, a receiving conductor adapted to receive desired signals and disturbances, a receiving circuit including an electron discharge tube coupled to said conductor, an auxiliary circuit for decreasing the effect of said disturbances on said receiving circuit, means for coupling said auxiliary circuit to said conductor including a transformer having a variable and relatively high transformation ratio, and means including a feed-back circuit from said tube for decreasing the damping in said auxiliary circuit.

**1,829,099. ELECTRO-ACOUSTIC MUSICAL INSTRUMENT.** JÖRG MAGER, Berlin-Neukölln, Germany. Filed Mar. 21, 1928, Serial No. 263,450, and in Germany Oct. 29, 1925. 9 Claims.

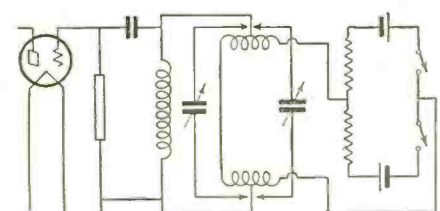

7. An electro-acoustic musical instrument comprising an oscillation circuit, a condenser in said circuit, a lever for adjusting said con-

denser, a switch on said lever for cutting said condenser in and out, a second oscillation circuit, a condenser in said second circuit, a lever for adjusting said second condenser, a switch on said second lever adapted to cut in and out said second condenser, said switches being related in such manner as to prevent cutting in of both condenser at a time, and a tube to which said two oscillation circuits are connected.

**1,828,094. ELECTRICAL FREQUENCY-CHANGING APPARATUS OF THE THERMIONIC TYPE.** HUMFREY ANDREWS, Highgate, London, England, assignor of fifty per cent. to Radio Patents Corporation, New York, N. Y., a Corporation of New York. Filed Mar. 5, 1926, Serial No. 92,433, and in Great Britain Mar. 5, 1925. 9 Claims.

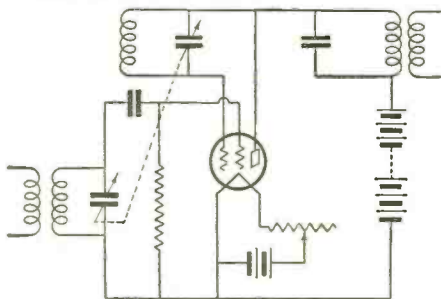

1. In a radio circuit, a four-electrode tube having a heated cathode, an anode and two grid electrodes, one of which is maintained at a positive potential with respect to the other, a grid leak resistance, an oscillatory circuit in which oscillations of the frequency of and due to the received signals are established, one of the grid electrodes being connected therewith, a local source of oscillations of different frequency, said second grid being subject to potential fluctuations therefrom and connected through said "grid leak" resistance to the cathode of the tube, an oscillatory circuit tuned to the resultant or "beat" frequency, and an anode connected to said last mentioned oscillatory circuit.

**1,828,706. OSCILLATION GENERATOR AND METHOD.** FREDERICK A. KOLSTER and GEOFFREY GOTTLIEB KRUESI, Palo Alto, Calif., assignors to Federal Telegraph Company, San Francisco, Calif., a Corporation of California. Filed Oct. 30, 1928. Serial No. 316,037. 8 Claims.

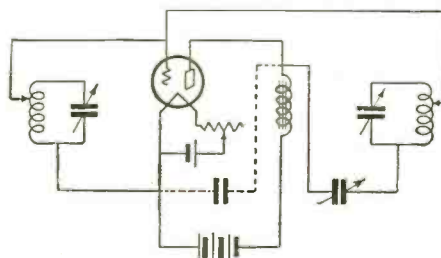

1. An oscillation generator comprising an electron relay having grid, anode, and cathode electrodes, a closed reactive circuit having points of different potential thereof connected to the grid and anode of the relay, and another closed reactive circuit having points of different potential connected to the grid and cathode.

**1,828,942. PRODUCTION OF CORRECTED SOUND RECORDS.** ROY J. POMEROY, Los Angeles, Calif. Filed May 22, 1928, Serial No. 279,791. Renewed Sept. 5, 1931. 10 Claims.

5. The method of compensating sound records that includes making original substantially undistorted photographic and mechanical sound records of the original sound, audibly reproducing sound from the me-

chanical record, said sound having distortions, differentially combining a representation of the distorted sound with a representation of original sound, thus producing a representation of distortion, combining a representation of the original photographic sound record with the representation of distortion in such a manner that the resultant sound representation is distorted negatively relatively to the normal distortions, and

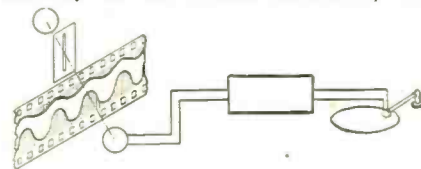

making from said negatively distorted sound representation a distortion compensated mechanical record, said compensated mechanical record being distorted negatively to the distortion of its audible reproduction.

**1,828,910. AERIAL ELIMINATOR.** JOHN W. SPEAKER and ANTON SELSEMEYER, Whitefish Bay, Wis. Filed Jan. 25, 1930. Serial No. 423,370. 1 Claim.

A device of the character described comprising a metallic plate conductively connected to a metallic core in the form of a cylinder, a winding mounted on said core, a resistance element secured to said plate, said resistance element including a carbon rod extending substantially parallel with said core but spaced therefrom, said plate being conductively connected to said resistance ele-

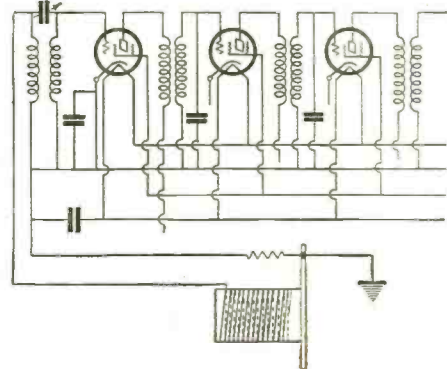

ment and having a ground connection, the said winding having an open circuit and an end connected electromagnetically and electrostatically with the input circuit of a radio receiving apparatus.

**1,827,054. COMMUNICATION BY ELECTROMAGNETIC WAVES.** GEORG VON ARCO, Berlin, Germany, assignor to Gesellschaft für Drahtlose Telegraphie m. b. H., Berlin, Germany, a Corporation of Germany. Filed Oct. 18, 1926, Serial No. 142,453, and in Germany Oct. 20, 1925. 2 Claims.

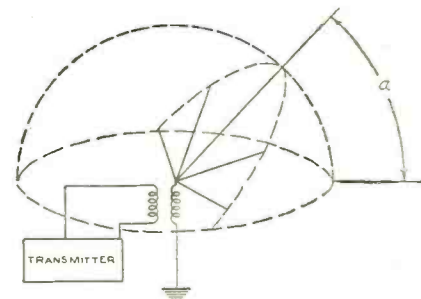

1. An antenna system for transmitting electromagnetic waves comprising a number of antennae positioned in the directions of the radii of a sphere, groups of the antennae being connected together, a reactance at the intersection of the radii of the sphere for



coupling the groups together, a transmitter, and means coupling the transmitter to the different component antennae through said reactance at the intersection of the radii of the sphere.

**1,827,191. SHIELDED INDUCTANCE.** WILLIAM L. CASPER, Summit, N. J., assignor to Bell Telephone Laboratories, Incorporated, New York, N. Y., a Corporation of New York. Filed June 6, 1930. Serial No. 459,449. 6 Claims.

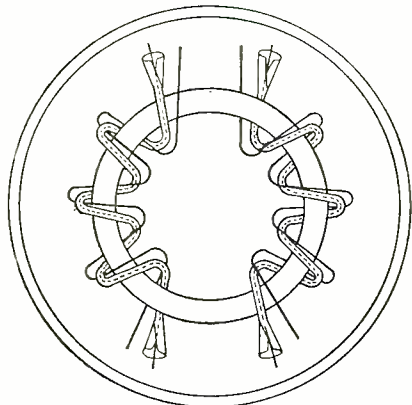

1. In a transformer having sectionalized primary and secondary windings, means for reducing unbalanced capacity effects which comprises a hollow conductor concentric with and insulated from the conductor of another section, said hollow conductor itself comprising a winding section.

**1,827,283. SOUND REPRODUCER.** LEE DE FOREST, New York, N. Y., assignor, by mesne assignments, to General Talking Pictures Corporation, a Corporation of Delaware. Filed Jan. 29, 1927. Serial No. 164,582. 9 Claims.

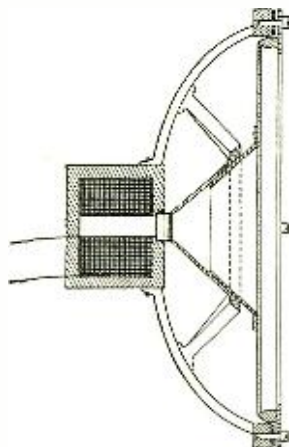

1. In a loud speaking device the combination with a support of a tympanum thereon, a conical diaphragm secured thereto, and means to vibrate said tympanum and diaphragm.

**1,829,219. PORTABLE RADIO APPARATUS.** WILLIAM M. HEINA, Long Island City, N. Y., assignor, by mesne assign-

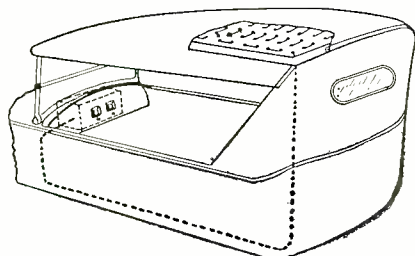

ments, to Transitone Automobile Radio

Corporation, Philadelphia, Pa., a Corporation of Delaware. Filed Jan. 15, 1929. Serial No. 332,620. 3 Claims.

3. In combination with the collapsible top of a vehicle, a radio antenna comprising a wire carried by said top and arranged to form a plurality of spaced lengths extending back and forth in succession and transversely of said top.

**1,828,571. PICTURE TRANSMISSION APPARATUS.** IRVING LANGMUIR, Schenectady, N. Y., assignor to General Electric Company, a Corporation of New York. Filed May 17, 1930. Serial No. 453,367. 3 Claims.

1. Picture receiving apparatus comprising an arc lamp of the flaming arc type, means for modulating the current supplied to the lamp in accordance with the received signal, a screen, means adapted to be operated in

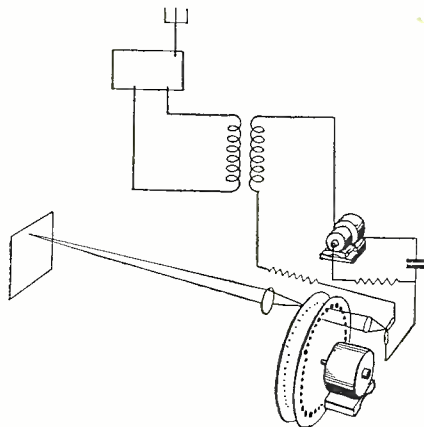

synchronism with the sending apparatus for projecting on the screen a spot of light from the arc of said lamp, and means for excluding from the screen light from the electrodes.

### Information Concerning Patents

**E**VERY experimenter, at one time or another, has some definite interest in patents and in the processes involved in making patent applications, obtaining information on, or copies of, existing patents, etc. It is advantageous to know something of the functioning of the Patent Office in Washington, whether one ever intends to apply for a patent or not, because much information, particularly on recently invented devices, is available through no other channels.

A request, addressed to the Government Printing Office, Washington, D. C., will bring, without cost, a comprehensive booklet entitled "Rules of Practice in the United States Patent Office." This booklet is written especially for the guidance of those who wish to take advantage of the facilities offered by this Federal Office.

Copies of the patents, on which abstracts appear in RADIO NEWS each month, may be obtained by sending ten cents (coin or money order), together with the number and date of the desired patent, and name of patentee, to the Commissioner of Patents.

**1,828,667. TRANSMISSION OF PICTURES.** RAY D. KELL, Schenectady, N. Y., assignor to General Electric Company, a Corporation of New York. Filed July 8, 1929. Serial No. 376,592. 3 Claims.

1. The method of utilizing a Kerr cell to

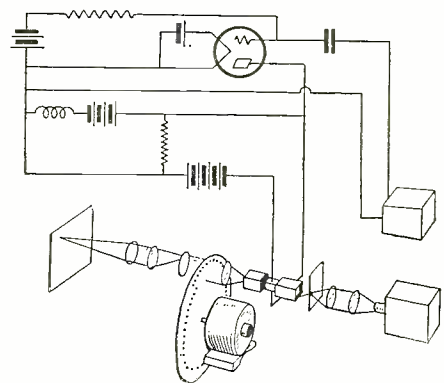

control light in accordance with signal impulses which includes biasing said cell to one of its higher volt-light characteristics, and applying said impulses to said cell.

**1,828,524. HEATER TYPE VACUUM TUBE.** DANIEL J. DELANEY, East Newark, N. J., assignor to Arcturus Radio Tube Company, Newark, N. J., a Corporation of Delaware. Filed Mar. 7, 1928. Serial No. 259,647. 5 Claims.

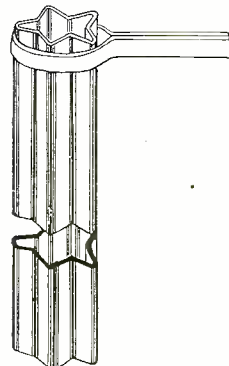

2. A cathode for thermionic tubes comprising an elongated shell having longitudinal corrugations around the entire surface thereof providing alternate depressions and ridges thereby both materially increasing the surface area and rigidity of said shell throughout its circumference.

**1,826,836. TELEVISION SCANNING DEVICE.** MICHAEL STACHO, Cleveland, Ohio. Filed May 1, 1930. Serial No. 448,965. 5 Claims.

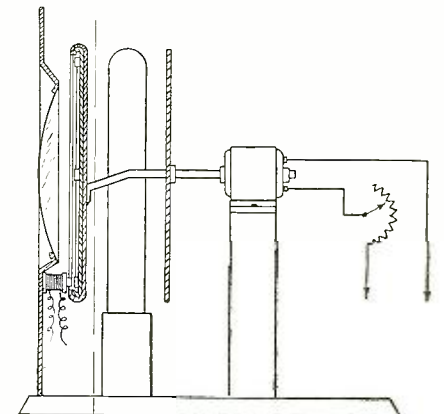

1. A television scanning device of the character described comprising a pair of rotatable disks having slots therein for the passage of light to a subject, and magnetic means for periodically retarding the rotation of one of said disks with respect to the other of said disks with each revolution thereof.



# What's New in Radio

*A department devoted to the description of the latest developments in radio equipment. Radio servicemen, experimenters, dealers and set builders will find these items of service in conducting their work*

## Short-Wave Coils with Wave-Band Switch

*Description*—This type of coil mounting with automatic wavelength switch eliminates the nuisance of plug-in coils. The four-position switch covers the entire short-wave band from ten to two hundred meters. This unit is designed for those who build their own superheterodyne short-wave converters or receivers. It consists of an aluminum bracket with mounting shelf 3 inches long by

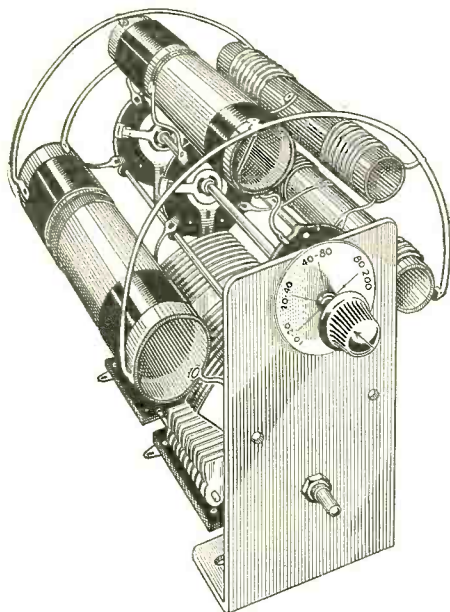

2½ inches high. Fastened to this bracket is the triple switch assembly which is rotated by a common bakelite shaft with a slot running through it, to engage the three switch levers concurrently. The coils are wound on bakelite tubing, supported by rigid bus bars. Three pillar posts, bolted at both end switches, are the main supports for the complete assembly.

*Maker*—Coast to Coast Radio Corp., 123 West 17th St., New York City.

## Shield Post

*Description*—An aluminum post of unique design for shield boxes, with tapped holes 1½ inches in from each end for fastening side plates and tapped holes at top and bot-

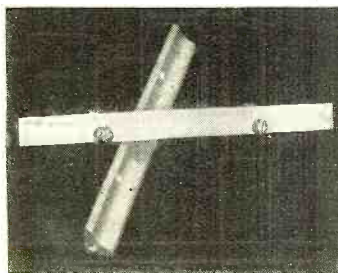

tom of post for fastening the top and bottom plates of shield. All holes are threaded to take size 6/32 machine screws. This design permits the shield plates to be interchangeable and provides a solid attachment

## Conducted by The Technical Staff

of all plates. The post is ½ inch wide (flat sides) and is available in two sizes—6 inches and 7 inches high. The post has a silver dip finish and is adapted to numerous shielding applications.

*Maker*—Blair The Radio Man, Inc., 89 Cortlandt St., New York City.

## Midget Receiver

*Description*—The Marquette six-tube mantle type receiver is a tuned radio-frequency circuit and is equipped with a tone control and the new type Utah 8-inch dynamic



speaker. The tubes employed are: two -35 type, one -24 type, two -47 pentode type and one -80 type rectifier. The walnut cabinet measures 18 inches high by 14½ inches wide by 11 inches deep. This receiver operates from 110-volt 60-cycle a.c. supply. A receiver for 110 d.c. supply is available in the same style cabinet and utilizes four -01A type tubes and two -71A type tubes in the push-pull power output stage.

*Maker*—Marquette Radio, Inc., 110 W. 18th St., New York City.

## Replacement Condenser Blocks

*Description*—A new line of condenser blocks for replacement purposes in standard radio receivers. These units meet a real

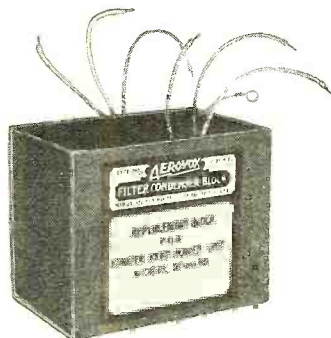

demand for the jobbers, dealers, and servicemen. The photograph shows a replacement

unit for Atwater Kent models 37 and 38 power supplies and consists of two .5 microfarad sections, two 1 microfarad section, two filter chokes and a speaker choke. Other replacement units are available for the Majestic type 9-P-6 and 7B-P-6 power supplies.

*Maker*—Aerovox Wireless Corp., 70 Washington St., Brooklyn, N. Y.

## Console Television and Radio Receiver

*Description*—The model A radio-vision console, by a unique interchangeable tuning system, is capable of receiving either tele-

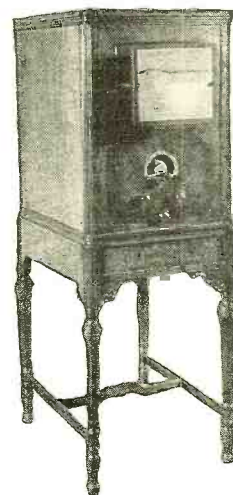

vision or broadcast signals on the short-wave or broadcast wavelengths. The power output stage of the audio amplifier utilizes two -45 type tubes in parallel. The loudspeaker is concealed from view and a pair of phonograph jacks is provided for reproduction of phonograph records. The projector type radio-visor employs a 60-line lens disc and the pictures are projected on a ground-glass screen, mounted in a frame in front of the console. The image may be adjusted and focused for any size up to 8¾ inches by 10 inches. The pictures may be viewed by a group arranged in a quarter circle, without troublesome distortion.

*Maker*—Jenkins Television Corp., Passaic, N. J.

## Convenient Aerial and Ground Connections

*Description*—The receptacles of this new antenna-ground convenience unit consist of

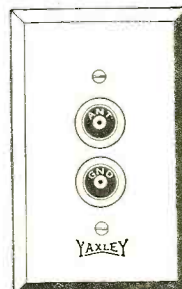

two specially designed jacks mounted on a strap which is separate from the cover



plate. The antenna and ground wires of the receiver are quickly and easily attached to the two plugs provided with the equipment. The face plates are available in either brass or bakelite.

*Maker*—Yaxley Manufacturing Co., 1528 W. Adams St., Chicago, Ill.

### Mantel Type Receiver

*Description*—The Sentinel No. 116 midget type five-tube superheterodyne receiver features a specially designed detector-oscillator system in which a single -24 screen-grid type tube performs both functions. Other features include special shaped oscillator tuning condenser plates to provide single-dial control,



and a tone modifier and acoustic compensator. The second detector stage employs the -24 screen-grid type tube, the -35 multi-mu tube is used in the intermediate-frequency stage and a -47 pentode tube in the power output stage. The -80 type tube is used for rectification. The dimensions of the cabinet are 15 3/4 inches high by 13 3/4 inches wide by 8 inches deep.

*Maker*—The United Air Cleaner Corp., 9705 Cottage Grove Ave., Chicago, Ill.

### Public-Address System

*Description*—A portable sound-amplifying system consisting of a two-stage audio amplifier, a dynamic type speaker, a microphone with a twenty-foot extension cord and an adjustable microphone stand. The audio amplifier and reproducer are mounted in a sturdily constructed leatherette-covered

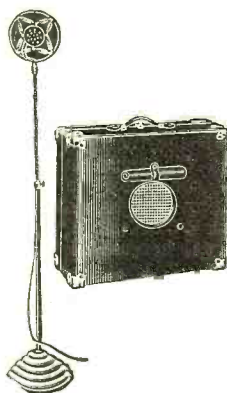

carrying case. The vacuum tubes employed in the audio-amplifier are as follows: one -27 type, one -47 pentode type and one -80 rectifying type. It is operated from 110-volt 60-cycle a.c. supply and is so designed that it may be set up ready for use in a few minutes.

*Maker*—Radio Receptor Co., 106 Seventh Ave., New York City.

### Portable A.C. Voltmeter

*Description*—This new instrument consists of a copper oxide rectifier known as a Rectox Unit and a d'Arsonval type d.c. gal-



### All-Purpose Power Amplifier

*Description*—This Tom Lab model 3250 three-stage audio-frequency amplifier, employing two -27 type tubes, two -50 type tubes and two -81 type rectifying tubes, is designed to meet the requirements for public address systems, for wax or aluminum recording work and wherever power amplifying equipment is desired. The amplifier is provided with a panel selector switch to a 200-ohm (for microphone) or a 500-ohm input. The output windings are standard for 15 and 500-ohm lines, although there is a choice of 4000, 500 or 15-ohm windings

(with 8, 4 and 2-ohm taps). The panel is equipped with a line-adjusting switch, an a.c. meter, a two-range milliammeter and a volume-indicating meter. The amplifier is enclosed in a heavy walnut cabinet measuring 40 inches long by 19 inches high by 8 inches deep. The cabinet is equipped with two iron carrying handles. While the black crystal finish is standard for the front panel, it is also available in a scratch brushed aluminum finish.

*Maker*—Thomaston Laboratories, Inc., 135 Liberty St., New York City.

vanometer. The principle of this new meter differs from the usual a.c. instruments in that the torque and deflection are directly proportional to the current, rather than to its square. Therefore, this instrument mea-

include four -35 multi-mu type and two -47 pentode type. The receiver is equipped with automatic and manual volume controls,

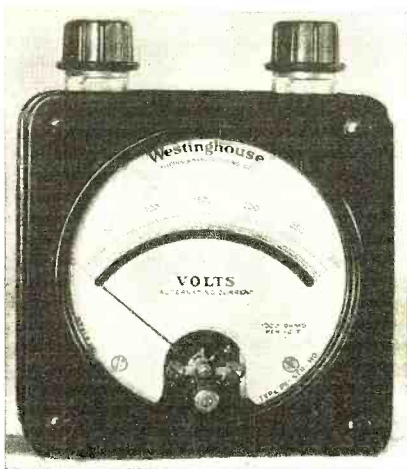

sures the r.m.s. value of the a.c. wave. These instruments are available as voltmeters in ranges from 4 volts up, at a thousand ohms per volt. Milliammeters are available from one-half milliamperes to twenty milliamperes. The following are only a few of the uses for this instrument: as an output meter for use with vacuum tube oscillators, a signal strength indicator, and for general use as a high-resistance a.c. voltmeter or an a.c. micro-ammeter.

*Maker*—Westinghouse Electric & Mfg. Co., East Pittsburgh, Pa.

### Console Receiver

*Description*—This model 237 twin-voice ten-tube superheterodyne receiver utilizes two eight-inch dynamic speakers of special design to provide improved quality and more lifelike tone. The vacuum tubes for this set



tuning meter and a power-quiet switch. The receiver chassis and the two speakers are enclosed in an American walnut cabinet of semi-highboy design measuring 42 inches high by 27 inches wide by 15 1/2 inches deep.

*Maker*—The Gulbrandsen Co., 3232 West Chicago Ave., Chicago, Ill.

### Power Amplifier

*Description*—This model 6039-R high-gain, three-stage audio amplifier utilizes a -35 multi-mu type tube in the first stage, a -27 type tube in the second stage and two -47 pentodes in push-pull in the output stage. The -80 type tube is employed for rectification. This amplifier meets the requirements for portable or permanent sound-on-film apparatus and works directly from the photoelectric cell. It has ample volume for an

(Continued on page 736)



# News and Comment

*A page for the news of the whole radio industry, including important trade developments, new patent situations, comments by leading radio executives, notes, rumors and opinions*

## **New NBC Appointments**

NEW YORK—At a recent meeting of the Board of Directors, Mr. Frank Mason was elected a vice-president of the National Broadcasting Company. Mr. Mason was formerly president and general manager of the International News Service.

Appointment of John F. Royal and Roy C. Witmer as vice-presidents was also announced by M. H. Aylesworth, president.

Royal, who has had a colorful career as a newspaperman and showman, will be vice-president in charge of programs. He formerly was director of programs. Witmer, successively a bank accountant, engineer and industrial sales manager, will be vice-president in charge of sales. He formerly was sales manager.

## **Texas in Tenth Place in the Radio Census**

WASHINGTON, D. C.—Among the 255 counties of the state of Texas, the U. S. Census Bureau enumerators counted 257,686 that had radios when the census of population was taken on April 1, 1930. With the issuance of the Texas figures this week, the Census Bureau has completed compiling the radio census for all the states with the exception of New York, New Jersey, Pennsylvania and Illinois. These figures are expected to be made available shortly.

Though the percentage of radio-owning families in Texas runs low in comparison with the northern, middle western and western states thus far reported, being 18.6 percent, its total places it among the first ten states for which the census figures have been completed. The states now rank as follows: California, 839,991 families with radios; Ohio, 810,767; Michigan, 599,196; Massachusetts, 590,105; Wisconsin, 364,425; Indiana, 351,540; Missouri, 322,252; Iowa, 309,237; Minnesota, 287,880, and Texas, 257,686.

## **Mica Condenser Specialists Join Dubilier Staff**

MT. VERNON, N. Y.—William Dubilier, president of the Dubilier Condenser Corp., announces important additions to his staff. William M. Bailey, C. D. Fletcher and F. A. Shailer, who were formerly and for many years the department heads of the Wireless Specialty Apparatus Co., in charge of design, manufacture and sale of Faradon mica condensers, have joined the Dubilier organization. These additions to the staff, as well as marked activity in research, engineering development and production, presage increased demands for Dubilier high-voltage capacitors.

## **Five Denied Television, Four Others Drop Cases**

WASHINGTON, D. C.—An appreciable let-down in the scramble for television wavelength privileges, which more and more broadcasters and non-radio interests have been seeking in recent months, is the latest development in the visual broadcasting field as viewed from the vantage point of the Federal Radio Commission.

Whether this is due to economic and technical handicaps or to a new lukewarm attitude toward television, federal officials can-

## **Reported by Ray Kelly**

not say. At any rate, five recent applicants for visual channels had their applications denied for failure to appear at hearings that were to be held before a commission examiner. Four others asked that their applications be dismissed.

The applicants failing to appear were the Crosley Radio Corporation, operating WLW, Cincinnati; Memphis Commercial Appeal, operating, WMC, Memphis; Easton Coil Co., New York City; National Co., Malden, Mass., and the Travler Manufacturing Corp., St. Louis. The latter three are equipment makers. Asking that their applications be dropped were WXYZ, Detroit; WIL, St. Louis; WCAO, Baltimore, and the Hochschild Kohn Co., Baltimore department store.

## **Television on the Stage**

NEW YORK—For the first time in the history of the theatre and of television, part of a dramatic performance was recently transmitted from one theatre to another. This demonstration was made between the Theatre Guild and B. S. Moss' Broadway Theatre at Broadway and 53rd Street, New York, before a distinguished audience of invited guests, each representative of a field which may be directly affected by the widespread use of television.

On the stage of the Broadway Theatre for receiving the projected performance was erected a special giant Sanabria television screen, measuring ten feet square.

It was because Sanabria had invented a giant-screen system of television that Mr. B. S. Moss, the veteran showman, who with Mr. William Morris arranged to make a pioneer experiment which will probably mean much both to television and the theatre.

"As soon as I saw television on a giant screen at the invitation of Mr. Morris I was convinced that the time had arrived to make an important theatrical experiment," said Mr. Moss. "Here was a means of transmitting a performance from one stage to another. I believe that television will reach a stage of unusual perfection in the next few years and that it will be developed basically with an eye to its theatrical potentialities and that the theatre should commence thinking at once as to how its future is to be linked with television."

## **Rural Radio Market**

WASHINGTON, D. C.—A rural market running into several million purchasers for the new air-cell battery-operated receivers is forecast in a statement recently issued by Federal Radio Commissioner Harold A. Lafount, of Washington, D. C., who believes that this latest development in radio engineering is one of the most important forward steps the industry has taken in recent years.

"The development of the new air-cell receiver, the first satisfactory radio set perfected for use in rural sections, will, in my opinion, result in a sensational growth in the American radio audience during the next year or two," he says.

## **High Power Broadcast Boon to Radio Listeners**

NEW YORK—Action of the Federal Radio Commission in granting applications of fifteen broadcasting stations for substantially increased power was strongly commended here by the Radio Manufacturers' Association in the statement by Bond Geddes, executive vice-president of the national organization, which includes virtually every prominent radio maker.

"The radio listening public and the radio industry should give the Federal Radio Commission a rousing big vote of thanks," said Mr. Geddes. "The radio public will enjoy greatly improved reception. The high power will increase signal strength and reduce static or interference. Especially in the southern and western states will the benefit of the increased broadcasting power be appreciated."

## **Firm Doubles Earnings**

CHICAGO—The U. S. Radio & Television Corporation, manufacturer of U. S. Apex and Gloritone radios, earned \$801,588.02 after all charges, including Federal income taxes, for the fiscal year ended July 31, 1931, more than twice the \$365,467 earnings for the preceding year, it was recently announced by J. Clarke Coit, president. Earnings on the 146,205 shares outstanding were \$5.48, as against \$2.56 on the 142,705 outstanding on July 31, 1930.

Cash on hand at the end of the fiscal year totalled \$1,066,588.93, an increase of \$681,469.80 over July 31, 1930, while net working capital stood at \$2,007,424.62 against \$1,188,291.77 on July 31 of last year. Inventories decreased from \$636,893.03 to \$445,606.17.

## **Station Loses Damage Suit**

MOBILE, ALA.—The Alabama Supreme Court recently denied a petition for the rehearing of a damage case of radio station WODX, located at Mobile, Ala., against Geo. E. Stone, treasurer of Mobile County.

The Mobile Broadcasting Corporation claimed \$375 due them for advertising Mobile County. The Supreme Court ruled that the county could not be held responsible for advertising charges under their contract with station WODX since the publicity was only incidental because of the station being located there.

## **Throat Opened by Radio Heat**

PARIS, FRANCE—A man whose throat was opened by radio waves after ordinary surgical methods had failed was reported recently to the Academy of Sciences, in Paris, by the veteran experimenter in this field, Professor J. A. d'Arsonval, as a case treated by Dr. Bordier. The victim had drunk a strong solution of caustic potash, or "potash lye." The result was a severe corrosion of the tissues of the throat and esophagus so that the latter tube, connecting the mouth with the stomach, closed up entirely. The surgeon in charge of the case then made an opening directly into the stomach and the patient was kept alive by liquid food supplied through this opening. In this condition, with the esophagus altogether closed so

(Continued on page 735)



# 63 FOREIGN COUNTRIES

get dependable 'round the world reception with

## SCOTT ALL-WAVE RECEIVERS

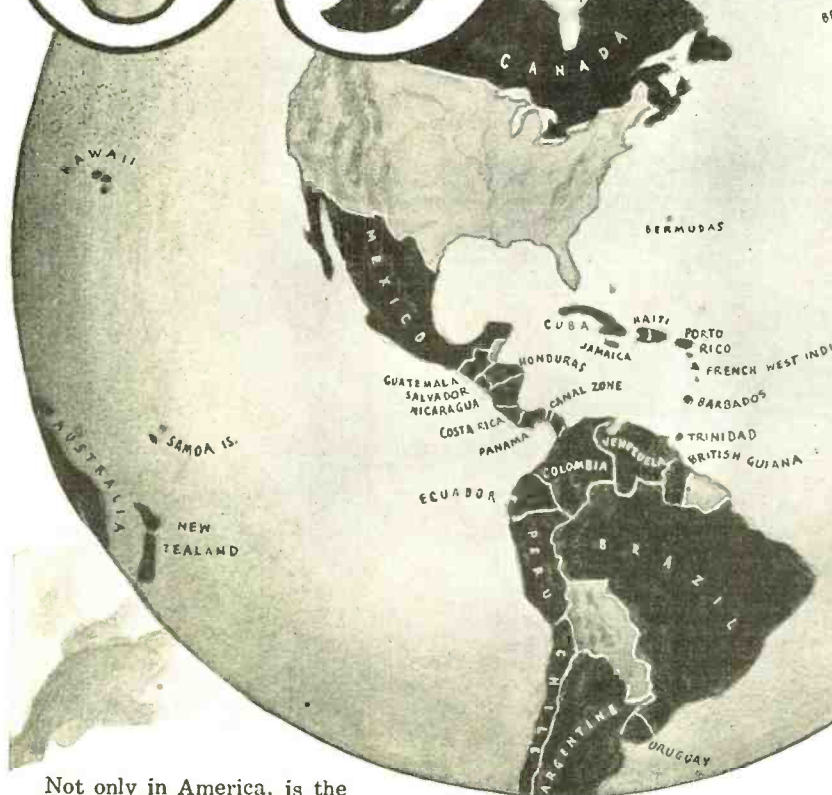

Darkened areas show the foreign countries in which Scott All-Wave Receivers are depended on for radio contact with the rest of the world.

Not only in America, is the Scott All-Wave supplying an entirely new concept of radio performance. In other lands too—in difficult spots, this receiver is doing equally sensational work. For instance, atmospheric conditions are so bad in the Canary Islands that reception there has always been considered almost impossible. Scott All-Wave Receivers located in the Canary Islands, bring in stations 9,000 and 10,000 miles away with good clarity and volume. But it is the underlying reason for such amazing performance that interests you!

The Scott All-Wave Receiver is so powerful and so sensitive, that when operated with the volume turned way down below the noise level, there is still more than enough sensitivity to give ample loud speaker reproduction of signals originating 9,000 and 10,000 miles away. This is one of the main reasons why Scott All-Wave Receivers are being used with complete success in 63 foreign countries today—why Scott owners in this country can tune 'round the world with their receivers whenever they choose—and why YOU will want a Scott!

### What is the Difference that makes the Scott All-Wave so much Better?

The Scott All-Wave is not a factory product. It is built in the laboratory by experts and to laboratory exactness. Physical measurements are by the micrometer—electrical measurements are computed to the smallest fractions—each nut and bolt, each wire, and each operation, no matter how small, is performed by a man with a thorough technical understanding of radio.

The result is a precision-built receiver capable of doing things that factory-built receivers can never hope to do. The result is sensitivity so great that Chicago owners can listen to G5SW, Chelmsford, England; 12R0, Rome; VK3ME, Sydney; HRB, Honduras; and many others any day they choose. The result is also perfect 10 Kilocycle selectivity. No "cross talk." And the resulting tone is nothing short of downright realism—full, round and natural.

### These Foreign Countries Now Served by SCOTT ALL-WAVE RECEIVERS

1. ALASKA
2. ARGENTINE
3. BARBADOS
4. BELGIUM
5. BERMUDA
6. BRAZIL
7. BRITISH GUIANA
8. BRITISH OCEANIA
9. CANADA
10. CANAL ZONE
11. CANARY ISLANDS
12. CHILE
13. CUBA
14. COLOMBIA
15. COSTA RICA
16. CUBA
17. CZECHOSLOVAKIA
18. DOMINICAN REPUBLIC
19. ECUADOR
20. EGYPT
21. ENGLAND
22. FINLAND
23. FRANCE
24. FRENCH WEST AFRICA
25. FRENCH WEST INDIES
26. GERMANY
27. GREECE
28. GUATEMALA
29. HAWAII
30. HAWAII
31. HONDURAS
32. INDIA
33. ITALY
34. JAMAICA
35. JAPAN
36. MALTA
37. MEXICO
38. NETHERLANDS
39. NETHERLANDS EAST INDIES
40. NETHERLANDS WEST INDIES
41. NEW ZEALAND
42. NICARAGUA
43. NORTH AFRICA
44. NORWAY
45. PANAMA
46. PERU
47. PHILIPPINE ISLANDS
48. POLAND
49. PORTO RICO
50. PORTUGAL
51. SALVADOR
52. SAMOA ISLANDS
53. SCOTLAND
54. SIAM
55. SOUTHERN RODESIA
56. SPAIN
57. SWITZERLAND
58. TRINIDAD
59. UNION SOUTH AFRICA
60. URUGUAY
61. VENEZUELA
62. WALES
63. YUGOSLAVIA

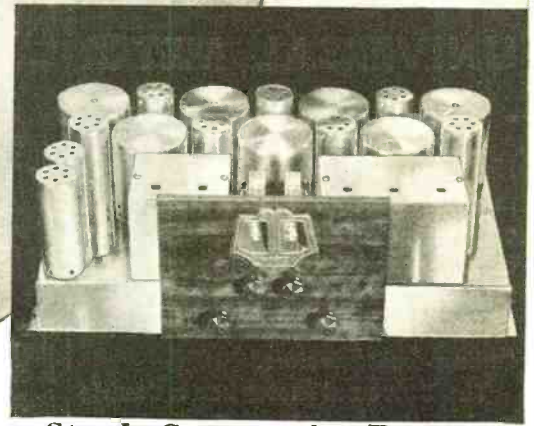

### Sturdy Construction Protects Precision Adjustments

The precision work, which gives the Scott All-Wave its supremacy is assured constancy by the heavy steel chassis—rigid as a bridge, and chromium plated to protect it from deterioration. The All-Wave chassis is so sturdily built that it is unconditionally guaranteed for five full years. Any part proving defective within that time will be replaced free of charge.

### Write for Full Details

Surely, a 15-550 meter receiver that will satisfy the exacting requirements of 63 different foreign countries, will suit your needs better than any other. Surely, a receiver that is tested on reception from London and Rome before shipping is the receiver you would rather own. Mail coupon today for full particulars of the Scott All-Wave Receiver. (Name and address of Scott owner in any foreign country, sent on request).

## CLIP

The E. H. Scott Radio Laboratories, Inc.  
 4450 Ravenswood Ave., Dept. N-2  
 Chicago, Illinois

Send me full details of the Scott All-Wave, 15-550 meter superheterodyne.

Check here if Set Builder  Dealer  Radio DXer

Name .....

Street .....

Town.....State.....

**The E. H. SCOTT RADIO LABORATORIES, Inc.**  
 FORMERLY SCOTT TRANSFORMER CO.  
 4450 Ravenswood Avenue, Dept. N-2, Chicago, Illinois



# MEASURES

## BOTH A. C.

## AND D. C.

# NEW



## UNIVERSAL METER ..... MODEL 301

Here's a handy inexpensive instrument every experimenter needs and can afford. For checking electrical circuits, the new Universal Meter, Model 301, is an ideal general purpose instrument—for bench work or for "home-built" testers.

The Universal Meter has a double scale—the upper for A. C.; the lower for D. C. The A. C. ranges are from 0-5 volts, 0-1 milliamperes; the D. C. are 0-50 millivolts (50 ohms) and 0-1 milliamperes. For higher values, external shunts and external resistors are available. The instrument matches in size and appearance the other Weston 3¼-inch diameter meters.

Designed primarily for experimenters, the Universal Meter is low priced—yet the famous Weston quality construction, reliable operation has been maintained.

Write today for FREE WIRING DIAGRAM, showing how you can hook up the Universal Meter with shunts and resistors.

**WESTON**  
ELECTRICAL INSTRUMENT CORP.  
615 Frelinghuysen Avenue, Newark, N. J.

# All-Wave Super Features High-Gain Design

(Continued from page 666)

for radio circuits. Since the power factor of all the circuits is identical, the selectivity of each must also be the same. This is shown by the amount of attenuation for frequencies 2% greater than the resonant frequency, which is 4.1 in all three cases. However, the reduction of an interfering carrier 10 kc. below the resonant frequency is far from uniform and is substantially zero in the 15,000 kc. circuit. This is in sharp contrast with the reduction of 77% shown in Figure 2 (A).

With the superheterodyne principle this difficulty disappears. By means of the local heterodyne oscillator, the 1000 kc. signal (which we shall assume to be the

above) is also reduced. Figure 2 illustrates very clearly the result of increased resistance in the intermediate coils. Curve "A" is the tuning characteristic of a single intermediate coil as used in the "Comet." Curve "B" is that of a coil of the same inductance having four times as much resistance. The loss of selectivity due to the higher power factor is considerable. For this reason the intermediate coils used in the "Comet" are wound with special "Litz" wire, resulting in a power factor of .01 (Q of 100), and no effort has been spared in their design and construction to make them highly efficient. Six of these coils are used, two in each transformer, in the tuned plate-

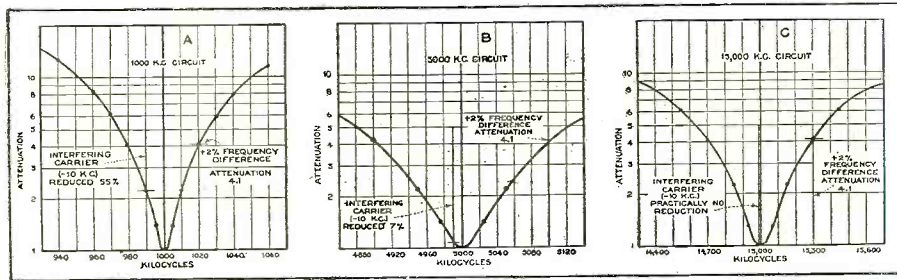

HOW SELECTIVITY VARIES WITH FREQUENCY

Figure 1. Shows the selectivity curves for three theoretical circuits which all have the same efficiency, but are designed for operation on three different frequencies. The one tuned to 1,000 kc. (curve A) shows attenuation of 2.25 for an interfering signal 10 kc. below resonance, whereas at 15,000 kc. (curve C) the interfering carrier would have to be separated from the desired signal by 150 kc. if the same attenuation were to be obtained. This explains why 10 kc. selectivity is so much more difficult to attain at the higher frequencies, and why a superheterodyne, using a relatively low intermediate frequency, offers advantages for short-wave use

one desired) is changed to 465 kc. At the same time the undesired 990 kc. signal is changed to 455 kc. and both signals are impressed on the intermediate amplifier. The intermediate amplifier then has the task of amplifying the 465 kc. signal (for which it is tuned) and reducing (or rejecting altogether) the 455 kc. interference. This is comparatively easy, as the percentage difference here is 10/465 or over 2%. The effective selectivity in this case has been more than doubled. This effect increases rapidly with increasing signal frequencies. In the case of the 15,000 kc. (20 meter) and the 14,990 kc. signals the same process takes place. The 15,000 kc. signal is changed to 465 kc. and the 14,990 kc. interference to 455 kc. This also results in a percentage difference of more than 2% (as was the case with the 1000 kc. and 990 kc. signals) which corresponds to a gain in selectivity of over 30 times, as the original percentage difference between the two signals was only 1/15 of 1%.

An important point must be considered here, however. This gain in selectivity as outlined above is only realized if the tuned circuits constituting the intermediate amplifier have low-loss characteristics comparable to the good tuning circuits used at broadcast signal frequencies in high-grade receivers. If the intermediate coils are, for example, only one-fourth as efficient (for reasons of economy), the gain in selectivity due to the shifting of the frequency (as outlined

tuned grid hook-up. This provides six sharply tuned low-loss circuits in the intermediate amplifier. While this arrangement affords extreme selectivity, the double-tuned, critically coupled circuits result in a steep-sided response curve with a rounded top, thus minimizing the type of radio-frequency distortion known as side-band cutting.

Figure 3 shows the actual tuning characteristics of a complete i.f. transformer using two of the Litz wound coils, each having a power factor of .01. While no overall selectivity curves are available at this time, a fairly accurate idea of same is given by Figure 4, which is a calculated curve of the selectivity of the complete intermediate amplifier based on the actual characteristics of one transformer as shown in Figure 3.

All superheterodyne receivers are subject to "image" interference, which, stated briefly, means an undesired signal whose frequency difference from the desired signal is exactly equal to twice the intermediate frequency used in the receiver. It naturally follows that a high intermediate frequency lessens interference from this source. A maximum spread between a desired signal and its image interference is especially important in short-wave reception. On the other hand, modern design necessitates the use of an intermediate frequency materially lower than that of any of the signals to be received. For these reasons 465 kc. was chosen as the i.f. for the "Comet."



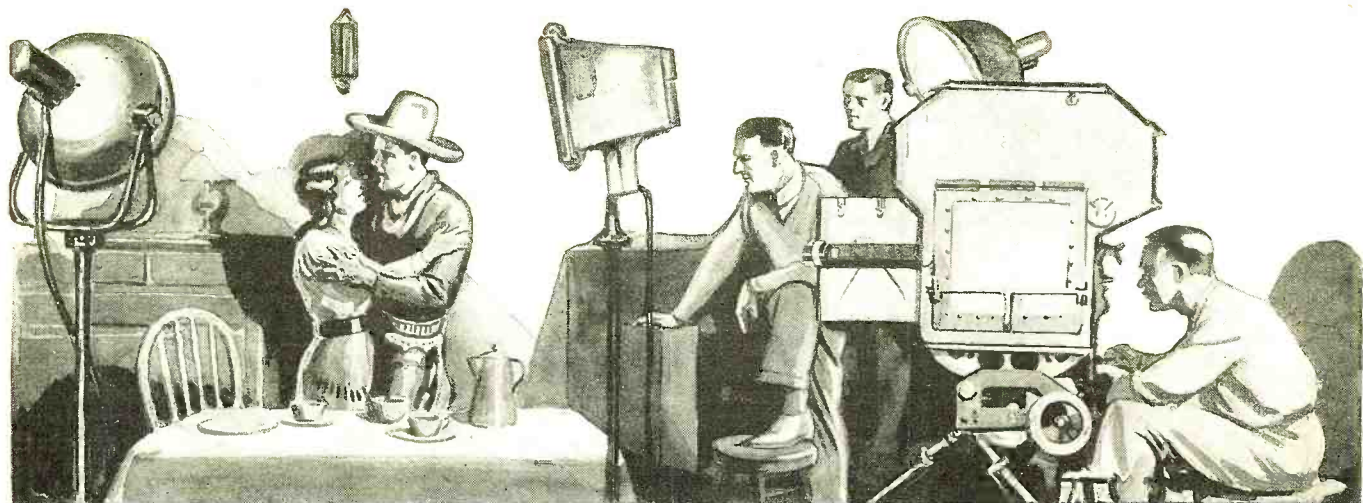

# LEARN RADIO-TELEVISION TALKING PICTURES in LOS ANGELES

Come to sunny California where many of the world's most famous Radio Stars make their home—where the great Laboratories of the American Television Corporation are located—where hundreds of trained Sound Engineers and Mechanics are employed in the Talking Picture Studios and Theatres of Hollywood.

## Railroad Fare Allowed to California

Don't worry about the expense of the trip! For a limited time we are allowing railroad fare to Los Angeles from any point in the United States. This is deducted from your tuition, so the trip costs you nothing extra. Take advantage of this opportunity to visit Los Angeles and Hollywood, and prepare for a good job at the same time.

### PRACTICAL SHOP TRAINING

#### At the Oldest Trade School in the West

For over 25 years National has been training men by the practical shop method. Over 20,000 ambitious men from all over America have come to National for their training. You'll find National graduates working in the famous Studios of Hollywood, in Talking Picture Theatres, great Broadcasting Stations, for Radio Manufacturers and Dealers, while many have gone into the Radio business for themselves and are making big money as their own boss. What they have done, you can do!

### MANY JOBS OPEN

10,000,000 Radio sets to be constantly serviced! 600 Broadcasting Stations employing trained Operators and Mechanics! 10,000 Theatres equipped for sound and the job only half done! Eight stations already sending out regular Television programs! New jobs will be opening up every day—hundreds of golden

### NATIONAL TELEVISION, TALKING PICTURE and RADIO SCHOOL

Dept. 211-E

4006 SO. FIGUEROA ST., LOS ANGELES, CALIF.

opportunities for the trained man. And you can prepare for them in 4 months at National!

### FREE EMPLOYMENT SERVICE Spare Time Jobs While at School

When you've finished National Training—four months of practical Shop Work in the great National Television, Talking Picture and Radio Shops,—then National's Employment Department will assist you in every possible way to get the job you want. And if you're short of money, National will gladly help you to get a spare time job to pay your living expenses while at school.

### MAIL COUPON FOR BIG FREE BOOK

Get all the facts! Mail coupon below for our Big Free Book, telling all about National's famous Shop Training and the many jobs opening up in these fascinating fields. No cost or obligation! Just mail the coupon.

National Television, Talking Picture and Radio School, Dept. 211-E, 4006 So. Figueroa St., Los Angeles, California.	
Please send me your big new Free Book on Television, Talking Pictures and Radio, and full details of your Free Railroad Fare offer.	
Name .....	
Street No. ....	
City .....	State .....



# A New Circuit

The Engineering Department of the Shallcross Mfg. Company has designed a general purpose

## Combination Multi-Range

### Voltmeter and Milliammeter, A.C. and D.C.

employing the new Weston A.C. and D.C. Type 301 Universal Meter and

## SHALLCROSS Super Akra Ohm

Wire  Wound  
**RESISTORS**

The voltage range is from 5 to 1000 volts, 1000 ohms per volt and the current range is from 1 to 500 milliamperes A.C. and D.C.

A complete diagram and full information on the construction of this circuit are contained in our Bulletin 150-D, which also contains very useful information on the application of Akra Ohm Resistors to multi-range voltmeters, ohm meters, etc.

Our new Bulletin 150-D will be sent upon receipt of 4 cents in stamps.



# free RADIO CATALOG



New 10th Anniversary Catalog just out! 144 pages crammed full of bargains. Everything new in radio at lowest wholesale prices. Replacement parts, tubes, kits, speakers, accessories, Lafayette 7, 8 and 10 tube Super-Heterodynes, etc. Brand new, nationally advertised radio merchandise. Write for this FREE 144 page book today.

**WHOLESALE RADIO SERVICE CO.**  
100 Sixth Ave.  
apt. B-12 New York, N. Y.

*new 1932 bargains*

## Wireless (Radio)

and Morse telegraphy taught thoroughly. School, oldest and largest; endorsed by Telegraph, Radio, Railway and Government officials. Unusual opportunities. Expenses low—can earn part. Catalog free. **DODGE INSTITUTE, Oak St., Valparaiso, Indiana.**



## UNIVERSAL

### 2-BUTTON HANDI-MIKE

**\$15.00 List**

Maximum volume, minimum hiss, scientifically damped. Truly natural in tone and the most rugged microphone yet devised. No delicate parts to be damaged if dropped, jarred or roughly handled. For announcing, transmitting or home recording. Our Engineering Department is at your service. New catalog covers twelve models from \$5.00 up.

**Universal Microphone Co., Ltd.**  
1163 Hyde Park Boulevard, Inglewood, Calif., U. S. A.

# The Radioman's Timepiece

(Continued from page 661)

in temperature. The amount of bend is of course very, very slight, but sufficient to lighten or to increase the load oscillated by the hairspring in just the right ratio to the weakening or strengthening of the hairspring by any particular variation in temperature.

The reason these free ends of the balance-wheel rim segments are bent out and in by variations in temperature is that brass and steel "have different coefficients of expansion." That is to say they each expand or contract at different rates. Brass contracts or expands more quickly than steel.

No matter whether there is a rise or a fall in temperature, therefore—no matter whether the metals are expanded or contracted, in other words—the brass part of the balance-wheel rim (the outer strip) will pull or push the steel part, the two being fused together.

So when there is a rise in temperature, lessening the elasticity of the hairspring (weakening it), the same temperature change lengthens the rim of the balance-wheel. As the brass expands quicker than the steel and is on the outside of the rim, it forces the two segments of the balance-wheel inward toward the center.

This virtually reduces the diameter of the wheel and proportionately lessens the load driven by the weakened hairspring. In a lowering temperature the balance-wheel is, in effect, enlarged, thus allowing a greater load on the hairspring which has been strengthened by the lowering of the temperature. Thus the rate of oscillation of the balance-wheel is not altered and for that reason the watch is not forever changing its regularity with every change of temperature.

### The New Type of Hairspring

The chromium-nickel-iron alloy, elinvar, developed by Dr. Guillaume has made possible the construction of a watch without a bimetallic, cut-rim, or "compensating" type of balance.

Because an elinvar hairspring does not lose or gain elasticity as the temperature changes, it creates no error and therefore requires no correction by a "compensating" device.

As magnetizable steel is therefore not necessary in the balance-wheel used with

an elinvar hairspring, it is now possible to employ a balance-wheel made of non-magnetic metal.

Another benefit also accrues. A defect of the compensating method heretofore necessarily used is the fact that while a watch would be correct at two extremes of temperature, such as 40° F. and 95° F., it would vary somewhat at intermediate temperatures. Watchmakers call this the "middle temperature" error or the "secondary" error.

Until Dr. Guillaume created this alloy, elinvar, there was known no way to overcome this secondary error by a device that could be produced at a price that would permit its general use.

But Dr. Guillaume in the creation of elinvar removed the original source of temperature error by rendering a hairspring indifferent to temperature changes. At one stroke he has eliminated the need for "compensation" and overcome also the "secondary" error that was never corrected by the conventional type of compensating balance.

### Rust—Advance Agent of the Repair Shop

In 60% of the watches that find their way to the repair bench, rust is found on the hairspring. Rust is a sure cause of inaccuracy. On so small a bit of metal as a hairspring, even a tiny spot of rust has considerable influence.

The moisture which produces rust may be an essential condition of the atmosphere in a shop, factory or laboratory in which a person may have to work. Or it may be natural to the climate in which one lives; or met with in voyages on the water, sojourns at the seashore or travels through lands where humidity is prevalent.

This frequent cause of watch inaccuracy is also overcome by elinvar because that metal is not subject to corrosion from atmospheric conditions. Indeed, it has shown little effect from rust even when left submerged in water.

By providing the means to combat the three great enemies of watch accuracy—rust, magnetism and temperature variations—Dr. Guillaume has rendered an invaluable service to radio and to many other industries and professions; in fact, to all watch users, regardless of vocational or hobby interests.

## The Revised Circuit of the MB-32 Tuner

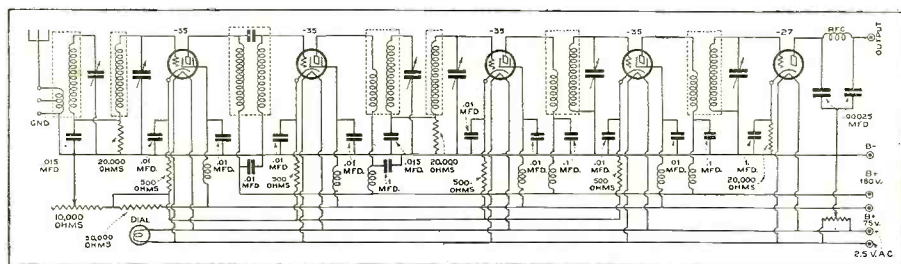

In Mr. Browning's article in the December issue, on the new MB-32 Tuner, the circuit diagram on page 477 was in some respects at variance with the circuit finally adapted. For this reason the circuit is shown again in correct form and with all parts correctly valued.



# Super Power

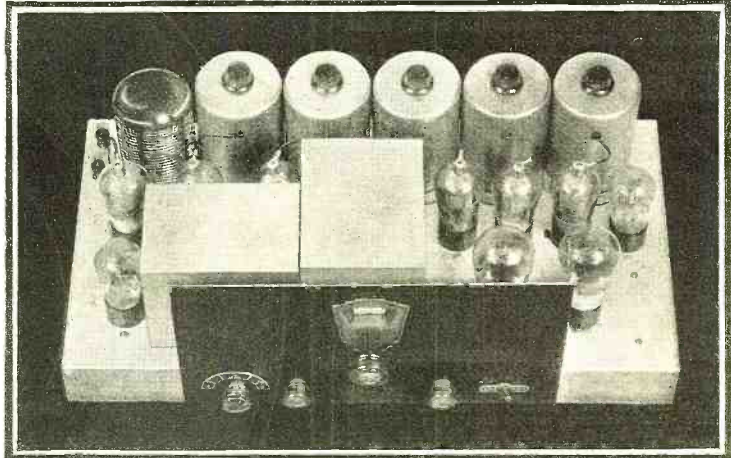

insures

## World-Wide Performance- 15 TO 550 METERS-NO PLUG-IN COILS

**T**HE phenomenal ability of Lincoln DeLuxe receivers to receive stations from every corner of the globe is largely due to Lincoln Super-Power. The tremendous gain of Lincoln's highly efficient circuit opens a new field for the radio listener. National and international programs, fascinating foreign broadcasts, short-waves, air-mail, trans-Atlantic phone,—these and many other features are available to the Lincoln owner.

### From 15 to 550 Meters at the Touch of a Switch

One of the outstanding advances in radio design of recent years is the elimination of plug-in coils for short-wave reception. Having designed the DeLuxe to tune from 15 to 550 meters, Lincoln engineers perfected an extremely efficient and ingenious design whereby a small no-capacity selector switch makes the contacts formerly made by the coil prong and socket contact. A Lincoln owner may change from broadcast to any one of four short-wave bands by merely turning the selector switch.

### A New Conception of Short-Wave Reception

The application of Lincoln's mighty power to the reception of short-waves produces truly amazing results. Stations half-way around the world come in with clock like regularity. Lincoln enthusiasts in the central states have

repeatedly reported *broadcast* reception of many trans-Pacific stations. The tremendous amplification of the highly engineered Lincoln circuit is always perfectly controlled in a channel less than 10 K.C. wide. A letter from Alaska reports reception of Mexico, Nebraska and Vancouver, B. C., all three stations 5 K.C. apart!

### Full, Rich, Life-Like Lincoln Tone

Lincoln tone is a revelation of purity and fidelity. Lincoln experts have designed an audio system that, with either radio or phonograph pick-up input, delivers tone of astonishing richness and realism. Artificial tone compensators or control devices are not required to bring out the natural vivid tone of the living artist.

### DeLuxe DC-SW-10, Battery Model, Is Extremely Efficient

The Lincoln DeLuxe DC-SW-10 is the battery model version of the famous DeLuxe SW-32 described above. Taking advantage of the new low drain 2 volt tubes, the DC-SW-10, when operated from an adequate battery source, provides exceptionally quiet, crystal clear reception of both broadcast and short-waves. This model, although intended for rural or un electrified areas, is finding increasing favor in congested city communities because of its absolute freedom from line noise and clear life-like tone quality.

*Clip* and Mail NOW!

**LINCOLN  
DE LUXE - SW-32**

**LINCOLN RADIO CORPORATION**

Dept. N-2, 329 S. Wood St., CHICAGO, ILL.

Please send descriptive literature to NAME.....

ADDRESS..... CITY..... STATE.....



# LEARN RADIO

this easy, practical way

WRITTEN by two widely known radio engineers, these three books cover every phase of building, repairing and "trouble-shooting" on modern receiving sets. The books include complete instructions for building short-wave and TELEVISION receivers.

## Radio Construction Library [1931 Edition]

Including Television Receivers

This practical Library includes: PRACTICAL RADIO—The fundamental principles of radio, presented in an understandable manner. Illustrated with working diagrams. RADIO CONSTRUCTION AND REPAIR—Methods of locating trouble and reception faults and making workmanlike repairs. RADIO RECEIVING TUBES—Principles underlying the operation of all vacuum tubes and their use in reception, remote control and precision measurements. The Library is up-to-the-minute in every respect and is based on the latest 1931 developments in the design and manufacture of equipment.

Three Volumes.  
6 x 9—1087 pages,  
605 illustrations.

See this  
Library  
FREE!

No  
Money  
Down

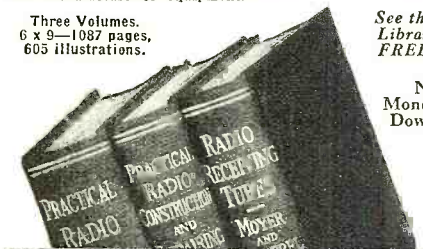

### FREE EXAMINATION COUPON

McGraw-Hill Book Company, Inc.  
330 West 42nd St., New York

Send me the new 1931 RADIO CONSTRUCTION LIBRARY, these volumes, for 10 days' free examination. If satisfactory I will send \$1.50 in ten days, and \$2.00 a month until \$7.50 has been paid. If not wanted I will return the books.

Name .....  
Home Address .....  
City and State .....  
Position .....  
Name of Company ..... RN-2-32

## F. & H. CAPACITY AERIAL



Price \$1.00 Complete postpaid

Every Instrument Tested on Actual 1127 Mile Reception  
A LARGE NUMBER ARE IN USE BY GOVERNMENT, IN NAVY HOSPITAL

The F. & H. Capacity Aerial Eliminator has the capacity of the average 75-foot aerial, 50 feet high. It increases selectivity and full reception on both local and long distance stations is absolutely guaranteed. It eliminates the outdoor aerial along with the unsightly poles, guy wires, mutilation of woodwork, lightning hazards, etc. It does not connect to the light socket and requires no current for operation. Installed by anyone in a minute's time and is fully concealed within the set. Enables the radio to be moved into different rooms, or houses, as easily as a piece of furniture. 8,000 dealers handle our line. Dealers! Over 80 leading jobbers carry our line or order sample direct. Write for proposition.

SEND COUPON, IT PROTECTS YOU

Name .....  
Address .....  
City ..... State .....

Send one F. & H. Capacity Aerial with privilege of returning after 3-day trial if not satisfactory, for which enclosed find  check  M. O. or dollar bill, or send  C. O. D.  Send Literature,  Dealer's proposition.

F. & H. RADIO LABORATORIES  
 Fargo, N. Dak. Dept. 19

### ALUMINUM BOX SHIELDS

Genuine "ALCOA" stock, silver-plate finish. 5x9x6 \$1.89  
Corner size \$4.95. 10x6x7 Monitor size \$3.25. 5x5x5  
Coil Shield (like picture on the right) \$1.00. Any size to order.



"BUDDY" Test Prod Always sharp pointed, using phonograph needles, 4-ft. wires, spade or phone tips. Colored nipples identify each lead, \$1.50 pair.

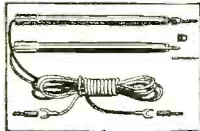

We can furnish all parts for the Set Tester Dr. Lutz described in October Radio News.

Parts for International Six Yaxley 7-Wire Connector, Male and Female, for 89c

We specialize in parts exclusively. We can furnish everything described in this magazine. Give us a trial. Please include postage.  
BLAN, the Radio Man, Inc., 89 Cortlandt St., Box N2, New York City

# Television Hits Broadway

(Continued from page 655)

of strength into the polished reflectors, and create weak currents in the photo-electric cells in accordance with the gradations of tone on the surface of the subject.

sisting of twelve 75-watt tubes in parallel. The whole amplifier is built up on a portable frame just like the photo-cell unit.

In the stage demonstrations the output of the audio amplifier is led by a short

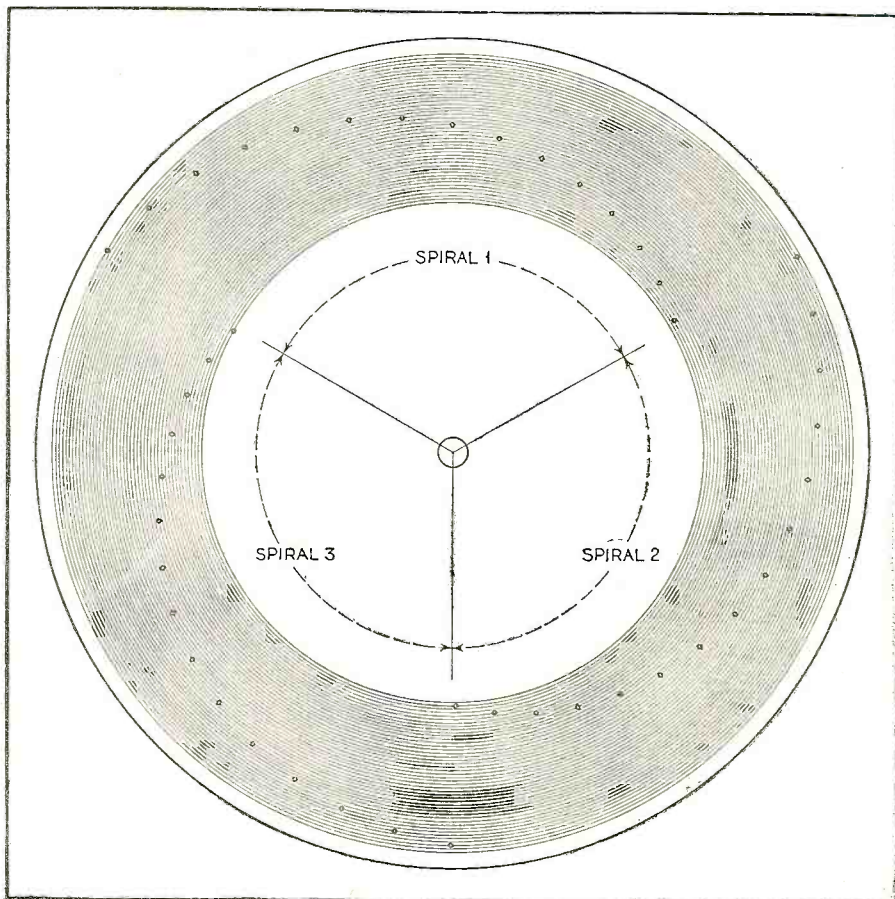

THE SCANNING DISC

Figure 1. A triple-spiral system of scanning is used. In the projector disc each "hole" is actually a two-inch lens

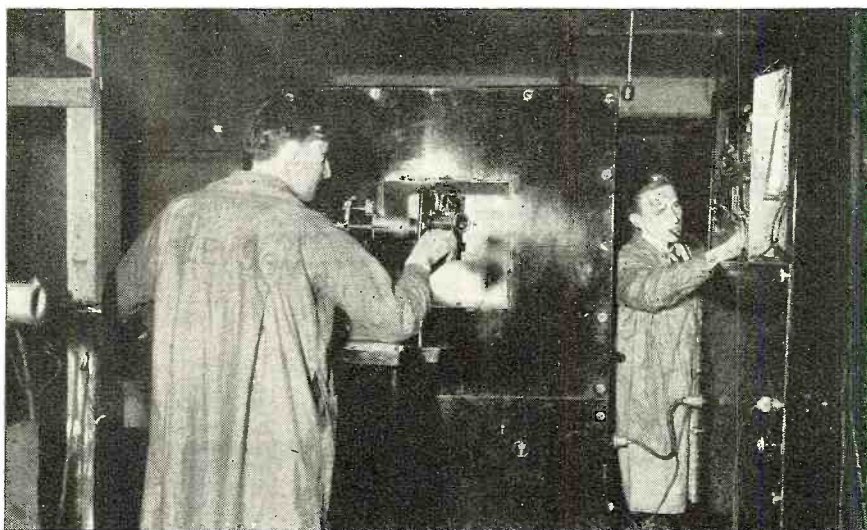

THE SCANNING MIRROR

The scanning ray is directed on a small mirror, by which it is reflected, through the square hole in the photo-cell frame, onto the subject being televised. The engineer is here shown adjusting this scanning mirror

The output of the photo-electric cells is amplified by an eight-stage audio amplifier terminating in an output stage con-

wire line directly to the projector apparatus, which is backstage about twenty-five feet away. Under these circumstances



there is no radio transmission problem, and the images are free of the phantom snowstorms and other ghostly effects produced by stray bits of radio interference. A frequency band about 50 kilocycles wide is covered by the transmission.

The projector is a piece of machinery worth seeing. The disc is *three and a half feet in diameter*, and is driven by a five-horsepower synchronous motor. It is fully enclosed for the protection of everyone concerned. Instead of having mere holes, it is fitted with 45 lenses, each *two inches in diameter*. Directly behind the disc is a Taylor projector lamp. The exact construction of this lamp is something of a secret, but it is known to contain a mixture of helium and carbon dioxide and draws an energizing current of one ampere at 100 volts from the audio amplifier.

The whole projector unit stands about six feet high and is raised on a wooden platform so that it projects an even image on the back of a translucent glass screen ten feet square. The distance between projector and screen is about eighteen feet. The projector is not visible to the audience, although the flickering light of the lamp can be discerned faintly through the screen.

The men traveling with the apparatus are good fellows, and will probably be glad to show you the very interesting projector if you identify yourself as a radio man and make the necessary arrangements at the stage door.

The designer of all this equipment is Ulysses A. Sanabria, a quiet and modest young man of only 26. He has been doing independent television research in Chicago for about five years and has built several transmitters for Chicago stations. He supervised the New York demonstrations and will travel with the apparatus to make sure that it continues to work.

The writer sat through a complete show with Sanabria at the Broadway Theatre while he directed the operators by telephone from a balcony seat, and he was impressed by his earnestness and evident knowledge. The man has been devoting his life to television, and he is only just starting.

### Radio Science Abstracts

(Continued from page 700)

used to control traffic. Some systems utilize photo-cells in conjunction with tube amplifiers and one system utilizes the time constant of a condenser-resistor circuit to control the traffic lights. The tendency evidently is to arrange these circuits so that the method now in general vogue of turning lights on and off at specific intervals without regard to traffic conditions can be eliminated in favor of control systems that are responsive to traffic conditions. The article reviews the systems of a number of companies making traffic-control devices.

### A Correction

In the article on the City Antenna Problem in the December, 1931, issue on page 540 the value of the terminal resistance was shown as 100 ohms. The correct value is 1,000 ohms.

# A THOUSAND RANGES from this HANDY KIT!

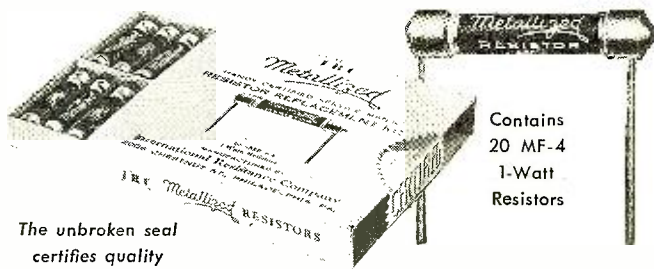

**G**OOD news for the Servicemen who have been asking us for a compact "resistor kit"! Good news for every repair man who wants to speed up his work.

This new Certified Kit contains 20 Metallized Units of the most-used sizes—500 ohms to 3 meg-ohms. It is

**FACTORY-SEALED, FACTORY-TESTED, and FACTORY-GUARANTEED**

It gives any value you want. A thousand ranges—two thou-

sand—or more are possible from this little kit. Free information with every kit tells you how.

Ask your jobber—and be sure the seal is unbroken when you receive the kit.

Metallized Resistors, at their new low prices, offer the greatest value in the resistor field today. The purchase of the Certified Kit entitles you to our I. R. C. Resistor Replacement Guide free—and in addition, our R. M. A. standard Color Code Chart. See your jobber today.

INTERNATIONAL RESISTANCE COMPANY  
PHILADELPHIA TORONTO



I. R. C. Resistor Replacement Guide.  
PRICE \$1. Free with purchase of 10 Metallized Resistors.



*Metallized*  
**RESISTORS**

EVERY SERVICEMAN NEEDS THE I. R. C. GUIDE. MAIL THIS COUPON

INTERNATIONAL RESISTANCE CO., 2006 Chestnut St., Philadelphia. N-2

Gentlemen:

I enclose \$1.00, for which please send I. R. C. Resistor Replacement Guide.

Please send complete data on Metallized Resistors. I wish to purchase assortment of 10, entitling me to Resistor Guide Free.

Name.....

Address.....

City..... State.....





(2 1/2 X 5 INCHES ACTUAL SIZE)

### The Mighty Midget That Gets Great Distance!

The original Gold Test Filtered Aerial is replacing unsightly and messy outside or inside aerials in thousands of homes all over the world. It is small and compact—only 2 1/2 x 5" and can be attached by anyone in just a minute, without the use of tools. Just connect a Wellston Gold Test Filtered Aerial to your radio and you will be surprised at the crystal-clear tone of distant stations—greater selectivity without distortion—reduced static—elimination of "overlapping" stations and the absence of AC aerial hum (because it does not attach to the lighting socket). Every electric set should have one. If your dealer can't supply you, order direct.

**RETAIL PRICE \$2.50**  
GOLD TEST REPLACEMENT PARTS

Gold Test Replacement Parts—Condensers, Transformers, Resistances and all miscellaneous repair parts for all makes of receivers are designed with ample margins of safety. Service men everywhere are using them with great success. Send for our new and enlarged Catalog No. 21.

**DEALERS and DISTRIBUTORS:** Stock Gold Test Aerials and Replacement Parts. Cash in on BIG DEMAND! Write today for prices and discounts.

**WELLSTON RADIO CORP.**

Dept. 203

St. Louis, Mo.

### Convert Old Sets Into Dollars!

Replace worn out condensers at little cost and put those old sets back into service. It's profitable business if you use the Special Dubilier Service Kit—a useful package containing 25 assorted sections for by-pass and filter block repairs, ranging from .1 to 2 mid., 200 to 400 volts. List price, \$10.50.



Order now, carry the kit in your service bag, and start cashing in on the profitable business of repairing old radio sets! Write for free copy of New General Catalogue No. 121.

**DUBILIER**  
**CONDENSER CORPORATION**  
4377 Bronx Boulevard  
New York City

**LOWEST PRICES IN HISTORY OF RADIO VALUES!**

**TO BUY RIGHT WRITE FOR OUR FREE**

132-page catalog listing over 4,000 items at the lowest prices in the history of radio.

"If it's radio, we have and sell it for less."

**BALTIMORE RADIO CORP.**  
N-725 Broadway New York, N. Y.

## The New KFI

(Continued from page 659)

to modulation. It also allows the crystal stage to be operated at very low power output which, in itself, makes for better stability.

Following the UX-860 stage is the modulated amplifier consisting of one UV-849 tube. This stage is modulated by two of the same type tubes. The power for this stage and the driving stage is furnished by six UX-866 tubes located in the first panel from the left and arranged in a three-phase, full-wave circuit. The output of this stage is a modulated radio-frequency with peak power of approximately 800 watts delivered to the grids of the succeeding 5 kw. amplifier stage.

The 5 kw. amplifier stage is the third

This instability manifests itself in poor quality, short tube life, interruptions of service and flashovers. The final power amplifier was virtually designed around the 100-kilowatt tube. A great amount of time and money was spent in the development of the circuit for this tube and this work has resulted in a very stable and highly efficient circuit.

A Class B or linear amplifier, by definition, is one that operates in such a manner that the power output is proportionate to the square of the grid voltage. This is accomplished by operating the tube with a grid bias of such value that it substantially cuts off the plate current without excitation. When grid voltage is supplying excitation to the tube, essen-

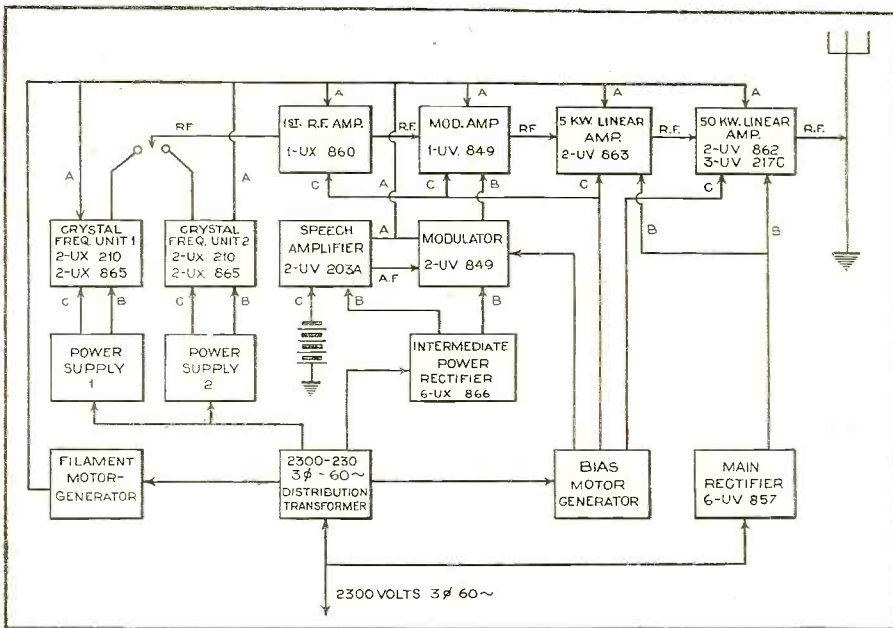

THE BASIC DIAGRAMATIC ARRANGEMENT

Figure 1. Here the functional divisions of the transmitter are shown in their sequential relationship, from crystal-controlled oscillator to the antenna

panel from the left. This stage utilizes two of the UV-863 high-power tubes connected in a push-pull circuit. This stage is operated Class B and is used to amplify the modulated carrier from the preceding stage. The UV-863's utilize water cooling on the plates. Filament power for this stage is secured from a filament motor generator set which is used to supply both this stage and the final power amplifier stage. Plate voltage is secured from the high-power rectifier in the same manner by means of a voltage reducer unit.

The next grouping of panels contains the final power amplifier unit which utilizes two UV-682, 100 kw. Radiotrons arranged in a linear balanced power amplifier circuit.

The 100-kilowatt tube was developed specifically for use in 50-kilowatt transmitters, since it was desirable, in the opinion of engineers, to avoid a paralleling of tubes in Class B operation. The adjustment of a Class B amplifier is very critical and unless extreme care is taken in the design and adjustment of the circuit, the amplifier will be unstable.

tial half sign waves of plate current are produced in the least negative half cycle of the grid voltage. The distinguishing characteristic of Class B operation is a medium efficiency of, say, around 33% and a relatively low ratio of power amplification.

The essential condition for a balanced linear amplifier stage, such as the 5 kw. unit and 50 kw. final power amplifier unit, is such that both tubes must be worked under identical conditions. Both tubes must receive equal excitation voltage, equal bias and must have equal characteristics. Since there has been very little written on the linear power-amplifier circuit as used in the last two stages of this transmitter, it might be well to explain briefly the operation of a Class B circuit.

The operation of a Class B push-pull amplifier can best be shown by a very simple diagram. Figure 3 shows the dynamic characteristic of two tubes in a Class B circuit. The dynamic characteristic curve of one side is inverted in respect to the characteristic curve on the opposite side. It can be seen from this



diagram that it is necessary to have the straight portions of the curve exactly in line, otherwise a distorted output wave will result. When the adjustment is properly made, the plate current for each tube forms a continuous wave of current which excites the plate tank circuit. When the tube is biased exactly to cut-off, each tube utilizes only one-half the grid voltage wave.

It can be noted that the output increases as the excitation is increased and that there will be required a tube ca-

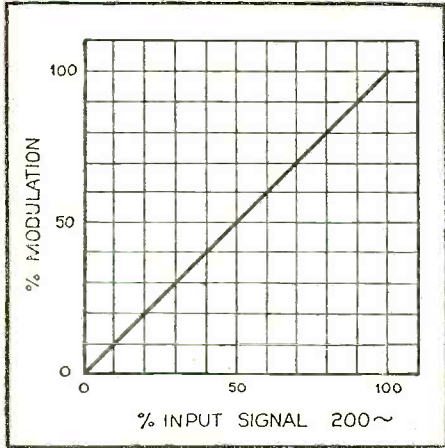
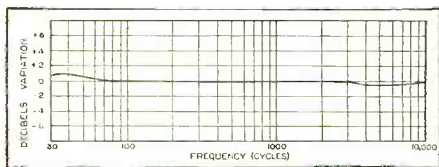

FIGURE 4

capacity of four times the normal carrier in order to provide available power when the excitation swings the output up and down the dynamic characteristic curve. The two UV-862 tubes provide more than the 200 kw. capacity on peaks. The limit of the curve that can be used is the point where the curve begins to bend over. If the tube is swung above this output, harmonics will be introduced into the output. The tubes, however, are of great enough capacity to readily supply 50 kw. of power modulated 100%, which means that on modulation peaks of 100% there is an instantaneous power produced of 200 kw. The curve, Figure 4, shows the amplitude characteristic of the KFI transmitter.

The single panel following the final



FREQUENCY CHARACTERISTICS

Figure 5. The overall audio-frequency characteristic, from speech input to antenna, is substantially flat from 30 cycles to 10,000 cycles

power amplifier stage is the main power control panel. This panel contains controls for the entire transmitter, including the 2300-volt primary circuit-breakers and special controls for the power circuits of the 5 kw. and 50 kw. amplifiers and power rectifier, indicating and graphic metering equipment, filament and plate voltage regulator, and protective devices.

The various devices used for safety of operating personnel and protection of the apparatus include the following: Water flow relays that prevent injury due to water failure.



# Reliable Short-Wave RECEPTION

To Use with your present Set, attached in 10 minutes NATIONAL NC-5—most powerful converter made.

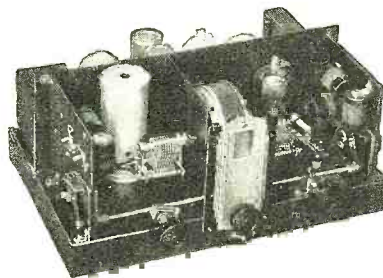

NATIONAL NC-5 Short-Wave Converter for use with any radio set.

No trouble to connect this powerful NC-5 to any radio set. Simply move the antenna wire from the set to the proper binding post on the converter; connect the converter wire to antenna post on the set and plug the electrical connection into baseboard alongside the one that goes to your set. No need to disconnect when receiving ordinary broadcasts.

#### WORKS WITH ANY SET

Owing to the super-power of the NATIONAL NC-5 Converter (there are two extra stages of amplification), it will bring in broadcasts and code on short-waves from all over the world on any radio set.

#### SINGLE CONTROL TUNING

Specially designed to make circuits "track" each other accurately. No interlocking or "dead spots". Operation is stable over the range.

#### NO PLUG-IN COILS

The NC-5 Converter has a new coil-switching system with practically perfect results for converter use, but without the inconvenience of plug-in coils. The new design helps, but R-39, the remarkable low-loss dielectric, really makes it possible. No ordinary insulating material works as well. There is no intercoupling between coils.

*A Change in Color of Dial-Light Indicates Which Coils Are in Circuit*

#### Attractive—Compact

Size, 8" x 1 1/2" x 12". Standard Model in beautiful finished metal cabinet.

#### DE LUXE MODEL

In hand-rubbed solid mahogany case with genuine inlay in front panel. Harmonizes with the most beautiful radio sets.

## NATIONAL NC-5 SHORT-WAVE CONVERTER

For Serious Short-Wave work, this outstanding instrument, the NATIONAL SW-5 THRILL-BOX

For those who wish to go into serious short-wave reception of broadcasts or code, or for experimental purpose, the NATIONAL SW-5 THRILL-BOX is recommended.

#### READ WHAT USES SAY:

"Truly a masterpiece in the SW field." . . . "No comparison possible with other receivers." . . . "Works perfectly and surely brings in the DX." . . . "Have had years of SW experience and I have never seen a receiver that nearly approaches the NATIONAL SW-5 THRILL-BOX in performance." . . . "5 continents and 23 countries received." . . . "They don't make SW Receivers better than the NATIONAL SW-5." (Names on request.)

#### HIGH-LIGHTS ON THE SW-5

Range 9-2000 meters. Extremely high signal to noise ratio. True single-knob tuning. Set and forget the antenna trimmer. Easy to log with NATIONAL projector Dial, type H, no parallax. Special 270° Type S.E. Tuning Condenser with insulated main-bearing and Constant-impedance pigtail makes gang-tuning possible on the short waves. Equipped with standard set of 4 pairs of R.F. Transformers covering range of 15 to 115 meters wound on forms of genuine NATIONAL R-39. Uses the new UX-235 Variable-Mu tubes, giving improved sensitivity and less critical operation. Humless A.C. Power Supply with special filter section. R.F. Filter on Rectifier Tube, and Electrostatic shield. R.C.A. Licensed. Made also in low drain battery model.



## NATIONAL SW-5 A. C. & D. C. THRILL-BOX

Send in this COUPON to-day.

NATIONAL COMPANY, INC.  
61 Sherman Street, Malden, Mass.

Gentlemen:

(Check which.)

- Please send me complete information and prices on your new NATIONAL NC-5 Converter.
- Please send catalog sheets on the improved SW-5 THRILL-BOX.
- I enclose 50c (stamps or coin) for your 64-page Handbook of Short-Wave Radio, describing in full the latest and best short-wave receiving circuits, adapters, converters, meters, etc.

NAME

ADDRESS

RN-2-32





## Won't I Ever Get Ahead in Radio?

Progress in radio is determined purely by *knowledge*. Even practical experience doesn't help if you haven't got **A FULL KNOWLEDGE OF RADIO FUNDAMENTALS**.

There's more to radio than just knowing *HOW* to repair or construct apparatus—you've got to know *WHY* it operates after you do!

To men who are striving toward a **REAL FUTURE** in Radio—whether as Service Men, Factory Engineers, Transmission Men, Operators or Broadcast Engineers—we offer an endorsed course of training that, by teaching **BASIC RADIO ENGINEERING**, makes you fit to hold these important jobs.

### Get the Details

The coupon brings you interesting booklet and full particulars by return mail. No obligation. Mail it now—while you think of it.

**Capitol Radio Engineering Institute, Inc.**  
 14th St. & Park Rd., N. W. Dept. B-11, Washington, D. C.  
 Without obligation, please send me details about your home study training in  Radio or  Television.

Name .....

Address .....

Town ..... State .....

## RADIO DEALERS RADIO SERVICEMEN

### NEW Radio Handbook

CONTAINING:

- Technical Information.
  - Volume Control Guide.
  - Transformer and Condenser Guide.
  - Radio Replacement Parts Catalog.
- Sent postpaid anywhere for only

**25 Cents**

### Specials from our Catalog

- Atwater Kent 37 Block with chokes } **\$2.95**
- Atwater Kent 37 Transformer, ea. }
- Majestic Super "B" Eliminator Block } **\$2.25**
- Electrolytic 2 anode Condenser, ea. }

Hard to Get Parts—We have them.  
Send us your repair work for estimate.

### Grant Radio Laboratories

6521-N South Halsted Street, Chicago, Ill.



R. C. A. No. 103  
**MAGNETIC SPEAKERS**  
at \$3.50 ea.

Hundreds of other like values in our new catalog. Write for it.

**STUYVESANT ELECTRIC CO.**  
53 WALKER ST. N. Y. CITY  
Phone CAnal 6-1688-1689-1690

- Water temperature indicating thermometers.
- Filament no-voltage protection on both d.c. and a.c. tube filaments.
- Bias no-voltage relays.
- Timed filament voltage build-up.
- Step starting for the power rectifier.
- Overload release on circuit breakers for both branches of power circuit.
- Power rectifier surge overload relay with automatic reset.
- Power rectifier sustained overload trip.
- Intermediate rectifier overload trip.
- Sequence interlocks that protect each successive operation in either starting or stopping.
- Thermal overload relays in each motor starter circuit.
- Fuses in all branch circuits.
- Disconnect switches in high-voltage circuits.
- Filament burn-out relay on the 5-kilowatt amplifier that removes plate power when circuit unbalance is caused by tube failure; and removes filament voltage where both tubes take their

The output from this rectifier is amply filtered by means of inductive reactors and banks of high-voltage condensers. The reactor is placed on the negative side of the high-voltage delivery circuit.

The transmitter can be thrown on and off by means of a single switch. This switch is provided in duplicate with one control located on the operator's desk.

The final stage contains a rectifier circuit utilizing a UV-217C for rectifying the r.f. and providing a source of power for the monitoring speaker and the oscillograph. The oscillograph enables accurate check on percentage modulation, distortion and improper adjustments. The frequency characteristic of the KFI transmitter is substantially flat from 30 to 10,000 cycles. This insures high-quality transmission. A characteristic curve is shown of the frequency plotted against decibels in Figure 5. This curve shows that perfect fidelity is secured as far as the human ear can detect, since the average ear cannot detect a change of less than 2 db.

Table 1  
Tubes Used in the KFI Transmitter

4 UX-210	2 UV-863
4 UX-865	2 UV-862
1 UX-860	6 UV-857
3 UV-849	3 UV-217-C
2 UV-203-A	10 UX-866

Ratings as Used in 50-B Transmitter

Type	Plate Current	Plate Voltage	Bias Voltage	Filament Voltage	Filament Current
210	30 ma.	350	minus 50 V.	7.5	1.25 a.
865	60 ma.	500	" 75 (Cl. C)	7.5	2
860	.1 a.	2,000	" 150	10	3.25
849	.1 a.	3,000	" 132	11	5
203-A	50 ma.	1,000	" 20 (audio)	10	3.25
863	.5 a.	12,000	" 340	22	52
862	4.2 a.	17,500	" 380	33	207
217-C	.15 a. with	3000 v. RMS applied		10	3.25
866				2.5	5

Peak plate current = 0.6-A.  
 On 3-phase, full-wave connection, the inverse voltage is equal to 1.045 times the average d.c. output.  
 In the single-phase, full-wave rectifier using two tubes, the inverse peak voltage equals 3.14 times the average d.c. plate voltage.  
 Fil. voltage, — 5. Fil. current, — 60 a.— maximum peak inverse 20 KV.  
 Maximum peak plate current 20 amps.  
 The remarks given in regard to the 3-phase, full-wave 866 rectifier apply here with equal force.

- filament current through a resistance.
- Switches on all doors that remove bias and plate voltages, thus protecting the personnel from accidental contact with high voltages.
- Timed water flow after removal of power tubes to assure complete cooling.
- Automatic drain of cooling water to prevent freezing in cold weather.
- Visual indicators as a guide to all important circuit conditions.

The panel to the extreme right shows the rectifier unit which contains the tubes and filter condensers, filament transformers, etc. The high-power rectifier, which is used to supply the final stage and the 5 kw. exciter stage, utilizes 6 UV-857 tubes in a three-phase, full-wave circuit.

The primary power source for the KFI transmitter is a 2300-volt, 3-phase, 50-cycle supply. This supply is converted by means of a frequency converter to 60 cycles. By using a converter the installation of a standard 60-cycle transmitter unit was made possible. It is interesting to note that this is the only 50 kw. installation in the United States operating from a 50-cycle power source.

When in regular operation there is approximately 100 kilowatts of power from the tubes which must be dissipated. This power is dissipated by means of a water-circulating system. Since there is a very high voltage on plates of the tubes, it is necessary to use distilled water so that the mineral content and conductivity will



be low. A long column of water flowing through a rubber hose on a reel is used to insulate the high voltage from the metal pipes. The cooling system consists, essentially, of the following: A water storage tank, centrifugal water pump, radiator and blower. The water storage tank is provided, since the system is a closed one. The pump, of course, circulates the water and has a capacity of approximately 55 gallons per minute against an 80-foot head. A by-pass system is provided around the pump with the control valve for pressure control. The pump forces the water through the radiator, where the water is diffused through a bank of radiating fins. The radiator is equipped with a centrifugal blower driven by a totally enclosed 7½-horsepower motor. The radiating system, as a whole, is designed to dissipate a much greater amount of power than is ordinarily required of it.

All power equipment, exclusive of that mentioned, is located on the basement floor. This consists of high-voltage transformers, filament motor generators, bias and motor generators, reactors and condensers and voltage regulator for the high-voltage plate supply.

The voltage rectifier is so designed that when voltage is thrown on the tubes it is only at 10,000 volts. The regulator automatically runs the voltage up to the normal voltage of 18,000 volts in a very short time. This gives added protection to the tubes. When the transmitter is thrown off, the voltage regulator drops immediately to 10,000 and the transmitter is ready to go into operation at low-value plate voltage. The regulator, of course, can be operated separately and by a raise-lower button.

The rectifier is of three-phase, full-wave system, employing a recently developed low-loss mercury vapor rectifier tube. The resistance of these tubes is so low that the IR drop is only 14 volts. The IR loss is consequently very low; so low, in fact, that water cooling is not used. This tube makes possible a great power saving over the older type of water-cooled power rectifiers. This UV-857 tube is rated, as will be noted in the description of tubes used in the transmitter, at 18,000 volts and 20 amperes.

The output of the 50 kw. amplifier is coupled to the antenna unit by a two-wire transmission line. This enables the antenna to be placed at a distance from the transmitter. The transmission line, properly terminated, has an efficiency of very nearly 100%; the only loss is that of the IR loss in the conductors, which is negligible. The antenna-coupling and tuning apparatus is housed in a separate building located directly under the antenna. The transmission line is terminated in an impedance equal to its own surge impedance. This condition being strictly met, all the power delivered to the transmission line is transmitted to the antenna. If the transmission line should not be properly balanced and terminated, the energy which would not be transmitted to the antenna, would surge back and forth from end to end (commonly called reflections) until it was dissipated in the line itself.

# NEW VISIONETTE

**The First Practical  
Televisor for the Home**

*Contains all necessary parts to easily  
assemble an efficient Television Set*

The ICA Visionette makes the viewing of television pictures a pleasure. The images are seen in an adjustable mirror. This exclusive method widens the angle of vision—permitting a number of people to enjoy the pictures at the same time. A specially designed and ground lens between the scanning disc and mirror magnifies the picture without loss of detail. A newly developed synchronous motor of radically different design (fully assembled, ready to operate) and 60-line scanning disc included.



List  
**\$37.50** (In Kit Form)



**SHORT WAVE RADIO TELEVISION SET**

For use with ICA Visionette or other standard television equipment. Powerful Pentode and Vari-Mu Tubes—power supply—built-in permanent coils. Tunes in short-wave radio stations or television telecasting stations—just throw a simple switch to change from one to the other. Wave length 80—200 meters. Single control—full vision tuning.

Supplied complete with blueprints and detailed information for quick and easy assembly.

*Write for additional information regarding  
ICA Radio and Television Apparatus*



**\$39.50** (In Kit Form,  
less tubes)

**INSULINE CORP. OF AMERICA**  
23-25 PARK PLACE, NEW YORK, N. Y.  
Subsidiary of STANDARD TELEVISION AND ELECTRIC CORP.

## Follow the Direct Road to Success

Do you want a better position and a larger pay envelope? Learn mathematics! Not a day passes in which you do not have to use mathematics in your work. A thorough knowledge of it makes clear so many things which are puzzling you today.

You can now have a mathematics education without having to go back to school or taking an expensive correspondence course.

### At Last! Mathematics Self-Taught This Simple, Easy Way!

Now you can have this easy method which has been worked out by an expert for those who do not wish to give the time and money required by other methods of mathematical study. A very simple and extremely interesting group of books has been prepared for you by a man who has devoted his life to teaching practical men the fundamentals of this important subject.

# MATHEMATICS FOR SELF-STUDY

By J. E. Thompson, B.S. in E.E., A.M., Dept. of Mathematics, Pratt Institute, Brooklyn

These books start right from the beginning with a review of arithmetic that gives you all special short-cuts and trick problems that save countless hours of your time. Then they go right into higher mathematics and show you how simple it is when an expert explains it for you. In no time at all you will be tackling with ease the most difficult question on this subject.

**An Expert's Simplified Methods**

Mr. Thompson, the author of these books, has had many years' experience in mathematical training. He presents each practical method and problem in the clearest, simplest way. He gets right down to the kind of information that you need in your daily work.

**A Complete Reference Work on Mathematics in These Four Inexpensive Books**

Arithmetic for the Practical Man.  
Algebra for the Practical Man.  
Trigonometry for the Practical Man.  
Calculus for the Practical Man. 4 Volumes—1240 Pages—Illustrated.

**Send No Money**

Examine These Books for 10 Days FREE  
MAIL THIS COUPON

D. Van Nostrand Co., Inc.  
250 Fourth Ave., New York

Send me MATHEMATICS FOR SELF-STUDY in 4 volumes. Within 10 days I will either return the books or send you \$1.65 as first payment and \$2.00 per month for 3 months—total \$7.65. (5% discount for cash.) (R.N. 2-32)

Name.....  
Address.....  
City and State.....  
Business Connection.....  
Reference.....

**Look up any mathematical problem that puzzles you in these books and see how quickly you get the solution.**





**FILTERMATIC PRODUCTS**

Help you to get the **BEST** possible reception from your **RADIO** set.



**SUPER-TONE CONTROL**

Will make your old Radio (battery or electric) equal in tone to the most modern set. Installed in one minute's time, no tools required. Will tune out much of your noises and so-called static. Positively cannot harm the finest radio in any way. Price \$2.50 postpaid. Satisfaction guaranteed or money refunded.

**SUPER-FILTERMATIC The Modern Aerial**

Thousands of satisfied users, praised by radio experts. Removes all other aeriols, reduces static, and noises. Especially good on distance reception. Helps to separate stations, does not connect in light socket (therefore eliminating hum and line noises). It is very compact, measuring only 1 1/2 x 2 inches, is absolutely non-corrosive and non-directional. Installed in one minute, no tools needed. Will never wear out. Eliminates trouble and expense of lightning-arrester.

Price only \$2.00 postpaid. Satisfaction guaranteed or money refunded.



**ALL PROGRAMS Are Good with a FILTERMATIC. For all radios only \$1.00 postpaid.**

Entirely automatic—no bothersome tuning. Improves tone, reduces static, brings in distance, increases volume, separates stations. Installed in one minute, no tools required, in series with your aerial or across your aerial and ground. Satisfaction guaranteed or money refunded.

Send check or money order. C. O. D. 25% with order. (No foreign C. O. D.) Money back guaranteed after 5-day trial. Service Men and Dealers Write for Particulars. Also information about Free local newspaper advertising.

**FILTERMATIC MFG. CO.**

(Dept. B-10) 4458 Frankford Ave., Philadelphia, Pa.

**Get Started in RADIO**



Write for free booklet telling about this growing and most promising industry. The radio operator is an officer aboard ship. His work is light, pleasant and interesting. He has many opportunities to travel to all parts of the world.

A new course in TELEVISION starting soon. Full information on request.

**EDUCATIONAL DEPARTMENT**

**WEST Y.M.C.A.** 17 W. 63d St. New York

**2 BOOKS By RIDER**

Servicing Superheterodynes—144 pages—price, postpaid... **\$1.00**  
Perpetual Trouble Shooters' Manual—1,000 pages—price, postpaid... **\$5.00**

Get them direct from us or your local dealer.

**RADIO TREATISE CO., Inc.**  
1440 Broadway, New York City, N. Y.

**SEND 25 CENTS**

for a booklet which tells you how to construct and operate the World's Greatest All-Wave Screen-Grid Super.

**TRAUL RADIO CO.**

1074 ATLANTIC AVE., BROOKLYN, N. Y.

**Using Graphs and Charts**

(Continued from page 676)

x also in logarithmic proportion, but with units of one-third that size (having three cycles in the same space that a and b have one), then the chart for this purpose is ready.

In order to make the construction in practice, it is most convenient to obtain semi-logarithmic paper of one cycle to the sheet and of three cycles to the sheet. Then, after measuring off the proper distances of p and q on a piece of cardboard, glue a strip of the one cycle to the sheet on line a, another on line b. A strip of three cycles to the sheet goes on line x.

In figure 3, the three lines are shown at an angle. In this case the relation between the three graduated lines is

$$x = \frac{2ab \cos \alpha}{a + b}$$

When the angle is 60 degrees  $2 \cos \alpha = 1$  and the formula becomes

$$x = \frac{ab}{a + b}$$

or

$$\frac{1}{x} = \frac{1}{a} + \frac{1}{b}$$

All these relations can be proved in the same way as was done in Figure 2. The equation so obtained is the well-known formula for resistances in parallel or condensers in series. It applies equally to the equations in optics for finding the focal distance of a system of lenses; and in any other case where such a form of formula is used.

The next important form of chart is the one in Figure 4. Here the three scales are drawn like a Figure N. In this case, the relation between the various lengths cut off by a straight line is

$$x = pa/q$$

The proof follows immediately from the theorems of similar triangles.

This chart is used for the solution of the measurements on a Wheatstone bridge. It applies to the type of bridge where the adjustment is obtained by sliding a con-

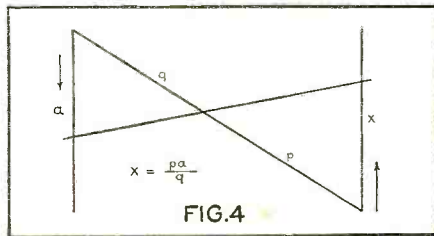

FIG. 4

tact along a wire. This wire is divided into 100 divisions. The diagonal line is likewise divided into 100 divisions, then along a, the standard resistance is measured off and along x the unknown can be read.

It should now be clear to the reader that for most types of equations an alignment chart can be made. It is only a matter of selecting the right angles and distances between the lines as well as choosing the correct scale.

If there are more than two variables, we cannot obtain the result at once, for a line is determined by two points. We must then do the graphical calculation in steps as illustrated in Figure 5.

For instance, suppose that we have an equation to solve where x depends on three variables, like

$$x = c \sqrt{ab}$$

We can introduce a new variable  $y = \sqrt{ab}$ . Then  $x = cy$ .

Now x depends only on two variables and so does y. The plan is now to make a chart as in Figure 1, for that solved this kind of formula, and then we use the

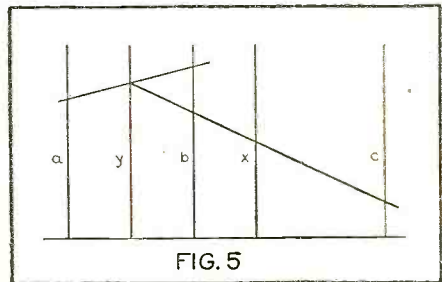

FIG. 5

line y as one of the lines for the other chart, solving  $x = cy$ . See Figure 4.

When the formula is more complicated, a different arrangement may have to be used and some of the lines may be at angles or curved, but the principle is the same.

Having determined the location and the directions of our graduated line, we have to examine the divisions themselves. It is seen in Figure 1 that the segment x equals 1/2 (a + b). If then we had an equation to solve which required x to be equal to 1/4 (a + b), it is only necessary to measure x with units twice as large as those along a and b.

Further, if the equation called for  $x = 1/4 (a + b) + 3$ , it is easy to see that we should move the entire scale of x three units.

In general, the type of equation is determined by the location of the lines; most of the constants can be taken care of by modifying the scale.

We now return to the formula of Thomson. Worked out for the frequency and microhenries and micromicrofarads, the formula becomes

$$f = \frac{159,200}{\sqrt{LC}}$$

It has been explained that, if three lines are drawn at equal distances apart, all three having the same size logarithmic scales, then any straight line cuts off segments a, x and b so that  $x = \sqrt{ab}$ . The rest of the equation is taken care of by juggling with the scale.

Writing the equation in logarithmic form:

$$\log f = \log 159,200 - \frac{1}{2} (\log C + \log L)$$

What we obtain on the middle scale is the form 1/2 (log C + log L). A point must be measured off along this line at a distance of log 159,200 from the beginning and we start counting kilocycles from there downwards. The result is shown in Figure 6.

The range of this chart may be extended by multiplying or dividing all values on the inductance and capacity scales by ten, hundred, etc., and dividing the frequency by the same amount or vice versa.



# Filming Radio Programs

(Continued from page 664)

vibrator; its movement (and with it the shadow and light impression upon a photographic film) being a true picture of the sound current.

The size of the air gap between the pole shoes of the electromagnet is only six-tenths of a millimeter, small enough to provide a satisfactory air-damping of the vibrating string. At the same time it is possible, by this narrow air gap, to make the power of the magnetic field several thousand Gauss, in spite of a relatively small amount of electric current. The latter amounts to about one ampere at 12 volts. The two pole shoes, mentioned above, in the small air gap between which the string is moving, are *hollow*. In their axes are placed the objective of a microscope. A strong beam of light is concentrated through this objective upon the string of the oscillograph.

This beam of light is "shaped" by means of a special diaphragm so as to build a small line of light only 12 microns in width (see Figure 3). Inclined to this line at a small angle, the string of the oscillograph is placed over the slit so as to cover it completely if no current is flowing through the string. The string is about ten times as thick as the fine image of the slit. Figure 3 shows the comparative size and the relative position of the slit and the string. Complete exposure or complete obscuration of the light line can thus be effected by only small amplitudes of the vibrator.

Figure 4 shows a cut-away view of the complete oscillograph. A beam of light coming from a strong light source through the hole 15 is brought, in the form of a narrow slit, through the diaphragm 20 which can be moved out of the way of the light path (for calibrating purposes) by means of the lever 21. A small glass prism 23 throws this small band of light upwards into the hollow pole shoe, which can be moved slightly up or down by means of the fine screw 37. Around this pole shoe are the windings of the electromagnet. At the top of the magnet, a microscopic objective 25 is inserted which concentrates the beam of light mentioned before into a small slit of about 12 microns in diameter. In the light path of this slit, and inclined to it with a small angle, is the string of the vibrator which is not pictured in this drawing. Over the slit is placed a collecting lens 27.

The oscillograph can be moved sidewise in the frame by the fine micrometer screw 53 and the position of the side movement can be read clearly with the dial and pointer 54. This is important, because with this adaptation multiple recording on one film can be made. Such a film on which several recordings have been made is shown in Figure 5.

Figure 6 shows a small film on which a single sound film recording has been made. The method works on the principle of sound recording by the variable-area method. This process has the advantage over the variable-density method in that no care whatsoever has to be taken upon the graduation of the photographic film.

On the small film, shown in Figure 7,

which is only 6 millimeters or about  $\frac{1}{4}$  inch in diameter, two records have been made. In looking closely at the picture of the film we see that each side shows a different sound picture. The black parts, unimportant for themselves within the reproduction, have been put together in the middle and so as to use the double area.

This placing of several sound tracks upon the same film has been shown in Figure 5, which shows no less than eight sound tracks, an economic procedure which makes it possible to unite a very long sound record on a relatively small length of film!

Figures 8 and 9 give a general view of the recording mechanism. The film is inserted in the box 3 and glides through the sound-recording device in the box 5. A small driving motor 12 of about  $\frac{1}{4}$  horsepower moves the entire system. Number 1 is the oscillograph, 2 is the film-feeding mechanism. The entire machine rests on the heavy base 6. The main driving shaft lies behind and parallel to the entire machine, as shown in Figure 4.

An interesting point of the recording mechanism is a special microscope through which it is possible to observe the recording procedure exactly, but through which no light can enter the machine from outside. Thus it is possible to arrange the tension and calibration of the oscillograph and the vibrator so that no part of the sound track may be cut off by too large a movement of the string. Also it is possible to use an acoustic control for the amplitude of the sound tracks. Instead of the microscope, after the modulated light has passed the film, a photocell is inserted and, by the usual circuit, connected with headphones of the operator of the oscillograph.

For the sound record, as usual in the sound film practice, film of normal width is used. The positive, however, can be copied upon small, unperforated film and two or more independent sound records, depending on the width of the film, can be copied upon it.

It is expected that the manufacturing of "canned programs" for broadcasting purposes will soon be a regular feature in Europe. The sound film has in this connection the advantage of the excellent sound quality that is expected by the public. It is possible to make longer records, up to about 40 minutes upon one roll of film, and to *re-edit* them for the purpose of selecting the important parts and to omit sections which are unnecessary. The films are, especially for long recordings, much lighter in weight than record discs and they are unbreakable. This is important in mailing.

Last, but not least, the cost of advertising programs and political campaigns, which until now have been broadcast over expensive chains and not always at a time equally desirable for the East and West can be brought to a larger audience at a cheaper rate and with more effective service.

Thus the sound-film apparatus soon may become a necessary asset of modern broadcast stations.

## NOW READY! PIONEER TELEVISION SCANNER

THERE JUST ISN'T ANY  
OTHER SCANNER ON THE  
MARKET LIKE IT

Assembled, Tested  
and Guaranteed

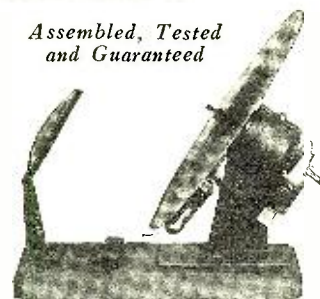

THE PIONEER TELEVISION SCANNER is the result of an intensive study of all known methods of scanning, and incorporates a combination of only the most desirable features of each. Particular care has been taken to simplify construction wherever possible and to make operation practically foolproof.

HERE ARE JUST A FEW OF THE  
MANY REASONS WHY PIONEER  
IS SUPERIOR TO ANY TELEVISION  
SCANNER ON THE MARKET TO-  
DAY

- Perfect vision . . .
- Does not necessitate stooping and stretching . . . as is the case with other makes of Television Scanners . . .
- Small and compact in structure . . .
- Special Pioneer Scanning Disc . . .
- Gives clear, brightly illuminated pictures . . .
- The Pioneer Disc has 120 holes rather than the 60 generally used . . .
- Gives perfect framing of the picture . . .
- Synchronous Drive . . .
- Functions continuously . . .
- No Rheostats or Speed Controls . . .
- Positive in action . . .
- Magnifying Lens . . .
- Gives a picture over 4 inches wide . . .
- Several persons can see it at one time . . .
- Simplified—can be hooked up in less than 5 minutes . . .
- Fully assembled and tested before shipped . . .
- Guaranteed to give satisfactory results . . .

Descriptive Circular on Request

**Price \$23.50**

Neon Lamp . . . . \$3.50 extra  
Lens and Holder . . 7.50 "

Pioneer 7-Tube All-Wave Receiver, \$39.50

Manufactured by the

**PIONEER TELEVISION CO.**

26 Exchange Place, Jersey City, N. J.

Penn. Dock and Warehouse Bldg. 4th Floor



## THE SWING FOR TRAINED MEN IS TO ELECTRIC REFRIGERATION

Read the Story of Lewis L. Mews of New York



"I had tried my hand at radio servicing, at selling and a dozen other things. No one of them held out when the depression came along. I heard of the demand which had arisen for trained service men in the electric refrigeration field—I found my experience in radio was a big help—in seven weeks I had completed my training—then came a good job—work—as long as you wish—field's not crowded—no doubt of a big future."

You, too, can have a job like Mews. Right at home you can study the "easy-to-learn" instructions or in our Pittsburgh school and shops—and in less than two months you will be ready for a good, steady job.

### Men Formerly Out of Work

Men who were laid off in their old line of work, learned today's new trade—electric refrigeration, installation and servicing work—through our practical method of training and are now enjoying steady employment with good pay. This is Electric Refrigeration's Biggest Year and NOW is a good time to learn this new trade.

We'll train you, too, like we have many others from many states. Send for descriptive folder and full information how you may prepare yourself for a job as an Installation and Service man in a short time.

Refrigeration Training School & Shops, Inc. RN  
104-106 Boulevard of the Allies  
Pittsburgh, Pa.

Kindly send me without obligation your folder, "More Jobs—More Money."

Name .....

Street and No. ....

City and State .....

## AMATEURS and BROADCASTERS

When visiting Washington, you will find a display of

# FLECHTHEIM

## SUPERIOR CONDENSERS

In the National Radio Equipment Exhibition in the National Press Building, Washington, D. C.  
Note: Write for Catalogs Nos. 23 and 24 gratis.

A. M. Flechtheim & Co., Inc.  
138 Liberty St., New York, N. Y.

## MAKE \$10,000

A year raising rabbits for us. We pay up to \$12.00 each for all you raise. Send 25c for full information and contract, everything explained. Send at once and find out about this big proposition we have to offer you.

THE EASTERN RABBITRY  
Route 1, Box 236 New Freedom, Pa.

### UNUSUAL BUYS

Samson 210 P.P. "A.M." Amplifier	\$25.85
Silver-Marshall 250 Power Amplifier	22.50
Acme Single Stage Power Amplifier	2.95
A. K. 37 Condenser, Choke Block	2.45
A. S. 40, 42 Power Pack	3.50
A. K. 53 Power Pack	7.95
RCA 64, 67 Power Transformer	8.00
RCA 60 Power Transformer	4.00
Colonial 32 Power Transformer	1.00

FULL LINE OF REPLACEMENT PARTS FOR ALL RECEIVERS AND AMPLIFIERS LISTED IN OUR NEW 64-PAGE CATALOG. SEND FOR YOUR COPY NOW.

RADIO SURPLUS CORP.  
56 N. Vesey St., N. Y. C.

# Annual Air Corps Maneuvers

(Continued from page 653)

from Langley Field, Virginia, to Rockwell and March Fields, California. This return trip for all the planes was completed as the 11th sailed back in perfect formation over San Diego.

As we were now again operating independently our radio activities increased. Instead of standing by for orders during long flights, we were able once again to tune in on Department of Commerce stations and after receipt of weather broadcasts to fly in formation, expectantly, until our weather adviser, Mr. Dean Blake, should hand out the regulation weather report which included Mr. Blake's observations and his advice of best flying altitudes to secure favoring winds.

Also we were able to take advantage of the huge network of radio beacons established by the Department of Commerce. The use of these beacons reduces the work of cross-country flying considerably, as the pilot is aware only of a long buzz in his radio helmet which changes to an A or an N if he gets to the right or left of his proper course.

At Wichita, Kansas, we renewed our broadcasting activities by working KFH of that city.

At Amarillo, Texas, an interesting half-hour was had with KGGM. Amarillo had welcomed us for lunch with characteristic Western hospitality, and as we left the genuine expression of friendship relayed us left a warm spot for Amarillo. As we neared the New Mexico line and were rapidly running out of conversation we learned that KGGM had had remote control broadcasts from every bordering state except New Mexico and asked us to continue and thus inaugurate KGGM's first remote control from that state via airplane. This was gladly done, but soon increasing distance ended the transmission.

As we approached the huge mountain that hides Albuquerque from flying eyes, KGGM was heard calling us and soon we were having a fine conversation with Mr. Whitmore of that station. On landing we enjoyed a pleasant evening at the studio. On resuming our journey the next

morning the transmission was continued for some 50 miles until, sensing that favoring winds might be gained by a change of altitude, we switched to the Winslow, District of Columbia, station and learned that easterly winds were blowing at 8000 to 9000 feet, so we left the surface and climbed to the area of friendly winds.

Approaching Kingman, KCAH was heard calling and soon we were checking with them. This contact with KCAH was an outstanding one, both for strength of signals and clarity of transmission. Every syllable came in beautifully. On continuing out of Kingman, communication was maintained a distance of some 200 miles up to Cajon Pass.

At Cajon Pass we switched to station KFXM at San Bernardino and a brief but satisfactory two-way transmission carried on. This was brought to a close by the landing of the squadron at March Field before starting the final 100-mile dash for Rockwell Field and home.

It is believed that the field use of radio on this aerial expedition has never been surpassed, especially in the impromptu connections established with so many different stations under widely differing conditions. Evidence of the public interest in this work was shown by the large number of complimentary telephone calls reported in by the various stations.

Back of it all, however, lies the thought of the great possibilities in the use of aircraft radio. It has already revolutionized marine navigation and will become just as important in the air.

Approaching Cajon Pass, a huge layer of fog was seen, apparently filling the whole canyon. This was approached with some misgiving, but KCAH came to the rescue with a detailed report of conditions existing over the Los Angeles area and the whole squadron went in under the fog, assured that sufficient ceiling existed for safe flying. It was later learned that some of the pilots were uncertain and doubtful as to this procedure but, confident that the lead ship had full radio information, closed into tight formation and followed through.

## Relays for the Experimenter

(Continued from page 682)

The iron plunger should be of soft iron and should fit the brass sleeve in the same manner as a piston fits a cylinder. This prevents binding due to any sideways pull that might be developed and prevents any hum from becoming a rattle. The first relay of this sort that was built by the author was quite loose and when it reached the end of its travel, raised such a terrible noise that it was unfit for service. Fitting the iron plunger to the brass sleeve removed this objectionable noise. It is necessary to drill a hole through the iron plug in the end to allow entrapped air to escape. The size of this hole determines to a large extent the rate of closing of the relay. It can easily

be made into a delay closing relay by making this hole small.

### Induction Type

This type of relay is one of the handiest an amateur can have around the shop. It will perform duties far above those of any other type of relay. It will delay the closing of circuits any definite length of time, or it will close one contact after another, doing duty as a sequence relay. In this light it is especially adaptable to the amateur transmitting station where the plate circuit should be delayed in closing until the filament circuit is closed and has allowed the fila-

(Continued on page 721)

Make a  
PROFIT

Service men make \$90 extra per month installing AMPERITE. Send \$1.62 to Dept. RN-2, for sample and sales helps.

AMPERITE Corporation  
561 BROADWAY, NEW YORK

AMPERITE  
Self-Adjusting  
LINE VOLTAGE CONTROL



# MacMillan Calls from the Arctic

(Continued from page 686)

broadcast program and listened to the Sharkey-Stribling fight, round by round, from Cleveland. Cruising north from Nova Scotia and coming into the territory affected by the Aurora Borealis and

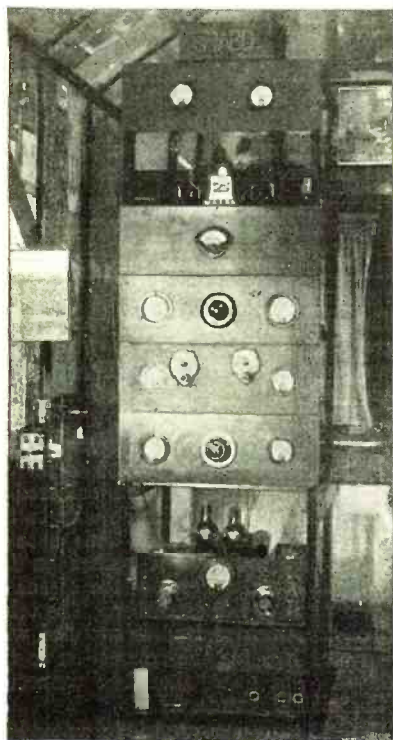

**AMATEUR TRANSMITTER PANEL**  
This photograph shows the four-stage crystal-controlled 20-meter transmitter using four 852 type tubes in the output stage

around in rough water. Every once in a while both our transmission and reception ceased, and investigation disclosed that the gaff of the foresail broke the antenna wire, necessitating frequent "trips" to the masthead to replace it. And in addition to this, a 60-horsepower Diesel engine, two Delco lighting plants and the cook's electric fans and (strange to relate) an electrical refrigerator, located immediately on the other side of the bulkhead from the radio room, tended to add

to the radio interference and other difficulties prevalent in the Arctic. But in spite of all, the radio "came through big."

In conjunction with our scientific work it was essential that accurate time should be known and maintained at all times. Daily observations were therefore made with the time signals from NAA to check our chronometer and to use with other scientific instruments for exact location and precision survey work. Sailing north from Nain to Fort Burwell, radio conditions improved and our message hook was cleared for the first time in about a week. Passing up the Labrador coast, reception was weakened to some extent, due to the high cliffs on the west. Farther north, in open water, signals began coming in stronger and with greater reliability. Good reception was encountered crossing Hudson Strait and in passing Resolution Island and the Savage Islands. From the Savage Islands the course led into Fro-bisher Bay, where conditions were poor, due again to the heavy iron content in the hills to the south and west. In spite of this difficult reception condition, daily contact was made with Johnson's station in Chicago, where he and Larson were sweltering in contrast with the intense cold on our end.

other magnetic disturbances, all signals were materially affected, making it more difficult to maintain two-way communication. One of our difficulties was in maintaining satisfactory communication while our small schooner was pitching

## Experimental Relays

(Continued from page 720)

ments to warm up before applying the plate current.

The first requisite of a relay of this sort is an old watt-hour meter. One of these can easily be secured from the junk pile of the local power company. The next step is to remove the gear train and dial. The question of removing the permanent magnets lies mainly with the use to which the relay is to be put, and the author leaves this point up to the constructor. If the magnets are removed, a very small current in the coils will operate the relay. If the magnets are left on, a much larger current will be necessary. For time-delay operation it is best to leave the magnets on. An old jack spring fitted to the shaft will furnish a contact as shown in Figure 4 (b). A spring attached to a piece of thread wound round the shaft will return the disc, as also shown in Figure 4 (b).

As the contacts are small, they should not be expected to carry over .2 or .3 ampere. The connections in Figure 4 (a) show this relay used as a time-delay relay for an amateur transmitter in the plate circuit.

On the return trip, conditions improved greatly, due to the longer night periods marking the advanced time of darkness and the signals both ways came in much stronger.

### E. E. Shumaker Resigns

CAMDEN, N. J.—Mr. David Sarnoff, president of the Radio Corporation of America, announces the resignation of Edward E. Shumaker as president of its subsidiary, the RCA-Victor Company. The resignation was accepted by the RCA-Victor Company board to become effective as of January 1, 1932.

Mr. Sarnoff stated that it had been Mr. Shumaker's desire to retire from active business when the Victor Talking Machine Company, of which he was president, was purchased by the Radio Corporation of America. At Mr. Sarnoff's request, however, Mr. Shumaker had agreed to accept the presidency of the new RCA-Victor Company which was formed in 1929 as a result of the merger and to serve in that capacity until the problems incident to unification had been solved and the reorganization completed, which has now been done.



**Get  
this Free Book  
telling how  
Centralab  
Fixed Resistors  
are Made**

Just off the press . . . an interesting, handsomely illustrated booklet describing the unique and different process of manufacturing CENTRALAB FIXED RESISTORS. It's yours for the asking . . . send for it.

**Note:** New low prices on Centralab Volume Controls. Effective Jan. 1st, prices have been radically reduced.

**Centralab**

MAIL COUPON NOW

CENTRAL RADIO LAB.  
929 E. Keefe Ave., Milwaukee, Wis.  
Please send me your FREE booklet, "A BAPTISM OF FIRE"   
Am enclosing 25c for your "VOLUME CONTROL GUIDE"

Name .....

Address .....

City ..... State .....

Radio News



# The Pentode Oscillator

(Continued from page 681)

Write for this book

## FREE!

You cannot possibly afford to be without this valuable book. It is not just another CATALOG—it is indeed a VERITABLE ENCYCLOPEDIA of the RADIO INDUSTRY.

### WHOLESALE PRICES TO ALL

**4-IN-1 SERVICEMAN'S TOOL:**  
Fits Your Vest Pocket! Combines a Universal Neutralizer and Compensator, 3/4-in. and 5/16-in. Nut Wrench, a miniature blade Neutralizing or Compensating Screwdriver, and a FULL SIZE General Purpose Screwdriver. Fully insulated! **\$1.25.**

**PHONO. NEEDLE MODEL TEST LEADS**  
Permits ready insertion of new phono. needles by merely inserting special chuck, 5/4-in. long bakelite handles—colored red and black. Needle prod "bites" through insulation or any corroded surface, eliminating resistance. . . . . **95c**

**COAST TO COAST RADIO CORPORATION**  
123 N West 17th St., New York N.Y.

## AERO WORLDWIDE SHORTWAVE RECEIVER

# \$6.45

Listen in DIRECT to London, Paris, Berlin, Buenos Aires and other broadcasting stations throughout the world via short waves. Your ordinary receiver cannot tune in these low wave stations. **WORLD-WIDE RECEIVER** gets 14 to 550 meters.

**AERO SHORT WAVE CONVERTERS**  
Converts Your Present Set into a Short Wave Super-Heterodyne  
**A. C. MODEL \$12.50—D. C. MODEL \$11.50**

**AT LAST! THE PERFECT AUTO RADIO**—Only \$20.00  
Built by pioneers in the manufacturing of Auto Radio. We guarantee 1,000 miles radius of reception, a masterpiece of radio engineering. Latest model 6 Tube Aero Pentode Auto Radio. Price of set only \$20.00. Set complete with tubes, batteries, dynamic speaker, antenna equipment and noise suppressor, \$35.50.

**NEW AERO MIDGET**  
Using the Latest Type Pentode and Multi-Mu Tubes. Price \$16.50  
We guarantee **COAST TO COAST RECEPTION**

Wonderful tone quality and selectivity. Full dynamic speaker. Full vision dial. Beautiful walnut cabinet. 5 Tubes Set \$16.50, less tubes. Complete set of 4 matched tubes, \$4.50 extra. **SEND FOR COMPLETE CATALOG**



**CHAS. HOODWIN COMPANY**  
Dept. O-30, 4240 Lincoln Ave., Chicago, Illinois

## RACON UNITS

### NEW—BETTER LOWER IN PRICE

An entirely new line of RACON Dynamic Units is now available. More efficient—broader frequency response and superb articulation.

Send for complete new catalog on Horns and Units.

**RACON HORNS & UNITS ARE COVERED BY U. S. PATENTS NOS. 1,507,711; 1,501,032; 1,577,270; 73,217; 73,218; 1,722,448; 1,711,514; 1,781,489; 1,832,608.**

Super giant electro-dynamic horn unit. Continuous operating capacity 7-10 watts.  
Address Dept. R.N.-12

**RACON ELECTRIC CO., Inc.**  
18 WASHINGTON PLACE NEW YORK  
LONDON, ENGLAND TORONTO, CANADA

## SAVE SERVICE TIME and MONEY

**TRUVOLT RESISTORS**, with adjustable clips, mean quicker service and fewer parts to stock. All standard sizes.

Write Dept. RN-2 for Folder

478 Varick St., New York, N.Y.  
**ELECTRAD**

the volume control connected to the pick-up itself.

The modulation percentage in our model oscillator was about 60% with 6 volts on the plate. When a higher plate voltage is used the modulation percentage becomes less. It then becomes necessary to add a speech amplifier. A transmitter of this type can be made extremely compact; it should be especially suited for airplanes.

The oscillator should find wide and varied applications among amateurs. The most obvious use is as a monitor or a heterodyne wavemeter. In this case the instrument does not have to be portable and large batteries can be used, thus insuring superior constancy of applied voltages.

When the proper precautions have been taken to keep the voltages constant, the frequency will be sufficiently steady to satisfy the Radio Commission. In a test in our laboratory the oscillator was checked against WEAf's carrier, having them beat against each other continuously for three hours. No particular precautions were taken to compensate for the voltage change in the batteries, yet after three hours no change in the oscillator frequency could be noticed.

For small amateur transmitters this circuit is one of the simplest that can be made.

The photographs show what can be done with this type of oscillator in the way of reducing size and weight. The unit shown was designed especially for the serviceman. Its hook-up is shown in Figure 5.

The oscillator can be used modulated or unmodulated by the simple throw of a toggle switch. The frequency is variable from 550 to 1500 kilocycles and the volume can be regulated from bare audibility to a high volume.

The entire instrument, including the batteries, has been placed in a metal box of 7 1/16 by 5 1/16 by 2 13/16 inches outside dimensions.

To reduce the size as much as possible brought many different problems. Let us start with the batteries. The original tests had all been conducted with a -33 type pentode using a 4 1/2-volt battery for the filament supply. This tube takes 300 mills at its rated voltage or approximately 225 mills at 4 1/2 volts. For use in service work this battery would run down too quickly, so the -38 was discarded in favor of a 2-volt tube.

This tube, the -33, has an oxide-coated filament and should be operated at its rated voltage so that we need more than one flashlight cell and probably a rheostat. It was thought best to include three flashlight cells and to connect a pilot light in series with the filament, as it is very easy to leave the filament turned on and forget all about it.

Next comes the B battery. It is entirely feasible to run the oscillator on a plate voltage of but 6 volts. Two pencil-type flashlight cells in series will suffice, because a 3-megohm grid leak limits the space current to 65 micro-amperes when the oscillator is modulated and 200 micro-amperes when unmodulated.

The tube has been mounted inside the tuning inductance to save space and a 43-plate midget condenser of 320 mfd. capacity has been employed. The coil can be made by winding 92 turns of No. 28 enameled wire on a form of 1 3/4 inches outside diameter. The coil is tapped at the 46th turn. This coil with the tuning condenser specified will tune throughout the broadcast band.

The coupling coil consists of one or two turns on the plate end of the tuning inductance.

As was recommended before, the output is regulated by a 400-ohm tapered potentiometer. The tapered end is on the ground side.

The filament batteries are clamped between two pieces of bakelite with screw heads as contact points. These screw heads in turn are so connected as to put the three cells in series.

The shielded single wire lead is connected at one end to the base of an old flashlight bulb. The shield is soldered to the outer shell and the inside wire to the center of the bulb base. This base is screwed into a flashlight socket on the outside of the box which is the means of connecting it to the oscillator. The other end of the shielded lead is supplied with two phone tips for the connection to the receiver. The shield should be connected to the ground terminal.

The -33 type pentode has its suppressor grid connected to the negative side of the filament and not to the center as the -47. Therefore, so as to maintain the symmetrical oscillating circuit it is necessary that we connect the filament battery with due regard for this polarity. It should be connected as shown in the diagram in Figure 5. Failure to do so will result in the inability of the builder to make the tube oscillate.

The shielded box was made of brass sheets on a framework of 1/4-inch-square brass rods. The construction should be clear from the photographs. Two sides of the box can be removed for the replacement of the batteries or the tube.

After the builder has finished his construction he should have no difficulty in making the system operate. However, for his convenience we give a little information on the detection of the oscillating condition and maladjustments which will stop oscillation.

A milliammeter in the second grid lead will dip slightly when touched with the finger if the tube is oscillating. When the tube does not oscillate no change can be detected. As the current is small in this circuit, a sensitive meter having a range of 0-1 ma. is used.

Oscillations will be stopped for one of three reasons in our experience. First, incorrect center-tapping; second, too close coupling to another circuit; and, third, too large a coupling capacity between the plate and the control grid leads. It is not likely that the builder will encounter these difficulties when he has followed instructions.

The frequency of the oscillator will vary slightly for different positions of the  
(Continued on page 723)



# Mathematics in Radio

(Continued from page 687)

of wire in a coil, is equal to the rate of change of the flux  $\theta$ , with relation to time,  $t$ , through the coil. The minus sign indicates in this case that the induced e.m.f.  $e$  is opposite in direction to the e.m.f. impressed by the supply voltage. For a coil containing a total of  $T$  turns:

$$E = -T \frac{d\theta}{dt}$$

Thus, a fundamental differential expression is shown which becomes familiar in more or less the same form in many of the other applications of radio circuits. We, therefore, find that a condenser current can be expressed as the rate of change with reference to time in the dielectric electric field.

$$i_c = \frac{d\theta}{dt}$$

Also, it can be proven that the condenser current is equal to the capacity of the condenser times the rate of change of the impressed voltage with reference to time.

$$i_c = C \frac{de}{dt}$$

Again, it can be shown that the inductance of a circuit is equal to the total number of turns  $N$ , times the rate of change of the magnetic flux with reference to the instantaneous current  $i$ .

$$L = N \frac{d\theta}{di}$$

A very few of the simple fundamental formulas of the differential calculus have been indicated here and it is well to study in more detail the proof of these fundamental relations.

### A Simple Geometric Application of the Derivative

It is important to visualize as much as possible the fundamental conception of the rate of change which is encountered so much in the study of the differential calculus. Geometry is a means of showing such a relation, and once this simple application has been thoroughly understood, many of the standard forms of differentiation are directly derived from it.

It is known that if an equation of the form  $y = \sec x$ , be analyzed that it can represent a curve. In order that the theory will be thoroughly understood from the beginning, the values of  $y$ , for various assigned values of  $x$ , will be determined as follows:

It is remembered from trigonometry that the secant of an angle  $x$  is equal to the hypotenuse  $h$  divided by the cosine  $x$ , that is  $= \frac{h}{\cos x}$ . But it has been shown

that the hypotenuse can be equal to 1, thus:

$$\sec x = \frac{1}{\cos x}$$

If, then,  $y = \sec x = \frac{1}{\cos x}$ , the following values of  $x$  can be assumed, and the corresponding values of  $y$  obtained.

If  $x = 0$ ;  $\cos x = 1$  ;  $\frac{1}{\cos x} = \sec x = 1$   
 "  $= 30^\circ$ ; "  $= +.866$  ; "  $= " = 1.15$   
 "  $= 60^\circ$ ; "  $= +.50$  ; "  $= " = 2$   
 "  $= 90^\circ$ ; "  $= 0$  ; "  $= " = \infty$

Continuing the values of  $x$  from  $270^\circ$  we have:

If  $x = 270^\circ$ ;  $\cos x = 0$  ;  $\frac{1}{\cos x} = \sec x = \infty$   
 "  $= 300^\circ$ ; "  $= +.50$  ; "  $= " = 2$   
 "  $= 330^\circ$ ; "  $= +.866$  ; "  $= " = 1.15$   
 "  $= 360^\circ$ ; "  $= +1$  ; "  $= " = 1$

The purpose of this analysis is only to have a curve available for further discussion. Such a curve is shown in Figure 4, and represents a graph of the equation  $y = \sec x$ , when the values of  $x$  from  $270^\circ$  to  $0$  and thence to  $90^\circ$  were taken.

It can be stated then that  $y$  is a function of  $x$ , in this case a function of  $\sec x$ . Let such a curve be shown in Figure 5, and a point  $P$  on the curve can be definitely located by its coordinates  $x$  and  $y$ . When the value of  $x$  changes, the point  $P$  changes and let it take some other position  $Q$  on the curve. This has resulted in the change of two variables, and thus  $x$  has changed by an increment denoted by  $\Delta x$  and  $y$  has correspondingly changed by an increment denoted by  $\Delta y$  as shown in Figure 5.

We have seen that  $y = \sec x$ , and for convenience we shall state that it is equal to a function of  $x$ ; i.e.,  $y = f(x)$ . Refer-

(Continued on page 725)

## Pentode Oscillator

(Continued from page 722)

volume control and it will also change a little when the modulation circuit is opened. The pitch of the modulation frequency will vary slightly when the oscillator frequency is varied.

These small variations are not serious when the oscillator is to be used for general service work or other work where extreme precision is not essential, but when used as a calibrated meter of high precision the adjustments used during calibration must be resumed if the calibration is expected to hold.

### List of Parts

- C1—Micamould .001 condenser
- C2—Hammarlund MC 325-M, 320 mfd. midget variable condenser
- R1—Clarostat 400-ohm tapered potentiometer
- R2—S. S. White Dental Lab. 3-megohm resistor, 1/2-watt size.
- L1—92 turns of No. 28 enameled wire on form of 1 3/4 outside diameter, tapped at 46th turn.
- L2—1 or 2 turns on plate end of coil L1.
- S1, S2—Toggle switches, s.p.s.t.
- 2 flashlight sockets
- 1 3.8-volt flashlight bulb.
- 1 five-prong socket
- 4 feet shielded cable
- 1 shielded box, 7 by 5 by 2 3/4 inches inside dimensions
- Miscellaneous hardware

# TODAY

is the time to

# STUDY RADIO

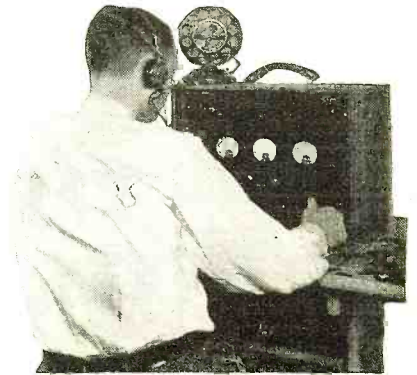

prepare yourself

... at RCA Institutes

A Radio Corporation of America Subsidiary

Now is the time to study radio . . . and get ready for the future. You make a wise investment when you take the radio training at RCA Institutes.

You may learn any of the many interesting branches of radio at RCA Institutes. It is America's oldest radio school, and associated with the largest, most complete research laboratory in the radio industry. What more need you know?

Four spacious *resident* schools, New York, Boston, Chicago, Philadelphia. *Extension* courses for home study. Splendid teachers. Up-to-the-minute equipment. Great variety of courses, elementary and advanced, in practical radio.

Free scholarships offered for outstanding graduates of both resident and extension courses. Day and evening classes. Courses start about every six weeks. Investigate by mailing coupon today.

"Practical Instruction in Radio and the Associated Electronic Arts"

**RCA INSTITUTES, INC.**  
 Dept. RN-2, 75 Varick St., New York  
 Please send me your General Catalog. I am checking below the phase of radio in which I am interested.

Aircraft Radio     Talking Pictures     Television

Disc and Film Recording     Broadcast Station or Studio

Servicing Home Entertainment Equipment

Name.....

Address.....

Occupation..... Age.....



**THE NEW  
RADIO PHYSICS  
COURSE**

By Alfred A. Ghirardi  
Greatly Enlarged  
Second Edition

Contains 990 pages. More than 500 illustrations. The Radio Physics Course, which is now running in Radio News, complete in one book.



\$3.50

The Greatest Radio Book  
Ever Written

SEND FOR FREE CIRCULAR

**AND NOW—A NEW BOOK**

**The Radio Servicing Course**

Here is a New Book that explains all about modern radio servicing methods and equipment, by the author of the Radio Physics Course and Bertram M. Freed, the noted specialist in radio servicing. 200 pages and over 100 illustrations.

RADIO  
TECH. PUB.

CO., Dept. J, 22  
W. 21 St., N. Y. City

Enclosed please find cash, check or money order for copies of Radio Physics Course at \$3.50 each, and copies of the Radio Servicing Course at \$1.50 each.

Name \_\_\_\_\_  
Address \_\_\_\_\_  
(Please Print)

**A PRACTICAL BOOK FOR  
THE SERVICEMAN**

PRICE \$1.50

RADIOTECH. PUB.

CO. Dept. J, 22  
W. 21st St.,  
New York  
City

**SHORT-WAVE**

Reception with Your  
BROADCAST RECEIVER

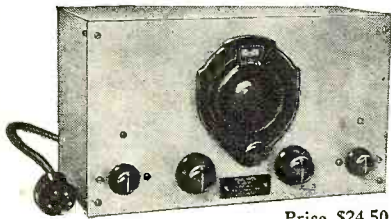

Price \$24.50

**THE "EXPLORER"**

PLUGLESS POWER CONVERTER

Real short wave reception with your broadcast receiver. Automatic Band Selector eliminates plug-in coils. Power Amplifier in converter. Wide-spread vernier, single dial tuning, numerous exclusive features. "EXPLORER" users report consistent loud-speaker reception of stations all over the world. New 1932 models ready, designed for every broadcast receiver.

Send Now for Free Literature

**RIM RADIO MFG. CO.**

695 Grand St., Brooklyn, N. Y., U. S. A.

2 Years RADIO NEWS \$1.00 with  
FREE Copy of "23 Lessons in Radio"  
See Page 732

**REAL JOBS OPEN**

**For Trained Electricians**

Earn \$40 to \$100 a week steady. I train you in 12 weeks at largest school of its kind in world. New practical shop plan. No books. No lessons. Learn with real tools on real equipment. Write quick for Big Free Electrical Book and Special Low Tuition offer. No obligation. Address J. H. McSweeney, Pres. **McSWEENEY SCHOOL** Dept. M Cleveland, Ohio E-20-2



**Radio Physics Course**

(Continued from page 698)

The units of current, e.m.f. and resistance (ampere, volt, ohm) have been derived entirely through consideration of the unit quantity of electrical charge. This system of units may be called the *electrostatically derived practical system*.

Because of the difficulty in precisely standardizing or calibrating electrical instruments such as ammeters and voltmeters in terms of the fundamental units by absolute methods, the International Electrical Congress at Paris in 1881 recommended that a commission be charged with formulating from the results of carefully made absolute measurements, specifications for practical standards to represent certain units of the practical system. These standards could then be constructed by anyone at any place and they would serve as exact references. This commission drew up specifications for practical physical standards of electric current, and resistance. These are known as the *International Standards* and the units derived from them are known as the *International Units*. By legislative actions of the various governments these International Standards have been made the legal standards of all the civilized governments of the world. The physical specifications for the International Standards as drawn by this commission follow:

The International Ampere is the unvarying current, which, when passed through a solution of nitrate of silver in water in accordance with standard specifications, deposits silver at the rate of 0.001118 grams per second.

The International Ohm is the resistance offered to an unvarying electric current by a column of mercury at the temperature of melting ice (0° C), 14.4521 grams in mass, of a constant cross-sectional area, and having a length of 106.300 centimeters.

The volt is the e.m.f. which will send a current of one ampere through a resistance of one ohm. Notice that this is defined in terms of the ampere and ohm.

While the International Standards were intended to represent in a practical form certain of the units of the Electrostatically Derived Practical System, they fail to do this precisely. Later absolute measurements carried on by the National Standardizing Bureaus indicate that the greatest discrepancy is about 0.05 of one per cent. For all industrial purposes, the discrepancy is negligibly small and these standards may be taken as being correct.

When thinking about the flow of electrons in a conductor it must be evident that the greater the e.m.f. is, the more electrons will flow past any point in the conductor each second. Also the greater the resistance of the conductor the less the number of electrons which will flow through. Dr. George Simon Ohm found that there was a definite simple mathematical relationship between the e.m.f. applied to a conducting circuit having a certain resistance and the current which would flow in the circuit. This relationship is now known as *Ohm's Law*. The law is stated thus: *The intensity of current in any circuit is equal to the electromotive force divided by the resistance of*

*the circuit.*

Expressed in the common electrical abbreviations this law becomes:

$$I = \frac{E}{R} \quad (1)$$

where I = current in amperes

E = e.m.f. in volts

R = resistance in ohms

Equation (1) enables us to calculate the current (I) which will flow when an e.m.f. (E) is applied to a circuit having a resistance (R).

Example: What current will flow through the filament of a 201A vacuum tube having a resistance of 20 ohms, when an e.m.f. of 5 volts is applied?

Solution: The current in a circuit may be calculated by Ohm's Law, using the

equation  $I = \frac{E}{R}$ . By substituting 5 for E

and 20 for R we obtain

$$I = \frac{5}{20} = \frac{1}{4} = 0.25 \text{ Amp. Ans.}$$

To find how much pressure or e.m.f. must be applied to a circuit to make a given current flow through a conductor having a known resistance, equation (1) can be put in more convenient form by simple mathematical transformation.

Thus since  $I = \frac{E}{R}$ , then  $E = I \times R$  (2)

Example: The resistance of the filament of a 201A vacuum tube is 20 ohms, and it requires 0.25 amperes for proper operation. What e.m.f. should be applied to obtain the correct operating current?

Solution:  $E = I \times R$ . Since  $I = 0.25$  amp., and  $R = 20$  ohms, then  $E = 0.25 \times 20 = 5$  volts. Ans.

When the e.m.f. (E) and the current (I) are known, the resistance R of the circuit may be calculated very easily by placing equation (1) in more convenient form:

Thus since  $I = \frac{E}{R}$ , then  $R = \frac{E}{I}$  (3)

Example: An e.m.f. of 5 volts applied to the filament of a 201A vacuum tube sends a current of 0.25 ampere through it. Calculate the resistance of the filament.

Solution:

$$R = \frac{E}{I} = \frac{5}{0.25} = 20 \text{ ohms. Ans.}$$

Ohm's Law is one of the most useful and important principles in all radio and electrical work and the student should study it carefully and commit it to memory. While it applies only to direct current circuits, a special form of this law is also used in alternating current work. The student should remember when using Ohm's Law that the current (I) should be expressed in *amperes*. So many current values in radio work are expressed in *milliamperes* that one often forgets and uses milliamperes in the formula. This results in incorrect answers. The current in *amperes* is equal to current in milliamperes divided by 1000. Thus, 5 milliamperes equals .005 ampere.



# Mathematics in Radio

(Continued from page 723)

ring to Figure 6, if the point P on the curve is as follows:

$$(I) y = f(x)$$

then the point Q on the curve can be represented as follows:

$$(II) y + \Delta y = f(x + \Delta x)$$

A mathematical trick is now employed in order to show the results obtained as the variables are changed. The method is perfectly straightforward, and very essential to the understanding of the differential calculus.

With reference to Figure 6, take the relation as expressed in equation II, and subtract equation I from it.

$$\begin{array}{r} \text{Subtracting} \\ y + \Delta y = f(x + \Delta x) \quad = NQ \\ y = f(x) \quad = MP = NR \\ \hline \text{III} \quad \Delta y = f(x + \Delta x) - f(x) = RQ \end{array}$$

Dividing III by the increment  $\Delta x$ , we have:

$$\frac{\Delta y}{\Delta x} = \frac{f(x + \Delta x) - f(x)}{\Delta x} = \frac{RQ}{MN} = \frac{RQ}{PR}$$

thus, we have proven that:

$$\frac{\Delta y}{\Delta x} = \frac{RQ}{PR}$$

and from Figure 7 this is seen to be equal to the tangent of the angle RPQ, which is also equal to the tangent of  $\theta$ . (It is remembered from geometry that the angle "a" is equal to the angle  $\theta$ .)

Introducing the idea of a continuous change of the variables, and referring to Figures 8, 9 and 10, respectively, it is seen as Q approaches P,  $\Delta x$  approaches zero and the secant line finally approaches the tangent PT of Figure 10 as the limit.

We have here the full definition of the derivative, for if  $\frac{\Delta y}{\Delta x}$  approaches a limit

as  $\Delta x$  approaches zero, that limit is called the derivative of y with respect to x. It is represented most generally by the symbol  $\frac{dy}{dx}$ . We have seen from Figures 8, 9

and 10 that  $\frac{\Delta y}{\Delta x}$  does approach a limit as

$\Delta x$  approaches zero, and that the limit is the tangent of the angle  $\theta$  as shown in Figure 10. Thus, the value of the derivative,  $\frac{dy}{dx}$ , at any point on the curve is equal to the tangent of the angle  $\theta$  for that point.

In order to make this more clear, let us take an expression and perform the identical operations as outlined in the above analyses. Consider the expression:

$$(I) y = 3x^2$$

Let x take on an increment  $\Delta x$ , then y will take on a corresponding increment,  $\Delta y$ , and we have

$$\begin{array}{l} y + \Delta y = 3[(x + \Delta x)^2] \\ \text{or } y + \Delta y = 3[x^2 + 2x\Delta x + (\Delta x)^2] \\ \text{or (II) } y + \Delta y = 3x^2 + 6x\Delta x + 3(\Delta x)^2 \\ \text{Subtracting (I) } y = 3x^2 \\ \hline \Delta y = 6x\Delta x + 3(\Delta x)^2 \end{array}$$

Dividing III by the increment  $\Delta x$ , we have

$$(IV) \frac{\Delta y}{\Delta x} = 6x + 3\Delta x$$

Now this is important, for if  $\frac{\Delta y}{\Delta x}$  approaches a limit as  $\Delta x$  approaches zero, that limit by definition is called the derivative, and is denoted by the symbol  $\frac{dy}{dx}$ .

We see from (IV) that, when  $\Delta x$  approaches zero, the  $3\Delta x$  will be equal to zero, for  $3 \times 0 = 0$ . That limit by definition is  $\frac{dy}{dx}$ . Thus (IV) becomes:

$$\frac{dy}{dx} = 6x$$

Therefore, the derivative of  $y = 3x^2$  with respect to x is equal to  $6x$ .

This method of reasoning is used generally in obtaining the several standard formulas for differentiating the various expressions encountered in radio theory.



# Readrite

No. 550

## OSCILLATOR

Licensed by A. T. & T. Co.

\$18 Net to dealer  
\$30 list

\$21 Net to dealer  
with output meter

If not at your Jobbers we will ship direct when remittance accompanies order.

A sturdy modulated instrument carefully made. Completely shielded with separate battery compartment. Furnished with 22½-v. and 3-v. batteries and one '30 tube. Direct reading broadcast band (550-1500 kc.) and intermediate band (120-185 kc.). Sharp 2d and 3d harmonics for 260 and 475 kc. Operating instructions attached in case cover with shielded wire leads. Very compact. In leatherette case, 6x11½x5½ in. Weighs but 8 pounds. Built to high standards. Every serviceman should have the No. 550 oscillator to align r.f. gang condensers, locate defective r.f. transformers, adjust i.f. transformers, check oscillator stage and determine sensitivity of a receiver. A necessary instrument. Get yours today. Write for catalog of servicing instruments.

# Backstage in Broadcasting

(Continued from page 691)

great masters. The director intends the series as an illustration of the great cultural possibilities of radio. This series does not in any way conflict with the Music Appreciation Hours broadcast Friday mornings. Damrosch feels that the radio audience is ready for entire symphonies rather than light compositions. "It is my intention in this new series," he said, "to perform in their entirety the symphonies of Beethoven, Brahms, Berlioz, Cesar Franck, Haydn, Kalinnikov, Saint-Saëns, Schubert and Tschaikevsky. Shorter selections by Bach, Chabrier, John Alden Carpenter, Debussy and Stravinsky will be included." Many operatic excerpts were in the original schedule.

OUR recent comment on radio announcers brought the following letter from Lester Spencer, staff announcer of Stations WOWO and WGL, Fort Wayne, Indiana:

"I would just like to say that we of WOWO and WGL agree with your article on extemporaneous or 'ad lib' announcing. All of our sustaining programs are simply given to the announcers by the program department without continuity of any kind. On commercial programs only the commercial announcements are prepared for the announcers."

And Mr. Spencer kindly postscripts: "We all read your stuff every month and really like it."

Readrite Meter Works  
20 College Ave.  
Bluffton, Ohio

Please send all information about Readrite Oscillator and other service instruments.

Name .....

Address .....

City ..... State .....

Readrite Meter Works

Established 1904

20 College Ave., Bluffton, Ohio



## Study RADIO in CANADA



A. L. Norris, president, Norris Radio Co., writes: "My service manager, George McCollum, is one of your graduates. His excellent training has been largely responsible for the success of our Service Department."

GEORGE MCCOLLUM

### DAY, EVENING and HOME STUDY Classes

Complete, new Radio Course approved by leading manufacturers in U. S. A. and Canada. Our free Employment Service definitely assists you to start in a radio business of your own, or get employment as engineer, inspector, tester, service representative, salesman, etc. Write for free booklet.

### RADIO COLLEGE OF CANADA

310-A Yonge St.

Toronto



### GET THIS

Free new No. 23. Edition of our greatly enlarged RADIO SERVICE TREATISE. Every radio man must have it. Contains some 75 new look-ups, circuit diagrams, over 350 illustrations. POSITIVELY THE GREAT-EST BOOK EVER PUT OUT BY ANYONE. Editorial contents: VACUUM TUBE TREATISE, with many illustrations; Vacuum Tube Average Characteristics Chart; How to Take Care of Your Tubes; How to Connect Phonograph Pick-ups; Improving Tone Quality of Old Sets; Connecting Additional Loud Speakers; all fully illustrated with diagrams. Other articles: Modernizing Old Radio Sets; How to Convert Battery to Power Sets; Selection of Tubes; Push-Pull Amplifiers; Replacing Audio Transformers; Phone Attachments; How to Choose Power Transformers; Voltage Dividers; Wastage of Power; Transformers; Selecting and Installing Replacement Parts in Radio Sets; Filter Condensers; Repairing Eliminators, etc.

**WRITE TODAY. Enclose 2 cents for postage. Treatise sent by return mail.**

### RADIO TRADING CO.

27 West Broadway

New York City

**FREE!** Every MANUFACTURER, DEALER, DISTRIBUTOR, SERVICEMAN should have on file the

New, 1932 Edition of the

### CLAROSTAT

CONTROL HANDBOOK and CATALOG containing complete specifications on Clarostat Variable Resistors, Volume Controls, Tone Controls, and Voltage Controls together with complete information on their use in experimental, service and replacement work.

Write Dept. RN for your copy

Clarostat Mfg. Co., Inc.

285 N. 6th St., Brooklyn, N. Y.

## Deaf 20 Years



But now I hear and will tell any deaf person FREE, who writes me, how I got back my hearing, and relieved head noises by a simple, invisible, inexpensive method which I myself discovered.

Geo. H. Wilson, President  
Wilson Ear Drum Company, Inc.  
1092 Todd Bldg., Louisville, Ky.

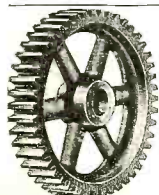

## GEARS

In stock—immediate delivery  
Gears, speed reducers, sprockets, thrust bearings, flexible couplings, pulleys, etc. A complete line is carried in our Chicago stock. Can also quote on special gears of any kind. Send us your blue-prints and inquiries.

Write for Catalog No. 40  
CHICAGO GEAR WORKS  
769-773 W. Jackson Blvd., Chicago, Ill.

# Superheterodyne Featuring 2-Volt Tubes

(Continued from page 675)

continue to transfer linearly if it is appreciably loaded. In the Class B amplifier, a transformer is used to link the input tube with the push-pull tubes usually of 1.1 ratio, or even of a step-down ratio, in order that it may be so designed as to result in a linear voltage transfer even when it is loaded, which occurs when the push-pull grids go positive. Thus in the Class B amplifier, the grid excursions which can be handled are not limited by the length of the relatively short negative side of the straight portion of the  $E_p-L_p$  curve—in other words, the grids can be rather well positive without distortion—the limit being only when the curve finally flattens off and a further increase in applied signal will not cause a substantially linear increase in plate current.

From the standpoint of the battery set, the Class B amplification is ideal, for the output tubes, being biased almost to cut-off, draw practically no plate current except when a signal is being received. Then the plate current drawn from the B batteries is dependent only upon the signal volume desired. It further permits quite high undistorted power outputs from tubes of ridiculously low output as ordinarily operated in a Class A amplifier. For example, the two output tubes in this receiver turn out up to 1 watt with an average plate current of 18 ma., and a filament drain of .12 ampere, while a pair of type -31 power tubes will turn out, in push-pull, only a maximum of .45 watt, or two type -33 pentodes in push-pull 1.3 watt—drawing an average plate current of 28 ma. to do it and .52 ampere A current. The two type -31 tubes, to develop .45 watt, would draw 14 ma. plate current and .26 ampere A. These figures more than justify the Class B amplifier, and to the writer's knowledge the receiver described here represents the first commercial application of the recently developed Class B amplifier theory.

A factor almost never considered with present a.c. sets, because operating power is cheap and easily obtained, is overall efficiency, or the ratio of power used by the set to the audio power output. The average a.c. set of today will draw about 100 watts input, and turn out 5 to 7 watts to the speaker, thus showing an efficiency of 5 to 7 percent. The 726-DC draws about 3.12 watts at low volume output and only 4.07 watts at full output of 1 watt to the speaker—an efficiency of about 25 percent—unquestionably the highest efficiency ever shown by any commercial radio receiver. This is attained by careful design, plus the use of the new Class B audio amplifier, which, incidentally, is bound to come into increasing use in power amplifiers because of its obvious ability to simultaneously accomplish two contradictory things—increase power output tremendously for a given tube capacity, and actually decrease power consumption.

From an examination of Figures 1 and 2 the mechanical layout of the receiver will be seen to be substantially that of the one described in the July, 1931, issue of RADIO NEWS, and this is the case, the

chassis, general parts and circuit being the same except for the inclusion of a first audio stage and the changes necessary for the 2-volt battery tubes. There is, therefore, little point in going into a discussion of the general features of the circuit, since it so closely resembles that of the earlier receiver. In general, however, the circuit consists of one stage of tuned screen-grid, radio-frequency amplification, a type -30 linear power second detector, a type -30 resistance-coupled first audio stage, and a push-pull audio output stage.

The only feature not found in the previously described receiver is the first audio stage, and, of course, the Class B output stage which has been discussed. The purpose of the first audio stage is twofold: first, to increase gain and second, to allow the Class B amplifier grids to draw current through a lower impedance than would be provided by a detector tube, in order that the voltage transformer may be made substantially linear for signal amplitude—something that would be

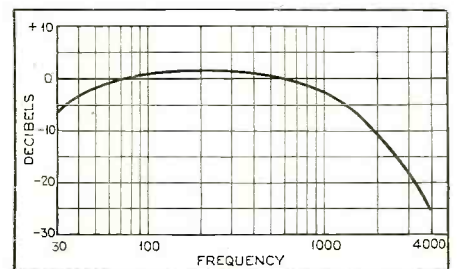

### THE FIDELITY CHARACTERISTIC

Figure 6. This curve shows response at audio frequencies, as measured from antenna to a constant impedance load. The dropping characteristic above 600 cycles is largely compensated in the speaker design

impossible if it were fed out of a high-impedance tube, due to the loading effect of the Class B amplifier grids when they draw grid current.

Volume is controlled by variation of the control-grid bias of the r.f. and first i.f. tubes. The Class B amplifier grids are biased by a 13.5-volt C battery, with the result that their unloaded plate current is only 4/10 of a milliammeter for the pair. Hence, for very weak signals, they function as Class A push-pull amplifiers, and for grid excursions causing plate current charges of more than 4/10 ma. per tube, as Class B amplifiers. This is highly desirable in order that there may be no gap between the cut-off of one tube and the pick-up of the other when a signal is impressed, as might be the case with individual tube variations were the bias to be set exactly at the cut-off point.

It will be noticed that the C bias for all tubes except the first detector and oscillator is taken from a bleeder circuit (R2, R3, R4 and R5) across the 13.5-volt C battery, rather than by taps from the battery itself. This is intentional, the bleeder resistance being so set as to cause a drain on the C battery proportional to the B drain of the set, so as to cause both B and C battery voltages to fall in

(Continued on page 727)



## With the Experimenters

(Continued from page 690)

Suppose that two wires, such as shown at A, Figure 3, were to be welded. First, scrape clean the wires at the point where the weld is to be made, and, if the wires are tinned, scrape off the solder at the same point. Next, attach the metal clip, which connects to one terminal of the water-cell, to the wires, about a half inch from the point where the joint is to be made. Now turn on the current, take hold of the carbon holder by the insulated handle, touch the tapered point of the carbon to the wires to be welded at the point indicated by the arrow in Figure 3 and slowly raise the carbon until there is a separation of about one-sixteenth of an inch between carbon and wires. Avoid jerking away the carbon after touching the wires, as in doing so the carbon is sure to be lifted too far and the arc extinguished.

Touching the wires with the carbon rod and then drawing it away a short distance starts the arc. After the arc has been flaming a second or two it will be noticed that the ends of the wires being welded have fused together. When this happens, the arc should be extinguished by raising the carbon and turning off the current.

When the welded wires have cooled sufficiently to be handled, examine them to see if they are badly discolored or if they are only slightly filmed. A badly discolored weld means that a too-heavy current has been used.

SYLVESTER BRUZAS,  
Chicago, Illinois.

## 2-Volt Superhet.

(Continued from page 726)

proportion, thus always maintaining a desirable balance. The tone control circuit, R8, C10, is across the detector plate circuit, and is the conventional progressive high-frequency attenuator.

The sensitivity, selectivity and fidelity curves appear in Figures 4, 5 and 6. The sensitivity is seen to range between 3 and 8 microvolts absolute, or .75 to 2 microvolts per meter—more than adequate for excellent distance reception in the rural locations in which the set will be used. The selectivity curve shows a band width of 26 kc., 10,000 times down—in a word, practical 10 kc. selectivity.

The fidelity curve shows considerable high-frequency attenuation. But this is only from antenna to constant output load, and does not show the speaker compensation. The speaker intended for the set is a special dynamic unit, having a permanent magnet substituted for the usual current-consuming field coil. It shows unusual high-frequency accentuation, so that in practice the overall antenna-to-ear response curve is practically flat up to 4000 cycles—but it can be leveled off or cut down at will by the tone control. However, as an output transformer is included in the set chassis, any good magnetic speaker can be used in place of the dynamic—such as the old favorite Western Electric 540-AW cone.

## Static Loudspeakers

(Continued from page 657)

linear temperature-coefficient and to eliminate them by a thermal after-treatment of the material. The abnormal state of the bakelite consists in the fact that in the course of time the volume of a pressed article made of this material becomes smaller, a fact which would have been of the greatest disadvantage for the constant maintenance of the mechanical tension of the diaphragm. According to the given measurements of the Bureau of Standards, the temperatures of about 60° and 100° C. were especially critical. Figure 6, illustrating the expansion of the material dependent on temperature and time, showed flaws at the temperature mentioned; instead of expanding, the material contracted. The cause of this phenomena, which can easily be proved and traced at the pressed electrodes, was due to the fact that at these temperatures certain liquids or gases, still contained in the bakelite, escape and cannot emerge during the bakelizing process. By means of a thermal after-treatment it was possible to effect this shrinking in a comparatively short time, to artificially age the material and thereby to make from the bakelite a first-class, reliable material for the precision parts. Within the temperature intervals from +10° to 50° the linear temperature coefficient of the bakelite was measured (with the already-mentioned measuring apparatus of Chevenard at 0,000,034-0,000,037), increasing with rising temperature.

The difference of this coefficient existing between the bakelite material and the foil material was not considered disadvantageous for the temperature differences occurring in practical use.

The bakelite electrodes were treated as follows: The side facing the diaphragm is machined, whereby the apertures are made free, and then coated with an electrically conducting colloidal carbon mixture which is brought into connection with the contact electrode. This conducting layer is then covered with an insulating material. This insulating means is produced on the nitro-cellulose basis and contains a high percentage of mineral additions. The coating of the highly perforated electrodes, according to the hitherto known varnishing processes, has proved itself as unsuitable. The insulating layer, contracting on drying, recedes from the edges, the points of highest field density (Figure 7). Just at these points an especially thick coating is necessary by reason of high disruptive strength. By constructing a special machine for applying the insulating material, it was possible to coat the ribs of the fixed electrodes in such a manner, as shown in Figure 8, to obtain a comparatively thick insulating layer at the points of highest field density. The insulating layer has a thickness of about 0.25 mm., at which thickness the disruptive strength amounts to about 2000 volts, alternating current. After varnishing has been effected, the surface of the insulating layer is leveled by a planing machine especially constructed for this purpose and at the same time exact distances between the diaphragm rim and the surface of the insulating means are produced.



# "Sitting on top of the World"

Permanent success in radio work—as in other things—comes from "making good"—not just "getting by". Making good means perfecting your skill and experience with equipment second to none. Radio men who challenge 1932 with the newest SUPREME INSTRUMENTS are literally "sitting on top of the service world"—abreast—ahead—of radio's swift strides. No true service man can resist the combination of simplicity and versatility of the Supreme "master" instrument—the complete answer to every service riddle, namely

## SUPREME DIAGNOMETER

### AAA 1

### \$147.50

5 ultra modern testing instruments in 1 at the price of . . . 1



Buy no instrument until you have sent the coupon for fullest information on AAA1 and the other new 1932 SUPREME INSTRUMENTS, viz.:

Model 90 Supreme Set Analyzer	\$78.50
Model 60 Supreme Oscillator	\$30.00
Model 70 Supreme Oscillator	\$49.75
Model 40 Supreme Tube Tester	\$30.00

All-Dealers' net prices F.O.B. Greenwood, Miss. Ask your Jobber to demonstrate.

SUPREME INSTRUMENTS CORPORATION,  
426 Supreme Building,  
Greenwood, Mississippi.

Please send me full particulars on

(Here indicate instrument or instruments interested in)

Name.....  
Address.....  
City..... State.....  
Name of Jobber.....  
City..... State.....



# You can't See It— But it's **THERE!**

NO nearly imitative rearrangement of the CARDWELL design, the original metal end plate—grounded rotor condenser, has ever matched the genuine CARDWELL for its unique electrical efficiency.

You can't see it—but it's there.

CARDWELL condensers are used by the Army and Navy and by the greatest radio engineering and manufacturing concerns in America, in apparatus where performance is the paramount requirement.

By what standard do you judge condensers?

Write for Literature

THE ALLEN D. CARDWELL  
MANUFACTURING CORP'N.  
89 PROSPECT ST., BROOKLYN, N. Y.  
"THE STANDARD OF COMPARISON"

# New Experimental Superheterodyne

(Continued from page 679)

may be brought up very strongly by the regenerative control in the second detector. Quality and signal strength largely depend on the proper choice of grid leaks. A choking or popping sound indicates too high a leak. Too low means a great reduction in sensitivity as well as volume.

baseboard, and holes drilled through the board to pass the wiring. Although special variable condensers are listed, any good condenser that will permit the stator to be separated into two parts may be substituted. These sections contain a single plate and a nine-plate section taken

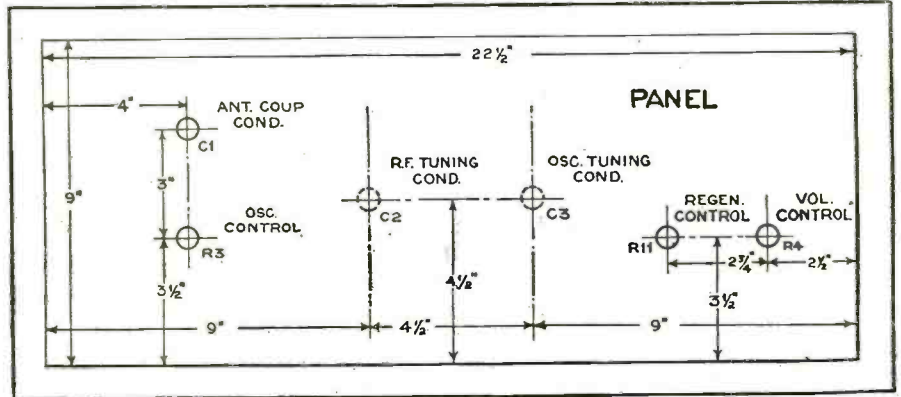

THE PANEL LAYOUT

Figure 2. All dimensions for drilling the front panel are included here

With the set operating, do not expect exceptional results until it is adjusted properly. All the controls must be properly disposed. It is quite important that the proper voltages should be available.

from a condenser whose original capacity was 500 micromicrofarads. The rotor may be left unchanged or a plate or so removed such that two plates mesh the single stator plate on the end section.

**"CHI-RAD"**  
**NEW NATIONAL AC-SW-3**  
3 TUBE THRILL BOX  
for amateur short-wave and all other reception.  
Tuner only \$32.34  
National A.C. Power Pack \$20.30  
Prices subject to change  
**BUT WE WILL NOT BE UNDERSOLD**  
**REPLACEMENT PARTS**  
Complete line of Condenser Blocks, Transformers, Volume Controls and Rheostats.  
**SHORT-WAVE KITS**  
sets, transmitter parts, supplies for power packs, high voltage condensers—low prices.  
**SEND FOR LATEST CATALOG**  
CHICAGO RADIO APPARATUS CO.  
415 S. Dearborn St. Dept. RN-2 Chicago, Ill.

You Can Become a Fast Capable **RADIO OPERATOR** at HOME  
By **CANDLER**  
Scientific Method  
In less than the usual time. Amazing results. Thousands fast Radio operators taught by CANDLER. FREE advice if you're "stuck."  
All questions answered personally. No obligation. If Radio operator, ask about **ADVANCED COURSE** for **SPEED and Copying Behind**, and "MILL" Course. **FREE BROCHURE** will save you time and money. Tune in on Candler Short Wave Station!  
Walter H. Candler, World's Only Code Specialist  
**THE CANDLER SYSTEM CO., Dept. RN-2**  
6343 So. Kedzie Ave., Chicago, Ill.

**SERVICEMEN—DEALERS**  
**SEND TODAY FOR THIS GREAT MONEY SAVING CATALOG**  
Thousands of original Factory Standard Replacement Parts at special low **WHOLE-SALE PRICES.**  
**Don't Wait—Act Today!**  
**DIXON RADIO & ELECTRIC CORP.**  
110 East 23rd Street, New York City

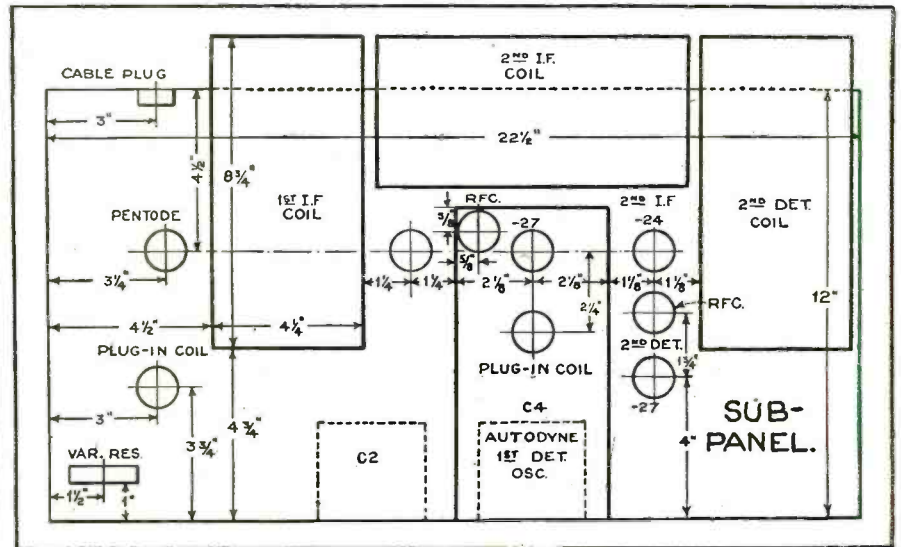

THE BASE LAYOUT

Figure 3. The positions of the various parts and shields on the chassis base are indicated exactly

The set described may seem expensive to construct. Much saving may be exercised, however, by a proper choice of substitute parts for those listed. A power pack may be purchased at cut-price stores for about ten dollars or it may be made up from parts. Miscellaneous parts may be utilized and some may be contrived. The pentode tube may be dispensed with and an ordinary screen-grid tube substituted for it by omitting the space-charge grid connection and joining the plate circuit to the 180 volts in place of the 250 volts as shown.

The usual type of UY socket may be mounted on top of the copper sheathed

The set has no body capacity if properly made.

Although this set has been experimented with for several months and is the fourth type developed during the past year, it is felt that many improvements may occur to investigators. However, as many sincere experimenters have found out, changes are not necessarily improvements. As outlined, this set offers almost endless opportunity for investigation and study.

However, after all, if the purpose of the operator is to listen in on the "whole wide world"—it were better to leave the controls intact, to be used just when they are needed.



# New Television Receiver

(Continued from page 684)

in for the purpose of tuning in the television signal.

Single control is provided for the three tuned circuits and a full-vision dial is used. The combination power switch and volume control is also at the front of the Visionette.

The circuit of the Insuline Television Receiver includes many important new features. R.f. transformers are of special design. The primary of each transformer is a specially wound r.f. choke, while the secondary consists of a number of turns of fine wire wound on a small composition solenoid and separately shielded. Capacitive coupling is utilized between the primaries and secondaries, small fixed condensers being used for this purpose.

A switch is available for changing the grid bias of the detector to a more suitable value for phonograph amplification, and the set may be used for such a purpose by means of phonograph jack connections which are provided at the rear. Between the detector and the output tube there is a special r.f. choke for keeping the radio-frequency currents out of the audio circuit. This is by-passed by a suitable fixed condenser.

The resistance coupling between the detector and output pentode tubes has been carefully designed to pass a wide band of audio frequencies, as required for best results in television work.

An important feature of the design is the use of a special impedance-matching transformer between the pentode and the neon lamp to insure even transmission of energy on all frequencies encountered in television. The receiver is adequately shielded and carefully by-passed to prevent unwanted interaction between the various circuits.

The power supply is equipped with an oversize filtering system, insuring absence of hum, which, if not taken into account, often results in interference streaks in the images.

Figure 3 is a schematic diagram of the Insuline short-wave and television receiver. The parts which comprise this receiver are listed at the end of this article. This receiver is built up on a compact metal chassis and is available both in kit form and as a completely wired chassis. The kit is furnished with a set of blue-prints and complete instructions for assembling and wiring. Due to the fact that the chassis is supplied with mounting holes drilled, it is a comparatively simple matter to fasten the various components in their respective positions. The simplicity of the circuit permits the wiring to be completed rapidly and without trouble.

### The List of Parts

- C3, C6, C8, C10—Three-section gang condenser, .00035 mfd. each section, with full-vision dial and 2½-volt dial light
- C2, C5, C7—Mica condensers, .0001 mfd.
- C1—Mica condenser, .00005 mfd.
- C4, C11, C15, C16—Cartridge condensers, .1 mfd.

- C9, C12, C14—By-pass condensers, 1 mfd.
- C13—Electrolytic by-pass condenser, 4 mfd.
- C17—Electrolytic filter condenser, 4 mfd.
- C18—Electrolytic filter condenser, 8 mfd.
- L1, L2, L3—Special short-wave television coil set, 75-200 meters, with shielded secondaries.
- L4—R.F. choke coil
- L5—Filter choke, 30 henries, 25 ma.
- R1, R2, R3, R5—100,000-ohm metallized resistors
- R4—30,000-ohm metallized resistor, tapped
- R6—1-megohm metallized resistor
- R7—418-ohm flexible resistor
- R8—5000-ohm to 250-ohm volume control potentiometer with switch, SW3
- R9—18,500-ohm tapped resistor, enameled
- R10—50,000-ohm potentiometer
- RFC—R.F. choke coil
- SW1—Phono "on-off" s.p.d.t. toggle switch
- SW2—D.P.D.T. switch for neon tube control resistance
- SW3—Power "on-off" toggle switch
- T1—Pentode output transformer
- T2—Special impedance-matching transformer for neon lamp
- T3—Power and filament supply transformer in metal case
- Long and short aerial binding posts—ground binding post
- J1, J2—Phono pick-up tip jacks
- J3, J4—Neon lamp tip jacks
- V1, V2—Type -51 variable-mu tubes
- V3—Type -24 screen-grid detector tube
- V4—Type -47 pentode power tube
- V5—Type -80 full-wave rectifier tube
- Dynamic speaker with 1400-ohm field
- 4 five-prong sockets
- 1 four-prong socket for speaker plug
- 1 four-prong speaker connection plug
- 1 four-prong socket for type -80 tube
- Metal chassis, shaped and drilled
- Tube shields for types -51 and -24 tubes
- Condenser shield
- Escutcheon plate, engraved "Television"
- Escutcheon plate, engraved "On-Off"

FEBRUARY, 1932

Technical Information Coupon  
 RADIO NEWS Laboratory  
 350 Hudson Street  
 New York, N. Y.

Gentlemen:

Kindly supply me with complete information on the attached question:

- I am a regular subscriber to RADIO NEWS and I understand this information will be sent me free of charge.
- I am not yet a subscriber to RADIO NEWS.
- I wish to become a subscriber to RADIO NEWS and enclose \$2.50 to receive the magazine regularly for one year, and to receive this valuable technical information service free of charge.

Name .....

Address .....

# LONG LIFE

and Efficiency in Filter Circuits

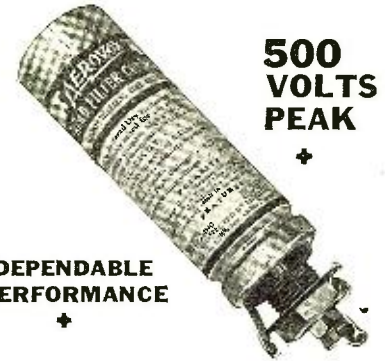

## HI-FARAD DRY ELECTROLYTIC CONDENSERS

Provide long life and high filtering efficiency, due to their design and inherent operating characteristics. They are compact, light in weight, low in cost per microfarad rating, low in leakage, stable in operation, and operate over wide ranges in temperature.



### AN AEROVOX CONDENSER OR RESISTOR FOR EVERY PURPOSE

The AeroVox line includes the most complete variety of fixed condensers and resistors for every radio requirement.

Send for Catalog

Complete specifications of all AeroVox units, including insulation specifications of condensers, current-carrying capacities of resistors, and all physical dimensions, electrical characteristics, and list prices of condensers and resistors, are contained in our 40-page catalog which will gladly be sent on request.



The AeroVox Research Worker is a free monthly publication issued to keep radio engineers, experimenters and servicemen abreast of the latest developments in receiver and power supply design, and especially with the proper use of condensers and resistors. A request on the coupon below will place your name on the mailing list.

### AEROVOX WIRELESS CORP.

78 Washington St., Brooklyn, N. Y.

Check and Mail This Coupon

AEROVOX WIRELESS CORP. Radio News  
 78 Washington Street Feb., 1932  
 Brooklyn, N. Y.

Gentlemen:  
 Please send me without charge or obligation:  
 ( ) Your 40-page Condenser and Resistor Manual and Catalog.  
 ( ) The Research Worker.

Name .....

Street .....

City ..... State .....





SLUMBERLAND-BOUND TO A MUSICAL ACCOMPANIMENT  
*The radio pillow, encased in a snowy linen pillow slip, can be used in place of a regular pillow and even the most wakeful listener will soon drift off to the strains of a favorite orchestra*

## A "Pillowful" of Music

*The problem of individual radio reception without disturbing others near by has heretofore necessitated the use of cumbersome and ear-wearingly headphones. The new radio pillow solves the problem in a new way and is expected to be widely used in hospitals, as well as homes*

**I**F you had the misfortune to be confined to a sick-bed for any length of time, you would probably appreciate your radio programs as you had never appreciated them before . . . provided, of course, that you were fortunate enough to have a radio set at home or a centralized radio service in the hospital where you were confined. And then, as the moments wore on into hours, and the hours into days and possibly weeks, you would probably begin to get mighty weary of your radio—not the programs, but those awful headphones pressed close to your ears. After a while your ears would become sore to the touch, and the headphones would seem to weigh tons instead of ounces. Ask any old-time radio operator who has had to wear the 'phones or "cans," as we used to call them . . . some of us actually grew corns on our ears in the old days of long watches and whispering signals that required headphones clamped as tightly to the skull as it was possible to adjust them.

But there you are, in a hospital bed, forced to choose between suffering the torment of the old headphones, or having discarded the things, just lying there bored to distraction, wishing you could hear a good radio program without getting a couple of earaches at once.

### *The "Radio Pillow"*

Then along comes the radio "pillow," and you get a new lease on life and happiness, because you can just rest your head comfortably against its soft surface and enjoy your favorite radio program without having to wear a hair-entangling harness. At last somebody has had the initiative to get out of the old rut and devise something new in radio reproducers. Why didn't they think of it long ago?

By E. Jay Quinby\*

Hospitals, hotels and other institutions equipped with centralized radio system are often faced with the problem of sound transmission through thin partitions, which condition sometimes becomes annoying especially during the late evening hours. Here again the radio pillow comes to the rescue, providing excellent sound reproduction to the interested individual listener without disturbing the unwilling ears in the next room. In the case of hospital wards, where many beds are located within the confines of one large room, it becomes possible through the medium of radio pillows to provide entertainment and amusement to those who desire it without disturbing the others.

### *Useful in the Home*

And the hospital patient is by no means the only one who benefits by this new device. Consider father, who wants to listen to the football game, but who couldn't have the radio turned on because it annoyed the Saturday afternoon bridge club that friend wife is entertaining. Now he can listen to the football game in comfort through his own private radio pillow, without fear of disturbing the ladies or any one else in the house. And little Willie goes to bed now without the usual objections, because he is anxious to hear the continuation of the bedtime serial program. He will soon be asleep after he gets his ear down against the radio pillow—and the program will not awaken his little infant sister in the next crib, because no one can hear the program but little Willie himself.

Aunt Phoebe is a little deaf and can't hear her radio programs well with the ordinary loudspeaker volume which others consider ample. The radio pillow delights her, because it permits her to enjoy the programs without annoying the rest of the family by having the volume turned up too far, and she can go on with her knitting while (Continued on page 735)

\*Engineering Products Division, RCA-Victor.







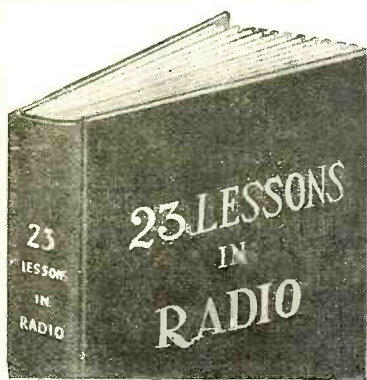

# FREE

With this New Money-Saving Offer From RADIO NEWS

SO many requests have come into this office asking us for a book covering the Junior Radio Guild lessons, that we have at last, with considerable time and effort, compiled this material (along with some other information) into a great new book!

"23 LESSONS IN RADIO" is not for sale anywhere! But by subscribing through this special offer, you receive not only this great book FREE, but you also receive two whole years of RADIO NEWS for only \$4, a saving of \$2 over the single copy price. Besides, you do not need to pay the entire amount now! Simply fill out the coupon below and send it to us with \$1! We will immediately mail your "23 LESSONS IN RADIO" and your first issue of RADIO NEWS. Then you may pay the balance later as we bill you, in easy installments of \$1 a month for 3 months. Renewal or extension of current subscriptions accepted on this offer, but payment must be made now, as specified above, not when subscription expires.

#### A Few of the Subjects Covered:

- Elementary Radio Theory
- How the Detector Tube Works
- Construction of a two-stage audio-frequency amplifier
- How the Radio-Frequency Amplifier Works
- How to Build a "Converter" which changes your 5-tube broadcast receiver into a Short-Wave receiver
- Principles of transmitting and receiving
- Complete Chart of Standard Radio Symbols
- How to Build R F Tuner
- How to Build a 3-stage resistance coupled audio-frequency amplifier
- The How and Why of B-Power Units
- Breaking into the Amateur Game
- How to build a code test outfit
- Circuit, constructional and operating details of a Low-Power Transmitter
- How the Vacuum Tube Works
- Battery construction details
- How to Analyze Receiver Circuits

RADIO NEWS, Dept. R-2  
350 Hudson Street, New York, N. Y.

Enter my subscription for two years of RADIO NEWS, and send me the book "23 LESSONS IN RADIO"—all for only \$4.00. I am enclosing \$1.00 herewith, and will pay the balance, \$1.00 a month, for the next three months. (One extra issue—25 months in all—if you send the full amount with your order.)

Name \_\_\_\_\_  
Address \_\_\_\_\_  
City \_\_\_\_\_ State \_\_\_\_\_  
If renewal check here   
Are you a Serviceman  Engineer  Dealer   
Experimenter  Radio Technician   
Canadian and Foreign Price, \$6.00

would be uncomfortably loud in the booster headphone. But by pressing this button when talking, or when dialing, the volume is instantly cut down to comfortable proportions. When released, the full amplification provided by the setting of the volume control is available.

As will be noted from the illustrations, the chassis type of construction is employed in the Booster. This is done for two reasons. In the first place, it simplifies construction because the entire unit can be built and wired out in the open before being placed in the case. Secondly, this type of construction provides for rigid mounting of all the parts. Specifications for the metal sub-base, the bakelite shelf and the metal fittings are shown complete in Figure 4. Those for the case, including the automatic switch, are shown in Figure 5.

In assembling the unit the first step consists of mounting the transformer, T, and the tube socket in their proper positions on the sub-base. The bakelite shelf is then prepared by mounting on it the four legs, the four battery contact springs, the binding post, and the rheostats R1 and R3. In mounting the binding post and the battery clips, soldering lugs should be included under the nuts, beneath the shelf. Lugs should also be placed under the nuts on the four terminals of the transformer. The shelf is next attached to the sub-base, and this completes the assembly.

The wiring can then proceed in accordance with the picture wiring diagram, Figure 6. It will be found most convenient to leave four long leads, each about one foot long, for the connections to the push-button and the switch (SW1) which are later mounted on the cover of the case. These can be cut to proper length after the chassis is installed in the case. In the case of the volume-control rheostat, R2, it is advisable to make the leads an inch or two longer than actually necessary. This is done for the reason that this rheostat is mounted on one wall of the case after the chassis has been slipped into position and a little slack in the wiring simplifies matters. The wire used for the connection to the telephone should be as long as the particular installation requires. Normally a standard four-foot connection cord will be adequate.

Remove the regular telephone receiver from its hook, hanging some weight on the hook to hold it down, and unscrew the receiver cap. It will then be found that the "insides" of the receiver can be slipped out. Examination will show two wires connected to this unit. Disconnect one of them by loosening the connection screw and insert under this screw one of the leads from the Booster. The other lead from the Booster should then be twisted around the tip of the wire which was formerly attached to this screw. This connection should be securely made and covered with two thicknesses of tape. Then the receiver unit can be slipped back into the case and the cap replaced. The wires from the Booster will, of course, have been drawn through the hole at the small end of the telephone receiver case.

It might be well to point out here that there is no hazard of any kind involved in

## Read Classified Advertising—It Pays

Advertisements in this section twenty-six cents a word for each insertion. Name and address must be included at the above rate. Cash should accompany all classified advertisements unless placed by an accredited advertising agency. No advertisements for less than 10 words accepted. Objectionable or misleading advertisements not accepted. Advertisements for these columns should reach us not later than 1st of 2nd month preceding issue.

**TECK PUBLISHING CORP.**  
350 Hudson St. New York, N. Y.

### Agents Wanted

**REPRESENT** Manufacturer of Shirts, Ties, Hose, Underwear. Beat store competition on price and value both. Startling Free Offers make orders come easy. You earn big money. Cash commissions. Free Shirts, Cash Bonuses. Write today for Giant Offer! Dept. F97, Albert, 300 Sixth Ave., New York.

**MEN, WOMEN** wanted to represent manufacturer locally. Earn Big Money. Pleasant work showing Shirts, Ties, Underwear, Hosiery. Guaranteed One Year. Amazingly Low Priced. Sensational Merchandising Idea gets orders. No Experience. Free Sales Outfit. Dept. V2 Quaker, Broadway and 51st Street, New York.

### Business Opportunities

**VALUABLE RADIO CIRCUIT** Patent Rights to responsible party. Famous International publicity rights included. Highest Banking reference requested, and given. F. W. Davidson, Terre Hill, Pa.

### Correspondence Courses

Used correspondence school courses sold on repurchase basis. Also rented and exchanged. Money-back guarantee. Catalog free. (Courses bought.) Lee Mountain, Pisgah, Alabama.

**CORRESPONDENCE COURSES**—Sold, Bought, Exchanged, Rented. Bargain Catalogue Free. Handling, C-799 Broadway, New York.

### Detectives

**DETECTIVES.** Work home or travel. Experience unnecessary. Particulars free. Write George Wagoner, 2190-A Broadway, N. Y.

### Instruction

**WANTED**—Names of men desiring steady outdoor jobs: \$1700-\$2400 year; vacation. Patrol parks; protect game. Write immediately, Delmar Institute, A-54, Denver, Colo.

**EARN \$25 WEEKLY**, spare time, writing for newspapers, magazines. Copyright Book, "How to Write for Pay" free. Press Institute, 117 Ozark Bldg., St. Louis, Mo.

### Inventions

**INVENTIONS COMMERCIALIZED.** Patented or unpatented. Write Adam Fisher Mfg. Co., 278 Enright, St. Louis, Mo.

### Meters

**METER SHUNTS**—5 to 500 Milliampere 75c. for Weston 201-1 Mil. and AC-DC Universal. Also Dials (Ohms—100,000, Volts—50—250—1000) and others 35c. with instructions. Van, 4323—54th St., Woodside, N. Y.

### Patent Attorneys

**PATENT YOUR INVENTION:** Send for FREE book, "How to Obtain a Patent," and "Record of Invention" blank. Consult us about how to protect your ideas. Victor J. Evans & Co., 616B Victor Bldg., Washington, D. C.

### Patent Attorneys

**PATENTS**—Write for Free Information. HOW TO OBTAIN A PATENT and RECORD OF INVENTION—or send Drawing or Model for Examination. Miller & Miller, Patent Attorneys (former Patent Office Examiners) 1605-D Woolworth Building, New York; 675 Earle Building, Washington, D. C.

**PATENTS, TRADE MARKS**—All cases submitted given personal attention by a member of the firm. Information and booklet free. Lancaster, Allrine & Rommel, Suite 414, 815 15th St., N. W., Washington, D. C.

**PATENTS**—Advice and booklet free. Highest references. Best results. Promptness assured. Watson F. Coleman, Patent Lawyer, 724 9th Street, Washington, D. C.

**PATENTS.** Time counts in applying for patents. Send sketch or model for instructions or write for free book, "How to Obtain a Patent," and "Record of Invention" form. No charge for information on how to proceed. Clarence A. O'Brien, Registered Patent Attorney, 3003 Security Savings & Commercial Bank Building (directly opposite U. S. Patent Office), Washington, D. C.

### Photography

**HAVE YOU A CAMERA?** Write for free sample of our big magazine showing how to make better pictures and earn money. American Photography, 3105 Camera House, Boston, Mass.

### Songwriters

**COMPOSERS—VERSE OR MUSIC.** Brilliant opportunity. Write at once. Van Buren, 2600 McClurg Bldg., Chicago.

### Telegraphy

**LEARN** Wireless (Radio) and Morse telegraphy. School, oldest, largest; endorsed by telegraph, radio and government officials. Expenses low—can earn part. Catalog free. Dodge's Institute, Couz Street, Valparaiso, Ind.



connecting this equipment to any telephone. It cannot damage the telephone, nor is it possible to receive a shock while handling the terminals in the telephone receiver. Moreover, it does not in any way affect the operation of the telephone.

**Operation**

After the Booster has been connected to the telephone, the rheostat R1 is first turned as far as possible in an anti-clockwise direction and then turned back about half-way in a clockwise direction. The volume control, R2, is then turned all the way on (clockwise direction). Then with the Booster headphone held to the ear, lift the telephone receiver off the hook and place it on the metal-plate switch on the top of the case. Then, listening through the Booster headphone, put through a telephone call in the usual way, preferably to some friend who will talk to you while making the proper adjust-

where. The transformer is another item in this class. The metal-plate switch and the chassis fittings are the only parts which are entirely special. However, all of the parts can be obtained from certain dealers who are specializing in the complete kit, which includes all the component parts as well as the sub-base, case and fittings. A study of the advertising pages will show these.

**The Parts List**

- BP—Eby insulated binding post
- P—Western Electric type 509W single headphone, 1100 ohms
- R1, R3—Carter midget 50-ohm rheostats, type M-50, equipped with 1½-inch knobs
- R2—Carter Imp 400-ohm rheostat, type IR-400, equipped with 1½-inch knob
- SW1—Phosphor-bronze switch (see Figure 5 for specifications)
- SW2—Push-button switch, panel-mount-

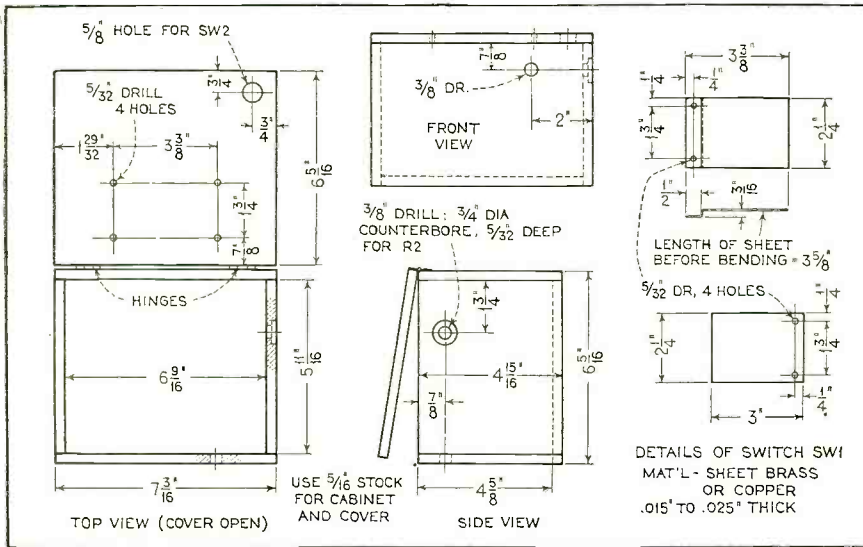

Figure 5. Dimensions of the cabinet and the metal-plate switch

ments of rheostats R1, R2 and R3. While the flashlight batteries are new, the setting already suggested for R1 will probably be found satisfactory. In any event, this rheostat should be set with the knob as close to the off position as is consistent with proper amplification. The closer it is to the zero setting, the longer the flashlight batteries will last. Having determined the proper setting of R1, talk into the telephone and, holding down the push-button SW2, vary the rheostat R3 until the sound of your own voice is just comfortably audible in the headphone. This may be considered a permanent adjustment of R3. Finally, adjust the volume-control rheostat R2, which is on the outside of the case. This should be done, of course, while the other person is talking.

With these operations completed the Booster is ready for service. It will bring a delightful relief from strain to persons who normally have considerable difficulty in understanding what is said over a telephone.

The parts employed in the model are listed below. A study of the list will show that many are standard radio parts which may be obtained in local radio stores. The headphone is a standard type but as a single unit is not available every-

- ing type
- T—Thordarson microphone transformer, type T2357
- VT—Type -30, two-volt vacuum tube with Pilot sub-panel mounting socket No. 216
- Batteries—(B) Two Eveready type 763, midget B battery blocks, 22½ volts each; (A) two Eveready type 950, standard 1½-volt flashlight batteries
- Phone cord, length optional
- Broderick wood case having inside dimensions of 5¾ x 6 9/16 x 4¾ inches
- Broderick fittings (see Figure 4 for specifications)
- Broderick "featherweight" headband for headphone or Blan headphone handle
- Wire, screws, nuts, etc.

This series of articles will continue next month with a description of a group hearing aid for use in churches or under other conditions where several persons of sub-normal hearing may desire to listen through a number of headphones connected to a single amplifier. It is planned to run one article covering one type of commercial equipment available for this purpose and a second article covering construction of such equipment using, so far as possible, standard radio parts.

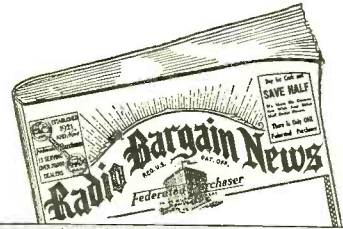

**Get this Radio Parts Catalogue FREE**

- 72 pages—3,000 items—8 valuable service charts. Prices
- lower than ever. Money-back
- guarantee. 24-hour shipments.

**Federated Purchaser**

25 Park Place, Dept. A, New York City.

**new 1932 BIG SAVINGS ON SUPERHETS MIDGETS AUTO RADIOS**

Lowest wholesale prices on the finest and the latest in radio. America's oldest mail-order radio house offers you now Varo-Mu, Pentode Superheterodynes at big savings. Also Midgets, Auto Radios, Short Wave Receivers, Radio Phonograph Combinations, etc. Be sure to send for new 1932 catalog now.

Western Radio Mfg. Co.  
126 W. Lake St., Chicago

**WESTERN RADIO**

**SERVICEMEN!**

**Resistor Replacement Manual FREE** with purchase of 10 Lynch Metallized Resistors, or \$1 cash MORE THAN 200 CIRCUITS

Gives the value and code of each resistor and its position in the circuit, of nearly every popular make of radio. SAVES TIME and experimenting. Eliminates guess work.

**LYNCH Resistors** ½, 1, 1½, 2, and 3 Watts  
Write for Manual today.  
LYNCH MFG. CO., Inc., Dept. N, 1775 B'way, N. Y.

**Radio News Telephone Booster**

Complete parts in stock including the special case, and fittings cut to size and drilled ready for assembly. Also for the **Radio News Ear Aid** as described in Radio News for January and for the attachment described on page 492 of the December issue, permitting headphones, with separate volume control, to be used with any radio without changes in wiring.

Write for prices. Special discounts to bonafide dealers and service men.  
**WILLIAM H. BRODERICK**  
40 East 49th Street, New York, N. Y.

**LEARN BY LISTENING Telegraphy Morse or Continental**

Step into this interesting—uncrowded—HIGHLY PAID Profession. Become a trained operator in Morse or Radio Code, easily, quickly, at home, with TELEPLEX, the Master Teacher. Used by the U. S. Government and leading schools. Entirely new code course in 12 rolls of tape. During last ten years TELEPLEX has trained more operators than all other methods combined.

Write for Folder E-2  
**TELEPLEX CO.**  
76 Cortlandt St., New York, N. Y.

Learn AT HOME With

**Teleplex**





# RADIO BOOKS

NOW SOLD  
AT  
MAGAZINE PRICES  
OR  
**FREE** with *Radio News*  
at a big saving!

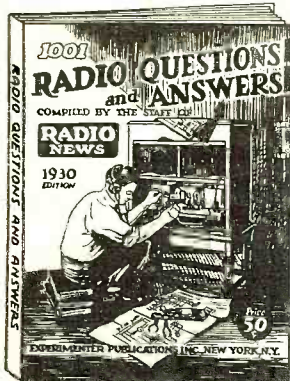

If you own a radio, you need this book. Everything you want to know about radio is in it, from "How to Kill Outside Radio Noises," to a clear description of the newest tubes and how to use them. If you have a question on radio, here is your answer and a thousand more. 96 illustrated pages. Large, 9 by 12 inch size. Beautiful colored cover. Shipped prepaid to your home for only **50c**

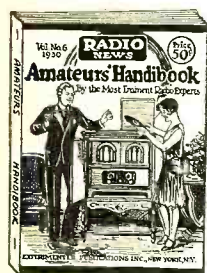

Sometimes called the Radio Amateurs' Bible. 30 profusely illustrated chapters bring you 10 How-to-Build articles, with complete instructions and diagrams; new radio wrinkles, DX hints, data on the new tubes, answers to AC problems, and helpful, money-saving ideas for the radio serviceman. Shipped prepaid to your home for only **50c**

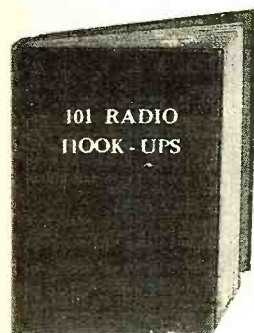

Here's a big, newly cloth bound edition of the book that every man interested in radio has been eagerly looking for! As its name implies this book contains complete diagrams and descriptions of the most popular types of receivers, short wave transmitters, test apparatus and amplifiers or units thereof used in virtually every field of radio activity. **50c**

**Cut and Mail Today**

Teck Publishing Corp.  
Dept. R-2, 350 Hudson St., New York, N. Y.  
Gentlemen: Please ship me postpaid the Radio Books I have checked below. Remittance is enclosed.  
 1001 Radio Questions and Answers  
 Radio Amateurs' Handbook  
 101 Radio Hook-Ups

Name.....  
Address.....  
City and State.....

**FREE!**

You may have any one of the above Radio Books ENTIRELY FREE with RADIO NEWS at a reduced price. To accept this offer check square below.  
 Ship me ENTIRELY FREE the Radio Book I have checked above and enter my subscription for the next eleven big issues of RADIO NEWS at the special price of only \$2, which I enclose. (Regular newsstand price of RADIO NEWS, \$2.75.)

## New Motor Radio

(Continued from page 668)

push-pull output transformer. This transformer is contained in the speaker proper. The secondary of this feeds into the voice coil of the dynamic speaker. This is rated at 6 ohms. One side of the voice coil is also grounded.

A third wire conveys the B voltage to the center-tap of the primary of the transformer on the speaker.

The two remaining wires supply the field of the speaker with 6 volts from the storage battery of the car.

A cable connects the receiver to the remote-control unit which consists of a key switch, the tuning and volume controls and a pilot light. This cable contains four connections. Two of these go to the key switch which turns the A power on and off. The other two are the connections for the volume control. The entire cable is shielded by a wire mesh and finished off with a cotton covering.

Although it is not necessary in an installation where new B batteries are used, the .1 mfd. condenser (C10), which is placed directly across the B voltage, becomes important when the batteries deteriorate and create a high resistance in the plate circuit, at which time audio oscillation would result. Without the use of this capacity, the tone under such conditions would become impaired and distortion would take place in the speaker.

## Meteors and Static

(Continued from page 669)

have been found consisting of iron apparently fused with other metals. But this does not surely indicate that the metals were heated in the earth's atmosphere—not at least to the melting point. The heating may have occurred on the body from which the piece loosed itself, possibly by volcanic action.

Static noises can also be traced to condensation of humidity in the atmosphere, I believe. This condensation creates clouds which in turn further condense into rain, in either case causing intense electrification of rain or cloud areas. These "growth" changes cause electrical discharges which are the cause of a vast amount of static.

On cold, frosty nights where there is little humidity in the air, very little static disturbances are noted. On the other hand, hot, humid nights, with the atmosphere surcharged with moisture, or with heavy "thunder heads," are always bad for static.

On clear nights, otherwise excellent for reception, it is noted that jarring noises, that have heretofore not been adequately explained, often are heard. I believe that these sounds are caused by meteors which we know are perpetually bombarding the earth's atmosphere, although the overwhelming majority of them are so small that their effect may be almost unnoticed, individually, in the commercial broadcast receiver, but resemble a faint hissing in the aggregate.

## INDEX TO ADVERTISERS

	PAGE
<b>A</b>	
Aerovox Wireless Corp. ....	729
Amperite Corp. ....	720
<b>B</b>	
Baltimore Radio Corp. ....	714
Blan the Radio Man, Inc. ....	712
Broderick, Wm. H. ....	733
<b>C</b>	
Candler System Co., The ....	728
Capitol Radio Engineering Inst. ....	716
Cardwell Mfg. Co., Inc., Allen D. ....	728
Central Radio Laboratories ....	721
Chicago Gear Works ....	726
Chicago Radio Apparatus Co. ....	728
Chicago Radio Apparatus Co. ....	726
Clarostat Mfg. Co., Inc. ....	722
Coast to Coast Radio Corp. ....	722
Coyne Electrical School ....	645
Classified Advertisements ....	732
<b>D</b>	
Dixon Radio & Electric Corp. ....	728
Dodge's Institute ....	710
Dubilier Condenser Corp. ....	714
<b>E</b>	
Eastern Rabbitry ....	720
Electrad, Inc. ....	722
Evans & Co., Victor J. ....	735
<b>F</b>	
F & H Radio Laboratories ....	712
Federated Purchaser, Inc. ....	733
Filtermatic Mfg. Co. ....	718
Flechthelm & Co., Inc., A. M. ....	720
<b>G</b>	
Grant Radio Laboratories ....	716
<b>H</b>	
Hammarlund Mfg. Co. ....	Second Cover
Hearing Devices Co., Inc. ....	735
Hoodwin Co., Chas. ....	722
<b>I</b>	
International Resistance Co. ....	713
Insuline Corp. of America ....	717
<b>J</b>	
J. M. P. Mfg. Co. ....	735
<b>L</b>	
Lincoln Radio Corp. ....	711
Lynch Mfg. Co., Inc. ....	733
<b>Mc</b>	
McGraw Hill Book Co., Inc. ....	712
McSweeney Electrical School ....	724
<b>M</b>	
Massachusetts Radio & Telegraph School. ....	735
Midwest Radio Corp. ....	646, 647
Morrill & Morrill ....	735
<b>N</b>	
National Co., Inc. ....	715
National Electrical & Automotive School. ....	709, 731
National Radio Inst. ....	643, 736
<b>P</b>	
Pioneer Television Co. ....	719
<b>R</b>	
Racon Electric Co., Inc. ....	722
Radio & Television Inst. ....	648
Radio College of Canada, Ltd. ....	726
Radio Surplus Corp. ....	720
Radio Technical Pub. Co. ....	724
Radio Trading Co. ....	726
Radio Training Association of America ....	641
Radio Treatise Co., Inc. ....	718
Radolek Co. ....	731
RCA Institutes, Inc. ....	723
Readrite Meter Works ....	725
RCA Victor Corp. ....	3rd Cover
Refrigeration Training School & Shops, Inc. ....	720
Rim Radio Mfg. Co. ....	724
<b>S</b>	
Scott Radio Labs., Inc., E. H. ....	707
Shalleross Mfg. Co. ....	710
Silver-Marshall, Inc. ....	Back Cover
Stuyvesant Electric Co. ....	716
Supreme Instruments Corp. ....	727
<b>T</b>	
Teleplex Co. ....	733
Traul Radio Co. ....	718
<b>U</b>	
Universal Microphone Co. ....	710
<b>V</b>	
Van Nostrand Co., D. ....	717
<b>W</b>	
Wellston Radio Corp. ....	714
Western Radio Mfg. Co. ....	733
Weston Electrical Instruments Corp. ....	708
West Side Y. M. C. A. Radio Inst. ....	718
Wholesale Radio Service ....	710
Wilson Ear Drum Co., Inc. ....	726



## The Service Bench

(Continued from page 695)

referred to. The upper right-hand terminal of the pre-heater-test switch should have been shown connected only to the wire which connects the heater-filament circuit to the lamp socket D. The connections as shown in the diagram in the December issue would result in a direct short circuit of the preheater transformer. The correct diagram is shown herewith.

The purpose of the lamp D, with its series resistance and switch, is to show filament or heater continuity. This test

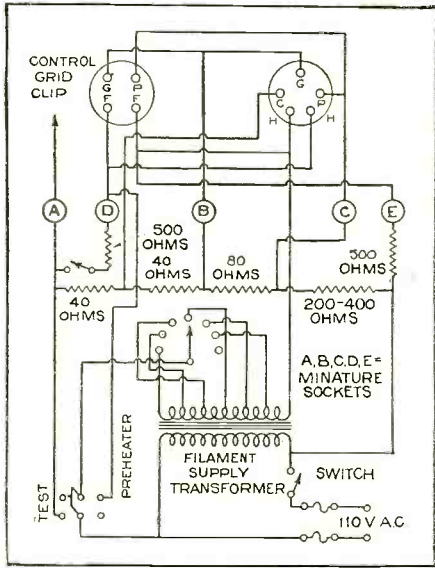

is made by closing the switch. If the filament of a tube inserted in either socket is unbroken, the lamps D and E will both light.

We thank the Radiotron Division of the R.C.A. for calling our attention to these errors.

### Victor, Crosley and Westinghouse

Paul J. McConnell, manager of the Radio Service Company, Buchtel, Ohio, sends the following comments on these receivers, along with a few notes on servicing in general:

"A Westinghouse WR5 super would not tune above 1000 kilocycles, but performed perfectly over the rest of the dial. Examination of the ganged condenser revealed no defect, but when the chassis was overturned, the grid coil contact of the first detector was observed to be touching one of the three tabs on the dial shaft which acts as a stop. Bending back the contact removed the difficulty.

"Victor receivers, models R-34, R-35 and RE-57, have some peculiar characteristics all their own. A loud roar, which

disappears only on very powerful signals, is usually caused by an open condenser or a rosin joint in the detector circuit. Low volume in these sets is usually due to an open voltage divider. A rushing noise, similar to but louder than a broadcast carrier, may be traced to a defective -24 tube in one of the r.f. stages.

"When a Crosley model 40-S goes completely dead, and tubes and voltages check okay, the trouble almost invariably is in the gang condenser which has slipped loose from the dial and is shorting the plates. In servicing these sets a few moments spend in correctly adjusting the tuning condenser will greatly improve sensitivity. Persistent oscillation in the model 77 is due to an open condenser across the cathode bias resistor in one of the r.f. stages.

"Since ours is a service organization, we sell nothing but accessories. We contract five large dealers in our territory at the rate of one dollar an hour. The rate to the customers is one-fifty an hour. A complete stock of replacement parts enables us to give one-day service in all but exceptional instances.

## News and Comment

(Continued from page 706)

that swallowing was impossible, the patient came to Dr. Bordier. For a period of twenty minutes each day Dr. Bordier passed through the chest at the spot where the esophagus had grown together powerful currents of high-frequency electricity of the kind used in radio and which have been applied by Professor d'Arsonval to many medical uses. After four days a tiny passage opened through the obstruction caused by the caustic scar. In a few more days the esophagus opened altogether.

## Pillowful of Music

(Continued from page 730)

listening, with the pillow tucked in between her head and the side of the old-fashioned wing chair.

Just what is the radio pillow? It is a specially designed porous-rubber sponge, in the shape of a small pillow, encased in the usual linen pillow slip. Located in the heart of the sponge-rubber structure is a sound-reproducing unit, which may be connected to a nearby radio outlet or radio set by means of a flexible conductor cord. By virtue of the porous-rubber construction of the pillow proper, the sound travels in all directions from the reproducer unit out toward the surface. However, the volume is greatest at the approximate center of the pillow surface, and diminishes toward the edges, so that a convenient form of volume control is to be found by moving the ear away from or toward the center of distribution.

### AROUND THE WORLD!

With your regular set

**SUBMARINER**  
**SHORT WAVE**  
**CONVERTOR**

**NOW ONLY**  
**\$12.50**



Television  
International Telephone  
Ship-to-Ship  
Police Calls  
Aircraft  
Loud Speaker Reception  
Distant Stations

READ WHAT USERS SAY—

J. W. Cantrall, Ill.: "I have used your 'Submariner' attached to my receiver for over two years and can say I got very good results. The usual stations I receive are G5SW, London, P.C.J. Holland, and D.H.C. Germany. I also hear VK2ME in Sydney, Australia and last Saturday A.M. had them with fine speaker volume. I don't believe there is a better way to get short waves than with the 'Submariner'."

Submariners available for all sets. Particularly adapted for superheterodynes. Price includes 3 interchangeable coils. Wave range—13 to 145 meters. Two additional coils available—wave range 140 to 300 meters at 60c each. **MONEY BACK GUARANTEE.**

**SERVICE MEN**  
Write for Information on the **ACROCYCLE OSCILLATOR**  
\$17.50

Order Today. Sent C.O.D. if \$1.00 accompanies order  
**J-M-P MFG. CO., INC.**  
3422 Fond du Lac Ave.  
Milwaukee Wisconsin

### SERVICEMEN SEND TODAY

for our  
**Exceptional FREE**  
offers  
Explained in  
Bulletin X-3  
**MORRILL CONDENSERS AND RESISTORS**  
are making a big hit with Servicemen everywhere.



**MORRILL & MORRILL** 30 Church Street  
New York City  
Sole U. S. A. Distributors of the Siemens & Halske Condensers, Resistors, Microphones and Interference Eliminators.

### Massachusetts Radio and Telegraph School

18 Boylston Street, Boston  
Send for Catalogue  
Tel. Hancock 8184 *Established 1905*

### HEARING DEVICE PARTS

Send for Our Price List Covering  
**DeForest Parts**  
To Make the Wonderful  
**RADIO NEWS AMPLIFYING EAR AID**

HEARING DEVICES COMPANY, Inc.

2448 Times Bldg., Times Square, New York

On Request We Will Be Pleased to Send Circulars Describing the New De Forest Audiphone for the Deaf Simple—Compact—Efficient—Moderate Price

### PATENTS TRADE MARKS COPYRIGHTS

"Little Ideas May Have Big Commercial Possibilities"  
PROTECT THEM BY PATENTS  
Send for our Free book. "HOW TO OBTAIN A PATENT" and "Record of Invention" blank.  
Prompt Service—Reasonable Charges—Deferred Payments.  
HIGHEST REFERENCES  
**VICTOR J. EVANS & CO.**  
Registered Patent Attorneys—Established 1898  
622-B Victor Building, Washington, D. C.

RADIO NEWS Export Service Department

Kindly put me in contact with American firms manufacturing the class of radio apparatus noted on attached sheets.

Name.....

Address.....

Business.....



## Electric Filter Design

(Continued from page 673)

The relation between decibels and current, voltage and power ratios from .0 to 20 decibels, is shown in Table I. By using the directions given at the bottom of the table its range may be extended upward to any desired value.

Now if we wish to state the absolute value of any of these quantities, we may say that it corresponds to power a certain number of db. above or below "zero level." In radio work, it is common to refer to zero power level as the power dissipated by  $\pi$  (3.1416) milliamperes flowing through 600 ohms resistance. This is approximately .006 watts. The zero level of current flowing in a particular circuit may then be computed, if desired, from a knowledge of the impedance into which it is flowing. For example, the zero level of a current flowing through a resistance of 60 ohms would be 10 mils. This is obtained by dividing .006 by 20 and extracting the square root.

When considering the total loss or gain of current by inserting a filter into a line, it is convenient to consider its components separately. This total loss is called the "insertion" loss and its components are the transfer loss, reflection loss and interaction loss. The insertion loss or gain of a filter is found in decibels by measuring the current  $I_1$  flowing through the load impedance before inserting the filter, measuring the current  $I_2$  through the load after inserting the filter, and taking 20 times the common logarithm of the ratio of the larger to the smaller current. If  $I_2$  is less than  $I_1$ , the filter gives an insertion loss. If  $I_2$  is greater than  $I_1$ , the filter gives an insertion gain. The same result could be accomplished by measuring the voltages across the load before and after insertion of the filter. A gain is possible when the filter matches the impedances in such a way that the reflection and interaction gains are greater than the transfer loss of the filter.

The transfer loss of a filter depends only upon the vector ratio of the series to its shunt impedances. The reflection loss depends upon how nearly the image impedances of the filters match the impedances into which and out of which the filter works. The interaction loss depends on both of these things. Only the transfer and reflection losses will be considered here, since the interaction factor is of minor importance and cannot easily be obtained from charts.

## What's New in Radio

(Continued from page 705)

auditorium having a seating capacity of from 300 to 400 people. The amplifier measures 15 inches long by 6 $\frac{5}{8}$  inches wide by 6 $\frac{1}{8}$  inches high and it weighs 18 pounds. While the model shown here operates from 110-volt 50-60 cycle a.c. supply, there are other models available to operate from 220-volt 50-60 cycle a.c. and 110-volt 25-40 cycle a.c. **Maker**—Webster Electric Company, Racine, Wis.



Broadcasting stations need trained men continually for jobs paying \$1,200 to \$3,000 a year.



Operators on ships see the world and get good pay plus expense.

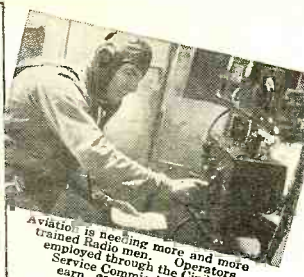

Aviation is needing more and more trained Radio men. Operators employed through the Civil Service Commission earn \$1,620 to \$2,600 a year.



Television—the coming field of many great opportunities—is covered by my course.



Talking Movies—an invention made possible only by Radio—offers many fine jobs to well-trained Radio men.

# You'll Get Thrills-Adventure BIG PAY in RADIO



J. E. Smith  
President

I will Train You at Home to Fill  
a Fascinating Job in Radio

Radio's Amazing  
Growth is Opening  
Hundreds of Big Jobs Every Year

Many Earn \$200 to \$1,000  
in Spare Time While Learning

You like action, romance, thrills! You'll get them in Radio—plenty of them! Big pay, too. That is why I urge you to mail the coupon below for my free book of startling facts on the variety of fascinating, money-making opportunities in this great, uncrowded field. It also explains how you can quickly learn at home to become a Radio Expert through my amazingly simple 50-50 method of home-study training. Hundreds of men who knew nothing about Radio before taking my course are today making more money than ever before.

You stay home, hold your job and learn in your spare time. (Lack of high school education or Radio experience are no drawbacks.) I teach you to begin making money shortly after you enroll. My new practical method makes this possible. I give you experimental outfits that give you practical experience building and servicing almost every type of receiving set made. Many of my students earn \$15, \$20, \$30 a week in spare time while learning. Lynn Henderson, 817 Elgin Court, Jackson, Mich., writes: "I have made at least \$1,500 servicing and repairing Radio sets and I am just starting my thirty-second lesson."

Thrilling Jobs That Pay  
\$50 to \$100 a Week

Get My Free Book

Send the coupon below for my 64-page book of opportunities in Radio and information on my home-study training. It has put hundreds of fellows on the road to bigger pay and success. I back my training with a signed agreement to refund every penny of your money if, after completion, you are not satisfied with the Lesson and Instruction Service I give you. Fill in and mail the coupon NOW!

Many fine jobs are open in Radio every year to men with the right training. For instance, you can see the world in grand style as a Radio operator on shipboard, with good pay plus your expenses. You'll also find thrills and real pay in Aviation Radio work. Broadcasting is another field that offers big pay and fascinating opportunities to men who know Radio. And think of the great, thrilling future for men with Radio training in Television and Talking Movies. My free book tells all about these and many other branches of Radio that bring you in contact with interesting people, pay big money, and make life pleasant, and how I train you for them.

J. E. SMITH, President,  
Dept. 2BRA  
National Radio Institute,  
Washington, D. C.

Act  
Now



Mail Coupon Today



\$400  
a Month

"The Radio field is getting bigger and better every year. I have made more than \$400 each month and it really was your course that brought me to this." J. G. Dahlstead, Station KYA, San Francisco, Calif.

Travelled  
75,000 Miles

"Dear Mr. Smith: I have traveled from 75,000 to 100,000 miles, visited ports in various countries, fished and motored with millionaires." (Signed) Robin D. Compton, Radio Station KSAC, Manhattan, Kansas.

Employment Service to all Graduates

J. E. SMITH, President  
National Radio Institute, Dept. 2BRA  
Washington, D. C.

Dear Mr. Smith: Send me your book, "Rich Rewards in Radio". I understand this places me under no obligation and that no salesman will call.

Name.....  
Address.....  
City.....  
State.....



# RADIO DEALERS and SERVICEMEN

*Here are two live items that wide-awake Dealers and Servicemen can cash in on.*

## THE RADIO DEALERS' ANTENAPLEX KIT

This RCA Antenaplex System, when properly installed, due to its superior design and complete shielding, transmits to the Outlet whatever the installed antenna receives. Interference that is not actually picked up at the antenna will be sealed out and not transmitted to the receivers. This system has been found very satisfactory to a great number of Dealers located in crowded and congested districts, where they have been bothered with a great deal of local interference. Many of you dealers who read this well know from sad experience what interference in radio reception will do when demonstrating good sets. It means many a sale lost through no fault of the set or your sales ability. Why not install one of these systems and decrease sales resistance?

The RCA Antenaplex Kit, Model RF-5000, consists of the following parts:

- 1—RCA Antensifier Box—Model RF-5001
- 1—RCA Antensifier—Model RF-5002
- 100 Feet—RCA Cabloy—Model RF-5050
- 100—RCA Cabloy Clamps—Model RF-5055
- 10—RCA Taplets—Model RF-5031
- 10—RCA Radio Outlet Flush Plates—Model RF-5634
- 1—RCA Terminet—Model RF-5091

Special Net Price to Dealers..\$100.00

*An attractive proposition awaits Radio Service Organizations or Servicemen doing a fair volume of business who are equipped to handle the RCA Antenaplex System. If you have contacts with Electrical and Building Contractors or are in a position to closely contact apartment house owners, write us for further information.*

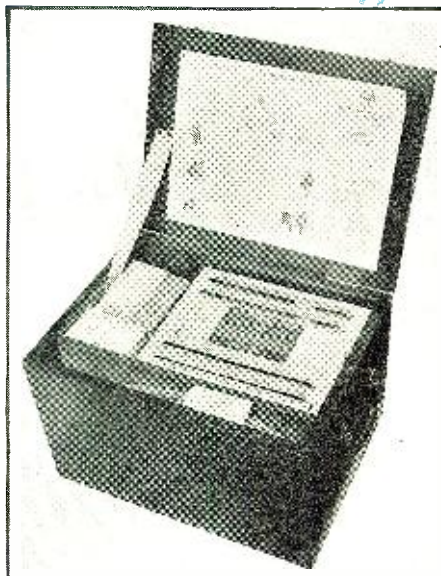

## The Radio Dealers' Antenaplex Kit

### THE RADIO PILLOW

Feature these Radio Pillows to your trade. Every customer is a prospect. Independent Servicemen and Servicemen connected with Radio Dealers send for literature telling of the many uses and sales appeal of this product. It allows an individual to listen-in to their favorite program without disturbing others. Ideal for use in Guest Rooms, Nurseries, Hospitals, etc.

List Price .....\$6.95



*One of the many uses of the Radio Pillow*



Centralized Radio System

## RCA Victor Co., Inc.

A Radio Corporation of America Subsidiary  
Camden, New Jersey

"RADIO HEADQUARTERS"

Centralized Radio Section  
RCA Victor Co., Inc.  
Camden, N. J.

Please send me full details on

- The Radio Dealers' Antenaplex Kit
- The RCA Antenaplex System (for Apts. etc.)
- The Radio Pillow

Name.....

Address.....



# SM

## THE FINEST BROADCAST RECEIVER THAT CAN BE HAD

In the 716-683  
Ten-Tube Broadcast  
Two-Unit Super  
Pentodes in Push-Pull  
Three-Vario-Mu Tubes  
Double Tone-Control  
Fractional Microvolt  
Sensitivity  
10 kc. Selectivity  
11 1/4" Electro-Dynamic  
Speaker



The 716 tuner as described above, completely factory wired, tested and RCA licensed. Size 16 1/2" long, 10 1/2" deep (exclusive of controls) 7 3/4" high. Shipping weight 25 lbs. Price \$69.50 LIST

The 683 amplifier is intended primarily for use with the 716 Tuner. Supplies required B, C. and heater currents. Designed to use with 855B Speaker (800 ohm field). See Page 7 of catalog for complete description. Factory wired and tested, RCA licensed. Price \$69.50 LIST  
The 855B Speaker..... Price \$20.00 LIST

### No All-Wave Receiver Will Beat the 726SW

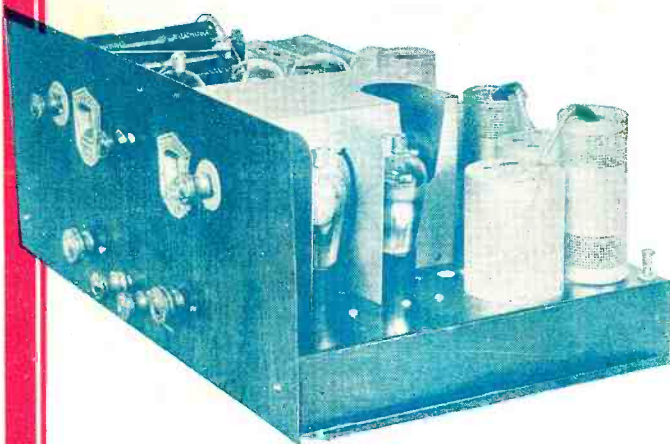

Tubes required: 2-'24's, 3-'27's, 3-'51's, 2-'47's, 1-'80.  
726SW All-Wave Superheterodyne, complete as described above, wired, tested, licensed, including S-M 855 11 1/4" electro-dynamic speaker unit. Size 20 1/2" long, 12" deep, 8 1/2" high. 110 volt A. C.....Price \$139.50 LIST

In the 726SW

Nine-Tube Broadcast Super  
Eleven-Tube Short-Wave  
Super  
No Plug-in Coils  
Pentodes in Push-Pull  
Three Vario-Mu Tubes  
Sensitivity Between .45 and .7  
Microvolts per Meter  
Selectivity Absolute 10 kc.  
11 1/4" Electro-Dynamic  
Speaker

SILVER-MARSHALL, Inc.  
6405 W. 65th Street, Chicago, U. S. A.  
 Please send me full technical details on the S-M 716-683 (enclosed you will find 2c).  
 Please send full technical details on the S-M 726SW (enclosed you will find 2c).  
 Please send me FREE your November General Parts Catalog.

Name .....

Address .....

**SILVER-MARSHALL, Inc.**  
6405 West 65th Street Chicago, U. S. A.

Canadian Division:

SILVER-MARSHALL of CANADA, Ltd.  
75 Sherbourne Street, Toronto

Export Office: 41 Water Street, New York City, U. S. A.