

SPECIAL SERVICEMENS' NUMBER

RADIO NEWS

**DECEMBER
25 CENTS**

**Ten Typical
Servicemens'
Workshops**

**"What I Think of the
Stenode Radiostat"**

**A Symposium by Leading
Radio Authorities**

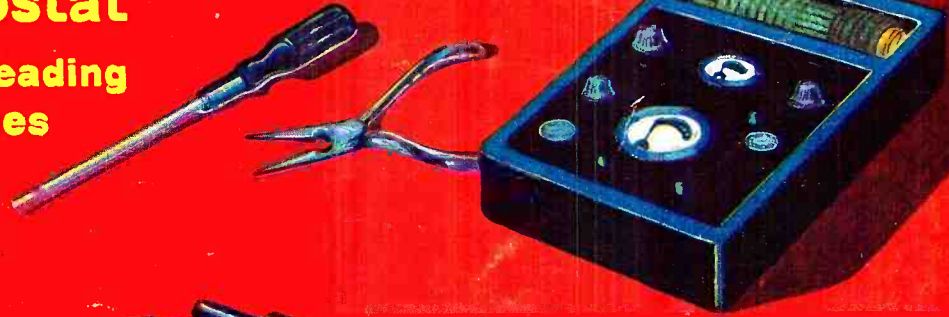
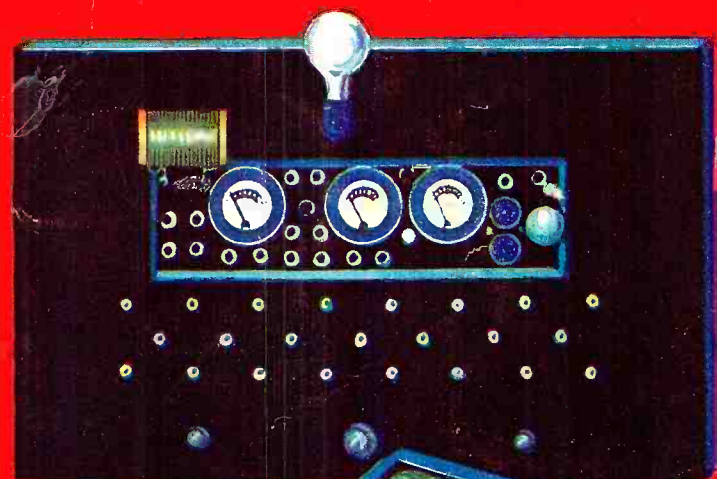

DAVID
SYNE

RADIO'S *Latest and Greatest*



Get This 168 Page Catalog

EVERYTHING AT LOWEST WHOLESALE! PRICES!

You Never Saw SUCH VALUES!

On every page of this remarkable Book of Bargains you will find items of interest—over 500 illustrations of the latest features in Radio receivers and equipment—sets, accessories, parts and kits.

Newest Improvements

All the 1931 marvels of Radioland—1931 Screen Grid, Tone Control, A. C. Humless All-Electric Sets, Mantle Sets, Public Address, Phono-Combinations, Dynamic Speakers, Beautiful Consoles—as well as battery operated sets. Also the brand new Slot Machine Radio—a big money-maker for restaurants, hotels, stores and public places.

A Slaughter of Prices

Old price standards are slashed to smithereens in our new quotations. The finest merchandise that skill can devise at lowest wholesale prices. We save you big money on any radio need.

At no time since the science of RADIO startled the world have you been able to secure such astounding values as the new Allied catalog brings you.

If you contemplate buying either a complete set or any single article of radio equipment, it will mean money in your pocket to have this 1931 book of wonderful radio values before you.

Our Buying Power

alone brings you these amazing values. With resources of over three million dollars, we maintain an enviable position in the buying market. You reap the benefit.

**Catalog is
FREE**

Every buyer of radio merchandise should have this catalog, with its myriad of money-saving features. Send for it today.



ALLIED RADIO CORPORATION

711 W. Lake St. Dept. B-3, Chicago

You Pay Only
\$48²⁵
for this
\$110⁰⁰ VALUE



We Could Have Placed 5000 More Qualified Men Last Year in Good Pay RADIO Positions

GET into the rich field of Radio via the training school that supplies big Radio employers with their new men! The Radio Training Association of America has a standing order from radio trade organizations, large manufacturers and dealers, for members qualified for full time work at splendid pay.

So great is this demand from Radio employers that positions offering good pay and real opportunity are going begging. If you want to cash in on Radio quick, earn \$3.00 an hour and up spare time, \$40 to \$100 a week full time, prepare for a \$10,000, \$15,000, \$25,000 a year Radio position, investigate the R. T. A. now.

Special Attention to Radio Service Work

Thousands of trained Radio Service Men are needed now to service the new all-electric sets. Pay is liberal, promotions rapid. The experience you receive fits you for the biggest jobs in Radio. The R. T. A. has arranged its course to enable you to cash in on this work within 30 days!

Would you like to work "behind the scenes" at Hollywood, or for a talking picture manufacturer? R. T. A. training qualifies you for this work. Television, too, is included in the training. When television begins to sweep over the country, R. T. A. men will be ready to cash in on the big pay jobs that will be created.

**Expert Supervision
Lifelong Consultation Service**

As a member of the Association you will receive personal instruction from skilled Radio Engineers. Under their friendly guidance every phase of Radio will become an open book to you. And after you graduate the R. T. A. Advisory Board will give you personal advice on any problems which arise in your work. This Board is made up of big men in the industry who are helping constantly to push R. T. A. men to the top.

Because R. T. A. training is complete, up-to-date, practical, it has won the admiration of the Radio industry. That's why our members are in such demand—why you will find enrolling in R. T. A. the quickest, most profitable route to Radio.

Mail Coupon for No-Cost Training Offer

Memberships that need not—should not—cost you a cent are available right now. The minute it takes to fill out coupon at right for details can result in your doubling and trebling your income in a few months from now. If you are ambitious, really want to get somewhere in life, you owe it to yourself to investigate. Learn what the R. T. A. has done for thousands—and can do for you. Stop wishing and start *actually doing something* about earning more money. Fill out the coupon and mail today.

**Radio Training Association of America
Dept. RNA-12 4513 Ravenswood Ave., Chicago, Ill.**

Fill Out and Mail Today!

RADIO TRAINING ASSOCIATION OF AMERICA
Dept. RNA-12, 4513 Ravenswood Ave., Chicago, Ill.

Gentlemen: Send me details of your No-Cost Training Offer and information on how to make real money in Radio quick.

Name _____

Address _____

City _____ State _____

KEEPING abreast of the times is one of the jobs which falls particularly to the lot of the serviceman if he is to maintain his standing as the neighborhood radio authority. In this issue of RADIO NEWS has been presented articles which the serviceman will find chockful of informative material.

George E. Fleming, our Technical Editor, made several rather complete visits through the RCA-Victor plant at Camden, New Jersey, and, in his article appearing in this issue presents the story of the exacting tests through which the RCA Radiola superheterodyne is put before it reaches the ultimate purchaser.

Joseph I. Heller describes in detail the design, construction and calibration of an extremely simple vacuum tube voltmeter for measuring radio or audio frequencies.

Serious-minded servicemen no longer depend on merely a pair of phones and a battery to do their testing. Take a look at the two-page photographic display of typical servicemen's test shops and note the character of the instruments and other testing apparatus with which they have equipped themselves.

RADIO NEWS for January

RADIO NEWS presents the exclusive story of the flight of the good ship "Pilot Radio" in the circumnavigation of two continents. Zeh Bouck, radio operator of the plane, presents the first in a series of three articles describing the high spots of this history-making flight.

More information on the Stenode Radiostat and other articles by leading radio authorities.

TABLE OF CONTENTS

Cover—From a Painting by David Hymes	
Frontispiece: The Three Musketeers of the Air.....	484
Editorial	486
Engineering Ingenuity in Production Testing..... <i>By George E. Fleming</i>	488
A New Vacuum-Tube Voltmeter..... <i>By Joseph I. Heller</i>	491
"What I Think of the Stenode Radiostat," a symposium of opinions.....	494
"No!" says Roxy..... <i>By Albert Pfaltz</i>	496
Eliminating Image Interference in Superheterodynes... <i>By McMurdo Silver</i>	499
Operating Schedules of the RADIO NEWS Radio Association.....	501
Explaining the Radio Laws..... <i>By Carl Butman</i>	502
In the Serviceman's Workshop.....	504
The Outstanding Design Features of the Unit-Built Receiver <i>By Donald Lewis</i>	506
Some New Circuit Developments in the Broadcast Superhet <i>By George E. Fleming</i>	509
Development of the Design and Testing of Broadcast Receivers <i>By Arthur E. Thiessen</i>	510
Making Modern Vacuum Tubes.....	512
Radio Helps Uncle Sam's Engineers Plan the Nicaraguan Canal <i>By Lieut. Stanley J. Horn and Sergt. Everett C. Smith</i>	514
Equipping the Waldorf-Astoria with Radio..... <i>By John Rutherford</i>	517
Practical Antenna Construction for the Amateur Transmitter <i>By Fred E. Schnell</i>	518
Tone Compensating Circuits for Audio Amplifiers (Part II) <i>By Julius G. Aceves</i>	520
A New A.C. Short-Wave and Broadcast Receiver..... <i>By Alex G. Heller</i>	522
How to Build the Audio-Scope..... <i>By J. D. Perdue</i>	524
Radio Revives the Lost Art of Reading..... <i>By H. Robinson Shipherd</i>	526
RADIO NEWS Home Laboratory Experiments.....	527
With the Manufacturers.....	530
RADIO NEWS Information Sheets.....	532
RADIO NEWS Manufactured Receiver Circuits.....	536
In the RADIO NEWS Laboratory.....	538
Junior Radio Guild.....	542
Index to Advertisers.....	574

25c a copy
\$3.00 a year

Published Monthly by

RADIO-SCIENCE PUBLICATIONS, INC.

183-10 Jamaica Avenue, Jamaica, N. Y.

Publishers, B. A. MACKINNON and H. K. FLY

Managing Editor, JOHN B. BRENNAN, JR.

Technical Editor, GEORGE E. FLEMING

Associate Editor, ALBERT PFALTZ

Editor, ARTHUR H. LYNCH

Entered as second class matter at the Post Office at Jamaica, N. Y., under the act of March 3, 1879.
Copyright, 1930, by Radio-Science Publications, Inc. Editorial and Executive Offices, 381 Fourth Avenue, New York, N. Y.
All Rights Reserved.

\$75,000.00 worth of standard merchandise at 75% off!

SEND FOR BIG FREE CATALOG

Going Big!

You are not fully equipped without our 40 page Catalog.

THE NEW MELORAD

Cathedral Tone

MANTLE SET

TRIPLE SCREEN-GRID

TRIPLE TONE CONTROL

MATCHED DYNAMIC

SPEAKER

Dealers and Servicemen!

Be prepared to meet the great demand for this popular radio set during the holiday season. Equals the performance of any console receiver and yet you can sell it for less than \$75.00 completely installed and still *double your investment*. Order your sample to-day and avoid the last-minute rush.

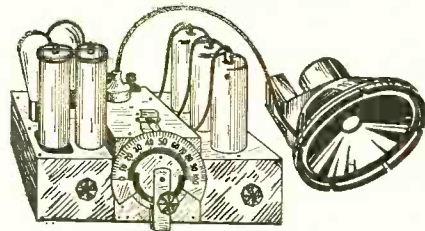

Chassis uses 3-224, 1-245 and 1-280 tubes and is equipped with matched dynamic speaker. For chassis and speaker. Tubes, \$2.50 extra.



Housed in this gorgeous walnut Gothic Cabinet 16 1/2" high, 14 1/2" wide and 10 1/4" deep. Only

\$26⁹⁵ | \$24⁵⁰

REPLACEMENT Condenser Blocks

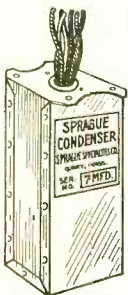

- Peerless Courier, as illustrated, ea. \$1.75
- A K 37 4.80
- Majestic B 2.95
- Victor R32 3.25
- R C A 18, 33 and 51 1.50
- R C A 17 4.95
- R C A 41 4.25
- R C A 60, 62 5.95
- Zenith 11B 3.25
- Brandes B15 2.95
- Kolster 6H 2.95
- Kolster K21 2.50
- Kolster K43 3.25
- Kolster K22, 20, 42 3.25



We Carry a Complete Line of Microphones, Turntables, Pick-ups and Amplifiers for Public Address Systems and Theatres.

Universal Baby Mike. A real microphone, single button, with covers and 25 ft. of cable. List, \$7.50. Our Price, \$4.50.

Carryola Synchronous Motor

Complete with turn-table. Silent, sturdy and compact, only 1 1/4" thick. No brushes. Only \$4.25.

Bosch Power Amplifier

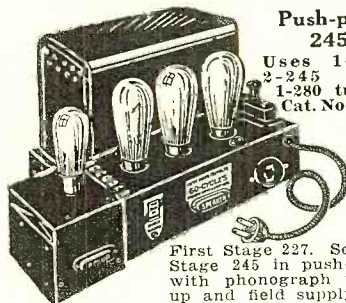

Push-pull 245 Uses 1-227, 2-245 and 1-280 tubes. Cat. No. 7031

First Stage 227. Second Stage 245 in push-pull, with phonograph pick-up and field supply for 2500 ohm D. C. dynamic speaker with or without input transformer (specify which). Also furnishes filament and plate voltage for 224, 227 tubes. Can be used to convert any battery set into an up-to-date A. C. receiver with 245 push-pull audio. **OUR NET PRICE, \$19.50**

Power Transformers For all Standard Sets Carried in Stock

VARIABLE LINE VOLTAGE → 105V. 115 120V.

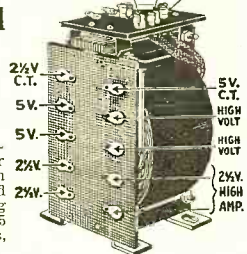

- Model illustrated is for A. C. Dayton Navigator and other sets using 224, 227, 245 and 280 tubes, \$3.85.
- Freshman Q \$ 6.75
- Freshman QD 7.85
- Philco sets 3.75
- Zenith 33, 35 3.25
- Radiola 44, 46 4.95
- RCA Double Choke95
- AK40-42 Power Pack 11.50
- AK46 Power Pack 15.00
- Sonora B33 4.75
- RCA Audio55
- Earl 21, 22 2.25
- Radiola 60, 62 5.95
- Kolster K20 2.25
- Stromberg-Carlson 642 3.95
- Step down 220 to 110V 3.95
- Kolster 6H 7.50

Dynamic Speakers

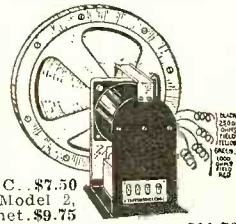

- Peerless Giant Auditorium, 12" Diaphragm, 110 V., A. C. \$14.50
- D. C. with 1000 and 2500 ohm fields \$10.00
- Peerless Courier, 7" D. C. \$7.50
- Baldwin, 9", A. C. \$7.50
- Temple A. C., Model 2, in Walnut Cabinet. \$9.75
- Peerless 17A, in cabinet. \$11.50

Voltage Dividers, Fixed Resistances and GRID Suppressors

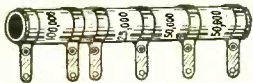

Ward-Leonard, Aerovox, Ohmite and Hy-wait wire wound resistances from 33 to 250,000 Ohms for all standard sets at 20 to 50c each. Full description in our catalog.



Centralab, Frost, Yaxley, Clarostat, Bradley-ohm, Carter and Electrad Variable Volume Controls and Potentiometers

All sizes from 2 to 500,000 ohms carried in stock for replacements in all standard sets. Prices from 20 to 45c each. ALSO Wire Wound and Carbon pigtail resistances from 10 ohms to 5 megohms at \$1.50 per dozen.

FOR PRICES GET OUR CATALOG

MAIL YOUR ORDER TO

Federated Purchaser

20 HUDSON ST., NEW YORK, N. Y.

TERMS:—20% with order, balance C.O.D. 2% discount allowed for full remittance with order only.

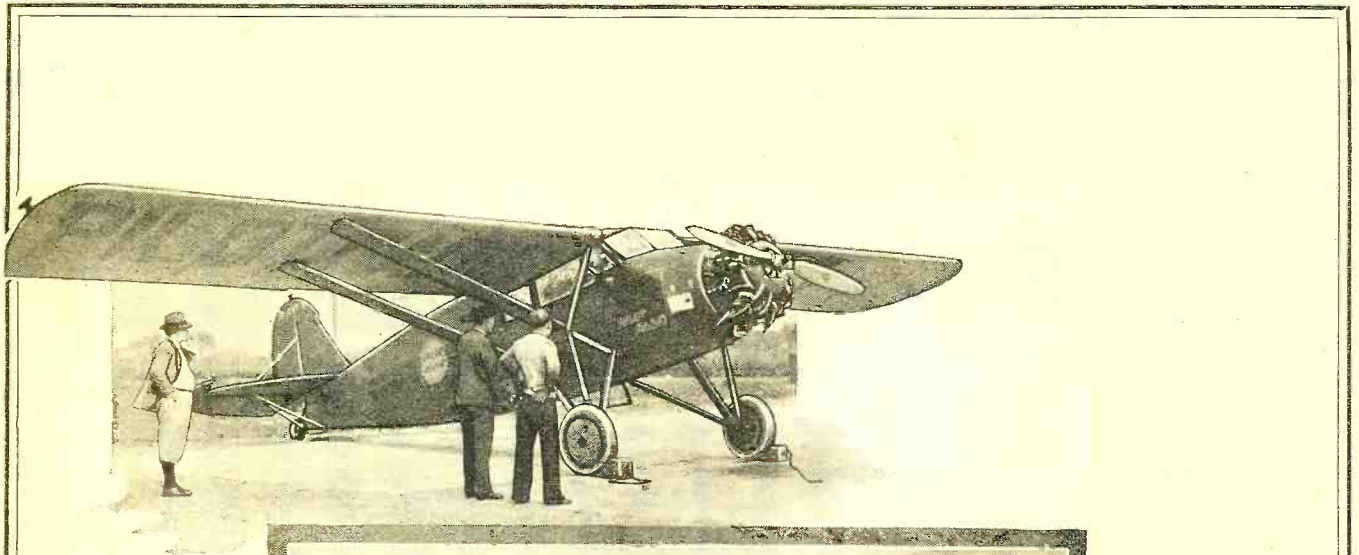

The Three Musketeers of the Air

EMIL BURGEN, pilot; Zeh Bouck, flight radio engineer; Lewis Yancey, navigator, and the good ship "Pilot Radio" at Roosevelt Field, New York, just before their take-off on the South American Good Will Tour. In three succeeding issues of RADIO NEWS Zeh Bouck will tell the inspiring story of this flight and how short-wave radio hung up some new records for itself

Get Into One Of These BIG PAY FIELDS

All practical work on real
Electrical machinery

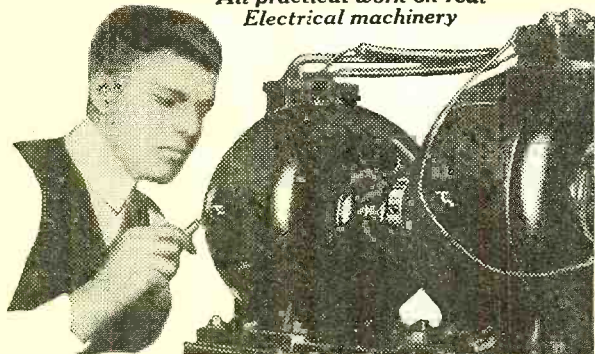

Amazingly Easy Way to Get Into ELECTRICITY

Don't spend your life waiting for \$5 raises in a dull, hopeless job! Let me show you how to make up to \$60, \$70 and even \$200 a week, in Electricity—NOT by CORRESPONDENCE, but by an amazing way to teach that makes you a practical Expert in 90 days!

Learn Without Books in 90 Days

No Books! No Lessons! You learn by doing actual electrical work right here in the Coyne Shops. You are trained on huge motors, generators, switchboards, transmitting stations, power plants, auto and airplane engines, etc. You don't need advanced education or previous experience. You qualify for real electrical work in 90 days!

Earn While You Learn

Don't worry about a job! You get FREE life-time Employment Service. And don't let lack of money stop you. If you need part-time work to help pay living expenses, I'll help you get it. Coyne is 31 years old. Coyne training is tested. You can find out everything FREE. Just mail coupon below and I'll send you my BIG FREE ELECTRICAL BOOK, telling all about jobs—salaries, etc. This does not obligate you. Just send the coupon below!

Student working on Television
transmitter in
Coyne Radio Shops



Learn RADIO TELEVISION TALKING PICTURES

Every branch of Radio is calling for trained men! 5,000 Service Men needed at once. Big call for Wireless Operators, both at Sea and in the Air. Many jobs open in Broadcasting Stations. Talking Picture and Sound Experts in great demand. And now Television is on the way! Soon there'll be a demand for thousands of Trained Men in this one branch alone.

Say "good-bye" to \$25 and \$35 a week—get into Radio, where thousands of jobs are open, paying \$60 a week and up.

NOT BY CORRESPONDENCE

By Actual Work — in 8 Weeks

Come to Coyne and learn Radio in 8 weeks! NOT BY BOOKS OR CORRESPONDENCE, but by actual Radio work on actual Radio equipment—on scores of Radio receivers, huge Broadcasting equipment, the very latest Television transmitters, Code Practice apparatus, Talking Picture and Sound equipment, etc. No experience needed. You learn all branches of Radio in 8 weeks.

Free Employment Service

After you graduate, I'll help you get the Radio Job you want—and if you need part-time work while at school, I'll help you get that, too. Coyne has been training men since 1899. Let Coyne train you for a Big Pay Radio Job! Mail coupon below for a copy of my BIG FREE RADIO BOOK, telling all about Radio, Television, Talking Pictures, Wireless, etc. This costs you nothing. Just mail coupon below.

MAIL THIS COUPON FOR BIG
FREE ELECTRICAL BOOK..

H. C. LEWIS, PRESIDENT
COYNE ELECTRICAL SCHOOL, Dept. 90-27
500 South Paulina Street, Chicago, Illinois

Gentlemen: Please send me your big Free Electrical Book with 151 illustrations. This does not obligate me.

Name

Address

City..... State.....

MAIL THIS COUPON FOR BIG
FREE RADIO AND TELEVISION BOOK

H. C. LEWIS, PRESIDENT
RADIO DIVISION, COYNE ELECTRICAL SCHOOL
500 S. Paulina St., Dept. 90-8C, Chicago, Ill.

Gentlemen: Send me your Big Free Radio Book and all details of your Special Introductory Offer. This does not obligate me in any way.

Name

Address

City..... State.....

Superheterodynes!

THIS will be a superheterodyne season. The recent decision made by the Radio Corporation of America to extend to its licensees the right to utilize its superheterodyne patents, which up to now have been held for exclusive use by the Radio Corporation alone, presages another new day in radio.

Most recognized radio authorities agree that with our present knowledge of the radio art, the superheterodyne, when properly engineered, can be made the radio receiver which most nearly approaches the ultimate. We believe with them that the superheterodyne can be made as sensitive as any occasion warrants, as selective as we may desire and capable of more than ordinary tone fidelity. We have our own ideas about how this trio of requisites should be incorporated in a single receiver. In our own ideal superheterodyne for receiving existing broadcasting, it should be operated from the light socket. It should be selective enough to provide 10-kilocycle separation even in the vicinity of high-powered local stations. It should have an intermediate-frequency amplifier capable of passing a band of frequencies 10 kilocycles wide, and a second detector capable of transmitting to the audio amplifier all of the frequencies necessary for 10-kilocycle reproduction in our homes.

Up to this point the building of a superheterodyne to meet these requirements is not a particularly difficult engineering feat. However, after we pass the detector tube a perfectly even response through the audio amplifier and the loud speaker from 1 to 10,000 cycles is an engineering problem which up to now has never been accomplished. It is in the audio channel, therefore, and in the loud speaker itself, that we look for the greatest improvement during the coming year.

Certainly the practicability of the superheterodyne should recommend itself strongly to every thinking radio engineer. It is comparatively simple to design, not at all difficult to turn out on a production basis and it lends itself as no other receiver does to the advantages to be gained by remote control. With the introduction of the superheterodyne and suitable tuning control systems, we believe that the next year will see most of the radio equipment in de luxe installations relegated to an out-of-the-way closet or cellar while the only devices found in our living-rooms will be the tuning control boxes and loud speakers. The application of this same idea to automobile, motorboat and aircraft radio receivers will enable us to utilize a type of remote control having no mechanical features whatever which will eliminate most of the troubles encountered in devices of this kind up to now.

At the same time that we see a particularly bright future for the superheterodyne we do not in any way believe that it will, as some authorities have prophesied, cause the complete abandonment of the tuned radio-frequency type of receiver. Receivers of the latter type are doing now what engineers a few years ago said would never be possible, and it is very likely that improvements in tuned radio-frequency receivers will keep step with the rapid development we expect in the commercialization of superheterodynes.

Arthur H. Szyck

R. T. I. R. T. I. QUALIFIES YOU TO MAKE MONEY AND ITS SERVICE KEEPS YOU UP-TO-THE-MINUTE ON THE NEWEST DEVELOPMENTS IN RADIO, TELEVISION, AND TALKING PICTURES R. T. I.



TRAINED AS R. T. I. TRAINS THEM AT HOME FOR PRACTICAL WORK

Radio wants trained men and pays them well. This great industry would rather pay Big Money to men trained as R. T. I. trains them, than low wages to untrained "tinkers" and "guessers." Trained radio men can easily make \$40 to \$50 per week and upwards. With training and experience many make \$75 to \$100 per week and are always in demand. Get the inside facts from leading radio men in the free "R. T. I. Radio Opportunity Book."

BETTER JOBS - BIGGER PAY

R. T. I. offers you the way to get into Radio right, and the definite path to the Better Jobs and Bigger Pay. You need no experience to start. You can quickly make \$10 to \$20 per week Extra Money in spare time while learning.

APPROVED TRAINING

R. T. I. training is endorsed by leading Radio Concerns and Radio Trade Associations. It is prepared and supervised by well known men in different branches of radio. You will find it interesting, practical, thorough and easy to understand.

LEARN AT HOME

Why? Because the fellow who trains at home the R. T. I. way learns rapidly and makes a most valuable man. R. T. I. gives you the training the radio industry wants you to have for important work.

Make your success certain. Start R. T. I. training in radio now. Go on up in this great money-making industry that is becoming part of all our daily life. Entertainment, Education, Business, Transportation, News—all depend more and more upon radio.

GET PAID FOR WHAT YOU KNOW

Be a trained man. R. T. I. gives you money-making radio training and keeps you up-to-the-minute with its service. No more worry about jobs when you complete R. T. I. training.

TELEVISION

This amazing new branch of radio is part of the R. T. I. training. (No extra charge.) Be prepared for this new work—Television Service-men will soon be in demand.

TALKING PICTURES

Require trained men—in the studios—the theatres—for servicing and installing the apparatus, and R. T. I. training covers this, too. Broadcasting Stations, Airplane Radio Apparatus; Sea-going Ship Radio Operating; Radio Factories; Selling; Repairing, etc. All these opportunities are included in R. T. I. training.

Free Opportunity Book

Get the facts about the opportunities in Radio, Television and Talking Pictures in this wonderful book—it is free.



Lot H. SCHNELL
and the R. T. I. Advisory Board Help You

20 years' Radio Experience. First to establish 2-way amateur communication with Europe. Former Traffic Mgr. of Am. Radio Relay League, Lieut. Com. U. S. N. R. Inventor and Designer. Cons. Radio engineer.

Assisting him is the R. T. I. Advisory Board, composed of men prominent in the Radio Industry—manufacturing, broadcasting, engineering and servicing. All these men know Radio and will help you succeed in their field.

RADIO & TELEVISION INSTITUTE
4806 St. Anthony Ct., Chicago, Dept. 849

Mail Coupon for Big FREE BOOK



RADIO & TELEVISION INSTITUTE
4806 St. Anthony Court, Chicago, Dept. 849

Send me Free and prepaid your BIG RADIO OPPORTUNITY BOOK, "Tune In On Big Pay," and full details of your three-in-one Home Training (without obligating me in any way).

Name.....
Address.....
City..... State.....

THE R. T. I. ADVISORY BOARD. These men are executives with important concerns in the radio industry—manufacturing, sales service, broadcasting, engineering, etc., etc. They supervise R. T. I. Work Sheets, Job Tickets, and other training methods.

R. T. I. R. T. I. TRAINS YOU AT HOME FOR A GOOD JOB OR A PROFITABLE PART TIME OR FULL TIME BUSINESS OF YOUR OWN

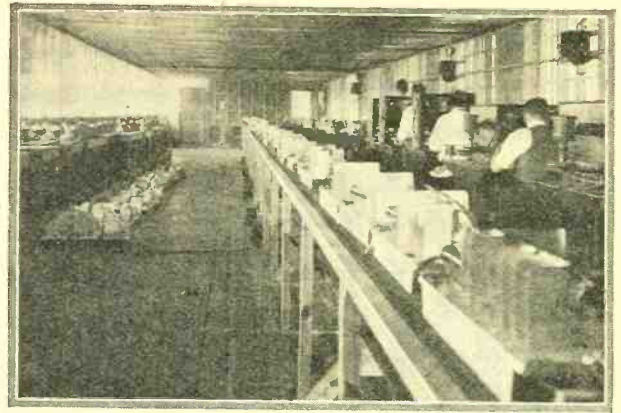
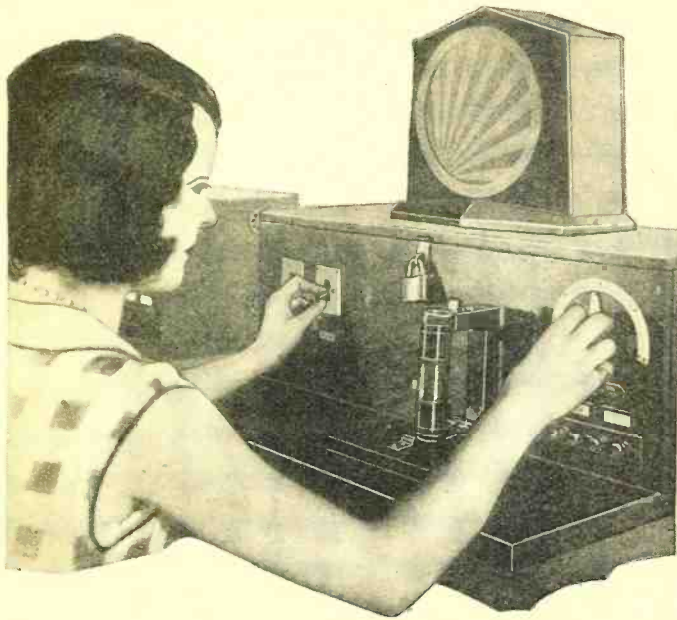

(Above) Production line of a large manufacturer. Six thousand receivers pass along such lines as these every day in this plant

(Left) Measuring tuning coils by utilizing them in an oscillating circuit. One of the most accurate methods known

ENGINEERING INGENUITY

IF the production of a commercial receiver involved only the design engineering of the receiver and the assembly of the parts, 'twould be a simple matter. However, these problems are frequently the simplest that the engineers encounter. They must not only know that the receiver is of proper design, and that the various units that comprise the complete assembly fit onto the chassis properly, but they must also know that the complete assembly is adjusted to maximum efficiency, that each and every part is fabricated in a manner that assures consistent operation in our homes. To accomplish this end, testing apparatus must be designed that will, within reason, tell the operator all that there is to know about the "innards" of each individual chassis, and when we consider that the production schedule calls for some six thousand sets a day, these tests must be very complete.

In the production of the current model of the RCA-Victor receiver every part is tested at least five times in the course of the building of the complete chassis. The first test comes at the time the part is raw material, the second when it is formed into a part, the third when it becomes a portion of an assembly, the fourth when the chassis is complete, and the final test when the chassis is a part of a complete receiver. It is to tell the story of the engineering ingenuity behind these testing units, many of which require far more work on the part of the engineers than the actual design of the receiver, that this story is written.

The production line is a movable belt that conveys the chassis along from one operator to another, so that each in turn may do their little bit toward building a receiver. Most of this work is done by women, for men, as a rule, lack the capability of taking infinite care in this tedious type of work. At strategic intervals along this line are located the test positions, and show up any defect that may exist in the chassis at that point. If a fault develops between one test position and the next, it is clear that the fault lies in the work done between the two positions, and it is a simple matter to catch and correct the fault, so that the chassis may again be placed on the line, and carried forward. But we are getting ahead of our story. Let us see just what

We little realize, sometimes, just what not sufficient to know that the best of sign of that product is of the best. What insure us that we are getting the best with materials used and design. The give us a good insight into the methods make sure that that

By George E.

tests are made on the individual parts, a resistor, for instance. The operator here, while probably unaware of the fact herself, is in reality making very exacting laboratory tests of resistance, for the circuit of her particular testing unit is a familiar Wheatstone bridge, which, instead of being adjustable for measuring wide ranges of resistance, is set to measure only this one value, and the galvanometer is calibrated to read "O. K." or "Reject." The unit is as accurate as any found in the laboratory, and operates in exactly the same manner, with the exception that the operator need not be an expert in measurement work, as the "thinking" has been done in advance by engineers.

A separate test position is used for each different value of resistance used, and the positions are calibrated daily.

Just as exhaustive are the tests upon the chokes and transformers used in the audio end of the receiver. In this case, a bridge circuit is again used, for inductance measurements. The meters are calibrated simply, "O. K." or "Reject," as in the previous instance. But here the test is carried further. The "Hipot" test is made by applying 1500 volts from the winding to the core, as a breakdown test. In this test, the choke, or transformer, is completely covered so that there will be no danger to the operator. If

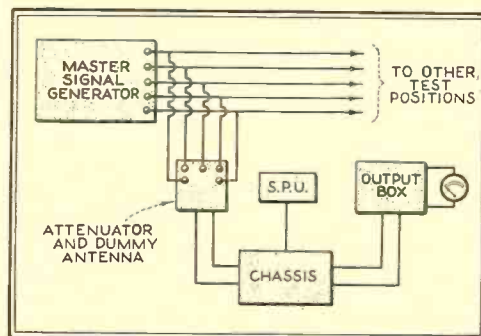
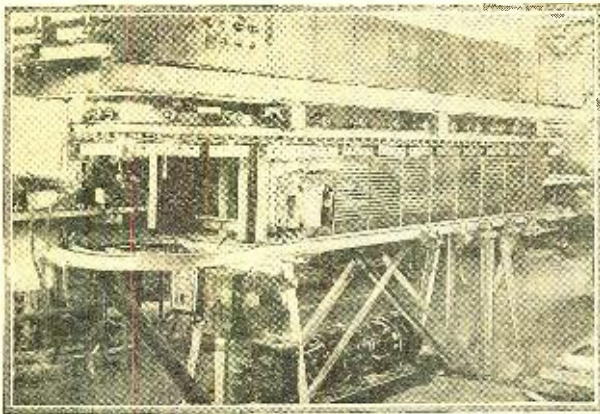
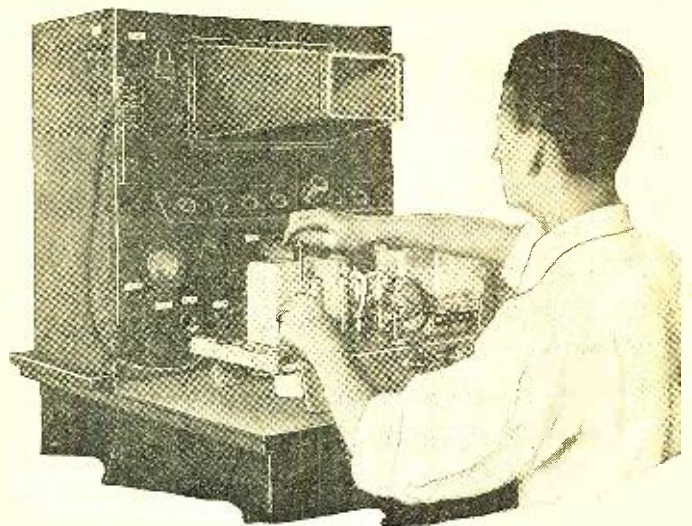

Fig. 1. Hook-up of the master signal generator to the various test positions. Five frequencies are available in each position



(Above) The machine for testing power transformers. This device is almost uncanny in its work, and more accurate than human testers



(Right) The visual tester for intermediate amplifiers. This machine draws a gain and selectivity curve in thirty seconds that would require hours of laboratory work if done by hand

in PRODUCTION TESTING

goes into the making of a product. It is materials are used, or even that the does count is what methods are used to product that can be given as compatible testing methods used by one company adopted by engineers in their effort to end is accomplished

Fleming

Again, the operator is relieved of the necessity of interpreting the readings.

The test unit for the tuning coils is another clever bit of applying good principle. Here, the coil is made a portion of an oscillating circuit, which beats with another oscillating circuit which uses a standard coil. If the two coils are identical, the resultant beat will be zero, but since this is rarely the case, the coil under test is tuned with a very small condenser. The dial of this condenser is calibrated to read "O. K." or "Reject" according to the amount of tuning necessary to accomplish a zero beat. This is said to be the most accurate method of testing coils known, and in production they are held to about one per cent.

When it comes to giving brains to a piece of machinery, however, the engineers have excelled themselves in the design of the device for testing power transformers. This machine consists, superficially, of a vertical belt that rotates around an oblong frame work, about ten feet long. Equispaced along this belt are fixtures for holding transformers.

However uninteresting this may look, in action it is extremely inter-

there is leakage from the winding to the core, a red light lights, if the unit is O. K., a green light flashes.

esting. The operator places a power transformer in a cradle, with the leads connected to appropriate spring clips on the cradle. The cradle is then placed in the fixture on the machine. As it passes various points on its journey around the belt, 120 volts is applied to the primary, and the voltage and current are in turn measured from each secondary. As a final test, 1500 volts is applied between all windings and the core, as a breakdown test. If any fault has been located in the transformer, it automatically is released from the machine onto a moving conveyor, is carried back to the salvage department. If it has been proven perfect it remains in place until the end of the trip, where it is released onto another moving belt that carries it to the assembly line. All this is done automatically, and requires no attention from operators except that of placing the transformer on the machine. Speaking of robots, here is one!

But to come along to the radio frequency tests. Here we find the greatest co-ordination of effort among the engineers, the highest type of operators, the very best apparatus that brains and money can build. In short, to all appearances, absolutely nothing has been neglected that would assure accuracy of results. For instance, let us take the visual test on the intermediate amplifier, after its assembly.

We all know that engineers interpret the gain and selectivity of amplifiers by the drawing of curves from data taken from careful quantitative measurements. To do this by hand on a production basis it would be well nigh impossible

for it would require an army of laboratory technicians. Yet these curves are drawn on each individual amplifier with all the care that a laboratory technician would take on the problem, and the entire test takes about thirty seconds!

The apparatus necessary to do this consists of an oscillator, which is tuned by a condenser driven by a motor. The same motor drives a mirror, so that the condenser and mirror revolve in exact synchronism. The mirror is four-sided, so it is geared to revolve once to every four revolutions of the condenser. The input to the amplifier is connected to the output of the oscillator, and the output of the amplifier is connected

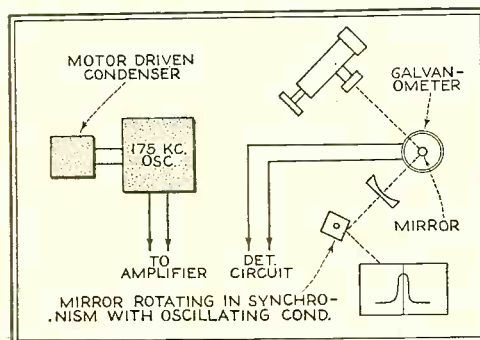
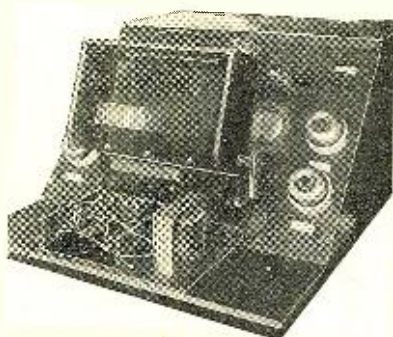
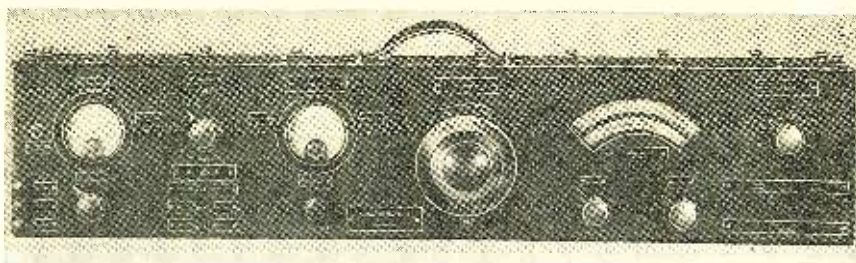

Fig. 2. The visual tester of intermediate amplifiers. This is the way the "curve drawing" machine is designed

to a galvanometer. The indicator of this galvanometer is a mirror. Referring to Fig. 2 will make this clear. The light from the lamp falls on the mirror of the galvanometer, from whence it is reflected through a condensing lens to the revolving mirror. The revolving mirror in turn reflects the light ray onto the ground glass screen. Now let us see what happens. As the condenser revolves, it approaches the 175 k.c. tuning point, (this is the frequency at which the amplifier is peaked), just as the revolving mirror picks up the ray reflected from the galvanometer. The motion of the revolving mirror moves the light ray along a horizontal axis, while the galvanometer mirror moves it along a vertical axis. When all actions are balanced, the peak of the vertical axis comes at the centre of the horizontal axis, just when the oscillator reaches the 175 k.c. band. The action is carried on to complete the curve, the condenser passing the 175 k.c. point, and the curve begins to drop. This action is repeated 16 times a second, so that the curve appears to be a solid light line on the ground glass screen. The operator adjusts the intermediate amplifier tuning units to make the curve fall between predetermined limits. It is interesting to watch this visual test, and see the curve assume various shapes as the operators align the amplifier. As a matter of fact, this test on the complete amplifier is the second visual test of this nature, as the same test has previously been made on the intermediate transformers individually before assembly into the complete amplifier.

After the alignment of the intermediate amplifier, comes the tests on the complete chassis. For this test, a double screened room is necessary. For when properly adjusted the receiver has a sensitivity of about .5 microvolts per meter. The necessity for the shielded room was graphically demonstrated to the writer, when one of the operators, for a demonstration, stuck a one-foot piece of wire out of a window, through the screen. This was in Camden, N. J., and WEAJ in New York was tuned in with ease.

A standard Master Signal Generator, with five frequency channels, is used to supply radio frequency current to the various test positions. Illustrative of the difficulties to be encountered in precision testing, months and months of work were necessary to develop transmission lines to operate at this fre-



(At top) The laboratory standard oscillator by which testing units are calibrated daily. (Above) Inductance, shorted turns and "Hipot" tests on chokes and transformers

quency. The master generator is crystal controlled and the output is kept constant at all times. The operator takes the complete chassis, and attaches the dummy antenna and ground. The attenuator circuit is set at a predetermined point, and the receiver adjusted to a given reading on the output meter. This is done at five frequencies. Here, too, the dial is set to read properly at the five frequencies used to test the receiver. This test, passed, the chassis is placed in its cabinet, and the entire test is again conducted. In this last and final test, two of the frequency bands are modulated with music furnished by an automatic phonograph, which changes records and needles automatically, so that a constant "program" is available. This test immediately shows up any speaker rattle that may have escaped the tester of the loud speaker unit, as the records are chosen with the end in view of having wide frequency ranges.

So we can readily see that designing a receiver is only the start of the engineers' job, if we may be pardoned repetition. They must know that the most minute part that goes into the assembly is perfect in every detail, and that the components are assembled and wired in a manner that assures their consistent operation in service. They must know that the finished product is just as good as the laboratory model.

Wholesale Production of Precision Measurements

How well the testing engineers have accomplished their aim is readily attested in the testing units that have been described in the foregoing article, as well as many others that space has forbidden mention, such as automatic micrometers for testing screws, gain and fidelity tests on individual audio transformers, capacity and breakdown tests on condensers, and many others. Literally the testing department is a laboratory dealing in wholesale production of precision measurements. While it is true that one department in a commercial organization is just as important as the next, nevertheless much of the excellence of the Radiola "super" is directly traceable to the exacting tests through which it passes.

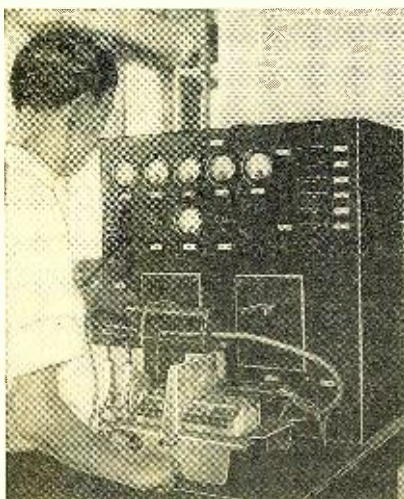

(Above) Resistors are tested by a Wheatstone bridge circuit. The galvanometer is calibrated "O.K." or "Reject"

(Left) Continuity test of entire chassis after wiring, at one operation. Dummy loads are used, consisting of fixed resistors, of proper value, so that operating conditions are simulated

(Right) The master signal generator, crystal control, on five frequencies. This unit furnishes radio frequency to the test positions, through a specially designed transmission line

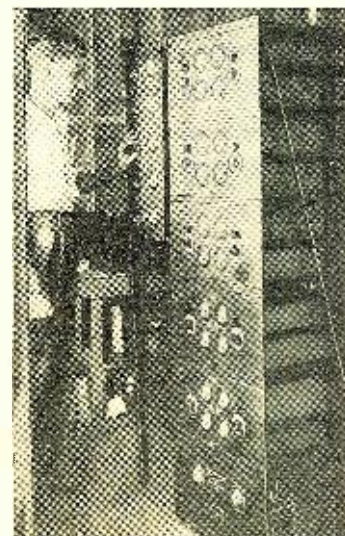

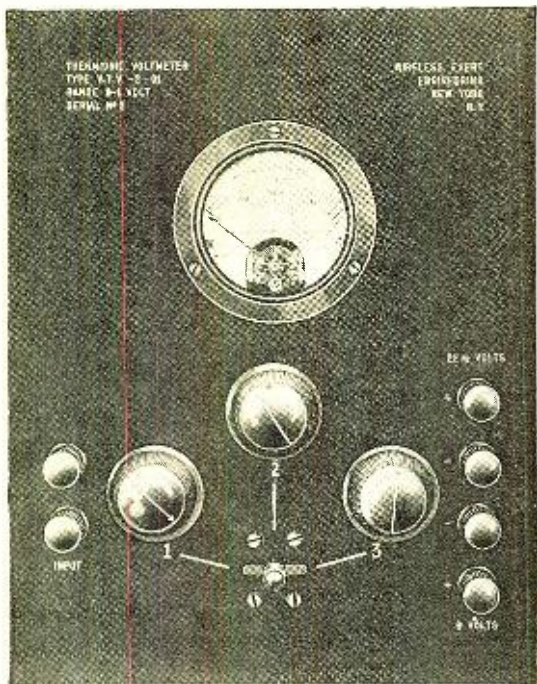

A New Vacuum-Tube VOLTMETER

For Measuring Audio and Radio Frequencies

By Joseph I. Heller*

With good tools a good workman can produce a better piece of work than if no tools or inferior tools were used. This is particularly true of the experimenter and laboratory man. One of his most important laboratory tools is the vacuum tube voltmeter, an accurately calibrated device for measuring audio and radio-frequency voltages. The author, well known to RADIO NEWS readers for his design and developmental work on laboratory equipment, describes here his latest radio tool

SOMETIME ago the writer of the present article brought before the readers of this magazine an article concerning the design and construction of a special vacuum tube voltmeter and current amplifier. Since the time of publication of the above mentioned article requests have been arriving for information concerning a vacuum tube voltmeter which would require fewer parts and yet remain perfectly stable and accurate. In response to these requests we have designed a vacuum tube voltmeter which is extremely accurate and which has several distinctly novel features contained in it. The most important of these features is the fact that the circuit includes, without any additional apparatus, an automatic calibration apparatus which insures the adjustment of the voltmeter to the exact point at which it was initially calibrated. This feature will be described in complete detail later.

Allow us, first, a few words of theory concerning the meter. When a circuit is arranged as in Fig. 1, and battery C is made a value high enough to completely or almost completely cut off the plate current through microammeter M, an impressed alternating voltage across terminals a and b will result in a net increase in current through M. The reason for this will be made quite clear by a study of Fig. 2. Consider the wave W to be

the alternating voltage impressed on terminals a and b of the circuit, Fig. 1. At the start of the wave as shown, the voltage rises positively. From W, the vertical lines r, s, t, etc., are drawn to the grid-voltage plate-current characteristic curve C of the tube. The vertical distance of these lines above the line O indicates the plate current at that particular instant. It can be seen, therefore, that while the input wave is increasing positively, the plate current goes through a corresponding increase as shown by the initial part of current wave V. As the impressed voltage begins to decrease the plate current will also decrease until it reaches zero. The grid voltage, however, continues in a negative direction. This part of the wave has practically no effect on the plate current since the plate current has already reached zero. As a result the shape of the plate current wave will be as indicated in Fig. 3. Since the plate current flows through a meter which does not follow rapid variations, the meter reading is indicated by the dotted line in Fig. 3.

I hope I have made clear in the above paragraph the reason for the plate current reading. At this point another problem presents itself. At the beginning of the design we set ourselves the problem of determining a circuit which would give full scale deflection on a 200-micro-

*Chief Engineer, Wireless Egert Engineering, Inc.

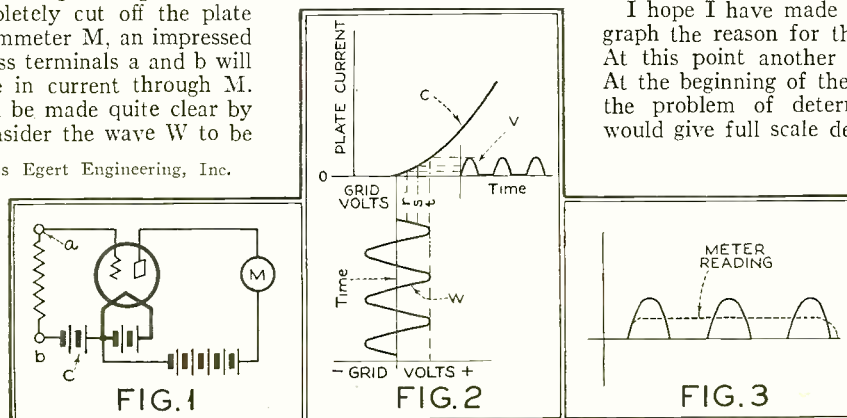

A simple tube circuit, with bucking battery to cancel out the normal plate current

When signal is impressed on the grid as shown in Fig. 2, the meter reading is as indicated in Fig. 3

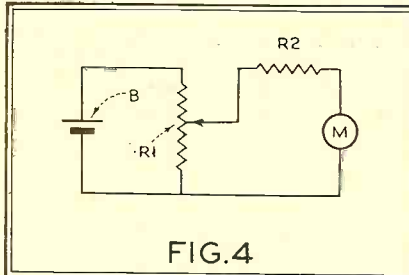

FIG. 4

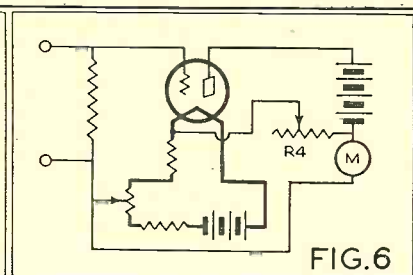

FIG. 6

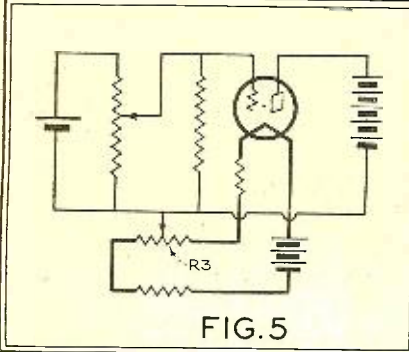

FIG. 5

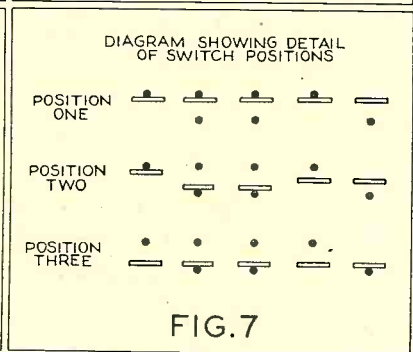

FIG. 7

The three circuits shown in Figs. 4, 5 and 6 are those which are obtained when the switch on the front of the panel of the v.t. voltmeter is thrown first to the left, then to the center and finally to the right. Fig. 7 shows the contact arrangement of the switch in its various positions

O-200 microammeter. The combination of R2 and M becomes a high resistance voltmeter (5000 ohms per volt) reading from 0-1 full scale. R1 is varied until the meter reads full scale whereupon the switch is thrown to the center position which transforms the circuit into Fig. 5. We now have a voltage of 1 volt on the potentiometer. Meter M has been shifted over into the tube plate circuit making the device a vacuum tube voltmeter, and the input voltage is exactly one volt. Potentiometer R3 is now varied so that the meter indicates a full scale deflection once more. It can be seen from the diagram that the adjustment made in Fig. 4 now serves to impress exactly one volt on the vacuum tube voltmeter. The switch is now moved to the right-hand position transforming the circuit into Fig. 6. R4, which

ammeter when a voltage of only one volt is impressed. We also limited ourselves to a plate voltage not exceeding 22½ volts nor did we care to use a separate c battery. Our reason for these requirements was that with every battery included in the device it becomes more difficult to reach the initial calibrating conditions.

For our own information we will list the disadvantages present in the usual type of vacuum tube voltmeter.

(1) Variation of tube characteristic due to operation at normal rating. By this is meant that due to the high temperature of the filament the electronic emission will gradually decrease over a period of time.

(2) Batteries are required, and no means are usually included to keep them at the proper voltage.

(3) There is no way of knowing whether or not the meter is operating at the same point that it was while being calibrated.

We have overcome the first disadvantage by running the ordinary 5-volt tube at 3 volts. This procedure results in a much longer and steadier life for the filament. When used in such a manner the tube can just as easily be enclosed in the cabinet, as replacement will not be necessary probably for years.

We overcame the second difficulty by using the remaining voltage of the 6-volt filament supply for the C bias. As it happens, the method shown for adjustment of the device automatically balances out any variation of plate voltage or battery current. If the voltages received from the batteries are not sufficient it is simply impossible to calibrate the device. When such a condition occurs in the standard form of voltmeter, the operator, usually ignorant of the fact, continues his readings, only to find out afterwards that the calibration was off. The third problem was very troublesome until we hit on the idea of using a standard voltage to calibrate the device. Roughly the operation is as follows:

When the switch, shown in the photograph, is thrown to the left-hand position the voltmeter assumes the circuit shown in Fig. 4, where B is a 1½-volt flashlight battery, R1 is a 400-ohm potentiometer, R2 is a 5000-ohm accurately wound wire resistor, and M is an

is a variable resistance of 100,000 ohms, serves to buck the small current usually flowing through the tube and makes the meter read zero.

The instrument is now ready to receive the voltage to be measured. It must be borne in mind that the full scale deflection of the meter is now no longer one volt, since the last operation of balancing out a small initial current, usually of the order of 30 microamperes, has reduced the full scale reading. This, however, is an advantage since a small voltage above one volt will not drive the meter off scale.

The operator now proceeds with his measurements. If at any time he should wish to check the device, or if he has any reason to believe that the characteristics of his batteries have changed, all that is required is to repeat the procedure outlined above. He need merely throw the switch to the left-hand position and vary the first knob for full scale deflection, then he throws the switch to center position and adjusts the center knob for full scale reading, and finally moves the switch to the right-hand position, adjusting the third knob to zero, and he is ready to continue with his tests.

To anyone familiar with vacuum tube voltmeters or voltmeter readings in general, an apparatus of this kind will probably appear as being exactly what he has wanted, for no one will question the fact that the greatest disadvantage hitherto present in thermionic voltmeters was the fact that the calibration varied from its initial values. The instrument described above does away with this disadvantageous factor and permits of closer calibration for this reason. The instrument will measure voltages without any appreciable error of any frequency including all the audio frequencies and radio frequencies up to and including 5000 kilocycles. In all radio-frequency work, however, it will be necessary to compensate for the capacity introduced by the voltmeter for making measurements. This capacity is made up of the grid-to-filament capacity of the tube and the capacity of the connecting wires. The capacitance is usually very low but might become troublesome at high frequency, low capacity circuits.

In order to ascertain whether any grid

JOSEPH I. HELLER is not a newcomer to RADIO NEWS readers. His delightfully clear articles on the design and construction of instruments of precision for the laboratory have won him deserved popularity. In the March and May, 1930, issues of RADIO NEWS he described the construction and operation of a serviceman's voltmeter and in the June issue he described a beat frequency oscillator.

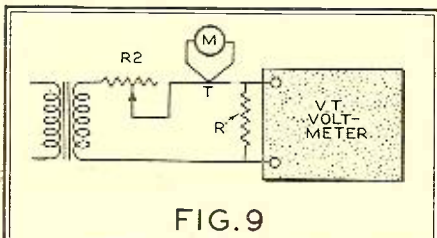

FIG. 9

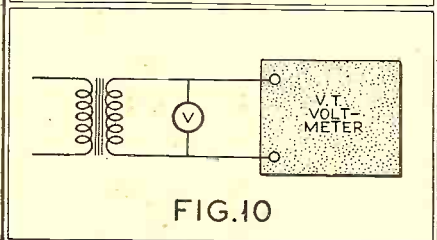

FIG. 10

Fig. 9. A simple means for calibrating the voltmeter by the use of an a.c. input and a thermo-couple meter. Fig. 10. Calibrating the use of a simple a.c. voltmeter

current was flowing, we connected an extremely sensitive meter (full scale 7.5 microamperes) into the grid circuit while one volt was impressed. No deflection was observed. Since we could easily read the scale to .1 microampere, the worst possible error in reading would be by this amount. Allowing for this

$$\text{error, } \frac{E}{I} = \frac{1}{.000001} = 10,000,000 \text{ ohms, ten million ohms}$$

should not worry the most exacting experimenter.

The input resistance of the voltmeter is 5,000,000 ohms. Since no current will flow through the grid, this resistor becomes the only loss in the input. Since watts = $\frac{E^2}{R}$, watts lost at

$$\text{full scale} = \frac{1 \times 1}{5} = \frac{1}{5,000,000} = .000002 \text{ watts, which is}$$

approximately the energy used by a fly when he bats an eye.

Although this meter is manufactured as a laboratory unit, some of our readers might like to build it themselves. For them the appended parts list is included.

PARTS LIST

- R1 = 400-ohm potentiometer.
- R2 = 5000-ohm accurate resistor.
- R3 = 400-ohm potentiometer.
- R4 = 100,000-ohm rheostat and switch, S.
- R5 = 10-ohm resistor.
- R6 = 5-ohm resistor.
- R7 = 5-ohm resistor.
- R8 = 5-megohm resistor.
- 1 special switch.
- 1 socket.
- 1 22½ volt battery.
- 1 6-volt battery.
- 1 112 type tube.
- 1 0-200 microammeter, Weston.
- 6 binding posts.
- 1 panel and box.

Calibration

There are several ways of calibrating a device of this sort and we will describe some of them. The method used in our laboratory is indicated in Fig. 9. While this method is applicable only to those experimenters who have a thermo-couple or a.c. meter available, nevertheless it remains one of the most accurate and simple means of calibration.

In Fig. 9, resistance R is a convenient standard resistance whose exact resistance in ohms is known. While in our laboratory we used a thermo-couple and galvanometer as shown, this combination may be replaced by an accurate alternating current meter. Resistance

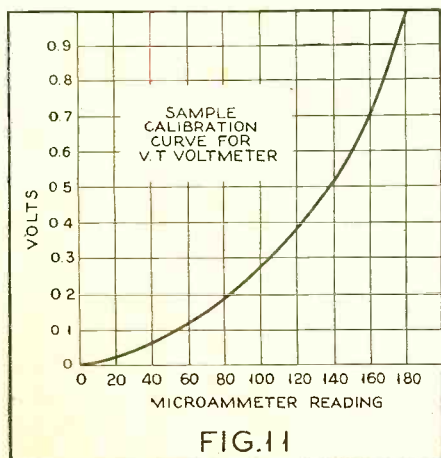

Above, Fig. 8, the complete circuit of the Heller vacuum tube voltmeter. The diagram has been drawn so that the location of the symbols conform with the general layout

Fig. 11. The calibration curve for the v.t. voltmeter

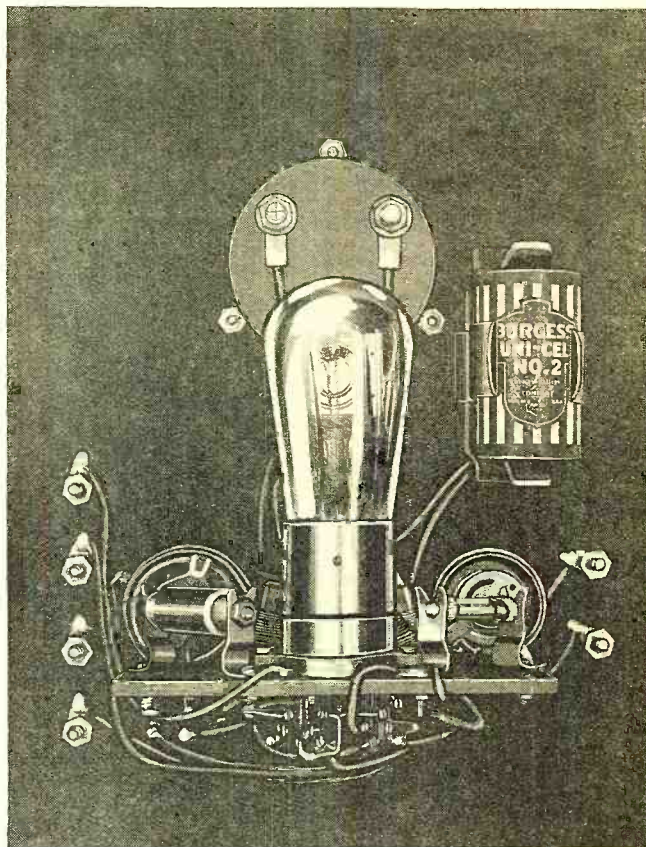

A rear view of the voltmeter illustrates the extreme simplicity of layout and assembly

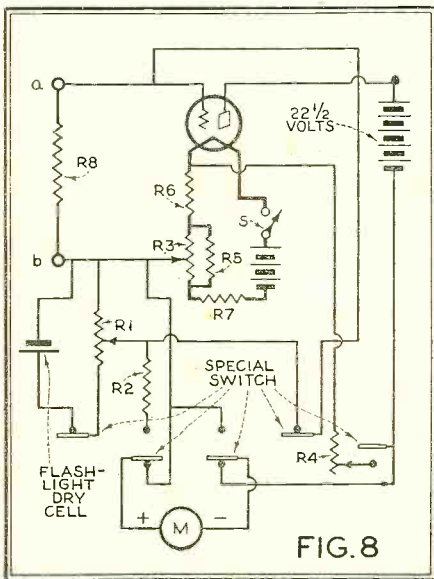

R2 is varied until the ammeter or thermo-couple galvanometer reads the proper current going through resistance R. Since the galvanometer used with the thermo-couple is calibrated to read in effective amperes, the current read, multiplied by the value of the resistance R, will indicate the voltage across the input to the vacuum tube voltmeter. Take for instance a resistance of 10 ohms as R. Starting at the high end of the calibration we desire one volt input to the voltmeter. We will, therefore, have to send .1 amperes through this resistance. R2 is therefore varied until the current-indicating instrument reads 100 milliamperes and the vacuum tube voltmeter reflection read. In order to get the voltmeter reading at .5 volts it would be necessary to send 50 milliamperes through resistance R, and so

on, for any values at which it is desired to calibrate the voltmeter.

Another method which may be used is shown in Fig. 10. This method is also quite simple and with an accurate voltmeter V, equal sensitivity may be had. The voltage is varied either by resistance in the secondary side of the transformer or resistance in the primary side of the transformer. The curve for the voltmeter built in our laboratory is shown in Fig. 11. From the shape of this curve you can see what an effective range it covers.

It may have appeared to the reader while reading this article that the calibrating circuit included in the vacuum tube voltmeter is intended for calibration over the entire range. This is not so. All that the device is used for is to insure getting the voltmeter back to the exact point at which it was calibrated. The reason for the method taken is that most vacuum tube voltmeters are adjusted at the zero end of the scale which, from an inspection of the curve, can be easily seen as the least sensitive to input variation. An unnoticeable error, therefore, in setting to zero, may cause a very (Continued on page 551)

“What I Think of the A Symposium by Leading

Cost Will Limit Application

By McMurdo Silver



McMurdo Silver hardly needs an introduction to the reader of Radio News. He has been intimately identified with super-heterodyne development and is responsible for some of the finest designs of this type of receiver.

THE Stenode Radiostat is a very interesting receiver design from a scientific viewpoint in affording an idea of what can be done by the use of an extremely selective i.f. amplifier. Through its use, a present balance between image frequency and adjacent channel selectivity is upset in favor of a higher i.f. frequency which will require less selection ahead of the first detector to give the image frequency suppression which present broadcast conditions require.

There appears to be nothing in Mr. W. T. Cocking's article, (October RADIO NEWS) nor in what has appeared in the British press, however, which vitiates the present theory of side-band transmission advanced by J. R. Carson and others. The fact that a great deal of audio-frequency compensation is necessary seems to corroborate this. Fortunately, a great deal of frequency in discrimination can be tolerated by the average listener, and this probably accounts for the arrangement sounding "very good."

Its high cost, with other shortcomings which are recognized by the designer will probably limit its application to experimental and special purpose receivers for some time to come, since extremely good adjacent channel selectivity may be secured by conventional circuit designs and at a much lower cost. It can also be shown mathematically that the fidelity of a series of broadly tuned circuits in cascade is better than that of a single circuit giving equivalent selectivity at 10 or 20 kc. from resonance. This practice is followed in the better current receiver designs and limits the amount of audio compensation required to a very reasonable value for excellent fidelity.

Crystals—or Tuned Circuits?

By Howard Rhodes

Howard Rhodes is now a director of the Electron Research Laboratories specializing in photo-electric cell work. For five years he was Technical Editor of Radio Broadcast magazine.

DEFINITE criticism of the Stenode Radiostat system developed by Dr. Robinson of England is difficult because of the lack of any definite laboratory data on the performance of the circuit. Most of the information which has been published on the system has been purely qualitative. Without definite data on the selectivity of the receiver with and without the crystal circuit it is impossible to say how much selectivity the crystal attributes to the circuit and how much of the selectivity is due to the use of many tuned circuits. It should also be realized that the ability of a receiver to separate the transmissions of two stations operating on carrier frequencies differing by only one kilocycle will depend largely on the relative field strengths of the two stations at the point where the receiver is being operated.

The task of separating two stations differing in carrier frequency by only one kilocycle is quite a problem—to say the least. If the two stations have equal field strengths an attenuation of something like 50 db. will be required at one kilocycle off resonance. If the two stations have relative field strengths in micro-

Apparently the very foundation of radio revised or at least our notions must be any event, very few folks realize that some very drastic tests in Europe; that Stenode Radiostat; that its performance tists and that orders for equipment have Corporation by many

volts-per-meter of 1,000, then an additional attenuation of 60 db. is required.

The articles on the system stated that some high frequency was produced in the r.f. system which was compensated by a rising characteristic at high frequencies in the audio amplifier. But it would hardly seem practical to compensate high frequency loss by such a method unless the amount of compensation required was relatively small.

Advances Idea of Trigger Detector

By Albert Allen



Albert Allen is a New England engineer connected with the Atlantic Precision Company. He will be remembered as the inventor of a high precision apparatus employing vacuum tubes for controlling variation in weight and thickness of sheet material.

I HAVE given this circuit a lot of careful study; it ought to go a long way toward helping the present congested condition of the air. Right away, it seems the Stenode Radiostat will get

clean away from all interference. Crystals have been standards of frequency in broadcasting; and now receiving sets will make use of them advantageously. And when this set has been finally developed it undoubtedly will open up unlimited channels for more broadcasting.

As an engineer, I've been interested in the way this receiver works, as well as what it will do when used. It isn't what it looks like by quite a lot, and I've gotten quite a kick out of the way I've doped out how it works.

My work with supers dates clear back to the early days and when I looked at this circuit (the Stenode Radiostat) the first time, I said it couldn't work at all. Using sharp tuned intermediates, the sharper you tune them, the worse you get into sidebands, and the worse becomes the quality of the received signal. If you keep on making the circuit sharper, it ought to get worse and worse, and end up with nothing at all. But I knew RADIO NEWS wasn't running an article about a set that wouldn't work, and so I sat down to use deductive reasoning to solve this one.

Suppose that the crystal lets through just one frequency, and that it's the intermediate carrier. Then the "second detector" doesn't act like a detector at all, but is more like a trigger. Your intermediates all act partly like detectors, and that's where your audio comes from, carried through on the battery leads. When you've got the Stenode Radiostat just exactly tuned in, your intermediate carrier all alone slides right through the crystal, and through to the detector grid. This more than balances the grid bias, and the tube starts pulling plate current, through the primary of the audio transformer. If the set isn't exactly in tune, there isn't anything gets through the crystal, and the detector takes pretty nearly zero current because there is a bias on the grid.

When the detector is drawing plate current, it couples the inter-

(Continued on page 561)

Stenode Radiostat"

Radio Authorities

telephone engineering theory must be altered to fit a reconstructed theory. In Dr. Robinson's invention has undergone ten million dollars are invested in the has been witnessed by European scientists placed with the British Radiostat European governments

Percentage of Modulation Important

By D. K. Oram

D. K. Oram, while not a frequent contributor to these columns, will undoubtedly be recognized when we say that he it is who designed the line of now famous Hammarlund Hi-Q receivers.



FROM the limited information available Dr. Robinson's Stenode Radiostat raises some very interesting questions not only on the theoretical side of the subject but also from the standpoint of practical results. Leaving out the possibility of a complete revision of the present broadcast frequency allocations (which is certainly impractical if not impossible in view of the enormous number of receivers now in use) this new receiver will unquestionably have a tremendous appeal to a certain group of experimentally minded radio listeners, as well as a quite practical value to many listeners located very close to one or more of our modern high-power transmitters. There is no doubt that a receiver capable of tuning out a 50,000-watt transmitter operating on say 660 k.c. and located a couple of miles from the receiver, so that a 670 k.c. station located several hundred miles away can be tuned in without any interference and without appreciable loss of quality, will find many purchasers.

(Continued on page 562)

Quantitative Data Omitted?

By L. M. Hull

Dr. L. M. Hull is one of the country's leading engineers and is associated with the Aircraft Radio Laboratories and also the Radio Frequency Laboratories of Boonton, New Jersey. He was formerly in the Radio Research Division of the U. S. Bureau of Standards, Washington, D. C.

AS to the performance of the receiver the facts disclosed are nothing more than the following: (1) The receiver rejects an interfering carrier at 1 k.c.; the same statement could be made about the Westinghouse 1922 receivers, since no lower limit is specified for the intensity of the interference; (2) the receiver limits the depth of modulation, i.e., it "trims" sidebands; most selective receivers do, unfortunately; (3) the receiver is highly selective; what is meant by "highly selective" expressed, say, in decibels attenuation 2 k.c. away from the resonant frequency, and how selective would this multitude of tuned circuits be if the

(Continued on page 562)

System Worthy of Serious Attention

By James Millen

Probably no one needs less of an introduction to RADIO NEWS readers than James Millen. Mr. Millen has written extensively on receiver and power amplifier designs and is best remembered by the fine engineering in the line of MB National receivers which he has designed.



THAT the American broadcasting situation is a complex one and fraught with many perplexing problems, especially in the matter of frequency allocation for all those interests which desire to erect broadcasting stations, is a fact which undoubtedly will not be disputed.

Where some six or seven hundred stations, all of them seemingly as important as the next wish to make use of only about ninety available transmission channels, we can readily understand the need for a Federal Radio Commission.

Any system then, that can make room for, say, one hundred stations where only one could exist before is surely worthy of the serious attention of the engineering world. RADIO NEWS is to be complimented in bringing to the attention of American radio men the technical features of the invention of Dr. James Robinson's Stenode Radiostat.

Many American engineers are looking forward with keen interest to the time when they will have the opportunity to witness a demonstration in this country of this much talked of Stenode Radiostat. Should this new European development perform in anything like the manner claimed for it in the numerous press releases, it will undoubtedly have a most important influence upon the future development of radio as a whole.

Sidebands? Frequency?

By R. H. Langley

R. H. Langley speaks with authority in the engineering world. He is the Director of Engineering of the Crosley Radio Corporation, and was formerly in the Radio Engineering Dept. of the General Electric Company, at Schenectady, N. Y.

THE question of whether sidebands have an actual physical existence has been discussed by radio engineers and technicians for years. To me these discussions have always seemed to contain certain inherent fallacies and to represent an attempt to reach physical relation in an intensely complicated electrical circuit without giving any attention to the more philosophical aspects of the problem. It seems to me to be a matter of no great consequence whether the sidebands have a physical existence, or not. It is more convenient to use this mathematical statement of the situation in certain cases but it must also be remembered that the equations probably do not represent the ultimate philosophical truth.

One point on which these discussions also seem to lose contact with that rigorouslyness of statement which should be adhered to in all physical reasoning, is the loose way in which the word "frequency" is used. Our fundamental idea of frequency is that it is the number of times which a periodic function repeats itself per second. In the case of modulated high frequency curves, there is no repetition at all unless it be at the audio frequency, each high frequency

(Continued on page 562)

Could This Theatre Exist Without the Aid of Radio Principles?

“No!”

*That S. L. Rothafel
value of radio and sound
the art of showmanship
his own world-*

By Albert



The curtain rolls back abruptly. There is a hard glare of white light on the vast, empty stage. The sense of strangeness is heightened by this unnatural brightness. From the sides of the orchestra two cone-shaped horns stand out in black relief, pointing toward the stage. A desk is now dimly visible, situated in the center of the orchestra in about the fifteenth row. On it is a small round microphone and a long piece of white paper.

Two men walk out from the wings. They look up at the top of the back-drop, then back into the wings, and walk off again, conversing softly. There is a sudden sound of talking from the projection room on the mezzanine floor, the clatter of switches—then silence.

You begin to wonder if this is really the time for a dress rehearsal of one of the world-famous Roxy stage programs, perfectly lighted, perfectly executed. The scene resembles a skeleton movie set minus the players.

Suddenly a stocky figure passes down the aisle. It is Roxy. He sidles in past the seats to his desk. Switching on the pulpit light, he scans the piece of paper, then turns off the light and sinks back in his chair, reflectively puffing a cigarette. The time is seven-twenty-five.

At the second of seven-thirty Roxy snaps on the light, leans forward and speaks into the microphone.

“Stand by.”

The familiar voice, carrying an unfamiliar note of authority, booms out in the silent theatre. Instantly four or five men appear from the wings. The little man with the oxford glasses turns around and peers into the darkness of the vast auditorium. There is a brief business of “Good morning, Mr. Rothafel.” “Good morning, sir.” “Ready, sir.”

The rehearsal has begun.

IT is seven-twenty on a Friday morning. Dress rehearsal at the Roxy theatre. The half-light that lies evenly over the huge fan-like sweep of the orchestra is fringed with a pale amber glow pierced by the red stencils of exit lights. At each side of the proscenium arch the cathedral stairways curve gracefully downward through a soft violet haze.

As you recline in an orchestra chair, awaiting the appointed hour of seven-thirty, the impression becomes stronger that this is another place. It is the Roxy theatre, but one subtly changed. From behind the wide black velvet curtain comes a faint tapping, then silence, then a man's voice, distant and muffled. Soft sounds like the tiny activities of gnomes. You look down at the blackness of the orchestra pit, a yawning semi-circle beneath the stage. Can this be where the magic platform, aglow with light, rises mightily from the depths, heralding its approach with the dynamic carnival of one hundred and ten instruments being tuned?

No—it is not quite the same place. This is the theatre itself. A theatre without lights, voices, music—without a sea of faces.

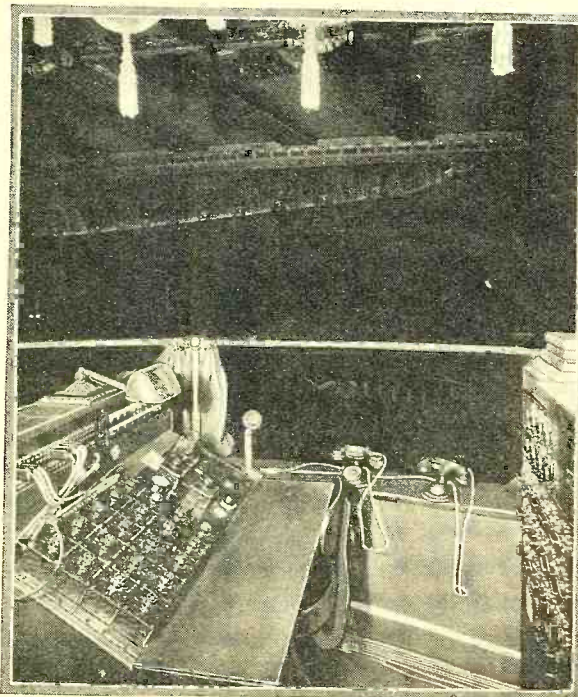

The top photograph shows Roxy directing a dress rehearsal with the aid of amplifying equipment which carries his voice to a score of strategic positions throughout the theatre. Below is the “crows’ nest” at the Roxy theatre, showing the speech input control board which is operated during every performance

says Roxy

fully appreciates the equipment in perfecting is best exemplified by famous theatre

Pfaltz

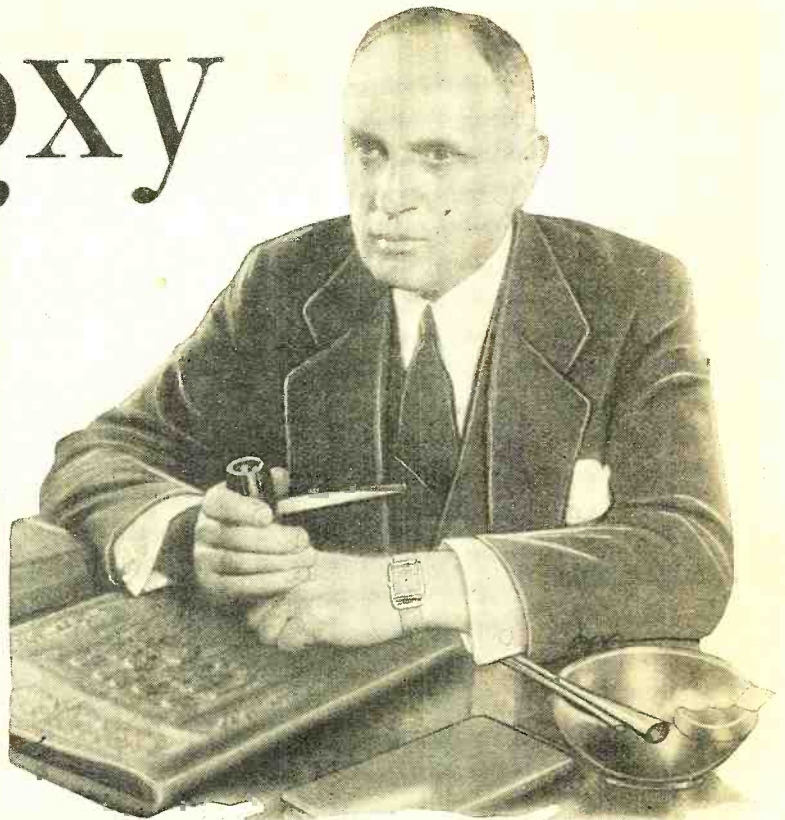

IT would not be an overstatement to say that Roxy talks a show into its finished form. For more than an hour at the beginning of each dress rehearsal he works on the lighting of the various scenes. His voice, amplified many times, emanates from loud speakers located at such strategic points as the electricians' control board, the Kino booth and several backstage locations such as the stage spot bridges. Considering the complexity of handling the lighting equipment of this theatre one is amazed at the rapidity with which Roxy's orders are executed. The beginning seems simple enough. One of several men on the stage is standing back

center holding up a red dress and a white dress. These are samples of the costumes to be worn by the ballet girls in the first number—a dance of two groups symbolizing War and Peace.

Without a second's hesitation, Roxy calls for his first lighting effect. Almost instantly the white glare of the stage is transformed as the stage bridge lights are brought into action. The giant-like voice demands Nos. 21, 22 and 23 in red. There is a quick sputtering sound overhead that dies away as three fiery beams descend on the stage from the Kino booth, move about searchingly for an instant, then remain fixed. Another order booms out. Two giant spots cut down across the darkened orchestra from the very roof of the theatre, intensifying the flood of light on the stage. The effect is complete. Hurried notations are made by the lighting director. The numbers are called aloud. The scene, thus far, is cued for lighting.

Another brief order is followed by a succession of sharp clicks. The deep glow painting the stage is magically erased again, leaving the hard glare of pure white light.

Another scene. Only a sample costume—corn yellow this time. It is to be the color scheme of the chorus of thirty-two Roxyettes. There is a moment's silence as the man at the desk in the center of the darkened orchestra switches on the light and looks at the piece of white paper. He does not do this very often. Roxy knows the numbers of the lights in his theatre as well as he knows the names of his "gang."

The light goes off. The stocky figure leans forward toward the microphone. More orders. The stage is again painted with light. It becomes a veritable canvas. Delicate hues creep subtly across the broad strokes of the basic colors. The scene is alive. Change follows change. The dusk above the orchestra is tunneled by pale shafts of light, criss-crossed in a weird pattern.

"Hold it!"

Then follows the final rehearsal. This is the ballet of War and Peace, the Roxyettes chorus. The dance directors appear from the wings. *Mirabile dictu*, as the Romans used to say, the director of the 32 Roxyettes is a mere lad, horn-rimmed glasses and all. George, or whatever his name is, backs out from the wings to the accompaniment of a snappy dance number, clapping his hands loudly.

"One-two-three-four. One-two-three-four."

The Roxyettes prance out from the wings in groups of six. Perfect rhythm. George is watching their feet. One-two-three-four. One-two-three-four. The sharp staccato of the

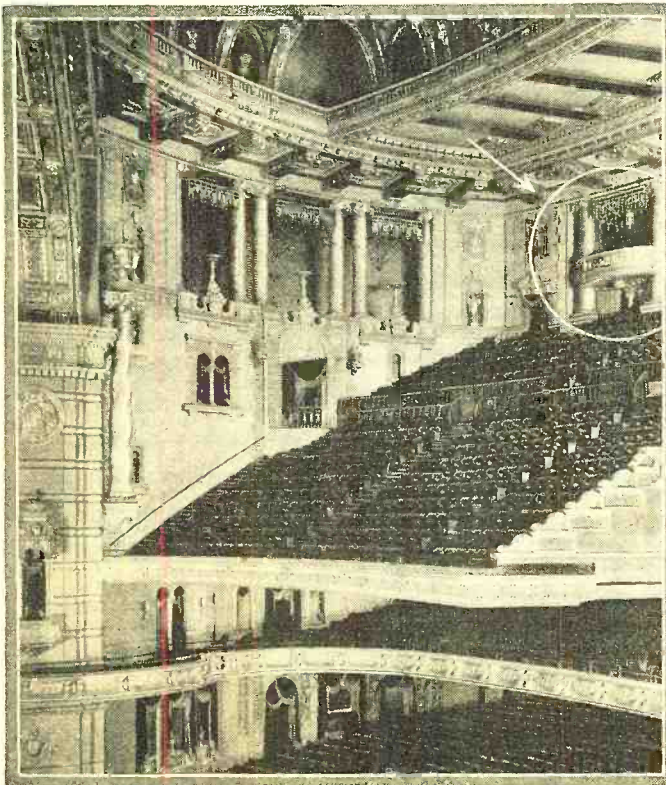

© Tebbs & Knell, Inc.

The white circle indicates the location of the sound amplifier control board pictured on the opposite page. This little "booth" is perched above the last row of the balcony on the right-hand side of the theatre

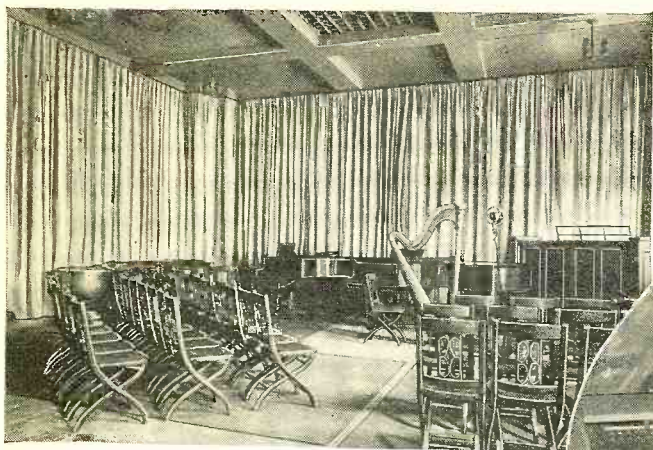

At the left is the broadcast studio of the theatre, from which originate the Sunday symphony concerts and the major portion of the Monday evening programs. Harry E. Hiller, communications engineer, is shown below in the control room of the Roxy studio



orchestra sets your feet to tapping. Finally the entire chorus advances toward the footlights. Kick-step-bend-kick-step-bend. Thirty-two girls moving as one person. The dance ends as the girls kneel in front of the footlights, arms around waists. Thirty-two smiling faces snap upward. A cymbal, with a muted off-beat stroke, expresses eloquent finality. The dance is over.

A quick order from Roxy and young George scuttles down off the stage to take a look at the tableau.

"Great heavens, that's awful!" Roxy's voice is cut abruptly as he walks away from the microphone to join the dance director in the side aisle. George takes another look. One of the girls is about three inches in advance of the others as they kneel before the footlights. It is only a detail. It will be corrected.

Roxy returns to his desk. It is the orchestra's turn to introduce one of the famous fade-in and fade-out prologues to the main picture, in this instance the well-known "Journey's End." Something is wrong. The tempo is not slow enough. Roxy blows a whistle. The shrill sound cuts through the majestic strains of Elgar's "Pomp and Circumstance" march. The orchestra stops—a few violins trailing off faintly. Silence. Roxy sings the melody to illustrate the tempo he wants. The orchestra tries it again. The whistle blows. It is not quite right. Roxy goes down and talks to little Joseph Littau, the leader. He sings it again and waves his arms. They will get it this time. The orchestra begins again. . . .

When the rehearsal ends it is a few minutes before eleven and outside a long queue is waiting for the doors to open.

This is show business.

The secret of a Roxy performance lies in perfect coordination. It is true that this coordination of effects, the moulding of countless colors, sounds and techniques into a spectacular stage show, is an instinctive gift of the man himself. But it is equally true that a Roxy performance could not be staged without the ever-present assistance of equipment based on radio principles. As radio developed and as the larger theatres began to exhibit sound pictures, Roxy was quick to see the possibilities of these scientific advances for the further development of the art of showmanship. From the day the Roxy theatre opened, the success of every performance has been in large measure dependent on speech amplification and the sound picture equipment.

In the case of the man who presented his first picture in a vacant store-room in Chester City, Pa., in 1907, and who is today known to millions of Americans as one of the world's greatest showmen, there are three points of outstanding significance.

The first of these is that Roxy is a master of each of the many arts and techniques, such as lighting, acting, music, which contribute to an effective stage presentation, whether simple or spectacular.

The second is his absolutely amazing grasp of detail and ability to seize on the one thing that is not correct in an otherwise flawless scene. Only one dress rehearsal is needed to demonstrate that fact a score of times.

The third point—and the one which has perhaps contributed the most in the sense that it has made his art possible—is Roxy's use of mechanical equipment in staging and presenting his programs.

As we remarked before, the smooth perfection of a performance in this theatre is a direct product of coordination. To break down the process of coordination into its three essential components, there is, first, the conception and direction of a stage program; second, the execution of the acting, singing and music by the various artists; third, the engineering of sound. Or, to take a specific and outstanding program of the past season, there are Roxy, Madame Schumann-Heink and Harry E. Hiller.

The very nature of a theatrical entertainment centers attention on the artists. In the case of the artists in Roxy's "gang" no further comment is necessary, for they are deservedly famous throughout the entire country. But the Roxy "gang" has a silent co-worker, a man whose artistry and knowledge of music is exceeded only by his skill as a communications engineer. Quiet, unassuming, an indefatigable worker, this man is comparatively unknown. Whether you are listening to one of the regular Sunday afternoon or Monday evening Roxy broadcasts or are sitting in the theatre itself, the quality of the sound will be in large measure due to his efforts. To Harry E. Hiller is assigned the difficult and important task of guarding the voice of the Roxy theatre.

Mr. Hiller has been with the Roxy theatre since it opened its doors to the
(Continued on page 552)

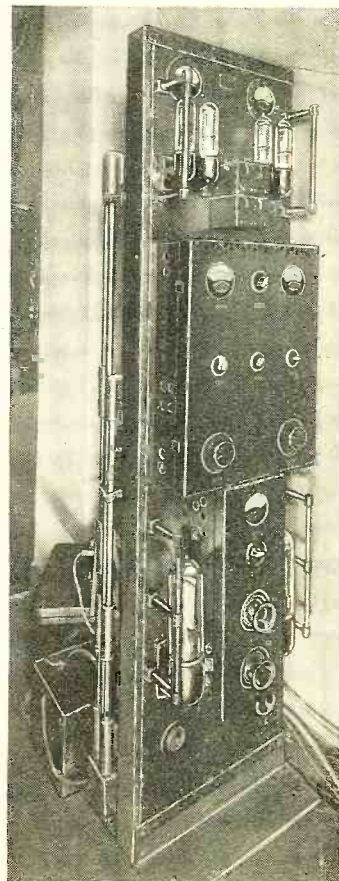

The amplifier panel at the Roxy theatre

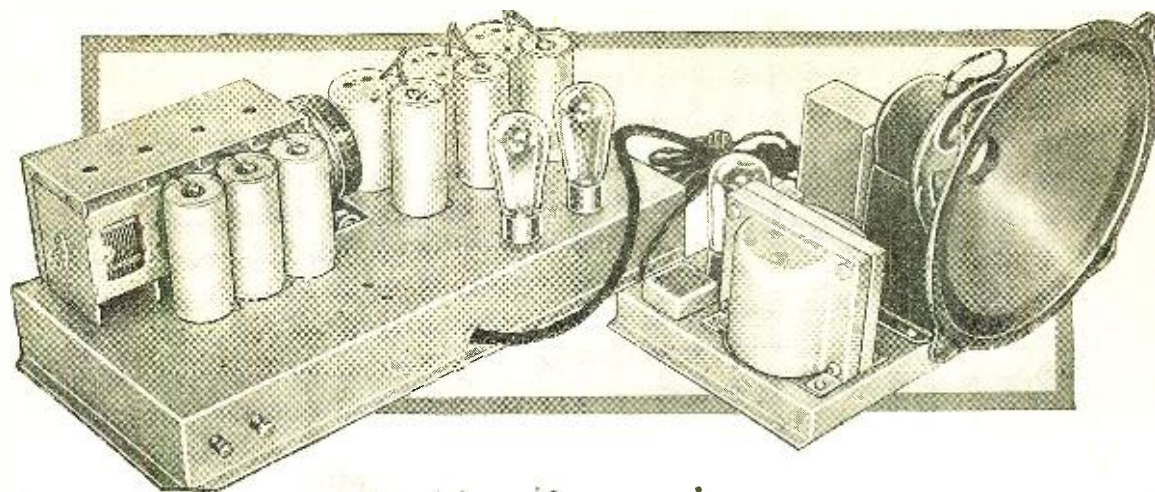

Eliminating Image Interference in SUPERHETERODYNES

This is the third and final installment of the series of articles prepared exclusively for RADIO NEWS readers by a man who has been intimately identified with the progress of superheterodynes ever since they were first given consideration as one of the most practical of radio receivers. In this article the author goes into detail concerning the reduction of image interference or "cross modulation" by the use of pre-selector circuits

By McMurdo Silver*

AS was pointed out in the first article of this series, which described the S-M 724 superheterodyne, the real problem is that of minimizing image frequency interference and heterodynes in the output of the receiver which result from beats between the local oscillator and either external carriers or harmonics of the second detector output.

"Siamese" or tuned-grid, tuned-plate circuits which permitted high adjacent channel selectivity were common in the earlier supers. The real progress in design has been in the selection ahead of the detector and in maintaining alignment between these tuned circuits and the oscillator.

Under present broadcasting conditions, the excellent adjacent channel selectivity which may be secured in the i.f. amplifier can be used only when the circuits ahead of the first detector are able to reduce the voltage of a powerful local to a value sufficiently low to prevent cross modulation. There is also the problem of having sufficient

selection ahead of the first r.f. tube, where one is used, to keep the voltage applied to the grid of the r.f. tube at a frequency half of that to which the circuit is tuned low enough to prevent the production of second harmonics in the output of the first tube from the local which will beat with the wanted signal. The present exacting requirements of broadcast reception made it important to keep the amplitude of these various spurious "beats" 50 or 60 decibels (a hundred thousand to a million to one ratio) or so below the level of the wanted signal.

At first glance it would appear that the solution of the problem lay in placing a suitable number of tuned circuits ahead of the first tube which would eliminate the problem of cross modulation and reduce the image frequency interference to a negligible value. In practice this cannot be done because in the reception of distant stations, when a receiver is operated under conditions of maximum sensitivity, the circuit and tube noise in the first stage definitely affect the signal to noise ratio and, therefore, the actual practical

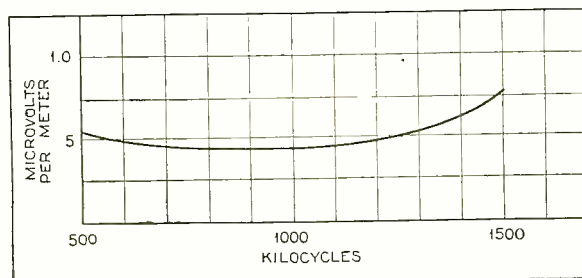

Fig. 2. The sensitivity curve for the SM-36 superheterodyne receiver shows that the maximum to minimum rate gain is less than 2 to 1. The average sensitivity is approximately 1/2 microvolt per meter

*Silver-Marshall, Inc.

value of the sensitivity. Assuming that the circuit and tube noises remain constant, it is evident that any improvement in signal voltage impressed across the first r.f. tube input will improve the signal to circuit and tube noise ratio. This noise is the hiss which sounds like escaping steam that is heard in very sensitive receivers. Some of it is due to the "shot" effect, or slight irregularities in the bombardment of the r.f. tube plate by the electrons, and partly to "thermal agitation" or movement of the molecules and free electrons in the input circuit.

The "Dual-Preselector"

A single tuned circuit will develop the highest transfer efficiency from antenna to input tube and would, therefore, be the most desirable from a signal or stray ratio viewpoint. On the other hand, a single circuit of this type, unless great care is taken to prevent rectification, may cause trouble due to the production of harmonics and to cross modulation. In areas where there are a large number of very powerful broadcasting stations, it is necessary to forego this advantage and to use two or more tuned circuits ahead of the first tube to prevent cross modulation. In the Model 36 Silver-Marshall receiver this compromise has been worked out in a very gratifying manner by the use of a single "dual-preselector" ahead of the first tube. This prevents cross modulation and yet does not lower the signal to circuit noise ratio enough to prevent excellent reception from distant stations.

The output of the r.f. tube is coupled to the second detector through a conventional interstage r.f. transformer. This gives a total of three tuned circuits which reduce the image frequency to wanted signal ratio to about 50 decibels (100,000 to 1).

Due to the lower transfer efficiency of the dual-preselector circuit when compared with the single tuned circuit used in the 724, higher gain i.f. transformers have been used in the

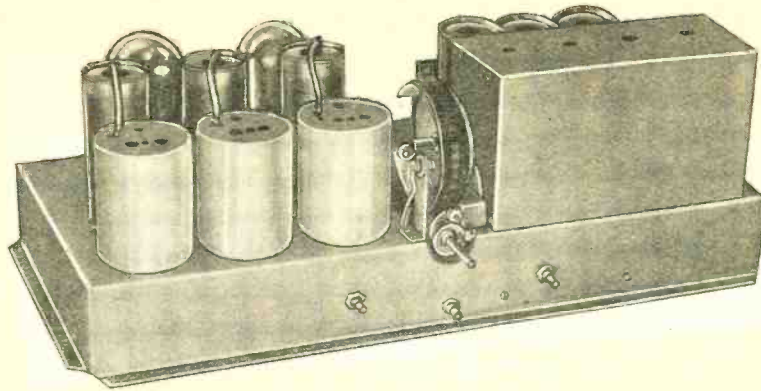

A front view of the "36" superheterodyne

Model 36 receiver. A gain curve for a typical stage is shown in Fig. 1. The peak voltage amplification of 85 gives a very high overall i.f. gain without the impairment of fidelity which would follow from the use of circuits with less damping and still higher amplification. It can be shown that better fidelity can be obtained from a series of broadly tuned circuits in cascade than from a lesser number of sharply tuned circuits giving equivalent selectivity at, say, 20 to 30

kc. off resonance. In the S-M 36 receiver a very satisfactory compromise between the number of tuned circuits used and side-band discrimination has been effected. Six dual selector circuits of the type described in the first article are used in this receiver, and the construction differs only in the use of a porcelain base which carries the trimmer condensers and the bracket on which the coils are mounted.

Sensitivity Constant Over Whole Band

Due to the increased gain of the r.f. circuits at the high-frequency end of the broadcast band, the special oscillator circuit used was designed to develop maximum voltage at the low-frequency end. Since the first detector is almost a straight line one for normal inputs, the output is proportional to the product of the oscillator voltage and the signal voltage. By increasing oscillator output, therefore, at the low-frequency end, the sensitivity of the receiver is kept almost constant over the whole broadcast band. The sensitivity curve is given in Fig. 2. It will be noticed that the maximum to minimum gain rate shown is less than 2:1, and that the average sensitivity is approximately 1/2 microvolt per meter. As a matter of fact, in the early experimental models this receiver was so sensitive that standard output could be secured over the entire band with absolutely no input to the set. In other words, the amplification was so great that the circuit and tube noise gave more than 50 milliwatts output. This has been possible in one other receiver but only at the most sensitive frequency.

In spite of the peak output of the oscillator, which is slightly over 10 volts, the ground returns in the receiver and the coupling elements have been so arranged that there is a negligible

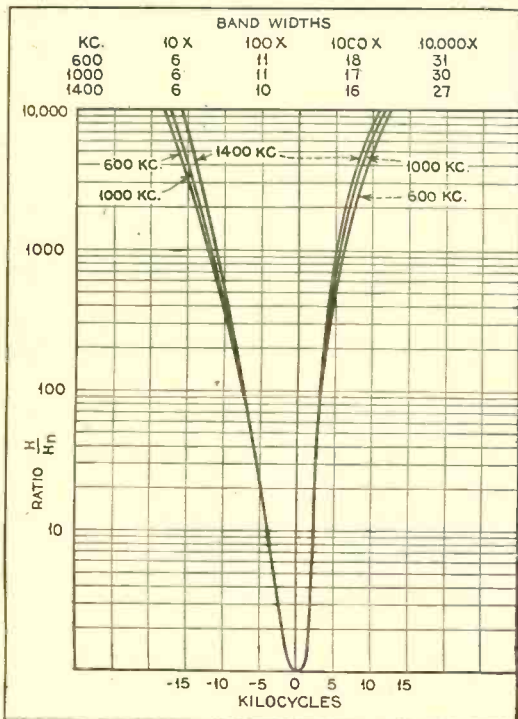
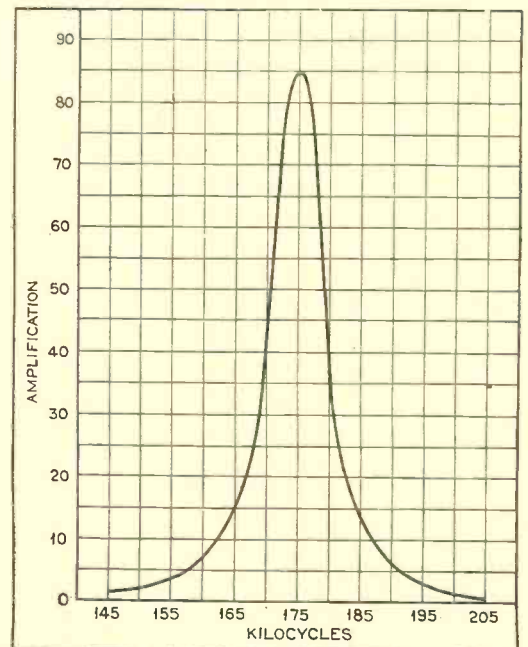

Fig. 3. Selectivity curves for the SM-36, measured at 600 kc., 1,000 kc. and 1,400 kc.

Fig. 1. A gain curve for a typical intermediate frequency amplifier stage. The peak voltage amplification of 85 gives a new high overall r.f. gain without serious impairment of fidelity of reproduction



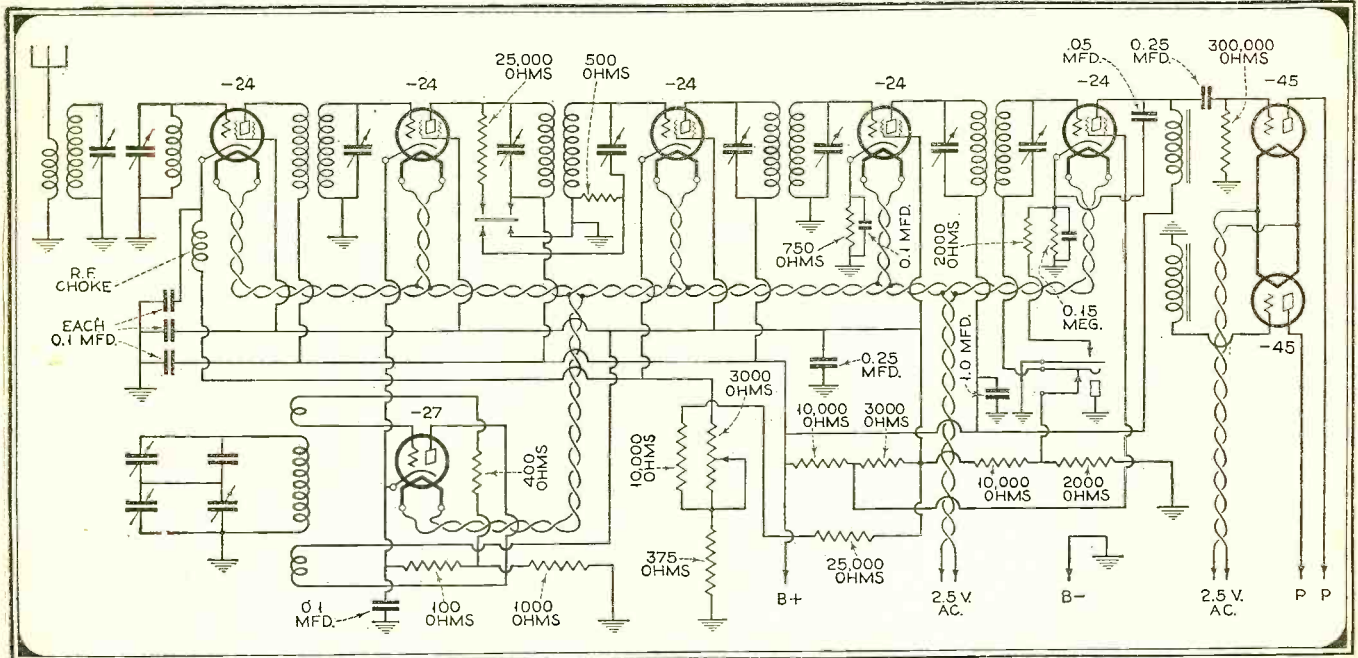

Fig. 4. The complete schematic circuit of the SM-36

amount of oscillator current in the antenna. The radiation is further minimized by tuning the antenna to slightly less than 200 kc. The question of radiation is a very serious one since, with the general adoption of superheterodyne receivers, there may be a large number operated with antennæ on the same roof. An extremely minute amount of oscillator energy in the antenna will cause sufficient radiation to heterodyne a signal in a receiver having a sensitivity on the order of a microvolt per meter. The oscillator energy of the S-M 36 chassis has been reduced to the point where it can hardly be heard in another receiver tuned to a local station, with the two antennæ parallel and about fifteen feet apart.

The overall selectivity of this receiver is slightly better than that of the receiver described in the first article, due both to the use of an additional tuned circuit in the r.f. end and to a

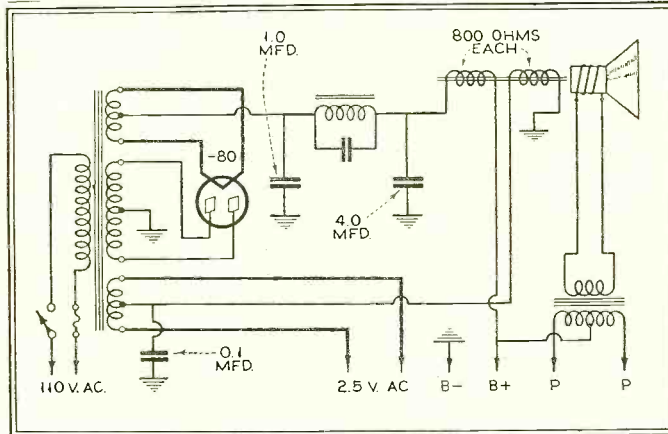

Fig. 5. The speaker windings are an enclosed part of the power supply circuit of the "36"

powerful local stations, it has been possible to get all but two channels which were 10 kc. either side of the locals. This means that in all but the very worst locations the user of such a receiver may reasonably expect to get a station on every channel when the outside noise level permits.

slight change in the intermediate-frequency amplifier layout. While there is a very slight difference in the selectivity at different frequencies within the limits of the precision of the measurements, the selectivity is practically constant over the entire broadcast band. The average band width at "ten thousand times down" is only 29 kc., which is better than that of any competitive receiver we have measured.

The reader is probably interested in the type of performance of the receiver, as well as in the quantitative data given in the various curves. In the heart of Chicago, with a large number of

Operating Schedules of R. N. R. A.

BEGINNING Monday, October sixth, the first code schedules of the Radio News Radio Association were put on the air over the RNRA short-wave transmitter W2RM.

Every Monday, Wednesday and Friday evening, at 8 o'clock, Eastern Standard Time, W2RM transmits four code lessons, each of fifteen minutes duration. From 8 to 8:15 the code speed is seven words a minute; from 8:15 to 8:30 the code speed is twelve words a minute; from 8:30 to 8:45 the code speed is twenty words a minute, and from 8:45 to 9:00 p.m. a message is sent in Phillips code.

Temporarily, until the actual RNRA transmitter is completed, we are using the 50-watt tuned-grid tuned-plate job

described in the October number of RADIO NEWS. As you will recall, this transmitter is equipped to work on either phone or straight cw. At appropriate intervals during the lesson periods suitable

announcements by phone will be made and the subject matter of the code lessons will be repeated by voice so that you can check up on your knowledge of the code.

Of course, the phone range of the transmitter is not as great as the cw. range and it is quite possible that some of the club members in outlying districts will be able to pick up the code signals but not the phone.

Let us know how you receive W2RM and tell your friends to join up and listen in. Watch these pages for future announcements concerning the doings of the Association. We will welcome any suggestions which will make our club of any greater value to the Association members.

Use the coupon herewith.

To join the RADIO NEWS Radio Association fill out this information slip and return it to the address indicated. Print the information required in ink.

Name

Address..... City.....

Do you own a short-wave receiver?...

What make?.....

Are you a transmitting amateur?...

What's your call?.....

What kind of a transmitter is used?.....

Explaining

Essential Don'ts for Radio Stations

Don't fail to have your station managers and operators read the Federal Radio Commission General Orders, as well as the Radio Act of 1927; keep a complete file of General Orders up to date and available for ready reference.

Don't build, install, rebuild or move your main or auxiliary transmitter unless so authorized by the Commission; Radio Act, Section 21.

Don't install frequency control devices without written authority from the Commission; General Order 77.

Don't buy or sell transmitter equipment unless in possession of construction permit covering same; General Order 91, Section 3, and Radio Act, Section 21.

Don't test after construction without first advising Commission and your supervisor, and don't operate until authorized; General Order 45 and new supplement to construction permit.

Don't operate without a station license and only on the frequency, with the power, and during the time specified in your license; Radio Act, Sections 1, 9, 10 and 11.

Don't operate your transmitter except when a licensed operator is on watch; Radio Act, Sections 5, 9 and 20.

Don't fail to announce call letters and location of station every fifteen minutes; General Order 8.

Don't change your call letters without permission of the Radio Division of the Department of Commerce; Radio Act, Section 8.

Don't fail to announce mechanical reproductions and records as prescribed in General Order 78.

Don't move main studio without authority; General Order 28 and Radio Act, Section 9, as amended on March 28, 1928.

Don't let your transmitter deviate over 500 cycles; keep a continuous check on your frequency; General Orders 7, 75 and 77.

Don't fail to comply with supervisor's request for report within three days if you are notified of violations; General Order 75.

Don't increase the power of your transmitter at any time without authority; General Orders 10, 48, 53 and 91.

Don't fail to read General Order 91 when calculating carrier power or rating your transmitter.

Don't seek power in excess of 25 kw. without studying General Orders 42 as amended, 91 and 92.

Don't apply for a new frequency or more power without consulting General Orders 40, 91, 92 and explanation thereof.

Don't operate a daytime, limited time or local sunset station without understanding General Orders, 10, 41, 48 and 53.

Don't operate daylight saving time without following General Order 61.

Don't fail to close down your station if required when an SOS is heard or officially requested; General Orders 66, and Radio Act, Sections 22, 23 and 28.

Don't fail to file renewal applications with supervisor thirty days prior to expiration date; General Order 89.

Don't fail to file all applications through supervisor of radio (who acts for the Secretary of Commerce) for your district; Radio Act, Section 10.

Don't fail to post station and operator licenses conspicuously in transmitter room; General Order 90.

Don't assign, lease or relinquish control of your station without consent of the Commission; General Order 95, and Radio Act, Sections 11 and 12.

Don't put an alien on your Board of Directors, or permit aliens to own more than one-fifth of stock; Radio Act, Section 12.

Don't participate in a hearing without reading General Order 93 and Radio Act, Sections 4, 5, 11, 14, 15 and 16.

Don't grant one candidate for public office the privilege of using your transmitter and deny it to another similar candidate; give equal privilege to all; General Order 31, Radio Act, Section 18.

Don't permit use of obscene, indecent or profane language, or broadcast anything not in public interest, convenience or necessity; Radio Act, Section 29.

Don't fail to announce sponsored programs; Radio Act, Section 19.

Don't rebroadcast programs without authority of the originating station; Radio Act, Section 28.

Don't fail to keep a station log; Radio Act, Section 4.

Don't fail to read penalties under Radio Act for violations; Radio Act, Sections 32 and 33.

By reason of his recent connection as its Secretary, probably no other in a more advantageous position than broadcasters, present and future, as may one day find themselves for not a common-sense understanding of the

By Carl

SINCE I have become a radio consultant I have observed that many of my clients seek my assistance after they find themselves in difficulties with the Commission, and despite the fact that if no more get into trouble I may starve to death. I feel kindly enough disposed to advise licensees by citing some experiences and at the same time aid the efforts of the Commission and field force of the Department of Commerce by keeping stations out of trouble.

Hence, this list of "Don'ts for Broadcasters," compiled from the Radio Act, as amended, and the General Orders of the Commission. This is the first such compilation as far as I can learn. If I owned a station I should keep such a list posted in a conspicuous place and make all employees read it at least once a month. Such practice might result in keeping the station on the air, or at least save hearings, with their attendant expenses and the loss of time required by a trip to Washington. Radio manufacturers, dealers, retailers, advertisers and agencies should also become familiar with radio regulations.

Why get into trouble for avoidable things such as not filing renewals on time, or not announcing call letters, location and phonograph records properly? Why let the transmitter wobble, varying over the prescribed maximum deviation allowed, when frequency checking or the installation of a crystal control will avoid it and also prevent Mr. Terrell's "detectives of the ether" from catching you off frequency?

Ignorance of the law, we all know, is no excuse, and yet many alibi-less station owners and operators make that plea when cited for a hearing. It is better to spend a few hours reading the law and regulations than to spend a year or so in jail or pay a fine of from \$500 to \$5,000. It may astound some non-informed radio folks to learn that the radio law states that for violating Commission rules and regulations, in addition to any other penalty provided, those found guilty are subject to a fine of not more than \$500 for each and every offense. Furthermore, persons found guilty of violating provisions of the Radio Act itself are subject to fines of not more than \$5,000 or by imprisonment for a term of not more than five years or both for each such offense. Imagine that; and you never knew it?

One day while I was Secretary of the Federal Radio Commission there came into my office a young man obviously much embarrassed and flustered. "My license is held up and I am afraid I will be taken off the air at the end of the period—what can I do?" he burst out.

"It's probably a question of what you have done," I suggested, urging him to post me. He told me his troubles, which essentially were as follows:

Sometimes when the regular licensed operator had to run out of the station a few minutes or wanted a half day off, he left the announcer in charge. The announcer was an amateur and as the set practically ran itself, no one thought it mattered. But one day an inspector visited the station while the operator was thus AWOL. He found the transmitter in operation but no one whom he considered responsible in charge. The announcer stated that he could pull the aerial switch if an SOS

the Radio Laws

with the Federal Radio Commission man in radio is better informed and the author of this article to advise to the legal pitfalls into which they sensibly acquainting themselves with existing radio laws and regulations

Butman

was heard, but the inspector called attention to the Radio Act, Sections 5 and 20. Apparently no one in the station had ever read the Act, except perhaps the operator, but he hadn't arranged to provide a proper substitute. Naturally the inspector sent an official report to Washington and then the wheels began to turn.

However, after the poor station owner had gone practically on his knees to members of the legal and engineering staff and most of the Commissioners, the charge was dropped, as it was believed that violation was unintentional, but the warning evidently sufficed. The operator was advised that another such breach of regulations would cost him his own license. I recall that twelve broadcasting stations lost their licenses for one reason or another between January 1 and June 1, 1930.

Station owners, managers and employees are urged to read the Radio Act and all the General Orders, copies of which are furnished each station and should be kept on file for ready reference.

Of course, if you only let the station transmitter jump clear over to another channel once in a while, have a good lawyer, and can prove the crystal broke, the thermometer exploded, or the lightning struck or something equally as convincing, you might get off with one fine of \$500, but it isn't worth while risking. Your staff is intelligent enough to get advertising for you, keep the books, announce the names of foreign composers and perhaps even fill in a renewal application; why in the world, the Commission wants to know, can't they read the regulations and the law and obey their mandates?

There has been little if any excuse in the past and there is less now that a list of essential "Don'ts" is printed herewith. Consider other activities which are rigidly controlled. You can't operate your automobile, even after you get a license for it in the form of a number plate, without a driver's license; neither can you operate a licensed station unless you, or someone you hire as a radio chauffeur, has an operator's license. No one in this country can operate an unlicensed car—nor a radio transmitter. A manufacturer can build a transmitter, provided, of course, he complies with patent laws, but neither he nor anyone can assemble, install, hook up or make ready to operate or test it without a construction permit. Once it is licensed, the transmitter can't be moved, rebuilt, improved or added to without the permission of the Commission, except to replace a burned out tube or change the speech input apparatus. These acts require a construction permit, and like all other applications must be filed through your supervisor, who, incidentally, is a good man to get acquainted with, even if you are afraid of him. He is the "traffic cop of the ether"; co-operate with him always. If he gives you a "ticket" be sure to answer his queries within three days, or be haled into radio court.

It is suggested for the convenience of all that an up-to-date schematic wiring diagram of your transmitter, with necessary explanations, be kept posted in your operating room alongside the operator's and station licenses, which must be posted conspicuously.

Speaking of applications, some of my clients think I am the ideal short cut to securing a construction permit or license



CARL BUTMAN, now a radio consultant, will be remembered as the first secretary of the Federal Radio Commission, the governmental agency charged with the enforcement of the laws governing radio communication in all of its various phases.

In the article here, Mr. Butman deals exclusively with the broadcasting angle of radio. But broadcasting is only a small part of the radio picture. In order to adequately cover the laws, rules and regulations governing radio activities in such fields as, ship-to-shore radio, coast guard and other governmental services, aircraft radio and amateur radio, the editors have commissioned Mr. Butman to write in his inimitable style about these other sometimes forgotten phases of radio. His articles on the subject will appear in succeeding issues of RADIO NEWS.

quickly, sending me their applications to file here. Nothing irritates the supervisors more. Proper procedure is to file all applications through the supervisors. Actually I can so serve only in emergencies and then only with the approval of the chief engineer of the Commission, Dr. Jolliffe, General Counsel Brown, or the chief supervisor, Mr. Terrell.

Probably one of the worst situations I ever saw a station get into, through sheer neglect to read and observe regulations, was unfolded when a Southern station operator came to me with tears in his eyes and said his construction permit for a new transmitter was being held up. His speech and *savoir faire* were perfect, so was his neat palm beach, but his lack of information as to proper procedure was pathetic. Imagine this, if you can: Having a chance to sell the transmitter then licensed and in use, he tore it out, packed it up and shipped it to a man who had just secured a new C.P. Rather than go off the air, this enterprising youth found enough spare parts to assemble a "hay-wire" transmitter rated at about half the assigned power. This he proceeded to operate while he designed and built a new set to replace (Continued on page 558)

In The Serviceman's



The picture above shows the service equipment of the Weslaco Electric Co., Inc., Rio Grande Valley, Texas. The equipment was built by G. C. McRoberts, a graduate of the Air Corps Technical School. Precision meters are employed exclusively in the permanent test panel and portable testers. A portable diagnetometer is used for outside servicing

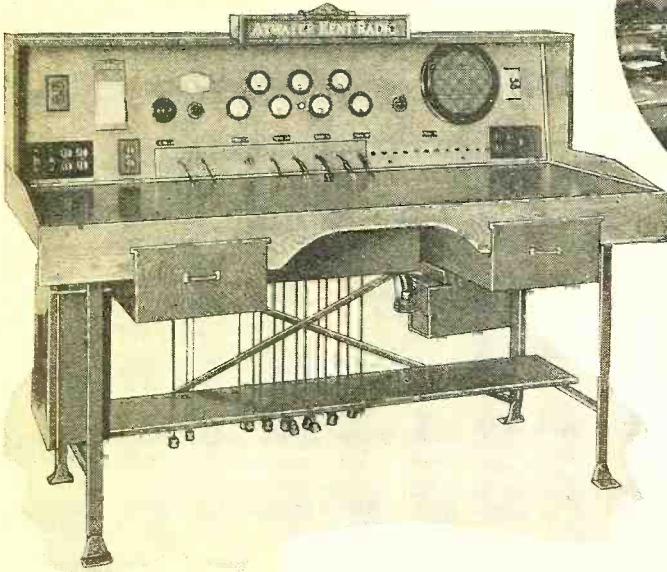

This interesting Atwater Kent test bench was designed by the Columbus Ignition Co., Columbus, O. Test leads, used for aerial, ground, speaker, continuity and meter leads, operate in conjunction with pulleys. Other features are battery binding posts, at right, a.c. and d.c. convenience outlets, speaker jacks and sockets and tool and tube drawers

The test bench at the right was designed by George R. Prell, of Oklahoma City, Okla. The meters are so connected, each with a separate switch, that they can be used in the different circuits of a set. A phone jack, located beneath each meter, permits external use

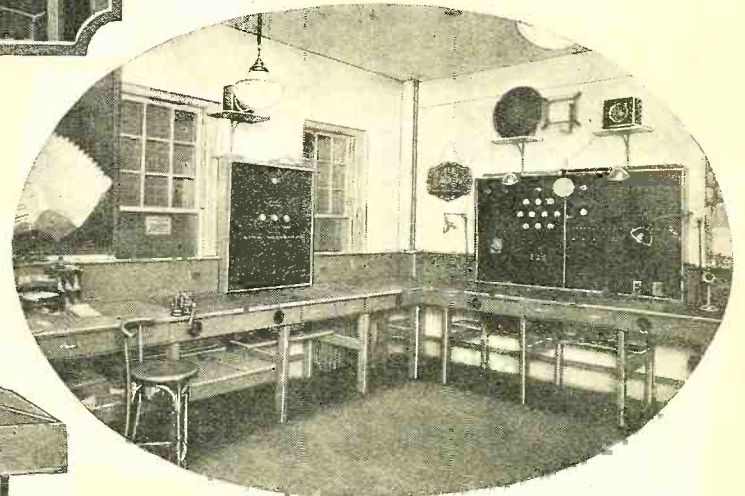
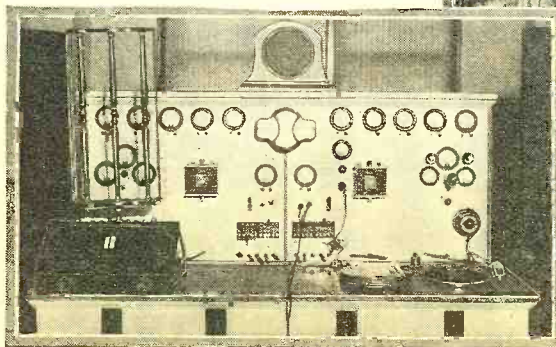

Radio Studios, Inc., New Rochelle, N. Y., submitted the photo shown above. The main test panel includes a complete set and tube tester, a high and low-resistance bridge, a 175 and 180 kc. oscillator. The small panel includes a continuity test, a milliammeter and a voltmeter connected to pin jacks. Both boards are wired with battery set voltages



Shown above is an interesting view of the radio department of the McLendon Hardware Company, of Waco, Texas. Clyde Clark, of the radio department of that company, submitted the photograph which shows an extensive use of test equipment

Workshop

pages have been submitted by RADIO NEWS Ten Dollar Service-Department. From all those as most representative of the type serviceman equips himself. In all feature is the reliance placed on for use in testing radio equipment. when we simply hooked an antenna receiver and in a hit-or-miss fashion ultimately locating the trouble

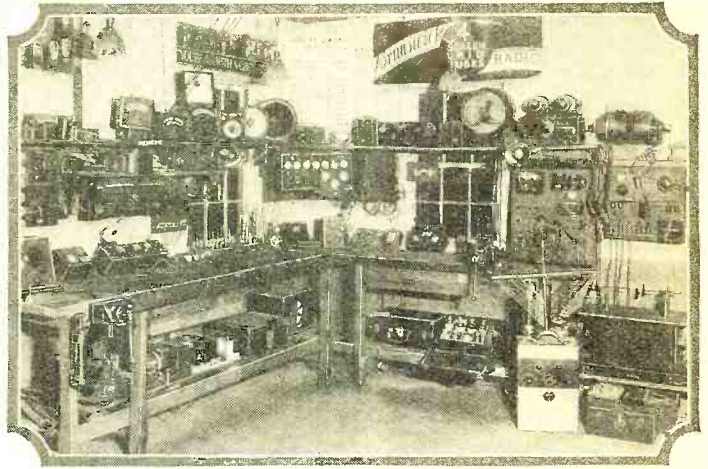

The above view is of the radio test and servicing equipment used by The Goodway, Ephrata, Pa. Practically every instrument needed in the testing and repairing of a radio receiver is included in this company's set-up from a simple filament emission tube tester to a metal penetrating X-ray set

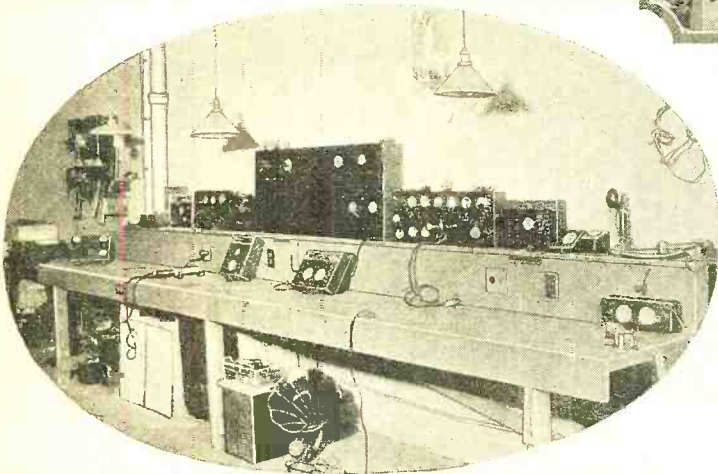

The neat and workmanlike layout shown in the photo above is the radio test bench of Bob's Battery and Radio Service, of Harrisburg, Pa. The unique construction of the bench, arranged in tiers, permits work on receivers without a great deal of shifting of test instruments.

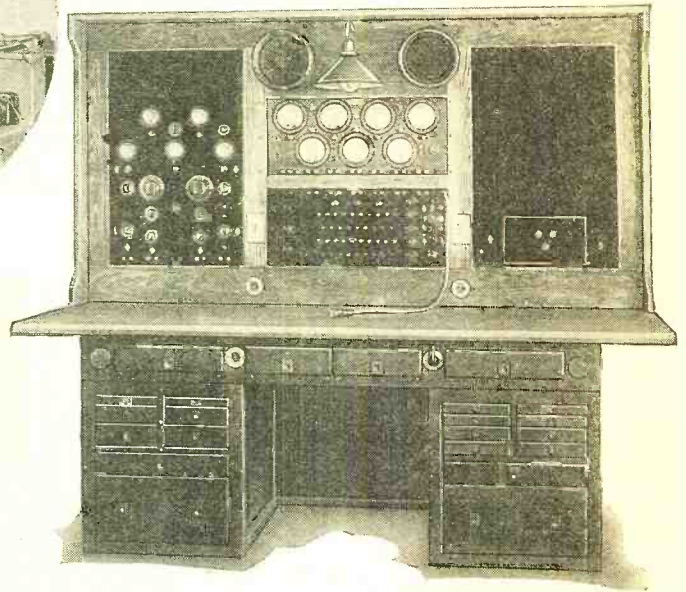

Willard W. Geiger, of Mt. Pocono, Pa., built the interesting test panel pictured above. The left hand panel contains a modulated oscillator, a vacuum tube voltmeter, a grid-dip meter and a wavemeter. Magnetic and dynamic speakers are located above middle panel. Tube sockets are at right

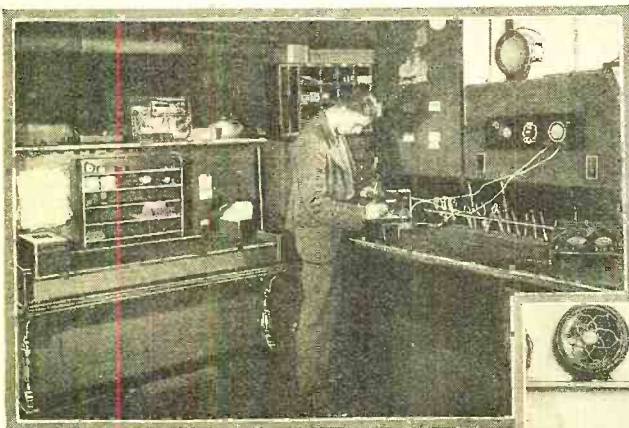

The service bench photo of the Thomas Music Co., Scranton, Pa., appearing above, was submitted by Albert Warren, serviceman of that company. Provision is made for both permanent and portable set testers and also a series of shelves for supplies for repairs

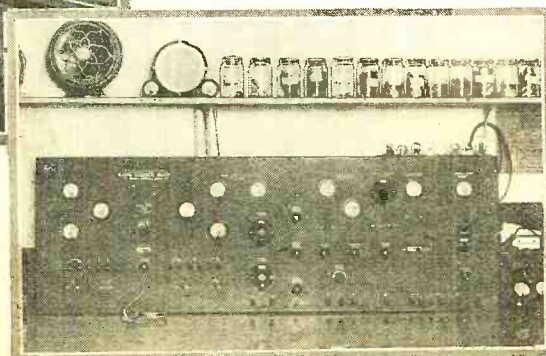

At the left is the test and set analyzing panel built for the Radio Service Shop, Rochester, N. Y., by Wendell Schneider. Each of the various sections of the panel is labeled

Automatic line voltage regulator compensates line voltage variations, maintaining the operation of the receiver at a uniformly high efficiency at all times.

A linear, automatically biased screen-grid detector increases efficiency and prevents detector overloading in the Hi-Q 31.

The Hi-Q 31 uses band-pass circuits coupled by inductance and capacity to give practically uniform selectivity and minimum side-band cutting over the broadcast band.

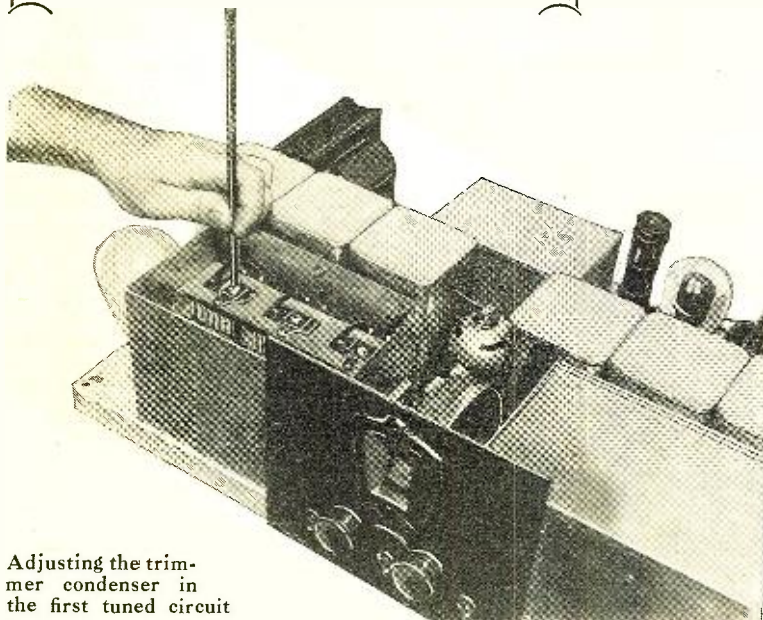

Adjusting the trimmer condenser in the first tuned circuit

IN last month's issue of RADIO NEWS we endeavored to paint a brief word picture of the Hi-Q 31 receiver, its features and performance characteristics. This article discusses the features and construction of the receiver in further detail. Practically a solid year of engineering in the laboratories of the Hammarlund Manufacturing Company is represented in the Hi-Q 31.

A feature which indicates the care which has been taken to produce a really fine receiver is shown by the fact that the designers have even engineered a special loud speaker having characteristics especially suited to the Hi-Q 31 receiver. We told you last month that the loud speaker has the unusual feature of employing two field coils, one of which acts as the second choke coil of the filter system, the other field coil having such characteristics that it can be placed in the filament circuit of the two type -45 power tubes, to supply C bias for these tubes. In this way some 3.5 watts of additional field power are obtained, which in most sets is just thrown away in a fixed resistance. In addition, this special Hi-Q loud speaker has a cone diameter and angle such as to produce best results with the receiver. Actually the characteristics of the Hi-Q 31 are such that excellent results can be obtained with any good loud speaker, but whenever possible we suggest that the receiver be used with the special double field coil loud speaker which has been especially designed for use with the set.

Many home constructors and custom set-builders who built the Hi-Q 30 receiver will want to know just how it differs in electrical design from this year's receiver: the mechanical design of the two receivers is quite similar, the general layout

The Outstanding Unit-Built

In this, the second of the series the author goes into further features of this receiver and ally from the previous model. find this information helpful in receiver

By Donald
Part

of parts used in last year's receiver being adhered to because the arrangement proved so satisfactory to the many builders who constructed the "30" model. The mechanical arrangement of the apparatus is such that the set is very easily put together and there is but little chance of making errors. All the high potential leads are short and the arrangement is such that feedback between the various circuits is completely eliminated. Although mechanically the receivers, Hi-Q 30 and Hi-Q 31, are quite similar, electrically they differ in many respects, many new circuit features having been devised. Let us explain how the two receivers differ.

The band-pass filter of the Hi-Q 31 uses combination inductive and capacitive coupling, rather than simple inductive coupling. This combination of capacities and inductive coupling gives this receiver even greater selectivity without side-band cutting. To find out why this is so, let us delve a bit into the theory of band-pass circuits—coupled circuits, engineers sometimes call them. Theory states and experiments prove that when two tuned circuits are coupled together and tuned to the same frequency that the combined circuits no longer respond to a

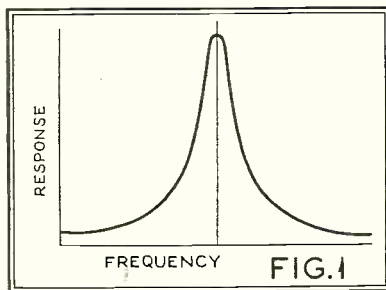
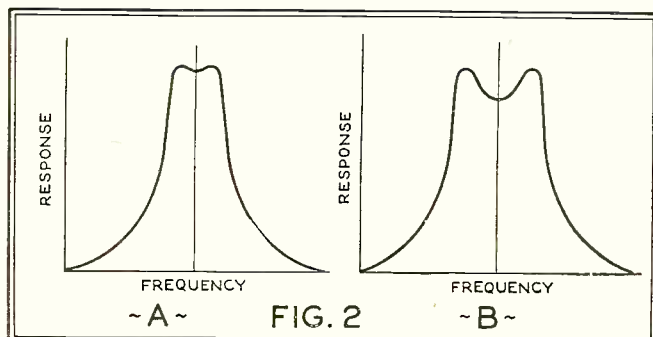
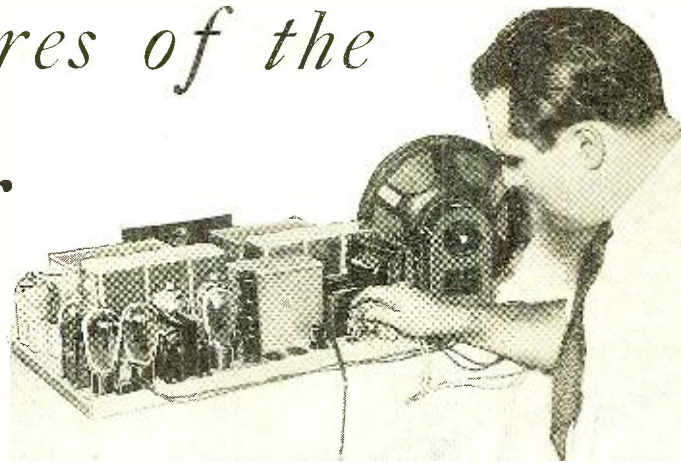

Fig. 1. The response characteristics of a simple tuned circuit, or of two circuits coupled together very loosely

Fig. 2. Characteristics of coupled circuits. Sketch A represents about the proper coupling for a band-pass filter of a broadcast receiver. Sketch B shows the effect of excessive coupling



Design Features of the Receiver



A four-prong plug provides easy connection of the loud speaker to the receiver through a standard socket

of the new 1931 Hi-Q receiver, detail concerning the design shows how it differs electric-Servicemen in particular will better understanding how the functions

Lewis*

Two

single frequency, but to a group of frequencies. If we measure the response of a single tuned circuit we obtain a curve like that shown in Fig. 1 and if we couple two circuits together *very loosely* we obtain a curve of practically the same shape. But if we increase the coupling the form of the curve undergoes a radical change. If the coupling is slightly increased we obtain a curve like A of Fig. 2; if we further increase the coupling we obtain a curve like Fig. 2 B. By varying the coupling we can evidently obtain a number of different characteristics. Which is most desirable? Let us look at Fig. 3. This curve shows the standard resonance curve obtained when simple tuned circuits are used. The top of the curve is very peaked. The two vertical dotted lines indicate the width of the sidebands from a normal broadcasting station and it is immediately evident that the simple tuned circuit, whose characteristic is always like that of Fig. 3, will cut sidebands and therefore reduce the high audio frequencies so essential if speech reproduction is to be natural and music is to have the sparkle and crispness that depend so much upon the upper audio frequencies. At 5000 cycles off resonance the circuit whose curve is shown in Fig. 3 would reduce the 5000

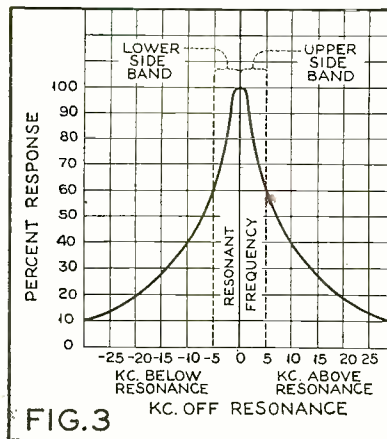

Fig. 3. The peaked characteristic of a simple tuned circuit causes it to cut sidebands. In this case the 5,000-cycle notes are reduced to 60 per cent.

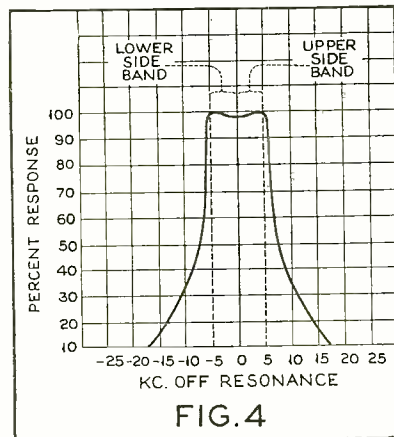

Fig. 4. Band-pass circuits, properly coupled together, eliminate side-band cutting and at the same time improve the selectivity due to the straight sides of the curve. Compare this characteristic with Fig. 3

cycle note to 60 per cent of its amplitude. Also, although the simple tuned circuit is too sharp at 5000 cycles off resonance it is not sharp enough at, say 20,000 cycles off resonance, in this case 20 per cent of the signal remaining at 20 k.c. off resonance. In other words we have the very peculiar condition where the selectivity is too sharp within the range of the sidebands but not sharp enough at frequencies beyond the sidebands. What we must do is *decrease* the selectivity within the range of the sidebands and *increase* the selectivity outside the

range of the sidebands. Band-pass circuits will do this. How this is accomplished will become clear by reference to Fig. 4 which shows the curve of a band-pass circuit with about the same coupling of Fig. 2-A. Here we note that within the range of the sidebands the side band cutting has been reduced to negligible proportions, the curve being essentially flat over a band of 10,000 cycles wide—just wide enough to accommodate the upper and lower sidebands, each of which extend 5000 cycles either side of the carrier frequency. The band-pass circuit will therefore pass without attenuation all the high audio frequencies, the reproduction of which means excellent reproduction, and the loss of which would result in a very mediocre receiver. Also note how the selectivity of the circuit has been improved outside the limit of the sidebands. The simple tuned circuit of Fig. 3 left 20 per cent of the signal at 20 k.c. off the carrier frequency. The band-pass circuit, Fig. 4, leaves only 10 per cent.

But there is a nigger in the woodpile. As our readers know, the reactance of a coil increases with frequency, so if the two circuits of a band-pass filter are coupled together by a common inductance (a coil) the coupling will be three times greater at 1500 k.c. than at 500 k.c. If the coupling is adjusted to give a characteristic like that of Fig. 4 at 500 k.c. then at 1500 k.c. the flat top of the curve will be three times as broad and the receiver will not be sufficiently selective. If we couple the tuned circuits together by means of a small condenser, whose reactance decreases with frequency, the conditions are reversed. If the coupling is adjusted to the proper value at 1500 k.c. the flat top will be three times as broad at 500 k.c. Therefore, if we use simple inductive coupling the selectivity is poor at 1500 k.c.; if we use only capacitive coupling the selectivity is poor at 500 k.c.

For these reasons we find that the band-pass circuits of the Hi-Q 31 are coupled together by *both* capacity and inductance. The result is practically uniform band-pass characteristics over the entire broadcast band. The selectivity is just as good at 500 k.c. as it is at 1500 k.c., or at 1000 k.c. At all times the essential sidebands are passed without attenuation—without loss—and the fidelity and selectivity of the set are therefore excellent and uniform at all points of the dial.

Such circuits are not easily designed; they require a great number of measurements in the Hammarlund laboratories but it is certainly true that if really excellent performance is to be obtained from a receiver it is essential that band-pass circuits be used, and furthermore that they use combined inductive and capacitive coupling, such as is found in the band-pass filter of the Hi-Q 31. Those experimenters who want to study for themselves the theory of band-pass circuits will find considerable information in Pierce's Electrical Oscillations and Electrical Waves or Morecroft's Principles of Radio Communication.

Another feature incorporated in the Hi-Q 31 receiver are special "uniform gain" radio-frequency transformers between the various screen-grid tubes in the r.f. amplifier. By means of a special arrangement these transformers have been designed to give a very high gain and to maintain this gain over the entire broadcast spectrum. Ordinary r.f. transformers give high gain at certain frequencies but much lower gain (amplification) at other points on the dial. Obviously if a receiver is to be uniformly sensitive to all frequencies, the r.f. transformers must have uniform gain characteristics. The radio-frequency transformers in the Hi-Q 31 have such characteristics. In addition, readers will be interested to know that all the variable condensers in the receiver are constructed using a new insulation material, "Parmica" which has but 10 per cent of the losses of ordinary insulating materials. The result is sharper tuning and greater gain.

The Hi-Q 31 also makes use of a linear screen grid power detector, with automatic bias. In this way and possibility of detector overloading is eliminated. R.f. feedback between the detector output and the antenna circuit, frequently a trouble experienced with many receivers, is prevented by means of the double section filter in the plate circuit of the detector—this filter shown in the circuit diagram Fig. 5, consists of two r.f. choke coils and two 0.00025 mfd. fixed condensers. The audio-frequency amplifying system consists of a resistance stage followed by a -27 and a push-pull output stage with -45 tubes.

The circuit of Fig. 5 assumes that the constructor will use the special loud speaker described in the first part of this article. If this loud speaker is used the four leads from the field winding are brought out in a four wire cable, attached to a four prong plug fitting a standard UX tube socket. When this plug is inserted in the socket mounted on the sub-panel marked "SPKR" the 3000-ohm field coil acts as the second filter choke and also replaces the top section of the voltage divider resistor (it will be noted that this top section is left open in the circuit Fig. 5). The 850-ohm field coil acts as the biasing resistor for the push-pull -45 tubes and replaces the bottom section of the voltage divider (which is also shown open in the circuit). This scheme supplies about 8 watts of field power without increasing the drain on the rectifier. The Hi-Q 31 can, however, be easily adapted to use any speaker having its own field supply. The additional parts required are a special 40 mil Hi-Q 31 filter choke coil and one

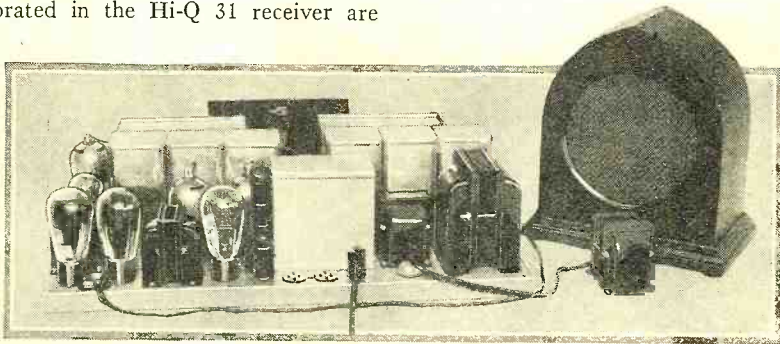

The completely assembled receiver and power unit with output transformer and magnetic speaker

four-prong plug. Two wires are soldered to the terminals of the choke and their other ends connected to the "P" and "F+" terminals of the four-prong plug—the "G" and "F—" terminals of the plug are left open. These wires from the plug to the choke should be of such length that the choke may be placed on the lower shelf (or any other convenient place) of the cabinet.

Then the wire from the "F+" terminal of the socket marked "SPKR" is moved to terminal No. 6 of the divider and a lead from the "G" terminal of the socket is connected to terminal No. 1 of the divider. These simple changes are all that is necessary to adapt the Hi-Q 31 to the use of any loud speaker having 110 volt a.c. supply.

The above discussion will have served not only to indicate some of the interesting and important features of the Hi-Q 31 but will also have brought out a number of ways in which the receiver differs from the Hi-Q 30. The Hi-Q 31 is actually considerably more selective due to the use of combined capacitive and inductive coupling in the (Continued on page 549)

Fig. 5. The complete circuit diagram of the Hi-Q 31

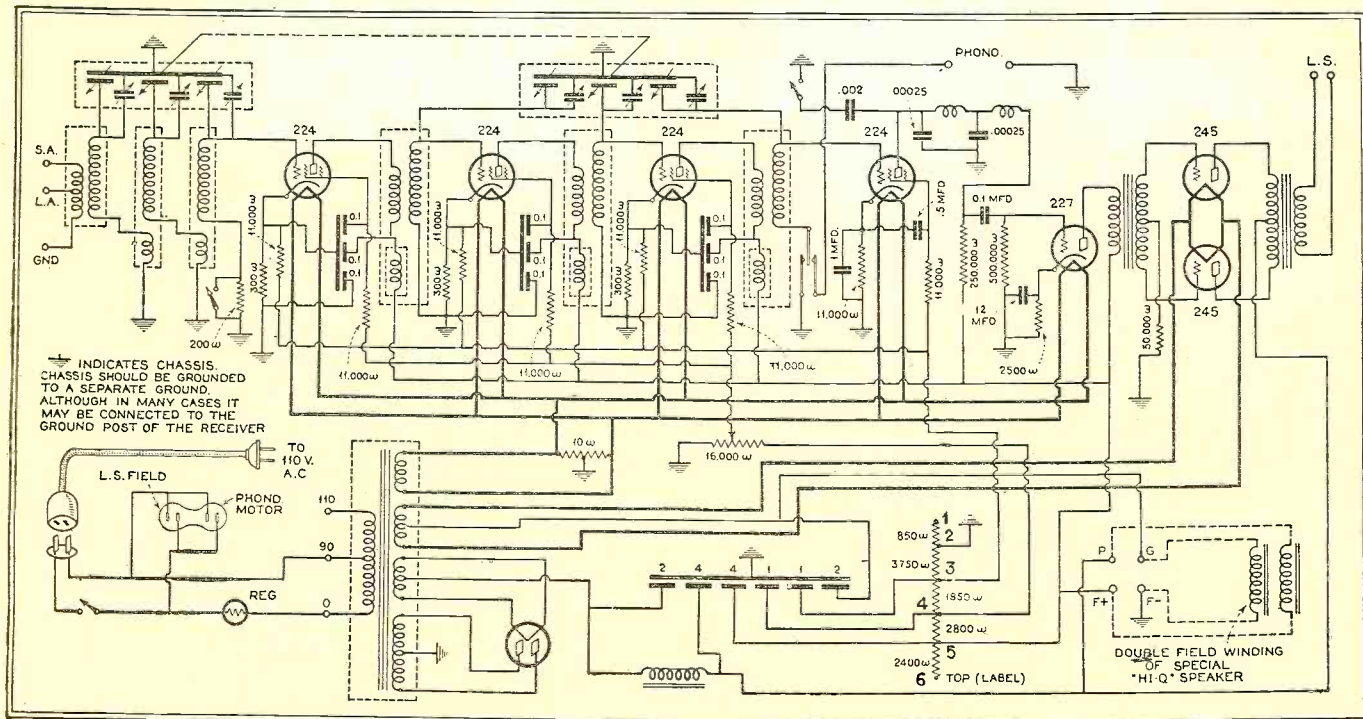

Some New Circuit Developments in the "Broadcast Superhet"

Some of the experimenters that have constructed the broadcast superheterodyne have experienced slight interference from high-powered locals. Herein is given a simple method of correcting that difficulty, with small outlay for parts

By George E. Fleming



The author is shown above examining the coils of this small and compact unit. At the left is a top view of the oscillator and first detector

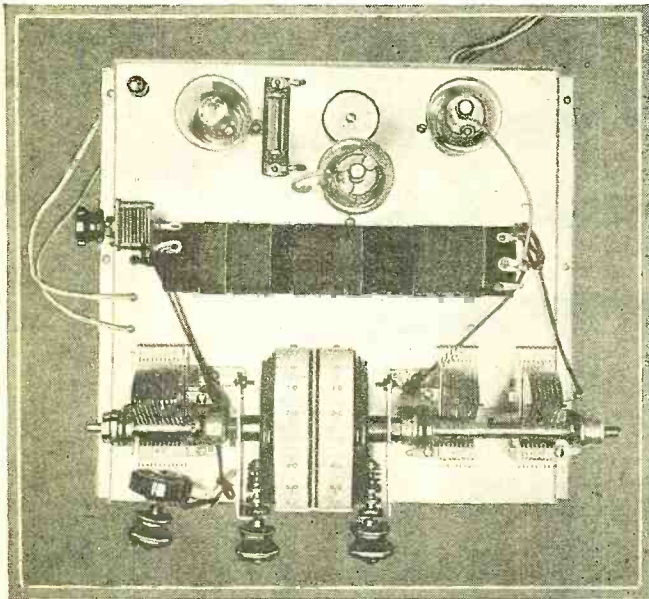

and coupling the oscillator to the first detector. This will be explained in turn later in this article. This system has several advantages over the more usual systems.

To begin with, we have the problem of controlling the volume output of the receiver. Much has been said in favor of different types of volume controls. In fact, quite a dissertation could be written on this question alone. Without going too deeply into pros and cons, let it suffice to say that the writer has always favored placing the volume control in the antenna circuit of a receiver. This has very definite advantages; in this position no distortion of the signal results when the control is almost fully retarded. Another advantage is that the resistance is carrying no current, so the danger of burning out or becoming noisy in normal operation is eliminated. The disadvantage of this system lies in the fact that when used the control is almost invariably used across an antenna coil. In this case, even in the full retard position, sufficient capacity coupling to the antenna exists to give (Continued on page 550)

ONE of the advantages in building a receiver on the "unit plan" is the ease with which alterations may be made to the assembly if occasion demands. While entirely satisfactory for the vast majority of cases, some few of the experimenters that have built the "broadcast superheterodyne" have experienced a little difficulty with interference if they happened to be located too close to a high-powered transmitter. This so-called image interference is due to the fact that with only one tuned circuit ahead of the first detector tube, it is possible to apply sufficient signal voltage to the grid of the first detector, if the unwanted station is of sufficiently high power and located close to the receiver, to drive the grid positive. Whenever this happens the wanted signal is modulated with the unwanted signal, and no amount of selectivity in the intermediate amplifier will prevent this happening.

The remedy was obvious, increase the selectivity ahead of the first detector. There were many ways of doing this, and most of them were tried, until the method described here was evolved. Briefly, the system employs a volume control in the antenna circuit that is a potentiometer, with the movable arm connected to the grid of the radio-frequency amplifier tube, the plate of which is tuned, and coupled into the grid of the first detector tube, which is also tuned, forming a band-pass or band-selector circuit. The balance of the circuit is practically unchanged, except the method of winding the coils

The circuit diagram of the oscillator and first detector

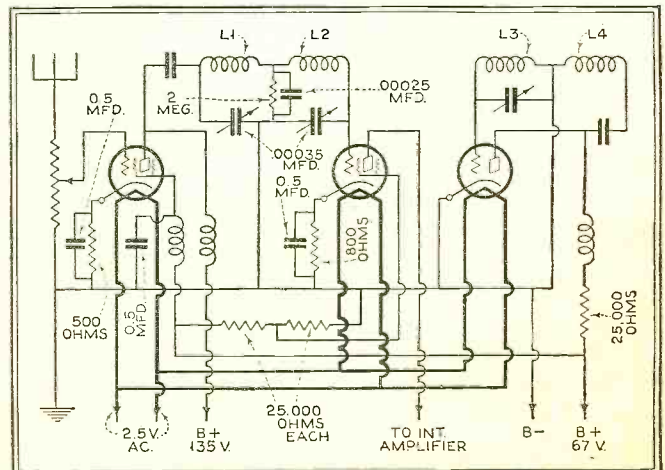

Development of the

FOR a long time after the first works of Hertz were published showing that electrical power could actually be transmitted through space without connecting wires, physicists and experimenters, greatly interested, tried various systems for the transmission and reception of these wireless waves as a laboratory experiment.

At first the mere repeating of the Hertzian experiments was considered to be quite a feat. Marconi was one of the first to appreciate the great commercial possibilities of the new art and he and his associates worked to find some practical means to transmit and receive the energy by wireless, which when properly coded would give them a new system for the transmission of intelligence. One of their most important contributions was the coherer, which was by far the most sensitive detector of the wireless signals devised up to that time. The transmitting systems depended entirely on brute force methods to get through. Huge, high-powered installations developing enormous voltages across a spark gap, which, connected to all manner of large and complicated antenna systems, were considered essential.

Although the general theory concerning these waves was known and accepted, methods of actually measuring what was going on were still unknown. The lack of measuring tools retarded the work to a great extent and things progressed on a more or less cut-and-try basis. Gradually, however, the nature of the problem became better and better understood. The frequencies involved were so much higher than any previously used in electrical work that a new technique of measurement had to be evolved. As these problems were gradually solved the art progressed until quite reliable communication up to several hundred miles became common. With the introduction of Poulson Arc and the high frequency Alexander alternators, which produced true undamped oscillations, the maximum transmitting range was increased until transoceanic handling of messages became a commonplace. So far, no one had become seriously interested in the transmission of the voice by wireless, and the major effort was still for more reliable point-to-point communication by code.

The discovery of the vacuum tube opened up new lines of thought and development. This device was an incomparably more stable and satisfactory oscillator, and more sensitive detector and amplifier for the high frequency wireless signals than anything known up to this time. Its introduction encouraged the development of the wireless telephone tremendously and in 1915 the engineers of the Bell System established voice communication between Montauk Point, L. I., and Wilmington, Delaware.

It was not until 1920 that the idea of public broadcasting of program amusements was conceived. These broadcasts were designed to stir the public interest in radio and to create a market for receiving sets.

The first sets were cumbersome, bulky, complicated and incon-

MR. THIESSEN, an engineer with the General Radio Company of Cambridge, Mass., has been able to draw on the long experience of his company in its work of supplying the laboratories and servicemen with all kinds of precision test equipment. In this article Mr. Thiessen succeeds in painting a word picture of the early history of receiver testing contrasted with the present-day trend. Servicemen particularly will find this discussion of value because they will appreciate the exactness of today's test methods only in the light of their development.



Mutual conductance is the best figure of merit of a vacuum tube. The instrument shown at the right measures the mutual conductance of any of the UX or UY tubes. When the bridge is balanced the mutual conductance may be read directly on the scale



venient to use. They were all adaptations of the various sets that had been used previously for the reception of code.

The three important qualities that are now looked for in receiving sets are sensitivity, selectivity, and quality. The last two of these were utterly neglected in those days when sensitivity was the great consideration.

The first broadcast receiving sets were nearly all hand made, and were mostly built by amateurs who were curious to hear the experiments being carried on by the pioneer broadcasting stations such as KDKA, WJZ and WGY. These early sets were constructed of such parts as could be gotten together easily out of the usual material lying around an amateur's laboratory. No one ever heard of the refinements of good quality of reception, and simplicity of operation which came later.

The interest in broadcast reception spread, and soon kits of knockdown sets were sold to a large and avid public who were beginning to become conscious of the entertainment value of some of the broadcast programs. Between 1922 and 1925 the set building craze reached its height and everyone was constructing his own receiver, being his own designer and service man.

At about this time a few manufacturers began to make completely assembled

The General Radio type 360 test oscillator (at left) delivers a properly modulated radio frequency which makes possible tests on the alignment and selectivity of the receiver. By turning a switch a second oscillator is started which provides frequencies from 175-180 kilocycles for testing the intermediate amplifiers in super-heterodyne receivers

DESIGN *and* TESTING of Broadcast Receivers

In this article the author traces the change which has taken place during the last eight or ten years in receiver design and testing. Then, it was thought satisfactory to give the receiver the most perfunctory of tests, if any at all. Today, due to the exacting conditions which a receiver must meet, manufacturers must necessarily perform accurate tests with precision measuring instruments so that the purchaser will be assured of the receiver's sensitivity in microvolts per meter, its band-pass qualities and its overall audio-frequency response

By Arthur E. Thiessen*

sets. In order to compete with the popular kits and homemade outfits that were already in such wide use, they began the development of a product which would be superior in performance and simple of operation. To this end they organized engineering laboratories. Many of the laboratory instruments of measurement which are in common use now had not been developed at that time. Great progress was made under these handicaps, however, and in a short time the majority of broadcast listeners were buying their sets ready-made.

The greatest emphasis in the design of receivers was still on greater sensitivity, but as the number of broadcast stations began to multiply it became obvious that more selectivity was necessary for satisfactory reception. All kinds of circuits were tried but the best for all-around work seemed to be the multiple tuned stage r.f. amplifier followed by a detector and one or two stages of audio amplification. This system with variations is still in general use. Some sets do all of the tuning in a pre-selector circuit followed by an aperiodic amplifier. Others use the superheterodyne by means of which the received broadcast signal is heterodyned down by a local variable frequency oscillator and amplified at a lower frequency, for example 175 kilocycles, by an amplifier tuned to this frequency only.

Telephone engineers had been working for a long time on the study of speech and its electrical reproduction. As the demand for better quality of reception grew, radio engineers drew on this fund of knowledge in order to help them to improve the voice frequency response of receivers.

However much engineering development the manufacturer of radio receivers expends on its design, there remains the problem of comparing the performance of the quantity-produced unit with that of the laboratory model. Without rigorous inspection some defective units are likely to reach the user, which causes expensive replacements and is bad for the name of the manufacturer.

It is usual to check the component parts before assembly and follow this by supplementary tests on the completed

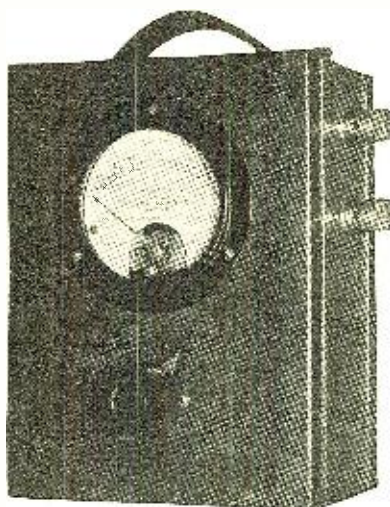

An ohmmeter is a most useful device for continuity tests and for checking the values of the various resistors in receivers. The one shown here reads from 0 to 10,000 ohms

chassis. Sometimes these tests are conducted by simply tuning in on a few broadcasting stations and judging by ear how it works. This try-it-and-see-if-it-works sort of test is rapidly becoming obsolete. Many manufacturers are installing very complete and accurate apparatus to conduct these tests in such a way as to eliminate as much of the human element as possible.

Tests of the overall sensitivity of the receivers are made by introducing a known amount of modulated radio-frequency voltage into the set at the antenna terminals exactly as would be gotten from a broadcasting station, except that the modulation is at only one frequency. The output of the set is connected to a meter instead of to the loud speaker, and the actual output power is read. The input is held constant and the set, in order to pass inspection, must deliver a definite predetermined output power. Inspectors are able to make rapid and most exact tests for sensitivity on the completed chassis in this way.

The RCA-Victor Company in Camden, New Jersey, has developed a means by which its operators can align the coils and condensers of the intermediate (175 KC) frequency amplifier visually. That is, the resonance curve of the coil and condenser are projected on a screen and the operator adjusts the coils until the peak of the resonance curve falls on a line that marks the point of the proper resonant frequency. (Mr. Fleming describes the RCA-Victor test procedure in another article in this issue.—Ed.)

The audio amplifier is a very important part of the receiver, since its performance determines in large part the quality of output of the receiver. There has been quite a concentration of effort recently in the development of satisfactory amplifiers and the performance tests on these units are quite important. Usually the tests are made to determine the response of the amplifier over the voice frequency band; and to this end devices have been evolved which enable an inspector to make these tests very speedily and accurately.

As a result of all of this development work and the careful examination of the complete receivers many of the receivers of today are very high grade. Like any other intricate piece of machinery they are apt to (Continued on page 565)

*Engineer, General Radio Co.

Making Modern

Few radio owners have any notion of the modern plant of Newton, Mass., and on these pages we show the interesting scenes in the plant of this highly specialized

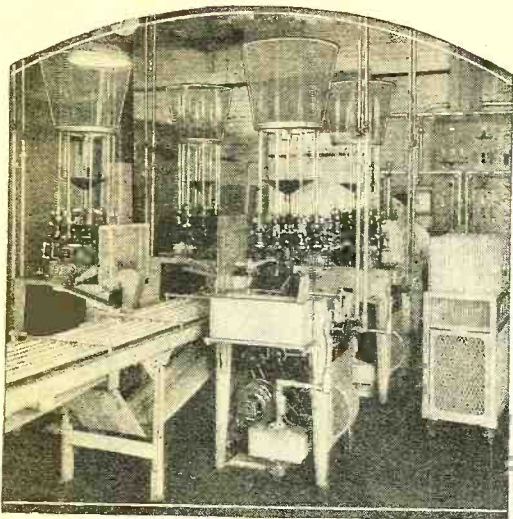

Automatic machines for making flares. Each machine delivers the finished flares to individual troughs on the conveyor for the purpose of quickly detecting and correcting any irregularities which may creep into the product

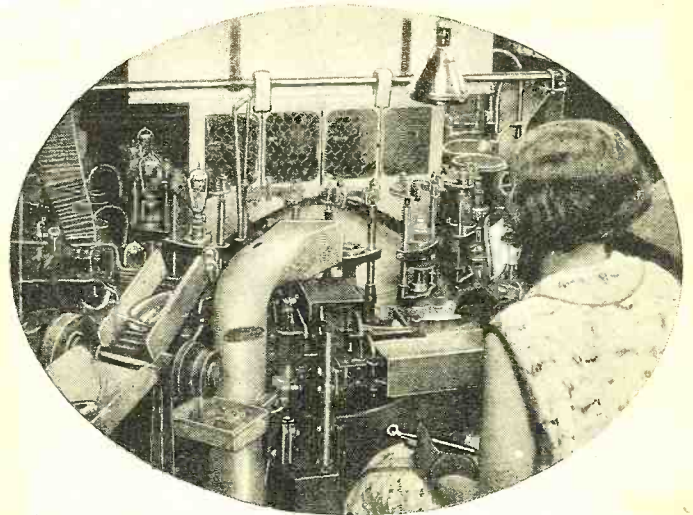

The sealing and exhausting machine shown above combines what were formerly two separate operations producing more tubes more uniformly by eliminating excessive cooling between the end of the sealing operation and the beginning of the exhaust operation

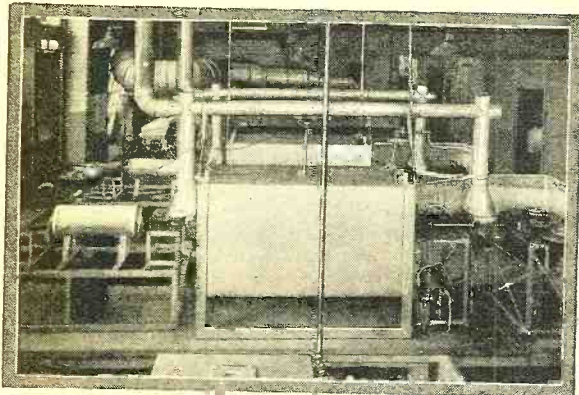

Above are the furnaces where material for plates is carbonized. The purpose of this operation is to impart improved heat radiating properties to the plates of the higher powered tubes, such as the -80 and the -45, rectifier and output tubes respectively. This material is usually purchased by tube makers in the carbonized state, but here carbonization is carried out under local control to insure uniformity of finished tubes

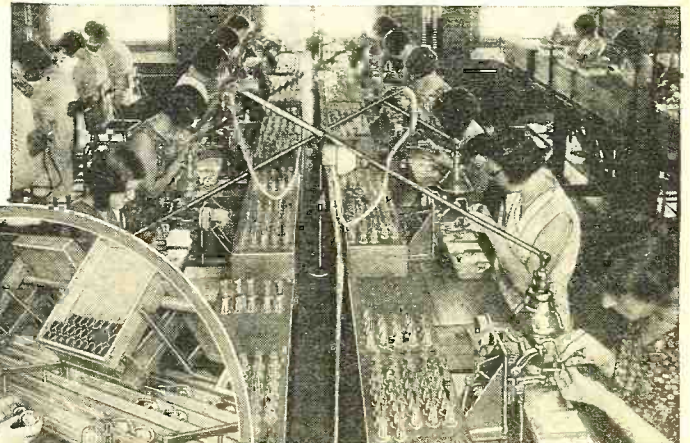

Above is the mount assembly. Glass flares from flare-making machines arrive at this department, where the various elements of the tube structure are assembled by means of small electrical welders operated by highly skilled workers

The girls shown below are inspecting the tubes for appearance. After the tubes have been completed and successfully passed the many electrical and mechanical tests, they are given a final inspection for uniformity and appearance before being packed in cartons

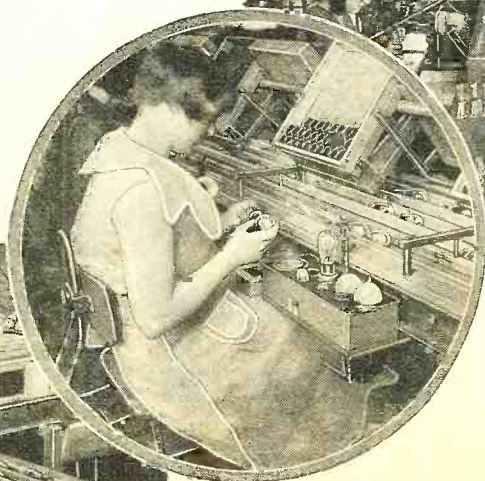

At the left (in circle) is the base wiring inspection. Instruments at the operator's right instantly detect any wrong connections before the final soldering



Vacuum Tubes

*how the tubes, which are the sensi-
made. One of our engineers has taken
the Eveready Raytheon Company at
have a camera recording of some of
illustrating the production technique of
manufacturing process*



Fred D. Williams, Manager Radio Tube Division, National Carbon Company. The motivating force behind this modern and efficient tube plant, Mr. Williams believes that defects should be discovered before leaving the factory. The story told here indicates the manner in which this belief has been put to practice



(Above) How X-ray photographs eliminate defective cathodes. A bright light below the film enables the inspector to locate defective cathodes in the film. The inspector places a pointer over the photograph of the defective cathode and a clever pantograph arrangement causes a similar pointer to come to rest directly over the defective cathode itself

Below—The X-ray tells the story. Cathode at right is defective

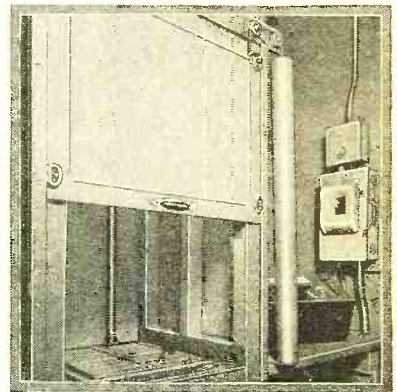
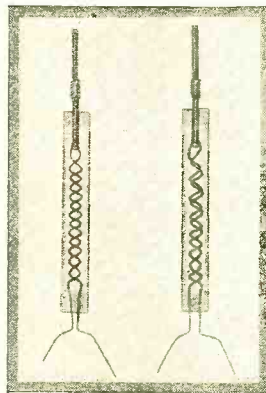

In the above X-ray cabinet where photos are made there is room for four shallow trays, each containing 100 complete cathodes

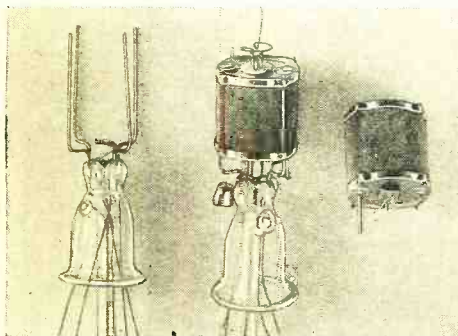

At the left, reading from left to right, are three stages of mount assembly: Four pillars sealed into glass stem, tube elements welded to four pillars, and complete assembly of tube elements

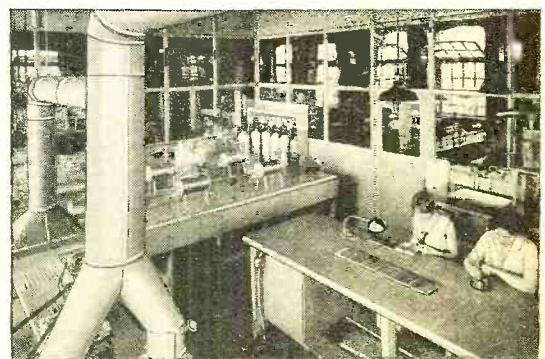

In the above room the complex chemicals which form the electron emitting surfaces are carefully compounded and applied to the filaments and cathodes under laboratory conditions. At the left the cathode assembly is shown. Reading from left to right: Bottom insulating plug, insulating support for filament, filament, top insulating plug, cathode thimble, assembly of parts 1, 2 and 3, assembly of 4, 5 and 6 uncoated cathode, coated cathode, finished cathode ready for mounting in complete assembly of tube elements

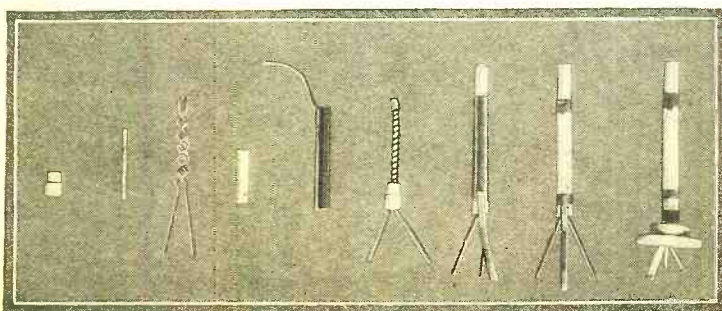

Radio Helps

The effective use of short-wave radio being made by the corps of army engineers, at present surveying the proposed canal across Nicaragua, is interestingly told in this article. Radio plays an all-important part in expediting every phase of the project whose completion may equal or exceed the engineering feat of the Panama Canal

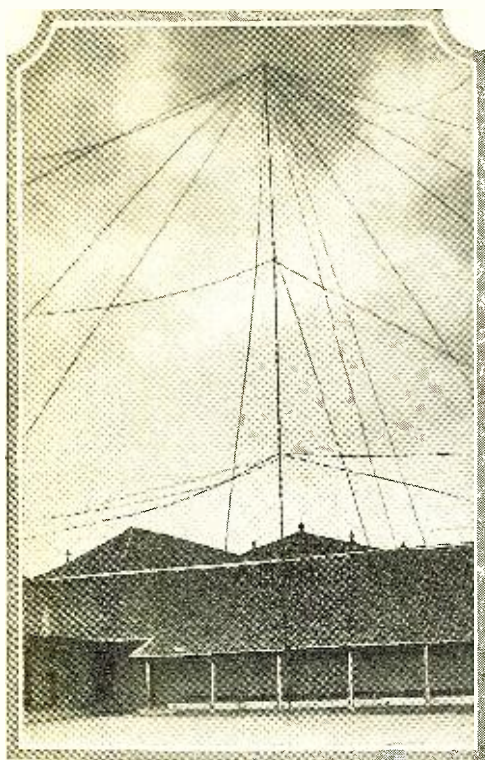

The radio mast and antenna at Granada, March, 1930. Remote control is used here. The transmitter is on the screened porch behind the mast while the receiving booth is across the patio

At the right is shown the radio tent at Camp Graves (Fort San Carlos), March, 1930



(Public Resolution—No. 99—70th Congress)

Sec. 2. The President is hereby authorized to cause to be made, under the direction of the Secretary of War and under the supervision of the Chief of Engineers, and with the aid of such civilian engineers as the President shall deem advisable, a full and complete investigation and survey for the purpose of revising and bringing down to date the reports of the Isthmian Canal Commission transmitted to Congress, with respect to the practicability and advantages and approximate cost of constructing a canal across Nicaragua, and for the purpose of obtaining all additional available information respecting (1) the most practical route for an interoceanic ship canal across the Republic of Nicaragua by way of the San Juan River and the Great Lake of Nicaragua, or by way of any other route over Nicaraguan territory, including suitable locations for harbors at each of the termini thereof; (2) the practicability and approximate cost of constructing and maintaining such canal; and (3) the approximate cost of acquiring all private rights, properties, privileges and franchises, if any, included in or necessarily affected by such canal route. (Approved March 2, 1929.)

IN order to carry out the investigation and survey authorized by the resolution partially quoted above, a provisional battalion of Engineers of the Regular Army was organized and designated as the U. S. Army Engineer Battalion in Nicaragua. It was composed of the following units: Headquarters and Service Platoon (29th Engineers, Fort Humphreys, Virginia), Company "A" (Company "A", 1st Engineers, Fort Dupont, Delaware), Company "B" (Company "A", 29th Engineers), and Company "C" (Company "F", 11th Engineers, Corozal, Canal Zone). The total strength of the battalion, with attached troops, was 25 officers and 250 enlisted men.

Major D. I. Sultan, Corps of Engineers, was placed in charge of the survey in Nicaragua and Major C. P. Gross, Corps of Engineers, was given command of the battalion.

Major Sultan, with Company "C", arrived in Nicaragua in August, 1929, and established headquarters in Granada. By October the majority of the company was encamped along the San Juan River and had begun the field work. The remainder of the battalion, with detachments of Medical Corps, Signal Corps, Quartermaster, and Finance troops sailed from Brooklyn on the "Chateau Thierry" on October 15th and arrived at Corinto on the 24th.

It was with a feeling of eagerness that we placed our feet on Nicaraguan soil. We were nearing the end of our journey. We were in a strange country, which was to be the scene of our activities for some time, no one knew just how long. We all felt that we would have big problems to face in the near future. The attached troops, while they did not anticipate any direct connection with the engineering features of the survey, knew that they were about to engage in something new and different. They were to have their problems along with the Engineers. A handful of Signal Corps men were to be faced with the job of providing dependable communication between widely separated jungle camps. A small Quartermaster detachment was to supply these camps over a "shoe-string" line of communication. The Medical detachment had to keep us well or cure us if we became sick, always a job in the jungles. But the sentiment down to the buck private was "Let's go!"

They were to have their problems along with the Engineers. A handful of Signal Corps men were to be faced with the job of providing dependable communication between widely separated jungle camps. A small Quartermaster detachment was to supply these camps over a "shoe-string" line of communication. The Medical detachment had to keep us well or cure us if we became sick, always a job in the jungles. But the sentiment down to the buck private was "Let's go!"



Above is an interior view of the station at Camp Hoover (Ochoa), February, 1930. The operators are First Class Privates, T. O. Cresnap and P. T. Peters

Uncle Sam's Engineers

Plan the Nicaraguan Canal

By Lieut. Stanley J. Horn
and
Sergt. Everett C. Smith

BOTH Lieut. Horn, Corps of Engineers, and Sergeant Smith, of the Signal Corps, are actively engaged in the Nicaraguan survey and are well equipped to give readers of RADIO NEWS a first-hand account of the radio story behind the brief newspaper reports that announced, more than a year ago, the initial step in this tremendous undertaking.—EDITOR.

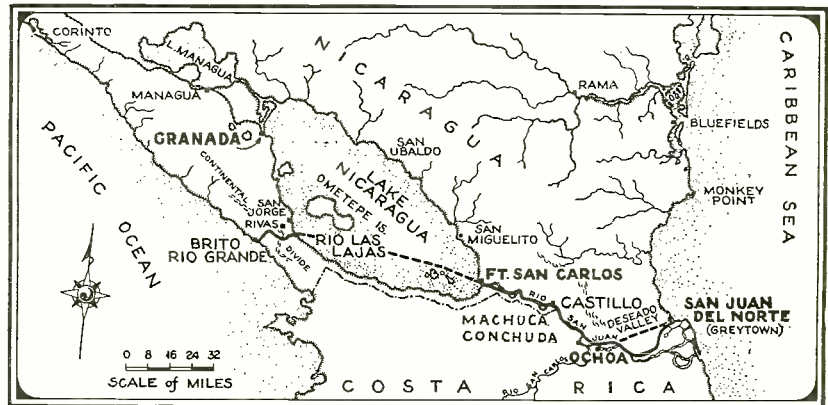

The route along which the work was to be carried on was about 180 miles in length, extending from Greytown generally along the San Juan River to Fort San Carlos, across Lake Nicaragua, and to the Pacific Coast in the vicinity of Brito. Along this route we found a wide variance in topographic and climatic conditions which necessitated a diversity of methods of work, supply, and habitation. At Greytown, where the annual rainfall is in the neighborhood of 300 inches, and where the dry season signifies the time of year when the sun comes out for short intervals between rains, we found one condition. Throughout the San Juan region there are no roads and the only possible communication is by boats on streams which are frequently so obstructed by fallen logs that they must be cleared before passage up or down stream is possible. On the Pacific side, instead of the practically impenetrable jungles of the San Juan region, we found coffee and banana plantations and a little cotton. Here there are some roads which are passable for ox-carts in the dry season, which extends from about December 1st to May 15th.

The above map gives a clear picture of the extensive scene of activities of the U. S. Army Engineer Battalion in Nicaragua at present engaged in surveying the proposed canal



At the left is an exterior view of the radio station at Camp Hoover (Ochoa)

"C" Company had established their headquarters at Ochoa and had their work well under way upon our arrival. "B" Company was assigned the eastern end of the work and left Granada early in November. They located at Greytown, built camp, and began clearing the streams which would permit them to push westward toward the East Divide where they were to join "C" Company. "A" Company moved to Brito at the beginning of the dry season, changing their camp sites as the work progressed toward the lake. A subsistence warehouse was established at Fort San Carlos for the supply of the river camps. The detachment there was also assigned the task of operating our river transportation.

Communication with the troops in the field is by a lake steamer which makes a round trip to San Jorge and Fort San Carlos once each week. This boat, named "Victoria", was built in Wilmington, Delaware, in 1883. Notwithstanding 47 years of hard service she is still giving dependable transportation. Leaving Granada on Tuesday morning she docks at San Jorge that afternoon and after a few hours' stop crosses the lake to Fort San Carlos, arriving there on Wednesday morning. After a short stop there she returns by the same route, arriving at Granada about noon on Thursday.

From Fort San Carlos down the San Juan to Greytown we had to provide our own transportation. A gasoline launch towing one or two Army pontoons, usually two, leaves San Carlos on Thursday morning and gets to Ochoa that night. Laying over there for the night it proceeds downstream the following morning, arriving at Greytown on Friday night. Saturday morning, bright and early, it starts bucking the current on the return trip, getting back to San Carlos on Monday night. This gives the detachment there two days to look over their motor, tend to a thousand and one little details, and get everything in shape for the next trip.

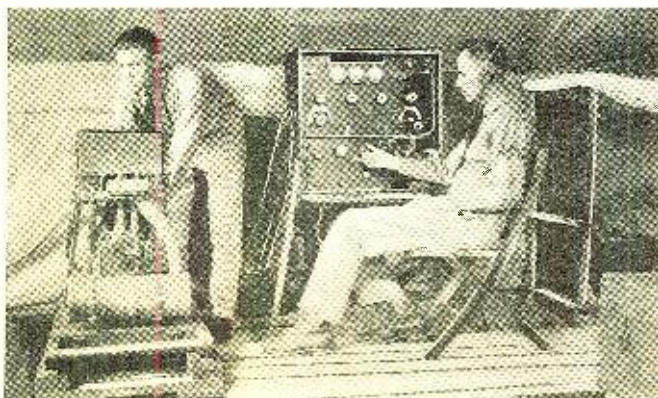

Camp Graves (Fort San Carlos, March, 1930), showing First Class Private Allen Points and Private Henry Elliot

Description of Technical Terms

SCR-132.—Radio transmitting and receiving set, type SCR-132. It is capable of communication by means of continuous wave telegraphy, modulated continuous wave telegraphy and telephony. Its maximum working range is considered to be 200 miles for telephone and 600 miles for telegraph. The transmitter is capable of operating within the frequency band of 150 to 350 kc. The receiver covers the frequency band of 100 to 1000 kc.

SCR-136.—Radio transmitting and receiving set similar in character to the SCR-132, but of lesser power. Its maximum ranges are: Telephone, 30 miles, and telegraph, 100 miles. Both the transmitter and receiver operate within the frequency band of 333 to 857 kc. The power supply for both the SCR-132 and the SCR-136 transmitters is obtained from gasoline engine driver generators.

T.G.T.P.—Tuned grid, tuned plate. A common type of transmitter.

QRM.—Radio procedure signal meaning interference.

BB-41.—A small-sized storage battery.

VT-2.—A 5-watt vacuum tube.

Counter E.M.F.—A voltage built up in a rotating motor armature or in a transformer which opposes the applied voltage.



The station shown above is Camp Hurley (Greytown)

From the above schedule it is evident that "by return mail" means a delay of at least nine days. Unless the company commander at Greytown answers all correspondence between supper and breakfast of the night that the river boat is there the delay becomes sixteen days instead of nine. Such slow communication with the troops in the field is not only exasperating at both ends but at times results in inefficiency and hardships.

Foreseeing these difficulties the War Department provided the expedition with a Technical Sergeant and eight privates of the Signal Corps, and four complete radio sets. They included two SCR-132 and two SCR-136 sets. This equipment arrived at Granada early in November, as a part of the initial shipment of equipment and supplies for the battalion.

This shipment began to pour into Granada, via the narrow gauge railroad which connects us with Corinto, on November 3rd. On the 3rd, 4th and 5th everybody turned to and assisted with the unloading. About 525 tons of Quartermaster, Engineer, Signal and Medical property, organization equipment, and some personal property were all arriving together and the big problem for everybody was to get the stuff unloaded, segregated, and piled out of the way.

By the afternoon of the 5th the work was sufficiently in hand so that the Signal Corps personnel was released from the unloading and they immediately began the work of opening, sorting and repacking the radio equipment. In the original

packing no attempt had been made to consolidate the equipment pertaining to individual stations. Consequently it was necessary to unpack nearly everything here. It was desirable to get the equipment for two of the stations down the river out of the way before the movement of "B" Company to Greytown took place, since this movement would tax our river transportation to capacity. For this reason the segregating and repacking was given priority over the establishment of the Granada station. After five long days of hard work this was all completed and the station here set up and in operation. Contact was made between Granada and NAZ, the Naval Station at Headquarters 2nd Marine Brigade, at Managua, on the evening of November 10th.

When the Victoria sailed from Granada on November 12th, she carried Sergeant Smith and four privates of the Signal Corps, an SCR-136 for Fort San Carlos, and an SCR-132 for Ochoa. Arriving at San Carlos on the 13th the Ochoa set was loaded on our river boat and Sergeant Smith and two men accompanied it down the river on the following day. Upon arrival at Ochoa they immediately set to work and with some assistance from the Engineers cleared a place for the station and put the equipment in place. The ground was so soft that it was necessary to lay logs as a foundation for the heavier pieces. They had the station in operation and were in contact with Granada on November 16th.

In the meantime the two operators who had remained at San Carlos had not been idle. Sergeant Smith had designated the site for the station before proceeding down the river and these two men had immediately gone to work. There is no transportation of any kind at San Carlos except boats. It is several hundred yards from the dock to the station site, up a hill, and over rough going. Notwithstanding the difficulties with which they had to contend, these two men, with such assistance as the small supply detachment was able to give them, installed their SCR-136 and called us on the evening of November 15th.

The other 136 and two operators left Granada on November 19th on its way to Greytown, 130 miles below San Carlos and at the mouth of the San Juan River. Sergeant Smith joined the shipment en route and arrived at Greytown on the evening of the 23rd. Here the station was opened and contact established on the following day, after about 10 hours of work and during a continuous and heavy downpour.

In order to obtain direct communication with the "Home Land" and civilization via Signal Corps channels, a high frequency transmitter was being born shortly after the initial rush of installing the four stations was over, and a requisition for a Navy type R.G. high frequency receiver was on its way to the "States." By using sundry old variable receiving condensers that naturally adhere to a traveling radio man, considerable ingenuity, and a little hay wire, a fifty-watt T.G.T.P. connected to a

(Continued on page 564)

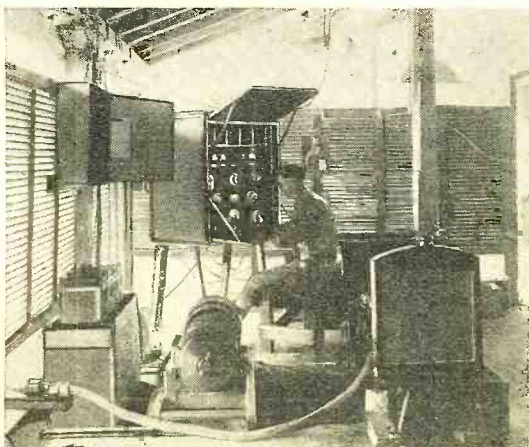

At the left are the transmitter and generator units at Granada. Private W. B. Smith is shown at the transmitter. A close-up of some of the apparatus at this station appears below

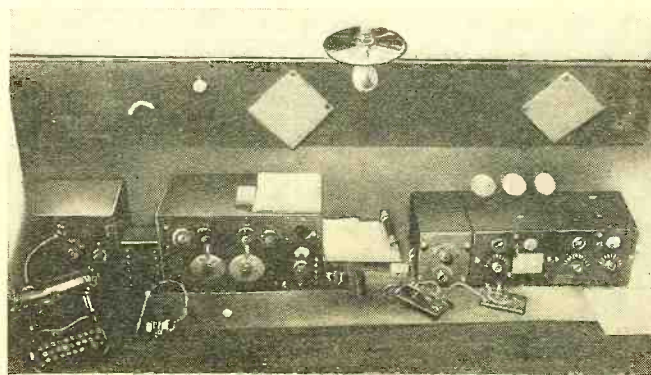

Equipping the WALDORF-ASTORIA with Radio

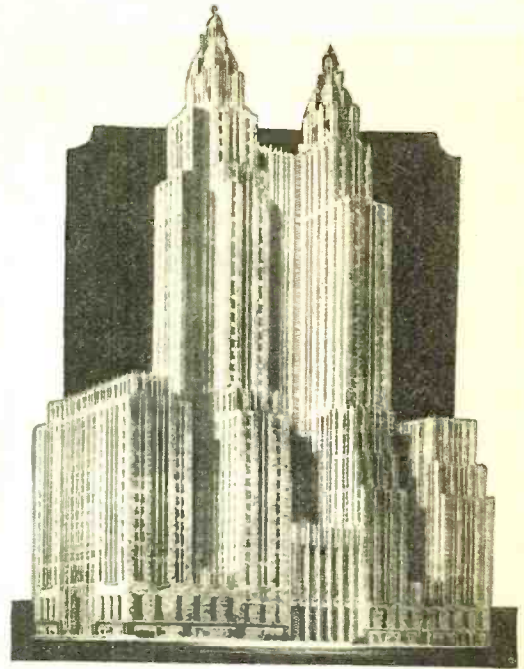

"The new hotel will be equipped with the largest combination radio, talkie, music reproduction and public address system ever installed in any building"

By John Rutherford

TRAVELERS are critical of hotels and the more traveled they are the more prone to point out the deficiencies of service. All hotels pride themselves on their service. The Waldorf-Astoria is no exception, although just now its service is mostly on paper and a matter of history. This famous hostelry first served the public as the Waldorf at 33rd Street and Fifth Avenue in 1893. Four years later the Astoria annex appeared on the site of William Astor's home at 34th Street and Fifth Avenue. The service of the Waldorf-Astoria was above reproach, yet news prints of 1902 told of Prince Henry of Prussia complaining about the hot water. Most of us, at lesser inns, have complained at one time or another about the cold water.

But at the new Waldorf-Astoria going up at 49th Street and Park Avenue, guest service includes conveniences far beyond the critical eye—or hands—of Prince Henry or most of the other more or less famous patrons of the great tavern that sheltered so many and varied dignitaries, from Li Hung Chang to "Diamond Jim" Brady. Guests of the new Waldorf will not even be annoyed by the necessity of going to the opera, except for the lure of the grand tier, and as for the talkies, they only

need to take the elevator to the ballroom. The sound film programs even, can be broadcast to other parts of the hotel when occasion requires.

The new hotel will be equipped with the largest combination radio, talkie, music reproduction, and public address system ever installed in any building. It is a system especially designed to meet the varied uses of a hotel the size of the Waldorf-Astoria with its many public rooms and thousands of guest rooms. In general, the equipment provides:

- 1—Facilities for reproducing in the various public rooms recorded programs or music originating in other sections of the building.
- 2—Facilities for distributing six programs to all of the 2,000 separate guest rooms where the entertainment desired can be selected and its volume controlled. These programs can either be obtained from the radio, the music reproducing system, or the public address amplifiers.
- 3—A centralized antenna system will enable patrons of approximately 140 apartments to connect their individual radio sets to a common antenna.
- 4—Public address facilities in each of the more important rooms.

The equipment will be so arranged that it can be used as six individual public address channels or six individual program supply channels to every guest room. The apparatus can also be connected so that part of the six channels can be employed for public address systems and the remainder for program supply entertainment. Any programs originating in the public address system can also be distributed to the guest rooms. In other words, if the voice of some well-known public speaker is being reproduced in the ballroom of the hotel, his voice can be amplified and heard in the various other public rooms as well as in the

(Continued on page 559)

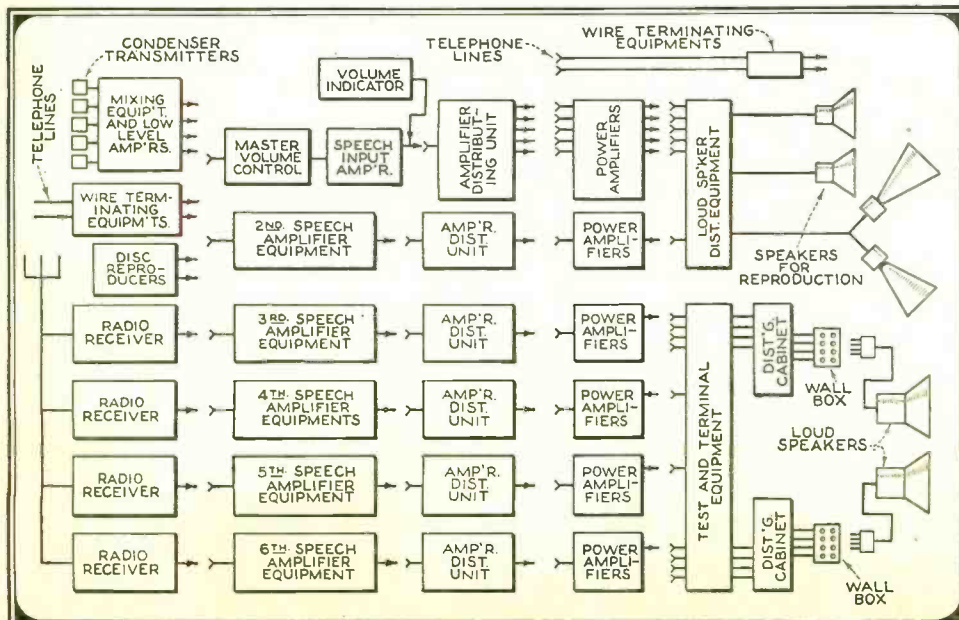

A diagrammatic presentation of the circuit arrangement employed in the speech amplifier system of the Waldorf Astoria

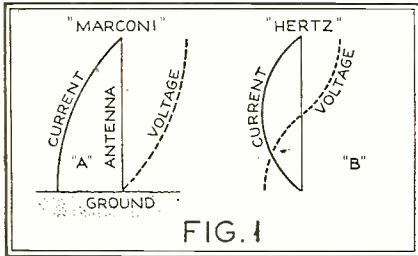
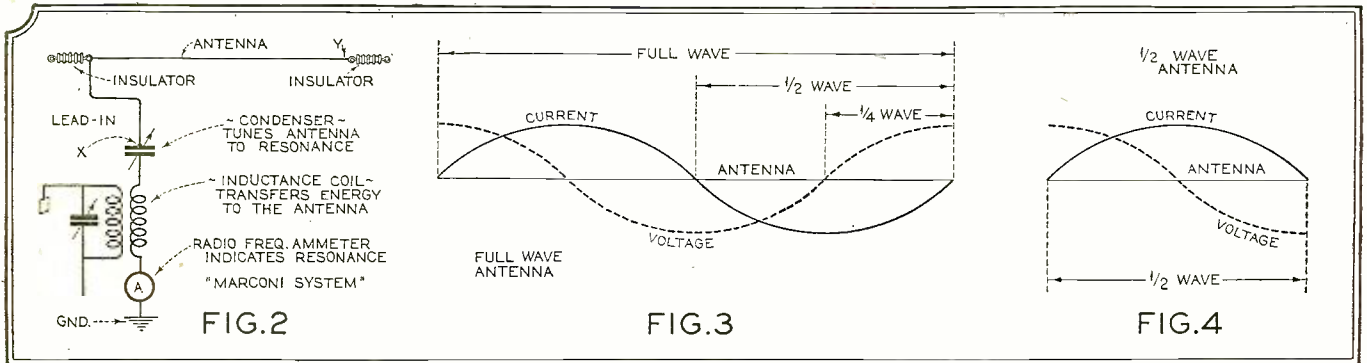

Figs. 1 to 5, inclusive, show diagrammatically the function of Marconi and Hertz antennas and also half wave, full wave, current feed and voltage feed antennas

QUESTION: What must be the length of a radiator for a Zepp-feed antenna system to operate efficiently on a wavelength of 41.4 meters? (7,250 kilocycles).

ANSWER: 64.998 or 65 feet.

AMATEUR transmitting antenna systems would be simple affairs if that was all there is to them—and yet, that's all there is to them. They may look like complicated and intricate affairs, but that is only because they haven't been studied carefully. Before attempting to design any type of transmitting antenna, for amateur use, an understanding of antenna principles and limitations should be reviewed.

This review will bring forth the information that there are but two types of antenna systems: the Marconi type and the Hertz type. The Marconi type, Fig. 1, A, uses a ground in which case the maximum antenna current indication appears at the base of the antenna system. The Hertz type, Fig. 1, B, uses no ground and the maximum voltage indication appears at the free end, while maximum current indication appears at the center of the radiator; in this case, a one-half wave radiator. Of the two types, the Hertz type is considered to be used in practically every amateur transmitter.

The Marconi type is seldom used by the amateur. Since it is so seldom used, it may be dismissed with a practical schematic arrangement, that shown in Fig. 2. The radiator, that length or section of the system from the point X to the point Y, must be approximately one-half wavelength long. This length is not particularly critical in the Marconi type antenna. It should be within a few feet of the proper linear length, which will be taken up later—the methods for determining feeder and radiator lengths. The ground lead should be as short as possible, not over three to five feet. The antenna inductance coil may consist of four to six turns of the same diameter and of the

Practical Antenna for the AMATEUR

Hertz or Marconi? Full Wave or Half Wave? more such questions on the design and construction wants to obtain utmost efficiency in the operation RADIO NEWS readers as the designer of the RADIO subject of antennas with an authority

By Fred H.

same size wire or ribbon as that used in the transmitter plate circuit. The coupling between the two should be variable, of course. The antenna tuning condenser should be of the transmitting type with sufficient spacing between the plates to withstand the voltage. Capacity, 250 to 350 microfarads.

Of the Hertz type antenna systems, three of them are used in general amateur practice; the full-wave radiator, Fig. 3; the half-wave radiator, Fig. 4, and the one-quarter wave radiator, Fig. 5. Of these three systems, the most popular, by far, is the half-wave radiator, either with a single wire feeder or with the Zeppelin feeders. Immediately



Fig. 9. The details of a "voltage feed" Hertz antenna frequency suitable for use in one of several frequency bands in the amateur frequency assignment. At the left, good mast design is an important feature of satisfactory antenna construction

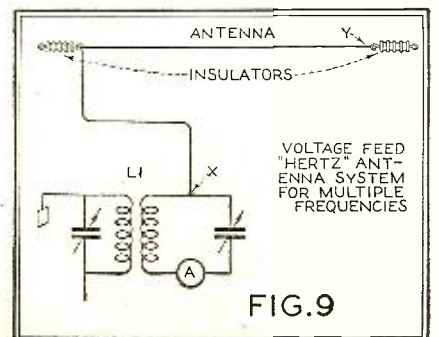

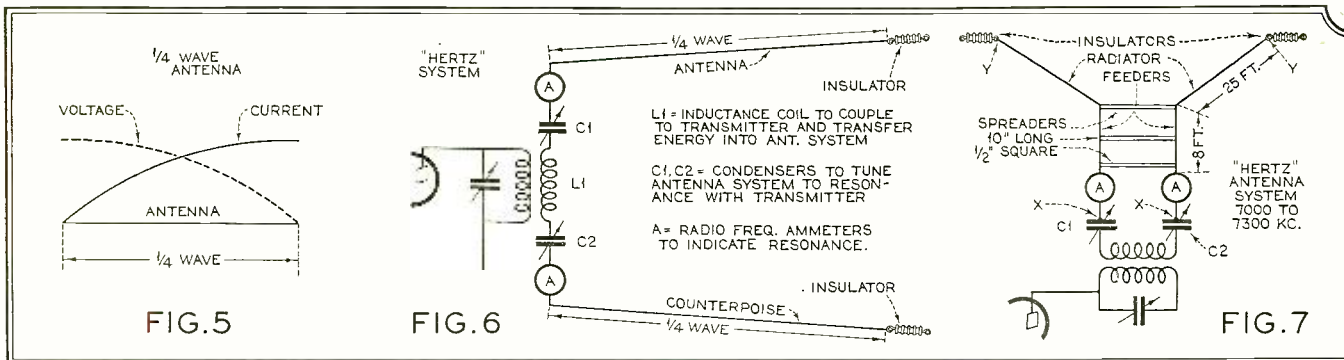

Construction TRANSMITTER

Current Feed or Voltage Feed? These and many of transmitting antennas perplex the amateur who of his "ham" transmitter. The author, known to NEWS Short-Wave Superheterodyne, writes on the born of long experience in the amateur field

Schnell, W9UZ*

after the discontinuation of the famous old spark transmitter, the popular antenna system was that shown in Fig. 6, antenna and counterpoise. In this system the antenna was one-quarter wavelength long, as was the length of the counterpoise. Good practice for the best adjustment soon taught us that the counterpoise should be slightly less in length than the antenna portion because of the greater capacity to ground between the counterpoise and ground. The best results were obtained when each ammeter, the one in the antenna and the one in the counterpoise, read exactly the same when the two condensers were set at approximately

*Chief of Staff, Radio & Television Institute, Chicago, Ill.

Fig. 10. In this current feed system note that the feeder is off center of the radiator portion of the antenna system. At the right is a Zepp antenna. Glass towel rods are used as spreaders

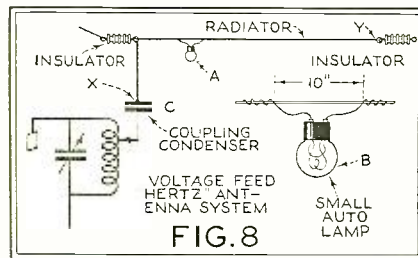
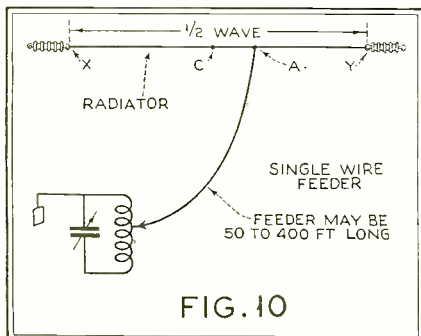

Figs. 6 to 8, inclusive, give some idea of the general construction details which enter into the erection of a suitable transmitting antenna

the same capacity.

A slight variation of this system is shown in Fig. 7. It is used quite generally and especially where space is at a premium. It is an ideal antenna system for an apartment dweller who lives on the top floor and who cannot erect any other satisfactory antenna system. For operation in the 7,000-7,300 kilocycle band each radiator is 25 feet long, and each feeder lead is 8 feet long, total length of each, 33 feet, or the equivalent of a one-half wave radiator, which would be about 66 feet. The tuning condensers, C1 and C2, each having a capacity of 350 micro-microfarads, would permit operation at any frequency in that band. This system is often called the "doublet antenna system." Certainly it is one of the simplest systems and thoroughly practical where space limitations do not permit some other desirable system. This antenna system was found to be the most satisfactory for use at W9EK-W9XH, Burgess

Radio Laboratory, Madison, Wisconsin, after experimenting with several different systems. One has to consider the surrounding objects, of which there are many at W9EK-W9XH, not to mention a high-voltage power line immediately overhead. Actual tests were made to determine the results. A galvanometer was connected in the output of a receiver, through a coupling transformer—merely something to indicate maximum signal at Mr. Hoffman's station, W9WF, located about one mile from the Burgess Radio Laboratory. Three different antenna systems were compared, all within a couple of hours, since we didn't want weather conditions to throw us off on readings. While the exact galvanometer readings are not recalled, the maximum deflection with the previous best antenna system was, let us say, 15. With the present antenna system the deflection was about 35 or 40, indicating that this antenna system and in this particular case delivered a greater intensity of signal at the receiver. Each transmitter uses this antenna system, one in the 14,000-14,400 kilocycle band, one in the 7,000-7,300 kilocycle band and the other in the 3,500-4,000 kilocycle band. (Cont'd on page 555)

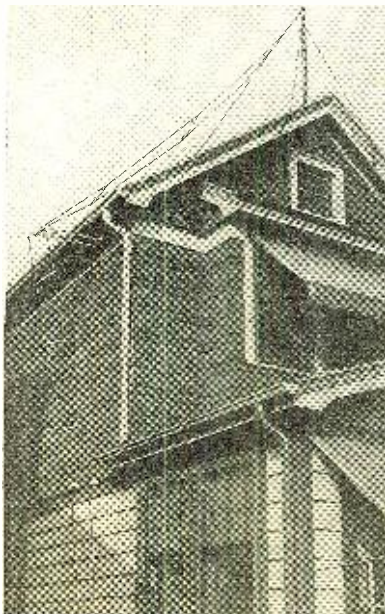

Tone-Compensating Circuits for Audio-Amplifiers

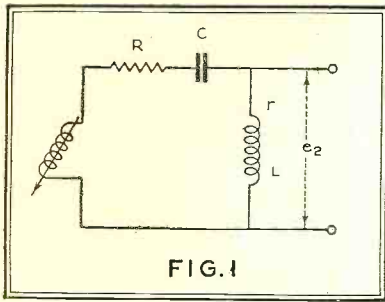

Fig. 1. Compensating for pick-up deficiencies

THERE are a number of problems or questions which will arise after pondering for a while upon the intricacies of the processes for both recording and reproducing sound waves.

In the first place, the sound waves with which we deal are very complex in shape; very seldom we find pure sine waves in music and never in speech. This being so, how can we understand the operations of the various apparatus and their results in view of the fact that in our theories we assume sine waves? A French scientist, while investigating heat conductivity in 1822 in his "Theorie de la Chaleur," gave to posterity the key to the solution; J. B. J. Fourier developed a theorem that applied to problems of the nature that we are discussing, and which will furnish the basis of the analysis. This theorem proves that any recurrent curve can be expressed by an equation containing a sum of sine and cosines and is well known to radio engineers, and in ordinary language means that any periodic curve can be expressed by a sum of sines of terms involving a fundamental frequency and its multiples. Consequently, any periodic wave can be studied by analyzing the effects of the individual components. There are cases, however, and quite numerous if not always present, where there is no repeated cycle. Such cases may be analyzed by decomposing the curve into an infinite number of frequencies infinitely close together like a continuous spectrum, as may be shown by Fourier's Integral. In either case, however, as long as in the final sound wave, the coefficients affecting each of the component frequencies are kept identical or at least in the same ratio with respect to each other as in the original sound wave that was recorded, there will be absolute fidelity even if, during the process, those coefficients lose their relative proportionality, and this seems inevitable. Therefore there is an absolute necessity of compensating for the inequalities in the way that the coefficients (or maximum amplitudes) of the various frequency terms in the expression of the complex wave will suffer.

It is very difficult to offer a mathematical solution to these problems a priori, without the aid of experiments, because there are many characteristics which are too complex to express by simple mathematical expressions, such as the relation between lateral motion of a cutting tool when it is making a record, and the applied E.M.F. to the terminals of its driving coil at various frequencies; the impedance of the loud speakers vary not only

Part One

with the frequency but with the acoustical conditions of the surrounding medium; the free vibrations in the mechanical

and electrical circuits which take place besides the impressed or forced vibrations at certain frequencies, and other innumerable non-linear links in the whole chain, the theoretical performance of which is only an approximation with plenty of limitations.

It is very fortunate that the amplifiers used in the recording and reproducing operations are susceptible of affecting the coefficients of the various frequency terms in the whole series of integral. By the introduction of compensating circuits it is possible to reinforce certain frequencies and subdue some other ones at will with a minimum of free vibrations introduced thereby.

Although, from a theoretical standpoint, there is no limitation to the way in which the coefficients of the various terms of a Fourier series, that expresses mathematically the complex wave, may be modified. Practical considerations will narrow these limits considerably, as we shall see in our present discussion.

In order to see more definitely the scope of our problem, let us glance over, rapidly, the progress of sound recording and reproducing in the last few years.

Since the invention of the phonograph until the time when the vacuum tube was developed more as an amplifying device than a radio instrument, the acoustic limitations of recorded music were so great that it is a wonder that people could sit down and listen to such musical monstrosities as we had in

those days. In the matter of vocal music and speech, conditions were not half so bad as in the case of instrumental music because the portion of the scale that was recorded and reproduced fell almost within the range of the human voice. Tones below middle A (435 international pitch) were heard almost only in their partials. Above A² (1340 c.p.s.) there was very little; consequently the articulation of such consonants as "S," "F" and "V" was very poor, and recorded violin tones near that pitch could not be distinguished from a flute playing the same notes.

With vacuum tube amplifiers and broadcast microphones it was possible to obtain records with a wider range in pitch which, when mechanically reproduced through diaphragms in the end of long exponential horns, sounded much better than the former records. Here we find fundamental tones of 200 c.p.s. and notes as high as F (2,760 international pitch). The absence of fundamental tones in the 50-100

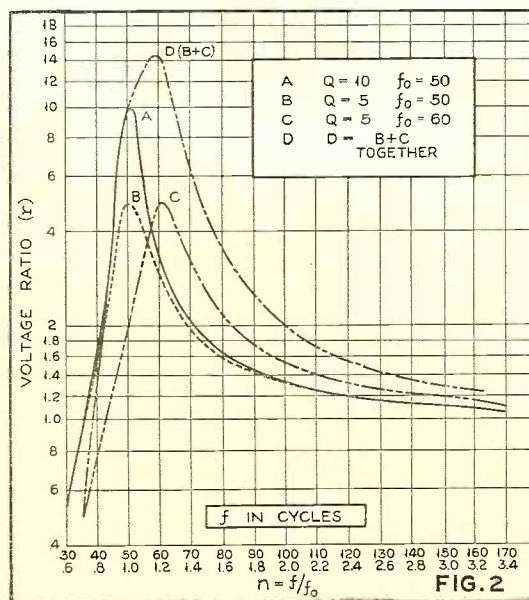

Fig. 2. Curves taken on a bass compensated amplifier

*Chief Engineer, Amy, Aceves & King, Inc.

An audio-frequency amplifier can be designed to give a reasonably straight-line response. But due to deficiencies in microphones, records, pick-ups and reproducers the overall response invariably has never been of a straight-line character. In this article, which is the first one in a series of two, the author tells how to accomplish straight-line frequency response by compensating for deficiencies in the apparatus. The system evolved, while applicable to radio reception, is more particularly adapted to use in the reproduction of sound from records or film

By Julius G. Aceves*

and 100-200 cycle octaves deprived the music of any majesty of effect and the depth of sonority that are the glory of the organ and the orchestra. From then on these low tones have been gradually introduced in records, and the last six months have seen a tremendous improvement in the quality of music from commercial phonograph discs, not only in classical music but also in dance music.

Many tests have been conducted to determine the effects of the suppression of given bands of frequencies from the musical scale while carefully listening to a variety of renditions. The Bell System Technical Journal may be consulted for information on this subject, and Dr. Fletcher has done a great deal of work not only in the effects of frequency suppression in music but also in speech and intelligibility of articulation on one side, as well as in naturalness on the other.

The unit of sound intensity which is commonly employed in engineering work is the decibel. As applied to an electrical circuit, it is defined as ten times the common logarithm of the ratio between two energies; as a rule between energy entering a network and energy coming out at the end. If the logarithm is positive, the output is greater than the input, and the circuit is said to have a "gain" of so many decibels. It implies the presence of an amplifier within the network.

As in all quantities involving a ratio, the logarithm of the ratio is the difference between the logarithms of the numerator and denominator. Consequently, when we say that there is a gain of 8 decibels, we simply mean that the energy "level" is higher by an amount of 8 decibels above a level which we take as reference. This is the same as to say that the output energy is about $6\frac{1}{4}$ times as great as the input, whatever the absolute value of this input may be. In practice, the softest audible sound is taken as "zero" level and the loudest sound, which is so loud that it actually causes pain, is about the sensation of one hundred decibels above the zero level. As the sensation of loudness appears to be a logarithmic function, a gain of 10 decibels, from zero to ten, is felt about as big as a change from 40 to 50. Hence, we are going to choose an arbitrary level and see the effect of increasing the tone energy by plus or minus ten or more decibels. Here it should be noted that the energy levels from the two thresholds; that of inaudibility, and that of pain caused by excessive loudness, are closer together at the extreme ranges of the audible spectrum, and for this reason a new problem arises in reproduction. What shall be the proper level for average intensity of reproduction

at which a balance between bass, treble and middle register should be reached? This can be solved only by a good pair of musically trained ears listening to a diversity of records in the room or hall in question.

Now that we have an idea of the problems to solve, let us see what are the inherent limitations in the records, particularly in discs as found at present in the market. In the lower register, it is apparent that if the bass tones were recorded following the same law as the middle and upper tones, the amplitude of the waves would exceed by many times the width

of the groove, and it would be necessary either to make the space between grooves larger, with consequent reduction of the duration of the rendition recorded, or the outside diameter should be greatly increased. Either of these alternatives would be commercially unfeasible; hence the necessity of reducing the amplitude of the low-tone waves. In the upper register, we also have a limitation which is imposed by the thickness of the needle point, which increases very fast during the first few revolutions of the disc on account of the excessive pressure (at the start it is some thirty thousand pounds per square inch). With a thicker point, the needle cannot follow the very fine indentations

in the record corresponding to the very high frequencies because they are smaller than the diameter of the section of the needle that is engaging the record groove, and if they are slightly larger the note will sound but not with full intensity. Hence it is necessary to compensate for this defect.

So far we have seen that we must supply something that is lacking in the record, but we must likewise eliminate other things that are not in the record but which appear in the reproduction. Of these, two are particularly offensive and are quite common. One is the "surface noise" or needle scratch, and the other is the resonant frequencies in the whole electrical and mechanical chain that links the recorded wave with the air pressure wave that affects the ears of the listeners. In this category we find that acoustic resonance in the loud speaker and in the surrounding space predominates.

From the preceding considerations we note that there are four corrections to be applied to the amplifiers that furnished the necessary energy from the pick-up excitation to loud speaker operation. These are:

- 1—Reinforcement of the bass tones (below 100 c.p.s.)
- 2—Reinforcement of the treble tones (above 1,000 c.p.s.)
- 3—Elimination of surface noise.
- 4—Elimination of natural periods. (Cont'd on page 569)

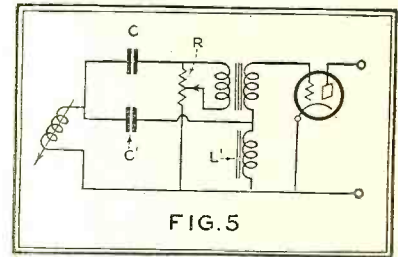

Fig. 5. Another means of high-frequency compensation for use in the pick-up circuit

JULIUS G. ACEVES, following his graduation from Columbia University as an electrical engineer, spent two and one-half years with the Bell Telephone Laboratories. For fifteen years he was personal assistant and research engineer for Prof. Pupin of Columbia. Mr. Aceves holds patents on a.c. radio reception and is an authority on audio amplification and sound reproducers.

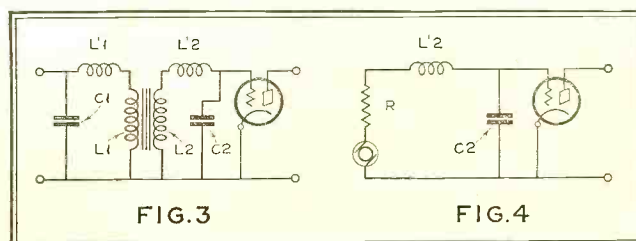
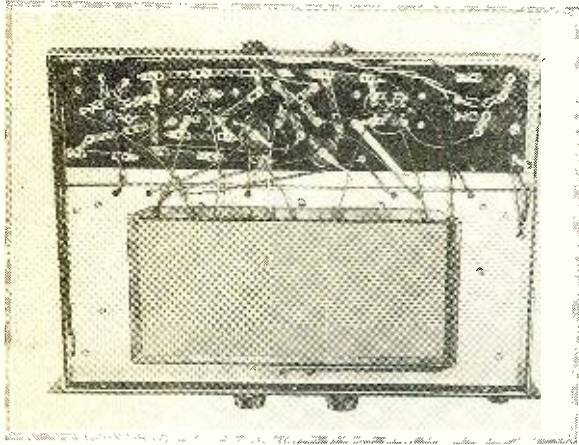

Fig. 3. High-frequency compensation. Fig. 4. Is the schematic of Fig. 3

“The Conqueror”—A New A. C. and Broadcast



An underside view of the chassis of the a.c. short-wave “Conqueror.” The kit is supplied in wired sections which are easily connected

The receiver described here incorporates discriminating experimenter, serviceman, Variable coupling between the antenna smoothly regenerative detector circuit amplification, one of which is resistance-attributes of this a.c. operated

By Alex G.

THERE have been so many “new” sets described in the past few years that the description of another one—no matter how outstanding it is—is likely to arouse just a casual interest and be called “just another set.” However, this set *is* a new one. It has features never before realized in short-wave design. Short-wave sets have never received the same careful consideration in design that has been given to broadcast sets; consequently they have never given the same dependable, reliable, efficient operation. But now these qualities have become a reality, and, although the writer has had nothing to do with the design of this set in any way, he is thoroughly familiar with the history of the set and has had the pleasure of operating it and fully recommends it to readers of RADIO NEWS.

This set is the result of over a year’s careful and painstaking research work by practical radio engineers, during which time all available short-wave sets were collected together, analyzed, tested, compared, pulled apart and their weaknesses revealed. Tests were made under extreme conditions—both in New York

City and in the tropics—and in the final design of the circuit which you see here, not a set was found, even in the super-heterodyne class, that could compare with it in any way. It outclassed them all, in both local and around-the-world reception.

Not a stone was left unturned to locate the bugs that lurked in short-wave circuits, and in the great number of sets tested many interesting characteristics were found. Some sets had dead spots in the tuning range that prevented the reception of important wavebands. Some lacked selectivity; code stations interfered considerably with broadcast stations. Some lacked volume; the foreign stations could not be heard distinctly on the loud speaker. Lack of easy tuning was a fault common to almost all of them; a.c. hum and instability marred many. Overcoming these obstacles was an interesting and fascinating battle. And the funny part of it all is that the final design of the set represents no revolutionary achievement. No great invention. It merely transcends the usual short-wave receiver in recognized radio design, using well-known principles pre-

Fig. 1. Five tubes in all are used in the circuit. The first is a screen-grid r.f. amplifier; the second a regenerative detector followed by three stages of audio-frequency amplification

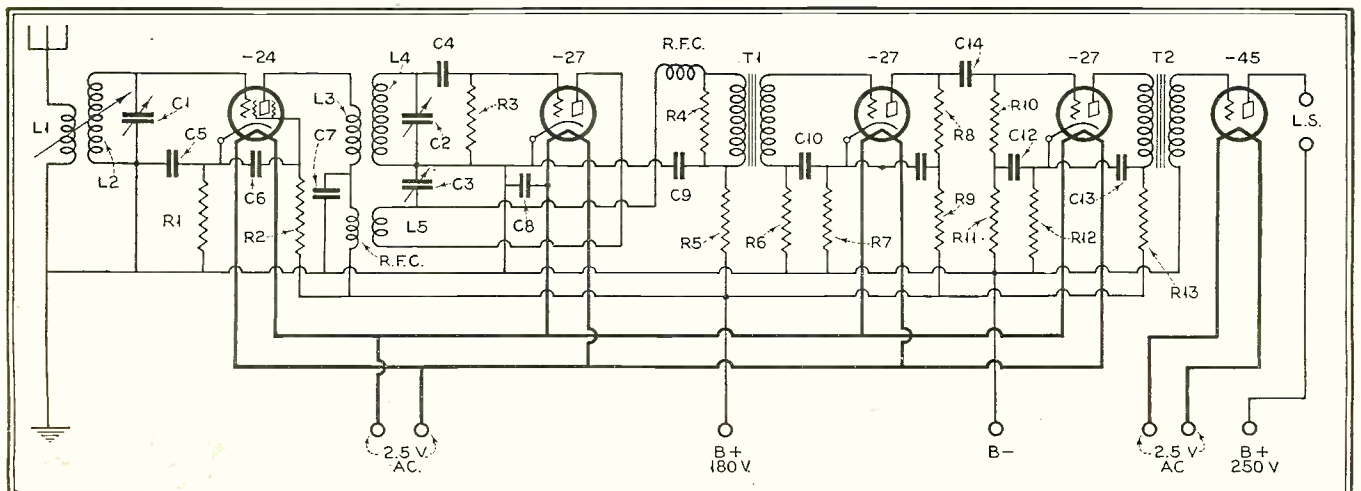

Short-Wave Receiver

some novel design features which the and short-wave fan will find to his liking. primary and secondary circuits, a and three stages of audio-frequency coupled, are only a few of the outstanding short-wave kit job

Heller*

viously ignored. It is the little details that count, and these little details have been fully appreciated. Whether you are a broadcast listener and desire the fascination of around-the-world reception or are a short-wave enthusiast, you will not be disappointed with the performance of this all-wave receiver.

The Circuit

The circuit comprises a one-stage radio-frequency amplifier, regenerative detector, and three-stage audio-frequency amplifier. It is the typical short-wave type, with plug-in coils to cover the entire short-wave and broadcast bands. Five tubes are used: A screen-grid type -24, three type -27's and a type -45. In the power pack is a type -80 full-wave rectifier.

Fig. 1 shows the set diagram. The one-stage radio-frequency amplifier uses the -24 screen-grid tube. The detector, using a -27 tube, is regenerative by means of the tickler feed-back coil. This allows stations to be tuned in by means of the heterodyne whistle and also gives extreme sensitivity. Regeneration is controlled by means of the variable condenser, C3, shown in Fig. 1. An audio-frequency transformer couples the detector to the first audio stage. The second audio stage is resistance coupled, and the third one, using the -45 output tube, is transformer coupled. The use of a three-stage audio amplifier gives great volume—so necessary for short-wave reception. The excellent tone quality obtained is due to the use of the combination of transformer and resistance coupling, transformers of good characteristics being used. The -45 output power tube handles the enormous power with sufficient facility to operate a dynamic speaker. The power pack is built into a separate unit, as shown in the pho-

*Insulinc Corp. of America.

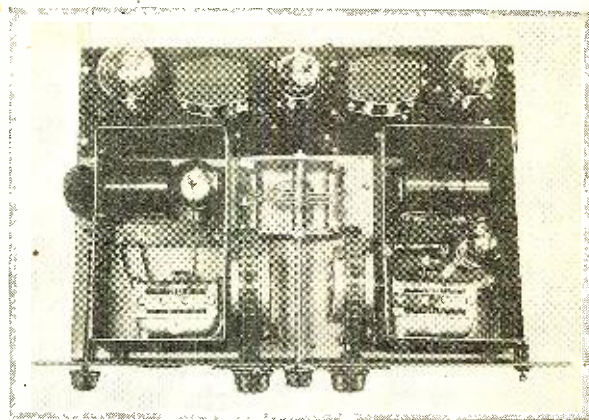

The two tuned circuits are completely enclosed in metal shield cans while the audio channel is situated along the rear of the chassis. Shown below is a front view

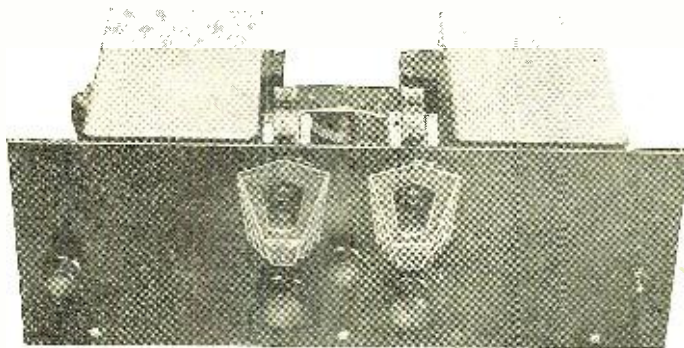

tographic views. This will be described in detail later.

Special Features

Now we come to the apparently insignificant yet important points in the design of this set that account for its amazing success. Taking them in order, we have first what is called the "Capacitively shielded inductive coupling to the antenna system." In plain English, this means that there is a fine wire screen, or copper sieve, placed between the antenna coil. L. Fig. 1, and the first or input r.f. coil in the set. This screen is represented at S in Fig. 1. It is made of copper and is grounded. All the signals have to pass through it by magnetic induction in order to get into the set. It makes the set independent of the antenna system. In other words, no matter what size, type, or location of aerial you have, the set tuning and control will always be the same. This is a great convenience. In addition, the antenna coil is mounted on a shaft so that it can be rotated by means of a knob on the front of the panel. This allows variable coupling between it and the first r.f. coil, and no matter how the coupling is varied, the tuning of the set remains unchanged—thanks to the screen. This variable coupling feature aids greatly in the discrimination of received stations, or selectivity, and in the case of powerful local stations is an ideal volume control.

Of the utmost importance in short-wave receiver design is the use of filtered connections and supply circuits. In this set all connections are thoroughly filtered by means of resistors and large by-pass condensers.

Dead spots in the tuning range of some short-wave sets were found to be due to the absorption of energy by the interconnecting wires—and not because of resonance points in the antenna system, as was generally supposed. It's the resonance points in the interconnecting wires that caused the trouble, killed regeneration and prevented oscillation at many points on the dial. In this set the dead spots are (Continued on page 573)

In the Next Issue

CARL BUTMAN continues his enlightening and instructive series of articles on just what the radio laws mean and how they apply to various classes of radio men.

* * *

A. Dinsdale, an authority on television here and abroad, tells of the practical and impractical side of television in his article, "Debunking Television."

* * *

More news on the Robinson Stenode Radiostat.

How to Build

Accurate determination of low lay for apparatus which, because of its experimenter or laboratory man. frequency analyzer which is both tically such a device is useful in such a motor generator, analyzing hum in a checking low frequency oscillators and themselves to the

By J. D.

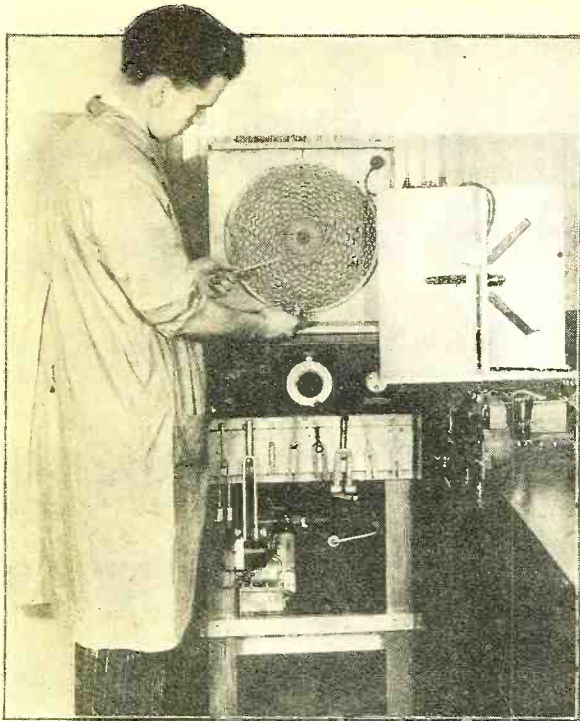

The inventor of the audio-scope is shown above holding one of the lamps used with it in his hand as he explains how the lamp makes the lines and figures appear stationary and indicate the correct frequency

At the right the audio-scope is shown in use. The operator is watching the numbers on the disc as he varies the oscillator vernier



down, stops, reverses, and is again lost in the confusion. And so a changing procession of figures—32, 40, 48, 60, 64, 80, 96, 112, and 128. These all form themselves in front of our eyes only to disappear an instant later. To the visitor the audio-scope is an entertaining and mysterious curiosity, but to the laboratory workers it is a simple, practical, and much used piece of apparatus.

In any laboratory which does work on loud speakers or on audio-frequency amplifiers it is necessary not only to have a source of variable audio-frequency oscillations, but it is also important to have an accurate means of determining the particular frequency being worked with. Using a conventional oscillator it is, of course, relatively simple to find six or seven points from 128 cycles to 4096 cycles by obtaining "zero beat" with standard tuning forks. Then by plotting these results any point between may be found by interpolation. Points above 4096 cycles may be found to a reasonable degree of accuracy by extrapolation as the frequency curve is relatively uniform at the upper end of the scale.

WHAT'S that? Television? Invariably that is the excited query of a visitor to the Acoustical Laboratories of the Stewart-Warner Corp. as he peers through the slit in a little black box and views a queer jumble of figures on a disc.

"Oh, no," we nonchalantly reply, "that is merely a direct-reading, stroboscopic, low range, audio-frequency oscillator calibrator." Then, to be obliging, we put "Stroby" through his paces. We start the motor which rotates the disc and then adjust the oscillator. As we turn the vernier the number "32" becomes clearly visible on the rapidly revolving disc. The number appears to rotate with the disc, then slow down, stop, and reverse its direction of rotation. Faster and faster it whirls as the oscillator vernier is advanced till finally it is lost in the general blur of the disc—but from this optical chaos another figure is emerging,—"40" this time. It, too, slows

quency curve is relatively uniform at the upper end of the scale.

Also an 8192 cycle fork may be used if there are not too many "birdies" in the upper range. However, finding points below 128 cycles with any degree of accuracy presents, in many cases, a difficult problem. Extrapolation can not be employed because the lower end of the frequency curve on most oscillators is far from uniform and, quite frequently, a vernier is used as the low-range oscillator control. Of course, a 64-cycle fork can be used, but it is very difficult to obtain accurate beats at so low a frequency and, at the best, it gives only one more known point. As oscillograph, with 60 cycles a.c. as the reference frequency may be used to determine those frequencies which have comparatively simple Lissajous figures. However, such a set-up is both cumbersome and expensive to use if a simpler and more efficient method can be found.

Fig. 1 shows the layout of the turntable and neon lamps. Fig. 2 shows how the radial lines are laid down on the disc, while Fig. 3 indicates the biasing circuit employed in the "flasher" neon tube circuit

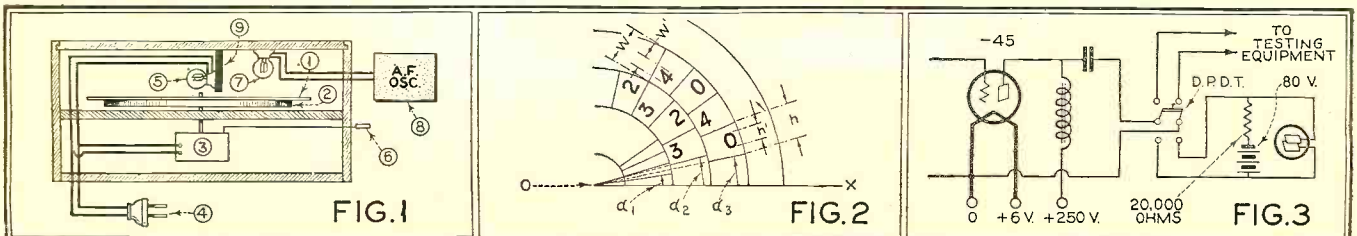

the Audio-Scope

frequencies often requires an out-great cost, is often unavailable to the Here is described a relatively simple inexpensive and highly accurate. Pract- instances as checking the frequency of receiver, determining resonance spots, numerous other uses which will suggest experimenter

Perdue*

A simple, inexpensive, but highly accurate solution of the problem is an improved form of stroboscope—the audio-scope, as it is sometimes called. The stroboscope (or “whirling watcher” as its name really means) is familiar to most of us either by experience or hearsay. Essentially it consists of a rapidly flashing light used to view a moving object. A crude, but interesting experiment is to look through the moving blades of an electric fan at another fan turning at approximately the same speed. The blades of the second fan appear practically stationary. This principal is applied by automotive and aeronautical engineers to study both reciprocating and rotating motions. It also is used extensively for checking the speed of phonograph turntables, television scanning discs, and other rotating devices. And now comes this new use for an old principle. Before considering the audio-scope in detail reference might be made to previous use of the stroboscope for frequency determination. In his treatise, “Theory of Sound,” Lord Rayleigh gives a concise explanation of how intermittent light may be used in frequency determination. Quoting Lord Rayleigh (Vol. 1, pp. 34-35.)—

“Another method of examining the motion of a vibrating body depends upon the use of intermittent illumination. Suppose, for example, that by means of suitable apparatus a series of electric sparks are obtained at intervals T. A vibrating body, whose period is also T, examined by the light of the sparks must appear at rest because it can be seen only in one position. If, however, the period of the vibration differs from T ever so little, the illuminated position varies, and the body will appear to vibrate slowly with a frequency which is the difference of that of the spark and that of the body. The type of vibration can then be observed with facility.

“A similar result may be arrived at by looking at the vibrating body through a series of holes arranged in a circle on a revolving disc. Several series of holes may be provided on the same disc, but the observation is not satisfactory

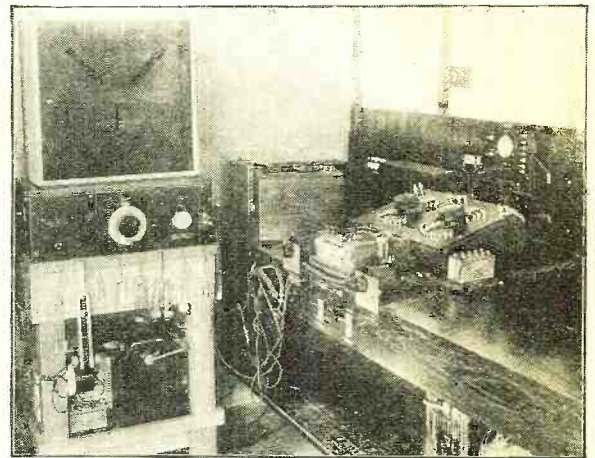

View of some of the equipment used for taking “frequency response curves” at the Stewart-Warner Acoustical Laboratories. The audio-scope and audio frequency oscillator are seen at the left

without securing provision for securing uniform rotation. “Except with respect to the sharpness of definition, the result is the same when the period of the light is any multiple of that of the vibrating body. This point must be attended to when the revolving wheel is used to determine an unknown frequency.”

Also reference should be made to the article “How to Make a Novel Frequency Meter”, by K. A.

Constant which appeared in the Radio Section of the New York Sun for Saturday, September 2, 1929. The

“frequency meter” was essentially a flashing neon tube viewed through sixty equally spaced holes on a rotating disc. A calibrated speed control on the turntable motor introduced considerable inaccuracy and there was ample opportunity for confusion of the fundamental and harmonics. A somewhat similar device, known as the “Drysdale frequency indicator” is mentioned by Sir Richard Glazebrook in his “Dictionary of Applied Physics” (Vol. II-pp. 26).

The advantage of the audio-scope over these more elementary frequency meters is readily seen in that the audio-scope is direct reading, requiring neither mathematical computations nor the interpretation of geometrical patterns; it is so constructed that a fundamental cannot be confused with its harmonics; and, by no means least important, it uses the 60-cycle a.c. as a frequency standard.

A good idea of the construction of the audio-scope may be gained from the accompanying photographs. One of them shows an audio-scope used in the Stewart-Warner Laboratories. The sliding cover (Continued on page 546)

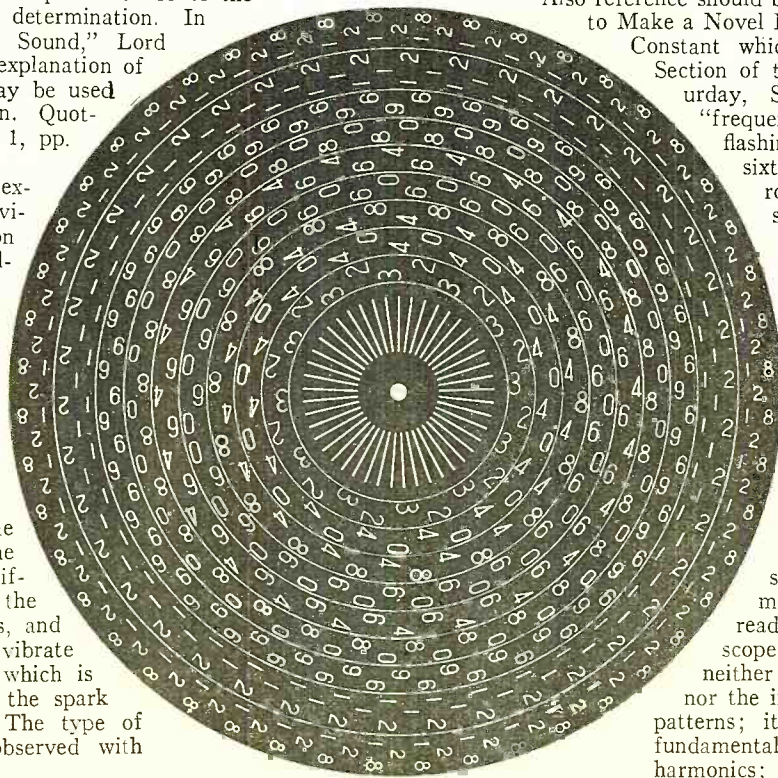

Fig. 4. above, is an exact photographic representation of the audio-scope disc. Space prevents us from showing its actual size. However, a photostatic copy enlarged to any desirable size may be made quite easily

*Acoustics Laboratory, Stewart-Warner Corp.

Radio Revives *the Lost Art of Reading*



Officers of the American Academy of Arts and Letters presenting the 1929 Gold Medal for Good Diction to Milton J. Cross, NBC announcer

It is a far cry from the once-fashionable "readings" of Dickens to the modern broadcast studio and a coast-to-coast program. The art of reading is today practised, or rather attempted, by thousands where it was formerly limited to a few skilled exponents. The criterion for modern radio artists is to "read as you talk"

A FEW minutes ago I got up to shut off a popular station, which was just then broadcasting a well-known actor and dramatic reader. Yet I have for years been greatly interested in reading and readings. Why did I shut this one off? Because the reader was too obviously just reading.

He was doing what most of us do when we read aloud: ironing everything flat. This is the point. The ordinary person, when he reads, becomes a mormon, a mere mechanic. When he talks, he gets meaning into all he says, through emphasis and pause and inflection and a dozen other interesting ways of expressing personality and point; and it's all vivid and human and real. But once he begins to read, he flattens it all to a deal level of tone and rate and squeezes out of it all the juice of interest and life.

This reader was giving a simple piece of verse, intended to mean something to plain people; but he was almost intoning it, so that the words that carried the real meaning had no chance to come out in any natural way.

The "natural way" is the key to the whole secret. If you read well enough, your radio audience will never guess that you are reading. That is, if *you read as you talk*, we shall feel your nearness and reality, and listen as long as you say anything worth listening to. Such reading is genuine, authentic; or better yet, dramatic.

The split-second timing of announcements and comments, and of programs generally, requires that announcers and speakers shall know exactly how many words they are to use, and then use so many and no more or less. Therefore they must write out what they are to say and then read it aloud at the microphone.

Not only for timing, but for smoothness, must this be done. Speaking to an audience of a few score or even a few hundred whose faces are visible to you is one thing—and it is best done with few or no notes. But speaking at a "mike" to thousands or hundreds of thousands you can't see, is something else again—and such a situation and such an audience demands that the radio speaker be completely sure of himself.

Of course, there are exceptions to this rule. Announcers who report sporting and historic events while they perch on hangars or duck foul balls must extemporize. But these are exceptions that show the value of the rule. Not many can do the McNamee job and do it well; and we don't wish our speak-

By H. Robinson Shipherd

AS chairman of the Fact-Finding Subcommittee, Advisory Committee on Education by Radio, Mr. Shipherd is undertaking, at the request of the Department of Commerce, an analysis of the extent to which radio may logically be employed in the educational work of our school system.

ers to use the extempore method unless they have to. The point I am getting at is this: Our new technique in broadcasting requires a superlative skill in reading aloud; yet reading aloud has been for many years a lost art. This means something else, too. If reading aloud is a lost art, being read to is a lost accomplishment. But here the broadcaster gets a break—and a real one. He too is invisible to his invisible audience; therefore *if he reads well enough, they never know they're being read to.*

Let me bear down on this point a bit, for the benefit of any young announcer who may feel he has to cultivate a lot of platform swank. God forbid! Naturalness in everything, if it's well done, is the best form of the dramatic. Natural speech is the reader's ideal. If that speech is strong with emotion and feeling, so should its reading be. If it would be spoken quietly and slowly, read it that way. If it was said rapidly, read it rapidly—provided your enunciation and the control operator can keep it clear. But it must have the natural *variety* of tone and rate that it always has when spoken, if it's to be accepted as human and real.

The whole thing is amazingly simple. Our best instructor is a live youngster. Listen to the way your six-year-old puts meaning into "But please, mama, I want that one!" or (to a naughty doll) "Don't you ever do such a wicked thing again!" Or listen to the rich expressiveness that a child puts into a single word like "Please!" We grown-ups get dry and conventional and stuffy in our speech sometimes, until we forget ourselves and mean business; and we're hopelessly dull and self-conscious when we start reading.

Listen to natural, animated talk among children, or women, or boys, or even business men; and you get the answer. When we talk, we forget ourselves, and think only of our meaning. We vary the vertical pitch of every phrase; we vary the emphasis on the words; we vary the rate of speed. This gives variety, and interest; but what is far more important, it makes the meaning stand out. What is the secret? Simply this: *thinking the meaning aloud.* When we talk, we are forced to think; when we read, we can keep going without thinking. Then reading becomes mechanical. The remedy, then, is to think aloud the meaning of what we read. I defy anyone to read anything with real thoughtfulness, and keep it from (*Continued on page 554*)

~RADIO NEWS HOME LABORATORY EXPERIMENTS~

Curves

What They Mean and How to Plot Them

ALMOST every day of a radio engineer's life is partially devoted to the plotting or interpreting of curves. They are one of the most useful and important tools of the engineer. But every serious experimenter must know how to plot and interpret curves if he is really to learn much about radio. Few things are more useful than a notebook full of curves, representing the results of actual laboratory experiments. The curve is the simplest and most convenient way of representing a group of related data; a single curve frequently represents the results of a month's hard work in the laboratory, or it may show in convenient form the variation of some factor in a complex mathematical equation. Simple curves are to be found in practically every article in this magazine. If maximum benefit is to be obtained from the information these curves show, we must know how they are plotted and how they should be read. If this information is understood, a single curve may mean more than a page of text. A few simple curves tell the engineer—and should tell the experimenter—all he needs to know about an audio amplifier, or a detector, or a tube. This sheet is prepared in the hope that some of the important facts regarding curves may be brought to light and with the hope also that it may encourage more experimenters to keep data in this handy form.

Probably few of us think of curves when we try to find a city on a map and yet the two cases are quite similar. Many maps contain a list of important cities on the back of the map and after the name of the city appear two letters, for example, Chicago BG. And most of us can find the city on the map by looking along the edge for "B" and along another edge for the letter "G" and then we proceed to follow along these two letters until they meet—and there's Chicago.

Now a simple graph or curve is no different from a map, although the bottom and side are not marked A, B, C, and so on, but are instead marked amperes, volts, milliamperes, watts or kilocycles. But we can locate points on a curve in the same manner as we locate Chicago on a map.

For example, suppose we apply various voltages across a resistance and measure the current through the resistance. We would, if the resistance was 10 ohms,

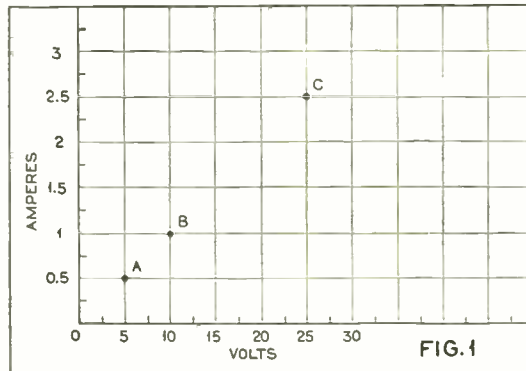

FIG. 1

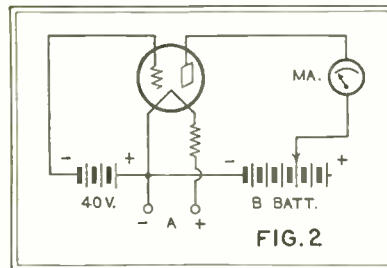

FIG. 2

obtain the following data:

Voltage	Current in amperes
5	0.5
10	1.0
25	2.5

Now let us see if we can locate these three points on a simple piece of cross-section paper. Refer to Fig. 1. Along the lower edge we have marked "volts," and along the left side we have marked "amperes." To locate the first point we move along the lower edge until we come to 5 volts, then we move our

finger up vertically along the paper until we come to the horizontal line corresponding to 0.5 amperes and we have located the first point, indicated as A on the diagram. The second point is located in the same manner. First move along the voltage axis until 10 volts is reached and then move vertically until the 1.0 ampere line is reached. This gives the second point at B. The third point, C, is found by moving along the voltage axis until 25 volts is reached and then vertically until we reach 2.5 amperes, which will be half-way between the 2-ampere and the 3-ampere line. A curve is then made by drawing a line through these three points. We have not drawn the curve; the reader can do that himself.

The plotting of a curve affords a very simple method of checking laboratory measurements. For example, suppose we measure the plate current of a tube with various values of plate voltage. Suppose we obtained this data, using the simple circuit of Fig. 2. (See table on Fig. 3.) Plotting these figures, we obtain the curve shown in Fig. 3 where each point has been marked to correspond to the letter in the third column of the above table. We then plot the curve by marking a line through the points. But we find that one of the points, C, falls way off to one side of the curve. This makes us suspicious, so we go back into the lab. and again measure

-71A TUBE GRID VOLTAGE, 40 VOLTS		
PLATE VOLTAGE	PLATE CURRENT (MILLIAMPS)	POINT ON CURVE FIG. 3
240	58	A
220	44	B
200	36	C
180	20	D
160	10	E
140	3	F
120	TOO SMALL TO MEASURE	

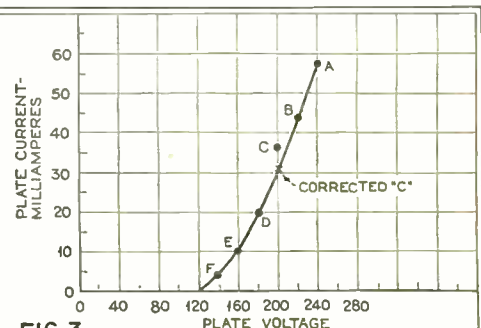
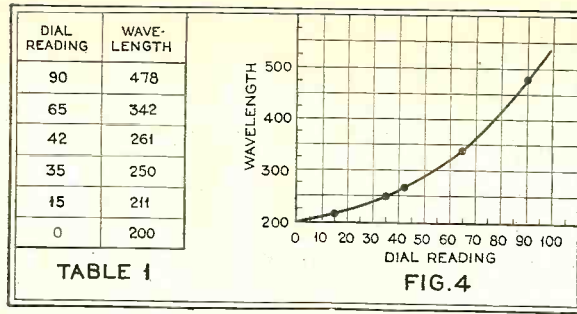

FIG. 3

the current at 200 volts. This time we get 31 milliamperes instead of 36 milliamperes. Evidently when first making the test we did not have the proper voltage or we read the meter incorrectly. It is in this way that curves can be used to check laboratory data. If one or two points fall out of line with the other points these particular measurements can be checked for error.

A use to which many experimenters have put the curve is in plotting a calibration of a receiver. The procedure is to tune in various stations and then look up their wavelength or frequency from a station list. This experiment will serve to indicate another useful feature of the curve; it enables us to locate points which could not be found experimentally. Suppose we tuned in various stations, looked up their wavelength in a list of stations and then noted it together with the dial reading at which the station was received. The data on such a test is given in Table 1. Then data was plotted as in Fig. 4. Now suppose we wanted to receive a station broadcasting on 300 meters. The curve shows that this station would be received at 53 on the dial. The curve therefore enabled us to determine where to adjust the dial for a 300-meter station though in our test we did



simple cross-section paper as was used in the preceding curves described in this Experiment Sheet, we obtain the curve shown in Fig. 6. A casual glance at the curve would probably lead most of us to say it was quite a good amplifier. But let us examine the curve more closely. It will be noticed that the space allotted to frequencies from

100 to 1,000 cycles, a ratio of 10 to 1 in frequency, is about the same as the space between 1,000 and 2,000 cycles, which is only a ratio of 2 to 1 in frequency. This gives misleading results, for audio-frequency characteristic curves ought to be plotted so that an equal amount of space is devoted to each octave of the musical scale. So far as curve plotting is concerned we can obtain this result by using log paper, which is so ruled that each octave of the scale will be of the same length. In Fig. 7 we have therefore replotted this same amplifier data on log paper. Compare it with Fig. 6. Fig. 7 is a much better representation of what the ears hear than is Fig. 6 and we must therefore decide that this amplifier, far from being quite good, is really pretty terrible. Perhaps this example serves to indicate how important it is to closely examine the manner in which a curve is plotted. Audio-frequency and loud-speaker curves

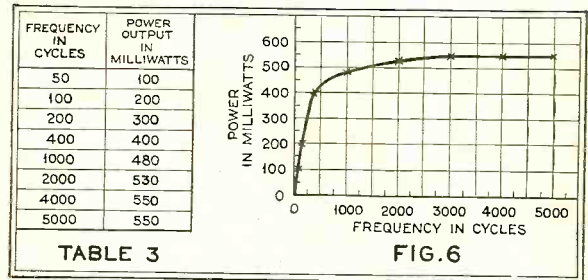
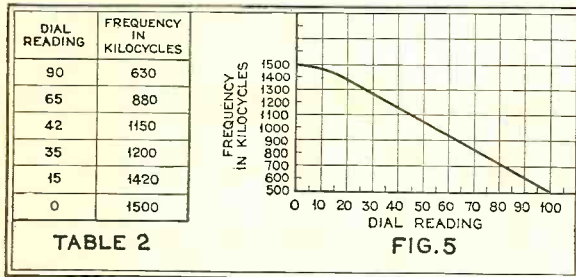

not tune in any station on this wavelength. In this way we can locate points that were not determined experimentally. Also this curve shows that this particular set does not use straight-line wavelength condensers, for if it did the curve of Fig. 4 would be a straight line. Perhaps they are straight-line frequency condensers. This can be determined by converting the wavelengths of Table 1 into frequency, which gives the figures of Table 2. Then plotting a curve between dial setting and frequency, we have the curve of Fig. 5. This curve, being straight throughout practically its entire length, indicates that the receiver uses straight-line frequency condensers.

Curves are frequently used to show the characteristics of audio amplifiers, but unless one knows how such curves should be plotted they can be very misleading. Data on audio amplifiers is obtained in the laboratory by impressing a constant input voltage on the amplifier and measuring the output power at various frequencies. Some sample data on an amplifier measured in this manner is given in Table 3.

In this case the two factors we must plot are the frequency and the power output. Plotting this data on

should always be plotted on log paper.

It will be evident from the preceding discussion that curves may be plotted either from mathematical formulas or from laboratory data—personally, our trust is in curves based on laboratory measurements. To plot such curves all one needs (besides the data to plot) is a hard pencil or ruling pen, some India ink, a rule, a French curve and some cross-section paper. The latter may be bought from Keuffel and Esser, Deitzgen, Codex and some other companies. Deitzgen No. 340-10 is ruled 10 x 10 and is punched for placing in a loose-leaf notebook. Another good paper is Keuffel and Esser No. 359-11, which is ruled 20 lines to the inch. Keuffel and Esser log paper No. 359-120 and Codex Nos. 3135 and 3112 are very useful in plotting audio characteristics, transformers, loud speakers, etc.

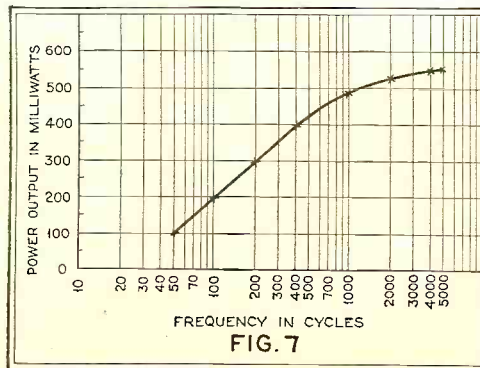

For January, 1931
The RADIO NEWS Home Laboratory Experimenter Sheet describes
Vacuum Tube Voltmeters
What They Are and How They Are Used



Pick the Job You Want and Fill It...in a Few Months.

By means of an actually proven kind of home study training sponsored by the Radio Corporation of America, hundreds of ambitious fellows are today enjoying financial independence in work that is thrilling.

Radio needs you. Opportunities are begging for men. Good money . . . fascinating work . . . adventure galore! Read all about this tremendous modern industry . . . send for this magnificent free book. Mail the coupon now!

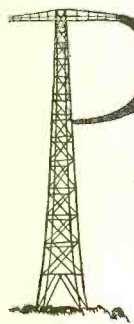

Prepare at Home

Only an hour or so a day is all you need. This Big League training prepares you for success in all phases of radio . . . manufacturing, servicing, selling, ship and shore broadcasting, photo-radiograms, radio equipment. Our graduates are now in demand everywhere . . . because they are posted right up to the minute in everything in radio. Radio's progress each year is measured by the accomplishment of the great engineers at work in the research laboratories of the Radio Corporation of America. This world-wide organization sets the standard for the industry . . . and stands back of every lesson in the course! A signed agreement by the president of the school assures you absolute satisfaction upon completion of the training—or your money will be promptly refunded.

RCA INSTITUTES, INC.
(A division of Radio Corporation of America)

THE ONLY COURSE IN RADIO SPONSORED BY R.C.A.



RCA INSTITUTES, Inc.
Dept. Exp.-12
75 Varick St., New York, N. Y.

Gentlemen: Please send me your big FREE 40-page book which tells about the brilliant opportunities in Radio and about your famous laboratory-method of guaranteed radio instruction at home.

Name _____

Address _____

NEWS from the MANUFACTURERS

Home Recording

The Radiola Division of the RCA-Victor Company has placed on the market a new device which makes it possible for anyone to make his own records in the home.

The home recording apparatus is part of a combination radiola-phonograph instrument so that all three functions of

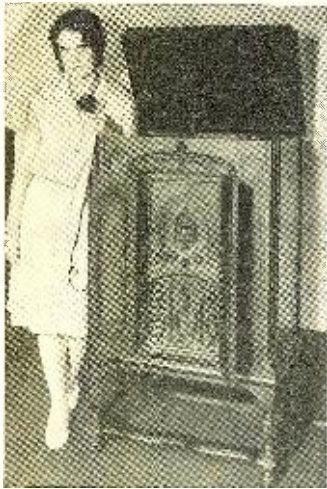

the complete instrument utilize practically the same mechanism. A special switch makes it possible to record excerpts from favorite programs at the same time that the radio set is operating.

The RCA Radiola 86, incorporating a new screen-grid superheterodyne receiver and an improved electric phonograph pick-up with the recording arrangement already described, is illustrated here.

Midget Receiver

The Ware Manufacturing Corporation, New York, announces a new compact model six-tube radio receiver to be known



as the "Ware Bantam." Two stages of screen-grid radio-frequency amplification, screen-grid power detector and a two-stage audio-frequency amplifier drive a full power electro-dynamic reproducer unit, the final stage utilizing the -45

power tube. Individual selective copper shielding is used for each stage to prevent interstage coupling and direct pick-up close to high-power stations. The gang condenser is of precision design with a ball-bearing rotor mounting. The compact unit chassis and reproducer unit are mounted in a walnut cabinet standing 16 $\frac{7}{8}$ inches high, 13 $\frac{1}{4}$ inches wide and 7 $\frac{11}{16}$ inches deep, weight 22 pounds, constituting the smallest full power electro-dynamic radio receiver on the market.

DeWald Receiver

A recent addition to the ranks of midget receivers is a product of Pierce-Airo, Inc., 117 Fourth Avenue, New York.

The cabinet is of solid walnut, modern-

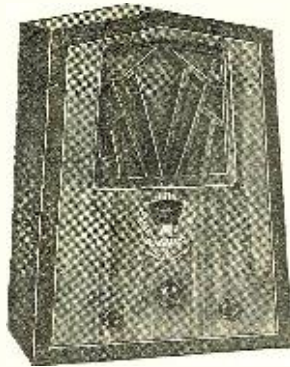

istic duo-tone, 16 inches high, 14 inches wide and 8 $\frac{1}{2}$ inches deep. The cabinet houses a large size electro-dynamic speaker assuring natural reproduction of tone. The tubes used are three -24 tubes, one -45 tube and one -80 tube.

Receiver Kit

The Acme Electric and Manufacturing Company of Cleveland, Ohio, is producing its new Acme model 98 chassis. This is an eight-tube chassis in kit form, the receiver using three -24, two -27, two -45 and one -82 tubes possessing high gain, to-

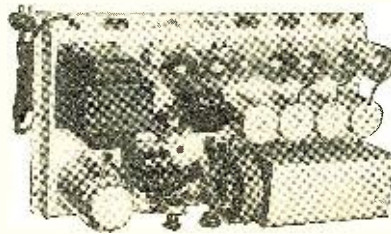

gether with both selectivity and excellent tone qualities.

At present this company is serving some of the large chain merchandising outlets and intends at a later date to follow this up to the custom set building trade.

Radio Clock

Westphal Company, Inc., 225 North Michigan Avenue, Chicago, is making an electric timekeeper, operating with a.c. light sockets, which may be used to turn on a radio set automatically at any hour

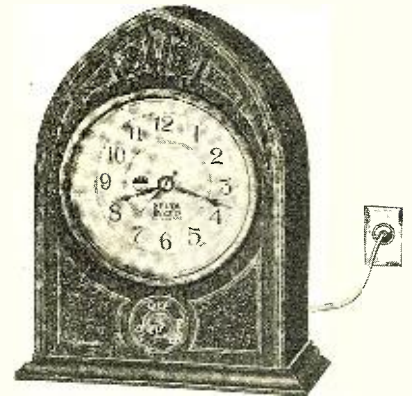

and also turn it off. It has an added advantage of a built-in radio antenna for use in those places where an outdoor antenna cannot be erected or where indoor antennas are not efficient due to steel or reinforced type of building construction. Its size is 7 $\frac{1}{4}$ inches high by 5 $\frac{1}{2}$ inches wide.

Dry Electrolytic Condenser

A new, self-healing dry electrolytic condenser is announced by the Concourse Electric Company of 294 East 137th Street, New York City. This condenser, made in several types and housed in either



round or rectangular containers, is absolutely dry. It is recommended expressly for operation under peak loads of 500, even 600 or more volts, standing up under the strain of excess loads. The capacities range from 1 mfd. or less to 200 mfd. or more.

Pacent Announces New Oil-Damped Pick-up

The oil-damped pick-up, one of the most remarkable contributions to the talking motion picture in the reproduction of sound-on-disc systems, is now available to the radio manufacturer for use in better-class radio-phonograph combinations, according to an announcement from the Pacent Electric Company, through arrangement with the Pacent Reproducer Corporation, whose engineers were responsible for the development and perfection of the new pick-up.

Faultless reproduction has been de-

(Continued on page 567)

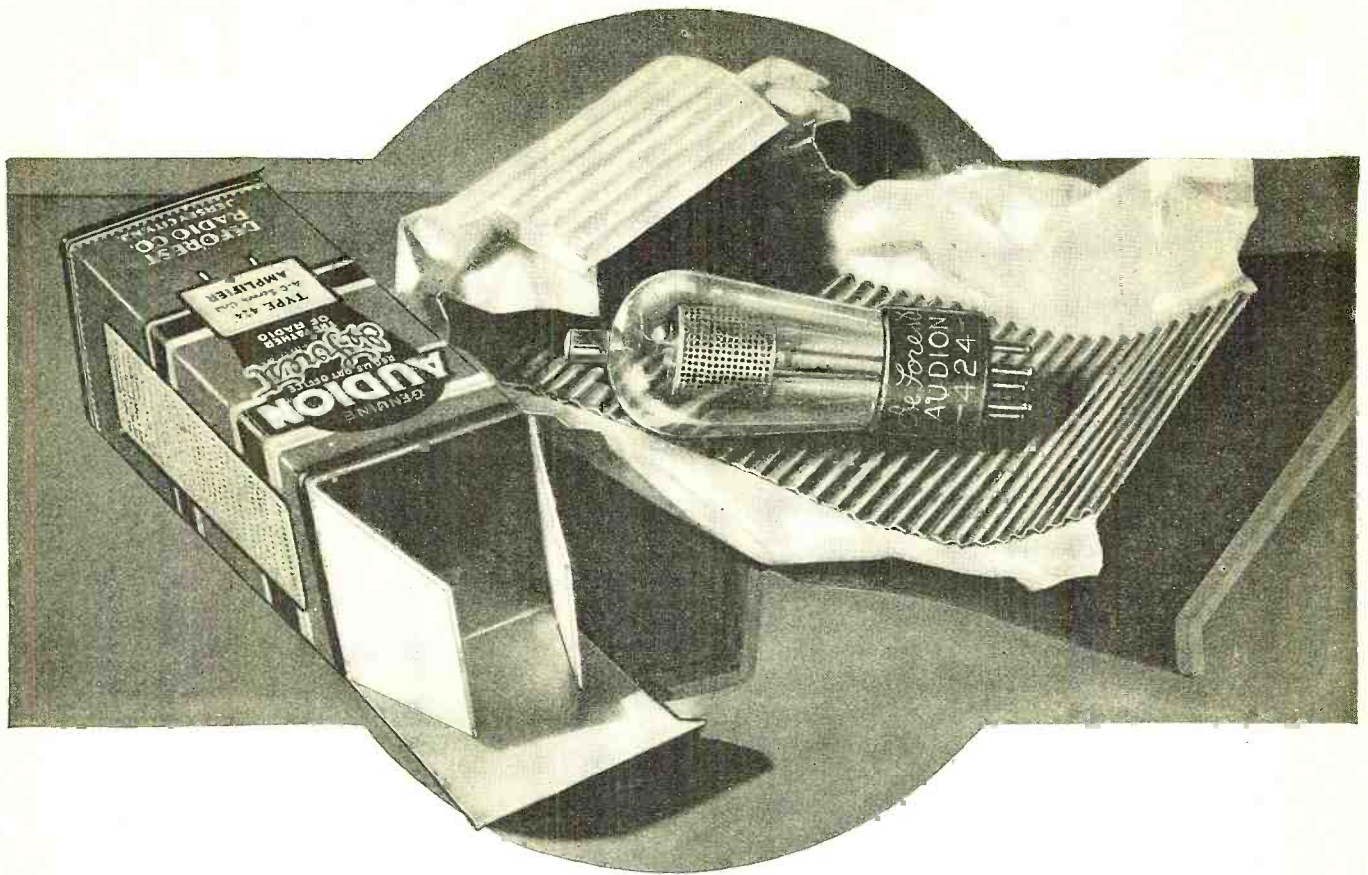

Insure That 1930 Tone!

TO realize the tone, selectivity, sensitivity and all-round satisfaction represented in those 1930 radio sets, you must place 1930 tubes in their sockets. Remember, notable improvements have been scored in radio tubes as well as in sets during the past twelve months.

Which is just another way of specifying DeForest Audions, because when you employ these tubes you are employing tubes produced during the past month or two. No danger of tubes from a huge inventory over a year old. No danger of 1929 or even 1928 tubes. The DeForest organization, operating on a rigidly controlled produc-

tion schedule, has never been confronted with a huge inventory of rapidly obsolescing tubes that *must be sold*.

The steady, untiring, far-seeing pioneering of yesterday, today and tomorrow, *plus* controlled production, insures for DeForest Audions the latest and the best the vacuum tube art has to offer.

Equip those sets with DeForest Audions—true 1930 tubes! At least recommend DeForest Audions for use in present-day sets when real performance is positively demanded. Insure that 1930 tone!

DeForest Tubes are approved as standard equipment in Crosley and Brunswick sets.

• DE FOREST RADIO COMPANY • PASSAIC, N. J. •

Branch Offices Located in

Boston • New York • Philadelphia • Atlanta • Chicago
 Pittsburgh • Minneapolis • St. Louis • Kansas City • Los
 Angeles • Denver • Seattle • Detroit • Dallas • Cleveland
 Export Department : 304 East 45th Street, New York City

de Forest
 AUDIONS

RADIO TUBES

RADIO NEWS INFORMATION SHEETS

By Elmore B. Lyford

Piezo-Electric Crystals—Part II

Index Number 537.65

IN the previous Information Sheet dealing with this subject, some of the characteristics of piezo-electric crystals were discussed. It was shown how use is made of these crystals, in transmitting stations, to control closely the frequency of the "master oscillator" circuit of such stations. Another manner in which these crystals may be used for the same purpose will be explained here.

This circuit, which is illustrated in the accompanying diagram, might be termed "an oscillator without a tuned circuit," for such it really is. The crystal effectively takes the place of the more usual combination of inductance and capacity, as will be shown.

Referring to the diagram, we see that the crystal is provided with two sets of similar coatings, rather than the more usual single set. The action of the circuit is as follows. Any slight change in plate potential will vary the electric field between the coatings B, thus setting the quartz plate into vibration—the so-called "reverse" effect.

These vibrations of the quartz plate will in turn induce charges on the coatings A (the "direct" effect) and thus vary the potential of the grid of the tube. This causes the usual plate voltage change—the cycle is complete,

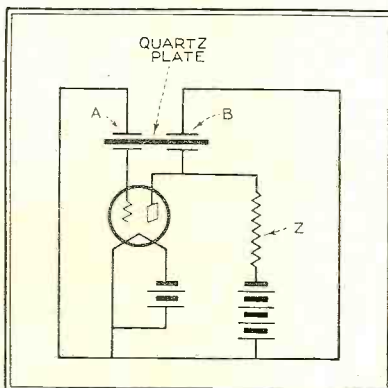

and starts again.

The oscillations are maintained by the amplifying action of the tube, but their frequency is controlled by the quartz plate, which vibrates at its natural mechanical period. The load Z in the plate circuit may be either an inductance or resistance, used to transfer the energy to an amplifying circuit. If this is tuned to the frequency of the generator or oscillations, their *intensity* will be increased, but there will be in no case any effect upon frequency—this is determined solely by the quartz plate.

Those interested in further or more technical information on the subject of piezo-electric crystals are referred to the very complete bibliography on the subject compiled by Professor W. G. Cady of Wesleyan University, and published in the Proceedings of the Institute of Radio Engineers for April, 1928 (Volume 16, Number 4, Page 521). Professor Cady did much of the pioneering work in this piezo-electric field, and is himself the author of many of the most valuable articles on the subject. August Hurd, a physicist with the Bureau of Standards, has also done much work with crystals. His papers also appear in the I. R. E. "Proceedings."

RADIO NEWS INFORMATION SHEETS

By Elmore B. Lyford

Carbon Microphones

Index Number R 385.5

OF all the different types of microphones which have been introduced at various times, none has enjoyed such universal use as has the carbon-granule type, literally millions of which are in use today.

In its essentials, this type of microphone consists simply of a diaphragm and one or more small "cup" of carbon grains. The diaphragm is free to vibrate as sound waves strike it, and this motion is used to alternately compress and release the carbon grains within the "cup", or "button" as it is generally called. Since the resistance of this button depends upon the pressure applied, it varies with the motions of the diaphragm. If we cause an electric current to flow through the button, it will also vary, and these variations will be, within limits, the electrical equivalent of the sound wave which struck the diaphragm.

Single-button carbon microphones of this type are universally used in commercial telephone work, and for this purpose their frequency characteristic is good enough, being comparatively flat from 400 to 2500 cycles.

For the more exacting needs of radio broadcasting, where simple intelligibility is not good enough, and really

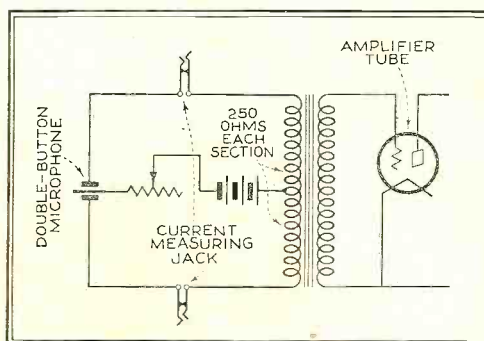

faithful reproduction is demanded, the double-button type is employed. Its frequency characteristic is generally quite flat from 50 to 6000 cycles or more. This double-button type consists of a similar diaphragm, but with a button on each side of it, rather than on only one side. They are in general much more finely made; polished carbon balls are used instead of carbon grains, and the diaphragm is much more tightly stretched, to eliminate resonance.

These double-button microphones are much less sensitive than the telephone type, but their fidelity and frequency characteristics are infinitely better.

Double-button microphones as made commercially are generally designed to work into the primary of a 500-ohm center tapped transformer, whose secondary feeds an amplifier tube, as shown in the diagram. The six-volt battery is regulated by the rheostat so that about 15 milliamperes current flows through each button of the microphone.

The output of a broadcast microphone is very small, needing two stages of audio amplification to bring it up to detector-tube volume, and four stages to bring it to loud-speaker volume.

It Packs the Punch

Capacity
8 MFD
Peak Voltage
430 DC
Can Negative



HERE'S a heavy-weight wallop in fly-weight form—the new Sprague electrolytic condenser. Packing 8 MFD capacity and a rating of 430 volts DC into a space of only $1\frac{3}{8}$ " diameter x $4\frac{11}{16}$ " high overall.

And what advanced construction you'll find inside the can! A one-piece rolled edge anode of pure aluminum, without welded joint or soldering. Absolute prevention of liquid leakage thru practically a one-piece rubber top with integral vent. Unequaled flexibility in mounting, due to standardized size and form. And individual screw socket mounting that makes attachment or adjustment almost instantaneous.

The Sprague Condenser is engineered and constructed for maximum efficiency in practical use. Let us send you illustrated folder showing in detail how the Sprague excels all other types.

SPRAGUE SPECIALTIES COMPANY
North Adams, Mass.

Radio Set designers, builders and service men are invited to get in touch with our engineering department, and learn more about successful tested circuits embodying Sprague Condensers in their design.

SPRAGUE

Electrolytic **CONDENSER**

RADIO NEWS INFORMATION SHEETS

By Elmore B. Lyford

Index Number R 376.3

Using Several Loud Speakers

It is often desirable to operate two, three, or even more loud speakers in different rooms from a single radio set, and with remote control of receivers now here, this practice bids fair to become even more common. Some listeners also find that a combination of two or three speakers together gives them a more pleasing tonal result than does any one speaker by itself.

When using two or more speakers on one receiver, it is very seldom satisfactory to connect them all in series or in parallel and let them blast away, regulated only by the volume control of the receiver. Some means of regulating each speaker individually is needed, and the accompanying diagrams show two ways by which this may be accomplished.

In the first diagram, the speakers are bridged across potentiometers, which in turn are connected in parallel across the output of the receiver. The volume of each speaker may thus be independently regulated with very little effect on any of the others.

In the second diagram, the speakers are similarly bridged across individual potentiometers, but these poten-

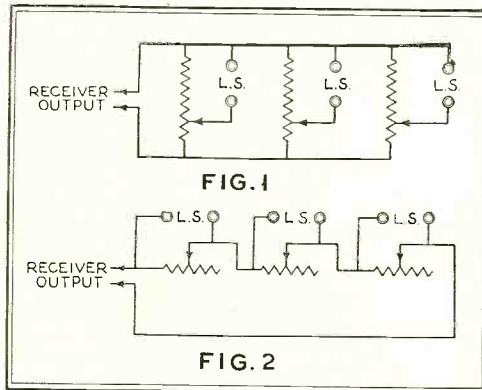

tiometers are all in series with the receiver outfit. This system is slightly better than the parallel method for here, with the potentiometers closed there is no loss, where with the other method is always some loss due to leakage across the potentiometer.

Three speakers are shown in each case, but any number from two to six or more may be so connected. Any such group must of course all be of a similar type—all magnetic or all dynamic. For magnetic speakers, the potentiometers should be about 10,000 ohms

each, while for dynamic speakers they may be 400 ohms each.

A combination of magnetic and dynamic speakers may also be used, if one precaution is taken. The output of the receiver must be suited to magnetic speakers, and wherever dynamic speakers are used, each must operate from an individual output transformer whose primary is connected across the potentiometer, with the speaker operating from its secondary. The potentiometer in this case should be of the 10,000 ohm type.

The two circuits are shown in Figs. 1 and 2.

RADIO NEWS INFORMATION SHEETS

By Elmore B. Lyford

Index Number R 586

Talking Movies

It has been said that the talking movies had photography for a father and radio for a mother. It cannot be denied that without the great advances which radio has made in the last ten years we would not yet have the "talkies," nor can it be denied that at least ninety per cent. of talking movie engineers came over from radio fields.

The diagram which accompanies this sheet shows an analogy between radio and the talkies, and shows why the newer art drew so heavily upon the other for its engineers. It may be seen from this picture diagram how close is the connection between the two. Both deal with the pick-up and amplification of similar audible sounds, accomplishing it with practically identical apparatus. Where radio engineers use this signal to modulate a broadcast wave, talking movie

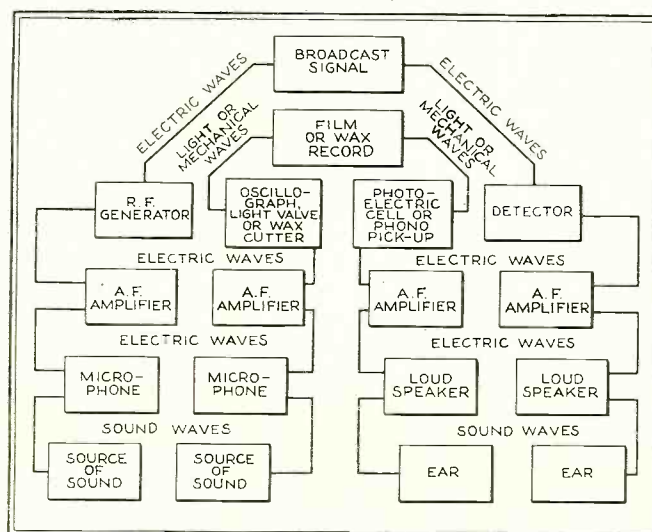

engineers use it to modulate a light beam, or the cutter of a wax record.

On the "receiving" side, the photo-cell (or pick-up, if a wax record) corresponds to the detector tube of a radio receiver. From here on, the chain through amplifier and loud speaker to the ear of the receiver is practically identical.

In talkies, of course, problems present themselves which are not met with in broadcasting. One such problem is that of obtaining synchronism between the recorded sound and the picture.

In disc recording the turntable is geared, mechanically, to the picture mechanism.

In sound on film, both sound and picture are recorded on the same film. However, since each picture frame is "jerked" past the shutter, the sound is recorded ahead of the frame to which that sound applies.

SM

Foreign Programs in Your Own Living-Room!

The S-M 738 is a self-contained converter that makes a powerful short-wave superheterodyne when attached to any broadcast set.

There is nothing that the finest commercial short-wave receiver (costing three times as much) will do, that the 738 will not duplicate and beat if your broadcast receiver has any punch at all. Under favorable weather and local receiving conditions, it will give you every American short-wave broadcaster and the principal foreign stations, for to every bit of the sensitivity and selectivity of your broadcast set is added the additional power of a 224, and a 227 tube!

The 738 Converter is built in a beautiful black crystalline case with a hammered silver dial escutcheon—a credit to any living room.

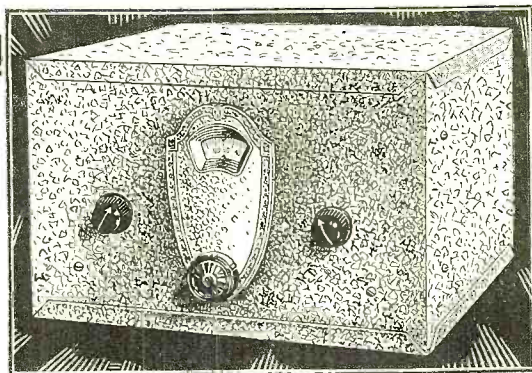

The wired model can be hooked up in three minutes—you merely remove the antenna lead from the broadcast receiver and connect it to the antenna post of the converter; then run two leads from the 738 to the antenna and ground posts of the broadcast set. That's all.

It tunes by a single dial, (which tunes the oscillator circuit) and an auxiliary

midget condenser.

It will give in addition to short-wave broadcasting, phone and i.c.w. where there is any carrier modulation at all.

Included in the list price are eight coils (four pairs) which cover the wave length range of from 18 to 206 meters. Tubes required: 1—'24, 1—'26, 1—'27.

Price, completely factory-wired, tested and RCA licensed, less only tubes \$69.50 List
Component parts total \$59.50 List

S-M 724 Superhet

The 724 is the finest complete custom-built superheterodyne chassis that Silver-Marshall has ever built—and that means the finest that has ever been built, for the S-M Laboratories know how and McMurdo Silver, himself, designed the first super ever to gain national popularity!

It has nine tuned circuits, with three double-tuned circuits in the i.f. amplifier, providing a degree of selectivity that has never before been attained in any commercially practical superheterodyne or t.r.f. receiver. Actually, the 724 is so selective that it will bring in a station for almost every broadcast channel, even

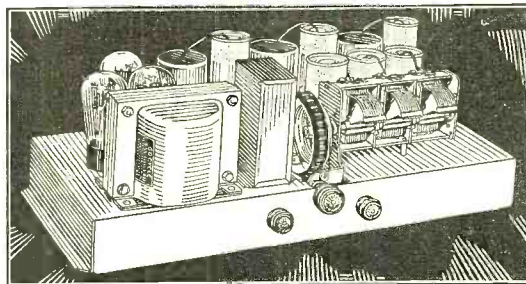

(724AC) uses 5—'24s, 1—'27, 2—'45s and 1—'80. The 724DC uses 5—'32s, 1—'30, and 2—'31s.

724AC chassis price, wired and licensed, \$99.50 List. Parts total \$87.50 List.

724DC chassis price, wired and licensed, \$82.50 List. Parts total \$68.50 List.

Four Screen-Grids

when located close to powerful locals. The use of two tuned circuits before the first detector prevents cross-talk and repeat points.

The sensitivity of the 724 ranges between .2 and 1 microvolt per meter!

It is available not only for a.c. but also for battery operations. The former

A Real t. r. f. Short-Wave Receiver

The 737 Short-Wave Bearcat is a bearcat! It has everything: built-in power supply, one-dial tuning, a real gang condenser, a screen-grid circuit with two s.g. tubes, and you can spread the ham bands by a twist of the wrist. And for distance and selectivity, it's head and shoulders above the most expensive short-wave chassis built.

737AC, wired, less tubes and speaker, \$139.60 List. Parts total \$119.50 List.

737DC (for batteries), wired, less tubes and speaker, \$94.50 List. Parts total \$69.50 List.

Write for your copy of the SILVER-MARSHALL 1931 GENERAL PARTS CATALOG. The Radiobuilder, Silver-Marshall's official publication, tells the latest news of the great S-M laboratories. Fill in the coupon for a sample copy.

SILVER-MARSHALL, Inc.
6405 West 65th Street • Chicago, U. S. A.

Silver-Marshall, Inc., 6405 W. 65th St., Chicago, U. S. A.
... Send your NEW 1931 CATALOG with sample copy of the RADIOBUILDER. Also Data Sheets as follows:
(Enclose 2c for each Data Sheet desired.)
..... No. 23. 738 Short-Wave Superhet Converter.
..... No. 24. 724 Screen-Grid Superhet Receiver.
..... No. 21. 737 Short-Wave Bearcat.

Name.....
Address.....

Radio News Manufactured Receiver Circuits

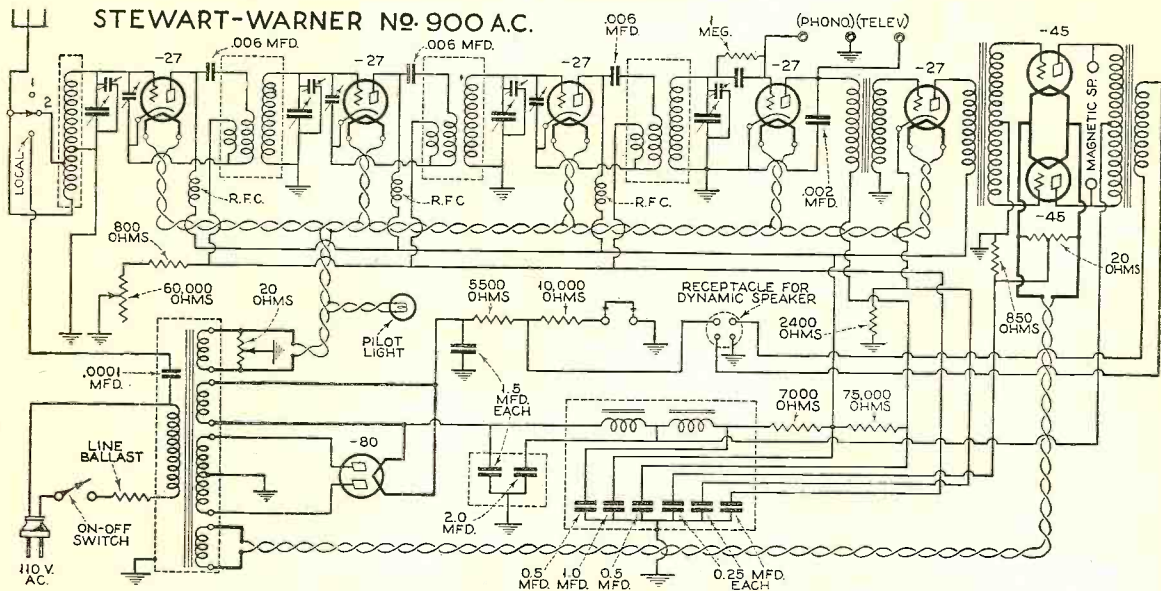

THE Stewart-Warner model No. 900 a.c. is a seven-tube receiver of the tuned radio-frequency type. Type -27 tubes are employed in the radio-frequency stages, the detector, and first audio stage. The power output stage consists of two type -45 tubes in a push-pull arrangement. Provision is made to use either a magnetic or dynamic speaker. The antenna stage is so arranged that either a short or

long antenna may be used. For local stations, no antenna is necessary, provision having been made in the receiver to use the electric lines as an antenna.

The power pack that supplies all operating voltages for the receiver utilizes an -80 type rectifier. A line ballast keeps the voltage across the primary of the power transformer constant.

Radio News Manufactured Receiver Circuits

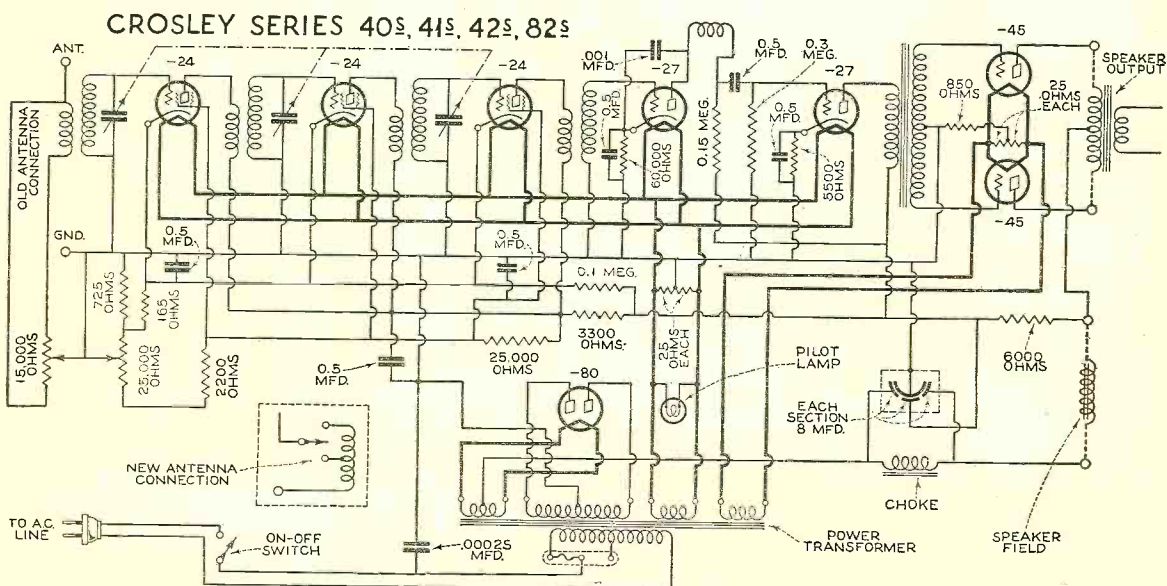

THE same circuit arrangement is used in the Crosley models 40, 41, 42 and 82. This is a tuned radio-frequency receiver utilizing three type -24 tubes in the radio-frequency stages, two -27 tubes in the detector and first audio stage, and two -45 tubes in the push-pull power output stage. Seven

tubes in all are thus used. Furnishing all voltages for the operation of the receiver, the power pack uses an -80 type rectifier. An electrolytic condenser is employed in the filter circuit of the power pack, thus assuring good filter action by its high capacity.

When the FOUNDATION is Right

YOU CAN RELY ON SOUNDNESS OF STRUCTURE

THE "FAIRFAX"

A charming Colonial desk containing also the complete HiQ-31 Radio. Just one of the ten classic HiQ-31 cabinet designs, including Radio and Phonograph combinations.

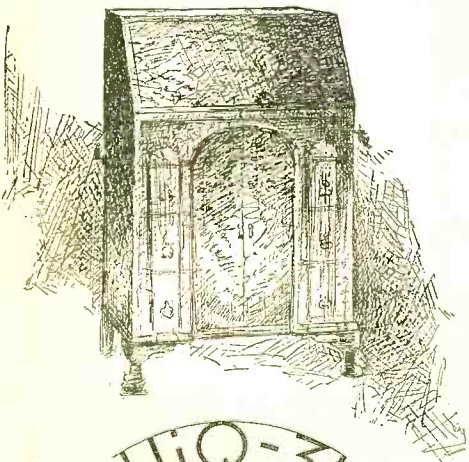

HiQ-31

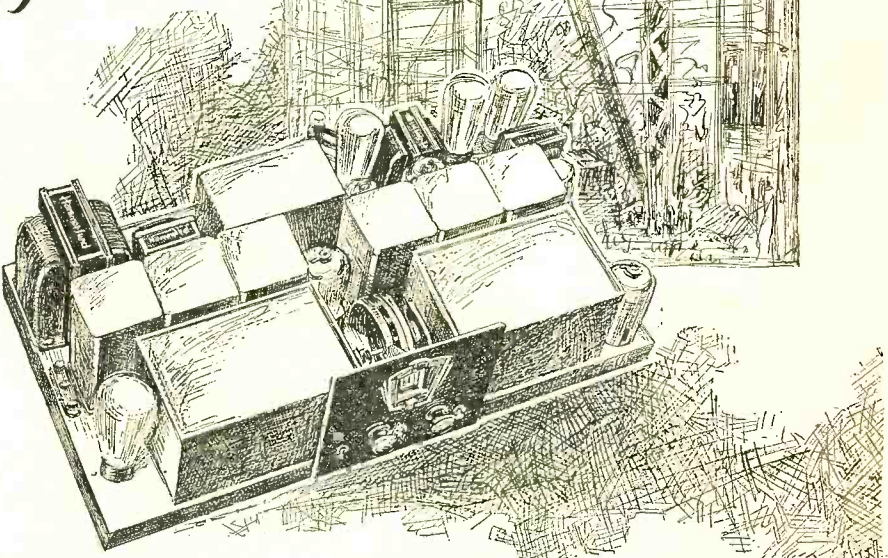

RADIO, too, is a "sky-scraper." Its FOUNDATION must be right, or it will fall.

The new HiQ-31 Custom-Built Radio really started its amazing career 30 years ago when Hammarlund laid its first foundation in the solid rock of sound engineering.

Here today is the very pinnacle of modern radio achievement—towering boldly above even the masterpieces which preceded it.

Not merely redesigned—but a completely new receiver, embodying every possible refinement that makes for superb performance.

Nine tubes; six tuned circuits—hair-splitting selectivity, penetrating range, uncanny quietness under all conditions and tone that beggars description.

And you may assemble it yourself from factory-wired units. Or it will be supplied complete, ready to operate, \$220 to \$1175, less tubes.

Mail the coupon now for your copy of the new 48-page HiQ-31 Manual. Study every detail before you even think of purchasing any radio of lesser value.

HAMMARLUND-ROBERTS, INC. Dept. RN-12, 424-438 W. 33rd St. New York

Custom-Built Radio by HAMMARLUND

HAMMARLUND-ROBERTS, INC., Dept. RN-12, 424-438 W. 33rd St., New York.

Enclosed 25 cents (stamps or coin) for 48-page HQ-31 Manual.

Name

Address



A department devoted to the presentation of technical information, experimental data, kinks and short-cuts of interest to the experimenter, serviceman and short-wave enthusiast

Conducted by George E. Fleming

Little Tricks That Help in Getting a Super to Perk Properly

Much of the sensitivity of a superheterodyne that is perking properly will be found to be due to the use of the proper coupling between the oscillator and the first detector circuits. Improper coupling at this point will give rise to numerous griefs, the worst of which is low sensitivity. There is a simple way to assure the proper condition, if one has available a very sensitive direct-current meter of any type, such as a microammeter or galvanometer.

If such an instrument is not available, one can be made by scatter-winding a couple of hundred or so turns of wire so that an ordinary pocket compass may be placed inside the coil and still be observed. This instrument will have to be placed so that the needle points parallel to the direction of the winding. The winding should be by-passed liberally with a non-inductive type of condenser. About a half mike will be plenty. With a current flow through the coil the needle will tend to assume a position at right angles to the coil. Carefully observed for a slight movement, this meter will indicate very small amounts of current. Thus we have a crude but sensitive galvanometer.

Now to adjust the oscillator coupling, the grid return of the coil ahead of the first detector tube should be opened and the meter connected in series with the coil and the point to which the coil was connected. Now, with no signal tuned in, the oscillator coupling should be adjusted to a point just below the point at which the grid of the first detector tube begins to draw current. Incidents have come to our attention where the sensitivity of a super was increased ten times by making this adjustment properly.

The next point to look out for is the adjustment of the tuning units in the intermediate amplifier. One should have

A New Laboratory Service for You

IN keeping with our policy of serving our readers, we announce that a recent acquisition of additional precision laboratory apparatus makes it possible for us to undertake practically any type of experimentation, research or quantitative measurement work that might be required by any of our readers in the development of their ideas.

To custom set builders and to small manufacturers we can supply curves or take any quantitative measurements on apparatus submitted, at very reasonable prices.

It is our firm belief that the future of radio lies as much in the hands of the experimenter and the short-wave fan as it does in the laboratories regularly engaged in development work. We wish to be as helpful as possible to the man who is without the facilities of a large laboratory but who has real ideas, and as we have expressed it before, we want you to feel that the RADIO NEWS Laboratory is your laboratory.

EDITOR.

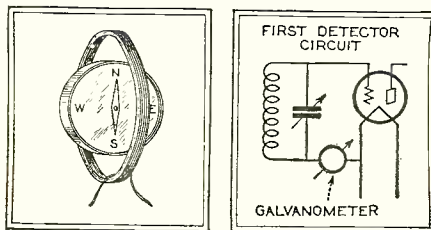

Galvanometer that is easily constructed for testing the coupling between oscillator and first detector. The coil of wire should "hug" the compass closely, hooking the galvanometer into the circuit. Adjust coupling to a point just below the point where the grid of the first detector draws current

an oscillator working at the proper frequency, but in its absence a good job may be done anyway. If the units are not hopelessly out of alignment, some signal may be heard in the output. If this is the case, insert a milliammeter in the plate circuit of the second detector tube, and the units adjusted in turn for the highest meter reading. If the units are so far out of line that no signal can be heard at all, a crystal detector will come in very handy. Hook a pair of by-passed phones in series with the crystal detector, and put the combination across the secondaries of the intermediate coils, beginning with the first one. In this way they may be approximately aligned, and then the job finished as described in the first part of this paragraph. This system is not intended for use with "band-passed" intermediates. A coming article in RADIO NEWS will go into that.

Another annoying thing may arise in the construction of a super. If the loud speaker is included in the same cabinet with the receiver. If your set happens to be very microphonic, don't run all over town trying to get a corner on the tube market. The chances are that it isn't a tube at all, but the condenser plates in the oscillator. A pure continuous wave, without modulation, has little or no decrement, so if these plates are free to vibrate they nicely modulate the signal. The obvious solution is to use a condenser at this point that has very heavy plates, or is die cast. However, that is not always practical, as we certainly have no desire to start a collection of discarded parts that we may not find other uses for in a hurry. The last instance we had of this was cured by soldering supports to the plates of the condenser at strategic points; that is to say, the points at which they were free to vibrate. This was a ticklish job, but accomplished by cutting strips from thick shim stock which were carefully tinned. Soldering paste was liberally used.

(Continued on page 540)

ALASKA
 CANADA
 GREENLAND
 MEXICO
 COSTA-RICA
 GUATEMALA
 HONDURAS
 PANAMA
 SALVADOR
 BERMUDAS
 CUBA
 WEST INDIES
 HAITIAN
 REPUBLIC
 COLOMBIA
 GUIANA
 VENEZUELA
 ARGENTINA
 BRAZIL
 URUGUAY
 BOLIVIA
 CHILE
 ECUADOR
 ENGLAND
 IRELAND
 FRANCE
 BELGIUM
 GERMANY
 HUNGARY
 SWITZERLAND
 POLAND
 RUSSIA
 GIBRALTAR
 ITALY
 PORTUGAL
 SPAIN
 BULGARIA
 RUMANIA
 TURKEY
 ARABIA
 PERSIA
 INDIA
 CEYLON
 JAVA
 PHILIPPINE
 ISLAND
 SIAM
 CHINA
 JAPAN
 ALGERIA
 EGYPT
 MOROCCO

Hear the U.S. Broadcast Programmes
 And Tune In
 Directly on



World Wide Short Wave Thrills!



With a **PILOT** Super Wasp

In KIT form - easily assembled \$29.50

SHORT-wave weather is here again. Australia, South America, India, China and the regular European short-wave broadcasts will soon be heard from thousands of Super-Wasp owners' loud speakers.

Pilot Super-Wasp, Short Wave and Broadcast Receiver (Range 14 to 500 Meters) brings in stations from all parts of the globe direct without dependence on local rebroadcasting. It lets you hear broadcast wave lengths whenever you desire, and widens your circle of radio entertainment millions of square miles. The first short wave receiver to have a tuned R. F. Screen Grid Stage ahead of regenerative detector. This gives sensitivity and selectivity far beyond ordinary circuits, and is necessary for bringing in distant stations and separating them from powerful local ones on nearby wave lengths. Pilot Super-Wasp is two years ahead. Loud speaker reception from Europe is frequent for Super-Wasp owners. Imagine the thrill to yourself and others who have never heard a station outside the U.S.A.

If you've had some short-wave experience you'll be grateful for the smooth powerful way Pilot Super-Wasp brings them in. If you're just starting on Short-wave work you'll be glad you never wasted your hours on any set less smooth and dependable than a Pilot Super-Wasp.

*Add to your Radio Joy This Season
 Invest in a Pilot Super-Wasp.*

At your local dealer or write direct for details

PILOT RADIO & TUBE CORPORATION

Chicago Office
 234 S. Wells Street

LAWRENCE, MASS.
 New York Office—525 Broadway

San Francisco Office
 1278 Mission Street

Kit K-110: The battery-operated Super-Wasp. Batteries and Tubes extra.

\$34.50

Kit K-115: The A. C. Super-Wasp. Use your own ABC pack or Pilot K-111, specially designed for the Super-Wasp. Power Pack and Tubes extra.

**YOUR PILOT
 RETAILER**

Is Part of Pilot's Plant

He is no mere middleman dealing through other middlemen. He is a representative of the factory chosen for his ability to cooperate with Pilot's laboratory engineers in seeing that you enjoy all the abundant satisfaction built into every Pilot product whether it be kit, set, tube or accessory.

Have your Pilot Super-Wasp completely equipped with Uniform Pilotron Radio Tubes. The exacting tube requirements of short wave work, on which Pilot alone of all tube manufacturers has specialized, has taught Pilot tube engineers methods which make tubes better for all purposes. Pilot precision standards are unexcelled.



PILOT SUPER-WASP RADIO
 FOR LONG AND SHORT
 WAVE RADIO RECEPTION

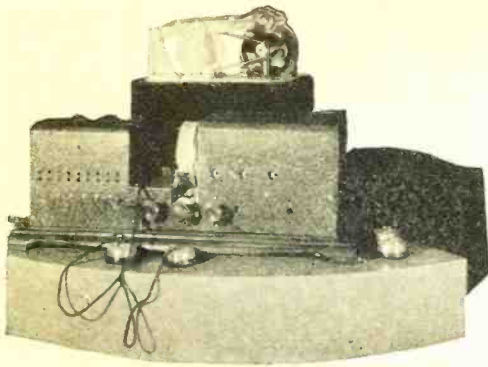

(Left) This machine jolts a vacuum tube eight hundred times a minute, but the tube still works. The tube is hooked up as a part of the circuit in the receiver below it

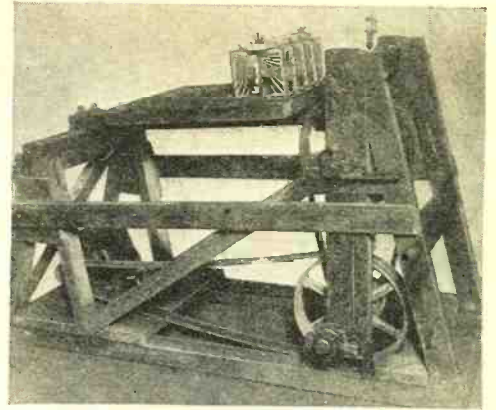

(Right) Some more jolts, but this time on automobile "B" batteries

ally applied to the edges of the condenser plates, and the shim stock held firmly in place with a small screwdriver. An alcohol torch played carefully on the shim stock caused the solder to run and made a very firm joint without excess solder smeared all around. Clean off the soldering paste with wood alcohol, and replace the condenser in the circuit. You will probably find that the microphonics have disappeared.

Some Interesting Tests

At the New York Radio World's Fair we saw a display that was very impressive. The machine shown in the picture literally threw a vacuum tube through an eight-inch arc eight hundred and forty times a minute. In spite of such rough treatment, the tube was actually working in a receiver, and the observer could listen to the music through earphones. The story as we got it was that some very progressive dealer in the Middle West invented the machine and made up one out of old sewing machine parts. He put the display in his window and challenged people to bring in their tubes to see if they would stand up under a similar test. We were told that his sale of tubes increased 1,000 per cent. in two weeks.

Another interesting point that has been brought to our attention are the tests that one battery manufacturer made on his "B" batteries intended for motor-car use. First they are put on a

IN asking questions of our Technical Information Department two types of questions are considered. Our method of charging for this service is as follows:

No charge for any question regarding the list parts to be used in any unit actually described in RADIO NEWS, or where they may be procured.

No charge for any subscriber's question except where the answer requires more than an ordinary amount of research and in such cases we will advise you what the charge is to be before going ahead with your reply.

A charge of \$1.00 for all technical questions regarding hook-ups, service, etc., received from non-subscribers with the same exception in connection with questions entailing more than ordinary research.

the immersion test is repeated. Then as a final test, the battery is placed in an oven at 140 degrees to further test the sealing. Unless perfectly sealed, the battery will dry out at this temperature, and after an hour or so of this the battery is torn down to measure its moisture content. Evidently, the manufacturers intend to take no chances on their batteries going bad in normal service.

By the Way

Have you read Fred Schnell's article in this issue about short-wave antennas? If not, by all means do so. Even if you have no intention at the moment of building an s-w transmitter at this time, you will find a whale of a lot of interest in this latest contribution by one of radio's outstanding authorities. Maybe after reading it you will decide that with such accurate information as this available you will want to give this ham game a try.

In the Future

We have been given the job in the laboratory of developing an automatic volume control that could be easily applied to an existing receiver, or incorporated in the design of a new receiver.

There are some points we are to stress, and among them are the ability to manually control the volume if one so desires, and to be able to receive music
(Continued on page 572)

"bumping machine" and bumped about a thousand times. Then the battery is immersed in a jar of water, and tested for current leakage. If the bumping machine has developed any cracks in the battery, water will seep in and current leakage result. Then the battery is frozen in a cake of ice at 20 degrees below zero. If any water has gotten into the battery it will freeze and burst. After this test,



(Above) Frozen into a cake of ice at subzero temperature

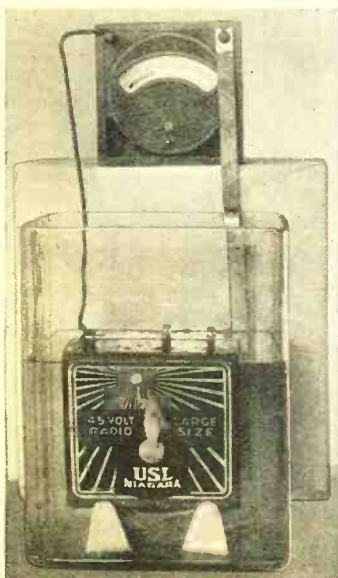

(Left) Submerged in water for a leakage test

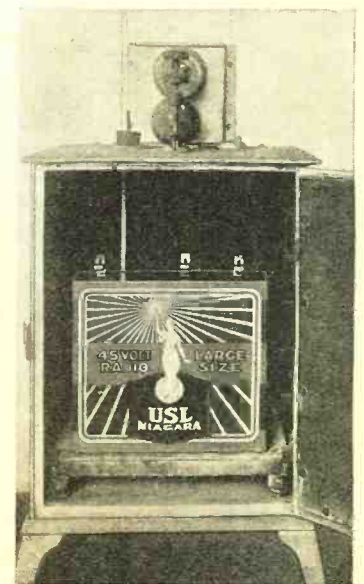

(Right) "Bake in a hot oven until brown, and then serve" seems to be a part of the recipe. 140 degrees of heat applied to test the sealing compound

H. F. L.

MASTERTONE

SUPER 10

WITH THE

HOPKINS

BAND-

REJECTOR

SYSTEM

POSITIVE
10-KILOCYCLE
STATION
SEPARATION

TRIUMPH!

IN THE FIELD OF FINE RADIO THIS AMAZING SUPER-HETERODYNE IS NOW A RECOGNIZED RADIO ENGINEERING

IT now stands out as the preeminently fine receiver in all the field of super-heterodynes. It actually affords reliable, definite 10-kilocycle separation and does that without sacrifice of quality. It reproduces with a fidelity, clarity and volume that has hitherto been unknown. It is laboratory, engineer-built. It is made of the finest units the art affords. Electrically and mechanically, it is distinguished as radio's first really great receiver.

Judge It By Results!

"Have always owned a high grade radio, but find I missed a lot of enjoyment by not having owned a Mastertone before. The clearness with which it performs is simply amazing and the ease with which distant stations roll in is almost miraculous"—L. M. M., Detroit.

"My last Mastertone customer has verified report showing reception of WEEI Boston at 12:30 PM (noon) and program held for half hour, loud and clear..."—E. P. C., Exeter, Cal

"Received over 132 distant stations in all parts of country, not counting locals in 100 miles. Also KGU, Honolulu a number of times. West Coast comes in wonderfully. Am only 20 air miles from New York City! Pull in Chicago one point from WJZ and others one point from WOR and WABC!—A. H. H., Mahwah, N. J.

Hundreds of such spontaneous expression from users everywhere are eloquent proof of the superior performance on this amazing receiver.

Buy a Super-heterodyne

Be satisfied with nothing less than the marvelously efficient operating characteristics, the magnificent tone and surging power of a super-heterodyne. The difference in cost is negligible. The difference in enjoyment is unmeasurable. But, make certain of a good superheterodyne by purchase of an H. F. L., the product of an organization with years of specialized experience in this field. There are marked differences in supers, as you will readily determine the moment you have seen, tuned and heard this amazing new 1931 Mastertone 10!

Try It Yourself

Give us the opportunity to prove all the unusual claims we make for this masterful set in your own home entirely at our risk. Feel its surging power. Experience the thrill of its sharp tuning, clipping powerful stations apart with a definiteness and reliability that is uncanny. Be carried to new heights of musical enjoyment by hearing your favorite stations with a naturalness of reproduction never before attained. Reach out to the far corners of the earth for a thrilling evening of DX hunting. Prove yourself that here is a receiver that is actually far ahead of anything radio has yet known.

HIGH FREQUENCY LABORATORIES
Dept. F1230, 3900 Claremont Ave, Chicago

Basic Advancement in Circuit Design

Not just another superheterodyne but one with an entirely new circuit arrangement, with the now famous Hopkins Band Rejector System. Employs a new operating frequency. New kind of pre-selection. New kind of R. F. amplification. The most highly advanced and developed super ever produced.

World Wide Reception

With improved sensitivity, with unhampered flow of each and every signal entirely through the circuit, this set has a reach that is truly amazing. At your finger tips always is the whole world of broadcast.

Backed by An Envious Record

H. F. L. have been pioneers in the field of making fine superheterodyne receivers. We have specialized entirely in this type of set since the early days of radio. Thousands of H. F. L. sets are in use the world over. All are enthusiastically owned.



THIS BOOK SENT FREE

Know how to quickly and surely tell the difference between good and best in radio receivers before you buy any set. That is the way to make your radio dollar do full duty. Send for this Brochure which describes fully this history-making receiver. It will be sent free without obligation. No salesman will call, you will not be urged to buy. Write now and soon begin to enjoy radio as it has never been possible before.

HIGH FREQUENCY LABORATORIES, Dept. F1230,
3900 N. Claremont Ave., Chicago.

Without cost or obligation, please send me a copy of your new Brochure describing the new 1931 H. F. L. Mastertone 10 and your liberal selling policy.

Name _____

Address _____

City _____ State _____



The Junior RADIO Guild



LESSON NUMBER FIFTEEN

Using Mathematics in Radio

EVERY radio student soon learns that mathematics is an essential part of his education if he is to arrive at the top of one of its many branches. Even to attain some position near the top requires a knowledge of figures, numbers and expressions which can be of direct benefit to one's vocation.

Mathematics, as we normally think of it, is divided into five branches, which are classified as follows: Arithmetic, algebra, geometry, trigonometry, and calculus.

The study of these divisions in mathematics is considered by some students to be intensely interesting, while to others it is a subject requiring much effort for a complete understanding. It is very often looked upon as a sort of abstract study, which is, of course, comprehensible if one has the time and facilities to attend school, institute or college. These ideas are sometimes obtained by the use of textbooks, but these do not always treat the subject in as interesting a manner as possible.

The student who is interesting himself in radio today realizes that it is fast approaching a high degree of engineering, and that he must become an engineer to ultimately reach the goal. For, throughout the various applications of radio, which cover the design, manufacturing, testing and servicing of radios, mathematics is involved for a most complete understanding of the work.

The most difficult thing to understand in attempting to study mathematics is to appreciate its ultimate value. We see, sometimes, just a mass of figures, numbers, or letters and know that we can understand them if sufficient time is taken, but very often we do not realize the actual application to the particular problem involved. Thus, a service man may think it unnecessary to understand algebra, geometry or calculus to do his work well and intelligently, but if he will investigate these possibilities, a wonderful opportunity of studying engineering is opened for him in the most practical way.

The purpose of these articles is to bring out in as interesting a manner as possible the use of mathematics in radio. These will be investigated under the following headings: Using arithmetic in radio; using algebra in radio; using geometry in radio; using trigonometry in radio; using calculus in radio.

There are many times that a radio enthusiast picks up a popular magazine or a technical article, dealing in some phase of radio, and reads a mathematical discussion on a favorite subject. He finds himself easily and quickly lost.

The student naturally is not satisfied to accept a formula, or any mathematical statement unless it is thoroughly understood and its function explained. Thus, in reading an article on radio frequency or audio frequency amplification, the design of loudspeakers, or power supply systems, we see that considerable thought was necessary to obtain the efficient and practical design towards a commercial product. One is not satisfied in obtaining an approximate idea of how it is done, but strongly desires to learn the fundamental method of design.

In reading and studying, formulas are involved which are difficult to comprehend. Intermediate steps and operations are very often omitted in some of the limited discussions and unless a knowledge of mathematics is available a rather difficult understanding of the problem results.

The solution to this trouble is to become familiar with mathematics, and to appreciate how interesting and important it is.

THE use of mathematics becomes more and more important as one gets deeper into the study of engineering in radio. By this time, the followers of The Junior Radio Guild have learned that without a thorough groundwork of "math" they cannot hope to have the grasp of the subject that one more familiar with mathematics can have. Therefore, starting with this issue, and extending over a period of several months, we will devote this space to a series of articles that if followed diligently will go a very long way toward a thorough understanding of the subject of mathematics. We are indebted to J. E. Smith of the National Radio Institute for this series.—EDITOR.

It is the purpose of these papers to show the practical applications of mathematics in radio, and to show how the algebra, geometry and calculus play such an essential part in its design. After noting how one can use mathematics in radio, it will give a new life and interest to furthering the studies of such an important subject.

Using Arithmetic in Radio

Dealing in numbers requires at first a good deal of mental exertion, and we must guard against the possibility of becoming discouraged with its progress. Such work is necessary to overcome the mental laziness of our minds, and it soon becomes apparent that progress is being made with less effort as we acquire periodic practice. Straight arithmetic is sometimes bothersome and a review now

and then of the important rules to consider, the practical limitations involved, and a few short cuts toward the answer will be helpful.

Column Addition

Where it becomes necessary to add large columns of numbers, it is found that a double check is essential to insure the right answer. Large and cumbersome additions are always encountered where an average data must be obtained.

Take the column of figures shown below, train the mind to work with the minimum of exertion and commencing at the top with the right-hand column, do not mentally repeat "6 and 8 are 14, plus 7 are 21, plus 6 are 27," etc., but merely state their sums as follows: 6, 14, 21, 27, 36, etc. It is best not to carry over the figures from one column to another, but put down the respective sums as shown. A good check is made by commencing with the left-hand column or adding the first column as indicated and putting down the sums of the respective columns as shown.

4826	
2958	
8277	
3936	
5729	
9127	
6344	
7413	
1662	
<hr/>	
52	45
32	49
49	32
45	52
<hr/>	
50272	50272

In order to gain practice in addition, do the following examples, check the results and occasionally come back to these exercises in order to keep the mind active in preparation for the higher mathematics.

3842	4139	53296	4257
4136	3146	19387	9316
6812	9357	23845	8297
9134	2879	72981	5489
5273	5764	68346	2568
7291	3192	71291	4697
8537	8653	36572	3963

(Continued on page 544)

Will you be one of the 800,000 who will die this year of preventable disease?

OF the hundreds of thousands who die from respiratory diseases, bronchitis, pneumonia, kidney diseases, tuberculosis, influenza, and intestinal disorders, a large portion would not have died if they had been able to recognize early symptoms and had known how to treat themselves.

Nature always warns of impending sickness. The occasional headache, that tired, exhausted feeling, loss of appetite, a casual cold and other slight disarrangements are Nature's warnings to you that your body isn't functioning properly or that you are not living and eating correctly.

You can rule your health just as surely as you can rule your actions. If you are not enjoying perfect health today it is because you haven't enjoyed the method provided by Nature to keep you well. If you don't know what her requirements are, you are sure to blunder into some kind of sickness—perhaps fatal disease.

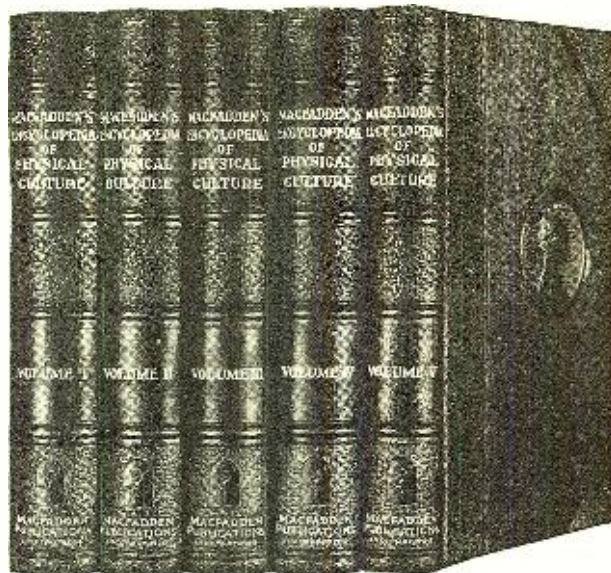

ENCYCLOPEDIA of PHYSICAL CULTURE New 8th Edition ~ Completely Revised

EVERY year more than ten thousand people die of bronchitis, sixty-four thousand die of pneumonia, seventy-five thousand die of kidney trouble, fifty thousand die of respiratory disease, one hundred and six thousand die of tuberculosis, approximately eighty-five thousand die of influenza, and more than ten thousand die of intestinal trouble.

Barring accidents and suicides, only a small percentage of these thousands should die.

It is a fact that only about one person out of three enjoys good health. And those who are physically a little "Off" right now, will more than likely be the ones to succumb to preventable diseases this year. And they are the ones who should not die.

Nature is constantly warning you of impending sickness. Seemingly trivial symptoms tell of serious trouble taking root in your body. And yet, ninety-nine people out of every hundred will absolutely ignore these danger signals. As long as they are not flat on their backs, they will fool themselves into believing that they are all right.

Nature is merciless. If you do not understand her laws and her methods of preventing and curing sickness, you suffer. She knows no excuse—she accepts no apologies.

The Average Person Pays Thousands of Dollars in Doctors' Bills

Those who do not know Nature's methods of preventing and curing sickness are ill an average of 21½ days each year. In fact, it is estimated that the average person in a lifetime spends \$4,100 on doctor and hospital bills, loss of time from business, medicine and other expenses due to illness. Thousands of people are living half-powered lives because they are ignorant of the laws of Nature. Many of these people will fill an early grave, when they might easily have lived to enjoy a ripe old age.

What would it be worth to you to be able

to instantly identify in its earliest stages any sickness or disease that might overtake you or any member of your family? To enjoy perfect health, almost complete freedom from sickness, doctor and hospital bills, and no days of suffering and worry, or salary lost through sickness?

How to—

possess exhilarating health every day in the year

- know your own body
 - eat for health
 - diet for the cure of disease
 - know the art of food preparation
 - build a powerful physique
 - correct physical imperfections
 - become a physical director
 - avoid unhappy marriages
 - avoid disease
 - fast as a curative measure
 - cure by hydropathy (heal by the use of water)
 - apply all methods of drugless healing
 - give first aid in emergencies
 - apply home treatment for disease
 - recognize diseases by manifestations
 - build nervous energy
 - treat the common form of disease
 - understand the process of reproduction
 - benefit by laws of sex and marriage
 - treat diseases of women
 - diagnose diseases
 - have healthy and vigorous children
 - treat female disorders
 - treat male disorders
 - obtain virility and manhood
 - care for the complexion
 - manicure; care for the hair and feet
 - cultivate the mind—
- These are only a few of the matters explained in the Encyclopedia.

The Encyclopedia of Physical Culture (8th Edition—Greater Than Ever Before)

This marvelous 5-volume work gives you the information you need to build up rugged strength, health and vitality. It is for every member of the family—it covers every phase of strength and body building for adults, children and babies. It gives invaluable information on fasting, dieting and exercise. A thorough and extensive treatment

is given of the laws of sex, the attainment of virile manhood and womanhood, and happy, successful parenthood, together with details for diagnosis and treatment of all sexual diseases. Handsomely illustrated charts on anatomy and physiology are scattered throughout the book.

It is neither dull nor technical, but is simple, comprehensive and complete in every sense. It is the crowning effort of Bernard Macfadden's rich, full experience in the science of health and physical culture. He has had more than thirty years' experience in guiding thousands of physical wrecks to glorious health and vigor. Out of that experience he built his Encyclopedia of Physical Culture.

Seven big editions of this popular work have been exhausted. And now the eighth edition—greatest of all—has just come off the press. This edition has been completely revised at great expense. Scores of new illustrations have been inserted. The binding has been changed to a beautiful all Fabricoid, more durable than leather. Altogether it is the finest edition of the Encyclopedia ever issued.

10 Days' Free Examination of Entire Set—No Money Needed

This is the most liberal offer we have ever made on the Encyclopedia—10 days' examination of the entire set at no expense to you. There is no money needed—no deposit to pay. Just fill in the coupon and we will send the five volumes to you, all shipping charges prepaid, for your inspection.

Take ten days to examine the set. Then, if you decide to purchase, send us only \$2.00 as your first payment. Additional payments may be made at the rate of only \$3.00 a month until the total cost of \$35.00 has been paid.

If you care to pay cash you may do so by sending us only \$31.50. This represents a 10 per cent discount.

If you purchase the set at once we will include, without extra charge, a one year's subscription to PHYSICAL CULTURE Magazine.

Remember, no money now, and no obligation to purchase. You simply agree to return the books at the end of ten days in case you decide not to keep them.

Macfadden Book Company, Inc.
Depts. RN-12, Macfadden Building,
1926 Broadway, New York City.

SPECIAL

Send me on 10 days' inspection the five volumes of the Encyclopedia of Physical Culture. If I find the set satisfactory I will either send \$2.00 in ten days and \$3.00 a month until \$35.00 has been paid, or \$31.50 cash. If I decide not to keep the books I will return them in 10 days postpaid.
Foreign orders—cash in advance.

Name.....
Occupation.....
Residence.....
Employed at.....
Business Address.....
I understand that this price includes a subscription to Physical Culture Magazine for one year.

An increase in price is planned. This increase will be substantial and will be announced within a short time. So, it is suggested that all who wish to take advantage of the present low price, order their sets before the increase takes place.

Junior Radio Guild

(Continued from page 542)

Multiplication

There are numerous cases where a number is multiplied by a $\frac{1}{2}$, a $\frac{1}{4}$, and $\frac{3}{4}$, and where a percentage of a number is required.

(A) To multiply by .5—

In order to multiply a number by .5, divide the number by 2. This is self-evident, as .5 is the same as $\frac{5}{10}$, which is equal to $\frac{1}{2}$. If the number is 15, we see that $15 \times \frac{1}{2}$ is the same as $15 \times \frac{1}{2}$, which becomes 7.5.

(B) To multiply by .05—

In order to multiply a number by .05, move the decimal point of the number one place to the left and divide by 2. Take the case where 5% of a number is required. Now 5% is expressed as $\frac{5}{100}$ of a number, which becomes in decimals .05. If the number is 15, move the decimal point of the number one place to the left, which gives 1.5 and divide by 2, obtaining .75.

(C) To multiply by 25—

In order to multiply any number by 25, add two ciphers to the number and divide by 4. Thus, if the number is 264 to be multiplied by 25, it is seen that considerable figuring would be necessary by multiplying out. But by adding two ciphers which gives 26,400 and dividing by 4, we quickly obtain the answer as 6,600. It is seen that we have the liberty to divide by 4, for it is remembered that 25 is $\frac{1}{4}$ of a hundred.

(D) To multiply by 75—

In order to multiply any number by 75, add two ciphers to the number, divide by 4 and then multiply the result by 3. Take the number 264 to be multiplied by 75. Applying the rule, we have 26,400, divided by 4 equals 6600 and multiplied by 3 becomes 19,800.

(E) To divide any number by 25—

In order to divide any number by 25, move the decimal point two places to the left, and multiply by 4. Taking the number 2640, moving the decimal two places to the left gives 26.40 times 4, equals 105.6.

Position of Decimal Point

It is not unusual for most of us to become somewhat confused and mistaken in the position of the decimal point when we are multiplying and dividing numbers. This is of common occurrence and probably the best method of determining the position of the decimal is by inspection.

(A) Inspection in multiplication—

Consider 3856×4.414 : Inspection will show that the answer will contain five significant figures, for the answer will be a little more than 4 times 3856. Thus, 3856×4.414 gives 17,030.

Consider 3856×441.4 : Think of the number as being multiplied by 4 with the decimal moved two places to the right. Then, the number multiplied by 4 will give five significant figures, plus two ciphers which will give the answer in 7 places. Thus, 3856×441.4 gives 1,703,000.

Consider $3856 \times .0004414$: Think of the number as being multiplied by 4 with the decimal moved 4 places to the left. Then the number multiplied by 4 will give five figures, but with the decimal moved 4 places to the left which will give the answer with 1 significant figure. Thus, $3856 \times .0004414$ equals 1.703.

(B) Inspection in division—

Consider the fraction $\frac{3856}{4414}$: Think of the denominator 4414 as having the decimal after the first figure. Then, move the decimal point in the numerator the same number of places in the same direction. Inspection easily shows the decimal point in the answer. Thus, making the above operations we think of the denominator as having the decimal after the first figure, thus 4.414, and then moving the decimal point in the numerator three places in the same direction, we have $.0003856/4.414$, where we see that 4 will go into the numerator about .00009. The correct answer being .0000874.

Consider the fraction $\frac{38.56}{.0004414}$: We have, by placing the decimal mentally in its proper place, $385600/4.414$, where we see that 4 will go into the numerator about 90,000. The correct answer being 87,400.

Examples

As an aid in applying the above rules, do mentally the following examples without using pencil and paper.

(A) Multiply by $\frac{1}{2}$ the following numbers:

106	5030	10.86	108.4	.112	.016
14	2750	38.94	941.7	.538	.007
808	4987	76.75	310.4	.999	.059
76	2684	60.26	518.5	.413	.098

(B) Multiply by .05 the following numbers:

308	3068	15.76	760.4	1.076	.025
936	9347	89.87	859.3	.897	.698
867	8512	36.05	643.7	.972	.097
49	9115	90.07	919.8	5.643	.005

(C) Take 5% of the following numbers:

5.	23	563	1050	15.8	.19
7.5	65	496	311	29.75	.058
15.	108	387	843	5.3	.779
2.5	33	95	612	26.45	.0085

(D) Multiply the following numbers by 25:

16	111	15.8	1236	2.95	.057
67	556	91.7	8940	.870	.93
32	310	26.55	3271	.653	.007
98	890	9.67	8765	.015	.193

(E) Multiply the following numbers by 75:

6.8	15.	5.	65.	100	.4
7.0	38.	32.	30.	350	.016
9.2	67.3	3.4	85.	664	.004
3.7	23.	.5	9.6	710	.8

(F) Inspect the following examples in multiplication for the position of the decimal point and show the number of significant figures the answer will contain. Remember the rule that it is well to consider the decimal after the first significant figure and move the cipher to the corresponding positions right or left.

35 x 2	103 x 6	1141 x 515
43 x 5	915 x 3	2730 x 318
16 x 3.1	436 x 21	7116 x 6.3
72 x 53	585 x 46	8990 x 25.6
93 x 89	398 x 27	9157 x 38.7
	10 x .3	.5 x .03
	215 x .67	.78 x .05
	335 x .061	1.51 x .3
	597 x .035	8.9 x .006
	1061 x .008	55 x .0004

(G) Inspect the following examples in division for the position of the decimal point and show the number of significant figures the answer will contain. Remember the rule that it is well to consider the decimal after the first significant figure in the denominator and move correspondingly the decimal in the numerator in the same direction.

105 ÷ 3	336 ÷ 6	531 ÷ 9	12 ÷ .3
.56 ÷ 8	.144 ÷ 1.2	1.96 ÷ .14	.025 ÷ .05
64 ÷ 8	49 ÷ .07	121 ÷ 1.1	
.0072 ÷ 9	225 ÷ .0015	1036 ÷ .04	

Show in the following examples the approximate number of significant figures in the answer:

51.36	3146	3.1416	981	1181
5.6	.067	518	.007	15006
.256	.189	.0589	.901	.005
.03	56.4	91.6	1.68	10.3

(The second article of this series will appear in the next issue.)

Commission Now Licensing "Hams"

LICENSING of all of the 17,000 or more amateur radio stations in the United States has been taken over by the Federal Radio Commission from the Radio Division of the Department of Commerce, which has issued such licenses since "ham" radio began before the war.

The fact that all amateur licenses will hereafter be issued by the Commission is

seen by many as another step toward an eventual fusion of the radio services of the Department of Commerce into the Commission. Such a move has been proposed in Congress, and more recently was endorsed by the Radio Manufacturers Association as a logical preliminary to the proposed establishment of a federal communications commission.

By taking over amateur licensing, the Federal Radio Commission is now the licensing authority over all classes of radio stations under the American flag. Amateur licenses are issued for periods of one year to bona fide citizens properly qualified in tests which will continue to be given through district offices of the Dept. of Commerce Radio Division.

The Giant with the Velvet Voice!

No Adjustment Arguments

ALL adjustment arguments . . . all unfair replacement claims are checked with Champion Ribbon Labels. Date of purchase, written in at time of sale, establishes a definite service, equitable alike to you and your customer. Champion Radio Tubes are factory-checked before they reach you. Power . . . long life . . . and perfect performance are established by the most exacting tests possible. Make your customer guarantee as strong as you want to . . . we stand behind every Champion Tube!



Champion

RADIO TUBES

CHAMPION RADIO WORKS, INC., 1190 Pine Street, DanVers, Mass.

4 Radio Books at Magazine Price or FREE with RADIO NEWS!

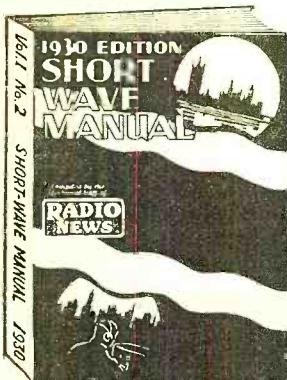

NEW SHORT WAVE MANUAL

Experience the thrills of the Short Waves—of hearing Europe, Africa or Australia direct as clearly as native stations. This big book, replete with illustrations and How-to-Build diagrams and plans, crowded with 28 chapters by Lieut. Wenstrom, Marshall, Spangenberg and other foremost S-W authorities, represents the last word in authentic S-W data. The most complete up-to-the-minute short wave manual ever published. Brings you more information than books selling at ten times its price. Shipped, prepaid, to your home for only **50c**

RADIO AMATEURS' HANDBOOK

Sometimes called the Radio Amateurs' Bible. 30 profusely illustrated chapters bring you 10 How-to-Build articles, with complete instructions and diagrams; new radio wrinkles, DX hints, data on the new tubes, answers to AC problems, and helpful, money-saving ideas for the radio service man. 96 illustrated pages. Large 9 by 12-inch size. Beautiful colored cover. Shipped, prepaid, to your home for only **50c**

RADIO TROUBLE FINDER & SERVICE MANUAL

Ever have your radio reception fail or become distorted just when a big program was on and you wanted to hear every delicate inflection of tone distinctly? That's when this big, new book is worth its weight in gold. In simple words and easy to understand charts and pictures, it shows you how to find and correct any radio trouble quickly. Just the book you need for improving the reception of your set, or for starting a profitable repair business of your own. Shipped, prepaid, to your home for only **50c**

1001 RADIO QUESTIONS and ANSWERS

If you own a radio, you need this book. Everything you want to know about radio is in it, from "How to Kill Outside Radio Noises," to a clear description of the newest tubes and how to use them. If you have a question on radio, here is your answer and a thousand more. 96 illustrated pages. Large 9 by 12-inch size. Beautiful colored cover. Shipped, prepaid, to your home for only **50c**

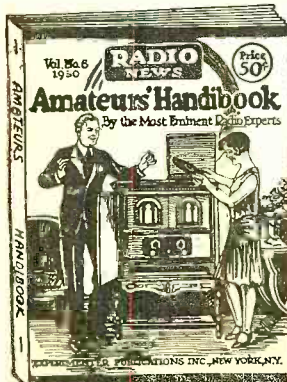

Clip and Mail TODAY!

Radio-Science Publications, Inc.
Dept. 2412, 381 Fourth Ave., New York, N. Y.
Gentlemen: Please ship me postpaid the Radio Books I have checked below. Remittance is enclosed.
 New Short Wave Manual Amateurs' Handbook
 Radio Trouble Finder and Service Manual 1001 Questions & Answers

Name
Address
City and State

FREE!

You may have any one of the above Radio Books ENTIRELY FREE with RADIO NEWS at a reduced price. To accept this offer check square below.

Ship me ENTIRELY FREE the Radio Book I have checked above and enter my subscription for the next eleven big issues of RADIO NEWS at the special price of only \$2, which I enclose. (Regular newsstand price of RADIO NEWS \$2.75.)



Watch
For The
First Announcement
OF A DISTINCTIVE
SELLING FEATURE..

**LIFE-LIKE
TONE** in the

SATURDAY

EVENING POST

and COLLIER'S WEEKLY

CLEAR, brilliant reproduction... that's the kind of performance you get with the *Life-like Tone* of Arcturus Blue Tubes.

We are telling radio set owners how to get it in a new series of unique advertisements. The opening "shot" appears in *The Saturday Evening Post* of November 1st, and *Collier's Weekly* of November 15th.

Radio tube buyers in your community, prospective customers of your store, will see and read these interesting advertisements. Be ready to get the extra profits that *Life-like Tone* can bring. Sell Arcturus Blue Tubes, "The Tube with the *Life-like Tone*." See your jobber, or write us for unusual Arcturus Facts. Arcturus Radio Tube Company, Newark, N. J.



THIS INDESTRUCTIBLE CARTON contains a complete set of Arcturus Blue Tubes ready for delivery with any radio receiver you sell—with the assurance that the tubes cannot be damaged in transit. The kits are easily identified by the black and blue design, similar to the well known Arcturus Tube Carton. Ask your jobber for the details of this attractive Arcturus plan.

**ARCTURUS
TUBES**

The **TUBE** with the **LIFE-LIKE TONE**

How to Build the Audio-Scope

(Continued from page 525)

has been removed and turned around to show the two neon lamps and the shield separating them. The slots in the cover, are, of course, to view the disc through. This especially designed rotating disc, which when viewed by the flashlight for reading the applied frequency directly in cycles, appears as a confused jumble in the photograph, but is shown in detail in Fig. 4. Fig. 1 is an assembly sketch of the few parts required for the audio-scope. It will be seen that the disc (1) is placed on a turntable (2) which is driven by a variable speed electric motor (3). The electric cord (4) supplies the motor and also the 60-cycle speed-regulating lamp (5), which indicates the proper setting of the governor control arm (6). The frequency indicating lamp (7) is lighted by the audio-frequency osc-

illator which is being calibrated (8). A shield (9) is so placed that the frequency indicating lamp illuminates about one-half of the disc, while the other half is lighted by the 60-cycle speed-regulating lamp. As will be seen from the photographs, the audio-scope was built into an especially designed box. The sliding cover, which may be removed to renew the neon lamps, serves to keep all extraneous light off the disc.

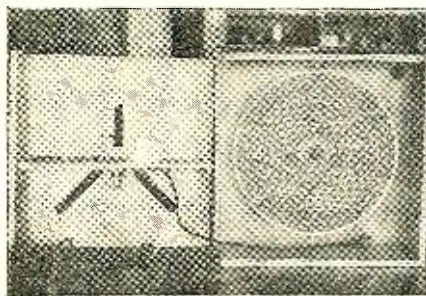

The above shows the audio-scope disc mounted in its frame

we realize that the 45 lines are 360/45 or 8° apart. Now it is easy to understand—in between flashes of light the line "a" has moved up 8° so that it is *exactly* where line "b" was at the time of the last flash. Line "b" in turn has replaced line "c" and so on. In other words, these 45 lines appear to stand still because, with every flash of the light they are actually turning ahead just the distance between lines. One might believe that the lines would appear to flicker instead of appearing stationary, but due to the phenomenon known as "persistence of vision" the eye keeps on "seeing" an object for about a tenth of a second after the object looked at has gone (unless another source of light comes within the field of vision). Thus before the eye has stopped "seeing" one line, a second line has replaced it and so the "seeing" of the line is not interrupted.

The above is, as was stated, on the assumption that the disc is rotating exactly 80 r.p.m. It is evident, therefore, that if the speed is not exactly 80 r.p.m. the lines will not appear to be stationary but (as might be inferred from Lord Rayleigh's explanation) will appear to rotate faster as the actual speed of rotation differs more and more from the desired speed. Therefore, we may, by adjusting the speed control of the motor until the lines are stationary, obtain a speed of 80 r.p.m., which is constantly checked by the 60-cycle lamp.

So much for the method of keeping the disc at a constant speed—now let's figure out how the offset numerals "3" and "2" manage to appear as a stationary figure "32" when the lamp lit by the audio-frequency oscillator is flashing 32 times a second.

(We must not neglect to keep in mind the fact that different lamps are used to regulate the speed and to read the oscillator frequency.) If we count the numerals we find twelve "3's" and an equal number of "2's". This means that the "3's" are 360/12 or 30° apart and with the "2's" in between we have either a "3" or a "2" every 15°. Next thing is, how far do these numerals move between light flashes? We have previously figured out that the disc is traveling 80 × 360/60 or 480° per second, this gives 480/32 or 15° of rotation between flashes. With the numerals 15° apart on the disc, and the disc rotating 15° between flashes, the action is obvious:—At one flash of the light we see a "3"—during the next 1/32 of a second the disc travels 15°, bringing a "2" alongside of the position where we viewed the "3". We see this "2" at the next flash. And so on, alternately viewing "3's" and "2's". However, owing to the fact, as mentioned before, that the eye has the power of "persistence of vision" the "3's" and "2's" appear to be seen together in the form of a "32".

The same reasoning applies to the "4" and "0" uniting to form a "40", the "4" and "8" to form a "48", etc.

Undoubtedly many readers are still
(Continued on page 547)

illator which is being calibrated (8). A shield (9) is so placed that the frequency indicating lamp illuminates about one-half of the disc, while the other half is lighted by the 60-cycle speed-regulating lamp. As will be seen from the photographs, the audio-scope was built into an especially designed box. The sliding cover, which may be removed to renew the neon lamps, serves to keep all extraneous light off the disc.

Obviously, the multi-numeraled disc is the heart of the instrument and hence a detailed explanation of it is in order. Perhaps the most logical starting point for this discussion would be a description of how the 60-cycle a.c. is used as the reference frequency. If we refer to the diagram of the disc, Fig. 2, we will find forty-five radial lines in the center of the disc. When in use these lines are illuminated by a neon lamp powered from the 60-cycle lines and hence flashing sixty times a second. The disc is turning at the rate of 80 r.p.m. Now how would these lines appear to an observer? Actually they appear stationary. Why? Well, let's figure it out. Let's see how far any line moves in between flashes of the lamp. The lamp we already know flashes 60 times a second, so we want to know how far the line travels in a 60th of a second. Since it travels 80 r.p.m. it must go 80 × 360 degrees per minute, or 80 × 360/60 degrees per second. Dividing this 480 d.p.s. by 60 we get the answer as 8° every 60th of a second. But that alone does not mean much until

Build the Audio-Scope

(Continued from page 546)

wondering why the figures on the disc are split into offset numerals instead of being written as a figure normally would be. Why the "3" and "2" are on the disc as "3₂" instead of "32", etc. This is a feature easier to demonstrate than explain. However, if the numerals were arranged as "32" they would, of course, appear stationary when viewed with the light flashing 32 times a second—but they would also appear stationary at multiples and submultiples of this frequency—at 64 cycles, 16 cycles, etc.). The stationary image formed by the 64 cycles harmonic would not be confused with the image formed by the 32 cycles, fundamental as the figures would appear to overlap due to the light flashing twice instead of once while the disc was turning through the angle separating two sets of "32's". The "32's" would then appear to be only half as far apart from center to center as they actually are. And as the numerals are made large enough to occupy about 2/3 of the allotted space for each number the doubling causes the numbers to overlap, thus making it impossible to confuse the appearance of the disc at 54 cycles with the way it looks at 32 cycles. However, no such distinction occurs at the submultiples of the fundamental frequency. That is, if the "3" and the "2" are placed on the disc as "32" they will appear exactly the same when viewed by a light flashing 16 times a second as when viewed by a 32-cycle light. True, the disc will rotate twice as far between flashes, but that will only mean that the second number in back of the one seen at one flash moves up and is seen by the next flash. There is then no doubling up or changing of the numbers at sub-multiples. Quite obviously, therefore, a disc with the thirty-two and sixty-four placed as "32" and "64" could not be used. By way of illustration;—at 64 the "64" would appear stationary and in its actual separation with the "32" appearing stationary and overlapping. So far so good: for that is as it should be. However, at 32 cycles complications would start; at this frequency both "32" and "64" would appear stationary and not overlapping, the operator would not know which to believe. And at 16 cycles (yes, a good oscillator will give a steady 16-cycle note) the situation is even worse—both "32" and "64" would appear stationary and not overlapping; and neither would be right! The solution of the problem that really makes the audio-scope possible is the splitting of the figures by putting the numerals down alternately as "3₂" instead of as "32".

Now consider the pattern "3₂". Since it takes up twice the space allotted for the simple 32-cycle figure it will appear stationary at 16 cycles (since the disc must travel twice as far between flashes). Of course, at the harmonic—32 cycles—this pattern will double and what is the result? It reads "3₂³²" which is entirely correct,—at 8 cycles (assuming one can hold the oscillator constant at that frequency) it would, of course, appear

(Continued on page 548)

AMERTRAN POWER AMPLIFIERS

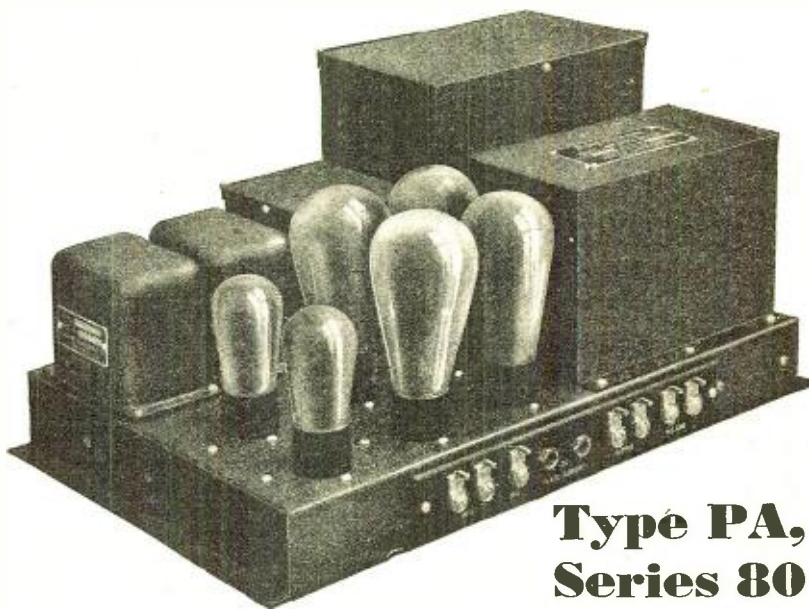

**Type PA,
Series 80**

An economical means of obtaining flawless reproduction of sound in large volume is available in a new series of Amertran Power Amplifiers, the result of months of laboratory experimentation and exhaustive field tests.

There are four sizes in the new Series 80, one to fill every requirement. The big Type PA-86, shown in the illustration, will flood an auditorium with a full volume of music or speech without distortion. Smaller models are made for installations in restaurants, clubs, dance halls, schools and homes—wherever exceptional fidelity of reproduction at high volume is desired.

The mounting and construction is such that they are installed easily, with no bothersome wiring and connections, and are proof against tampering or damage. Simple controls and ease of portability are added features that contribute to the popularity of Amertran Power Amplifiers whose record of performance has won the distinction of being considered The Standard of Excellence for Audio Reproduction.

Licensed under patents of R.C.A. and Associated Companies

**AMERICAN
TRANSFORMER COMPANY**
178 Emmet Street Newark, N. J.



For complete description and information contained in Bulletin 1079 send us the coupon below:

AMERICAN TRANSFORMER COMPANY
178 Emmet Street, Newark, N. J.

HN 12-30

Gentlemen: Send me Bulletin 1079 with complete description of Type PA, Series 80 Amertran Power Amplifiers.

Name

Street

City and State

How to Build the Audio-Scope

(Continued from page 547)

the same as at 16 cycles (the fundamental for the pattern) but no one is going to confuse "32" with "64", so the difficulty is eliminated. To again use the illustration of thirty-two and sixty-four cycles—at 64 cycles the pattern "32" would be twice doubled, so a stationary but overlapping "32" would be seen—however, the pattern "64" would only be once doubled and would appear stationary as "64"—at 32 cycles the "32" being once doubled would appear as "32" but "64" being viewed by the fundamental for that pattern would appear as "64"—and at the 16-cycle the "32" pattern being viewed at its fundamental and the 42 pattern at half its fundamental they will both appear as they are on the disc "32" and "64". This situation, of course, applies equally well to all the frequencies indicated on the disc.

A secondary advantage of the "offset" numbers has probably become evident to most—though space on the disc limits the number of frequencies which it may be used to indicate by direct-reading, the appearance of the staggered patterns at half the indicated frequency and the overlapping figures at twice the frequency may very handily be used to increase the actual number of points which may be accurately determined.

To recapitulate—the figures appear stationary only at the indicated frequency (f), at multiples of that frequency (Nf), at sub-multiples (f/N), and in a few cases, at simple fractions of the fundamental (Nf/n). However, *only* at the fundamental itself (f) is the indicating figure clear, complete and not overlapped. At multiples 2f, 3f, etc., the figures overlap. At sub-multiples such as f/2, f/4, etc., the figures are incomplete—that is, the numerals are staggered. At f/3 and f/6 the figures will actually appear stationary and in line, the same as they do at the fundamental, but due to the lessened amount of light and other factors there is no chance of confusing these readings.

Perhaps it would be well to give the method used in laying out these figures on the disc. Radial lines were first laid out as shown in Fig. 2 and the numerals placed on the lines so that in the following derivation the distance between lines may be interpreted as meaning the distance between numerals. It will readily be understood from the previous discussion that the spacing of the lines (or numerals) on a stroboscope disc should, for clearest image, be such that the distance between lines (in degrees of arc) is equal to the distance moved through (in degrees of arc) by the disc during the interval between flashes of light. That is, if the light is flashing f times a second and the disc is rotating a speed of w° per second the lines should have an angular

separation d of $\frac{w^\circ}{f}$ and the disc will have on it $\frac{360}{d}$ or $\frac{360}{w/f}$ lines. For a disc rotating at a given number of revolutions per minute R we have $w = \frac{360 \times R}{60} =$

$6 R^\circ$ per second. Therefore, the angle between the lines is $d = w/f = \frac{6R}{f}$.

Hence the expression for the number of lines (n) on the disc for a given frequency (f) and a given number of revolutions per minute (R) is $n = \frac{360}{d} = \frac{360}{w/f} = \frac{360}{6R/f} = \frac{60f}{R}$.

Obviously any convenient speed of rotating the disc may be used. For low frequency indicators, such as the one described, it is practical to use a phonograph turntable (driven by a variable speed electric motor) with the speed adjusted to 80 r.p.m. by the method previously related. Or a good synchronous motor may be used and the 60-cycle speed control lamp dispensed with.

On the bias of 80 r.p.m. the following table of values for n and d was calculated from the above formulae:

Frequency (f)	No. of radial lines on disc (n)	Angle between lines (d)
32	24	15
40	30	12
48	36	10
60	45	8
64	48	7½
80	60	6
96	72	5
112	82	4 2/7
128	96	3¾

Fig. 2 also shows the important points to consider when laying out the disc. The size of the numerals must be so chosen that the width of any numeral is less than half the width of the compartment in which it lies (that is $w < \frac{w}{2}$); and the

height of any numeral must be more than half the height of the compartment it is in (that is $h > \frac{h}{2}$). It is evident that the

numerals must be so placed that the size, shape and position in the compartment of all corresponding numerals will be identical. Care in laying out the disc is absolutely essential to the success of the audioscope; hence, it should be done by a competent draftsman if possible.

The use of either rubber stamps or stencils may facilitate the construction of the disc if the job cannot be turned over to a draftsman. Making a negative photostat of the disc is helpful as it is much easier to read white-on-black figures than it is black-on-white.

No human instrument is perfect—and accordingly the audio-scope may present certain difficulties. Assuming the disc to be accurately laid out, the motor to be smooth running and evenly controlled, and the lamp powered by an oscillator that does not drift excessively there is one source of possible—or probable—trouble which may cause considerable difficulty. This is the tendency of a glow-

(Continued on page 550)

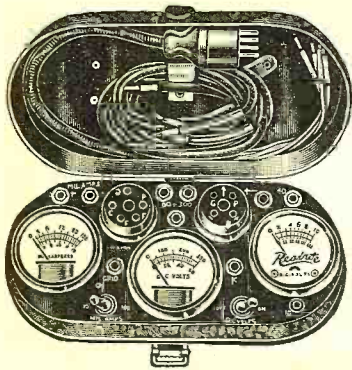

No. 245-A

Set and Tube Tester

More service men use the No. 245-A tester because it does all necessary field work, is dependable, rugged and most compact. Simple to use. A complete tester for checking all voltages at the socket, also line voltage. Tests all usual tubes. Complete illustrated instructions.

\$12 NET to No. 245-A Dealer No. 400 \$20 List Each At Your Jobber's

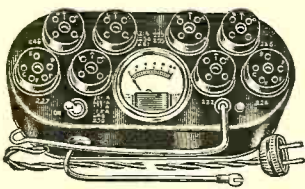

No. 400

Counter Tube Tester

For testing tubes direct from A.C. supply. Simple to use. Gives the required test for accurately determining the condition of all tubes. Attractive baked enamel finish. Full instructions.

Ohmmeters and other radio instruments in our new catalog.

Readrite Meter Works

Established 1904

19 College Ave. Bluffton, Ohio

The Unit-Built Receiver

(Continued from page 508)

band-pass filter and to the use of low-loss insulating material in all the variable condensers. These features also improve the fidelity. The sensitivity is also increased by the low-loss condenser construction and by the use of the screen-grid detector which is some ten times more sensitive than the -27.

What will the receiver do on the air? An automobile manufacturer always puts his new car on a road test to determine how fast it will go, how quickly it can be stopped, how long it will run without falling apart, and other tests more severe than it will be given by its ultimate user. In much the same manner the Hi-Q 31 receiver has been laboratory tested under conditions much more severe than it will ever experience in use. In all cases it has been found to be sensitive enough to go down below the noise level—in all localities where it has been tested it has been found to be sensitive enough to receive any station that was above the noise level. At a location some eight or ten miles from WEAf with 50 k.w. in the antenna this station could be tuned out in about two divisions on the dial. Chicago stations were received very loud. Stations throughout the east and south were easily tuned-in. All in all the receiver performed in very excellent fashion.

The Hi-Q 31 receiver is available in a number of different kits. The tuners include the resistance-coupled first stage audio amplifier required for proper operation of the screen-grid detector. External power amplifiers connect to the output of this first stage. A complete list of parts for the construction of the complete a.c. receiver is given below. This list assumes the use of the special Hi-Q loud speaker. If some other type of loud speaker is used an additional choke and plug are required as explained in the preceding text.

List of Parts

- 1 Hammarlund three-stage band filter unit, BS-31.
- 1 Hammarlund three-stage screen-grid r.f. amplifier unit, RF-31.
- 1 Hammarlund knob-control drum dial, SD.
- 2 Hammarlund shielded polarized r.f. chokes, SPC.
- 1 Hammarlund push-pull input transformer, AF-1.
- 1 Hammarlund push-pull output transformer, AF-D.
- 1 Hammarlund power transformer, PT-60.
- 1 Hammarlund filter choke—100 mils., C-100.
- 4 Hammarlund tube shields, TS.
- 1 Hammarlund foundation unit, FU-31.
- 1 filter condenser block, CHQ-31.
- 3 triple by-pass condensers, BP-3.
- 1 special by-pass condenser, 1/2 mfd., 200 volts, BP-12.
- 1 1-mfd. by-pass condenser, 200 volts, BP-1.
- 1 1/10-mfd. by-pass condenser, 300 volts, BP-110.
- 1 20-mfd. by-pass condenser, electrolytic type, BP-20.
- 1 voltage divider, RHQ-31.
- 1 center-tapped resistor, 10 ohms.

(Continued on page 551)

Be a Radio Expert

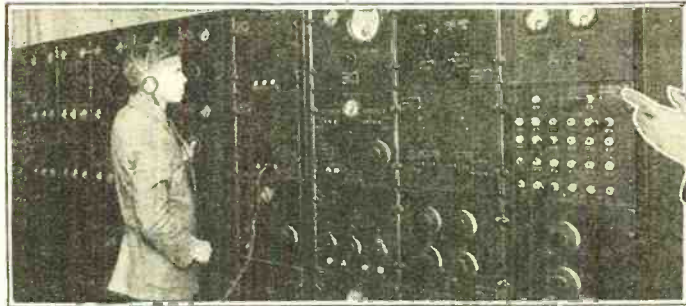

J. E. Smith
Pres.

I've trained hundreds of fellows at home in their spare time for Big Pay Radio Jobs.

Look at These Earnings

Has Made \$10,000 More in Radio



"I can safely say that I have made \$10,000 more in Radio than I would have made if I had continued at the old job. When I enrolled with you I didn't know a volt from an ampere. I advise all ambitious young men to get into Radio. There is no greater opportunity."

Victor L. Osgood,
7101 Bay Parkway,
Brooklyn, N. Y.

Over \$400 Monthly
"I had 15 years as traveling salesman and was making good money, but could see the opportunities in Radio. Believe me I have made more money than I ever did before. I have made more than \$400 each month. I can't say too much for your school."

J. G. Dahlstead,
1484 So. 15th St.,
Salt Lake City, Utah.

Made \$700 in 5 Months Spare Time

"Although I have had little time to devote to Radio, my spare time earnings for five months after graduation were approximately \$700 on radio sales, service and repairs. I owe this extra money to your help and interest."

Charles W. Linsey,
537 Elati St.,
Denver, Colo.



RADIO'S amazing growth is making hundreds of big-pay jobs every year. Trained men are needed. You young ambitious men starting out who are looking around for something really good and you older men who aren't satisfied but want more money—here's a field that is growing fast enough to bring success in a year or two. I have doubled, tripled, quadrupled the salaries of men in one year. My book points out the many jobs in Radio. Clip the coupon. Get a copy now. Why be satisfied with anything less than \$50 to \$250 a week when that's what Radio pays its good men?

So Many Opportunities Many Begin Making \$10 to \$30 a Week Extra Almost at Once

You don't have to wait one year, two years, not even six months to begin getting the extra money you want. I'll show you the plans and ideas that are making \$10, \$20 and \$30 a week extra for my students—show you how to begin doing it too the first month if you study hard and follow my plans. G. W. Page, 1807 21st Ave., S., Nashville, Tenn., made \$935 in his spare time while taking my course. Earle Cummings, 18 Webster St., Haverhill, Mass., writes: "I have made as high as \$375 in one month in my spare time." No need to worry about money; this is the famous course that pays for itself.

Learn at Home

Don't lose a minute from your job. All I ask is part of your spare time. My practical method of training with eight big outfits of Radio parts makes learning at home easy, fascinating, a pleasure. Boys 14, men up to 60 have finished my course successfully. You don't need a high school education. Many of my most successful graduates didn't even finish the grades.

You Must Be Satisfied

The day you enroll I'll give you a contract agreeing to refund every penny of your money upon completing if you are not satisfied with the lessons and instruction service.

Get This Book at ONCE

"Rich Rewards in Radio" shows where the big jobs are, what they pay, what others are making. It has started hundreds of fellows on the road to bigger money who thought success was not for them. Get a copy. Not the slightest obligation. Do it Now.

J. E. SMITH
President
Dept. ONSS
National Radio
Institute
Washington, D. C.

Television and Talking Pictures Included

My course not only gives you a thorough training in Radio—all you need to know to get and hold a good job, but also your choice, without extra charge, of any one of these special courses: Television, Aircraft Radio, Broadcasting, Commercial and Ship Radio Stations, Sound Pictures Systems, and Advanced Radio Servicing and Merchandising. You won't be a "one job" man when you finish my course. You'll know how to handle a job in any one of Radio's 20 different branches of opportunity.

You can build over 100 circuits with the eight big laboratory outfits I give you!

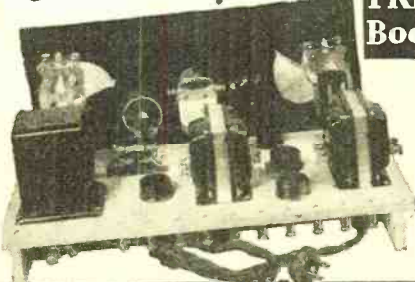

THIS IS RADIO'S BIGGEST YEAR

Get this FREE Book



Mail Coupon NOW

J. E. SMITH, President,
Dept. ONSS, National Radio Institute,
Washington, D. C.

Dear Mr. Smith: Send me your Book "Rich Rewards in Radio." I want to know about the money making opportunities in Radio and your practical method of training men at home. This request does not obligate me and it is understood no salesman will call.

Name.....
Address.....
City.....State.....

New Weston

MODEL 565

The complete
test set for
radio service



THE new Weston Model 565 is the most complete instrument designed for radio service work. It makes every required test on every modern set, and checks every type A.C., D.C., Pentode and Rectifier tubes. Besides, it is made in the typical Weston fashion with the refinements in design, ruggedness in construction, precision in manufacture, and dependability in performance such as only Weston can build with its years of experience as manufacturers of the world's highest quality electrical measuring instruments.

In this one instrument, the Weston Model 565, you have a complete radio service laboratory—Set Tester, Tube Checker, Oscillator, Ohmmeter, A.C. Ammeter, D.C. Milliammeter, A.C. and D.C. Voltmeter, with more and wider ranges than ever before.

The new Weston Model 565 set and tube service unit with its compact construction and complete testing facilities is designed to save you time and money. It operates similarly to the popular Weston Model 547 Set Tester—quickly, conveniently, accurately, and with the widely-known Weston dependability.

So valuable is this new Weston Model 565 that every radio dealer and service man who builds his business prestige on quality service work cannot afford to be without it.

Write today for illustrated folder which gives complete information.

WESTON ELECTRICAL
INSTRUMENT CORPORATION
615 Frelinghuysen Ave. Newark, N. J.



How to Build the Audio-Scope

(Continued from page 548)

lamp when powered by alternating current to flash on both halves of the cycle if the two electrodes are similar and approximately equal in size. The double flashing tends to blur and confuse the images if, as is usually the case, one flash is brighter than its complement. When the two flashes are of equal intensity the audio-scope will read double the frequency being worked with. The most obvious remedy—and the one advised—is to obtain glow-lamps having dissimilar electrodes. Unfortunately, however, the lamp which is easiest to obtain (a standard "Mogul base" lamp rated at 110 volts and retailing for 55c) has similar electrodes and therefore has the tendency to "double flash". Where such a lamp is used the image can be cleared up to a very considerable extent by providing a biasing potential through a high resistance. The exact values used, of course, depend on the operating conditions, hence, no fast rule can be given. However, using the type G-10 lamp fed through a condenser from a -45 tube about 90 volts in series with a 20,000 ohm resistance was found to be satisfactory. The method of applying this biasing potential is clearly shown in Fig. 3. If it is not convenient to use a bias the doubling effect is sometimes re-

duced by putting a choke coil in parallel with the lamp.

Before any precision instrument can be accepted for use in the laboratory something must be known about its accuracy. Obviously the audio-scope, given proper construction and a careful operator will be just as accurate—but no more so than the 60 cycles a.c. which is used as a frequency standard. Consultation with the local Edison load-dispatcher brought out the fact that the "normal variation" (99% of the time) is $\pm 1/20$ of a cycle or less and that the extreme variation is $\pm 3/20$ of a cycle.

This means a maximum error of 4/10 of one per cent. with a nominal accuracy of 99.9%. For all ordinary frequency work below 128 cycles this is sufficient.

Thus we find that the audio-scope takes its place on the shelf of scientific instruments by filling a recognized need—and filling it well. Though easy and inexpensive to construct it is accurate and dependable in operation. This unique combination of simplicity and reliability makes it a device equally adapted to the whims of the scientific curiosity seeker, the needs of the amateur experimenter, or the exacting requirements of the industrial research worker.

New Circuit Developments in "Broadcast Superhet"

(Continued from page 509)

a very appreciable signal in the output of a sensitive receiver. This disadvantage was overcome by not using a coil ahead of the first tube, but rather feeding the signal directly into the tube. The potentiometer used was a tapered, 10,000-ohm, wire-wound job. The resistance should be so tapered that on a powerful local station the signal will not be too great on the first few turns of wire.

The gain lost by the elimination of the antenna coil is easily recovered by tuning the plate circuit of the first tube. The grid circuit is also tuned, and the two circuits coupled together. This coupling is accomplished in two ways. The plate coil of the radio-frequency tube and the

grid coil of the first detector tube are wound on the same form. (The oscillator coil is also wound on this same form, but it does not enter our discussion at the moment.) These two coils are placed one inch apart, with the low potential ends of the coils nearest each other. In this way, inductive coupling exists between the two. Also, the low-potential leads from the two coils are not directly connected together, and are rather connected together, and returned to ground through a .00025 condenser. The reactance of this condenser is thus common to both circuits, and the circuits are capacitatively coupled due to

(Continued on page 553)

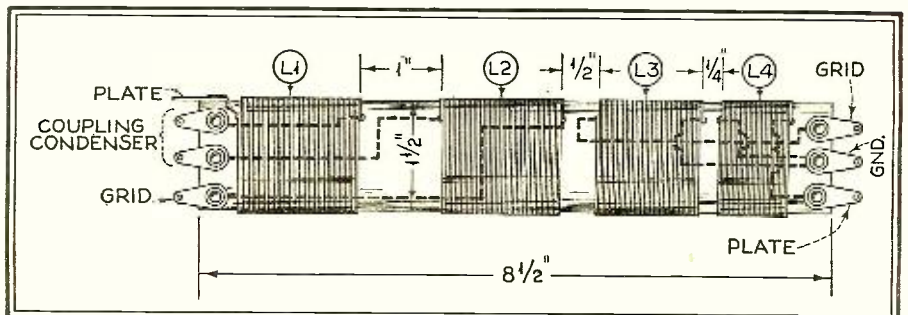

Complete coil assembly for first detector oscillator circuit. The specified spacing between coils should be carefully followed

The Unit-Built Receiver

(Continued from page 549)

- 1 phono twin-tip jack.
- 1 speaker twin-tip jack.
- 1 triple binding post.
- 1 socket, marked "Speaker."
- 2 sockets, marked "245."
- 4 sockets, marked "224."
- 1 socket, marked "227."
- 1 socket, marked "280."
- 1 socket, marked "Regulator."
- 1 volume control potentiometer.
- 2 bakelite moulded mica condensers, .00025 mfd.
- 1 line toggle switch.
- 1 local-distance toggle switch.
- 1 tone control switch.
- 8 11,000-ohm resistors.
- 1 250,000-ohm resistor.
- 1 200-ohm resistor.
- 3 300-ohm resistors.
- 1 2,500-ohm resistor.
- 1 50,000-ohm resistor.
- 1 500,000-ohm resistor.
- 1 connector cable.
- 1 duplex receptacle.
- 1 midget receptacle.
- 1 .002-mfd. bakelite moulded mica condenser.

Accessories

- 4 -24 tubes; one amperite voltage regulator; 1 -80, 1 -27 and 2 -45 tubes.
- 1 Hammarlund d.c. speaker, type HQ-SP.
- 1 Hammarlund phono pick-up, type HQ-PU.
- 1 Hammarlund phono motor and turntable, type HQ-PM.
- 1 console or cabinet.

The kits for the Hi-Q 31 are sold in the form of a number of completely wired factory tested units. This makes the construction of the receiver a comparatively simple task and almost completely prevents any possibility of other than perfectly satisfactory performance. With each kit is included the drilled metal sub-panel, wire, screws, etc., and all necessary assembly and operating directions.

Vacuum-Tube Voltmeter

(Continued from page 493)

appreciable error at height of the scale. We have overcome this by making our adjustment at the most sensitive part of the scale, viz., the high end. In actual operation after the meter has been calibrated by one of the two methods shown above, without touching any controls except the switch which should be pushed to the left. The reading of the microammeter should be observed. The left-hand knob should then be turned until the meter reads 200. Then the switch should be raised to the center position and without touching anything else the meter reading should be noted. Thereafter, at any time that it is desired to bring the voltmeter to working condition, this same reading should be duplicated. What we are actually doing is merely making sure that the same voltage will read the same amount at any time the meter is used.

The Condenser that repairs itself

An inexpensive, self-healing, puncture-proof filter condenser that actually improves with use

DESIGNED upon an entirely different electrical principle, this filter condenser is immune from damage from high voltage surges—an effect that costs dealers and distributors a goodly portion of their yearly profits. It protects its associate equipment, as well, by offering a high-resistance path for the dissipation of surges when they occur. Immediately the surge has passed this condenser HEALS ITSELF and continues normal operation. The dielectric of the Mershon Condenser is formed electrically by a patent special process. Continued operation does not harm it in any way, but to the contrary, actually improves it. THE MORE A MERSHON IS USED, THE BETTER IT BECOMES.

Costs No More Than Other Condensers

Mershon Puncture Proof Condensers cost no more than other condensers, yet their first cost is their last. Once you have them installed you can forget about condenser troubles. That is why thousands of service men are using Mershons to replace burned-out condensers in their daily work. Because of their larger capacity, Mershons improve the filtering of the power-pack with the result of considerably reduced hum.

30 Prominent Manufacturers Use Mershon Condensers in Their Receivers

Zenith, Sparton, Crosley, Colonial, Kennedy, Howard, Amrad and DeForest-Crosley of Canada are among the numerous manufacturers using Mershons. Rigid tests in their own laboratories have proved that Mershons provide better filtering, greater reliability, almost unlimited life—all at lower cost.

Several Different Capacities and Mounting Styles

Single Unit Mershons have positive terminals at the top or bottom as desired, with capacities of 8 or 18 mfd. Multiple Unit Mershons have positive terminals at the top, and may be obtained in either Double Unit or Triple Unit Styles. The latter are the most economical filter condensers available.

How You Can Use Mershons

If the receiver you handle, or the ones you repair, give you filter condenser trouble, Mershons will eliminate it for you. Use them for replacements. If you build power-amplifiers or transmitters, Mershons in the power-packs will assure you of freedom from condenser replacements. This new booklet shows you how to use them. A FREE COPY will be sent you for the asking.

Mail the coupon and learn how to eliminate condenser trouble

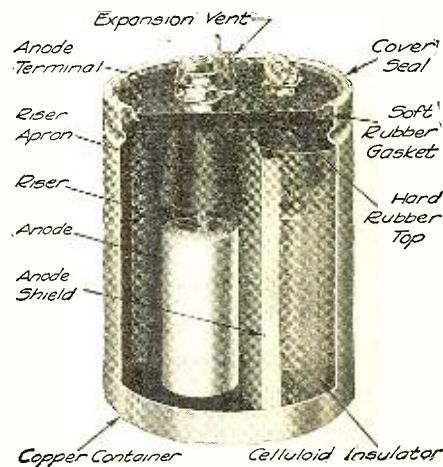

Showing the Interior of the New

Electrolytic MERSHON Condenser

WHAT USERS SAY

NDR, Augusta, Maine, says, "Having great success with Mershons. Using a bank of Mershons Sunday, put new NDR on the air and got Xtal report first QSO." "Our only worry is that someone will buy them right out of our filter system." WIBES says, "I successfully blew a 4,000 volt bank of Mershons before acquiring the condensers before acquiring the condensers before acquiring the condensers before acquiring the condensers since." WICOP says, "Had 'RAC' reports on my transmitter before, but now am getting 'DC' and 'pure DC.'"

From a radio distributor, "Zenith has been using your condensers for more than two years, and we as jobbers have found them to be all that is claimed for them." From a dealer, "Have sold Crosley and Amrad for three years, and have yet to have a Mershon go bad." A service manager, "Have not known of one going bad in a receiver yet."

THE AMRAD CORPORATION,
390 College Avenue,
Medford Hillside, Mass.

Please send me Mershon Prices and a FREE COPY of this booklet.

I want to use Mershons in this set (circuit attached). How do I do it?



NAME.....

STREET.....

CITY.....

STATE.....

IT'S HERE!

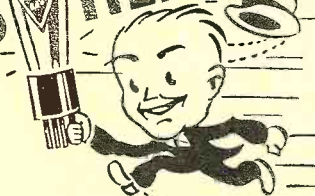

the new perfected

TRIAD

T-224 TUBE

a great achievement



Think of it—a new T-224 construction practically eliminates microphonics and burn-outs! Combined with that, a purity of tone that is startlingly life-like—and all of it the direct result of TRIAD research and engineering skill. Here is a splendid achievement in tube manu-

facture. Give your radio the added advantage of TRIAD T-224 equipment—and get for yourself a far greater radio enjoyment.

The new TRIAD T-210 tube, Tungsten Filament greatly increases the life of the tube and allows it to be easily reactivated. Molybdenum construction—withstands excessive heat far better than nickel, and eliminates grid and plate emission, which is the chief cause of noisy tubes. Another TRIAD achievement!

TRIAD
RADIO TUBES

TRIADS are now manufactured under R. C. A., G. E. and Westinghouse patents.

TRIAD MFG. CO., Inc.
Pawtucket, R. I.

“No!” Says Roxy

(Continued from page 498)

public and in that time has not missed one of Roxy's broadcasts. Perhaps some of the old-timers will remember Harry Hiller as one of the pioneer operators of WJZ in 1921 when that station was located in Newark, N. J. He was then known by the initials “O.H.N.,” signifying “Operator-Hiller-Newark.”

The production and reproduction of sound and sound effects is under Mr. Hiller's supervision. This activity is divided into three parts—i.e., radio broadcasting, sound pick-up and reinforcement and sound picture projection.

Broadcasting

Broadcasts from the theatre are over station WJZ and can originate in either the special broadcast studio, the stage, or the orchestra pit. A total of fourteen microphones may be employed, divided



Harry E. Hiller

in the following manner—four in the studio, five in the orchestra pit and five on the stage. Each microphone may be individually controlled, while each group as a group may in turn be controlled by faders. Condenser mikes are used throughout.

These microphones, through their individual amplifiers, are fed into an 8A W.E. amplifier which is equipped with manual volume controls, volume indicator, meters and jacks, where the program is monitored.

At this point it would be well to mention that a further monitoring procedure is also followed. In Roxy's office, an assistant listens in on a speech amplifier conveying the program from the studio to him as it goes out on the air. He is also provided with a radio receiver to check the broadcast program quality against the speech amplifier quality. Thus, three monitoring points are provided.

Rehearsals of all broadcasts are attended by members of the National Broadcasting Company who will handle the broadcast with Mr. Hiller. This preliminary work insures a completely coordinated monitoring of the program.

Every two weeks the frequency characteristics of all the pick-up and transmission lines are checked to guarantee fidelity of reproduction in the broadcast.

Speech Amplification

Although it is not generally known, and even little realized by a personal visit to the theatre, every sound, whether it be speech, song, or music, is picked up by groups of microphones separate from those employed for radio broadcasting and passed along to a Western Electric speech amplifier system for step-up. The input from this battery of microphones is controlled by an operator located high up in the right rear of the balcony. He also controls the output of the amplifier which feeds ten loud speakers in various positions throughout the theatre. Because of this system a vocalist on the stage need not strive for unnaturally large volume to fill the theatre. The loud speakers are arranged so that six of them, located in the grille work above the proscenium arch, supply the upper parts of the house. There are two at the sides to supply the mezzanine and loges and two more for the orchestra. Every part of the theatre is adequately covered and there is no appreciable time lag apparent to a patron who may be sitting in the last row of the balcony.

Talking Movies

The Roxy theatre is Western Electric equipped to reproduce sound pictures by means of any of the commercially available talkie systems—namely, the Fox Movietone variable density constant width system, the Fox Grandeur Film (wide-width), the RCA Photophone variable width constant density system or any sound-on-disc system. Two large exponential type dynamic speakers, located behind the screen and removable to the upper lofts by means of cables, completely supply synchronized sound to accompany the projection of the picture.

Rehearsals

We have seen that it would be practically impossible to rehearse a single show in the Roxy Theatre without the telephone and amplifying equipment used to carry commands to the dozens of men who are, in the general sense of the term, “backstage.”

The same speakers, minus the two located at either side of the orchestra during the dress rehearsal, are connected with a smaller amplifier to provide a means of direction during the first few performances. Roxy is thus able to sit in the control box, observe the show and give any cues or changes in lights, spots or curtain cues to any part of the stage operations over a microphone. And he can see his corrections carried out without the delay that would result if the orders were telephoned to the stage manager and then transmitted from there to the proper party.

"Broadcast Superhet"

(Continued from page 550)

this common reactance. The combination of inductive coupling and capacitive coupling will give practically constant coupling throughout the frequency spectrum covered by the coils and condensers. The 2-megohm grid leak must be used across the coupling condenser to bias the detector tube.

As we are not attempting to obtain extreme selectivity in this circuit, selectivity being a function of the intermediate amplifier, trimmer condensers on the tuning condensers may be eliminated if the coils are carefully made, and the condensers track pretty well. As a matter of fact, it is better to have this circuit a little too broad than too sharp. However, if one desires to match them perfectly, trimmers may be used.

The oscillator circuit is the same as was previously used, but the method of coupling into the first detector is a slight departure from usual practice. Eliminating the condenser and resistor previously used, we revert to the simple expedient of winding the oscillator coil on the same form that the other windings are on, so that the grid end of the oscillator coil faces the grid end of the first detector coil. Coupling is thus accomplished through their mutual inductance. The spacing of these two coils has been carefully worked out, and will be found to be correct for average tubes. Too much deviation from the specified 1/2 inch should not be tried, as much of the sensitivity of the entire receiver depends upon the proper coupling here.

So we see that we have one coil form, upon which all windings are placed. The form may be bakelite tubing, although the writer used a paper mailing tube carefully dried and dipped in melted paraffine. Its size should be 1 1/2 inches in diameter and 8 1/2 inches long. The windings are all of No. 28 d.s.c. wire and are wound in the same direction. L1 is 85 turns, L2 is 85 turns, L3 is 55 turns, and L4 is 35 turns. The connections should be carefully made in the manner shown in the drawing of the coil assembly, for if even one coil is reversed the entire circuit will be thrown out of kilter.

A word of caution is in order concerning radio-frequency chokes. By all means use the best one that you feel you can afford. Both the radio-frequency tube, and the oscillator tube are "parallel fed" and poor chokes will cause trouble no end.

In the photographs you will notice that the writer has completely rebuilt this unit of his receiver. This was considered advisable, due to the fact that the experiments performed on it had resulted in its distinctly resembling a Swiss cheese. It will not be necessary for you to go to that end. All you will need to do is to obtain another .00035 variable condenser to match the one you already have, and one more five-prong tube socket. Discarding the coil previously used may appear to be an extravagance, but one justified in improved results.

These changes are only suggested where one experiences interference.

HUMBLESS A. C. Operation

on the Short Waves
with the New A. C. THRILL BOX

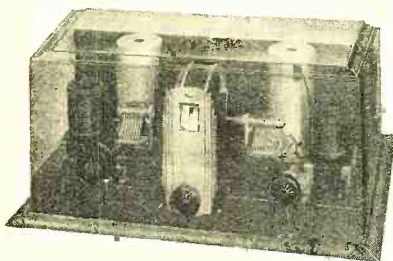

COMBINES every requirement of the expert Short-Wave Experimenter and Amateur, and the Radio Enthusiast who wants good loud speaker reception of SW broadcasts from all over the world. Not a compromise between a Short-Wave and Broadcast circuit. A.C. Model gives FULL A.C. OPERATION. No hum, even with headphones. DOUBLE SCREEN-GRID with grid-leak detection. Special New R-39 Type R.F. Coupling Transformers. No special tubes required. Uses standard heater tubes throughout. Single dial operation, easy to operate and log. Uses New NATIONAL Projector Dial. No grunting or backlash, no hand capacity; Loud Speaker operation from Foreign Stations; push-pull audio with special phone-jack after first stage.

Thoroughly shielded chassis. Easy to assemble and wire. Ideally suited not only for Short-Wave Broadcast reception, but for all S. W. amateur communication uses. Easily adapted for still spread of amateur bands, if desired. Performance down to 9 meters, using NATIONAL R.F. Transformers No. 10.

Also available in new battery model, using the UX 230, 231 and 232 tubes.

NATIONAL

PRECISION SHORT-WAVE
RADIO PRODUCTS



The New NATIONAL A. C. SW-5 THRILL BOX is easily assembled by anyone with genuine NATIONAL Radio Parts. Some of the more outstanding of these are described below.

R. F. Transformers



Standard set of four pairs covering from 21.2 to 2.61 m.c. Special coils can be supplied for the 33-21.2 m.c. and the 2.61-1.5 m.c. ranges. Forms are moulded R-39, the new low loss coil material, developed by Radio Frequency Laboratories. Blank forms also available for winding experimental coils.

The Condensers

The type S-100, specially designed for short-wave work, not a cut-down broadcast condenser. Insulated main bearing and constant impedance pigtail. 270 degrees straight frequency line plates.



The Dial



The NATIONAL Projector Type Drum Dial, standard equipment on the A. C. Thrill Box has the same easy control that is characteristic of the National Velvet-Vernier Dials. Equipped with non-metallic drive, avoiding clicking and de-tuning. The dial scale is projected in magnified form on to a ground glass screen which reads the same from any position, without parallax. The escutcheon, of beautiful modern design, is finished in brush silver.

Sherman, Abbott and Jackson Sts.
Malden, Mass.

Gentlemen:
 Please send me, free, Short Wave Bulletin No. 141.
 Enclosed, please find 50c (stamps or coin) for your new NATIONAL SHORT WAVE HANDBOOK, describing all the new Short Wave Circuits (just off the press).

Name

Address

RN-12

HEADQUARTERS



THE RADIO NOISE REMOVER

Get your copy of the 74-page TOBE BOOKLET, "RADIO NOISES AND THEIR CURE." Shows how to eliminate static caused by oil burners, electric refrigerators, soda fountains, sign flashers, etc., 25c; Foreign, 35c.

NEWARK ELECTRIC CO.

"Nothing But Radio"

226 WEST MADISON STREET

CHICAGO,
ILLINOIS.



RACON'S

Latest Development

NEW TYPE

No. 3320 A

PORTABLE HORN

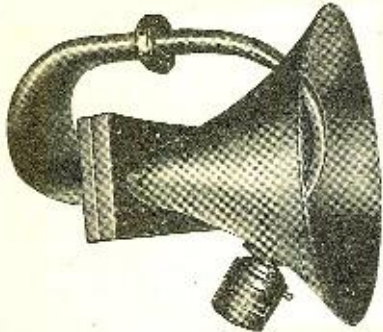

Air column length—slightly less than 7 feet. Oval bell 27" x 35", depth 28". Can be separated in two halves for portability. Excellent for music as well as speech.

Newest Storm-proof Horn

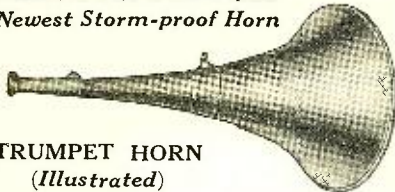

TRUMPET HORN

(Illustrated)

Bell 22 inches round, length 40 inches. Equipped with cast aluminum ferrule and suspension ring.

For Public Address and all Outdoor use. This horn has been perfected after years of exhaustive research in Racon Laboratories. Will withstand all weather conditions. Requires no replacements or servicing after heavy rainstorms. Guaranteed for one year. Prices slightly higher than regular horns.

Radio Revives the Lost Art of Reading

(Continued from page 526)

being interesting; and he may start with the multiplication table and come on up through the Doxology and the Lord's Prayer. Have you ever tried reciting some very familiar piece so as to make it express its real meaning? Try it; you'll be surprised. (I wish I could illustrate what I mean; but ink and paper won't admit of it—I'd have to have a microphone.)

Announcers are showing much skill nowadays in using a few sentences to set or dramatize musical numbers; a touch

pitch, emphasis, and rate. Let me suggest briefly how these work out in good reading.

Nobody ever talks in a monotone—on one level of tone or pitch; therefore no one should read that way. Yet an amateur reader will buzz along like a sewing-machine, so many words to the minute; and a professional will fill his throat with tremolo weeps and chant or intone. One is as false as the other; but the professional is more to blame because he ought to know better. Poetry, of course, gets the worst deal—because it has a musical rhythm and measure that invites the lazy reader to drop into sing-song and ignore its meaning—which is always more important than its music. (If this weren't so, it wouldn't have words.)

Vertical pitch or range ties in very closely with *emphasis*. Both must be used to express meaning. Pitch selects words and phrases on which the expressive voice rises or descends. Someone predicts that you will fail in what you are planning to do. You pick up that word "fail," and repeat it: "Fail?" If your meaning is disbelief that you can have heard correctly, or incredulous questioning, you start the word with a low pitch and carry the tone half-way up the scale—like a full-length question. If you repeat it to show that the idea is ridiculous as well as incredible, you start the word with a high pitch and drop to one much lower.



Alwyn E. W. Bach, N. B. C. announcer and winner of the 1930 gold medal for good diction on the radio

Either way the word is emphatic; and the beginning more emphatic than the end. If a full-length question is asked around it, other less important words are used, which serve to make the emphasis on "fail" even more striking. "You don't really think this thing is going to fail?" No one would ask that question without varying both pitch and emphasis; but we have all suffered under readers who flatten such expressions into lifelessness.

Varying the *rate* or *speed* is the third universal method of getting meaning into what we say or read. All good singers, though bound by time and measure, carefully "phrase" their words. No normal speaker utters a sentence at a uniform rate of so many syllables to the second.

This sentence I have just written, for example, could be read without pause or varying speed; but certainly it would be far more interesting and intelligible if it is "spoken" and "phrased." This is a kind of translating which it has to go through; and you do it to bring out its meaning. You may break the phrases by very slight pauses after "speaker," "sentence," and "rate." You may stress each of the first three words of the sentence, speed up on the fourth and fifth, skip quickly over "at a" to rest with emphasis on the first syllable of "uniform" and with deliberateness on the last syllable and then emphasize "rate!" and so on.

How about the danger of standardizing everybody to a level of uniformity? The *naturalness* we are talking about will forever remove that danger. No two people talk alike; and no two people will read the same matter with just the same

(Continued on page 556)

of natural scenery, or a hint of human story, or—best of all—two or three lines of verse from the song that will follow. The dramatic simplicity of this is above praise; but its *meaning* is always the main purpose. When those few words or verses are *thought aloud*, the result is perfect. When they are repeated mechanically, they are only 25 per cent. of what they ought to be; they may even become a handicap in mood and effect, which the music must overcome—if it can.

This raises a big question. Does poetry always mean something? I believe there is only one answer: if it doesn't mean something, it isn't poetry, and it doesn't deserve the high tribute of being broadcast. Only the best is good enough for the microphone. All true poetry means something to the mind—from Poe to Browning; and if your reader or announcer can't see that meaning and express it, he is a dud. When he reads, he takes the part of the man who thought that idea and wrote it out; and he must think that thought aloud as though it were his own. Or, if you like, he is a salesman, and must sell that idea to his hearers.

Now this life and naturalness, this true expressiveness, that we must get back to, is mostly a matter of natural *variety*; variety in three directions—

ACME WIRE PRODUCTS

Parvolt Filter and By-Pass Condensers, Magnet Wire-All Insulations, Varnished Insulations, Coils.

THE ACME WIRE CO.
NEW HAVEN, CONN.

ELLIS MICROPHONES



Models 29N and 30N, \$75.00 list. Approved by every high grade Amplifier Manufacturer in the country. Used by Broadcast Stations and Public Address Systems everywhere. Complete line of stands, cords, etc. Write for descriptive literature and name of nearest jobber.

ELLIS ELECTRICAL LABORATORY

337 W. Madison St. Chicago, Illinois

Dealers and Service Men Send for the Latest Issue of

NUBOR FLASHES

It contains hundreds of Radio and Electrical bargains
Have You Received Your Copy?
NUBOR RADIO CO., 14R Warren Street, New York City

Antenna Construction for Amateur Transmitter

(Continued from page 519)

There are two popular voltage-feed antenna systems in the amateur field, Figs. 8 and 9. The Fig. 8 system is for transmission on a single frequency, while Fig. 9 is an arrangement for multiple-frequency transmission; that is, transmission on one of several frequency bands in the amateur assignments. The radiator length between points X and Y is one-half wavelength long for the Fig. 8 arrangement. C is a very small coupling capacity, 50 to 100 micro-microfarads.

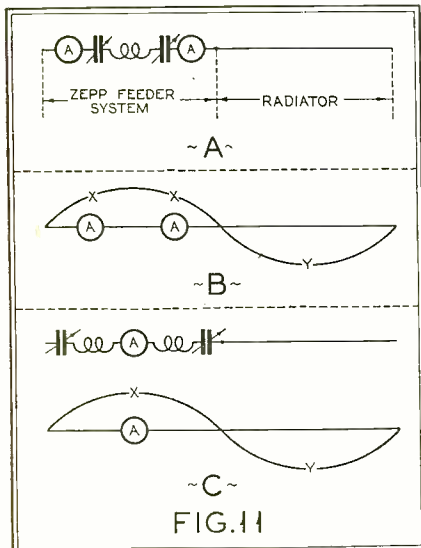

Fig. 11. "A" shows the Hertz (Zepp-fed) antenna straightened out; "B" the distribution of current in the feeders and radiator; "C" the same if it were possible to place a current meter in the electrical center of the feeder circuit

The clip on the plate inductance is adjusted to the point where the tube draws normal plate current. A small auto lamp may be shunted around 8 or 10 inches of the radiator at a point half-way between the ends, shown at A and B, Fig. 8. Maximum brilliancy indicates maximum current in the radiator. For fine adjustment, the plate tuning condenser is used for maximum resonance.

The arrangement shown in Fig. 9 can be used for one, two or three frequency bands. To operate on three amateur bands (3,500-4,000, 7,000-7,300 and 14,000-14,400 kilocycles) the length between the points X and Y must be 130 to 132 feet, in which case it will operate on about 3,600 kilocycles, 7,200 kilocycles and 14,400 kilocycles. The fundamental would tune to a frequency of about 3,600 kilocycles (one-half wave radiator); the second harmonic of the full-wave antenna would tune to about 7,200 kilocycles and the fourth harmonic would tune to about 14,400 kilocycles. If the length between the points X and Y is 65 feet, then the antenna system will tune, to the frequencies, 7,200 kilocycles for the half-wave radiator and 14,400 kilocycles for the second harmonic. This also may be used for 28,800 kilocycles, in which case it would be the fourth harmonic.

(Continued on page 557)

Always Abreast of Modern Radio Requirements ELECTRAD

Resistors and Voltage Controls

Constant progress is the keynote of the radio industry. New receivers, new circuit adaptations, new developments come from the research laboratories of the radio industry every week.

Constant progress in the development of resistors is necessary to keep up with this steady advance—for more and more are engineers emphasizing that the efficiency of modern receivers can be insured only through the proper use of highest quality resistors.

In the development of *new* resistors for *new* purposes, and in the adaptation of *standard* resistors to *new* uses, Electrad Engineers have persistently pioneered, basing their developments on the policy that highest quality alone can endure.

On this basis, Electrad has built up an enviable reputation among radio manufacturers, engineers and fans as well. For, remember, Electrad Engineers are always ready and willing to assist *anyone* in the solution of his *radio resistor problem*, large or small.

Send us *your* problem—or mail coupon for literature covering the complete line of Electrad Resistors and Voltage Controls for every radio purpose, including Television.

ELECTRAD INC.

ELECTRAD

Super-TONATROL
TRUVOLT
ROYALTY
VITMONEL

Resistors and Voltage
Controls for Every
Radio Purpose.

ELECTRAD, INC., Dept. RN12,
175 Varick St., New York.

Please send information on all Electrad Resistors.

Check here for Loftin-White Amplifier circulars.

Name.....

Address.....

Specialists in
LOFTIN-WHITE
Direct-Coupled
Amplifiers.

Electrad, builder of the first commercial direct-coupled amplifier, presents three new kits, for all usual requirements, with '45, '50 and '50 push-pull outputs.

NO SLUMP IN ADAPTATIONS!

NEW adaptations of long known fundamentals continually reveal some necessity for condensers different in form from the usual standard types heretofore found inadequate.

With the ever-increasing traffic on the shortwave channels—selectivity and sensitivity become of paramount importance in the modern radio receiver. Many operators acclaim the merits of the push-pull system, using double section variable condensers in the tuning circuits. To meet this demand our 202-E has been developed, giving a total capacity of .00075 mmfds. with 2 sections in series. With interchangeable coils a tuning range of 5 to 80 meters can be covered readily. Write for literature.

THE ALLEN D. CARDWELL MANUFACTURING CORPORATION
81 Prospect Street, Brooklyn, N. Y.

YOUR Ultimate Choice

WILL BE

FLECHTHEIM SUPERIOR CONDENSERS

For the same reason that—
"OVER 50% OF THE BROADCAST STATIONS ARE USING THEM"

So—
WHY WASTE MONEY WHEN YOU CAN GET THE BEST FIRST



Type T200—2 mfd.
1500 v. D.C.—1000 rms RAC

Catalog No. 22 is yours—for the asking
A. M. Flechtheim & Co., Inc.
138 Liberty St., New York City, N. Y.

Radio Revives the Lost Art of Reading

(Continued from page 554)

shades of meaning and color and emphasis. This is true, and we can't change it, and don't want to change it; for in it lies the fascinating iridescent color of human personality—the most interesting thing in the world. One person speaks quietly, deliberately, thoughtfully—and should read as he speaks (provided he speaks well). Another has a rapid, impetuous, animated manner; and this animation must be kept in his reading if that reading is to have reality for those who listen. And so on; you can fill out the list for yourself.

Which is harder to read well—prose or poetry? Almost anyone is willing to try prose; and I believe it is less often read well. I mean that most readers of prose plow along like a truck through a snowdrift, making yardage in a straight line as long as the gas holds out. But I submit that such "reading" means nothing to man or beast; and until we learn how to read with truthful, expressive color and human naturalness, radio will miss one of its greatest opportunities—interest and appeal to the *minds* of listeners.

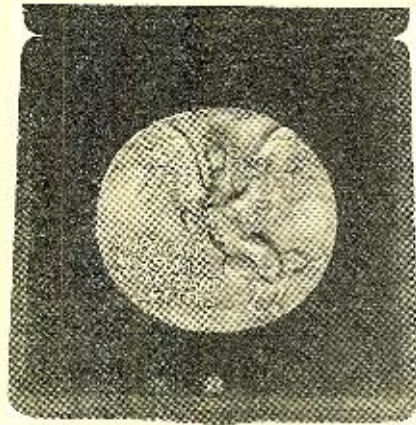

A reproduction of the gold medal awarded to M. J. Cross in 1929 and to Alwyn Bach the following year

ward. Choose your poetry carefully; and then choose readers who can express with faithfulness the poet's meaning; and you will have delighted listeners everywhere. Poetry is meaning in its most beautiful and impressive form and no normal person is without appreciation for it—if he has a fair chance to get the true article, unspoiled by dullness or by the vaudeville manner.

Let me add a word about one other kind of matter sometimes read at the microphone—prose or poetry or story from the Bible. It's no wonder that it is usually read very badly. Most clergymen—who of all men ought to read it well—read it so that it means little to most of their hearers. I believe that those hearers can be interested in it only so far as they can get some meaning from it. To chant it in a kind of monotone may be reverent but it means very little to those who listen. It is difficult to believe that the story of Job or the Sermon on the Mount were intoned. If they were, that is not the delivery that in these days can bring these literary masterpieces home to us. Try reading aloud the 5th chapter of II Kings, as an impressive human story, and you'll get my point. All it needs is a chance to have its real meaning faithfully expressed, with naturalness and simplicity.

New sciences require new arts. The vast new science of radio demands many new arts, and one of its great needs is for a rediscovery of the fine art of reading aloud. Which is only a way of saying that we shall have to read as we speak—provided we speak well: with naturalness, faithfulness, thoughtfulness.

"Morro Castle" Has Elaborate Radio Equipment

The \$5,000,000 Ward liner *Morro Castle*, newest pride of the American merchant marine, which recently started on her maiden voyage to Havana, has been wired with the most advanced radio apparatus ever placed on a merchant vessel, according to engineers of the RCA-Victor Company, who made the installation.

A central radio receiving station of the newest superheterodyne type, together with an electric phonograph, has been installed on C deck of the spacious liner from which programs from near-by and distant stations are distributed to the public rooms in the various parts of the vessel. Special types of music and entertainment are also available from a large record library for the electric phonograph. Improved electro-dynamic reproducers are concealed in the luxurious furnishings of the smoking room, the main salon and the tourists' lounge. The radio system is operated by the ship's radio staff.

NEW NATIONAL SHORT-WAVE

A new powerful AC or DC operated receiver. Tunes in foreign stations with remarkable regularity on wavelength range of 15 to 550 meters. Complete Receiver, or in Kit form.

S-M SHORT WAVE CONVERTER

Makes short wave superheterodyne of any broadcast receiver.

1930 CATALOG FREE

Set Builders! Write for your copy. Complete line of short-wave supplies, standard parts and accessories.

CHICAGO RADIO APPARATUS CO.

415 S. Dearborn St., Dept. RN12, Chicago, Ill.

ALUMINUM BOX SHIELDS

Genuine "ALCOA" stock, silver-epin finish. 5x2x3, \$1.89—Cornet size \$4.65, 10x2x7 Monitor size \$3.25. 4x4x5 Coil Shield (like picture on left) \$1.00.

ANY SIZE TO ORDER.

Coil Shields, Coil Hole Covers, Shielded Wire, Dubilier Duratrons, Neon Test Lamp, \$1.00, Service Men's Test Leads 65c, 75c and \$1.00 pr. Drum Dial cable by foot or mile. Octo Coils, Pilot Coils, Kits and Parts. Please include postage.

BLAN, the Radio Man, Inc.
89 Cortlandt Street, Box 1, New York City

AUTOMATIC MOTOR CAR RADIO

Write Now!

112 Canal St. Boston, Mass.

Antenna Construction

(Continued from page 555)

The basis for all discussion at amateur conventions with regard to what is the best antenna centers around the two methods of feeding energy into the radiator—the single wire method or the “Zepp” method. All other problems may be forgotten, but these two long will remain the major points of contention of which is the better and the only possible way of settling the discussion in the mind of any one amateur is for him to use the one which satisfies him and him alone. Each system, like transmitting circuits, is as good as the other. It all depends upon the familiarity of the operator with each system and the results he secures with

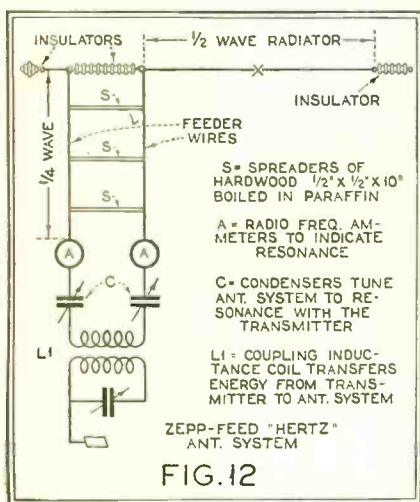

Fig. 12. The design features of a Zepp-fed Hertz using a one-half wave radiator

one or the other. If a vote could be taken on the choice of amateurs, the single wire feed as against the Zepp feed, one system would show a majority today while the other would show a majority next month. Summed up, it amounts to about the same as whether you like shaving cream in a jar or in a tube—the main point, after all, is to have cream with which to shave. Likewise, the main point is to feed maximum energy into the radiator so the radiator can push it out into space or the ether and not down a gutter pipe or a clump of trees.

Each system is about as simple as the other and common sense is all that is required to design and erect an antenna system, using either arrangement. Fig. 10 is the single wire feed system. The radiator is one-half wave long, between points X and Y. C is the exact center between X and Y. A is the point where the feeder wire connects to the radiator and it is important that this be connected at the right distance from the center. The feeder length may be anything from 50 to 400 feet without great loss of efficiency. The radiator length is first determined in feet. Suppose we go back to that question of radiator length for 41.4 meters. Instead of multiplying 41.4 meters by 3.2808 (the number of feet per meter) and then dividing by 2 and then

(Continued on page 563)

FERRANTI

Special Audio and Output Transformers for Precision Circuits

Now made in U. S. A.
on 48 hours' notice.

Ferranti, Inc. now have to offer a specially designed and complete line of precision audio and output transformers, suitable for the exacting requirements of broadcast stations, laboratories, recording devices, amplifiers, telephone lines, special testing equipment and other uses where flat curve is required over a wide frequency range. These transformers can be supplied for tube to line, tube to speaker, line to line, line to speaker, line to tube, microphone to tube and for numerous other purposes.

Amplifying Equipment

The type R. P. M. panel shown at the right is typical of this class of equipment, which is highly recommended for educational institutions, public buildings, etc.

Prices and specifications forwarded on request.

FERRANTI, INC.

130 West 42nd Street, New York, N. Y.

A completely new development of amplifying equipment.

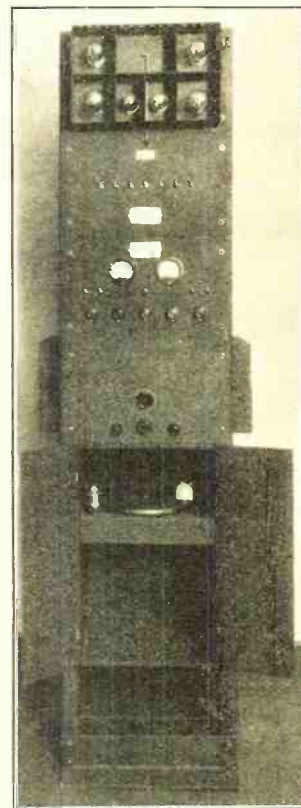

RESISTORS

No longer any problems

With our new Resistor Replacement Guide you control the situation. This remarkable booklet shows clearly and concisely: (1) how to locate cause of trouble in radio sets, (2) proper types and values of resistors to use in all popular types of radio receivers manufactured in years 1927, 1928, 1929. Both service men and amateurs will find this guide most valuable. Write for it today.



MADE BY THE MAKERS OF



Metallized RESISTORS

INTERNATIONAL RESISTANCE COMPANY
2006 Chestnut St. Phila., Pa.

Explaining the Radio Laws

(Continued from page 503)



Write

today for the only Volume Control Guide ever published showing specifications for practically every set ever made.

Invaluable for every dealer and service man... enables you to service almost every make with a small stock.



Send 25c to Dept. 125-C for this booklet

Centralab

CENTRAL RADIO LABORATORIES
Dept. 125-C 22 Keefe Ave. Milwaukee, Wis.

FREE Radio Bargain CATALOG and FREE RADIO GIFT



1930-31 EDITION

Authorized Mail Order Source for PILOT RADIO Products

200 West Jackson, Chicago, Ill.

20th Century MAIL ORDER CORP.
200 West Jackson, Chicago, Ill.

GENUINE PILOT PRODUCTS

Make 20th Century your headquarters for everything in radio. Lowest prices assured. Every article guaranteed. Complete equipment for regular and short wave receivers and transmitters. Sets, Parts, Kits, Pilotron Tubes and other Pilot Radio products. Send for catalog NOW.

Standardize on **LYNCH METALLIZED Resistors**

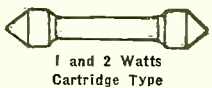

1 and 2 Watts Cartridge Type



1/2, 1 and 2 Watts Pigtail Type

New low prices—new liberal discounts. More value for less money. Greater safety factors. Accuracy in construction and ratings. Give your customers the BEST at less cost. **GUARANTEED.**

JOBBERS—DEALERS—SERVICE MEN

Send for new illustrated, descriptive catalog "N".

LYNCH MFG. CO., Inc.
1775 Broadway, N. Y. C.

Precision Wire Wound

that sold. One day when he was about half through the inspector dropped in and suggested the desirability of filing an application for a construction permit pronto. After some delay, this was done, but when it wasn't rushed through, inquiries revealed that this station was *persona non grata* with the Commission. An official of a big chain confirmed this when asked to aid and suggested that the owner visit Washington with a flock of attorneys and engineers, and perhaps Congressional aid, if he ever wanted to get back on the air, for he was literally off, having violated about four regulations at once. He came and after about two weeks' time spent in supplication, pleas and promises, an emergency permit and later a license was granted him, but the supervisor was requested to make a special inspection and report.

Actually the Commission was very lenient in that the station didn't have to go off the air, but the owners weren't. The operator was replaced. The Commission has now set the renewal application for hearing and the whole matter will be thrashed out. The moral is merely observe this case and don't do likewise.

With the advent of each renewal date the Radio Commission is becoming what might be termed more "hard boiled." At this writing, thirty-one of the quarterly renewals have been granted temporarily, pending a careful investigation by the legal division and hearings before October 31. Some of these licenses may be cancelled for infractions of the rules, depending on the results of the hearings.

During the past year the legal division has established a complaint section, which co-operates with the radio supervisors, and checks up on all complaints filed against broadcast stations. Such stations as continue to violate the rules will find themselves and their licenses in most unfavorable positions when renewal dates arrive.

At the beginning of the last period some sixteen stations were cited for violations of the Act and General Orders. Following hearings, two stations were deleted, chiefly because they used excess power, deviated or transmitted without an operator, the others were warned and relicensed. It may be recalled that one station was deleted recently for having permitted broadcast of what was considered indecent or improper language.

Station owners or licensees must realize that they are responsible for everything that goes out over the air, whether or not they actually utter the statements. Another station recently lost its license, although the case has been appealed in the courts, because it was held to be making a private use of the air and not operating in public interest.

A short time ago an alleged station owner of St. Louis was convicted for violating the Radio Act. This man was sentenced to be imprisoned in Leavenworth for a year. It so happened that this sentence was suspended later when it was discovered that the prisoner was an alien. He was turned over to immigra-

tion authorities for deportation. This individual had operated a broadcasting station without a license, or licensed operator, and had also rebroadcast programs without obtaining permission from the originating station. In announcing this conviction the Commission pointed out that it now had facilities for carrying out the spirit of the law and that no alibis from offenders would be accepted in the future.

A part of these facilities is of course the erection of the new radio monitor station at Grand Island, Nebraska, which station it is estimated can check any of the 20,000 government-controlled stations and ascertain when they are off frequency. Daily reports of deviations will be wired directly to the Radio Commission through the co-operation of the Navy, so the Commission will be in a position to take action against offenders almost immediately.

Station owners who seek additional facilities, such as more time or power, or what is considered better channels, should ascertain whether such facilities are available before making application. Incidentally a definite frequency has to be specified. To this end, General Order 40, which defines the classes of channels and amounts of power assigned by zones, should be read carefully, and an up-to-date kilocycle list consulted. To be sure, General Order 87, seeking to revise General Order 40, was approved some time ago, but the date on which it was to go into effect has been extended indefinitely. However, as soon as some court matters are cleared up, General Order 87 or a revision thereof will undoubtedly be put into effect.

Another General Order of importance is 91, covering the maximum rated power of transmitters. Check your new applications against it. Stations must not show high-power ratings and operate with less. This prevents what advertisers might consider misrepresentation.

General Order 92 and explanation thereof also affect new assignments, since they show definite unit values of station assignments and the quotas by zones and states. They should be studied in order to ascertain in advance of filing what possibility there is of having an application approved; you can find out whether a zone is over quota or not and whether or not the state is over or under quota. If the state and zone are both over quota, an application for increased facilities is practically hopeless, since the granting of it would further increase the assignment.

There is a chance that licensees in under-quota states and zones may secure better facilities if found in public interest, but in under-quota states in over-quota zones applicants have to seek facilities used by stations in over-quota states so as not to increase the zone figures, even then the undertaking is difficult.

Most applications of this sort are now being automatically designated for hearing. An application from any applicant or licensee is almost sure to affect the li-

(Continued on page 560)

Equipping the Waldorf with Radio

(Continued from page 517)

guest rooms. Likewise, any program originating in the music reproducing system or over the radio can, in addition to being available in each guest room, also be heard in any or all of the public rooms.

Another feature of special interest to radio engineers is the complete interchangeability of all of the major elements comprising the equipment. Units such as the radio receiver, the transmitter mixers, the main amplifier, power amplifier, voltage dividers are all so arranged that they can be used interchangeably either in the program distribution or in the public address combination.

The centralized antenna system consists of a radio antenna which will be located between the two towers 600 feet above the level of the street. Three antennae

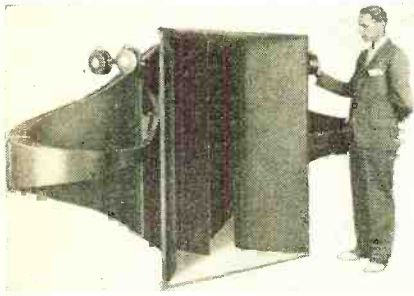

Sound projector horn used in the talking picture equipment installation

will be provided, one for the six programs which will be distributed throughout the building and two for use by apparatus occupying the area between the 20th and 42nd floors. Approximately seventy apartments will be connected to each of the two antennae. To insure satisfactory service to all of the apartments, of which there is to be a total of 140, and to permit each of them to tune their own radio set to whichever station they desire, a special radio-frequency transmission line will be installed between the antenna and the outlets to the various apartments. This radio-frequency transmission line will be loaded at definite intervals in order to maintain a high quality of transmission and reduce interference between the various radio sets. A radio-frequency amplifier will also be inserted between the antenna and the outlet terminal in each apartment. This amplifier will make up for the losses in the transmission line and give an outlet to the apartment antenna terminal comparable with the energy which would be received if an individual antenna were wired to each apartment.

In the design of these receivers and amplifiers, convenience and simplicity of operation were considered paramount. Minimum maintenance is an important factor particularly when it is considered that the total number of circuits to public rooms and guest rooms is between 12,000 and 13,000. Troubles on any of these circuits due either to the functioning of the apparatus itself, the improper handling of some associated equipment by the guests must be quickly located and removed.

(Continued on page 571)

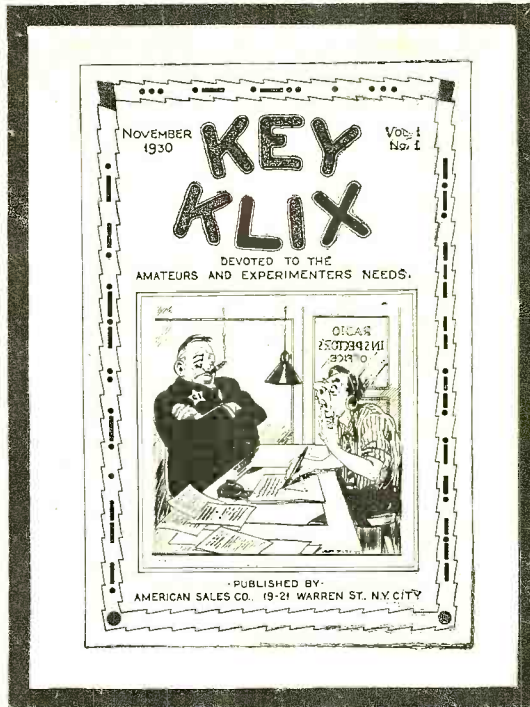

WRITE FOR SPECIAL PRICES ON FOLLOWING EQUIPMENT: R.E.L., Vibroplex, Amertran, Gen. Industries, Electrad, Jewell, Flechtheim, de Forest, Universal, Teleplex, Pilot, Esco, G. W. Walker multi-units.

A Few of Our Bargains for Servicemen, Experimenters and Amateurs

- Thordarson 250 watt transformer, 1200 v. center tapped, two 7.5 v. and 3 v. winding.....\$5.75
- Thordarson 175 watt transformer, 1150 v. center tapped, two 7.5 v. and 3 v. winding.....\$4.25
- Thordarson Filter Choke, 30 henrys, 150 m.s.....\$3.25
- Thordarson Double Choke, two 18 henry, 250 mil windings...\$6.25
- Dubilier 7 mfd. Condenser, 2 mfd. at 1000 v., 2 mfd. at 800 and 3 mfd. at 400 volts.....\$3.00
- American Double Button Mike, excellent for fone transmitters, high nickel finish.....\$31.50
- R. C. A. 216-B rectifiers.....\$2.35
- Dubilier 10 1/4 mfd. Condenser Block, 3 mfd. at 800 v., 3 at 600, 3 1/4 at 400 and 1 at 200 volts..\$4.50
- R. C. A. filament rheostat for hi-power tubes, 15 amps....\$3.00
- American 50 watt socket....\$2.50
- Bradleystat for 852 tubes...\$.95

Send a card for our FREE magazine, "Key Klux." Articles by W2BRB, W2CCD, W9BBA and W2WK. Contains lively items of interest to servicemen, experimenters and amateurs.

AMERICAN SALES COMPANY
DEPT. "N"
19-21 Warren Street N. Y. C.

World-Wide Reception With the NEW Short-Wave Norden-Hauck SUPER DX-5

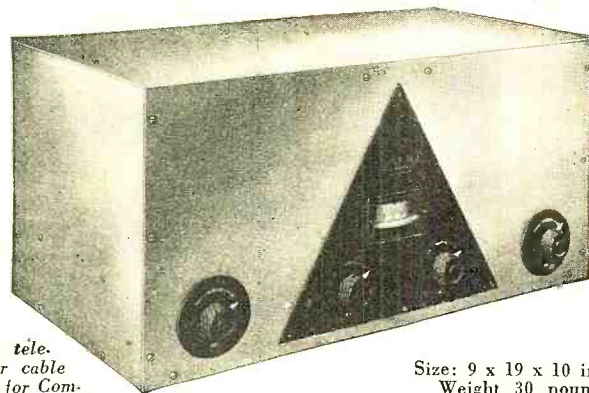

Write, tele. phone or cable TODAY for Complete Information

Size: 9 x 19 x 10 inches
Weight 30 pounds

Entirely New Advanced Design New Pentode Tube
Sensational Distance Range 20-200 Meters
Reliable Performance
Adaptable for Long Waves and down to about 10 meters
for Experimental Reception
A-C and D-C Models

We have an attractive proposition for the progressive dealer and professional service man.

NORDEN-HAUCK, Inc.

Engineers

South St. and Delaware Ave.

Philadelphia, Pa., U. S. A.

Cables: "Norhauck"

Enjoy **SHORT WAVE** reception on your radio.



"THE SUBMARINER"

Short wave reception from all parts of the world is now possible with the SUBMARINER. No need to buy a special short wave receiver when the SUBMARINER will bring in reception at a fraction of the cost. Plugs in on your present broadcast receiver. Vernier tuning device with a ratio of 64 to 1 makes tuning exceptionally easy, thus enabling you to pick up stations otherwise impossible to get. The SUBMARINER is made since 1926 is completely shielded—a quality product throughout.

Prices: Regular model AC or DC, fixed wave band 19-50 meters, \$17.50. Interchangeable coil, 13-145 meters \$22.50. The "J" feature, an exclusive "Submariner" achievement, gives five times the volume of any other adapter. AC or DC, prices as follows: Fixed wave band, 19-50 meters, \$22.50. Interchangeable coil, 13-145 meters, \$27.50. In ordering give model of set and numbers on tubes in it. Five-prong tube for AC receivers recommended for short waves, \$2.50.

Will be sent prepaid on receipt of price, or C.O.D. if \$1.00 accompanies order. Foreign orders, add 60c postage, no C.O.D.

J-M-P MANUFACTURING CO., INC.
3416 Fond du Lac Ave. Milwaukee, Wis., U.S.A.

RADIO OPERATORS WANTED



Radio operators are officers aboard ships. Well paid, pleasant work, travel. You can qualify in a short time in our well-equipped school under expert instructors.

Write now for free booklet on "Opportunities in Radio."

West Side YMCA
Radio Institute
113 West 64th St., New York, N. Y.

You'll bring in scores of new stations using Radex. It's "the greatest book they've ever seen" write hundreds. Gives you the ideal log; complete timetable of all ethnic programs; and other keenly interesting data.

Logged 2400-mile-away Station

Radex gives the radio a new "kick." Don't miss having it. Your news dealer, radio store or Kresco's has a copy of Radex for you or we'll supply you on receipt of

coming from
Cuba, Mexico,
Canada or U. S. A.

this book shows you
where to dial for it.



RADEX PRESS 1305 E. Sixth Cleveland, Ohio

PHOTOELECTRIC CELLS
By Dr. Norman R. Campbell and Dorothy Ritchie
Research Staff, General Electric Co., Wembley, England. A complete, practical treatise. Illustrated. \$4.50

TELEVISION Foreword by John L. Baird
By Sydney A. Moseley and H. J. Barton Chapple
History, latest theories and developments. Illustrated. \$2.50

ISAAC PITMAN & SONS, 2 W. 45th St., New York

MASON, FENWICK & LAWRENCE
PATENT LAWYERS
600 F St., N. W., Washington, D. C.
Estb. over sixty years. Send sketches. Electrical, Aeronautical and Chemical Inventions carefully handled. Practice before the U. S. Courts and the Patent Office. Prompt and careful service. Write us. Protect your inventions.
TRADE MARKS REGISTERED

Oxford Chromatrope

The Oxford Chromatrope is another new item of the Oxford Radio Corporation, 2035 W. Pershing Place, Chicago. This is made in the straight radio and the combination radio and electric phonograph. Superb tone and beautiful cabi-



nets are only two of the features of this new line.

The Oxford Chromatrope is made up of tuner, special amplifier, two speakers and a system of baffles which reproduces the complete range of frequencies from 12 to 8,000 cycles.

RCA-Victor Receiver

The RCA-Victor Company of New York announces the R-39 receiver. This receiver is unchanged from last year's Victor in micro-synchronous principle but in other fundamentals it has been radically altered. It employs eight tubes in a



five-tuned circuit hook-up with a screen-grid chassis, a new scientifically improved corrugated cone loud speaker; simplified straight-line tuning, Victor-perfected tone control, and a cabinet which is a modern adaptation of the classical Italian.

Stromberg-Carlson Receiver

The Stromberg-Carlson Telephone Manufacturing Company, Rochester, N. Y., announces, among others in its new line, the receiver No. 12, which embodies automatic regulation of signal strength to



meet variable reception conditions. A visual tuning meter insures accurate station selection, while a "silent key" gives quietness in operating the dial. Provision is made in the radio chassis for electrical phonograph pick-up attachment and for installing electrical remote control. A walnut, half octagonal cabinet with six solid walnut ornamental legs houses this instrument.

Explaining the Radio Laws

(Continued from page 558)

cense of an existing station and the Commission therefore desires a full hearing before taking something away from one and granting it to another. Applicants, therefore, should anticipate such hearings and prepare themselves in advance.

General Order 93, adopted June 25, should also be read carefully, since it outlines Commission procedure and practice, preceding and during hearings. Your counsel, if you have one, should have a copy so as to be thoroughly posted on such matters. It defines evidence, shows what is admissible and when and how presented. Unsworn letters and petitions, for example, are not acceptable. This order does not become effective until September 1, but if you have not received this pamphlet write the Commission for a copy. One of the new requirements is that an applicant, whose application is designated for hearing, must notify the secretary within twenty days, if he desires the hearing, forwarding a statement covering the facts he expects to prove at the hearing and an affidavit stating that he has sent copies of his statement to all parties concerned in the hearing, as listed in the Commission's notice. Several applicants have failed to comply with this procedure within the time specified and in consequence their hearings have been classified as defaults.

Stenode Has Military Value

By Fred Schnell

Fred Schnell is an authority on matters pertaining to short wave transmission and reception. He is the designer of the RADIO NEWS Short-Wave Superheterodyne, described in our August, September and October issues.

I AM not completely familiar with the Stenode Radiostat circuit as invented by Dr. James Robinson but can see if all that is claimed for it is so it will undoubtedly excite interest experimentally and possibly develop into a commercial broadcast receiver for congested areas where maximum selectivity is not only desirable but necessary. Of course it has uses in other radio fields as well and possibly may be of military value.

Idea of Trigger Detector

(Continued from page 494)

intermediates to the audio through the battery leads and the transformer. You don't get this unless the set is just in tune and the second detector is drawing plate current.

With the super there's plenty of power to make this work. The crystal will work so that nothing at all comes through unless the set is exactly in tune.

I'm waiting to get one of these sets for myself. It will be some receiving when I can tune out all the howls and squeals and static, and listen to just the music I want. And as it is developed further, it ought to be possible to put on the air just as many broadcast stations as anyone wants.

Speaker



The speaker shown is the new midget just put out by the Oxford Radio Corporation of 2035 W. Pershing Place, Chicago, Illinois. This is made up in three different types, the d.c., a.c. and the automobile speaker. It is furnished with 9", 11" or 12½" diaphragms.

These speakers are built with the idea of keeping them as compact as possible. The diaphragms are of specially impregnated cloth which is impervious to atmospheric conditions.

Appliance Switch

The Eagle Electric Manufacturing Company, Inc., of 59 Hall Street, Brooklyn, N. Y., announces a new appliance switch plug in bakelite. It is small, neat and compact and its mechanism is of sturdy construction. The heat-resisting phosphor bronze contact clips are employed in the construction of this switch plug.

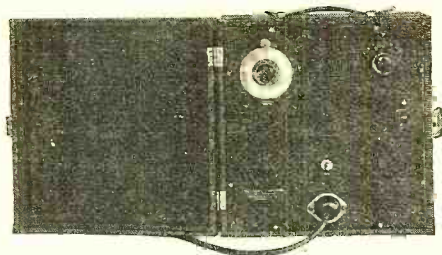

TYPE 404 Test-Signal Generator, Price \$95.00

SENSITIVITY MEASUREMENTS FOR THE SERVICE MAN

THIS new General Radio instrument makes it possible for the independent service man to make sensitivity measurements on radio receivers in addition to the usual neutralizing and aligning adjustment tests. When used in conjunction with an output power-measuring device the TYPE 404 Test-Signal Generator will show the approximate sensitivity of a receiver at any point in the broadcast band.

Further details will be supplied on request to all who ask for them on their business letterhead.

GENERAL RADIO COMPANY

OFFICES, LABORATORIES, FACTORY — CAMBRIDGE A, MASSACHUSETTS

Pacific Coast Warehouse: 274 BRANNAN STREET, SAN FRANCISCO

SPECIAL BARGAINS



No. 106

RADIOLA SPEAKER

Here's a real bargain! Genuine R. C. A. latest model Dynamic Speaker, equipped with DOUBLE WESTINGHOUSE RECTIFYING ELEMENTS. Housed in beautiful cabinet. Price complete, only \$14.50. Send \$2.50 with order, bal. on delivery. Satisfaction guaranteed.

\$14.50

No. 103
RADIOLA
SPEAKER



Genuine R. C. A. Model 103 Magnetic Speaker. Very attractive cabinet. Special price only \$4.50. Send \$1.00 with order, bal. on delivery. Satisfaction guaranteed.

Lafayette RADIO RECEIVERS

The new 1931 Lafayette Radio Receivers are here—the finest radio money can buy! Thirty days' free trial in your home allowed. Bonded by a \$10,000,000 Indemnity Company for your protection. Every new engineering refinement, including Triple Screen Grid, Tone Control, 245 Push-Pull, etc. Write for FREE CATALOG giving full information TODAY.

BIG CATALOG FREE!

Mail This Coupon to

Wholesale Radio Service Company, Dept. M-12
38 Vesey Street, New York.

- () Send 1 Model 106 R. C. A. Speaker, Price \$14.50. I enclose \$2.50 and will pay balance on delivery.
- () Send 1 Model 103 R. C. A. Speaker, Price \$4.50. I enclose \$1.00 and will pay balance on delivery.
- () Send FREE 1931 Radio catalog, showing nationally advertised merchandise and new Lafayette Receivers at Wholesale prices.

Name..... Address.....
Town..... State.....

JOHN F. RIDER

Is Now Conducting

An

ADVANCED RADIO and ELECTRONIC COURSE

for serious minded

RADIO SERVICEMEN EXPERIMENTERS PROFESSIONAL SET BUILDERS

who wish to study at home, in order to increase their earning power and prepare for the future.

JOHN F. RIDER, Steneck Trust Bldg., Hoboken, N. J. RN-2
Dear Mr. Rider: Please send me all details about your SPECIAL HOME STUDY COURSE. This does not obligate me in any way.

Name.....
Address.....
City..... State.....

Measure Easily Resistance — Voltage — Current

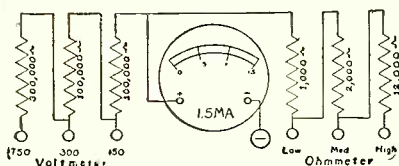

Super Akra-Ohm wire-wound Resistors and Shunts afford an inexpensive means to build test equipment for the measurement of resistance, voltage and current with accuracy.

A combination for the measurement of voltages and resistances is shown in the above diagram.

Super Akra-Ohm wire-wound Resistors are manufactured in any value from 100 ohms to 10 megohms. They are carefully designed to insure an accuracy of one per cent and a constant permanency of calibration. Their use is highly recommended for Laboratory Standards, High Voltage Regulators, Telephone Equipment, Television Amplifiers, Grid and Plate Resistors, Electrical Apparatus, and Test Equipment, etc.



Prices range from \$1.25 for 100 ohms to \$4.00 for 500,000 ohms

Send us your dealer's or jobber's name and we will send you a copy of

Bulletin 73-D

We manufacture special multiplying resistors for A. C. voltmeters. Full information will be sent on request.



Quantitative Data Omitted?

(Continued from page 495)

operator removed the quartz plate from its mounting?

With regard to the potentialities of the system disclosed in the circuit diagram of Mr. Cocking's article I may state that the width of band transmitted or passed by the crystal stage is determined not only by the band of "resonance" of the quartz plate but also by the constants of the bridge circuit. The effective capacity of a quartz condenser may vary by as much as 50 to 1 as the frequency is changed through a resonance point of the quartz. But the effect of such a variation upon the transmission through the bridge depends upon the ratios of the capacities constituting the bridge arms. No information is given on this point.

In short, it appears that the author shares with most English radio writers not connected with the N. P. L. of the Radio Research Board the habit of omitting all the quantitative data which are essential to a significant appraisal of the apparatus by the reader.

Modulation Percentage Important

(Continued from page 495)

All of the above, of course, assumes that the receiver does possess the marvelous selectivity claimed for it. Although successful reception has been had from a broadcast station even though a local oscillator was operating on a frequency separated by only a few cycles from the broadcast carrier frequency, it is interesting to speculate on what will happen when the interference consists of the almost completely modulated carrier of one of our American 50 k.w. transmitters. It would seem to the writer that the degree of modulation of the interfering carrier would play an important part in determining the extent of the interference produced. Although no data is handy on this point, the writer is under the impression that the average percentage of modulation of our American stations is greater than that of the stations on the other side of the Atlantic.

There is also a very significant theoretical consideration involved in the design of the Radiostat. This is the fact that the extreme selectivity of the device is obtained in the crystal controlled circuit which is the *last* r.f. circuit in the receiver. This presents no difficulty in the separation of two signals having a very small frequency separation when the two signals are of roughly the same intensity. However, this circuit layout is the exact opposite of our American receivers, where the trend has been definitely toward a rather high degree of signal separation ahead of the r.f. amplifier tubes. This trend in the design of our American receivers was the direct outcome of efforts to prevent the cross-modulation of a desired signal by the more powerful radiation of a near-by transmitter. It would seem to the writer that the new Radiostat should be even more vulnerable in this respect than our older American receivers. In the last analysis, real selectivity means the ability to receive the program of *any* one station within the range of the receiver to the *total* exclusion of *all* other stations on the air. Mere knife-like sharpness of tuning is in itself a distinct disadvantage. Consequently, the forthcoming demonstrations of this new receiver in America should prove very interesting.

Sidebands? Frequency?

(Continued from page 495)

cycle differing from the cycle preceding and the cycle following it. If we define frequency as the number of cycles which would occur in one second if all subsequent cycles were like the one under consideration we are again putting into the discussion words whose physical interpretation is extremely difficult.

Much of our discussion is based upon the assumption of steady states but in the actual case these steady states do not exist and an ordinary broadcast signal represents a continuous stream of changes in modulation depth and modulation frequency, as well as in the number of modulation frequencies existing at any one time. It is necessary to remember that in the actual case there are in all the circuits involved so-called transient currents which, however, in this case are not transient at all but follow along continuously, due to the continuous changes in the modulated wave. These "transient" currents play a very important part in what actually happens and cannot be neglected in any rigorous mathematical treatment of the circuits.

The principle of "compensating distortion" in which one portion of the circuit is known to have an undesirable frequency characteristic but which is overcome by arranging another portion of the circuit to have an opposite distorting effect so that the final result is reasonably linear, is by no means new. There have been many reasons, however, why this principle could not be successfully applied in broadcast receivers. There has been a lack of uniformity over the broadcast band which meant that if compensation was attempted it would be correct only at one broadcast frequency and incorrect at all other frequencies. It is not clear from the present paper (Mr. Cocking's article) whether the action of the crystal stage is sufficiently uniform to make compensation in the audio amplifier entirely possible. It is, however, entirely reasonable to expect that such an arrangement can be more successfully used in a circuit with such a high inherent selectivity than was possible with circuits of the conventional type.

Increase in Cost

The Robinson method represents an improvement in performance but only at a very obvious increase in cost. It is ordinarily not difficult to improve the performance of a mechanism by making it more complicated and therefore more expensive. It is those inventions which show how to obtain greater performance with less parts and lower cost that can be most rapidly embraced by an industry. The superheterodyne circuit is in itself inherently more expensive than the straight tuned radio-frequency circuit and the Robinson method seems to add still more complication to the superheterodyne method. It is reasonable, therefore, to question whether this new method can be rapidly adopted and it seems to be reasonably certain that although the Robinson method might permit a decrease in the spacing of broadcast channels, that no such change can be expected because of the tremendous number of receivers now in actual use which would be rendered obsolete if any such change were made. There is also the unquestionable fact that with modern receivers and modern broadcasting the radio listener has a program choice available to him which far exceeds his needs and no method of increasing the number of programs available seems to be necessary or desirable at this time.

All You Need to Learn TELEGRAPHY

*Morse or Continental
with Teleplex*

Learn Telegraphy—the world's most fascinating profession—by hearing real messages—sending them. Interesting, simple—you learn quickly—at HOME.

Teleplex is the Master Teacher. Used by U. S. Army, Navy and leading radio and telegraph schools.

Write for Folder E-12

TELEPLEX COMPANY
76 Cortlandt St., New York

WANTED MEN

To Manufacture Metal Toys and Novelties

Big demand for Toy Soldiers, Animals, 5 and 10c Store Novelties, Ashtrays, etc. We cooperate in selling goods you make also buy them from you. Small investment needed to start and we help you build up. WE FURNISH COMPLETE OUTFITS and start you in well paying business. Absolutely NO EXPERIENCE and no special place needed. A chance of a life time for man with small capital. CHRISTMAS RUSH is now starting, so if you mean strictly business and want to handle wholesale orders now being placed, write AT ONCE for full information.

METAL CAST PRODUCTS COMPANY
Dept. 12 1696 Boston Road New York City

EVEREADY RAYTHEON RADIO TUBES

Trade-marks

Antenna Construction

(Continued from page 557)

by using a correction factor, the factor for determining antenna length in feet is to multiply the wavelength in meters by 1.57—found by years and years of experience to be safe and sane. Thus, 41.4 x 1.57 gives a length of 64.998 or 65 feet. That becomes the length of the radiator. Now, where does the feeder connect? Fourteen per cent. of the total length of the radiator gives a figure of 9.1 feet or 9 feet and 1 inch, close enough. So, using the center of the radiator as a starting point, we measure off 9 feet and 1 inch and that is where the feeder is connected. Surely nothing could be easier.

Now to the Zepp feed. When the Zepp-feed Hertz antenna system is straightened out it looks somewhat like Fig. 11-A. The feeder makes up one-half of the system and the radiator makes up the other half—the whole thing being a full-wave antenna stretched out on the floor. The maximum current will be found at Y in Fig. 11-B, the two ammeters shown at X only indicating resonance when each reads the same as the other. If we could get an ammeter exactly in the center of the coupling inductance as shown in Fig. 11-C, maximum current at that point would indicate maximum current at Y in the radiator portion of the system. Again, the same method of determining radiator length applies here. However, suppose instead of working in wavelength, it is desired to work in frequency. The radiator is to work at 7,250 kilocycles—the same as 41.4 meters. Instead of going to all the bother of multiplying 300,000 by 1.57 and then dividing by 7,250, it is only necessary to divide 471,000 by 7,250 and determining the answer, which is 64.998 or 65 feet. It makes no difference whether it is figured using the wavelength in meters or the frequency in kilocycles. For wavelength in meters, multiply the wavelength in meters by 1.57 to determine the half-wave radiator length in feet. For frequency in kilocycles, divide 471,000 by the frequency in kilocycles to determine the half-wave radiator length in feet. For a full-wave radiator, multiply the length of the half-wave radiator by 2 and for a quarter-wave radiator, divide the half-wave radiator length by 2.

Fig. 12 shows the arrangement of the Zepp-feed Hertz antenna system, using a one-half wave radiator. The Zepp feeders, that is, the length of each feeder wire, should be one-quarter wavelength long, or one-half the length of the radiator. An indicating device, lamp or meter, can be connected at X to indicate resonance. The spreaders, 1/2" x 1/2" x 10", should be of hard wood and boiled in paraffin. The distance between spreaders may be three to five feet. For multiple-frequency operation, two feeder controls are used—series-feed control, Fig. 13, A, and parallel-feed control, Fig. 13, B. In this case the radiator would have to be 130 feet long and each of the feeder wires would have to be 60 feet long. To operate in the 3,500-4,000 kilocycle band, series tuning would be used. Both the 7,000-7,300 and the 14,000-14,400 kilocycle bands would require parallel tuning.

The inductance coil L1 and the con-

(Continued on page 566)

Now you can get the whole wide world!

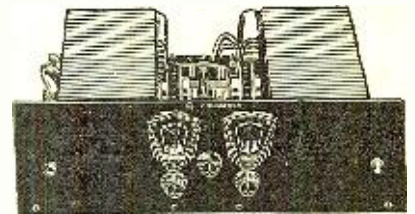

Any short-wave station in the world. The new ship-to-shore type coils and the scientific precision of this new set give revolutionary results.

I. C. A. CONQUEROR SHORT-WAVE RADIO SET

Here is the thrill of thrills. Tune in on the whole world and get them all. Even novices get Europe and South America at the first try. The I. C. A. Conqueror (A. C. operation) is the last word in high power, stabilized short-wave reception.

The coils and circuit are the combined achievement of I. C. A. engineers and a foremost ship-to-shore short-wave expert. The I. C. A. Conqueror will do all that the most expensive custom-engineered sets will do and far out-performs the popular sets on the market, yet the Conqueror sells at a popular price—in kit form, complete with all coils, quickly assembled.

The I. C. A. Conqueror uses a 224 screen-grid in the R. F. One 227 for detector and two 227's

and one 245 in the transformer-resistance-transformer-type audio. For broadcast-band reception, special coils of scientific design are used.

Although any A and B power supply may be used, we recommend the I. C. A. Conqueror Power Pack, scientifically designed to be extremely constant in voltage flow.

Dealers, professional set builders and servicemen! Make real money assembling and selling the I. C. A. Conqueror. A splendid opportunity for part or full time profits. Order from jobber or mail order house. If they can't supply, send direct. List Price of set \$55.—Net \$39. A. C. Power Pack. List Price \$34.50—Net \$19.75. Catalog and full information free on request.

INSULINE CORP. OF AMERICA, 78-80 Cortlandt, St., New York, N. Y.

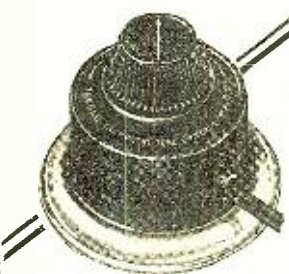

Bring Your Radio Set UP-TO-DATE

by adding the

CLAROSTAT Tone Control

Special INTRODUCTORY OFFER!

To introduce this latest development of the engineering staff of the Clarostat Mfg. Co. we will send postpaid this \$2.35 list price item for \$1.25 if accompanied by the coupon in lower right hand corner. Send cash, check or M. O. No C. O. D. orders filled. This special offer expires December 30, 1930.

The Clarostat Tone Control modifies the tone gradually to suit individual musical tastes. Neat, easy to install. Packed in compact case. Full instructions with every unit.

Clarostat Mfg. Co. Inc.
285 N. 6th St. Brooklyn

Enclosed, please find \$1.25, for which please send me one Clarostat Tone Control by return mail.

CLAROSTAT MFG. CO.,
285 N. 6th St., Brooklyn, N. Y.

Name.....
Address.....
City.....
State.....

RIGHT NOW!

Send for Our

NEWEST CATALOG

Largest Assortment and Biggest Bargains in

Hammarlund, National, Amertran, Aerovox, Yaxlev, Samsø, Sylvania, Arcturus, de Forest, RCA Tubes, Public Address Amplifiers, Weston, Jewell Meters, Jensen, Rola, Best Speakers, Universal Microphones, etc.

ALL MERCHANDISE AT WHOLESALE

S. HAMMER RADIO CO.

142 Liberty Street, New York
Tel. Hitchcock 1152—Dept. N

Yes! It's a new **RADIO!** Try any outfit—**30 days** **Free** BEFORE YOU BUY

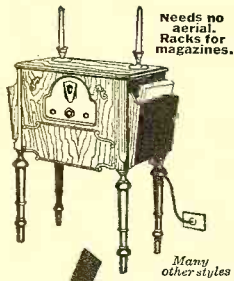

Needs no aerial
Rack for magazines.

Factory to you
SAVE to 50%

SUPER Screen Grid
Push-Pull Latest
Electric Radios

Enjoy a powerful new 1931
Miraco outfit for 30 days
—at our risk. No obligation
to buy. Get Send-No-
Money, Amazing Special
Factory-to-You Offer

Many other styles

MIRACO

11th
Successful Year

Compare with Costliest Sets!

America's big, old, reliable Radio
Factory springs its 11th anniversary
sensations! Latest SUPER
Screen Grid, perfected
Push-Pull Super Dynamic
Electric AC sets of finest
construction with costliest
features—Varitone and
automatic sensitivity
control and *no hum*—at
astounding low factory prices.
Clever new cabinets—big vari-
ety—exclusive designs. Com-
pare with costliest radios—un-
less 100% delighted with Miraco's sharp
selectivity, RICH, CLEAR, TONE,
and DISTANCE-GETTING, don't buy
Delighted thousands report programs
from Coast to Coast with tone and power
of expensive outfits. *Still near's quar-*
anty. Play safe, insure satisfaction, save
lots of money—deal direct with big, old
factory—pioneers in fine set making—11th
successful year. Write and be convinced!

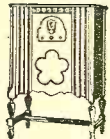

SUPER
Screen Grid
\$49.88
COMPLETE
less tubes

Send postal or coupon.
Amazing "Send No Money"
Offer. No Obligation.

USER-AGENTS!
Exclusive Territory
Big Money, No Risk



Free

MIDWEST RADIO CORPORATION
Pioneer Builders of Sets—11th Year
804-CD Miraco Dept., Cincinnati, Ohio
Send Amazing Special Factory Offer.
 Interested in Agents' Proposition

NAME
ADDRESS

FREE BOOKS of BUSINESS HELPS

We publish over 200 Home Study Books, each a complete treatise of its subject. We have one or more for you. Books on

- Commercial Art
- Lettering
- Advertising
- Sign Making
- Radio
- Aviation
- Painting
- Silk Screen Process
- Decoration
- Automobiles
- Battery Work
- Electricity
- Carpentry
- Building
- Contracting
- Sheet Metal Work

and many other subjects. All fully described in our FREE CATALOG. Check the subjects in which you are interested and write today.
FREDERICK J. DRAKE & CO., Publishers
Room 510—179 No. Michigan Blvd., Chicago
Drake books are for sale in all book stores

TYPEWRITER 1/2 Price

Save over 1/2 Rock Bottom Price on all standard office models—Underwood, Remington, Royal, etc.—Easiest terms ever offered. Also Portables at reduced prices.
SEND NO MONEY
All late models completely refinished like brand new. Fully Guaranteed. Sent on 10 days' trial. Send No Money. Big Free Catalog shows actual machines in full colors. Greatest bargains ever offered. Send at once!
231 W. Monroe St.
International Typewriter Exch., Dept. 1293 Chicago



Radio Helps Uncle Sam's Engineers

(Continued from page 516)

voltage feed antenna began causing occasional QRM to the amateurs back home late in December, 1929. A 250-watt tube soon replaced the 50 and regardless of a little smoke from the old double spaced receiving condensers, gave notice to the homeland that we would be heard. However, endeavors to improve our note continued and not until February, 1930, did we have the courage to ask WVL (Quarry Heights, C. Z.) to test. The first attempt, on February 10th, was successful and this new channel immediately took over the burden of our traffic for the outside world, which up to this time had been routed through NAZ.

The air line distances between the stations of our net are approximately as follows:

- Granada-San Carlos 96 miles
- Granada-Ochoa 144 miles
- Granada-Greytown 167 miles
- San Carlos-Ochoa 48 miles
- San Carlos-Greytown 75 miles
- Ochoa-Greytown 32 miles
- Granada-Quarry Heights,
- Canal Zone 480 miles

In our original plans it was expected that traffic between Granada and Greytown, and possibly between San Carlos and Greytown, would have to be relayed through Ochoa. This plan was followed in the beginning but during December, due to a lessening of atmospheric, direct contact between these stations became possible. Late in February atmospheric again became bothersome and it was again necessary to relay between Granada and Greytown, although San Carlos and Greytown have continued to work direct.

Considerable interference is caused at Greytown by ship spark stations and at Ochoa a considerable loss of radiated energy is experienced due to its location in the heart of the jungle, surrounded by giant trees and not too favorable terrain.

During December, January and February we noticed very little static during the day at any time, but shortly after sun-down and during the night low frequency reception became nearly impossible. Since about March 1st atmospheric throughout the twenty-four hours have gradually become stronger until at times it has been almost impossible to receive an ordinarily strong signal on low frequency, while high frequency reception has been undisturbed. Immediately upon the beginning of the rainy season, about May 20th, there was a very noticeable improvement in low frequency reception.

During the five months from December 1st to April 30th, our average monthly traffic was 1,122 messages and 49,750 words. There are several reasons for the large amount of traffic handled. The slowness of other methods of intercommunication between units of the battalion makes it desirable and often necessary to handle by radio much correspondence that would ordinarily be taken care of by some other means of communication. The same is true of a great deal of correspondence with the War Department. Three weeks must be considered as the minimum for regular mail to the States and air mail

takes nearly a week. And any matter that is at all urgent must be handled by radio. Also, the fact that during parts of the year a large number of messages must be relayed within our own net causes an appreciable increase in the total messages transmitted.

We had one rather unusual accident here at the Granada station when a "zope-lote" (a Nicaraguan buzzard) flew into one of the guys of the antenna mast and broke it. It happened to be a rather vital guy and the mast fell as a result, breaking two sections. The incident happened during the morning, at a time when our schedule did not permit any unnecessary delay. A temporary small antenna was hurriedly improvised and traffic continued. Fortunately, we had some spare sections, so as soon as time permitted the mast was again assembled and erected. Any one who has ever erected an 85-foot, wood section mast, in a patio surrounded by tiled roofs, will agree that such an accident is greatly to be regretted.

The San Carlos station was out of operation for nearly a month, due to failure of the engine piston. Unfortunately, the only oil available was a little too light for an air-cooled motor, operating at the speed at which these motors run. Although great care was taken to provide plenty of oil and change it regularly, before the proper grade of oil could be obtained from the States the sides of the piston had worn to almost paper thickness and it suddenly broke. Attempts to purchase the necessary parts locally were unsuccessful and a radio was sent to Panama in an effort to obtain them. Panama didn't have them so it was necessary to get them from the States. Granada and San Carlos are connected by commercial telegraph which provided a means of emergency communication, but traffic from Granada to San Carlos was transmitted on the regular schedules and copied blind with excellent results.

On the whole the equipment has been very satisfactory. Some trouble has been encountered, and was to be expected, especially when one considers that the equipment is designed for brief periods of use under temporary conditions. Our stations have become in fact permanent installations, and the daily operating time runs into hours.

Charging of the two BB-41 batteries of the SCR-136 was arranged for by placing one of these batteries in series with a VT-2 transmitting filament and connecting it in shunt to the eleven-volt generator line, the voltage of the battery acting as a counter E.M.F. to prevent the burning out of the tube filament or an excessive charging rate. Opening the battery circuit before the generator was stopped prevented the battery from discharging back through the armature. By using this arrangement one battery was charging during the time the transmitter was operating and the other battery discharging. It also proved possible to charge a battery in this manner and use it simultaneously for receiver filament supply. With a weak sig-

(Continued on page 565)

EXPLORE THE SHORT WAVES
with the
EXPLORER PLUGLESS CONVERTER
Covers 15-200 Meters without Plug-in Coils
Price only \$14.50
WRITE FOR FREE DESCRIPTIVE LITERATURE
RIM RADIO MFG. CO.
695 Grand Street Brooklyn, N. Y.

Radio Helps Our Engineers

(Continued from page 564)

nal, however, the slight noise caused in the receiver becomes objectionable. This system was found to be practical only when the hours of listening-in considerably exceeded those of transmitting.

In charging the batteries for the SCR-132 it was only necessary to connect the required number of 110-volt lamp bulbs (fortunately a part of Engineer equipment) in parallel and in series to the battery, across the 110-volt generator terminals.

The use of window sash cord, even when paraffined, or any other type of hemp or cotton cord for antenna guys has been found to be unsatisfactory in a country subject to the winds, rain, and sun of the tropics. Also the white ants have a tendency to devour anything of that nature with which they come in contact. Foreseeing difficulties in this connection our 85-foot masts were erected with galvanized wire (GI-14), broken at intervals with insulators. This solution is not ideal but is a solution. It would seem that for semi-permanent installations under conditions such as these the best solution would be the substitution of a light flexible cable, broken at intervals with small strain insulators.

H
A
M
M
A
R
L
U
N
D

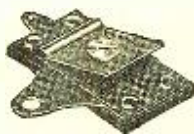
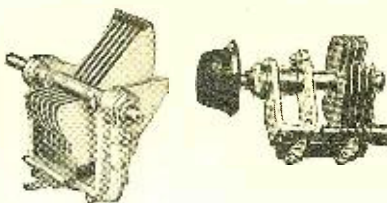
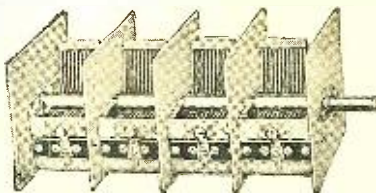
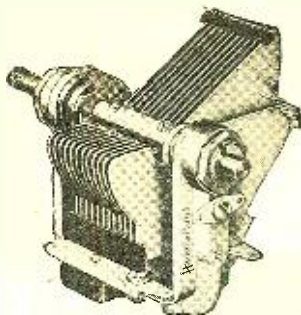

For Every Purpose

C
O
N
D
E
N
S
E
R
S

SINCE Radio began, Hammarlund has been condenser headquarters.

Not by chance has Hammarlund leadership been consistently maintained—but simply by the art of better engineering, better manufacturing and better values.

Whether it is for tuning a single broadcast circuit—multiple circuits from two to four—short-wave work—balancing or trimming—Hammarlund supplies precisely the condenser needed.

And you can rely on that full measure of superiority which has always made Hammarlund the preferred condenser by radio experts throughout the world.

Write Dept. RN-12 for literature on condensers and other Hammarlund Precision Products.

HAMMARLUND MFG. CO.
424-438 W. 33rd Street, New York

For Better Radio
Hammarlund
PRECISION
PRODUCTS

Design and Testing of Broadcast Receivers

(Continued from page 511)

develop troubles after a time in service, due to, perhaps, the deterioration of a part, damage in shipment, or mishandling by an inexperienced owner. To correct these troubles the radio serviceman has become an important figure. He must understand the tests that have been given to a receiver, and what the manufacturer is trying to accomplish by them, in order to intelligently correct troubles.

Any number of tools are now at the disposal of service men to help in running down and correcting troubles. A few of these are the ohmmeter, to check the values of the various resistors; the test oscillator, which is essentially a small portable broadcasting station by means of which the serviceman has at his disposal a radio signal at a known frequency and constant amplitude to enable him to properly align the tuning units, to set the tuning scale; and to make selectivity tests; set analyzers which provide a means for determining the voltages and currents in the circuits; tube testers which measure the characteristics of the tubes and enable him to locate defective and worn-out tubes. These are only a few of the instruments now on the market, and others are being constantly developed to make the increasingly complicated tests necessary as the art of receiver design advances.

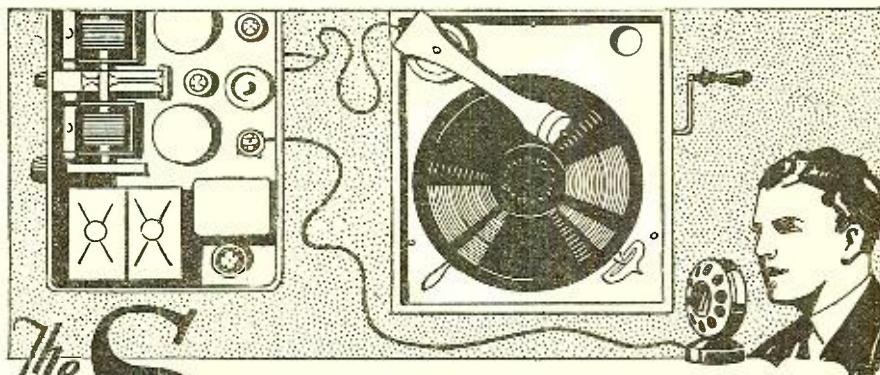

The SIMPLIMUS HOME RECORDING OUTFIT

HOME RECORDING was the Hit of the New York Radio Show and will be the sensation of the year. Public interest shows that the idea will sweep the country, millions of homes will be equipped. Simplimus, Inc., presents a Home Recording outfit that can be attached to any radio and any phonograph.

With this simple, inexpensive home-recording apparatus, you can make phonograph records of everything you'd like to rehear. Special radio programs, concerts, the voices of your children and friends as well as your own, unusual events, all can be recorded for future reproduction with this new outfit. Outfit comes complete with recording arm, pickup apparatus and microphone, or, the parts can be bought separately. Priced exceptionally low. Send for further information. Special discounts to dealers and service-men.

This new device opens up an unlimited field for radio dealers and service-men.
Write for full information today

SIMPLIMUS, Inc. 67 CHURCH ST. BOSTON, MASS.

COUPON

SIMPLIMUS, INC.
67 Church St., Boston, Mass.

Please send, without obligation, all information regarding the Home Recording outfit.

NAME

ADDRESS

CITY

OCCUPATION

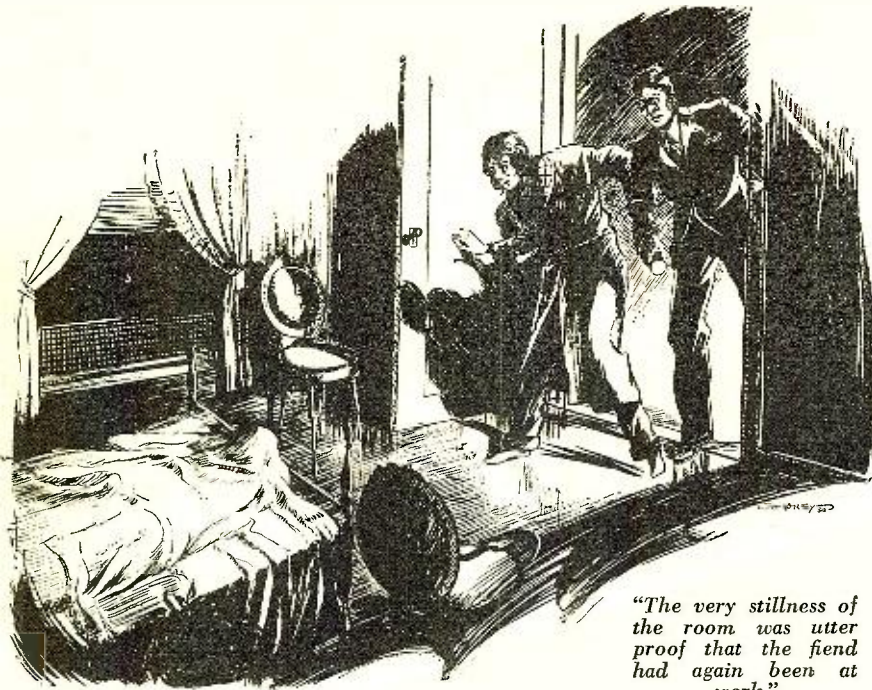

"The very stillness of the room was utter proof that the fiend had again been at work."

The Killings in Carter Cave

ON the night that Mr. Carter, bred a Virginia gentleman, and land wealthy but money poor, opens to the public the mammoth cave discovered recently on his property, he is found cruelly stabbed to death in a hidden recess of the cave by a pointed stalactite.

In the celebration party are the guide, named Lem; a famous geologist; the secretary to the geologist; a newspaper reporter who is in the party in order to describe the newly discovered cave to his paper; a young couple, obviously bride and groom; a well-known actress; and a maiden-lady from Boston. Because of the difficulty in entering the cave, it is practically impossible for any one outside of the party to kill Carter. But at the inquest every one seems to have a perfect alibi. Two members of the party, however,

do not believe that the killing was accidental or done by persons unknown. They secretly think it a fiendish plot, carried out for reasons unknown, and set to work to prove their beliefs.

If you were in their shoes, and had the same facts presented to you, what would you do? Could you have prevented the additional crimes that were committed?

Here in "The Killings in Carter Cave" is a complete book-length detective novel, exactly the same sort you pay \$2 for in the bookstores. Now you can read it for the first time at only 25c.

Get a copy of Complete Detective Novel for December today and settle down to an inexpensive, delightful evening of dramatic, soul-stirring mystery.

Now You Can Read it in December

COMPLETE

DETECTIVE NOVEL

Magazine

ONLY 25c A COPY AT ALL NEWSSTANDS

Antenna Construction

(Continued from page 563)

condensers C in Figs. 9 and 12 are identical for multiple-frequency band operation. L1 consists of 12 turns of No. 12 enameled copper wire wound on a form 4 inches in diameter—turns spaced 1/4 inch. The capacity of the condenser, C, is 450 micro-microfarads.

Length of Radiator

In any Hertz type antenna it is quite essential that the radiator be very close to the right length in feet and inches. More especially is this true when a crystal oscillator is used, in which case it requires some method of antenna adjustment to bring the whole system into resonance. This is one reason why the W9EK-W9XH antenna systems were of such arrangement that the antenna system could be tuned to resonance with the amplifier frequency—the Fig. 7 arrangement. Of course, if the radiator can be cut to the exact length to resonate with the amplifier frequency, in the case of a crystal oscillator, all well and good. But,

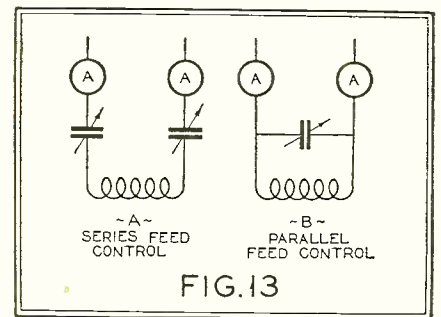

FIG. 13

Fig. 13. Condensers arranged either in series or parallel in the feeder line provides for multiple frequency operation

surrounding objects have much to do with the correction of the radiator length and it may get down to a case of cut-and-try where inches become a factor.

However, if some other form of oscillator is used which will permit adjustment to radiator resonance, then the length of the radiator isn't so important, but it should be cut to the proper length by measurement and not by guess. No. 12 solid copper wire is quite satisfactory. It has the mechanical strength to stand up under severe weather and sleet conditions. Bare wire is not as good because it corrodes quickly and eventually it will cause trouble. It is far better to use a heavy solid wire than a light one. Anything smaller than No. 14 B. & S. gauge is to be avoided.

Good wooden masts are to be chosen instead of metal masts which can cause all sorts of re-radiation. Guy wires should be broken up into short lengths with good insulators.

There is nothing like a well-designed and well-constructed antenna system for maximum efficiency. Too often the amateur puts brute power into his transmitter only to be wasted in a poorly constructed antenna system when he might do considerably better work with less power and a well-balanced antenna system.

News from Manufacturers

Tone Control and Capacity Aerial Eliminator

The F. & H. Radio Laboratories, Fargo, N. D., is manufacturing a new tone control and noise eliminator which operates in practically any set and does not affect the tuning of the receiver. It



is finished in crystalline and comes complete with adapters and twelve-foot silk cord for remote control. The aerial eliminator manufactured by this company does not consume current or connect to the light socket in any way. It derives its energy from the earth waves and has



increased selectivity, is easier to install and the advantage of eliminating the use of poles, guy-wires, mutilation of wood-work for lead-in wires, etc. It is for use with a.c. sets only. It has a capacity of a regular outdoor 75-foot aerial.

N. S. Tobey Elected Vice-Pres. of Dubilier Condenser Corp.

At the last meeting of the Board of Directors of the Dubilier Condenser Corporation, N. S. Tobey, sales manager, was elected executive vice-president of the company. Mr. Tobey, who has been busily engaged in building up the radio and industrial sales of the Dubilier organization during the past year, is going to devote a considerable portion of his time from now on to the production and other phases of the business.

DeJur-Amsco Expands

The DeJur-Amsco Corporation, manufacturers of variable condensers and power rheostats, has taken 20,000 square feet in the new loft building at 25 Morton Street, New York. Benjamin Price, sales manager, states that their laboratory and machine shops have been enlarged and modernized so that the company is now equipped and tooled to produce 10,000 multiple condensers daily.

The company has also introduced a line of heavy-duty rheostats and potentiometers for sound picture use.

Oil-Damped Pick-up (Continued from page 530)

manded insistently by the theatre ever since the day when the first talkie made its appearance. The oil-damped pick-up was the result of the efforts of Pacent engineers to produce a unit that would not only add an octave to the possible range of reproduction, but also eliminate record jumping and reduce record wear, two of the greatest evils in the exhibition of sound-on-disc shows.

The new oil-damped pick-up brings with it many highly desirable features: better record tracking, less record wear, no rubber bearings, constant viscosity oil making possible elimination of undesired resonance and an added frequency range, greater than that possible with previous types by more than an octave.

The reduction of the armature mass not only reduces record wear, but increases the responsive frequency range of the instrument as well. Elimination of rubber bearings precludes the possibility of this medium losing its resilience after a period of time with the consequent ill effect in the operation of the unit as a whole. The use of a constant viscosity oil as a damping medium prevents the armature from going on a rampage at certain frequencies to which it is most responsive—a condition which must be avoided if faithful reproduction is wanted.

All these desirable features are now available to manufacturers of phonographs and radio-phonograph combinations in the new oil-damped pick-up announced by Pacent which is a counterpart of the instrument used so successfully in theatres. In fact, the only difference between the two is the introduction of a brand new idea in counterbalancing in the unit offered to radio manufacturers. In place of the customary counterweight, an adjustment has been incorporated in the base of the tone arm so that the actual pressure of the needle upon the record can be varied at the will of the operator.

The new oil-damped pick-up can be had with or without tone arm.

Booklet

Aerovox Wireless Corporation, 70 Washington St., Brooklyn, N. Y., has published an interesting booklet on the Hi-Farad dry electrolytic condenser. Every phase of the subject of electrolytic condensers is covered as are also the characteristics of various types.

Tone Control

With practically every new set a tone control is included for the purpose of varying the tone from a sharp treble to a mellow bass, as well as suit the rendition to musical taste, to program, and to room acoustics. With the old set, however, without a tone control, there is something lacking. But, fortunately, in-

(Continued on page 568)

The answers to your questions on building, testing and repairing radio sets



The three volumes of this Library cover the entire field of building, repairing and "trouble-shooting" on modern radio receivers. The Library is up-to-the-minute in every respect and is based on the very latest developments in the design and manufacture of equipment. The rapidly-growing interest in short-wave reception is thoroughly covered in a complete section which deals with the construction of this type of apparatus.

Radio Construction Library

By JAMES A. MOYER and JOHN F. WOSTREL

Faculty, University Extension, Massachusetts Department of Education

Three Volumes — 993 Pages, 6x9
561 Illustrations

VOLUME I: presents the fundamental principles of radio so clearly and simply that anyone of average training will be able to read, understand and apply them. In one chapter alone, it gives actual working drawings and lists of materials for the construction of eight typical sets.

VOLUME II: fully discusses all of the elementary principles of radio construction and repair. An explanation of the necessary steps for "trouble-shooting," repairing, servicing and constructing radio sets successfully. Practical data is also given on antenna systems, battery eliminators, loud speakers, chargers, etc.

VOLUME III: covers the essential principles underlying the operation of vacuum tubes in as non-technical a manner as is consistent with accuracy. It discusses the construction, action, re-activation, testing and use of vacuum tubes; and an interesting section is devoted to remote control of industrial processes; and precision measurements.

EXAMINE these books for 10 days FREE

This Library is not only a thorough home-study course, but a handy means of reference for the

paid. If not wanted, will return
expense.

Name

Home Address

City and State

Position

Name of Company RN-12-30

Makes Your Radio BEHAVE!

ENJOY steady radioperformance with uniform volume undisturbed by the everchanging house electric supply.

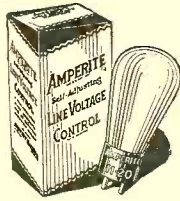

The new AMPERITE for electric radio smooths out current fluctuations automatically. Requires no attention. Install AMPERITE in the electric radio you buy or build, or in the radio you now have.

Ask your dealer or write Dept. RN12, naming make and model number of your set.

AMPERITE Corporation
561 BROADWAY, NEW YORK

AMPERITE Self-Adjusting LINE VOLTAGE CONTROL

Home-Study Business Training

Your opportunity will never be bigger than your preparation. Prepare now and reap the rewards of early success. Free 64-Page Books Tell How. Write NOW for book you want, or mail coupon with your name, present position and address in margin today.

- | | |
|--|--|
| <input type="checkbox"/> Higher Accountancy | <input type="checkbox"/> Business Corres. |
| <input type="checkbox"/> Mod. Salesmanship | <input type="checkbox"/> Credit and Collection |
| <input type="checkbox"/> Traffic Management | <input type="checkbox"/> Correspondence |
| <input type="checkbox"/> Rail. Station Mgm't | <input type="checkbox"/> Modern Foremanship |
| <input type="checkbox"/> Law: Degree of LL.B. | <input type="checkbox"/> Personnel Mgm't |
| <input type="checkbox"/> Commercial Law | <input type="checkbox"/> Expert Bookkeeping |
| <input type="checkbox"/> Industrial Mgm't | <input type="checkbox"/> C. P. A. Coaching |
| <input type="checkbox"/> Banking and Finance | <input type="checkbox"/> Business English |
| <input type="checkbox"/> Telegraphy | <input type="checkbox"/> Commercial Spanish |
| <input type="checkbox"/> Business Mgm't | <input type="checkbox"/> Effective Speaking |
| <input type="checkbox"/> Railway Accounting | <input type="checkbox"/> Stenotypy—Stenog'y |
| <input type="checkbox"/> Paper Salesman's Training | |

LaSalle Extension University, Dept 1294-R, Chicago

Wireless (Radio)

and Morse telegraphy taught thoroughly. School, oldest and largest; endorsed by Telegraph, Radio, Railway and Government officials. Unusual opportunities. Expenses low—can earn part. Catalog free. DODGE INSTITUTE, Oak St., Valparaiso, Indiana.

NEW NOVELS

Now you can buy the best of the new detective novels in complete book-length form at all newsstands. Ask for Complete Detective Novel for December today!

NOW ONLY 25c

News from Manufacturers

(Continued from page 567)

genuity steps in as usual and solves the problem with a tone control applicable to any radio set.

The Clarostat Tone Control developed by the engineering staff of the Clarostat Mfg. Co., Brooklyn, N. Y., is compact,

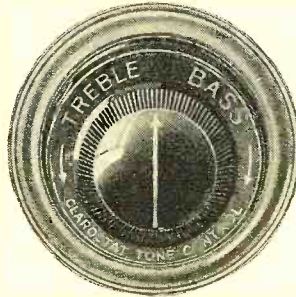

simple and entirely workable with any set. Outwardly, it takes the form of a small case with top knob turning from "Treble" to "Bass" positions in providing any degree of sharpness or mellowness from the loud speaker. The device is provided with two flexible leads, terminating in connectors that fit about the prongs of the usual power tubes inserted in their sockets, thus establishing the necessary connections without tools or special skill. Inwardly, the device consists of an adjustable absorption circuit and audio filter which by-passes more or less of the higher frequencies before they reach the loud speaker, thereby lowering the fundamental pitch and mellowing tone to any desired degree, precisely as in the case of the built-in unit. In the case of a single power tube, connections are established between the power tube and the set "Ground" binding post.

Wire-Wound Resistors



International Resistance Company of Philadelphia, Pa., is making a precision-wound resistor in ranges up to and including 2½ megohms. The unit has a number of unique features, in that it has a molded cap as against a soldered wire contact and the wire itself is carefully tested and insulated. These resistors are held to accuracies as close as ¼ of 1 per cent. They are adaptable to test meter equipment, voltage amplifiers and as standards in laboratory equipment. A special folder has been printed on these wire-wound resistors.

HOTEL LUDY

SOUTH CAROLINA AVE. AT THE BOARDWALK
ATLANTIC CITY'S
NEWEST
CENTRALLY
LOCATED
FIREPROOF
HOTEL

\$6.00

DAILY
AND UP
AMERICAN
PLAN

WIRE PHONE OR WRITE R. B. LUDY M. D.

HOTEL WASHINGTON

Opposite the United States Treasury
PENNSYLVANIA AVENUE
AT 15TH & F STREETS
400 ROOMS—400 BATHS

Floor clerks on each floor. Desks open from 7.30 A.M. until midnight. A service particularly attractive to ladies traveling alone.

Easy of access yet located at the very center of life in the Capital City.

RATES NO HIGHER THAN ANY OTHER FIRST CLASS HOTEL

Booklet sent upon request
S. E. BONNEVILLE
Managing Director
WASHINGTON, D. C.

Radio's Biggest Values

**Send for
FREE
Complete
Catalog**

Up-to-the-minute offerings at lowest wholesale prices. Includes newest Tone Control, Screen Grid Superheterodyne, Radio - Phonograph combinations, short wave receivers, automobile radios. Public address attractive walnut consoles and latest accessories, parts and kits. Don't buy until you see our big catalog.

Western Radio Mfg. Co.
128 W. Lake St. CHICAGO

GEARS

In stock—immediate delivery

Gears, speed reducers, sprockets, thrust bearings, flexible couplings, pulleys, etc. A complete line is carried in our Chicago stock. Can also quote on special gears of any kind. Send us your blue-prints and inquiries.

Write for Catalog No. 40
CHICAGO GEAR WORKS
769-773 W. Jackson Blvd., Chicago, Ill

BUILD YOUR RECEIVER with the Aid of BLUEPRINTS!

A limited supply of blueprints still available on the following receivers:

The Junk Box Short-Wave Receiver .25c
A Two-Tube Reflex Receiver 25c
How To Construct the Pre-Selector . . 25c
A Bloopless One-Dial Two-Tube Set . . 25c

Write to
Radio News, Blueprint Dept., 381 Fourth
Avenue, New York City

Tone-Compensating Circuits

(Continued from page 521)

1—Reinforcement of the Bass Tones (Below 100 C.P.S.)

The lowest frequencies found in records are confined to about 50 cycles and up. Also in radio broadcast rarely is there anything below this mark, as it has been found almost impossible to detect the difference in quality with frequencies below 50 eliminated or with them present in the musical rendition. The pianoforte is practically devoid of foundation tone in its last octave, and in the orchestra only the bass viol is able to give a bass with strong fundamental below even 100. The bass tuba is full of overtones which are much louder than the fundamental in the 50-100 c.p.s. octave, although nominally it should go down to 43 c.p.s. For organ music I must admit that I would be sorry to hear it deprived of the glorious 32-foot bass stops, but even then these tones would be missed only on rare occasions, as they are never alone, for the organists play them or should play them always accompanied by stops sounding one or even two octaves above, which are much more powerful. It follows that for ordinary purposes, excellent music may be obtained even with the bass end of the scale limited down to 50 c.p.s.

Our aim, then, should be to reinforce the octave between 50 and 100 c.p.s. with an amplitude increasing towards the low end. There are several means of accomplishing this end, but one has been found to be extremely simple and effective, and requires but two condensers and two chokes to be added to the conventional two-stage transformer-coupled audio amplifier. The schematic circuit of one stage is shown in Fig. 1.

Let us consider the circuit comprising the pick-up with its regulating potentiometer or "fader" and the condenser and inductance of the primary winding of the first transformer. If we call R the resistance (effective) of the pick-up combination, or that of the plate of the tube in the case of the second stage, and if L and C are the inductance and the capacity in the series circuit, and if the resistance in the coil is negligible in comparison with the reactance, the voltage across the coil will be

$$e_2 = I\omega L$$

Where I is the current and L is the frequency in radians, the generated voltage will be

$$e_1 = I \sqrt{(R + \eta)^2 + \left(\omega L - \frac{1}{\omega C} \right)^2}$$

the ratio of impressed to generated voltage will be

$$\frac{e_2}{e_1} = Y = \frac{\omega L}{\sqrt{(R + Y)^2 + \left(\omega L - \frac{1}{\omega C} \right)^2}}$$

and if for simplicity we take into account the ratios of the resistance of the tube, R, or pick-up to the reactance of the coil ωL , or that of the condenser

$\frac{1}{\omega C}$ at the frequency for which they are

equal, and calling this ratio Q, then

$$Q = \frac{\omega L}{R + Y} = \frac{1}{\omega C (R + Y)}$$

Calling f_0 the frequency for which these reactances are equal, and designating the ratio between any frequency f_2 to f_0 by n, so that $f = nf_0$, then the reactance of the coil at any frequency is $X = nX_0 = nQR$, and that of the condenser will be $X_c = n^{-1}X_0 = n^{-1}QR$.

The gain in voltage at any frequency between the impressed e.m.f. and the voltage across the coil (which multiplied by the ratio of transformation is the impressed voltage at the grid of the first tube) will be given by the expression:

$$Y = \frac{nQ}{\sqrt{1 + Q^2 (n - n^{-1})^2}}$$

By giving numerical values to Q, we find the corresponding values of the gain Y for various frequencies, we derived the curves in Fig. 2. The abscissæ represent n, or ratios of any frequency to the resonant frequency f_0 . The first curve, marked "A," was calculated with $Q = 10$, while curve "B" was obtained with $Q = 5$. It will be noted that the first of these two curves will not give a very satisfactory shape to the bass octave voltage curve because the gain is so sharp. If, however, we are content with a smaller gain, like in curve "B," and we follow the first stage with a second stage having a similar circuit, but the frequency f_0 moved, say about 20%, we will obtain curve "C" in a similar manner. If the ordinates are logarithmic, such as in our graphs, the combined gain of the two stages will be represented by the sum of the ordinates of curves "B" and "C," and this is represented by curve "D," which shows a gradual increase in level from normal (1:1 gain exclusive of tube amplification) at high frequencies to a maximum of 15 times at $n = 1.7$ approximately. By making $f_0 = 50$ c.p.s., the bass range will be sufficiently compensated for practical purposes. If, however, the bass is too pronounced in certain records, the curves can be brought down almost flat by shunting the coils with a resistance, the values of which may vary between $R = X_0$ and $R = \infty$.

It will be noted that it is relatively easy to change an ordinary transformer-coupled amplifier to a bass compensated amplifier. All that is required is to put a parallel feed into the plate of the tubes by means of chokes or resistances, and insert in series with the "P" terminal of the transformer primary windings a condenser such that $4\pi^2 f^2 LC = 1$ for $f = 50$ in one stage and for $f = 60$ in the second. It is well to observe this order, because when the first stage is tuned to $f = 60$ the slightest hum will be picked up and magnified considerably. Needless to say, also, that the hum elimination becomes correspondingly more difficult when a compensated bass amplifier is fed from an a.c. source than in the case of the straight or slightly "drooping" characteristic amplifier of the commercial types

(Continued on page 570)



**Manufacturers of
The Most Complete
CONDENSER and
RESISTOR Line
in Radio**

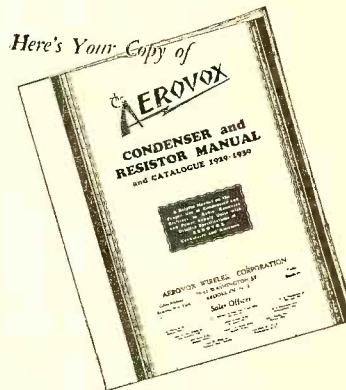

Sent Free on Request

This interesting and helpful Manual and Catalogue containing a wealth of information on condensers and resistors and complete electrical and mechanical data on the complete line of Aerovox condensers and resistors will be mailed free of charge on receipt of the coupon below.



The Aerovox Research Worker is a free monthly publication issued to keep radio engineers, experimenters and servicemen abreast of the latest developments in receiver and power supply design, and especially with the proper use of condensers and resistors. A request on the coupon below will place your name on the mailing list.

Check and Mail This Coupon

AEROVOX WIRELESS CORP.
78 Washington St.
Brooklyn, N. Y.

Gentlemen:

Please send me without charge or obligation:

- () Your 32-page Condenser and Resistor Manual and Catalogue.
- () The Research Worker.

Name

Street

City State



RUPTURE NOT A TEAR

NO BREAK TO HEAL

Rupture is not a tear, but is due to a muscular weakness in the abdominal wall. Trusses merely brace these muscles but do not strengthen them—on the contrary, the gouging of the ordinary truss pad often increases this weakness as it tends to shut off circulation of the blood.

STUART'S ADHESIF PLAPAO-PADS are patentably different—being mechanico-chemico applicators—made self-adhesive purposely to keep the muscle- tonic called "Plapao" continuously applied to the affected parts, and to minimize danger of slipping and painful friction. The adhesive fabric is soft as velvet and clings to the body without straps, buckles or springs. Easy to apply—comfortable—inexpensive. Awarded Gold Medal, Rome, Grand Prix, Paris, Honorable Mention, Panama Pacific Exposition, San Francisco, etc. For almost a quarter century stacks of sworn testimonials from many different countries report success—without delay from work. The epidermatic absorption of Plapao utilizing "mechanico-chemico therapy" tends toward a natural process of recovery, after which no further use for a truss.

Stop wasting your time and money on old-fashioned devices. Learn how to close the hernial opening as nature intended, so the rupture can't come down. Send no money; just mail the Free Test coupon below. For your own good—write today—tomorrow may be too late.

FREE TEST COUPON

Plapao Laboratories, Inc.
686 Stuart Bldg., St. Louis, Mo.

Send me a Free 10 day test supply of the remedial factor Plapao and 48-page illustrated book on Rupture; no charge for this now or later.

Name _____
Address _____

RADIO BARGAINS

- Low Power Transmitter adaptable for phone or code. With plug-in coils\$14.75
 - Auto Radio—Uses 3—224, 2—227 tubes and 1—245 power tube, single dial, tremendous volume. Compact. Fits any car. We guarantee this set to perform better than sets selling up to \$150... 20.00
 - B Eliminator, Bone Dry with 280 tube, 180 volts, will operate up to ten tube set, fully guaranteed. 6.75
 - AC—A B C power packs 8.75
 - Tubes: UX type, 30-day replacement guarantee. No. 210, \$2.25; No. 250, \$2.35; No. 281, \$1.85; No. 245, \$1.25; No. 224, \$1.25; No. 227, 75c; No. 226, 65c; No. 171, 75c.
- CHAS. HOODWIN CO., 4240 Lincoln Ave. Dept. M-3, Chicago

QUIT TOBACCO

Don't try to banish unaided the hold tobacco has upon you. Thousands of inveterate tobacco users have, with the aid of the Keeley Treatment, found it easy to quit.

KEELEY TREATMENT FOR TOBACCO HABIT Quickly banishes craving for tobacco. Successful for over 50 years. Write today for FREE BOOK and particulars of our MONEY-BACK GUARANTEE.

THE KEELEY INSTITUTE, Dept. L-610, Dwight, Ill.
Home of the famous Keeley Treatment for Liquor and Drugs.
Booklet Sent on Request. Correspondence Strictly Confidential.



The CROSLEY ROAMIO

AUTOMOBILE RADIO RECEIVING SET

Tone-Compensating Circuits

(Continued from page 569)

found in radio sets. In order to show the actual effects of the bass tone compensation an organ or an orchestral record may be played through a resistance-coupled amplifier and then through the compensated amplifier.

2—Reinforcement of the Treble Tones (Above 1,000 C.P.S.)

The high-frequency tones are not so much reduced in relative magnitude as the bass in the average modern record. The lack of high-frequency response comes, as a rule, from worn-out needles and from stray capacities in the windings of transformers, wiring, etc. In some instances the records themselves are lacking brilliancy, and in radio sets an excessive selectivity may mutilate the upper band of the audio range. Some volume controls of low resistance, across a pick-up, actually ruin the upper frequency response.

The evil effects begin to be felt a little above one kilocycle; hence our aim should be to raise gradually the level of the trouble from about 1,500 c.p.s. to about at least 3,000 for good articulation, or up to 6,000 for the preservation of the overtones in instrumental music, such as violin solos, where the individuality of the instrument must be kept. It is to be noted that the "apparent" loudness of a musical rendition is closely connected with the intensity of the upper register.

There are many ways of reinforcing the high tones, but amongst the simplest expedients are two which have several advantages:

- (a) By suitable transformer design.
- (b) By separate transformer to boost frequencies above a given value.

The first method (a) has fixed characteristics and hence it is not adjustable. The second (b) is adjustable and it may be given any pre-assigned shape.

In the first method (a) advantage is taken of the leakage reactance and distributed capacity in the transformer windings. Fig. 3 represents the equivalent circuit. If L_2 is about 10 times L_1 and C_2 is about the same value as C_1 , which is the ordinary case in interstage transformers, we can ignore, without serious error, C_1 and L_1 and consider the circuit L_2, L_2, C_2 as one in which an e.m.f. is generated across L_2 which is common to primary and secondary (M) and the resonant circuit L_2, C_2 will allow maximum current flow when

$$f = \frac{1}{2\pi\sqrt{L_2 C_2}}$$

and as there is an effective resistance R_1 not shown in the circuit, it will be seen that we can reduce the circuit of Fig. 3 to the schematic circuit of Fig. 4, which is of the same type as the bass boosting arrangement previously discussed but with different characteristics. There are many transformers in the market that have a treble boosting characteristic when suitably utilized.

The second means (b) for the reinforcement of high frequencies, which requires a minimum of additional apparatus,

(Continued on page 572)

See the Craters in the MOON!

Astronomical and Terrestrial TELESCOPE
Magnifies 30 Times

Owls a genuine Astronomer's Telescope. See thousands of miles away. Make Sun, Moon Planets, Stars your next door neighbors. Moon Craters, Sun Spots, Eclipses, Comets enlarged 30 times. Strange thrills!

Hours of fun looking at scenery, games, bathing beauties. Great for trips and voyages. Made like telescopes used in observatories. Gerding wrote, "Moon seemed 10 yards away."

Price Only \$3.95

Diameter 2 inches. Special friction adjustment for focusing. Adjustable bracket and clamp can be fastened to chair, fence, branch, etc. Finest materials. Will last a lifetime.

Five Days' Free Trial
Rush only \$1.00 now. Pay balance (\$2.95 plus postage), when postman delivers. Keep 5 days. If not delighted, return telescope and money will be refunded.

EARN \$10 A DAY
Charge 25c to look at the moon

ROLL-O SPECIALTY CO., Dept. R-335
220 E. 3rd St., Cincinnati, O.

How I Got Back my Hearing

By own, simple, inexpensive invention after being deaf 20 years, told FREE, to any deaf person who writes me. Geo. H. Wilson, Pres., WILSON EAR DRUM CO. 497 Todd Bldg., Louisville, Ky., U. S. A.

STATEMENT OF THE OWNERSHIP, MANAGEMENT, CIRCULATION, ETC., REQUIRED BY THE ACT OF CONGRESS OF AUGUST 24, 1912, Of RADIO NEWS MAGAZINE, published Monthly at Jamaica, New York, for October 1, 1930. State of New York } ss. County of New York }

Before me a notary public in and for the State and County aforesaid, personally appeared J. T. Van Zile, who, having been duly sworn according to law, deposes and says that he is the President of the Radio News Magazine.

And that the following is, to the best of his knowledge and belief, a true statement of the ownership, management (and if a daily paper, the circulation), etc., of the aforesaid publication for the date shown in the above caption, required by the Act of August 24, 1912, embodied in section 411, Postal Laws and Regulations, printed on the reverse of this form, to wit:

1. That the names and addresses of the publisher, editor, managing editor, and business managers are:
 Publisher—Radio-Science Publications, Inc., 381 4th Avenue, New York City.
 Editor—Arthur H. Lynch, 381 4th Avenue, New York City.
 Managing Editor—John B. Brennan, Jr., 381 4th Ave., New York City.
 Business Managers—None.
2. That the owner is: (if owned by a corporation, its name and address must be stated and also immediately thereunder the names and addresses of stockholders owning or holding one per cent or more of total amount of stock. If not owned by a corporation, the names and addresses of the individual owners must be given. If owned by a firm, company, or other unincorporated concern, its name and address, as well as those of each individual member, must be given.)
 Radio-Science Publications, Inc., 381 4th Avenue, New York City.
 Mackinnon-Fly Publications, Inc., 381 4th Avenue, New York City.
 (Stockholders more than 1%—B. A. Mackinnon and H. K. Fly, 381 4th Avenue, New York City.)
 All stock allocated and pledged as security for loans.
3. That the known bondholders, mortgages, and other security holders owning or holding one percent or more of total amount of bonds, mortgages, or other securities are: (If there are none, so state.) None.

J. T. Van Zile,
President.

Sworn to and subscribed before me this 30th day of September, 1930.
(Seal) Joseph H. Kraus
My commission expires March 30, 1931.

Equipping the Waldorf with Radio

(Continued from page 559)

edied. On the other hand the cost had to be held within reasonable and practical limits.

The public address system is arranged to provide service for the following public rooms:

- Empire Room
- Rose Room
- Main Ballroom
- Main Lobby
- Main Foyer
- Men's Restaurant
- Canadian Club Dining-Room
- Restaurant
- Small Ballroom
- Exhibition Space
- Main Ballroom Foyer
- Astor Gallery
- Roof Garden
- Small Ballroom Foyer

Some of these rooms are equipped for both pickup and reproduction, while others

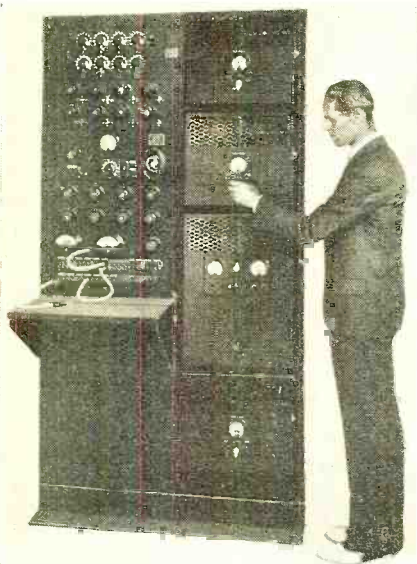

One of nine amplifier and distributing boards used in the Waldorf-Astoria

are arranged only for reproduction. In rooms such as the Empire Room, Rose Room, Ballroom and Roof Garden, where the position of a speaker at a banquet or other gathering is not definitely known, microphone and loud speaker outlets are provided so that they can be placed in the most advantageous position, corresponding to the location of the speaker's table. In all cases, observer's telephone equipment is provided to permit an observer to report to the control room any data of importance.

Engineers of the Bell Laboratories are co-operating with the architects and the engineers representing the Waldorf-Astoria in order that the location of permanently installed loud speakers will harmonize with the building design and with the interior appearance of the various public rooms. While in practically all cases, the No. 555 type loud speaker is being employed, many different types of horns are used in combination with the loud speaking telephones. The most unusual is perhaps the No. 6016-A which was designed especially

for the purpose of reducing the depth required for housing the horn.

Magnetizing current for the No. 555 receivers will be obtained through circuits leading to the control room where indicating lamps will designate which circuits are in use.

Pickup microphones will be of the condenser type. Suitable amplifiers will be associated with the transmitters. Energy from the transmitter will lead through mixing panels where the level can be varied in small steps to the desired value or where in case orchestra or other musical selections are being picked up, the relative volume of the various selections of the orchestra can be blended to obtain a pleasant result.

The voice frequency current is then carried through amplifiers where it is amplified many times before being distributed to the loud speaker. Volume indicators are provided so that the control operator can immediately determine the amplification required in order to raise the level of the sound being picked up by the microphone to the desired point.

A total of 42 amplifiers will be employed. Twelve of these amplifiers will be of the high gain type, employing three stages of amplification and having an amplification of eighty decibels. The remaining 30 will be power amplifiers in single stages and will have a gain of 20 decibels. These 42 amplifiers will require a total of 174 vacuum tubes. It may also be of interest to note that the total amplification which it is possible to obtain from each channel based on the minimum desirable input to the maximum desirable output is 10,000,000,000 times.

The Waldorf-Astoria Hotel is located in a d.c. district. Since high powered amplifiers require a.c. for their economical operation, motor generator sets will be provided to convert d.c. current into a.c. These motor generators will have a capacity of 15 kilowatts, a spare machine being supplied for emergency use.

In view of the large amount of amplification employed in the system, extreme precautions must be taken to insure that there is no interference between the feeble currents picked up by the microphone and the larger currents distributed to the loud speakers. For this purpose specially shielded wire will be employed in the control room. In fact, the wire used throughout the building in the public address and program service in itself represents a sizable item. Close to one million feet will be used. Some of this will be rubber covered, some will be enclosed in lead and some will be shielded with copper.

The circuits to the guest rooms will terminate in the baseboard in a special receptacle accommodating six pairs of wires. The loud speaker used in the guest rooms will be a portable type equipped with a flexible cord to which is attached a special plug terminating in six pairs of wires. The guests can select the desired program by operating selector switches to the program to which they desire to

(Continued on page 572)

SERVICE MEN and DEALERS:

WE SPECIALIZE IN REPLACEMENT PARTS

BAL-RAD
REPLACEMENT BLOCK
For Atwater Kent No. 37
This unit contains the proper chokes and high voltage condensers. All flexible wire colored leads identical to the original. Fully guaranteed **\$4.95 each**



BAL-RAD
Replacement Block for Majestic "B" Eliminator
The condensers in this block are composed of high voltage condensers. Guaranteed for 1 year **\$2 each**



VICTOR CON-
DENSER BLOCKS
Replacement in All Victor Sets
Contains 10% mfd. Our price **\$3.25**



EARL & FREED
Power Transformers

For models 95, 78 and 79, using 5-227, 1-280, 2-245 tubes.
60 cycle **\$4.50**
25 cycle **4.75**

Model 22, using 3-226, 2-171A, 1-280, 2-227 tubes.
60 cycle **\$3.50**
25 cycle **3.75**



BAL-RAD HY VOLTAGE
Surge-proof Condensers
For General Repair and Power-Pack Work
We guarantee these condensers for 100 per cent. free replacement. Repairmen should carry a few dozen in stock.

	MFD.	Working Volts	Each
One	600	"	30c
Two	600	"	40c
Four	600	"	60c
One	800	"	50c
One-half	300	"	25c



THORDARSON Power TRANSFORMERS
For Replacement in Zenith Sets
Models ZE 10-33-33X-34. This transformer can also be used for circuits employing the following type tubes: 5-227-1-171A-1-280.
Our price **\$3.50**

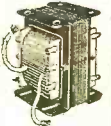

POLYMET
Hi-Volt 1 mfd. Filter Condenser.
300 Volts D. C.
35c ea.
\$3.60 per doz.



PIGTAIL CARBON RESISTANCES

500 ohm	15000 ohm	10000 ohm	} \$1.25 Per doz.
1000 ohm	25000 ohm	20000 ohm	
4700 ohm	2 megohm	75000 ohm	

— SPECIALS —

Sonora Thordarson Power Transformer—	
50-60 cycle	\$ 2.75
25 cycle	3.25
Edison Audio Transformer, Ratio 3 1/2-1.....	.85
Edison Input Transformer, Ratio 3-1.....	.85
T. C. A. Input Push Pull Transformers.....	.95
T. C. A. Output Push Pull Transformers.....	.75
Kolster-Brandes 5.1 Mfd. Condenser Block.....	.95
Dubilier P. L. 1145 Condenser.....	3.95
R. C. A. 103 B Loud Speaker.....	4.50
R. C. A. 103 Loud Speaker.....	5.25
R. C. A. 106 Electro-Dynamic Speaker.....	14.50
Centralab 2000 Ohm Potentiometers.....	.25
Aerial Kit—Complete75
Aerial Wire, 7 Strand (Lots of 12).....	.21
Shielded Lead-in Wire (100 ft.).....	1.50
Griptite Ground Clamp (Lots of 50).....	2.00
Sonora Arcturus R A 1 Tubes.....	.75
Beebe Radio Set Analyzer and Tube Tester, 1931 Model	14.25
H. & H. Toggle Switch20
Soldering Irons75
4-Gang Condensers	1.50
Eagle Type L Audio Transformers, 3 1/2-1.....	.60

TERMS 20% with order, balance C. O. D. 2% discount allowed for full remittance with order only.

No Orders Accepted for Less Than **\$2.50**
BALTIMORE RADIO CORP.
47-N MURRAY ST., N. Y. C.
Send for Our Latest Bargain Bulletin

Read Classified Advertising—It Pays!!!

Advertisements in this section twenty-six cents a word for each insertion. Name and address must be included at the above rate. Cash should accompany all classified advertisements unless placed by an accredited advertising agency. No advertisements for less than 10 words accepted. Objectionable or misleading advertisements not accepted. Advertisements for these columns should reach us not later than 1st of 2nd month preceding issue.

Agents Wanted

Guaranteed Genuine Gold Leaf Letters anyone can put on store windows. Large profits, enormous demand. Free samples. Metallic Letter Co., 422 N. Clark, Chicago.

Automobile Accessories

Automobile Carburetor Booster. Saves Gasoline; adds Power. Mailed, \$1. Give make and year. John Hanley, 816 Ford Bldg., Detroit, Mich.

Business Opportunities

Screw-Holding Screw Drivers! Remove, insert screws from inaccessible places! Factories, garages, electricians, mechanics, auto, radio owners buy on sight! Exclusive territory. Free Trial! Manufacturer, 1711 Winthrop Bldg., Boston.

Correspondence Courses

CORRESPONDENCE COURSES—Sold, Bought, Exchanged. Rented. Bargain Catalogue Free. Handling, C-199 Broadway, New York.

Used correspondence school courses sold on repurchase basis. Also rented and exchanged. Money-back guarantee. Catalog free. (Courses bought.) Lee Mountain, Pisgah, Alabama.

Detectives

DETECTIVES. Work home or travel. Experience unnecessary. Particulars free. Write George Wagoner, 2190-X Broadway, N. Y.

Equipment

BATTERY CHARGERS for Service Stations. Prices lowered. Direct from factory. Write for bulletin 19. Adams-Barre, Columbus, Ohio.

For Inventors

INVENTIONS COMMERCIALIZED. Patented or unpatented. Write Adam Fisher Mfg. Co., 278 Enright, St. Louis, Mo.

Help Wanted—Instruction

Detectives Earn Big Money. Experience unnecessary. Write American Detective System, 2190-K Broadway, N. Y.

Male Help Wanted

GET outdoor government jobs; \$135-\$200 month; vacation. Patrol forests and parks; protect game. Details free. Write DELMAR INSTITUTE, B-37, Denver, Colo.

Miscellaneous

HAVE YOU A CAMERA? Write for free sample of our big magazine showing how to make better pictures and earn money. American Photography, 3105 Camera House, Boston, Mass.

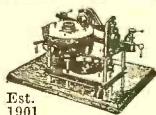

CODE AT HOME Has Helped Thousands
LEARN RADIO AND TELEGRAPHY
 NOW! On Land, Ships, and Air—Your Career
 Future is Secure. Know Code. The Auto-Omnigraph teaches you easily and quickly. Learn by Listening. Models \$15-\$40. Catalog Free.
 THE OMNIGRAPH MFG. CO., 810 E. 39th St., N-7, Brooklyn, N. Y.



Famous

For years as the hotel where courteous service, unexcelled food and comfortable rooms make a visit to Chicago a memorable event. The atmosphere prevailing is surprisingly homelike. Directly adjoining principal office buildings, shops and theatres.

Rooms, \$2.50 up—
 with bath, \$3.50 up.

NEW
BISMARCK
 HOTEL CHICAGO

Write for Booklet with city map.

TELEVISION EXPERIMENTER ATTENTION! My protected television idea needs improvements, your ideas may mean a fortune. Send 25c. no stamps for blue prints and handling costs. M. Stacho, 4324 Ardmore Ave., Cleveland, Ohio.

Patent Attorneys

PATENTS—Write for Free Booklet, HOW TO OBTAIN A PATENT and RECORD OF INVENTION—or send Drawing or Model for Examination. Miller & Miller, Patent Attorneys (former Patent Office Examiners), 1006-D Woolworth Building, New York; 262 McGill Building, Washington, D. C.

PATENTS, TRADE MARKS—All cases submitted given personal attention by a member of the firm. Information and booklet free. Lancaster, Alwine & Rommel, 209 Quay Building, Washington, D. C.

Inventors—Should write for our Guide Book, "How to Obtain a Patent," and Record of Invention Blank, sent Free. Send model or sketch of inventions for our inspection and instructions free. Radio, Electrical, Chemical, Mechanical and Trademark Experts. Terms Reasonable. Victor J. Evans & Co., 922 Ninth, Washington, D. C.

PATENTS—Advice and booklet free. Highest references. Best results. Promptness assured. Watson E. Coleman, Patent Lawyer, 724 9th Street, Washington, D. C.

Personal

TALKIE AND MOVIE PRODUCERS are clamoring for new short story ideas, plots, etc. Perhaps you can write one that we can shape and sell for you. One writer (V. M.) received \$3,000. New York best market. Write for full particulars. Daniel O'Malley Company, Suite B, 1776 Broadway, New York.

Radio

Wanted—Men to work with National Radio Service organization. No selling scheme. Radio Doctors, Inc., Dept. N, Essex St., Salem, Mass.

Radio and accessories—long or short wave—in exchange for used shotguns or rifles. A. M. Boyd, Dept. RN, 300 First Ave., Waterlily, N. Y.

Song Poem Writers

COMPOSERS—VERSE OR MUSIC. Brilliant opportunity. Write at once. Van Buren, 2201 McClurg Bldg., Chicago.

SONG POEM WRITERS—"REAL" proposition. Hibler, D-191, 2104 Keystone, Chicago, Ill.

SONGWRITERS! Advance royalty payments, new talking picture song requirements, etc., fully explained in our free instructive booklet. Write today. Song poems examined free. Newcomer Associates, 1674-VV Broadway, New York.

Wireless

LEARN WIRELESS (Radio) and Morse Telegraphy. School, oldest and largest; endorsed by Telegraph, Radio, Railway and Government officials. Expenses low—can earn part. Catalog free. Dodge's Institute, Cour St., Valparaiso, Ind.

Equipping the Waldorf

(Continued from page 571)

listen. A volume control is provided so that the volume output can be adjusted by the listener. Patrons need not fear that they will be annoyed because of excessive volume in adjoining suites, the maximum volume obtainable will be controlled at the central point.

The circuits to the guest rooms will be distributed through three riser shafts with junction boxes at each floor and with test and terminal equipment in the control room on the sixth floor. This test equipment will provide approximately 900 jacks for test and interconnection purposes. Some will be used for testing the various circuits to the floor junction box. In case of necessity, sections of the floor in trouble can be disconnected from the system, if desired.

Sound Picture Equipment

In addition to the public address, music distribution and program supply system, the Waldorf-Astoria Hotel will be equipped with the W. E. type sound picture reproducing equipment. This equipment will be arranged for projecting and reproducing sound pictures in the ballroom. The system will be entirely independent of the public address apparatus.

The size of the ballroom is slightly more than 500,000 cubic feet.

In the Radio News Laboratory

(Continued from page 540)

that varies widely in volume in its various passages without reducing the passages to one level. It is possible that you have already done some work along that line, or are contemplating doing so. If so, send in your pet brain child. We will do all the development work on it and give you full credit for the original idea.

And along the same line, we are doing quite some work on visual tuning devices and tone controls. These will be ready for publication in the very near future.

Tone-Compensating Circuits

(Continued from page 570)

is shown schematically in Fig. 5. It will be noted that the impressed voltage between grid and filament of the first tube consists of two components; one which is practically constant in magnitude at all frequencies above the middle register and is in phase with the generated voltage, and another component which varies rapidly with the frequency and comes from the circuit comprising a resistance and a condenser. The same e.m.f. is impressed across the condenser and resistance CR as it is across the choke L1 (which may be the primary of an audio transformer), neglecting the small reactance of the condenser C1 which, by the way, serves the purpose of reinforcing the bass as discussed in Section 1.

December Issue Amazing Stories

THE ECLIPSE SPECIAL, by William Lemkin, Ph.D. The time for the observation of a total eclipse of the sun is measured by the seconds. And the seconds are so supremely valuable that the scientists, who are busy with their apparatus, do not get a chance to see it. What superb results might be obtained if some means were found to arrange matters so that hours, instead of seconds, could be spent in studying this greatest cosmic phenomenon that ever greets the earth. Dr. Lemkin, himself a scientist, gives us some unique ideas in this excellently written story.

THE SECOND MISSILE, by Earl Repp. Strange and unexplainable matter has been projected to the earth—nobody knows exactly from where. Stories have been written about foreign missiles, but this tale stands alone in its unusual interest. This is one of the best stories we have seen by this author.

REAPING THE WHIRLWIND, by I. Tooke. Since time immemorial, there were those called "rain-makers." It is not impossible to some day, comparatively soon, be able to arrange climatic conditions to order. But there are attendant dangers, also.

ANACHRONISM, by Charles Cloukey. Numerous requests have come to us for a sequel to this author's "Paradox" stories. Here it is at last, beyond even the expectations of the fans. Yet those of our readers who have missed the two preceding stories will find in this a fascinating tale of scientific interest, for "Anachronism" is complete in itself.

THE DRUMS OF TAPAJOS, by Capt. S. P. Meek, U. S. A. (A Serial in three parts) Part II. Those who have read the first instalment of this absorbing novel, need no urging to read further. Those of our readers who have missed the previous issue should get it now. There's a treat in store for them.

OTHER SCIENTIFIC FICTION

New A. C. S-W and Broadcast Receiver

(Continued from page 523)

completely wiped out by the use of the filters. Regeneration can be increased to the point of oscillation gently and gracefully throughout the entire tuning range.

"Fringe howl," that annoying audio-frequency groan occurring when a set is adjusted so as to be just on the verge of oscillating, was also traced to improperly by-passed and filtered circuits, allowing audio-frequency feed-back through modulation of the generated r.f. current. Needless to say, fringe howl has been completely eliminated in this set by correct filtering.

You will note in the diagram, Fig. 1, the resistors in the plate leads of the audio amplifier tubes, by-passed to ground by the large fixed condensers. The grid returns of the first two audio stages are

An objectionable feature with many sets is the fluctuation of voltage supplied by the power pack when operating the set. With a regenerative detector, the detector plate current varies considerably, depending upon the degree of regeneration. On power packs in which an unusually high ohmage resistor is used to cut down the voltage to the desired amount, the variation in load, caused by the variation in regeneration, produces a great voltage fluctuation, resulting in unstable and unreliable set operation and difficulty in tuning. In this power pack an unusually low ohmage bleeder resistance is used. This causes a rather large current drain from the power pack—large in proportion to the drain caused by the detector tube of the set. Therefore, any change in detector plate current has little effect on the supply voltage and steady operation is obtained.

Mechanical Features

The mechanical features, or general layout and assembly of the parts, together with the electrical values as given in the diagrams, should enable anyone to build the set in a very short time. However, for convenience in assembling, the parts are furnished by the Insuline Corporation in kit form, partly wired and so arranged that only a screwdriver is required to complete the job. Strip connectors, instead of wires, are used. These are held with small screws, which eliminate all soldering. The resistors and by-pass condensers are mounted underneath the base, as shown in the photographs. Two shield cans are used, one for the r.f. stage and one for the detector. The plug-in coils go inside of these cans, in sockets provided for them.

You will note that the screen that shields the antenna coil is clamped on the side of the shield can. This is a copper screen, with all the wires on one side soldered together and grounded. The antenna coupling coil is wound in a disk form between two hard rubber disks and is mounted on a shaft controlled from the panel. It can be rotated so as to be close and parallel with the screen or at right angles to it. The first plug-in coil containing one winding is mounted inside the shield can adjacent to the screen.

The variable condenser, C1, for regeneration control is mounted in the center of the base at the rear and is controlled by means of a long shaft connecting to a knob at the center of the panel. This mounting eliminated hand capacity. The two tuning condensers are mounted in the shield cans. The a.c. line switch, at the extreme right, completes the panel layout. The panel measures 7" by 18" and the metal base 17" by 12" by 1 1/4" deep. A bakelite panel is mounted on the rear of the metal base, on which the a.f. transformers and tube sockets are mounted. The whole arrangement is of the utmost simplicity and should cause no trouble in building.

Accurately made, rigid, well-balanced
(Continued on page 575)

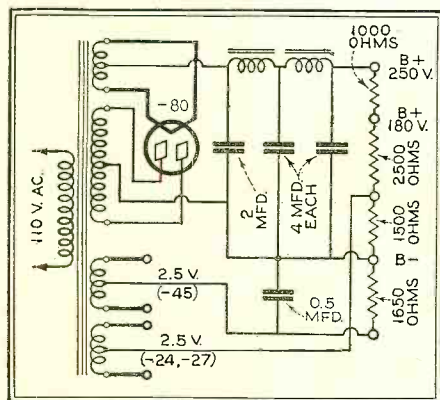

The circuit employed in the power supply unit for the "Conqueror" a.c. short-wave receiver

also filtered by resistors and condensers. The two 2,000-ohm resistors are for obtaining the proper "C" biasing voltages. The r.f. chokes shown in the radio-frequency amplifier and detector plate leads are also important for efficient filtering.

Excessive a.c. hum in short-wave sets was traced to the detector. Probably the a.c. magnetic field surrounding the detector heater causes modulation of the plate current by affecting the electron stream. However, this has been completely wiped out by proper filtering. In the first place, the detector heater is maintained at a positive bias of 65 volts—by means of the bias resistor in the power pack, Fig. 2. This biasing voltage, together with the .001 mfd. by-pass condenser connected between the detector heater and cathode and placed directly at the detector socket, reduces a.c. hum to a point where it is imperceptible—even with headphones connected to the output of the three-stage audio amplifier.

The Power Supply

The power supply is clearly shown in the diagram of Fig. 2. It supplies the 180- and 250-volt plate leads and the two 2 1/2-volt filament leads to the set. It is built separately in a metal case as shown in the photographic illustration.

The Latest Data!

Complete and up-to-date information covering the entire field of radio—all arranged for ready reference in this one big guide book.

BYRD'S Antarctic Radio Equipment—Receivers, transmitters, and latest navigation aids used on this epochal flight fully described.

TELEVISION—Mr. C. F. Jenkins, father of television and radio movies gives you in his own words complete directions for building practical television equipment.

INTERFERENCE ELIMINATION—New methods systematically outlined by W. F. Fleming, radio engineer.

RADIO AUTO ALARM—Description of new device for ships which keeps the SOS watch while operator is off duty.

SHORT WAVE APPARATUS—Commercial and amateur, described and illustrated.

NEW BROADCASTING EQUIPMENT—Temperature-controlled Piezo crystal oscillator; 100% modulation panel and other new apparatus.

—and these are only a few of the new subjects added to the most complete radio handbook ever published.

THE RADIO MANUAL

A Handbook for Students, Amateurs, Operators, and Inspectors

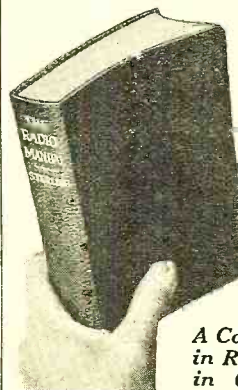

Here's the answer to every question about the principles, operation, and maintenance of apparatus for radio transmitting and receiving. Important new chapters have been added to bring it right up to the minute. Many new photographs and diagrams have been included. It is now more than ever the one complete handbook covering the entire radio field.

A Complete Course in Radio Operation in ONE VOLUME

Prepares for Government License

20 big chapters cover: Elementary Electricity and Magnetism; Motors and Generators; Storage Batteries and Charging Circuits; The Vacuum Tube; Circuits Employed in Vacuum Tube Transmitters; Modulating Systems and 100% Modulation; Wavemeters; Piezo-Electric Oscillators; Wave Traps; Marine Vacuum Tube Transmitters; Radio Broadcasting Equipment; Arc Transmitters; Spark Transmitters; Commercial Radio Receivers; Marconi Auto-Alarm; Radio Beacons and Direction Finders; Aircraft Radio Equipment; Practical Television and Radio Movies; Eliminating Radio Interference; Radio Laws and Regulations; Handling and Abstracting Traffic.

Prepared by Official Examining Officer

The author, G. E. Sterling, is Radio Inspector and Examining Officer, Radio Division, U. S. Dept. of Commerce. The book has been edited in detail by Robert S. Kruse, for five years Technical Editor of QST, the Magazine of the American Radio Relay League, now Radio Consultant. Many other experts assisted them.

Examine It FREE!

The revised edition of "The Radio Manual" is now ready. Nearly 800 pages; 369 illustrations. Bound in flexible Fabrikoid. The coupon brings the volume for free examination. Within 10 days you may return the volume or send the price of \$6.00.

MAIL THIS COUPON

D. Van Nostrand Co., Inc.
250 Fourth Ave., New York

Send me the Revised Edition of THE RADIO MANUAL for examination. Within ten days after receipt I will either return the volume or send you \$6.00, the price in full.

(R. N. 12-30)

Name.....
St. and No.....
City and State.....
Business Connection.....

Tune in on This



New Radio Course

IT PROVIDES an easy way to prepare for a good position in radio work. It furnishes a broad knowledge of radio that applies to the job at hand, whether that job be the simple act of removing a tube or figuring on the most modern installation. It explains the technicalities of radio in clear, understandable language, first laying a fine mathematical background.

There is no better way for you to succeed in radio than to study this new course of the International Correspondence Schools. Every day new students are finding out its many advantages. The course is endorsed by leading radio experts and radio manufacturers.

Mark and mail the coupon today and let us tell you what the new Radio Course can do for you.

Mail the coupon for FREE booklet

International Correspondence Schools
Box 8284-J, Scranton, Penna.

Without cost or obligation, please tell me all about the **NEW RADIO COURSE**

Name _____
Street Address _____
City _____ State _____

We Are Headquarters For AC POWER TRANSFORMERS

- For 4-226, 2-227, 2-171A, 1-280 **\$2.95**
- For 4-224, 2-227, 2-245, 1-280 **\$3.75**
- For 4-227 or 4-224, 2-250, 2-281 **\$5.95**

REPLACEMENT CONDENSER BLOCKS

- For Majestic "B" Eliminator \$2.95
- For A-K No. 37 4.95
- For Majestic 171 Sets. 5.88
- For Majestic 245 Sets. \$5.88
- For Majestic 250 Sets. 5.88
- For Majestic Master "B" Eliminator.... 3.83

Send Check, Money Order, Stamps—Include Postage
SEND FOR OUR FREE CATALOG
RADIO SURPLUS CORPORATION
56 N Vesey St., New York

Index to Advertisers

A	
Acme Wire Company	554
Aerovox Wireless Corp.	569
Allied Radio Corp. Inside Front Cover	
American Sales Co.	559
American Transformer	547
Amperite Corp.	568
Amplex Instrument Laboratories	568
Amrad Corp., The	551
Arcturus Radio Tube Co.	546
Automatic Radio Mfg. Co., Inc.	556
B	
Baltimore Radio Company	571
Blan, the Radio Man	556
C	
Cardwell Mfg. Corp., The Allen D.	555
Central Radio Laboratories	558
Champion Radio Works	545
Chicago Gear Works	568
Chicago Radio Apparatus Co.	556
Clarostat Mfg. Co.	563
Classified Advertising	572
Coyne Electrical School	485
Crosley Radio Corp.	570
D	
DeForest Radio Co.	531
Dodge Institute	568
Drake, Frederick J., & Co.	564
E	
Electrad, Inc.	555
Ellis Electrical Laboratory	554
F	
Federated Purchaser	483
Ferranti, Inc.	557
Flechthelm & Co., Inc.	556
Freed Radio Sales and Service Co.	575
G	
General Radio Co.	561
H	
Hammarlund Mfg. Co.	565
Hammarlund Roberts, Inc.	537
Hammer Radio Co., S.	563
Heiss Hotel System	574
High Frequency Labs.	541
Hoodwin Co., Chas.	570-575
I	
Insuline Corp. of America	563
International Correspondence Schools	574
International Resistance Company	557
International Typewriter Exchange	564
J	
J M P Mfg. Co., Inc.	560
K	
Keeley Institute	570
L	
La Salle Extension University	568
Ludy Hotel	568
Lynch Mfg. Co., Inc.	558
M	
Macfadden Book Co., Inc.	543
Mason, Fenwick & Lawrence	560
McGraw-Hill Book Co., Inc.	567
Metal Cast Products	562
Midwest Radio Corp.	564
N	
National Carbon Co., Inc.	562
National Co., Inc. Third Cover and	553
National Radio Institute. Back Cover and	549
Newark Electric Co.	553
New Bismarck Hotel	572
Norden-Hauk, Inc.	559
Nubor Radio Co.	554
O	
Omnigraph Mfg. Co.	572
P	
Pilot Radio & Tube Corp.	539
Pitman, Isaac, & Sons	560
Plapao Laboratories, Inc.	570
R	
R C A Institutes, Inc.	529
Racon Electric Co., Inc.	554
Radex Press	560
Radio Surplus Corp.	574
Radio & Television Institute	487
Radio Training Association of America.	481
Readrite Meter Works	548
Rider, John F.	561
Rim Radio Mfg. Co.	564
Roll-O Specialty Company	570
S	
Shallcross Mfg. Co.	562
Silver-Marshall, Inc.	535
Simplimus, Inc.	565
Sprague Specialties Co.	533
T	
Telex Company	562
Triad Mfg. Co., Inc.	552
Twentieth Century Mail Order	558
V	
Van Nostrand Co., Inc., D.	573
W	
Washington Hotel	568
Western Radio Mfg. Co.	568
Western Electrical Instrument Corp.	550
West Side Y. M. C. A. Radio Inst.	560
Wholesale Radio Service	561
Wilson Ear Drums	570
Y	
Yahr-Lange, Inc.	575

ST. LOUIS' FINEST HOTELS

8th and St. Charles

MAYFAIR

In center of business district. Floor and bed lamps; fan, circulating ice water and bath in every room. Garage service. COFFEE SHOP.

400 ROOMS
BATHS

\$3.00 to \$6.00

9th and Washington

LENNOX

NEW, smart, beautiful. Ice cooled dining room, and coffee shop. Fans, and circulating ice water; tub—shower in every room.

400 ROOMS
BATHS

\$3.00 to \$6.00

Opposite beautiful Forest Park

KINGS-WAY

West Fine at Kingshighway. 20 minutes from downtown. Room and bath \$2.50 to \$4.50.

K M O X

Heiss Hotel System

Owners and Operators

IN SCIENCE AND INVENTION

For DECEMBER

Our \$3,250.00 Ideal Tool Shop Equipment Is in Full Swing. Get in on it. Movie Portrays City of the Future—Buildings 250 stories high and nine levels for traffic arteries are among the wonders of New York in 1980, as described by Edwin Schallert.

Why Are Circus Freaks?—Dr. Frederic Danrau furnishes a scientific explanation of these phenomena.

The Wingless Plane—A description of the latest in aviation—a plane which employs rotors instead of wings.

Why Television Images Split, by our managing editor, A. Dinsdale; **Locating Gold by Radio**; and **What's New in Radio**; for our radio-minded readers.

Will America Capture World's Olive Oil Market?—You may not know it, but we have a flourishing olive oil industry here. Count Mirzaoff compares our product with that of other countries.

How to Build an Outboard Motorboat (with complete drawings); **How to Construct a Built-in Wardrobe**; **How to Make a Dressing Table**, **A Motor-Driven Sea Sled**, **A Brass Novelty Box**, etc.; **Chemical and Physical Experiments** for those who like to make and do things.

New A. C. S-W Broadcast Receiver

(Continued from page 573)

coils are essential to properly cover the entire range and maintain selectivity and proper regeneration control. The coils are probably the most important part of the set. The form is of genuine hard rubber, 2" in diameter, rigidly held on metal end supports. The wire is wound in grooves in the hard rubber and cannot slip. The wire ends are connected to socket terminals on the coil base. Plug contacts are placed in the set. The absence of plug contacts on the coil makes it less vulnerable to damage when lying about not in use.

The Coils

17-28 Meters

R.F. coil 6 turns.
Det. coil 4 turns on the secondary, 1 turn on the primary, 4 turn on the tickler.

27-45 Meters

R.F. coil 11 turns.
Det. coil 8 turns on the secondary, 3 turns on the primary, 6 turns on the tickler.

40-80 Meters

R.F. coil 19 turns.
Det. coil 18 turns on the secondary, 4 turns on the primary, 8 turns on the tickler.

75-150 Meters

R.F. coil 34 turns.
Det. coil 30 turns on the secondary, 10 turns on the primary, 15 turns on the tickler.

145-300 Meters

R.F. coil 54 turns.
Det. coil 54 turns on the secondary, 15 turns on the primary, 18 turns on the tickler.

295-600 Meters

R.F. coil 107 turns.
Det. coil 139 turns on the secondary, 30 turns on the primary, 50 turns on the tickler.
Antenna coil is 1-15/16" in diameter 10 turns.

The complete set of coils covers the range of from 14 to 600 meters. Two coils are used to cover the broadcast band. This is an advantage; it spreads the low wavelength broadcast stations over the entire dial and they are more easily separated and tuned in. As far as broadcast reception is concerned, this set ranks with the best. This type of coil is the same as that used in almost all ship and shore stations.

The two tuning condensers and the regeneration control condenser are each of the "bathtub" shielded type and have nine plates. Two illuminated drum dials give ease in tuning and control. No dial is used for the regeneration control condenser.

After the set and power pack have been assembled and the leads brought out to the correct binding posts, the two may be connected together and tested. Standard types of tubes are used, and when placed

in the correct sockets and the aerial and ground connected, the set is ready for operation. A good dynamic speaker is recommended, although any type of magnetic speaker may be employed. Sometimes one tube will work better than another as detector; therefore all of the -27's should be tried after a station is tuned in to find the one which gives the best results.

It is a good plan to start with the broadcast coils and get familiar with the set's operation by tuning in the broadcast stations. The dial settings on the two tuning condensers should be about the same. The important controls are the regeneration control and the antenna coupling, both of which may be used for controlling the volume, although the antenna coupling should be reduced as much as possible, as this increases selectivity.

After testing the set on the broadcast band, a set of short-wave coils may be inserted and further tests made. It is well to try all the coils, and make sure that the set oscillates easily throughout the entire range. It will give no trouble from this source if all the connections were correctly made.

In tuning in short-wave stations, extreme care should be used as regards the tickler adjustment. It is best to tune the stations in first by means of the heterodyne whistle and then adjust for maximum volume without oscillation, in the case of phone stations. Remember that short-wave stations sometimes fade considerably and are received differently at different times of the day. Furthermore, static interferes sometimes, but it was found that even in the tropics there was absolutely no static at wavelengths below 30 meters. Above 30 meters static increases considerably. Man-made static, such as noises caused by sign flashers, motors, and other electrical machinery seems to cause more annoyance in the short-wave band than in the broadcast band. Therefore, if you have any noisy machinery in your vicinity, be sure to take the proper steps to thoroughly filter the apparatus.

The best type of aerial to use with this set cannot be definitely described. Sometimes the "worst" type gives the best results on short waves. A good plan is to try your regular broadcast aerial and also erect a shorter one as far from it as possible without making the lead-in unreasonably long, and use either one or a combination of both. Of more importance is the ground connection. This should be as short as possible and well-connected to the cold-water pipe. A poor or high resistance ground connection will cause serious difficulty from body capacity while tuning the set.

It is the unusual selectivity, sensitivity, and volume that pleased all those who have had occasion to try this set. In addition, the ease in tuning and control makes it ideal for the broadcast listener who wants to pick up the European and other foreign stations night after night, winter or summer.

Amazing Reception • RED ARROW ANTENNA

(Sponsored by Yahr-Lange of SUPERBALL fame)

A new "all directional" aerial which in addition to giving marvelous reception has the added advantage of being a handsome weather vane.



\$650

Complete with Installation Kit

Does away with unsightly wire aeriels and makes a real ornament for any home. Easily brings in distant stations with amazing clearness, due to patented condenser which neutralizes entire system.

Write for more complete description.

SUPERBALL ANTENNA

Over 1,000,000 in Use

Join the million satisfied owners of the famous SUPERBALL ANTENNA.

Enjoy greater selectivity, volume and distance with the SUPERBALL ANTENNA, which brings out the hidden powers of any radio set.

Buy a SUPERBALL ANTENNA today and really begin to enjoy radio reception.

Get one TODAY at your RADIO DEALERS.



\$325

Complete with Installation Kit

YAHR-LANGE, INC.

205 E. Water St. Milwaukee, Wis.

WORLD-WIDE



Span the World with this Set!

A new radio thrill for you! Listen in DIRECT to London, Paris, Berlin, Buenos Aires and other broadcasting stations throughout the world via short waves. Enjoy unique foreign programs from strange lands. Your ordinary receiver cannot tune in these low wave stations. WORLD-WIDE RECEIVER gets 14 to 350 meter stations with surprising clarity. SEND NO MONEY! Just write your name and address on a postcard and ask us to send you this wonderful guaranteed short wave set. Pay postman \$6.45 plus a small delivery charge. All orders West of Rockies must be accompanied by \$1.00 deposit. Foreign countries must remit in full. Write today!
CHAS. HOODWIN CO.
4240 Lincoln Ave., Dept. M-30, CHICAGO

We carry a full line of Replacement Parts for

Earl-Freed-Freshman and Freed-Eisemann Receivers

Write for service parts bulletin
FREED SALES SERVICE CO.
16 Hudson St. New York City

NEW BOOKS at Magazine Prices.

Each of the following 50c books is of the large size, 8½ x 11½ inches, containing 96 profusely illustrated pages, bound in beautiful colored covers. The contents of any one of them is equivalent to the average 300-page volume, and in ordinary book form would probably cost you from \$2.00 to \$10.00. Get these exceptional bargains TODAY, while we still have them in stock!



NEW RADIO TROUBLE FINDER & SERVICE MANUAL

Ever have your radio reception fail or become distorted just when a big program was on and you wanted to hear every delicate inflection of tone distinctly? That's when this big book is worth its weight in gold. In simple words and easy to understand charts and pictures, it shows you how to find and correct any radio trouble *quickly*. It's just the book you need for improving the reception of your set, repairing sets for friends, and for starting a profitable repair business of your own. Shipped, prepaid, to your home for only **50c**

HOW TO WIN AT BRIDGE

by Wilbur C. Whitehead

The world-famous Bridge authority's newest book. His easy picture method shows how to play both Auction and Contract Bridge TO WIN! Complete rules of play and methods of scoring for both Auction and Contract Bridge. Contains 500 hands to bid and play, with complete solutions and analyses in back of book. The biggest 50c worth ever offered to Bridge fans. Printed in 2 colors. Hearts and diamonds shown in red throughout. 96 pages. Large 8½ x 11½-inch size. Beautiful colored cover. **50c**
Price postpaid, only... **50c**

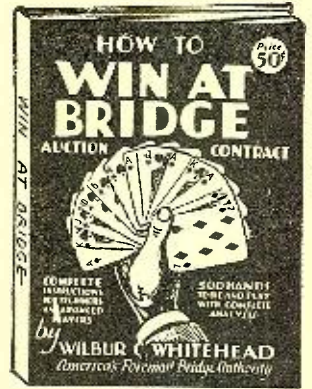

LUCKY BREAKS

Read about the \$315,000 fortune waiting for some Lucky person! Read what Belasco, Copeland, Untermyer, Taft and others think of Luck. Read about Luck in the movies, in athletics, above the clouds! Read about the Luck of the real person who actually did break the bank at Monte Carlo. Read about the Luck of Columbus, Napoleon, Lafayette. The Luck that made Presidents. Read these true stories of amazing Lucky Breaks and be prepared when yours comes along. **50c**
Price, prepaid, only.....

FLYING FOR EVERYBODY

19 Chapters—More than 120 Photographs, Maps and Diagrams. This book is the one complete Aviation Manual which covers every phase of flying from the ground up. Condensed in its pages is the essence of years of experiences of Aviation's foremost authorities. No air-minded person should be without it. Price, prepaid, only **50c**

POPULAR MAGIC AND CARD TRICKS

Mystify your friends; charm the ladies; be the life of any party. Make glass bowls vanish, cards fly, coins disappear. Do hundreds of other magic tricks and games as easily as a professional. Over 200 described and illustrated in this big book **50c**
on magic. Prepaid, only.....

NEW SHORT WAVE MANUAL

Experience the thrills of the Short Waves of hearing Europe, Africa or Australia direct as clearly as native stations. This big book, replete with illustrations and How-to-Build diagrams and plans, crowded with 28 chapters by Lieut. Wenstrom, Marshall, Spangenberg and other foremost S-W authorities, represents the last word in authentic S-W data. The most complete up-to-the-minute short wave manual ever published. Brings you more information than books selling at ten times its price. Shipped, prepaid to your home for only..... **50c**

RADIO AMATEURS' HANDBOOK

Sometimes called the Radio Amateurs' Bible. 30 profusely illustrated chapters bring you 10 How-to-Build articles, with complete instructions and diagrams; new radio wrinkles, DX hints, data on the new tubes, answers to AC problems, and helpful, money-saving ideas for the radio service man. 96 illustrated pages. Large 8½ x 11½-inch size. Beautiful colored cover. Shipped, prepaid, to your home for only..... **50c**

1001 RADIO QUESTIONS AND ANSWERS

If you own a radio, you need this book. Everything you want to know about radio is in it, from "How to Kill Outside Radio Noises," to a clear description of the newest tubes and how to use them. If you have a question on radio, here is your answer and a thousand more. 96 illustrated pages. Large 8½ x 11½-inch size. Beautiful colored cover. Shipped, prepaid to your home for only..... **50c**

ANATOMICAL MANIKINS MALE & FEMALE

By Dr. David H. Keller
Book measures 6 x 14 inches. Contains 12 large plates of the human body, male and female, with complete descriptions of every muscle, nerve, gland, bone, organ, etc., including reproductive organs of male and female. Books of this kind ordinarily cost from \$10 to \$25 when bought through medical supply establishments. **\$1**
Price, complete and prepaid, only.

Also the Following at Only 25c Each

- How to Make It (working in wood, metal, cement, paint, etc.)
- How to Electrify Your Radio Set
- What Radio Set Shall I Buy
- How to Build the Famous One Knob Set
- 101 Radio Hook-Ups
- The Neutrodyne and All About It
- Cookoo Nuts (A game in book form for parties)
- S'matter Pop (the famous comics in book form)

MAIL TODAY

RADIO-SCIENCE PUBLICATIONS, Inc.
Dept. 2412, 381 Fourth Ave., New York, N. Y.

Gentlemen: Please ship me, prepaid, the books whose titles I have listed below. Remittance is enclosed.

.....

.....

.....

.....

.....

Name.....

Address.....

City.....

State.....

**Buy Them at Your Newsdealer
or Mail Coupon AT ONCE! ➡➡**

RADICALLY NEW!

RADICALLY DIFFERENT, RADICALLY FINER

New NATIONAL MB-30 and AMPLIFIER-SPEAKER UNIT

Setting New Standards of Performance and Tone Quality
Based on the New Vreeland Band - Selector Principles

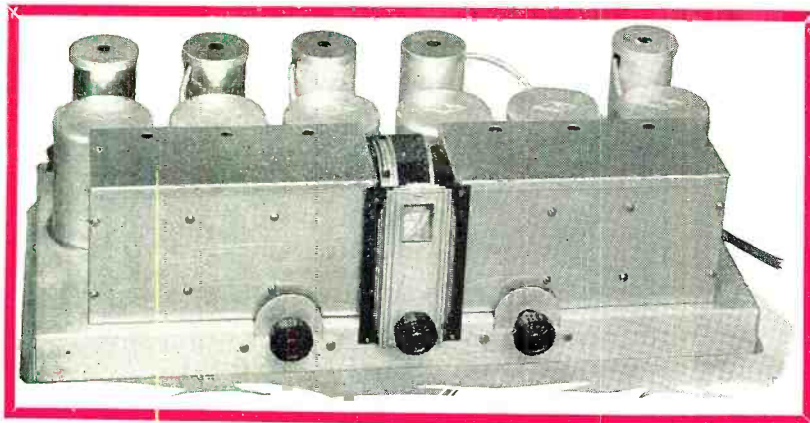

NOW, a new Radio Principle makes possible the NATIONAL MB-30, with entirely new standards of performance and tone quality. The advanced Band-Selector Patents of Dr. Frederick K. Vreeland, combined with the basic work of Glenn H. Browning and James Millen on the MB-29, have produced a new and finer instrument in the MB-30—with performance second to none. Dr. Vreeland has been in the forefront of radio development ever since his early work on the Superheterodyne.

HERE is a tuner with uniform sensitivity over the entire band of the order of one microvolt per meter, or better, very high selectivity without loss of tone quality, no cross-talk, no oscillation at any frequency.

EQUALLY suitable as Radio Pickup for existing amplifiers and easily adapted for rack panel mounting.

CIRCUIT DETAILS. Double pre-selector stage, six (6) Tuned Circuits, 4 Screen-Grid R. F. Stages, low impedance output 227 Power-Detector, making possible operation with any standard audio amplifier. Chassis is thoroughly shielded and mechanically rugged.

AVAILABLE either completely wired and laboratory tested and adjusted (Licensed under Vreeland Patents), or as assembled unwired parts for those who prefer to do their own wiring. For special amplifier-speaker unit and consoles designed expressly for use with the MB-30, see descriptions at right.

Write us today! Use Coupon.

NATIONAL

Precision Built
RADIO PARTS



Amplifier Speaker-Unit



Specially designed for easy installation with the MB-30. Provides proper operating voltages. A new Jensen Speaker comes as part of equipment. This is quickly and easily mounted on amplifier chassis and a special cord and plug connects it instantly. Output is Push-Pull through 245 tubes.
Licensed under R.C.A. Patents

Beautiful Consoles

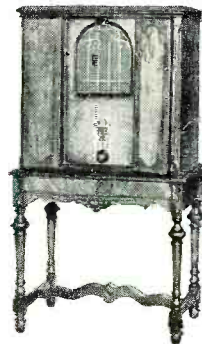

National Company has available beautiful consoles for housing the MB-30 and National Amplifier - Speaker. These consoles are built to our standards of heavy, honest construction, and are of restrained and beautiful design which will harmonize with the finest surroundings.

Simple Installation

Installation of the MB-30 and Amplifier-Speaker is exceedingly easy. The Amplifier-Speaker is simply inserted in the upper section of the cabinet, the Tuner in the lower section. Everything is arranged and ready. There is no difficult or fussy fitting or planning.

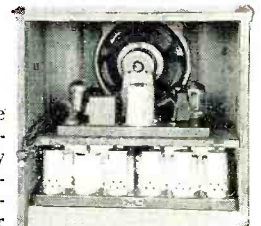

**Send Coupon Today
for Free Book**

COUPON

NATIONAL CO., INC.
Sherman, Abbott & Jackson Sts., Malden, Mass.
Gentlemen:

- Please send me new free bulletin describing the new MB-30 Tuner.
 Enclosed please find 10c (stamps or coin) for your MB-30 HANDBOOK.

Name.....

Address.....

I will train you at home



Here's Proof

to fill a **BIG PAY** Radio Job!

If you are earning a penny less than \$50 a week, send for my book of information on the opportunities in Radio. It is free. Clip the coupon NOW. Why be satisfied with \$25, \$30 or \$40 a week for longer than the short time it takes to get ready for Radio.

Radio's growth opening hundreds of \$50, \$75, \$100 a week jobs every year

In about ten years Radio has grown from a \$2,000,000 to a \$1,000,000,000 industry. Over 300,000 jobs have been created. Hundreds more are being opened every year by its continued growth. Men and young men with the right training—the kind of training I give you—are needed continually.

You have many jobs to choose from

Broadcasting stations use engineers, operators, station managers and pay \$1,800 to \$5,000 a year. Manufacturers continually need testers, inspectors, foremen, engineers, service men, buyers, for jobs paying up to \$15,000 a year. Shipping companies use hundreds of Radio operators, give them world wide travel at practically no expense and a salary of \$85 to \$200 a month. Dealers and jobbers employ service men, salesmen, buyers, managers, and pay \$30 to \$100 a week. There are many other opportunities too. My book tells you about them.

So many opportunities many N. R. I. men make \$10 to \$25 a week while learning

The day you enroll with me I'll show you how to do 10 jobs, common in most every neighborhood, for spare time money. Throughout your course I send you information on servicing popular makes of sets: I give you the plans and ideas that are making \$200 to \$1,000 for hundreds of N. R. I. students in their spare time while studying.

Talking Movies, Television, Wired Radio included

Radio principles as used in Talking Movies, Television and home Television experiments. Wired Radio, Radio's use in Aviation, are all given. I am so sure that I can train you satisfactorily that I will agree in writing to refund every penny of your tuition if you are not satisfied with my Lessons and Instruction Service upon completing.

64-page book of information FREE

Get your copy today. It tells you where Radio's good jobs are, what they pay, tells you about my course, what others who have taken it are doing and making. Find out what Radio offers you, without the slightest obligation. ACT NOW.

J. E. SMITH, President
National Radio Institute Dept., ONS.
Washington, D. C. **Our Own Home**

Pioneer and World's Largest Home-Study Radio training organization devoted entirely to training men and young men for good jobs in the Radio industry. Our growth has paralleled Radio's growth. We occupy three hundred times as much floor space now as we did when organized in 1914.

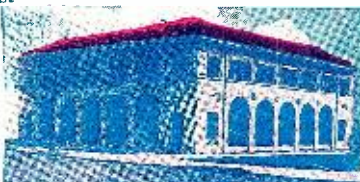

\$500 extra in 6 months

"In looking over my records I find I made \$500 from January to May in my spare time. My best week brought me \$107. I have only one regret regarding your course—I should have taken it long ago."

HOYT MOORE
R. R. 3, Box 919,
Indianapolis, Ind.,



3715 S. Kingshighway,
St. Louis, Mo.

E. E. WINBORNE
1414 W. 18th St.,
Norfolk, Va.



Jumped from \$35 to \$100 a week

"Before I entered Radio I was making \$35 a week. Last week I earned \$110 servicing and selling Radios. I owe my success to N. R. I. You started me off on the right foot."

J. A. VAUGHN



I will give you my new **8 OUTFITS** of **RADIO PARTS** for a home Experimental Laboratory

You can build over 100 circuits with these outfits. You build and experiment with the circuits used in Crosley, Atwater - Kent, Eveready, Majestic, Zenith, and other popular sets. You learn how these sets work, why they work, how to make them work. This makes learning at home easy, fascinating, practical.

Back view of 5 tube Screen Grid A. C. tuned Radio frequency set—only one of many circuits you can build with my outfits.

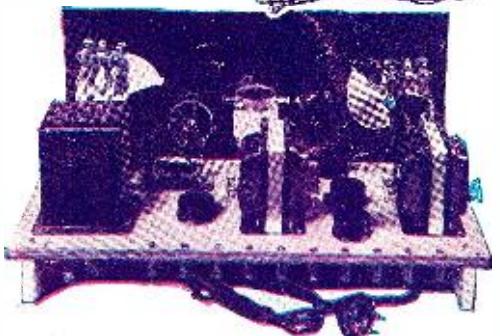

I am doubling and tripling the salaries of many in one year and less Find out about this quick way to

BIGGER PAY



FILL OUT AND MAIL THIS COUPON TODAY



J. E. SMITH, President,
National Radio Institute, Dept. ONS.
Washington, D. C.

Dear Mr. Smith: Send me your book. This request does not obligate me.

Name
Address
City State

Lifetime Employment Service to all Graduates