

TELEVISION

RADIO'S GREATEST MAGAZINE

RADIOVISION

# RADIO NEWS

APRIL  
25 Cents

Over 200  
Illustrations



BROADCAST  
**WRNY**  
STATION



Edited by HUGO GERNSBACK



The SPIRIT of  
**RADIO**

EXPERIMENTER PUBLISHING COMPANY, 230 FIFTH AVENUE, NEW YORK

RADIOVISION

# Startling Price Reductions

On Everything  
In RADIO

**Buy Now!**

Allied has cut prices to the bone—your big profits in radio can now be bigger—no need to wait any longer. This new low level of prices places before you the season's outstanding values.

**RADIO**  
**1929**  
**PRE-INVENTORY**  
**CLEARANCE**  
**EVERYTHING IN RADIO**  
**A.C. SETS-D.C. SETS**  
**DYNAMIC SPEAKERS**  
**PARTS-KITS**  
**ACCESSORIES**

THE  
PRICE  
SLASHING  
EVENT  
OF THE  
YEAR

**NET**  
**WHOLESALE**  
**PRICES**

**ALLIED RADIO**  
**CORPORATION**  
**711 W. LAKE ST. CHICAGO, ILL.**

## Brand New Catalog for 1929

A pre-inventory sale that is featuring some of the most drastic price reductions known to radio. Everything in our tremendous stock is offered in this sale—and this large new catalog has been prepared to bring before you this tremendous array of radio values.

Every branch of the radio industry is represented—appealing to set builders interested in parts and kits—to dealers interested in the new sets and modern accessories—as well as agents who are interested in tying up with one of the season's most successful lines of A.C. and D.C. receivers.

### Wholesale Prices

Selling as we do on an exclusively wholesale basis, the prices we now offer you are establishing new standards in radio values—new A.C. sets for as low as \$32.95—attractively designed consoles for as low as \$16.25. Corresponding values are offered in kits, parts and accessories in nationally-advertised, quality merchandise—the products of the country's foremost radio manufacturers.

**The Catalog is Free**

**Send for Your Copy Now**

*Knight Receivers for A.C. and D.C. operation have established an enviable record for performance. See them in this new large catalog.*

**Allied Radio**  
**CORPORATION**

711 W. LAKE ST.

Dept. B-6

CHICAGO



# 5 Easy Ways to Make \$3.00 an hour in Your Spare Time in RADIO

Each of these plans, developed by the Radio Association of America, is a big money-maker. Set owners everywhere want to get rid of static, to have their sets operate from the electric light socket, the tone improved, and the volume increased, and transformed into single-dial controls. Phonograph owners want their machines electrified and radiofied. If you learn to render these services, you can easily make \$3.00 an hour for your spare time, to say nothing of the money you can make installing, servicing, repairing, building radio sets, and selling supplies.

Over \$600,000,000 is being spent yearly for sets, supplies, service. You can get your share of this business and, at the same time, fit yourself for the big-pay opportunities in Radio by joining the Association.

## Join the Radio Association of America

A membership in the Association offers you the easiest way into Radio. It will enable you to earn \$3.00 an hour upwards in your spare time—train you to install, repair and build all kinds of sets—start you in business without capital or finance an invention—train you for the \$3,000 to \$10,000 big-pay radio positions—help secure a better position at bigger pay for you.

*A membership need not cost you a cent!*  
The Association will give you a comprehensive, practical, and theoretical training and the benefit of its Employment Service. You earn while you learn. Our cooperative plan will make it possible for you to establish a radio store. You have the privilege of buying radio supplies at wholesale from the very first.

**Earned \$500.00 Spare Time**  
Frank J. Deutsch, Penn.: "I have made over \$500 out of Radio in my spare time."

**Radio Engineer in One Year**  
Claude De Grave, Canada: "I knew nothing about Radio when I joined a year ago. I am now a member of a very exclusive organization of Radio Engineers, and my income is 225% greater than it was."

**Doubles Income in 6 Months**  
W. E. Thon, Chicago: "Six months after I enrolled I secured the managership of large Radio Store and doubled my income."

### ACT NOW — If You Wish the No-Cost Membership Plan

To a limited number of ambitious men, we will give Special Memberships that may not—need not—cost you a cent. To secure one, write today. We will send you details and also our Radio Handbook filled with dollars-and-cents radio ideas. It will open your eyes to the money-making possibilities of Radio.

**Radio Association of America, Inc.**  
4513 Ravenswood Ave., Dept. RN-4, Chicago, Ill.

**Radio Association of America, Inc.**  
Dept. RN-4, 4513 Ravenswood Ave., Chicago, Ill.

Gentlemen: Please send me by return mail full details of your Special Membership Plan, and also copy of your Radio Handbook.

Name.....  
Address.....  
City..... State.....

# RADIO NEWS

Volume 10

April, 1929

Number 10

HUGO GERNSBACK, Editor-in-Chief

C. P. MASON, Associate Editor  
H. M. BAYER, Technical EditorBERYL B. BRYANT, Laboratory Director  
C. WALTER PALMER, Director Information Service

## Contents of This Issue

Radio in the Sphere of Music By Hugo Gernsback	905	The "Home Builder's Seven"—A Super Set (Blueprint Article) By B. B. Bryant	924
Movies Bring Radio Messages to Lay Audiences By Herndon Green	906	RADIO NEWS Blueprints—New Terms of Our Offer to Readers	929
Experiments with "Light-Sensitive Cells" By H. M. Bayer	909	The "Space-Charge Autodyne" (Blueprint Article) By Joseph Riley	930
What's New in Radio	912	The Service Man	933
The Radio Beginner—Pickups, and How to Make Your Radio a Phonograph	914	The Radio Constructor's Own Page	935
Some Methods of Detection—and Their Respective Merits By C. Walter Palmer	916	Fifty Dollars for an Improvement in Short-Wave Sets	935
Aerials and Grounds for Short-Wave Reception By Ashur Van A. Sommers	918	List of Broadcast Stations	936
Popular Handiwork—How to Make a Handsome Radio Console (Blueprint Article) By H. L. Weatherby	920	On the Short Waves	938
A New Departure—Announcement	920	I Want to Know	939
Successful Television Experiments in the Home and Workshop	923	RADIO NEWS Laboratories	940
		Popular Handiwork Ballot	971
		Book Review By H. M. Bayer	973
		RADIO NEWS Blueprint Coupon	973

## In Our May Number

**A COMBINED RADIO AND PHONOGRAPH CONSOLE:** The second Handiwork Blueprint article will describe the construction of a very attractive piece of furniture for the music room. Its construction, whether for personal use or profit, will interest every set builder who is striving for attractive appearance in his product.

**THE "PERIDYNE" A.C. SCREEN-GRID FIVE:** While the recent announcement of this receiver was premature, the numerous Peridyne fans will be glad to learn that it has been developed into a set with improvements worth waiting for. Very

high amplification with "Peridyne" quality, and greater ease of construction and operation are afforded by this new design.

**THE "NEW YORK TIMES" SHORT-WAVE RECEIVER:** How to construct an electrical duplicate of the receiver with which Commander Byrd's messages from the Antarctic are received day in and day out reliably, will be told by F. E. Meinholz, manager of the *Times* station at the New York end of this 10,000-mile communication lane.

Blueprint Notice—see page 929

RADIO NEWS is published on the 10th of each preceding month. There are 12 numbers per year. Subscription price is \$2.50 a year in U. S. and possessions. Canada and foreign countries, \$3.00 per year. U. S. Coin as well as U. S. Stamps accepted (no foreign coins or stamps). Single copies, 25 cents each. Checks and money orders should be drawn to order of EXPERIMENTER PUBLISHING CO., INC.

All communications and contributions to this journal should be addressed to Editor, RADIO NEWS, 230 Fifth Ave., New York, N. Y. Unaccepted contributions cannot be returned unless full postage has been included. All accepted contributions are paid for on publication. A special rate is paid for novel experiments; good photographs accompanying them are highly desirable. Publishers are not responsible for loss of manuscripts, although every precaution is taken with such manuscripts, upon receipt thereof.

RADIO NEWS. Monthly. Entered as second-class matter, July 12, 1924, at the Post Office at New York, N. Y., under the Act of March 3, 1879. Additional entry at Dunellen, N. J. and San Francisco, Calif. Title registered U. S. Patent Office, Copyright, 1929, by The Experimenter Publishing Co., Inc., 230 Fifth Ave., New York. The contents of this magazine are copyrighted and must not be reproduced in the United States without giving full credit to the publication. Translation into foreign languages must not be made unless permission is

The contents of RADIO NEWS are indexed in the Industrial Arts Index, copies of which can be found in every library.

obtained from the publishers. Copyrighted in Germany. Reproduction of articles in Germany is reserved for Radio, Berlin 42.

RADIO NEWS is for sale at all newsstands in the United States and Canada, and at Brentano's, Ave. de L'Opera, Paris, France. European agents: S. J. Wise Et Cie, 40 Place Verte, Antwerp, Belgium.

**HOW TO SUBSCRIBE FOR RADIO NEWS.** Send your name, address and remittance to Experimenter Publishing Co., 230 Fifth Ave., New York. Mention the name of the magazine you are ordering. We also publish SCIENCE AND INVENTION, RADIO LISTENERS' GUIDE and AMAZING STORIES. Write clearly.

**RATES AND TERMS.** The subscription rate for RADIO NEWS is \$2.50 per year. (12 numbers). When remitting do so by check, money order, or registered letter if cash is enclosed. Avoid sending cash through the mail if possible. Subscriptions for less than one year are not accepted. Subscription may be made in combination with SCIENCE & INVENTION, RADIO LISTENERS' GUIDE, and AMAZING STORIES.

**POSTAGE.** We prepay postage in all parts of the United States, Mexico and island possessions. For foreign or Canadian subscriptions we require 50 cents in addition to the subscription price for additional postage charge.

**CHANGE OF ADDRESS.** Notify us as far in advance as possible. It requires several weeks to make an address change on our records. Always write clearly.

Published by **Experimenter Publishing Company, Inc.**

H. GERNSBACK, President      S. GERNSBACK, Vice-President and Treasurer      IRVING S. MANHEIMER, Secretary

Member: Audit Bureau of Circulations      Radio Magazine Publishers Association

Advertising Representatives: RHODES & LEISENRING

New York Offices: 624 Graybar Building

Chicago Offices: 307 North Michigan Ave.

Editorial and General Offices

230 Fifth Avenue, New York City

# ELECTRICITY

## Becomes Amazingly Easy When Taught Without Books in 90 Days

No Experience  
No Advance  
Education  
Needed

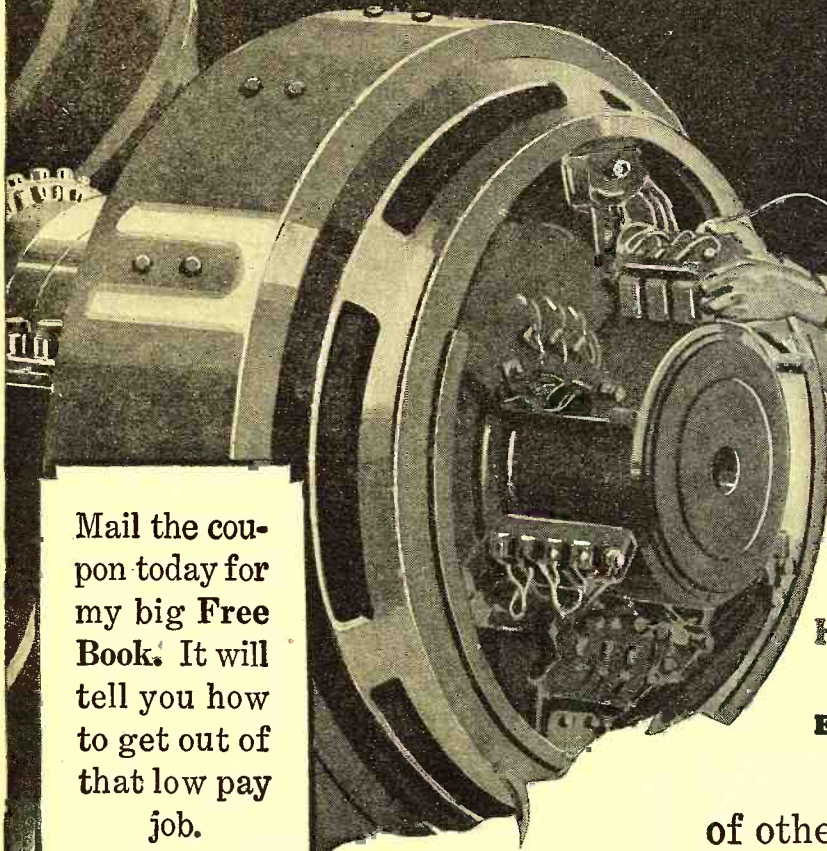

Mail the coupon today for my big Free Book. It will tell you how to get out of that low pay job.

**H. C. LEWIS**  
President  
**COYNE**  
**ELECTRICAL**  
**SCHOOL**



Let me tell you in my big free book a **sure, easy, quick** way to get into a field that offers you a real future.

I train you in **90 days**. Not by correspondence and not by books but on **real electrical machinery**. You don't need advanced education and you don't need previous electrical experience. If you're short of money I'll help you get a job so you can **Earn while learning**. This big book I'm telling you about shows you what I've done for thousands

of other fellows just like you and it gives you the absolute proof.

Right now I'm including my big new **Aviation** course as well as **Radio** and **Auto Ignition** course.

Mail the coupon today and get a copy of this book. It tells you an **amazingly easy** way to get into a big pay field.

Sincerely

**H. C. LEWIS**

**COYNE ELECTRICAL SCHOOL**  
500 South Paulina Street,  
CHICAGO, ILLINOIS.

Mr. H. C. Lewis, President  
**COYNE ELECTRICAL SCHOOL**  
500 So. Paulina St., Dept. 49-02 Chicago, Ill.

Dear Mr. Lewis: Without obligation send me your big free catalog and all details of Free Employment Service, Radio, Aviation and Automotive Electrical Courses and how many "earn while learning."

Name.....

Address.....

City..... State.....

# INDEX TO ADVERTISERS

PAGE	PAGE	PAGE	PAGE
<b>A</b>	<b>D</b>	<b>L</b>	<b>S</b>
Advance Electric Co. .... 960	DeJur-Amsco Corp. .... 953	Lentz, Inc., C. R. .... 971	See Jay Battery Co. .... 956
Aerovox Wireless Corp. .... 946	Drake, The ..... 970	Loveless Antenna Co. .... 953	Setbuilders Supply Co. .... 953-961
Aero Products, Inc. .... 960-968	Dresner Radio Mfg. Corp. .... 959	Lynch, Inc., Arthur H. .... 953	Silver-Marshall, Inc. .... Back Cover
Allen-Rogers-Madison, Inc. .... 953	<b>E</b>	<b>M</b>	Smith, B. Hawley ..... 948
Allied Radio Corp. .... Inside Front Cover-944-946-953-956-970	Electrad, Inc. .... 960	M & H Sporting Goods Co. .... 944	<b>T</b>
American Technical Society ..... 942	Electric Specialty Co. .... 975	Mason, Fenwick & Lawrence .... 959	Teleplex Company ..... 956
Arc-Aerial, Inc., The ..... 953	Electric Storage Battery Co. .... 956	Midwest Radio Corporation ..... 957	Thordarson Electric Mfg. Co. .... 941
Arcturus Radio Corp. .... 960	Excello Products Corp. .... 952	Myers, M. W. .... 975	Townsend Labs. .... 955
Aviation Institute of U. S. A. .... 965	<b>F</b>	<b>N</b>	<b>K</b>
<b>B</b>	Ferranti, Inc. .... 955	National Radio Institute ..... 901	Underground Aerial Products.... 943
Barawik Co., The 942-951-953-955-975	Flash Sales Corp., The ..... 944	National School of Visual Edu- cation ..... 963	<b>V</b>
Birnback Radio Company ..... 953	Franklin Institute ..... 944	Norden-Hauck, Inc. .... 964	Van Nostrand Co., D. .... 961
Browning-Drake Corp. .... 942	<b>G</b>	<b>O</b>	<b>W</b>
<b>C</b>	General Amplifier Co. .... 953	Omnigraph Mfg. Co. .... 952	West Side Y. M. C. A. Radio Institute ..... 944
Carborundum Co., The ..... 973	General Radio Co. .... 957	<b>P</b>	Western Radio Mfg. Co. .... 948
Carter Radio Co. .... 959	<b>H</b>	Pacific Radio ..... 968	Wirt Company ..... 944
Clark, Paul L. .... 953	Hammarlund Mfg. Co. .... 951	Pilot Electric & Mfg. Co. Inside Back Cover	Wizard Wire Winder Co. .... 961
CeCo Mfg. Co., Inc. .... 967	Hammarlund-Roberts, Inc. .... 904	Polk, J. L. .... 951	<b>X-Y-Z</b>
Celeron Co., The ..... 902	Hoodwin Co., Chas. .... 952	Press Guild, Inc. .... 946	X-L Radio Laboratories ..... 946
Central Radio Labs. .... 948	<b>I</b>	<b>R</b>	Yaxley Mfg. Co. .... 975
Chemical Institute of N. Y., Inc. 947	Insuline Corp. of America ..... 953	Radiall Company ..... 970	
Chicago Radio Apparatus Co. .... 956	<b>J</b>	Radiart Labs. .... 953	
Chicago Stock Gear Works..... 957	J-M-P Mfg. Co. .... 961	Radio Assn. of America, Inc. .... 897	
Clarostat Mfg. Co., Inc. .... 956	Jensen Radio Mfg. Co. .... 969	Radio Doctors, Inc. .... 957	
Cornish Wire Co. .... 953		Radio Equipment Co. .... 968	
Coyne Electrical School ..... 899		Radio Institute of America.... 903-949	
Craftsman Radio Products ..... 973		Radio Specialty Co. .... 945	
Cunningham, Inc., E. T. .... 956		Raytheon Mfg. Co. .... 959	
		Royal Eastern Electric Supply Co. .... 959	

# Now! in limp, suede leather binding S. Gernsback's Radio Encyclopedia

THE most valuable of Radio Books—S. Gernsback's Encyclopedia—now the most beautiful. This foremost Radio Encyclopedia is now offered in this luxurious new binding to meet the demand for a more handsomely bound volume. The limp suede leather edition sells for \$5.00. The Keratol-leather stiff binding still can be had for \$2.00.

Remember—this is an encyclopedia—not a dictionary! It took over two years of intensive labor to compile it. It is the first Radio Encyclopedia ever published.

S. Gernsback's Radio Encyclopedia contains the

meaning of every word and phrase used in the entire Radio Art. Every circuit, part and apparatus is thoroughly explained. A complete cross index is just one of the many features of this remarkable book.

There are 1,930 definitions—549 diagrams, photographs and drawings—all simple and easily understood. The book is nearly 1 inch thick and measures 9x11 inches.

**SEND NO MONEY**

Simply pay the post-man on delivery. Over 25,000 copies in the stiff binding already sold.

S. GERNSBACK, 230 FIFTH AVENUE, NEW YORK CITY



S. GERNSBACK  
230 Fifth Ave., New York City  
Kindly send me one copy of the  
Radio Encyclopedia. I will pay post-  
man.

Limp suede leather binding  
\$5.00 plus postage.

Keratol-leather binding  
\$2.00 plus postage.  
(check which binding you want)

Name.....

Address.....

Town.....

State.....

# FREE!

# MEN! Here's the dope you've been looking for

## HOW TO GET INTO THE RADIO BUSINESS-

J.E.S.

Many Earn \$50 to \$250 a Week in Work That is Almost Romance



### I Give You 6 Big Outfits of Radio Parts

With them you can build 100 different circuits—learn the "how" and "why" of practically every type of Radio set made. This kind of training fits you to step into the good jobs—sends you out an experienced Radio expert. When you complete, my Employment Department will help you get a real big Radio job like Graduate Edward Stanko, now Chief Operator of Station WGR, or Frank M. Jones, 922 Guadalupe St., San Angelo, Tex., builder and operator of Station KGF1 and Manager of the best equipped Radio shop in the Southwest, or help you start a Radio business of your own like Richard Butler, 1419 No. 17th St., Phila., Pa., who made around \$500 a month compared with a small salaried, no future job as motorman when he enrolled.

**My Radio Training is the Famous "Course That Pays for Itself"**

Spare time earnings are easy in Radio almost from the time you enroll. G. W. Page, 1807 21st Ave. S., Nashville, Tenn., made \$935 in his spare time while taking this course. Al Johnson, 1409 Shelby St., Sandusky, O., \$1,000 in four months, and he didn't know the difference between a condenser and a transformer when he enrolled. I'll give you a legal contract, backed by N. R. I., pioneer and largest home-study Radio school in the world, to refund every penny of your money if you are not satisfied, upon completing, with the lessons and instructions received. Find out what Radio offers you—get the facts. Mail coupon—RIGHT NOW.

If you're earning a penny less than \$50 a week, clip coupon now for FREE BOOK! New 64-page book pictures and tells all about the Radio business, hundreds of opportunities—in work that is almost romance! YOU can learn quickly and easily at home, through my tested, proved methods to take advantage of these great opportunities! Why go along at \$25, \$35, or \$45 a week when you can pleasantly and in a short time learn how to hold the big-pay jobs?

### Clip Coupon for Free Book

Don't envy the other fellow who's pulling down the big cash! My proven home-study training methods

make it possible for you too to get ready for better jobs, to earn enough money so you can enjoy the good things of life. One of the most valuable books ever written on Radio tells how—interesting facts about this great field, and how I can prepare you in your spare time at home, to step into a big-pay Radio job. GET THIS BOOK. SEND COUPON TODAY.

J. E. SMITH, Pres.,  
National Radio Institute  
Dept. 9QT  
Washington, D. C.



I Have Trained Hundreds of Men at Home for Big Radio Jobs. My Book Proves I Can Do the Same for You.



J. E. Smith, President, National Radio Institute, Dept. 9QT, Washington, D. C.

Dear Mr. Smith: Without obligating me in any way, send me your big FREE BOOK, "Rich Rewards in Radio," and all information about your practical home-study Radio Course.

Name..... Age.....

Address.....

Town..... State.....

**ACT NOW—COUPON BRINGS MY**

**FREE BOOK**

# SOLVING

*your molding problems  
before they get to you*

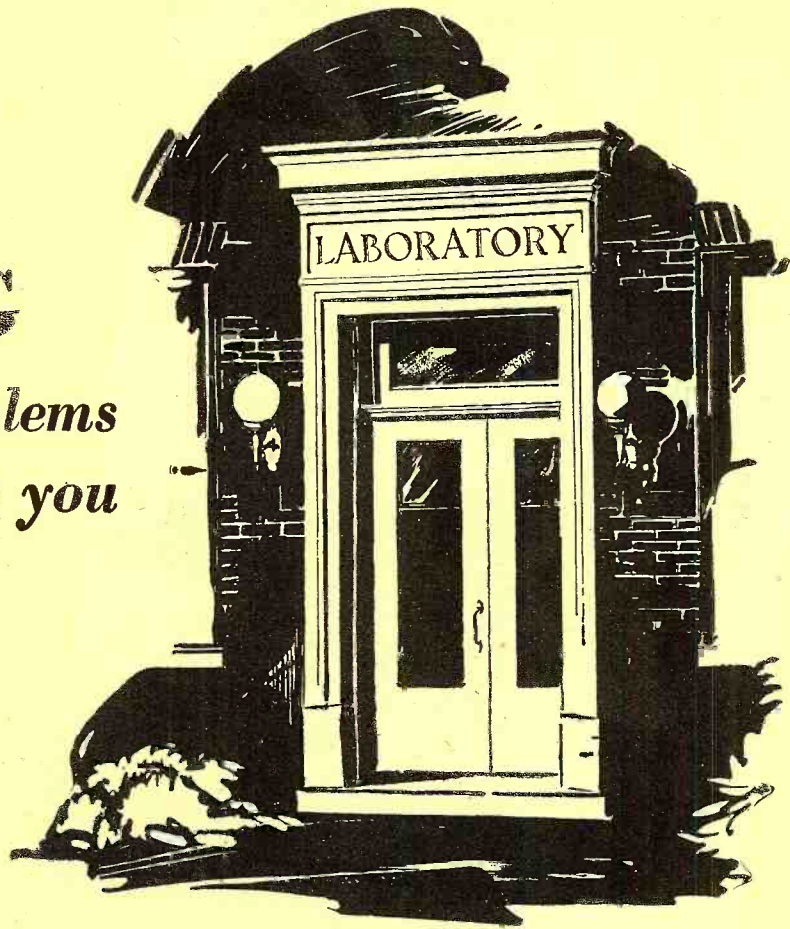

To facilitate your work, to improve your molded products, to cut your production costs—is the aim of every engineer and chemist responsible for Celoron Molding Powders.

To this end, the Celoron Research Laboratory has spent years of study of the actual workaday problems of molders making every imaginable type of product, before attempting to produce a molding powder better adapted to their needs.

To this end, the Celoron Research Laboratory has sent to the four corners of the earth for the substances from which to make countless molding compounds for comparison with

every other existing material for the purpose.

To this end the Celoron Research Laboratory has duplicated actual production conditions in their model molding plant, to prove in advance that Celoron Molding Powders will really solve your molding problems.

Today, there is no doubt that Celoron is better. It has been demonstrated in many plants and in competition with every other molding powder on the market. But the Celoron Research Laboratory is not content with merely offering you this improved material. These skilled experts in the production and application of phenolic resinous compounds want to give you the benefit of their unlimited practical experience, so that you may gain the maximum benefit through the most intelligent use of this new and better material.

Call upon them. Consider the



Celoron Laboratory as a part of your own plant's resources.

**THE CELORON COMPANY**  
Bridgeport . . . Pennsylvania  
In Canada: 350 Eastern Ave., Toronto

### CELORON PRODUCTS

Celoron Molding Powders; Impregnated Fabric and Paper for Molding; Synthetic Resins, Varnishes and Cements; Laminated Celoron sheets, rods and tubes for electrical and industrial purposes; Celoron Silent Gears.



DIVISION  
of  
**DIAMOND STATE  
FIBRE CO.**  
Established  
1891

# CELORON

## MOLDING PRODUCTS

Please say you saw it in RADIO NEWS



# MEN...an amazing SHORT-CUT to SUCCESS in RADIO!

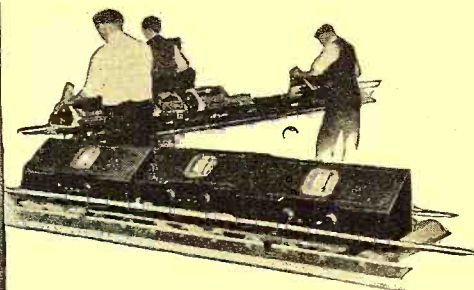
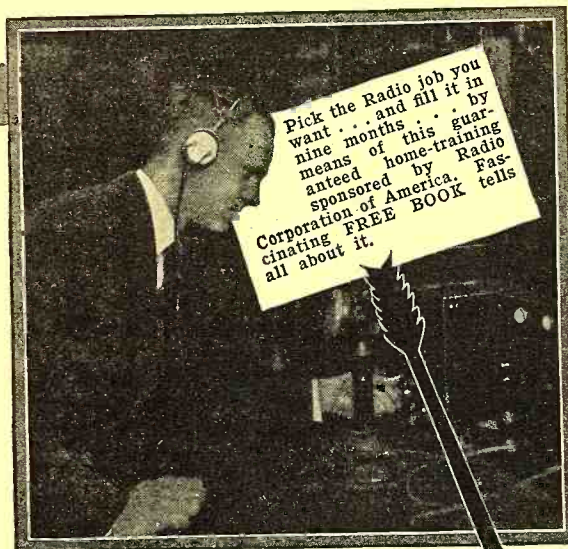

poration of America. This Radio organization sets the standards for the industry... And because it sponsors every lesson in the course, you know you are getting the real "dope."

### Money Back If Not Delighted

The fascinating lessons prepare you for success in all phases of Radio manufacturing, servicing, selling, ship and shore broadcasting, Photoradiograms, Television, and airplane Radio equipment. A signed and sealed agreement assures you of complete satisfaction upon completion of the training—or your money will be refunded.

### Read This Free Book

It tells you all you'd like to know about Radio. Its 50 fascinating pages and photos describe Radio's brilliant opportunities for adventure and success. It describes in detail the famous training that has enabled us to place thousands of our students in fine positions, usually from 3 to 10 days after graduation! Read this great book... it may mean the turning point in your life! Mail the coupon now—the book is absolutely free! Radio Institute of America, Dept. RN-4, 326 Broadway, New York.

**MEN**... here's a contract! No matter how little you may know about Radio... no matter what branch of the industry you'd like to get into... here's a short-cut method that guarantees you absolute satisfaction...or no cost to you!

As a result of this unique home-laboratory method, hundreds of ambitious men everywhere, are making the biggest money of their lives. Their days are full of adventure and success! For Radio is today one of America's greatest industries.

### A Tremendous Opportunity

Over 20,000,000 Radio sets need servicing. Thousands of ships carry Radio transmitting and receiving apparatus. Long distance Radio telegraph communications are being opened in more and more countries. Hundreds of broadcasting stations are in operation. The number of Radio dealers has increased to 50,000. And the number of Radio manufacturers has increased to 4,000. And now Television and Radio-telephony too are opening up hundreds of additional opportunities! Thousands of men are needed! The pay is big and the opportunities for success and adventure are limitless! Don't pass it by!

### This Home-Laboratory Method Teaches Faster Than Text-Books

Radio authorities are astounded at this new short-cut to success in Radio. For it

cuts the time of theoretical study down to the lowest minimum! This expert training gives you the real *practical* side of every phase of Radio! As part of the course you get a magnificent outfit of fine standard Radio apparatus. With it you work out with your own hands and mind the Radio problems that command big pay. With it you can build many fine sets and dozens of different circuits. So that when you complete the training you will not be just a theorist... but a practical, down-to-earth Radio expert!

### Training Sponsored By the Radio Corporation of America

Our graduates are in big demand everywhere. They enjoy greater success because they're posted right up-to-the-minute in *everything* in Radio. Radio's progress each year is measured by the accomplishment of the great engineers at work in the research laboratories of the Radio Cor-

**GUARANTEE**

If upon completion of your course you are not thoroughly satisfied that you have received full value and more, the Radio Institute of America will return to you the entire tuition fee paid on the course, in accordance with the terms of the agreement. In that way, you cannot lose, for you are fully protected.

(Signed) R. L. Duncan  
President  
RADIO INSTITUTE OF AMERICA

Sponsored by the Radio Corporation of America

Dept. RN-4  
Radio Institute of America  
326 Broadway, New York, N. Y.

Gentlemen: Please send me your big FREE 50-page book which tells all about the opportunities in Radio and describes your famous home laboratory method of guaranteed radio instruction.

Name.....

Address.....



Please say you saw it in RADIO NEWS

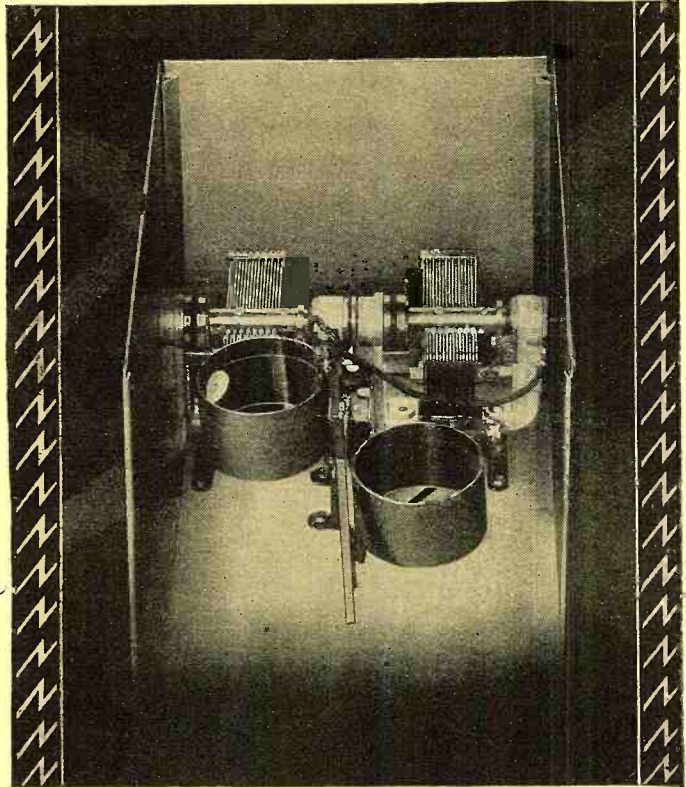

# P AND P FILTER

**T**HE Master Hi-Q 29 is the only circuit permitting the use of shield-grid tubes at their maximum amplifying ability.

So remarkable has been the performance of this receiver that not only are professional men everywhere building it, but the engineers of nearly a score of the foremost radio companies have purchased it either for personal use or for laboratory experiment.

Due to the characteristics of loosely tuned circuits, each of the doubly tuned radio-frequency transformers used in the Hi-Q '29 actually constitutes a "band-pass filter", the effect of which is shown in the graph below. Space does not permit full description of the many advantages thus gained but the informed radiomans should quickly grasp the results

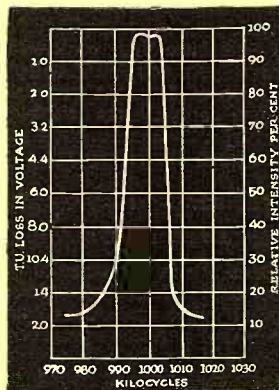

Effects  
**FLAT-TOP** tuning  
**10 K.C.** selectivity  
**PERFECT** tone

shown in the exclusive Hi-Q "flat-top" response curve.

The sum total of Hi-Q '29 design is a finer degree of both sensitivity and selectivity than has ever been known before with the added advantages of tone quality which experts admit is nothing short of epoch-making.

It will pay you to write for our 80-page illustrated book on Hi-Q "Band-Pass Tuning" and construction details of the four Hi-Q models. Price is 25c. Use the coupon.

# Hi-Q 29

HAMMARLUND-ROBERTS, Inc., 1182C Broadway, New York

Enclosed find 25c for my copy of your book on Hi-Q Band Pass Filter Circuits and full construction details on your four Hi-Q models.

NAME.....

ADDRESS.....

Please say you saw it in RADIO NEWS

# Radio News



Hugo Gernsback Editor & Publisher

Editorial and General Offices, 230 Fifth Avenue, New York

Vol. 10

APRIL, 1929

No. 10

## Radio in the Sphere of Music

By HUGO GERNSBACK

**D**URING the past eight years a peaceful, yet most amazing, revolution has taken place, not only in this country, but practically throughout all the civilized world, wherever radio is now a household word. The revolution that I have in mind is the enhancement that has come to pass in musical appreciation, which is now permeating practically all strata of our population.

It is true that the phonograph, previous to the era of broadcasting, had left an indelible stamp upon the musical education of the masses; but even this cannot be compared in magnitude with the musical movement brought about by the universality of radio.

The reason is simple. Unless a family were extremely well-to-do, it could not own the number of phonograph records required for a musical education; because the investment in even a moderate library, in phonograph records, of the standard composers' works would run into a formidable sum. On the other hand, today, the average family with a moderately-priced radio set brings the entire musical world into its modest home, and even into the smallest tenement.

Nor was it possible for the phonograph to present complete the lengthy works of certain composers; because phonograph records are too small, considering the length of time it takes to play the entire score. All this, radio has overcome.

Incidentally, works of famous composers, hardly ever heard in the old days, except by confirmed music lovers, are now familiar to the man in the street; who is just as apt to whistle *Kammenoi Ostrow* or snatches from the *Nutcracker Suite*, instead of the "popular" music that once made up practically the entire musical fare of our average population.

Indeed, it may be said that radio has been the direct cause of the public's new appreciation of the best kind of music, in preference to jazz and the highly-specialized "popular" music. Recent investigations, made by some of the foremost radio stations in this country, have shown conclusively that, though the younger element is still calling for jazz (mainly as dance music), the demand for classical music is becoming greater every day.

Some time ago, the New York Edison Company (in connection with its "Edison Hour" broadcast over WRNY) made a survey by sending out a questionnaire in numbers which ran into several hundred thousands. When the returns were compiled, it was found that the majority of the listeners had voted for classical music, and that "popular" and jazz music were quite in the minority.

Such a finding, ten years ago, would probably have been called fantastic, or could have been secured only through a canvass among musicians and a special class of music lovers; whereas today, the demand for good music comes from practically every stratum of the population.

It may therefore be said without fear of contradiction that, during the last few years, the public at large has heard more music of the better kind than it has ever had available before. Indeed, the various stations, in order to avoid duplicating their own offerings too frequently, and because of the competition of other stations, find it continually necessary to broadcast compositions which were hitherto practically unheard of, even in symphony concerts and chamber music.

Only in the past few years have we begun to hear over the radio the compositions which formerly were played only by professionals;

in other words, music in which the theme is not easy to follow, and which could not have been understood at all by "the man in the street" only five years ago.

Music, in this respect, is much like a new language. If I recite a poem in a language familiar to you, you have no trouble in quickly digesting it. If, however, I try you with a recitation in a tongue with which you are not well acquainted, you will find it difficult to understand, and many repetitions will be required before you finally become familiar with it. It is exactly so with music; particularly when it is in the advanced style of composers.

For instance, some of the heaviest operas of Wagner must be played a number of times before the average man can understand and interpret the meaning of the composer. It is quite patent that, before the advent of radio, it was hardly possible for the man in the street to listen repeatedly to the same opera (even if there were an Opera House available to him) and to familiarize himself with its harmonies. Radio, however, has changed all this because, if the same score is given at intervals, the average man finds little trouble in understanding even the most difficult composers.

And it is here that radio has done its musical work, and is still doing it, and will continue doing it in the future. It is only by constant repetition that we become well acquainted with composers, and I know of no instrumentality through which this can be done better than by radio; it is, as I will show, far superior to even the best orchestra seat.

Most people are "eye-minded," and even such a trifle as observing an orchestra detracts momentarily from the musical impressions that are reaching the ear. In the privacy of your home, as a rule, the eye has nothing to distract it and the impression upon the ear is all the stronger; and, therefore, the effect of music is made more lasting.

From the technical side, radio audition offers another great advantage over the large symphony hall. Unless you are fortunate in obtaining a perfect seat in the theatre or hall, you are not unfrequently disturbed by bad echoes, loud neighbors and other noises about you, which prevent you from enjoying the music to the fullest degree.

Ever since the advent of the loud speaker, which became universal only about three years ago, the technique of broadcasting has kept pace with the perfection of the reproducer. It is now possible, for that reason, to hear and enjoy a concert to a far greater degree in your own home than you could while actually sitting twenty feet away from the orchestra. For one thing, modern microphone technique is such, that it picks up all the instruments perfectly, but practically no outside noises such as arise in the audience itself.

On the other hand, a good loud speaker will reproduce all tones from the lowest of the drum to the highest of the piccolo, without difficulty; and it may, therefore, be said that (given a good microphonic pick-up, which is common nowadays, and a good loud speaker) it should be possible for everyone to obtain in his own home music such as no one heard in former days, since the beginning of music itself.

Incidentally, it should be noted that there are springing up, already, composers of music dedicated expressly to radio purposes. The point is, not that any good composition cannot be rendered faithfully over the radio, but that an entirely new technique can be and, right now, is being evolved.

# Movies Bring Radio Messages to Lay Audiences

Dots and Dashes of Commander Byrd's Signals Are Heard by Theatre-Goers Ten Thousand Miles From the Antarctic Wastes

By Herndon Green

**R**ADIO MOVIES" of a new kind, differing from the near-television demonstration implied by the term, were presented throughout the country a few weeks ago, when the dispatches of Commander Byrd from his base in the Antarctic, ten thousand miles away, were heard clearly and loudly through hundreds of theatres.

While these dispatches, reproduced in the identical dot-and-dash form of their transmission, were not in themselves intelligible to more than a few of their hearers, the accompanying translation and explanation were sufficient to arouse the interest of hundreds of broadcast listeners; who had never before fully appreciated the wonders of short-wave communication, now being carried on daily and nightly over distances far exceeding the reception range of the most powerful broadcast stations.

The messages thus heard by them were not being received directly, however (though any good short-wave receiver which could pick up such signals might readily enough be attached to an amplifier and give volume enough to fill any auditorium). They had instead, for greater ease in reproduction, been recorded upon a roll of motion-picture film; and the positives of this were distributed with a well-known newsreel feature and reproduced by the "Movietone" process.

*The strips of film, reproduced about actual size, differ from the ordinary kind in that they carry in a band at the left of each (as shown) streaks of light and darkness corresponding to sound waves impressed on them, and which are reconverted into sound by the mechanism shown on the opposite page.*

## WHAT WAS DONE

The master film was made in the radio station, WHD, of the *New York Times*, which has been in constant communication with the Byrd expedition since its sailing; and shows the operation of the radio apparatus, both receiving and transmitting. The first action reveals Fred E. Meinholtz, manager of the station, at the key of the transmitter, who first reads a message from the producers to Commander Byrd, and then sends it over the air. Instantly the audience hears the continuous note of the transmitter, broken up by the telegraph key into the signals; which amateurs and other operators present in a theatre could follow easily. There is a pause, and Mr. Meinholtz is seen with headphones adjusted receiving the prompt reply that leaped upward from the bottom of the world. The message, announcing that all is well, and that geographic exploration has just revealed a new bay to be named after a heroic companion of former flights, Floyd

Bennett, is written down; and then a hand holds up the headphones of the receiver before the sensitive microphone, and the veritable message of the Byrd operator, as he signs off for the night under the Antarctic midnight sun, is heard by the audience in the theatre. Many, no doubt, could not repress a feeling of awe; and even "hard-boiled" hams (or "owls") would enjoy the excellent handling of the presentation.

## RADIO METHODS IN THE FILMS

The processes of recording and reproduction of the sounds may be of interest here. Like the television methods which have become more or less familiar to our readers, they depend upon the use of a flash-lamp and of a photoelectric cell; although these devices need respond only to audible frequencies. The system, however, has so much in common with radio apparatus that it is not surprising that the same engineers have been active in both radio and the "talkies."

The sounds which accompany each action in a "sound" motion picture are made upon the same strip of film as that which carries the action, in the Movietone system; although, because of the different characteristic of the record, the sound corresponding to the exposure at a given instant must be made on the margin of another "frame" or picture, a short distance above the first.

The microphone which picks up the sound is connected into a powerful audio amplifier; its output, however, is not used for carrier-wave modulation, as in a broadcast transmitter, but controls a special flash-lamp of high actinic power. This lamp has a filament coated with oxides of calcium and barium, which give an electronic emission, and has a plate of polished nickel. The tube is of a special quartz composition, to pass the actinic light freely, and contains helium gas to add to its luminosity. It responds very quickly to fluctuations in the current feeding it; unlike the ordinary receiving tube, in which it is sought to equalize the emission of electrons.

Through a tiny slit in the hood covering this tube (Fig. 2) an oblong streak, hardly more than a point of light, is thrown upon one side of the film, which has been screened from previous exposure to the image gath-

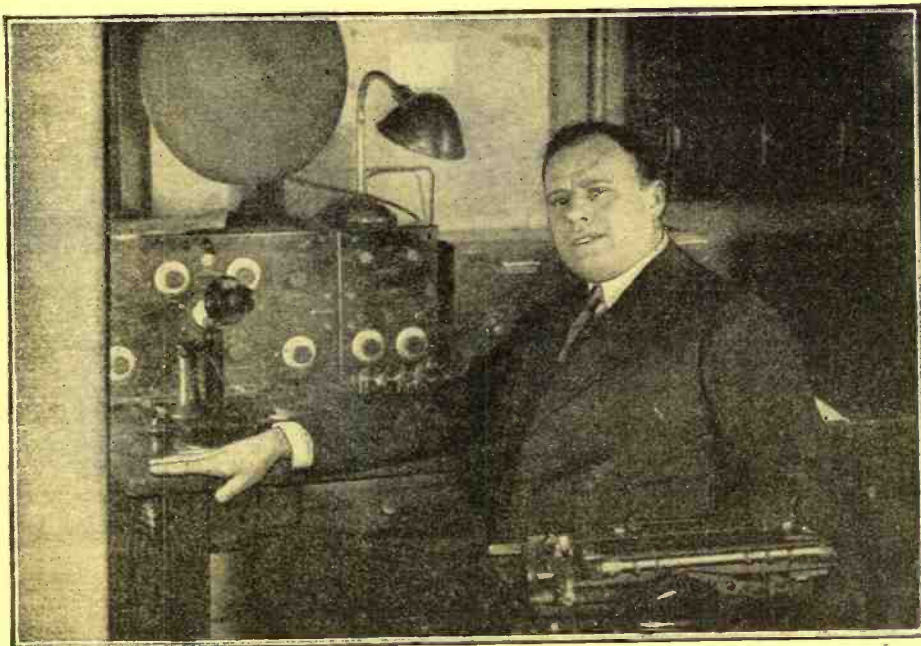
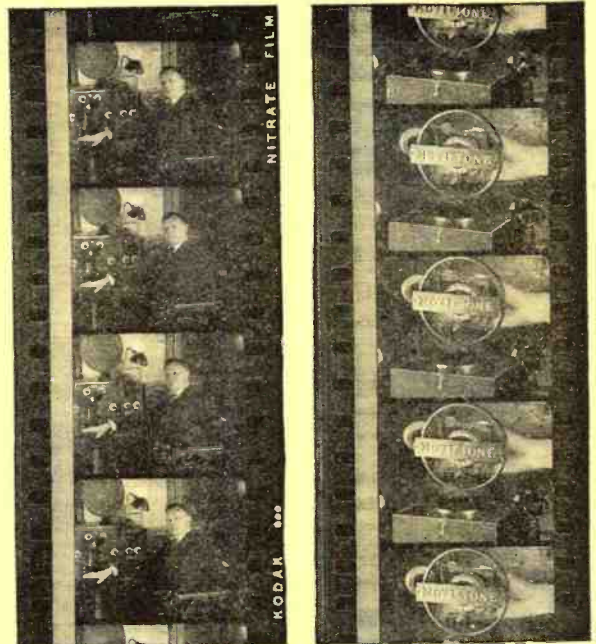

An enlargement of one "frame" of the "sound film" illustrated above. The bands which record the waves of sound may be seen quite clearly at the left. (Courtesy Fox Film Corporation.)

ered by the camera lens. As the glow-lamp or "AEO" (alkaline-earth-oxide) lamp fluctuates in accordance with the received sound-frequencies, it creates alternate streaks of light and darkness; the reproduction of which will be seen more clearly in the enlarged pictures of single "frames." (If it were possible for us to see the air in which sound waves are moving, the effect of compressions and expansions produced in the atmosphere would be very similar to the alternations which appear in the "sound-track" of the films.)

A very ingenious mechanism was necessary to accommodate the same film to both sight and sound reproduction. The camera acts instantaneously over a total area; it is necessary to stop the film, expose a "frame," and then move it until it clears the field of the lens, at a rate of sixteen times a second. But the sound, with its

the method, are now familiar to every movie fan.

A demonstration of the practicability of reproducing film records by radio was given on January 24 from the RADIO NEWS stations WRNY and W2XAL, New York, when the records of "Weary River," a new sound picture, were broadcast on both long and short waves; and probably have been heard on the latter in distant continents. To accomplish this, it is necessary only to lead the output of the amplifier to the modulator of a broadcast transmitter, instead of to a system of reproducers.

AIRPLANE RADIO DX RECORDS

Hard after the movie demonstration of reliability of communication with the Byrd base at the Bay of Whales (in the Ross Sea, amid the eternal ice of the Antarctic) an even more remarkable feat, from the

THE NEW YORK TIMES SHORT-WAVE RECEIVER

(1,500-30,000-kc.—10-200-meters)

*THE instrument in use at the office of the New York Times to receive the messages of the Byrd expedition is the latest model, constructed by the staff of the radio station to meet greater demands than have been heretofore put upon any receiver for continuous long-distance reception.*

*This receiver, which is illustrated in two of the views accompanying this article, will be described fully in the May issue of RADIO NEWS, with construction details showing the components arranged in a standard-size cabinet which is obtainable by any of our readers, and with simplified shielding. It will be especially worthy of construction by every advanced short-wave listener. Blueprints will be available, if required.*

*The receiver has two tuned stages, the first one of screen-grid radio frequency, and the other an oscillating detector; these are controlled by a single vernier dial! Four knobs on the front panel are all the minor controls required by this set, whose remarkable efficiency may be gauged from the work it has been doing, day in and day out, in handling traffic with the Byrd expedition and other parties in remote, almost inaccessible corners of the world. The short-wave fan will find this set the next piece of construction to be considered.*

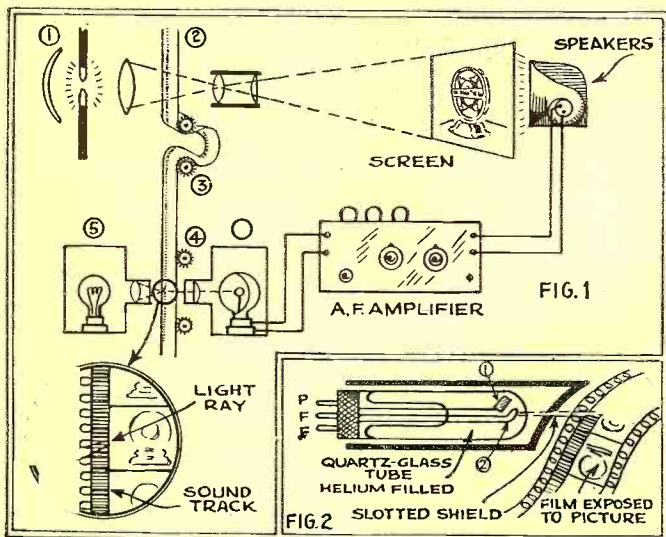

Fig. 1 shows the method of reconverting the film record into sound; the film is fed jerkily by the usual sprockets (2, 3) past the arc light 1; it is then caused to move smoothly by 4, taking up the slack, and passes a slit through which the lamp 5 shines. Each streak causes a corresponding "kick" in the photoelectric cell. Multiply the number on one "frame" by 16, and it will be seen there is an audio frequency to be amplified and reproduced. In Fig. 2 we have the original recorder; the filament 2 of the glow-lamp flickers and its light is reflected by the plate 1 through the slot, making the alternating streaks we see—and hear.

continuous waves, could not be recorded on a jerkily-moving surface of this kind without very complicated compensating mechanism. Therefore, a certain amount of slack in the film is allowed between the set of sprockets, moving jerkily, which govern the picture exposure, and the set of sprockets, moving steadily, which guide the same film past the sound-recording glow-lamp.

IN THE THEATER

After the usual processes of printing, development, duplication, etc., the film is taken to the theater to be reproduced. Here a similar duplex winding mechanism (Fig. 1) governs its operation; the picture is moved (upside down) one frame at a time, past the projector in the combination apparatus. On the other hand, a short distance further down, the film is passed before a photoelectric cell (see page 910 for a description of the photoelectric action of the alkaline-hydride cell). Behind it a small, specially constructed incandescent lamp throws a wide, shallow spot of light through the film into the cell. Wherever a black bar crosses the path of the beam, the latter is cut off, and the current output of the cell drops; while each streak of light in the "sound-track" gives an impulse of current. These, passed through an audio amplifier of sufficient size, operate large dynamic and exponential units placed conveniently near the screen; and reproduce every sound originally recorded at the same frequency, but with high volume. The effects, if not

radio standpoint, was accomplished when the Byrd plane, the *Stars and Stripes*, while in flight, communicated with the *Times* station; thus establishing a distance record for both successful reception and transmission by aircraft, on the evening

of January 25 at New York, which was the following morning at the Byrd base. The transmission was carried on in the 34-meter channel which has proved so effective at this distance. The plane, operating with the call WFC, sent out mes-



As this picture appears on the screen, the audience hears the radio dot-and-dash message. While the sound is photographed on another frame from that with which it is synchronized, it will be noticed that the quality of the sound shown here differs from that in the picture opposite.

sages also on 65 meters; but this wave proved unsatisfactory. Two-way communication was also established with the Mussel Rock station at San Francisco.

The power used by the *Stars and Stripes* in this test was but 50 watts; supplied by direct coupling to the shaft of a motor, rather than by a wind-driven generator, as usual. A fixed antenna, stretched across the tips of the wings, is used by the plane for short-wave work! The receiver used in this test by Malcolm P. Hanson, radio expert of the expedition, is a four-tube super-regenerator of his own design.

STATION WHD

The interior and equipment of the *Times* station, located in the very heart of mid-town New York, is shown in more detail by another of the reproduced photographs accompanying this article.

The operating table before which Mr. Meinholtz is seated is the station's center of activity, in that it mounts the telegraph keys which control the transmitter. The latter is located on the seventeenth floor of the same building and remotely controlled from the operating room shown. The main short-wave receiver handling Byrd's traffic is on the same table, as is the Kennedy intermediate and long-wave receiver. (While long-wave to the broadcast listener may mean anything between 300 and 500 meters, the term in this case, represents 20,000 meters.)

What appears to be a number of receivers along the wall to the left of the operating table is really a number of units comprising a single long-wave receiver; (long-wave, here, as above, represents 20,

000 meters.) The size of these units may cause some wonder to those unaccustomed to sets tuning to high waves but, when it is absolutely necessary to receive every day stations such as Rome, Italy, Rugby, England, and Nauen, Germany, with sufficient intensity to operate a loud speaker, receivers must be, not built, but engineered.

When mention is made of receiving these stations on the loud speaker this, of course, does not mean that the messages are copied in this manner. Loud-speaker intensity is desired, so that the receiving operators can be assured of at least headset reception when receiving conditions are poor. In other words, it is a matter of having a reserve of amplification.

Another long-wave receiver, at the right of the operating table, is not shown in the photograph; with the apparatus illustrated, it completes the receiving equipment in the "shack."

TRANSMITTER 200 FEET ABOVE

The short-wave transmitter heard by Byrd's operators in the Antarctic is a 500-watt, "500-cycle," tuned-grid tuned-plate arrangement; it is located on the seventeenth floor of the *Times* building where it is remotely controlled from the operating room on the third floor. This is the only transmitter used by the *Times* and is operated only on short waves, with the call WHD.

A number of interesting facts are found about the make-up of the station; the two long-wave receivers, each running for five feet along the walls on one side of the operating table, are the first to attract the attention of the station visitor. Each comprises nine tubes, functioning as two stages

of untuned-radio-frequency amplification, two stages of tuned-radio-frequency amplification, one oscillator stage, one detector and three stages of tuned-audio-frequency amplification. The waveband each covers is between 5,000 and 20,000 meters.

The two large units at the left of the operating table compose the Kennedy receiver and its two-stage audio amplifier; this is merely a stand-by emergency set and used for that purpose only.

The short-wave receiver at the right comprises four tubes functioning as one stage of screen-grid tuned-radio-frequency, a regenerative detector and two stages of transformer-coupled audio-frequency amplification. As customary in the design of commercial code receivers, a phone jack is mounted on the front panel for the convenience of the operator. One drum dial of the illuminated type controls the two variable condensers tuning the grid and plate coils of the screen-grid tube. The set covers a waveband from 10 to 200 meters.

A BIG LOOP

The experimenter who possesses a loop antenna of conventional size may be interested to learn that a large one of this type is employed at this station in conjunction with a 250-foot single-strand, vertical aerial, for long-wave reception. However, the sum of the sides of the loop happens to be 1,000 feet! A 250-foot single-wire aerial is dropped from the tower of the building to provide an aerial for the short-wave receiver. The ground system for the receivers is similar to that employed by other fans in the city—the water-pipe system.

(Continued on page 946)



In the central picture, above, a view of the radio station of the New York Times. The short-wave receiver used to pick up the messages from the Byrd expedition, and which will be described in the next issue of RADIO NEWS, is on the table at the right. Behind Mr. Meinholtz are his transmitting key and a long-wave receiver for emergency use. At the left, with horn, the long-wave set (up to 20,000 meters) in daily use for press-dispatch reception.

In the picture at the left, below, the long-wave transmitter of the City of New York is at the left, next is the radio compass, and in the center the 1,500-watt short-wave transmitter now connecting the Byrd party with the outside world. In the view at the right, the Byrd short-wave receiver is seen in front, and the ship-wave set in the center. A broadcast receiver is on the shelf above. Photos © J. V. Candido.

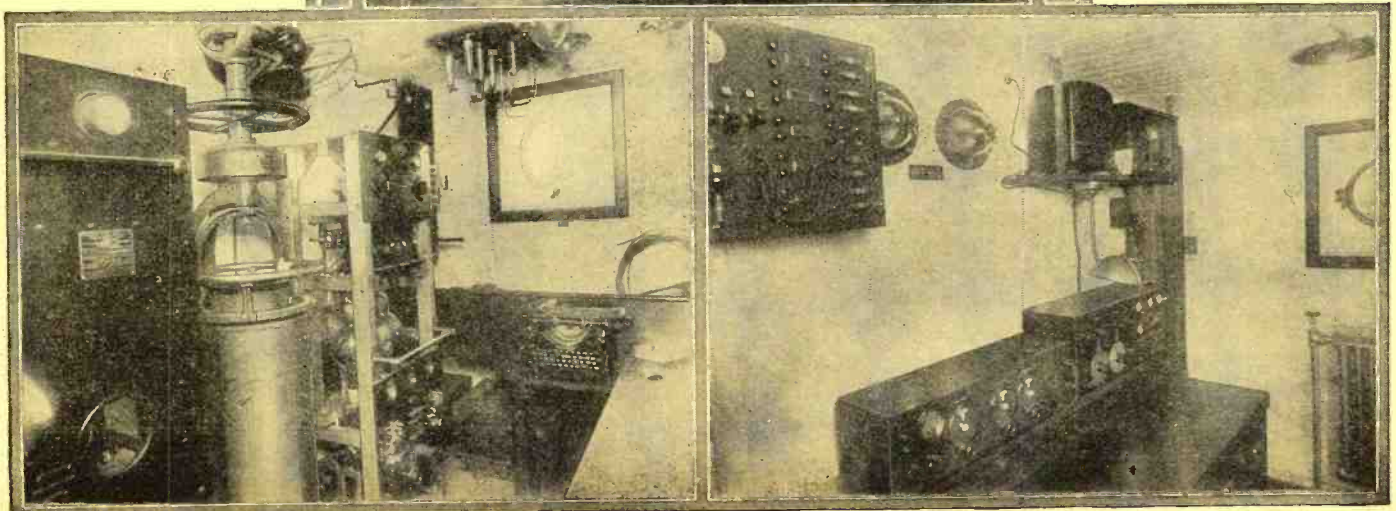

# Experiments with "Light-Sensitive Cells"

Circuits Adapted to Use for Various Photometric Purposes

By H. M. Bayer

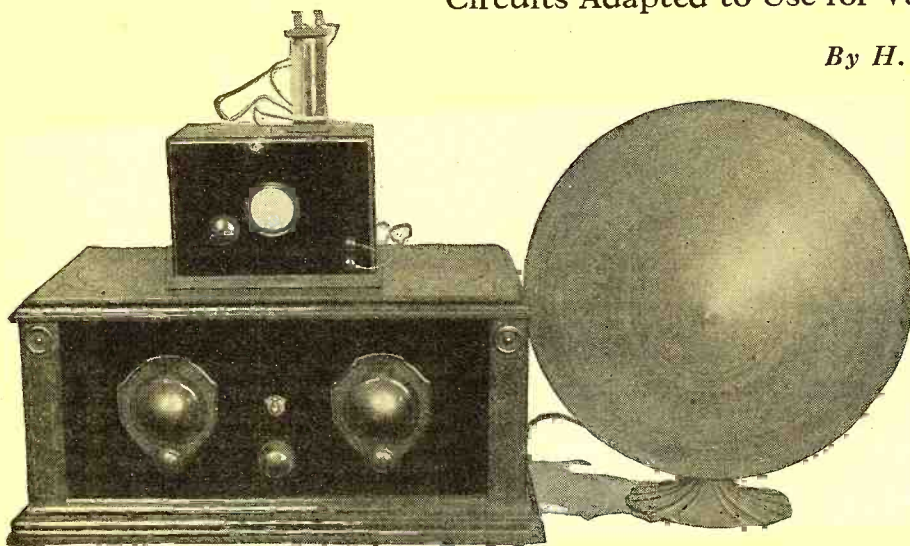

Fig. A

When the light in the room is turned off, the photo-voltaic cell (shown above its relay box) will throw the switch of the receiver. When the light returns, the switch is again thrown.

"LIGHT-SENSITIVE" apparatus has undoubtedly figured in the mind of the average home experimenter, when he has read of it, as a kind of device originated by deep-thinking research scientists, bearded physicists pondering over laboratory tables strewn with mysterious glassware, and engineers plowing through reams of profound calculations in quest of the unknown. True, these devices occasionally emerge, as all know, to make a display of sublimated parlor magic at expositions of scientific progress; but it is probable that few indeed appreciate the fact that the automatic operation of recording and other machinery by the action of light has become almost a commercial commonplace with more enterprising manufacturers.

The experimenter is looking on the photoelectric cell and its companions as he did, perhaps, on the vacuum tube fifteen, ten, or five years ago, whenever he began his radio education. Going back still further, we find a day when many practical "wireless" men discussed the vacuum tube with bated breath, and looked upon it as a device too fragile to endure outside the laboratory where it had been born.

Today every schoolboy of an inquiring turn of mind is familiar with the theory and operation of the vacuum tube, its construction and its functions in a radio receiver. It is true that its design and some of the engineering connected with its adaptation to special purposes require much skill and calculation; but the art of using it for ordinary reception requires no mystery or complex figures, and can be comprehended with a little study and thought by any layman.

This holds true for the light-sensitive cell also; there is nothing mysterious about its action, nor is its application to practical usage limited to the trained engineer or confined to the laboratory. It is the purpose of this article (and of others which will follow it) to acquaint the experimenter with some practical types of cells now

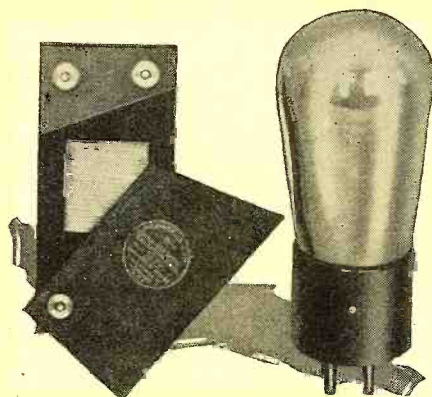

Fig. B

The old-style selenium cell, at the left, compared in size with a standard vacuum tube.

available to him, their methods of operation and some of their practical applications; so that he may perform many interesting experiments in his home with surprisingly little equipment. The field for these home experiments is unlimited; for example, a radio receiver can be turned on automatically when the room in which it is placed is illuminated. With the same arrangement, the receiver is automatically turned off when the light in the room is turned off; the circuit diagram for this experiment is illustrated in Fig. 1. However, this is only one of a multitude of stunts that will suggest themselves to the ingenious experimenter after he has obtained his equipment.

#### CURRENT-OPERATED CELLS

There are three distinct classes of light-sensitive cells, in each of which the phenomenon, or the manner in which it reacts to light impulses, is different. The first is classified as the "actino-electric" or *photoresistive* type; this cell consists of a metal (or compound) to which there is connected a source of potential. On the exposure of the cell to light it will exhibit a change of resistance, thus affecting a flow of current

across its terminals. Cells of this type, which most commonly use the element *selenium*, have been in use for many years. A commercial form of this cell consists of a small porcelain, or marble, slab on which a thin coat of crystalline selenium is deposited, and two or more copper or gold wires wound bi-spirally over the slab. This assembly is enclosed in a bakelite case, which is equipped with a shutter of the same material. Such a cell (as illustrated in Fig. B) lends itself to the needs of the experimenter because of its simplicity; but it has the disadvantage of operating with a distinct amount of lag or *inertia*. That is, it requires a short, though measurable, time to recover its resistance after its exposure to illumination. Thus, it can be seen, in experiments requiring response at very high frequencies to the action of the shutter this type of cell will not do. It is not, therefore, adapted to television, though it may serve for many other purposes, commercial and experimental.

The second type, which is perhaps now most familiar to the experimenter because of its use in television and the consequent publicity it has received, makes use of the *photoelectric* effect. In this cell a film of an alkaline metal, such as potassium or sodium, is deposited on the inner surface of the glass of a vacuum tube, and a centrally fixed "collector" is placed in the center of the bulb so that it faces the "coating"; a large cell of this type is illustrated in Fig. C. When the cell is exposed to a source of light, the alkaline metal emits electrons in much the same way as the heated filament of a vacuum tube;



Fig. C

A photoelectric cell of the alkaline type; it has a seven-inch bulb. Note the "collector."

only, in this case, the emission of electrons is caused by light instead of heat. Thus, it can be seen, in this cell the circuit is closed through the electrical path provided by the flow of electrons from the alkaline coating to the central "collector." Fig. 2 shows the elements of its construction.

The simplest circuit for a cell of this type is shown in the first diagram (A) in Fig. 3. The cell is connected to the grid of an amplifier tube (a 112A-type will do) which must be correctly biased for best operation; this biasing voltage should be near that specified for the tube, and should be variable so that the best operating point may be found.

A more elaborate and better arrangement is shown (at B in the same figure) wherein a separate battery is required for the cell. The value of the resistance is determined by actual test. In a further refinement (shown at C) a suitable transformer is employed as a coupling between the cell and the amplifier tube. A resistance-coupling arrangement may prove more satisfactory, when a wide range of light-variations is to be handled accurately; in which case the arrangement shown at D may be preferable. In the last, the coupling unit may be the same as that employed in the audio amplifying system of a receiver; increased amplification will usually be experienced with this arrangement.

On the vacuum-type cell, high potential is essential for best operation; voltages up to 600 (D.C.) are recommended. The gas-filled cells, on the other hand, should be operated as close to their "ionization-voltage" as possible. The best way to obtain this condition is to expose the cell to the maximum light to be used, and gradually increase the applied voltage until "ionization" occurs, evidenced by a pinkish glow in the cell. This voltage is noted; and a voltage about ten lower is then selected as the best to be applied.

**A VOLTAGE-GENERATOR**

The third classification is that of a newly-devised cell which may be, perhaps, of most

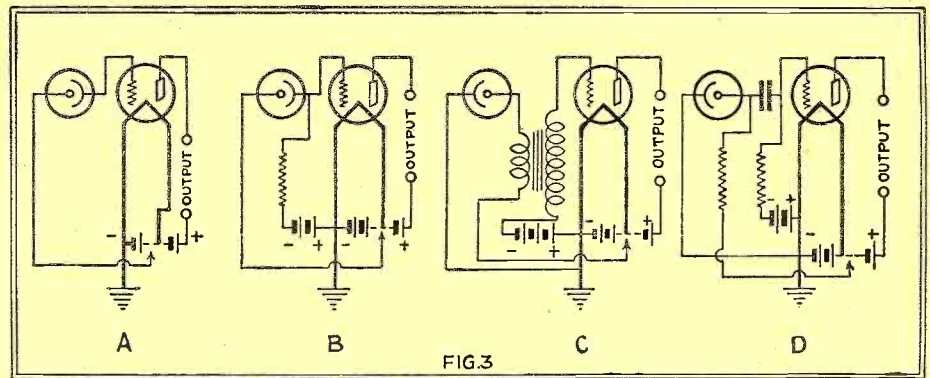

FIG. 3  
Four circuits adapted for use to amplify the output of a photoelectric cell for practical application; C and D are the two most commonly used. This is the type of cell illustrated in Figs. C and F; it is extremely sensitive and has little lag, but its output is very small.

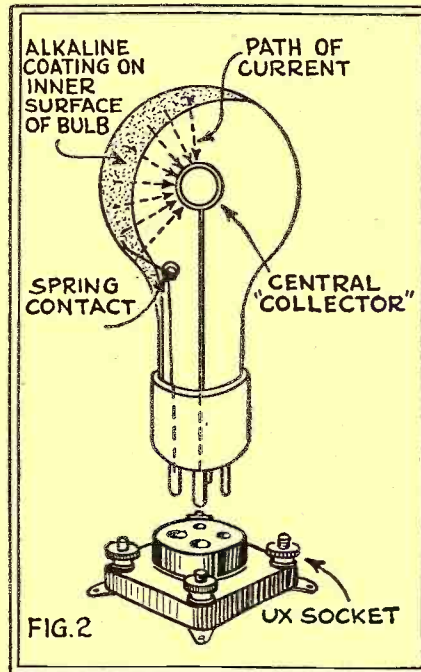

FIG. 2  
The photoelectric cell generates a minute current in the form of a stream of electrons picked up by the anode, or "collector." It has made television possible.

interest to the experimenter because of the fact that it may be operated without vacuum-tube amplification. In this device a source of potential is obtained as the result of exposing to light one of two plates immersed in an electrolyte, thus creating the photo-voltaic effect. The voltage created across its terminals is the result of chemical action on the plates, the degree of which varies with their exposure to light. This voltage is then employed to actuate a sensitive relay, which in turn actuates another relay; the terminals of the latter are connected to whatever apparatus is to be operated.

In detail, the photo-voltaic cell consists of a cylinder of special glass, which is very transparent to light-rays of visible and other frequencies; to this are cemented bakelite top and bottom plates. The top plate holds the electrode assembly, which consists of a coated copper plate and one of lead brought out to two binding posts; the electrolyte is a weak acid solution. The apparatus is shown in Fig. D, with its relays.

The cell, when placed in a circuit with a low-resistance milliammeter, gives a minute "dark current." However, when it is exposed to ordinary diffused daylight, a current of 0.3- to 0.4-milliamperes is obtainable; this is ample to actuate a meter-relay. This fact brings us to the outstanding feature of this cell; it is capable of supplying sufficient power, without vacuum-tube amplification, to actuate an inexpensive relay which in turn will perform the desired operations.

**METHODS OF OPERATION**

When the cell is connected in a circuit as shown in the first diagram (A) in Fig. 4, the meter response will be at maximum for any given light intensity. However, if left in this circuit, the cell will soon dissipate its useful energy, even while in the dark, just as would a dry-battery cell; the useful life of the cell in such a circuit would be about 50 hours.

On the other hand, if the hook-up shown at B in the same figure is used, the cell may be left closed (in the dark) almost indefinitely, without affecting its sensitivity, or causing the cell to lose its effective power. The charging current from the 1.5-volt cell (an ordinary flashlight unit) with nothing in parallel with the cell should be 0.4 milliamperes. The resistor R1 is variable between zero and 10,000 ohms.

Perhaps the best method of controlling the cell is shown at C in this sketch; but in employing this circuit care should be taken not to leave the potentiometer arm too far



Fig. 6

"The Electric Dog," invented by John Hays Hammond, Jr., some years ago, is an ingenious toy; but the principle may be applied to practical purposes. The movements of the little self-propelled box are guided toward or away from the light, as desired by the operator.



to one side. If it is left too far to the left (toward the positive side), the cell is short-circuited; if too far to the right, the charging current from the 1.5-volt dry cell will be too high. The potentiometer should be adjusted so that 0.4-milliamperes flows through the light-sensitive cell; as this has been found the optimum value of battery current needed to keep the cell in condition when in a closed circuit.

**THE METER-RELAY**

If we provided a meter with a stop which would make contact with the needle, or pointer, at a certain position on the dial, and close a circuit, it is obvious that the meter would then operate as a sensitive relay as well as a current indicator. Such a contact arrangement is illustrated at the left of Fig. 5.

To do this, a thin vane of pure silver or platinum is fastened to the pointer, and a contact point of the same metal is used as a stop. The instrument may be of the one-milliamperes full-scale type, having a resistance of 20 or 30 ohms. The stop should be then placed so as to make contact at about the 0.6-milliamperes point on the scale, as indicated in the sketch at the right of Fig. 5.

This relay, which we will describe as a meter-relay, is capable of actuating a power relay (the heavier relay performing the actual operation) when the proper circuit hook-up is employed; this circuit is shown in Fig. 1. (Though the details of the meter-relay are shown, the experimenter is advised not to attempt its assembly, unless he is an expert mechanic trained in precision work; instruments of this nature can be purchased, reasonably enough, to insure successful experiments and applications without going to the trouble of attempting to build a meter-relay. It is painstaking work and quite beyond the mechanics of the average experimenter.)

The circuit shown at the left of Fig. 1 should be used by the experimenter in his operations. It will be noted that when the meter-relay A closes (because of the current supplied by the light-sensitive cell as soon as it is exposed to light) resistor R1 is shorted; this causes a sufficient increase in current flow through the secondary relay circuit B to actuate and cause it to operate any device which may be connected to its terminals D and E. It should be remembered that the cell will operate in reverse fashion, as well, in the presence of a source of light; for example, it will be noted that relay ter-

minals C and D are closed when no current is flowing through the cell or relays, or, in other words, when the cell is dark. This feature makes it possible to break one circuit and make another when a light is directed upon the cell; that is, while the cell

of a non-inductive type, and be capable of carrying 10 milliamperes; each should have a resistance of 1,000 ohms. A 2,000-ohm potentiometer will do nicely.

**THE AUTOMATIC RADIO SET**

An application which may serve as an example of the experimental possibilities of light-sensitive cells, is illustrated in the same figure, and may be employed to the amusement and mystification of the uninitiated. The stunt is merely a matter of connecting one of the "A" posts of the re-

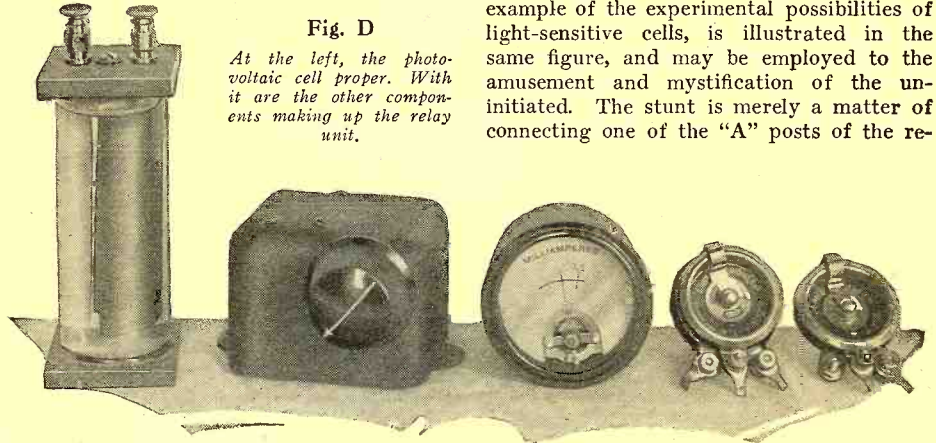

**Fig. D**  
At the left, the photo-voltaic cell proper. With it are the other components making up the relay unit.

is dark, terminals C and D will be closed; in the presence of light, however, these terminals open and C and E will close.

Since the meter-relay and the cell have been described, it will be necessary to identify only the resistors and the secondary

receiver and one of the terminals of the storage battery (as shown at the right of Fig. 1) to relay terminals C and E. In this manner, the receiver will be turned on automatically whenever the light in the room is turned on; when the light is turned off, the receiver also will be turned off.

By placing the cell on top of the set as shown in Fig. A, and properly adjusting the potentiometer controlling the bias, it is possible to control the action of the receiver whenever anyone steps between the cell and its source of light. Should anyone do so, the set will automatically cease playing; but, on his stepping away from the cell, the receiver will again operate.

Of course, there are many simple experiments that can be performed with the apparatus outlined above; buzzers and bells may be operated by employing the same circuit illustrated for the receiver. Modifications of this experiment are employed in burglar-alarm systems, fire-alarm systems and numerous other operations where light is a controlling factor.

As a suggestion: construct a miniature lighthouse, in the tower of which is placed a six-volt lamp connected in series with a storage-battery and relay terminals C and D. Noting the circuit diagram we find that employing these terminals will cause the bulb to light when the cell is "dark." In

(Continued on page 961)

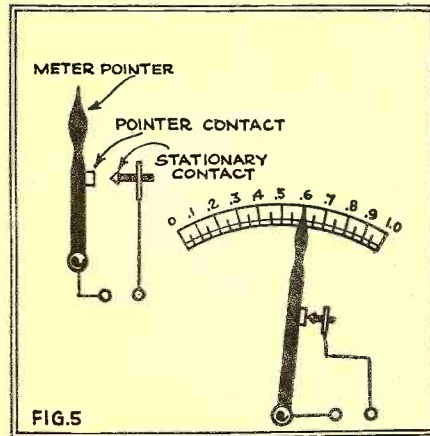

**FIG. 5**  
An ordinary milliammeter makes a sensitive relay, if we have a contact to close a circuit with the pointer at some reading.

relay; the latter should be capable of actuating on 3 to 6 milliamperes of current, and should have a resistance of about 700 ohms. Resistors R1 and R2 must be

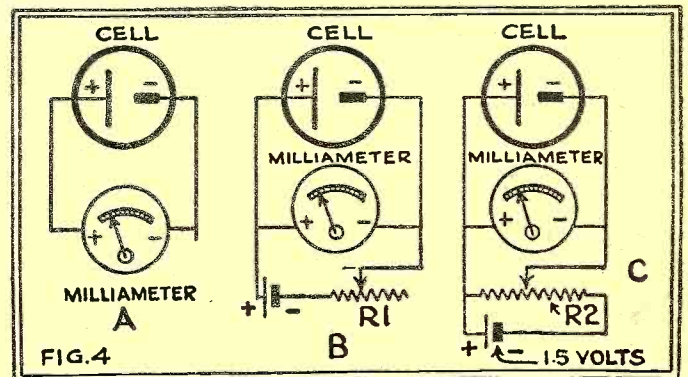
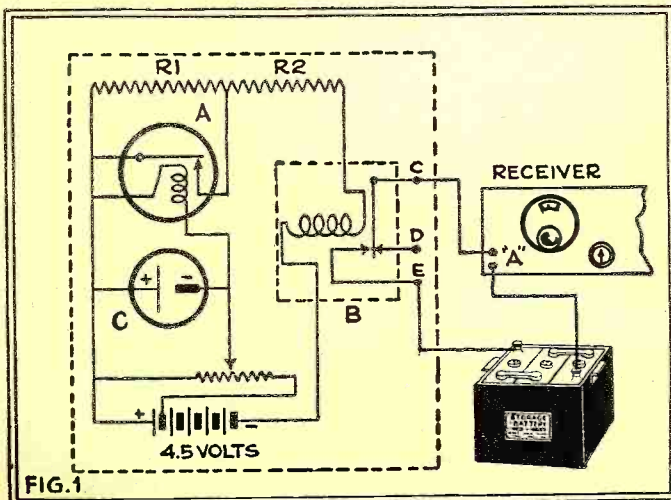

The development of the circuit of the photo-voltaic relay is shown above; A and B are experimental, C the practical circuit of the cell. This is incorporated in the more complete arrangement of Fig. 1 at the left; the unit illustrated in Fig. A with the cell outside the cabinet uses this circuit.



# What's New in Radio

All apparatus described in this department has been tested in the RADIO NEWS Laboratories and found of high quality in design and construction.



## A Complete Testing Outfit For Radio Work

ALMOST indispensable as an addition to the serviceman's equipment, is a complete test unit, which must comprise a number of meters and all the necessary adapters for testing both A.C. and D.C. circuits and tubes. The apparatus illustrated herewith is designed especially for the trouble-shooter, and affords instruments to make any conceivable test or adjustment that might be encountered by a serviceman. It is equipped with three meters: the first a D.C. voltmeter with three scales (0-10, 0-100, 0-600); the second an A.C. voltmeter, also with three scales (0-3, 0-15, 0-150); and the third, a milliammeter, with two ranges, 0-2.5 and 0-125 milliamperes. A system of plugs and jacks provides means for finding all desired values in the operation of a receiver, and of making the connections at all points desired.

Contained within the case is a step-down transformer, tapped in the secondary to provide the various voltages required by the numerous types of A.C. tubes. The unit is provided also with a tube rejuvenator operating from the same step-down transformer; with this arrangement the serviceman may reactivate tubes of the thoriated-filament type. An oscillator, for testing different types of tubes under actual operating conditions, as well as for balancing single-control receivers, and for re-neutralizing purposes, is incorporated, and adds greatly to the convenience of operation.

Various cabled plugs, tube sockets and adapters are provided to facilitate the testing of all tubes and all circuits; a tap at the base of one of the sockets gives an additional connection for testing screen-grid

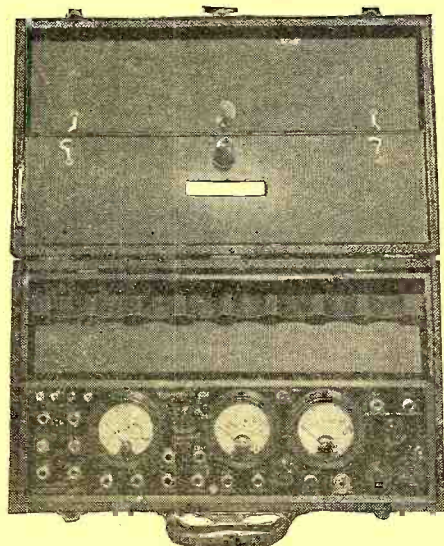

Fig. A

This is practically a portable radio laboratory for all measurements. A novelty is the inclusion of an oscillator for set testing.

tubes. Rectifier tubes may be tested by comparing the output with the normal for the type in question.

The complete unit is housed in a leather-covered carrying case, measuring 14x12½x5 inches; snap fasteners and a key lock are provided, as well as a complete servicing manual containing complete instructions for its successful operation.

Manufacturer: *Supreme Instruments Corporation, Greenwood, Mississippi.*

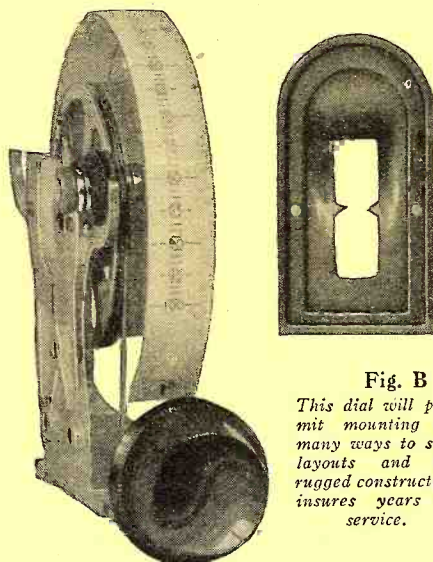

Fig. B

This dial will permit mounting in many ways to suit layouts and its rugged construction insures years of service.

## Drum Dial Permits Flexibility of Arrangement

A NEW, illuminated drum-dial presenting a number of interesting features is illustrated (Fig. B) with its accompanying window. The dial consists of a die-cast metal drum carrying a translucent 100-degree scale, and a die-cast bracket which, in turn, carries the drum, a miniature lamp socket, and the driving shaft. The die-cast bracket is arranged so that it may be fastened upon a chassis and, when so mounted, will be rigid enough to carry a single, double or triple tuning condenser, which will require no other support. The bracket is pierced with five holes so arranged as to accommodate almost any standard condenser.

A feature of the assembly is that the bracket itself need not be fastened down; thus, in case a set's condensers are firmly fastened to a chassis, it is necessary merely to clamp the dial drum to the condenser shaft, and allow the bracket and drive shaft to "float." The bracket is prevented from turning by a ¼-inch hole in the front panel or escutcheon plate, through which the ¼-inch driving shaft projects.

The dial has an 8:1 reduction ratio, and is controlled entirely by a knob on the front panel, located directly below the center of the scale window. The scale itself, about six inches long (drum diameter, 3⅞ inches), provides a full 1/16-inch for each scale division; making it easy to read to a half-di-

vision, or closer. While it is of the so-called "string-drive" type, this dial uses, not the usual fish-line, but a bronze cable, wound from shaft to drum and vice versa. The drum is free to turn a little more than 180 degrees; then it is arrested by rubber-cushioned bumpers, preventing strain on the condensers or the dial cable.

Two models are available; they differ in the position of the bracket, at the right or left of the scales. Both turn in the same direction, and are essentially similar, except for their scales.

Manufacturer: *Silver-Marshall, Inc., Chicago, Ill.*

## Double Adapter Mounts Two Tubes in One Socket

AN ingenious unit designed for those who desire to parallel two output tubes as a simple means of increasing reserve power in an A.F. amplifier is being marketed by an eastern manufacturer; it is designed for the purpose of expediting the use of an additional power tube in this manner, by the conversion of a single-tube output stage into a parallel arrangement without the necessity of rewiring the audio system, or changing the voltages applied.

As shown in Fig. C, the device consists of two sockets of the UX type, mounted upon a bakelite strip, and with the filaments, grids, and plates of both wired in parallel. While the change from a single output tube to parallel amplifiers requires some extra wiring, the latter is entirely contained within this device.

It is installed by simply removing the last audio tube from its socket, and in its place inserting the prongs of the unit; two tubes answering the requirements of the receiver's voltages are then inserted in the twin sockets of the converter. No

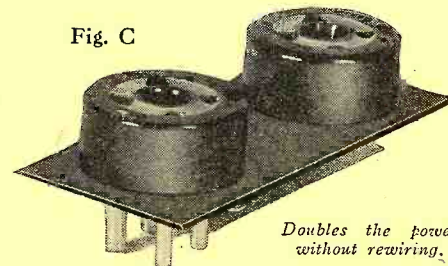

Fig. C

Doubles the power without rewiring.

other changes are required, except the replacement of a filament-ballast suited to the additional current requirement, perhaps.

Electrically, the use of this unit provides satisfactory power transfer between the power stage and the speaker, since the output impedance of this stage, by using parallel tubes, is reduced to half its value when a single tube is employed; a condition making for better quality, especially on low tones, than when the impedances are fully matched.

Manufacturer: *Arthur H. Lynch, Inc., New York City.*

### Six-Tube Kit Designed For Rapid Assembly

A KIT of all parts for a six-tube, all-electric receiver of simple construction and low cost has been brought out by a prominent parts manufacturer, and will appeal to both the home constructor, who builds sets for his own amusement, and to the custom radio builder, who makes them for resale at a profit; for it involves a minimum of labor in assembly and is of a "sure-fire" electrical design that assures good results out of the loud speaker. Full-size blueprints showing the assembly and wiring are furnished with the kit; these are clear enough to enable even a tyro to put the instrument together successfully.

The various parts are mounted on a metal front panel and a metal sub-panel, both of which are accurately drilled for all mounting screws. A sample kit submitted to the Radio News Laboratories was assembled in two hours without difficulty, all the instruments fitting nicely in place.

The front surface of the front panel is grained to resemble fine wood and presents a tasteful and decorative appearance, shown in Fig. D. The vernier dial controls a triple tuning condenser (C2), which extends at right angles from the back of the front panel; it is mounted securely to the sub-panel by means of machine screws.

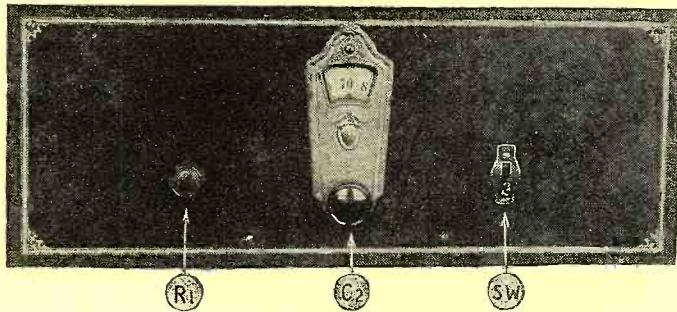

Fig. D

The metal panel has a neat appearance. It comes ready-drilled.

At the right of the tuning condenser are three R.F. transformers of the tuning circuits (L1, L2, L3); the sockets for the R.F. tubes, (V1, V2); the antenna series condenser (C1); the oscillation-control resistor (R2); the filament-lighting transformer (PT); and a receptacle into which the plug from a power unit is inserted. The kit does not include the "B" unit, whose purchase is made optional; the manufacturer recognizing that many users of old sets already have "B" devices of some kind.

At the left of the tuning condenser are the components of the audio-frequency amplifier, which has two stages, the last push-pull. The detector socket (V3) is directly before the first stage transformer (T1). The sockets for the three A.F. tubes are mounted along the rear edge of the sub-panel. The push-pull input transformer (T2) and the output impedance (T3) fill the remaining space in the left section of the sub-panel.

The latter is braced to the front panel by means of two end brackets, additional rigidity being given to the assembly by the mounting of the tuning condenser.

On the underside of the sub-panel, which is shaped like a shallow dish, are the assorted fixed condensers and fixed resistors C3, 4, 5, 6, 7 and 8, and R3, 4, 5. The metal panels form the ground and the negative side of the "B" circuit, and many of the connections of the set are made directly to them. (Wherever a connection in the schematic diagram is shown running to a ground symbol, it actually goes to one of the panels.)

Electrically, the receiver is of the straight

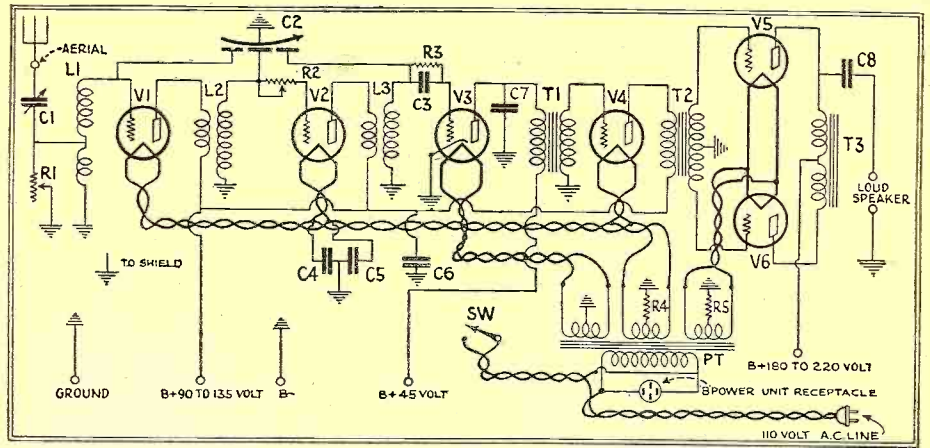

Fig. 1

The circuit of the receiver as assembled below gives all features of the standard R.F. set, with antenna tuning for sensitivity, push-pull output stage and filter to speaker.

tuned-radio-frequency type, being perfectly straightforward without complicated controls. The three R.F. transformers are exactly alike in construction, each being tuned by a section of the triple tuning condenser. The adjustable grid resistor R2 controls oscillation in the second R.F. stage, while the variable resistor R1, in shunt with the primary

stage is rather unusual; but makes it possible to keep the price of the kit at a lower figure.

Practically any "B" power unit using a rectifier tube of either the 280 or the BH (filamentless) type, and designed to furnish the usual "B" potentials between 45 and 200 volts, can be used with the receiver to complete it. Grid bias for the tubes V1, V2 and V4 is furnished by the voltage drop across the resistor R4, (through which the plate current of these tubes flows) and bias for the push-pull stage by a separate resistor R5, in the filament circuit of the last tubes.

Manufacturer: Pilot Electric Mfg. Co., Inc., Brooklyn, N. Y.

### New A.C. Tubes Designed

TWO new vacuum-tube types have been announced by a leading manufacturer, one a new A.C. screen-grid tube and the other a new power tube; the latter is of particular interest, because it provides a very satisfactory power output with a relatively low plate voltage. It will find ready application as a replacement tube, to be used in place of the 210; unfortunately however, its amplification constant value is less than that of the 210. The accompanying figures speak for themselves.

The A.C. screen-grid tube has a surprisingly low value of plate impedance, considering the high amplification-constant factor. This tube is of the heated-cathode type, utilizing raw alternating current on the heater filament; the cathode, as in the 227, is the source of electrons; a five-prong (UY) base is therefore required.

(Continued on page 946)

of the antenna coupler, controls the volume of the entire set and oscillation in the first stage. This control is a very smooth one, and is very effective; by limiting the incoming energy right at the antenna coupler, it prevents detector overloading, a serious cause of distortion.

The adjustable condenser C1, in series with the aerial, is very useful in suiting the receiver to its particular aerial; its setting is determined by trial, and once found is not disturbed.

Each section of the triple tuning condenser is fitted with a tiny midget condenser, by means of which the tuning stages are adjusted to exact resonance. The single-control feature works out very nicely, the set being sensitive and selective over the whole tuning range.

Alternating-current tubes of the 226 type are used in all R.F. and A.F. stages, while a 227 is used for the detector. The use of 226 tubes in push-pull for the last audio

Fig. E

Simple, inexpensive, but strong construction is a keynote of the metal chassis, which makes assembly a quick process.

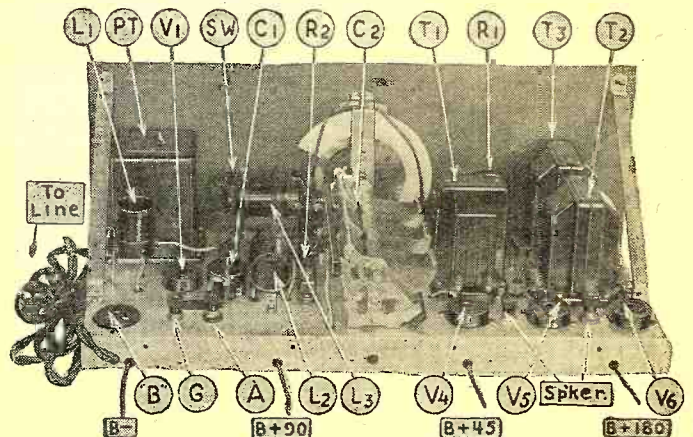

# The Radio Beginner

## Pick-Ups—and How to Make Your Radio a Phonograph

**M**ANY of our older readers would remember the debates which were waged in the pages of radio magazines during the years 1922 and 1923, with reference to the increasing vigor of the competition between radio and the phonograph as means of public entertainment. One article in particular (which appeared in the June, 1922, issue of RADIO

whether radio reproduction could ever reach the perfection of phonograph quality.

What a surprise a radio "Rip Van Winkle" of 1922 would receive if, after sleeping peacefully for seven years, he were awakened to be confronted by a modern phonograph equipped with an amplifier of the type used so extensively for radio reception! Who would have thought, a few years ago, that radio would not only soon reach the perfection of the phonograph, but pass it and even cause the phonograph to be modified to obtain radio's degree of "perfection"? Yet, this is just what has happened.

The same article discussed the outcome of the conflict between radio and the theater—and, of course, we all know that the vacuum-tube amplifier (the same, fundamentally, as that used in the new phonographs) is now being used in the new popular "talkies." The tables have certainly

been turned; for the question now appears to be "Can the phonograph compare with radio in quality and fidelity of tone?" The best way to answer this question is to compare the two, draw your own conclusions. It is not very costly, nowadays, and not at all difficult to construct a really good electric phonograph.

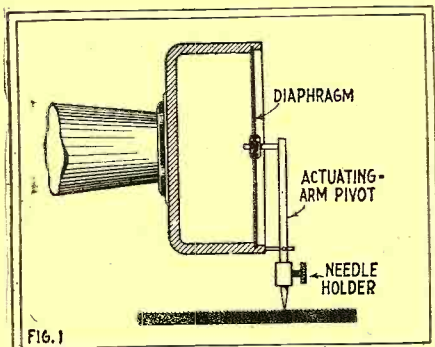

The old-fashioned phonograph unit depended upon mechanical leverage to produce sounds.

News) explained that, although radio was growing fast and was certain to become a great industry, it could never supplant the phonograph in public favor. One reason assigned was that the radio receiver cannot be called upon to reproduce any desired selection, chosen arbitrarily, at any time, but is governed by the station programs which are actually being broadcast at the moment within its range. Of course, we must recognize the truth of this statement, so far as the receiver alone is concerned.

The same article voiced also some opinions as to the comparative fidelity of the tones reproduced by the radio and the phonograph, and evidenced some doubt as to

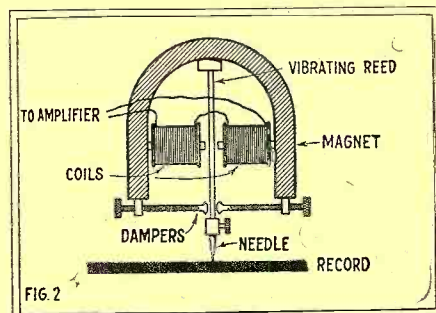

The electric pick-up vibrates more freely than the older unit; but its output may be amplified to any volume desired.

### RADIO IN PHONOGRAPH PRACTICE

The question has been brought up, just what differences are there between the old and new methods of phonograph reproduction? The grooves in a phonograph record are so cut that the needle vibrates from side to side, as the record turns. In the old system, these vibrations are carried to a diaphragm by the mechanical motion of a lever and a suitable hinge. The vibration of the needle causes a corresponding motion of the diaphragm, which in turn sets up a vibration of the air in the horn. In this way the sound is transmitted to the ears of the listener. This system is both low in cost and reliable but, unfortunately, it causes a considerable amount of distortion. Both the

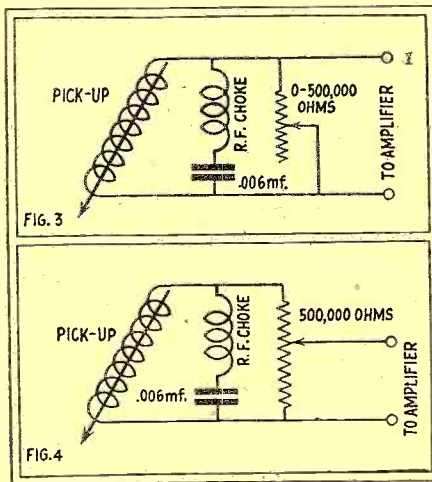

Optional connections for a volume control.

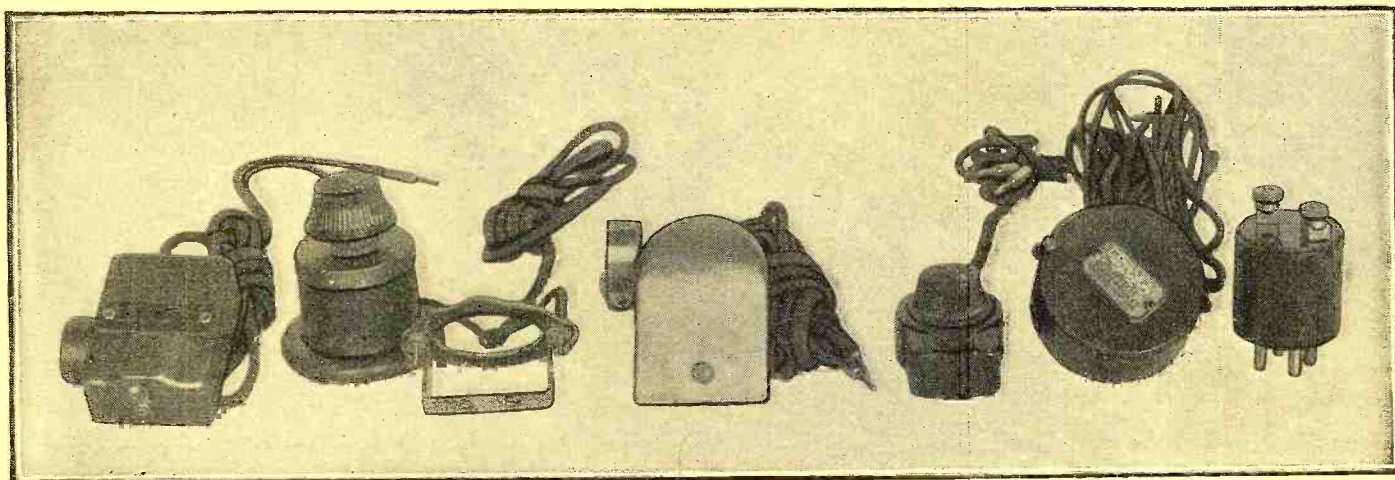

Commercial apparatus for converting a receiver to phonograph use. Left to right, a pick-up with control, an adapter making a detector the first A.F. stage, a pick-up, a remote-control device, a

pick-up of a third type, and an adapter which replaces the detector tube in its socket. The latter is less used because of the greater advantages obtained by rewiring the receiver.

DEVELOPMENT OF SOUND DEVICES

The history of the electric pick-up (to adopt the common term) can be carried back as far as 1875, when Alexander Graham Bell first developed the telephone; the operation of the pick-up device is almost identical with that of the early microphones used by Dr. Bell. The first microphone consisted of a permanent magnet, around which was placed a coil of wire; a thin piece of magnetic metal (iron), placed in front of the magnet, was suspended by its edge so that the center could vibrate. By speaking directly in front of the diaphragm, it was caused to vibrate; and this caused to be generated in the coil a weak current, due to changes in the magnetic field around the permanent magnet. The fluctuating current in the coil was found to be almost identical in its "wave form," with the motion of the diaphragm and, in this way, an electrical equivalent of the sound was obtained. A similar magnet, coil and diaphragm were placed at the

horn and the moving mechanism have "points of resonance" and, of course, notes corresponding to these in pitch are brought out much louder than the others. The construction of the old-fashioned short horn, moreover, destroys some of the low notes.

The new system depends on changing the energy created by the vibrations of the needle into pulsating electric currents in a "pick-up" coil; this will be described more fully, later. The currents set up in the coil are transferred to an audio amplifier, a device well-known to all radio enthusiasts, and, finally, a loud speaker coupled to the amplifier brings out the notes which were originally impressed on the record.

"Pick-up" units of this type were introduced to the radio public about the middle of 1926 and, since that time, a dozen or more of good quality have been placed on the market. (The term "pick-up" is almost a misnomer, since the unit really does not pick up anything. The word "reproducer" or "converter" would be

better; since the "pick-up" merely converts a mechanical motion into an electric current.) The difference between the two units is shown in Figs. 1 and 2; the first, the old phonograph "sound box"; the second, the magnetic pick-up for electrical reproduction, which gives also amplification.

other end of the wire and the electric currents were re-converted into sound in just the reverse manner. In the electric phonograph pick-up, a permanent magnet is also used, a coil, or several coils, is placed near the magnet and a thin bar of metal or "armature" is used instead of the diaphragm. The metallic bar is fastened to a phonograph needle with a suitable clamp, and the complete unit is placed over the record in place of the usual needle and sound-box assembly.

(Continued on page 956)

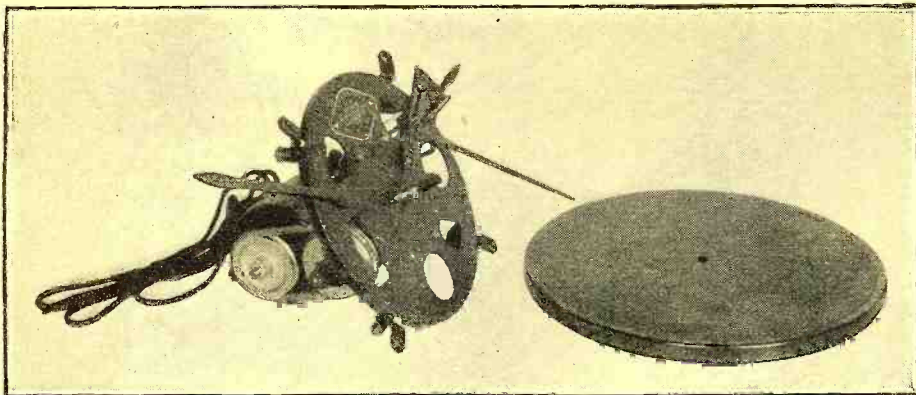

The owner of a radio receiver may convert its A.F. amplifier for phonograph reproduction, by building an electric motor and turntable like the above into the console.

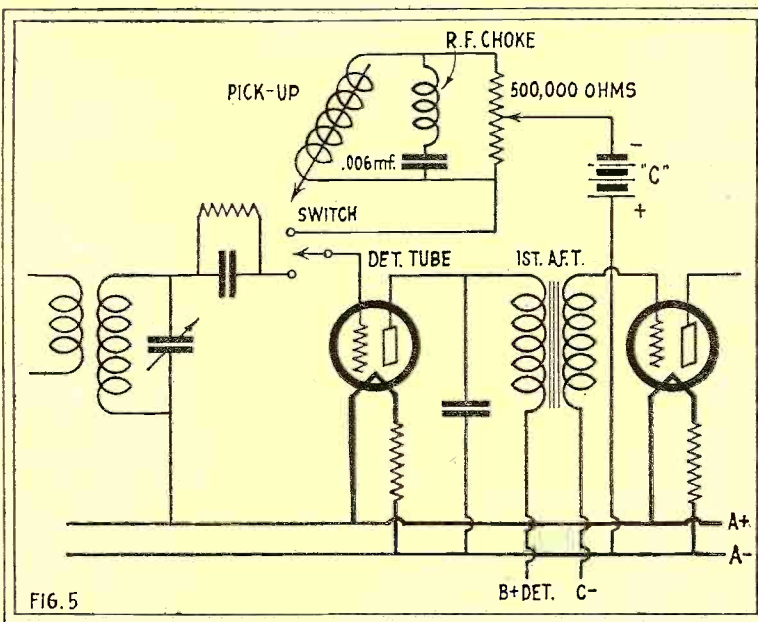
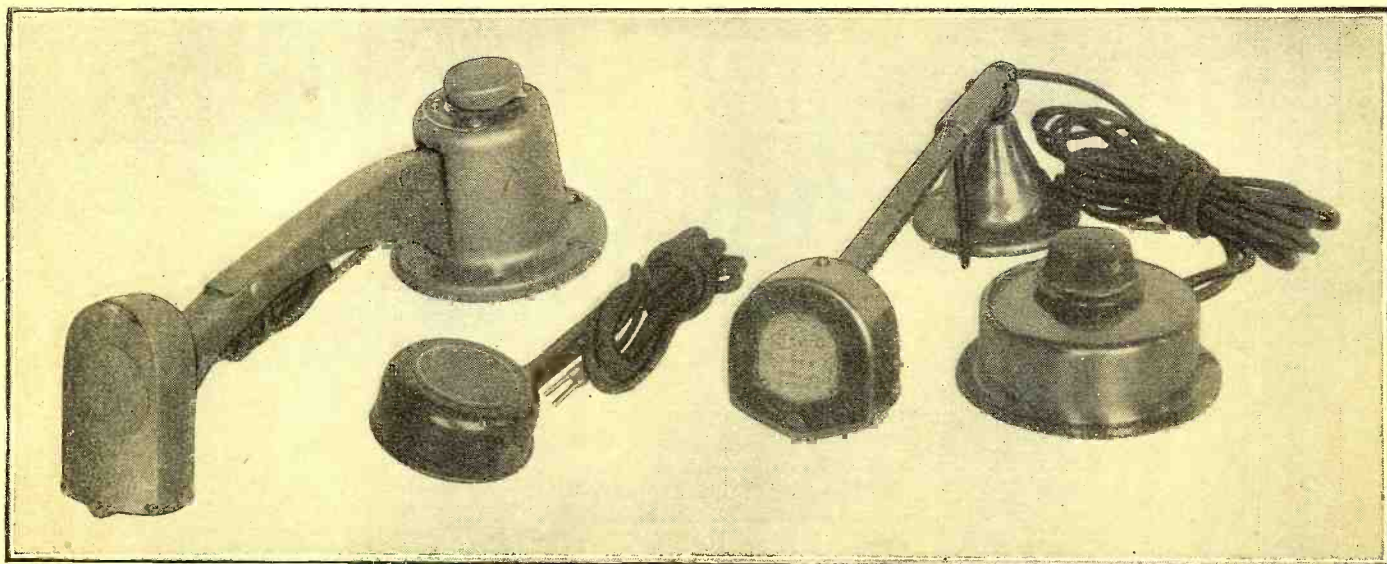

FIG. 5

The circuit shown in Fig. 5 gives the largest possible amount of volume from a given pick-up and amplifier, for it utilizes the detector tube of the set as an additional A.F. stage. The switch may be inside or outside of cabinet, as convenience dictates.



The pick-up devices illustrated opposite are designed to be used with a phonograph already in use, and to slip over its tone-arm. Those pictured above are complete in themselves, with the aid of a motorboard, to construct an electric phonograph suitable for incorporation in a radio set. The pick-up at the left incorporates its own volume control in the base.

# Some Methods of Detection—and Their Respective Merits

## What Takes Place When a Radio Wave is "Demodulated," and Why Detection is Always Accompanied by Some Distortion

By C. Walter Palmer

**F**OR the last few years, magazine articles and books on radio reception have emphasized the importance of reducing *distortion* in receivers. Long discussions have been written to urge the use of good apparatus and the correct application of certain principles in order to obtain the best results. For this reason, it has come as rather a shock to many set builders

frequency amplifiers. If a pair of headphones were connected to the R.F. amplifier, we could not hear the signals, for two reasons. In the first place, the diaphragms of the phones can not vibrate as fast as the variations in the current; and, in the second place, our ears would not respond to such high notes. The average human ear will not respond to sounds higher than 10,000 or 12,000 cycles, and the lowest carrier-frequency used by broadcast stations in the United States is 550,000 cycles.

have sensitive spots over their surface and the sharp point of the "cat whisker" is necessary to find these points.

There is also a type of crystal detector which requires the addition of a battery in order to work properly. This type of detector uses a piece of carborundum, with a heavy spring contact. In itself, it is not

By referring to the form of the modulated waves, we find that their general lines correspond to the variations in the current in the microphone, except that the variations occur on each side of the zero potential line. If we could cut off one-half of the wave, along this line, and also eliminate the high-frequency variations, we would have a line exactly similar to the original changes in the microphone current. This is accomplished by the detector.

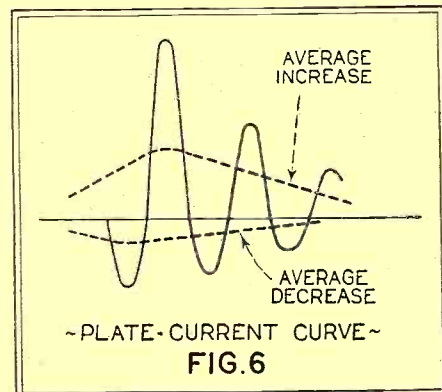

In detection, the wave is so distorted that one side is practically suppressed. The resulting current is largely audio-frequency.

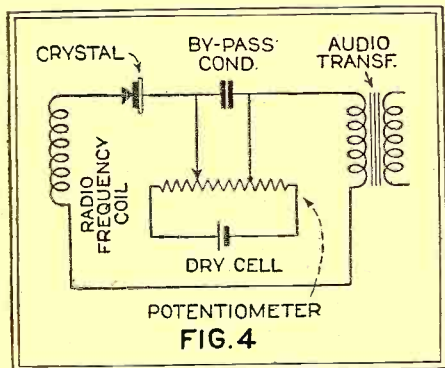

A "fixed" crystal whose bias is regulated in this manner gives detection of very good quality; it does not, of course, amplify.

### CRYSTAL DETECTORS

The crystal detector is a type of electric one-way "valve." The currents can travel in only one direction through the crystal and the impedance of the phones or amplifying transformer prevents the high-frequency variations from passing. The usual crystal detector uses a contact which presses on only one point of the crystal. Most crystals

nearly as sensitive as galena and similar detectors, but the operation can be improved by placing a small battery in series with the crystal. The conductivity of the crystal is greatly increased by a certain small voltage, and the lowered resistance produces a much greater signal strength. A potentiometer and condenser are used to allow a critical adjustment of the bias. This is shown in Fig. 4.

### DETECTING WITH A VACUUM TUBE

The discussion up to this point is rather off the track of showing why distortion in the form of the waves must be encountered when detecting with a tube; but it serves to bring to mind several facts and will help in understanding the action later. There are two common methods of obtaining a detecting action in a tube. One uses a "C" battery in the grid circuit and is known as the *plate-current* method. The other uses a grid-leak and grid condenser and is known as the *grid-current* method. The latter is the more common and we find this method used in almost every broadcast receiver made. The first is more suitable for large sets, because of some of its characteristics. However, the comparative merits of the two systems will be discussed later.

### DETECTING WITH A GRID BIAS

The tubes used for both methods are the same and most of the common tubes may be adapted to either, by several simple changes. The first system mentioned above, or plate-current rectification, is so called because of its unusual effect on the plate current at certain points, when the grid bias is varied.

and fans, who have spent so much time and money, that their apparently-fine receivers will under no conditions receive without some distortion. This certainly appears to be a paradox, and it is necessary to make some explanation of such a broad statement. Fortunately, the explanation is not very difficult, and the statement is not as radical as it first appears.

The articles usually written on the elimination of distortion apply entirely to amplifiers and are not concerned with detectors. The principles given for the reduction of distortion do not apply to the detector and it is at this point that we find an explanation of the statement made above. In order to understand exactly what happens, we must have a good idea as to just what is meant by detection.

### MODULATION OF RADIO WAVES

The signal sent out by a transmitter consists of two parts or "components"; first, the "carrier-wave," which is a very high-frequency alternation and, when unmodulated, can be represented as in Fig. 1. The second component consists of the variations of voltage caused by the microphone. When we speak or sing into the microphone, we cause a change in the current in the microphone, and the amplification of this by the "modulator" serves to change the carrier-wave to conform with these current changes. The changes in the current in the microphone, and the resulting wave form are shown in Figs. 2 and 3.

These modulated radio-frequency currents cause "waves" which are transmitted, picked up by the receiving antenna, in which they cause currents which are amplified by radio-

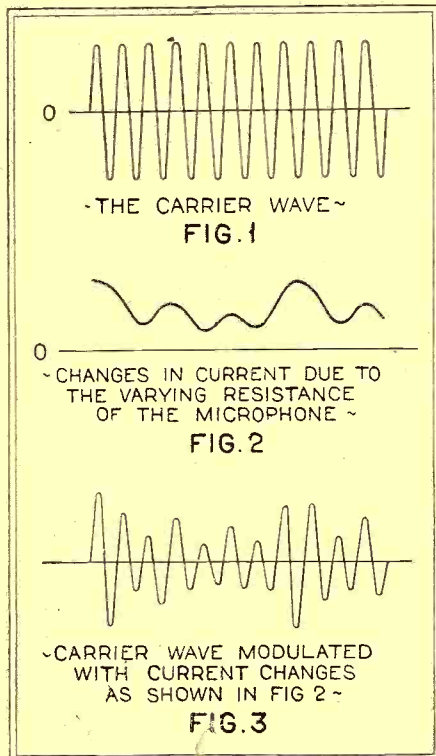

The unmodulated carrier-wave and the audio-frequency wave picked up by the microphone blend to form the complex wave of Fig. 3.

To understand this more fully we will refer to a *graph* of the grid bias and the plate current. (See Fig. 5.) Most of us are familiar more or less with the uses of graphs. They are used wherever a direct comparison is desired between two varying figures or values. Graphs are made in a number of different ways, but in this case, a paper ruled with lines intersecting at right angles to form equal adjacent squares, is employed. At the top of the square thus formed, we mark off the various grid voltages which might be used. Since the bias may be either positive or negative, we use one line for a zero voltage and the others for voltages either positive or negative within the required range. (In a detector, the grid bias will rarely exceed five or six volts.) On the left side of the graph we mark the various values of plate current which may be encountered and, by measuring the actual plate currents for various grid voltages with an actual tube, we obtain a curved line or "characteristic" similar to the one shown. Of course, the line for a given tube does not always correspond exactly to the one shown, but it does follow a similar general direction.

If, now, we connect the tube in a radio receiver and tune in a signal, the grid bias will change in value, every time the current of the received signal changes. These changes are extremely fast; in short-wave reception, they occur several million times every second. However, we can indicate a few of these changes on a curved line similar to the one shown at the bottom of the graph.

CHANGE OF CURRENT FORM

If the correct plate and grid voltages are used, a line through the center of the curve representing the signal will strike the original curve in the graph, just at the point where it bends suddenly. If we draw vertical lines to the curve, and then record the corresponding changes in the plate current, we find that a curve somewhat similar to the original signal curve is obtained. There

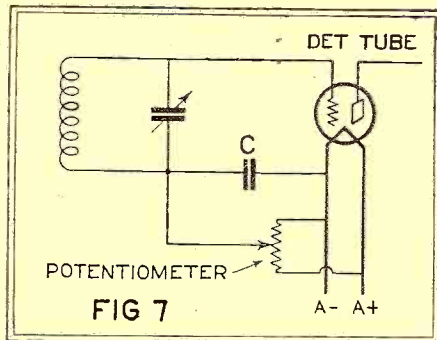

FIG 7  
The necessary adjustment of grid voltage for plate-current rectification is most conveniently made with a potentiometer, as shown above.

is one great difference, however, and on this difference depends the whole detecting action. If we look at the curve, we find that a line drawn at "X" at right angles to the vertical line at this point, divides the plate-current curve very unevenly. On one side of the line, the variations are very great, while on the other, they are comparatively small. The shape of the curve is undoubtedly distorted in relation to the incoming signal curve, and this is the distortion mentioned at the beginning of this discussion.

If we make a second graph of the plate-current changes (Fig. 6) and mark the average variation, we find that the increases in the current greatly exceeds the decreases; and this average upward change will be sufficient to actuate a telephone receiver connected in the plate circuit of the tube. The extremely high frequency-variations in the current are blocked by the impedance of the phone winding and, when an audio amplifier is used, the impedance of the first primary winding, or the R.F. choke which follows the detector, serves the same purpose.

A condenser is usually connected in the plate circuit of the detector, and carries the high-frequency currents away from the plate. The condenser is connected to the filament lead or to ground, and these currents are disposed of in this way. The low-

frequency variations are carried through the audio-frequency amplifier and are amplified in the usual way. If we refer back to Fig. 5, we find that the average variation in the plate current of the detector tube is larger than the average variation on one side of the incoming signal curve, and from this we can see the *amplification* which is obtained in the detector when using a vacuum tube. This amplification can be increased tremendously by using regeneration; but this is beyond the scope of the present article.

OBTAINING THE "C" BIAS

There are several ways of obtaining the required "C" bias and a satisfactory adjustment for the above method of detection. The first is shown in Fig. 7. A potentiometer is connected across the filament terminals, with the grid return leading to its adjustable arm. By moving the arm from the positive to the negative side, the bias will be increased and the best point can be found by experiment. This method is quite satisfactory for small sets where the signals are not very great. The grid-voltage "swing" is limited by the filament voltage and, if the signals are very strong (as they are when several stages of radio-frequency amplification are used), the grid voltage might change over the zero point to the positive side and cause an overloading of the detector. The potentiometer should have a resistance of about 400 ohms and a by-pass condenser of at least .001-mf. should be connected between the center arm and the negative side, to keep the *radio-frequency resistance* of the circuit low.

A second method of obtaining the bias is shown in Fig. 8. This method is better suited to larger sets, since the potential on the grid can be made as large as necessary by increasing the size of the "C" battery. The potentiometer is used in this case also to obtain a close control of the voltage, and a by-pass condenser is connected as described above.

(Continued on page 952)

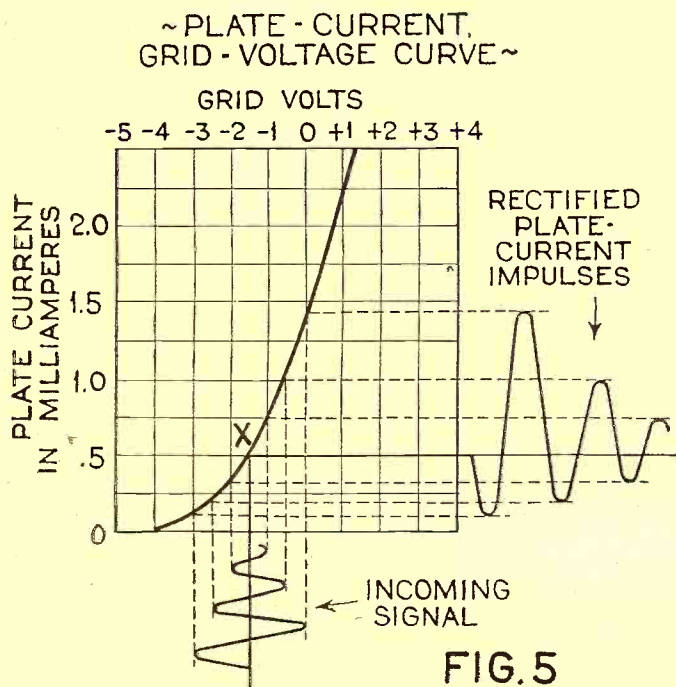

FIG. 5

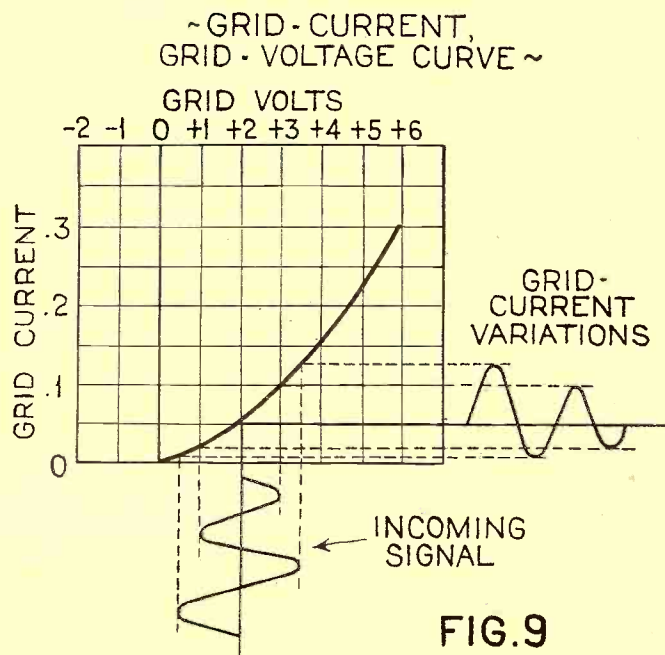

FIG. 9

In the tube with a "characteristic curve" such as the above, voltage "swings" on the grid, corresponding to the vertical wave at the bottom, produce a distorted output wave-form like that at the right.

With a "+" voltage on the grid, a tube operates at a different slope of its "characteristic," and the "+" half of the signal alternation, increasing the total voltage, causes an increase in current flow greater than the decrease due to the "-" half. Result, distortion again.

# Aerials and Grounds for Short-Wave Reception

Some Basic Principles Which Have a Bearing on the Efficiency of Antenna Systems for Reception on Varying Wavelengths

By Ashur Van A. Sommers

**T**HE short-wave broadcast listener who begins with too much enthusiasm is apt to be disappointed, particularly if he is one of the many not blessed with an exceptionally good location for reception. He has read with interest about those who can count on Australia for breakfast, England for dinner, and television movies before retiring; and, after he has built a "junk-box" set, or plugged a short-wave adapter into the handsome A.C. receiver which adorns his parlor, he expects to hear Eindhoven or Bandoeng come booming in when the dial is turned. If he has no results, or if he hears only code stations—unintelligible to him, but at the least proof that his set is operating—he may murmur that short waves are a "lotta baloney," and that something has been put over on him. In other words, he will be repeating the emotional experience of many a fan of the old days who toiled all evening in the hope of finding the right spot on the galena, and concluded that radio was "the bunk."

Not so: short-wave broadcast technique has not reached perfection, though it is improving. It must be regarded as to a certain extent experimental, even yet; but it is based on a foundation of solid performance, especially appreciated by thousands living in parts of the world outside the normal range of any long-wave broadcast station. To these the great short-wave stations are their "locals;" as many of the letters received by RADIO NEWS testify.

It is true, of course, that short waves are capricious; they are easily turned aside by obstacles in their path. A listener in the congested district of a large city, surrounded by steel construction, may readily be disappointed of short-wave reception; but then, too, he may also find it impossible

### What Do You Need in Addition to a Receiver?

**Y**OU have a short-wave receiver or an adapter and expect to receive, not only American short-wave broadcast stations, but also England, Holland, Australia, and other distant countries. While it is not possible to receive all short-wave stations from all points in the world, it should be possible to receive many of them if your location is at all suitable, and not subject to too much local interference. But, no matter how good your location, and how good your receiver, there is always something between you and the signals you want to hear. *That is your antenna.*

*How good are your aerial and your ground? Are they suitable for the purpose under the new conditions of receiving short waves? What changes should you make in them?*

This article describes the principles underlying all aerial and ground systems, and the special modifications necessitated by change in wavelengths received. You should read it to see whether you are getting the most out of your short-wave set, and whether there is a possibility of improving reception. No matter how good your receiver, the results you will get from it are no better than your antenna; for that provides the "raw material" (signals) on which the set must operate.

A study of the following is recommended to every new short-wave fan, whether he is operating a short-wave set with moderate satisfaction, whether he is still disappointed in the results, or whether he is just hoping to obtain them.

to get his nearest local on the upper broadcast wavelengths.

What is even more fundamental is the nature of the "skip-distance," explained later in connection with Fig. 6. There are great rings on the earth's surface where even a powerful short-wave station cannot be heard. These vary in position with the hour of the day, and the conditions as to sunlight, etc., between them and the station. Especially when the sun is rising or setting between transmitter and receiver do these belts of no-reception shift quickly; thus producing rapid fading of the signal. Each

"skip-distance" varies with the wavelength, as well as with the condition of the atmosphere. It is possible that this trouble will be overcome, by means of beams directed at varying angles against the "Heaviside Layer." For point-to-point transmission between Europe and South America, experiments of this kind have been conducted. For the present, however, we must fall back on

the amateur's analysis of reception conditions: "Either you get 'em, or you don't."

#### AERIAL TYPES

However, assuming that our listener is so located that some signals from short-wave broadcasters are passing in his vicinity, he must take some steps to intercept them and to feed them into his radio receiver, before he can operate the latter. The conventional idea of an aerial-and-ground system at once occurs; and it is probable that he has already taken some steps to utilize the antenna which is bringing in local long-wave broadcasts very successfully. Perhaps it will be quite successful with the short waves: in which case his problem is concerned with proper operation of the set to extract the greatest possibilities out of every squeal. On the other hand, there may be conditions which make the present antenna system less efficacious for waves one-third to one-fortieth of the length of those for which it was designed. Let us consider the nature of an aerial.

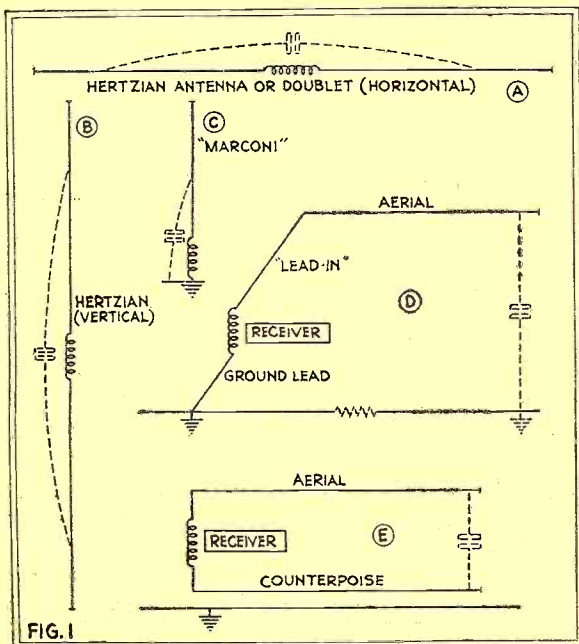

Left, the fundamental aerial types; it will be seen that the ordinary receiving aerial is an adaptation of the Marconi type, and that capacity and resistance figure in the circuit. Right, a view of a transmitter's field in one cross-section at one instant.

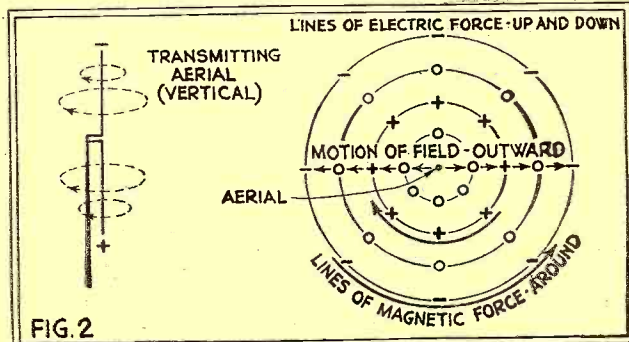



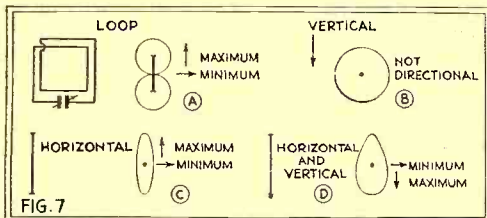

Theoretically, a vertical aerial would be best for broadcast reception. Practically, however, a horizontal one is more convenient. With short waves, remember, small capacities, as shown at the right, make important losses.

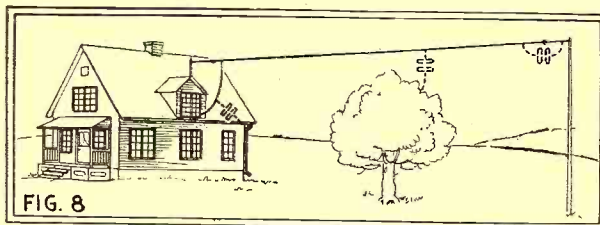

The first radio system devised by the experimental genius of Heinrich Hertz comprised simply two rods with capacity sufficient to carry an electric charge, by which an oscillatory flow of very high frequency could be maintained between them. A Hertzian antenna, therefore, is one which has two equal and opposite members, theoretically in line with each other. Between the two there exists a certain slight capacity, as indicated in Fig. 1 at A and B.

It is obvious that we must have two parts in the antenna system, in order that the electricity which flows out of one may have some place to store itself during half a cycle. The same condition, however, may be obtained if we simply connect the half-antenna to the earth, as in the "Marconi" type aerial at C.

These were evolved during the first period of development in radio, and with the idea of getting a wave into the air. Corresponding antennas for reception, of course, may be constructed. Either of them, however, would have certain practical difficulties connected with its use in connection with the ordinary broadcast receiver. We may see the fan's usual equipment in schematic form as at D. His lead-in is a part of the aerial, and gives the latter, electrically, vertical height as well as extension. On the other side of the set from the aerial is the ground lead and the ground.

WHERE DOES THE GROUND BEGIN?

The poet has told us where the West begins; but where the ground begins is another question. The simplest radio calculations are based on the idea that the earth is a perfect conductor, charged at a certain, very negative potential. For certain purposes, it might be said to be such; but when radio frequencies are considered, the earth is decidedly far from a perfect conductor.

As a matter of fact, if we connected to the ground post of our set by a large copper cable some very extensive sheets of metal and sunk them into the deep sea, we would have what might be called a "ground" to about four-fifths of the earth's surface. It would not, of course, be a perfect conductor, even at that; but we may see why the nearest thing to a true "ground" may be obtained on a ship at sea.

We may, however, do away with the ground and substitute a "counterpoise," of wire as a rule, which is for our purpose an artificial ground, and gives us a Hertzian system folded over, as we may say. The counterpoise should be some distance above the actual ground, and between the latter and the aerial.

We have now, as one might say, a net to catch not fish, but waves. What are these

(antenna or otherwise) of a short-wave receiver, which will respond at 12,000 miles to no more power than there is in a Christmas-tree bulb.)

THE "WAVE" STARTS

With the flow of current from one end of the aerial toward the other, "lines of force" build up around it with incredible swiftness. They bulge out, they sink in again as the current (at every half cycle) falls to nothing. But, as the field of force caused by the previous current collapses, it meets halfway the force of the current building up in the opposite direction, and is forced outward again. The result is that a part of the energy in the aerial escapes at every alternation of current, and goes outward in all directions, forming a "wave." We can compare this to a wave of water, except that the latter is formed almost entirely on the surface, while the radio wave moves in three dimensions, so that we cannot make a satisfactory picture of it on a sheet of paper. If we modeled it in glass, it would be not unlike half an onion in shape, above the earth.

How far the wave enters into the earth is another question. If the latter were a perfect conductor, as assumed in the theory of ground, the wave would be reflected from it, like light from a sheet of silver. On the other hand, it has been proved by experiment that radio reception can be had quite successfully from a buried aerial, and even at a considerable depth in the earth. The grounded wave must, therefore, travel for some distance in the earth, especially where the latter is a poor conductor.

WAVES ARE NOT CURRENTS

It must be borne in mind by the reader that a wave is not a current; a wave travels in a non-conductor, a current in a conductor of electricity. When a wave reaches a conductor, such as an aerial wire, it causes a current to flow in the latter; thereby losing energy. A wave thus makes a current, as a current makes a wave in the first place. The current is the actual motion of free electric particles, or electrons; the wave is the changing position of the "lines of force" connected to these electrons—in other words, a rearrangement of the equipment.

(Continued on page 963)

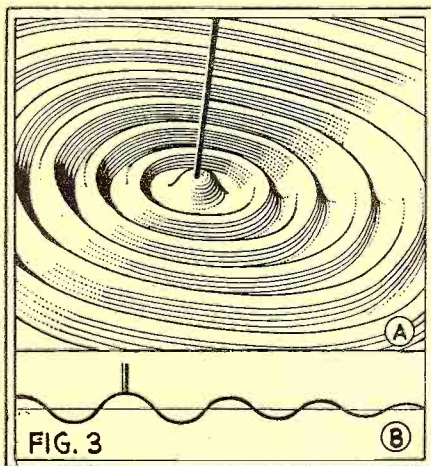

A diaphragm churned up and down into waves radiating with decreasing height is the usual illustration of an electric field.

waves, and what do we do with them after we get them?

In a rod (which, for convenience, we will show as vertical, like many short-wave transmitting aerials), we cause an electric current to flow up and down very fast. As the current alternates more frequently, the sharpness of the disturbance to the surrounding medium (whatever it may be, "ether" or "curvature of space" or what you will) increases. At 60 cycles a few watts of current will hardly cause a ripple a few feet away. At 15,000,000 cycles, a receiver on the other side of the world may respond to the pulsations. (Fig. 2.)

(Someone—Darwin or other great authority—said that the brain of an ant seems to be the most remarkable bit of intelligent matter in the world. Certainly, the most sensitive bit of matter is the tuned circuit

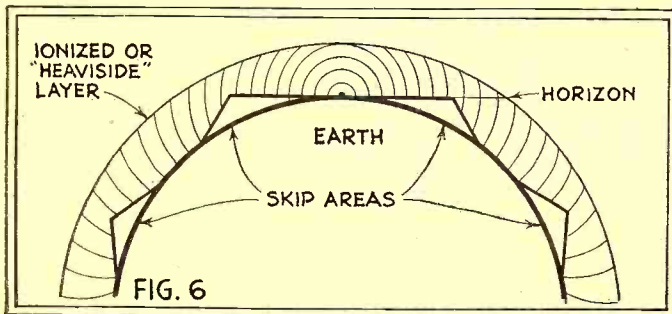

Waves—particularly shorter ones—are reflected by earth and sky. This makes them skip over certain areas, varying with the hour of the day, in which they cannot be received

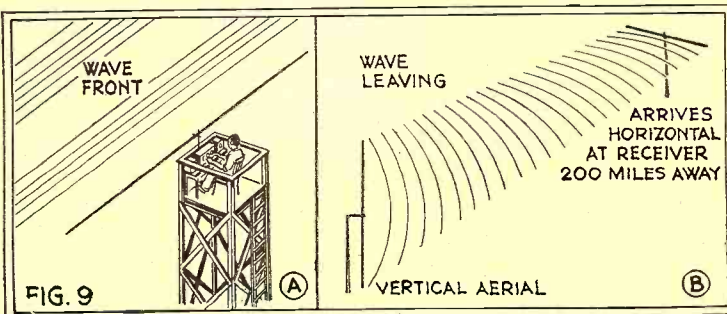

Short waves especially have a great tendency to wiggle around, as soon as they leave the aerial. This effect can be measured by an aerial, such as that at A, which can be turned to the angle of greatest signal strength.



## How to Make a Handsome Radio Console<sup>\*</sup>

By H. L. Weatherby

**E**VERYONE who has a radio wishes to house it in a suitable piece of furniture; while radio consoles are becoming more and more beautiful and expensive, as the radios themselves are becoming more efficient. The amateur who builds his own set need no longer feel that he cannot have a beautiful cabinet for it—nor the set owner who has purchased his set in a box—for the building of a console, in either case, is a comparatively simple matter.

The radio console illustrated in this article is not as difficult to build as it may look. To the average worker, in his home shop, it will present no unsurmountable

obstacles; he need not let the carved mouldings scare him, for they can be purchased in any variety of designs from the finer cabinet shops. The legs may be taken to the mill for turning, if one does not have a lathe; and the wood is largely plywood which comes already sanded. The joints themselves are all of the simplest sorts; and to have a truly beautiful radio console means only to secure suitable wood and then to work it up with a reasonable degree of accuracy.

Mahogany or walnut is recommended, but one of the cheaper woods will finish well and will be a very good imitation of the harder and more expensive wood. Painted

furniture is quite the vogue now and any close-grained wood will paint well.

Having selected the wood and cut it out according to the material list below, construction operations are in order.

### CONSTRUCTION

The cabinet part and the table are constructed as two separate and complete units. It is suggested that the table be built up first. The legs may be made from 1¼-inch square material, in which case, slabs to make up the desired thickness of 2 inches must be glued on at the wide part near the top, and enough to make 1½ inches at the bottom. The legs are turned

## A New Departure!

**A** MAJORITY of the readers of RADIO NEWS (as a recent survey among some 25,000 of them indicates) do constructional work of one kind or another, whether radio set building or other forms of craftsmanship. If you have a flair for mechanics, and skill with tools, there is no reason why you should confine your activity, for either pleasure or profit, to radio alone.

To make broader activities by our readers more readily possible, RADIO NEWS will therefore present each month one or more Handiwork articles (of which this is the first) of a nature not confined solely to radio. While our first article gives details for the construction of a handsome radio console, and the second will be devoted to a combination radio-and-phonograph cabinet, we intend in the future to publish in RADIO NEWS other Handiwork Blueprint articles along non-radio lines. For those who enjoy cabinet work, we may say there is a tremendous demand today for the angular, so-called "modern" furniture, as well as in the old Colonial designs. Then, too, there are possibilities in work beyond the scope of furniture, such as metal work, airplanes, telescopes, and many others alluring to the enterprising home constructor.

The important message we wish to convey is that we have found, by past experience, in the vast majority of cases, the man who has completed an attractive piece of work at once finds a demand from friends and others who wish to purchase it or another like it. It has taken him some time and trouble to learn how to make the first; but thereafter it is much easier to make duplicates *which may be sold at a handsome profit*. We can therefore recommend to the versatile radio set builder to consider as a side line the construction of other utilities which will, often, net him more money than the sale of home-made sets.

We have engaged a number of expert authorities on different forms of craftsmanship to prepare for us a series of articles along their special lines, and we shall publish, in the Handiwork Blueprint series, the best of designs, instructions, and advice that brains and money can obtain. The blueprints will be particularly elaborate and so prepared that it will be easy to build from them.

## Important!

Note that it is unnecessary to do your own lathe-work, cut your own veneer, make your own friezes and cut-outs, or perform other work requiring special machinery; any more than to make your own condensers, tubes or A. F. transformers, when you build a radio set. The designs presented in these pages will lend themselves to simple assembly and, with few exceptions, any materials required can be bought, when desired, in the open market.

Thus you can obtain practically all the material required for Radio Console No. 1, described here, from a number of houses such as are found in every large city. (For those who do not know them, names and addresses of firms will be found on the specification sheet which comes with the blueprint.) Wooden material usually comes in the natural finish, and will have to be stained and varnished; but this is comparatively simple. You will be surprised to note how low the cost of building such a console as that shown here—only a small fraction of the price you would pay for the completed furniture. Of course, some of your time will be required; but it will be well paid, as you are saving the cost of a high-priced factory worker's labor.

We would especially like very much to hear from our readers as to what they think of our new departure, and we particularly ask you to fill out and send in the coupon printed on page 971. It will help us a good deal to shape our policy, and to give you what you most desire to see, in the Handiwork Department.

H. GERNSBACK, Editor.



No. 1A

from the rail section down, and mortises are made for the rails. The decorative grooves at the top should be cut before gluing the slabs to the legs. The rails, as indicated, and for which patterns are furnished on the prints, are to be shaped with the band saw and then filed and sanded. The table top may be of a cheaper material, since very little of it will show; and after gluing the legs and rails together, the top should be fastened securely to the frame with screws, either from above or below. The drawer slides and partitions are then placed; after which the table section should be set aside while work is continued on the upper part.

**CABINET SECTION**

The cabinet or upper portion is made up as one would construct a box, open front and back, with exception of braces. It may be fastened together securely with nails, after which glued corner blocks are used to reinforce the corners. The nails, of

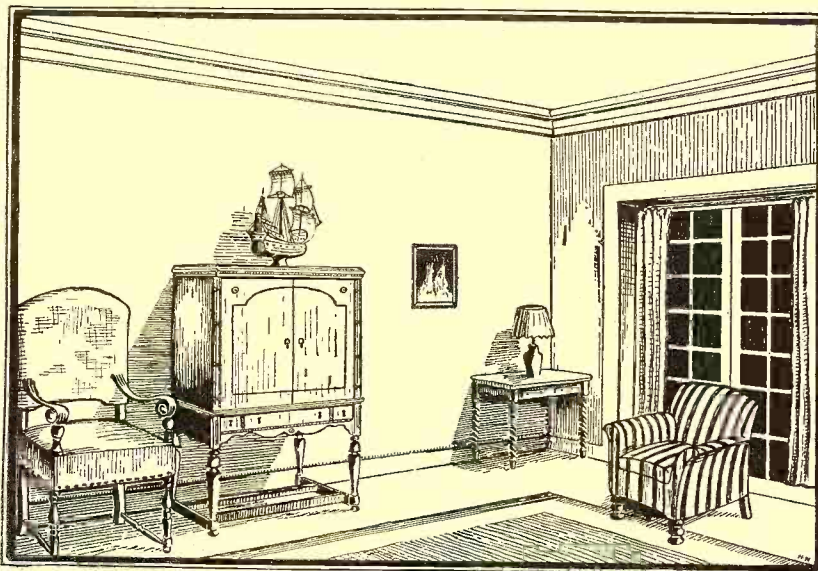

THE console, shown in the illustration above, will cost for raw materials from ten dollars up to fifteen, depending on the locality. The mouldings, handles and turnings, which it would not be profitable for the constructor to attempt, will cost around eight dollars. Such cabinets, when finished, retail up to as high as \$75.00. The set builder will find a source of profit in supplying consoles of high quality in which his own labor saves a considerable cash investment.

course, are to be set and the holes filled later.

This cabinet was planned to fit a popular radio receiver and is suited to the average A.C.-operated set. It is suggested that one plan the radio compartment to fit his individual needs. If a home-built set is planned it should be made to fit the compartment; while, if a set is purchased, the size of the compartment may be altered to suit. The dimensions given will be found to be ample for most of the sets on the market.

The speaker compartment is of a size sufficient to care for batteries, if batteries are used, or for power units. Where neither is used, doors may open out to the front on either side of the grille, thus providing book space.

The grille should be cut out with jig saw or hand coping saw; after which the front panel slides into position in grooves already prepared for it. This front panel should be figured grained plywood. It is also reinforced with glued blocks; the moulding

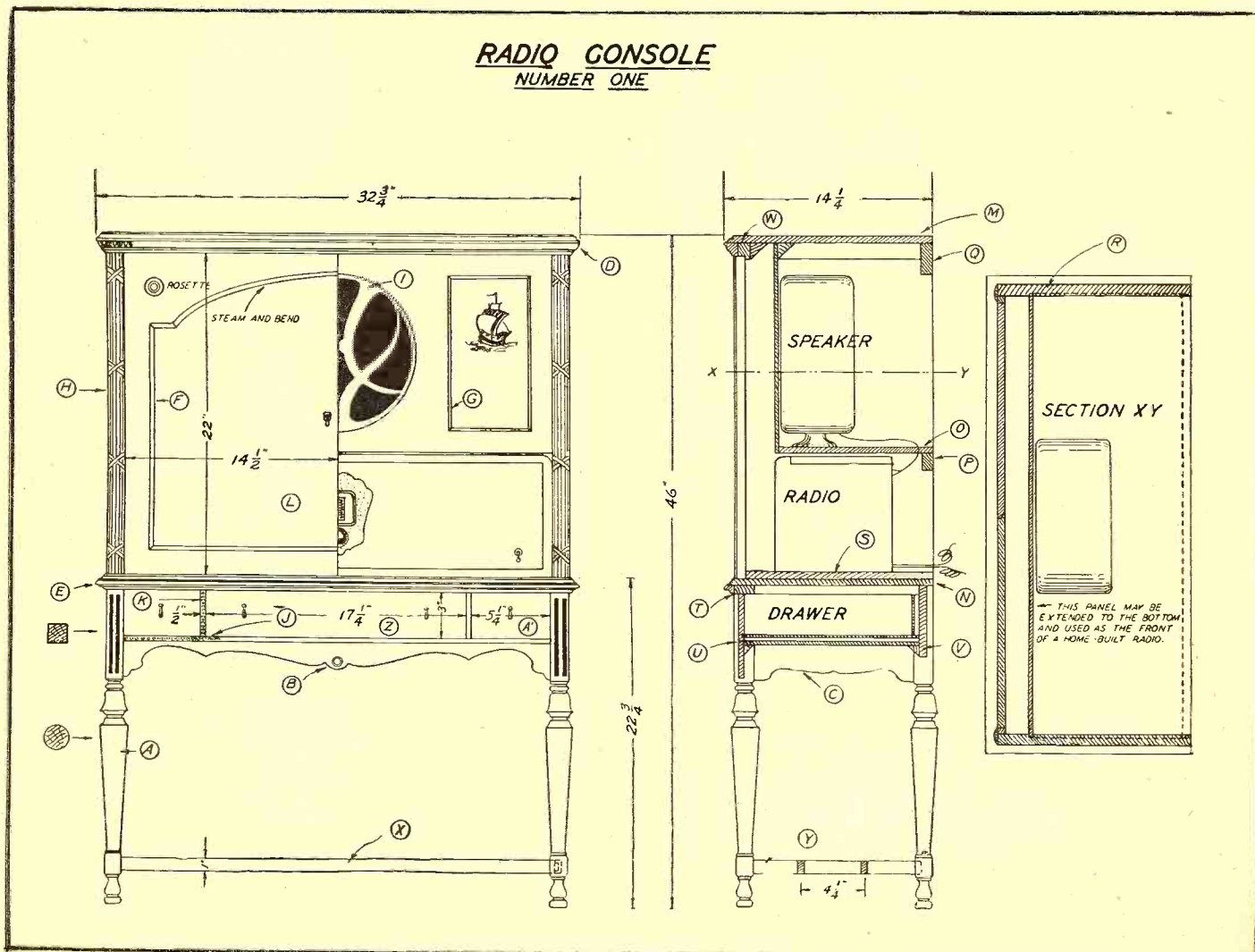

Above, front and side elevations of the console, giving dimensions. The finished cabinet appears as shown in the picture at the top of the page; it will grace any surroundings.

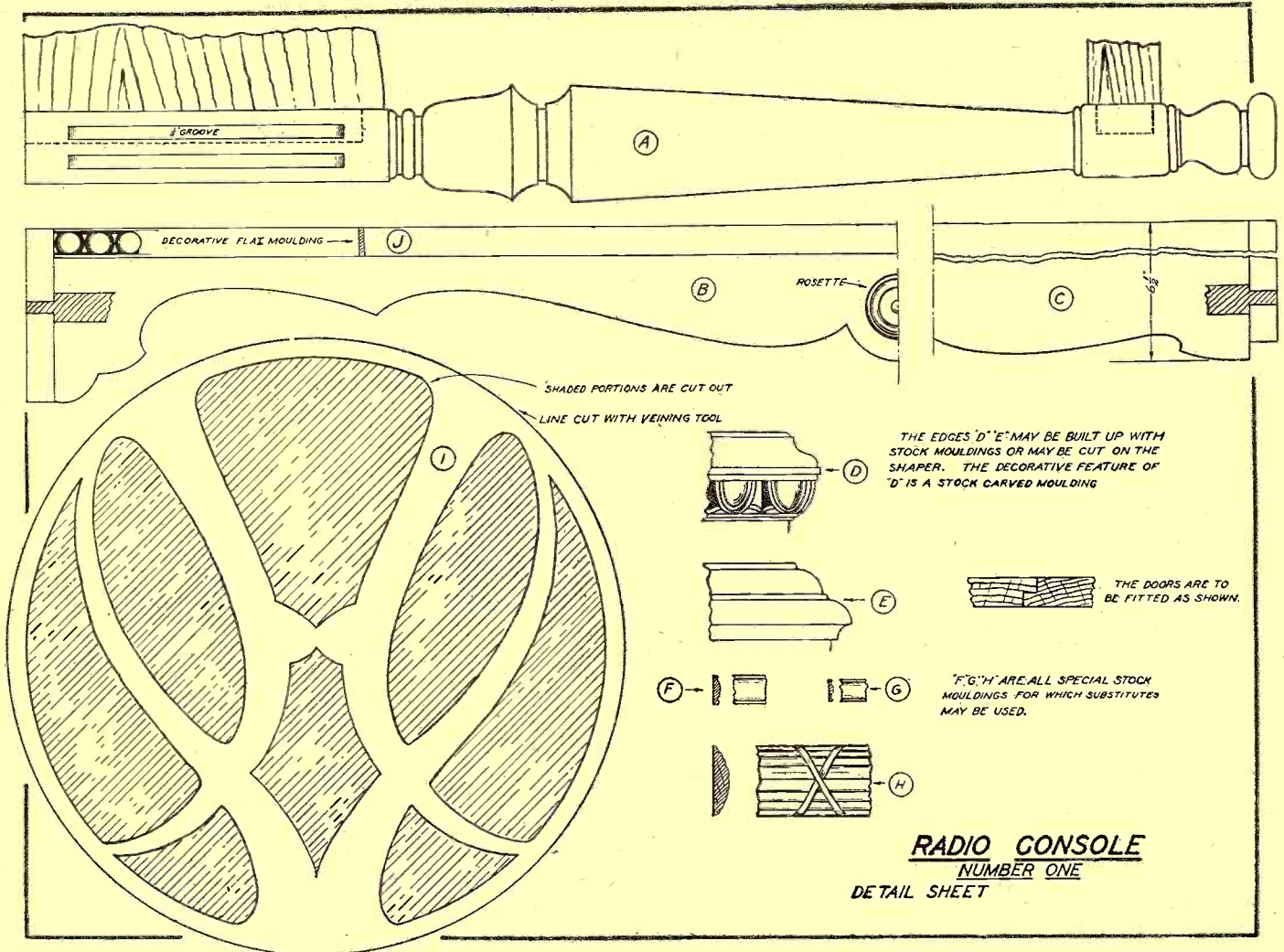

is tacked and glued in place, forming the panels, and we are ready for the doors.

**FINISH IMPORTANT**

Since the doors are the most noticeable portion of the cabinet, the wood for these should be selected for its beauty, and matched figured-grain panels are recommended. They should be very carefully fitted, and hinges of the type illustrated should be used. If anything but plywood is used, warping is likely to occur. The moulding on the front completes the doors. The curved portion of this must be steamed before attempting to bend it.

As a final step in construction, the decorative mouldings should be tacked and glued in place to the front and ends of the table and cabinet tops. Great care should be taken to get carefully-fitted mitered corners.

The finish should be natural, if real mahogany or walnut, or stained first if a substitute is used. A good finish is essential for the good appearance of the console and great pains must be taken. A filler rubbed into the open grain should be followed by one or more coats of white shellac thinned down with equal parts of alcohol. This in turn should be followed by several coats of rubbing varnish; each coat should be rubbed lightly with sandpaper until the last, which should be rubbed with pumice stone and oil on a pad.

We have called this Radio Console Number 1. Next month we will give the readers of this magazine complete directions for constructing a cabinet for combined radio and phonograph, both using the same

This entire radio console can be built complete for from

**\$10.00**

to

**\$15.00**

depending on locality. It can be sold at a profit of from \$20.00 to \$30.00.

**RADIO NEWS**, until further published notice, will pay \$50.00 for every constructional article used in **POPULAR HANDIWORK** Department; from which, however, articles of a strictly radio nature are **EXCLUDED**. The article must lend itself to blueprint purposes and, in order to be acceptable, it should preferably describe constructional work that has actually been done by the author.

Photographs showing the progress and completion of the work should accompany the manuscript. Complete drawings (showing all dimensions, material used, etc.) should be included.

Address all communications to **POPULAR HANDIWORK DEPARTMENT**.

speaker and with an electrical pick-up on the reproducing machine.

**MATERIALS**

- Four legs, 2 x 2 x 21½ inches; turn by pattern given; grooved with circular saw, mortised for rails (A);
- One front rail, ½ x 2⅜ x 30 inches (B); and
- Two end rails, ½ x 6½ x 11¾ inches, cut to shape with band saw (C);
- One egg and dart moulding, ¾ x 1 inch x 6 feet; if difficult to secure, another moulding may be used (D);
- One moulding, ¾ x ¾-inch x 6 feet (E);
- One moulding, ⅛ x ½-inch x 7 feet (F);
- One moulding, ⅛ x ⅜-inch x 6 feet (G); (These mouldings may all be hand-made, or purchased made-up.)
- One moulding, special, ⅛ x 1⅛ inches x 4 feet (H);
- One front panel, ¼ x 14¼ x 30¼ inches; with transfer designs (I);
- One flat moulding, ⅛ x ½ x 38 inches, to face front edge of partition rails and front rail (J);
- Two partition rails, ½ x 3 x 12¼ inches, running from front to back (K);
- Two doors, ½ x 14½ x 22 inches, figured, matched-grain plywood (L);
- Two tops, ½ x 14 x 32¼ inches, glued up from well-seasoned wood (M, N);
- One shelf, ½ x 10½ x 30¼ inches, for speaker; the compartment on either side of the speaker may be utilized and doors opening from the front installed (O);
- One support, ¾ x 1¼ x 30¼ inches, mortise into sides (P);

(Continued on page 967)

A "ham's" station, with receivers, transmitter and, latest of all, a television receiver in working order. The disc removed for this photo will be seen in that on page 942.

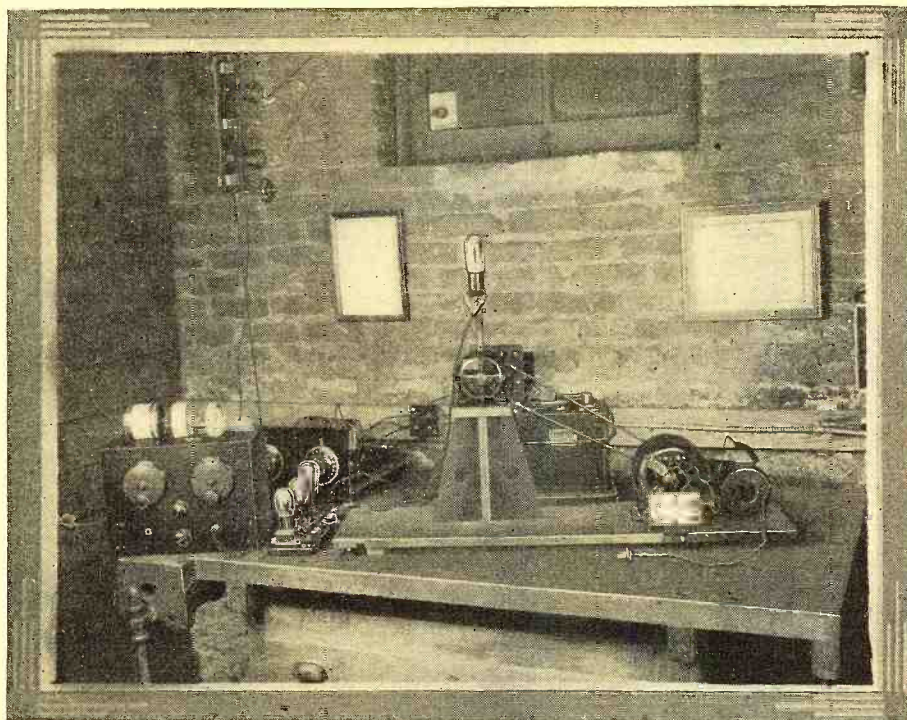

Anton Demikis, Jr., of Chicago, is the owner of this equipment. Among the ideas he is trying out is that of a coil of adjustable high impedance as a speed regulator on the television receiver.

## Successful Television Experiments in the Home and Workshop

THE television apparatus illustrated in the photographs reproduced on this page is that constructed by Anton Demikis, Jr., a Chicago amateur (W9EYK) and operated by him with some success. A point of novelty will be found in the control of disc speed; the motor, which is not of the synchronous type, is coupled to a reactance coil (instead of a condenser, as in some models used for television).

Two receivers have been used in this work, to detect the transmissions from station WCFL, Chicago, and on W3XK, the Jenkins Laboratories in Washington. At the distance of the latter, however, fading was conspicuous on the 45-meter wavelength and, with signals at R-3 (new standard), satisfactory images were not obtained with a three-stage resistance-coupled amplifier. The local television, however, was received with good quality on a variety of receivers and with several types of amplification.

A high-quality six-tube commercial receiver, with two transformer-coupled audio stages, did not give an image equal to that obtained with three of resistance coupling and a short-wave receiver. This set, shown at the left in these views, was fitted with a plug-in coil for the broadcast band in order to bring in WCFL at 309 meters. (Behind it will be seen Mr. Demikis' short-wave transmitter.)

The circuit diagram of the apparatus (omitting the standard "B" power unit) is given. The output stage comprises a CX-310 with 450 to 500 volts maximum available from the unit; its output, and the consequent illumination of the neon television-lamp, are controlled by varying the grid bias, which may be as high as 80 volts. Phones are used to enable the operator to tune the receiver to best signal strength, as well as follow announcements made at the station in the interval between image broadcasts.

### SYNCHRONIZING THE DISC

With the motor, which operates from the light line, loaded by the reactance coil, the voltage across it is 102; giving 920 revolutions per minute. With an iron plunger inserted into the center of the coil, the voltage may be reduced until the revolutions fall to 890. However, this method is still experimental, as it is difficult to obtain a plunger to work smoothly.

On the other hand, by friction it has been found possible to maintain an image "in frame" for a good period; pressure is applied lightly to the edge of the disc, whose speed is known to be slightly above standard. As the friction becomes more pronounced, the image will be seen to take form and move rapidly downward in its frame. A very slight increase of pressure, now applied, will fix the synchronism. If the image is divided, it may be restored

(Continued on page 942)

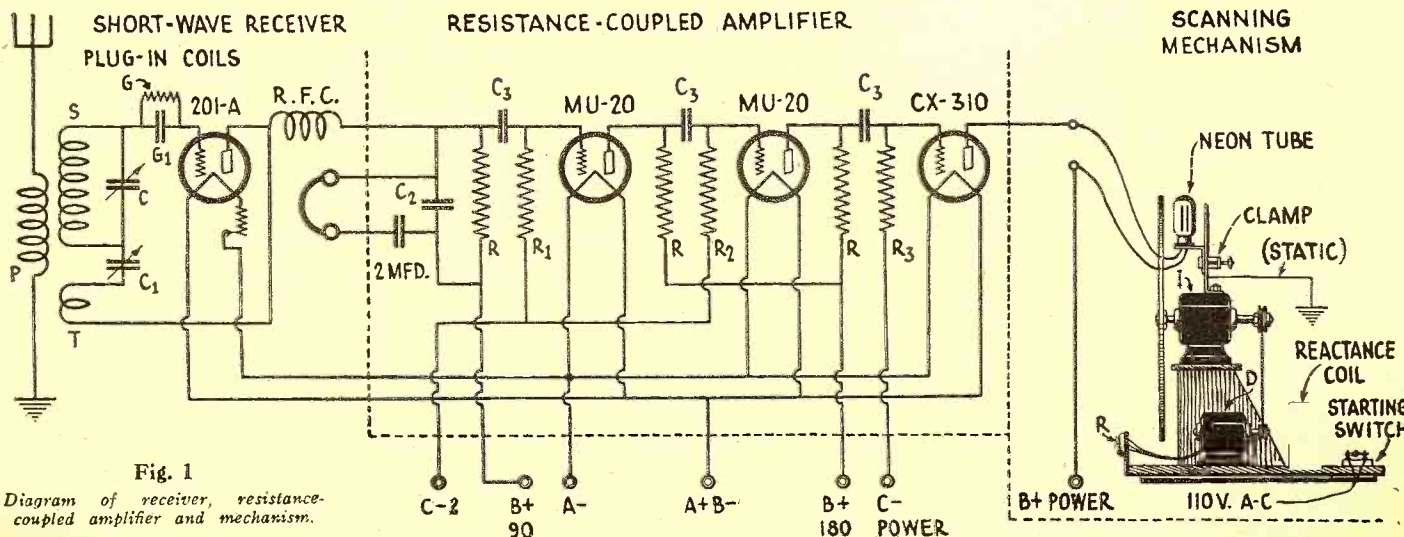

Fig. 1  
Diagram of receiver, resistance-coupled amplifier and mechanism.

# The "Home-Builder's Seven"—A "Super" Set\*



A Receiver Meeting All Requirements and Which May be Built by the Constructor Himself in Largest Measure

By B. B. Bryant

THE development of modern radio receivers has been steadily toward a greater degree of complexity; and this, no doubt, has led many builders who are not in the veteran class to approach gingerly the job of constructing larger sets. The necessity of a high degree of selectivity, the desire for increased fidelity of reproduction and larger output, the vogue of all-electric operation, and the problem of producing a set to rival the appearance and performance of the commercial receiver—all these things have caused too many radio fans to forsake their hobby. Many still have the itch for distant reception but, while ready enough to undertake a four- or even five-tube job, are cautious about tackling the job of building a larger and more complicated receiver, even though the above desirable qualities are assured. Others find in ready-made, elaborate kits the possibility of building a powerful and finished-looking set in which the work of assembly has been reduced to a routine, but miss the pleasure of actually preparing the essential parts of the apparatus with their own hands.

With a view to the needs of several classes of both custom set builders and fans, the writer set about the task of designing a receiver of moderate cost (its merits considered) which should embody the desirable requirements listed above, be comparatively simple to build, and in which as large as possible a number of parts should be within the resources and skill of the home constructor to make for himself. After the construction of a series of five successful receivers, the somewhat simplified model described here was determined upon. While, if the directions are followed, it should equal in appearance and performance the finest of commercial receivers, only a few tools are required for the work—pliers, a wire-cutter, a hacksaw, a hand drill with a suitable selection of



**"THE HOME-BUILDER'S SEVEN"** is a superheterodyne set which has been designed especially for those who like to build their own receivers, as completely as possible. Its intermediate amplifier is a single screen-grid stage which, however, utilizes a new arrangement to increase its amplification until it equals that of nearly three general-purpose tubes; while an additional tuned R.F. stage before the modulator gives added selectivity now much needed. The quality also will be found eminently satisfactory to the most critical listener. In addition to the battery-operated set described here, an alternative circuit is provided, carefully worked out to give equal results with the convenience of A.C.-operation. In either model, this set will be found attractive by the custom builder as a receiver worthy of selection by discriminating purchasers who are willing to pay for quality, yet which can be produced by him with a low outlay for components. It presents also to the home builder a circuit giving high amplification, with excellent appearance and worthy of being housed in an attractive cabinet; but which will not be a task requiring more than a moderate amount of experience and constructive ability. Blueprints of large size have been prepared for the "Home-Builder's Seven," and may be had for the customary price of 25 cents, postpaid. A convenient order blank will be found on page 973. Specify No. 78.

sizes, a hammer, screwdriver and soldering iron are sufficient.

### THE CIRCUIT

An inspection of the schematic diagram (Fig. 1) will show that three elements have been adopted in the system of radio-frequency amplification. The well-known and efficient Ultradyne frequency-converter, preceded by a tuned radio-frequency stage which is controlled by a plate resistor, is followed by a single stage of intermediate frequency (1,400 meters, or 214 kilocycles) in which, however, the use of a screen-grid tube gives a high degree of amplification. The regenerative detector following is used (with the peculiar arrangement which will be noted), not so much for the sake of added amplification as for the purpose of affording a suitable high-impedance load, required by the 222-type tube. A conventional two-stage transformer-coupled amplifier, with a 171A in the power stage, completes the hook-up, and provides sufficient amplification for any reproducer adapted to the home. The result thus obtained is great sensitivity, with selectivity enhanced by the additional tuned R.F. stage, and quality which does not suffer in the inductively-coupled intermediate band-filter. It will be found that more amplification is thus obtained than from the conventional superheterodyne circuit, in which a first-detector stage coupled to the antenna is followed by 201A tubes in three I.F. stages and a non-regenerative detector.

After some consideration, it was decided to feature here the circuit using direct-current (storage-battery) tubes; while, in order that those who prefer alternating-current operation may be able to proceed with that type of construction, an alternative circuit is given in Fig. 1A. The latter uses throughout heated-cathode or 227-type tubes, except an A.C. 22 in the I.F. stage and the power tube; the necessary alterations in the

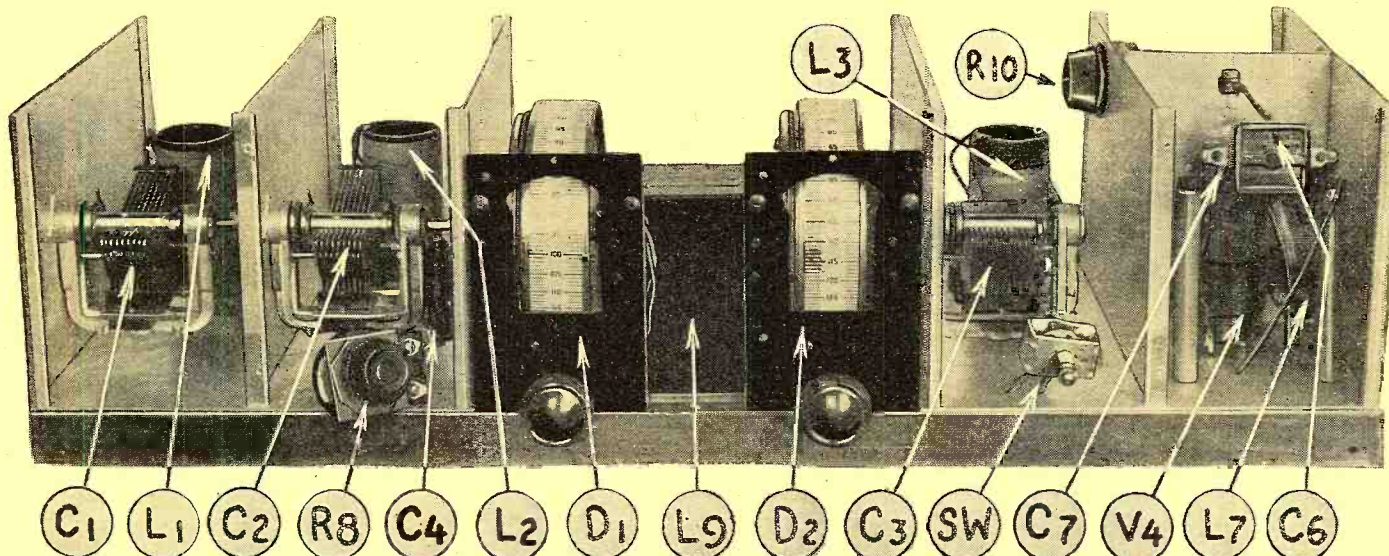

A front view of "Home Builder's Seven," with its panel removed and the shield cans partially disassembled, to show the simplicity of its construction. The first shield at the right is partitioned to screen the detector circuit from the intermediate-amplifier stage.

\*Radio News Blueprint Article No. 78. (See page 973.)

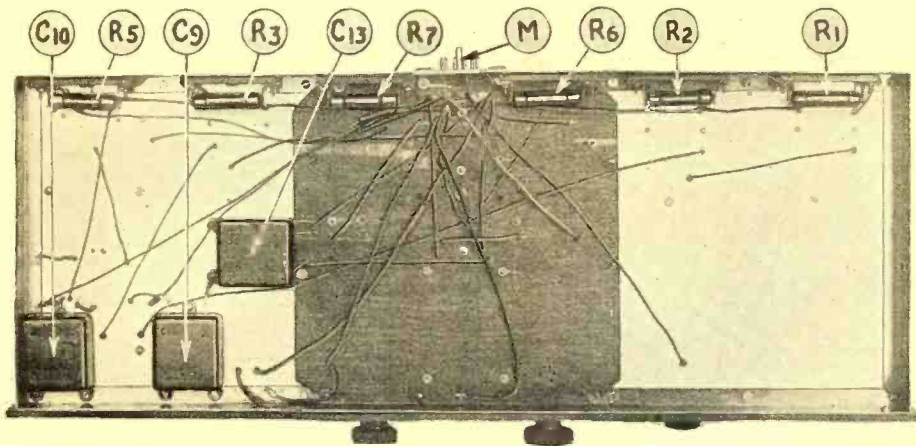

The central sub-panel, of insulating material, and the bottoms of the shield cans on either side, carry the limited apparatus shown on the under side. The wiring which comes through should be carried direct from point to point, and be well insulated.

circuit and the values of the additional parts required are indicated in the diagram. On the other hand, those who adhere to D.C. set operation, whether from choice or necessity, will find the receiver first described highly satisfactory; while a good "A" unit will give equally convenient lump-socket service with these tubes, and a "B and C" unit presents exactly the same features with either A.C. or D.C. tubes in the similar circuits shown.

**MECHANICAL CONSTRUCTION**

The use of a chassis, or metal frame, to support a receiver's parts, marks the third and latest stage of design in radio sets. The original "breadboard," used for convenience by the experimenter, was long kept in use even when hook-ups had become both more permanent and more elaborate. Yet

it was in many ways inconvenient and inefficient because of the great lengths of wire required by the fact that all components were in one plane and it was necessary

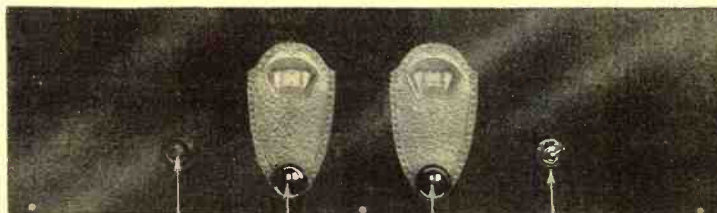

R8 D1 D2 SW

The neatly balanced panel with its two illuminated vernier tuning dials, the volume control R8, and the switch.

to loop and dodge the wiring about them. Complete insulating sub-panel mounting, the second stage, presented a great improvement in neatness, as well as in operation; because it made wiring more direct and gave greater freedom in the arrangement of components. It is, however, more costly,

and requires much strengthening to present a good appearance and rigid construction.

The metallic chassis enhances at once appearance, firmness of assembly and, owing to its conductivity, ease of wiring. With the vogue of shielding all high-frequency stages, it has become almost necessary. As used in this set, the chassis may be made by the constructor with slight expense and labor, and will lend a professional touch to the assembly. The metallic shielding cans, needed by every receiver of high sensitivity under present-day conditions, add to the ease of wiring and form an integral part of the construction. The audio stages are supported by a small sub-panel, just sufficient in size to accommodate the necessary parts, which may be of metal or insulating material as preferred.

**COMPONENTS NEEDED**

Any equivalent components may be substituted in this circuit, with the exception of the four special coils used in the I.F. stage, detector circuit and the oscillator. The symbols appearing below and in the schematic diagrams, in connection with the respective components, correspond with

those used throughout the text and illustrations. Those required are:

- Two variable condensers, removable-shaft type, .00035-mf. (C1 and C2);
- One variable condenser, .0005-mf. (C3);
- Two semi-variable condensers, mica type, .0001 to .0005-mf. (C7 and C8);
- Two mica fixed condensers, .001-mf. (C4 and C5);

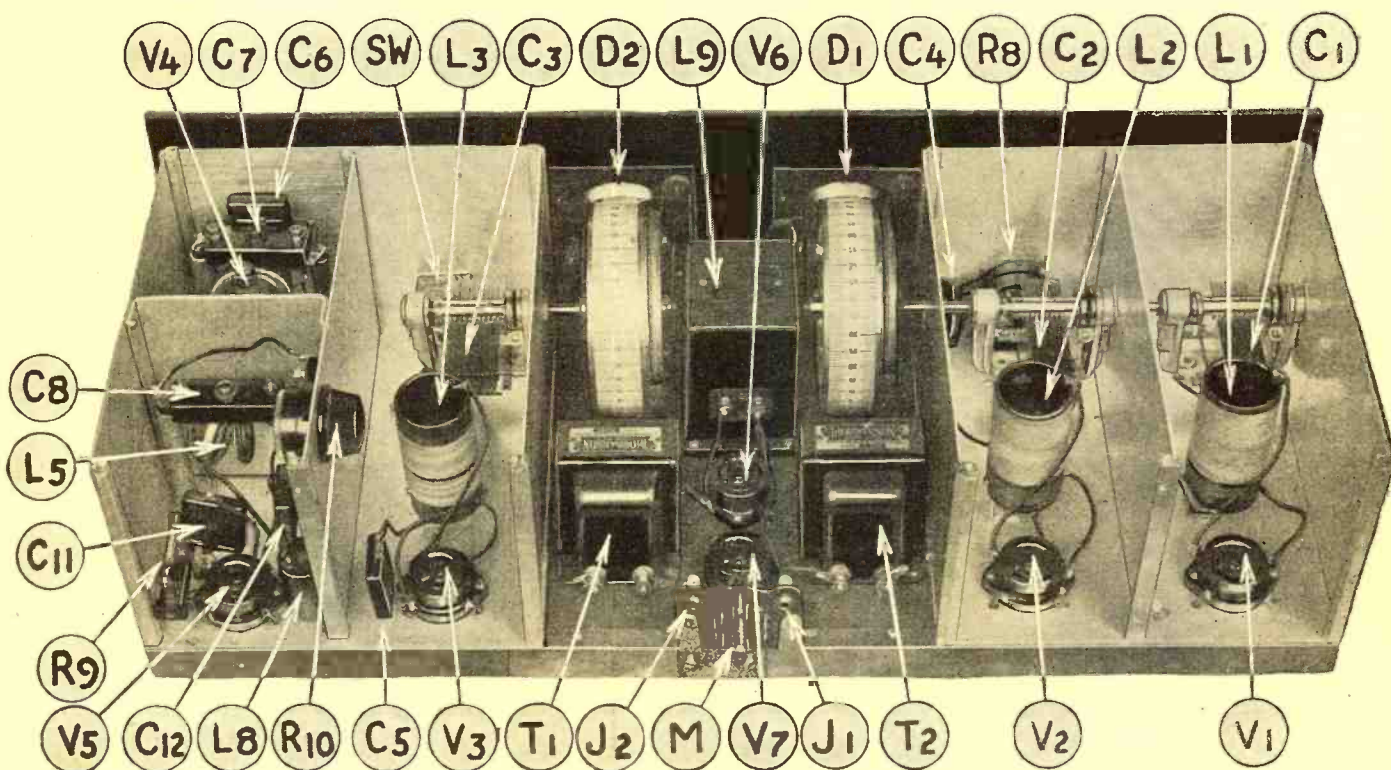

The detector-intermediate amplifier compartments at the left contain the "heart" of the circuit. In the rear compartment are the detector components; in the front one, the intermediate transformer,

L5, its compensating capacitor C8, the regeneration control R10, R.F. choke coil L8, and grid leak R9. The top terminal of the screen-grid tube V4 may be seen above the shielding.

- Two mica fixed condensers, .0005-mf. (C6 and C12);
- One mica fixed condenser, .00025-mf. (C11);
- Two by-pass condensers, paper type, 0.5-mf. (C9 and C10);
- One by-pass condenser, paper type, 1-mf. (C13);
- One antenna coupler (commercial or home-made) to tune over broadcast band with .00035-mf. condenser (L1);
- One R.F. transformer (commercial or home-made) to tune over broadcast band with .00035-mf. condenser (L2);
- One oscillator coil, home-made (L3);
- Four intermediate coils, home-made (L4 and L5);
- Three R.F. chokes, 80-millihenry or more (must not be of smaller value) (L6-L7-L8);
- One 30-henry iron-core choke coil (L9);
- Five 1A amperites (R1-R2-R3-R5-R6);
- One power-tube amperite (R7);
- One 25-ohm fixed resistor tapped at 10 ohms for shield-grid bias (R4);
- One 0- to 500,000-ohm variable resistor for volume and R.F. oscillation control (R8);
- One 2-megohm grid-leak resistance and mounting (R9);
- One 0- to 2,000-ohm variable resistor for regeneration control (R10);
- Two audio transformers 2:1 ratio (T1 and T2);
- Seven UX sockets—not more than 3/4-inch high (V1 to V7);
- One 12-wire cable and terminal (M);
- One filament snap switch (SW);
- One bakelite panel, 7 x 24 x 3/16-inch;
- Two aluminum double cans, size 8 3/4 inches long, 7 3/4 inches wide and 5 3/4 inches high, with two equal compartments (S1, S2);
- One piece of sheet aluminum 4 1/2 x 5 1/4 inches;
- Two drum dials, with knob immediately under scale (D1-D2);
- Two cord-tip jacks (J1 and J2);
- Two binding posts, aerial and ground;
- Six feet angle brass, 1 x 1/2 x 1/32-inch, for chassis;
- One piece of 1/32-inch aluminum (or 3/16-inch wooden board, hard rubber or bakelite) 8 3/4 x 9 inches, to form a sub-panel support.
- Ten-inch 1/4-inch brass shaft for condensers;
- Two 25-foot rolls hook-up wire, single-strand push-back type;
- Two lengths spaghetti tubing;
- Four 1/2-inch wooden dowels, 3 3/4 inches long;
- Screws, nuts and other small hardware.

**CONSTRUCTING THE I.F. COILS**

Most receivers of the superheterodyne type offer difficulty to the home builder in the construction of the intermediate transformers or coils. The construction of the coils L4 and L5 used in this receiver is simple and offers no difficulty. They are efficient and, while reasonable care is necessary, they need not be exactly the same. Exact matching of their inductance is not necessary; as two are adjustably tuned.

For their construction, a small form is required; this is made of three wooden discs held together by a screw as shown in Fig. 4. The wire is wound in the resulting slot. The central disc is 1 inch in diameter and 3/16-inch wide; the side discs are 1 1/2 inches in diameter and of such thickness as to be rigid. The central disc may be sawed from a broom handle. The side discs may be made from a cigar box and need not be round; three slots are sawed in them, at equal distances around their circumference;

these slots should be 1/4-inch deep. A hole is drilled through the center of each disc. They are then assembled with the 1-inch disc in the center, and held securely together with a long 6/32 or 8/32 bolt and nut. After assembly the slots are aligned and a length of strong linen thread placed in each slot across the surface of the central disc; these are tie strings to hold the winding in shape when the form is taken apart.

Three coils are now wound, each with 200 turns of No. 32 D.S.C. or D.C.C. wire in the large slot. The ends of each tie string are then tied around the winding, after which the nut and bolt are removed.

The side discs will now fall aside, leaving the tied winding with the central disc in the center. The latter is now pushed out, taking care to preserve the shape of the coil.

The fourth coil is made in the same manner, but with 75 turns of No. 28 D.S.C. or D.C.C. wire.

No particular care in winding the wire in the slot is used; as a matter of fact the greater the "scrambling" the better, as this will result in lessened distributed capacity. Highly distributed capacity would result in high resistance and broad tuning. When all the slot-wound coils are finished they are soaked in airplane dope or celluloid

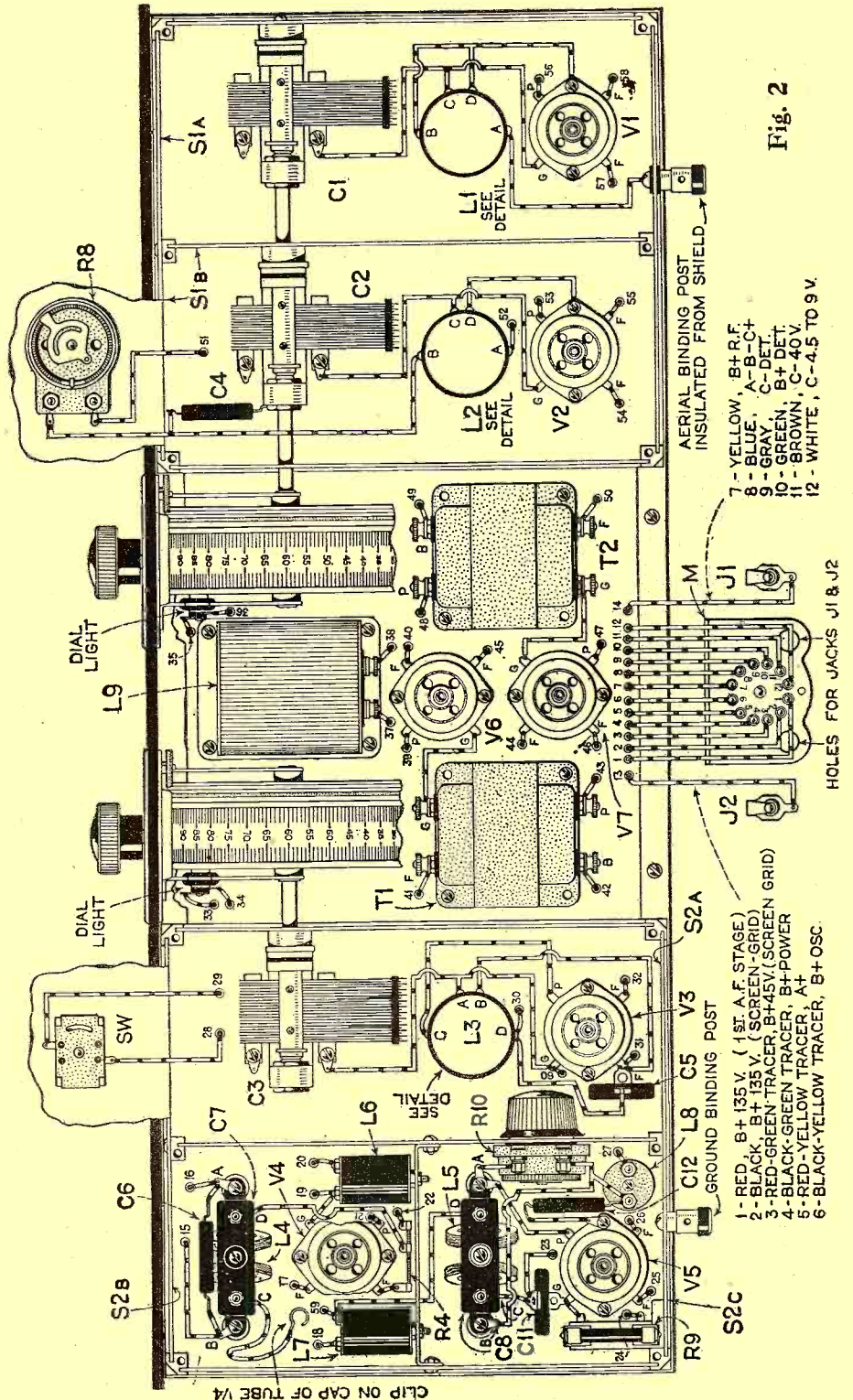

Fig. 2



cement; after removal they are pressed between two boards to remove the excess dope and to make them flat. They are then put aside until hard and dry.

**ANTENNA, R.F. AND OSCILLATOR COILS**

While commercial coils may be used for the antenna and R.F. couplers, they are easy to make. The secondary windings of L1 and L2 consist of 100 turns of No. 28 D.S.C. wire wound on pieces of 1½-inch tubing 3¼ inches long. The primary of L1 consists of 20 turns of No. 28 D.S.C. wire wound at the filament end of the secondary with a separation of ⅛-inch. The primary of L2 is wound in the same manner as

the antenna primary, but consists of 30 turns of No. 32 D.C.S. wire. (See Fig. 5.)

A thick coating of airplane dope or celluloid cement is applied to these windings, and immediately wiped off with a clean cloth. When it is applied and removed in this manner, sufficient dope remains for protection and adhesion of the windings.

Terminals for connection are provided by drilling small holes around the base for anchoring the beginning and end of each winding. The insulation is scraped from the free ends of the windings, which should be left about 5 inches long, and looped several times through the small hole near the base. If done properly, this will provide

a soldering contact ¼-inch long and 1/16-inch wide.

The oscillator coil L3 is made in the same manner. The secondary or grid coil consists of 48 turns of No. 28 D.S.C. wire wound on 1½-inch tubing; the plate or primary coil consists of 35 turns of No. 28 D.S.C. wire wound at the filament end of the grid coil. The windings are spaced ¼-inch; soldering terminals are provided as for the antenna and R.F. coils.

All the various windings are wound in the same direction.

**MAKING THE CHASSIS**

Six feet of angle brass 1 inch by ½-inch by 1/32-inch thick, is obtained. Measuring on one side from the center, points are marked at 11¾ inches, 20½ inches, 32¼ inches and 33¾ inches. On the other side from the center, points are marked at 11¾ inches, 20½ inches, 32¼ inches. The length is sawed off at the ends (at the 32¼-inch point and 33¾-inch point). The 1½-inch section next the 33¾-inch mark is sawed off on the ½-inch side, leaving on the 1-inch side a tongue 1½ inches long, for a lap joint. Right-angle wedges are now sawed out at the 11¾- and 20½-inch marks, also on the ½-inch side of the angle brass. The apex of each right angle should be directly on the points marked at the edge of the 1-inch width.

After the angle brass strip is prepared as explained above, it is shaped into a rectangular frame, 8¾x23½ inches, by bending at the apex of the "V" shaped notches made by the removal of the wedges. The tongue prepared for the lap is placed on the inside. The top of the frame, which is formed by the ½-inch side of the angle, is made to butt closely. While it is in this position, holes are drilled through the top angle and through the tongue. Screws are then inserted into the holes, nuts placed on the inside and tightened. The chassis is thus formed.

**ASSEMBLY OF CANS**

The bottom plates of the cans are now placed flat on top of the brass frame, with their sides even with ends of chassis frame. With a pencil, the positions of the holes in the can bottom are marked on the chassis. The points indicated are then drilled through to pass 6/32 screws, ½-inch long. The screws should extend through the can bottoms and should turn into the corner and center pillars of the cans.

The sides and front of the cans are slipped into their grooves temporarily; the 8¾x9-inch strip of aluminum, wood or bakelite is now placed in position in the open space of the chassis between the cans, fitted underneath the ½-inch flange, and fastened in position by 6/32 screws and nuts.

**MOUNTING CONDENSERS AND DIALS**

For mounting the variable condensers, four of the side pieces of the cans are drilled for ⅝-inch holes, at proper places. The condensers are now fastened to these plates with the large bushings provided, and the sides are now replaced in their regular positions.

The 10-inch shaft is placed through the two .00035-mf. condensers C1 and C2; it should protrude about two inches for the drum dial D1. The shaft of the .0005-mf. oscillator condenser C3 is made to extend out to the same length. After loosening the set screws of the hollow shafts of the drum dials, D1 and D2, they are slipped

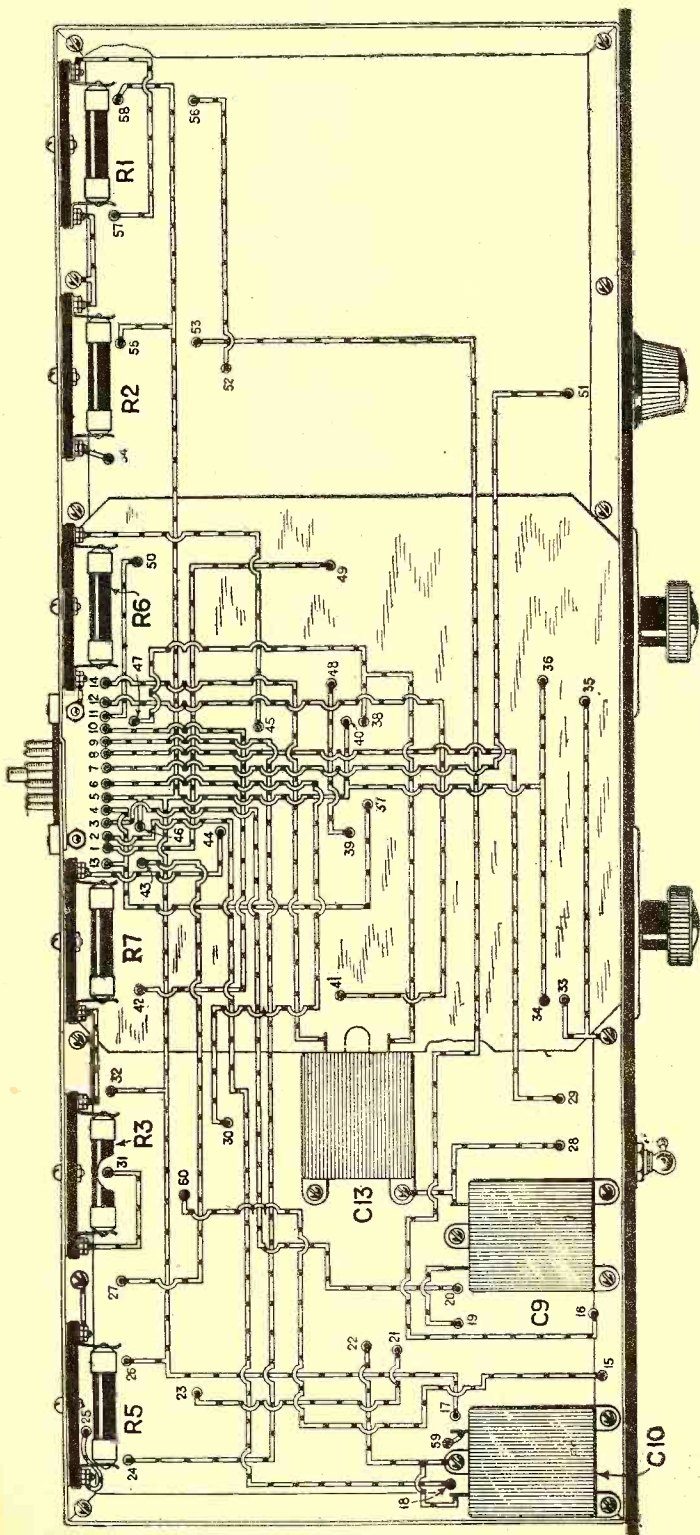

**Fig. 3** The layout of all parts, and all wiring connections of the "Home-Builder's lines between its terminals. Holes are numbered correspondingly in both upper and lower views. The constructor who follows the usual precaution of crossing out each lead on these diagrams after its connections are soldered will avoid any possible error in constructing this receiver.

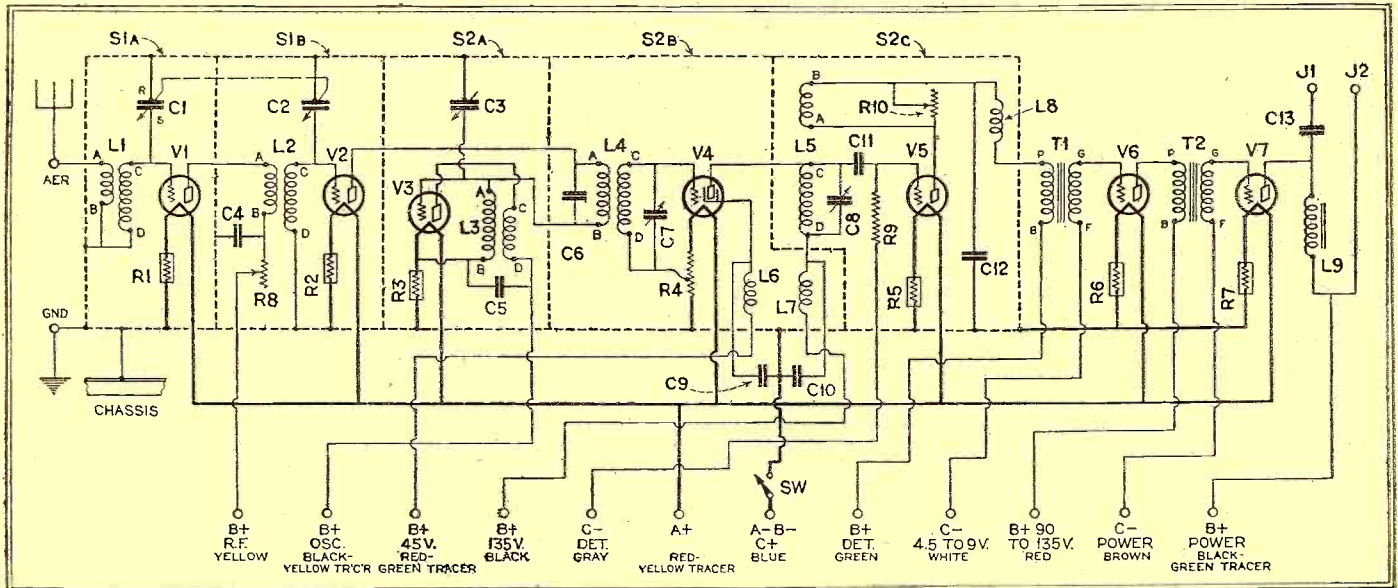

Fig. 1

The circuit diagram of the "Home Builder's Seven" for use with D.C. tubes. The changes necessary to adapt it to A.C. tubes can be determined readily from the corresponding diagram, Fig. 1A, on page 968. The shielding used saves much of the wiring.

over the extended shafts of the condensers. The edge of the drum-support frames should be flush and against the edges of the cans. Mark on the chassis positions of the holes in the turned-over edge of the drum-support frame, and drill holes for 6/32 screws. Pass the screws through holes of the chassis and fasten the frames of the drums rigidly to the chassis; after which all set screws of the condensers and drums are tightened.

The choke L9 is now placed in position at the front edge of the chassis between the drums, and the audio transformers T1 and T2 are fastened in position back of the

drums, close to the sides of the cans. This leaves a rectangular space in which the two audio sockets, V6 and V7, are equally spaced and fastened to the sub-panel. In the exact center of the rear edge of the chassis frame, the cable-plug receptacle is mounted. The cord tip jacks J1 and J2 are then put in the holes provided on the cable terminal.

MOUNTING THE COILS

L-shaped brackets, 1 1/4 inches long, are used to mount the antenna coil L1, the R.F. coil L2 and the oscillator coupler L3. After

the brackets have been fastened to the coil forms as shown in Fig. 5, the coils are mounted in their respective shield cans; L1 in S1A, L2 in S1B, and L3 in S2A. When mounting the coils, sufficient space must be left for the socket and tube at the rear of each compartment; the sockets in these three compartments may be mounted at this time.

Mounting of the I.F. coils is equally simple, although care is required. The 1/2-inch dowel is now cut into 3 3/4-inch lengths. Small holes are drilled, 1/2-inch in depth, in the exact centers of their ends. These are for the wood-screws used in mounting the semi-variable condensers.

Most small semi-variable mica condensers have two holes, provided for fastening to the baseboard. On the under surface of the molded bases are seen the flat heads of the condenser's terminal screws. To these heads are soldered the flat heads of 6/32 brass screws, 1-inch long. Four bakelite strips 1/8-inch thick and 1/2-inch wide, are cut to such lengths that, when holes are drilled near their ends, they will slip loosely over the screws. These pieces serve as clamps for the special coils already described.

To assemble, one strip is placed over the screws and the coil is held in position while another strip is passed through its center and slipped into place over the screws; nuts are then screwed down over the clamping strips and tightened until the coils are held firmly in position. Care should be taken that the windings are placed so that they run in the same direction.

The entire assembly as shown in Fig. 5 is fastened to the bottom of its respective can compartment (S2B and S2C) by passing wood-screws through the metal bottom and screwing them into the lower ends of the wooden dowels.

FINAL ASSEMBLY

The sockets are placed in compartments S2B and S2C as shown in Fig. 2; after which the partition is placed in position and the positions of holes for mounting the chokes are marked. One hole for the "B+135" lead to the I.F. plate is drilled above the choke L7; the partition is re-

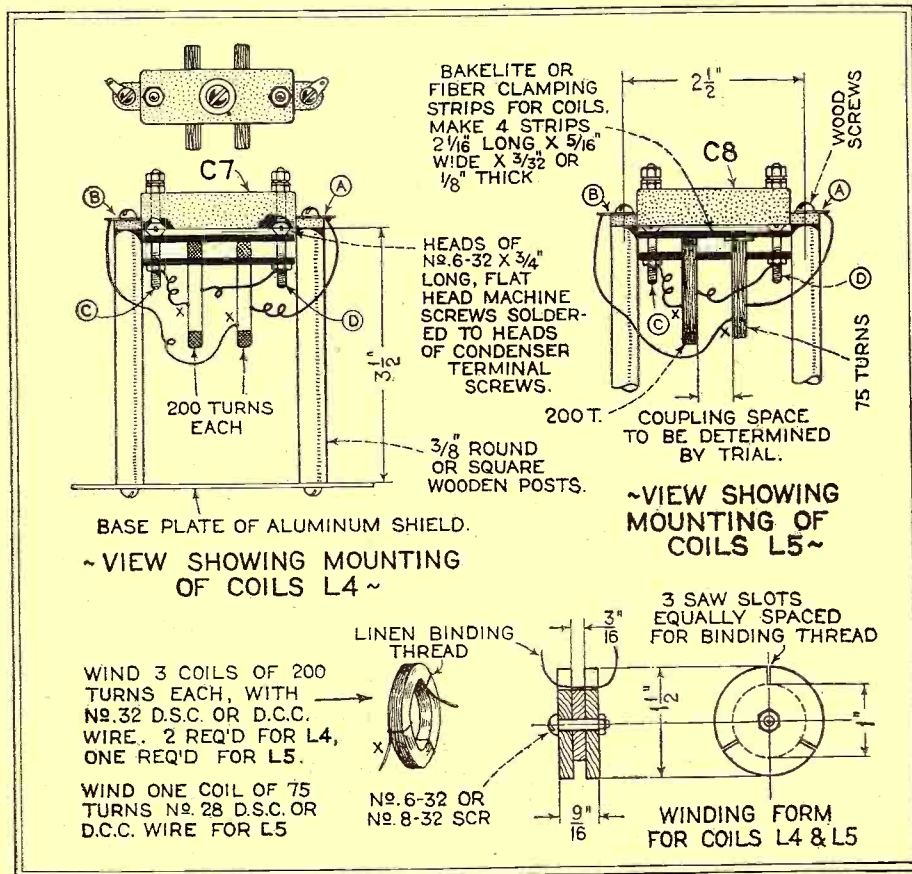
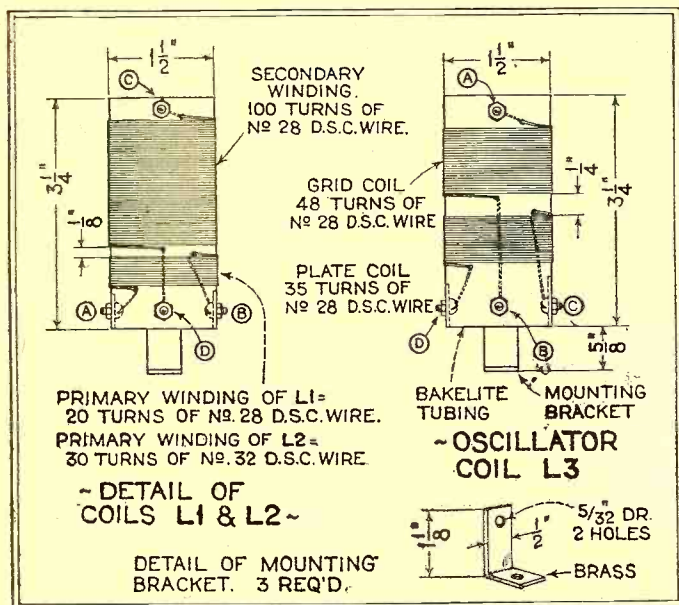

Fig. 4

The details for making and mounting the 214-kc. intermediate transformers required.



S2B, as shown in Fig. 2. The vertical grid leak mounting is fastened to the back of S2 in compartment C; conveniently close to the detector socket. The grid condenser C11 is soldered to the

are placed in their proper sockets. A tube of almost any type may be used at V5 as a special bias lead is provided; in a great many cases, locals will be of such strength that overloading the detector can be prevented only by the use of a negative bias, resulting in plate rectification. Otherwise, on distant stations greater sensitivity and volume will be obtained by the grid-leak-and-condenser, or grid-rectification, method.

**Fig. 5**  
Data for construction of the two R.F. coils and the oscillator coil of the "Home-Builder's Seven"

socket "G" terminal of V5 at the same time the lead of the mounting is soldered.

**WIRING AND ADJUSTMENT**

Wiring of the receiver is simple. The method recommended is that of "point-to-

When the tubes are in their sockets, the cable M, which previously should be connected to the "A," "B," and "C" supply, is now plugged in. The aerial lead-in and the ground wire are connected to their binding posts, and the speaker cord tips to J1 and J2.

The filament switch SW is turned on and, while rotating the drum D1 slowly over the scale, the drum D2 is worked back and forth over its scale until a signal is heard. If possible, a signal should be selected at a condenser setting that will allow the builder access to the set screws C1 and C2, which may now be loosened. Slowly turn the rotor of condenser C1 until the signal is loudest. Keeping this preliminary adjustment, the adjusting screws of condensers C6 and C8 are adjusted in turn for loudest signal strength. After this adjustment, regeneration in the detector circuit may be too great. Regeneration control is obtained by adjusting R10 to a point just under sustained oscillation of the tube, or until the audio beat-note disappears and the signal becomes loud and clear. The controls D1 and D2 are now readjusted. When tuned to a station, the R. F. stage V1 should oscillate; if it does not, readjust the rotor of C1. Should the aerial be too long, or if the signal is from a powerful local, it may prove difficult to make the R.F. stage oscillate. In this case, the aerial should be

(Continued on page 967)

moved and the chokes L6, L7 and L8 are mounted in their respective positions.

The holes for mounting the volume control R8; the regeneration control R10, and filament switch SW are marked and drilled in the can fronts and the central partition of the S2 can (the latter for R10). The can fronts and partition are again placed in position, and the respective parts are mounted; care should be taken that R8 and R10 are insulated from the cans, as otherwise a short will result.

The by-pass and output condensers C9, C10 and C13 are fastened into the positions as shown in Fig. 3. At this time the amperite holders are mounted on the inside of the vertical section of the chassis frame as shown. The element R4 is soldered to the "A—" prong of the socket in compartment

point," marking out the lead on the wiring diagram when the connection on the set is completed. When passing each lead through the hole drilled in the bottom of the cans for that purpose, a 3/4-inch length of spaghetti tubing is slipped over the wire and through the hole. This procedure will prevent abrasion of the wire by the cans and possible short circuits.

For those who prefer to wire from the schematic diagram (as the writer does) it is recommended that all grid leads, plate leads, grid returns, plate returns, "A+," "A-," and the remainder of the connecting leads be wired in the order given.

After the builder has tested the various circuits for shorts and is sure that everything is in perfect order, the various tubes

# RADIO NEWS BLUEPRINTS

## New Terms of Our Offer to Readers

(Read This Before You Write)

**B**EGINNING with the publication of RADIO NEWS for March, we announced a new policy with respect to the distribution of blueprints to our readers. A charge of 25 cents for each set furnished will be made; the filling of this order will be expedited by using the coupon printed on page 973 of this issue.

This will apply to all blueprints (from No. 52 up) issued by RADIO NEWS, except those called for by the Free Blueprint Coupons printed in our December, 1928, January and February, 1929, issues; these will be sent free, in exchange for these coupons, until our present stock on hand is exhausted. All other blueprints which we have issued in our free distribution series will be charged for at the rate of 25 cents a set. (Those made up prior to April, 1928, were produced by a more costly individual process and cannot be furnished at the above price.)

We believe that our readers are entitled to a frank explanation. During the past year we have distributed to them more than 68,000 blueprints—over 12,000 of the well-known "Junk-Box" alone. This has necessitated frequent reprints of the blueprints, and the maintenance of a large staff whose time is given up to this alone. The postage bill has been very large, as may be imagined. As RADIO NEWS has no apparatus for sale, it cannot recoup the outlay in this manner, like a manufacturer who sells kits at from \$20 to \$200. The price which we have established, 25 cents, is our average cost of a set of blueprints—a low figure obtained only by quantity production. The free distribution has entailed a huge expense, which has increased from month to month; and there is no doubt that thousands who are not regular readers have been taking advantage of it.

We have therefore decided to charge a uniform price of 25 cents for each set of blueprints; not with the expectation of making any profit from them, but with the intention of breaking somewhere near even. Those desiring previously-issued blueprints, not specified in any of the three "Free" coupons we have mentioned, must send this sum with their orders; which will be filled more promptly if the form printed on page 973 is used, as we have said. Other requests will not be supplied; nor will our "I Want to Know" department send any longer free hook-ups, diagrams, or other circuit information by mail.

We have said many times before that we have no blueprints of commercially-manufactured apparatus for sale at any price; nevertheless, ten or fifteen letters asking for them are received every day. Neither can we furnish blueprints to use the particular set of parts the constructor has in mind; it costs several hundred dollars to prepare a set of blueprints; and we cannot undertake to do this to order for a nominal sum.

We shall, however, continue to issue blueprints of sets of our own design that will, we think, appeal to our readers; and to publish full circuit and wiring diagrams in the pages of RADIO NEWS, as we have done. Those of our readers who wish, in addition, full sized blueprints of these sets may obtain them by sending in a Blueprint Coupon with 25 cents for each set requested. This applies to Blueprints Nos. 78 and 79, the "Home-Builder's Seven" and the "Space-Charge Autodyne," published in this issue, and to all later sets for which blueprints will be prepared.

# The "Space-Charge Autodyne"

A Short-Wave Receiver Employing the High Amplification of Screen-Grid Tubes in Both Detector and R. F. Stages

By Joseph Riley



Fig. A

The compactness of the receiver is evident by comparison with the tube beside it. Yet, with the layout given, it works perfectly. Plug-in coils like that at the right are used.

**T**HIS receiver has many features which will recommend it to the constructor who has become interested in the remarkable possibilities of short-wave work. It is very efficient, very compact, draws very little battery current; and is well adapted to the use of those far from the cities. But, while it is just the set you would want to take to a desert island, it is also a set to give maximum satisfaction in a big city. Completely shielded, it is very sensitive to signal pick-up, and produces very high amplification through its two 222-type tuned stages. It is capable also of loud-speaker output with its 120-type power tube.



No. 79

**I**MPROVEMENTS in design of short-wave receivers are not unlike those which we look for among sets covering the broadcast range. Previous to the inception of short-wave broadcasting, when the channels below 200 meters were used solely for the transmission of code, little attention was paid to the tone-quality factor of an audio-frequency transformer in a short-wave receiver. If it amplified, that was sufficient for the experimenter or the transmitting amateur who desired nothing more in a receiver than ability to reproduce readable dots and dashes. If they happened to be received slightly off-key, the operator was unaware of this musical discrepancy, which was, after all, utterly unimportant. Signal intensity was the one and only goal.

However, with the advent of short-wave broadcasting, faithful reproduction is becoming as desirable on the high-frequency band as it has become on the broadcast

channels. Whereas code reception required nothing more than a definite degree of amplification, it was found that such amplification was practically of little avail if it aided the phones or speaker only to reproduce a blurred mess of unintelligible syllables. And so faithful reproduction of short-wave broadcasts became an absolute necessity.

Similarly, a change in the design and layout of a short-wave receiver has been found essential for the benefit of the broadcast listener who, while desirous of lending an ear to short-wave radiations, finds that his limited knowledge of technical radio somewhat hinders him in entering the new field. The earlier types of short-wave receivers were acceptable to the transmitting amateur; for the simple reason that he knew what it was all about, what he wanted, and required no technical guidance in laying out and designing his own receiver to suit his own needs. As a rule, his set was

spread out, bread-board fashion, and possessed a multitude of controls of which only he knew the idiosyncrasies.

Today, the short-wave receiver must be compact, easily controlled and operated, must be sufficiently sensitive to answer the needs of very distant reception, should not offer too difficult a constructional problem to the beginner, and must be capable of reproducing voice broadcast with a fair degree of fidelity.

### THE "SPACE-CHARGE" DETECTOR

A short-wave receiver meeting these qualifications has been assembled in the Radio News laboratories and is herewith offered to the broadcast listener who desires a separate receiver for his short-wave travels into far countries; so that the rest of the family may enjoy their programs in peace.

Its tuning circuit is somewhat similar to that of the "Copper-Clad Special" (which was described in the February issue of

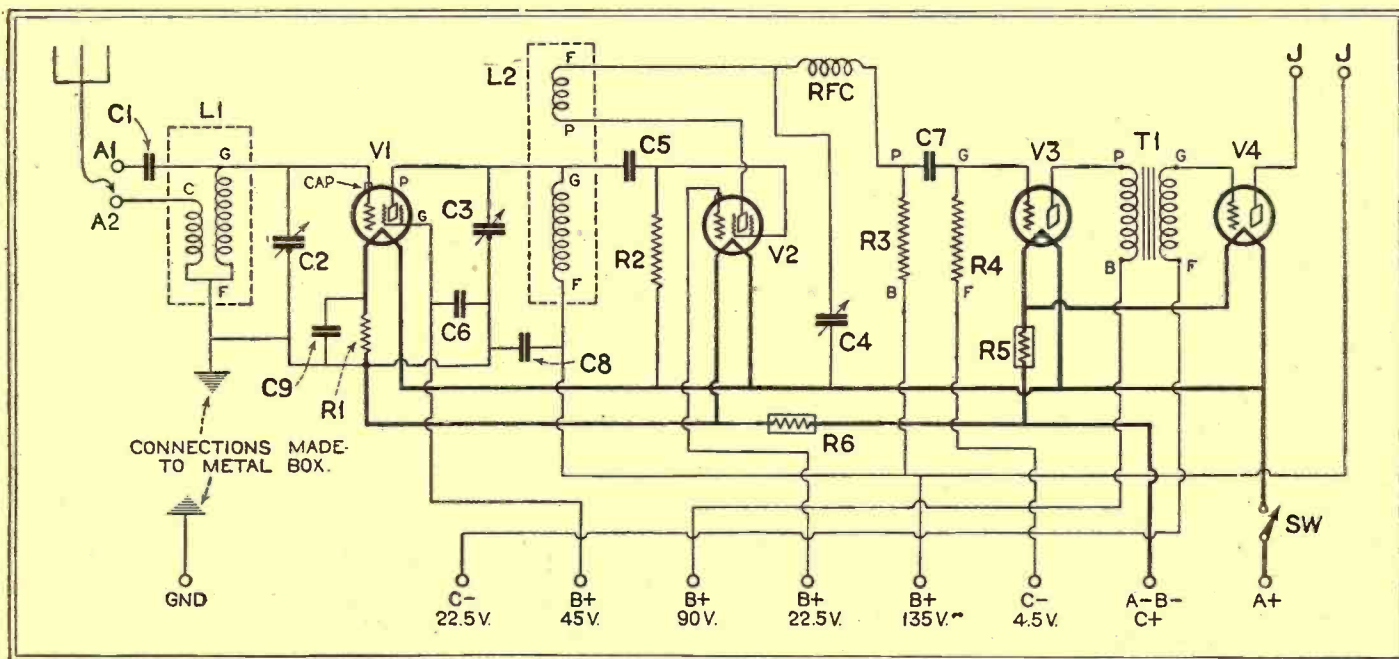

Fig. 1

The circuit diagram shows clearly the distinctive point of its operation—the screen-grid detector tube V2 has a "space-charge" on its control-grid which enables it to function as an oscillator, giving very high amplification under control.

\* RADIO NEWS Blue Print Article No. 79. (See page 973.)

RADIO NEWS) in that it comprises a screen-grid tube in a tuned stage of radio-frequency amplification preceding a regenerative detector; however, in place of the usual 201A-type tube in the detector socket, another screen-grid tube (222-type) is employed. The additional sensitivity obtained from the use of this four-element tube, in place of the conventional "triode," amply repays the constructor for the difference in the initial cost.

Before proceeding any further, it might be best to glance at the circuit diagram of this receiver and note the difference in hooking up the two screen-grid tubes even though both are identically the same type.

It will be noted that the first screen-grid tube, V1, is wired in the usual manner called for when this tube is employed as a radio-frequency amplifier; that is, the inner control-grid (which is connected to the metal cap on top of the bulb) functions just as does the grid in the triode. In this circuit, the tube is functioning in the customary manner. The outer or screen-grid is connected to a positive potential of 45 volts. As the prong of the second grid makes a connection to the usual grid contact in the standard UX socket, care should be taken to avoid the possible error of thinking this post to be the regular control-grid and wiring accordingly.

However, on observing the wiring of the screen-grid detector, V2, we find a reversal of the grid connections; that is, the grid which has a metal cap is connected to the positive potential of 22½ volts, and the grid leading to a prong in the tube base is wired to the plate of the preceding radio-frequency amplifying tube. In other words, the connections at the socket terminals are those of the usual detector, except for the 22½-volt potential on the metal cap. When functioning in this capacity, the screen-grid tube acts as a "space-charge detector."

These differences should be carefully noted; so that there be no errors when wiring the receiver.

**LOW VOLTAGE REQUIREMENTS**

Following the detector are two stages of audio-frequency amplification; the first, using a 199-type tube and resistance-coupled, is followed by a stage of transformer-

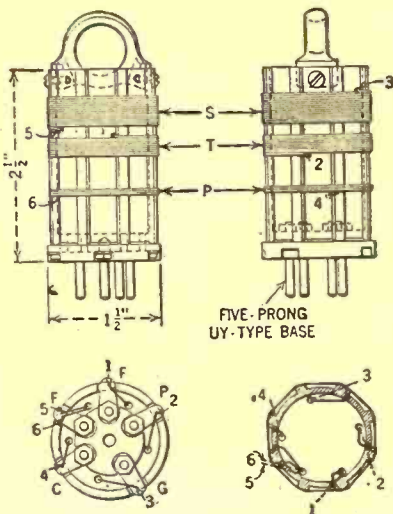

COIL	WAVE LENGTH RANGE		PRIMARY TURNS	SECONDARY TURNS	TICKLER TURNS	SIZE • WIRE
	MIN	MAX				
A	17	30	2	3½	5	24 D.S.C.
B	30	52	2	7	9	24 D.S.C.
C	48	105	3	18	10	24 D.S.C.
D	93	203	4	44	17	24 D.S.C.

\* SAME SIZE WIRE USED ON ALL WINDINGS

Fig. 3

Plain tubes may be used, or the ribbed forms obtained, with or without windings as shown.

coupling employing a 120-type tube. This may serve to bring up another feature of this receiver; because of the low filament-voltage demands of the screen-grid tubes, it is possible to operate the set with either dry-cells or, if the constructor desires, a storage battery.

As specified in this article, the receiver functions with dry cells; however, in order to change over to 5-volt tubes (it is desirable to change only the two audio-frequency tubes), it is necessary merely to substitute the proper amperite, and, of course, substitute a storage battery for the dry cells.

Incidentally, the dry-cell feature makes this set ideal as a portable for the traveller, camper or tourist; employing the smaller

type of plate batteries, it is possible to pack all the necessary batteries into a box no larger than the receiver itself.

**COMPONENTS**

The following parts make up the receiver:

- Two midge variable condensers, .0001-mf. (C2-C3);
- One A.F. transformer, 6:1 ratio (T1);
- Four UX and two UY (5-prong) sockets;
- One resistance coupling unit (incorporating R3-R4-C7);
- One R.F. choke coil, 1½-millihenry (RFC);
- Two amperites, ¼-ampere type (R5-R6);
- One variable condenser, compression-type, .00025- to .001-mf. (C4);
- Two sets of short-wave coils, five-prong plug-in type, to cover from 17 to 230 meters (L1-L2);
- One 2-megohm grid-leak with mounting (R2);
- Three fixed condensers, .006-mf. (C6-C8-C9);
- One fixed condenser, .00025-mf. (C5);
- One resistor strip, 10-ohm (R1);
- Two bakelite vernier dials;
- One filament switch (SW);
- One shield-can, aluminum, 8½x7¾x5½ inches, with dividing partitions;
- Two pin-tip jacks (J-J);
- Three binding-posts, bakelite top (A1-A2-G);
- Two test clips for screen-grid caps;
- Two screen-grid tubes, 222-type (V1-V2);
- One vacuum tube 199-type (V3);
- One vacuum tube, 120-type (V4).

While the layout of this receiver was being planned it was found that a manufactured shield-can made an ideal combination cabinet and shielding arrangement for the receiver; the one chosen is of the knock-down type. When assembled, it makes up a very good-looking shield (or, in this case, cabinet), measuring 8½x7¾x5½ inches; there is no danger of bending or denting the sides of the "can" as heavy aluminum is used in its assembly. The constructor who desires to assemble his own shield unit is strongly advised to use heavy stock so that no trouble be experienced when mounting the components; this is especially important for the section of the

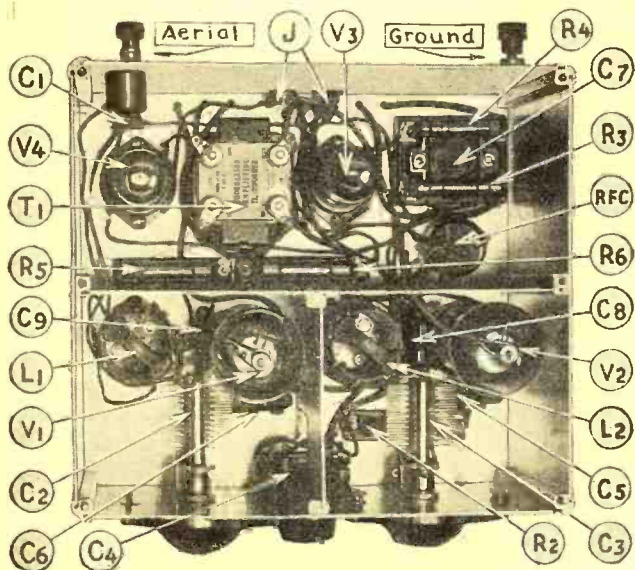

Fig. B

The "Space-Charge Autodyne" from above, showing the compact layout inside the compartments. Care is necessary to make everything fit.

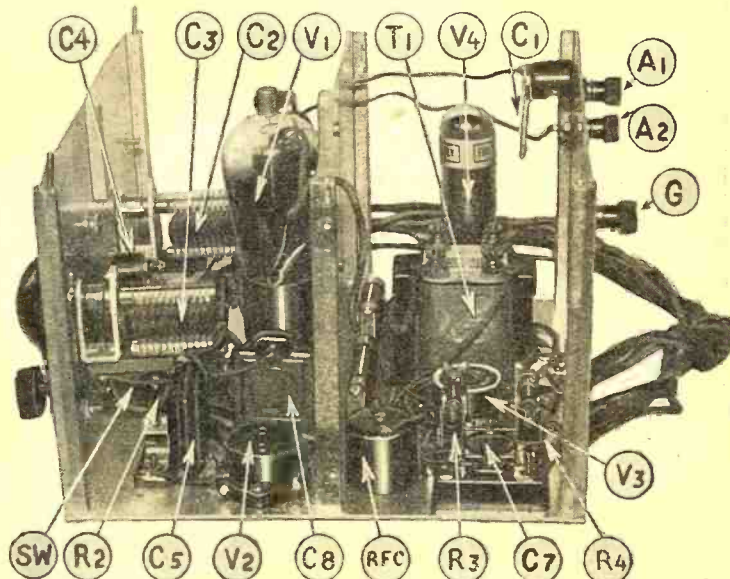

Fig. C

Another view of the receiver, without the sides of the shielding cans, showing more fully the placement. Note C1, at the upper right.

shield upon which are mounted the tuning dials, the filament switch and the oscillation condenser.

Of course, the builder need not adhere to the shield specifications given here; as with many other home-built receivers, the layout of this one may be altered to conform with the ideas and the material of the constructor; providing always that proper shielding is employed and the circuit diagram followed.

ASSEMBLY

The first step in the construction of this set is to lay out the bottom section of the

shield; before drilling any of the mounting holes for the components it is advisable to assemble the entire shield, including partitions, and draw pencil lines along the

bottom section to indicate the position of the partitions. This should be done to prevent the mounting of a socket in a place later to be occupied by a partition.  
(Continued on page 948)

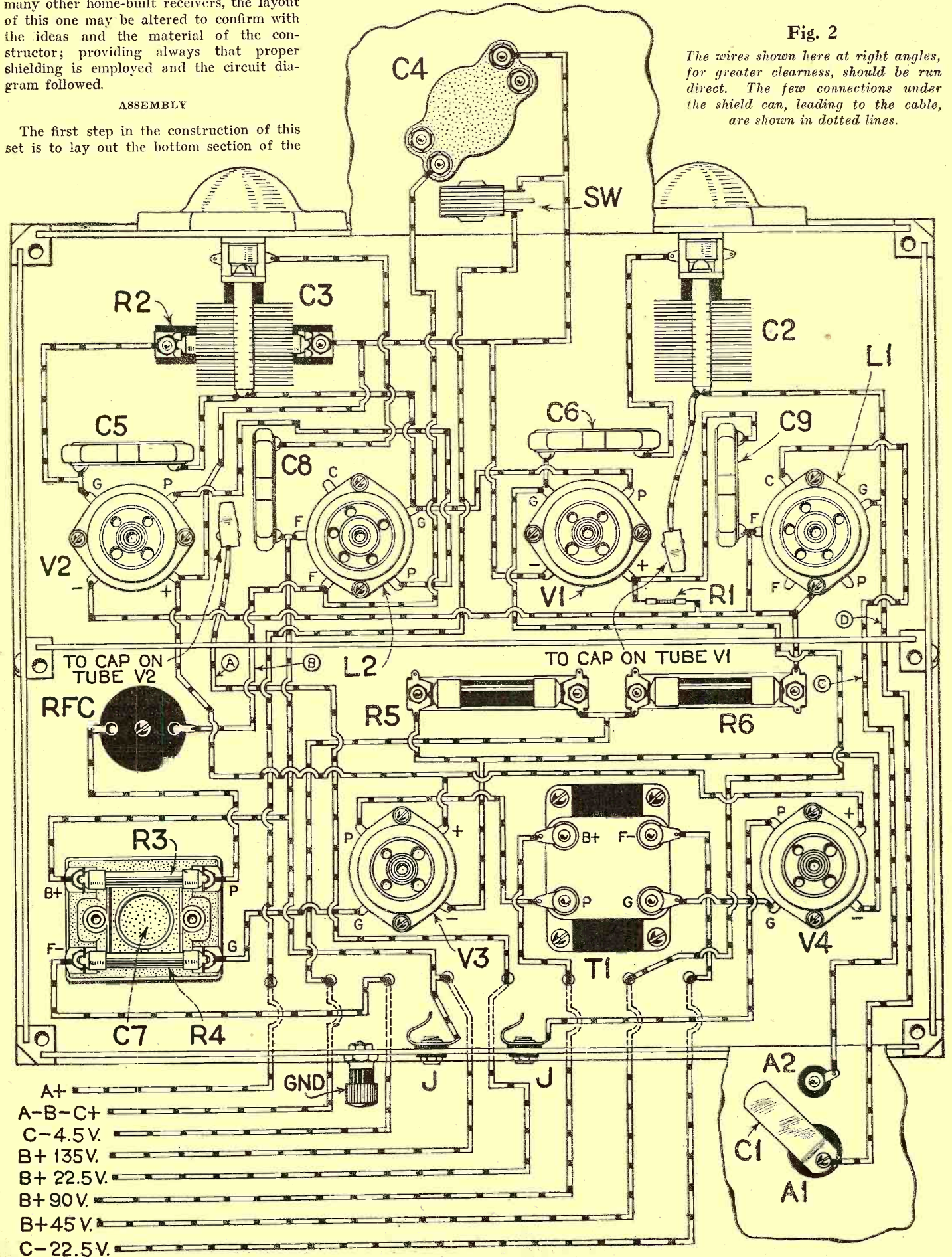

Fig. 2

The wires shown here at right angles, for greater clearness, should be run direct. The few connections under the shield can, leading to the cable, are shown in dotted lines.



## How to Locate Interference

Editor, RADIO NEWS:

Can you supply information regarding a hook-up or instrument for "trouble locating?" We have all kinds of noises in our sets here and as the city (which owns the power service) does not seem to care, we are trying to work out a portable set that will locate some of the trouble.

G. R. McCLURE,  
McPherson, Kansas.

Radio dealers and servicemen in all parts of the country continually encounter cases of interference from local electric apparatus, defective power transmission apparatus and lines, radiating radio sets and other sources. The construction of a small radio set which will help locate these noises should be of interest to a great number of custom set builders, radio clubs and dealers, and for this reason, we print the diagram and constants of such a set (Fig. 2).

It consists of one R.F. stage, a detector and one A.F. stage. The "noises" are picked up by a small loop coupled to the input of the radio amplifier. The other apparatus in the set, including the battery supply, is enclosed in a metal shield, to prevent pick-up through this apparatus, which would spoil the directional effects of the loop.

The operation of the "noise finder" is as follows: It is carried by hand or transported in an automobile to the general neighborhood of the source of interference. The loop is then rotated and the set tuned until the interference is picked up with the greatest volume. The direction of the loop is noted and the set is moved to another position; the experiment is then repeated. Three positions at a sufficient distance are usually sufficient to find the location of the offending apparatus. This method of locating the source of the interference is known as "triangulating" and is very similar to the systems used for locating the exact positions of ships with direction finders (See Fig. 1).

The actual construction of the set is not very difficult. The tubes are of the dry-cell type such as 199s; the use of these allows the complete unit including the batteries, to be enclosed in the metal shield. The latter is made of copper or aluminum and is just large enough to hold all of the parts. The values of the condensers and resistors are shown on the diagram; the transformer should have a ratio of 3 or 4 to 1. The R.F. coil is either home-constructed or may be purchased for the purpose. If it is desired to simplify the receiver, an untuned transformer (such as those employed several years ago) can be used in place of the coil and tuning condenser in the detector grid circuit.

The tuned R.F. coil (if one is used) may be made by winding a primary of about 15 turns of No. 24 D.C.C. wire and a secondary of 75 turns of the same wire on a tube 2 inches in diameter and 3 inches long; about  $\frac{1}{4}$ -inch is left between the two windings.

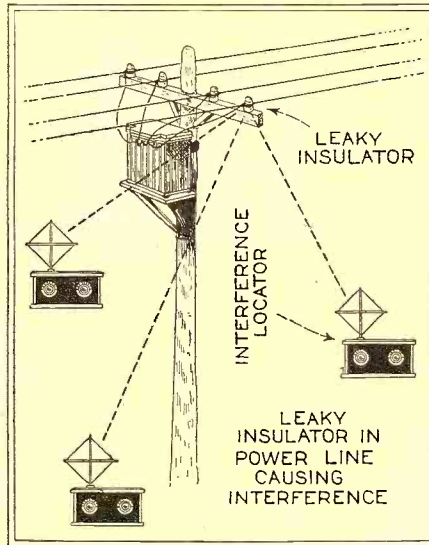

Fig. 1

The loop indicates the direction of noises.

When the interference has been located, it is sometimes difficult to determine just what piece of apparatus or circuit is causing the trouble; and an analysis of the sounds produced by different types of apparatus will help solve this problem. A steady howl is usually caused by a radiating receiver. A rapid and steady clicking noise is often caused by a vibrating-armature battery charger or other electric apparatus with vibrating reeds for opening or closing circuits. (The electric bell is one example of this type of apparatus.) Intermittent rasping and crackling noises may be due to defective insulation or loose connection in power lines, or they may be "static" caused by natural means. A more or less steady crackling noise may also be caused by an arc light or some medical appliances; while a rapid whirring noise or, in some cases, a hum may be caused by a generator or motor in the neighborhood. Crackling noises repeated at regular intervals are often caused by electric-sign flashers. Noises encountered only for certain periods of the day or night

"SERVICE MEN" have problems just like those of every home builder and experimenter, and others which are very different; because every day they are called on to work over receivers and apparatus built by other people, and about which they have not the necessary data. A good service man must be a regular Sherlock Holmes; he has to find clues and solve mysteries by putting two and two together to make five.

While the general information for constructors carried in RADIO NEWS is of actual or potential value for the service man, a large part of his work goes outside of this field. He has to deal with sets and apparatus which other people have built; and has often no way of getting information about the circuits except to trace them out. The rapid changes that radio has gone through have left millions of "orphan" pieces of apparatus; their makers are out of business, and diagrams are not to be had. Many requests for such information are received by RADIO NEWS, and in many cases we have been unable to supply the complete information; though in some we are able to help out the inquirer. The veteran radio man, who grew up with the trade, will have some facts still in his file or in his head; but the younger repair man has nowhere to turn for it. So, also, the junior radio servicer needs a lot of advice that is not in the books, and can be derived only from older heads. With the co-operation of our readers—who are always willing to do another a friendly turn—RADIO NEWS will provide a clearing house for such information.

We can publish here only articles and illustrations which will be of value to a large number of service men; replies to questions of less general interest will have to be handled in the same way as in the "I Want to Know" department. We regret that some well-known manufacturers conceal necessary information concerning receivers and other equipment they have made; and others, while willing that it should be given by letter, forbid its publication. We cannot recommend the use of any specified commercial apparatus as against competing makes, or compare the relative merits of equipment when all is of approved quality. Because many readers need diagrams and data not available here, we will publish (up to a reasonable number) general requests for information on specific obsolete models; so that any fellow radio man who has it may send it to the inquirer direct. We can only print here information on such a discontinued model when it is evident that the demand for it is very large and widespread.

We will be glad to get articles describing layout, construction and equipment of apparatus especially useful in servicing, and the methods of employing it in the shop and on outside calls; systems of trouble-shooting, reconstruction and modernizing of apparatus; special installations; and time-, labor- and money-saving ideas, by practical men who have tried them out. When these are of suitable length, evidently interesting to other service men, and may be suitably illustrated, we will pay for them at regular rates. Very short contributions containing useful hints will be compensated by yearly subscriptions, as with those used in our "Wrinkle" department.

may be attributed to electric refrigerators or blowers in oil-burning furnaces. There are also other noises which are peculiar to certain types of apparatus, but those described above are the most common.

After the interference has been chased to its "lair" the problem arises, what can be done to eliminate it? Some cities and towns have adopted legislation to compel owners of radiating sets or interfering apparatus to overcome the trouble. In this case, it is usually necessary only to inform the owner in order to obtain action. In other cases, however, it is not so easy. Power companies are usually willing to eliminate the sources of trouble if they are informed. In cases where the apparatus is privately owned, a filter of the correct design can usually be installed in the line and several radio manufacturers have placed filters for this purpose on the market.

A booklet published by the Radio Manufacturers Association supplies more information on this subject. The book is priced at \$0.25 and may be obtained from the office of this organization at 11 West 42nd Street, New York City.

### "Music Master-Ware" Reflex

Editor, RADIO NEWS:

I have received an old receiver to be repaired, and I would like to get a copy of the diagram, if one is available. The set is one of the old Music Master-Ware receivers using three tubes of the 199 type. I believe that this receiver was known as the type "T."

If the values of the apparatus are known, I would also like to have you mark them on the diagram. In case these values are not known, the diagram will be sufficient. Can you help me?

RALPH MILLER,

Miller's Radio Shop, Schenectady, N. Y.

At the right, the "Music Master-Ware" three-tube reflex circuit, for which we have had many requests. The information printed here gives all the data on this one-time popular set that we have been able to obtain, and may aid in tracing connections.

### Increasing Antenna Pick-Up

Editor, RADIO NEWS:

I have a Radiola 28 receiver. Is there any way that an outside aerial can be connected to this set, other than an aerial coupler? Is an underground or buried aerial all right to use to reduce static?

T. W. HILMERS,  
Chicago, Ill.

A loop set, such as the Radiola 28, can be adapted to operation with an outdoor aerial in several ways. The aerial may be coupled to one side of the loop aerial and the ground wire to the other (Fig. 4A). This will improve the volume but may broaden the tuning too much. The loop continues to oper-

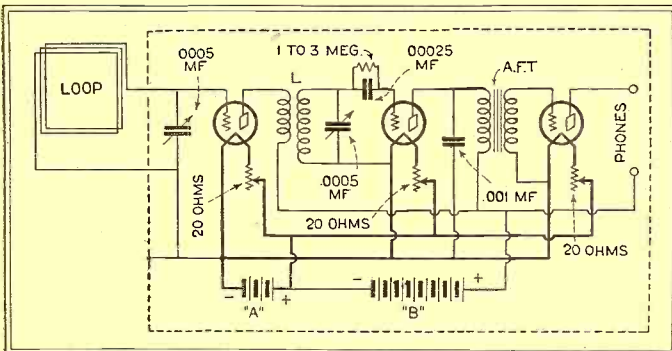

Fig. 2

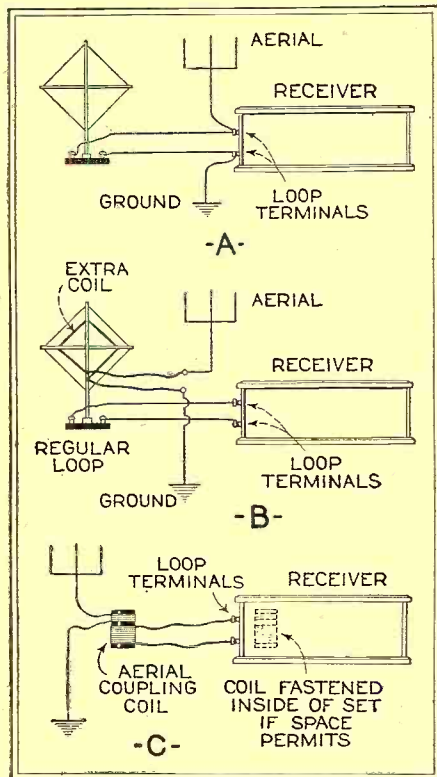

Fig. 4

The combined pick-up of loop and aerial at A makes the set more sensitive but less directive. The directive effect is lost at B, and C corresponds to the ordinary tuned-coupler aerial circuit.

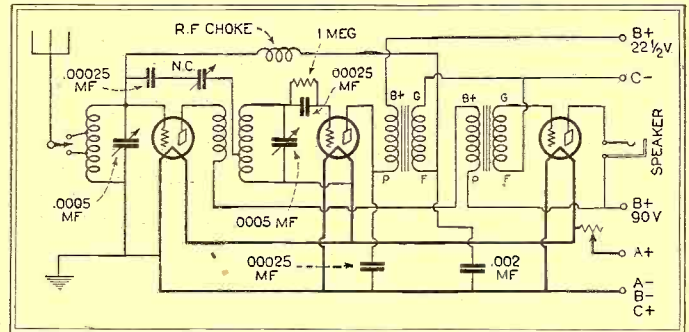

Fig. 3

At the left, circuit for a three-tube receiver of a type which may be used to locate the electrical sources of noises which interfere with radio reception. A dry-cell set will be handiest, as batteries and everything but the loop must be totally shielded.

We are printing the diagram of this receiver as Fig. 3. There are a large number of these sets in use at the present time and many of them require attention from time to time. As you will notice from the diagram, the set is a three-tube reflexed neutrodyne. The first tube acts as both R.F. and A.F. amplifier at the same time. The second tube is the detector, while the third is a straight A.F. (output) stage.

The two tuning condensers have a maximum capacity of about .0005-mf. There are, in the receiver, several by-pass condensers, the capacities of which are marked on the diagram. Much of the trouble encountered with this set is found in the A.F. transformers, and it is usually advisable to test these first in cases where the set fails to operate. The transformers have a ratio of about 3 to 1 and, because of their design, the quality of the receiver can be improved very much by replacing them with new ones of more recent design.

Trouble is often encountered in the tube sockets also; it will often be found that the contacts bend down and lose their spring. In this case, it is best to replace them, since they will undoubtedly be a continual cause of trouble. The final cause of trouble is in the wiring and the battery cable. These should be checked over in the usual way with a battery and pair of phones. Because of the metal panel used in these sets, a short-circuit can very easily occur between the "A—" or ground terminal and the plate circuits, or the "A+"; and extreme care should be exercised when checking the continuity of the wiring.

ate, and the outside aerial merely increases the pick up.

Another way to couple an aerial and ground to the set is to fasten several turns of wire around the loop, and connect the aerial and ground to the new coil (Fig. 4B). The inductive coupling between the aerial coil and the regular loop will allow an increase of signal strength, while the selectivity is better than with the first method.

The most satisfactory way of increasing the efficiency of the set, however, is to disconnect the loop and insert a coupling coil in its place. The coupling coil is wound with a primary of about 8 to 10 turns of No. 22 D.C.C. wire and a secondary of 50 turns of the same wire. A 3-inch tube is employed and a space of about 1/4-inch is left between the two coils. The secondary is connected in place of the loop and the primary is connected to the aerial and ground (Fig. 4C).

#### UNDERGROUND PICK-UP SYSTEMS

The buried "aerial" usually operates quite satisfactorily with an ordinary broadcast receiver and, in many cases, the static level is reduced quite noticeably. The operation of this antenna system depends (in the same way as with the usual type of overhead aerial) on the location, the way in which the aerial is installed and the actual design of the aerial.

Such complaints regarding the performance of an underground aerial as are usually received may be traced to the fact that the users expected too much. The underground aerial is shielded; therefore it receives no disturbing impulses from the minute electrified particles which fill the air, and are continually lighting on an exposed wire. It also avoids some other sources of interference; but no device yet suggested which reduces all interference does so without reducing some of the signal pick-up. This undesired result may be overcome by increased amplification; thus taking full advantage of the reduced noise level.

In addition to this, the underground  
(Continued on page 956)



# The Radio Constructor's Own Page

Wherein Custom and Home Set Builders and Experimenters  
All Over the World Swap Experiences and Suggestions About  
Hookups and Accessories

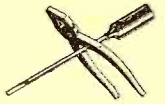
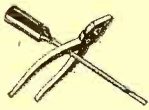

## "JUNK-BOX" ENTHUSIASM

Editor, RADIO NEWS:

I have constructed the "Junk-Box" and it is a wonderful set. The word "Junk" should be "Joy." I am a set builder, and would not take \$25.00 for it. I do not use an aerial, as I find I can get more distance without it. I use a copper panel 5x13 and have no trouble with body capacity. I would be glad to hear from any young constructor who is also interested in this type of set.

JOHN MULLINS, JR.  
3921 Asher Ave., Little Rock, Arkansas.

Editor, RADIO NEWS:

Many thanks for the blueprints which you sent me; I have constructed the "Junk-Box" so often that I know it by heart. I am using a 112 tube for a detector and find that if I turn up the rheostat a little way above the point where the tube starts oscillating, the regenerative control works much better. Also, those who have added another stage of audio will find that if the "F—" lead is disconnected from the transformer secondary, it will make it much clearer with some loss in volume. (This old ham trick substitutes capacitive coupling, with

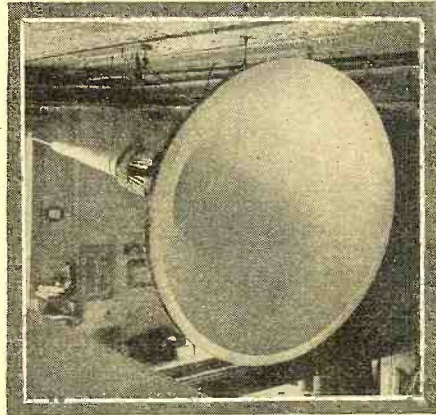

Mr. Morrison's 12-foot exponential horn (see page 969) has a graceful appearance. The bell is linoleum-lined.

the capacity between the transformer windings carrying on the signal to the last tube. It should be unnecessary with good transformers.) I use a 7-megohm grid leak; I am sure that if this set is constructed carefully and the coils wound properly, it will outdo any other receiver of its size.

JOHN D. HAYDEN, JR.,  
Rowlesburg, West Virginia.

## A SET BUILDER SATISFIED

Editor, RADIO NEWS:

I have built the J.B. from blueprint 58, and have received very clearly on only 15 feet of aerial and a common ground, 5SW, 2ME, PCJJ, CJRX, 2XAL, 2XAF, KDKA and many C.W. stations. It is a wow for volume, and I only use the two-tube hook-up. I have also built the "Extension" two-tube set (blueprints 53 and 55) with two stages of audio, and spent only a few hours logging stations; but after three nights I have received forty, including KNN, Los Angeles, three nights straight.

I can only say you surely put out wonderful circuits; having been a satisfied reader since 1922. I have enjoyed every issue, and the information therein. Just a word of advice to other readers; if they

(Continued on page 969)

## Fifty Dollars for an Improvement in Short-Wave Sets

**I**N keeping with the belief which RADIO NEWS has always expressed, that the technical progress which radio has made is in no small measure due to the ingenuity and industry of home experimenters, and that many more good ideas are to come from their workshops, we will pay \$50.00 for each accepted and published constructional article from the builder of a *successful short-wave receiver that contains a novel feature of value, electrical or mechanical, which increases its efficiency or makes its operation more satisfactory.* This price will apply only to an article covering *one printed page or more* containing a complete description of the receiver; and the Editor of RADIO NEWS will decide whether any article submitted contains the requisite amount of value and novelty to justify its publication in this form. If a contribution submitted does not measure up to this standard, but contains some matter of interest, the writer will be offered compensation at regular rates for a shorter article, or for a Wrinkle, as the case may be.

No article of this nature will be considered unless the author states that he has built a working model, and is prepared to submit it upon request. We cannot accept under this offer any contribution, no matter how ingenious, dealing with *a theory which has not been reduced to practice.*

Before preparing manuscript at great length, or working drawings, write to RADIO NEWS, stating the elements of your construction, the new feature which it presents, and enclose a clean *schematic diagram, in ink, of the circuit.* You will then be instructed how to proceed further, or whether to send the set to this office for test. *Do not ship any apparatus to us without being first instructed to do so.* As illustrations of a constructional article must be prepared in this office by our staff artists, we reserve the right to construct new apparatus for the purpose, using the same circuit but employing other parts; and to correct the article submitted to conform with our illustrations and customary editorial style.

All communications with respect to this subject and other new ideas, discoveries and inventions in radio should be brief and direct as possible, legibly typewritten or written *in ink (not pencil)* and well spaced. If an idea is worth describing, it is worth describing clearly. We will, when so desired, hold in confidence any communications made to us by experimenters, until the latter release them for publication; but we can give no opinion upon the value of their ideas until we are informed of the essential details of their work. All inventors who believe that they have found something new which may be patentable should immediately put on record their evidence of conception, in the manner described in RADIO NEWS for December, 1928 ("How Inventors May Guard Their Rights"); they may then communicate their ideas with the assurance of security. On the other hand, the secretive experimenter runs two risks; he may be working out toilfully something already discovered, which he cannot patent, or he may be failing to show "due diligence" and others on the same track will pass him.

What have you in the way of an improvement in your short-wave set that is new and different? Write to *Short-Wave Editor, RADIO NEWS, 230 Fifth Avenue, New York City,* and begin your letter by saying that you have built a set, and have a story to offer for that Fifty Dollars. Enclose the circuit diagram in *schematic form,* or make a sketch of the layout or new parts.



Main table listing radio call letters, broadcast stations, locations, wave meters, and power watts for various stations across the United States.

LIST OF CANADIAN BROADCAST CALLS

Table listing Canadian broadcast calls, including stations like CFAC, CFRB, CFCF, and others, with their respective locations and technical specifications.

LIST OF SHORT-WAVE STATIONS OF THE WORLD

(Some calls may have been altered under new international regulations.)

Large table listing short-wave stations worldwide, categorized by region: AFRICA, AUSTRALIA, AUSTRIA, BELGIUM, CANADA, COSTA RICA, DENMARK, ENGLAND, FINLAND, FRANCE, GERMANY, HOLLAND, ITALY, JAPAN, JAVA, MEXICO, MOROCCO, NORWAY, SWEDEN, SWITZERLAND, UNITED STATES, and SPAIN. Includes call letters, locations, wave meters, and power.



# On the Short Waves



## EDUCATING THE NEIGHBORS

Editor, RADIO NEWS:

I have a complaint to offer and, not knowing just how to handle it, decided that you will do as well as any. Lately I purchased a fairly good short-wave receiver to learn a bit more about the code. No sooner was it installed than I found myself host to a number of friends who looked at the receiver and forthwith assumed dancing poses. Not to disappoint them, I turned the dials hoping that I might be able to pick up some short-wave phone outfit which, by some stroke of luck, would be grinding out some dance music. As might be expected, the first sound to come through the speaker chanced to be one of the commercial outfits zipping along about 40 per; a few more frantic turns on the dials only brought forth more Continental—I turned sheepish to my assembly and gave vent to a whooper; I explained the darn thing was designed only for code reception, for which I know I have been forgiven.

I find that most people are unaware of the existence of code stations and, try as I might, I cannot get them to understand what it is all about. What I want to know is, how can the public be educated in regard to this matter?

IVAN GILL,  
Fort Lyon, Col.

(We might suggest that Mr. Gill refer his friends to the first article appearing in this issue; also to the rescue of the entire crew of the Florida by the America when the former ship foundered recently, and the accounts of the Vestris disaster.—EDITOR.)

## INVITES RECEPTION REPORTS

Editor, RADIO NEWS:

The town of Fleming, Saskatchewan, is located over 200 miles west of Winnipeg, and we broadcast over this station simultaneously with CJRX every afternoon except Sundays, from 4:30 to 7:00 P. M., Central Standard Time. We greatly appreciate reports from listeners on our broadcasts and would like your readers to co-operate in this.

D. R. P. COATES,

Broadcasting Manager, James Richardson and Sons, Ltd., 1018 Grain Exchange Bldg., Winnipeg, Manitoba.

(While the 500-watt stations, CJRM and CIRV, are on 500 watts, CJRX on 25.6 meters has two kilowatts, and has been heard very loudly over a large portion of the United States. It operates also from 7:00 to 8:30 P. M., Sundays with church

service, 9 to 10 with a concert; from 8:30 to 10:30 on Tuesdays, and from 8 to 9:30 on Thursdays, according to program enclosed.)

## CHANGES IN STATIONS

Editor, RADIO NEWS:

May I suggest the following changes in your short-wave list. These corrections are based on actual reception, of which I have verifications; which are available if you wish them.

PCJJ, the Philips transmitter, has changed its call to PCJ. GBS, besides being on 24.4 meters, is also on 16.375 every day, and 34 meters also. G5SW changed its wavelength from 24.0 meters beginning December 3, and will in the future continue to work on 25.55 meters. AFK, at Berlin (Doberitz) Germany, beside working on 67.65 is also on, and heard here, on 37.65. There is no JB on short waves, as we have ascertained by writing to that broadcaster in Johannesburg.

A new station which you do not have listed, and which just opened officially on January 16, is PHOHI, a Holland-India radio-telephone transmitter at Huizen, Holland, on 16.88 meters. They have heard here R-7 testing several mornings from 1430-1500 GMT. FW, the transmitter of La Compagnie Generale Telegraphique Sans Fil, at Sts. Assise (Paris), has long since stopped working on 24.5, and now regularly works with Buenos Aires several days a week; Buenos Aires is the station on 15.02-m, and FW is on 15.55-m. The call letters of Buenos Aires are unknown; they are generally R6-7 here in the morning.

A slight error is in PCLL's wavelength—they are on 18.4 instead of 18.1. There is also some error in Java's wavelength. PLE, formerly ANE, is on 15.74 meters, and PLF (was ANH) on 17.00.

All these stations have been received in Pittsburgh. I have confirmations from PCJJ, PCLL, PHOHI, CJRX, 5SW, 2NM, GBS, FW, AFK (first time he was heard in U. S.), 2FC, 2ME, 3LO, ANH, ANE, and Buenos Aires. My receiver is built according to specifications in October, 1927, RADIO NEWS, with changes in some cases. Aero coils are used as inductances, tuned by Karas condensers.

The station heard by Arthur J. Green on Nov. 23, at 4 A. M., was 3ME, the short-wave transmitter of 3LO, at Melbourne, Australia. I was listening to them at that time and date. He may have confirmation by writing to The Broadcasting Co. of Australia, Melbourne, Australia.

Trusting the information as to stations will be of aid to some of your listeners and readers, I am,

GEORGE MORECROFT, JR.,

212 Fruit Exchange Bldg., Pittsburgh, Pa.

Editor, RADIO NEWS:

I wish to thank you for the story in the February issue, and at the same time tell you that JHBB (Hirasio, Japan) has changed its call letters to JIAG. I am informed of this in a verification by Mr. E. Takagishi, of the Ministry of Communications. My last verification from ANE shows his present wave is 15.74 and he is on the air from 1240 to 1440 GMT, with 25 kilowatts power. In the same mail is a verification stating that 3LO, Melbourne, is 5 kw. on 32 meters; but he comes in like he was using 40 kw. A2ME is 27.50 meters, 20 kw. Short waves is all the talk on the Pacific Coast; it won't be long now.

DONALD WRIGHT,

1123 South Meyler St., San Pedro, Calif.

(RADIO NEWS wishes to thank all its friends who have good listening posts for data on short-wave changes; as there has been a great deal of reallocation since the first of the year, and official reports of the situation come very slowly.)

## NOTHING MORE BEYOND

Editor, RADIO NEWS:

I beg to report reception of the following stations for which I have received verifications: 6AG, Perth, Australia on 32 meters rebroadcasting 6WF programs; Godhaven, Greenland on 28 meters at 10:00 A. M. eastern standard time every day; NRH, Costa Rica, around 30 meters, comes in real well here, considering their low power; and ANE, Bandoeng, Java on 33 meters at various hours, received with fair clarity. In my estimation your magazine is always in the lead on short-wave news.

FRED J. HELLMER,  
Detroit, Mich.

(Paradoxically, Mr. Hellmer's reception of 6AG places him in an unfortunate position; he has reached the limit of his DX work; for Perth, Australia, is the farthest city in the world from the United States. Incidentally, this is the first report we have had of a fan in the central states hearing Perth.—EDITOR.)

## AN SOS FROM A STRANDED JUNK

Editor, RADIO NEWS:

If there is a fan in or near Chicago who has built the "Junk-Box" and had any success with it, I wish he would write to me. I would like to make arrangements to go and hear it work. (You have to show me: I'm from Missouri.) I have had no success after one month of worrying with it.

DONALD HOWARD,

3724 Parrish Avenue, East Chicago, Ind.

(Will one of the numerous short-wave fans in the Chicago district help out Mr. Howard by a little practical demonstration?—EDITOR.)

## TUBES FOR SHORT-WAVE RECEPTION

Editor, RADIO NEWS:

We are pleased to note that the short-wave field is the subject of your editorial for the February issue. As you know, we are the pioneers in the short-wave adapter field, having advertised constantly in your magazine since July, 1926. During this time, we have been very particular in informing our customers of the true facts of short-wave reception.

We delayed putting on the the market our A.C. model "Submariner" for something like six months, because of the failure of the UY-227 tubes to function properly below 50 meters. In answering all our inquiries in reference to an A.C. short-wave adapter, we always include the following paragraph: "While the 'Submariner' operates as effectively as any short-wave receiver or adapter when using a UY-227 5-prong detector tube in its socket, we invariably recommend the use of an Arcturus No. 127 5-prong detector tube, as the UY-227 tube does not operate satisfactorily under 50 meters."

We might state our experience with 5-prong tubes is this: all 5-prong detector tubes which use

(Continued on page 969)



The Malabar station at Bandoeng, Java, in addition to code work, maintains with Holland the longest regular radio-telephone service in the world; its broadcasts, now under calls PLE and PLF, have been heard by many in the United States. The aerial system, not shown here, is suspended from cables crossing the valley in which the buildings are located.



Conducted by C. W. Palmer

IMPORTANT NOTICE TO CORRESPONDENTS

BECAUSE of the large influx of mail, RADIO NEWS now finds it necessary to discontinue answering free of charge, all inquiries to this department. With several hundred letters received daily by this department, the editors have been taxed so severely in answering the present mail that the magazine has begun to suffer. Hereafter, therefore, only letters accompanied by our standard fee (which, by the way, covers only the actual writing of letters and stenographic help) can be considered. Kindly note these simple rules, now in effect:

(1) Correspondents asking answers by mail must enclose 25c for each separate question. Simple radio problems will be answered, but for this nominal charge we cannot make long calculations or thorough investigations.

(2) We cannot give blueprints or layouts for commercial apparatus, or data which the manufacturers have kept secret.

(3) We cannot advise, *even confidentially*, on the respective merits of trade-marked apparatus or "what make to buy."

(4) We cannot send either replies, blueprints, books or magazines C.O.D.

(5) When in doubt, please inquire as to the cost for our services, before remitting.

(6) Be brief. Typewrite or write legibly in ink, on one side of the sheet only. *No attention can be paid to pencilled matter.*

OUTPUT COUPLING DEVICES

(2334) Mr. M. J. Joseph, Chicago, Ill., writes: (Q.) "Will you please supply as much information as possible as to the use of an output coupling device for a receiver? When is one required, and just what type is necessary for a particular installation? I notice that almost every set now in use uses a filter of some type; although they differ greatly in their construction."

This direct current does no useful work in actuating the speaker, but is necessarily produced by the normal operation of the tube. If some method is used to separate the alternating-current component from the continuous or direct-current, the speaker operates just as efficiently, and actually gives better quality, since it is not loaded with unnecessary current. Also, the windings of the speaker are not endangered, since the actual signal variation is comparatively small when compared to the plate potential.

The output filter supplies a means of separating the two currents; it has also another use, that of providing a means of matching the impedances of the tube and the speaker. In order to obtain the greatest efficiency from a speaker, its impedance should be close to that between the filament and the plate of the last tube in the set. A transformer with properly designed windings will supply these requirements.

Fig. Q-2334 shows three common methods of coupling. The first (A) is that of using an output transformer; as mentioned above, this serves the double purpose of keeping the plate voltage away from the speaker and matching the impedance. The second method (B) employs a choke coil CH and a condenser C1; the condenser prevents the direct current from passing through the windings of the speaker, while the choke coil prevents the alternating component from being by-passed around the speaker through the "B" battery. The choke coil has, usually, an inductance of about 30 henries and the condenser a capacity between 2 and 4 mf. There is one fault in this system, and that is the possibility of getting a shock when the speaker and the ground are touched at the same time, as the speaker is at the highest "B+" voltage. This may be overcome by connecting an additional condenser (C2) at the point shown by the dotted lines; the speaker is thus entirely insulated from the plate supply.

The same results may also be obtained, without using the additional condenser, by connecting the loud speaker between the condenser and the negative filament lead. In this case, as shown at C, the alternating component still passes through the speaker, but the direct current is entirely separate.

and a variable voltage-divider or potentiometer is employed for the center tap of the filament circuit, the adjustable arm of the resistor may be used to counteract the unbalancing. A series resistor might also be connected directly to the filament terminal on the tube socket. In this way, the center arm of the tapped resistor would not need to be moved

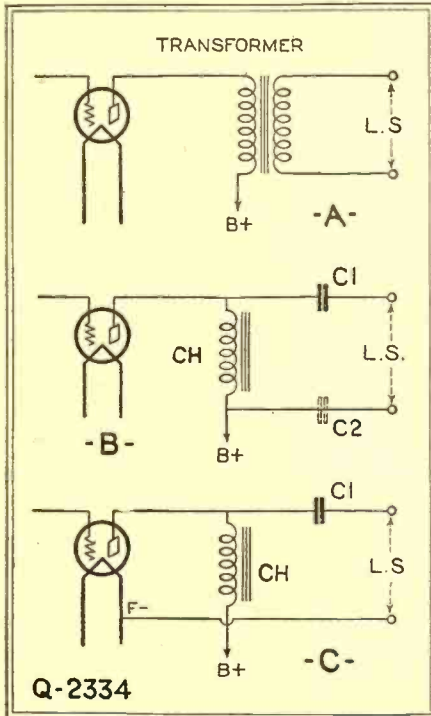

The three standard methods of output coupling which obviate the flow of direct plate current through the speaker: A, transformer; B and C, output choke. The last is somewhat preferable.

(A.) The value of the current which actually operates the loud speaker is continually varying as the signal changes. The plate current, or output, of the last tube may be considered as an alternating current superimposed on the direct current in the plate circuit; since the variations in the current follow, exactly, the form of an alternating current. When an output filter is not used, the direct plate current of this tube is continually passing through the windings of the speaker; the amount of this current is dependent on several factors, including the plate voltage, the "C" bias and the resistance of the plate.

REDUCING A.C. FILAMENT SUPPLY

(2335) Mr. M. R. Smith, Flushing, N. Y., writes:

(Q.) I have a filament transformer designed for 7½-volt tubes, such as the 210 and the 250. I am using a 171 tube in the last stage in my set and I would like to use this transformer. I have tried to place a resistor in series with one side of the line to the filaments, but this produces an excessive amount of hum. Can you help me?"

(A.) In order to keep the filament current of the tube in a balanced condition (which is necessary to keep the hum at a minimum) the potential on each side of the center tap of the transformer must be the same. If resistance is added on one side, the voltage on that side of the filament is reduced and the filament is unbalanced.

If the center tap of the transformer is not used,

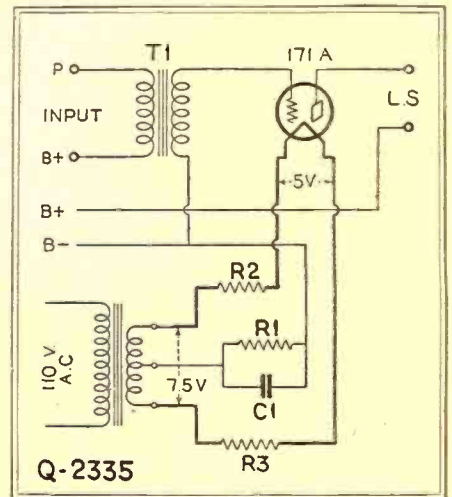

When a 171A tube is used with a 210-type transformer, hum must be filtered out as shown. The two resistors R2-R3 balance the voltage drop.

from the mechanical center, and a fixed tapped resistor could be employed.

When using a center-tapped transformer, however, this method of reducing the voltage is not practical; since it causes an unbalancing of the filament circuit. The obvious way of overcoming the difficulty is, of course, to place two resistors (R2, R3, in Fig. Q-2335) in the circuit, one in each side of the filament supply. In this way, the voltage on each side of the center tap is kept the same and the hum is naturally reduced to a minimum. The actual value of the resistors depends on the filament current and the amount of voltage reduction required. Ohm's law is used for this calculation—that the resistance is equal to the voltage drop divided by the current in amperes. In this case, the voltage drop is equal to 7½ minus 5 volts or 2½ volts; the 171A tube draws ¼-ampere, so the resistance should have a value of 10 ohms. Each side would then need 5 ohms, in order to produce the required voltage-drop. The center tap of the filament transformer is connected to the negative "B" lead and grid return through the resistor R1 in order to supply the required "C" bias for the power tube. R1 is 2,000 ohms and C1 at least 0.5-mf.



# Radio News Laboratories

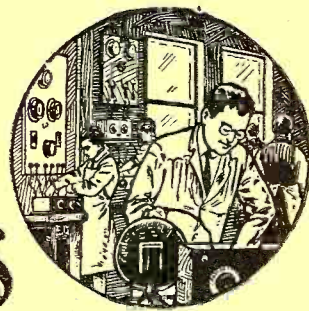

**R**ADIO manufacturers are invited to send to RADIO NEWS LABORATORIES samples of their products for test. It does not matter whether or not they advertise in RADIO NEWS, the RADIO NEWS LABORATORIES being an independent organization, with the improvement of radio apparatus as its aim. If, after being tested, the instruments submitted prove to be built according to modern radio engineering practice, they will each be awarded a certificate of merit; and that apparatus which embodies novel, as well as meritorious features in design and operation, will be described in this department, or in the "What's New in Radio" department, as its news value and general interest for our readers shall deserve. If the apparatus does not pass the Laboratory tests, it will be returned to the manufacturer with suggestions for improve-

ments. No "write-ups" sent by manufacturers are published in these pages, and only apparatus which has been tested in the Laboratories and found of good mechanical and electrical construction is given a certificate. As the service of the RADIO NEWS LABORATORIES is free to all manufacturers, whether they are advertisers or not, it is necessary that all goods to be tested be forwarded prepaid, otherwise they cannot be accepted. Apparatus ready for, or already on, the market will be tested for manufacturers free of charge. Apparatus in process of development will be tested at a charge of \$2.00 per hour required to do the work. Address all communications and all parcels to RADIO NEWS LABORATORIES, 230 Fifth Avenue, New York City. Readers will be informed on request if any article has been issued a Certificate of Merit.

### VOLTAGE REGULATOR

The "Type VR-1" A.C. voltage regulator shown, submitted by the Acme Apparatus Corporation, Cambridge, Mass., has been designed to maintain a

constant output of 110 volts when operated from a supply, in which there are variations from 90 to 135 volts. The automatic regulation is accomplished by introducing a combination of capacity and inductance which governs the effective voltage by

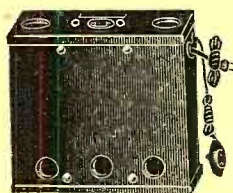

setting up a phase-difference between two portions of the primary circuit. It is designed to handle a continuous load of 60 watts; and was tested under full load at four input values, 100, 105, 115 and 120, from all of which was obtained a 110-volt output. The device is 7 3/4 inches wide, 6 3/4 inches high and 3 1/2 inches long, and is provided with a six-foot two-wire cable and plug for the light-socket supply and a two-wire cable and "on-off" switch. An output receptacle at the top of the housing connects to the device to be operated. The metal housing is of black crystalline finish, with ventilating holes.

AWARDED THE RADIO NEWS LABORATORIES CERTIFICATE OF MERIT NO. 2546.

### PHONOGRAPH PICK-UP AND TONE ARM

The phonograph pick-up submitted by the Buckingham Radio Corp., 440 West Superior St., Chicago, Ill., is of the electro-magnetic type and when used in connection with the amplifying system of a radio receiver, will give excellent reproduction of music and speech from phonograph records. The balanced armature is factory-adjusted for maximum sensitivity and volume.



The pick-up unit is housed in a closed case of horse-shoe shape, 2 1/2 inches wide, 2 3/4 inches long and 3/4-inch thick. A special bracket, fastened to the back of the housing by screws, forms part of a hinged joint, the other side of which is integral with the tone arm; the length of the latter is 9 1/2 inches and its height 3 3/4 inches. It is pivoted and swings over a restricted arc on its base support, which has three holes for fastening to the motor-board by wood screws. Both pick-up and tone arm are of a polished bronze finish. A special adapter is provided for connection to a radio receiver.

AWARDED THE RADIO NEWS LABORATORIES CERTIFICATE OF MERIT NO. 2550.

### POWER SWITCH

The "Type 70-50 Feed-Through" switch submitted by the Cutler-Hammer Manufacturing Company, P. O. Box 1564, Milwaukee, Wis., has been designed for insertion in a power circuit to control current not exceeding 6 amperes at 125 volts. The switch mechanism is of the toggle



two-button type, and housed in molded brown bakelite; connections are made or broken by snapping in or out the buttons which, by a molded bake-

lite lever, operate a spring connected to the movable contact arm.

AWARDED THE RADIO NEWS LABORATORIES CERTIFICATE OF MERIT NO. 2551.

### LOOP ANTENNA

The collapsible loop antenna submitted for test by Paul Rinkel, Charlottenburg 4, Sybelstra. 69, Germany, when tuned by a .0005-mf. condenser will cover the broadcast waveband from 200 to 550 meters. The trapezoidal loop is of box type, having 14 strands of flexible wire separated 1/2-inch, and is supported at the base of the walnut frame by a special wooden support which pivots on a special wooden tripod. The width of the frame is 5 inches, and it is held apart at each of the four corners by threaded bakelite rods; the alternate threads of the rods are used for spacing the turns. The over-all height when extended is 26 inches, 24 inches long and 6 1/2 inches wide; when collapsed the loop can be stored in a space 24 inches long, 2 1/2 inches deep and 7 inches wide.

AWARDED THE RADIO NEWS LABORATORIES CERTIFICATE OF MERIT NO. 2552.

### POWER-ANTENNA SOCKET

The "Beldentenna" shown here, submitted by the Belden Manufacturing Co., 2300 S. Western Ave., Chicago, Ill., has been designed for use where both an extension for the 110-volt house lighting supply and a light-socket antenna are desired for a radio receiver; it consists of a 10-foot double twisted cable, provided at one end with a receptacle plug and at the other with a molded receptacle in which is placed a condenser for connection to the "Aerial" post of the receiver. The capacity is .00015-mf. A five-foot single lead, provided with spade terminals, is used to connect the condenser terminal on the molded receptacle to the "aerial" post.

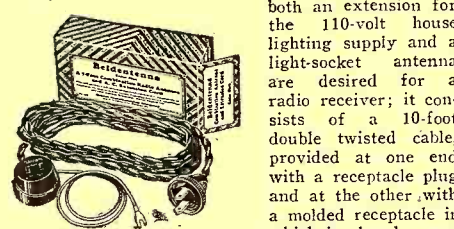

AWARDED THE RADIO NEWS LABORATORIES CERTIFICATE OF MERIT NO. 2553.

### CABLE PLUG AND SOCKET

The "No. 780" cable assembly submitted by Herbert H. Frost, Inc., Elkhart, Indiana, has a black molded-bakelite socket of substantial construction. Further to increase its strength, the pin sockets have been spun into the molded socket base and prevent possibility of cracking, which might occur if they were molded together. The terminal prongs are of ample size, and present a large contact surface; they are so constructed and fastened within the plug that they cannot be loosened by ordinary usage. The color code of the wires is molded into the bakelite to prevent possibility of confusion; their special arrangement prevents the contacts being made in any but the proper positions. The cable leads are encased in a braided and woven sheath; the length over all is five feet.

AWARDED THE RADIO NEWS LABORATORIES CERTIFICATE OF MERIT NO. 2555.

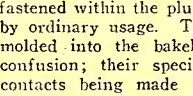

### DYNAMIC SPEAKER CHASSIS

The reproducer shown here, submitted by the Leslie F. Muter Company, 76th and Greenwood Ave., Chicago, Ill., is of the A.C.-operated electro-dynamic type. The moving coil, of low resistance, is connected to the output of the radio receiver through a specially-designed speaker input transformer. The field winding is of the 100-volt type with high resistance; power is supplied from a step-up power transformer, whose output is converted to direct current by a full-wave (280-type) rectifier tube, and filtered by a specially-designed unit. The cone, 8 inches in diameter, is anchored to the speaker frame by thin kidskin strips 1 inch wide, which are cemented around the edge of the cone. The chassis base is 11 inches long and 5 inches wide; the depth of the speaker is 8 inches, its height 10 1/2 inches and its width 11 inches. The speaker handles tremendous power, with good reproduction of music and speech.

AWARDED THE RADIO NEWS LABORATORIES CERTIFICATE OF MERIT NO. 2557.

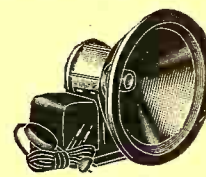

### AUDIO TRANSFORMER

The "No. 391" audio transformer submitted by the Pilot Electric Mfg. Co., 323 Berry Street, Brooklyn, N. Y., has a winding ratio of 3 1/2-1, and is of excellent mechanical and electrical design. Upon measurement it was found to have a very good frequency-characteristic. The transformer is mounted in a molded bakelite case where it is held in position and sealed against moisture by the impregnation of a black waterproof

sealing compound. The whole height of the transformer is 3 1/2 inches; it is 3 inches long and 2 1/2 inches wide. Terminal designations are etched on a metal plate, which is riveted to the top of the transformer case.

AWARDED THE RADIO NEWS LABORATORIES CERTIFICATE OF MERIT NO. 2558.



### SHIELDED R.F. COIL

The "Type A.C. 226" R.F. transformer shown here, submitted by the Twin Coupler Co., Poughkeepsie, New York, has been designed for use as an interstage radio-frequency transformer when used in connection with the 226-type A.C. tube. This coil may be used also in battery-operated sets, in which the 201A-type is employed, with very satisfactory results. Its measured secondary inductance is 240 microhenries; and when tuned with a .00035-mf. condenser, it covers the waveband from 200 to 550 meters. The coil is of the small-field type; being wound on a 1 1/4-inch tube, 2 1/2 inches long, and mounted on a disc (provided with either four prongs for an interstage coupler, or five prongs for use on an antenna coupler) which is in turn placed in the bottom of an aluminum can 2 1/2 inches in diameter and 3 3/8 inches high. The arrangement of the prongs on the base is adapted for plugging into the standard UX or UY tube sockets.

AWARDED THE RADIO NEWS LABORATORIES CERTIFICATE OF MERIT NO. 2559.



(Continued on page 971)



## Supreme Musical Performance - "Built To Exceed Your Expectations"

IT IS significant that the manufacturers of the world's finest radio receivers have almost universally turned to Thordarson for their power supply and audio transformers.

Thordarson power supply transformers exhibit an efficiency of design, an abundance of power and a constancy of performance that practically eliminates the necessity for service calls.

Thordarson audio transformers provide a fidelity of tonal reproduction that renders the finished receiver a musical instrument of the highest calibre.

If you seek the ultimate in radio performance, insist on Thordarson transformers.

THORDARSON ELECTRIC MFG. CO.  
*Transformer Specialists Since 1895*  
Huron, Kingsbury and Larrabee Streets  
CHICAGO, ILL.

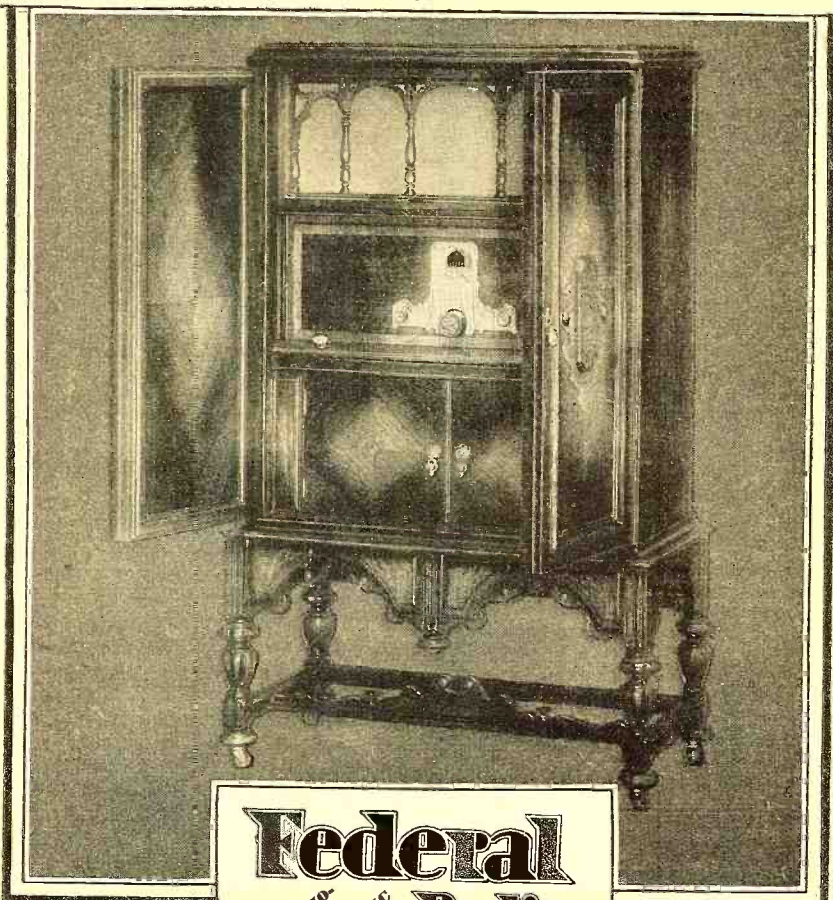

**Federal**  
ORTHO-SONIC  
**Radio**

Thordarson products have been chosen for incorporation in Federal Ortho-Sonic Radio Sets because we have always been certain that we would receive a quality of product entirely in keeping with the high standard set by us for Federal receivers.

*Lester E. Nolle*

President, Federal Radio Corporation

**THORDARSON**  
**RADIO**  
**TRANSFORMERS**

S U P R E M E I N M U S I C A L P E R F O R M A N C E

Please say you saw it in RADIO NEWS

# ELECTRICAL ENGINEERING

BOOKS SENT FREE

New Edition Containing 100 Pages on  
**A-C RADIO!**

**8 FLEXIBLE MAROON VOLUMES**  
4300 pages, 3200 illustrations, deluxe gold stamped binding, index in each book, general index in Vol. 8. Covers every subject in Electricity—Light, Power, Transmission, Generators, Motors, Switchboards, Radio, Telephone House Wiring, Railways, etc.

We're glad to send a set to your home to examine and use as your own for 15 days—to show you that here is the most up-to-date and complete work on Electricity ever published. Written by CROCKER of Columbia U. MILLIKAN of Calif. "Tech." —HARRISON of General Electric and 26 other noted Electrical Engineers. Starts off with elementary Electricity in simple, non-technical language for the beginner and includes every Engineering branch for use of experts on the job.

## Complete Electrical Reading Course

Electricity, the biggest industry in the world, continues to grow the most rapidly. And it offers better jobs, bigger salaries and a brighter future than any other field. Every dollar, every hour invested in learning Electricity will come back to you a thousand-fold. Learn in spare time with these books at one-fifth the cost of trade courses. Outline for organized study, quiz-questions and a year's free consulting membership in the American Technical Society included without extra cost, if you mail coupon immediately.

**Look it up!**  
Thousands of these sets are used as REFERENCE books by men employed in electrical, building construction and allied lines. The JIFFY INDEX puts the answers to 20,000 questions right at your finger tips.

**AMERICAN TECHNICAL SOCIETY**  
Dept. E-425  
Drexel Ave. & 58th St., Chicago



**American Technical Society**  
Dept. E-425 Drexel Ave. & 58th St., Chicago

Please send for 15 days' free trial 8-volume set of Electrical Engineering just off the press, subject to return if I wish to. (I pay the few cents express charges on receipt of books, you will pay express if returned.) If I decide to keep them, I will pay \$2.00 after 15 days trial, then \$3.00 a month until \$34.50, special advertising price, is paid, after which books become my property. Year's Consulting Membership to be included free.

Name.....  
Address.....  
Employed by.....  
Employer's Address.....

## Custom Set Builders

Browning-Drake has an interesting and unusual proposition. Take advantage of the fact that more Browning-Drakes are built than any other.

Write today  
**BROWNING-DRAKE CORP.**  
CAMBRIDGE, MASS.

## SET BUILDERS

**Get this Book** **LATEST RADIO GUIDE** **FREE**

Barwik, the first and oldest radio specialty house, offers you unusual service this year. Bigger stocks, quicker shipments, lower prices. Deal with an old established, reliable house. Get honest goods, honest service, honest prices. Barwik service makes you more money. Send now for big new Catalog showing lowest wholesale prices.

**BARWIK CO.** 24K Canal St., CHICAGO, U. S. A.  
Mail This Coupon Now for Free Radio Guide

Name.....  
Address.....

## Successful Home Television

(Continued from page 923)

readily. Decrease the friction, and the image will rise if the speed is too great, or descend if it is not sufficient; in either case, it will be quickly brought to adjustment.

Mr. Demikis, whose station is at 3128 Warren Avenue, Chicago, gives the following figures for the constants of his apparatus, diagrammed herewith (Fig. 1): Coils for short-wave set, primary 8 turns No. 18, S.C.C.; secondary 40 meters, 6 turns No. 18, 80 meters 13 turns, broadcast range 70 turns No. 24 S.C.C.; tickler 6 to 10 turns

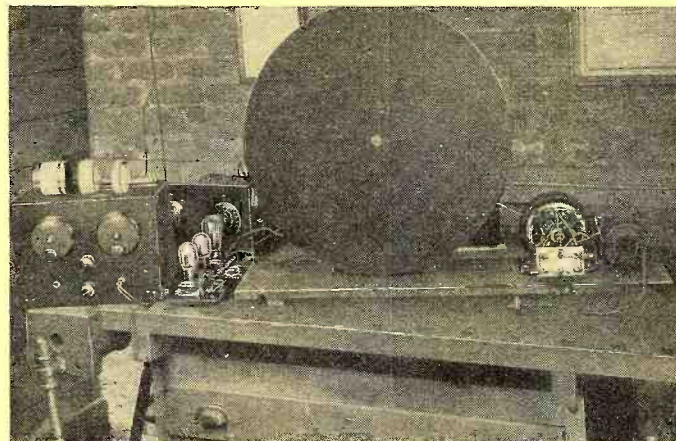

A glimpse at Mr. Demikis' television assembled for operation. The constructional data are given in the text.

No. 24 S.C.C.; grid leak, 3-megohm; grid condenser .00025-inf.; variables, C 170-mmf., C1 300-mmf.; choke coil RFC, 150 turns No. 28 D.C.C. on a one-inch tube; C2, .001-mf.; C3, .01-mf.; R, 0.1-meg.; R1, 1-meg.; R2, 0.5-meg.; R3, 0.25-meg. In sketch, I is an idle motor used as a bearing, D the driving motor of the disc, and R the reversing switch.

The reactance coil used, whose dimensions are given, is wound with No. 13 S.C.C. wire.

### TELEVISION SCHEDULES

RADIO NEWS will be glad to hear from other experimenters who have had good results with picking up television signals, and who have found changes or adjustments in the apparatus effective. While

The connections of the regulating mechanism. A plunger iron, by increasing the reactance of the coil, slows the motor accordingly.

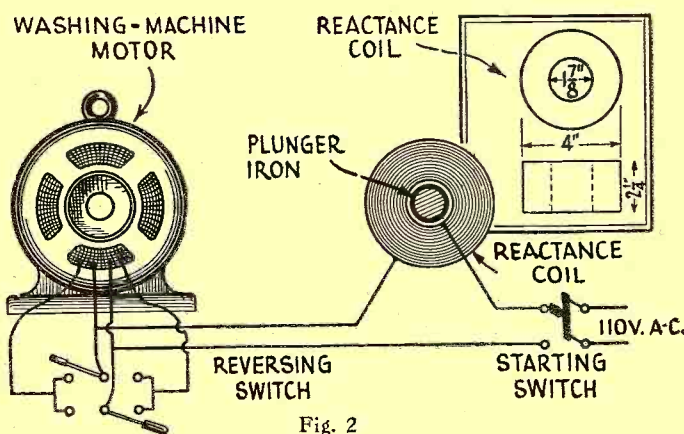

Fig. 2

there has been some delay in the progress of television broadcasting on the longer waves, because of the restrictions placed on this work by the rulings of the Radio Commission, it is still continuing on short waves. Some of the more or less regular schedules reported are:

W1XAY, Lexington, Mass., 62 meters (just below KDKA); "standard" scanning—48 lines, 15 frames a second—3 to 4 p. m. and 7:30 to 8 p. m., E.S.T. Power 300 watts.

W8XAV (KDKA) 62.5 meters, 60-line, 20 frame; largely motion-picture work. 5:10

to 6 p. m., E.S.T., Mondays, Wednesdays and Fridays. Power, 2 kilowatts.

W3XK, Washington, D. C., 187 meters and 47 meters, standard; 8 to 9 p. m., E.S.T., Monday, Wednesday and Friday. Radio movies only. Power, 250 watts, with a 5-kilowatt transmitter authorized.

W2XAD (WGY), Schenectady, N. Y., has been conducting tests on a special 19.56-meter wavelength, considerably shorter than its former wave, on Tuesdays, Wednesdays and Fridays from 1:30 to 2 p. m., E.S.T. and from 11:45 to 12:15 p. m. on Sundays. W2XAF, on 31.48 meters, operates on Tuesdays from 12 to 12:30 p. m. These are 24-line, 20-frame pictures.

Other stations are under construction, or awaiting a final assignment of frequency and hours, like WRNY-W2XAL and WCFL-W9XAA. In these cases the short-wave transmissions had been made simultaneously with those on the broadcast band. By the time that this issue reaches the

reader, it is probable that greater activity will be under way in television broadcasting.

The Radio Corporation of America has been authorized to operate at New York a 5-kilowatt transmitter on 20 meters, under the call W2XBW. The short-wave transmitter W4XA of station WREC, Memphis, is on 122.5 meters; that of W6XC, Los Angeles, on 66 meters. (As television channels for short-wave work run up to 100 kilocycles, they are much wider than speech transmission in their tuning.)

Experimental visual broadcast channels between 130.36 and 149.76, and between 101.63 and 109.03 meters have also been indicated by the Commission; and for the amateurs, the lower part of the uppermost band (150-175 meters) and the 5.00-5.35-meter range. The latter, however, is highly experimental for even the most advanced amateurs.

### TELEVISION ON A RURAL ROUTE

Another experimenter who has been receiving the "radio-movie" transmissions over



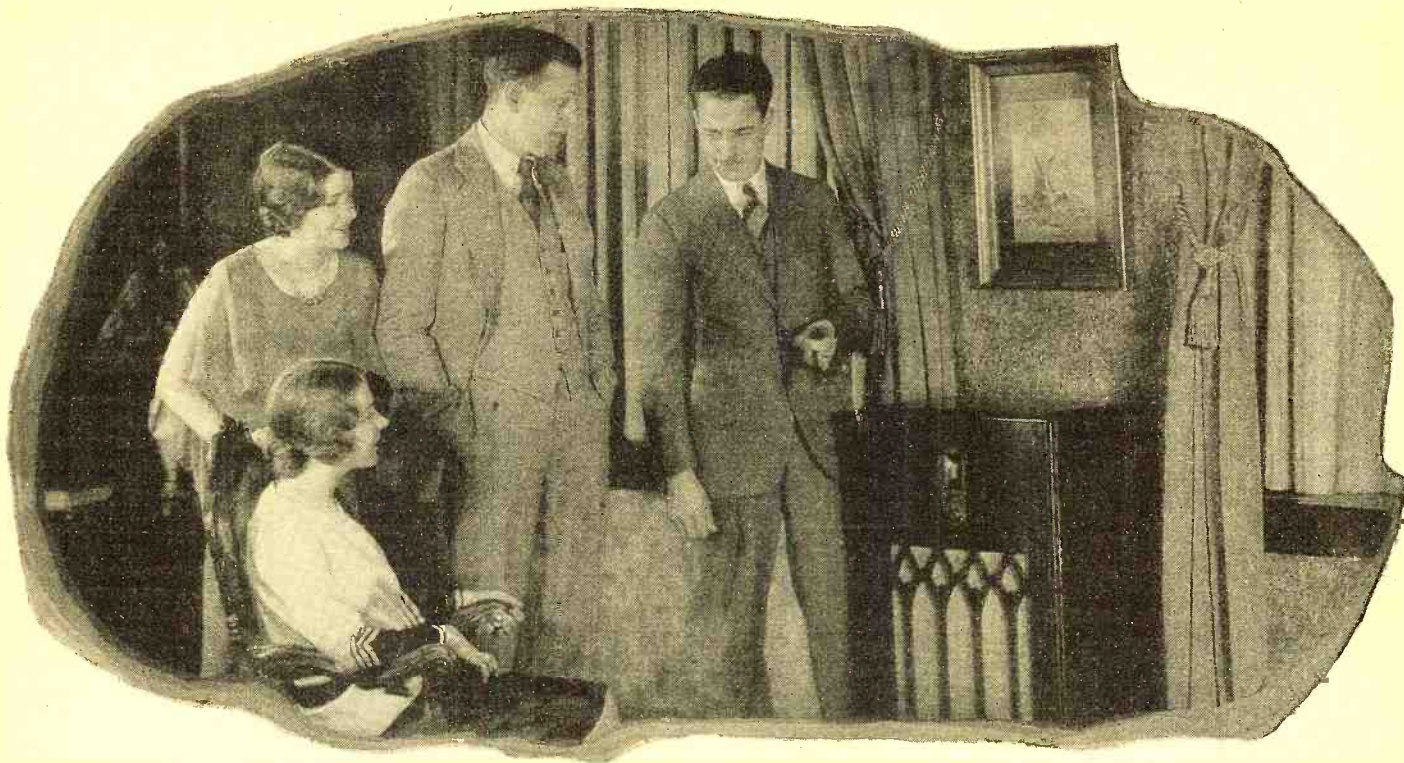

# They Could Hardly Believe Their Own Ears - when I Switched to *Ground Wave Reception*

"IT'S no use trying to listen in to-night," said Bill as I took his hat. "Jane and I tried to get reception during dinner but all we got was static. It's usually this way—just the night they broadcast Paul Whitman's band or some other good program it's spoiled by howls and fading. Why own a radio at all?" he ended up disgustedly.

"Perhaps my set will do a little better," I suggested. I had a surprise in store for him!

"He looked doubtful as I turned on the set switch. I had left my old aerial antenna attached on purpose and soon the room was filled with an ear-splitting excuse for music. Manipulation of the dials only served to make it worse or to choke down reception until it was hardly audible. Occasionally it faded out altogether and I could picture the roof aerial swaying helplessly in the strong wind. Then the jumble and howls would start up again until my wife finally shouted above the din, "Turn that thing off—it's terrible!"

"Satisfied, I laughed and disconnecting the old aerial and ground wires, I then attached the lead-in wires of my new underground antenna, which I had installed just before dinner. "Now listen!" I commanded.

## The Thrilling Test

"As though by magic, the sweet high notes of

violins, the stirring sobbing of saxophones, the clear pure notes of a clarinet brought Bill to his feet! Jane looked dumbfounded. Even my wife, who had not paid much attention to my preliminary tests, was amazed. "What did you do to it?" she demanded. "I think he bewitched it," Jane accused. The music went on, clear and strong, with only a long moan or slight jumble now and then to remind us of the storm raging outside. The static was so greatly reduced that we hardly noticed it. The important thing was—we were getting one of the year's best programs with scarcely any trouble on a wild, stormy night.

"You see," I explained later to Bill,

"I buried my new underground aerial about two feet below the ground, where wind and storms can't affect it so easily. It has certainly been proved tonight that radio waves are just as strong in the ground as they are in the air. They call this thing "Subwave-Aerial" and it's insulated some way to keep out interference and noise. It's combined with a scientific ground so I'm sure now that I have the correct ground connection. And all this isn't costing me any more than my old aerial antenna that I've nearly broken my neck repairing after wind storms like this. And last but not least," I finished triumphantly. "I'll never need to touch it again. It's guaranteed for 25 years."

"Hardly necessary to say that Bill went home with the name and address of the Subwave-Aerial manufacturers in his pocket."

## Test It Yourself—Free!

The above story illustrates the results for which the designers of the Subwave Aerial struggled for months. At last, enthusiastic reports such as this from Radio Experts reproduced here, proved that they had succeeded. Now you have a chance to prove the merits of this great new radio development for yourself. Try, if possible, to pick a night when static is bad and make the thrilling test. It's fun! And if you are not more than pleased with Subwave-Aerial, the test won't cost you a cent. We feel safe in saying, however, that once you've heard the amazing difference in reception and realize the wonderful convenience of this modern combined antenna and ground, you'll wonder how you ever put up with the old-fashioned, dangerous, inefficient methods. Be sure to send at once for all the interesting details on the development of Subwave-Aerial. It's the newest, most thrilling thing in the romantic world of radio! Use the coupon below. Fill it in and mail it NOW!

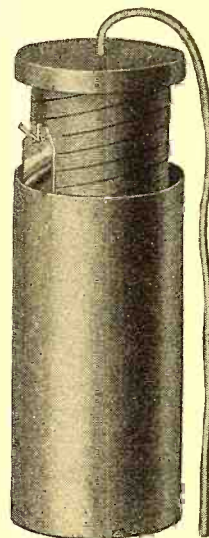

### SUBWAVE-AERIAL GETS DX INSTALLED FEET FROM 60,000 VOLT POWER LINE

Underground Aerial Products, Suite 618, St. Clair Bldg., St. Clair and Erie Sts., Chicago, Ill.  
Gentlemen: Regarding a test with your underground aerial, "Subwave-Aerial." On January 27, 1929, Mr. Frank Smith and I drove out near the Sanitary District power plant in a Ford Sedan. We stopped about 50 feet distant from the plant's 60,000 volt transmission line and dug a small hole, into which we dropped the Subwave-Aerial. We left the two sets we came in with us in the sedan, attaching the lead-in wires of the Subwave-Aerial first to one, then the other. One set was a 5-tube Freshman—the other a single dial Atwater-Kent, Model 35. We used the Ford battery. At 15 minutes to six we got WCCO, St. Paul, Minnesota. It came in loud and clear at 27 on the dial. There was not the slightest interference from the 60,000 volt power transmission line only 50 feet away. At 20 minutes after six, we got Toronto, first on one set and then the other. We plainly heard the program, which was being sponsored by a Spartan Radio dealer. It was impossible to get reception at all with an overhead aerial under the same conditions.

Yours truly,  
F. Bennett Smith,  
Harry R. Jackson.

### UNDERGROUND AERIAL PRODUCTS

Suite 618, St. Clair Bldg., Dept. 827-E.W., St. Clair & Erie Sts., Chicago, Ill.

UNDERGROUND AERIAL PRODUCTS, Suite 618, St. Clair Bldg., Dept. 827-E.W., St. Clair & Erie Sts., Chicago, Ill.

Rush illustrated literature on the new Subwave-Aerial and details of your Free Test Offer.

Name.....  
Address.....  
City..... State.....

Please say you saw it in RADIO NEWS

**RUSH-ABSOLUTELY FREE!**  
 THIS E-F ANGLE SCREWDRIVER—of tempered crucible Spring steel—has 7 powerful edges for large & small screws. Works under obstructions where other won't—D. other uses. Carries like pen-knife—often more valuable. Sent Free on Receipt of Coupon.

Name \_\_\_\_\_  
 Route No., St. \_\_\_\_\_  
 P. O. \_\_\_\_\_  
 City, St. \_\_\_\_\_

Interested in Factory Representative Proposition!  
 In User Literature!

**THE FLASH SALES CORP**  
 DEE-4809 N. Ashland Ave., CHICAGO, ILL.

**CLIP HERE—MAIL TO—**

Also FREE ON COUPON—the "\$5,000" CIRCULAR giving amazing 125-Picture story of **The "Pocket Machine Shop!"**

with its 1-TON POWER-GEAR It Outgrips a 40-Lb. Vise!



The 'hand-grip' of a tiny Rubber band holds the Hardest-to-Hold thing Known against a 300-Pound Pull!  
 Its 10-to-1 ratio Power-Gear-Transmission gives YOUR hands the 1-TON GRIP of 20 Hands—yet—YOU CAN GRIP A HAIR.



**An Automatic Lock-Grip Ratchet Wrench**  
 Speed VISE Parallel PLIERS Plus

No. 3—for all Wire, chain, spring-making, fence work, etc.  
 No. 2—for all Pipe work, "chewed" nuts in tight places, etc.  
 No. 1, Universal—for ALL Pliers, Nut Wrench, Vise and Clamp, Spring-making Work, etc.

**EIFEL-FLASH PIERRENCH KIT**  
 (Say "Eye-fel-Flash") "The T.N.T. of Tools"  
 You get the amazingly Quicker, Better, Easier, Universal Tool service of Nos. 1, 2 & 3—Convertible in 1/5 second—in this new 24-Ounce Master Tool Kit—for the Price of One Good Tool; yet it Does the Work of the best other tools Weighing 60 pounds and Costing \$50.00!  
 Hundreds of Thousands of Men and Women are using these wonder Kits to make Homes and Estates more comfortable—Farms, Shops, etc., more profitable; to get more and better service from Auto's and all mechanical devices with a huge saving in money, time and energy!  
 Used by the U. S. Army and Navy. Just try a Pierrench Kit Once, and you'd no more go back to other tools than to the ancient Ox-cart!  
 With each Kit a 64-page Manual of Mechanics (A GUARANTEED) SUPER-QUALITY PRODUCT (© 29 J.E.)

Also Big Spring and Summer Money Maker for Pierrench Factory Representatives—Full or Part Time. Amazing Demonstrations—sell at sight—make \$75-\$200 weekly all year 'round, seasonal Demand Doubles Profits. A Ga. Repr. made \$97 in 20-Min. Group Sale; a Mich. Repr. \$368 in 12 days; another \$379 in 5 days. Everybody wants the Kit!

Mail Valuable Coupon Above NOW!

**RADIO OPERATORS WANTED**

Radio operators are officers aboard ships. Well paid, pleasant work, travel. You can qualify in a short time in our well equipped school under expert instructors.

Write now for free booklet on "Opportunities in Radio."

West Side Y. M. C. A.  
 Radio Institute  
 319 West 57th St., New York, N. Y.

**Everything in Radio at Wholesale**

We supply every radio need from our mammoth stock of kits, parts and sets of latest design. Lowest wholesale prices. Expert attention; immediate service. Write for big, illustrated Catalog "B-6."

**Allied Radio CORPORATION**  
 711 W. LAKE STREET, CHICAGO

a considerable distance is Bernard Bierhals, of Fond du Lac, Wisconsin, which is nearly 700 miles airline from Washington. He writes: "I have been receiving these for the past several weeks, and have received some good images, though I have been bothered a lot with fading. On January 11

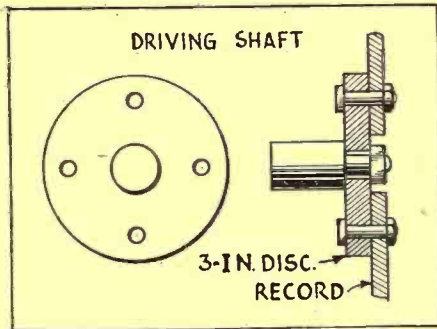

Fig. 3  
 The taking up of screws on one side or the other corrects warping of a record disc.

I was able to see the movements of the little girl with the ball very plainly for about ten minutes.

"I am using a detector and five stages of resistance coupling; the scanning disc is a 12-inch phonograph record drilled with 48 apertures, 1/32-inch. Several images appear at the same time, but I am able to maintain better synchronization. I use a 6-volt auto-horn motor, which drives the disc nicely, because I have no electric light.

"As all discs wobble, I mount my disc by the following method, which may be of interest to other experimenters; a 3-inch disc is cut from a piece of hard rubber. A hole is drilled in the center and four around the edge; the record is then drilled to match. Four 6/32 screws are run through disc and

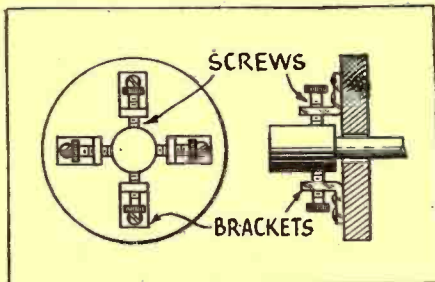

Fig. 4  
 The screw method indicated is to center the phonograph record used as the scanning disc.

record, and by adjusting them the record may be made to run very smoothly. In case there is a slight eccentricity, brackets may be mounted as shown (Fig. 2) and by adjusting these it may be removed." (NOTE: The high speed of revolution of a television disc renders it highly desirable to know that its fastenings are strong enough to withstand any strain which may be put upon them, even though the disc be of light material.—EDITOR.)

**A RADIO MYSTERY**

For four years or so, we have been experimenting with a device to improve radio reception. Our innumerable tests show, yes prove, that our device has real merit—that it "sweetens" music and the speaking voice, that it stops much, if not all, of the ordinary static—that it increases selectivity—that it sharpens DX reception very perceptibly.

**But we are not satisfied**

However conclusive our own tests seem, we are not satisfied. We want to find out what happens when you try our device—we want to know how much you can better your radio performance. For want of a call our device perhaps "Super bettername, we a "static filter" tone" more accurately describes its performance. Anyway the price is only \$2.25—a very nominal price, if even a small part of your static interference and noise is eliminated. And you run no risk—for we positively guarantee our "Supertone" device to pass your tests, or we refund your money in full.

Unusually explicit directions accompany every "Filter", and it is easy to install and adjust. Send your \$2.25 today. We will greatly value your judgment.

**WIRT COMPANY**

Makers of Dim-a-lite and AC Voltage Regulators  
 5221 Greene St. Philadelphia, Pa.

**M&H**  
 Radio's largest kit supply house  
 ESTABLISHED 30 YEARS

**We Have Complete Kits FOR ALL CIRCUITS**  
 Now appearing or which have appeared in "Radio News" and other publications.

Dealers and professionals Set Builders, write for our

**NEW WHOLESALE CATALOG**

**Hi-Q 29 Kits in Stock**

**Silver Marshall Kits**

**National and Aero Short Wave Kits**  
 Convert your present set to the low-wave bands.

**Amertran Power Equipment**

Write for **FREE BLUE PRINT** for the new 250 push-pull power amplifier.

M. & H. Sporting Goods Co.  
 512 Market St., Phila., Pa.

Travel on  
**"Uncle Sam's" Payroll RAILWAY POSTAL CLERKS MAIL CARRIERS**  
 \$1700 to \$3000 Year  
 Many U. S. Government Jobs Obtainable  
**MEN—WOMEN, 17 UP SHOULD MAIL COUPON IMMEDIATELY**  
 Steady Work No Layoffs Paid Vacations

COUPON

FRANKLIN INSTITUTE  
 Dept. P182, Rochester, N. Y.

Sirs: Rush to me, WITHOUT CHARGE, FREE 32-page book with list of U. S. Government positions open to men and women, and full particulars telling how to get them.

Name.....  
 Address.....

Please say you saw it in RADIO NEWS

# WHOLESALE PRICES

for Dealers, Community Set Builders, General Repairmen and Agents!

NEW ISSUE!  
JUST OFF THE PRESS!

Our new, HUGE 260 PAGE WHOLESALE CATALOG No. 19 enjoys the enviable distinction of being universally accepted by the RADIO TRADE in the same manner that a school treasures the Dictionary and Encyclopedia Britannica—or the home the Bible and Almanac!!

The preparation and distribution of this MAMMOTH Catalog COSTS A TREMENDOUS SUM—the huge volume of business derived from it warrants this cost as well as the genuine pleasure it gives us to know that those “in the know” regard our catalog AS THE OFFICIAL ORGAN OF THE 1929 RADIO SEASON!!!

This FREE CATALOG is literally a most valuable ENCYCLOPEDIA—YOU cannot well afford to be without one—and, you do not have to. Your request for one is all that is needed! A day or two later, it is in your possession. Surely, a TEST OF OUR PROMPTNESS PLEDGE!

And we are right on the job, ready to supply television apparatus, too!  
We list more such parts than appear in any other Radio Catalog.

Those having No. 18 Catalog should immediately send for No. 19. ALL PRICES HAVE BEEN REDUCED TREMENDOUSLY!

We can supply any parts and kits described in this issue.

Send for prices at once!

BIG PRICE CUTS

New 75 HOOKUPS  
1500 ILLUSTRATIONS



THIS 260 PAGE RADIO CATALOGUE FREE

## BUY from Radio's Oldest Mail Order House!

In these many years we have been in the Radio Mail Order Business, we have learned from EXPERIENCE how such an organization must be efficiently run in order to GAIN AND RETAIN THE GOOD WILL OF OUR CUSTOMERS. In this, our DETERMINED GOAL, RADIO SPECIALTY COMPANY OFFERS TO SHIP ALL ORDERS IN FROM 6 TO 24 HOURS—OFFERS YOU 100% QUALITY MERCHANDISE ON A STRICT MONEY-BACK BASIS IF NOT THOROUGHLY SATISFIED—AND OFFERS YOU ALL MERCHANDISE AT ABSOLUTE ROCK BOTTOM NET PRICES! Our employees—our executives, are all pledged to handle your every order and inquiry in an intelligent manner. Our 24-HOUR SHIPMENT SCHEDULE MUST BE UNSERVEDLY MAINTAINED! And to this pledge, we owe our daily increasing patronage. It will pay YOU to be numbered among our many thousands of customers! A trial is all we ask!

### "RASCO" has it

And, if we do not list in our catalog your Radio requirements, WE WILL OBTAIN SUCH PARTS, BILLING YOU AT THE USUAL TRADE DISCOUNTS!

OUR CATALOGUE CONTAINS THE LARGEST ASSORTMENT OF RADIO MERCHANDISE IN THE COUNTRY. Only the most successful manufacturers' products are listed—such lines as PILOT—SILVER—MARSHALL—CARTER—AERO—YAXLEY—TOBE—HAMMARLUND—AMERICAN—CUNNINGHAM—DONGAN—THORNTON—MUTER, etc., etc. THE LATEST IMPROVEMENTS IN RADIO ARE LISTED AND THOROUGHLY DESCRIBED IN THIS GREAT CATALOG: A.C. ALL ELECTRIC Sets with self-contained ABC power supply—Public Address Amplifier systems—A.C. Set Converters—A and B eliminators—Dynamic Speakers and Units—Magnetic Speaker Chasses—250 Tube Amplifiers—Airplane Cloth Speakers—Push-Pull Power Amplifiers—Electric Phonograph Turn-Tables—Combination Radio and Electric Phonograph Consoles—Speaker Tables—Short Wave Sets and Adapters—Shield Grid Tube Kits—Television Parts. LOGICALLY, HOW CAN YOU AFFORD TO BE WITHOUT OUR CATALOG—SEND FOR ONE NOW!



# Radio Specialty Co.



98W PARK PLACE, NEW YORK

Please say you saw it in RADIO NEWS

# Enjoy LOUD SPEAKER OPERATION from a CRYSTAL

**NO "TUBES" - NO "B" BATTERIES - NO COSTLY "ELIMINATORS" WITH THE SKINDERVIKEN TRANSMITTER UNIT**

Simple microphone unit provides a most effective and inexpensive way to satisfactory speaker operation. Easy to build and operate circuit.

Everybody can do this now with a Skinderviken Transmitter Unit. The unit is fastened to the diaphragm of the speaker unit. It will act as a "microphonic relay." Every time an incoming signal actuates the diaphragm, the electrical resistance of the microphone unit will be varied correspondingly and the current from the battery, in series with it and the loud speaker, will fluctuate accordingly.

Thus the problem of securing sufficient power to actuate the loud speaker is simply and adequately solved.

The results from this very novel and simple unit will astound you.

The expense of this hook-up is trifling compared to the elaborate tube circuits that give no greater actuation of the speaker.

Besides this there are many other valuable uses in Radio Circuits for this marvelous little unit. Every builder of Radio sets should have a few on hand.

**LISTENING THROUGH WALLS**  
This Unit makes a highly sensitive detectaphone, the real thing—you listen through walls with ease. Plenty of fun and real detective work too.

**CONDUCTING SOUND THROUGH WATER**  
Make yourself a miniature submarine signaling apparatus like those used during the war. Simple circuit with this microphone unit gives splendid results.

**12-PAGE INSTRUCTION BOOKLET** containing suggestions and diagrams for innumerable uses, furnished with each unit.

**P. G. MICROPHONE TRANSFORMER**

A Modulation Transformer specially designed for use with the Skinderviken Transmitter Unit. Has many other uses. Primary resistance, 1/2 ohm; secondary, 55 ohms. **\$2**

**FOR SALE AT LEADING DEALERS**  
Or Order Direct, Using Coupon Below  
**SEND NO MONEY**

When the postman delivers your order you pay him for whatever you have ordered, plus a few cents postage.

**PHRES GUILD, INC.** R.N.-4-29  
16-18-R—East 30th St., New York, N. Y.

Please mail me at once as many of the following items as I have indicated.  
...Skinderviken Transmitter Units at 95c. for 1; \$1.75 for 2; \$2.50 for 3; \$3.20 for 4.  
...P. G. Microphone Transformers at \$2.  
When delivered I will pay the postman the cost of the items specified plus postage.

Name.....  
Address.....  
City..... State.....

**Movie Radio Messages**

(Continued from page 908)

Storage batteries are used throughout for all receivers, the former being cared for by means of a "charge-discharge" cabinet in which all batteries are contained; suitable charge-discharge switches are mounted on the doors of the cabinet.

A remarkable feature of the traffic now being carried on with the Byrd expedition is found in the "duplex" transmission and reception being accomplished by both sides. In order to meet the extremely heavy traffic of transmitting press dispatches, which often total 3,000 and 4,000 words during the course of an evening, Byrd's operators have found it more convenient to employ two transmitters, operating simultaneously and each handling its share of the traffic.

To co-operate with this emergency measure the *Times'* radio staff has installed a "remote-control" receiver, located in Mr. Meinholtz' home, about twenty-five miles from Times Square. In this manner, the latter receiver and the set in the station are engaged in copying simultaneous transmissions from the Antarctic; thus cutting the time required in half.

**What's New in Radio**

(Continued from page 913)

The characteristics of the new tubes, which may be preserved for reference with previous tables, are:

	A.S. Screen-Grid Tube	Intermediate Power Tube
Filament volts (A.C.)	2.25-2.5	2.5 2.5
Control-grid volts	1.5	.....
Screen-grid volts	.75	.....
Plate volts	180	180 250
Bias volts	.....	33 50
Amplification	420	3.5 3.5
Plate resistance, ohms	400,000	6,000 6,000
Mutual conductance	1,050	1,800 1,850
Plate current, milliamps	4	26 32
Output impedance, ohms	.....	1,950 1,900
Max. undisturbed output, milliwatts	.....	750 1,600

Manufacturer: *Radio Corporation of America, New York City.*

**40 Non-Technical Radio Articles**

every month for the beginner, the layman and those who like radio from the non-technical side.

**SCIENCE AND INVENTION**, which can be bought at any newsstand, contains the largest and most interesting section of radio articles of any non-radio magazine in existence.

Plenty of "How to Make It" radio articles and plenty of simplified hook-ups for the layman and experimenter. The radio section of **SCIENCE AND INVENTION** is so good that many **RADIO NEWS** readers buy it solely for this feature.

Radio Articles Appearing in April  
**SCIENCE AND INVENTION Magazine**

- NEW RADIO PICTURE SYSTEM
- DYNAMIC SPEAKERS—  
By Paul L. Welker
- NEW RADIO DEVICES
- RADIO ORACLE
- LATEST PATENTS



**False Economy Is Costly**

Nothing is likely to prove as costly as a cheaply made, over-rated condenser or resistor.

Whether you are a manufacturer, professional set builder or experimenter, you cannot afford the high cost of a cheap condenser or resistor.

Aerovox condensers and resistors are conservatively rated and thoroughly tested. They are not the most expensive, nor the cheapest but they are the best that can be had at any price.

A COMPLETE CATALOG with illustrations and detailed descriptions may be obtained free of charge on request.



The Aerovox Research Worker is a monthly publication that will keep you abreast of the latest radio developments. Your name will be put on the mailing list free of charge on request.



**100% VOLTAGE CONTROL PLUS 5 EXCLUSIVE FEATURES**

1. Double Socket Outlet for A.C. Set and Dynamic Speaker or for A and B Eliminators.
2. Antenna and ground connections.
3. Line Switch.
4. Fuse protection of entire set.
5. Perfect Link between your Set and light socket.

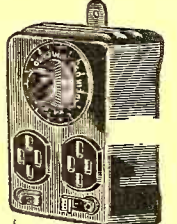

**X-L LINK**  
Eliminates all irregularity in line voltage—the bane of A.C. reception. With the X-L Link your tubes last full life and give maximum service because they are protected from the destructive effect of high voltage fluctuations which weaken or burn out the filament. Reception is smooth and clear without strain or distortion.

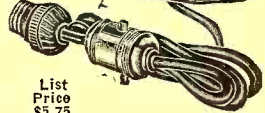

No complicated connections—one wire operates everything including ground and antenna. Perfect, unailing control of line voltage surges that gives you full reception value. Install an X-L Link and note the difference in tube performance. At your dealer or postpaid on receipt of price. Write for FREE folder.  
Also Manufacturers of X-L Variodensers and Push-Pests.



**WRITE TODAY**

Send for large, new illustrated Catalog "B-6," showing the latest of everything in radio at wholesale prices.



Please say you saw it in RADIO NEWS

An  
**EXTRA**  
**\$12.50**  
 a week  
 as a  
**starter!**

Rockville, Conn.

Chemical Institute of New York, Inc.,  
 66 West Broadway,  
 New York, N. Y.

Gentlemen:

You will probably be pleased to learn one of the lessons gave me an idea to turn my chemical knowledge to profitable account. I am now making a varnish and paint which undersells the other type products by \$2.60 a gallon, in some cases more. Have been receiving gallon orders from painters during past week which has netted me a profit of \$12.50 for my "spare-time chemical industry. Many thanks for your training thus far.

Yours very truly,

*James J. Kelly*

## Chemistry Student turns Knowledge into big Sparetime Profits!

Because he knew how to prepare his product from a knowledge of chemistry, J. J. Kelly produced a highly profitable article far below the price of organized competition. Sales came easy—because competition was overcome. Chemistry solved his problem.

### Boundless Sparetime profit opportunities from Chemical Formulas—for those who grasp them

Chemical Formulas are the basis of, not one, but *thousands* of big profit sparetime businesses, such as selling soaps, cleaning and polishing compounds, paints, acids, inks, cements, extracts, glues, gold, silver, and bronze lacquerings, oils, perfumery, rust removers, etc.

With a knowledge of chemistry you can beat J. J. Kelly's record by many dollars a week. You need not be dependent on wholesale or retail companies to supply your finished products for sale.

You can make up your own products at home and sell cheaper than any competitor. That means quick sales in large quantities.

#### YOU CAN BE A TRAINED CHEMIST Through Our Home Study Course

To qualify for this remarkable calling requires careful specialized training. For-

merly it was necessary to attend a university for several years to acquire that training, but thanks to our highly perfected and thorough system of instruction, you can now stay at home, and let us educate you in Chemistry during your spare time. Even with only common schooling you can take our course and equip yourself for immediate practical work. Dr. Sloane gives every one of his students the same careful, personal supervision that made him celebrated throughout his long career as a college professor. Your instruction from the very beginning is made interesting and practical, and we supply you with apparatus and chemicals for performing the fascinating analyses and experimental work that plays such a large part in our method of teaching, and you are awarded the Institute's diploma after you have satisfactorily completed the course.



**T. O'CONOR SLOANE**  
 A.B., A.M., LL.D., Ph.D.

Noted Instructor, Lecturer, and Author. Formerly Treasurer American Chemical Society and a practical chemist with many well-known achievements to his credit. Not only has Dr. Sloane taught chemistry for years, but he was for many years engaged in commercial chemistry work.

#### EASY MONTHLY PAYMENTS

You don't have to have even the small price of the course to start. You can pay for it in small monthly amounts—so small that you won't feel them. The cost of the course is very low, and includes everything, even the chemistry outfit—there are no extras to buy with our course. Our plan of monthly payments places a chemical education within the reach of everyone.

#### EXPERIMENTAL EQUIPMENT FURNISHED TO EVERY STUDENT

We give to every student without additional charge his chemical equipment, including fifty-two pieces of laboratory apparatus and supplies, and fifty-two different chemicals and reagents. These comprise the apparatus and chemicals used for the experimental work of the course. The fitted heavy wooden box serves not only as a case for the outfit but also as a useful laboratory accessory for performing countless experiments.

Don't Wait—Mail Coupon Now!

**CHEMICAL INSTITUTE OF NEW YORK, Inc.**  
 16-18-R—East 30th Street                      NEW YORK, N. Y.

#### MAIL THE COUPON FOR FREE BOOK

Clip the coupon below and mail it at once. Your name and address on the coupon will bring you by return mail our interesting free book, "OPPORTUNITIES FOR CHEMISTS," and full particulars about the course and what it will do for you.

**CHEMICAL INSTITUTE OF NEW YORK, Inc.**      RN-4-29  
 Home Extension, Division 4, 16-18-R—East 30th St.  
 New York, N. Y.

Please send me at once, without any obligation on my part, your free Book, *Opportunities for Chemists*, and full particulars about the Experimental Equipment given to every student. Also please tell me about your plan of payment.

Name.....  
 Address.....  
 City..... State.....

## A Voltage Regulator for Three Dollars!

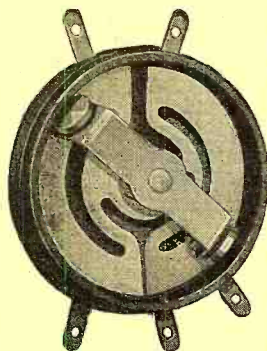

LIST PRICE  
**\$3.00**

The problem of line voltage control is very important but not at all difficult nor expensive to solve.

A Centrallab Radio Control Box will adjust the line voltage to adapt it to any set. It

is easily attached by simply plugging the set into the Control Box and the Control Box into the wall. Then a simple adjustment and your set is permanently protected from the danger of excessive voltage caused by line fluctuations.

Send for interesting Booklet—*"Volume and Voltage Controls—Their Use."*

Central Radio Laboratories

**Centralab**

20 Keefe Avenue

Milwaukee, Wis.

## NEW! 90 Volt Power Unit

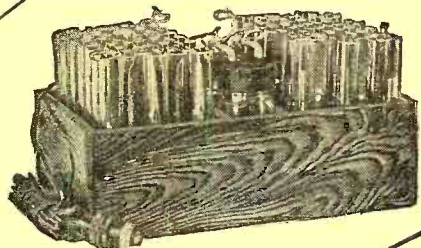

Positively Eliminates Hums, Line Noises, etc. **\$12.75**  
Greater Volume and Clarity Guaranteed

Non-acid and noiseless. All detector and intermediate voltages plainly marked. Simpler to hook up than dry cells. Operates 1 to 12 tubes. If not thoroughly satisfied return after using 30 days for complete refund. Guaranteed further 2 years. For 110-120 volts A.C. 25 to 60 cycle current, 90 volts, \$12.75; 112½, \$15.25; 135, \$17.50; 157½, \$19.50; 180, \$24.00; 202½, \$26.00. Also built for D.C. current 110 and 32 volts at only \$3.00 additional, any size above. Ample stocks—same day shipments. Simply say—ship C.O.D. or write for my interesting literature, testimonials, etc.

**B. HAWLEY SMITH**  
350 Washington Ave., Danbury, Conn., U.S.A.

### Send for WESTERN RADIO New 1929 Catalog

LATEST and FINEST nationally known A.C. sets, consoles, cabinets, speakers and accessories at LOWEST PRICES. Catalog sent FREE on request.

WESTERN RADIO MFG. CO.  
128 W. Lake Street, Dept. RN-4, Chicago

## The "Space-Charge Autodyne"

(Continued from page 932)

After the proper precautions have been observed, the shield is taken apart and the proper components are mounted on the bottom section; the matter of exactness in drilling hardly need be mentioned, after the illustrations have been seen. So close are the components mounted in relation to one another, that it is obvious the design of the set shown here will not tolerate an error in mounting any instrument.

While it is true that the possibility of grounding the terminals of the various components is constantly before the constructor during the course of assembly, there are actually only two cases where special care must be taken; these in mounting the amperites, R5 and R6. One of the mounting details is shown in Fig. 4 and illustrates a simple but efficient method of avoiding short-circuits to the shield; simply elevate the mountings on three or four metal or fiber washers. Still another method is to place a strip of cardboard under the mounting.

In the same compartment with the amperites are the audio-frequency transformer T1, which is a rather small component having a 6:1 ratio, and the resistance coupling

BASE PLATE OF ALUMINUM SHIELD BOX.

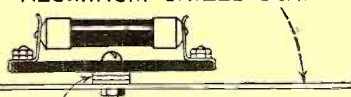

SPACERS (METAL OR CARDBOARD)  
- SHOWS HOW TO MOUNT RESISTORS R5 & R6 -

Fig. 4

The metal end pieces must be kept from contact with the shield, to avoid a short-circuit of the "A" battery.

unit comprising the .01-mf. fixed condenser C7 and two resistors, R3 with value anywhere between 50,000 to 250,000 ohms, and R4 with a value up to one megohm. The latter two constants are to be found by experimentation and the best resistance, when determined, is adopted. The radio-frequency choke coil RFC is a manufactured product with inductance of 1½ millihenries, and is convenient for this particular type of layout because its bakelite casing prevents any danger of shorts to the shield. The sockets, of course, require no special mounting instructions, nor do the phone-tip jacks, J-J; in the former the solid bakelite form offers no difficulty, while in the latter fiber washers are supplied by the manufacturer for mounting these components on conductive surfaces.

### ANTENNA REGULATION

The antenna coupling condenser C1 may be constructed by the builder in any form he desires; such a capacity-introducing device has been described so often that it has become something of a pastime to devise new methods of assembling these gadgets. Some builders employ coins, such as pennies, dimes or nickels, separated by the space of a fraction of an inch, which is adjustable; others construct more pretentious affairs weighed down with adjusting screws and what not, offering very fine adjustment.

All in all, the antenna coupling capacity is obtained by nothing more than two small pieces of metal forming a condenser; such

# Learn ALL ABOUT AVIATION

EVERYBODY'S AVIATION GUIDE is a complete discourse on practical aviation, by MAJOR VICTOR W. PAGE, one of the leading men in the field. Unlike most books of instruction, EVERYBODY'S AVIATION GUIDE is written in a unique question and answer fashion, which makes the subject far easier to study and a great deal more attractive as an instruction course.

This book was recently published and is absolutely up-to-date in every way. It has had very favorable criticism throughout country-wide aviation circles and has been highly recommended by all those in a position to pass judgment.

We list here the contents in order that you may see for yourself how completely the field of Aviation is covered.

### Contents:

- Early Aeronautic History—First Flying Machines—The Atmosphere
- Forms of Aircraft—Airplanes and Airships
- Lighter-Than-Air Craft—Balloons and Dirigibles
- How An Airplane Flies—Elementary Aerodynamics
- Airplane Parts and Their Functions
- Fuselage Forms and Landing Gears
- Wing Arrangement and Construction
- Power Requirements, Engine Types and Engine Location
- Aircraft Propellers, Design and Application
- Airplane Equilibrium and Control
- Official World and American Air Records

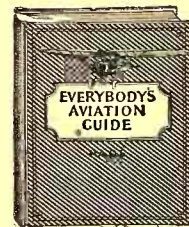

Price **\$2.00**

Over 248 pages  
Beautiful red cloth binding—Title in gold  
Replete with illustrations

WRITE DIRECT TO

**CONSRAD CO., Inc.**

230 Fifth Ave. New York, N. Y.

CONSRAD COMPANY, Inc.  
230 Fifth Ave., New York, N. Y.

Gentlemen: Kindly send me one copy of your book, EVERYBODY'S AVIATION GUIDE Enclosed find \$2.00.

Name.....

Address.....

City..... State.....

A component is shown in Fig. 5. A hard-rubber or wooden block, about  $\frac{3}{4}$ -inch square, will serve for the base. The mounting block used in this receiver measures  $\frac{3}{4} \times \frac{1}{2}$ -inch and is cylindrical in form; however, this does not mean that the constructor need run about looking for an object resembling in every detail the one used.

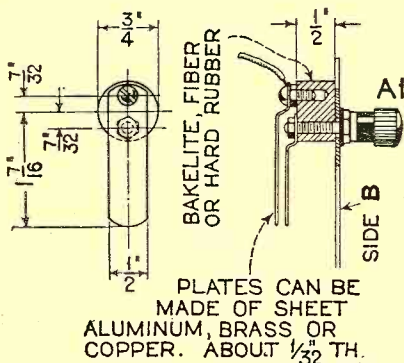

**DETAIL OF CONDENSER C1**

Fig. 5

Any means of varying the distance between two small, flat, insulated pieces of metal will do for this purpose.

The illustration requires no further explanatory note as its simplicity is obvious. The aerial post A1 must not make contact with the shield, and for this reason a fiber or pasteboard washer is placed between the shield and the post; the second aerial post A2 also is mounted with similar precautions. In the case of the ground post, however, matters are quite reversed; here care should be taken to see that this post makes proper contact with the shield.

The arrangements in the other two compartments, housing the radio-frequency and detector units, are sufficiently simple to require no detailed instructions regarding their assembly.

**COIL DATA**

The wavelength range of this receiver is 17-203 meters; this is covered by the use of two sets of four coils each. Each coil has three windings—primary, secondary and tickler—and is wound on a special bakelite form somewhat larger than a UY-type vacuum-tube base, although fitted with the prongs of the latter. As one wire from the primary winding is connected to one end of the secondary, only five prongs are required; even though the coil has three windings which at first glance may appear to require six terminals. To standardize construction when employing these forms, the prongs have been so arranged that they fit all UY sockets.

While these coils and forms may be made by the constructor, the forms, or even the completed coils, may be obtained so cheaply that it does not pay to go to the trouble. However, for those who must exercise their ingenuity, data for these coils are offered in Fig. 3. The manufactured coil form is ribbed to reduce the area of contact between the wire and the dielectric; but this is not an essential construction, although it does increase slightly the efficiency of the coil.

In winding the coils, No. 24 D.S.C. wire is used throughout; the primary is located near the base of each form, the secondary is wound at the top and the tickler in the center. All are wound in the same direction and a distance of  $\frac{1}{4}$ - to  $\frac{1}{2}$ -inch



# Wanted

## RADIO OPERATORS

\$90 to \$200 a month (board free)

... and a chance to See the WORLD!

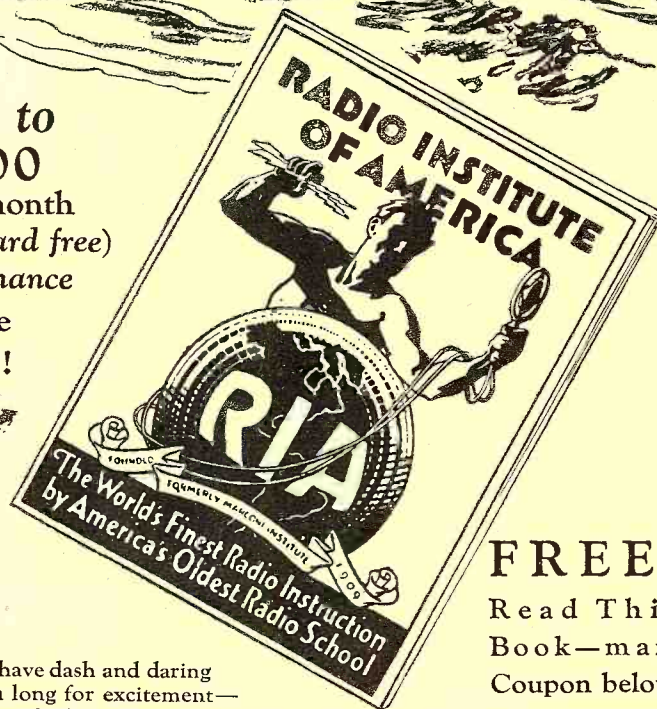

**FREE!**  
Read This Book—mail Coupon below

**If** you have dash and daring ... if you long for excitement—adventure—thrills... become a radio operator!

Fascinating work... rollicking fun aboard ship... a chance to see the world... popularity... the rank of an officer... free maintenance... and \$90 to \$200 a month, besides, for the pleasure!

What can beat that? No wonder enterprising, red-blooded fellows everywhere are jumping at the chance to get into this marvelous profession!

**Become a Radio Expert this fascinating way**

No matter how little you may know about Radio, you can become a full-fledged Radio specialist in a short time. By means of an amazing, unique home laboratory course conducted by the Radio Institute of America, you can now learn every phase of Radio in your spare time! You get the "how" as well as the "why" of Radio with this fine training. Only a couple of hours a day is all you need to devote! As part of your course, you receive absolutely free of extra charge—a magnificent outlay of apparatus. With this out-

fit you learn to build fine sets and solve every problem in repair work. That is why our graduates have the confidence and ability to command big pay.

**Training Sponsored by RCA . . .**

Our graduates enjoy greater success because they're posted right up-to-the-minute in everything in Radio. Radio's greatest achievements originate in the gigantic laboratories of the Radio Corporation of America. This great organization sponsors every lesson in the course.

**Money back if not satisfied**

The RIA course prepares you for quick success in all phases of Radio—Radio operating, manufacturing, servicing, selling, ship and shore broadcasting and many others. Includes Television, Photoradiograms and Radio equipment. A signed agreement assures you of complete satisfaction upon completion of the course—or it won't cost you a single penny!

Send for this Free Book Now. Think what Radio offers you. Money—thrills—success—adventure! Don't wait—get into this amazing field at once. Read this Free Book. It tells you things about this amazing profession you never dreamed of. And it tells you all about the famous course that has enabled us to place thousands of our students in fine positions, usually from 3 to 10 days after graduation! Mail the coupon now. Radio Institute of America, Dept. WS-4, 326 Broadway, N. Y.

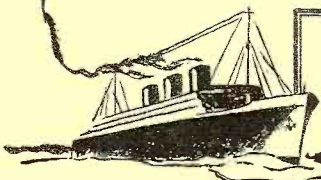

**RADIO INSTITUTE OF AMERICA,**  
Dept. WS-4, 326 Broadway, New York, N. Y.  
Gentlemen: Please send me your big FREE 50-page book which tells about the thrills and opportunities in Radio and about your famous laboratory-method of guaranteed Radio instruction at home.  
Name.....  
Address.....

Please say you saw it in RADIO NEWS

# ANATOMICAL MANIKINS

A NEW BOOK By DR. DAVID H. KELLER, M. D.

## The Only Popular Priced CHARTS Ever Published

**\$1.00** the copy

(Add 10 cents for postage in U. S. and 20 cents for foreign countries.)

A unique new manual of sectional anatomical charts prepared by medical experts.

TABLE OF PLATES	
1	Nude Male
2	Nude Female
3	Blood Circulatory System
4	Muscular System (Posterior)
5	Muscular System (Anterior)
6	Nervous System
7	Skeletal System
8	Respiratory System
9	Digestive System
10	Male Genital Organ in Detail
11	Female Genital Organ in Detail
12	Cross-Section of Pregnant Female Body with Child

All of the twelve plates are printed in actual natural colors.

**T**HERE IS nothing more interesting than any study connected with the human body. The history of its development from a one-celled organism form a startling and fascinating story of the most amazing type. From the standpoint of the electrician or engineer, the structure of the body, and the control of its various parts by a central nervous system, present many unexplained wonders. The chemist, biologist and scientist have been trying to solve the secrets of the human organism for many centuries, and still are forced to admit their imperfect knowledge.

Up to the present time, however, even the average well-educated man has remained ignorant of the elementary facts about the anatomical parts of his own body and their functions. It certainly is an interesting commentary on our civilization that a man who is able to name correctly the parts of his radio or automobile cannot name accurately the parts of his own body or describe the manner in which they function to promote his health and happiness. In many instances, the vocabulary that he is forced to use is not only childish but even vulgar. The well-educated man is thus unable to discuss his own body, in consultation with a physician, without using the terminology of the street.

Our Anatomical Plates are intended to correct this deficiency in the education of the average man and woman. It is really a series of artistic blueprints, showing the body as a whole, as well as its separate systems. It is not intended to be a perfect anatomical guide, suited to the needs of the medical student; its purpose is simply to do for the human body what has been done for the automobile and radio in the way of instruction and guidance for the layman.

Thus far, plates such as those presented here have been so high in price as to be inaccessible to the general public. Our plan in producing these charts is to make them available to every home. It is impossible to estimate their value in the home, but it certainly will help in the education and in the moral and ethical progress of any family possessing them.

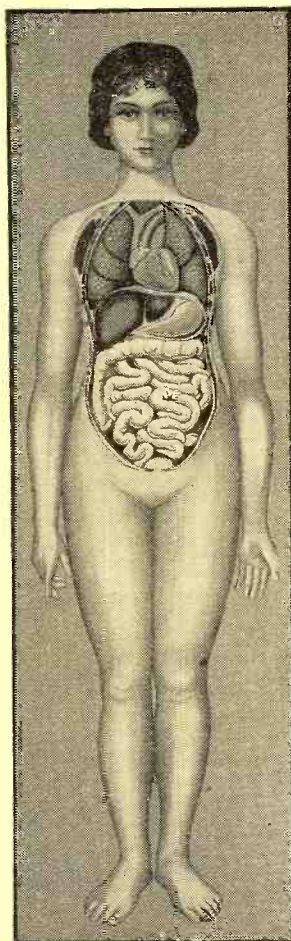

The book is 14 inches high and 6½ inches wide. It contains twelve full page color plates and twelve text pages illustrated with fifty photographs and drawings.

Opposite each plate, an explanatory text is provided, written by Dr. Keller, and illustrated with photographs and drawings to show in detail the different organs and other features of the human body. The book is especially recommended for the use of nurses, art students, to lawyers for use in litigations, lecturers, physical culturists, hospitals, sanitariums, schools, colleges, gymnasiums, life insurance companies, employee's health departments, etc.

But every man and woman should own a copy of *Anatomical Manikins*, for effective knowledge of his or her own physical self!

Money Back If Not Satisfactory

CLIP COUPON

CONSRAD COMPANY, INC.,  
230 Fifth Avenue, New York, N. Y.

Gentlemen:—Enclosed find \$1.00 plus postage (10 cents in U. S., 20 cents in foreign countries) in full payment for a copy of Anatomical Manikins by Dr. David H. Keller. (RN4)

Name .....

Address .....

City .....

State .....

**CONSRAD COMPANY, Inc. 230 Fifth Ave., New York**

Please say you saw it in RADIO NEWS



is left between each pair of windings. After the coils have been completed, some distinguishing mark may be placed on each so that they may easily be identified. Painting each, or some part of each, a different color is a rather efficient way of solving the problem; the manufactured coils are red for the shortest waves, then orange, yellow and green. Fig. 3 gives the number of turns required on each winding, and also the wave-length range of each coil.

**ACCESSORIES AND OPERATION**

After the receiver has been completed, it is suggested, all circuits should be gone over with a meter; in order that short-circuits may be caught before such treasures as screen-grid tubes could be sacrificed on the altar of high-voltage. First of all no "A" or "B" power units of any type should be used with a short-wave receiver; this narrows us down to batteries. Following this course, the constructor must decide what type of tube he desires to employ; if he chooses the dry-cell type, he must obtain three cells of the familiar bell-ringing type commonly referred to as No. 3s; these are wired in series—that is, center post of one to outer post of the next, and so forth.

The "B" batteries must meet the same requirements, regardless of the type of tubes used; three 45-volt blocks are required for efficient operation of this receiver. The matter of "C" batteries depends upon the type of tube employed; when using the 199- and 120-types as specified in this article, a 22½-volt block having a 4½-volt tap is required. However, if the constructor uses storage-battery tubes he will require two 4½-volt "C" blocks; as the 201A-type requires just 9 volts for "C" biasing with 135 on the plate, while 4½ volts "C" is sufficient for the first audio stage.

When changing to the 201A-type tube in the audio stages, it will also be necessary to change the value of the amperites to conform with the tubes and voltage of the supply used.

**AERIAL AND GROUND**

Another important consideration in the use of this receiver as in all others, is the choice of aerial and ground systems. The circuit employed allows the use either of the regular broadcast antenna or, if the constructor desires to erect it, of a special antenna for short-wave reception. When the former is utilized, the lead-in is connected to the aerial post A1; in which case grid coupling results through the antenna coupling condenser C1; a short aerial, not over 40 or 50 feet in length over-all, would be connected to the aerial post A2. At any rate, it is suggested that the experimenter try a number of antennas to find which one is best suited for his particular locality. (See also page 918.)

The ground system is purely a matter of convenience; try everything available.

**AT THE EXHIBITION**



**RADIO PEST:** "Gosh, what kind of a little set is that?"

**RADIO HAM:** "This is a short-wave set that will tune in Australia. It works from 15 to 75 meters."

**RADIO PEST:** "Where are all them meters? I can't see but one."—*Rudolph W. Nothnick.*

# The HAMMARLUND "Battleship" Condenser

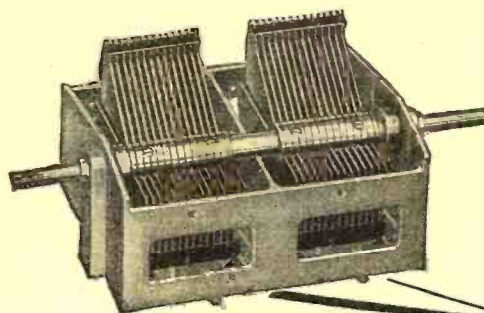

*Sections Matched to Within 1/4 of One Percent*

Sections can be balanced with absolute precision, with Hammarlund Equalizing Condensers directly attached to recesses provided in the "Battleship" Chassis.

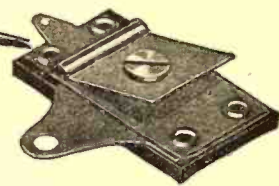

**R**REAL ONE-DIAL CONTROL is assured by using the new Hammarlund "Battleship" Multiple Condenser.

Two, three and four-gang models, with accurately matched sections, provide the finest possible capacity tuning for modern radio receivers. Slight variations in individual circuits can be perfectly compensated for by directly attaching Hammarlund Equalizing Condensers to each unit.

Rugged "Battleship" frame; oversize shaft, except on dial ends, and every feature of the famous Hammarlund "Midline" Condenser make this the prince of multiples.

Made in two capacities—350 mmfd. and 500 mmfd.—2, 3 and 4 gangs—\$9.50 to \$18.00.

*Write for Descriptive Folder*

**HAMMARLUND MANUFACTURING CO.**  
424-438 W. 33rd Street, New York, N. Y.

For Better Radio  
**Hammarlund**  
PRECISION  
PRODUCTS



**PATENTED**

**SENSATION OF THE NATION**

**POLK**

**BINDING POST**

15 Cts. Each

Insulated. No holes to fish for. Insert wire in any position. Quick action and holds tight. Standard markings.

J. L. POLK  
41 Belle Ave. TROY, N. Y.

**SET BUILDERS**  
*Get this Book*

**LATEST RADIO GUIDE**  
**FREE**

Barawik, the first and oldest radio specialty house, offers you unusual service this year. Bigger stocks, quicker shipments, lower prices. Deal with an old established, reliable house. Get honest goods, honest service, honest prices. Barawik service makes you more money. Send now for big new Catalog showing lowest wholesale prices.

**BARAWIK CO.** 24H Canal Sta., CHICAGO, U. S. A.  
*Mail This Coupon Now for Free Radio Guide*

Name \_\_\_\_\_  
Address \_\_\_\_\_

Insure your copy reaching you each month. Subscribe to Radio News—\$2.50 a year, Experimenter Publishing Co., 230 Fifth Avenue, N. Y. C.

Please say you saw it in RADIO NEWS

# PHONO Radio Consoles



STYLE R-53

For Radio or Phono-Radio Combination. A beautiful Walnut Cabinet with sliding doors of matched Butt Walnut. Ample space for Receiver, Speaker, and Phonograph equipment.

A descriptive bulletin of new 1929 styles sent free on request.

EXCELLO PRODUCTS CORPORATION  
4832 West 16th St., Cicero, Illinois

## Used RADIOS AS LOW AS 9.90

5 tube UNHEARD OF VALUES!

Take your choice. All in beautiful table model cabinets. Lot No. 1 Can hardly be told from new. Guaranteed \$14.90 Lot No. 2 Perfect working order. Guaranteed... 12.90 Lot No. 3 Requires slight adjustment. Sold as is... 9.90 Mail your order today or send for circular. We ship promptly. Upon arrival pay price of set ordered plus a small delivery charge. Foreign countries send money order with order.) CHAS. HOODWIN CO., 4240 Lincoln Ave., Dept. 416 Chicago Dealers in Bankrupt Radio Stocks

## DEALER and SET-BUILDER Bargains

Transformers, 75c. Condensers, 50c. 2 Mfd. Condensers, 65c. Rheostats, 25c. Potentiometer, 35c. 30 Henry Chokes, 90c. Vogue Loop Antennas, without base, 95c. Tubes, 201A, 60c. UX171, \$1.50. UX226 A.C., \$1.00. UX280, \$1.75. UX227, \$1.75. Raytheon, B.H., \$2.85. Crosley Cone Unit, \$2.00. Diats, 4", 10c. Battery Cable, 25c. Aerial Kits, 75c. Send money order with order. Complete list upon request. CHAS. HOODWIN CO., 4240 Lincoln Ave., Dept. 416 Chicago Dealers in Bankrupt Radio Stocks

## Code Learned Easily at Home

HAS HELPED THOUSANDS TO BETTER POSITIONS IN RADIO AND TELEGRAPHY

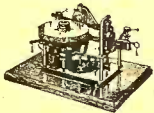

The OMNIGRAPH Automatic Transmitter will teach you the Wireless or Morse Codes, easily, quickly and cheaply. Start now. Ideal opportunities for you as an operator, broadcaster, experimenter or railroad official, etc. U. S. Army, Navy, radio schools and scientific institutions throughout the world use the OMNIGRAPH. Dept. of Commerce tests all applicants for a Radio license with it. List your friends in every corner of the world. Catalog G2. OMNIGRAPH MFG. CO. 810 E. 39th Street Dept. M Brooklyn, N. Y.

Don't Miss  
**AMAZING STORIES**  
"The magazine of scientific adventure, excitement and romance"  
The 25c Copy  
At All Newsstands

## Some Methods of Detection

(Continued from page 917)

### DIFFERENCE IN RESULTS

The distortion mentioned at the beginning of the article should now be understood more thoroughly and we can see that, although some distortion is always present, it does not have much effect on the quality of the signals. The advantages of the plate-current method of detecting are in the amount of current which may be handled without overloading the detector. By increasing the plate voltage and readjusting the grid bias, the tube may be arranged to handle much more current than usual and, in some cases, plate voltages of 100 to 200 are used with correct "C" biases in order to handle the very large grid-voltage variations produced by the incoming signals. The disadvantages of the system are the lessened sensitivity and the necessity of using a separate battery for the detector's grid bias.

In describing the action of the vacuum

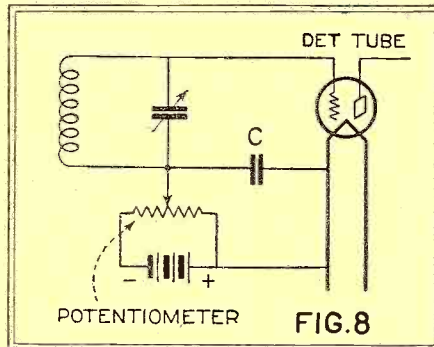

When a detector has many tubes ahead of it, the arrangement shown is preferable to that of Fig. 7, as it permits a larger signal-voltage "swing."

tube as a detector when using the grid-current method, it is advisable to refer to the action of the electrons sent out by the hot filament. When a positive bias is placed on the grid, the grid attracts the electrons sent out by the filament. But when a negative bias is used, the grid repels the electrons.

Rectification in the grid circuit (as in the plate-current method) is also dependent on an unequal variation of current, as the signal changes from positive to negative during each cycle. In this case, it is the varying of the grid current that produces rectification. In Fig. 9, we have another graph similar to Fig. 5, but with the grid current plotted in place of the plate current. It will be noticed that in this curve, there is a comparatively sharp "bend" at the lower end.

If the grid leak is of the proper resistance, it will bias the grid circuit to the point indicated. Since the "+" half of the radio-frequency current has a greater effect on the grid current (as shown in the shape of the resulting curve due to the sharp bend) the grid current gradually increases. This increase in the grid current causes an increase in the current flowing through the grid leak. This increase in the current flowing through the grid leak causes an increase in the voltage drop, in accordance with Ohm's law (voltage drop equals the product of the current and the resistance) and

(Continued on page 953, opposite)

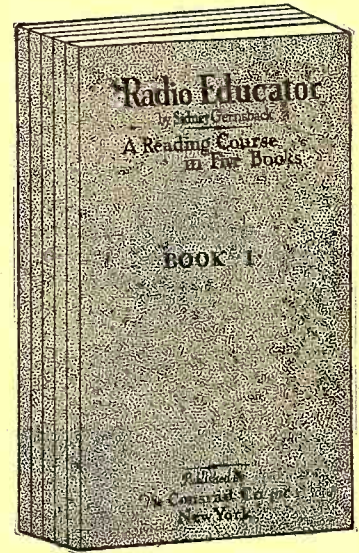

Price \$1.97

# A RADIO EDUCATION IN 5 VOLUMES "THE RADIO EDUCATOR"

Theory, Design, Construction,  
Operation and Maintenance

LEARN AT HOME

THESE five component parts of a complete Radio Instruction Course are outlined in five volumes that contain not merely the essentials as so many books do, but more, they contain all that any modern up-to-the-minute textbook on any subject would cover. They are in themselves a COMPLETE radio education teaching every possible portion of Radio science.

Size of each book 6 by 9 inches, handsomely bound and illustrated with charts, diagrams, descriptions of equipment, etc. Each volume 52 pages.

SEND NO MONEY for these books. Just forward your name and address. We send you the books at once. On receipt of same you pay the postman \$1.97 plus a few cents postage and then they are yours.

Distributed by

**The Conrads Co.**

Incorporated

230 Fifth Ave., New York, N. Y.

# RADIO DIRECTORY

## LOVELESS ANTENNA

Compact (seven-inch pyramid) Volume, Tone, Less Static, Distance. Installed in Five Minutes.

THERE IS ONLY ONE ANTENNA WITH ALL THESE FEATURES Delivered by mail, \$10.00. Money order or C.O.D.

LOVELESS ANTENNA, Inc. Box T Bath, N. Y.

## The Arc Aerial



An outside aerial that can be attached in 10 minutes — without climbing on the roof. Write today for details and price.

The Arc-Aerial, Inc. Green Bay, Wisconsin

## Power Amplifiers

The General Amplifier Company specializes in the design and manufacture of power amplifiers. All devices possess unusually good frequency characteristics due to advanced engineering design. Models range from those capable of delivering 25 watts of undistorted energy to the speaker, to amplifiers having a single UX250 power tube in the output stage. Your problems regarding power amplification are solicited. Bulletin A will be sent on request. GENERAL AMPLIFIER CO. 27 Commercial Avenue Cambridge, Mass.



## Moisture-Proof Extension Cords

Birnbach Extension Cords permit the Loud Speaker to be moved to any room in the house. Attaches instantly. Install a Birnbach Cord and put an end to distortion so often due to badly insulated cords. Your neighborhood dealer has these sizes in stock: 10-20-30-40-50-100 foot lengths. Send for Catalog.

BIRNBACH RADIO CO. 254 W. 31st St., New York

**Television** MULTI-POWER Revolutionary  
Speed Indicator  
Synchronous Disk Integral with centrifugal  
SPEED INDICATOR  
Plunge for holes 15 inch diameter, 25 square toes.  
Speed circles red, blue, blue.  
Send \$1.00 with order for catalog.  
Know Your Speed!  
Synchronous Disk  
PAUL'S MARK  
SPECIAL IN TELEVISION 22 YEARS  
250 E. 42nd ST., BROOKLYN, N.Y. **new**

## FREE Wholesale CATALOG

Send for the most complete book of nationally known Parts, Kits, Cabinets, Consoles, Speakers, Power Units, Sets, etc. All at lowest wholesale prices. Quick service on all your needs. Write now, it is FREE—

Setbuilders Supply Co. 1315 Romberg Bldg., Chicago

200,000

RADIO NEWS readers carefully scan the RADIO DIRECTORY every month.

Your product here, at the lowest cost in the world's largest and most widely read radio magazine.

RATE PER ISSUE—\$25.00

No order for less than three insertions accepted.

Write for Information

RADIO NEWS, 230 Fifth Ave., New York City

## LOWEST WHOLESALE PRICES!

Set Builders and Dealers! Let the largest Radio Mail Order House in the East serve you! You'll get better service and better merchandise at the lowest wholesale prices obtainable anywhere.

NEW 1929 BUYING GUIDE Your copy is ready for you. It lists all the latest Radio Parts, Accessories, Sets and Kits. Catalog K also lists Electrical Supplies, Household Appliances, Golf and Tennis Equipment, Cameras, Traveling Bags, etc. Send for your copy now. It's free. Allison-Rogers-Madison, Inc. 35 W. 31st St., New York

## Send for This

We have a new illustrated catalog showing our up-to-the-minute stock of kits, parts and sets — everything you want in radio, all at dealers' wholesale prices. Write today for Catalog "B-6."

ALLIED RADIO CORPORATION 711 W. Lake St. Dept. "B-6," Chicago, Ill.

## SEND FOR NEW RADIO BOOK

All the new hook-ups, Parts, supplies, A.C. sets, television, short wave, etc.

Write for free copy now.

The Barawick Co. 11D Canal Sta., Chicago

## SEND NOW

### for New 1929 WESTERN RADIO'S CATALOG

LATEST and FINEST, nationally known A.C. sets, consoles, cabinets, speakers and accessories at LOWEST PRICES. Catalog sent FREE on request.

WESTERN RADIO MFG. CO. 128 W. Lake St. Dept. RNC4 Chicago



Dealers, write for catalog. W. C. BRAUN CO. 552-D Monroe St., Chicago

**Braidite** HOOK-UP WIRE THE BRAID SLIDES BACK  
AT ALL DEALERS  
25 ft. Stranded 35c  
25 ft. Solid 30c  
Red Blue Black  
Send 10c for sample  
CORNISH WIRE CO. 24 Church St., New York

**HELLO JAPAN!**  
Hello China; Hello Australia; Hello New Zealand; Hello Ireland; Hello Danzig, 9,000 miles away; Hello Iceland, 10,000 miles away. All confirmed reception. Most amazing performance of any Radio Receiver ever designed. U. S. Stations all located on the Magnafomer AC-29. Write for FREE X-RAY Wiring Diagrams, New instruction sheet and complete information. Radiart Laboratories Co. 1012D Assn. Bldg., Chicago, Ill.

RADIO'S HALLMARK OF QUALITY  
**DeJur Amsco** WORLD'S LARGEST MANUFACTURER OF HIGH GRADE RADIO PARTS  
USED BY LEADING SET MANUFACTURERS AND SPECIFIED IN ALL THE BEST CIRCUITS  
WRITE FOR CATALOG DE-JUR AMSCO CORP. BROOME AND LAFAYETTE STS. NEW YORK CITY

The RADIO DIRECTORY is your buying guide. Space permits display of only one product at a time.

Write advertisers for complete catalogue.

## LYNCH TUBADAPTA

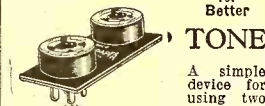

A simple device for using two tubes in parallel. For radio frequency or last audio stage. Prolongs life of tubes. Eliminates distortion.

ARTHUR H. LYNCH, INC. 1775 Broadway New York

## TELEVISION Kits and Parts

Complete receivers assembled in 15 minutes. 5 models from \$37.50 up.  
DISCS MOTORS NEON TUBES AMPLIFIERS and other parts  
Write for Catalog Insuline Corp. of America 78-80 Cortlandt St., N. Y. C.

The RADIO DIRECTORY is your buying guide. Space permits display of only one product at a time. Write advertisers for complete catalogue.

(Continued from previous page)  
causes a reduction in the positive grid potential. Since a reduction in the grid voltage causes a reduction in the plate current, there is a gradual increase and decrease in the plate current following the signal changes; and this produces the required rectification.

With rectification occurring in the grid circuit, the amplification factor of the tube is utilized, and causes this system to be more sensitive than the plate-current rectification method. The use of a "high-mu" tube as a detector will increase the sensitivity, although the detector is apt to be more critical. The advantage of the grid-current method of obtaining rectification is apparent from the above description. The disadvantage is in the fact that the bend in

the curve (Fig. 9) occurs at a point very near to zero potential and, for this reason, the detector is liable to be overloaded very easily. It will be noted that the signal curve

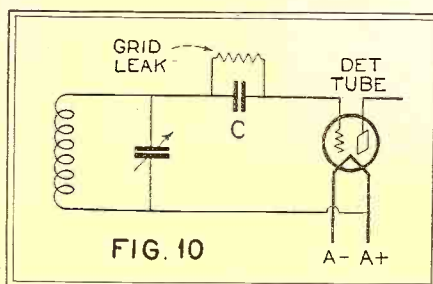

FIG. 10

The most common method of detection is that shown; it is best for small sets.

is distorted in this method as well as the other.

The method of connecting the gridleak in the circuit is shown in Figs. 10 and 11; the grid leak may be across the grid condenser as in the former, or lead directly to the filament, as in the latter. In order to find the most efficient point for the detector, the grid leak may be connected to the center arm of a potentiometer in the filament circuit (Fig. 12). The arm is then moved until it is found that the detector is operating at its best.

## REMOVING TUBE DISTORTION

In this analysis of the effect of the tube's characteristic on the waveform of the de-

(Continued on page 953)

**IRIEAD** ==  
**RADIO LISTENERS' GUIDE  
 AND CALL BOOK**  
**Timely Articles for the  
 RADIO ENTHUSIASTS**

NEW ISSUE JUST OUT

Modern — Up-to-the-Minute — Complete!!

Profitable Data for the Professional Set Builder, Fan Radio Constructor,  
Service Man, Broadcast Listener

**F**OR the Professional Set Builder — How to sell his products—how to apply his knowledge—how to secure profitable outlets. . . . Problems of speech amplifier installation in theatres, hotels, restaurants—wiring—connection of speakers . . . are discussed for the first time by an expert. . . . This is priceless information. . . . Also FREE listing of all Custom Set Builders in the Radio Set Market Section.

**For the Set Constructor** — The most modern A.C. receivers with detailed explanation of technical features. . . . Why these receivers perform so well. . . . How to apply scientific design to receiver construction. . . . Details of the first receivers designed to accommodate the new A.C. screen grid and the new intermediate power tubes. . . . Short-wave station directory of the world. . . . Broadcast station directory of the world. . . .

**For the Service Man** — The secrets of A.C. tube operation. . . . A tester for testing commercial B battery eliminators. . . . Methods of eliminating man-made static. . . . How to identify electrical disturbances. . . . The design of multi-scale meters—internal resistance specifications of all popular meters. . . . Technical details of manufactured products. . . . **JUST CHOCK FULL OF VITAL, USEFUL, MODERN DATA.** . . .

**For the Broadcast Listener** — All broadcast stations listed by call letters, wavelength, states and cities. . . . Cross

index makes identification and location marvelously easy. . . . The ownership, power and frequency also given. . . . All short-wave stations of the world. . . . Broadcast stations of Canada and foreign countries. . . . The most complete station directory in the world. . . .

**CONTENTS**  
**Spring 1929 Issue**

- Technical Training for the Custom Set Builder
- How to Sell Custom Built Sets
- The Problems of Speech Amplifier Installation
- A "B" Battery Eliminator Tester
- 10 K.C. Band Pass Receiver
- S-M 720 A.C. Screen Grid Six
- The H.F.L. Special A.C. Nine
- Superheterodyne Band Pass Filters
- A "Midget" 171 Power Pack
- Ten Meters in One
- The Elimination of Man-Made Static
- Listeners' Accessory Guide
- Short-Wave Stations of the World
- Successful Operation of A.C. Tubes
- Broadcasting Stations of the World

*JOHN F. RIDER, engineer and author of several radio text books, who has been connected with the art of Radio since 1911, is now MANAGING EDITOR of our magazine.*

**THE 50c COPY**

At All Newsstands,  
or Write Direct

**CONSRAD CO.**  
**230 Fifth Avenue, New York, N. Y.**

CONSRAD CO.,  
 230 Fifth Ave., New York City, N. Y.  
 Enclosed find 50c for which please send me a copy of your remarkable book, Radio Listeners' Guide and Call Book.  
 Name.....  
 Address.....  
 City.....  
 State.....

## Methods of Detection

(Continued from page 953)

ected signal, we have illustrated the R.F. component. But it is evident that this distortion must apply also to the waveform of the A.F. signal, even though to a smaller extent. As a matter of fact, this effect is

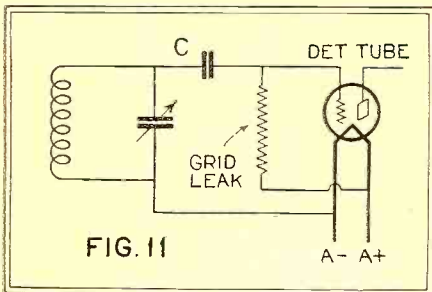

FIG. 11  
The leak serves the same purpose as in Fig. 10 but is not in series with the tuned circuit or across the condenser. A more convenient connection when using a gang condenser.

difficult to recognize in a properly-made receiver, unless the detector is overloaded, but is nevertheless present and to be accounted for. Several systems have been advocated for the reduction of this, but most of them do not improve the results to a worth-while degree. One which has been suggested is the use of an audio-frequency choke coil in place of the usual grid leak in the grid-current detection method; this is satisfactory except for one thing. The impedance of most A.F. choke coils is not even over the audible frequency-range, and this will introduce distortion of its own; so that the results are not improved but might rather be made worse.

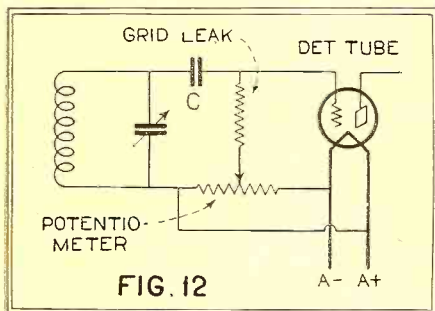

FIG. 12  
Even with the grid leak, the potentiometer will be convenient for adjusting the grid bias and finding the point of greatest sensitivity.

For the average set, using one or two stages of tuned-radio-frequency amplification, the grid-leak method is probably the most satisfactory, because of its greater sensitivity. For superheterodynes, or sets using a greater number of radio-frequency stages, the "C" bias method is more satisfactory, because of its higher current-carrying capacity.

### CROSS YOUR FINGERS—NOT YOUR WIRES



Of all sad words of radio boobs—  
The saddest are,  
"I've blown the tubes!"

—Ted Hagedorn.

# MAKE GOOD RECEPTION EASY

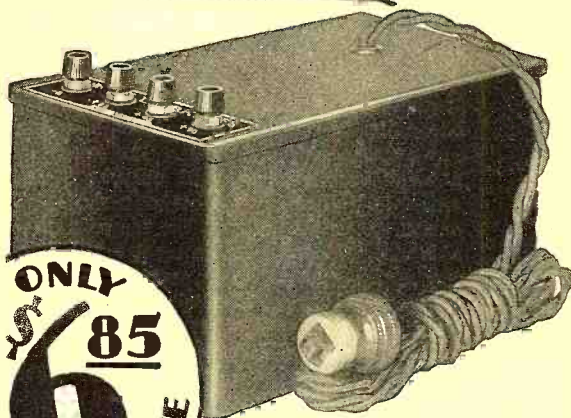

ONLY \$6.85 COMPLETE

## TOWNSEND "B" POWER UNIT

Thousands of users marvel at the difference in reception with a Townsend "B" Power Unit. Full, sweet tone, clarity, volume and greater distance are among the many advantages reported daily.

Hooked up in a few minutes; just plug into the light socket and forget it. Delivers up to 100 volts on any set—D.C. or A.C.—any cycle.

OVER 100,000 NOW IN USE

There's no longer any reason for putting up with the expense, the inconvenience and undependable performance of "B" Batteries—when you can own a good "B" Power Unit for the surprising, low cost of \$6.85. Over 100,000 Townsend "B" Power Units now in use—a substantial proof of satisfaction.

SEND ONLY \$1.00

Fill in coupon and send with only \$1.00. Prove this marvelous value to yourself. Use it ten days. Then if it fails to do everything we say, return it and money paid us will be refunded. Make a REAL receiver of your set.

APPROVED AND PASSED by the rigid laboratory tests of "Popular Radio" and "Radio News."

TOWNSEND LABORATORIES

713 Townsend Street, Chicago, Ill.

TOWNSEND LABORATORIES,  
Dept. 25,  
713 Townsend Street,  
Chicago, Ill.  
Gentlemen:

Attached find \$1.00. Kindly send at once Townsend "B" Socket Power Unit, C.O.D. \$5.85, plus postage, on guaranteed 10-day Free Trial.

Name .....  
Address .....  
City ..... State .....

ATTACH ONLY \$1.00 TO THIS COUPON

4-29

## FERRANTI Radio Products for Real Reception

Highest quality heavy duty audio and output transformers for power and general purpose amplifiers, and for all kinds of speakers.

Technical data and prices sent on request.

FERRANTI, INC.

130 W. 42nd St., New York, N. Y.  
FERRANTI, Ltd. FERRANTI, Ltd.  
Hollinwood England ELECTRIC, Ltd.  
Toronto, Canada

## SET BUILDERS Get this Book

LATEST RADIO GUIDE FREE

Barawik, the first and oldest radio specialty house, offers you unusual service this year. Bigger stocks, quicker shipments, lower prices. Deal with an old established, reliable house. Get honest goods, honest service, honest prices. Barawik service makes you more money. Send now for big new Catalog showing lowest wholesale prices.

BARAWIK CO. 24-M Canal Sta., CHICAGO, U. S. A.

Mail This Coupon Now for Free Radio Guide

Name .....  
Address .....

Insure your copy reaching you each month. Subscribe to Radio News—\$2.50 a year. Experimenter Publishing Co., 230 Fifth Avenue, N. Y. C.

Please say you saw it in RADIO NEWS

www.americanradiohistory.com

# Cunningham RADIO TUBES 1915-1929

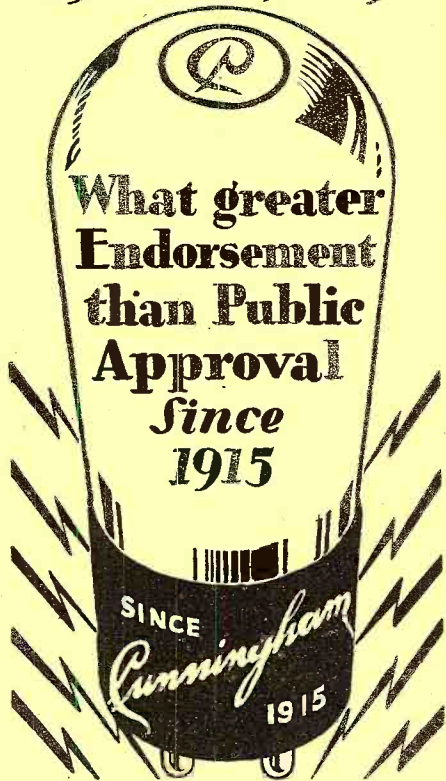

## Complete Stock of Silver-Marshall Parts

Including  
No. 730 "Round-the-World" 4  
We are authorized jobbers of Silver-Marshall apparatus. Complete stock on hand at all times. Special prices on No. 730 Short Wave Receiver.

### 1929 Catalog—FREE

Includes description and complete parts for Remler 29 Shield-Grid Receiver, Madison-Moore "A. C." New Thordarson Power Amplifier, World's finest Dynamic Speaker.

Discounts for Set Builders

### CHI-RAD

CHICAGO RADIO  
APPARATUS CO.

415 S. Dearborn St., Dept. RN  
CHICAGO

## LEARN TELEGRAPHY

Be an expert Morse operator! **BIG PAY**—WITH CONTINENTAL CODE TELEPLEX!  
TRAVEL—FUN—ADVENTURE. After a few short weeks of practical study with Telex you will be an expert operator. This amazing instrument teaches you right in your own home. Works like a phonograph. No knowledge needed—beginners learn at once! **NOT A SCHOOL.** Free 30 days' trial. Write for FREE booklet D-11.



TELEPLEX CO., 72 Cortlandt Street, New York City

# Exide

RADIO BATTERIES  
Manufactured by  
THE ELECTRIC STORAGE BATTERY CO.  
Philadelphia

## The Service Man

(Continued from page 934)

aerial, like the overhead aerial, must be extended at full length to give maximum pick-up. This involves digging a trench (or, in some soil, a hole might be "jetted" as in laying small water pipes) and is not possible for many set owners whose grounds are limited; but if it can be done, it is worth the effort.

On the other hand, an underground aerial may be coiled into small space, but, as with a loop, the lessened area of the electric field which it cuts results in less flow of current in the aerial. With a set of very high amplification in the R.F. stages, this matters little; because there is ample reserve of power for any but the weakest signals. The owner of a small set, however, will observe a decrease in the signal; and perhaps blame the aerial. Even in this case, the use of a suitable variable tuning condenser in series with the aerial—just as if it were overhead—may enable him to take advantage of the greatly-increased sensitivity of a tuned antenna system. The discussion of antenna characteristics in the article on "Short-Wave Aerials and Grounds," elsewhere in this issue, will be helpful; as the principles there laid down apply equally to reception on a somewhat higher waveband.

## The Radio Beginner---Pick-Ups

(Continued from page 915)

The original phonograph was developed soon after the telephone; the first commercial record was a wax cylinder upon which the mechanical vibrations engraved grooves by means of a sharp needle. (The needle was connected to a metallic diaphragm, similar to the telephone's, and the selection was played directly in front of the diaphragm.) In reproducing the music from the wax cylinder, a needle was again connected to a diaphragm and the cylinder was revolved by a suitable spring mechanism. The needle passing over the surface of the cylinder, in the grooves, was forced from side to side and this made the diaphragm vibrate, thus reproducing the sound. Later, the cylinder was replaced by a more compact disc, and the diaphragm was placed in the small end of a conical horn, in order to direct the sound more effectively.

### MODERN DESIGN

The design of the electric pick-up required much research in order to overcome the usual difficulties from distortion. The amplifiers, with their new power tubes, could be made sufficiently perfect for the purpose; but there were several difficulties inherent in the design of the pick-up device, which caused trouble at first. The vibrating reed, or armature, was found to have a "resonant point," and distortion was caused through this. By careful design, it was found, a suitable magnetic reed could be made with its resonant point above the audible band and this source of distortion was eliminated. The magnet, case and support of the pick-up also had to be considered from the standpoint of resonant frequencies, but these problems were comparatively simple.

The rigidly-mounted vibrating reed was too stiff in motion at first and caused an excessive amount of wear on the record; so, in order to prevent this wear, the reed was supported in bearings and allowed to vibrate

## SCREWDRIVER RESISTANCE

**DON'T GUESS** at resistance values! You can't fool electricity. Instead, use a **DUPLIX CLAROSTAT**, with its double-barreled resistances, instantly adjustable to any values by means of an ordinary screwdriver. Neat. Compact. Practical. Inexpensive. Foolproof. Just the thing for plate and grid-bias voltages for any set. And don't forget



### There's a Clarostat for Every Purpose

No matter what your resistance problems, no matter what circuit, tubes, power, line voltage and so on, there's a **CLAROSTAT** of proper size, range and type for the job.

WRITE for literature regarding the **CLAROSTAT** line. Better still, send 25 cents in stamps or coin for "The Gateway to Better Radio"—the best investment in radio happiness.

**CLAROSTAT MFG. CO., Inc.**  
Specialists in Radio Aids  
281 N. 6th St.  
Brooklyn, N. Y.

## GOOD BUYS IN "B" BATTERY POWER

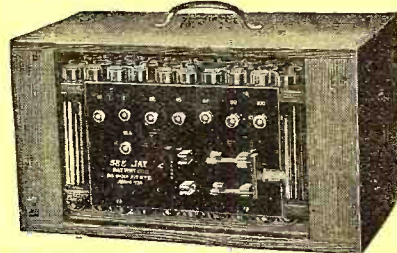

100 Volt Edison Element. Non-Destructive. Rechargeable "B" Battery with charger. Shipped dry, with solution, \$12. 140 Volt with charger, \$17. 180 Volt Power Unit, with Trickle Charger, \$24.00.  
**SEND NO MONEY—PAY EXPRESSMAN**  
Write for our Free Literature  
**SEE JAY BATTERY CO., 915 Brook Ave., New York**

## Wholesale Prices

Tremendous stock and sales volume, with rapid turn-over to the thousands of radio dealers we serve enables us to make you worthwhile savings at lowest wholesale prices. Write for latest, new illustrated Catalog "B-6"

## Allied Radio CORPORATION

711 W. LAKE STREET, CHICAGO

1929

## RADIO NEWS AMATEURS' HANDBOOK

Greatest edition of them all  
See Page 972

freely. By using small pads of rubber or other suitable material, the record was prevented from vibrating too far.

The weight of the complete unit and the way in which it was mounted also had a great deal to do with the wear on the records and, with most of the units, it was found necessary to use a balanced type of mounting in order to prevent the records from being scratched too much.

The actual difficulties encountered in the design of a pick-up are comparatively small, and most of them can be overcome by carefully balancing the parts and the weight.

**VOLUME CONTROL AND "NEEDLE SCRATCH"**

Another point which had to be considered was the method of controlling the volume of the reproduced currents. A large amount of distortion could be introduced in this way, if the volume were incorrectly controlled. The use of either a resistor connected fully across the pick-up (Fig. 3) or a potentiometer connected as shown in Fig. 4, is the most common method; although other systems are also suitable. A resistor connected in the audio amplifier, across the secondary of one of the A.F. transformers, or across the speaker may be used. Many of the commercial pickups are already equipped with volume-control systems; usually of the simple resistor or potentiometer type. These resistors are placed either in the pick-up mounting base or in a separate case, connected in the leads to the amplifier.

Music from the old type of phonograph reproducer was accompanied, in most cases, by an annoying scratchy noise known as the "surface noise" or "friction noise." In reproduction of the old type, it was not possible to eliminate this; but, fortunately, the new electric reproducer allows a great reduction of these noises, and in many cases the scratch is almost inaudible. The reduction of these noises involves the use of a filter which is tuned to a frequency near to that of the undesirable tone. These noises are rather high-pitched and the absence of harmonics of the music, which are cut off at the same time, do not affect the quality sufficiently to cause any trouble. In fact most listeners could not discern most of them anyway; since the average person can hear only up to 9,000 or 10,000 cycles. Broadcast stations carry signals only up to 5,000 cycles, because of the interference problem; and the loss of the higher frequencies is hardly noticeable even by musically-trained hearers, when the transmission and reception are otherwise perfect.

The filter used for reducing these noises is very simple in construction; it consists of a choke coil of suitable design and a fixed condenser in series. The complete filter is connected directly across the terminals of the pick-up. Most commercial pick-ups are already equipped with a suitable filter and, in case one is not incorporated in the device, it can be improvised very easily by using a radio-frequency choke coil of approximately 200 millihenries and a fixed condenser of .006-mf. The connections of such a filter are shown in Figs. 3 and 4.

**CONNECTING THE PICK-UP**

Almost all commercial units are equipped with plug-in devices, so that the experimenter can use the regular audio amplifier in his radio set for phonograph reproduction. Ambitious fans can build separate amplifiers for the purpose by using power

This Beautiful \$245 Fully Guaranteed **SUPER AC-8** Electric Radio Console *Factory to you for only* **\$98.50** Nothing More to Buy **COMPLETE!**

**30 Days Free Trial**

Notice that our price (if you buy) includes EVERYTHING—tubes, aerial, latest Power Speaker, beautiful console and newest shielded 1-dial, Super-powered Miraco Super AC-8 Electric Radio of finest construction and costliest features (including phonograph pick-up connection) ready to plug into light socket and enjoy.

**3 Year Guarantee if You Buy**

Get our Send No Money, 30 Day Free Trial, 3-Year Guarantee Offer. Remember you save 1/2 or more by dealing DIRECT with factory—the big, old, reliable Midwest Radio Corporation, 9th successful year. Send coupon!

**Turn One Dial for Stations Coast to Coast**

Compare with radios at 2 to 4 times the price. Unless your Miraco proves itself the MOST SELECTIVE, RICHEST, CLEAREST TONED and MOST POWERFUL DISTANCEGETTER, don't buy! Return everything OUR expense. Delighted users by thousands enjoy programs from Coast to Coast, Canada, Cuba, Mexico with the magnificent clear Cathedral tone of costliest radios. So can you! Send coupon!

**Many Other Beautiful Styles**

Any kind of cabinet you want—consoles with built-in Power speakers (Dynamic or Magnetic)—wood or metal table cabinets with separate speakers—Phonograph-Radio combinations—at ASTOUNDING LOW FACTORY PRICES ON 30 DAYS FREE TRIAL. Send coupon!



41 in. high, 26 in. wide, 15 in. deep  
A dandy little "arm chair" console in handsome walnut

Also in Battery Models

**AGENTS! Make \$100 to \$250 Weekly! Exclusive Territory. Demonstrator Supplied**

**Two More Examples of our many bargains**

**\$114.52 Complete**

**Walnut Spinet Console (at right) \$108.95 Complete**

on 30 Days FREE trial. We have the most wonderful EXCLUSIVE TERRITORY, money-making proposition ever made. No contract, no experience required. Devote evenings, spare time or full time to demonstrating. Our sets sell themselves by their unbeatable performance, tone quality, beauty and high-grade construction. They put competition into the shade. Get full particulars quick! Check agent square  on coupon!

**MIDWEST RADIO CORP'N**, 404-VA Miraco Bldg., Cincinnati, O.  
BEAUTIFULLY ILLUSTRATED CATALOG, AMAZING SPECIAL FACTORY OFFER, TESTIMONY OF NEARBY USERS—All the proof you want—of our honesty, fairness, size, financial integrity, radio experience and the performance of our sets—including Amazing Factory Offer—sent with catalog.

**Free** MIDWEST RADIO CORP'N 9th Successful Year

404-VA Miraco Bldg., Cincinnati, O.

WITHOUT OBLIGATION, send free catalog, Amazing Special Factory Offer, testimony of nearby users, etc.  User  Agent  Dealer

NAME \_\_\_\_\_  
ADDRESS \_\_\_\_\_

**THIS COUPON IS NOT AN ORDER**

**BE A RADIO DOCTOR**



If you are interested in radio, the quicker you decide to make radio your life work the sooner you will be assured of success and Big Money. **\$5,000** a year is possible for men connecting at once with our big National Radio Service organization.

**I Need 1200 Men at Once for Chain Service Stations**  
Don't be a "tinkerer," get in on the ground floor with a big proposition. Investigate at once.  
"Have a licensed Radio Doctor fix it" is the slogan where our men operate.

Write today for our free booklet, "Why the Radio Doctor"  
E. W. PARKER, Pres. RADIO DOCTORS, INC.  
Dept. N, 6 Essex St., Salem, Mass.



**GEARS—All Kinds—Small**

The most accurate made and prices reasonable. We carry a complete line of gears in stock for immediate shipment. Can also quote on special gears of all kinds. Send us your inquiries.

Write for Catalog 40  
**Chicago Stock Gear Works**  
105 So. Jefferson St., Chicago

**RADIO PARTS**

Every "Old Timer" and every newcomer knows what GR stands for. Bulletin 931 is our latest. Have you sent for your copy?

**GENERAL RADIO COMPANY**  
30 State Street Cambridge, Mass.

# Get Your Copy of

## POPULAR CARD TRICKS

By Walter B. Gibson

### Pleasant Entertainment For All

Walter B. Gibson has written what is conceded to be the most complete book of card tricks ever published. There are literally hundreds of these clever little tricks. You need not be a professional in order to work them out. There is no sleight-of-hand required. You can do any of them with little or no practice. Simple to perform—difficult to guess. Complete instructions—Hundreds of illustrations.

Once you have mastered a few of the tricks that this book contains you will become extremely popular—always entertaining. Imagine the fun you can have at a party. Just nonchalantly pick up a deck of cards and inquire if anyone has “seen this one.” Then, while all attention is focused on you, do these tricks one after another to the admiration and wonderment of all.

**25c**

THE COPY

AT ALL NEWSSTANDS OR  
WRITE DIRECT

Experimenter Publishing Co., Inc.

230 Fifth Avenue, New York, N. Y.

tubes and suitable power supplies. A number of amplifiers of this type have been described in back issues of RADIO NEWS; that in the February, 1929, issue is designed for high quality and great volume, and a special phonograph amplifier was published in the January, 1928, issue.

The pick-up may be coupled to the set in several ways; to either the primary of the first audio-frequency transformer, the grid circuit of the detector tube, or the grid circuit of the first audio-frequency tube. These methods are shown in Figs. 6, 5, and 7, respectively. The method of Fig. 5 will probably supply the greatest volume, since it converts the detector into an amplifier tube; although this is a matter for experimentation. It is necessary to connect a “C” battery in the circuit in order to obtain the best quality. The battery would need only a small potential: probably several flashlight batteries connected *in series* will be the easiest way of obtaining this bias.

The second method (shown in Fig. 6) uses the pick-up in the plate circuit of the detector tube, across the *primary* of the first audio-frequency transformer, thus using the amplification of this instrument. The final method connects the pick-up across the *secondary* of the audio transformer. Although

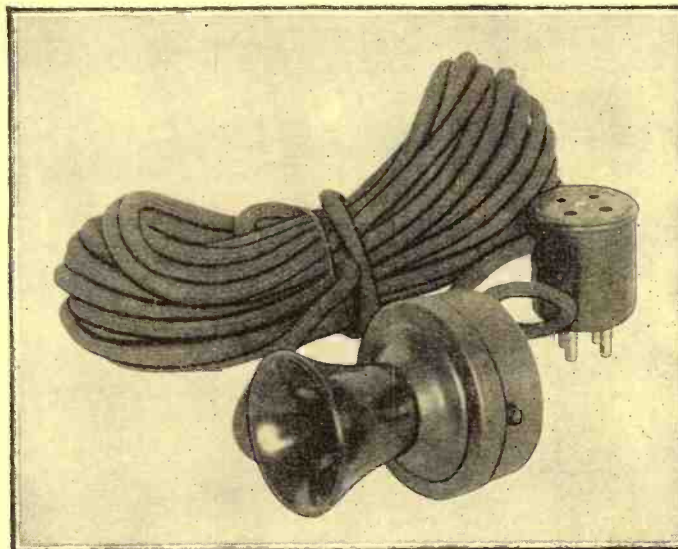

With a small microphone connected to the detector socket by a plug, speech is clearly reproduced through the A.F. amplifier of a receiver.

this system supplies the least volume of the three methods, it is quite satisfactory in cases where the required volume is low or where a very powerful amplifier is employed. Either jacks or switches may be employed for changing from radio to phonograph, or an “adapter” may be used.

The “adapter” supplied with a pick-up is plugged into the detector socket and connects the unit to the plate circuit of this tube; the connection thus made being equivalent to that in Fig. 6. In some cases, adapters are obtainable for both the four- and five-prong sockets; so that the unit will be equally adaptable to battery sets and A.C. sets using the 227-type detector. The connections for power-operated sets are the same as for the ordinary battery sets using the common (201A-type) detector tube. The only change necessary is in the method shown at Fig. 5. In this case, the “C” battery is connected to the *cathode* terminal instead of to the filament wiring; this is done in order to keep the hum at a minimum.

In order to make operation of the phonograph entirely electric, an electric motor may be used in place of the usual spring

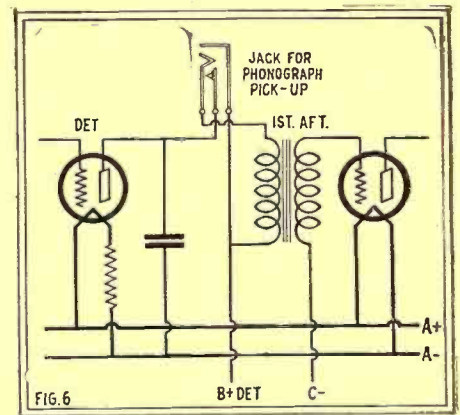

A handy connection for record reproduction.

mechanism. A number of constant-speed motors, some of which are equipped with turntables, speed controls, etc., have appeared on the market; one of these motors is illustrated in this article. The motor is of the “induction” type and is equipped with a friction-type governor to keep the speed constant. The switch may be so arranged that the motor is automatically turned off when the record is finished, or that it will continue until it is turned off by hand.

For those who have neither a phonograph nor the inclination to purchase an electric motor and turntable, there is one very good way of making a cheap but good unit. The small portable phono-

graphs which were made several years ago (and in fact are still being made) have a very satisfactory operating spring mechanism and, with an

electric pick-up, one may be made into a high-quality phonograph. These portable phonographs will take full-size records. If desired, the mechanism may be removed from the case and mounted in another cabinet; in fact, this is a very good way of making a good combination phonograph-radio console. A switch placed on the panel

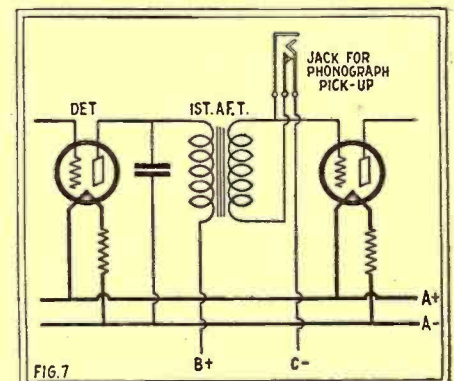

This connection gives somewhat less volume than others, but is often satisfactory.



## WALL PLATES



CARTER

Dress the Home for Radio Reception

Radio outlets can be installed in new or finished homes and apartments, eliminating the unsightliness of loose wires, etc. Can be supplied in a wide variety of designs, in brass, bakelite, and statuary bronze. Folder free on request.

Send for a Complete Catalog

Carter Radio Company

300 S. Racine Ave. Chicago, Ill.  
CARTER RADIO COMPANY, LTD., TORONTO

# Carter

THE NAME GUARANTEES THE PRODUCT

## DRESNER Shielded SHORT WAVE CONVERTER

16<sup>50</sup>  
Complete with 5 COILS



The Only Set with a Wave-length Range 15 to 550 Meters

First time offered! New 1929 model—completely assembled; can be used on any set; built in beautiful mahogany finished metal cabinet. Highest efficiency at amazingly low price. Gets programs broadcast on short waves by many powerful stations throughout America and Europe.

If your dealer cannot supply you, send money or order direct and we will ship at once. Guaranteed. (When ordering unit, be sure to specify whether it is to be used on AC or DC set.)

DRESNER RADIO MANUFACTURING CORP.  
640 Southern Blvd., Dept. R-4, New York, N. Y.

## FREE TO SET BUILDERS AND DEALERS NEW 100 PAGE CATALOG

HAMMARLUND OFFICIAL DISTRIBUTORS  
SILVER - MARSHALL KIT HEADQUARTERS  
NATIONAL COMPANY AUTHORIZED JOBBERS  
AERO SHORT-WAVE AND DAVEN TELEVISION

We are ready to ship all kits or parts produced by the above manufacturers as well as any others specified in any radio publication.

31 Years of Service to the Trade

ROYAL-EASTERN PAYS THE FREIGHT  
Lowest Wholesale Prices

Send for your copy of our catalog

ROYAL-EASTERN ELECTRICAL SUPPLY CO.  
20 West 12nd Street, New York City, N. Y.

## MASON, FENWICK & LAWRENCE

PATENT LAWYERS

600 F. ST. N. W., WASHINGTON, D. C.

ESTABLISHED OVER SIXTY YEARS—SEND SKETCHES Electrical and Chemical Inventions Carefully Handled. Practice before the U. S. Courts and the Patent Office.

Prompt and Careful Service

Trade-Marks Registered

of the radio connects the pick-up to the amplifier when desired.

### "HOME BROADCASTING"

While on the subject of uses for the audio amplifier of a radio set, it may be well to mention the pick-up devices now made for home "broadcasting." Such an outfit (one of which is pictured herewith) consists of a microphone, a long lead and an adapter to be plugged into the detector socket of the set. By connecting the microphone in this way, a great deal of amusement can be realized from "broadcasting" programs and announcements at home. Such devices also have another use, besides experimental amusement; in cases where it is desired to make any public announcement and more volume is desired than the unaided voice can supply, the microphone with an audio amplifier and a speaker will serve the purpose.

### MANUFACTURE OF RECORDS

The distortion in the old type of phonograph was not due entirely to the reproducer and horn used; the records themselves were made under conditions which cut off the low notes and distorted some of the higher ones. The apparatus for cutting the records consisted, fundamentally, of a large horn, a rotating ("screw-feed") mechanism and cylindrical record blanks of wax of the original type, mentioned before. The artist or artists (and there were often too many for the available space) were placed directly in front of, and very close to, the large horn. The wax record was then rotated and the needle, which was connected to a diaphragm at the small end of the horn, cut a wavy line in the wax. The wax master record was then used to make the great numbers of records which were sold.

The defects of the system were that the horn was incorrectly shaped, the diaphragm had resonant points, the artists were too closely crowded before the horn to play correctly, and the volume of the music was too weak to allow the diaphragm to be vibrated over a sufficiently wide range. The result was that the low notes were cut off because of the horn and the diaphragm, the higher notes were distorted because of the resonant frequencies of the apparatus, and the result was generally far from perfect.

### RADIO METHODS ADOPTED

Even if an electric reproducer were used with these records, the sounds would not be natural and, for this reason, the method of making records was changed most radically some years ago. The modern phonograph studio resembles the radio broadcast studio very closely. Standard broadcast microphones are used, as many of them as necessary to give the best results. They are very carefully placed, and the sounds picked up are "mixed," or proportioned so that the instruments of even a large symphony orchestra are brought out properly. The musicians do not have to play softer, or shift around, in order to prevent some of the instruments from being drowned out. All this is regulated at the control board. The sounds are picked up through the "mikes" and the audio-frequency currents passed into power amplifiers. They are then converted into the required mechanical motion for cutting the records, by using light rays with a photoelectric cell and other suitable equipment. The advantage of this is apparent; the light rays have no "time-lag" or

## Raytheon Kino-Lamp

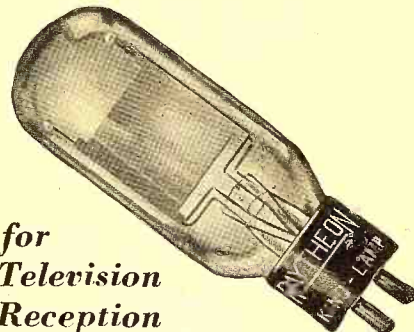

for Television Reception

This lamp is made in numerous types and styles, which provide suitable light sources and light-sensitive relays for all systems.

List Price, \$7.50

## Raytheon Foto-Cell



for Television Sending

This is an extra-sensitive broadcasting tube, supplied in either hard vacuum or gas-filled types, and in two sizes of each.

Information and prices on application

## Raytheon BH LONG LIFE RECTIFYING TUBE



for "B" Power Eliminators

Over a hundred different makes of "B" Eliminators require this tube, and take no other. There are millions of them in daily, satisfaction-giving use.

List Price, \$4.50

Write for further information on any of this equipment

RAYTHEON MFG. CO.  
CAMBRIDGE, MASS.

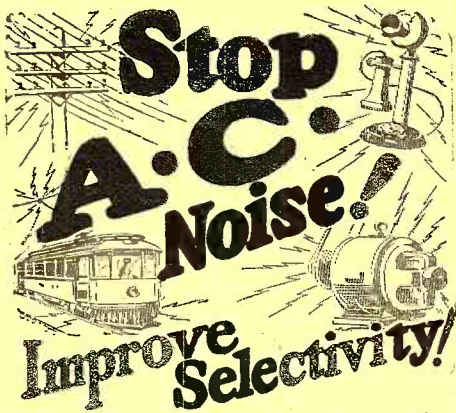

To eliminate "static" from motors, street cars, telephones and electrical appliances, plug in a Falck Claroceptor between wall socket and radio set. This new improvement by a pioneer manufacturer grounds and thus blocks out line interference noise and radio frequency disturbances. Also improves selectivity and distance. Requires no changes in set. Measures just  $3\frac{1}{2} \times 5\frac{1}{2} \times 2\frac{1}{2}$  inches. Thousands all over America now use the Claroceptor for clearer A.C. reception. Get one right away—at radio parts dealers. Write for descriptive folder.



**\$7.50**  
with cord and plug

# Falck CLAROCEPTOR

Manufactured by ADVANCE ELECTRIC CO.  
1260 W. Second Street Los Angeles, Cal.  
JOBBERs AND DEALERS, GET OUR PROPOSITION



## ARCTURUS BLUE LONG-LIFE TUBES

ARCTURUS RADIO TUBE CO.  
Newark, N. J.

Write for descriptive circulars on  
Electrad Specialized Controls.  
Dept. RN-4, 175 Varick St., New York City, N. Y.

# ELECTRAD

"inertia," and they carry all the impulses equally well, regardless of their speed or frequency. For this reason the low notes of a large orchestra or organ are heard with normal volume, while the high notes are left natural. Special cutting machinery has been developed with practically no resonant points on the audible band and this takes care of another point at which distortion might be introduced.

The fan who wants the best quality should use the new records, and should be sure of getting that type when new records are purchased.

### OTHER ELECTRICAL REPRODUCERS

Up to this point, the only unit which we have mentioned has been of the magnetic type. Besides this type, there are at least three others; the crystal, condenser, and carbon types; of these only the magnetic type is at present commercially important. One large corporation has experimented with a crystal pick-up, but this device is still in the experimental stage, and no information is available at this time as to the method of construction, or the quality obtained.

A pick-up of the condenser type was described in RADIO NEWS some time ago, but this unit is no longer on the market, notwithstanding its theoretical merits. A condenser reproducer has also been developed by one company which is interested in the use of the device for other purposes, but this unit is not at present available for public use. The condenser pick-up differs in operation from the magnetic type in the fact that it is connected to the radio-frequency section of the set. A vibrating element is used as one side of a condenser and when it vibrates, the capacity changes. A small oscillator-tube circuit is employed and the variations in the capacity of the pick-up modulate the output of this oscillator. The resultant "signal" sent through the set is very similar to a broadcast signal picked up over the air. It is amplified and detected by the radio-frequency and detector tubes, and then amplified again by the audio amplifier. A description of the device and its operation will be found in the April, May, and June, 1927, issues of this magazine; but, as we have said, it is not being manufactured now.

Pick-ups of the carbon type have been known for a number of years, but only a few which will supply a high quality of reception have been developed. Such a pick-up depends for its operation on the changes of resistance in a mass of carbon granules when they are alternately compressed and released. This is the same principle as that used in the ordinary hand microphone or telephone transmitter (See RADIO NEWS for May, 1928, page 1206). When the needle vibrates, it compresses or releases the carbon grains in a small box attached to the unit. This type of pick-up is somewhat different from the magnetic type and is designed to operate a speaker without the use of an amplifier.

As explained above, however, the only type which is as yet of commercial importance is the magnetic, which is both cheap in production and good in quality. The difficulties of design are comparatively small and are easily overcome by the use of good material and careful consideration of the parts which might cause distortion or noise.



## New "Aero Call" Short-Wave Converter Shielded, Filtered

FACTORY-BUILT, READY TO PLUG INTO YOUR PRESENT RADIO SET

The Aero 1929 Converter is a compact factory-built short-wave adapter equipped with special short-wave coils. It is designed for both A.C. and D.C. sets. Operates perfectly on A.C. or D.C. sets without motorboating, by an auxiliary filter system control. It can be plugged instantly into any regular radio set. This amazing radio instrument now makes it possible for you to reach 'round the world—England, Germany, Holland, Australia, Panama, Java and many foreign stations are some that are tuned in regularly on short wave. Permits you to enjoy international programs and many others from coast-to-coast that your regular receiver cannot get. What a thrill it is to plug this into a tube socket on your regular set and instantly be in another world! No change or wiring required. All complete, ready to operate, tubes and coils hidden, no apparatus in sight, except the neat, golden-brown, compact metal cabinet in crackle finish. Size,  $9\frac{1}{2} \times 5\frac{1}{2} \times 2\frac{1}{2}$  in. The only converter we know of that really works on all sets. Two models—A.C. and D.C. Write for Catalog and literature, or send \$25.00 and name of your dealer.

Model A, without tube, for A.C. sets \$25.00  
Model D, without tube, for D.C. sets \$25.00

At leading dealers' and jobbers'

## AERD PRODUCTS INCORPORATED

4611 E. Ravenswood Ave. Dept. 1449  
CHICAGO, ILL.

## The FUTURE By Professor A. M. Low

"THE FUTURE" is one of the most remarkable books of the age. Professor Low, the author, is a scientist of international reputation, also an experimenter and inventor in the many branches of science. This book written by him has aroused wide-spread interest. It deals with the world of the future, certainly an unusually absorbing subject. Written in the popular, non-technical fashion, "The Future" reveals the many advances and changes that are in store for humanity in a new life to come.

This book has received favorable comment in book reviews the world over. Do not neglect to read this treatise on the future by Professor A. M. Low. It is a literary treat for everyone.

Mail your order now! Don't wait, everybody is reading this remarkable book,

**Price — \$2.00**

Experimenter Publishing Co.  
230 Fifth Ave., New York, N. Y.

Gentlemen: Enclosed find check or money order (check which) for \$2.00. Kindly send me a copy of Prof. A. M. Low's new book "THE FUTURE."

Name .....

Address .....

City..... State.....

Sent Prepaid Anywhere in the U.S.

Real Good News for Radio Builders

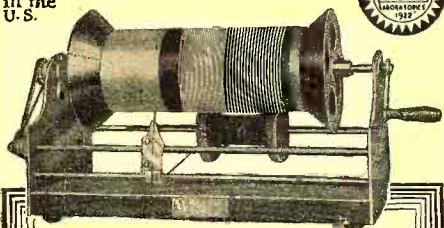

You can get the **WIZARD WIRE WINDER \$7.50** for only

Saves hours in time and waste. Winds automatically any thickness of silk, cotton or enameled wire into practically any STYLE COIL, Spaces perfectly. Strongly built. Ready for instant use.

ORDER NOW!!!

We'll send your Wizard C.O.D. or you can enclose \$7.50 with your order—either way we pay the postage.

**WIZARD WIRE WINDER CO.**  
6706 South Main Street  
Dept. X  
Los Angeles, Cal.

Sold on an Absolute Money Back Guarantee

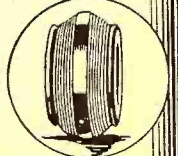
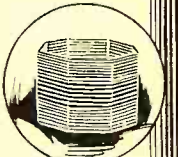
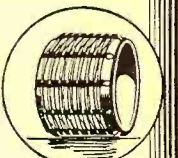

**TUNE IN ON THE SHORT WAVES**

Get distance—escape static on the long wave broadcast band. See Call Book for short wave stations. SUBMARINER wave band includes all powerful stations that broadcast programs on short waves—thousands of SUBMARINERS now in use—short waves are the new adventure—a new thrill awaits you. Short Waves Popular. The SUBMARINER has taken the country by storm. Nothing made like it. Many users have been getting London, England; many get Holland, even in summer. Short waves are great distance carriers, with less static.

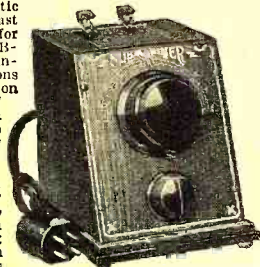

Your present radio receiver, whether battery operated or all electric, will bring in short wave broadcasting when used with **THE SUBMARINER**. Simply remove a tube from receiving set and place in SUBMARINER socket; then insert SUBMARINER plug in place of tube. Attach regular aerial and ground to clips on SUBMARINER. That's all. No changes in wiring of set necessary. No additional tubes or batteries required. If set operates a loud speaker, it will do so with SUBMARINER. We guarantee that the SUBMARINER will operate within the wave band covered equal to any short wave receiving system known when attached to your receiver. Completely shielded metal cabinet. Fine tuning dial, ratio 32 to 1. Get the short wave musical programs and other activities, including television signals. Never before has so much in radio been offered for so little money! Order a SUBMARINER now!

**FOUR MODELS:**  
20 to 65 meter range—for battery operated radios, \$15.00. For all electric radios, \$17.50. 10 to 160 meter range—for battery operated radios, \$22.50. For all electric radios, \$22.50. 10 to 160 meter range models have three interchangeable coils. A fourth coil: 100 to 340 meter range will be supplied when specified as extra equipment—price \$2.00.  
If your dealer does not carry, order direct from factory. Sent anywhere in the U. S. postpaid upon receipt of price. Canada and Foreign, 60c additional. Money order only. Also sent C.O.D. plus postage in U. S. if \$1.00 accompanies order to insure carrying charges. In ordering be sure to name set and tubes used, such as UV199, UX199, 201A, UX226, or UV227. See dealer or order direct today. **J.-M.-P. MANUFACTURING CO., Inc.**  
3409 Fond du Lac Ave. Milwaukee, Wis., U. S. A.

**FREE Wholesale Radio Catalog**  
**Set Builders-Dealers! Save Money!**  
Send for the most complete book of nationally known Parts, Kits, Cabinets, Consoles, Speakers, Power Units, Sets, etc. All at lowest wholesale prices. Quick service on all your needs. Write now, it is FREE—  
**SETBUILDERS SUPPLY CO.**  
Dept. 1314 Romberg Bldg. Madison and Market Sts. CHICAGO, ILL.

Insure your copy reaching you each month. Subscribe to RADIO NEWS—\$2.50 a year. Experimenter Publishing Co., 230 Fifth Ave., N. Y. C.

**Light-Sensitive Cells**

(Continued from page 911)

this manner, the action of an automatic lighthouse is duplicated with startling realism.

Toy-trains may be controlled, using the same circuit; a flashlight being employed as a source of illumination for this experiment as well as any others which suggest themselves to the experimenter.

**A LIGHT-CONTROLLED PET**

As an example of what may be accomplished by the ingenious constructor, the reader is referred to the July, 1923 issue of RADIO NEWS; an article in this number describes a development by John Hays Hammond Jr., comprising two light-sensitive cells in combination with suitable components, mounted on wheels, which could be made to perform many complex maneuvers.

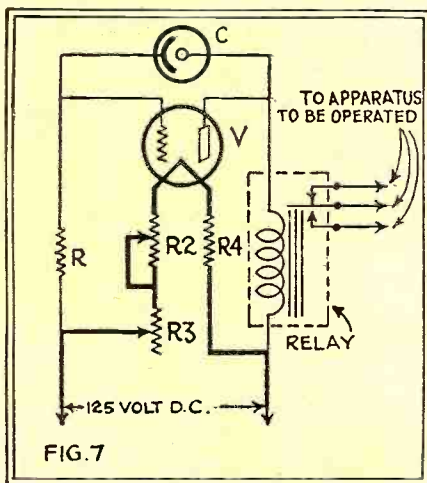

How a photoelectric cell operates a relay to open a door or throw a switch, etc.

By throwing a flashlight on the cells Mr. Hammond was able to make the "Electric Dog," as he termed it, follow him about, turn in circles or (by reversing the current to the motor it contained) back away from him or, more properly, from the source of light he controlled (Fig. 6).

Among some of the practical applications suggested is a highly-desirable arrangement for closing the windows with the coming of daylight. This same circuit may include, also, an arrangement for firing the boiler, lighting the stove, heating the morning coffee, and, for our modest readers, pulling down the shades. In these cases, of course, suitable motors or other electrical accessories will be needed.

**AN AUTOMATIC DOORKEEPER**

For those interested in these experiments, the opening of a garage door with a beam of light from the car's headlight or from the usual flashlight, is something at once practical and thrilling. In accomplishing this stunt, a light-sensitive cell employing the photoelectric effect was utilized; the circuit diagram is given in Fig. 7, wherein R is a 20-megohm resistor, R2 a 200-ohm resistor, R3 a 50-ohm variable resistor, and R4 a 420-ohm fixed resistor. The high-voltage current may be taken direct from a D.C. lighting main, or can be supplied from a "B" power unit or a set of "B" batteries. Several different tubes have been tried

**WHATEVER YOU WANT TO KNOW**  
about RADIO—principles, methods, apparatus — you will find instantly in

**THE RADIO MANUAL**  
A Complete Course in Radio Operation In a Single Volume

A Handbook for Amateurs Operators Inspectors

For the first time an entire course of training in one book — the most complete and up-to-date work on radio. Developed simply and clearly from the elementary stage right through all phases of principles, practice, and apparatus so that a beginner with no knowledge of electricity may get all he needs either for amateur operation or to qualify for a government license as operator or inspector.

**Prepared by Official Examining Officer**

The author, **G. E. Sterling**, is Radio Inspector and Examining Officer, Radio Division, U. S. Dept. of Commerce. The book has been edited in detail by **Robert S. Kruse** for five years Technical Editor of QST, the Magazine of the Radio Relay League. Many other experts assisted them.

**16 Chapters Cover:** Elementary Electricity and Magnetism; Motors and Generators; Storage Batteries and Charging Circuits; The Vacuum Tube; Circuits Employed in Vacuum Tube Transmitters; Modulating Systems; Wavemeters; Piezo-Electric Oscillators; Wave Traps; Marine Vacuum Tube Transmitters; Radio Broadcasting Equipment; Arc Transmitters; Spark Transmitters; Commercial Radio Receivers; Radio Beacons and Direction Finders; Radio Laws and Regulations; Handling and Abstracting Traffic.

**New Information** never before available such as a complete description of the Western Electric 5-Kilowatt Broadcasting Transmitter; description and circuit diagram of Western Electric Superheterodyne Radio Receiving Outfit type 6004-C; Navy Standard 2-Kilowatt Spark Transmitter; etc.; etc. Every detail up to the minute.

**Free Examination**  
"The Radio Manual" has just been published. Nearly 700 pages. Profusely illustrated. Bound in Flexiblo Fabricoid. The coupon brings the volume for free examination. If you do not agree that it is the best Radio book you have seen, return it and owe nothing. If you keep it, send the price of \$6.00 within ten days.

**Order on This Coupon**

**D. Van Nostrand Co., Inc.,**  
8 Warren St., New York

Send me THE RADIO MANUAL for examination. Within ten days after receipt I will either return the volume or send you \$6.00, the price in full. (Radio News 4-29)

Name .....

St. & No. ....

City and State .....

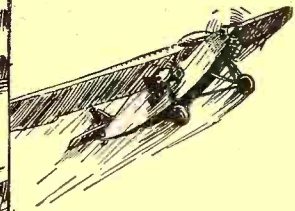
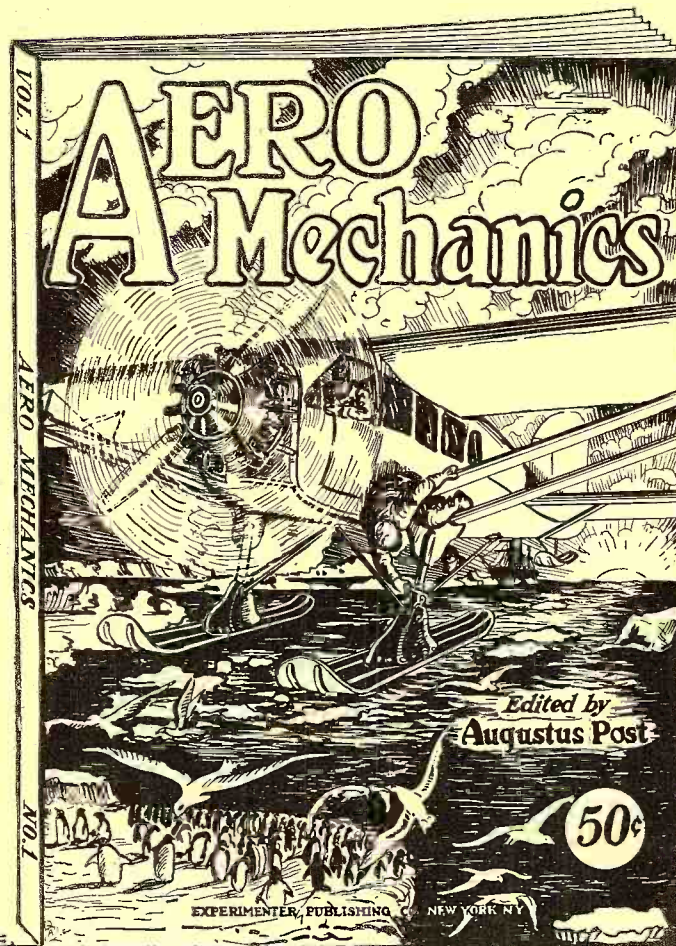

# AERO MECHANICS—THE BOOK OF THE AGE

The greatest book on modern aviation ever published. The many ramifications of the aeronautical field that it covers can be better appreciated by a glance at a synopsis of its contents.



**MR. AUGUSTUS POST**  
Editor of AERO MECHANICS

Mr. Augustus Post, editor of AERO MECHANICS, has been prominent in aeronautical circles throughout the country for over twenty years, his experience and adventures have made aviation history and placed him in a position to pass on to the readers of AERO MECHANICS honest, accurate and entirely dependable information on every phase of Aviation. Says the *North American Review* of Mr. Post: "No man in America has been more continuously at the centre of aeronautic activities in this country, and in touch with more history-making airmen here and abroad, than has Augustus Post who, besides having the "history of the air" in his head, has personally participated in some of the most thrilling adventures of aviation."

### CONTENTS IN BRIEF:

- Theory and Fundamental Principles of Flight.*
- Stability—How an Aeroplane Flies.*
- Complete Design, Construction and Assembly.*
- Scale Drawings—Names of Parts.*
- Flying Instructions—How to Become a Flyer.*
- Motors—Latest Inventions—Instruments, Use and Function.*
- Radio Installations.*
- Gliders.*
- Airports and Lighting.*
- Glossary of Aeronautical Terms.*
- The Aeroplane Mechanic.*
- Model Making.*

AERO MECHANICS, written by Augustus Post, is the most complete treatise of its kind ever published. It deals with every phase of aeronautical construction and operation, and its entire contents is passed upon by Mr. Post, who is one of the best known pioneers of aviation. Learn all about this great new field. Obtain your copy of AERO MECHANICS today. Over 112 pages. Fully illustrated. Large 9" x 12" size.

**THE 50c COPY**  
At All Newsstands, or Write Direct  
**Experimenter Publishing Co., Inc.**  
230 Fifth Avenue, New York City

EXPERIMENTER PUBLISHING Co., Inc.  
230 Fifth Ave., New York City, N. Y.

Gentlemen:

Enclosed find 50c, for which please send me a copy of your remarkable new book, AERO MECHANICS.

Name .....

Address .....

City..... State.....

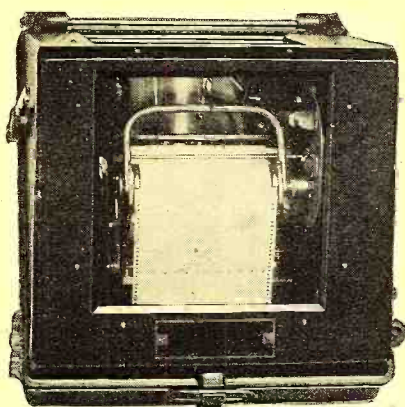

Fig. E

The apparatus shown above is a typical commercial design of a recorder which makes a graph in ink showing the amount of light which has fallen on it each minute during the day.

in this circuit; but the 112A-type has proved most satisfactory. When the cell is in darkness, about 0.25-milliamperes flows in the plate circuit of the vacuum tube; but when a flashlight is placed close to the cell, a current of about 6.25 milliamperes flows.



Fig. F

Above we have illustration of another type of photoelectric cell. This is over a foot long and presents a very large "window" to a light-source. It is a gas-filled tube.

### Aerials and Grounds for Short-Wave Reception

(Continued from page 919)

librium or balance of the electrical forces of the world. It is a "wave," because a definite time is required for the impulse to be felt over a given distance; and consequently many alternations, or changes in the electrical arrangement at one place, may take place before the first of them is felt at the receiver. We have read how new stars light up, and are extinguished, again, hundreds of years before we see the conflagration. So, on a smaller scale, half a million radio alternations may be sent into space at New York before the wave set in motion by the first arrives at Melbourne, Australia.

In Fig. 2 we look down on the aerial and its surrounding waves; unfortunately, we can see here but one cross-section, horizontally, through the field. The impulses are spreading out in every direction from the vertical aerial; electric lines of force (perpendicular to the paper) in an electrostatic field and magnetic lines of force in an inductive field revolving round and round in directions changing with the flow of current. These two types of lines of force are simply two directions in which a very complicated form of energy is exerting itself; and one does not exist without the other.

In Fig. 3 we have a classic example of an illustration of the wave: the electric field is a membrane—like a sheet of rubber, with a rod attached to its center, so that it can be moved up and down. A very slight motion up and down causes waves to roll outwards from the center, their height increasing as they spread. (A fixed-edge cone speaker illustrates formation of waves

The relay should have a resistance of 8,000 ohms or thereabouts. It is easily operated by a flashlight at a distance of ten feet from the cell. The relay actuates at about 2.5 to 3 milliamperes, and will "hold down" at about 1.0 to 1.5 milliamperes. The garage door may be slid or swung by a suitable motor drive; or an even simpler method is to arrange a self-actuating system whereby the relay, when operated, releases a trip holding the door; a sufficiently powerful spring or counterweight, depending upon the operation of the door, does the rest.

Obviously, the light-sensitive arrangement in the above application must be equipped with some form of cover; so that it can be turned off during the day and actuated at night. With this arrangement, it is necessary only to drive up in front of the garage door, as is the usual custom, and turn on the bright lights of the car; this will supply more than enough illumination for the purpose.

The light-sensitive cell used in this experiment was spherical and gas-filled, mounted upon a standard tube base so that it may be inserted into a UX socket, and is known as a 3GS; its ionization voltage is about 150.

of this kind in its diaphragm.) However, as we have said, this represents only one cross-section of the wave, which is moving in three dimensions. Let us consider how it is to be met at the other end.

#### THE WAVE RECEIVED

In Fig. 4A we have schematically represented an aerial of the ordinary outdoor type, directly coupled to the grid of a vacuum tube. If it is encountered by an advancing electromagnetic wave, the latter exerts a pressure on all the free electrons in the system, tending to rearrange them. The result is a flow of current, resulting from the rearrangement. As a matter of fact, in any antenna system, hundreds and thousands of waves are crossing and recrossing; and the actual current flow in the system is the composite of them. If a nearby transmitter sends waves to which the antenna is resonant, or nearly so, the influence which it will exert is so great that ordinary tuning methods will not eliminate its effects. However, if the signals being received are nearly of a strength, we may tune the aerial to one particular wavelength, and the flow of current in it will conform to this frequency.

We can use this current in a receiver, however, in only one way—that is, if we have the usual vacuum-tube amplifier and detector. We must convert it into a voltage or potential difference between the grid and the filament of a tube; that means, we must find some way to obstruct the flow of that current. At the same time, that current, in the case of a distant short-wave station,



## Big Pay Jobs for You in Electricity

You Learn by Seeing It Work

NOW you can fit yourself for a big pay job in electricity by watching real motion pictures in your own home! Easy and fascinating as seeing a show at the theater! You see electrical machinery in operation. Moving diagrams make all the facts easy to understand.

### Easier, Quicker, Surer

Radio and other branches of electricity need men to fill jobs paying from \$70 to \$200 and more weekly! Practical electrical men praise this new way as the easiest and best way to learn how to do electrical work.

### You Get This Pledge

We promise in writing to give you the training and employment service necessary to get you a better job and more money, or you need not pay a cent.

### \$75 Projector Given

Every student is given a DeVry Motion Picture projector to keep, at no extra cost. So simple anyone can operate it without experience. Used with regular light socket, farm lighting equipment, or automobile battery. Thousands of feet of motion picture film are supplied.

### FREE Our Big New Book, "The Film Way to Bigger Pay"

Tells how we use moving pictures to train you for bigger pay. Get your copy now. Send the coupon. Representatives with School Experience, Write.

### The NATIONAL SCHOOL of VISUAL EDUCATION

"The Film Way to Bigger Pay"  
 537 S. Dearborn St., Chicago, Ill., Dept. 4-N  
 Send your book, "The Film Way to Bigger Pay," with full facts about this new, easier way to master Electricity.  
 Name..... Age.....  
 St. or R.F.D.....  
 City.....  
 State.....

# NEW NORDEN-HAUCK MODELS

ARE  
NOW READY

- Super Electroponic
- Shielded Super-10
- Super Dynamic Speakers
- Power Packs
- Short-Wave Apparatus
- Etc.

Write Today for New Literature

NORDEN-HAUCK, INC.  
Engineers  
Marine Building  
Philadelphia, Pa.

## A CHALLENGE



NEW—  
**Solve them!  
if you can**

HERE are 116 pages of extraordinary puzzles. Sam Loyd, the master puzzler, has devised a new set to try your mind. Puzzles of all sorts, with a special 26-page section of scientific puzzles for the mechanic, the engineer or the man with a scientific trend of mind. It is fine fun and excellent training for the mind.

Get the Book Now  
Sam Loyd's Tricks and Puzzles

**50c**

On All Newsstands, or Direct  
EXPERIMENTER PUBLISHING CO.  
230 FIFTH AVENUE NEW YORK, N. Y.

is so minute that we cannot afford to waste it.

The inductance of a coil L, placed across the filament (which is grounded) and the grid (which is connected directly to the aerial, as at A), affords opposition, or *reactance*, to the flow of the alternating signal current. The current is driven into the tuning condenser between the coil and the tube, and builds up a voltage until the current has ceased to flow. This voltage is impressed on the tube grid; it begins to fall as the stored energy of the condenser is driven back through the coil; and its alternations are recorded in the output of

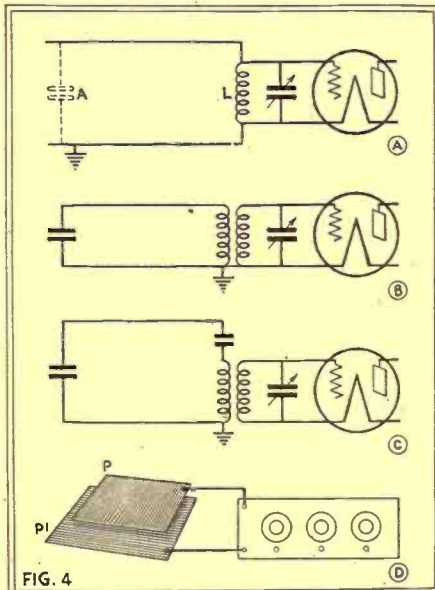

FIG. 4  
The ordinary type of aerial, showing schematically the effect of condensers in tuning it. At D, a condenser-type aerial actually tried.

the tube, the last determined by the nature of the circuit used.

### AERIAL TUNING

It will be noted that the aerial forms a capacity with the ground—the two represent the plates of a condenser of very large size, but of small capacity—and that this is in parallel with the tuning condenser. For this reason, in addition to the self-capacity of the tuning coils, wires, etc., it is impossible to tune a circuit to as short a wavelength as the minimum capacity of a condenser would suggest. A condenser with a maximum of, say, .00015-mf. has a minimum capacity of .000005-mf. This would suggest that it should tune over a range from, say, 33 meters down to 6 meters (the wavelength increases or decreases with the square root of the capacity); while, as a matter of fact, if it will cover a third of that range of frequencies, the circuit is low-loss.

If we arrange the circuit as at B, the tuning condenser is no longer across the aerial; and the tune of the antenna is determined by its natural inductance and capacity. This inductance is coupled magnetically to the tuned secondary circuit which, therefore, does not respond to its own inductance alone; but is affected also by the "mutual inductance," or effect upon it of the aerial coupler. This is one reason why single-control tuning becomes increasingly difficult on the very short wavelengths.

The commonest method used is shown at C; a small condenser is placed in series be-



Complete instruction course in three volumes. Every point of aviation efficiently and thoroughly treated. Subjects covered in these volumes—



MODERN AIR CRAFT

700 Pages  
500 Illustrations

Contents of each chapter—  
I. Aircraft Types. II. Lighter-than-Air Craft. III. Early Airplane Designs. General Design Considerations. IV. Design and Construction of Aerofoils. V. Arrangement, Fabrication and Bracing of Airplane Wings. VI. Airplane Fuselage and Landing Gear Construction. VII. Airplane Power Plant Types and Installation. VIII. Aviation Engine Design and Construction. Air-Cooled Engines. IX. Aviation Engine Design and Construction. Water-Cooled Engines. X. Aviation Engine Auxiliaries. XI. Aircraft Propeller Construction and Action. XII. Airplane Equilibrium and Control Principles. XIII. Uncrating, Setting Up and Aligning Airplane. XIV. Inspection and Maintenance of Airplanes and Engines. XV. Details of Modern Airships and Airplanes. XVI. Seaplanes, Flying Boats, Amphibians and Other Aircraft. XVII. Some Aspects of Commercial Aviation. XVIII. Aircraft Instruments and Aerial Navigation. XIX. Standard Nomenclature for Aeronautics Report No. 240, Part I.

This book is written in simple, understandable language.

PRICE \$5.00

### AVIATION ENGINES

This treatise, written by a recognized authority on all of the practical aspects of internal combustion engine construction, maintenance, and repair, fills the need as no other book does. The matter is logically arranged; all descriptive matter is simply expressed and copiously illustrated, so that anyone can understand airplane engine operation and repair even if without previous mechanical training. This work is invaluable for anyone desiring to become an aviator or aviator mechanic.

274 PAGES

PRICE \$1.25



### A. B. C. OF AVIATION

This book describes the basic principles of aviation, tells how a balloon, or dirigible is made, and why it floats in the air. Describes how an airplane flies. It shows in detail the different parts of an airplane, what they are, and what they do. Describes all types of airplanes and how they differ in construction, as well as detailing the advantages and disadvantages of different types of aircraft. It includes a complete dictionary of aviation terms and clear drawings of leading airplanes.

PRICE \$1.25

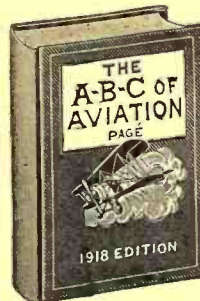

Remit by cash, stamps, check, or money order  
No C.O.D.'s

We Pay Postage On All Books

CONSRAD COMPANY, Inc.  
230 FIFTH AVENUE NEW YORK

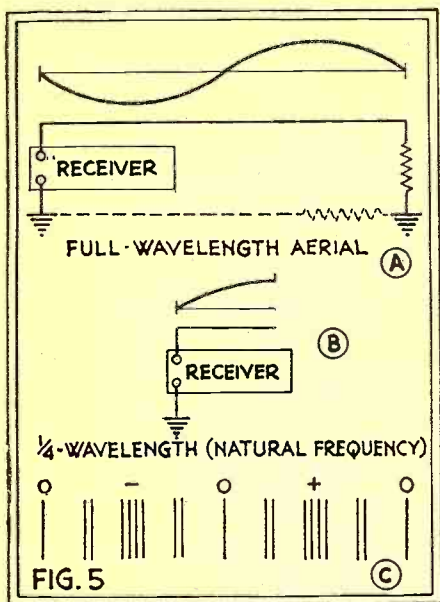

If an aerial were the full length of the wave received, there would be no voltage difference between its two ends. The natural wavelength of an aerial is four times its actual length.

tween the aerial and the primary coil. The result is that the aerial is "shortened," because its total capacity value is reduced below that of the aerial condenser. The latter, if its value is properly regulated, will tune the aerial to an incoming signal, and enormously enhance the response. It is therefore one of the most important adjuncts to short-wave reception.

If the aerial is only one plate of a condenser, why can we not hook our aerial and ground posts to a condenser and receive? As a matter of fact, some years ago the Bureau of Standards made tests on an antenna of this type. Two metal plates (copper screening was used satisfactorily) were separated about 32 inches and connected to a receiver and signals were measured. The lower plate was larger than the upper, to shield it from the ground, but was only 16x18 inches. The wavelength of the antenna was estimated at 16 meters. (Fig. 4D.)

However, for a longer wave, it would be desirable to increase the size of the antenna system; because, after all, and notwithstanding the fact that partisans of "kilocycles" say that "wavelengths" are obsolete—a wavelength is a physical fact.

THE NATURAL FREQUENCY

It is commonly stated, as most readers know, that an aerial has a "fundamental frequency" equal to that of a wavelength four times its own length. In other words, an aerial 10 meters (32 feet 9.7 inches) in length—including lead-in—has a fundamental or natural frequency of 40 meters. The reason is that, as shown in Fig. 5 at B, the quarter-wavelength represents the greatest uniform tendency, toward creating a voltage, set up by a wave of a certain strength. At half a wavelength, the difference may be between "+ Max." and "- Max." or it may be between 0 and 0. At a full wavelength, the two ends of the wire will be always at the same potential, as shown at A. An aerial over a wavelength long may have one end grounded, if there be sufficient resistance in the exterior circuit, without "shorting" it, as would be the case with the quarter-wave type; the latter is more selective, and more critical. The longer wire

allows the flow of more current, and gives a better pick-up; but if there is interference, it picks that up also, and signals as well on longer waves. The rule, therefore, arrived at by amateurs, is that it is better to use an aerial shorter than the quarter-wavelength of the signal which is desired. On the other hand, in transmitting, a longer aerial is used.

It must be borne in mind, also, that there are some limitations which should be observed. An amateur is forbidden to couple the oscillating circuit of his transmitter directly to the aerial. The reason is that the range of a short-wave transmitter is so tremendous that it is necessary to minimize radiation. A receiving set with an oscillating tube coupled directly to the aerial, as in Fig. 4A, would be a transmitter of the type prohibited; and even a 201A tube, with its small output, is capable of sending a radiated signal a long ways. For that reason, this direct coupling should not be used. The addition of a screen-grid amplifying tube ahead of the oscillating detector in a short-wave set is becoming necessary as a precaution; just as a stage of amplification ahead of a regenerative detector is required in broadcast receivers. Previous to the development of the screen-grid tube, R.F. amplification at very high frequencies was not practicable; but it is now quite successful. It will be preferable to bring up signals by tuning the antenna, rather than try to "lower its resistance" by oscillating into it from the detector plate circuit.

We have commented on the skip distance; Fig. 6 may help to make it clearer. Suppose radiation escaping from an aerial at the top of the figure; it cannot enter the earth and, consequently, if the wave pursues a straight path, it cannot be received at a point below the horizon of the aerial, and consequently out of sight. This is true of very short waves, while longer ones cling to the surface of the earth and bend round it. The short waves above the horizon continue out until they encounter the "Heaviside layer," from which they are turned back toward earth; not sharply, as from a mirror, but gradually. After they come down to earth again, outside the first "skip-distance" ring, they are again detectable for a distance, depending on the angle of their refraction. Then there is another "skip-distance" and perhaps another zone of reception, and so on. Much experiment is now being made to determine skip-distances most accurately; as upon this knowledge depends the future success of international short-wave broadcasting. The effect of daylight upon transmission of this kind is disconcerting to the effect to maintain a long program, though very good results at long range are obtainable when conditions are at the best.

AN ALL-AROUND AERIAL

Unfortunately, many of the things that should make for high receiving efficiency are of no use to the broadcast listener who is desirous of bringing in *everything*. If he could specify, like the transatlantic telephone service, that he wanted to receive from a certain transmitter three thousand miles away, and from no other source, the engineers could give him a blueprint of a system that would work wonders. As a matter of fact, a good many broadcast listeners get the transatlantic telephone, though not quite as satisfactorily, perhaps, as the gentleman who is paying \$5 a minute

Here's a...  
half-hour with  
Walter Hinton  
about  
Your Future  
in Aviation



HOW would you like to sit face-to-face with Walter Hinton and talk to him like this:

- "Just what does Aviation offer ME?"
- "How can I become a pilot?"
- "What kind of 'ground jobs' are open?"
- "What training is needed to get into the real-money class?"
- "Why should I get into Aviation Now—instead of a year or two from Now?"
- Would you like to put questions like these up to the man who was first to fly the Atlantic—first to fly from North to South America? If you would, send for "Wings of Opportunity."

Hinton is Ready to Talk to You NOW

"Wings of Opportunity" is more than a FREE book. It is virtually a FREE interview with a world-famous aviator and one of the industry's recognized leaders.

In it, Lieut. Hinton shows you why Aviation offers the BIGGEST OPPORTUNITIES that men of this generation will ever see—and why those who wake-up, look and act-ahead NOW—will CASH IN.

You'll see how Hinton is preparing ambitious, farsighted men right at home for real-pay jobs on the ground and in the air in all branches of Commercial Aviation.

Without sacrificing your present job or investing a lot of money you can get Hinton's help. That means the ground work training, PLUS his personal advice and co-operation and the FREE assistance of his Employment Bureau which is placing men in real jobs at real pay right along.

"Wings of Opportunity" tells you How and Why. If you are over 16 years of age, clip the coupon.

Aviation Institute of U. S. A.  
WALTER HINTON, President  
1115 Connecticut Ave., Washington, D. C.

**Mail Now for Facts**

Walter Hinton, President,  
Aviation Institute of U. S. A.,  
1115 Connecticut Avenue, Washington, D. C. **5-S**

I want to know what you think about MY future in Aviation. Send my FREE copy of "Wings of Opportunity" quick.

Name.....  
Street..... Age.....  
(Must be over 16)  
City..... State.....

# Short-Wave Manual

Prepared by Eminent Short-Wave Experts

Edited by H. M. BAYER, Tech. Editor of RADIO NEWS

Up-to-the-Minute Data — All Worth-While Circuits

**50c**

THE COPY

FULL SIZE BLUEPRINTS BOUND IN BOOK

As practically every one today knows, some of the finest programs are being broadcast over the short-wave bands. There are many reasons for this. Paramount among them all is the fact that that entertainment, broadcast in this band, can be received over distances which with the ordinary broadcast receiver would be impossible! Thousands of letters, which pour in an unremitting stream into our offices tell the same tale—it is a common and everyday matter to receive programs from all foreign countries, from the most distant climes. England, France, Germany, towns on the African continent, from every conceivable corner of the globe where a station is located—programs come in with surprising volume and clarity. One would think they were hearing a New York, Chicago or San Francisco station until the voice of the announcer, many thousands of miles away discloses the true location of station.

In the SHORT-WAVE MANUAL you will find complete diagrams, full size blueprints pasted into the book. These tell plainly how to construct all these short-wave circuits, which our tireless laboratory researches have shown to be most efficient.

The SHORT-WAVE MANUAL contains complete information on everything concerning Short-Wave reception. Large size book (same size as Radio News) with a beautiful colored cover. Replete with illustrations, diagrams and will FULL SIZE BLUEPRINTS. This big valuable book will show you how to receive all the foreign countries clearly and easily. Write today for your copy.

EXPERIMENTER PUBLISHING CO., Inc.

230 Fifth Avenue New York

Mail This Coupon

EXPERIMENTER PUBLISHING CO.,  
230 Fifth Avenue, New York.

Gentlemen:

Enclosed find 50c for which please send me a copy of THE SHORT-WAVE MANUAL.

Name .....

Address .....

City..... State.....

for his call. But, in order to receive also Australia and Java at their strongest, one will require a receiving system pointed in a different direction. (What, may be another question; the shortest line from New York to Java runs through the North Polar regions, but radio waves at long distances do not follow exactly the shortest path, because of their reflection and refractions.

It is well known that a loop gives a much stronger response when it is set edgewise toward the direction of a signal; the same is true of a horizontal aerial pointed away from the station received (See Fig. 7). A vertical aerial, on the other hand, should receive with equal strength from any direction; and the practical combination at which we arrive is an aerial with both a horizontal member, and a nearly vertical lead-in, which alters its characteristics. This is not as sensitive in the direction of its length as if it were brought directly in to the set, without bending it; but it has more strength of signal in response to a wave advancing from one side, to which the straight horizontal wire aerial would be almost unresponsive, if not entirely so.

We have therefore only the following advice for the broadcast listeners who are fortunate enough to be able to follow their fancy in aeriels: every collecting system is stronger in one direction than it is in others. Two aerial systems, one at right angles to the other, with switches permitting a choice, will give the option of greater signal strength in two directions. It would be well to have one of them pointing, approximately, away from the station which it is desired to make a standby for distance reception. Such a line should follow the great circle course—say to England and Holland, which are close enough together for the purpose of regarding them as one, from America; they are about east-north-east from New York. Another at right angles to this would afford a greater opportunity of reception from the southern hemisphere.

Since an aerial for broadcast reception on the longer waves is intended to receive 200- to 550-meter signals, it might be 164 feet long and keep below the quarter-wavelength of the shortest wave. But, with a 50-meter wave, 41 feet would be a long aerial; and at 15 meters, 12 feet over all would be suggested. However, unless such a short collector of energy were tuned, it would be advisable to use the longer aerial with a very small series condenser, and loose coupling (variable) to the secondary. A very small degree of coupling at such enormously high frequencies is sufficient.

For this same reason—the penetration of the high frequencies into the dielectric—it is necessary to keep a short-wave aerial away from other objects more carefully than other collecting systems. A mast, a tree, the eaves of a house, all offer slight losses (Fig. 8). For that reason, some use a single straight wire, brought in through the center of a window pane, or through a glass bowl, as aerial and lead-in. It is, however, more directional than the bent aerial.

### HOW WAVES WIGGLE

We have considered the vertical aerial; it is non-directional, and it is used for transmitting quite frequently. Though there are certain difficulties connected with its erection, why should it not be the ideal for the broadcast listener?

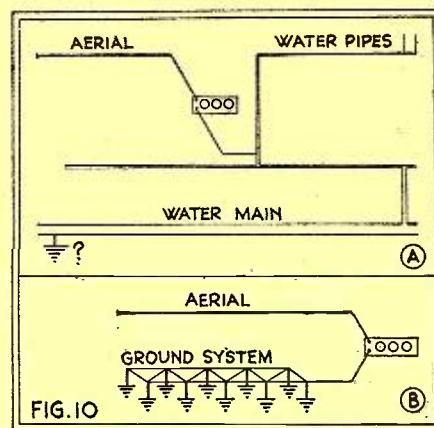

FIG. 10  
The set is connected to a "ground" which is often much larger than the aerial. What is the ground connected to? At B we have a system often used by amateurs and DXers.

Undoubtedly it would be an excellent addition to our proposed optional horizontal aeriels—one pointing west and the other south. It would pick up some signals to which neither of them would respond. But it would not be a panacea. Some years ago the vertical aerial was considered the thing for short-wave reception. Then Dr. Pickard, a leading radio engineer, investigated; he built an ideal aerial for reception: it was of the Hertzian type, with long, opposite rods, as in Fig. 1A. It could be turned to any angle with the horizon, from horizontal to vertical; it could be turned to any point of the compass. Its length could be adjusted—within reason—to any of the short wavelengths on which it was to receive. The only trouble was that a tower as illustrated (Fig. 9) was needed for the mounting of the aerial; as the receiver had to be in the middle of it. The short-wave fan who wishes the perfect aerial may try this stunt. It can be adapted to anything; except that for the sixty-meter band a tower (built of wood) about sixty feet high will be needed and, also, a good highly-insulated swivel mounting of considerable strength.

What this experiment showed was that, though waves are emitted vertically from a short-wave transmitter, they have turned on their side after going a few miles; and, from say sixty to three hundred miles away, the horizontal aerial wire receives them more strongly. After a few hundred miles more, the advantage in favor of horizontal reception dies away. Another curious thing is that the waves emitted horizontally do not turn over—but apparently a short wave has the same objection to standing upright that a cat has to landing on its back. These conditions, of course, do not prevail with the much longer waves of even the highest amateur band.

### WHAT IS THE GROUND SYSTEM?

We have now a short, selected aerial, of heavy wire (theoretically copper tubing of a fair size might be better, for high-frequency current flows on the surface) protected against corrosion by enamel and heavily insulated. It is spaced very carefully away from all nearby conductive objects until it is connected to its condenser in the set. Then we attach our ground—to what?

A glance at Fig. 10 shows us that the ground system is often composed of a mass of metal several times the length of the aerial, and exposed to radio waves. Consequently, we may take the aerial com-



pletely off and find that signals come in without change in strength. We will probably find that local "harmonics," at least, do not show the loss of the aerial by the slightest falling off. For that reason, for short-wave work, we may find the ground a source of trouble. It will be well to experiment.

In the country, or even the suburbs, where the short-wave fan may control the ground beneath his aerial, an excellent ground is secured by driving several metal pipes to moist earth and connecting them by wire to the ground lead of the set, as shown at Fig. 10B. This reduces the "antenna resistance," which is important when we are putting power into it; and should be considered when we are trying to get the most out of what little power it can pick up out of the air for itself. The ground is part of the antenna; and should be of very low resistance, as well as the aerial. The only place where it is desirable to check the flow of signal current—except on very strong signals—is in the reactance of the tuned circuit across the first tube grid, where it will create a voltage that counts in results.

In conclusion, a few suggestions may be repeated as to making connections to set and antenna, if the conventional type of the latter is to be used:

Try every accessible ground; quite often it will be found that a combination of two or three grounds gives better results than

one. First try each singly; then try them in combinations. The one, or the combination, giving the greatest signal strength on a station which has been tuned in to test the different arrangements should be used. If water pipes or radiator pipes are used, scrape the section of the pipe where the ground-clamp is to be secured until the bare metal glistens; fasten the ground-clamp securely and then solder the ground-lead to the clamp. If it is convenient to do so, solder the ground-lead to the pipe without recourse to a clamp; however, where this proves inconvenient, a clamp may be used with good results if due care is exercised in securing it to the pipe.

Soldering the lead-in to the aerial has always been considered quite a task; because of the almost general belief that this operation must take place after the aerial has been erected. It is far simpler to perform this operation in the house while aerial and lead-in wires are still rolled up; merely scrape an end of each roll, solder, tape; and both may then be taken to the roof and unrolled for their respective duties.

When using paste to solder that new job, go over each joint immediately after it has cooled, and with a clean piece of muslin wipe it clean of any paste which may have remained. Failure to do this will eventually cause corrosion at the joint, with resultant loss in efficiency, and noisy reception. For this reason it is best to use as little paste as possible—preferably, none at all.

## Popular Handiwork—How to Build a Handsome Radio Console

(Continued from page 922)

One brace,  $\frac{3}{4} \times 2 \times 30\frac{1}{4}$  inches (Q);  
Two sides,  $\frac{3}{4} \times 13\frac{1}{8} \times 23\frac{3}{4}$  inches; front edges to be faced with moulding H (R);  
One sub-base,  $\frac{1}{2} \times 12\frac{3}{4} \times 29$  inches, to hold

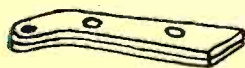
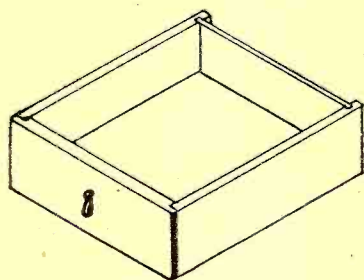

Detail of drawer and "invisible" hinge.

top section together; fastened to N with screws (S);  
One rail,  $\frac{3}{4} \times 11\frac{1}{8} \times 30$  inches, mortise into posts (T);  
Four drawer slides,  $\frac{1}{2} \times 1\frac{1}{2} \times 11\frac{3}{4}$  inches, to be attached with screws and nails (U);  
One back rail,  $\frac{3}{4} \times 5 \times 30$  inches; mortise into legs (V);  
One top cabinet rail,  $1 \times 11\frac{1}{4} \times 30\frac{1}{4}$  inches; mortise into sides (W);  
Two stretchers,  $\frac{3}{4} \times 11 \times 30\frac{1}{4}$  inches; mortise into end rails (X);  
Two end rails,  $\frac{3}{4} \times 1 \times 11\frac{3}{4}$  inches; mortise into posts (Y);  
One drawer front,  $\frac{1}{2} \times 3 \times 17\frac{1}{4}$  inches (Z);  
Two drawer fronts,  $\frac{1}{2} \times 3 \times 5\frac{1}{4}$  inches (A1).  
Drawer materials: Corner glue blocks; drop pulls; friction catches for doors; rosettes; transfer designs; nails and screws; and invisible hinges, as shown, to be used at top and bottom of doors.

## The "Home-Builder's Seven" Superheterodyne

(Continued from page 929)

shortened or a weaker station selected. Oscillations of the R.F. stage are controlled by the panel knob of R8 which serves also as a volume control.

At this time the oscillator tube V3 should be removed from its socket; upon which the signal should immediately disappear. If it does not, the coupling between the primary and the secondary of L4 is too great. The normal separation of the coils should be about one inch, where medium selectivity is desired. Great selectivity may be obtained by greater separation, or by placing the coils in right-angle relation. It should be

remembered that, as selectivity increases, signal strength decreases. A compromise must be struck for the peculiarities of the location and the aerial which is used.

In rare cases, it may be difficult to cause V3 to oscillate. A simple test is to place a pair of phones in series with the plate return of this tube and its lead "B+Osc," with battery connected. With the tube in its socket, upon touching the grid and plate socket terminals with a wet finger tip loud and distinct "plops" should be heard. In some cases the turns of the plate coil of L3 must be increased, to ob-

**Back in  
April  
19 28!**



## CeCo Announced This Type AC-22 Screen Grid Tube

*The five prong tube of the separate heater type operating directly on alternating current*

—now recognized as the most outstandingly successful amplifying tube of the season.

CeCo pioneered—and did its pioneering without the fanfare of trumpets. But it is pleasing to know that an increasing number of radio engineers and experts look with confidence to the CeCo laboratories for each new development in the tube industry... a reward not measured in dollars and profits.

*Do not miss CeCo's entertaining radio broadcast each Monday evening at 8:30 Eastern time (7:30 Central time) over the Columbia Broadcasting System.*

CeCo Mfg. Co., Inc., Providence, R. I.

**Radio  
Tubes**

# GET THIS BIG GREEN BOOK NOW!

New!

AERO KITS 1929

The Big Green Book gives the very latest details on Aero Coils and Kits, Short Wave Radio, newest broadcast radio receivers, short wave converters, telephone transmitters, coil kits, adapters and a host of new wrinkles for 1929.

## 24 Different New Kits Shown for 1929

The kits everyone is talking about are fully described in the new 1929 Aero Green Book—Aero 7-29, Aerodyne 6-29, Chronophone, Metropolitan, Trio, International, Standard, Radiophone—in Shield Grid, A.C. and D.C. models.

Be sure to send for your copy of this 25c Big Green Book—worth \$25.00 to anyone who wants to keep up with the latest radio wrinkles.

Mail coupon for your copy today—NOW!

### AERO PRODUCTS

INCORPORATED

4611 E. Ravenswood Ave., Dept. 149  
CHICAGO, ILL.

MAIL THIS COUPON NOW

AERO PRODUCTS, INC. Dept. 149  
4611 E. Ravenswood Ave., Chicago, Ill.

Send me your Big Aero Green Book, 25c, giving the latest information on What's New in radio, short wave, etc.

Name \_\_\_\_\_

St. and No. \_\_\_\_\_

City \_\_\_\_\_ State \_\_\_\_\_

Single dial control

# 7 TUBE SUPERPHONIC RADIO

All parts mounted

COAST TO COAST RECEPTION

Only \$16.95

**FREE!** Beautiful, massive, walnut table model cabinet, with every Superphonie 7. A \$10.00 value FREE while they last!

Superphonie 7 is a world beater! An exceptionally high grade receiver that is amazing the Radio World. Latest 7-tube tuned radio-frequency circuit. Extremely selective, marvelous sensitivity. Single drum dial control. Clear and realistic reception guaranteed. An exceptionally beautiful, walnut finish, metal front panel 7"x18". Complete chassis. All parts mounted ready to wire. Hook-up wire and colored battery cable included. Value \$60.00; our price \$16.95.

**WIRED OR READY TO WIRE**

Very easy to wire this set with the instructions we furnish. Just a few connections. Can be wired in a few minutes by anyone. If you would rather receive Superphonie 7 completely wired we will be glad to do so for an additional charge of only \$2.00. Please indicate on your order whether or not you want Superphonie 7 wired.

**SEND NO MONEY — ORDER NOW!**

We ship right away. Upon arrival pay only \$16.95 plus a small delivery charge. (Foreign countries send \$19.50 with order. We pay shipping charges.)

**RADIO EQUIPMENT CO.**  
549 S. Wells St. Dept. 12-D Chicago, Ill.

## ALL ELECTRIC

Radio Receiver fully guaranteed. Offered to the Radio Public at more than 50% savings. Write for particulars.

**PACIFIC RADIO**  
1063 W. Van Buren Street  
Chicago, Ill.

Don't Miss  
**AMAZING STORIES**  
"The magazine of scientific adventure, excitement and romance"  
At All Newsstands

tain oscillation. A defective condenser at C5 will also prevent oscillation.

As the builder becomes acquainted with the operation of the receiver, excellent distant reception will be obtained. The DX possibilities of this receiver, as with any other sensitive set, will depend on the locality, the efficiency of the aerial and grounds, "atmospherics," and the ability of the operator.

#### BIASING A.C. TUBES

If the constructor wishes to build this set for A.C. operation, it is recommended that he use only tubes of the heated-cathode (227, AC-22, and similar) types except in the power stage. Here a 171A, or other power tube of any desired type, may be used with raw A.C. on the filament and the proper plate voltage, in the conventional way.

be one and a half milliamperes, or .0015-ampere; and to give 1.5 volts "C" bias a resistance of 1,000 ohms will be required.

For the detector tube V5 it is recommended that the resistor be variable from 0 to 2,000 ohms; the proper resistance value is then conveniently found when the set is placed in operation. The value for the resistor in the cathode return of the power tube V7 should be 2,000 ohms, when 180 volts is used as the plate supply.

As the "C" biasing voltage is taken from the plate potential of the particular tube supplied, it follows that, to obtain the correct bias at the recommended "B" voltages, that the voltage output of the power unit must be increased at each "B+" tap by the amount of the "C" voltage. Thus, for the power tube, 40 volts plus 180 volts would require 220 volts at "B+180" for normal operation; as the cathode of the

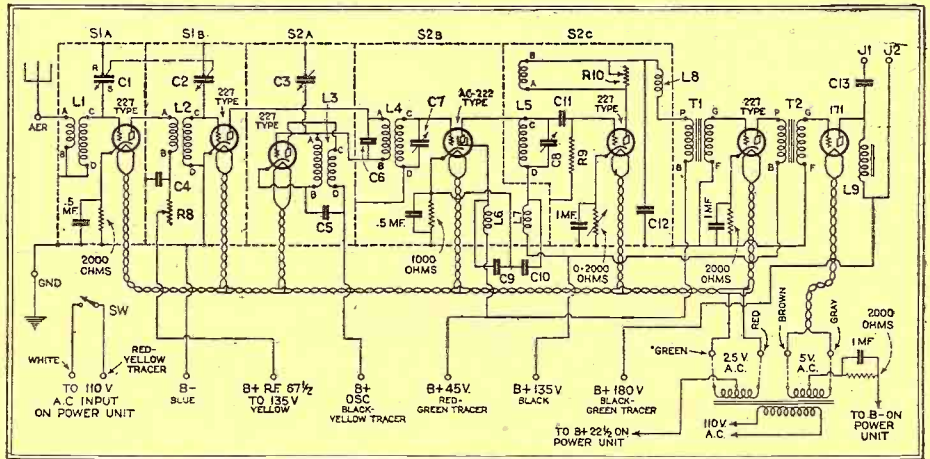

Fig. A

The "Home-Builder's Seven," constructed to use A.C. tubes, follows the same layout as in the constructional drawings; the resistors and condensers shown replace the filament ballasts.

If we compare the circuit for battery operation (Fig. 1) with that given here for A.C. tubes (Fig. 1A), it will be seen that the latter eliminates the amperites R1-R2-R3-R5-R6-R7 and the tapped resistor R4. All grid returns (including that of the detector) are made to ground and "B—" on the shielding, instead of to filament; and the cathodes of the tubes are maintained above ground potential by resistors, the voltage drop through which provides the necessary bias. This is the usual method employed in A.C. tube operation; the values of the necessary resistors may be calculated by dividing the bias (in millivolts) required for a given tube by its plate current (in milliamperes); for instance, if a tube requires a 6-volt bias, this is six thousand millivolts; the plate current of a 227-type tube is normally three milliamperes. Division of six thousand by three gives two thousand; and, accordingly, a 2,000-ohm resistor is what we need between cathode and ground to give a six-volt drop.

Therefore, resistors of this value are required by the cathode returns of V1 and V6, in series with their ground leads. On the other hand, V2 and V3 do not require a grid bias; the former has no "B+" potential on its plate (because of the peculiarity of the Ultradyne modulation system) and the latter is an oscillator, and should a bias be put upon its grid, greater plate potential would be required to cause oscillations. The A.C. screen-grid tube V4 requires a "C" bias between 1 and 1.5 volts. With 45 volts on the screen-grid, and 135 on the plate, the normal plate current will

tube is 40 volts positive above ground potential.

#### BY-PASS CONDENSERS

To prevent the blocking of either the R.F., I.F., or the A.F. frequencies by the biasing resistors, the latter must be bypassed with suitable condensers; these, in the cathode circuits of the audio tubes, have a value of 1 mf. Where either I.F. or R.F. frequencies are by-passed, a 0.5-mf. condenser will be sufficient.

To prevent excess of hum, the proper value of "B+" potential should be applied to the center tap of the 2½-volt winding supplying the heaters of the 227-type tubes. Usually, this should be 45 volts.

For placing the A.C. set in operation, the same procedure is followed as with the battery-model receiver, as described above.

#### IT HAPPENED (?)

**RADIO FAN** (who finds the usual atmospheric conditions accompanying a demonstration of his new hook-up before company): "Gee, what a rotten night! I can't seem to hold any stations at all!"

**VISITOR**: "Oh, the weather is nice out Maybe the radio stations are not sending out enough ether!"—C. Walker.

#### RADIO MATHEMATICS

**INSTRUCTOR**: "In measurements, "micro" means "one-millionth"; a microampere is one millionth of an ampere, and a microfarad is one-millionth of a farad. Now, can anyone give me further examples?"

**STAR PUPIL**: "Yes, sir: a micrometer is one-millionth of a meter and a microphone is one-millionth of a phone."—Bernard Ring.

## The Constructor's Own Page

(Continued from page 935)

build these sets strictly in accordance with the diagrams, proper plate voltage and low-loss parts, they will not be disappointed with results. I will be only too glad to help anyone wishing my advice on either of the above sets. I started in the radio field seven years ago and (being a N.R.I. student) I can appreciate a good circuit when I see it.

CHESTER L. PRICE,  
One River St., Cohoes, N. Y.

### WANTED, A GOLD FINDER

Editor, RADIO NEWS:

I have noticed that the "Hams" are always

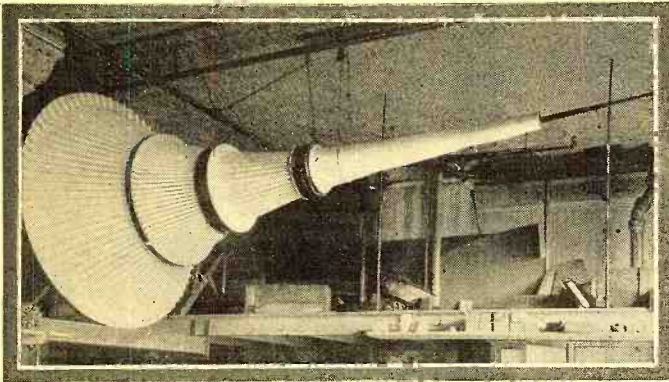

Al Morrison, of 81 South Sherman St., Denver, Colo., has just built the third and largest of the exponential horns he designed from data in RADIO NEWS. This is 12 feet long and 64 inches across the bell, which is lined with battleship linoleum. The rest is built of heavy seasoned lumber. The resultant volume is tremendous and the tone quality remarkable

ready and willing to lend their knowledge and aid to a fellow-worker in the experimental field. Thanks to their generosity.

Now I have a problem in which I would like very much to enlist their aid. My father buried twenty thousand dollars on our farm and we have never been able to find it. It was all gold dust and nuggets. He died suddenly of apoplexy and left no information as to where the exact spot was.

I have experimented for years trying to get an oscillating circuit that I could detect it with. But so far, I have been able to detect any non-magnetic metal only about eighteen inches. I would gladly give a prize to the one who offered the best known circuit that would detect it, say six feet away. Please tell me how to get their aid in this matter.

A. R. ENYEART,

48 1/2 North Orange St., Medford, Oregon.

(Those having a hook-up of the required sensitivity are invited to communicate directly with Mr. Enyeart.—EDITOR.)

## On the Short Waves

(Continued from page 938)

a screen mesh for a plate have an abnormal characteristic when tuning below 50 meters. All other tubes using a metal plate we have found satisfactory.

Another thing that might be of interest is the fact that when using a 171 power tube, the output when attached to a short-wave adapter is much less than if a 112-tube is used. Good speaker volume is usually available with the 112-tube on very weak signals, whereas it takes tremendous signal strength to deliver speaker volume with a 171-tube.

J. M. PETERSON,

The J-M-P Manufacturing Co., 3407 Fond du Lac Avenue, Milwaukee, Wisconsin.

(The information contained in this letter will be of interest to many A.C. set owners. Such complaints as we have received from a few readers, as to difficulty in accommodating adapters (of whatever make) to their sets, have arisen from the use of an A.C. detector. While we do not think that, considering the number of A.C. sets thus in use, the percentage of dissatisfied users of adapters can be high, the suggestions given by Mr. Peterson from his long experience should be of great value to many who are not getting maximum results.—EDITOR.)

### SHORT-WAVE R.F.

Editor, RADIO NEWS:

It is reasonable to suppose that there are not many —no, not even amongst the "dyed-in-the-wool" hams—who have a short-wave receiver with two stages of screen-grid R.F. Amplification. Now, I should be the last to say that this is easily possible to have; but, on the other hand, I shall not be such a pessimist as to think it is impossible.

### FB (FINE BUSINESS) OM!

Editor, RADIO NEWS:

Your Audio Amplifier for the "Extension" receiver, the "Bloopless" receiver and the "Lamp-Socket Five" are all wows; I sold the latter for a net profit of \$32.54! It was constructed of dime-store parts and worked better than a well-known commercial model. I would like to correspond with boys about my own age—which is thirteen.

JACK B. KAMMER,

(Some of the readers of RADIO NEWS who express a desire to communicate with other fans are: Jack B. Kammer, 1531 Andrew Street, Fort Wayne, Ind.; Louis C. Skipper, Jr., 3295 Carnes Avenue, Buntyn, Tenn.; S. Kwieciak, 527 Graham Avenue, Brooklyn, N. Y.; S. N. Kalra, c/o

The Wireless House, Lahore, India; Raymond Loken, Box 308, Heron Lake, Minn.; M. P. Nemitz, Box 286, Hampton, Iowa.

### RADIO IN THE ARMORY

Editor, RADIO NEWS:

It is the desire of this unit to express thanks for the recent blueprint of the televisor. We are assembling this at the present time and are planning on using it with a Pilot Short-Wave set as described in RADIO NEWS for December. Enclosed is a coupon for blueprints 69 and 70, for which we thank you in advance. This unit owns and operates station W8AJM.

MILTON K. BROWNE,

First Sgt., 2nd Battalion Hq. Co.,  
10th Inf., N. Y. Natl. Guard,  
Binghamton, N. Y.

By the time these lines are in print I hope to have one such receiver working upon the lines set out. I am not altogether sure at present as to whether it would not be better to omit the aerial inductance in the first stage and insert a 10,000-ohm resistor in its stead. I shall probably try both.

Will my American friends who want to make an electro-dynamic speaker sit up and take notice, when the output from such a receiver is administered to the input of said speaker from such a station as G5SW, please endeavor to construct according to these lines? Should they care to correspond with me upon their success or otherwise, I shall use my endeavors to see that their letters are answered if they will be so good as to enclose international postage order.

On the 28-Megacycle amateur band it is surprising to hear "W" stations come in at from 1,300 to 1,530 on Sundays at QSA4 and, if a few clouds roll up it is interesting to note the signal strength die down. What is still more amazing is to hear "G" stations about 200 miles away come in at QSA2—thus rather damping the skip-distance theory on ultra-high frequencies.

Here is another field to experiment in with two stages of R.F. as outlined, and here let me sound a word of warning to the uninitiated—be particularly careful in your shielding arrangements when using two UX-222's on such high frequencies and do not omit chokes in their plate leads.

I want to congratulate you upon your very fine write-up and diagrams of your screen-grid short-wave receiver. I have made mine work perfectly smoothly up to 28 megacycles and shall very shortly be experimenting upon using two screen-grid tubes; Marconi S.610's (like the 222); for R.F. amplification at signal frequency. This has, of course, been done by Capt. Round; but not to my knowledge by ordinary individuals such as myself!

A power tube just brought into use over here

# WATCH Jensen in 1929

Every radio authority knows what Peter L. Jensen did in 1927 and 1928. His perfection of the dynamic speaker assured the qualities in a radio reproducer which the perfection in audio circuits demanded. His reproducers served as the pattern for the entire radio industry.

And now watch Jensen in 1929!

The new Jensen Auditorium Speaker has already been announced. It is designed to operate with all types of amplifiers from the smallest with one tube to the largest with push-pull stages employing type 250 tubes.

And in sensitivity, in brilliance and separation of tones, in its ability to reproduce tremendous volume, this speaker is unmatched by any other reproducer ever made.

Write today for literature and technical data.

## JENSEN RADIO MFG. COMPANY

338 N. Kedzie Ave., Chicago, Ill.  
212 Ninth St., Oakland, Calif.

JENSEN PATENTS ALLOWED  
AND PENDING  
Also Licensed under Lektrophons  
and Magnatone Patents

Type	Jensen Standard	Unit	Dynamic Cabinet	Console
D4-6 volt	-	-	-	-
D4 AC-110 volt A.C.	-	\$35.00	\$55.00	\$70.00
D5-90 to 180 volt D.C.	-	45.00	65.00	80.00
		35.00	55.00	70.00
Jensen Auditorium Speaker				
DA-110 volt D. C.	-	-	\$55.00	-
DA5-220 volt D. C.	-	-	55.00	70.00
DA5 AC-110 volt A. C.	-	-	55.00	70.00
Cabinet and Console Models and Prices to be announced shortly.				

The  
1929  
Jensen  
DYNAMIC SPEAKERS

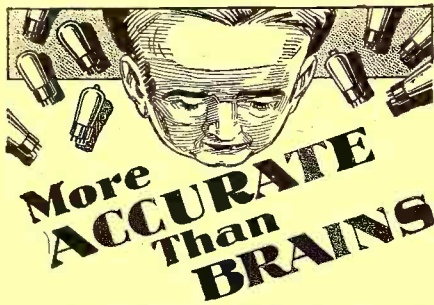

**Amperite-controlled tubes are correctly controlled tubes. Amperite automatically regulates the filament supply to your tubes despite "A" voltage variations—more accurately than you can do it with fine meters and hand rheostats. Tube life is prolonged—reception improved. Insist on Amperite by name. A type for every tube—A. C. or D. C. \$1.10 with mounting in (U. S. A.) at all dealers.**



Radiall Company  
10 FRANKLIN ST., NEW YORK  
Write Dept. RN-4

FREE "Amperite Blue Book" of modern circuits and valuable construction data.

**AMPERITE**  
REG. U. S. PAT. OFF.  
The "SELF-ADJUSTING" Rheostat.

THE DRAKE HOTEL is wonderfully located. On the lake, yet within easy walking distance of the heart of downtown Chicago. For tempting food and remarkable service, THE DRAKE is known far and wide. Rates are reasonable—as low as five dollars a day single room with bath, six double. Special discounts for extended stays. Write for Illustrated Booklet, Edition 29.

Under the Blackstone management known the world over

**The DRAKE HOTEL Chicago**

**This Wholesale Catalog Will Save You Money**

Write today for our large illustrated new Catalog "B-6," showing how this organization of men with years of experience in Radio can give you personal service.

**Allied Radio CORPORATION**  
711 W. LAKE STREET, CHICAGO

Insure your copy reaching you each month. Subscribe to RADIO NEWS—\$2.50 a year. Experimenter Publishing Co., Inc., 230 Fifth Avenue, New York City.

has the same impedance as the 171A, but twice the amplification factor—it is the Marconi P.625 and is really magnificent. It intrigues me to be consuming only 0.55 amps on my S.G.S.W. receiver!

It appears to me that there are channels available for good people like yourselves, WLW, and the General Electric on the short waves; as, over here at any rate, I never hear anyone between 17.4 and the amateur 20-meter band. Another gap is between 8XK and 2FC, Sydney, on 28.5-meters; W2XAF and W8XK are full loud-speaker volume almost nightly now.

PLE and PLF (late ANE and ANH) are now on the air on Sundays instead of Wednesdays on 15.74 and 17.00-meters respectively.

The B.C.L. Band is in a shocking mess since Jan. 13, when the new "Plan de Bruxelles" came into force allowing only 9-kilocycle separation—I certainly don't possess such a receiver!! The heterodynes caused by the powerful ones—G5GB, Toulouse, Langenberg, etc.—are awful!

We are having a very cold winter and I long for Africa with its warmth and sunshine!! I haven't heard your short-wave transmitter for sometime: the "stars" at present being those who transmit below 20 meters. Kindest regards from,

E. T. SOMERSET, G-BRS 125,

Inholmes Park, Burgess Hill, Sussex, England.

#### "SWINGING" IS NATURAL

Editor, RADIO NEWS:

I can understand why it is hard to pull in the really DX stations, but I'm getting through with patience; but they are very faint. But why don't I get the U. S. stations apart from WGY and KDKA? I had 2XAL on Nov. 29; faint, but intelligible. But there must be at least 25 more with fair power and they don't come in. One more question—is the swaying of the signals caused at the transmitting end, or is it in part due to receiver faults? My aerial is a 50-foot vertical wire, held really taut. And, once again, congratulations on your magazine. You have no idea what it means to me, away here in the bush, and the nearest radio fan who is interested in the technical side over fifty miles away.

J. E. WILKS,

Forest Gate, Saskatchewan, Canada.

(Perhaps his "location" is against Mr. Wilks, and perhaps he will find the stations easier to get later; they are easy to pass over. Some experiments with the ground, and with the aerial condenser, may bring better results. The swinging of the signal is an effect caused by the electrical condition of the atmosphere between transmitter and receiver, and cannot be remedied.)

#### A DOUBLE GROUND

Editor, RADIO NEWS:

My receiver is somewhat similar to the Pilot short-wave, except that my coils are of the basket-weave variety, and my aerial is indoors—about 42 feet of wire around the moulding in the living room. I have reduced body capacity to a minimum by using a double-ground system. I have the tuning condenser encased in a shield, to which are connected the "A—" and the rotor of the condenser, and one of the grounds. The other ground is connected to the primary, which consists of ten turns. Hoping that this may be of interest to brothers in the radio game.

RUFINO RAMIREZ,

No. 1 Jose M. Fernandez St., Santurce, Porto Rico.

#### A CORRECTION

Editor, RADIO NEWS:

I have received quite a few letters asking for details on my set (shown on page 655 of the January issue) which I have answered to the best of my knowledge. Will you allow me to compliment the artist for the fine piece of work which he did in drawing the circuit from the meager details I furnished him? However, a slight oversight may be corrected: namely, the grid return of second detector in Peridyne part of the circuit is also connected to "A+" lead. The piece of wire you take out here may be used to bridge the "B—135," so this correction does not necessitate any extra outlay.

J. H. VAN KOOLBERGEN,  
Montreal, Canada.

#### A JUNK-BOX ADAPTER

Editor, RADIO NEWS:

Here are some hints concerning the "Junk-Box," which I made into an adapter for my broadcast receiver, besides shielding it. I bought a small pan, approximately 6 inches long, 3¼ wide and 2¼ high, with tapering sides, and mounted the two sockets for tube and plug-in coils on the top of the upturned pan. The condensers are all mounted on

one side, and the "A+" leads grounded to the pan. The grid condenser and the leak (5-meg) and the choke are also mounted on the inside of the pan. No rheostat or switch is necessary, as these are in the regular set. The aerial coupling condenser is mounted on the base of an old upright crystal detector on one end of the pan. Leads from the choke coil and the filaments are taken direct to a plug which may be inserted in the socket of the broadcast set.

The set is very neat and complete and the pan provides a shield which reduces body capacity to almost nothing. Fans who cannot get distant stations might try Mr. Peadro's suggestion of using another aerial connected to the plate coil of the set. I find that this greatly increases the volume, particularly on coil No. 1; though it greatly increases body capacity.

JOSEPH ROWE,

R. F. D. 3, Smithburg, Md.

(As stated elsewhere in this issue, direct coupling of the oscillator of a transmitter to the aerial is prohibited. While listeners are not under license restrictions, the increasing vogue of short-wave work is almost certain to bring about official action for the prevention of radiation. It appears that this is already being done around the Canal Zone. For that reason, short-wave listeners should begin looking forward to the necessity of screen-grid tube coupling ahead of their detectors; just as broadcast listeners are now—that is, all should be—using a nonregenerative first stage.—EDITOR.)

#### ELABORATE EXPERIMENTS

Editor, RADIO NEWS:

When I first completed my Junk-Box I could hardly hear 5SW and they were very hard to tune in. Now I have not missed hearing at least a part of their program every day they have been on the air for six weeks. I have had PCJJ six times on the loud speaker.

The first thing I did on my set was to substitute two 5-plate condensers for the midgets and add two vernier dials; it now takes three complete turns of the knob to go from KDKA on 24.5 meters to 5SW, who are supposed to be on 25.53 (but I get them on 25.20). I next put cardboard extensions on my tube bases, made the coils 1½ inches in diameter, and wound them with No. 18 and No. 22 wire; the secondaries being space-wound. The improvement was surprising. It required the same number of coils to cover the 20-80 meter band. I next wound a primary coil of 6 turns of No. 18 wire, space-wound, and made it variable above the secondary. I find that on my set inductive coupling is the best. However, I can change from one to the other by merely changing from one aerial post to the other. I advise all Junk-Box owners to try this. Next, I put a CX300A special detector tube in; and I advise everyone to do the same. I then added another audio stage; this can easily be done, provided both transformers are kept away from all detector elements.

I then cut my aerial in half and took two lead-in wires, one from each side of the insulator, placed one on the "P" post of my first audio transformer, and used the other as a regular aerial. Try this! (This evidently increases the plate to grid feedback; but the same effect may be more easily accomplished.)

My best experiment was with choke coils. I have a \$1.50 special choke, but I can beat it with some paper and about fifteen feet of No. 30 wire. At first I made coils as spools, some slot-wound and others space-wound, etc.; but finally I took a piece of linen paper, wrapped it around a lead pencil, and wound it full of No. 30 wire. I can go down to 13 meters and not leave any holes. (I got this idea from RADIO NEWS, so I do not take credit for the invention.) I have experimented with an R.F. stage and with putting my short-wave detector ahead of the R.F. on my large set, but without much success. In conclusion, I may state that the entire six weeks of my experimenting have been stormy and foggy. I would like to hear from anyone trying any of these experiments.

I should like to identify a station on 28 meters heard on Nov. 3 using Spanish; no English was spoken. On Nov. 23 a station on the same wave stopped the program to give three sharp code signals at exactly 1 p. m., Greenwich time. On Dec. 11 a station between 16 and 17 meters was calling San Francisco in Spanish and four persons were laughing and talking at once.

I would like to know, also, how to send stamps or money to stations in foreign countries in order to get verifications of reception.

ARTHUR J. GREEN,

700 Alpha St., Klondyke, Ohio.

(International postage coupons may be had at large postoffices, and may be obtained by all postmasters. They are exchangeable in any country in the Postal Union for stamps of that country's issue.)

**Radio News Laboratories**

(Continued from page 940)

**MOLDED TIP JACKS**

The molded tip jack shown, submitted by The H. Eby Manufacturing Company, 4710 Stenton Avenue, Philadelphia, Pa., is designed for output terminals on radio sets of chassis construction, and consist of a molded brown bakelite plate in which have been placed two tip jacks spaced one-inch apart. It is 2 inches long, and



1 1/16-inch wide; the thickness is 11/16-inch and the over-all depth to ends of jacks 1/4-inches. Holes are provided at each end to fasten the device to the chassis by 6/32 machine screws. These tip jacks are available with "Speaker" or "Phonograph" markings.

AWARDED THE RADIO NEWS LABORATORIES CERTIFICATE OF MERIT NO. 2560.

**MICROPHONE TRANSMITTER**

The microphone transmitter shown, submitted by the Amplion Corporation of America, 280 Madison Ave., New York City, is of a new type in which the metal diaphragm and carbon buttons have been eliminated. Its internal construction comprises a thin rubber membrane stretched across a channel-way 1 1/2-inch wide, 3/16 of an inch deep and 3 inches long. The cavity of the latter is closed by the mem-

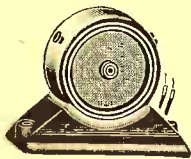

brane, which also holds in place specially prepared carbon granules. Sixty milliamperes of current has been passed through this arrangement without the usual hiss or packing; while satisfactory sensitivity has been obtained with as low as 5 milliamperes of current. Its measured internal impedance at 1,000 cycles is 500 ohms. For proper operation, it is recommended that a 4,000-ohm variable wire-wound resistor, capable of carrying 60 milliamperes, be inserted in series with the microphone and a 45-volt storage battery. The manufacturers also recommend impedance coupling of the microphone to its transformer in order to prevent core saturation of the latter; this system is identical with the choke or impedance output system used in the plate circuit of a radio receiver's power stage.

AWARDED THE RADIO NEWS LABORATORIES CERTIFICATE OF MERIT NO. 2561.

**AMAZING STORIES**

In Our April Issue:

**The Revolt of the Atoms,** by V. Orlovsky. This tale, which comes to us from Russia, is an excellent story of absorbing interest, not only as a piece of fiction, but for the science contained in it also.

**Into the Green Prism,** by A. Hyatt Verrill. Part II. Absorbing as the first instalment was, the concluding paragraphs exceed it by far with the astounding findings which the Indian scientist makes by looking through the green prism. Along with its surprise episodes, there is plenty of science in the story.

**Buried Treasure,** by Miles J. Breuer, M.D. We all know, that which is extremely rare constitutes the greatest treasure. It is interesting to conjecture what might be a rarity a thousand years or more from now. Dr. Breuer has given us a brilliant scientific story in which is included a novelty feature, which we have gone to some trouble to reproduce for our readers in its original interesting form.

**The Terror of the Streets,** by George McLoiard. With the continually increased production of automobiles and the ease with which almost anybody can obtain a car, the streets have become a dangerous place, not only for the pedestrian, but for the motorist as well. The author of this story, however, conceives an absolutely original idea and method for effectively combating the evil and weaves as clever a story around his invention as his invention is ingenious.

And others.

**THE NEW**

**Seven Seas Console**

**FIRST WITH A/C SHIELD GRID TUBES**



**Features:**

- A/C Operation
- Single Dial
- Dynamic Speaker
- Push-Pull Audio
- 2/210 Power Tubes
- 100% Shielding
- Adjustable Selectivity
- Shield Grid Tubes
- Heater Type Tubes
- Unit Construction
- 9 Tubes
- Maximum Range
- Tremendous Volume
- Perfect Reproduction
- Walnut Console

Once again LEUTZ leads, introducing the first A/C Console to use the superior A/C Shield Grid Tubes. The result, a superior Console which will meet all competition. Franchise applications are invited from established dealers.

Literature on Request

**C. R. LEUTZ, INC.**  
 Long Island City New York, U. S. A.  
 Cables: "Experinfo" - - New York

Editor, RADIO NEWS,  
 230 Fifth Avenue, New York, N. Y.

I have read the article on page 920, entitled "A New Departure." My opinion of your new department, entitled "Popular Handiwork," is:

.....  
 .....  
 .....

I would like to have you publish *Handiwork* Blueprints on the following articles:

.....  
 .....  
 Name .....  
 Address .....  
 City ..... State .....

# The RADIO NEWS AMATEURS HANDIBOOK



Only  
**50c**  
the copy

## A Guide to Radio For Every Fan

No radio enthusiast should be without a copy of the Radio News Amateurs' Handbook, the most complete chronicle of radio advancements available. Every known development, each worthwhile circuit, various methods of amplification, electrifying battery sets, all theories and practices,—in fact, everything noteworthy that has occurred since the beginning of radio is fully treated. Hundreds of the most popular radio receiving circuits of all times—circuits ranging from the early type of crystal sets to the latest and most elaborate multi-tube receivers of the present day. And with each circuit there is a complete set of constructional details explaining in full the principle on which the operation of each receiver is based together with step-by-step instructions for building.

Every "fan" should have a copy of this book. Its contents constitute a complete education in radio. The handiest of reference guides. A real encyclopedia. Fill in the coupon now. Do not wait. Get your copy of this most valuable of radio books, **THE RADIO NEWS AMATEURS' HANDBOOK.**

116 pages—Fully Illustrated  
Large 9 x 12

THE **50c** COPY  
WRITE DIRECT

Experimenter Publishing Co., Inc.  
230 Fifth Avenue, New York, N. Y.

EXPERIMENTER PUBLISHING CO., INC.,  
230 Fifth Avenue, New York, N. Y.  
Gentlemen: Enclosed find 50c. for which send me a  
copy of RADIO NEWS AMATEURS' HANDBOOK.  
Name.....  
Address.....  
City..... State.....

### AUDIO COUPLING UNITS

The "Type 225" interstage audio coupling device shown, submitted by Silver-Marshall, Inc., 846 W. Jackson Blvd., Chicago, Ill., has been designed to couple a detector tube to the first audio-frequency tube. When used in the plate circuit of a 227-type A.C. tube, and in connection with the second stage unit described below, almost straight-line response is obtained from 30 to 5,000 cycles. This device consists of a resistor in the plate circuit of the tube, connected on the plate side through a .01-mf. condenser to the center tap of an auto-transformer. The units described above are contained in a black baked enamel container 4 inches high, 3 1/4 inches long and 2 1/2 inches wide. All terminals are located on one side, and insulated from each other and from the metal container by a strip of bakelite. Designations of the terminals are stamped on the name-plate, which is riveted to the top of the container.



AWARDED THE RADIO NEWS LABORATORIES CERTIFICATE OF MERIT NO. 2562.

The "Type 226" audio coupling unit which was submitted by the same manufacturer is designed as a second-stage audio coupling unit, when used in an audio amplifier, in which the "Type 225" unit described above is used. When used in this way, it has a frequency response of nearly straight-line characteristics from 30 to 5,000 cycles. The dimensions are identical with those of the 225.

AWARDED THE RADIO NEWS LABORATORIES CERTIFICATE OF MERIT NO. 2563.

### OUTPUT IMPEDANCE

The "Type 251" output impedance shown here, submitted by the same manufacturer, is designed for use between the plate circuit of a power amplifier and the loud speaker. It consists of a choke coil, of approximately 30 henries inductance, providing a direct-current path for the plate supply. A 0.1-mf. condenser, one side of which is connected to the plate terminal of the choke and the other side to the loud speaker, affords a low-resistance path for the A.F. currents to pass through the speaker and return to a terminal connected to the "B+" terminal of the choke. This unit may be used in the plate circuit of any last audio stage where the plate current is not greater than 30 milliamperes. The choke and condenser are encased in a black enamelled container, 2 3/4 inches long, 2 1/4 inches wide and 2 inches high.



AWARDED THE RADIO NEWS LABORATORIES CERTIFICATE OF MERIT NO. 2564.

### CONE SPEAKER

The cone speaker shown here, submitted by the Ottawa Furniture Company, Holland, Mich., is of the balanced-armature type; the cone is 8 inches in diameter. A die-stamped conical frame, serving as a support for both the unit and the cone, is 9 1/2 inches in diameter and 4 inches deep; it has oblong perforations around its sides to prevent resonant frequencies and to allow the passage of sound waves. The inside of the frame is lined with thick felt, which also serves to prevent resonant tones. The frame, cone and unit are fastened within a walnut-finished cabinet 12 inches high, 11 inches wide and 8 inches thick, whose front and back are gridded for the passage of the sound waves. It is provided with doors which open outward, and which may be closed when the speaker is not in use.



AWARDED THE RADIO NEWS LABORATORIES CERTIFICATE OF MERIT NO. 2565.

### CABLE AND CONNECTOR PLUG

The "No. 612" cable and connector plug shown here, submitted by the Yaxley Mfg. Company, 9 South Clinton Street, Chicago, Ill., consists of twelve wires, 5 feet long, enclosed in a woven and braided sheath and terminating in a molded bakelite head. The 12 split sockettes are molded into the head, and to their exposed ends are soldered the ends of the cable leads. The junctions of the sockettes and cable leads are

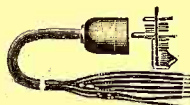

protected by a metal cap, which fits over the cable, and screws to the head. The terminal unit consists of a bakelite body to which are riveted twelve plug prongs in such positions as to fit into the respective sockettes of the head. A large central prong serves as a guide, and another prong as a guide and lock for the proper position of the terminal head. The bakelite frame is 2 1/2 inches long, 2 inches high and fitted with two metal brackets for mounting; each of the upper corners provides holes for the insertion of tip jacks.

AWARDED THE RADIO NEWS LABORATORIES CERTIFICATE OF MERIT NO. 2567.

### FILTER CONDENSER

The filter condenser shown, submitted by the Gerd Electric Co., Kendall Square Building, Cambridge, Mass., and designed to operate continuously on 400 volts D.C., is of the paper-and-tinfoil type, wound and vacuum-impregnated with a special insulating compound. It is enclosed in a metallic housing of black crystalline finish 4 3/4 inches long, 5 inches high and 1 inch thick. The tip-jack terminals are located at each end of the housing near the top. The capacity of the condenser tested was found very close to its rating of 1-mf.



AWARDED THE RADIO NEWS LABORATORIES CERTIFICATE OF MERIT NO. 2570.

### POWER RESISTOR

The resistor shown here, submitted by C. W. Love & Company, 3567 Cottage Grove Ave., Chicago Ill., is of the compressed-carbon type. Four samples, of various values, were submitted for test, and found within 5% of their rated values for the low-resistance, and 10% for the high-resistance types. The resistance element is 1 1/2 inches long, 5/16 of an inch in diameter and is provided with wire terminals; which are molded into it, thereby providing electrical contact at all times. These resistors were found to dissipate 5 watts of energy without appreciable change in resistance, or heating to any great extent.



AWARDED THE RADIO NEWS LABORATORIES CERTIFICATE OF MERIT NO. 2571.

### BINDING POST

The binding post shown, submitted by the X-L Laboratories, 1224 Belmont Avenue, Chicago, Illinois, is of the push type, and consists of three parts; the cap, the body and a 6/32 mounting screw. The cap consists of an aluminum sleeve 7/16-inch in diameter and 1/2-inch long, molded into the bakelite top on which the designations are marked. The sleeve is pierced through its side with a 3/8-inch hole, which becomes aligned with another in the aluminum body when the spring contained in the cap is compressed by the finger. The cap is held to the body by an oval slot engaging a pin on the side of the latter. The post is furnished engraved with any standard radio terminal lettering.



AWARDED THE RADIO NEWS LABORATORIES CERTIFICATE OF MERIT NO. 2572.

Station  
**WRNY**  
NEW YORK  
297 METERS—1010 KILOCYCLES  
and W2XAL, 30.91 METERS

is owned and operated by the  
publishers of this magazine  
Our Editors will talk to you  
several times every week—  
See your Newspaper  
for details  
**TUNE IN ON  
WRNY**

**Book Review**

By H. M. BAYER

**THE RADIO INDUSTRY, THE STORY OF ITS DEVELOPMENT**, a compilation of lectures. Published by A. W. Shaw Company, New York City. 9 1/4 x 6 1/4 inches; 330 pages. Fine drawings and half-tones. Price \$5.00.

The book contains a series of lectures which were delivered at the Harvard School of Business Administration by gentlemen who need no introduction to those connected with the radio or kindred industries: General J. G. Harbord, president, Radio Corporation of America; David Sarnoff, vice-president and general manager, Radio Corporation of America; E. E. Bucher, assistant vice-president, Radio Corporation of America; Dr. F. B. Jewett, vice-president, American Telephone and Telegraph Company; E. P. Edwards, manager, radio department, General Electric Company; Judge Stephen B. Davis, New York City; H. P. Davis, vice-president, Westinghouse Electric and Manufacturing Company; Merlin H. Aylesworth, president, National Broadcasting Company; J. L. Ray, general sales manager, Radio Corporation of America; Pierre Boucheron, advertising manager, Radio Corporation of America; and H. C. Weber, Massachusetts Institute of Technology.

There is no doubt that it would be difficult to find a body of men better fitted than those listed above for such an undertaking; but we cannot help wondering whether the lectured did not find themselves snoozing now and then during the course of these dissertations. However, it must be said that those who managed to remain awake were treated to a carefully-balanced course in the commercial development of radio, its commercial application and other phases of interest to the business executive.

Opening with an introduction by Mr. Sarnoff and a foreword by Dr. Anton De Haas, the lectures unfold themselves in what was no doubt their given order: a resumé of early radio development; radio in the world war and the organization of an American-owned transoceanic radio service; the development of the radio art and radio industry since 1920; the development and use of radio telephony as a means of communication; research and manufacture in the radio art; the law of the air; the early history of broadcasting in the United States; the "National Magazine" of the air; the distribution and merchandising of radio equipment; advertising radio to the American public; and a final lecture on applications of radio principles and devices in industry, offered by Mr. Weber who, also, has appended to the volume a brief chapter on the basic principles of radio transmission and reception.

Some interesting facts contained in these lectures, although published time and time again in the past, are worthy of notation. "From a nominal volume, (of radio sales), in 1920 to a half-billion-dollar industry in 1928! Such is the amazing growth of radio program broadcasting (no doubt the writer meant radio sales.—REVIEWER) in the United States. In less than eight years, seven and a half million people had become users of radio sets—a potential audience of thirty million listeners! A public that spent nearly two billion dollars for radio sets and equipment in six years—and is still spending half a billion dollars a year for the output of twelve hundred factories, employing three hundred and twenty thousand workers!"

The sales and advertising policy of the Radio Corporation of America is outlined and illustrated. Its size and a rather imposing binding, make this volume an attractive addition to the library.

**LOUD SPEAKERS**, by Joseph Morgan, Published by International Resistor Company, Philadelphia, Pa. Leaflet, 13 pages; line drawings, curves. Free distribution.

Mr. Morgan (who, it is said, fills a chair of one of our larger universities in its electrical engineering departments) has spoken more words of wisdom; this time anent speakers and their relative merits. It is gratifying to note that, throughout the doctor's little treatise, the laboratory graph stands head and shoulders above personal prejudice and commercial interests. The pamphlet's contents make an excellent course for the radio beginner, and enlightening reading for the advanced student who may possess a bias or two regarding speakers. Some of the author's conclusions are worthy of publication:  
"A good exponential horn should have a small



**COMPANY  
NIAGARA FALLS**

**TONE QUALITY**

Now the Carborundum Detector is adjustable. A turn of the pressure screw gives you perfect balance—gives you perfect tone. The detector then remains fixed and permanently sensitive, by tightening the lock nut.

Tone Quality is everything in radio; here is another improvement that further assures it. Recommended by noted radio-circuit designers.

DEALER OR DIRECT, \$1.50 IN U. S. A.

Send for Free Book "Carborundum in Radio"—D-1

THE CARBORUNDUM CO., NIAGARA FALLS, N. Y.  
Canadian Carborundum Co., Ltd., Niagara Falls, Ont.

Carborundum is the Registered Trade Mark of The Carborundum Company for its Silicon Carbide and is its exclusive property

**CARBORUNDUM**  
REG. U. S. PAT. OFF.  
**DETECTOR**



**\$1 SAVES YOUR SPEAKER**

**THE CRAFTSMAN DOLLAR SPEAKER FILTER** is Guaranteed to relieve your speaker of the plate Direct Current (up to 250 volts). It reduces overloading, giving Speaker a chance to operate at its best. Can be used as a headphone coupling. Complete protection, attached in a second. Send dollar bill NOW! Refund if it does not work on your set.

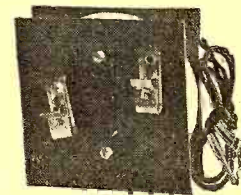

CRAFTSMAN RADIO PRODUCTS, 351 Halsey St., NEWARK, N. J.

**RADIO NEWS BLUEPRINTS Nos. 78, 79 and 1A**



To encourage the construction of radio apparatus illustrated in this magazine, and make it easier for our readers, RADIO NEWS makes up each month large blueprints of the diagrams which accompany the principal constructional articles; these sets include full-sized drilling templates, coil data, etc., where required, and in each case a list of the apparatus originally used, with full specifications. Several thousand of these have been distributed each month.

If you desire a set of blueprints for any or all of the apparatus described in this month's Blueprint articles, fill out the attached coupon as directed and send it in with 25 cents for each set requested. The blueprints requested will be mailed to you postpaid. We cannot send blueprints with magazines.

Back-number RADIO NEWS blueprints can be obtained at the same rate while the stock lasts. We cannot furnish blueprints of commercially-manufactured radio apparatus.

Blueprint Department, RADIO NEWS: (E)  
230 Fifth Avenue, New York, N. Y. (U. S. A.)

I enclose 25 cents for each item checked; for which please send me a set of large RADIO NEWS blueprints.

- No. 78. The "Home-Builder's Seven" Superheterodyne.
- No. 79. The "Space-Charge Autodyne" S-W Set.
- No. 1A. A Handsome Radio Console.
- No. ....

Name .....

Street Number .....

Postoffice .....

State (Province, etc.) .....

(Please typewrite your name and address or print it with a pen—not a pencil—as many signatures cannot be read. This will avoid errors in addressing the mail.)

# OPPORTUNITY AD-LETS

Follow these advertisements every month. Reliable advertisers from all over the country offer their most attractive specials in these columns.

Classified advertising rate twenty-six cents a word for each insertion. Names and addresses must be included in the above rate. Cash should accompany all classified advertisements unless placed by an accredited advertising agency. No advertisements for less than 10 words accepted.

Objectionable or misleading advertisements not accepted. Advertisements for the June issue must reach us not later than April 2nd.

**CIRCULATION LARGER THAN THAT OF ANY OTHER RADIO PUBLICATION**

EXPERIMENTER PUBLISHING CO., INC., 230 Fifth Avenue, New York, N. Y.

### Agents Wanted

Guaranteed Genuine Gold Leaf Letters anyone can put on store windows. Large profits, enormous demand. Free samples. Metallic Letter Co., 422 N. Clark, Chicago.

Make \$10 every day introducing New Automatic Window Washer. Amazing Invention. Send for Free Sample offer. National Industries, 67 E. Lake, Dept. 854, Chicago.

\$50.00 Weekly. Men wanted to demonstrate and take ten orders daily direct from motorists. Amazing Magnetic Trouble Light. Sticks anywhere. More orders, bigger pay. Write for demonstrator and particulars. Magno Co., 6 Beacon St., Dept. 794, Boston, Mass.

### Business Opportunities

Amateur Cartoonists: Sell Your Cartoons New Plan. Smith's Service EX1194, Wenatchee, Wash.

Free Book. Start little Mail Order business. Hadwil, 5A-74 Cortlandt Street, N. Y.

Inventions Commercialized. Patented or Unpatented. Write Adam Fisher Mfg. Co., 278 Enright, St. Louis, Mo.

### Chemistry

Learn Chemistry at Home. Dr. T. O'Connor Sloane, noted educator and scientific authority, will teach you. Our home study correspondence course fits you to take a position as chemist. See our full page ad on page 947 of this issue. Chemical Institute of New York, 16 E. 30th Street, New York City.

### Correspondence Courses

Used correspondence school courses sold on repurchase basis. Also rented and exchanged. Money-back guarantee. Catalog free. (Courses bought). Lee Mountain, Pisgah, Alabama.

### Detectives

Detectives Needed Everywhere. Travel. Experience unnecessary. Particulars Free. Write, American Detective System, 2190 Broadway, N. Y.

### For Inventors

Inventions Commercialized. Patented or Unpatented. Write Adam Fisher Mfg. Co., 278 Enright, St. Louis, Mo.

### For Sale

3-Branch Tool Co., Rapid Radio Panel Engraving Machines. New, in original shipping boxes from factory. \$39.50 each. Send cash with order. D. C. Leonard, 94 Morris St., Greenville, S. C.

Alfalfa Seeds, hardy common varieties \$8.40, \$10.20, \$12.60 bushel; Grimm variety Alfalfa seed \$18. Scarified sweet clover \$3.90, \$5.20; Alsike or red clover \$15. Bags Free. Send for samples and catalogue. Kansas Seed Co., Salina, Kan.

### Help Wanted—Instructions

Wanted Immediately, names of hard-working men and women, 18 to 55, who want to make more money. Write, Instruction Bureau, 251, St. Louis, Mo.

### Instruction

Learn Chemistry at Home. Dr. T. O'Connor Sloane, noted educator and scientific authority, will teach you. Our home study correspondence course fits you to take a position as chemist. See our full page ad on page 947 of this issue. Chemical Institute of New York, 16 E. 30th Street, New York City.

### Male Help Wanted

A Paying Position open to representative of character. Take orders shoes-hosiery, direct to wearer. Good income. Permanent. Write now for free book, "Getting Ahead." Tanners Shoe Mfg. Co., 2354 O St., Boston, Mass.

### Male Help Wanted (Cont.)

Firemen, Brakemen, Baggage-men (white or colored). Sleeping Car, Train Porters (colored). \$150-\$250 monthly. Experience unnecessary. 237 Railway Bureau, East St. Louis, Ill.

### Miscellaneous

Forms to Cast Lead Soldiers, Indians, Marines, Trappers, Animals, 151 kinds. Send 10c for illustrated Catalogue. H. C. Schiercke, 1031 72nd St., Brooklyn, N. Y.

Inventions Commercialized. Patented or Unpatented. Write Adam Fisher Mfg. Co., 278 Enright, St. Louis, Mo.

### Old Money Wanted

Old Coins. Large Spring selling catalog of coins for sale—free to collectors only. Catalog quoting prices paid for coins, ten cents. William Hesslein, 101E. Tremont St., Boston, Mass.

Old Money Wanted. Will pay Fifty Dollars for nickel of 1913 with Liberty head, (no Buffalo). We pay cash premiums for all rare coins. Send 4c for Large Coin Folder. May mean much profit to you. Numismatic Co., Dept. 112, Ft. Worth, Tex.

\$2 to \$500 each paid for hundreds of Old or Odd Coins. Keep all old money. It may be very valuable. Send 10c. for New Illustrated Coin Value Book 4x6. Guaranteed prices. Get posted. We pay Cash. Clarke Coin Company, 14 Street, Leftoy, N. Y.

### Patent Attorneys (Cont.)

Patents—Send for form "Evidence of Conception" to be signed and witnessed. Form, fee schedule, information free. Lancaster and Allwine. Registered Patent Attorneys in United States and Canada, 269 Ouray Bldg., Washington, D. C.

Patents—Write for Free Instructions. Send Drawing or Model for Examination. Carl Miller, Registered Patent Attorney (former Patent Office Examiner), 262 McGill Building, Washington, D. C.

Inventors—Should write for our Guide Book, "How to Obtain a Patent," and Record of Invention Blank, sent Free. Send model or sketch of inventions for our inspection and instructions free. Radio, Electrical, Chemical, Mechanical and Trademark Experts. Terms Reasonable. Victor J. Evans & Co., 922 Ninth, Washington, D. C.

Patents—Send drawing or model of your invention for examination and instructions. Advice and booklet free. Highest references. Best results. Promptness assured. Watson E. Coleman, Patent Lawyer, 724 9th Street, N.W., Washington, D. C.

### Patents

Inventions Commercialized. Patented or Unpatented. Write Adam Fisher Mfg. Co., 278 Enright, St. Louis, Mo.

### Printing, Engraving and Multigraphing

Your Own Correspondence Stationery. Name and address on 125 DeLuxe lettersheets and 125 envelopes \$2.20 post-paid. Oberman Company, Box 1042, Chicago.

Multigraphing, two dollars thousand. Miscellaneous Printing. Mayera Corporation, Monmouth, Illinois.

### Printing Outfits and Supplies

Print Your Own Cards, Stationery, Circulars, Advertising, etc. Complete outfits, \$8.85; Job Presses, \$11, \$29; Rotary, \$149. Print for others; big profit. Easy rules furnished. Write for Catalog Presses, Type, Paper, etc. Kelsey Company, J-13, Meriden, Conn.

### Radio

Build Your Dynamic Speaker with our castings and instructions. Send M. O. for \$8.50 to A. C. Klein Co., 1058 N. 10th Street, Reading, Pa.

Bargains, used radios. Guaranteed perfect working order. Blue Ribbon 5 tube, 2 dial, Console, \$19.95. Freshman, \$14.95. Atwater Kent, \$19.50. Many famous makes. Send money order with order. Bargain list on request. Surplus Radio Co., Dept. 2-D, 4611 N. Clark St., Chicago.

Wanted: Men to work with National Radio Service organization. No selling scheme. Radio Doctors, Inc., Dept. N. Essex St., Salem, Mass.

Dealers and Set Builders—Write for lowest prices on A and B power devices. D. L. G. Mfg. Co., 2937 West Lake, Chicago.

Three Crystals—"World Beaters"—60c. William A. Talley, "Crystal Set Wizard," Beaudry, Ark.

### Song Writers

Songwriters!—Substantial Advance Royalties are paid upon publishable work. Anyone having original ideas for songs may submit poems for examination and advice. Walter Newcomer, 1674 B'way, N. Y.

Song-poem writers. Address, Monarch, 236 West 55th Dept. 322, New York.

### Telegraphy

Telegraphy—Both Morse and Wireless taught thoroughly. Big salaries. Wonderful opportunities. Expenses low, chance to earn part. School established fifty years. Catalog free. Dodge's Institute, Cour St., Valparaiso, Ind.

## Read! Opportunity Ad-Lets

Who knows but that the opportunity of your lifetime may be hidden in one of them. Read them each month—they can easily be turned to earning dollars and cents for you.

### Patent Attorneys

Patents—Free instructions. Former Patent Office Examiner. Moderate terms. Booklet. Albert Jacobs, 740 Barrister Bldg., Washington, D. C.

Patents—Time counts in applying for patents. Don't risk delay in protecting your ideas. Send sketch of model for instructions, or write for free book, "How to Obtain a Patent" and "Record of Invention" form. No charge for information on how to proceed. Communications strictly confidential. Prompt, careful, efficient service. Clarence A. O'Brien, Registered Patent Attorney, 309 Security Bank Building (directly across street from Patent Office), Washington, D. C.



initial throat area, a slow rate of taper and a large final opening."

"A system of distortion does not end with the speaker, but with the listener."

"A speaker possessing all the desirable qualities demanded by science, such as that it should not produce any frequencies not present in the original sound—it should be capable of delivering its output with sufficient volume without the introduction of distortion due to overload—its ratio of sound output-power to the electrical input-power should approach as nearly as possible to unity—its performance should be independent of atmospheric changes, etc.—cannot be found this side of paradise."

The author describes the respective advantages and disadvantages of the common horn speaker, the balanced-armature, or cone speaker, the exponential horn, and the moving-coil or dynamic speaker. The information offered is simply and clearly told, and makes highly interesting and informative reading. It deals, of course, solely with the theory of loud speakers.

**A TREATISE ON TESTING UNITS FOR SERVICE MEN**, by John F. Rider, published by Radio Treatise Company, New York City. 9x6 inches, 43 pages; circuit diagrams, curves. Price \$1.00.

Doubtless, times have changed. It was only a few years ago that Johnny, the neighbor's son, and a bright lad at that, was considered the radio genius of the town. His duties, much like those of the country physician, were to bring your receiver into the world, and thereafter tend to its ills and ails. His curative methods were interesting if not startling; at any rate some excerpts from his "Materia Medica" may be recalled by those who had occasion to use his services.

If we remember correctly, dry-cells (the WD12 tube was popular then) were tested by the simple method of placing the tongue across the terminals. Exactly what this test indicated is somewhat of a mystery; but, as it was accompanied generally by a scholarly wrinkling of the brow, this act of engineering was passed by along with the famed "B" battery test. Regarding the latter, the innocent spectator knew little except that he had once heard it referred to as "a-lulu"; whatever that meant. The test itself required nothing more than a piece of bare copper wire, one end of which was connected to one terminal of the battery; the other end of the wire was then rapidly flicked across the other battery post. The result was a miniature display of pyrotechnics which, incidentally, cost the battery three-fourths of its life; but, somehow or other, the young engineer found in the result of his test an indication of the battery's condition.

The one remaining item on the test schedule offered no difficulty; if the filament of the tube refused to light after the filament prongs had been placed across a cell, the tube was considered out of the running and another was sent for. On the other hand, if the filament lighted, all was well. (All this was some time ago.)

Today "Johnny" deals with cathode-ray oscillographs, beat-note audio oscillators, reactivating voltages, electronic-emission tables and resonance indicators. And, if we take it from Mr. Rider, all this must be known by the modern service man, and a good deal more.

What he is supposed to know, what the instruments he is supposed to use, and how he is to use them, are comprehensively told in Mr. Rider's "Treatise for the Service Man." A servicing or trouble-shooting instrument is listed for every conceivable affliction which might befall a present-day receiver; and, from the number and types of instruments described, their afflictions must be legion.

Complete constructional data are given, so that the service man may build his own equipment. Among the apparatus described, including those mentioned above, are: a tube reactivator, a calibrated vacuum-tube bridge, a tube tester, a "B" unit tester, output indicating systems, a tube voltmeter, an improvised high-resistance voltmeter, and a description of a complete service station's test bench and its panel equipment.

To the real service man, a book of this type should prove invaluable.

**TO SAY NOTHING OF LANGUAGE!**

HINT to constructors from the *Radio World*: "You can push back the insulation of the solid, single-strand wire with your ANGER after having cut the wire to the desired point." Yes, and after an unexpected collision with the warm end of the iron, our anger had risen to such a degree of solidity that you could punch a hole through the panel with it.—R. A. Bell.

**Any A. C. Socket Power Set can be used on D. C. supplies— if an "ESCO" Motor Generator or Dynamotor is used**

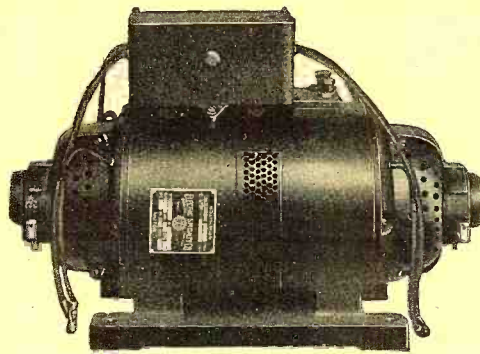

Motor Generator with Filter For Radio Receivers

Machines for operating 60-cycle A. C. Radio Receivers, Loud Speakers and Phonographs from Direct Current Lighting Sockets Without Objectionable Noises of any Kind.

The dynamotors and motor generators are suitable for radio receivers and for combination instruments containing phonographs and receivers. Filters are usually required. The dynamotors and motor generators with filters give as good or better results than are obtained from ordinary 60-cycle lighting sockets. They are furnished completely assembled and connected and are very easily installed.

These machines are furnished with wool-packed bearings which require very little attention, and are very quiet running. Write for Bulletin No. 243-C.

**ELECTRIC SPECIALTY COMPANY**

211 South Street

Stamford, Conn., U. S. A.

TRADE "ESCO" MARK

Manufacturers of Motors, Generators, Motor - Generators, Dynamotors and Rotary Converters for Radio and other purposes

**BUICK 4-DOOR SEDAN** **4 CARS GIVEN!**

Puzzle fans attention: J. C. Long, Charles Vogtmann, Mrs. J. E. Fields, Viola Javins, Alvin Smith, Mrs. John Gillies, Jacob Braucher, each won sedans in our last auto puzzles. Over 800 prizes awarded in one year. Over \$1,000.00 in prizes paid by us in October, 1928. In next few months will award between 300 and 400 prizes through our puzzles. Here's the new one for you.

**FIND THE "DIFFERENT" AUTO**

The cars in the oval all look exactly alike at first glance. They are not all alike. One is different from all the others. There is a real difference. Something is purposely left off all the other cars but this one. The difference may be in the fenders, bumper, nameplate, radiator or top. The one that is "different" is the real Buick Sedan I am giving away in addition to three other cars in my great friendship advertising campaign. You may be the one who will find it.

**AND WIN BUICK SEDAN OR \$1800.00 CASH**

4 sedans and 28 other prizes totaling over \$5,000.00. 32 prizes and duplicate prizes paid in case of ties. If you can find the "different" auto you may be the one to get this great prize.

**Certificate for \$480.00 to apply on grand prize sent immediately as below if you find the "different" car.**

Immediate quick action—no delay—we send certificate for \$480.00 to add to the first prize at once if you win and directions for getting Buick Sedan. We spend over \$150,000.00 this way each year to advertise our products. **NO MORE PUZZLES TO SOLVE.** No lists of words to make or write or any other puzzles. This is all. Everyone rewarded if actively interested. No cost or obligation. Nothing to buy now, later, or ever. Just send the number of the "different" auto in a letter or on a post card. That's all. send no money.

M. W. MYERS, Dept. 149  
500 N. Dearborn St.,  
Chicago, Ill.

**SEND NO MONEY TO DAY** **\$480.00 PROMPTLY FOR PRIZES!**

Wire Your Home With

**YAXLEY**

Radio Convenience Outlets

FOR every radio need, in brushed brass or Bakelite. Fit standard electrical switch or outlet box. Single plates and in gang in many combinations.

No. 135—For Loud Speaker	\$1.00
No. 136—For Aerial and Ground	1.00
No. 137—For Battery Connections	2.50
No. 138—For AC Connections	1.00

(Bakelite, 25c. additional per plate)

AT YOUR DEALER'S

**YAXLEY MFG. CO.**

Dept. N—9 So. Clinton St., Chicago, Ill.

**SET BUILDERS**

Get this Book

LATEST RADIO GUIDE

FREE

Barawik, the first and oldest radio specialty house, offers you unusual service this year. Bigger stocks, quicker shipments, lower prices. Deal with an old established, reliable house. Get honest goods, honest service, honest prices. Barawik service makes you more money. Send now for big new Catalog showing lowest wholesale prices.

**BARAWIK CO.** 241 Canal Sta., CHICAGO, U. S. A.

Mail This Coupon Now for Free Radio Guide

Name \_\_\_\_\_

Address \_\_\_\_\_

IT'S SO EASY TO BUILD FROM THIS BOOK

**New!**

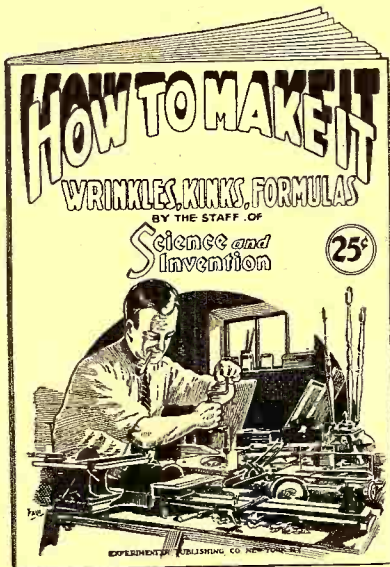

Fully Illustrated  
only

**25c**

Per Copy

At All Newsstands  
or Write Direct

## Hundreds of Things You Can Do!

“THAR’S GOLD IN THEM THAR HILLS, PARDNER.” How often have you read that expression? How often have you longed for a machine that would tell you the exact spot at which to dig in order to locate the gold about which the prospector speaks? How often have you been told that a pot of gold has been buried on an estate somewhere and which would make the individual fabulously wealthy if he could but discover where that pot of gold is to be found? There are mechanisms which will do that. One of them is an electrical treasure locator built on the principle of an induction balance. The construction of such a treasure locator is described in detail in this “How To Make It Book.” In it you will find many other treasures. Full details for the grinding of a mirror and the making of a telescope, building a model tug-boat, a deaf-phone that is of real benefit, the construction of a small lathe, an enlarging machine, a telegraphone (a machine which electrically records the voice on a steel wire), and myriads of wrinkles, recipes and instructional articles too numerous to mention, and written so you can understand it by the staff of SCIENCE AND INVENTION, publishers of this magazine.

“Thar’s gold in them thar hills, Pardner,” and there is a wealth of information in this well-illustrated book.

This big book of mechanical formulas—  
fully illustrated — large magazine size.

**EXPERIMENTER  
PUBLISHING CO., INC.**

**230 FIFTH AVENUE      NEW YORK**

MAIL TO-DAY

EXPERIMENTER PUBLISHING CO., Inc.,  
230 Fifth Avenue, New York, N. Y.

Gentlemen:  
Please send me a copy of your book, “How To  
Make It.” Enclosed please find 25 cents.

Name .....

Address .....

City..... State.....

# PILOT TRANSFORMERS

NEW TYPE

No moisture penetrates the hermetically - sealed Bakelite cases of Pilot's new line of moisture-proof transformers! No longer need you fear transformer breakdown due to moisture corroding the fine wire. All popular types. See complete line!

Pilot's complete line, produced in the world's largest radio parts plant, includes: Fixed and Variable Condensers, Transformers, Dials, Controls, Chokes, Power Equipment, Sockets, Coils, Resistors, Switches, Power Packs, Short-Wave Kits, All-Electric Kits, etc.

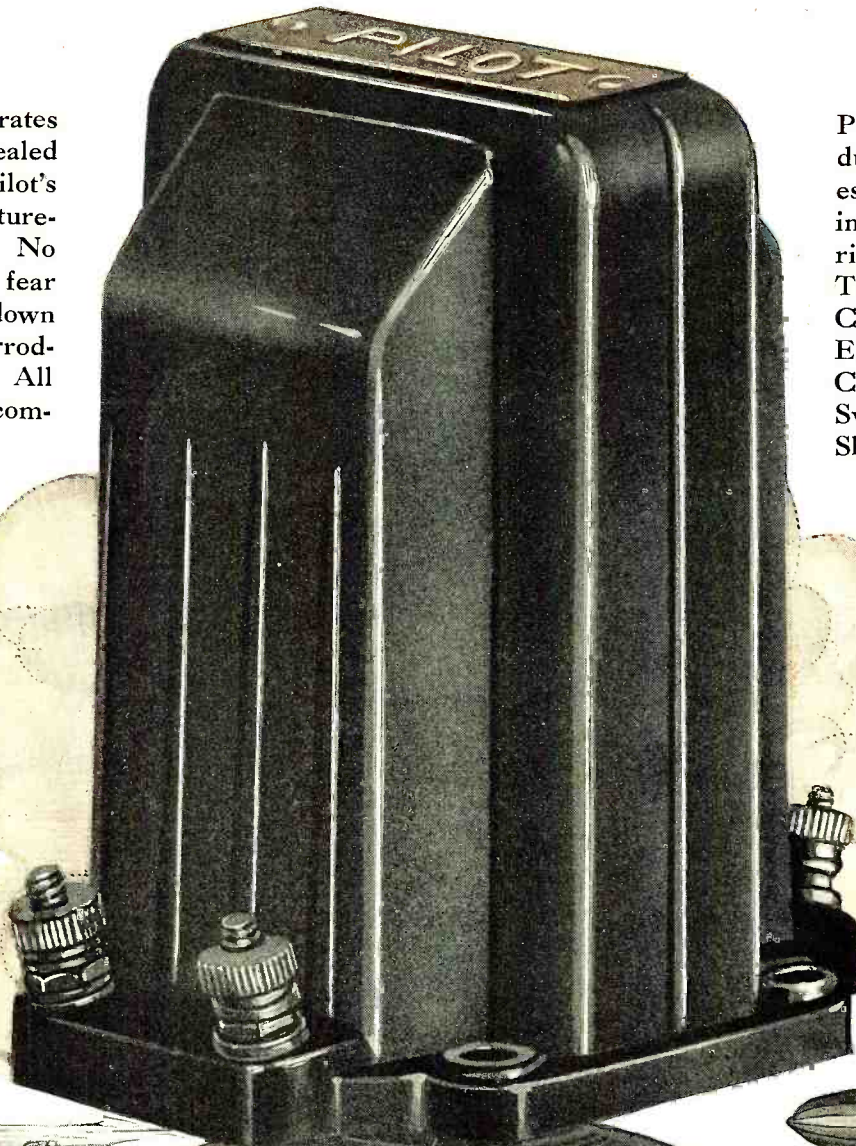

*World's  
Largest  
Radio Parts  
Plant*

**PILOT ELECTRIC M'FG. CO.**  
323 BERRY ST.  **BROOKLYN, N.Y.** INC.

TRADE MARK REGISTERED

*Radio  
Manufacturers  
Since  
1908*

# SM

## Be the **FIRST** to build the **FIRST**

set designed  
around **1930** tubes

the  
long-  
awaited

## **S-M All-Electric Screen-Grid Six**

**H**ERE is your chance—be the first in your neighborhood to own a real 1930 receiver—a set actually designed around tubes of a type utterly new—not found at all in 1929 sets! Just as the 222 tube set new standards in 1928—so the new RCA-Cunningham A.C. screen-grid tube—an even better r.f. amplifier than the '22—will be the central feature of fine receivers for 1930.

Also, in the 720AC, for the first time, the new medium-voltage output tube gives all the volume which could be desired for home use without high-voltage wiring. And every feature of the record-breaking 720 (D.C.) Screen-Grid Six has been embodied and still further improved.

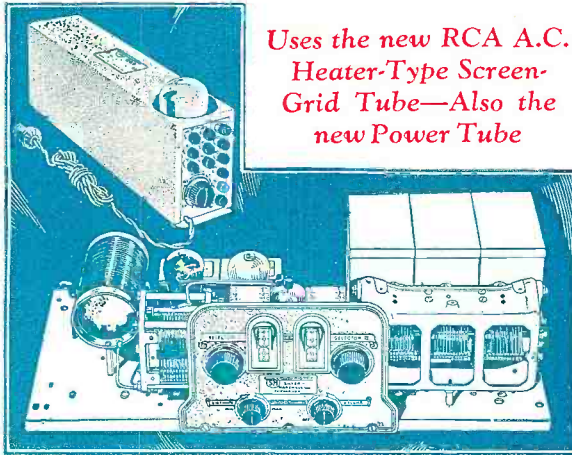

Uses the new RCA A.C. Heater-Type Screen-Grid Tube—Also the new Power Tube

### See How Next Year's Best Receivers Will Tune and Sound!

**T**HE S-M 720AC Screen-Grid Six, used with the new S-M 669 power supply, is a complete all-electric receiver designed especially to bring out the extreme possibilities of the new RCA screen-grid tube. Three of these tubes are used in the r.f. stages, one 227 tube as detector, another as first stage audio amplifier, and one output tube of the new super-power intermediate-voltage type. Price (less tubes) complete KIT without cabinet \$78.00; S-M 700 cabinet, extra \$9.25. Receiver WIRED complete in the beautiful 700 two-tone shielding cabinet, less tubes and power unit, \$107.50.

### Australia to New York—Verified!

Correspondence  
2B. L. Service



We are in receipt of your letter, undated, and have pleasure in confirming the items mentioned by you as having been broadcast by this station. We are always glad to hear from over the seas, and hope to hear from you again with regard to our transmission.

Mr. William Parzelt,  
128 Post Avenue,  
New York City,  
U.S.A.

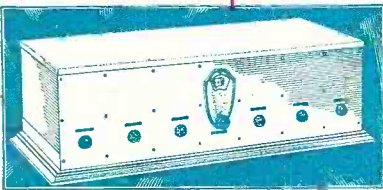

An ultra-sensitive and knife-edge tuning set, which can, nevertheless, be operated when desired as a real one-dial set—with tone quality unsurpassed even in sets not designed for unusual selectivity. All this at \$130.00 for the KIT, or \$175.00 WIRED—both prices including cabinet!

**AUSTRALIA** to New York City on 353 meters! Direct verification from Station 2BL in Sydney, New South Wales, to a listener by the Hudson—one of the many thousands who have successfully employed the S-M Sargent-Rayment Seven to break through congested local interference.

We congratulate Mr. Parzelt on this feat of reception, and are happy to be able to supply, to all who desire it, a receiver of such caliber.

The great Sargent-Rayment 710—aptly termed "The Boss of the Air"—is everything the most fastidious listener might want—the superb tone quality of the S-M Clough audio system is, in the Sargent-Rayment, imparted not only to ordinary near-by reception, but to full firm voices from thousands of miles distant.

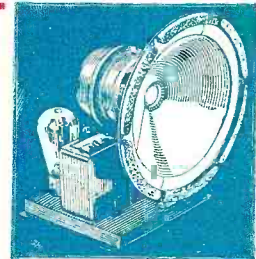

### Now a Speaker Made as Good as S-M Amplifiers

The S-M Dynamic Speaker, now announced for the first time, establishes still more firmly the superiority of S-M sound amplifying equipment—a speaker supreme in its ability to handle without distortion an amazingly large amount of power. Has the new S-M 229 output transformer built in, with output taps providing proper impedance matching for use with 171, 250, or the new intermediate power tubes, singly or in push-pull. Two types: S-M 850, for 110 volts A. C. (using '80 rectifier tube) \$58.50. S-M 851, for 110 volts D. C. \$48.50.

The Radiobuilder, a monthly publication telling the very latest developments of the S-M laboratories, is too valuable for any set-builder to be without. No. 9 (Jan. 1929) gave full particulars about the new apparatus described above, long before it was available in any other form. Send the coupon for free sample copy, or to enter your subscription if you want it regularly.

If you build professionally, but do not have as yet the S-M Authorized Service Station appointment, be sure to ask about it.

**SILVER-MARSHALL, Inc.**  
848 West Jackson Blvd., Chicago, U. S. A.

- Silver-Marshall, Inc.  
848 W. Jackson Blvd., Chicago, U. S. A.  
.... Please send me, free, the complete S-M Catalog; also sample copy of The Radiobuilder.  
For enclosed..... in stamps, send me the following:  
.... 50c Next 12 issues of The Radiobuilder  
.... \$1.00 Next 25 issues of The Radiobuilder  
**SM DATA SHEETS** as follows, at 2c each:  
.... No. 1. 670B, 670ABC Reservoir Power Units  
.... No. 2. 685 Public Address Unipac  
.... No. 3. 730, 731, 732 "Round-the-World" Short Wave Sets  
.... No. 4. 223, 225, 226, 256, 251 Audio Transformers  
.... No. 5. 720 Screen Grid Six Receiver  
.... No. 6. 740 "Coast-to-Coast" Screen Grid Four  
.... No. 7. 675ABC High-Voltage Power Supply and 676 Dynamic Speaker Amplifier  
.... No. 8. Sargent-Rayment Seven  
.... No. 9. 678PD Phonograph Amplifier  
.... No. 10. 720AC All-Electric Screen-Grid Six.

..... Name  
..... Address