

RADIO PHONE
WRNY
STATION

RADIO NEWS

REG. U.S. PAT. OFF.

25 Cents

MARCH

Over 200
Illustrations

Edited by HUGO GERNSBACK

FOY
3157-
3162

**DRAW
YOUR IDEAL
RADIO SET
\$1000.00
IN PRIZES**

SEE PAGE 1258

SPECIAL PRIZES
FOR WOMEN

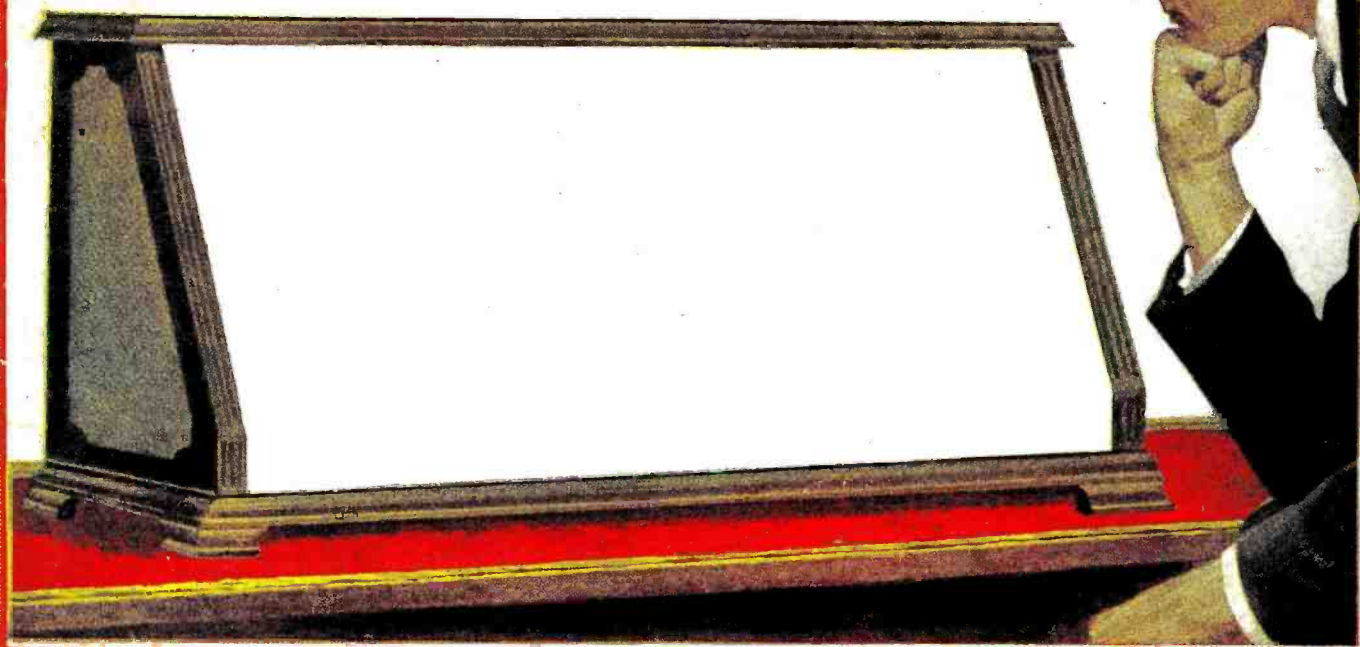

RADIO'S GREATEST MAGAZINE

EXPERIMENTER PUBLISHING COMPANY, NEW YORK, PUBLISHERS OF

SCIENCE and INVENTION

THE EXPERIMENTER

MOTOR CAMPER & TOURIST

Cunningham

RADIO TUBES

Since 1915—
Standard for all Sets



PROVEN DEPENDABLE

In millions of homes where Radio is Entertainment; in thousands of homes where Radio is a Hobby, and in thousands of laboratories where Radio is a serious matter for Research—Cunningham Radio Tubes have proven dependable.

The familiar Orange and Blue Carton is famous the world over as representative of tube quality in reception plus rugged endurance.

Since 1915---Standard for All Sets



TYPES C-& CX—

E. J. Cunningham Inc.

NEW YORK

CHICAGO

SAN FRANCISCO

Tower

REG. U.S. PAT. OFF.



Wherever There Are Ears To Hear

There's a Tower Speaker or Headset to fit every taste, every pocketbook.

The Meistersinger Speakers, the Scientific Speaker and the famous Tower Phonograph Attachment are equipped with the wonderful new double diaphragm—the greatest single contribution to sound reproduction since Bell invented the telephone receiver. These Tower Units recreate *all* the instruments of the orchestra,—as well as choral singing and the spoken word—in their original, living vividness with full resonance, color and shading. Before you buy—Hear a Tower Speaker.

On Sale by Good Dealers From Coast to Coast

TOWER MFG. CORPORATION
BOSTON, MASS.



\$2.95



\$3.95

Phonograph Attachment

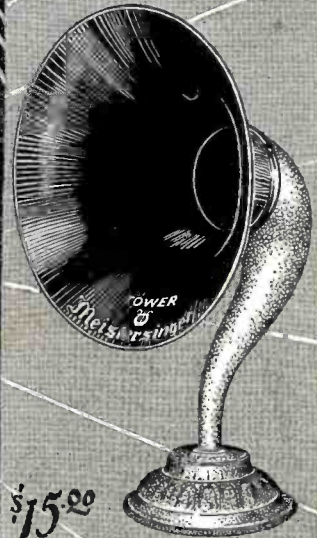

\$15.00

Meistersinger

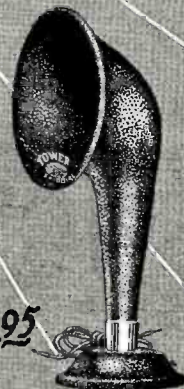

\$4.95

Little Spitsire



\$8.50

Scientific

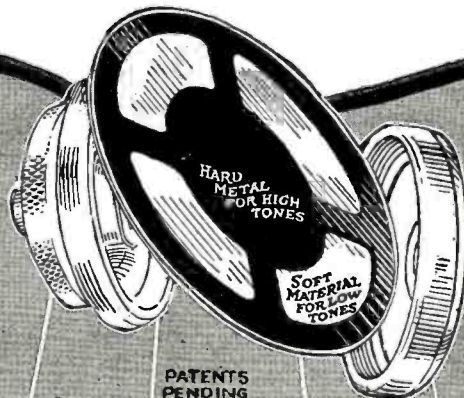

PATENTS PENDING

** Only Tower Products are equipped with this New Diaphragm*



\$15.00

Meistersinger
CABINET MODEL

WORLD'S GREATEST SPEAKER VALUES

RADIO NEWS

Published by EXPERIMENTER PUBLISHING COMPANY, INC.,
 Publishers of "Radio News," "Science and Invention,"
 "The Experimenter" and "Motor Camper & Tourist."
 Editorial and General Offices: 53 Park Pl., New York City
 H. GERNSBACK, President. S. GERNSBACK, Treasurer.
 R. W. DEMOTT, Secretary.
 MEMBER: AUDIT BUREAU OF CIRCULATIONS
 RADIO MAGAZINE PUBLISHERS ASSOCIATION

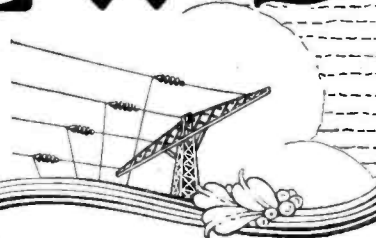

VOLUME 7

CONTENTS MARCH, 1926

NUMBER 9

In Our Next Issue

A New Five-Tube Radio Frequency Amplifier, By the Staff of RADIO NEWS LABORATORIES

Which represents the latest developments in experimental receivers. This receiver was specially designed in the laboratories of RADIO NEWS.

The Latest Super-heterodyne, By Joseph Bernsley

This is a change from the ordinary super-heterodyne, in which special design has been employed to furnish the best kind of results. This receiver has been designed from start to finish, not merely assembled.

New Developments in Radio Receivers, By the Staff of RADIO NEWS

This department is continued from month to month in RADIO NEWS, and is proving extremely valuable to those who are interested, either directly or indirectly, in the radio industry or in radio experimenting.

Further Developments in Vacuum Tubes, By Dr. Chas. B. Bazzoni

Dr. Bazzoni has been writing for RADIO NEWS for some time, on the application and design of vacuum tubes, not only in the radio art, but in allied branches of science as well.

In This Issue

Is There Money in Radio Inventions? By Hugo Gernsback	1253	Speech Currents in Radio-phony. By John B. Bront	1285
Radio Experts Discuss Future Problems. By G. C. B. Rowe	1254	Tracing Interference to Its Lairs. By S. R. Winters	1286
What Happens in Vacuum Tubes? By Dr. Annemarie Katsch	1255	An Automatic Double-Range Receiver. By Sylvan Harris	1287
Radio Forecasting. By E. B. Rideout	1256	A "B" Eliminator from Matched Parts. By George Ames	1290
"Interference." By Colman Galloway	1257	List of Broadcast Stations in the United States..	1291
\$1,000 Prize Contest. WRNY Broadcasts Christmas Greetings from Germany.	1258	An Easily-Constructed Crystal Receiver. By M. L. Hartman and John R. Meagher.	1292
By Stanley McClatchie	1260	The Duodyne Circuit. By Ashur Van A. Sommers	1293
Awards of the \$370 Radio Play Contest.	1262	A Parlor Music Maker. By Volney G. Mathison	1294
Radio Beats the Ticker. By Marius Logan	1263	A Piezo-Electric Loud Speaker. By R. F. Shropshire	1296
When Nations Listen In. By Charles D. Isaacson	1266	Something New in Wave Traps. By Donald H. Menzel and Winfield W. Salisbury	1297
International Radio. Set Owner's Information.	1267 1268	A Regenerative Loop Receiver. By G. C. B. Rowe	1298
How Shall I Begin? By A. P. Peck	1269	Constructing a Real DX Receiver. By Marvin S. Olson	1299
Short Wave Work in IRAQ (Mesopotamia). By Lt. R. F. Durrant	1271	The Crystal Classified and Analyzed. By J. F. Carrigan	1300
Radio as an Ally to the Theatre. By Colman Galloway	1272	The Loop Antenna. By Leon L. Adelman	1301
New Developments in Radio Apparatus. By A. K. Laing	1273	Correspondence from Readers	1302
The Manufacture of Modern Low-Loss Condensers. By Franklyn L. Francis	1276	Awards of the \$50 Wrinkle Contest	1303
Radio Beacon Guides Night Air Mail. By A. M. Jacobs	1277	Radiotics	1306
Thirty Years in the Dark Room	1278	Standard Hook-Ups	1307
Controlling Power and Motion by Radio. By A. K. Laing	1280	What Wave Shall We Work On? By Jack Milligram	1309
How Radio Tubes Are Evacuated. By Dr. Chas. B. Bazzoni	1282	RADIO NEWS LABORATORIES	1310
A Radio Sounder and Interference Eliminator. By Capt. H. W. Webbe	1284	I Want to Know. By Joseph Bernsley	1312

RADIO NEWS is published on the 10th of each preceding month. There are 12 numbers per year. Subscription price is \$2.50 a year in U. S. and possessions, Canada and foreign countries, \$3.00 a year. U. S. Coin as well as U. S. Stamps accepted (no foreign coins or stamps). Single copies, 25 cents each. A sample copy will be sent gratis on request. Checks and money orders should be drawn to order of EXPERIMENTER PUBLISHING CO., INC.

All communications and contributions to this journal should be addressed to Editor, RADIO NEWS, 53 Park Place, New York, N. Y. Unaccepted contributions cannot be returned unless full postage has been included. All accepted contributions are paid for on publication. A special rate is paid for novel experiments; good photographs accompanying them are highly desirable.

RADIO NEWS, Monthly. Entered as second class matter, July 12, 1924, at the Post Office at New York, N. Y., under the Act of March 3, 1879. Additional entry at Long Island City, N. Y., and San Francisco, Calif. Title registered U. S. Patent Office. Copyright, 1926, by The Experimenter Publishing Co., Inc., 53 Park Place, New York. The Contents of this magazine are copyrighted and must not be reproduced without giving full credit to the publication. Copyrighted in Germany. Reproduction of articles in Germany is reserved for Radio, Berlin 42.

New York City
 General Advertising Dept.
 53 Park Place

Western Advertising Representatives
 Finucan & McClure
 720 Cass St., Chicago, Ill.

New England Advertising Representative
 T. F. Magrane, Park Square Building, Boston, Mass.

RADIO NEWS is for sale at all newsstands in the United States and Canada, and at Brentano's, Ave de L'Opera, Paris, France. European agents: S. J. Wise Et Cie, 40 Place Verte, Antwerp, Belgium.

HOW TO SUBSCRIBE FOR RADIO NEWS. Send your name, address and remittance to Experimenter Publishing Co., 53 Park Place, New York. Mention the name of the magazine you are ordering. We also publish SCIENCE AND INVENTION, the EXPERIMENTER and MOTOR CAMPER & TOURIST. Write clearly.

RATES AND TERMS. The subscription rate for RADIO NEWS is \$2.50 per year. (12 numbers). When remitting do so by check, money order, or registered letter if cash is enclosed. Avoid sending cash through the mail if possible. Subscriber for less than one year are not accepted. Subscription may be made in combination with SCIENCE AND INVENTION or the EXPERIMENTER. POSTAGE. We prepay postage in all parts of the United States, Mexico and island possessions. For foreign or Canadian subscriptions we require 50 cents in addition to the subscription price for additional postage charges.

CHANGE OF ADDRESS. Notify us as far in advance as possible. It requires several weeks to make an address change on our records. Always write clearly. ON EXPIRATION of your subscription, we enclose a renewal blank in our last number to you; we stop our delivery to you on expiration.

Pacific Coast Advertising Representatives

A. J. Norris Hill Co.
 Hearst Bldg., San Francisco, Calif.
 Detwiler Bldg., Los Angeles, Calif.

Kansas City Advertising Representatives

Davies and Dillon
 15 W. Tenth St., Kansas City, Mo.

Detroit Advertising Representative
 Roy Buell, Donovan Bldg., Detroit, Mich.

The Newest Achievements of POWEL CROSLLEY JR.

Industrialist—Pioneer Radio Builder—Master of Mass Production

Four Entirely New 4- and 5-tube Radio Sets—Also the Crescendon

Never before has Crosley engineering and manufacturing genius been so brilliantly demonstrated as in this group of new Crosley sets.

Here, at prices so low as to be literally revolutionary, are three 5-tube sets and one 4-tube set—entirely new in principle, design, circuit, and appearance—entirely unique in the results they give on distant and local stations—entirely unprecedented in the values they now introduce.

On two of these sets is offered the Crescendon, a new and exclusive Crosley feature—an extra volume control by which average incoming signals can be built up or modified in a manner nothing short of amazing. Introduced on the new 4-29 and 5-38, the Crescendon principle makes its first appearance in the low price field, its use having hitherto been restricted to one set costing several times as much.

Particular emphasis is directed to the new Crosley RFL receiving sets that utilize an entirely new and patented circuit which provides true cascade amplification and closely approaches the theoretical maximum of efficiency per tube. Non-oscillating at any frequency and absolutely non-radiating, the RFL Crosleys are specifically recommended for use in congested areas and for satisfactory performance in the hands of inexperienced operators.

In addition to their truly marvelous selectivity, sensitivity, and purity of tone, these new Crosleys have been given a new order of beauty that cannot help but win the highest admiration.

We do more than urge you to go to the nearest Crosley dealer for a demonstration! We ask you to go prepared for the most startling revelation in radio ever announced in the entire history of the industry—and predict that your expectations will be more than satisfied!

Crosley manufactures radio receiving sets which are licensed under Armstrong U. S. Patent No. 1,113,149, or under patent applications of Radio Frequency Laboratories, Inc.

THE CROSLLEY RADIO CORPORATION, CINCINNATI, OHIO

Owning and Operating WLW first remote control super-power broadcasting station in America



The Crosley 4-tube—4-29
in which the Crescendon is equivalent to one or more additional tubes of tuned radio frequency amplification . . . **\$29**



The Crosley 5-tube—5-38
All the volume, selectivity, sensitivity and purity of tone available in the best 5-tube set—plus the Crescendon . . . **\$38**



The Crosley—RFL-60
A set so marvelous in performance that its appearance on the market is bound to create a new standard of comparison . . . **\$60**



The Crosley—RFL-75
For simplicity and speed in tuning, fidelity of tone, and decorative beauty—it stands unchallenged at twice the price . . . **\$75**

West of the Rocky Mountains all prices as published are 10% higher

INDEX
TO
ADVERTISERS

INDEX TO ADVERTISERS

	Page		Page		Page
A					
Acme Apparatus Co.	1324-1325	Dongan Electric Mfg. Co.	1326	Karas Electric Co.	1337
Acme Electric & Mfg. Co., The	1371	Donohue Lumber Co., L. R.	1376	Kellogg Switchboard & Supply Co.	1368
Aerial Electric Co.	1374	Dubilier Condenser & Radio Corp.	1332	Keystone Products Co., The ..	1376
Aerovox Wireless Corp.	1342	Duke Radio Co.	1370	Klosner Radio Corp.	1338
Alden Mfg. Co.	1320	E			
All-American Radio Corp.	1360	Economy Radio Sales Co.	1375	L	
All Radio Co.	1379	Electric Specialty Co.	1346	Lancaster & Allwine	1369
Allen-Bradley Co., Inside Back Cover		Electrical Engineers Equip. Co.	1380	M	
Ambassador Sales Co.	1354	Electro Thermal Co., The	1348	Mack Laboratories	1370
Ambu Eng. Inst.	1338	Evans & Co., Victor J.	1348	Marko Storage Battery Co.	1366
American Electric Co.	1356	F			
American Hard Rubber Co.	1358	Fahnestock Electric Co.	1362	Midwest Radio Corp.	1252
American Radio Engineers	1360	Fansteel Products Co., Inc.	1335	Miller Rubber Co. of N. Y.	1362
Amplion Corp. of America, The ..	1360	Ferbend Electric Co.	1377-1380	Movison Electrical Supply Co., Inc.	1326
Amsco Products, Inc.	1361-1379	Fishwick Radio Co.	1368	Murdock Co., Wm. J.	1375
Apex Electric Mfg. Co.	1362	Fornica Insulation Co.	1353	Myers Radio Tube Corp.	1368
Arrow Battery Co.	1360	Freshman Company, Inc., Chas.	1357	N	
Atwater Kent Mfg. Co.	1329	G			
B					
Bakelite Corp.	1384	G-S Radio Research Lab.	1322	National Carbon Co., Inc.	1317
Baker-Smith Co., Inc.	1377	Garfield Radio Mfg. Corp.	1370	National Company, Inc.	1346
Barawik Company, The 1344-1356 1359-1366-1369-1377-1381		Gearhart-Schluter Radio Corp.	1362	National Radio Institute	1251
Barkelew Elec. Mfg. Co., The	1338	Gem Tube Co.	1354	Niagara Metal Stamping Corp.	1356
Belden Mfg. Co.	1345	General Electric Co.	1330	Norden-Hauck, Inc.	1338-1344
Benjamin Elec. Mfg. Co.	1336	General Radio Co.	1247	O	
Bluebird Tube Co.	1357	Gold Medal Radio	1360	Ohio Electric & Controller Co., The	1322
Brady, John B.	1362	Golden-Leutz, Inc.	1371	Omnigraph Mfg. Co.	1336
Brant Battery Co.	1383	Goldstein, S.	1358	Owen, Richard B.	1354
Boice, W. B. & J. E.	1369	Gould Storage Battery Co.	1369	P	
Braum Co., W. C.	1383	H			
Bremcr-Tully Mfg. Co.	1365	Hammarlund Mfg. Co.	1359	Pacent Electric Co.	1250
Bristol Company, The	1333	Heath Radio & Elec. Mfg. Co.	1342	Parker, C. L.	1359
Brownlie & Co., Roland	1365	Henninger Corp., A. F.	1366	Phenix Radio Corp.	1341
Buescher Band Instrument Co.	1371	Hommel & Company, Lud- wig	1365-1380	Photion Electric Co.	1334
Butts, Inc., C. W.	1346	I			
C					
C. E. Mfg. Co., Inc.	1348	Indiana Mfg. & Electric Co.	1367	Pilot Electric Mfg. Co., Inc. 1248-1249	
Camfield Radio Mfg. Co.	1331	International Correspondence Schools	1356	Potter Mfg. Co.	1326
Carborundum Company, The ..	1374	J			
Carter Radio Co.	1381	Jewell Electrical Instrument Co.	1340	Powerola Radio Corp.	1360
Chalfonte-Haddon Hall	1368	K			
Chaslyn Co., The	1354	K Electric Co.	1380	Precision Coil Co., Inc.	1377
Chelsea Radio Co.	1380	K & H Electric Co.	1374	Press Company, The	1362
Chemical Institute of N. Y., Inc.	1351	L			
Chicago Electric Devices Co.	1379	M			
Chicago Stock Gear Works ..	1344	N			
Clark & Tilson, Inc.	1358	O			
Conrad Co., Inc., The ..	1364-1372	P			
Coyne Electrical School	1362	Q			
Crain Bros. Radio & Mfg. Co.	1374	R			
Crescent Radio Supply Co.	1359	S			
Crosley Radio Corp., The	1243	T			
Cross Gear & Engine Co.	1344	U			
Culver-Stearns Mfg. Co.	1361	V			
Cunningham, Inc., E. T., Inside Front Cover		W			
Cutler-Hammer Mfg. Co., Back Cover		XYZ			
D					
Daven Radio Corp.	1373	X L Radio Laboratories ..			
DeWitt LaFrance Co.	1370	Y. M. C. A. Radio Institute ..			
E					
F					
G					
H					
I					
J					
K					
L					
M					
N					
O					
P					
Q					
R					
S					
T					
U					
V					
W					
XYZ					

Send for this
New Hookup

Silver- Cockaday

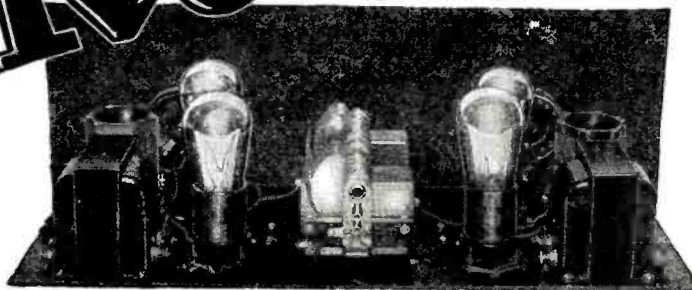

Four Tube Receiver

Here is a new radio receiver sensation in which are combined the genius of McMurdo Silver and Laurence M. Cockaday—than whom there are no others more prominent nor more favorably known in radio receiver design today. Here is a receiver for the home builder that will represent for several seasons to come a far greater dollar for dollar value than any other design available. Send for the book. Read how to obtain the following

Startling New Features

SINGLE CONTROL—But one tuning or station selector control.

SELECTIVITY—In a residential district of New York City, within a few hundred yards of powerful stations, thirty-five stations were heard between 9 and 10 p. m. on the loud-speaker. KFI, in Los Angeles, was heard with ample volume to fill two rooms. Tests in Chicago brought in either coast with ample speaker volume, and indicated that a consistent range of 1,000 to 2,500 miles might be expected.

QUALITY—Two new-type Thordarson power amplifying transformers possessing a substantially flat frequency characteristic over the range of 40 to 6,000 cycles, give a quality of reproduction so perfect that comparison by the best trained human ear with other types of amplifiers will not reveal any superior type.

VOLUME—In all cases the volume will exceed that obtainable from other four-tube receivers, and in practically all cases equal or exceed that obtainable from standard five and six-tube receivers.

UNLIMITED WAVE LENGTH RANGE—Through the use of interchangeable coils, the wave-length range is practically unlimited.

WIRING AND ASSEMBLY—All wiring is carried in a special harness. Since each wire is exactly the right length, and has a special color, it is impossible to go wrong in wiring. No soldering is needed unless preferred by the builder. Only a screwdriver and a pair of pliers necessary to assemble this set in less than two hours.

Over-all design, rugged and solid. Adapted to practically any standard cabinet, any standard tube, any battery or eliminator source of supply, outdoor antenna or loop. While the parts are the best that the leading laboratories of the country afford, the set can be built at an extremely low cost. Full description of the receiver will be published in the March issue of Popular Radio.

Get the hand book at your nearest Radio Dealer or clip the coupon and send with 25 cents TO-DAY. Address

**The S-C Merchandising
Committee**
110 S. Wabash Ave.
Chicago

No choicer group of radio products has ever been embodied in a single radio receiver. Not only are these manufacturers nationally known and accepted as the leaders in radio design and construction, but they have developed for the Silver-Cockaday receiver several new features which will create a new standard in reception throughout the radio world.

Contributing Manufacturers:

Belden Mfg. Co.
S-C Wiring Harness

Central Radio Laboratories
Central Lab Resistance

Polymet Mfg. Corporation
Fixed Condensers, Leak
and Leak Clips

Silver-Marshall, Inc.
Variable Condensers, Coil Sockets,
Coils, Tube Sockets, Vernier
Dial, Mounting Brackets

Thordarson Electric Mfg. Co.
S-C Power Transformers

Walart Electric & Mfg. Co.
[Continental Fibre Co.]
Drilled and Processed Front Panel
and Drilled Sub-Panel

Yaxley Mfg. Co.
Rheostat, Jacks, Switch

The Key to the
Silver-Cockaday
Receiver

PRICE
25
CENTS

The S-C
Merchandising
Committee:

110 S. Wabash Avenue · Chicago

Gentlemen: Please find enclosed 25c, for which send me hand book of the new Silver-Cockaday Receiver.

NAME _____

ADDRESS _____

RADIO NEWS READERS' BUREAU

Time and Postage Saver

IN every issue of RADIO NEWS you undoubtedly see numerous articles advertised about which you would like to have further information. To sit down and write an individual letter to each of these respective concerns, regarding the article on which you desire information, would be quite a task.

As a special service to our readers, we will write the letters for you, thus saving your time and money.

Just write the names of the products about which you want information, and to avoid error the addresses of the manufacturers, on the coupon below and mail it to us.

If the advertiser requires any money or stamps to be sent to pay the mailing charges on his catalogue or descriptive literature, please be sure to enclose the correct amount with the coupon.

We will transmit to the various advertisers your request for information on their products.

This service will appear regularly every month on this same page in RADIO NEWS.

If there is any Manufacturer not advertising in this month's issue of RADIO NEWS, from whom you would like to receive literature, write his name, address and the product in the special section of the coupon below.

TEAR ALONG THIS LINE

READERS' SERVICE BUREAU,
 Experimenter Publishing Co., Inc., 53 Park Place, New York, N. Y.

RN-3-26

Please advise the firms listed below that I would like to receive detailed information on their product as advertised in the issue of RADIO NEWS.

 **DO NOT USE THIS COUPON FOR TECHNICAL QUESTIONS**

NAME	ADDRESS (Street — City — State)	List here specific article on which you wish literature.	If Catalogue of complete line is wanted, check in this column
.....
.....
.....
.....
.....
.....
.....
.....
.....
.....

Use this space if you desire information from a manufacturer whose advertisement does not appear in this month's issue.

NAME	ADDRESS (Street — City — State)	
.....
.....
.....

Your name Dealer's name
 Your address His address
 If you are dealer check here. City State..... City..... State.....

The circuit that has won the
Nationwide Approval
 of Set-Builders
 by its **PERFORMANCE**



Get this Booklet

Ask your local dealer for free booklet containing diagrams, templates, and complete instructions for the building of the "UNIVERSAL". If he is unable to supply the necessary information and instruments write to Dept. "UNIVERSAL," General Radio Company, Cambridge 39, Mass.



The RADIO BROADCAST
UNIVERSAL
 FOUR TUBE RECEIVER

The "UNIVERSAL" was designed by Arthur H. Lynch, editor of *Radio Broadcast*. It has been chosen as the one outstanding circuit which would meet the most rigid requirements of amateur set-builders from a standpoint of performance, simplicity and economy of construction and operation.

This circuit has been tested under a wide variety of receiving conditions and compared by competitive tryouts with other receivers of creditable performance and has proven well worthy of its name "UNIVERSAL".

To the set-builder who expects real results from his set and wants advance assurance that he will get them we recommend the "UNIVERSAL" as the circuit to build.

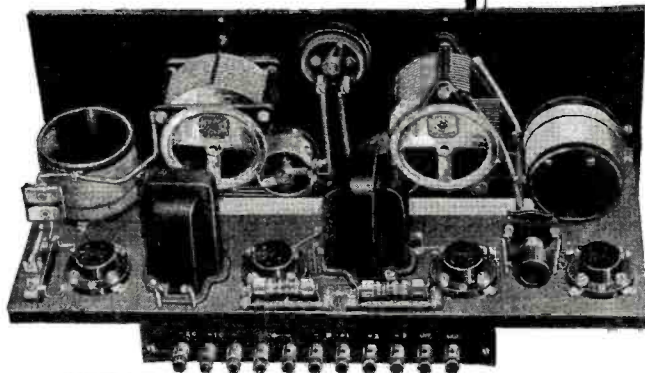

GENERAL RADIO CO
 Cambridge, Mass.
 U. S. A.

GENERAL RADIO
INSTRUMENTS
 "Behind the Panels of Better Built Sets"

WORLD'S GREATEST PILOT AGAIN

PIONEERS — BUILDERS OF RADIO PARTS FOR 18 YEARS.

TRIPLE CAPACIGRAD

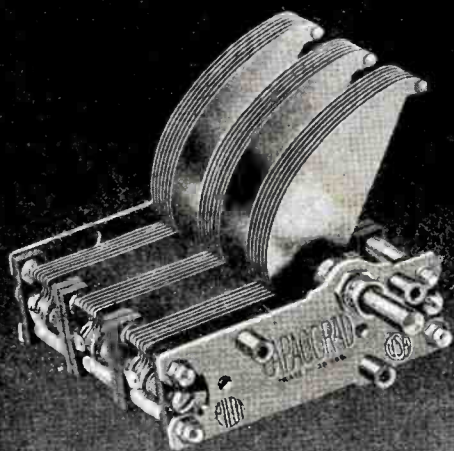

A triple condenser mounted on common shaft, for one-dial control. Built with the precision which made Pilot paramount as World's Largest Parts Producer.
[Made also in double condenser style]

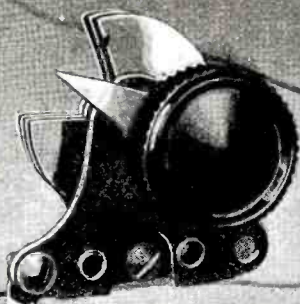

"NEUTROGRAD" Midget Compensating Condenser

"Takes up" variations in coils, etc. Especially important where uni-control is employed, resulting in balanced stabilized circuit. One-hole mounting.

PILOT'S NEW CAPACIGRAD

"Velvet Feel"



A true, straight line frequency condenser, solid brass plates. Built like a watch, it is the pinnacle of precision. Special bushings give that "velvet feel"—free from chatter. CAPACIGRADS cost no more than ordinary condensers because produced by the World's Largest Parts Producer.

ASK for and GET PILOT PARTS
Volume production cuts the cost
Laboratory control insures accuracy.

PILOT parts for sale at all S. S. Kresge Stores, or if no Kresge Store near you, write us and we will see that you are supplied.

PILOT ELECTRIC M'F'G.

RADIO PARTS PLANT

LEADS THE WAY

**PIONEERS — BUILDERS OF
RADIO PARTS FOR 18 YEARS.**

KILOGRAD



A New and Improved Vernier Dial [ratio 10 to 1] which makes fine tuning not only possible but simple! Marked in Degrees and Kilocycles, both. A fine "job" in genuine Bakelite, made by the World's Greatest Parts Manufacturer.

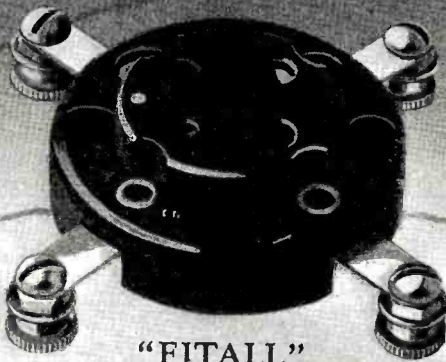

"FITALL"

UNIVERSAL SOCKET

For UV 201 A tubes with old style bases and for all the new UX tubes (both Storage and Dry Cell type). Equip your set with these modern sockets and use whatever tubes you please. Genuine Bakelite.

PILOT JACK



Special connecting lugs abolish soldering, and the sturdy frame helps support sub-panel, which is easily attached with screws through three holes provided for that purpose.

PILOT RHEOSTAT



The Solid Bakelite Knob is adjustable for any panel thickness! Slider built as unit assembly. Constructed with characteristic Pilot precision in all standard resistances. (Also made in Potentiometers). Will brighten-up the face of any set!

**CO. INC. 323 BERRY ST.
BROOKLYN, N.Y.**

First Honors!

The Pacent
TRUE
Straight Line
Frequency
Condenser



“—the nicest working straight-line affair I have encountered”

The above testimonial is taken word for word from an unsolicited letter we have received from a prominent and well known Radio Pioneer.

Engineering Reasons:

- 1—True Straight - Line Frequency
- 2—Negligible losses
- 3—Perfect insulation. Isolantite properly placed
- 4—All metal parts except shaft are brass
- 5—Plate of special brass, rigidly soldered
- 6—Rigid channel frame construction
- 7—Permanent plate alignment
- 8—Extra tie bars
- 9—Oversize, dust proof, uni-bearing
- 10—Positive effective, enclosed stop
- 11—Provision for both one and three hole mounting
- 12—Design provides for uni-control, tandem mounting
- 13—Distinctive, compact, and sturdy

Yet this is but one of the many striking testimonials we have received from all sources.

Part by part—from start to finish—this PACENT Condenser is built for TRUE straight-line frequency. Not a makeshift or a left over part is used in the entire construction. Everything is new.

You will wax enthusiastic over this distinct engineering achievement. It will give you not only wider dial separation of stations, but more stations, easier tuning and NO mechanical trouble. That is what you want, that is what you can expect.

Get a set from your dealer today, or if he cannot supply you write us direct and we will send you a set at once from our stock on hand. Accept no substitute.

- Cat. No. 251-B, 17 Plates, Min. 12 mmf. Max. 350 mmf. Ratio 3 to 1. PRICE \$3.50
- Cat. No. 251-C, 23 Plates, Min. 14 mmf. Max. 500 mmf. Ratio 3 to 1. PRICE \$4.50

PRICES ON OTHER CAPACITIES ON REQUEST

Pacent Electric Company, Inc.
91 SEVENTH AVENUE, NEW YORK CITY

- | | | | |
|-------------|---------------|--------------|--------------|
| Washington | San Francisco | Philadelphia | Jacksonville |
| Minneapolis | Chicago | St. Louis | Pittsburgh |
| Boston | Birmingham | Buffalo | Detroit |
- Canadian Licensees: White Radio Limited, Hamilton, Ont.

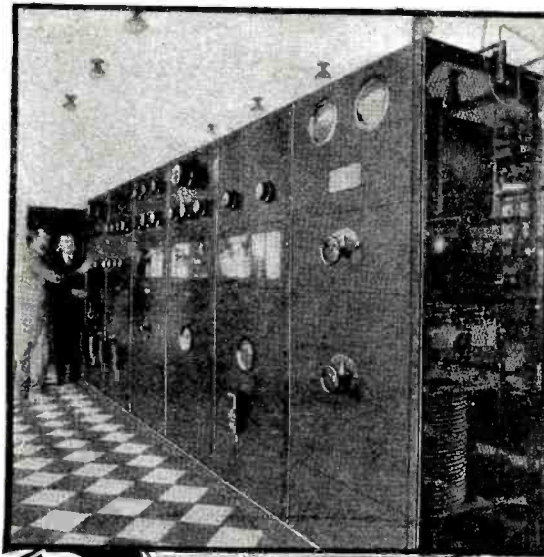

**\$50. to \$250 a week
IN WORK THAT IS
ALMOST ROMANCE**

Be a Radio Expert



Get into the great new Big-Pay Industry—Radio. If you're earning a penny less than \$50 a week, clip coupon now. Send for AMAZING FREE BOOK. Be a Radio Expert, and draw down big money for the easiest and most fascinating work in the world. Positions everywhere. Thoroughly-trained men are in big demand. Need for Radio Experts in every community. Short hours. BIG PAY. Free book gives all the facts. Astonishing opportunities—thousands of them! Every day N. R. I. trained men are taking good places in the Radio field. Free book tells all about their success. Send for it now!

LEARN QUICKLY AND EASILY AT HOME

Master Radio Engineers will show you how to qualify quickly and easily at home, for Radio's fine jobs. We guarantee to train you successfully. Lack of experience no drawback—common schooling all you need. Our tested, clear methods make it easy for you. Send coupon now for free proof.

Instruments Given with Course

All instruments shown here and many others given to students for practice work while learning. Receiving sets, from simplest kind to thousand mile receiver, an UNEQUALLED OFFER. Many other big features for limited time only.

Famous Training That "Pays for Itself"

Spare earnings are easy in Radio. Increase your income almost from the start through practical knowledge we give you. This is the famous practical training that pays its own way.

Get this Amazing Book

Most amazing book on Radio ever written—full, interesting facts about this great field and how we prepare you and help you start. You can do what others have done. GET THIS BOOK.

Send Coupon

Send coupon today for special limited offer, including all instruments—you'll get full particulars by return mail.

National Radio Institute

Dept. CW1, Washington, D. C.

You get
all of
these

MAIL THIS NOW

NATIONAL RADIO INSTITUTE
Dept. CW1,
Washington, D. C.

Without obligating me in any way, send me your free book, "Rich Rewards in Radio," and all information about your practical, home-study Radio course.

Name

Address

Town..... State.....



Operates WMAQ

"Accepted a position with Chicago Daily News—Station WMAQ. My income practically doubled, thanks to your fine course."

KEITH KIMBALL, Chicago.



Gets Big Job

"Just been made Sales Manager of this Radio concern—a big raise in pay. Regret I did not take course sooner."

R. E. JONES, Bay City.



LARGEST RADIO SCHOOL IN THE WORLD

ORIGINATORS OF RADIO HOME-STUDY TRAINING

Now only \$59.50
For Volume, Selectivity, Clearness and Long Distance it's unsurpassed—Find it better than \$200 Sets—All you claim—and more
GET SPECIAL OFFER
Retail



Built like—looks like—performs like a \$200 set. 27 in. long.

Get Amazing Offer

MIRACO RADIO GETS 'EM COAST TO COAST

Notice!

Enormous demand for the celebrated Miraco Ultra 5 (resulting from its many enthusiastic users so highly recommending it to their friends) enabled us to add hosts of costly new features, latest refinements and up-to-the-minute improvements such as you might expect to find only on the newest sets selling at much higher prices. So the improved Ultra 5 for 1926 is even a better set—a more beautiful set—more selective and more powerful set—admirable as this may sound!—for less money than ever before.

COAST TO COAST RECEPTION VERIFIED BY USERS

Reports from Ultra-5 users everywhere leave little for us to add. These are only a few of the many in our files and which we receive daily. Send coupon for plenty of additional proof. Let testimony of users instead of high-sounding claims convince you.

CUTS THROUGH CHICAGO LOCALS

Only a half mile from WENR, one mile and a half from KYW and WMAQ and with the other stations in full blast I was able to cut through last Saturday and pull in WSAI, KDKA, WSM, WREO, WRZ, WJLD, WJR, WOC, WSN, WLW, WEA, WBEI, KST, and several others. Your Ultra 5 is all that you claim it to be and more than that. L. J. K. . . . Chicago, Ill.

GOES THROUGH NEW YORK LOCALS

Received Ultra-5 two weeks ago and in addition to all local stations, have picked up 41 out of 42 stations on loudspeaker. Louis H. . . . New York City

NORTH DAKOTA HEARS COAST TO COAST

Received my Miraco Ultra-5 about two weeks ago in fine shape. I like it fine. Have received programs from about 40 stations all over the U. S., including Los Angeles, Calif., Dallas, Texas, and Schenectady, N. Y. Also stations in Canada. For a Radio Set it's a knockout. Would recommend it to anyone wanting a good receiving set. For volume, selectivity, clearness and long distance it cannot be surpassed. A. O. A. . . . Brinsmade, N. D.

KANSAS GETS 'EM - CUBA TO CALIFORNIA

Am well pleased with my new Ultra-5. Have received over fifty stations between P.W.K. Havana, Cuba and KFI and KHJ Los Angeles, Calif. Chas H. R. K. . . . Hope, Kas.

IOWA GETS NEW YORK THROUGH LOCAL STATION

On your wonderful Ultra-5 I have heard stations in New York as well as two in San Francisco, Calif., and our own local station (WIAS) is going full blast. I have sold two already and have some more sales in view. Edw. F. D. Burlington, Iowa.

OUTPERFORMS \$200 SETS

I have tried out the Miraco Ultra-5 and find it better than \$200 sets; it can't be beat for the money. Jos. F. C. . . . Rayland, Ohio.

ILLINOIS HEARS COAST TO COAST

The Ultra-5 works marvelously bringing in stations from coast to coast. Dean L. S. . . . Roodhouse Ill.

"GREENHORN" GETS 86 STATIONS IN TWO WEEKS

We received the Ultra-5 and are well pleased with it. Had it about two weeks and have gotten 86 stations. That's pretty good for a greenhorn. It sure is easy tuning. Elmer M. . . . No. English, Iowa.

MINISTER PRAISES TONE QUALITY

I have had your Ultra-5 set now for three weeks and I listen in every night. I admit I never heard a set with such a wonderfully nice and full tone as this. I am convinced that it will not be long before quite a few in this country will also have their Ultra-5's. Rev. F. L. R. Ferburn, Minn.

ALABAMA HEARS EVERYWHERE CLEARLY

My Ultra-5 is working fine. All stations are as clear as I want them. I get stations all over the U. S., Canada, Cuba, and ships far out at sea. Mark M. T., Collinsville, Ala.

MISSOURI HEARS 'EM DISTINCTLY COAST TO COAST

Are enjoying my Ultra-5 very much. It's all you recommended it to be. We think the loudspeaker is fine. I have heard many loudspeakers but this is the plainest and most distinct. For distance we have heard WJZ, New York, and KNX, Hollywood, Calif. Ed. R. . . . Bolckow, Missouri

TENNESSEE GETS DISTANT STATIONS BETTER THAN HIGH PRICED SETS

I think my Miraco Ultra-5 is a wonder. It is better than some of the higher priced sets I have seen. It also has a wonderful volume on long distance stations. William T. . . . Blanche, Tenn.

GETS 'EM ALL OVER THE U. S.

On our Ultra-5 we have logged 40 stations from Detroit, Mich. to California, and down the coast to Florida, Louisiana, Tennessee, Georgia, Minnesota and back around to Cincinnati, to Chicago, and home. W. L. R. . . . Lyons, Kans.

EQUALS A \$200 SET IN PERFORMANCE

I received my Ultra-5 and it works fine. Just as good as a \$200 set I heard. H. E. O. . . . Wright, Pa.

HEARS DISTANT STATIONS CLEARLY

Our Ultra-5 is a beautiful set; for performance it can't be surpassed. On first test trial received a distance of over fifteen hundred miles during a rain storm, yet it came in clear and strong. E. T. S. . . . Nashville, Tenn.

COAST TO COAST WITH ECONOMY

Have used your Ultra-5 Miraco for 140 hours and it hasn't weakened the "B" Battery a half of a single volt. I'll say it's the most economical five-tube outfit and the easiest tuned in far or near. The Ultra-5 is the most faithful of all radios that I've heard. By just a little move of the three dials have tuned in as high as 36 stations in one string. Stations from Los Angeles, Calif., to Florida, Calgary, Canada, as if it was right in our own house, only a little louder. New York City Stations come in good. A. G. . . . Ryder, North Dak.

UNEQUALLED FOR CLEARNESS

We are satisfied with our five-tube Miraco and so far have not heard another set that equalled it for loudness and clearness. John L. . . . Paulina, Iowa.

Send coupon for Amazing Special Offer!

The Powerful New MIRACO Ultra 5

Guaranteed by One of the Oldest Radio Builders

Tested and Approved by Radio's Highest Authorities

[ULTRA SELECTIVE FIVE TUBE SET IN MAHOGANY CABINET]

You can either *save* or *make* a lot of money by sending coupon today for our **Amazing Special Offer**. It will astonish you. We also allow **10 Days Free Trial**—satisfaction *unconditionally guaranteed*. The wonderful selectivity, long distance range, clarity of tone, power and loud speaker volume of this famous set—plus its beauty of appearance and splendid construction—will sell it to your friends. Big profits easy for you—accepting their orders. No salesmanship required—no agreement to sign. Even at its retail price this latest improved big beautiful 1926 model Miraco Ultra-5 is an astonishing bargain in the opinion of radio authorities. Remember, too, that each Miraco comes *completely built, thoroughly tested and fully guaranteed* by the great Midwest Radio Corporation—one of America's oldest, reliable and most successful makers of quality sets. Send coupon now.

Compare its construction with highest priced sets

Note the neat, sturdy, high-class construction. All wiring concealed under genuine Formica base panel (A). Wiring is flexible to prevent broken or noisy connections. Genuine Formica panel (B)—handsomely gold-etched on front. Oscillations are easily controlled on all wave-lengths and "B" battery consumption is minimized while selectivity, distance range, clarity and volume are amazingly increased by the patented "Counter-Balancer" (C) and "Duploformer" ultra low loss inductance coils (D, E and F). Adjustment for different length aeriels (G). Shielded transformers, of celebrated make, amplify without distortion (H and I). Lowest dielectric loss type sockets—riveted into base panel. Low loss plate condensers—and other latest features of costliest sets. Literature describes fully—send for it!

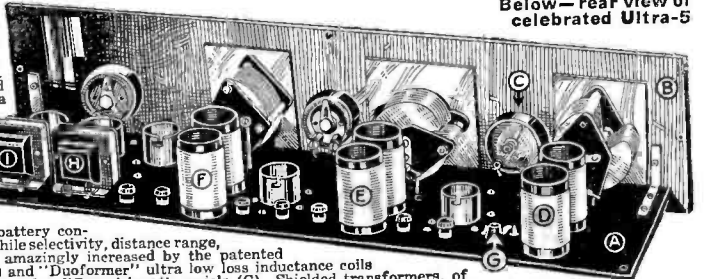

Below—rear view of celebrated Ultra-5

AGENTS! DEALERS!
 Write for the new Miraco proposition. Nation-wide use and popularity of Miraco sets, coupled with their amazingly low prices make them wanted everywhere.



Other Miraco Long Distance Sets \$13⁷⁵ up
 Get Special Offer!
 Remember you are dealing with a big, responsible corporation—one of the oldest and most successful in the industry, a concern which has grown to immense size through the recommendations of satisfied customers—when you buy a Miraco. Absolutely no risk on your part. All Miraco sets work on storage or dry batteries, are easily connected, operated, and logged. Approved by Radio's Highest Authorities. Unmatched values! Let testimony of users convince you. Send coupon for complete literature and AMAZING SPECIAL OFFER!



All the Proof you want is waiting for You!

Reports from hosts of users in every state prove Miraco sets—at rock-bottom factory prices—outperform sets costing up to three times as much. Send for latest literature, SPECIAL OFFER and plenty of additional testimony leaving no doubt that Miraco Radio Gets 'em Coast to Coast!

MIRACO RADIO GETS 'EM COAST TO COAST

MIDWEST RADIO CORPORATION
 Pioneer Builders of Sets
 Cincinnati, Ohio

404-Y East Eighth Street
 Send free literature, AMAZING SPECIAL OFFER and all particulars regarding your big money-saving proposition on Guaranteed Miraco Sets and all radio supplies.
 Agent User Dealer.

NAME _____
 ADDRESS _____



RADIO NEWS

H. GERNSBACK, Editor and Publisher
SYLVAN HARRIS, Managing Editor

EDITORIAL AND GENERAL OFFICES, 53 PARK PLACE, NEW YORK

Vol. 7

MARCH, 1926

No. 9

IS THERE MONEY IN RADIO INVENTIONS?

By HUGO GERNSBACK

“WHO makes the money in radio today?” is the question that is asked most frequently. When, in 1922, the real radio boom was launched, everybody, as it seemed, with a few dollars to spare, jumped into the radio business. Most of those who did have probably regretted this step, on account of their inexperience in either radio matters, business matters, or both.

Speaking generally, it may be said that whatever real money is made today in radio is made by a number of set manufacturers and manufacturers of certain parts. There are, of course, others connected with the radio industry who are prospering as well, but the types mentioned seem to comprise the bulk of the successful ones.

Not every set manufacturer is prosperous. Quite the contrary. Many are not; and those who are not, may trace their failure to first, lack of capital, and second, lack of knowledge of the business itself, or both.

The industry has now settled down to such a degree that we need not expect any revolutionary radio inventions for some time to come. Just the same, the future radio historian will be impressed with the fact that every year has brought about what may be termed “silent revolutions”; not at all conspicuous immediately, but working on gradually, nevertheless. To appreciate this, all you have to do is to compare a 1926 radio set with one as late as 1924. You will be struck immediately with the number of vital changes, if you observe it closely enough.

For instance, in 1924 the straight-line frequency condenser was never heard of. We were still using the straight-line wave-length condenser. Of the vernier dial, now so popular, people had only the vaguest notion. Now look at the present-day sets and notice the silent revolution that has taken place. Nearly all of the new sets have straight-line frequency condensers and many are equipped with vernier dials. To be sure, these improvements are not vital; they do not affect the entire operation of the set. A set without a vernier dial and without a straight-line frequency condenser, may yet be an excellent set; and there are hundreds of thousands of these being operated every day right now by their owners.

But there must be good and sufficient reasons for using straight-line frequency condensers and vernier dials, otherwise the manufacturers would not adopt them. This brings us to the question, Is there money in radio inventions?

After scanning the field and making investigations, I find that the answer must be in the affirmative. There is, indeed, a tremendous amount of money to be made in radio inventions, or shall we call it “radio improvements”? For instance, I find that within the last eight months considerably over two million straight-line frequency condensers were manufactured by a number of radio concerns. This does not represent all of the manufacturers; and the total output must be considerably higher. In fact, there is very little demand for the old type condenser right now, and certain of such types could not be given away.

If it had been possible for some one to patent the straight-line frequency condenser, he would have made a fortune out of this idea alone. Unfortunately, or perhaps fortunately for the radio industry, the principle of the straight-line frequency condenser was not so new that a patent could be granted; so the entire industry shares in the benefits. As soon as one manufacturer started to make this type of condenser, and realized its value, all of them followed suit, and practically all of them have reaped a harvest on this comparatively simple idea.

Exactly the same thing may be said of the vernier dial. Here is a

close parallel to the condenser just mentioned, and while the first vernier dial, manufactured by a Chicago concern, was patented, the patent, for obvious reasons, could cover only certain mechanical elements. It was not possible to obtain a basic patent on the idea. So the minute it was seen that here was a valuable thing, dozens of other radio manufacturers started to make vernier dials. Practically all of them have been successful in marketing their products. There is one manufacturer in the East who has already manufactured close to half a million of these dials. He, as well as a number of others, is also reaping a harvest from this simple invention.

The vernier dial and the straight-line frequency condenser are two excellent examples to show prospective inventors or designers that, given a meritorious radio idea, and provided it is worked out satisfactorily, a good-sized fortune can be made from such an idea. The important thing to remember is that the device in question must do something that existing devices do not do, or must improve present devices.

If I may make a broad statement, I would put down as an axiom that *anything making for better radio reception will be welcomed by the radio industry* and, providing it can be manufactured cheaply and economically, will bring its originator a good-sized fortune, also granting that he has business ability.

Further, the designer and inventor should always be sure to know the tendency of the times. Most radio parts manufacturers have found out to their sorrow that it is a most expensive thing not to keep up with the times. Four years ago, for instance, the demand for crystal detector receiving sets was tremendous. There was more demand than it was possible for the manufacturers to meet. Overnight, with the appearance of the first popular vacuum tube set, the demand for crystal sets fell off, and is today at its lowest ebb. It is doubted whether the crystal set can come back. Within a few months the demand decreased sharply, due to the appearance of the tube sets. Several large manufacturers lost fortunes because they did not follow the tendency of popular demand, but committed themselves for huge amounts of parts going into crystal sets. They still have these parts on hand, if they did not sell them for scrap.

The inventor who is dreaming of fortunes in an improved crystal receiver is, therefore, on the wrong track. He may make the most wonderful crystal receiver imaginable, and he may get the best patent in the world on such a receiver. The chances are, however, that he will not reap a fortune on it, simply because the present tendency is against crystal receivers; and while, of course, there are still some being manufactured, in goodly quantities, the demand is on the decline. The same may be said of a host of other clever inventions on which it would not even pay to take out a patent.

My desk is a clearing house for many hundreds of new ideas, and there is not a day that some new idea does not crop up. The most popular one, during the past few months, has been that of improvements on switchpoints, particularly those that do not require soldering. The misguided inventors and would-be inventors, however, fail in every instance to notice that no one is using switchpoints today. How many radio sets are now using switches in which switchpoints are required? It is true that in 1921 and 1922 there were actually carloads of switchpoints sold. But even most of the radio stores today do not carry switchpoints any more, for the simple reason that there is no demand for them.

There is money in radio inventions, if you can hit upon something for which there is a crying demand, and something that will make for better radio reception.

Mr. Hugo Gernsback speaks every Monday night at 9 P. M from Station WRNY on various radio and scientific subjects.

Radio Experts Discuss Future Problems

By G. C. B. ROWE

Every person, who is at all interested in the radio industry and broadcasting of today, is most certainly deeply interested in the problems of the future. The opinions expressed in this article by men who are recognized as leaders in radio should be read by every radio enthusiast.



MR. DAVID SARNOFF

ALTHOUGH radio, in all its many branches, has made phenomenal progress in the last five years, yet the future of this most popular phase of science confronts some problems that must be overcome if further steps forward are to be made. It makes little difference with which type of receiver a broadcast program is heard; there are always some flaws that can be perceived in the reception.

It is in these flaws that the radio experts are chiefly interested. It is admitted that there are some difficulties that are beyond human control, such as the continual changes in atmospheric conditions; but there are many other problems that have arisen in connection with man-made apparatus. It is admitted that the present methods of putting programs on the air have reached a very high degree of perfection; but even in this phase of radio, according to some of the expert opinion below, there is a great deal of room for improvement.

The average radio fan is more concerned with the problems that must be faced in connection with apparatus for receiving programs. In every section of the country today, engineers are trying to find some way to make reproduction reach the acme of perfection. Radio and audio frequency

DR. LEE DE FOREST

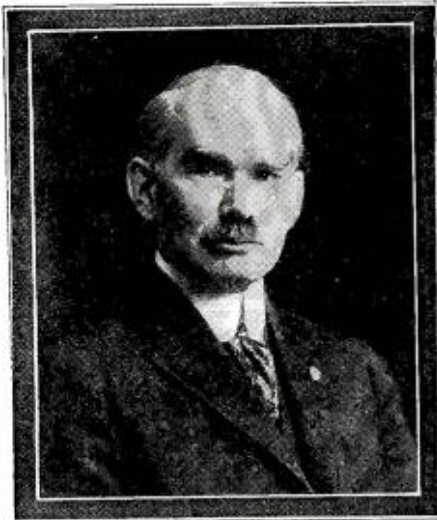

transformers are getting their share of the attention; for in these instruments originates a great amount of the distortion that is heard in the loud speaker. Then, too, the loud speakers themselves, although they have been vastly improved in the last year, still have a long period of development to go through before the engineer can lean back in his chair and say, "There's no better possible."

Being naturally deeply interested in these vital problems that affect the whole radio public, RADIO NEWS has interviewed men who are recognized as leaders in the world of radio.

GREATER BROADCAST POSSIBILITIES

Mr. David Sarnoff, the vice-president of one of the largest radio corporations in the world, the Radio Corporation of America, said:

"No matter what new developments in the manufacturing or selling end of radio may demand our attention from year to year, there still remains the perennial problem of improving broadcasting, and making it available to an ever-increasing number of people.

"Great advances have been made during the past year, and we may confidently expect even greater developments in 1926. Already there are 'on the air' two super-power broadcast stations reaching out to possibly hundreds of thousands of additional homes. The world's greatest artists are being made available to the broadcast listener. New developments have raised the standard of loud speaker performance to unbelievable levels. Receiving sets are being manufactured which are more efficient and more economical. And still we regard these tremendous forward steps as mere indications of future growth."

PERFECTING THE WAVE THEORY

It is natural that the interview with Dr. E. F. W. Alexanderson, of the General Electric Company, should have a more scientific trend, as most of his work has been investigation of the behavior of radio waves.

"The most important problem in radio at the present time is the study of wave propagation," said Dr. Alexanderson. "We must acquire an understanding of the physical phenomena that take place in space between the sending and the receiving station if we wish to learn to make use of radio waves to full advantage. The solution of the present crowding of the ether must come from scientific research, which will open up new channels of communication. We have effectively explored only the waves up to 1,000,000 cycles, and we are beginning to learn more about waves up to 10,000,000 cycles. Perhaps we will soon use waves up to 100,000,000 cycles.

"Much has been learned recently regarding the behavior of these short waves and a new set of ideas has been introduced, such as refraction and polarization. This is only the beginning of a new science. The radio wave is the only known means for exploring the upper layers of the atmosphere, and important discoveries may be expected. This new science can progress only by accumulation of a mass of evidence; and it is the radio fraternity that must be counted on to furnish the evidence.

IMPORTANCE OF AMATEUR OBSERVATION

"The radio magazines are at present the forum where new observations are brought into light and discussed. The contributing parties are government officials, amateurs, universities and the corporations directly



MAJ. GEN. C. McK. SALTZMAN

engaged in radio. The General Electric Company has an experimental radio plant in which seven transmitters with different antenna systems are operated simultaneously. Observations on these transmission tests are being made all over the world.

"This, I believe, points the way to the solving of the new problems of radio. The large corporations must be counted on to furnish the expensive part of the experimental equipment, the transmitting plants; but the observers will be largely volunteers, amateurs, professionals and universities. The observations will be promptly published and freely discussed, so that the evidence can be statistically arranged and made available as a basis for new theories."

FOR THE BROADCAST LISTENERS

Dr. L. W. Austin, president of the International Union of Scientific Radio Telegraphy, and physicist of the Bureau of Standards, says:

"The broad problem in broadcasting is, of course, to bring to the listener the best quality of program, together with the best quality of reproduction. The interests of the DX listener may perhaps be left out on account from a purely broadcasting standpoint; as, apart from the wonder of listening to stations two thousand or more miles away, which soon becomes commonplace, his

DR. L. W. AUSTIN



real interests lie in experimenting with his circuits, and he comes, in reality, into the amateur class.

"Coming now to the class who are really interested in the programs, we must divide them into those who are near a good local

listeners, who can, under favorable circumstances, hear talk and dance music without much disturbance. For these distant listeners, the highest aesthetic enjoyment of fine music is generally made impossible by static and other noises over which we at present have little or no control.

"In my opinion, the big problem confronting radio," said Dr. DeForest, "is how to give fewer and better quality programs, distributed with ample power over the United States. I agree with the opinion expressed at the recent radio convention that there



DR. J. H. DELLINGER

broadcast station, which can be heard without much disturbance from static or the noises which are unavoidable even in the best receiving sets, and the more distant

IMPROVEMENT OF REPRODUCTION

"I believe, however, that more than half of the broadcast listeners of the country belong in the first of these classes; and it seems to me that the greatest effort must be made for the improvement of musical programs, especially in the smaller cities, and in the reproduction. That reproduction is very far from perfect must be evident to anyone who listens to a high-grade piano recital, even with the best apparatus of the present day. Some of this imperfection certainly lies in the transmitting system; but the more important faults are undoubtedly to be traced to the audio-frequency circuits of the receivers and to the loud speakers. In many cases, the most expensive apparatus seems to be no better than the more moderately priced. This improvement of quality seems to me, therefore, the most important problem of broadcasting."

FEWER AND BETTER BROADCASTS

Dr. Lee DeForest, well known to the readers of RADIO NEWS, thinks that the industry, as a whole, would be benefited by a reduction in the number of stations broadcasting programs and, also, a decided change in program policy.

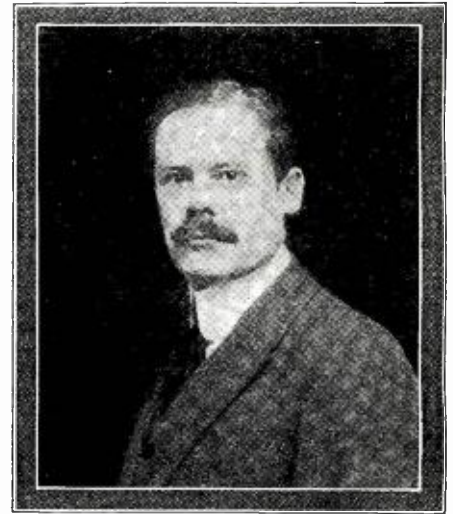

DR. E. F. W. ALEXANDERSON

are now too many small broadcast stations. Most of these send out a very ordinary form of entertainment. In my opinion, a hundred
(Continued on page 1358)

What Happens in Vacuum Tubes

By DR. ANNEMARIE KATSCH*

Dr. Katsch in this article describes and illustrates in a clear manner the behavior of the smallest things on earth, the electrons, in their wanderings in a radio vacuum tube.

NEW types of receiving tubes are constantly appearing. Physicists and engineers are continually trying to improve radio reception and amplification through researches and novel constructions. The roads to such improvements are difficult. Could a completely developed theory of the vacuum tube action be achieved, which would be in sufficient harmony with practice, yet systematic deduction from both the theoretical developments and practical results would be necessary to yield the best possible tube. There certainly exists a fundamentally correct, although complicated theory, developed by Langmuir, Richardson, von Laue and other scientists. But this contains so many generalizations that only in very simple and rare cases does it accord with practice. The physicist must, therefore, depend on research and many of his experiments are in vain, because he never can see in advance whether the path he is following is the right one or not.

The vacuum-tube effects depend entirely on the flow of electrons emitted by the filament, under the influence of the anode and grid potential. It is difficult to determine these electron paths by any given mechanical arrangement of the individual

electrodes (plate, grid, filament). If new mechanical arrangements are made in the hopes of obtaining more favorable results, it will be necessary to conduct extensive experiments in order to produce the best effects.

TUBES WITH A GAS RESIDUUM

These difficulties can be readily disposed of by an experimental investigation, which indicates immediately the influence of any particular arrangement and form of the electrodes on the electron paths.

The way to accomplish this is as follows: The usual vacuum tubes are high-vacuum (hard); that is to say, the tube is evacuated to such a point that the electrons pass from cathode to the anode without collision with gas molecules. But if enough gas is left in the tube to permit a collision of the electrons with gas particles (without, however, allowing these collisions to become so strong and numerous as to result in trouble from disturbing ionization) then the resulting collisions will become noticeable through a glow, varying with the gas used. This condition corresponds to a vacuum of from 1/10,000 to 1/100,000 of a millimeter of mercury. In ordinary tubes, the vacuum is as high as 1/10,000,000 mm. Wherever,

therefore, a glow occurs, collisions between electrons and gas particles are taking place. So the extent and form of the glow shows us the paths along which the electrons are moving, if the pressure in the tube is so low that we are dealing with a glow produced by excitation rather than ionization. Whereby further deductions can be made, from the intensity of the glow, as to the density of the electron stream. These considerations can be proved by simple theoretical calculations.

If a definite arrangement and shape of the tube electrodes is given, and if the shape and intensity of the glow is investigated at various plate and grid potentials, then an exact determination of the electron motion, and from this the special characteristics of the tube, is obtained. This leads to deductions concerning the variations of shapes and distances required for improvement.

SHAPES OF THE ELECTRON STREAM

By way of example, reproductions from photographs of such experiments are shown. As a model, a system similar to the simple two-plate DeForest tube is selected. In this arrangement, the filament is placed between two plates, one of which is the anode and
(Continued on page 1361)

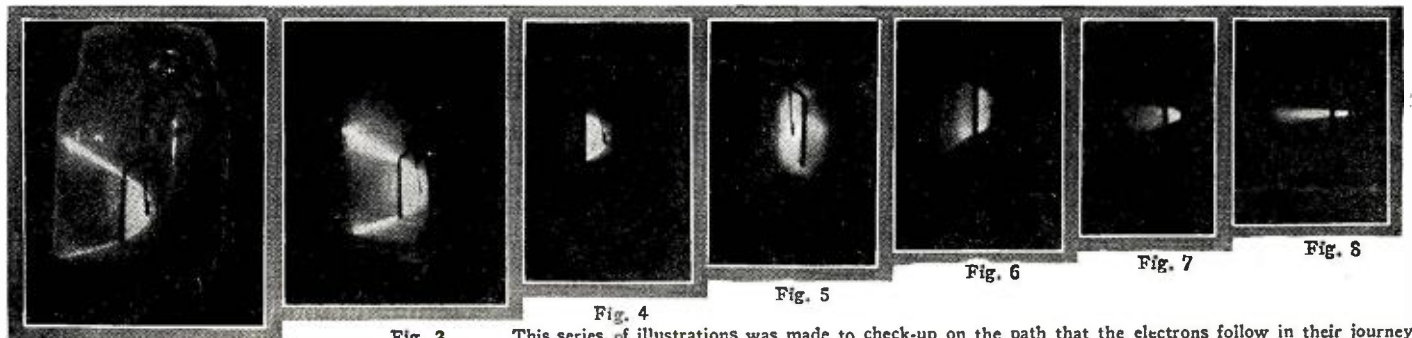

Fig. 2

Fig. 3

Fig. 4

Fig. 5

Fig. 6

Fig. 7

Fig. 8

This series of illustrations was made to check-up on the path that the electrons follow in their journey from the filament of a vacuum tube to the plate. The different parts are explained in the text.

*Of the Dr. Erich F. Huth Corporation, Berlin, Germany.

Radio Forecasting

By E. B. RIDEOUT

Mr. Rideout, whose profession is that of a meteorologist, shows us here what happens to radio broadcasts when a storm gets between the broadcast station and the listener. The weather changes over an area of a million square miles are very considerable in the course of a day, and constitute the great barrier to consistent DX reception.

THERE have been many theories advanced on the forecasting of radio reception. The great majority of those considered and tried by the radio forecast-seeking public have been based only on the meteorological conditions observed by listeners in their immediate surroundings. In cases where broadcasting and receiving stations are only a very few miles apart, surrounding weather conditions alone need be taken into consideration, at times; but not always, and decidedly not when unseen meteorological influences are interfering with receptibility. To use this theory of local weather influences on reception from a broadcast station many miles away, the state of weather at the transmitting end and in the intervening areas is disregarded; therefore, we know by a moment's thought that this theory is worthless. Weather conditions surrounding the broadcast station and those at the point of receiving, as well as in the intervening territory, may be manifesting great differences in relation to one another; and, therefore, the state of reception is affected accordingly. Not only this, but the weather is constantly changing so that reception involving the same two points may differ decidedly in quality within a period of a few hours.

Regarding theories based on the consideration of weather influences between the transmitting and receiving points, the writer has found, and is putting to use in his daily forecasts, many facts that have come to light only through long, tedious work.

WHY SUMMER RECEPTION IS POOR

It is indisputable that radio reception in winter is far superior to that of summer. This very thing alone reveals the fact that, barring northern lights and like phenomena, weather wholly affects radio receptibility. The two most important things that enter into the influence of weather on reception are temperature and barometric variations. Snow or rain and sky conditions are more local and are of minor importance.

Atmospheric pressure slightly below normal, and with but very little departure from normal, accompanied by high temperatures, is the greatest hindrance to radio reception. This combination is characteristic of the summer type of weather. A "flat map" (as the United States Weather Bureau meteorologists term it) is a map where the barometric pressure is quite uniform, with very little difference between the highest and lowest pressure extremes over the country. This uniformity of pressure naturally induces no wind movement to speak of; therefore, there is a stagnation of air movement over the land surfaces; and from the hot sun of the summer months, a local and varying heating of the quiet air takes place.

These bodies of air begin to rise, carrying moisture with them, and mix with much colder layers in the upper altitudes, caus-

ing condensation of moisture into clouds; and this mixture of air layers sets up friction, thus creating electrical energy. As the electrical discharges begin to occur, they cause static waves, which travel in all directions, and these static waves are the very things that cause the noises of static in the radio receiving sets. The same heated and ascending currents of air mixing with the colder air of the upper layers produce the thunder storm. With the development of great areas of thunder storms, which is common under favorable conditions on a summer afternoon, it stands to reason that, when every storm is radiating its innumerable lightning-discharged static waves, the distance of radio reception will be greatly cut down.

In the following paragraphs a description of radio receptibility will be given as the writer copied the facts from his most recently kept records which were in absolute verification of his forecasts given in advance to the newspapers.

THE PROGRESS OF A STORM

To begin with, on Sunday, November 29, 1925, the weather became overcast generally over Florida; and by late Sunday night,

at southern Florida stations was much in evidence. The reason for the fading was, that the storm was beginning to cut across the writer's line of reception.

Tuesday morning, December 1, the tropical storm had swept diagonally northeastward over central Florida and was east of Titusville at 8 a.m. with a further increase of fading. Tuesday night, reception from Florida was much poorer than the previous night. Fading was more pronounced so that southern Florida stations would, at times, fade out entirely.

The accompanying weather map, taken from the 8 p.m. observations of the United States weather bureau stations, shows the weather conditions as they were Wednesday night, December 2. Observations of reception were more interesting on this particular night than at any other time, not only from the severity of the tropical storm, but also concerning reception from other parts of the country. The center of the storm Wednesday night was just a short distance west of Cape Hatteras. There was also a storm in the West with the lowest pressure reading over Nebraska. On the map are marked the lines from the broadcast stations to the receiving point, at which place the writer

took the observations. Upon listening in and checking up the reception, a few New England stations were tried first. They were found to be clear, strong and without static or fading. The writer then went out for more distant stations.

BLANKETED BY THE STORM CENTER

First taking the southern direction, it was noticed that the earliest evidence of fading occurred at New York, N. Y., on all stations that were available. It was not bad, but it was due to the fact that the storm's influence had reached north even beyond its rain area. Atlantic City, Philadelphia and Washington

were then brought in on the air and checked up. Fading was very pronounced; these stations had come in the previous night with practically no interference. The next station that was "pulled in" was Atlanta, Ga. Although fading was in evidence, it was no worse, and it came in with the same volume that Atlantic City did, due to the fact that Atlanta's line of reception was at an angle further away from the line of the storm than Atlantic City was. The next stations to be checked were the Florida broadcasters; but for the first time since the tropical storm had been in progress, receptivity from Miami and Fulford-by-the-Sea failed to come in, even following ten-minute periods of listening.

The next step was to go after the western stations; and without any difficulty at all, Detroit, Cleveland, Chicago, Kansas City and Fort Worth came in with only slight fading.

(Continued on page 1322)

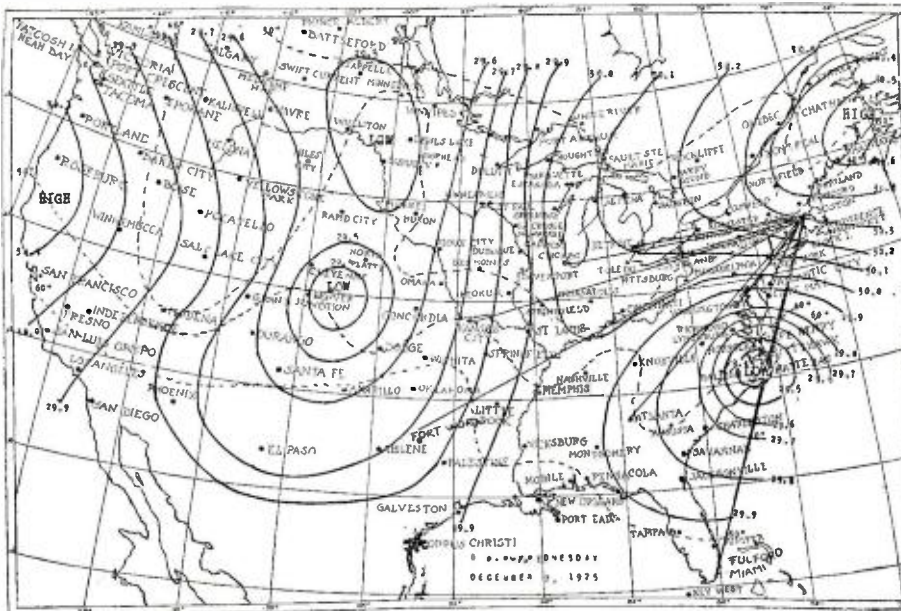

The map above shows a "Low" centre crossing the line of reception, making it impossible to bring in Florida stations from Boston. Fading results from static discharges too far away to be heard as separate noises.

rain began falling heavily over southern sections, with a record fall at Miami. Increasing winds accompanied the rain, however, the storm had not developed enough to affect noticeably radio reception at that time. The United States weather map of Monday morning, November 30, charted a belated tropical storm over western Cuba, moving north-northeastward. Terrific rains and thunder storms, with strong winds and gales, started sweeping along in connection with the low pressure.

Monday night the storm had advanced with increasing energy and was centered off the southern part of the Florida west coast and the whole Florida peninsula was under its influence. From the writer's position of observation at Boston, Mass., fading

"Interference"

By COLMAN GALLOWAY

Mr. Galloway's moving little narrative of the adventures of a group of self-appointed radio experts, in trouble-shooting the performance of a brand-new radio set, will strike a responsive chord in the breasts of all B. C. L.'s who have found that there is not always safety in a multitude of counsellors.



.....
 "... he rose hurriedly from the stool which he was sitting on and knocked over the rectifier. The solution made its way over a very pretty rug, proving that it was not so much of a wool rug as the furniture salesman had claimed it to be."

while he explained to me the difference between direct and alternating current.

He had about finished when the Missis discovered what had happened to her aluminum mixing bowl. Having got more or less acquainted with my wife in the four years we have been married, I felt no cause for actual alarm; but as Frank was something of a stranger, he rose hurriedly from the stool which he was sitting on, and knocked over the rectifier. The solution made its way through a very pretty rug, proving that it was not as much of a wool rug as the furniture salesman had claimed it to be.

Naturally, I promised the Missis a new bowl. But Frank was in tears. He had brought a hydrometer with him, and found that it measured over 1,280 in the "A" battery. He tinkered with the "B" batteries, then looked at me through tears.

"I thought you said your batteries were low?"

"Jim McIntyre said they were."

"Why didn't you test them?"

I bowed my head in shame. How was I to explain to Frank that I had thought the little glass tube with the rubber bulb on the end had been intended for use in cleaning the set? There was nothing I could say.

"There is nothing wrong with your batteries," insisted Frank. "The trouble is with your aerial."

He brought Dan Howdin around with him

(Continued on page 1336)

I DIDN'T know the difference between a tube and a rheostat, and told the salesman so.

"That doesn't matter," he assured me. "You will soon learn." He spoke so confidently that I believed him. I later found that he spoke the truth.

"You don't have to be an electrician to operate a receiving set," he added. "A child can do it. Once it is installed, it is a source of continual pleasure."

I have since found that his ideas of pleasure must have been queer, to say the least.

I bought the set. It arrived ready for installation. The batteries were in a handsome oaken box. The set was encased in imitation mahogany, with each point of connection plainly marked. There were four tubes, and a place for each.

The aerial had been installed the day before, the leads run into the room with little green tags to show which was the "ground" and which the "antenna."

It was simple. Nothing to do except connect each wire as marked to its proper clip, pull a small switch, and listen to the music.

The four tubes flamed into a dull glow, and I twisted the button on the loud speaker.

"Rattley - crack - rattley - cracklety - crack-crack-crack!"

So this was radio!

It had sounded somewhat different in the store.

Bill Heenan had come over with the family to listen to the music. Yes, I had invited him.

"Loose connection," volunteered Bill.

I gurgled with pleasurable relief. I admitted I was an amateur.

"I didn't know you were an expert. Bill. Here!" I offered, "you take 'er in hand. Get us some music."

Bill looked for loose connections, and found several. He tightened them carefully, smiled encouragingly, placed his hand on the switch—and we listened for the music.

It didn't come.

"Static," said Bill, "is something terrible. Sometimes it spoils reception for an entire evening, and you can't hear a thing."

"Not anything?" I asked, disappointed. "Can't we even tell if the set is working? I want to hear KGO."

"Oh, it's working, all right," Bill assured me. "Listen to it oscillate."

If what we heard was oscillation, the set was certainly working on all four cylinders—I mean, tubes. A stranger might have guessed that the Battle of the Marne was being broadcast next door. I stuffed a sofa pillow in the horn and turned both switches.

We played pinochle that evening, and Bill won two bits.

"I'll come around tomorrow night," he promised. "Maybe there won't be any static tomorrow."

He came. He brought Jim McIntyre with him. Jim also was a radio expert. Bill said he was, and Jim didn't deny it.

"Your batteries are run down," decided Jim, after he had twisted all the dials, screws and bolts he could find. "They're probably sulphated, too."

"The set is new!" I protested. "Only got it yesterday."

Jim's voice was sarcastic—so much so that I was ashamed of my temerity in doubting his decision.

"That doesn't mean anything," he declared. "Listen to your set. Does it sound like a radio?"

"Maybe it is just static," I ventured hopefully.

"Static," growled Jim, "was nothing like that. Get a battery expert."

Frank Meegan, who played with an adding machine in our office all day, confessed to me that he knew more about batteries than Mr. Eveready himself.

"If yours are sulphated, I'll fix up a rectifier and we'll knock down the sulphation in no time." He promised that, and I was greatly encouraged.

Frank made the rectifier, with a lead plate mounted on a block of wood across from another plate made from an aluminum bowl; suspended them in a solution of ammonium phosphate and distilled water in a porcelain jar; mounted a battery of five 100-watt lamps in series; and then rested for half an hour,

.....
 "So we moved it—the aerial I mean, not the roof."

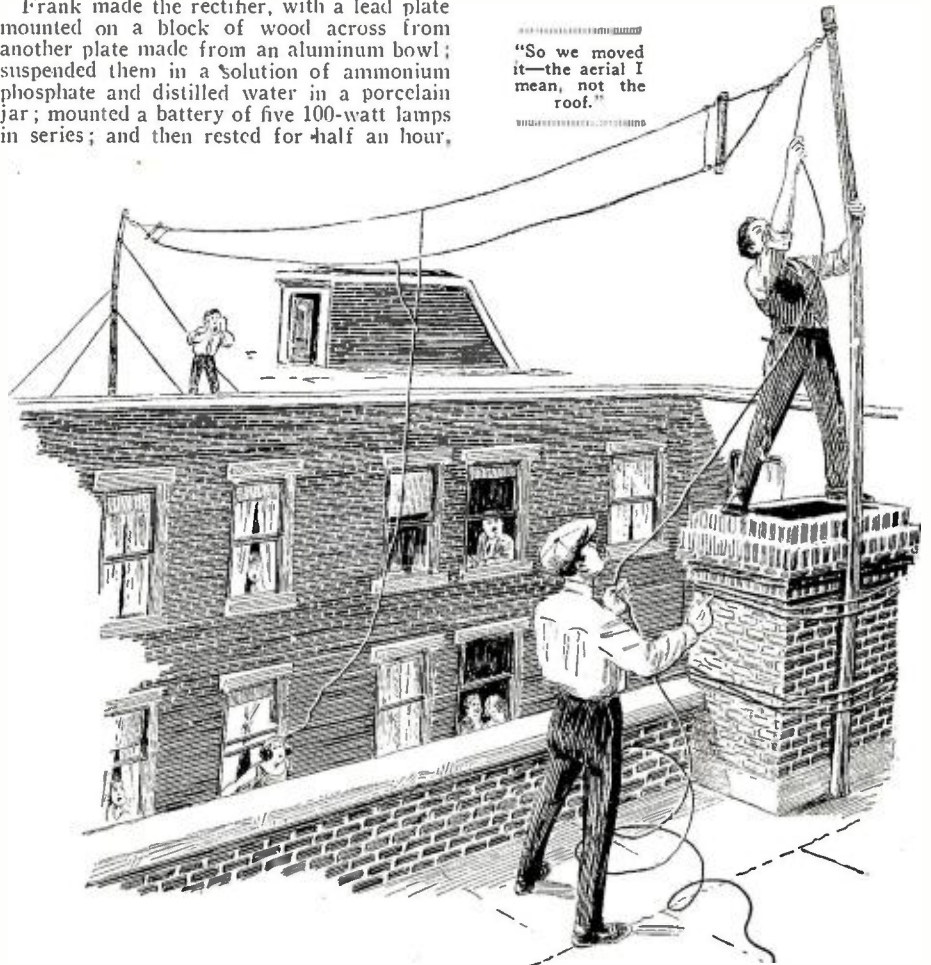

\$1,000 Prize Contest

Draw Your Own Ideal Radio Set

WHAT type of a radio set does America want? What type of a radio set does the world in general want? This is a question that is being asked every day. The radio industry in general would highly welcome the information by which to build their future receivers.

In order to show the world, and the radio industry in particular, just what set the majority of people want, RADIO NEWS, as the largest and most influential radio publication, has undertaken to solve the problem for all concerned.

Here is a contest that is new and differ-

set within reason, if there is proven to be a demand for such. The circuit, as well as the inside parts, can be adapted to the public's demand, if only the manufacturer knows just what the public wants; therefore, the present RADIO NEWS contest is staged for the purpose of finding that out, and for no other reason.

WHAT DOES YOUR IDEAL SET LOOK LIKE?

Does the public want, in general, a three-dial set with a number of other controls? Does it favor six dials and ten controls? Does it favor, rather, a single, solitary knob

We presume that most people want a loud speaker with their sets. If you do, what is your preference? Is the loud speaker to be a separate one, to be placed near the set, or is it to be built right into the set itself?

Do you like a voltmeter or other current-indicating device on your set, telling you when the batteries are fully charged or not? Do you wish the tubes concealed inside the set, or do you wish the tubes exposed for better handling, as is now done on some sets?

Do you wish the cabinet with a slanting front, or straight up-and-down? Do you wish your ideal radio set in the form of



If your tastes run along console lines, you will see one illustrated herewith. This also gives you an idea how to submit your entries for this prize contest. It is NOT necessary to send in fancy designs. Just simple outline drawings like these, with the dials and other radio items on the panel drawn in by you, will do nicely. The lower part of the console has been left blank purposely so you can draw in anything your fancy dictates. You may either cut out this design or trace over it; or make your own design exactly as you wish.

ent, something that has never before been attempted. There are in use today between four and five million radio sets. There are all sorts of sets, all sorts of shapes, sets that do all sorts of things.

Look at the first automobile, and compare it with the present-day one. Look at the old-type phonograph, with its funny funnel-like horn, and then look at our present creation. It took years and years for the automobile and phonograph manufacturers to arrive at the present state of evolution. Very likely it will take many years from the first radio set to the final one—if there is ever to be such an instrument. But we can hasten evolution, at times, in certain arts.

The present contest is working toward such a goal. The contest, in other words, is, "What is your ideal radio set?" This is not a technical contest, and it has absolutely nothing to do with the inside of a set. We are not concerned as to the circuit used, or even the parts used inside. *We are most concerned, however, with the looks and general appearance of the set itself.*

The radio art has now reached a stage, we are happy to say, where it is possible for our set manufacturers to give the public any

on the set? Does your ideal set use an aerial, or do you prefer a loop aerial? If you prefer a loop aerial, do you wish the loop outside of the cabinet, or do you wish it concealed?

The whole Radio Industry will benefit by this contest. Be sure to join in it.

\$1,000 in Prizes in Gold

	\$750.00 for Men	\$250.00 for Women.
First	\$200.00	\$100.00
Second	150.00	50.00
Third	100.00	25.00
Fourth	75.00	20.00
Fifth	50.00	15.00
Sixth	40.00	10.00
Seventh	35.00	5.00
Eighth	30.00	5.00
Ninth	25.00	5.00
Tenth	20.00	5.00
Eleventh	15.00	5.00
Twelfth	10.00	5.00
Total	\$750.00	\$250.00

a cabinet, to be placed upon a table, or do you prefer a console or other fancy cabinet? Or has your ideal radio set an entirely different shape from the present ones?

FINDING THE MOST POPULAR TYPE

All these are questions that we would like you to answer. Usually there is a tendency toward a definite goal. In any contest of this kind a great number of people will have similar ideas, AND THAT IS EXACTLY WHAT WE WANT.

(Continued on page 1371)

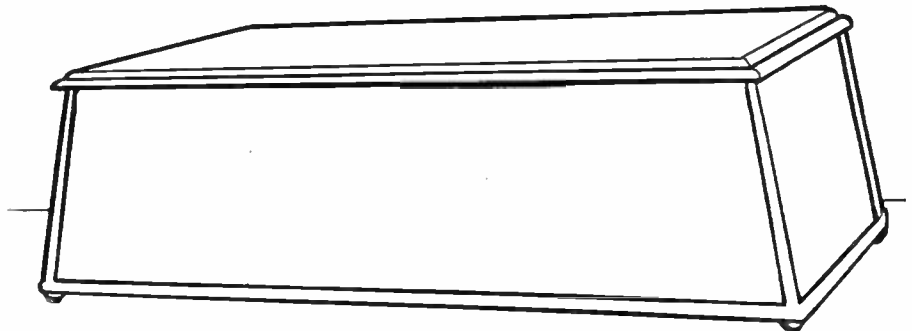

For those who like the cabinet idea, we are giving a suggestion herewith. What is said under the caption on the console set holds true for this and all other entries as well. You may either use this illustration to work on, in order to draw on it the dials and all other radio paraphernalia, if you so desire, or you may trace over this design, or make a new one. If you do not like the sloping sides, you may make up your own design any way you desire. We are showing these two designs merely as a guide to show the simple style in which entries for the contest should be submitted. Nothing fancy is necessary. Plain outline drawings of this kind, with the rest of the radio items indicated will do nicely.

WHAT IS YOUR IDEAL SET?



VARIETY OF RADIO SETS
 Fig. 1 shows one of the most elaborate and ornamental sets; Fig. 2, a so-called "unicontrol" with indicating volt-and-ammeters; Fig. 3, sloping panel, concealed dials, and indicating voltmeter; Fig. 4, unicontrol type; Fig. 5, elaborate 2-control set with built-in loud speaker; Fig. 6, standard 3-dial control set; Fig. 7, 2-control set with indicating volt-and-ammeter; Fig. 8, a strictly 1-control, 1-dial set, with no other controls; Fig. 9, 2-control, straight sides, sloping panel type; Fig. 10, an odd design, 4 controls with built-in loud speaker; Fig. 11, a novel 2-dial set, with sloping panel and new wheel-type "dials"; Fig. 12, console type, 3-dial control; console holding batteries and loud speaker; Fig. 13, 3-dial type, sloping panel, with exposed tubes.

WRNY Broadcasts Christmas Greetings from Germany

By STANLEY McCLATCHIE

ON CHRISTMAS Day, at 5 P.M., the German Republic greeted the American people through a number of German celebrities. The broadcast took place through WRNY, the RADIO NEWS station at The Roosevelt, New York.

This was the first time in history that an attempt was made to broadcast a special program, originating in Europe, by statesmen and famous personages, to American listeners.

The first speaker on the program was Dr. Gustav Stresemann, Minister of Foreign Affairs of the German Republic (for details of his speech, see end of this article). Dr. Stresemann spoke in German. Immediately following, the announcer of WRNY translated the speech, giving the English version of the speech.

Then came Cläre Dux, world-famous prima donna of the Berlin State Opera, with a solo entitled, "Silent Night, Holy Night."

The second speaker was State Secretary Dr. Hans Bredow, who, in radio, occupies a similar position to Secretary Hoover in this country. Dr. Bredow's speech is also published at the end of this article. This speech was also translated by the announcer of WRNY.

Cornelis Bronsgeest, well-known tenor of the Berlin State Opera, and impresario of the opera broadcasts of the Berlin broadcast stations, then sang two songs, "O Come All Ye Faithful," and a German Christmas carol.

Following Herr Bronsgeest, the President of the German Reichstag, Dr. Paul Loebe, delivered his talk, the English version of which was also given by the announcer of the station.

Then followed a duet, sung by Miss Cläre

On Christmas Day, 1925, Germany broadcast a message of good will to America through WRNY, the RADIO NEWS station in New York. On this occasion, however, an entirely different system of reproduction was used, for the first time in an international program. The atmospheric, which are still such a problem in long range broadcasting, were side-stepped by the employment of electrically-made voice records of wonderful fidelity. These were made at the Vox Studio in Berlin, rushed on a swift liner to New York, and put on the air in the WRNY studio in The Roosevelt, through the electrical device known as the Panatrope, a description of which is given below.

In the following article Mr. Stanley McClatchie, explains in simple language the new developments made by radio engineers in the matter of voice reproduction. Mr. McClatchie, who made the necessary arrangements in Germany for preparing the records used in transmitting this notable program, has just returned from that country, where he has been active in furthering international radio communication. —EDITOR.

Dux and Herr Bronsgeest, entitled "O Tannenbaum" (the music of which is the same as our own "Maryland, My Maryland").

Following these artists, Dr. Hugo Eckener, who brought the Zeppelin ZR-3 (now the Los Angeles) across the Atlantic to America, was heard also in greeting to the radio audiences of America. This, too, was translated by the announcer in the English version.

After Dr. Eckener's speech, there was a cello solo by the well-known artist, J. Berger, followed by a trio of cello and violins.

The whole program took one hour to broadcast.

OVERCOMING TRANSMISSION DIFFICULTIES

The novelty of the present plan was that the voices of these celebrities were heard by a new electrical system never before attempted in this country. There have been plans on foot whereby German broadcasting could be picked up and relayed in this country; but, for many technical reasons, such a plan is as yet not

feasible, and must be postponed for at least another year.

A new arrangement was therefore evolved whereby the German broadcasting was brought to America on Christmas Day in

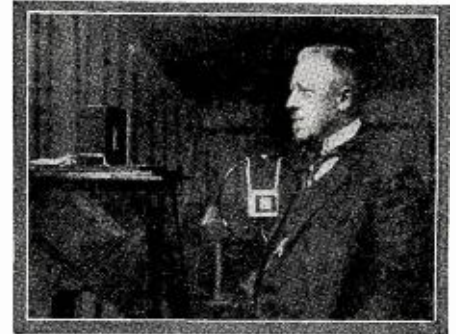

DR. HUGO ECKENER

perfect and undistorted form. Through the Foreign Institute in Stuttgart, I arranged for the making of a new sort of record of an original German broadcast, arranged for this special occasion, and which was broadcast through RADIO NEWS Station WRNY.

The records were made in the radio laboratories of the well-known Vox Company, in Berlin, by a special process. A condenser microphone was set up in the studio, while an electrical reproducer was connected on a specially-prepared wax disc. A number of these original discs were made and were used at WRNY. These special records were rushed by special messenger across the Atlantic and only arrived on the *Amerika* on December 24, just in time for the broadcast. The quality of reproduction given by this process was such that the listeners were enabled to hear the program exactly as it was originally recorded.

This method should not be confused with the ordinary phonographic method, for the reason that the wax records themselves were re-broadcast through WRNY by means of a special electrical reproducer connected directly to the transmitting equipment of the station. While the broadcast was going on, no sound was audible in the studio, as the entire transmission and pick-up was electrical throughout. The transmission was effected by the new *Panatrope*.

OPERATION OF THE PANATROPE

This is a new musical reproducing instrument which, for the first time, utilizes the electrical principle in the reproduction of sound. The instrument was developed by the General Electric Company, in conjunction with the Westinghouse Electric & Mfg. Company and the Brunswick-Balke-Collender Company. The phonograph cannot faithfully reproduce all the delicate vibrations of the electrically recorded records. Through the Panatrope, it is possible to take an original sound, cause it to be changed to electrical waves and finally reproduce it again with a loss which is infinitesimal.

The Panatrope, as the accompanying illustrations show, is an electro-magnetic device similar to a telephone receiver. In operation it employs a phonograph needle, E, attached to a diaphragm or armature, C, mounted between the poles of a permanent magnet, A, in such a manner that the vibrations imparted to the needle by the record will set up currents in the magnet; and, by induction, in the electromagnet, B. These currents are put through an amplifier, which may be at-

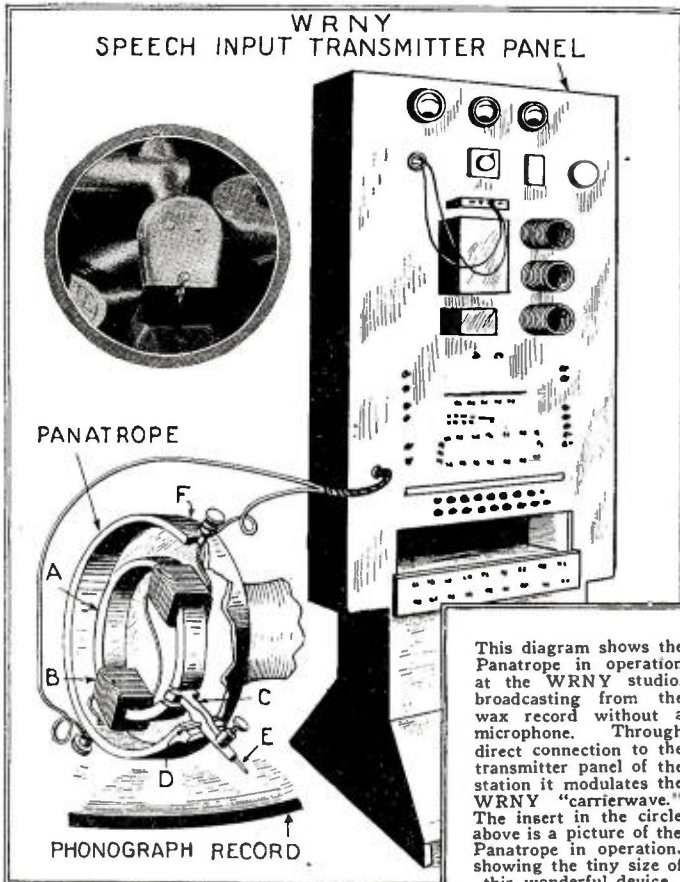

This diagram shows the Panatrope in operation at the WRNY studio, broadcasting from the wax record without a microphone. Through direct connection to the transmitter panel of the station it modulates the WRNY "carrierwave." The insert in the circle above is a picture of the Panatrope in operation, showing the tiny size of this wonderful device.



DR. GUSTAV STRESEMANN

CLÄRE DUX

DR. HANS BREDOW

CORNELIS BRONGSEEST

tached to either a loud speaker or to a broadcast transmitter. It was the latter method, which was employed during the Christmas broadcast from WRNY, as shown in the diagram on the previous page. The impulses are transmitted to the ether without the slight distortion which must result from their translation into sound and back again into electrical waves.

This system should not be confused with the microphone system, in which a microphone is attached to the phonograph needle. This latter usually gives rise to the so-called "needle scratch," which is entirely absent in the Panatrope. It is almost impossible, with the Panatrope, to distinguish between the record and the actual human voice.

PERFECT REPRODUCTION OF THE VOICE

A test program was put on during Christmas Eve, December 24, to test out the records, and reports came in from all over the country stating that the program received was excellent—not one of the radio listeners having any idea that the voices and music were coming from a record, and not from the artists themselves.

An interesting point is that, while the broadcast of the records was going on, a number of newspaper reporters and writers viewed the process in the studio at WRNY. *There was not a sound to be heard anywhere in the studio.* The wax disc was revolving silently, and the Panatrope itself does not give forth any outward sound whatsoever.

The electrical collection from the Panatrope was made directly to the transmitter of WRNY and there was, therefore, no intervening microphone. Transmission was perfect, because the entire system was electrical throughout.

The German records arrived only one day before the broadcasting was to take place. The messenger who brought them across the Atlantic was taken sick aboard the ship, and had to be rushed to the hospital upon his arrival in New York. By raising heaven and earth, the records were finally located in a trunk, and rushed to the station. At this stage it was found that the records had come unaccompanied by the manuscripts of the speeches of the famous statesmen. It was necessary, however, to translate these speeches into English, and this was finally accomplished, as follows:

An expert German stenographer was routed out of bed and brought to the station at midnight of Christmas Eve. She was given a pair of phones,

which were attached *directly* to the Panatrope. *No batteries or electrical power of any kind were used.* The little Panatrope made its own electrical energy from the vibrations of the phonograph record; just as

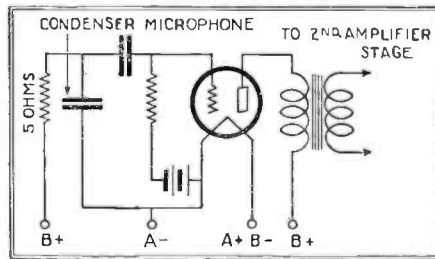

Above is shown the circuit diagram of the condenser microphone, which is explained on page 1370.

two ordinary telephone receivers, when connected by two wires, will become a transmitter and a receiver.

The German stenographer then listened to

the speeches, which she took down in German, and they were then written in German on the typewriter, after which a German translator translated them into English.

The thousands of letters which came pouring in after the broadcast had taken place showed that the test had been a full success. The words in all cases were understood and there was only one letter received which stated that the speeches of the German statesmen had been unintelligible.

The RADIO NEWS station, WRNY, of New York, was the only station in this city to broadcast the special German program.

The program was also broadcast simultaneously over the Westinghouse chain of stations by a slightly different method, as follows:

THE TELEGRAPHONE AT KDKA

While the wax records were being reproduced on Christmas Day at WRNY, the same program was also being broadcast by KDKA, of Pittsburgh; WBZ, Springfield, and KYW, Chicago, but instead of using wax records, the Telegraphone system was used.

About 28 years ago, a Danish inventor, Poulsen, devised what is known as the telegraphone. He showed that speech and music may be magnetically recorded on a steel wire. Such a record can be almost of any desired length, and the reproduction given is extremely faithful. Why not apply the idea to broadcasting, by making exact records of European programs, sending the records across the water just as a moving picture film is sent, and re-broadcasting the original program from the records?

The idea seemed quite feasible, so the writer set about building a magnetic recorder, or telegraphone, for the purpose, records of German broadcasts were made on this machine and brought over to America. In the accompanying illustrations is shown the apparatus as set up in the studio of KDKA.

OPERATION OF THE TELEGRAPHONE

The telegraphone, shown in Fig. 1, carries two spools, 2, so arranged that the steel wire is wound from one to the other, and passed in the process over an electromagnet. Immediately over them is a speed indicator for checking the speed of rotation. Means are provided for automatically guiding the wire back and forth so as to give even distribution over the winding spool. The wire used for recording is

(Continued on page 1369)

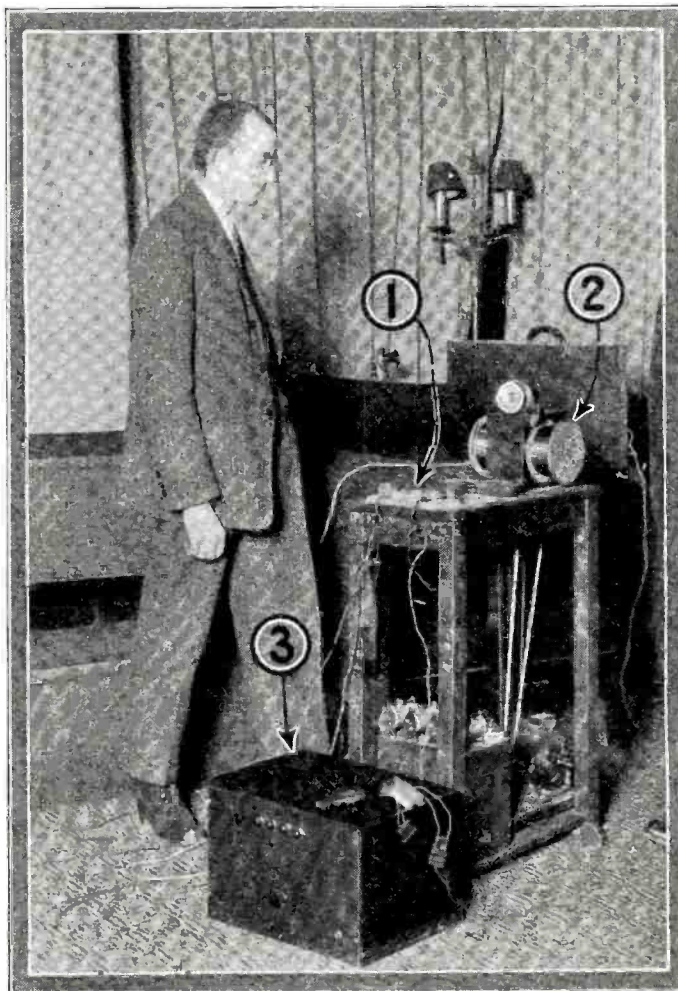

Fig. 1. Mr. McClatchie and the Telegraphone. 1 is the electromagnet; 2, the spools carrying the wire, and 3, the amplifier.

Awards of the \$370 Radio Play Contest

In the October, 1925, issue, a Radio Play Contest was held. The publishers desired to have a new sort of radio play; namely, a short play in which the radio interest was uppermost in the action. They wanted such a play for Station WRNY, owned and operated by the publishers of RADIO NEWS.

THE Radio Play Contest, which was announced in the October, 1925, issue of RADIO NEWS, was held in order to stimulate playwrights to devote more effort to the writing of good one-act plays, suitable for broadcast purposes, and dealing primarily with radio. To say the least, this idea was welcomed with open arms by a great number of playwrights, if the number of manuscripts that poured into the editorial offices may be taken as evidence.

Playwrights admit that it is a comparatively difficult task to write a play for broadcast production; as there is but one medium, sound, to convey impressions to the audience. This means that the number of characters must be limited to five at the most, as more voices are liable to be confusing. Also, the entire action of the play must be described, either in the lines of the play or by some noise-producing mechanism. Some of the plays submitted in the contest have excellent plots, but were practically useless for broadcast production; others were written in a manner which described the action of the play in the dialogue or by noise-making mechanism, but did not follow the rules calling for radio interest.

The judges feel that a slight explanation should be made as to the reasons for selecting the seven prize winning plays, out of the number of excellent competitors.

"THE HIDDEN WITNESS" is a very ingenious idea, and handled in a manner that seems utterly plausible. It is brief, laconic and concise. Further, the subject matter is of radio and requires nothing to substitute for the missing visual qualities. Except for a few points, the sketch might be compared with a Molnar manuscript in quality and terseness. This play is published in this issue of RADIO NEWS.

"THE FUGITIVE" is a play which creates complete probability, and will be published in the April issue of RADIO NEWS. "A RADIO CHRISTMAS CAROL" would have won first prize for its characterization, sentiment, and sincerity, but it falters slightly in complete acceptability of the situation, which mars the denouement.

"GETTING THE AIR" is a skit which will get many a laugh because it happens everywhere. The love element is not intro-

duced perfectly, and some changes will be required in the text. It wobbles a bit in drama, but holds up in comedy.

"THE LOUD SPEAKER" shows the best knowledge of radio and, we venture the

Prize Winners for the \$370 Radio Play Contest

First Prize \$150.—"THE HIDDEN WITNESS," by Brian Holloway, 51 Arnold Road, Woking, Surrey, England.

Second Prize \$75.—"THE FUGITIVE," by James F. Conway, 3443 Clay St., San Francisco, Cal.

Third Prize \$50.—"A RADIO CHRISTMAS CAROL," by Edward C. Garrett, 71 Halliday Ave., Bryn Mawr Park, Yonkers, N. Y.

Fourth Prize \$35.—"GETTING THE AIR," by Miss Alice Krajnak, Sellersburg, Ind.

Fifth Prize \$25. "THE LOUD SPEAKER," by Harold W. Gammons, 711 Prescott Ave., Scranton, Pa.

Sixth Prize \$20.—"MR. CARTER TUNES IN," by Jennie E. Ross, 3014 Peralta Ave., Oakland, Cal.

Seventh Prize \$15.—"THE THIRTEENTH MAN," by Dorothy M. Bailey and John B. Cleaveland, 17 Trinity Place, Montclair, N. J.

"THE HIDDEN WITNESS" will be broadcast from Station WRNY on February 15, at 11 P. M.

suggestion, the best knowledge of broadcasting. The characters are excellent, but the situation involves less quickening of the pulse and imagination than the first and second prize winners.

"MR. CARTER TUNES IN" is in the class of "The Loud Speaker," but not quite so well handled.

"THE THIRTEENTH MAN" is truly dramatic and of radio first, last and all the time; but it is not as truly plausible as some of the plays that were awarded some of the higher prizes. The authors should write again, as they have excellent qualities.

The judges requested that the following plays be acknowledged for honorable mention.

"THE PRIDE OF THE NEIGHBORHOOD," by George Knox, 1726 Lancaster Ave., Wilmington, Del.

"THE WAVE-LENGTH OF CONSCIENCE," by Lloyd G. Penney, 2435 Moerlein Ave., Cincinnati, O.

"THE STORM," by John J. Long, Jr., 33 W. 42d St., New York City.

"RADIO—ENTERTAINMENT AND PROTECTION," by Lyndall L. Duell, radio operator M. S. Steelvender, Chicago, Ill.

"TOONERVILLE'S NEW RADIO STATION," by Jesse Crunkleton, 29½ Strauss St., N. S., Pittsburgh, Pa.

"THE RADIO SALESMAN," by Jackie Bricker, Box 622, Madera, Cal.

"DADDY BUYS A RADIO," by Ralph L. Wood, 392 E. Central St., Franklin, Mass.

"GHOSTS," by Mrs. Hazel S. Kerr, 5065 Bernard St., Chicago, Ill.

"RURAL RADIO REVELRY," by G. M. Hewsons, Drawer 705, Drumheller, Alberta, Canada.

"PROF. HINKLEMAN'S GREASO-DYNE CIRCUIT," by Adolph Pflieger, 589 Bunnecke Court, Brooklyn, N. Y.

"RADIO AND WOOLEN GOODS," by George W. Gilman, 377 Park St. Peterboro, Ont., Canada.

"THE RADIO WIDOW," by Ethel Lipincott, 426 N. Shawnee St., Lima, O.

A number of prize winners will be published in subsequent issues in RADIO NEWS, and broadcast by the Radio Theatre Players from WRNY, the RADIO NEWS broadcast station at New York.

The Hidden Witness

By BRIAN HOLLOWAY

CHARACTERS

JANE, MRS. WARREN, MR. MARSHALL, MR. WARREN.

ACTION OF THE PLAY

(The sound of switching-on to a microphone in a private room is heard. In the room a clock is ticking close to the microphone. The clock strikes eleven.)

MRS. WARREN: Eleven o'clock. He ought to be here by now.

(A slight pause, then a knock, and door opens.)

JANE: Gentleman to see you, Madam. Said he had an appointment.

MRS. WARREN: Oh, it is Mr. Marshall I expect. Show him in please, Jane.

JANE: Yes, Madam.

(Door shuts.)

MRS. WARREN: (Sighing with relief). At last!

(A slight pause, door reopens.)

MR. MARSHALL (An elderly man with smooth, oily voice): Good evening, Mrs. Warren. You see I have kept my appointment.

MRS. WARREN (agitated): Yes, yes, you said you had something to say which would be to my advantage to hear. Oh, I am sorry, won't you sit down?

MR. MARSHALL: Do not be alarmed.

(Continued on page 1376)



MRS. WARREN: "Jack, Mr. Marshall came to see me to threaten that, if I didn't pay him \$1,000, he would tell you he had seen me flirting."

Radio Beats the Ticker

By MARIUS LOGAN

"YOUNG man, if I didn't have the gout, I'd give you the reply you deserve!"

"Thank you, Mr. Kahn"—edging away—"I'm sorry. I must have spoken out of turn. But tell me why? Marie seems to take me seriously, she seems to love me; so what really is the great objection to my suit?"

"I'll tell you briefly. You cannot support Marie in the manner to which she has been accustomed, and the match will bring nothing but unhappiness. I don't want her to be unhappy. Go out and earn a bank account in five figures and then you may hope to ask for her hand."

"Mr. Kahn, I'll lay you a bet of ten thousand dollars this minute that I will have that amount in two months, with the provision that if I make the terms of the bet, win it, in other words, beside collecting the principal sum, I receive the hand of your daughter in marriage besides."

Mr. Kahn did some quick thinking. In many years in the business world he had learned never to take the boast of anyone lightly. He knew that any man who had the nerve to make a really large boast lightly, usually had the nerve to carry it through—if he was clever and the stake was large enough. So he considered the proposition which James Michael Machilenny had just submitted to him for several moments, before he gave a definite answer. The truth was that he really liked this Machilenny person very much. The only reason he could conjure up afterward for his first statement to the chap who had just, out of a clear sky, proposed marrying his daughter, was the fact that he rather envied him. From what he had heard of James Michael (through his daughter, of course) the fellow had a fairly wide knowledge of the world, collected from travels of one sort or another. His voyages had been made mostly through the good nature of cooks and first mates of tramp steamers, and the effectiveness of a gift of gab which could not be denied the young gentleman. In one way Mr. Kahn liked James Michael and in another thought him quite an ass. He could never make up his mind as to what were his real feelings toward Machilenny. In his office, however, he had learned that the best method of handling young men was through the agency of a stiff bit of advice. They all were appreciative and in most cases followed it to the good of the firm and the yearly balance sheet—which was, after all, the primary concern of Kahn and Company, International Bankers.

But to be tackled in this manner was something entirely different. Any ordinary young man could have been expected to quail before the famous president of Kahn and Company, International Bankers. Since James Michael Machilenny did not, the president of the company aforesaid had more respect for him, but by the same token became more angry and, therefore, more red in the face. He had been challenged and he was mad; therefore, in spite of his good judgment and in spite of the fact that if the young squirt lost he would be unable to collect, he must accept. He had been accepting challenges in the game of finance for a number of years—and profitably—so he accepted this one.

"Young man, I'll take your bet and lay you one better"—it was up to him, Mr. Kahn felt—to make the thing really worth while. "I'll throw in a year's rent of the house you take."

"May I call Marie as a witness to this little bet?" asked James.



"As a matter of fact, radio is the only way to help. Now I have the germ of an idea—"

"You may, for it will probably be the last time you'll see her."

So Marie was called in to witness the terms of the wager. When James told her about it, Mr. Kahn became more and more stern. Marie laughed and promised not to see James again unless he won—at least not in the parental home.

As soon as she had been told, Mr. Kahn gave James to understand in no uncertain terms that the interview was at an end and that he had better hurry and find himself a job, if he were going to make the amount specified in two months. It sometimes took him (Mr. Kahn) as much as two weeks to collect that amount, he told the young man; since the young man had had much less practice than himself (Mr. Kahn) he'd probably need the whole twenty-four hours of the day for the business of getting the money. And he did not fail to add that using the twenty-four hours would probably be less than useless, for, after all, a five-figure bank account meant at least ten thousand dollars.

With the interview at an end, there was nothing for James Michael Machilenny to do but leave. He and Marie left the large room, called by courtesy to Mr. Kahn the study; and walked into the great hall leading to the door and the street.

As soon as they were out of the presence of the old gentleman, Marie asked anxiously how James intended to start on his knightly journey to soothe the wrath of her father. She was very anxious, you know, for she

really loved James; too much, it was generally known, for the taste of her extremely rich father.

"I don't know—not yet, that is. I'll get it—I'll have to. Don't you see?"

"But, James, ten thousand dollars is a lot of money. Good heavens, you don't just pick money off of greenback trees or anything."

"Yes, I know you don't, but leave it to me. I'll dope out a way to take it away from someone. I should have made that time limit a little longer. But, anyway, I've got to get it, dear. Good-bye, I'll call you as soon as I dope out the scheme."

And with a breezy wave of his hand, he walked down the steps of the great Kahn home with a determined resolution to collect the stipulated amount of money in the two months; and thereafter as soon as possible to take the other stake into the bargain. He caught himself planning the manner of his marriage just one week after he had collected the money. He always enthused over his prospects, whether they were good or not. But to save his soul at the present moment, as he walked down the street, he had not the faintest idea as to how he was going to get the money.

When he got home to dinner that night he was uncommonly morose. His brother Alfred questioned him concerning the nature of the trouble and received a curt "None of your affair" in reply. But that was primarily for the good of the family. They

(Continued on page 1346)

Recent Radio Photos

The photograph below shows M. M. Titterington demonstrating his invention, the super-pioneer earth inductor compass, which makes it possible for air pilots to fly at night or in foggy weather without danger of coming too close to the earth. It is also effective in preventing tail-spins. © Kadel & Herbert.



The illustration at the right shows Sergius B. Garde demonstrating an artificial throat and larynx before the microphone. The bellows held under Mr. Garde's right arm substitutes for the human lungs and diaphragm. At the end of the tube in front of his mouth a rubber membrane is located. This corresponds to the vocal cords. © P. & A.

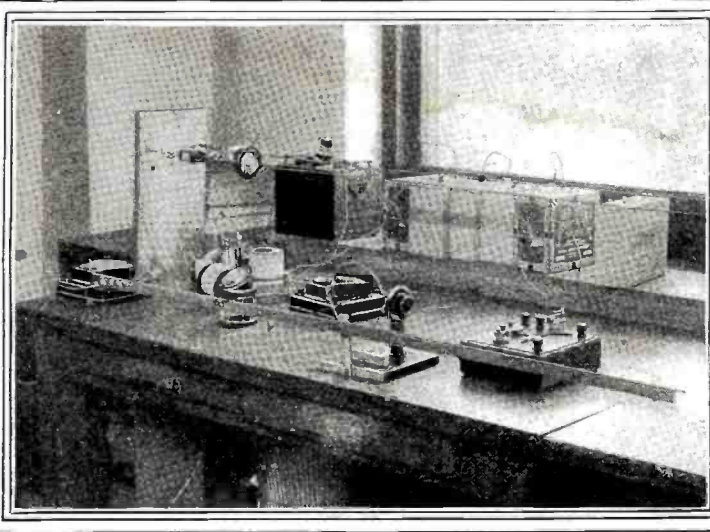

A corner in RADIO NEWS LABORATORIES, showing apparatus set up for experiments with very short wave-lengths. Two Lecher wires are stretched between the upright board at the left of the illustration and another to the right that is not shown. These are tuned to the oscillator below by means of a sliding wire incorporating a meter which measures the current. At the right may be seen a wave-meter and detector. With a UV-201A tube, wave-lengths below two meters were generated.

2AGW is a "hole in the wall" station maintained by students of Brooklyn Technical High School. Using but five watts of power on 40 meters, this station has been heard in every state in the Union, and has worked other stations in most of them. The transmitter is mounted upside down on the top board. The receiver is below. © Kadel & Herbert.

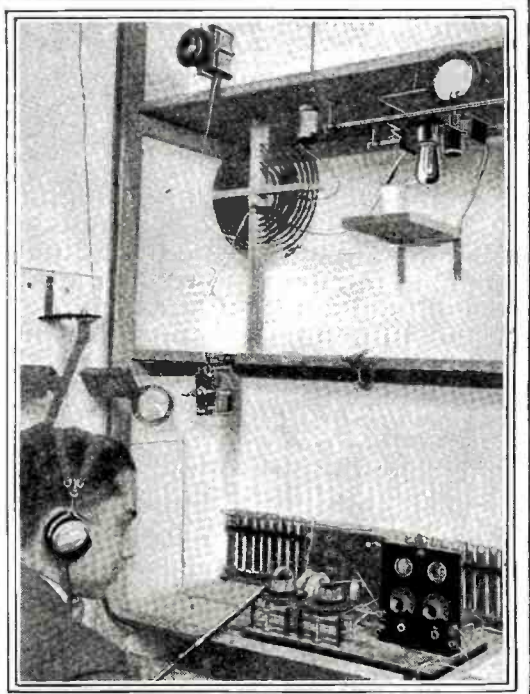

The portable radio transmitter of the American Telephone and Telegraph Co., used in mapping the effect of tall steel structures upon radio waves. "Contour maps" were made of Westchester County, New York, and parts of Long Island and Connecticut. The results were published in an article on page 956 of RADIO NEWS for January.

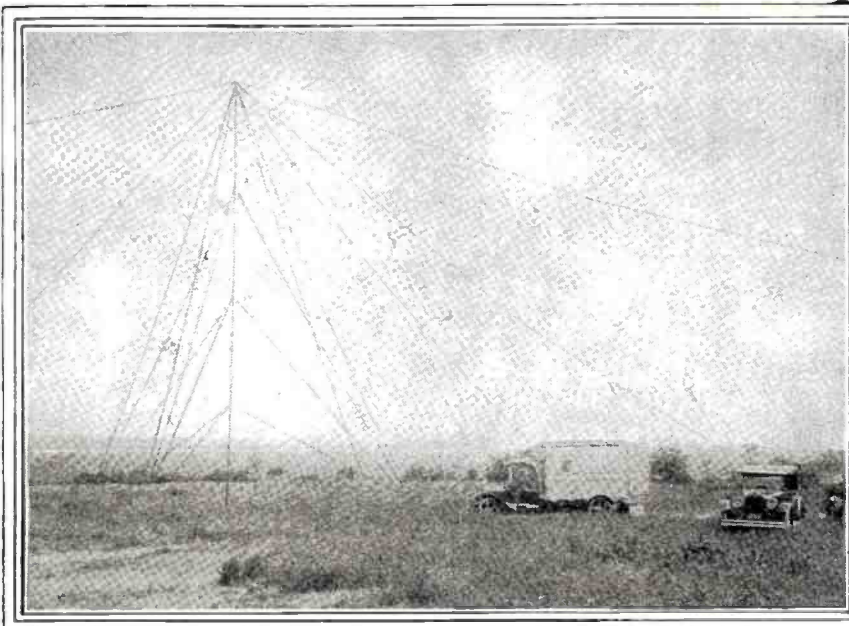

New Radio Developments

DEVELOPER OF NEW PHOTO-ELECTRIC CELL. Shown below is V. K. Zworykin, of the Westinghouse Electric Research Laboratories at East Pittsburgh, Pa., holding one of the new thermionic photo-electric cells, which converts the impulse of light falling on it into electric current, which is amplified in the three-element arrangement in its base. This tube, one of the most sensitive appliances known to physicists, is shown on a larger scale at the bottom of the page. © Wide World Photos.

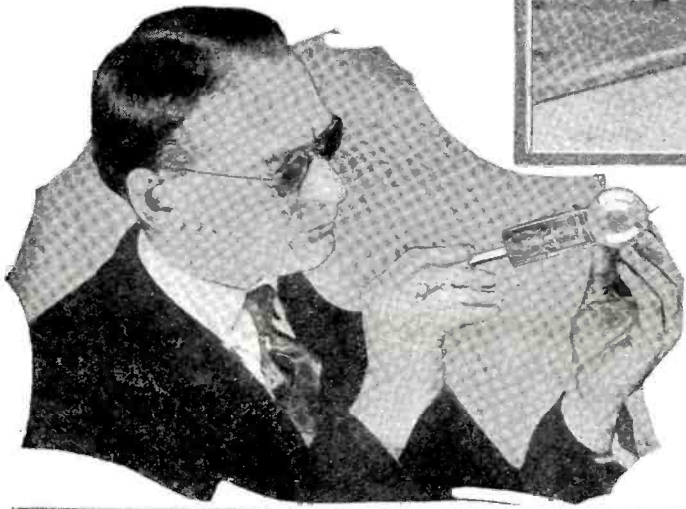

EIGHT RADIO MESSAGES SENT SIMULTANEOUSLY. Above is shown John Hays Hammond, Jr., with his staff of radio assistants at Gloucester, Mass., where he conducted a demonstration for naval radio experts by broadcasting eight telegraphic code messages from one radio transmitting tube simultaneously, on the same wave-length, and received them all on one receiving set. This is the first transmission of multiplex radio messages ever accomplished. The general principle of the Hammond system is that a short-length carrier wave is sent out and upon this are impressed one or more "modulatory" waves. © Wide World Photos.

WORLD'S LARGEST RADIO RECEIVER. On the right is shown Robert J. Sieglack with his receiving set, which is said to be the largest in the world. It contains twenty-three tubes and was designed, as well as built, by its owner. A special super-heterodyne circuit of his own devising is the basis of the whole scheme, but, by an original idea, three stations can be tuned in at the same time, and distributed at will on any or all of the six loud speakers, which are installed in various parts of the hotel operated by Mr. Sieglack. In the illustration below is shown the bank of batteries necessary to furnish power for this gigantic radio equipment. These batteries are connected with charging device, which starts automatically when the batteries are in a discharged condition; and when they have been sufficiently charged, the current is automatically shut off. Robert Sieglack, Jr., the son of the builder of this monster receiver is shown, overseeing the power equipment of the set; and from reports it seems an easy job. It is stated that the reception of European stations by loud speaker with this outfit is remarkably satisfactory. ©Kadel & Herbert.

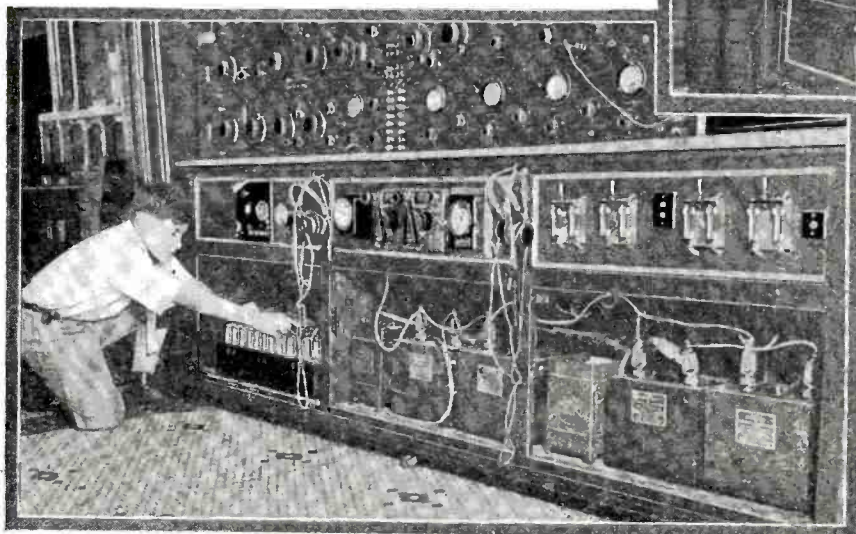
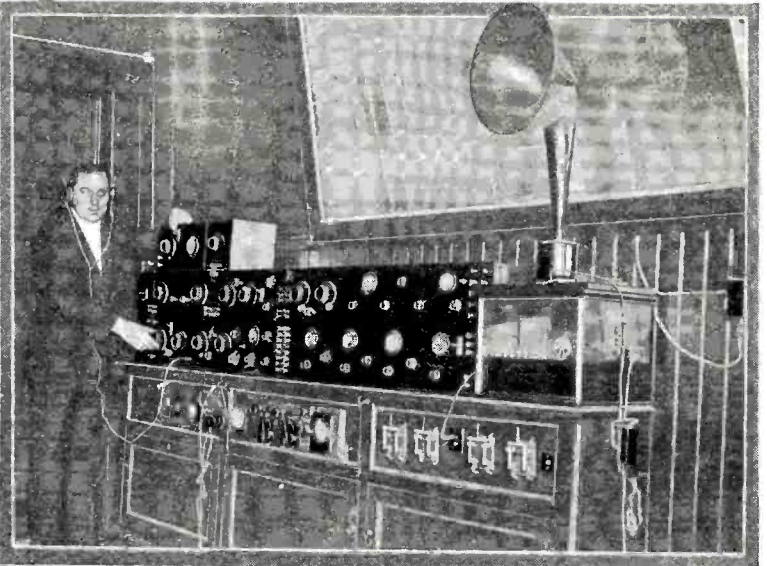

IMPROVED RADIO TUBE TELLS SOUND OF SHADOWS. The tube shown on the right is that developed by Mr. Zworykin, who is shown above examining it. It sends out radio impulses in response to rays of light; and is so delicate it will "howl" if a shadow falls on it, when connected in a suitable circuit. Among its possible applications are television, "talking movies," automatic control of ships, trains and airplanes, recording the light of stars, etc. © Wide World Photos.



When Nations Listen In

By CHARLES D. ISAACSON



"SVANHILDE"
The radio name of a brilliant soprano, Astrid Fjelde, who broadcasts Norse songs over WRNY.



PIETRO SOLDANO
"The Ballade Minstrel," a fine young American baritone of operatic and concert popularity, who sings winsomely through WRNY.



RAFAEL ODIERNO
Baritone of the Odierno Quartette, heard in leading theatres and at WRNY.



YOU have elsewhere had recounted to you how WRNY on Christmas Day gave Germany's greetings to America, in the words of the eminent leaders of the German republic, speaking exclusively and specifically through this station to the people of America. I shall not attempt to do more than remind you of it at this time.

Georgette Nyrelle will be in Paris in February as the special representative of WRNY, broadcasting a message from America to the people of France, from the important stations of that country. She will speak in English and French, and will sing a program of French songs as a symbol of American friendship for France, and as a forerunner of future possibilities of intercommunication.

John St. Loe Strachey, the famous English journalist, at the close of his visit to the United States, gave a farewell greeting of amity between the English-speaking nations through WRNY.

Radio is cementing, not only the cities and regions of the United States, but the nations of the world in the bonds of a better common understanding.

WHERE ALL RUB SHOULDERS

Speaking of cities, perhaps you heard WRNY when Mayor Kendrick, of Philadelphia, and Mayor-Elect Walker, of New York City, exchanged felicitations in connection with the coming Sesquicentennial celebration in the City of Brotherly Love?

Or, speaking of religions, perhaps you have heard the great Jewish and the great Catholic leaders sending their messages upon the air through WRNY?

Or, speaking of the mingling of past and present, perhaps you heard Governor Henry J. Allen, of Kansas, speak at the unveiling of the Roosevelt plaque at The Roosevelt, the home of WRNY?

Speaking of arts, perhaps you have followed the talks on painting, sculpture, architecture, at WRNY? Now, think of it, there has been an exhibition of the works of Zeitlin, Dugas, Gibson, Musgrove, March, Essman, Blume, and of the floral designs of Irene Hayes and other artists, at The Roosevelt, expressly for the radio listeners of WRNY.

Radio is the greatest of meeting places.

RELIGIONS OF THE WORLD

At WRNY, the venerable Anaragika Dharmapala, one of the foremost teachers among the hundreds of millions of Buddhists of the world, met with Jewish cantors, Mohammedan muezzins, Arab chanters, and many others, in their native costumes and singing their own religious music. For the first time in the 2,500 years of Buddhism, one of their teachers has spoken by radio. Carl L. Bemies has arranged these wonderful meetings of Musics of All Religions. Regularly, Dr. Christian F. Reischer, of the Chelsea Methodist Episcopal Church, addresses WRNY listeners each Sunday.

FROM STAGE TO MICROPHONE

At WRNY, one night, were Harry Kemp, "the tramp poet," and Harold Vinal, editor of *Voices*, the magazine of modern poetry. Here were, one night, Rollo Peters, Estelle Winwood, Ann Harding, and others from the production of "The Taming of the

(Continued on page 1358)



ANITA SELF
A charming soprano, who is heard always with Miss Callow at WRNY.



DR. ISAAC LANDMAN
Editor of "The American Hebrew," rabbi, and director of WRNY's Jewish Circle.



JUNE LEE
"The Singing Vagabond," whose popular songs through WRNY run the gamut from comedy to pathos.



JACK SMITH
"The Whispering Baritone," whose frequent numbers at WRNY are enjoyed by all his hearers.



FRANCES MARIE CALLOW
This distinguished harpist appears fortnightly at WRNY, together with Miss Self.

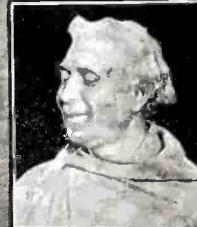

ANARAGIKA DHARMAPALA
The first Buddhist teacher to put his message on the radio, spoke recently from WRNY.



LOUISE STALLINGS
Prominent American soprano, who appeared with Maestro Sapio in a grand opera recital at WRNY.



CHEVALIER De LANCELOTTI
Director of a song series at WRNY, has been honored by the British, French and Italian governments.



BELLE BENNETT
Creator of "Stella Dallas" gave WRNY fans a genuine thrill by her recent appearance in person.



WILLIAM S. LYNCH
Assistant program director of WRNY, looks after popular music and sports features.



GIUSEPPE ADAMI
WRNY's "Crooning Violinist," plays with soulful, tender, liting style.



ROSE BECKER
Violinist of the Becker String Quartette at WRNY. Others are Paul Ross, Isaac and Samuel Kass.



CARL L. BEMIES
Director of "Music of All Religions," the picturesque Sunday afternoon feature of WRNY programs.

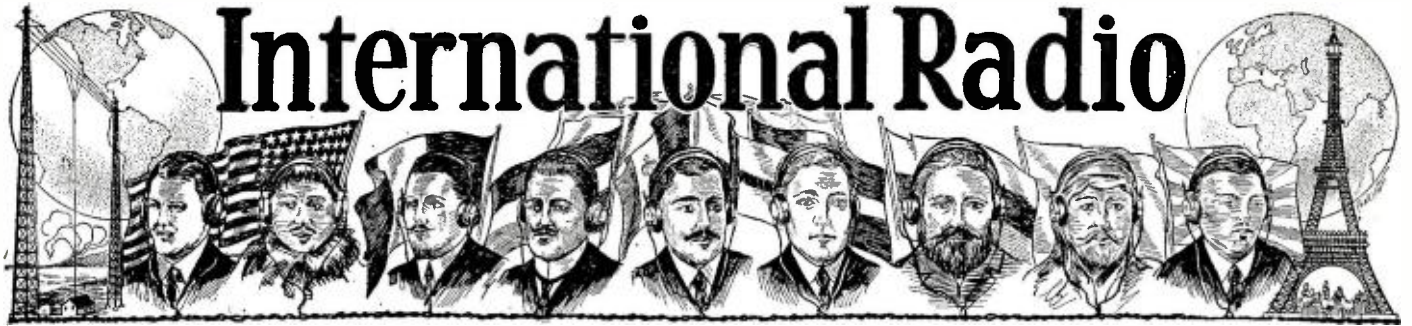

International Radio



GREAT BRITAIN

2LO Has New Microphone

It is announced that station 2LO, the London broadcast station of the British Broadcasting Co., has installed a new type of "mike." It is called the Reiss microphone and, although very sensitive, it is claimed to be impervious to outside vibrations, which would spoil transmission for the ordinary instrument. Instead of the usual carbon, it contains a patent crystal powder welded into a mass by means of hydraulic pressure.

The Radio Revel

On the night of December 15, 1925, thousands of persons in England gathered to celebrate the first Radio Revel. In London, the party was held at Olympia, where several thousands enjoyed the dancing. At Manchester, the feté was held in the Bell Vue Gardens, and was attended by at least 2,000 persons. More than 500 were present in the King's Hall, Stoke-on-Trent. These figures show that a great sum of money was raised for charity, with radio as the main attraction.

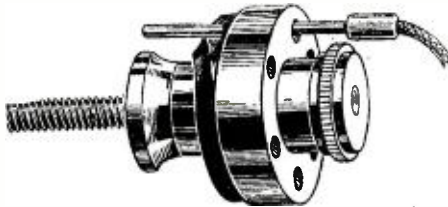

The binding post shown in the sketch is designed principally for receivers with insufficient volume to operate a loud speaker. Each hole in the rim of the binding post will accommodate the tip of a phone cord, or a wire of about the same diameter. The clamping process is done by a flexible strip placed around the post directly beneath the rim which contains the holes. This English binding post will accommodate six connectors.

An interesting part of the evening's amusement was the relayed programs from European stations. Transmissions were relayed to the different parties from Berlin, Spain, Switzerland and Holland, and it is reported that the novelty of dancing to music coming from different countries was greatly enjoyed.

Gold Finding by Radio

Sir Robert N. Kotze, a mining engineer in the employ of the South African Government, is confident that it is possible to discover gold and other mineral deposits by



The filament rheostat that is shown in the accompanying illustration is of an English make. The resistance wire is wound on the cylinder that is attached to the central shaft, which is rotated by the knob that projects through the panel. The contact to the wire is made by the clamp that encircles it on the right side. As can be seen, the instrument is designed for a single-hole panel mounting.

the aid of radio. It is already possible, he states, to send radio waves through the crust of the earth; and as various kinds of min-

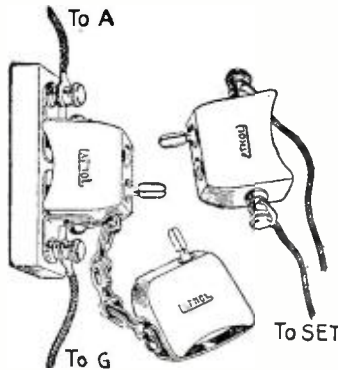

The antenna-and-ground plug is an arrangement whereby the antenna may be safely grounded when the set is not in use. As may be seen from the sketch, one plug is connected to the receiver binding posts; and when the one that is chained to the stationary plug has been removed from its connection, both the antenna and the ground are connected to the set by merely plugging in. This is an English invention.

erals respond to waves in varying ways, it should be possible to devise some system of distinguishing the mineral composition of the layers one encountered.



FRANCE

A Novel Periodical

The club of Lille and district radio amateurs have started a new venture, which is believed to be unique, as far as can be ascertained. This is a bi-monthly paper which will be entirely

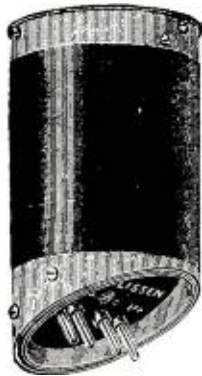

The radio frequency transformer shown in the sketch is of the plug-in type, so popular in England. These transformers are manufactured in sets of three; and to accommodate the wide bands of wave-lengths in Europe, are made in five ranges. They can be used to receive any wave between 260 and 3,300 meters.

edited, printed—and read—by the members of the club. No copy will be on sale and members will not be allowed to give away their copies. This ought to have, incidentally, the effect of making this little paper something of a journalistic curiosity and rarity.



GERMANY

Lightning Plays with Radio Installation

Recently, in Eberon, Franconia, lightning struck the spire of the village church, which was not provided with a lightning conductor. Part of

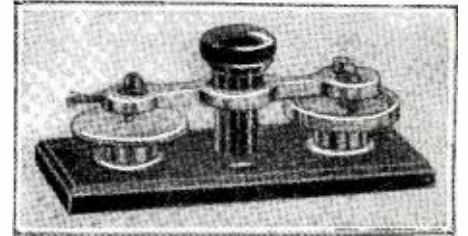

The English crystal detector shown in the above illustration is of a balanced type and its main advantage, as claimed by the manufacturer, is that the contact on the crystal will not vary because of vibrations.

the charge seems to have worked its way along a series of iron nails in the roof and penetrated to the clock in the tower, which was stopped, but not damaged. The bulk of the charge, however, was attracted by the three-wire antenna of the village priest's radio set, which he had rigged up on the side of the church tower. The antenna entirely disappeared. The set was grounded to a water cistern; and while there were traces of burns on the window sill of the vestry, where the lead went to the cistern, no further damage could be observed, the set itself being entirely undamaged.

Radio and the Dairy

Dr. von Stetten, a noted German physiologist, as the result of experiments among the cattle in the high feeding grounds of the Alps, announces that cows give more milk if music is played while they are being milked. The music employed was that broadcast by a Swiss radio station; and it was played to the cows by means of a loud speaker while the milking process was going on.

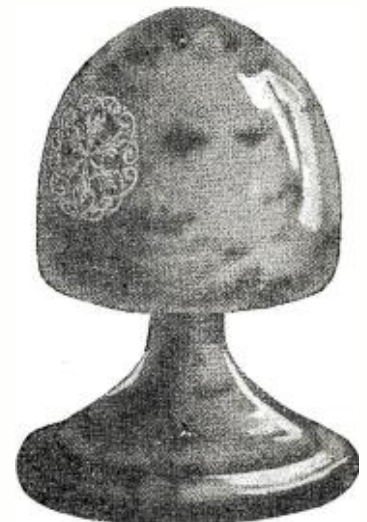

The loud speaker, made by an English firm, is unique for its size. It is only four inches in height. It resembles a small vase of tortoiseshell, and it is claimed by the maker that there is a complete absence of distortion and vibratory noises. It is made in three types, 4,000-ohm, 2,000-ohm and 120-ohm.

Radio Set Owner's Information

CLEANING CRYSTALS

1. John B. Mahann, of Columbia, S. D., asks:

What is the best way to clean the crystal of a crystal detector?

Never use water as a cleansing medium for crystals. If the crystal is of the detachable type (that is, one that can be removed from the containing cup after the small setscrew is loosened), take it from the cup. It will be wise to provide yourself with a pair of long-nose pliers or some similar tool for handling the crystal after it is cleaned, as the oil from the hands makes a coating on the crystal, which reduces its electrical efficiency. After the

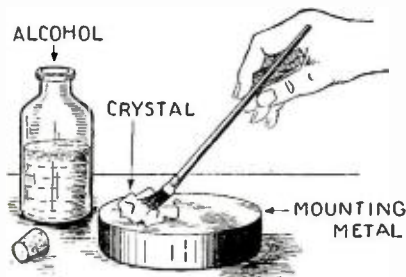

Crystals are best cleaned with a brush moistened with alcohol.

crystal is removed, dip a small, clean brush into some alcohol and with this remove as much of the dust on the crystal as possible. Allow this to dry thoroughly and then repeat the operation to insure that the crystal shall be as clean as possible. Then, with the long-nose pliers, replace the crystal in the cup and tighten the setscrew.

If your crystal detector is not provided with a glass cylinder, protecting the crystal from dust and dirt, it will be a good idea to clean your crystal every three or four weeks, to insure good reception at all times; for nothing will reduce the efficiency of a crystal detector like dust.

CONNECTING BATTERIES TO THE SET

2. Henry L. Battleston, of Los Angeles, Calif., asks:

What is a good, neat way of arranging the wires from the batteries to my receiver?

One of the neatest methods is to make a cable of the wires; that is, instead of having them strung separately in an unsightly manner, the wires are fastened together compactly. Of course, when such a cable is made, it is necessary that the wires be insulated or covered, so that the different batteries will not be ruined by the bare wires touching. Ordinary bell wire is excellent for this purpose, as this has an insulation which is waxed and so will lend itself nicely to cabling.

Place the batteries and the receiving set in the positions that you wish them to occupy. Start with the two leads from the "A" battery, which is either one or more dry cells or a storage battery. Run a wire

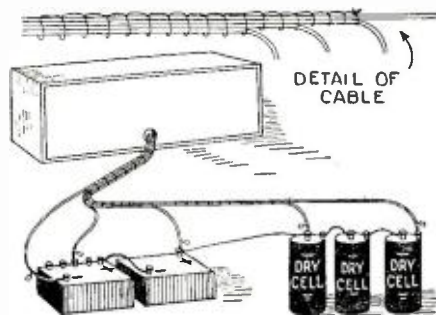

A neat method of connection is to construct a cable as shown above.

THIS page constitutes what is to be known as the SET OWNERS' INFORMATION department, and is to be conducted regularly each month in RADIO NEWS. The purpose of the department is to furnish assistance to those readers who have not yet acquired any extensive knowledge of radio, but who are the possessors of radio receivers and wish to know how to handle them.

There is always new blood coming into the fraternity of radio enthusiasts; and it is obviously unreasonable to expect that they can intelligently read the articles which are written for the more experienced fans. Consequently this new department has been started for their benefit; and we invite anyone who desires to do so, to write an account of his troubles to the editor of this department. No letters will be answered by mail. The editor will select from the letters which he receives those queries that seem to be of most practical interest to all, and will answer them fully and in detail each month. There will be no charge for this service. Simply write to SET OWNERS' INFORMATION DEPARTMENT, RADIO NEWS, 53 Park Place, New York City.

from the plus side of the battery (which is the center post of a dry cell, or, in the case of a storage battery, either marked with a plus (+) sign or painted red) to the plus terminal of the receiver. In measuring these wires, choose a path from the batteries to the set that every wire can follow, as they are all to be bound together later. Provide yourself with a dozen or so small tags that can be attached to each end of the wires. When you have measured a wire and scraped the ends clean of insulation, attach at once, at each end of the wire, a tag which is marked "plus A." Do the same for the "A" minus lead, and for leads that are run to the "B" battery. Fasten all the leads in their proper places, and bind them together with stout string, starting where the first two wires join. The easiest method of binding is to use a series of half-hitches along the cable; and then, when it is necessary to bring a wire off to a battery terminal or binding post, the wire can be securely fastened.

If the receiver is in a cabinet, the cable may be run through a hole in the back of the cabinet and thence to the respective binding posts. If the wires are neatly tied, this method of binding will eliminate the "messy" look that so many sets have, and at the same time will provide an efficient aid when it becomes necessary to substitute new batteries.

CAN A LOOP ANTENNA BE USED?

3. James R. Kidder, of New York City, asks:

My set has a detector tube and two stages. Can I operate this on a loop antenna?

We assume from the question that the set has two stages of audio frequency amplification, and the answer, in that case, is in the negative. It is almost useless, and a waste of time, trying to get satisfactory results from a loop antenna with a set of this type. These three-tube receivers are designed primarily for use with an outside antenna; and

it is seldom that even locals can be brought in on the loud speaker when a loop is used. We advise the use of an antenna, of a single wire about 125 feet in length. Put the antenna as high as possible; and remember that the length of the lead-in, that is, the wire connecting the antenna to the set, must be counted in as part of the effective length of the antenna. For example, if the wire from the antenna to the set is 30 feet long, then the stretch of wire between insulators need be only 95 feet.

It might be mentioned here that a loop antenna should be used only when there are five tubes or more in a set; that is, when there are at least two stages of radio frequency amplification, a detector, and two stages of audio frequency amplification. Of course, sets of the reflex type sometimes accomplish the same number of steps with three tubes, and some of these sets operate satisfactorily on a loop.

TESTS FOR LOUD SPEAKERS

4. Henry K. Swain, of Media, Pa., asks:

When I plug in my ear-phones to my set, the music is loud enough to hear all over the room; yet, when I plug in the loud speaker, there are no results at all. Why is this?

First, we would advise that the loud speaker be tested. Procure a dry cell and, with your ear close to the loud speaker, hold one of the terminal tips to one of the terminals of the battery and tap the other terminal of the cell with the other tip. There should be a decided sharp click audible in the horn or cone. If there is no answering click, the next places to look are the leads, or wires connecting the instrument to the receiver. One of these may be broken; and, in this case, the speaker cannot function. These leads may be tested in several different ways; one of the best being to have a

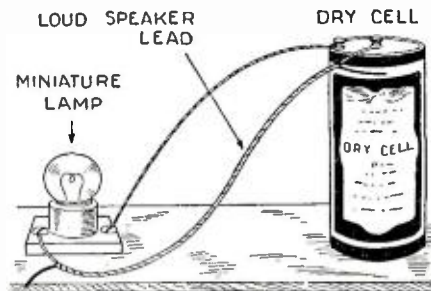

Above is shown the method for testing leads of any sort for continuity.

dry cell and a miniature electric lamp that will light with 1½ volts, the voltage of a dry cell. Connect one side of the lamp to the cell and then, for the other side of the line, use the lead that is to be tested. Be sure that you get the ends of the same wire, as they run in a common silk sleeve for part of their length. Test both wires. If the lamp lights, then the wire is continuous, and the trouble must be searched for elsewhere. The other place where the trouble might be is in the loud speaker itself; and the best thing to do, in that case, is to take the instrument to the place where it was purchased and let the dealer look it over.

REACTIVATING VACUUM TUBES

5. Morris S. Green, of Baton Rouge, La., asks:

I have a three-tube regenerative receiver. The tubes light, the batteries are in good condition, and all the connections seem to be OK. Why can I not get any music?

Assuming that Mr. Green has thoroughly

(Continued on page 1368)



The Radio Beginner

How Shall I Begin?

By A. P. PECK

FOR many months this department has been running in the pages of RADIO NEWS, and during that period of time has received hundreds of letters from various readers on different phases of elementary radio reception. One of the most frequent questions asked, and one that has not been definitely dealt with in these columns, is that indicated by the heading of this article.

When a beginner, or one unversed in the art of radio reception, first considers that field from a layman's standpoint he is apt to obtain a very erroneous impression of the entire situation. If he approaches it by reading some of the technical articles appearing in various publications, he is liable to believe that radio might almost be classed with the "black arts" in complexity. Such is not at all the case, and this impression must be banished if radio reception is to progress as fast as it should in the next few years. Rather than a most complicated

who likes to construct his or her own sets. Of course, the experimenter belongs to a certain extent in this classification; but, then, there are others who want to build just one radio set, so that they can listen to it and

Here, again, we find the rich and the poor, or those who want to buy the best set and those who do not want to spend too much money.

FIRST, THE AERIAL

Now let us consider the specific needs of the various classifications listed above and just how they should begin. The first thing that everyone will need, be he experimenter, builder or buyer, is a good outdoor aerial and a ground connection; both of them being connected by means of wires to a point where the radio set is to be located. The construction of aerials and the installation of ground connections has been dealt with in past issues of this magazine, and a very simple way in this same department.

The aerial, as you undoubtedly know from observation, is a more or less lengthy wire, stretched between two convenient supports. It should be placed as high as possible and may be any length from 40 to 100 feet. The general results will not be greatly affected by the length; but we may say in passing that a short aerial will enable you to tune out stations better than a long one; whereas, a longer aerial will give louder signals than a short one.

The aerial wire must be insulated or cut off from its supports so that the weak currents picked up by it from a broadcast station will not leak off to the ground and be lost to the receiving set. These insulators should be of glass or of glazed porcelain, and should be securely fastened to the aerial wire and also to the supports. A casual glance at the insulators themselves, after they have been purchased, will show just how the wires are to be fastened to them. If you want to have the very best possible aerial, and one that will not be affected by weather conditions, use enameled solid copper wire. Use the same material for the lead-in, or the wire that connects the aerial to the radio receiving set; and where the lead-in and aerial join, solder the joint firmly so that no losses will take place. At your nearest radio store, get any standard type of lead-in insulator, either that designed to be placed in a hole in the wall or along the window sill, and by means of it, connect your lead-in to the receiving set.

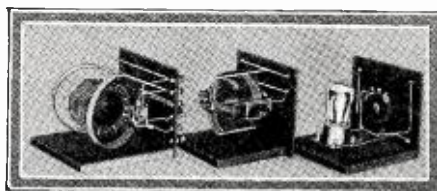

Fig. 1. The above shows examples of unit-panel mountings, for instruments to be used in experimental work.

show it to their friends, and with pride in their voices announce to the world in general that they have actually built a radio receiving set that works. This class usually wants to build just one good set and use it

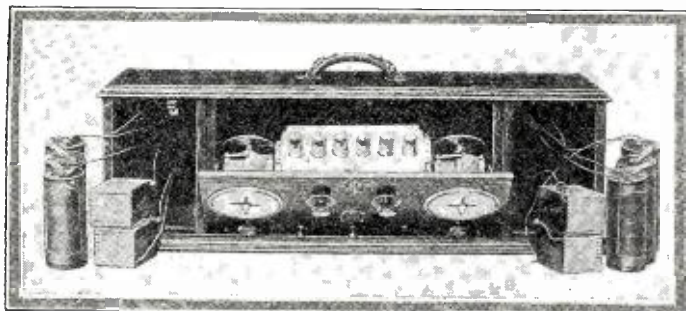

Fig. 7. Left: A standard type of six-tube super-heterodyne, which is an excellent one for the radio beginner who knows little, if anything, about the science. It is entirely self-contained and gives good results.

Photo by Courtesy Radio Corp. of America.

subject, the operation and use of a radio receiving set is most simple; and in these columns we will deal with its various phases in such a way that, we hope, the result will be the removal of many of the mistaken impressions that are abroad regarding radio.

THE AMATEURS

In this greatest of indoor sports, there are several different classifications of people to be considered when we want to talk about how to begin. First and foremost, we have the experimenter. He is the man, or woman for that matter, who likes to work with radio apparatus, either for the sheer fun of it, or for the valuable information to be obtained by experimental work. Usually, listening to the various broadcast programs is, on the part of the experimenter, merely a secondary matter. Many times programs are listened to only for the sake of testing out some new circuit or new adjustment, and not for the programs themselves.

In this present article, it will hardly do to deal in detail with the needs of the experimenters. Most of them have already started along this line, and a good many more of them will develop out of the other classes of broadcast listeners once they have become initiated in the game. Therefore, these few words will suffice for the experimenter.

BUILDERS AND BUYERS

Then we have two other main classifications. The first is the builder, or the one

for a considerable length of time. Under this general classification there are two types who must be considered. One is the person who wants to spend as little money as possible in the construction of a set, and the other is the one to whom money is little, if any, object. More of this later.

The second general classification, after the builder, is the buyer, or man who wants a radio receiving set, but wants it completely installed and equipped, so that all he has to do is turn the dials and listen to programs.

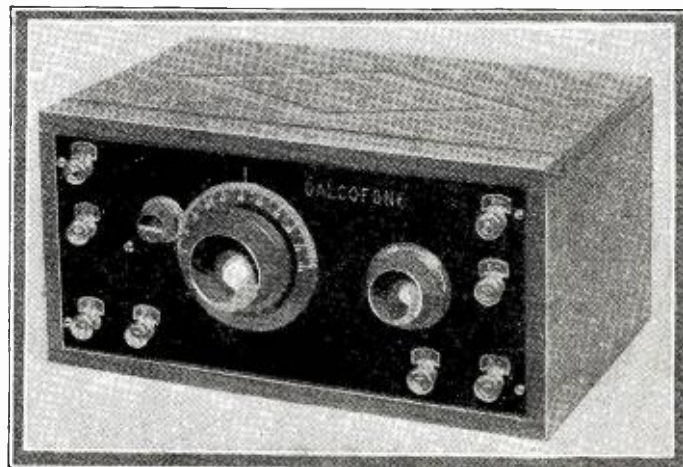

Fig. 5. A single-tube set, for the radio beginner who does not desire to invest much money in radio, is shown at the right. Under good reception conditions, this set will give exceptional results, considering the amount of equipment used.

Photo by Courtesy Dalco Radio Co.

The ground connection may be made to a cold-water pipe by scraping the surface of the pipe perfectly clean, applying a clamp to it, and soldering or bolting a wire firmly to the clamp. This wire is then led to the "ground" binding post on the receiving set.

CONVENIENCE IN SET BUILDING

After the aerial and ground installation has been made, we will turn our attention to the receiving set to be used. We take it for granted that few, if any, of our readers will desire to use a set with a loop aerial; at least until they have become thoroughly familiar with radio reception. Therefore, we have left this phase out of this discussion.

For the benefit of the experimenter, we illustrate, in Fig. 1, how various separate instruments are mounted, in what is called unit style; so arranged that they can be quickly and easily connected to each other, and then changed around until the best results are obtained. For the man who wants to make several different types of receiving sets and experiment with them without buying many different and duplicate parts, the unit panel idea is a mighty good one.

Then, for the man who builds his own and wants to find out just what goes on in his set and study it carefully, we show the type of set in Fig. 2 that will lend itself admirably to this purpose. Here, again, no definite details are given as the photograph is shown merely to illustrate the point. The various instruments are laid out on a base-board and mounted by means of wood screws, or short mounting strips; and then the instruments are connected together, following any one of the standard circuits that may be found in the pages of various radio publications. The particular type of set shown was assembled for the purpose of experimenting with a vacuum-tube detector and one stage of tuned radio frequency amplification. However, the same form can be followed for any type of set; and the instruments can be connected together, and the connections changed, until the best results are obtained. This type of set is recommended for the beginner who is handy with tools and does not want to spend any more

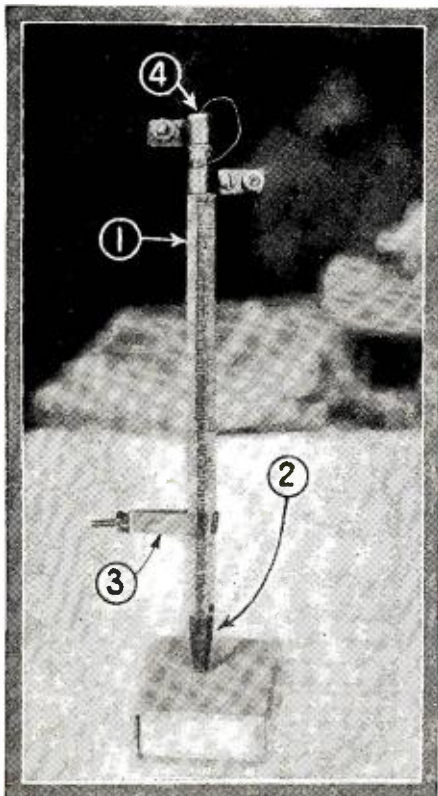
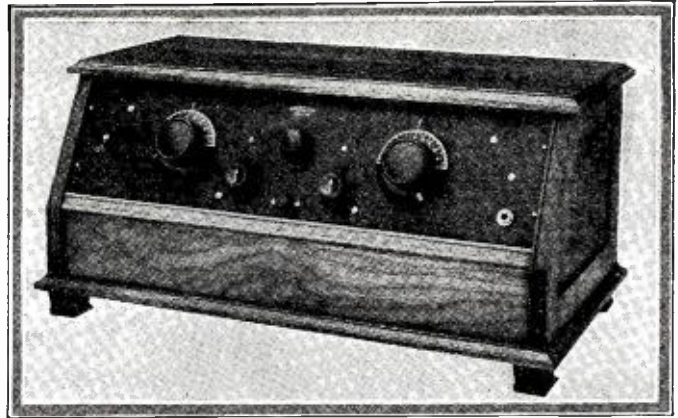

Fig. 4. Above: A "freak" crystal receiving set, built on and about an ordinary lead pencil. 1, coil; 2, pencil core; 3, sliding clip; 4, crystal and catwhisker.

Fig. 6. Another type of set for the radio beginner who desires to buy a good one is shown at the right. Using three tubes, this set works as well as many four- and five-tube sets. It is selective and gives excellent volume.

Photo by Courtesy Crosley Radio Corp.



money than is absolutely necessary. As will be noted, there is nothing at all used in connection with a set of this nature that is not absolutely necessary in its operation. Such frills and fancies as panels and cabinets have been eliminated and every cent expended on the set goes toward working apparatus only.

THE BUILDER WHO WANTS SIMPLICITY

Now we have the third builder to consider. He is the man who wants to build a good,

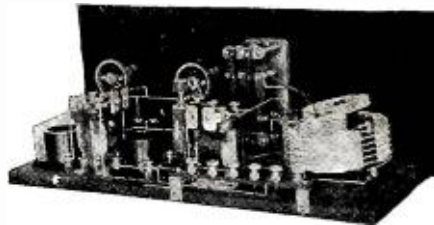

Fig. 3. The above is an example of a home-made set that can be readily made by the radio beginner if instructions are followed.

set simple, set; but does not want to go into technicalities which may lead him into future trouble. Therefore, a set as simple as the one shown in Fig. 3 should be selected. This is a standard type of receiver, known as a three-circuit tuner, employing a vacuum-tube detector and two stages of audio frequency amplification.

Just to show what can be done by someone who desires to build a very cheap radio set, we illustrate the one shown in Fig. 4. This was a set that was entered in a prize contest conducted some time ago by *Science and Invention Magazine*. It comprises a complete crystal set, less aerial, ground and phones. However, it works and gives quite good results for local reception; and it goes to show just what can be accomplished when an ingenious builder finds out a little bit about radio and tries to build a simple, cheap receiver.

THE READY-MADE SET

At last we come to consideration of the buyer. Knowing nothing about radio, the very best thing for him to do is to go directly to some large radio dealer and inquire about the purchase of a complete set, with all the necessary accessories, and at the same time ask the price of installing the same set. If he does not want to spend very much money, some type of single-tube receiving set should be decided upon. Such a set, complete with all accessories, such as batteries, phones and tube, should not cost more than \$25.00; and any reliable radio dealer will usually install this set for an additional \$5.00 or \$10.00. If, however, the various articles appearing in this department have been followed and read carefully, the purchaser of any type of set should have no trouble in installing it himself, and thus save himself a little money. A very simple type of single-tube receiving set that is easy to operate is shown in Fig. 5.

If it is desired to spend even more money in the purchase of a receiving set, and yet economy be desired, there are several different types of so-called reflex sets on the market, in which some of the tubes employed are made to do twice their normal work. This is accomplished by means of clever arrangements of various instruments, and in the set illustrated in Fig. 6, three tubes are so arranged as to do the work of four. By using a set of this nature, the number of tubes required for given results is reduced, and the consequent battery current consumption is also cut down. It is obvious that it will be more economical to use three tubes than four, and therefore, a set of this nature is to be recommended. In its manufactured form, it is easy to handle and tunes very nicely. It is sharp enough in tuning for all ordinary purposes; or, in other words, you can select any station you desire to listen to, without interference from others.

RADIO RECEIVERS DE LUXE

For the man who wants to buy the very best possible in radio receiving sets, the initiated immediately thinks of something on the order of what is known as the super-heterodyne. One of the several types available today for both the buyer and the builder is illustrated in Fig. 7. This set is sold only in its manufactured form and would be rather difficult for the builder to imitate; but, on the other hand, practically every radio periodical carries a super-heterodyne constructional article in almost every issue. If you lean toward the best in reception, it will pay you to consider the construction of such a set after you have mastered the simpler sets.

For the buyer, however, ease of construction is no criterion, inasmuch as he will have nothing to do with it. Therefore, with money at his command, he can purchase a set such as the one shown in Fig. 7, or an even more elaborate one, have it installed in his own home and then proceed to enjoy himself. In any event, one thing that every radio beginner should do is to become familiar with the various radio stores in his vicinity or with the various mail order houses through the

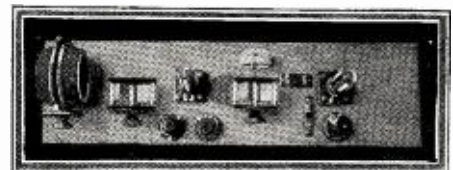

Fig. 2. The so-called breadboard layout, shown above, is a very good type for the radio beginner and experimenter to employ.

mediums of their catalogues. By looking over their various sets or studying pamphlets and catalogues, much information relative to radio in general can be picked up, and by talking to the salesmen in the stores, you can find out many things that will be of interest to you.

Short-Wave Work In 'IRAQ [Mesopotamia]

By FLIGHT LIEUT. R. F. DURRANT, A.F.C., R.A.F.

The results, set forth in this article, of tests conducted in Mesopotamia, should be of the greatest interest to everyone who works on the shorter waves. Lieut. Durrant worked with stations on every continent and reached some very excellent conclusions as a result.

BOTH the amateur and professional experimental radio world have been so busily engaged in collecting data on the wave-band, 15 to 100 meters, that I offer no apology for intruding on this subject and setting down my experiences, obtained in the atmospheric-laden ether of 'Iraq (Mesopotamia).

My work extended, geographically, from Basrah, in the Persian Gulf, up country to Baghdad, and more particularly in the Mosul Vilayet.

At Basrah, in southern 'Iraq, one has a large sector of swamp country to work over for radio communication; it is here that static and atmospherics of the "grinder" type, originating in the Indian Ocean, appear with venomous regularity, rendering rapid communication on the higher wave-lengths at times slow and inaccurate.

When I left England in 1923, experimental long-range, short-wave work was entirely confined to a few British and French experimenters carrying out nightly tests with the United States of America on 100 meters and above, and, as far as I am aware, communication had not been established with any experimenter east of Suez.

CONSTRUCTION OF STATION

It was with the object of ascertaining the strength, fading effect, etc., of signals on short waves from Europe and the United States, and also to compare the strength of static on a wave-band of 70 to 100 meters, that the first receiver was constructed. As an aerial, I had two 30-foot field masts, 45 feet apart, and a four-wire equally-spaced counterpoise on spreaders directly underneath the aerial, the antenna consisting of a four-wire sausage on eight-inch spreaders; the lead-in, which was twenty feet in length, ran direct to an ebonite tube, inverted L; on one side, practically against the aerial, was a bamboo matting fence. Scattered around were buildings, mostly with tin roofs.

The receiver used was the ordinary aperiodic aerial, tuned secondary, and reactance—owing to the absence of any coils or proper formers, and in order not to waste time obtaining supplies from England, circular cardboard boxes were used, wound with No. 28 D.C.C. wire; condensers, also, were a problem, the only available being of an obsolete pattern. Crude wooden handles were fitted to avoid body capacity effects.

It was with great curiosity that I spent a memorable night and dawn in sweeping around trying to intercept a definite call-sign. One valve was used, an ordinary dull emitter, which took normally 20-40 volts H.T., but the set could not be persuaded to oscillate unless H.T. of the value of 80-90 volts was applied.

FIRST CALL FROM SWEDEN

After several hours a steady R7 note was heard, which turned out to be SMYY (Vaxholm, Sweden), using, it was afterwards verified, an input of 30 watts on 90 meters; hardly had I copied this call-sign ere G5NN came through, and I had the great satisfaction of intercepting in 'Iraq the first British station.

Nightly watches were kept, and G2NM and G2LZ came on the scene, followed by others whose call-signs follow. Steps were then taken to rig up a transmitter, and the following very roughly-improvised gear was wired up, using a direct-coupled aerial circuit. Aerial coil and reactance were both on cardboard formers wound with seven-

stranded No. 22 bare copper wire, a D.C. motor generator giving 1,000-1,500 volts run from the lighting mains, and a 250-watt transmitting valve with a 14-volt accumulator for filament lighting.

No great hopes were entertained of reaching farther than a thousand miles with this extraordinarily primitive apparatus. One week's tests were arranged with G5NN and in the early dawn (0200 GMT) I had the great satisfaction of hearing him telling me I was quite readable, the signals at the British end growing steadily in strength while the sun was rising in 'Iraq—during the first test, which was the first time direct two-way wireless communication between England



Flight Lieut. R. F. Durrant, A.F.C., R.A.F.

and 'Iraq had been obtained. The atmospherics were too fierce to read signals on the higher waves and, although reception was difficult on the one valve, each word was only sent twice; and at the finish, as the atmospherics dwindled with the sun rising, each message was sent once only. These tests were satisfactorily carried out without interruption for one week.

RECEPTION OF BRITISH STATIONS

After this, regular nightly watch was maintained, and communication established with G2NM and 2LZ, both gentlemen giving me the greatest assistance with various improvements and changing of waves that were tried.

As soon as regular communication was a nightly occurrence, investigations were made to find the periods for reliable work during the twenty-four hours.

Owing to the fact that the British stations were unable to transmit during broadcasting periods, some very valuable data were not able to be obtained. There was not another short-wave set within a thousand

miles, and I was entirely reliant on the British experimenters for all information. From December to March, communication would be opened up at 1815 G.M.T. (9:15 P.M. in 'Iraq) on 90 meters—this could only be carried out until 1900 G.M.T., owing to the British stations having to close down for the B.B.C. transmissions—the next period available being usually 2300 G.M.T., or 2 A.M. with me. Signals from Great Britain were always R6-7 at 1815 G.M.T. At 2300 G.M.T. this strength would increase to R9 plus, and they would reach their maximum at 0130 G.M.T., after which period they would go to R7 and finally fade out at 0530 G.M.T., when it had been sunlight for three hours with us.

It was at first thought that atmospherics in 'Iraq would be sufficiently moderate on low waves to insure continuous communication with the United Kingdom every night. I had great hopes that this would be the case; everything during December, January, February and March pointed to that end—but with the advent of the summer it was found that there were certain nights when atmospherics were too strong to read U.K. on any wave from 20 to 100 meters. The percentage of "bad air" nights was, however, very few in comparison with high waves. Only those who have listened in around the Equator and South America will realize what I mean by X's. It is no exaggeration to say that, with a 3-valve receiver, with the phones on the table, X's can be heard one hundred feet away. They are at their maximum at night, but herald the approach of a sandstorm during the day, and often continue throughout the twenty-four hours. Their minima, as measured by D.F., were N.E. or S.W.

'SUNSET AND SUNRISE TESTS

The first tests with Great Britain were always carried out on waves varying from 82 to 95 meters. Watch was also kept directly the sun was slipping below the horizon, and to my astonishment Australia and New Zealand stations could be heard "tuning up" and giving preliminary calls. They would then fade out for two hours and reappear two hours after sunset, when communication was opened up with A3BD and A2BQ, and New Zealand 2AC, 4AA and 4AK. These stations would fade out about 1930 G.M.T. and, strange to relate, could never be heard at sunrise in 'Iraq, but only at sunrise in Australia.

The best low-power results were always obtained with Finland, and all the Finns could be worked each way on 12 to 20 watts. They were mostly students in military colleges.

The average power of GHH was 100 watts. Let me remark that, of the many English stations read, it was only stations who had a steady, clear note, like 2OD, 2NM, 2LZ, who could be read through the static. An amazing frame aerial test was carried out with G6KK, who, with twelve watts input using an eight-inch square frame, was situated on the first floor of a three-story house in Blackpool. He was worked for several hours, being received R5 on two valves—on switching over to his ordinary outdoor aerial, the received strength was only two points higher.

UNITED STATES, CANADA, BRAZIL

A lookout was then kept for the United

(Continued on page 1340)

Radio as an Ally to the Theatre

By COLMAN GALLOWAY

Sol Lesser, theatrical and motion picture magnate, tells Colman Galloway what he thinks about it, and predicts the co-operation of the two methods of entertainment on a scale never before attempted.

IN a recent issue of RADIO NEWS the writer found an interesting statement by Theodore H. Nakken to the effect that "... the talking or musical motion picture film will come into its own only after a severe and bitter fight with the powers that be in filmland." Mr. Nakken was discussing the possibility of combining radio with the movies.

Every modern invention has in its inception threatened to be a bogie to some industry. In the beginning, radio broadcasting



Sol Lesser at the microphone of KFI.

was frowned upon by theatre owners and producers throughout the country. In the spring of 1922 the Actors' Equity Association went on record as opposed to its members appearing in radio concerts, and the statement was made regarding broadcasting: "If this thing grows, and it bids fair to assume enormous proportions, there will soon be no incentive to go to the theatres. When audiences can hear everything in their homes they won't have to go out to be entertained."

DOES RADIO THREATEN THE THEATRE?

Never at any time has radio attempted to combat the movies, but it has had to fight frank opposition. "It is bound to prove a detriment to the box office!" was the cry, and as a result theatrical co-operation was withheld for some time.

In contrast to this attitude, the West Coast Theatres of California and the Metro-Goldwyn-Mayer Film Corporation recently staged one of the largest radio-movie tie-ups ever conducted. The whole-hearted co-operation of the officials of the two organizations was so sincerely and enthusiastically given that there could be no question of opposition.

Yet there are now over 550 broadcast stations in the United States, and receiving sets installed in 4,250,000 homes, and radio sales of sets, parts and accessories for 1925 are estimated at \$450,000,000. What has this meant to the theatrical box office?

Because of his gigantic activities and

prominence in the motion picture and theatrical world, I went to the "Little Napoleon of the Films," Sol Lesser, for my answer.

There are, perhaps, few men more interested vitally in national entertainment problems than Mr. Lesser, and he sees them from the showman's viewpoint. So when I asked him if the radio was a menace to the theatrical box office he was in a position to answer authoritatively. And he did.

"Positively no!" he declared. "It is one of the world's most delightful entertainments, and with every added improvement is becoming a greater ally of the theatre.

"I know," he continued with a smile, "that broadcasting has been regarded as a menace from a theatrical viewpoint, but the few who still cling to that attitude are in the minority. Motion pictures, the legitimate stage, and radio are furnishing the world with mass entertainment today, each one contributing its quota toward keeping the world happy and contented. While at present each one of the three is independent of the other, the day is coming when they will be close allies. This is particularly true of the future of radio and moving pictures.

RADIO AND MOVIES TO FUSE

"When I prophesied this some years ago, I astounded some of my associates who considered the attitude visionary for one enjoying a practical reputation. I was familiar with the predictions made by Hugo Gernsback and his ideas of the motion picture and radio functioning together, and the success of some recent tests along that line have been as pleasing to me as they undoubtedly are to him.

"Your publication recently carried an article concerning these tests made by the Metro-Goldwyn-Mayer Corporation and the West Coast Theatres, and I believe the attitude of co-operation displayed by the West Coast Theatres is impressive evidence that we consider radio an ally.

"In addition to whatever service we can render in experiments and tests, our vaudeville division bills one of the Los Angeles radio stations twice each week in the same manner we bill a theatre, and is constantly furnishing talent for various radio programs without charge."

In the evening I visited the home of Sol Lesser. Radio was the principal form of entertainment, and Mr. Lesser proved to be as enthusiastic a fan as his two children.

Using the home as an illustration, he pointed out:

"You can picture the effect it would have on our home, on Mrs. Lesser and our boy and girl, if the radio were taken from their lives. It has developed into a part of our daily life, from both an educational and an amusement standpoint. True, like the average American family, we are fond of the movies and stage presentations, and devote some evenings in each week to them. In order to get this par-

ticular form of entertainment, attendance at the theatre is necessary. But there are so many hours when the radio renders service and pleasure that the two do not conflict. Our home is typical of the average, I believe, and my own experience teaches me that those in the theatrical industry who oppose such a valuable adjunct to home life are making a grievous error.

"This is from the personal viewpoint. It shows how radio has reached me, through my home.

RADIO MOVIES AS A COMMERCIAL PROPOSITION

"There is another angle. As a showman, radio represents a commercial proposition with valuable possibilities to me and the industries with which I am affiliated. As I have said, radio is now practically independent. It will be for some time. It is in a process of development, and when it has mechanically reached that point where it can be adapted to the motion picture as an aid in film screening and entertainment there will be a commercial alliance effected un-

(Continued on page 1344)

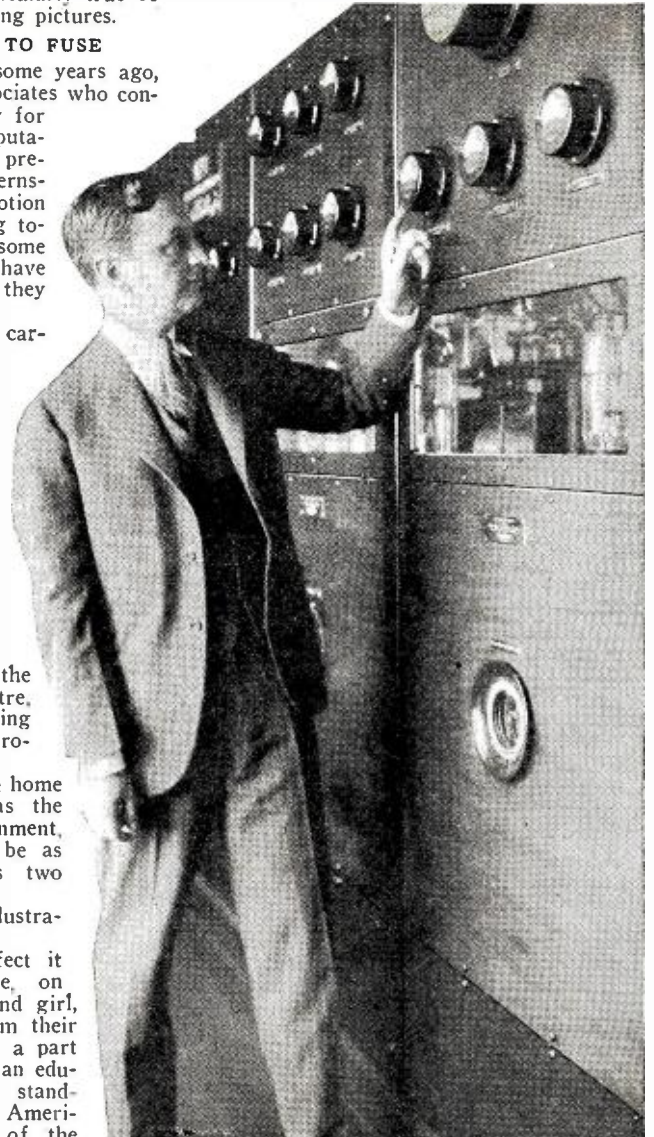

Sol Lesser, president of the Principal Pictures Corporation, in the broadcast station of Earl C. Anthony, Inc., KFI, Los Angeles, Calif.

New Developments In Radio Apparatus

By A. K. LAING



Radio continues to advance as rapidly as in the earlier days of the broadcasting boom. Each season brings its crop of new sets and parts, and of late no prominent manufacturer has placed upon the market a product that does not embody at least one unique feature. The apparatus presented on the following pages are all typical of up-to-date ideas in design and manufacture.



FANS who live in or near large cities, in which powerful broadcast stations are situated, are quite satisfied with receivers having two stages of audio frequency amplification; as with such receivers, it is often necessary to turn down the rheostats or volume controls in order to keep the loud speaker from chattering. But in many isolated districts, and in localities where reception of all stations is poor, because of natural obstructions, the need is felt for a receiver that will give full loud speaker volume on signals that are very feeble when they reach the antenna.

The receiver illustrated in the accompanying halftones was engineered and manufactured in a small town where receiving conditions are poor, and has been designed to give satisfactory service under similar conditions elsewhere. For this reason, it employs the

Provision has been made for antennas of varying length by arranging taps on the antenna inductance. The "C" battery is so arranged that the six tubes draw less "B" battery current than half that number would, if used without a "C" battery.

PHONE AND SPEAKER CONNECTIONS HIDDEN

The appearance of the set, when in use, is improved by the fact that the jack for phones or loud speaker is located in the back of the cabinet instead of on the front panel. The panel itself is of bronze, and the markings are in raised old gold finish. The cabinet is Adam brown.

All connections to batteries and to the antenna and ground are made through a combination plug, the socket for which is situated in the back of the cabinet. This is a feature that will be especially pleasing to

fact that three stages of audio frequency amplification are employed, the tone is quite satisfactory. This is due in a large part to the use of transformers of low ratio, 2:1.

The dial is calibrated accurately in wavelengths, making it a simple matter to find any desired station without the necessity of keeping a separate calibration chart.

BATTLESHIP CONSTRUCTION IN A BROADCAST RECEIVER

The receiver which is illustrated in the photograph on the following page is one

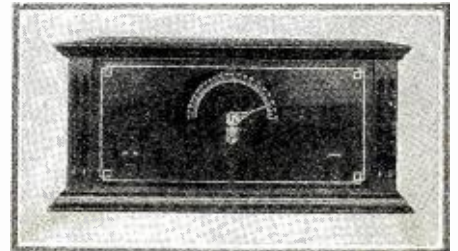

Front view of the receiver showing uni-control knob for tuning, and volume and clarity controls.

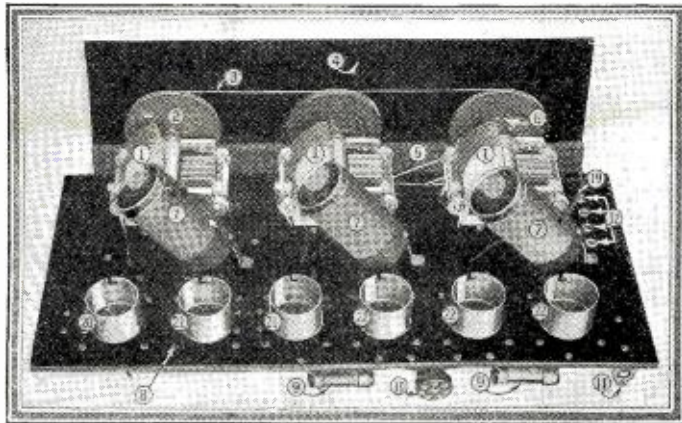

1, shows the three variable condensers; 2, the pulleys; 3, the connecting cable; 4, the metal panel; 5, belt for vernier condenser; 6, R.F. transformers; 8, suspended panel; 9, ballast resistance; 10, plug for battery connections; 11, phone jack. Other numbers correspond to those in the illustration below.

Photos on this page by courtesy of Simplex Radio Co.

standard arrangement of two stages of tuned R.F. amplification and detector, but has three stages of A.F. amplification instead of the customary two. This provides for full loud speaker volume from stations that, in an ordinary set, would come in but faintly.

NOVEL METHOD OF SINGLE-CONTROL

A unique method of single-control is used to vary simultaneously the condensers in the radio frequency stages and in the detector circuit. The shafts of all the condensers carry large pulleys and anchored belts made from steel wire. Tension springs, which may be seen in the illustrations, are used to keep the belts taut, and to prevent end play. A provision is made to adjust the first and third condensers, to bring them back into synchronism with the central one should they happen to get out of adjustment. In addition, to compensate for any detuning caused by the effect of the antenna circuit, there is provided on the first condenser a vernier, controlled by the small knob situated in the center of the main single-knob control. This brings all of the tuning controls into one location on the panel.

The two small knobs in the lower corners of the panel control volume and stability in the receiver. The volume control varies the potential on the grid of the second audio amplifying tube. It consists of a 100,000-ohm potentiometer shunted across the secondary of the second audio transformer, with a variable tap connected to the grid.

The stability control is another variable resistance connected in series with the plates of the radio frequency amplifying tubes. This is varied to increase sensitivity and clarity, up to the point at which the tubes break into oscillation.

housewives; as all of the connections may be made or broken with one simple operation, so that it is an easy matter to move the set for cleaning, or any other purpose.

The receiver has been designed with special care in the audio frequency portion of the circuit, insuring good tone. Despite the

of a series designed by engineers who formerly did much work for the Navy. In consequence, many of the features to be found on battleship sets are incorporated into this receiver.

A glance at the top view shows the sturdy construction of all parts, and the separation into shielded units of all stages carrying radio frequency current. The circuit employs three stages of tuned radio frequency amplification, an untuned detector, and two stages of audio frequency.

As may be seen from the illustration and the circuit diagram, only a portion of the primary winding of each of the coupling transformers is coupled in a fixed position to the secondary. A few turns are mounted on the same shaft that carries the condenser rotor plates; and they make a complete half revolution from the "aiding" position to the

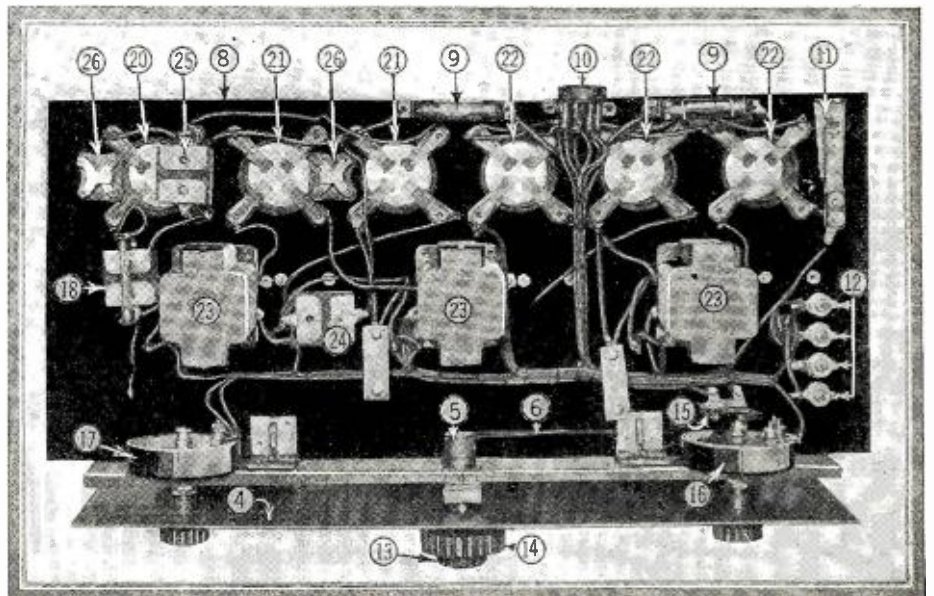

The bottom view of the receiver. 5, vernier pulley; 6, tension spring; 8, sub-panel; 9, ballast resistance; 10, plug for receiving battery leads; 11, phone jack; 12, coil taps; 13, vernier control knob; 14, main condenser control; 15, cam switch for opening "A" battery across potentiometer; 16, potentiometer; 17, rheostat; 18, grid condenser and grid leak; 20, detector; 21, R.F. amplifier; 22, A.F. amplifiers; 23, A.F. transformers; 24, by-pass condenser; 25, by-pass condenser; 26, rubber supports for section of sub-panel.

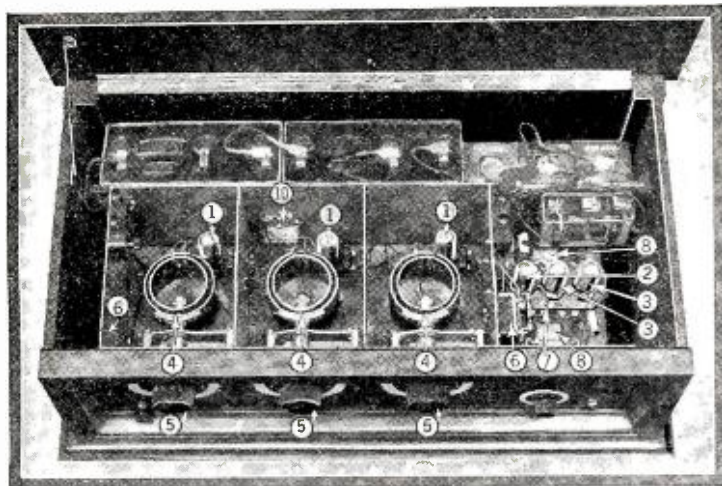

Interior view of the receiver. 1, R.F. amplifier tubes; 2, detector; 3, A.F. amplifier tubes; 4, balancing coils; 5, tuning controls; 6, shielding; 7, cushioned sockets; 8, A.F. transformers; 10, by-pass condenser. Photo by courtesy of Colonial Radio Corp.

"opposing" position. In this manner, the tendency to oscillate is controlled progressively over the whole scale, and the balancing process does not detract from the efficiency at any point.

PROVISION FOR DIFFERENT ANTENNAS

A selectivity switch is provided, as seen in the diagram. This inserts in series with the antenna a condenser of .0001 μ f. capacitance, and makes the tuning very sharp. Provision is made as well as for an inside antenna, connected directly to the grid of the first tube. Either will give good results, although the outdoor antenna with the small condenser in series allows the three dials to work more nearly in synchronism than the other arrangement.

Coupling between the output of the third radio frequency amplifying tube and the grid circuit of the detector is accomplished with an untuned radio frequency transformer, the primary of which is shunted by an adjustable condenser. The detector is of the usual grid condenser and leak type, the output of which is bridged by a .002- μ f. condenser. The two amplifier stages are of conventional construction, except for the small switch at the right, which employs a novel method of changing from one to two stages.

DIFFERENT TYPES OF BATTERIES

This receiver is supplied in several similar models. One type uses small dry-cell tubes throughout. Another uses small dry-cell tubes in the three high-frequency stages, and storage battery tubes for the detector and low frequency stages. It is the circuit diagram of the latter which is shown on this page. Note the series resistance that cuts down the storage battery voltage to an amount suitable for the three smaller tubes, and allows the full voltage, regulated by the rheostat, to be used on the large tubes.

The cabinet has been designed by a well-known coach builder and designer of custom automobile bodies, and has a graceful simplicity and sturdiness of line. It is the policy of the manufacturers of this set to make it completely practical for users who know nothing whatever of the technical side of radio.

THIS RECEIVER USES NO BATTERIES WHATEVER

The illustrations on the facing page show a receiving set which is nearly as foolproof as it is possible to build one today. It uses no batteries of any kind, and is sealed permanently by the manufacturer, making it impossible to tamper with the "works" without vitiating the guarantee that accompanies it. A glance at the top view shows how completely the set is inclosed. Nothing is visible except the holes provided for the insertion of tubes; and these are the only elements in the receiver which need replacement or attention, except under unusual conditions.

The fact that it is now possible to market a completely sealed receiver is significant for two reasons. First, it shows that the manufacturer is willing to accept complete responsibility for maintenance over a period of years. Second, it indicates that radio has become at last quite as simple as the automobile or the phonograph. In the early days of the automobile, every man who owned one had to be a competent mechanic. In the early days of radio, every fan needed a fairly complete technical education. The appearance of receivers like this batteryless one marks the passing of the old order, and opens radio to all classes alike.

HIGH EFFICIENCY OVER BROADCAST RANGE

The receiver is conventional in that it employs five tubes; two tuned radio frequency stages, detector, and two audio frequency stages. The tuning elements are arranged to cover the range of 220 to 600 meters;

and a special balancing arrangement allows high efficiency without oscillation, at all points on the dial.

Three separate tuning controls are located on the front panel, together with two rheostats, one for filament and one for volume control. The audio frequency transformers are also mounted on this panel. A smaller panel in the rear of the set mounts two binding posts, two jacks, and the terminal of the cord and plug that connects to any light socket. The binding posts are for connection to aerial and ground, and the jacks are for headset and loud speaker. On the reverse side of this rear panel the chokes, resistances, etc., are mounted.

CONNECTIONS WITH CURRENT SUPPLY

All circuits are wired with spaghetti-covered stranded cable. No bus-bar wiring is used, and it is impossible, in consequence, to short-circuit the receiver at any point.

In houses wired for 110 volts, direct current, the plug from the receiver may be inserted directly in the socket. Where the supply source delivers alternating current of from 40 to 60 cycles, at 110 volts, a special rectifier is inserted between the set and the power socket. No hum is noticeable in either case, and the maximum current consumption in either case costs less than half a cent per hour. As the filaments of the tubes are connected in series, it is not necessary to step-down the supply voltage as much as when rectifiers and filters are attached to a normally wired set.

The cabinet is of two-toned mahogany, and has been designed with great care to prevent tampering, breakage of seals, or the entry of dust, dirt, and metal objects.

SPIRAL-CAM CONDENSER

The skeleton drawing on the facing page illustrates a new condenser, incorporating in its construction several unique features. The most interesting is the substitution of a moulded spiral groove for the usual gearing arrangements common to condensers in which both sets of plates move simultaneously. This provision allows a complete revolution of the dial between maximum and minimum settings, instead of a half revolution, as in the case of ordinary condensers. The plates and cam grooves are so designed that an approximately accurate straight-line variation is obtained over the band of broadcast frequencies.

The plates are made from unusually springy material, and will retain their alignment even when subjected to rough handling. Referring to the numbers on the illustration, 1 is one of the two groups of movable plates; 2 is the specially-grooved cam plate; 3 is the guiding arm for the rotary plates, running in the cam groove; 4 is the pigtail connection from the movable plates to the binding posts; 5 is the vertical supporting post.

PREVENTS LOST MOTION

One of the unique features of this con-

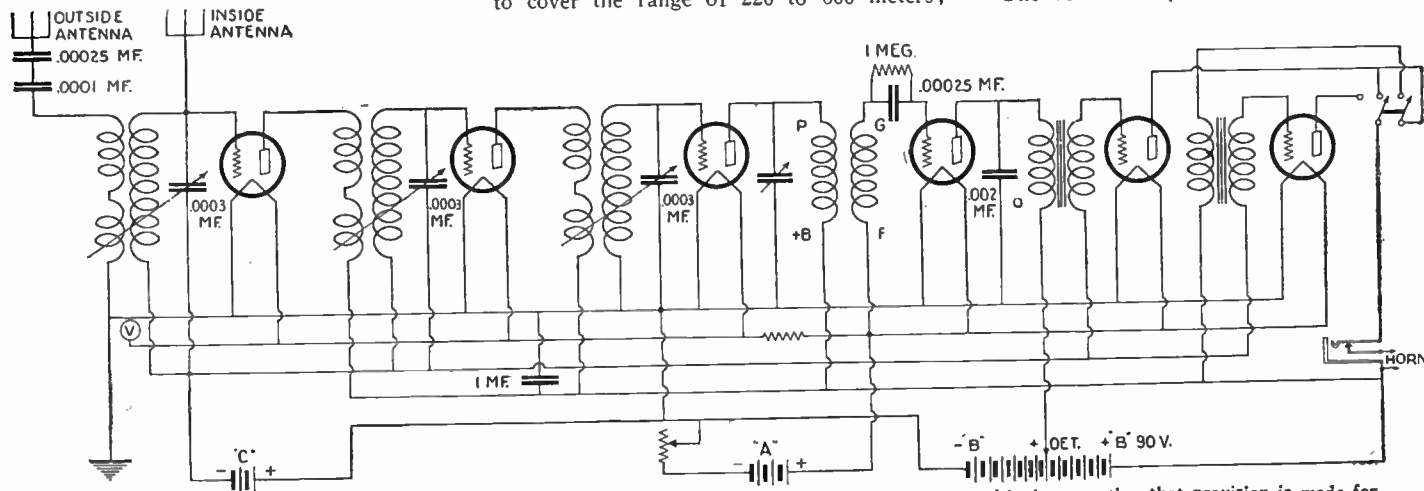

This is the complete wiring diagram of the receiver shown in the illustration at the top of this page, with the exception that provision is made for storage battery tubes as detector and A.F. amplifiers.

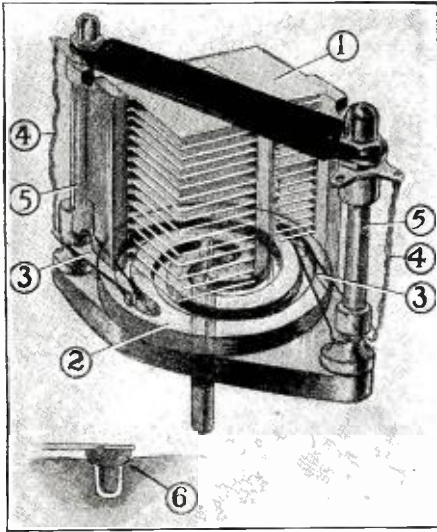

This is the latest development in S.L.F. condensers. The rectangular plates are guided into mesh at varying rates by means of the cam arm 3, which follows the groove in the plate 2. Detailed description is given in the text.

Photo by courtesy of Signal Electric Mfg. Co.

denser is illustrated at 6 in the drawing. This is the manner of preventing "end play" or wasted motion in tuning. Most gear arrangements have a little "play" when the direction of the dial is reversed. That is, in the vicinity of any setting the dial may have to be tuned half a degree or so before the teeth of the gears engage sufficiently to make the condenser plates move. This is very annoying in tuning in a "sharp," or distant station. In the condenser illustrated, the difficulty is overcome by means of the special construction of the tip of the guide rod, 6. It will be seen that this has, besides the vertical pin that fits loosely in the groove, a hemispherical part which touches both rims of the groove. As the spring guide rod, 3, has a constant downward tension, both rims of the groove maintain a constant pressure against the small hemisphere. Thus, a motion in either direction is felt instantly, and there is no room for end play.

As almost all of the metal in the condenser is concentrated in the plates, and as these are separated by a considerable margin from the insulating material used to support the movable parts, the condenser has very low losses. It is rated at .0005 $\mu\text{f.}$, and has an unusually low minimum capacitance.

A FLEXIBLE-TONE-COLUMN REPRODUCER

Last month, in this department, mention was made of the fact that the fad for resonant tone chambers in radio loud speakers is passing. In that article, the use of cone speakers to overcome the resonant feature was discussed. The loud speaker shown in the accompanying illustration embodies another method of combating the faults of the old-style horn.

It must be remembered that the chief drawbacks of the rigid horn speakers are a tendency to under-emphasize the low notes, and a tendency for the horn to vibrate at a fixed frequency, which causes over-amplification and distortion of any notes of that frequency that are set up by the diaphragm. The column of air in a horn of any type has a certain advantage over cone speakers in that it allows "tone amplification," or amplification of the actual sound itself; whereas, the possibilities of amplification in a cone speaker are all in the electrical portion of the apparatus, and once the electrical energy is converted into sound energy it cannot be further amplified. The disadvantage, as stated above, is the difficulty encountered in amplifying all frequencies of sound to an equivalent extent.

LOW NOTES DIFFICULT TO AMPLIFY

This is due, mainly, to the use of too

short a column of air in the ordinary type of horn, which allows room for the sustained vibration of only the waves that are not longer than twice the length of the pipe itself. For this reason, notes with a wavelength of more than four or five feet are under-amplified in an ordinary horn. In other words, frequencies below middle C on the diatonic scale become increasingly less distinct.

The horn shown is peculiar in construction in several ways, and overcomes most of the disadvantages common to other types of inclosed-air-column speakers. It is about six feet in length, and allows resonant tone amplification of notes considerably under "C below middle C," and some amplification on notes even below fifty cycles. No other horn manufactured commercially for the general public will do this.

NON-VIBRATING MATERIALS USED

In addition, the walls of the horn are made in such a manner that there is no noticeable tendency for the horn to vibrate as a whole at some fundamental frequency, as is the case with all rigid horns. The flexible tone column is made up from several "soft" materials. In its manufacture a few layers of

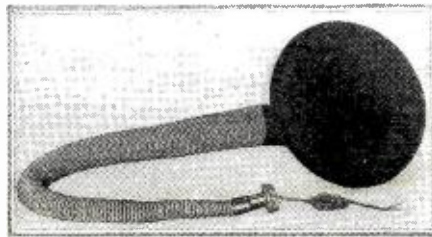

This tube may be twisted or bent into a very small space without impairing the tone qualities of the horn.

Photo by courtesy of Bel-Canto Radio and Telephone Equipment Co.

linen cloth are wound on the mandrel, or form, and over this several hundred feet of slender rattan are wound spirally. Then more linen cloth is put on, and a special secret impregnating compound is used to coat the whole and to permeate between the turns of rattan.

The whole make-up results in a horn which is very flexible, non-resonant, and capable of reproducing with about the same degree of amplification almost all of the tones of the human voice, as well as those of the standard musical instruments. Even the low notes of a large organ come through fairly well. Because of its flexible nature, this reproducer may be coiled up in a small space, and really takes up little more room than an ordinary short horn. This coiling detracts in no way from the quality or volume of the sound reproduced.

The manufacturer of the flexible tone column produces, also, a loud speaker unit especially designed for use with the horn. The diaphragm is larger than usual, providing additional aid in the reproduction of low notes.

NEW RADIO METAL

As a result of a search by scientists over a period of one hundred years all over the world, a new metal of immediate value and vast possibilities has been added to the world's technical resources, in the form of pure metallic ductile thorium, which has been prepared for the first time by the Research Laboratories of the Westinghouse Lamp Company, according to a statement by Dr. H. C. Rentschler, head of the Research Department, and Dr. J. W. Marden.

Thorium is of particular interest to the radio enthusiasts because it is the active constituent of practically all radio tube filaments. The present method of making radio tube filaments consists of compounding thorium oxide in the tungsten wire, as thorium has the ability to throw off electrons with great ease and at a very low temperature. As the tube is heated, the thorium oxide comes to the surface of the wire in the form of minute quantities of thorium metal, which gradually dissipate through the emission of electrons. As the thorium on the surface of the tungsten is used up, more of the thorium oxide in the filament comes to the surface, the life of the tube ending when the thorium is all used up. Through the use of the new method, thorium can now be produced commercially in filamentary form as contrasted with the minute admixture with tungsten used at present.

A receiver that uses no batteries. The coming radio receivers will undoubtedly be operated entirely from the house mains. This is the logical way in which to supply current, and we feel that radio designers must eventually come to this. The illustrations shown here picture one of the first of this type of receiver. The utmost simplicity, both in operation and appearance, is obtained; there is nothing for the operator to worry about, with regards to the charging or replacement of batteries, and altogether the whole equipment is made entirely fool-proof. The cabinet is sealed so that the apparatus cannot be tampered with by inexpert hands.

Photo by courtesy of Powerola Radio Corp.

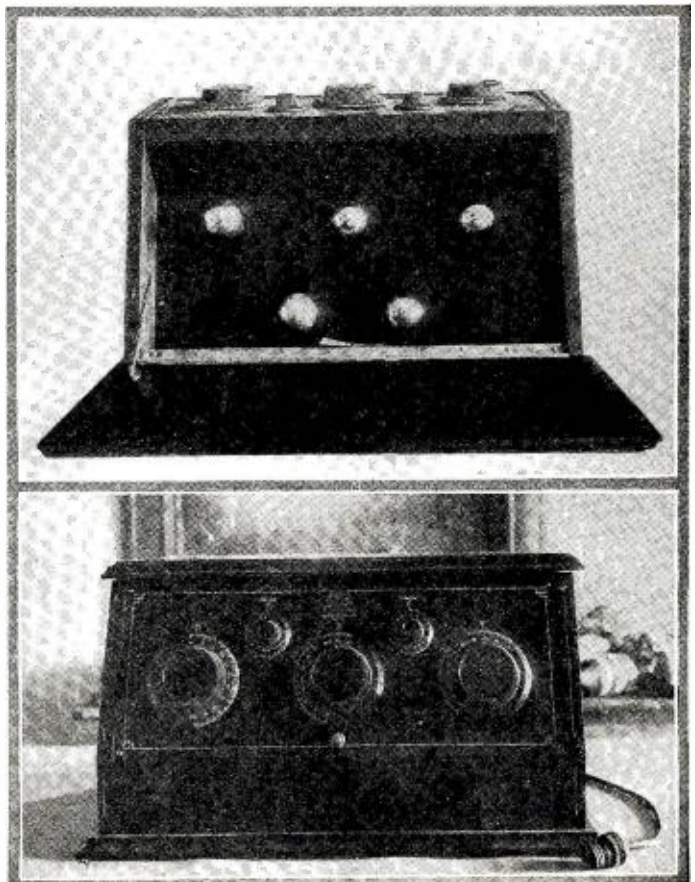

The Manufacture of Modern Low-Loss Condensers

By FRANKLYN L. FRANCIS

In this article Mr. Francis traces the manufacture of low-loss condensers from the time when their raw material, in sheets and rods, enters the factory to the point at which they leave the testing department, ready for shipment. Machinery has replaced most of the old hand methods.

THE radio manufacturing industry has been revolutionized completely by the sudden increase of orders from the public in the last three or four years. When the buying public was restricted to five or ten thousand amateurs, a radio concern manufacturing condensers considered it a successful year when five hundred or a thousand were sold. In consequence, nearly all manufacturing and assembling was done by hand, almost unaided by any type of machinery. An investment in costly machines could not possibly be expected to pay for itself.

Nowadays, the radio-buying public numbers as many millions as it did thousands before the war, and some manufacturers of condensers report an output of several hundred thousand per year. This new condition has made possible the use of complicated machinery and all kinds of labor-saving devices. In addition, it has made possible the manufacture of all parts in one shop. While formerly it was necessary to let out some of the work to plants that specialized in making small parts for the trade, it is now possible to increase efficiency and lower costs, by making everything under one roof. The manufacturer buys raw material in the form of sheets and rods, and turns out a finished product.

The accompanying illustrations show a factory in the manufacturing district of Manhattan (New York City), typical of the latest methods in large-scale condenser manufacture. When inspecting it one may follow successively all stages of manufacture, from the original punch presses and the automatic screw machines that turn out small parts from raw stock, to the final testing operation in which each condenser is checked for both efficiency and accuracy.

COMPLEX AUTOMATIC SCREW MACHINES

Fig. 1 is a view of the main machine shop, in which the stamping, turning, milling and threading operations are performed. The long boxes in the foreground, and the racks in line with them further back in the picture, contain round and octagonal brass rods ten feet in length. These are fed through guiding pipes into the automatic turret lathes, which form the first row of machines in the picture.

Fig. 3. In the foreground, the parts that go to make up one condenser are shown. In the middle background may be seen the semi-finished parts as they come from the assembling and riveting machines. The complete condenser is at the rear.
Photo by courtesy of Amsco Products, Inc.

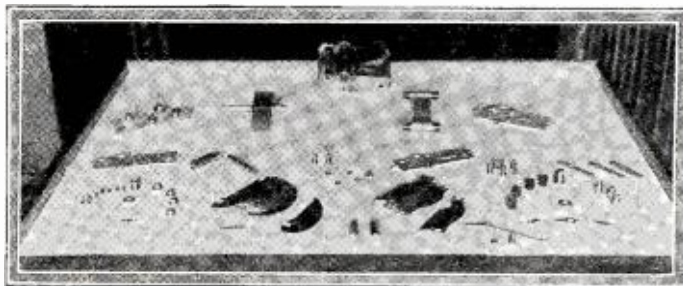

Each of these machines turns out some specific small part of the many that go to make up a condenser, such as are seen in the foreground of Fig. 3. Many of the machines perform several operations at once; and all of them are equipped with "turrets," holding several tools for successive operations. One machine, for example, cuts off lengths of octagonal rod, drills and forms one end, and turns down the other to make a round bearing. This part becomes the central portion of the rotor shaft. Another machine takes the same piece and mills three sets of slots on three sides of the shaft. Into these slots the rotor plates are later forced at high pressure. The latter opera-

tion is guided by hand, but the former is entirely automatic.

Fig. 2 shows the machine that performs the most complex function of all. It turns out small parts, upon each of which seven distinct operations are performed. Three of these small bushings may be seen in the lower right corner of the layout of parts in Fig. 3. By the machine of Fig. 2 the rod is cut off, drilled to two different inside diameters, turned down at one end, rounded

and countersunk at the other, and finally tapped for a machine screw and deposited in the tray below the machine. Notice that there are two revolving cutting-heads; and that a faucet above each keeps the cutting tool and the work constantly bathed in a stream of mingled oil and water, or "soup," as it is called in shop parlance.

This machine requires no supervision whatever until the tools become dulled, or until the ten-foot rod has been used up. It works all day, practically without adjustment, turning out hundreds of intricate parts per hour. Many of the machines that perform simpler operations are even more rapid.

Aside from the automatic lathes there are large punch presses that cut condenser plates and end plates out of solid stock, smaller presses for forming the cups that hold the insulating bushings, assembling machines and riveters.

FOLLOWING THE STAGES OF CONSTRUCTION

Fig. 3 shows, in the foreground, all of the single parts that go to make up the condenser, just as they come from the automatic lathes, punch presses, etc. Even the small screws and lock washers are made in the same factory. In the middle background may be seen the parts as they come from the assembling and riveting machines; and at the extreme rear the finished condenser is shown.

When the unit parts come from the machines they are tested for accuracy, and then sent to the assembling department. Here the bushings, and similar parts, are riveted to the end plates, and the stator and rotor units are assembled. In the latter process, all of the plates are slipped into grooves in a special machine, and the milled shafts are forced into place under high pressure. As the plates are a bit too thick for the slots, the forcing process scrapes the surfaces of both plate and slot, and causes a clean metal-to-metal contact, under pressure; which is really as good a contact as can be made with solder, perhaps better. The plates, in addition, are "swedged" to hold them in place to improve the contact. That is, the whole line of plates is stamped and spread slightly, close to the slot in the shaft or supporting bar, removing any possibility of its coming loose; and improving still further the electrical contact between plates and shaft.

(Continued on page 1365)

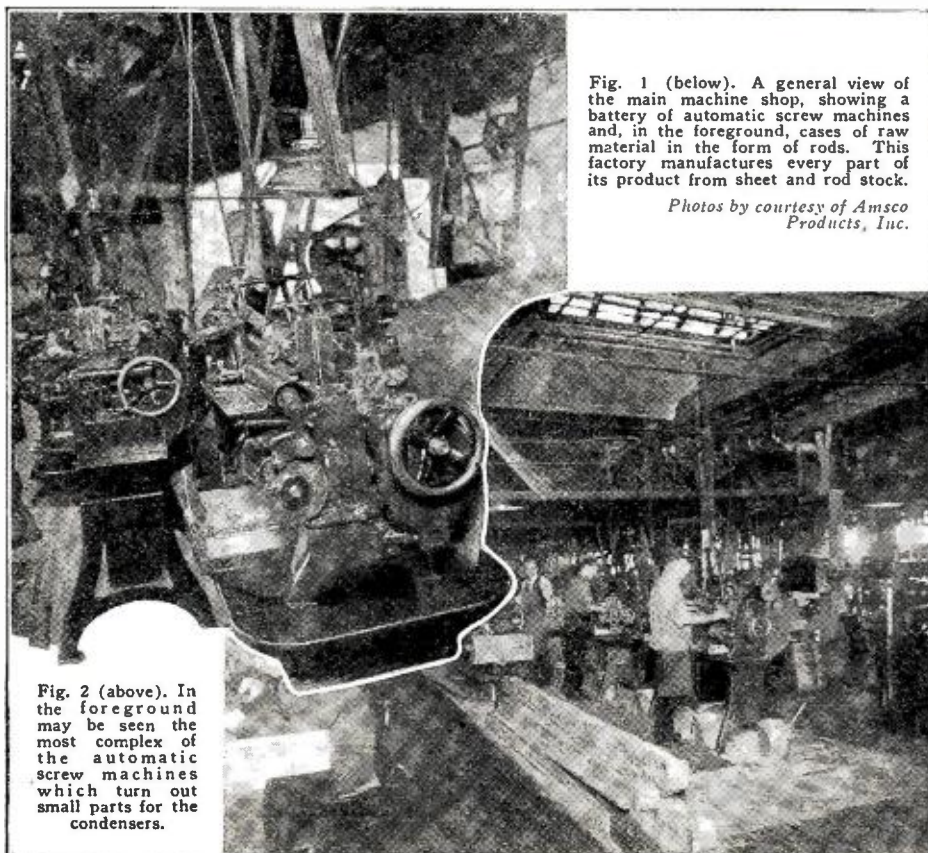

Fig. 1 (below). A general view of the main machine shop, showing a battery of automatic screw machines and, in the foreground, cases of raw material in the form of rods. This factory manufactures every part of its product from sheet and rod stock.

Photos by courtesy of Amsco Products, Inc.

Fig. 2 (above). In the foreground may be seen the most complex of the automatic screw machines which turn out small parts for the condensers.

Radio Beacon Guides Night Air Mail

By A. M. JACOBS*

The two articles below describe the latest improvements in radio for airplane service. The first one deals with the guiding of the planes at night, or during fogs, by means of radio. In the second article is told how the ignition system of the airplane motor must be shielded in order to reduce interference in the radio receiver.

THE announcement of a radio beacon tower, to be erected at Monmouth, Ill., under the supervision of the Radio Laboratory, McCook Field, Dayton, Ohio, for the Air Mail Service, brings to light another development by the Engineering Division achieved in co-operation with the Signal Corps officers stationed there for the purpose. For some time, test flights in radio finding have been conducted by McCook Field, using the beacon tower at Wilbur Wright Field as a base. Pilots have flown out and purposely lost themselves, using the direction-finding signals as their only guide in returning home. Within a radius of 200 miles, these experiments have invariably been successful.

The former method by which this was accomplished was known as the equi-signal system. The present one, which has been in use for something more than a year, is an outgrowth of the old equi-signal system, and is known as the interlocking-signal system. That is, the pilot trying to keep his course in the direction of the transmitting beacon hears certain signals. To the right and left of the course, these signals have somewhat the character of the Morse "N" and "A," respectively.

FOLLOWING THE COURSE BY EAR

On the course, where these two interlocking signals are of the same intensity, a third signal is formed, such as the Morse "T," which is a continuous and unbroken sound. Hearing this constant sound, the pilot knows he is on his course.

If the sound becomes broken into either of the two signals before mentioned, he knows he is to the right or left of the course and must try for correction by resetting the nose of his plane until he hears the constant signal once more. One difficulty with the system has been that the flyer has had to depend entirely upon his hearing, involving considerable concentration and the possibility of personal error.

A FLASHING BEACON IN THE PLANE

To correct this difficulty a visual indicator has been devised. This consists mainly of

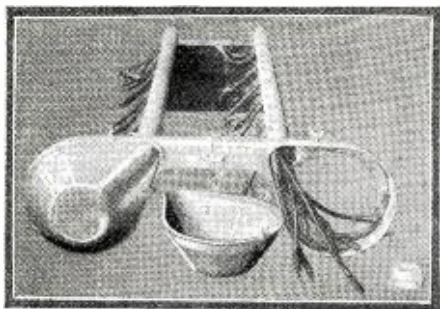

This type of shielding for the ignition system of the Liberty motors prevents motor noises from being picked up in the receiver.

three small lights, mounted on the instrument board and connected with the receiving set, which flash constantly. The unbroken signal obtained by the interlocking of the two separate signals, at a point of equal intensity, causes a relay to operate a telephone selector, which, in turn, causes a white light to flash. While the white light

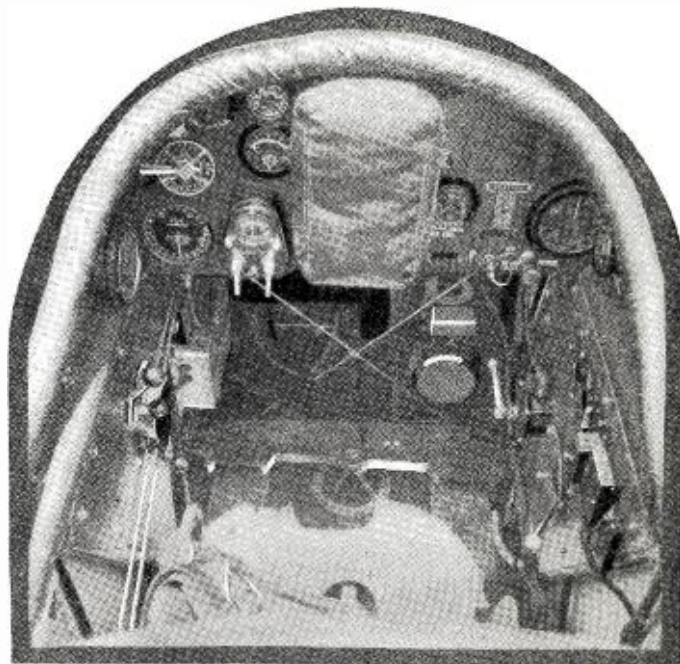

From a photograph of the arrangement of the front cockpit of a standard D.H. airplane; showing the battery and dynamometer for the 134 set and the interphone jacks.

is flashing, the pilot knows he is on his course. To either side of the course, the component signals operate relays, which, in turn, cause the selector to close the circuit, lighting a green or red light. These indicate the pilot is on the right or left of the course, respectively. For economy of space, these light bulbs are of small, Christmas-tree size.

Perfecting the radio beacon is bound to be of inestimable value, especially on set courses, such as are used in airway-flying and by the Air Mail service. It is past the experimental stage and success for it is assured. Tests show the visual indicator to be a most promising improvement.

How Airplane Telephones Are Shielded

By S. R. WINTERS

RECENT newspaper reports of successful radio-telephone communication between two airplanes in flight, and between aircraft and ground radio stations, failed to disclose the underlying secret of this accomplishment. However, when we are told that the Air Service of the War Department has devised a system for effectively shielding aircraft motors, so that they will not impart ignition noises to airplane radio-receiving equipment, it can be realized that the chief obstacle to radio reception when navigating through the air has been overcome.

Electrical disturbance, caused by the ignition of airplane motors, has long been recognized as the outstanding interference to the reception of voice communication on board aircraft. Both the War Department and Navy Department have attacked this problem, realizing that two-way radio telephone communication can not be established unless these airplane engine noises are suppressed, or shielded against entry into the radio receiver. These organized efforts, however,

have only met with partial success. The truth is, the Naval Research Laboratory at Bellevue, D. C., is now seeking a solution to this problem, but results are not sufficiently satisfactory to warrant publication of a progress report.

Meanwhile, the Engineering Division of the United States Air Service has coped with this difficulty for the time being, if it has not offered a permanent remedy. Practical results afford convincing proof of this statement; namely, the reception of radio signals from broadcast stations located at St. Louis, Chicago, and Cincinnati, when airplanes are in flight in the vicinity of Dayton, Ohio. By virtue of this same arrangement, two-way voice communication has been conducted between an airplane in flight and the McCook Field ground radio station, 75 or 80 miles intervening. The volume of these signals has been reported, officially, as being good.

SUPERSENSITIVE RECEIVERS

While the Air Service has installed the most sensitive type of radio receiver on its airplanes, namely, the super-heterodyne, this of itself has not accomplished the satisfactory results reported. In fact, the more sensitive the receiving set, the more disturbing is the noise emanating from the motors of the airplane. Radio fans who use super-heterodyne receivers can testify that they are so extremely sensitive that the electric fan, electric sweeper, or other simple electrical appliance, operated by a next-door neighbor, may create annoyance when receiving signals from broadcast stations. Thus, it is reasonable to assume, the din of noise resulting from a whirring airplane motor, in close proximity to the radio receiver, may sound like pouring lead on a tin roof.

Captain L. A. Walton, of the Engineering Division of the Air Service, McCook Field, Dayton, Ohio, tells this writer that, "Since (Continued on page 1340)

The illustration on the right shows the type of radio set employed on the airplanes in the use of the U. S. Air Mail service. The straps on each side of the cabinet terminate in heavy springs, which are used to take up any jars that might damage the delicate apparatus.

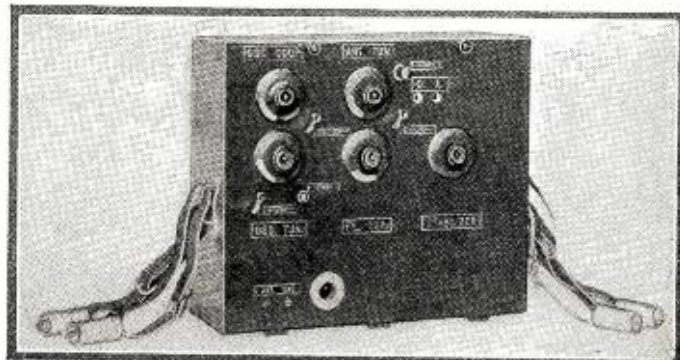

*United States Army Air Service.



Thirty Years In the Dark Room

The Experiments of D. McFarlan Moore

The fourth installment of a biography written by A. K. Laing, of RADIO NEWS, telling of Moore's experiences after he left Edison and organized his own Electric Company.



"THE greatest advances of modern science will depend, not as indirectly as some might think, upon the phenomena resulting from the combination of electricity with a vacuum." This prediction was made more than a quarter of a century ago by D. McFarlan Moore. It was made at a time when the incandescent lamp and the experimental Geissler tube were the only devices in which this combination had been used except by experimenters in a very few research laboratories. At the time it was considered startling, or foolish, depending upon the

unseen; a belief, though perhaps blind, in what the future would bring, and which seems to lodge strangely in the brains of a chosen few.

The period of Moore's employment with the first Edison company, reviewed in the last issue of RADIO NEWS, saw the beginning of many ideas which later were developed more fully. In the early nineties he invented and patented several devices, one of which was an electro-magnetic steering control for large vessels. While still head of the draughting department of the Edison company, he received offers of positions with a number of newly-formed concerns, one of which was organized by Mr. Ward Leonard, whose name is synonymous today with electrical resistances of all kinds. Moore preferred to remain with Edison, however, until the opportunity came to organize a company of his own.

One day late in 1891 Moore happened to notice in the *Electrical Record* a squib stating that only .3 of 1% of the energy in the coal pile was turned into light by the methods of lighting then in use. As he pondered upon this enormous waste, the ambition suddenly grew within him to supply humanity with a more efficient form of illumination, with something approaching true *cold light*. It was to mean years of hope and failure, faith and disappointment, and unceasing toil many hours a day before the goal appeared possible. At one time death waited just around the corner, and at many more times than one the end of financial resources was imminent. Had he realized all of this in advance, the young inventor might have been tempted to take the easier path that offered itself many times while he was head draughtsman for Edison.

THE "TURN-DOWN" ELECTRIC LAMP

Moore's first really novel idea in the construction of an electric lamp came in February 1, 1892. He happened to be holding in his hand a carbon lamp with a broken filament, but still attached to the socket by a flexible cord. He noticed how dim the light was when the ends of the filament vibrated back and forth, barely touching one another at intervals. This appeared to be a good way of making a "turn down" lamp, and he decided to construct one with a vibrating contact in the base. In consequence he spent some evenings filing and fitting and adjusting a model in his boarding house room, and then showed the finished model to some friends. It performed its work quite satisfactorily. He then called on the late T. C. Martin, then editor of "The Electrical Engineer," and asked his opinion of the invention. Martin said it was worth \$10,000, and advised Moore to go to E. P. Thompson. The resulting interview caused Moore to prove his faith in his idea by making his first patent-money deposit—\$40.00.

STEERING BY ELECTRICITY

On April 25, 1892, Moore's first patent was allowed. He called his device the "regulating socket." On May 24 of the same year he installed his electrical steering gear on the monitor *Miantonomoh*, and had an adventurous first voyage, steering the ship himself. An article on the steering gear was published in "The Proceedings of the Institute of Electrical Engineers" for June, 1892, and another in Frank Leslie's Monthly.

In the next year or two Moore experienced most of the sensations of hope and hopelessness, imminent success and heart-breaking re-

verses, that come to every young inventor. He learned as well of the suave audacity of the business world when dealing in ideas. It was in this period that he invented "electrical writing," one of the most important advertising ideas ever evolved, and was argued out of his right to the invention by his financial backers, at a price vastly below its true worth.

But experience, the great teacher, is more effective the more one loses, and it is probable that this and other reverses were worth the price paid. For Moore soon learned how to deal with business men, and while he has never let the business side of his nature effect or overlap the idealistic side, he was able in later years to hold the whip hand in controversies with financiers.

On June 20, 1894, Moore was admitted to the American Institute of Electrical Engineers. When elected he was the youngest man who had been so honored. His election was due in part to his granted patents, but perhaps in a greater extent to the articles that he had read and published on various theoretical aspects of the new industry and on allied topics. The inventor, indeed, states that his best biography would be a volume containing all of the articles and speeches that he has made public at fairly regular intervals throughout his career. It would form a select record of the most important workings of his mind; it would be a biography of the brain.

PREDICTED ARTIFICIAL DAYLIGHT

The most important of the early articles was published in Cassier's magazine for July, 1894. It was entitled "The Light of the Future." Today Moore admits that it was an air castle, built of light. It was more than that, it was prophecy, the second startling prophecy of this man's career. Moore calls it a dream because it was based upon no actual experimentation whatever. But it was perfectly sincere, for it described a method of illumination which he felt absolutely sure that he would be able to develop, given the capital and resources.

The Cassier's article sketched a radical departure from the lighting systems then in vogue. Instead of concentrated points of high brilliance scattered about a room, he



D. McFarlan Moore, from a photograph taken in January, 1896, when the young inventor was beginning to attract national attention.

mental attitude of those who read it. Today it has become so obvious that it appears trite.

Hardly had the prophecy been uttered when the world was astonished by Roentgen's discovery of the X-ray tube. This was followed by a brilliant succession of other inventions: Moore's own series of gaseous conduction lamps, the Fleming valve, the Cooper Hewitt light, the audion, the photo-electric tube, and dozens of other developments have appeared, all making use of electricity operating in a vacuum. And the most arresting feature is the probability that no more than the surface of this great field of development has been touched. Scientists as a group feel certain that motion pictures by radio will be a practical possibility within a few years; perhaps sooner. The development of this new field is tied up inextricably with various forms of the vacuum tube.

Since his first prophecy, and down through the entire development of vacuum-electric devices, D. McFarlan Moore has been associated with the industry more closely than any other single individual. He has undoubtedly spent a larger number of hours, day and night, winter and summer, year in and year out, on this class of scientific work than anyone else in the world.

THE REASONS OF "THE DARK ROOM"

At the outset of his great life work, the electrical glimmerings that were developed in vacuum tubes were so faint that Moore knew a "dark room" would be required in order to study them intelligently. But more was demanded than a dark room. There was needed in addition an abiding faith in the



The actual original model of Moore's "Turn-Down" electric lamp. A vibratory contact inside the glass is operated by an external magnet.



Chauncey M. Depew posing for a photograph taken with the aid of the Moore light exhibited at the first great electrical show.

foresaw a method that would have broader light surfaces at a lower intensity, and emitting colors that would blend to equal daylight. It must be remembered that the yellow light from the carbon filament lamp and the bluish light from the arc were the only types then in use. In addition, the illumination would be of a type much more efficient than was possible by means of incandescence, in which heat is an unavoidable factor of loss because it is the cause of the light, and must be present before light can be produced.

During the summer and early fall of 1894, Moore was making plans to strike out as an independent worker, and to devote all of his time to the development of his ideas. Finally, in October, Moore signed an agreement with Messrs. Wessels, Wallach, and Livingston, providing that he should work upon vacuum-tube lighting for one year, and that they should finance him and share in the profits of any practical development. Livingston was the hardest to win over, but the continual advice of Wallach finally broke down his resistance. He capitulated with the remark, "Oh well, I might as well do that as blow it in on the races." Livingston was a man who boasted that he had never done a day's work in his life.

In this manner was organized "The Moore Electric Company," and D. McFarlan Moore entered upon his life work, which has never ceased to hold the interest of the electrical world.

But Moore entered as well upon a heart-breaking strain of unlimited duration. It must be remembered that his backers were practical men, whose investment was made for profit, nothing more. They expected quick results, and cash returns. Moore found himself faced by the necessity of giving periodic demonstrations showing what advances had been made. Otherwise aid would have been withdrawn. Continually he realized that a demonstration was expected, and that he had nothing to demonstrate. Pioneering in an entirely new field is not an occupation productive either of peace of mind or of infallible results. Moore had his troubles, mental as well as financial.

THE VALUE OF IGNORANCE

His first dark room was located in an almost deserted incandescent lamp factory at 321 Sussex Street, Harrison, N. J. Today, speaking of his work in this laboratory, Moore says, "Much depended upon the vigor of youth, and upon *not knowing too much.*" Moore believes firmly that knowledge has been one of the greatest deterrents to the progress of the world. The more of hard, cold fact one acquires, the more weird and

fantastic become any ideas outside of fact. The comparatively ignorant youth has in many cases gone ahead with an idea that the learned man would have dropped as idiotic, and the inexperienced youth has proved the correctness of the idea and scrapped old erroneous conceptions. There are many treatises in existence, written in the nineteenth century, "proving" that mechanical flight is impossible. Yet two boys named Wright, who were ignorant of these proofs, went ahead and flew. Moore, in the same manner, was told that a gaseous-conduction lamp was impossible. Even after this type of lamp had been passed upon favorably by the patent office scientists continued to disbelieve. Indeed, this patent was later disallowed, because the invention "operated on no known principle." Moore went to Washington and had to make an actual demonstration before his patent was issued.

The financial backers arranged for Moore to call in Wall Street once a week for his salary. Each time he appeared he was asked if the light was finished. The financiers had no idea of the time and experimenting necessary in bringing about a revolutionary scientific achievement. So the weekly report became weekly crucifixions, and for months and years the young inventor continued to struggle along, making one small advance after another, always bringing the goal nearer to fact, farther from fancy. Yet the years were full of trouble and disappointment. At one time the doctor told him that unless he went to live in a high climate and took better care of his health he would be dead within three months. But he worked on steadily, holding to life as he held to his dream of better light, by sheer force of will.

FIRST AMERICAN "X-RAY"

Early in 1896, Moore moved to the second of his series of dark rooms. This was located at 52 Lawrence Street, Brooklyn. For the next twelve years it was to be the scene of countless experiments which led, at last, to the development of the Moore Light.

When the first descriptions of Roentgen's X-ray tube filtered across the Atlantic, scientific opinion divided between calling it an exaggerated newspaper story and calling it an actual fact. Moore was called upon to make an experimental model, the first ever made in America. It was unsuccessful, how-

ever, due to the use of crown glass, the lead content of which filtered out the X-Rays. The reason for this was not known until later.

In this period of his work, Moore came into contact with most of the eminent scientists and many of the great public figures of his day. Michael Pupin, Governor Morton, Admiral Sicard, A. B. Chandler, Chauncey M. Depew, Park Benjamin, and many others either called at his laboratory or evinced great interest at various demonstrations that were given. By the end of 1896 Moore was beginning to realize his dream. What he wanted was a bright glow, set up in a partial or complete vacuum, by the passage of a current of not too high potential. It soon became possible to produce this light with high voltages from a transformer, but the problem of practical installation at competitive cost was still very great.

In consequence Moore worked on through the closing years of the century, giving frequent public demonstrations and arousing widespread public and scientific interest in his work, waiting for the more complete fulfillment of his dream that was to come later. The history of these years is mainly a record of minor developments, each bringing the goal a bit nearer, none a radical advance. The work was concerned in the main with two problems. One was to discover a proper gaseous content for the tubes. The other was to devise the best manner to cause this gas to glow by means of electricity. In working on the latter problem many forms of transformers, interrupters, alternators, etc., were tried. Polyphase current were used as well. The positive column, or brightest portion of the light set up in a Geissler or Crookes tube, was used in most of the experiments, but the short negative glow portion also was used in a part of the work. This was another feature that was declared impossible until it was done.

Moore's recognition was not to come until after the entry of the new century: but he worked on quietly and ceaselessly, winning the friendship and admiration of many of the foremost men of his time, laying the foundations of a new branch of science, and paving the way to a better understanding of many of the problems that would come up in the great new industry of the twentieth century, Radio.

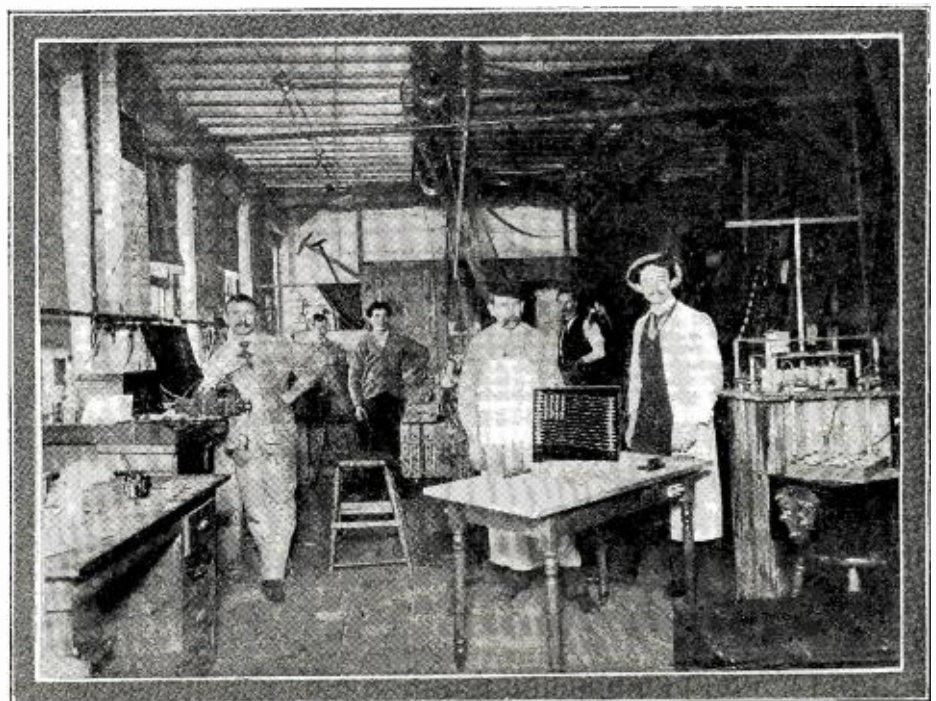

Moore measures the progress of his many inventions by the series of "dark rooms" in which they were developed. Here he may be seen with his assistants in the first dark room, located at 321 Sussex Street, Harrison, N. J.

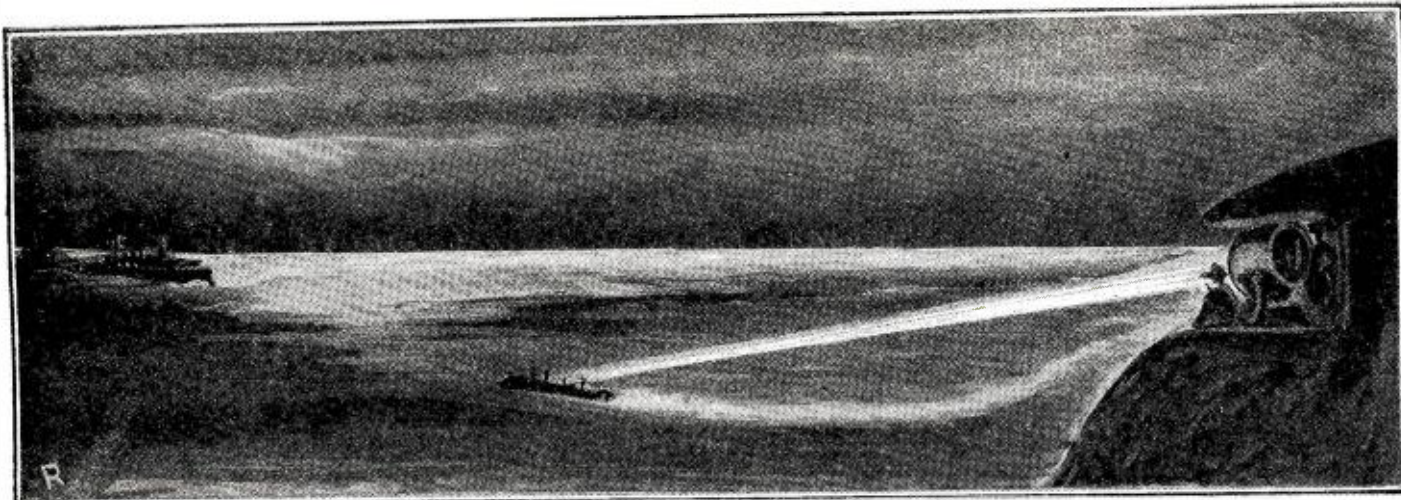

The heat waves, as well as the light waves, of an ordinary searchlight may be used to control the speed and direction of a torpedo. This illustration shows a torpedo, equipped with sensitive heat detectors, being guided by a searchlight situated on the shore.

Controlling Power and Motion By Radio

By A. K. LAING

Radiodynamics, or the science of controlling mechanisms at a distance without the aid of connecting wires, is not restricted to the type of waves used in broadcasting. Sound, light, and heat radiation may be used with success. This article describes, in a non-technical manner, the various systems that have been used.

THE history of wireless telegraphy is as old as that of the human race. It is only recently that we have come to look upon it as a new science. This is due to a widespread misapprehension of the meaning of the name. The only new feature is the application of Hertzian waves as a more efficient means of signaling. As this new system is so much better than any of its predecessors, we have come to forget that the semaphore, the heliograph, even the smoke cloud of the Indian and the drum of the African savage, are all instruments for wireless telegraphy, in the true sense of the term.

It is customary at the present time to use the word "wireless" to embrace all forms of signaling without wires, and "radio" to designate the restricted field of Hertzian waves. But even this is a misnomer. "Radio," in its proper sense, refers to any kind of radiant energy; and takes in, therefore, sound, heat, visible and ultra-violet light, as well as Hertzian waves.

CONTROL WITHOUT PHYSICAL CONTACT

Radiodynamics is practically the only science to which the prefix "radio-" is properly applied. Broadly speaking, radiodynamics is the science of controlling mechanisms at a distance, without the aid of wires or other connecting materials. It does not imply the transmission through space of enough energy to run a motor, but merely the transmission of impulses by means of which some mechanism at a distance can be controlled. For example, let us suppose that there is a steam engine fired, and ready to start at a movement of the throttle. If this throttle is built with great care, it can be turned on or off with the pressure of a finger; yet this slight action will liberate hundreds of horsepower of energy. If we can construct a radio receiving set with an amplifier powerful enough to build up a received signal until, passing through a magnet, it could be made to open the throttle, we can start this engine by merely depressing a key hundreds of miles away. This is a crude instance of the function of radiodynamics. It is intended to show the wide difference between the scope of this science and the dreamed-of radio power transmission, which has the function of supplying energy, not control.

Any radiodynamic system may be divided and classified as follows:

- (1) The controlling station, or transmitter.
- (2) The medium for conducting impulses radiated by the transmitter to the receiving station.
- (3) The detector, or receiving station.
- (4) The local mechanism for releasing and directing the local source of energy, called relay, selector, etc.
- (5) The source of power to be controlled by the distant station.
- (6) The actual mechanism (torpedo, or airplane, for example) that is to be directed.

In describing the practical systems of applying radiodynamics, however, we are able to condense these six divisions into two. The first is the apparatus for the transmission and reception of the controlling energy. The second includes the bodies or mechanism to be controlled.

FIVE MEDIUMS OF SIGNALING

An analysis of the first of the above two divisions reveals five principal systems that have been used. Generally speaking, all these utilize forms of radiation of one kind or another, although the second and third differ in structure from the rest.

- (1) Light waves, visible and ultra-violet.
- (2) Sound waves in air, earth and water.

- (3) Earth conduction of electric charges.
- (4) Hertzian or "radio" waves.
- (5) Heat, or infra-red waves.

Although its roots extend backward through time to a period before the dawn of written history, radiodynamics as an organized science may be called no more than thirty years old. Teledynamics, which is a broader science, including radiodynamics and control by telegraphic means, is now about one hundred years old; and really dates from the invention by Morse of the telegraphic sounder, and its refined form, the relay. In one form or another, the relay is the most important instrument in the apparatus to be controlled; for it has the function of releasing a local supply of energy upon the reception of a much smaller amount of energy from an outside source.

CHOICE OF MEDIUMS

The most important consideration in the first division of radiodynamics, that is, transmission and reception, is the type of energy to be used. Inspection of the foregoing table shows that we have at least five distinct forms of radiation from which to choose. In radiotelegraphic communication, Hertzian waves outclass so completely all other types that it will be a matter of surprise to many to learn that sound and heat waves had been used, quite as successfully as the former, in the control of distant moving objects. At the present time it seems likely that Hertzian waves will become, eventually, the standard form of communication in radiodynamics; but in the past, searchlights and submarine bells have been used with about as much reliability as could be had with Hertzian-wave transmitters. This is due to the importance of several considerations, aside from the actual transfer of energy. Directional characteristics, freedom from interference, opportunity for working entirely unknown to a possible enemy—all these tend to make the use of each of the above five forms of energy desirable under certain specific circumstances. These considerations will be taken up separately.

SOUND WAVES

The use of sound waves in air, as a means of controlling mechanisms at a distance, is impractical, if for no other reason than that

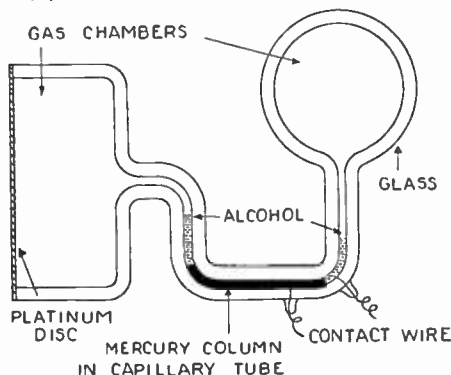

FIG 1
A very sensitive heat detector. Heat waves falling on the platinum disc warm the gas in the adjacent chamber, causing it to expand and force the mercury column to the contact wires.

sound travels more rapidly and to a greater distance underground or in water. The fact that it takes a sound wave nearly five seconds to travel a mile in air might prove a very great fault in time of war.

Sound under water, however, has proved very valuable in pure radiodynamics, and for modified instruments working in the same medium. The sound waves may be created in any convenient manner, such as striking a submerged bell; and the receiving device may be any type of microphone, properly incased to protect it from water. The energy created in the diaphragm of the microphone can then be converted into electrical impulses and made to actuate controlling devices, by operating a relay.

One practical use to which sound-wave radiodynamics has been put is detection of submarines, through the reflection of waves sent out by a ship or shore station. When such an apparatus is made to work automatically, and ring an alarm bell, the action is truly "radiodynamic"; but when a human listener is employed it becomes merely a form of communication.

THE EARTHQUAKE DETECTOR

The seismograph is an instance of sound-wave radiodynamics operating in the earth. In this case, the "transmitter" is not of human origin, being some kind of earthquake shock. The sound vibrations from such a source frequently travel through the entire earth, actuating "earthquake detectors" everywhere.

Our interest, however, lies more in the deliberate control of some moving object than in such chance manifestations as the above. Unfortunately, from the point of view of Locarno, the object usually selected as typical of radio control is a torpedo, or an airplane loaded with bombs. Perhaps, in the near future a valuable peace-time usage for radiodynamics will present itself; but in the course of this article the torpedo will be used as an illustration of the practical application of radiodynamics.

LIGHT WAVES

From the earliest times light waves have been used in signalling devices of one kind or another. Until the last half century, however, the human eye has been the only satisfactory receiving device. Cumbersome photographic processes were devised to use in this type of signalling, but none of them was practical. In the radiometer (described and illustrated in a foregoing article on page 1131 of last issue), and in various kinds of photo-electric cells, we now have proper receiving instruments for impulses transmitted by means of a beam of light. But further experiments in this field have shown that the visible rays of the spectrum are inferior to waves longer and shorter, when control at a distance is desired.

Ultra-violet waves have the property of facilitating the discharge of electrons from negatively-charged conductors; and this factor has been utilized to cause an electrical

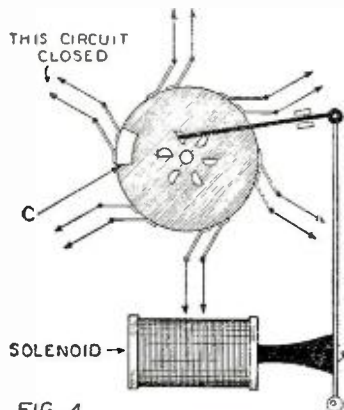

FIG. 4

In this type of selector the solenoid pulls the armature, and turns the wheel through one-sixth of its circumference, causing the contact piece "C" to close the various circuits successively.

effect at a great distance, by means of a beam of ultra-violet waves. This system has the added advantage that the beam of rays will be invisible to anyone unequipped with a special detecting or filtering device.

HEAT WAVES

The infra-red, or heat waves that lie below the visible spectrum of light, have proved to be the most practical in radiodynamics, with the possible exception of Hertzian waves. One reason for this may be found in the fact that the average searchlight beam is composed of less than 10 per cent. of the visible rays, and 90 per cent. or more of infra-red rays. At the present day it is impossible to produce "cold light," or anything approaching it, on a commercial scale.

Another reason for employing radiant heat, as a medium for radiodynamics, lies in the fact that it is comparatively easy to build sensitive detectors of this form of energy. During the late war instruments were developed, so sensitive that they would respond to the heat radiated by a single candle, at a distance of one hundred miles. This is an exaggerated example, it is true, and has little practical value, due to the fact

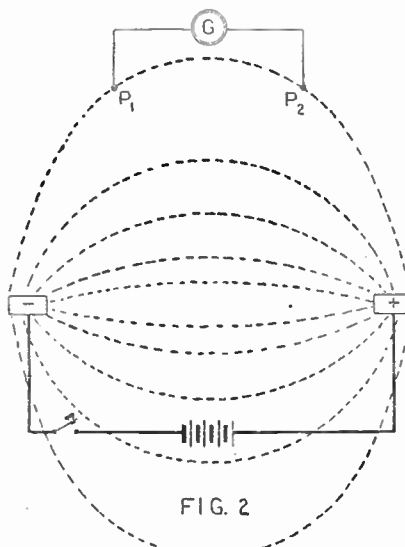

FIG. 2

The tendency of a current, traveling between two buried plates, to spread over a large area is used at times for communication, and for radiodynamics as well. When the key is closed, a difference of potential will be felt between P1 and P2.

that nearer radiations of all kinds would entirely upset the balance of the instrument; but it serves to show the extreme sensitivity of which such an instrument is theoretically capable.

USING INFRA-RED WAVES

In all practical infra-red radiodynamic work an ordinary high-power searchlight is employed as the "transmitting instrument." As the visible rays emitted by the searchlight are not used in energizing the receiving instrument, they may be filtered out; and the actual energy beam will be invisible to the naked eye, just as in the case of the ultra-violet radiations. The distance at which a searchlight beam may be used with success is limited, due to the spreading of the beam. One with a diameter of five feet at the searchlight usually spreads to a diameter of five hundred feet at a distance of five or ten miles. It may be possible to combat this spreading tendency still further in designing searchlights specifically for radiodynamic work. In ordinary searchlights, however, the spreading effect is necessary as, for example, it may be necessary to illuminate the full length of a war vessel at the distances noted above.

There are several kinds of detecting devices for use with infra-red radiations. These rays may be made to cause the following effects:

- (1) Expansion of solids and of gases.
- (2) Molecular stresses in gases.

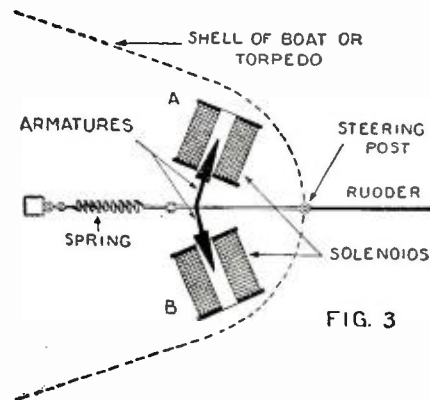

FIG. 3

Two solenoids, arranged in the manner shown above, may be used to control the rudder of a torpedo or other moving object, when radio impulses release the current of a local battery.

- (3) Change of resistance in electrical conductors.
- (4) Thermo-electric currents.

A SUPERSENSITIVE THERMOMETER

One simple and efficient form of radiant heat detector is shown in its fundamental form in Fig. 1. It consists of two glass gas containers, connected by a capillary tube containing a thread of mercury between two threads of alcohol. The thin platinum disc which forms a wall of one of the containers is exposed to the radiations, and conducts heat to the adjacent gas chamber. This causes an expansion of the gas, and forces the mercury column to move along the capillary tube until contact is established with both of the electrodes sealed in its walls. Similarly, a reduction in heat causes the gas to contract, and the mercury moves in the other direction, breaking the contact. Thus, a very minute change in temperature, at a considerable distance, can be made to liberate a large amount of current in the local circuit connected to the two contact wires in the bulb.

The thermostat, such as is commonly used to regulate furnaces automatically in many buildings, may be built in a much more delicate and sensitive manner, to be used as a detector of radiant heat. While it is not as sensitive as the mercury-gas relay described above, it is more rugged and, at shorter distances, will give more reliable results.

EARTH CONDUCTION

One of the oldest means of wireless telegraphy using electricity as energy is known as earth conduction. It is dependent upon the fact that a current traveling through the earth, such as is set up in the "ground return" of a telegraph system, does not travel in the direct path between two terminals, but spreads out over a large area. This is illustrated in Fig. 2. Here we have an electrical circuit completed by the earth between two buried plates. Most of the current will flow in a restricted area, as shown, but a small part of it will take a circuitous path that actually covers two or three times the distance between the plates. A difference of potential is set up in the ground between the two plates. Therefore, on the principle of voltage drop between points of differing potential, any two points (P1 P2) in the field of the plates, provided their ratios of distances from both plates are not identical, will have a different potential, and a current will flow in a wire connecting these two points.

It is obvious that the effective potential decreases with the distance from the plates, so the maximum distance at which an appreciable current can be noted is limited. The system works very well in water, however, and finds a practical application in guiding ships into harbor through a dense fog.

In practice, several submerged plates are

(Continued on page 1366)

How Radio Tubes Are Evacuated

By Dr. CHARLES B. BAZZONI*

In this latest of his series of articles, Dr. Bazzoni gives a most interesting and clear description of the different types of pumps used to exhaust the air from vacuum tubes. He also describes a method of evacuating tubes that can be used by the home experimenter at a very small outlay of funds.

THE growth of modern radio has been due almost entirely to the development of the three-electrode vacuum tube, which has been due, in turn, to the progress of research in general physics; bearing particularly on thermionic emissions and on the technique for the production and control of high vacua. Since progress in these different, yet related, lines has taken place simultaneously, each step forward in one field stimulating an advance in another, it is not correct to say that improvement in vacuum apparatus has made possible the radio tube in its present form. Nevertheless, it is plain that the modern radio tube would never have been produced, if the modern vacuum pumps had never been invented.

Questions as to how a tube vacuum can be produced, renewed or altered, have come up time and again in the experience of every active radio amateur. It may be that the worker wishes to replace the filament of a favorite tube which has burned out and then to re-evacuate the bulb; or it may be that he is filled with a desire to improve on the electrode arrangements in a regulation tube—an operation demanding the release of the original vacuum and subsequent repumping. Speaking generally, however, there is no subject in the radio field on which the ordinary amateur has less knowledge than on this subject of vacuum production—a state of affairs existing partly because radio publications have devoted little attention to this phase of the art.

AN UNSUCCESSFUL EXPERIMENT

We have known of an actual case of two energetic, but misguided, experimenters who reconstructed a number of tubes, producing the new vacuum by lung power—one sucking on the end of a rubber tube slipped over the tube tip, while the other did the sealing off. Needless to say, these tubes had very short lives.

In this article we propose to describe the methods by which evacuation of air can be successfully carried out. Although these methods generally involve the use of somewhat expensive apparatus, which the ama-

teur is not likely to have at hand, it is, nevertheless, well for the tube-user to have a definite understanding as to how the thing is done in practice. We shall also be able to describe one or two thoroughly practical methods of evacuation which any careful experimenter can carry out himself at a small expense.

HOW PRESSURE IS GAUGED

In the first place, let us see what is meant by "normal atmospheric pressure," and how fractional pressures are specified. Air, like other gases, has a tendency to expand indefinitely; and if it is not confined, it will be completely dissipated, its molecules flying

gravitational force and is compressed by the weight of the air lying over it up to the limits of the atmosphere. The atmospheric

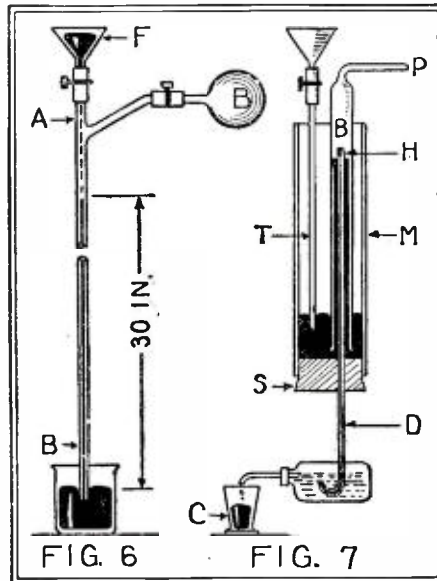

Fig. 6 shows a slow but effective Sprengel mercury pump and Fig. 7 a Guichard type of Sprengel pump.

off in all directions. This is what would happen if we released a volume of air in interstellar space. At the surface of the earth, however, the air is held down by

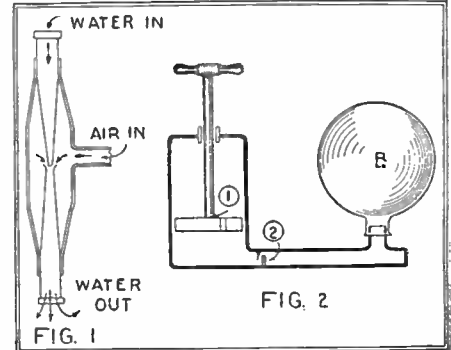

Fig. 1 shows a water aspirator and Fig. 2 an ordinary piston air pump of an old-fashioned pattern. 1 and 2 are the valves.

pressure is, consequently, at its maximum at the surface of the earth and decreases with the elevation.

The pressure is equal to the weight of a column of air of a unit cross-section from the place of measurement up to the top of the atmosphere. Such a column, over an area of one square inch, weighs about fifteen pounds. The weight of air on a square foot is, consequently, about 2,160 pounds—over a ton. Since the superficial area of the human body is about eight square feet, we sustain an enormous pressure, due to the air; but we do not feel this, since it is balanced by air pressure from the inside.

It is customary to measure pressures in terms of the column of mercury which they will support—normal pressure supports, for instance, 30 inches (76 centimeters) of mercury. With this in mind, it is easy to understand what is meant by a pressure of "1/2 inch," or of "1 centimeter," or of "1/100 of a millimeter," and so on.

METHODS OF PRODUCING VACUA

Air can be removed from a bulb by pumps of various types, by absorption in certain materials as charcoal, by chemical action as in "flashing" electric light globes, or by using an electric discharge in a certain way. Practically, however, if we wish to pump out a bulb which contains air at atmospheric pressure, we must start with the use of some kind of air pump. This article does not pretend to be a complete treatise on the production of vacua; yet it will be well at this point to classify air pumps on the basis of construction and operation, as follows:

- (1) Water or steam injector air pump (water aspirators),
- (2) Ordinary piston air pumps,
- (3) Oil-sealed piston air pumps, of the Geryk pattern,
- (4) Oil-sealed rotary air pumps, of the Trimount pattern,
- (5) Stationary mercury air pumps, of the Sprengel pattern,
- (6) Rotary mercury air pumps, of the Gaede pattern,
- (7) Mercury jet diffusion air pumps, of the Langmuir pattern,
- (8) Rotary cylinder molecular pumps, of the Holweck pattern.

THE ASPIRATOR

Pumps of Classes 1 and 2 have only secondary uses in modern practice, but they are,

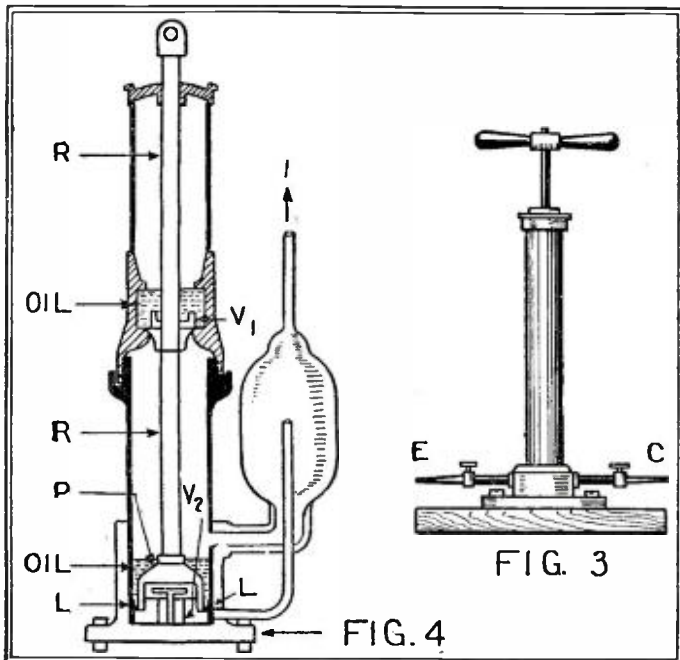

Fig. 3 shows a piston type air pump that may be used for either exhaustion or compression, depending on whether the vessel is attached to either E or C. Fig. 4 is a Geryk pattern pump, whose limit of exhaustion is .05 of a millimeter. P is the piston; RR the piston rod; V₁ upper valve; V₂ the piston valve; I, to evacuated vessel; and LL, leather piston washer.

*Professor of Experimental Physics, University of Pennsylvania.

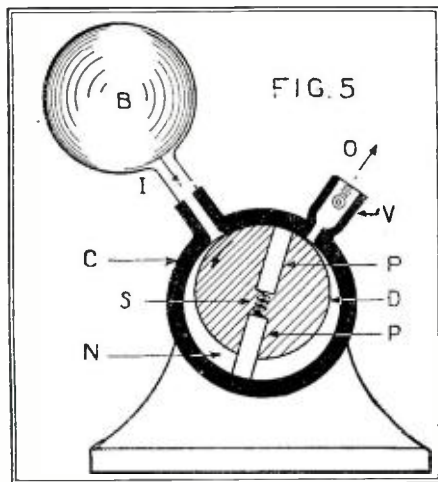

Diagram of a rotary oil-sealed pump, where D is the rotating drum; P-P, steel plates in a slot, held apart by springs; S; I, the inlet; and O, outlet; N, expansion space.

nevertheless, very convenient in an experimental work shop.

The water aspirator (Fig. 1) is screwed to an ordinary water faucet. It costs two or three dollars. At the top, inside, is a small jet opening into a larger tube. The pressure in the narrow part of the jet is below that of the outside air, due to the high velocity of the stream; and the air is, therefore, forced into it and carried out of the discharge pipe. This operation causes air to flow in continuously through the side tube.

If the water pressure is about that normal in city mains, say 30 to 40 pounds per square inch, a considerable draught of air will be drawn by these pumps, making them useful for drying out bottles and for similar purposes.

When attached to a closed receptacle, as, for instance, to a bulb which is to be evacuated, the limiting pressure reached is, however, never very low. At the best, less than 99 per cent. of the air may be drawn out; so that the normal pressure of 76 centimeters of mercury (30 inches, roughly) may be reduced, at the best, to about 1 centimeter (1/2 inch, roughly).

In any case, since the evacuated bulb must always be filled with water vapor, the final vacuum pressure must at least equal the vapor pressure of water at the temperature of operation. This vapor pressure itself is around 1 1/2 centimeters, at ordinary room temperature.

Recently, some high-pressure steam injector pumps have been introduced which do considerably better; but these require high-pressure steam and are of no interest to amateur laboratory workers.

THE OLD-STYLE AIR PUMP

The "ordinary piston air pumps" are of the pattern used originally by workers in reduced pressures a hundred years ago. They consist of a piston moving in a cylinder: valves being provided, as shown in Fig. 2: opening and closing from the pressure changes, due to the movement of the piston. When the piston is drawn up, valve 1 closes, and the pressure in the cylinder is reduced. The air in the bulb B then expands, opening valve 2, and part of this air passes into the cylinder. When the piston is pushed down, valve 2 closes and valve 1 opens. The air in the cylinder then passes out through valve 1.

It is evident that at each stroke a fraction of the air in the bulb B will be removed. It is also evident that, no matter how often the piston is operated, some air will still remain in the bulb. When the pressure of this air becomes insufficient to lift valve 2, evacuation will cease. In some pumps, these valves are operated mechanically by push rods, but even with this improvement, the limiting vacuum attainable is not good. One-

tenth of an inch (2.5 mm.) may sometimes be reached, but a 1/4-inch to 1/2-inch limit is more usual.

OIL-SEALED PUMPS

A principal cause for this limit in vacuum is the presence of a certain amount of "dead space" below the piston in its lowest position, in which the contained air is continuously compressed and expanded without evacuation. Fig. 3 shows a typical pump of the kind here described. Such pumps cost from ten to fifteen dollars.

Pumps of Class 3 are improvements on Class 2 pumps in two respects; first, their valves are operated mechanically, rather than by air pressure, and, secondly, the "dead space" is eliminated by filling the bottom of the cylinder with a pool of oil into which the piston descends. These improvements are of great importance, since we are enabled thereby to attain immediately a (comparatively) very superior vacuum. Such pumps are extensively used at the present day, particularly in field work, or where portability is desired. With them, it is quite easy to reach a pressure of 1/10-mm., or sometimes as low as 1/20-mm. These pumps, when well made and in good condition, are also rapid in action. One of them will, for example, produce a pressure of 1/20 mm. in a 5-quart bulb in about fifteen minutes, beginning at full atmospheric pressure.

THE GERYK PUMP

Fig. 4 shows the construction of a Geryk pump. When the piston is down, it is completely immersed in the pool of oil at the

bottom of the cylinder—the valve in the piston being, at this point, opened by striking against the bottom of the casing. When the piston is up, the upper valve is lifted by the top of the piston and the two pools of oil combine—thus making certain that the air space at the top is completely eliminated. Here, as with a water pump, the limiting vacuum is determined by the vapor pressure of the liquid. Now, dry oil has a very low vapor pressure, but, unfortunately, oil readily takes up water from the air. Once it has done this, the limit of the vacuum rises to the vapor pressure of water and the pump does not operate well. With all oil pumps, therefore, great care must be taken to keep water vapor out as far as possible. This can be done to a large extent by introducing bottles of calcium chloride, which absorbs water, into the vacuum line.

As is evident from their complicated construction, Geryk-type pumps are comparatively expensive—costing around \$100. They are readily operated with a hand lever and are effective and convenient. They do not, however, produce a sufficiently good vacuum for "hard" radio amplifying tubes.

PRODUCING COMMERCIAL VACUUM BULBS

When we come to the rotary oil-sealed vacuum pumps (Class 4), we are speaking of devices which are actually used in manufacturing, not only radio tubes, but also electric incandescent lamps and similar appliances. This type of pump was, apparently, first introduced by the German physicist, Gaede. The Trimount pump, which is extensively used commercially, in-

(Continued on page 1355)

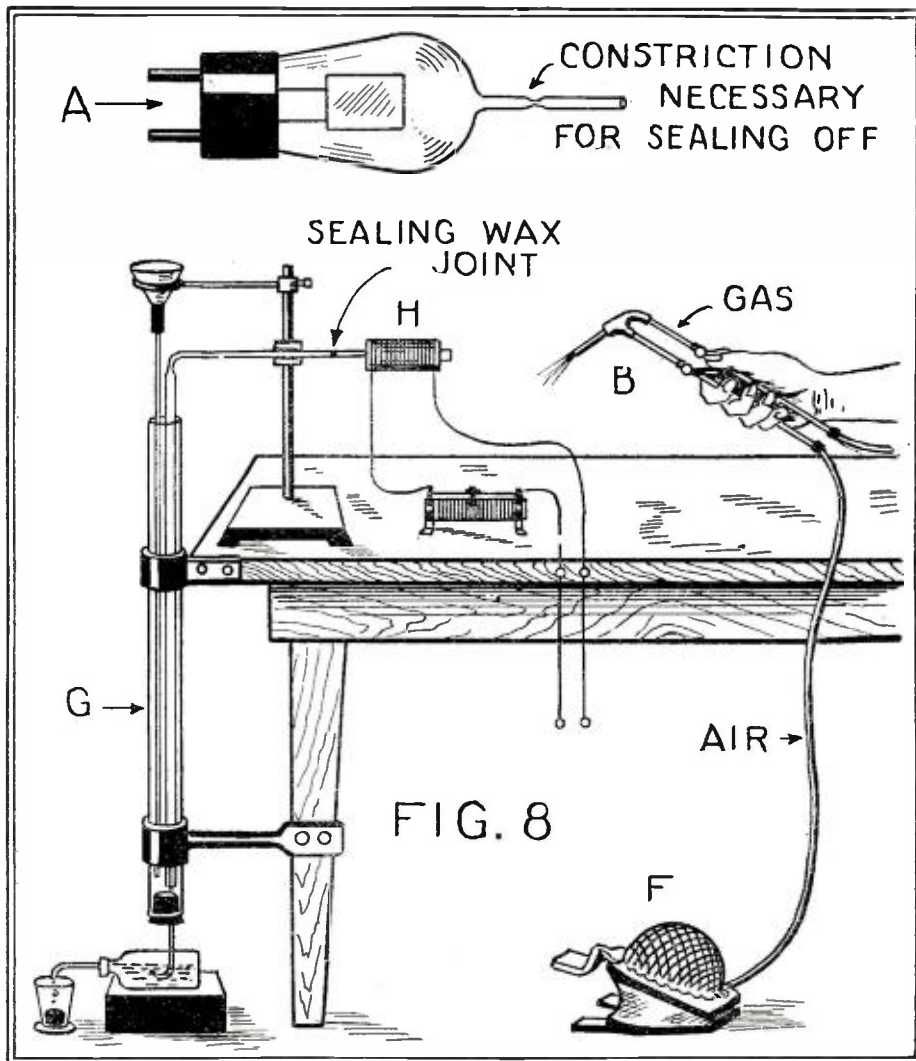

H, heater coil, of nickel wire, for heating tube; G, Guichard-Sprengel vacuum pump, clamped to table; B, hand blow-pipe for sealing-off; F, foot bellows for air supply.

A Radio Sounder and Interference Eliminator

By CAPT. H. W. WEBBE*

In this article Capt. Webbe describes the conception and ultimate invention of a device that materially aids in the reception of radio signals. It will be well worth the time spent in its perusal.



IN THIS paper will be described the inception and subsequent development of a theory which has resulted in a patent, granted to the writer under date of November 25, 1925, on "Radio Sounders and Interference Eliminators," after pending since the spring of 1923. A number of aspects of the case will be discussed: how the idea was hit upon; the use to which the instrument may be put as a radio sounder and enunciator; its value as an interference eliminator; and, finally, the most important function to which the principles here involved may be put; namely, radio control.

HOW THE IDEA WAS FOUND

The writer was stationed, during the fall of 1922, at Ohio State University as assistant professor of Military Science and Tactics. Capt. James A. Code, Jr., the senior officer on duty with the signal unit at that university, organized a research laboratory and placed the writer in charge. The object of the laboratory was to afford an opportunity to develop any interesting ideas that might present themselves. As assistants, there was a staff of very zealous and ambitious students of the electrical engineering college. One of the first problems was that of constructing a radio-controlled wagon to be used for demonstration purposes in a lecture the writer was asked to give before the local chapter of the American Institute of Electrical Engineers.

When we experienced difficulty in employing the Hammond patents to make the apparatus work, a student, Paul Edwards, suggested the use of the well-known principle of the tuning forks as a means of differential control. It will be recalled that Bell was engaged with similar apparatus when he discovered the principles involved in the telephone. Further difficulty in actuating the tuning forks was encountered, because of the feeble currents of the plate circuit of an audio frequency radio amplifier; but just as we were about to despair of our efforts the idea was conceived of inserting a telephonic relay between the fork coils to impart sufficient energy to set the forks into motion.

A patent is now pending on this use of the telephonic relay and it is mentioned to carry the reader through the stages which led up to the principles involved in the patent now under discussion. A telephonic relay, by the way, is nothing but a telephone receiver with a contact which engages a point on the diaphragm as the latter vibrates. When

sufficient amplification is used, such as a No. 7a W.E. power amplifier, the action of such a relay is quite positive and effective.

Noting with the finger that the diaphragm of the telephonic relay made a perceptible movement under the influence of a musical note coming in over the radio, the writer reasoned as follows: "If I stretch a violin wire, with a thumbscrew device to tune it, across the diaphragm of the receiver, so that it will bear upon a ridge in the center of the diaphragm; and tune the wire to the frequency of the incoming musical signal; will not the wire go into motion, as it would if bowed on a violin, emitting a loud, clear musical note? If the wire does go into motion, cannot that motion be put to some practical use, by having it engage a contact; or, if the wire is of steel, having it vibrate in the presence of a magnetic field?"

This was the hypothetical question. The working out of this query and the results obtained form the subject matter of this paper.

AS AN INTERFERENCE ELIMINATOR

If across the diaphragm of any sensitive "phone," a wire is stretched in such a way that it rests on a small ridge in the center of the diaphragm, and if a thumbscrew is provided to change the tension on the wire, the result is an interference eliminator. Note that it is not called "a static eliminator"; there is no such thing. Static will eventually be rendered unimportant by increased power output; and may be alleviated by any method which will increase the ratio of signal strength to static in its milder form, but a static eliminator is, more or less, an idle dream.

Continuous-wave signals can be made to pass through the musical scale merely by heterodyne tuning. Let us, by turning the thumbscrew, set our wire to any note decided upon and tune in on our radio station. When the C.W. radio note is in resonance with the fundamental frequency of the wire, the wire emits a loud, resonant tone many times in excess of the signal of the receiver. Here is where the principle of interference elimination comes in. The noises which are in the receiver, such as ordinary static, spark signals, or jamming C.W. signals, not being in resonance with the wire, do not affect it.

The point can be better illustrated by a concrete example. The model was given a short tryout one night at station WVZ, located at Fort Hayes, Columbus, Ohio. The operator on duty, pointing to a SCR-140 re-

ceiving set, said: "When the batteries are charging in the basement we cannot use that set because of the 60-cycle hum. I will go downstairs and turn on the charge and we will see if we can copy one of the stations on the Pacific Coast by using your sounder."

The charge was started. There was an irritating static grind in the air, which, in addition to the 60-cycle hum of the charging circuit, rendered the set practically unserviceable. The interference eliminator was hooked up and tuned in on a station on the Western coast. The operator copied without trouble.

The station had been forgotten when, twenty minutes or more later, it came in

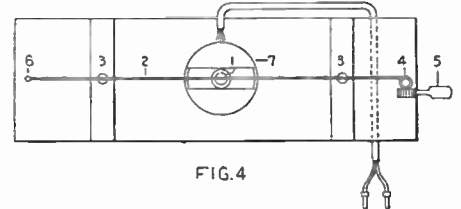

FIG. 4

This diagram is a plan view of the sounder device. The numbers are similar to those in the other diagrams.

again, and the sounder emitted a loud, pleasing call. The instrument had acted as an enunciator, and in such a capacity it has a valuable mission. For example, take a station like WVC, Fort Leavenworth, or any station that operates with a number of wave-lengths, during standby periods, or at night. At such a station these wave-lengths could be put on enunciators, each wave and enunciator tuned to a different musical note.

AS A MAGNETIC FILTER

The principles involved in this patent permit the use of a magnetic filter, whereby the signal is made dependent upon a vibrating wire, rather than on the disturbance in the ether. A C.W. signal is coming in. The diaphragm is in motion, and because it is in resonance with the wire, the wire goes into motion. If we allow this steel wire to vibrate in the presence of a magnetic field, such as the coils of an auxiliary receiver, it cuts this field and induces a current into the auxiliary receiver. This current, put through an audio frequency amplifier, gives a pleasing signal in a pair of headsets.

It is obvious that no interference can be received in this secondary, or auxiliary circuit, since the tone is dependent on the movement of the wire. One must be cautious here, however, for interference, when of sufficient magnitude, destroys the original identity of a signal.

APPLICATIONS TO RADIO CONTROL

Now we come to the most important function of this invention, its application to radio control. If the schematic drawings of the patent are examined, you will observe in one of them that a contact is provided to engage the wire when it goes into motion. In the patent this contact is to pick off the signal by a purely mechanical device, which also obviously eliminates interference. This is merely a by-product, however, and not the most important use.

What the writer wishes to show is that this contact and the principles involved in this patent have a wider application. Suppose we have a wire stretched across a diaphragm and bearing on a raised ridge in the center, as already mentioned. What really happens is this—when the vibrating diaphragm is in resonance with the wire it

(Continued on page 1354)

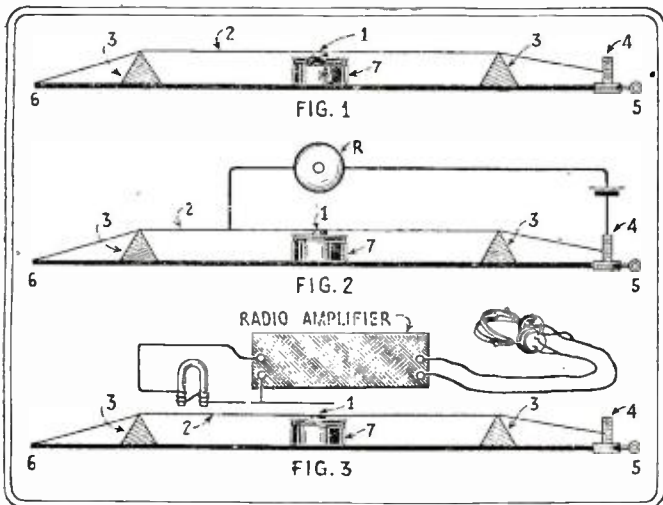

Fig. 1 is a diagrammatic side view of the device showing the receiver in fixed position.

Fig. 2 is a similar view showing the receiver free to move in a vertical direction.

Fig. 3 shows the device connected to an audio amplifier and the receiver adapted to be either fixed or movable. A Baldwin receiver 7 is placed under a vibrating wire 2. The wire rests lightly on a raised ridge 1 on the diaphragm of the receiver 7. The wire is further supported by the bridges 3-3 and held fast by set screws 6. Thumb screw 5 tightens or loosens the wire.

Fig. 2 shows a contact which engages the wire when in motion and gives a tone to the receiver 7.

*Signal Corps, U.S.A., Member A.I.E.E.

Speech Currents In Radiophony

By JOHN F. BRONT

An excellent exposition of the theory of the transmission of radio telephony waves. Every radio enthusiast should be familiar with this part of the theory of the science.

IN better understanding the underlying principles of radiophony, the novice has difficulty in grasping the why and the wherefore of the complicated apparatus and its action in speeding the voice across the vast space without the aid of wires. Some homely comparisons can be made with simpler and more familiar apparatus which is in daily use.

In the first place the action of a microphone, a small battery and a phone receiver in a simple circuit is more or less understood at once by the most uninitiated. With the battery inserted in series with the other components, there is maintained a steady flow of current consistent with the emf. applied and the total resistance of the circuit. When the vibrations of the air caused by the voice impinge upon the microphone diaphragm, there occurs a varying pressure upon the carbon granules transmitted through the vibrations of the diaphragm. The alternate stages of compression of the granules cause alternate stages of resistance in the circuit. Nearly corresponding with the voice vibrations there are produced variations of the current flowing in the circuit of which the carbon granules, the battery and the receiving phone are components. In the receiving phone fairly accurate reproductions of the original voice are transmitted to the air through the action of the diaphragm, thus rendering operative the simplest form of phone circuit.

RADIOPHONY

However, in radiophony there are many difficulties to overcome and more complicated apparatus involved. In the first place, to attempt radiophony by the use of induction currents between two simple phone circuits would be resultant in the carriage of speech over only infinitesimal distances. Long distance effects from one circuit carrying speech currents are impossible in practice through the medium of pure induction, without the application of most enormous powers whose ponderous effects would be most unsatisfactory for the transmission of speech. Earth conduction transmission is effective over only

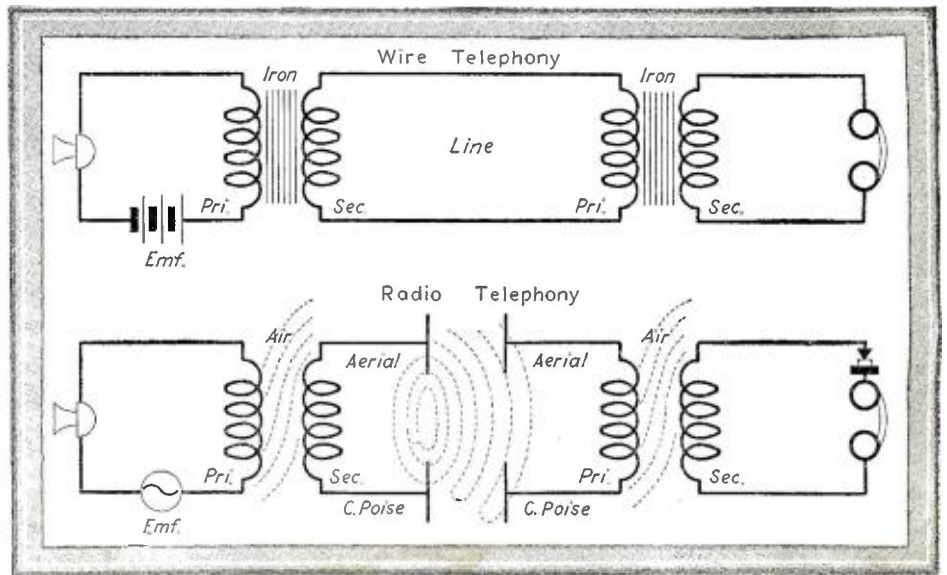

Diagrammatic description of the manner in which signals are conveyed over the telephone line and, at the bottom, over the air by radio.

short distances with any amount of power.

Closed circuits with concentrated inductances are feeble radiators of electromagnetic disturbances in the ether. Take, for instance, the high voltage power lines which cause many amateurs difficulty in receiving when their antenna is close to these lines. If an experimental antenna is erected at a moderate distance, no radiation is detected from the power lines, even though the tension of the current carried may be as in case of some lines upwards of 80,000 volts, even 120,000.

Radiation from any given circuit depends greatly upon the frequency of the current flowing in that circuit. In the case of the power line, the frequency in most cases is the standard commercial 60 cycles and the line acts only as a most extensive loop system. Were the frequency, say, of 10,000 cycles with little or minimum impedance on the line, the effective radiation would be increased to a great extent. Open circuits are more effective radiators of energy than closed ones. Although all circuits radiate to some extent, one in which a high frequency current is flowing and which is of the open or antenna type will be the most prolific in radiation.

In studying long distance effects from radiating circuits we must not confuse wave

propagation with purely inductive effects. Referring again to the simple circuit described at the beginning of this paper, the voice current effects possible between two such circuits are due solely to the interlinking of lines of force of one circuit with the conductors of another similar circuit. It is manifest that since there is little or almost negligible radiation into space (never to return), there is proportionately small possibility of long distance effects upon other circuits. These distant effects are not caused by direct induction from the actual magnetic field of one circuit but by disturbances caused in the ether by portions or quantities of the force in the field being thrown off, and which never return but go forward and outward in the ether without returning upon the collapse of the magnetic field around the conductors of the original circuit.

We have referred to the fact that a high frequency current in a circuit will radiate more energy in proportion than is thrown off by a circuit carrying a lower frequency. Suppose we compare the effects produced in two circuits, one carrying 60 cycles and another carrying 800 cycles? It will be demonstrated by simple tests that the latter will

(Continued on page 1370)

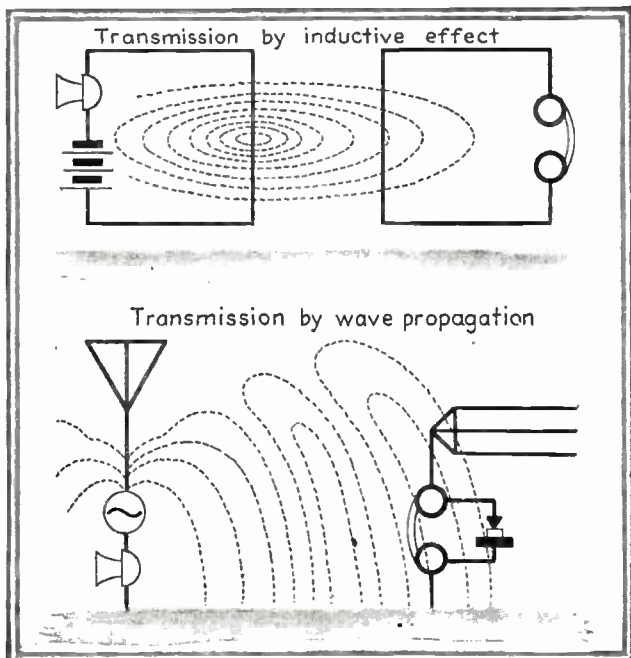

At the left is shown the difference between transmission by an inductive effect coupling the two circuits and below the transmission by waves in the ether.

On the right are shown sustained and modulated direct current and high frequency current, giving an idea of how the current is affected by audio frequency current.

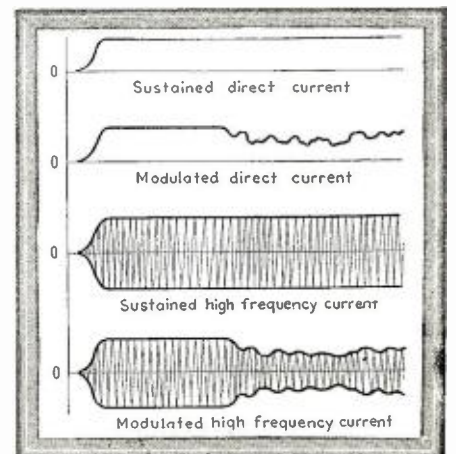

Tracing Interference to Its Lair

By S. R. WINTERS

The great bugbear of radio—interference—is being thoroughly investigated. Interference is of two kinds, man-created and nature-created. In this article is explained how various power companies, the Bureau of Standards and certain Universities are studying, with great thoroughness, interference arising from sources of electric power and power transmission lines.



Here is a photograph of the kind of equipment that is required to make a study of the sources of interference from power lines. A small radio receiver which can be easily transported, a coil antenna and batteries are all that are required for the general study.

devices is practically inevitable and must be regarded, like atmospheric disturbances, as part of the inherent limitation of radio reception," asserts Dr. J. H. Dellinger, President of the Institute of Radio Engineers, as the result of analysis of the findings of recent trouble-hunting errands by private individuals and Government radio inspectors.

"In other words," to quote this radio authority, "the limitation upon radio reception is not only the distance and the power of the transmitting stations and the sensitiveness of the receiving set, but also the omnipresent background of slight electrical disturbances which drown out signals below a certain intensity. This background of electrical disturbances is the underlying reason why reception from local stations is inherently superior to reception from distant stations."

means have proved their efficacy in lessening the amount of extraneous noises, caused by the "age of electricity," that seep their way into your radio receiving sets. An outline of the sources of such disturbing factors and the methods described by the Radio Laboratory of the Bureau of Standards should elicit widespread interest among radio amateurs and broadcast listeners. A recital of these sources and means of eliminating them suggests methods for adoption by radio communities so afflicted.

"A frequent cause of interference is the presence of alternating current power wires near the antenna or receiving set," indicates this Government report based on an extensive study of electrical interference with radio reception. "Low frequency voltages (usually 60 cycles) are induced and the re-

If extraneous noises—sputtering, hissing, crackling, grinding and crashing sounds—mar the clarity of music issuing from your radio receiver, the usual procedure is to draw up a blanket indictment against static. Therein you unjustly malign "Old Man Static," the arch enemy of radio reception, to be sure, but a factor that should not be held responsible for all the ills which beset radio communication.

The occasion for your denunciation of atmospheric disturbances may owe its true origin to the ringing of your neighbor's doorbell, the buzzing of an electric sweeper or battery charger, or the operation of an X-ray apparatus or violet-ray machine. That is to say, electrical devices and leaking power lines create objectionable disturbances in your radio receiving set, and in the absence of specific evidence you may wrongly blame static.

"Radio reception is, in some localities, seriously disturbed by interference arising from electrical apparatus in the vicinity," declares the Radio Laboratory of the Bureau of Standards, upon having concluded recently an exhaustive study of such possible sources of interference. Equipped with a coil antenna and a sensitive radio receiving set, radio inspectors of the United States Department of Commerce may be seen tracing electrical interference to its lair. Once the source of such trouble is determined, the co-operative effort of users of radio equipment and the owners of electrical devices of disturbances alone can mitigate the disturbing effects.

"Part of the disturbance from electrical

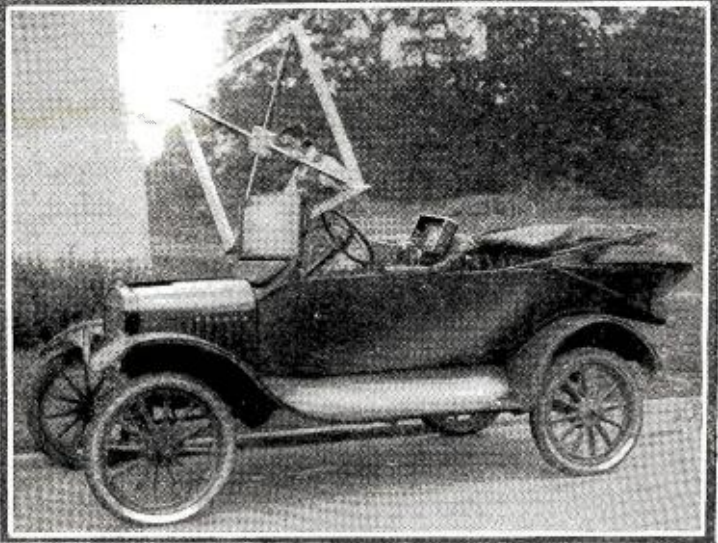

A well-known car is used by one concern to carry those making the study over the various districts covered by their power lines. Needless to say, care must be exercised to keep the interference from the ignition system of the automobile at a minimum.

Trouble-sleuthing excursions, however, afford proof that much of the disturbing effects caused by leakage of power lines and sparks from electrical devices may be eliminated or minimized. Filters, shields, chokes, and other artificial methods or precautionary

sultant current flowing in the receiving circuit causes a 'humming' sound in the telephone receivers. The low pitch of the hum will usually identify this source of interference. A method of eliminating or at least reducing the magnitude of this interference is to place the antenna as far as possible from the wire lines and at right angles to them. When the interference cannot be eliminated by such means, the proper choice of a receiving set may help. An inductively coupled (two-circuit) receiving set is less susceptible to such interference than a single-circuit set. The use of one or more stages of radio frequency amplification should also help to filter out the audio frequency interference. It has been suggested that audio frequency interference might be shunted around a receiving set having a series antenna condenser by connecting between the antenna and ground terminals of the set a high resistance, which will offer lower impedance to the audio frequency than the set itself.

"Sparks are produced in the normal operation of many types of electrical apparatus (such as motors, doorbells, buzzers, gasoline engines, X-ray apparatus, violet-ray machines, some forms of battery chargers, rural telephone ringers, heating-pad thermostats). Sparks are also sometimes produced at defective insulators, transformers, etc., of electric wire lines. Sparks usually give rise to electric waves which travel along the electric

(Continued on page 1332)

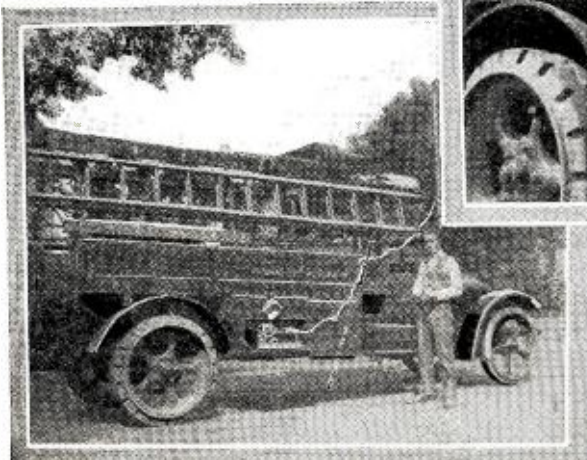

The Potomac Electric Company makes its investigations from the same truck that carries the linemen and their tools to their job. The truck therefore serves both its usual business of taking care of repairs and installations, and the new one of carrying the apparatus for studying interference.

An Automatic Double-Range Receiver

By SYLVAN HARRIS

Here a new circuit in which, contrary to the general rule, no attempts are made to avoid close coupling. On the contrary, the operation of the set depends upon close coupling, at least in one set of coils. The set responds to two different wave ranges without using any kind of switch of tapped arrangement, and is very suitable for both B.C.L.'s and Hams.

TIME and again, readers of radio publications and builders of radio receivers have been warned against the ill effects arising from the employment of too close coupling in the various resonance transformers used in the tuned R.F. receivers. The average reader knows little about coupling; he rarely has an idea as to how close is "close coupling," or how loose is "loose coupling." In the December, 1925, issue of RADIO NEWS I tried to present some of this information in the article entitled, "Coupling—Tight or Loose?" (Page 800.)

In that article, the results of some measurements made in the RADIO NEWS laboratory were presented; and if the present reader has studied it, he will have some idea as to whether the coupling in his coils is 10 per cent. or 90 per cent. He will also



The front view of the receiver is as neat as can be. There is nothing there excepting what is absolutely required. For the meanings of the numbers see the full-page lay-out.

know what close and loose coupling mean; but he will not necessarily be acquainted with the various effects that follow when different values of coupling are employed.

REASON FOR LOOSE COUPLING

The reason why loose coupling is so often employed in tuned R.F. amplifiers is that we do not desire reaction between the two circuits to occur. When a current flowing in the primary coil of the resonance transformer induces a current in the secondary, this secondary current establishes a magnetic field, which reacts on the primary winding. As a result of this, the effective inductance of the secondary changes with the wave-length very considerably; and it is this effect that limits the wave-range of a receiver more than anything else.

Many will tell you that the reason why your receiver does not tune down to 200 meters is because there is too much distributed capacity in your coils. Bosh! (Unless you are using multi-layer coils, which, we all know, passed out of vogue some time ago.) It is true that the presence of coil capacity helps to limit the wave-range, but this effect is very little compared with the decrease of inductance due to the close coupling. This also helps reduce the signal strength in the receiver in many cases; but the coupling generally is not so close as to decrease the signal strength materially.

In the paragraphs above we have been referring more particularly to the resonance

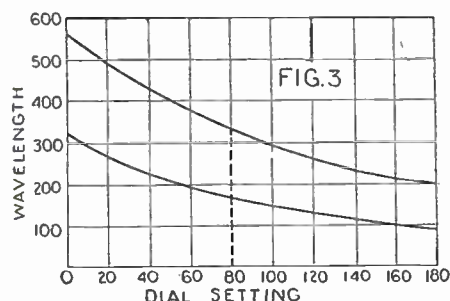

transformer which has a tuned secondary and an untuned primary. When both the primary and secondary circuits are tuned, very different results are obtained and, in fact, a considerable increase in the energy

this account, the tuned primary circuit was rejected by designers of sets, especially when the five-tube set came into vogue, with its three R.F. stages. There are four oscillatory circuits in such a receiver; we have only

Here is the plan view of the automatic receiver. The numbers of this photo agree with those on the full-page lay-out (page 1289), where their meanings are given. Note the neat arrangement of the parts, without due crowding, behind a standard-size panel. The gearing of the condensers, 3-6, reduces the number of controls to two, making the set convenient to tune.

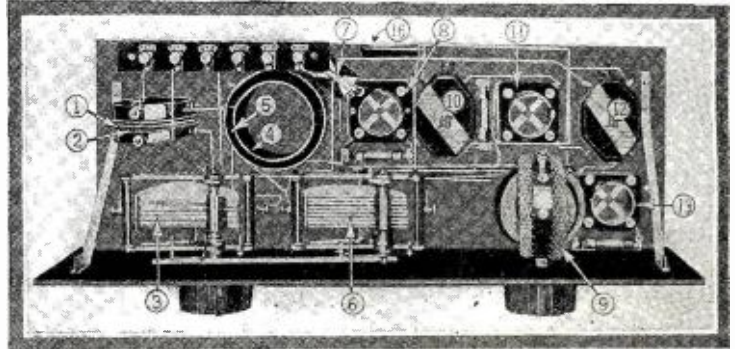

transfer from the primary to the secondary can be secured. This is the reason why, in all transmitting stations, the antenna circuit and the closed oscillatory circuit are each separately tuned to the desired wave-length.

TOO MANY CONTROLS TO HANDLE

The application of the principle of the resonance transformer employing variable condensers, for tuning both primary and secondary, results in the tuned primary and tuned secondary circuit, which was em-

two hands, and three dials are about all that one can manipulate simultaneously. Hence, the antenna circuit was made untuned, or, as the classicists would have it, aperiodic.

We are going to use a resonance transformer in the set to be described here, which has both its primary and secondary tuned. However, we are going to find a way in which this can be done without increasing the number of controls. Furthermore, it will not be a five-tube set, but will employ only three tubes, and besides all this, it will have the following features:

ADVANTAGES OF THIS RECEIVER

It will be an automatic two-range receiver without any range-shifting switches.

It will be about as selective as one could want a radio receiver to be. There will be no difficulty in tuning through any or all of the locals when hunting for DX.

It will be regenerative, so that there will be plenty of R.F. amplification.

It can be used for receiving two stations simultaneously, if these are working on the proper wave-lengths.

It will have neither more nor less controls than the ordinary regenerative three-tube set.

It will furnish plenty of volume.

It uses two variable condensers, which work on the same dial, in spite of which fact no hair-splitting need be done to balance up the condensers.

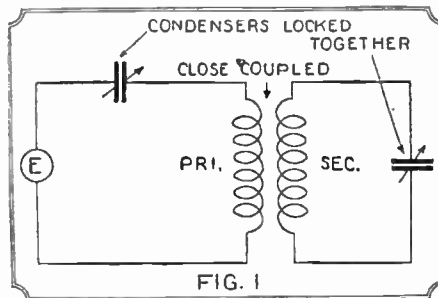

The operation of the set is based on the phenomena which occur in the coupled circuits shown here. The secondary circuit becomes resonant to two different frequencies, on account of the coupling.

ployed for a long time in radio receivers. In fact, it provides the most efficient method of tuning. The difficulty lies in the fact that extra controls are required, and the tuning of the receiver becomes more difficult. On

The double-range effect is plotted in the log curve of Fig. 3. The top curve is for the broadcast range, and the lower for the amateurs. To the right is shown the rear view of the receiver. The numbers are the same as those on the full-page lay-out. The specifications for the antenna coil, 1 and 2, and the close-coupled resonance transformer, 4 and 5, are given in the working plans on page 1288, and must be followed exactly.

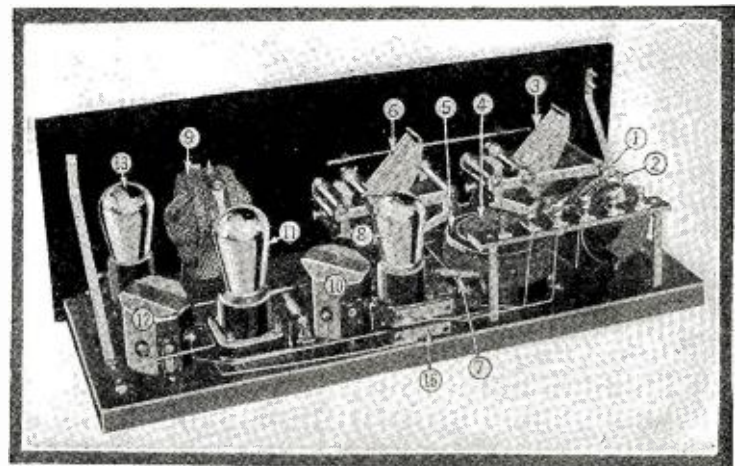

What more could one want? But to find out how all this is done, we must first consider the circuit shown in Fig. 1, upon which the design of the circuit is based. This figure shows a source of alternating electromotive force, E, connected in series with a variable condenser and the primary of a resonance transformer. In the secondary of this transformer, there is also a variable condenser. The coupling between the coils is supposed to be rather tight.

UTILIZING CLOSE COUPLING

Now, suppose that each of these (that is, the primary and the secondary circuits) is tuned separately to the same frequency. Or, in other words, let us suppose that the condensers are lashed together, so that no matter where the dial is set, there will always be the same amount of inductance and the same amount of capacity in each of the circuits. The circuits will then be resonant for currents of two different frequencies, one higher and the other lower than the frequency for which the circuits are tuned. No doubt many of our readers have noticed

$$f_1 = \frac{f_0}{\sqrt{1+k}} \text{ and } f_2 = \frac{f_0}{\sqrt{1-k}}$$

in which f_0 is the natural frequency of the tuned circuits, f_1 and f_2 are the two resulting frequencies at which the circuits will be resonant, and k is the co-efficient of coupling,

tionally unbalanced as much as 30 or 40 divisions on the dial. This is a very interesting feature about this system, and is worth a little experimentation.

So it will be seen that the mere unbalancing of the circuits by a division or two on the dial will not produce any serious results. The two circuits have been designed to be

The fundamental circuit arrangement around which the receiver is built. This circuit is evolved from the circuit of Fig. 1, by replacing the generator with the antenna and ground, and using intermediate tuning circuit between the detector and the antenna system.

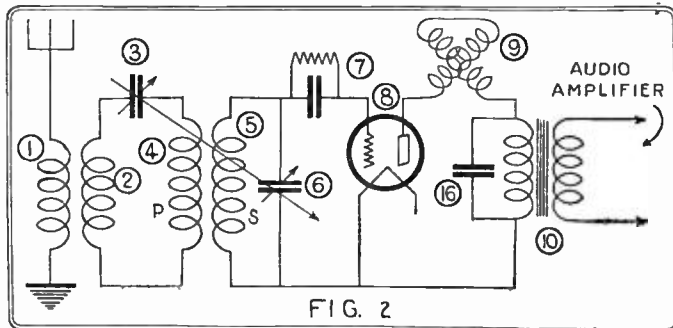

FIG. 2

as explained in my article, "Coupling—Tight or Loose?" before referred to.

Now, the value of the coupling k may be so chosen that the relation between the two frequencies, f_1 and f_2 , may be almost anything we please. For instance, suppose we want the one frequency, f_1 , to be twice the other frequency, f_2 . By means of these formulas, we find that for this case the coupling must be about 60 per cent. This is the value of coupling that we use in the set described in this article.

APPLYING THE PRINCIPLE

We will now see how the principle is applied to the radio receiver. In Fig. 1, it is a simple matter to replace the source of high frequency oscillations, E, with a pick-up coil coupled to an antenna circuit. We can also easily connect an electron-tube detector across the terminals of the secondary condenser, and we can also increase the amplification by making the tube circuit regenerative. These additions to Fig. 1 are shown in Fig. 2.

Attempts have often been made in the ordinary R.F. amplifier to tie two of the variable condensers, either on the same shaft, or by means of gears or pulleys. To enable the condensers to work in synchronism and to tune in the stations properly, it has been found necessary to make the tuning of the various stages a little broad. This is because it is not possible to build coils which are so identical that the tandem condensers will always cause each circuit to resonate exactly. In this circuit, however, it will be found perfectly feasible to do this, on account of the closeness of the coupling between the two tuned circuits. Therefore, the two condensers shown in Fig. 2 are geared together by means of a rack and pinions, as shown in the illustrations.

To satisfy the reader that this can be done in practice and work perfectly, it may be mentioned that it is possible to tune in the local stations, and a few distant ones, even when the two condensers have been inten-

identical. The coils have been so designed that the sum of the inductances of the pick-up coil 2 and the primary 4 is equal to the inductance of the secondary coil 5. The two variable condensers are also identical, and are geared together by means of the rack and pinions so that their capacities are the same at all dial settings.

The log of this receiver is shown in Fig. 3. It will be seen that there are two ranges. The set has been so designed that the upper range covers the broadcasting wave-lengths,

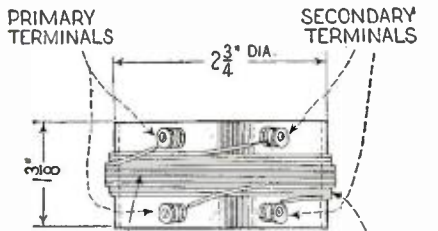

PRIMARY- 9 TURNS OF NO. 22 D.C.C. WIRE. ① SECONDARY 12 TURNS OF NO. 22 D.C.C. WIRE ②
PRIMARY WOUND ON TOP OF SECONDARY

The dimensions must be followed very carefully in building this set, as the slightest deviation in the diameters, number of turns, etc., will unbalance the inductances. This is the antenna coupling coil.

this effect, as it often occurs in radio receivers.

For instance, when receiving a certain station, it is often possible to notice two positions of the tuning dial where this station will come in strong. Generally these two positions, in the ordinary receiver, will be only a division or two apart on the dial, or less, depending upon how close the coupling between the circuits happens to be. Sometimes the two positions are so close together on the dial that they cannot be distinguished apart, and then we merely say that the tuning is broad. Actually, the tuning may not be broad, but, at least, the effect is the same as that of broad tuning.

THE MATHEMATICAL FORMULAS

But to get back to our circuit, we are going to utilize this effect for obtaining two tuning ranges. The closer the coupling between the two tuned circuits become, the farther apart will the two frequencies be at which the circuits are resonant. The relation between these two frequencies and the natural frequency of the tuned circuits is given by these formulas:

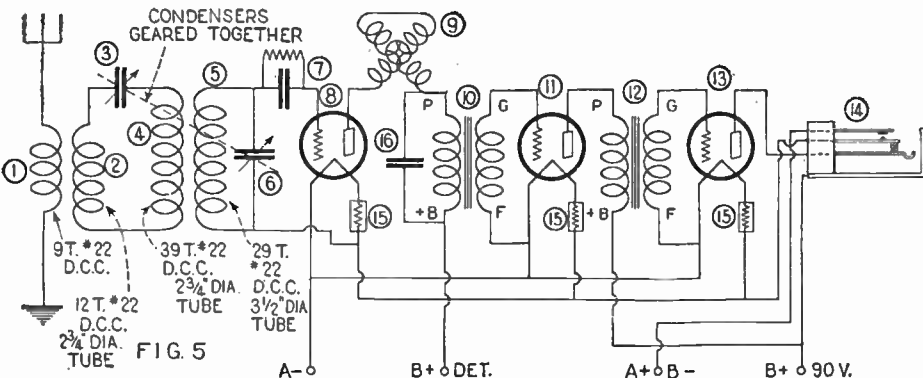

The complete wiring diagram of the receiver. The numbers on this diagram are identical with those on the full-page layout, where their meanings are given. The audio frequency amplifier is as usual, the only variation being in the design of the tuned circuits.

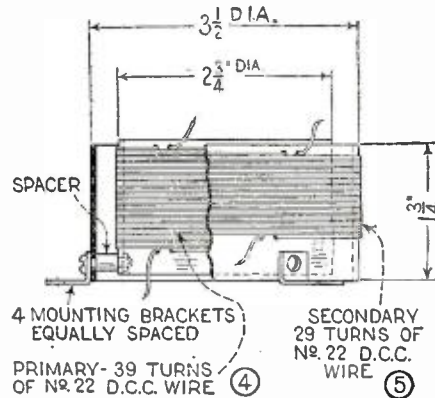

This is the close-coupled resonance transformer. The diameters and number of turns must be followed very carefully. Number 22 D.C.C. wire is used throughout.

and the lower range covers the amateur band. As we have seen before, the circuit is resonant to two different frequencies (or wave-lengths) at any position of the condensers. Therefore, it is possible to tune in an amateur station and a broadcast station at the same time. For instance, as shown on the log curves of Fig. 3, when the condenser dial is set at 80, the receiver will be tuned to an amateur wave-length of 172 meters and a broadcast wave-length of 336 meters at the same time.

The reader may raise the question, "Will this not lead to a good deal of interference?" The answer is, "No." Because it is next to impossible that these two stations will be located in the same part of the country, or will be transmitting at the same time. Moreover, it will be found that different settings of the variometer will be required for amplifying these two wave-lengths, so that this makes the possibility of interference nil.

Thus we have a two-range receiver, as we mentioned before, without any switches or plug-in coils. We have also a duplex receiver, which may also be utilized in a system of secret transmission with a special transmitter. It will also be found by the experimenter that this is about the most selective receiver that he has ever used.

(Continued on page 1290)

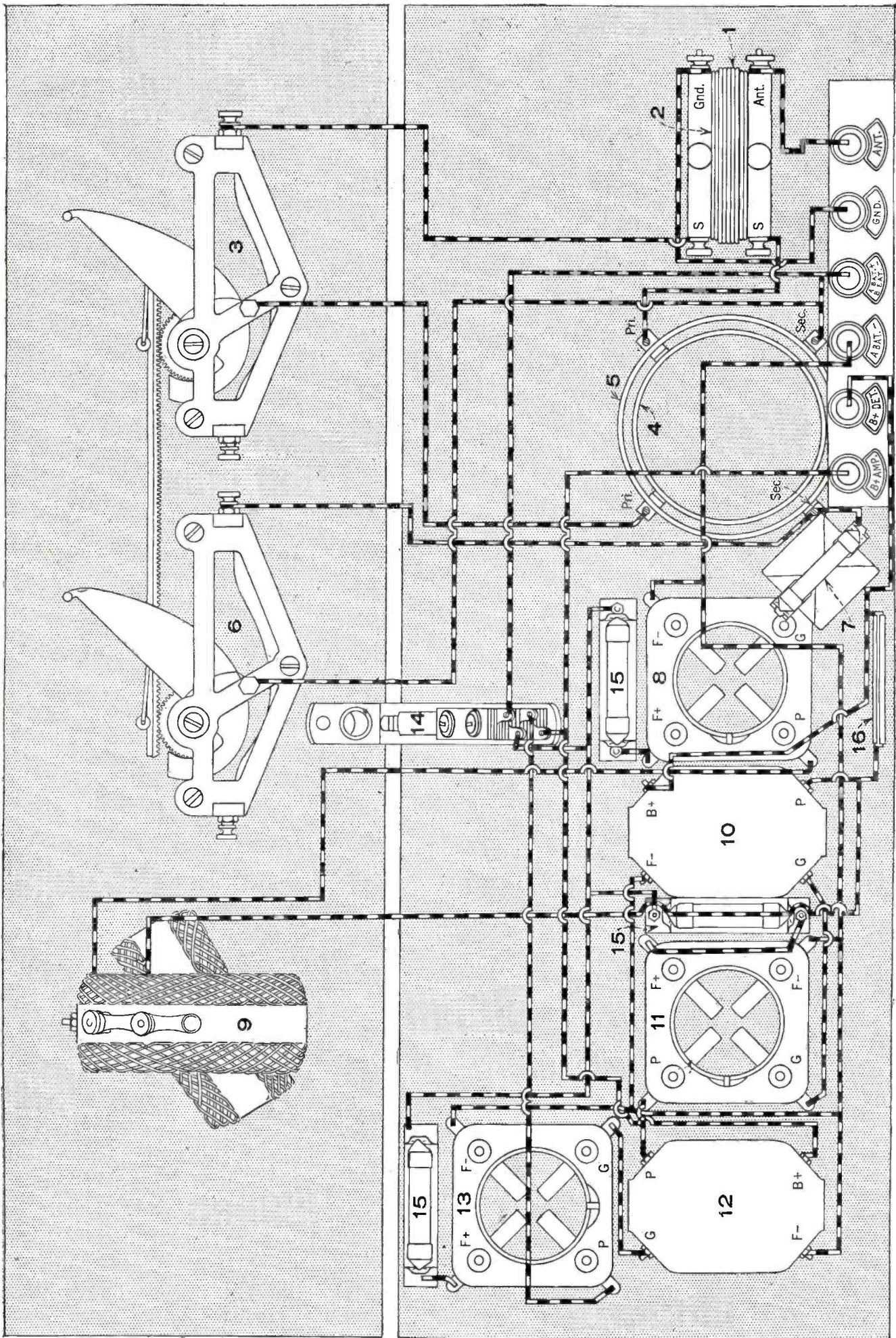

1, antenna coupling coil, primary; 2, secondary; 3, first tuned circuit tuning condenser; 4, primary coil of close coupled resistance transformer; 5, secondary of same; 6, detector tuning condenser; 7, grid leak and grid condenser; 8, detector tube; 9, variometer in detector plate circuit; 10, first A.F. amplifier transformer; 11, first A.F. tube; 12, second A.F. amplifier transformer; 13, second A.F. tube; 14, filament control jack; 15, amperites; 16, by-pass condenser.

A "B" Eliminator from Matched Parts

By GEORGE AMES

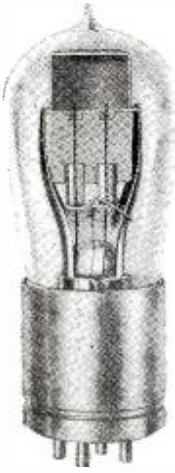

Many home-made "B"-eliminators fail because the parts, although perhaps excellent, are not mutually suited. This eliminator overcomes the difficulty.

Left: The Raytheon tube, which is the heart of this eliminator. It has no filament.

- 1 step-down transformer.
- 2 choke coils.
- 1 rectifier tube.
- 1 10- μ f. condenser.
- 2 2- μ f. condensers.
- 1 0.5- μ f. condenser.
- 2 0.1- μ f. condensers.
- 1 resistor, 10,000 ohms.
- 1 resistor, 15,000 to 150,000 ohms.
- 1 SPDT switch.
- 1 vacuum tube socket.
- 5 binding posts.

shown made up of five 2- μ f. units, as these are obtained more easily than the larger size. Any reliable make may be used.

smoothing out the rectified current; as practically noiseless eliminators may be constructed with much smaller condensers. This large condenser acts as a storer of energy, much in the same manner as a storage battery, which is sometimes connected across the output of a generator to take care of unexpected demands for current that will be in excess of the generator output. The Raytheon tube does not supply a high current output, but its output is sufficient for all normal purposes. When an unusual drain is occasioned by a powerful low note, the storage condenser bolsters up the normal output.

It is important, in connecting the "B"

ONE of the outstanding disadvantages that confronts the fan, who wishes to construct a "B" power supply unit at home, is lack of knowledge in the choice of parts that will work in harmony. This is especially true of the filter system, which must be designed with great care in order to suppress the ripple of the pulsating direct current delivered by the rectifier tubes or cells.

The photograph which is reproduced upon this page shows an arrangement of standard parts that has been approved by the engineers of a prominent radio manufacturing concern. Each of the components has been designed or chosen especially for use in conjunction with the others. As a result, the builder finds himself free from the annoyance of making further adjustments and substitutions when the eliminator has been completed.

The tube used is the Raytheon Rectifier, described on page 613 of RADIO NEWS for November, 1925. As this tube has two small anodes and a large cathode, full wave-rectification is obtained with one tube. In addition, the tube has no filament, and thus is longer in life and more economical in operation than the hot-cathode type.

As the theory of this tube has been presented fully in the article referred to in the above paragraph, this paper will be concerned with details of assembly only.

LIST OF PARTS

The following parts are recommended for use in conjunction with one another:

In the illustration the 10- μ f. condenser is

This eliminator is as fool-proof as one can be made at present. The bank of five condensers in parallel, at the upper right, serves to store energy for unusual drains.

Photos and diagram by courtesy of Acme Apparatus Company.

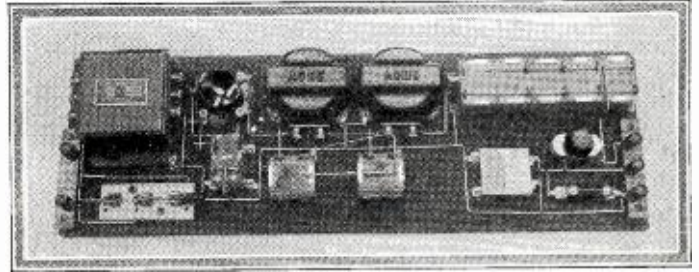

As in the case of any apparatus used in radio equipment, it is of the utmost importance that parts of the best workmanship be employed. It is useless and a waste of time for constructors to try to get 100% operation with 10% apparatus.

The baseboard arrangement and connections should be clearly understandable from the illustration and the schematic wiring diagram. Notice especially that the frames of each condenser and choke, and of the transformer, are grounded at some point. This is very important. A small ground symbol appears upon the diagram at every point that should be grounded; and an inspection of the picture will show the corresponding drop of solder at each such point.

LARGE CAPACITANCE RE-ENFORCES OUTPUT

Some builders may be surprised at the use of so large a capacitance as 10- μ f. across the output. This is necessary, not solely for

eliminator to the power circuit and the set. to use closely bunched leads. Ordinary twisted lamp cord is suitable for a connection to the light socket; and a triple cable, such as may be purchased in most radio stores, may be used for the connections to the set. If this is not available, use three strands of lamp cord tied together in a bundle.

The single-pole double-throw switch may be used to disconnect the line voltage, as well as to change from high to low voltage. When it is in the vertical position the line circuit is open. When changing the switch from high to low voltage, it is necessary as well to adjust the detector voltage, by means of the variable resistor.

A "C" battery is an absolute necessity on any set that uses moderately high voltage on the plates of the amplifier tubes. If this "C" battery is not adjusted accurately for a given plate voltage, distortion and lower amplification will result. The following table gives the exact voltage to use with any tube, or combination of tubes.

C-BATTERY VOLTAGE FOR NUMBER OF TUBES USED—HIGH VOLTAGE TAP

NUMBER OF TUBES	1	2	3	4	5	6	7	8
Type of Tube								
UV201-A or C301-A.....		19	16.5	15	12	10.5	9	
UV199 or C299.....							21	
201A or 301A plus one UX or CX112.....	10	16.5	15	13.5	12	10.5	9	
UV199, C299 plus one UX or CX220.....							21	18
CX112 or UX112.....	19	16.5	13.5	12	12	9	7.5	6
CX220 or UX220.....						21	15	12 10.5 7.5

C-BATTERY VOLTAGE FOR NUMBER OF TUBES USED—HIGH VOLTAGE TAP

NUMBER OF TUBES	1	2	3	4	5	6	7	8
UV201-A or C301-A.....	10.5	9	7.5	6	4.5	3	1.5	1.5
UV199 or C299.....	18	15	13.5	12	10.5	7.5	6	4.5
201A, 301A plus one UX or CX112...	7.5	6	6	4.5	3	1.5	1.5	
UV199, C299 plus one UX or CX220...	13.5	12	10.5	7.5	6	6	4.5	
CX112 or UX112.....	9	7.5	6	4.5	3	1.5		
CX220 or UX220.....	15	12	7.5	6	3	1.5		

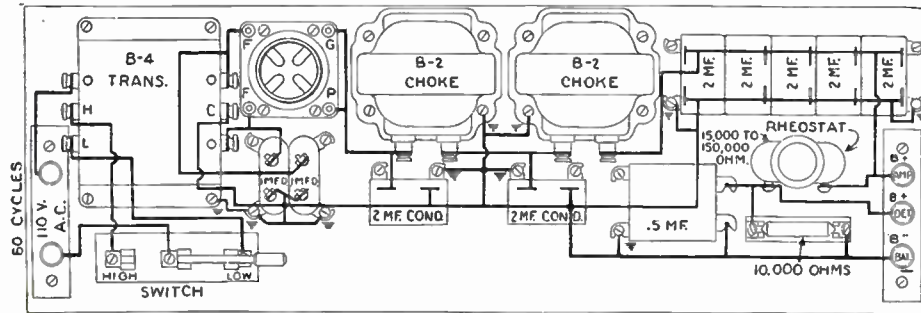

This schematic wiring diagram preserves the identical layout of the photograph reproduced above. Note especially the small ground symbols, marking the points at which the cases of the various parts are grounded. This feature is very important.

(Continued from page 1288)

SPECIFICATIONS MUST BE FOLLOWED

Great care must be taken in the construction of the coils, especially in the construction of the closely-coupled coil. The diameter must be exactly the same as indicated in the diagrams, and the number of turns and wire sizes exact. If there is any departure from these figures, the co-efficient of coupling will change, and the wave-ranges will change correspondingly. Great care must be taken also that the center lines of the two wind-

ings of the closely-coupled coil coincide.

It is interesting to note how few turns are required on the secondary of this coil, as compared with the number generally required to tune with a 0.0005- μ f. condenser over the broadcasting range of wave-lengths. The reason for this is: when we tune to a certain station with this receiver, we tune the individual circuits to a wave-length either less than that of the signal, or greater, depending upon which range we are work-

ing on. For the short wave-lengths, the closeness of the coupling so affects the inductance of the coils that we can use more capacity in the circuit; and for the longer wave-lengths, we can use less capacity than is ordinarily required. Instead of using less capacity, therefore, we are using less inductance, which accomplishes the same results, in addition to keeping the resistance of the circuits low, and enhancing the selectivity and sensitivity.

List of Broadcast Stations in the United States

Radio Call Letter	BROADCAST STA. Location	Wave (Meters)	Power (Watts)	Radio Call Letter	BROADCAST STA. Location	Wave (Meters)	Power (Watts)	Radio Call Letter	BROADCAST STA. Location	Wave (Meters)	Power (Watts)	Radio Call Letter	BROADCAST STA. Location	Wave (Meters)	Power (Watts)
KDKA	East Pittsburgh, Pa.	309.1	Var.	KFJV	Portland, Ore.	212.6	50	WBAO	Decatur, Ill.	270	100	WFBG	Philadelphia, Pa.	234	5
KDLR	Devils Lake, N. D.	231	5	KFXB	Big Bear Lake, Calif.	202.6	500	WBAF	Fort Worth, Texas	475.9	1500	WFBE	Seymour, Ind.	226	10
KDYL	Salt Lake City, Utah	216	50	KFXC	Santa Maria, Calif.	209.7	100	WBAX	Wilkes-Barre, Pa.	256	100	WFBH	Altoona, Pa.	278	100
KDZB	Bakersfield, Calif.	209.7	100	KFXD	Logan, Utah	205.4	10	WBBL	Richmond, Va.	229	100	WFBM	New York, N. Y.	273	500
KFAB	Lincoln, Neb.	340.7	100	KFXE	Colorado Springs, Colo.	250	500	WBBM	Chicago, Ill.	226	1500	WFBP	Camden, N. J.	230	250
KFAD	Phoenix, Ariz.	273	101	KFXH	El Paso, Texas	242	50	WBPP	Petoskey, Mich.	238	200	WFBQ	Collegeville, Minn.	230	100
KFAF	San Jose, Calif.	217.3	50	KFXJ	Denver, Colo.	215.7	10	WBBR	Rossville, N. Y.	273	500	WFL	Sracuse, N. Y.	252	100
KFAJ	Boulder, Colo.	261	100	KFXM	Beaumont, Texas	227	10	WBSB	New Orleans, La.	252	50	WFBM	Bridgewater, Mass.	220	10
KFAL	Boise, Idaho	282.8	750	KFXN	Flagstaff, Ariz.	205.4	50	WBBW	Norfolk, Va.	222	50	WFBP	Baltimore, Md.	254	100
KFBB	Harre, Mont.	275	50	KFYF	Oxnard, Calif.	205.4	10	WBBY	Charleston, S. C.	208	10	WFBZ	Galesburg, Ill.	254	20
KFCB	San Diego, Calif.	221	10	KFYJ	Houston, Texas	238	10	WBBZ	Chicago, Ill.	215.7	50	WFOF	Flint, Mich.	234	100
KFCB	Sacramento, Calif.	218	100	KFYR	Bismarck, N. Dak.	248	10	WBCC	Chicago, Ill.	266	500	WFL	Philadelphia, Pa.	394.5	500
KFBL	Everett, Wash.	221	100	KGO	Oakland, Calif.	351.2	3000	WBDC	Grand Rapids, Mich.	256	50	WFKB	Chicago, Ill.	217.3	500
KFBG	Trinidad, Colo.	258	10	KGTT	San Francisco, Calif.	224	50	WBES	Takoma Park, Md.	222	100	WFLR	Brooklyn, N. Y.	205.4	100
KFBV	Laramie, Wyo.	270	50	KGU	Honolulu, Hawaii	270	500	WBNY	New York, N. Y.	209.7	500	WGLA	Lanester, Pa.	248	10
KFCB	Phoenix, Ariz.	238	100	KGW	Portland, Ore.	191.5	500	WBOQ	Richmond Hill, N. Y.	236	100	WGBB	Freeport, N. Y.	244	100
KFCF	Walla Walla, Wash.	256	100	KGY	Lacey, Wash.	246	50	WBRC	Birmingham, Ala.	248	10	WGBG	Memphis, Tenn.	278	10
KFDD	Boise, Idaho	278	50	KHJ	Los Angeles, Calif.	105.2	500	WBRE	Wilkes-Barre, Pa.	231	100	WGBF	Evansville, Ind.	256	100
KFDJ	Corvallis, Ore.	282.8	500	KHJ	Spokane, Wash.	273	500	WBT	Charlottesville, N. C.	273	250	WGBL	Seranton, Pa.	240	100
KFDM	Shreveport, La.	315.6	500	KJBS	San Francisco, Calif.	220	5	WBZ	Springfield, Mass.	331.1	2000	WGBK	Johnstown, Pa.	248	5
KFDX	Beaufort, N. C.	250	100	KJR	Seattle, Wash.	381.4	1000	WBA	Boston, Mass.	242	250	WGBM	Providence, R. I.	234	30
KFDY	Brookings, S. Dak.	273	100	KLDS	Independence, Mo.	410.9	1000	WCAC	Mansfield, Conn.	275	500	WGBR	Marshfield, Wis.	229	10
KFDZ	Minneapolis, Minn.	231	10	KLS	Oakland, Calif.	252	250	WCAD	Canon, N. Y.	263	250	WGBS	New York, N. Y.	315.6	500
KFEC	Portland, Ore.	248	50	KLX	Oakland, Calif.	508.2	500	WCAE	Pittsburgh, Pa.	401.3	500	WGBT	Greenville, S. C.	236	15
KFEL	Denver, Colo.	254	50	KLZ	Denver, Colo.	206	250	WCAJ	University Place, Neb.	251	500	WGBU	Pulford, Fla.	278	500
KFEQ	Oak, Neb.	303	500	KMA	Shenandoah, Iowa	252	500	WCAL	Northfield, Minn.	336.9	500	WGBX	Orou, Me.	252	100
KFEY	Kellogg, Idaho	233	10	KMI	Fresno, Calif.	234	50	WCAP	Baltimore, Md.	275	100	WGCP	Newark, N. J.	252	500
KFFP	Moberly, Mo.	242	50	KMD	Tacoma, Wash.	250	100	WCAR	Washington, D. C.	468.5	500	WGES	Oak Park, Ill.	230	500
KFFY	Alexandria, La.	275	50	KMTR	Los Angeles, Calif.	238	500	WCAT	San Antonio, Texas	203	500	WGH	Clearwater, Fla.	266	500
KFGH	Stanford Uni., Calif.	270	500	KNRC	Los Angeles, Calif.	208.2	250	WCAT	Itapida City, S. D.	240	50	WGMU	Detroit, Mich.	270	1500
KFGQ	Boone, Iowa	226	10	KNX	Los Angeles, Calif.	336.9	500	WCAU	Philadelphia, Pa.	278	500	WGN	Richmond Hill, N. Y.	256	100
KFHA	Gunnison, Colo.	252	50	KOA	Denver, Colo.	322.4	5000	WCAX	Burlington, Vt.	250	100	WGR	Buffalo, N. Y.	319	750
KFHL	Oskaloosa, Iowa	240	10	KOB	State College, N. M.	348.6	1000	WCBA	Allentown, Pa.	254	15	WGST	Atlanta, Ga.	270	500
KFI	Los Angeles, Calif.	468.5	8000	KOCH	Omaha, Neb.	258	250	WCBC	Ann Arbor, Mich.	229	200	WGY	Schenectady, N. Y.	379.5	5000
KFIF	Portland, Ore.	218	100									WHA	Madison, Wis.	535.4	750
KFIQ	Yakima, Wash.	256	100									WHAD	Milwaukee, Wis.	275	500
KFIU	Juncos, Alaska	226	10									WHAM	Rochester, N. Y.	278	100
KFIZ	Fond du Lac, Wis.	279	100									WHAP	New York, N. Y.	240	500
KFJB	Marshalltown, Iowa	248	10									WHAR	Atlantic City, N. J.	275	500
KFJC	Junction City, Kansas	218.8	10									WHAS	Louisville, Ky.	399.8	500
KFJF	Oklahoma City, Okla.	261	500									WHAT	Minneapolis, Minn.	263	500
KFJI	Astoria, Ore.	216	10									WHAV	Wilmington, Del.	266	100
KFJM	Grand Forks, N. Dak.	278	100									WHAZ	Troy, N. Y.	379.5	1000
KFJR	Portland, Ore.	263	50									WHB	Kansas City, Mo.	365.6	500
KFJY	Fort Dodge, Iowa	246	50									WHBA	Oil City, Pa.	250	10
KFJZ	Fort Worth, Tex.	251	50									WHBC	Canton, Ohio	254	10
KFKA	Greeley, Colo.	273	50									WHBD	Bellefontaine, Ohio	222	20
KFKU	Lawrence, Kans.	275	500									WHBF	Rock Island, Ill.	222	100
KFKX	Hastings, Neb.	288.3	5000									WHBG	Harrisburg, Pa.	231	20
KFKZ	Kirksville, Mo.	266	10									WHBH	Culver, Ind.	222	100
KFLR	Albuquerque, N. Mex.	251	100									WHBJ	Fort Wayne, Ind.	234	50
KFLU	San Benito, Tex.	236	10									WHBK	Ellsworth, Me.	231	10
KFLV	Rockford, Ill.	229	100									WHBL	Logansport, Ind.	215.7	50
KFLX	Galveston, Tex.	240	10									WHBM	Chicago, Ill.	233	20
KFLZ	Atlantic, Iowa	273	100									WHBN	St. Petersburg, Fla.	238	10
KFMQ	Fayetteville, Ark.	299.8	750									WHBP	Johnstown, Pa.	256	100
KFMR	Sioux City, Iowa	261	100									WHBQ	Memphis, Tenn.	233	50
KFMW	Houghton, Mich.	263	50									WHBU	Anderson, Ind.	218.8	10
KFMX	Northfield, Minn.	336.9	500									WHBW	Philadelphia, Pa.	215.7	100
KFN	Shenandoah, Iowa	263	500									WHDI	Minneapolis, Minn.	275	500
KFOA	Seattle, Wash.	454.5	500									WHDC	Rochester, N. Y.	258	100
KFOB	Burlingame, Calif.	236	50									WHK	Cleveland, Ohio	273	250
KFOJ	Moberly, Mo.	242	10									WHN	New York, N. Y.	361.2	500
KFON	Long Beach, Calif.	235	500									WHO	Des Moines, Iowa	526	500
KFOO	Salt Lake City, Utah	236	250									WHT	Des Moines, Iowa	526	500
KFOR	David City, Neb.	226	100									WIAD	Ocean City, N. J.	250	100
KFOT	Wichita, Kans.	231	50									WIAB	Burlington, Iowa	254	100
KFOX	Omaha, Neb.	248	100									WIBC	Madison, Wis.	236	100
KFOY	St. Paul, Minn.	252	50									WIB	St. Petersburg, Fla.	222	100
KFPL	Dublin, Texas	252	15									WIBG	Elkins Park, Pa.	222	50
KFPM	Greenville, Texas	242	10									WIBH	New Bedford, Mass.	209.7	5
KFPR	Los Angeles, Calif.	231	500									WIBI	Flushing, N. Y.	218.8	50
KFPW	Cartersville, Mo.	258	20									WIBJ	Chicago, Ill.	215.7	50
KFPY	Spokane, Wash.	266	100									WIBK	Toledo, Ohio	205.4	100
KFQA	St. Louis, Mo.	261	100									WIBM	Chicago, Ill.	215.7	10
KFQB	Fort Worth, Texas	263	150									WIBO	Chicago, Ill.	226	1000
KFQP	Iowa City, Iowa	224	10									WIBR	Weirton, W. Va.	246	50
KFQU	(Alma) Holy City, Calif.	217.3	100									WIBS	Elizabeth, N. J.	202.8	10
KFRW	North Bend, Wash.	215.7	50									WIBU	Poynette, Wis.	222	20
KFRZ	Hollywood, Calif.	226	50									WIBW	Logansport, Ind.	222	100
KFRB	Beerville, Tex.	248	250									WIBX	Utica, N. Y.	205.4	150
KFRS	San Francisco, Calif.	268	50									WIBY	Henderson, N. C.	263	25
KFRU	Columbus, Mo.	499.7	500									WIBZ	Montgomery, Ala.	231	10
KFRV	Olympia, Wash.	218.8	50									WIL	St. Louis, Mo.	273	250
KFSG	Los Angeles, Calif.	275	500									WIP	Philadelphia, Pa.	508.2	500
KFUL	Galveston, Tex.	258	50									WJAD	Waco, Texas	352.7	500
KFUO	St. Louis, Mo.	545.1	500									WJAG	Norfolk, Neb.	270	200
KFUP	Denver, Colo.	234	50									WJAK	Greentown, Ind.	254	50
KFUR	Ogden, Utah	224	50									WJAM	Cedar Rapids, Iowa	268	100
KFUS	Oakland, Calif.	256	50									WJAP	Providence, R. I.	305.9	500
KFUT	Salt Lake City, Utah	261	100									WJAS	Pittsburgh, Pa.	275	500
KFUV	Oakland, Calif.	226	50									WJAX	Jacksonville, Fla.	336.9	1000
KFVU	Springfield, Mo.	252	10									WJAZ	Mount Prospect, Ill.	322.4	500
KFVD	San Pedro, Calif.	205.4	50									WJBA	Joliet, Ill.	206.8	50
KFVE	St. Louis, Mo.	240	500									WJBB	St. Petersburg, Fla.	254	100
KFVG	Independence, Kansas	236	10									WJBC	La Salle, Ill.	234	100
KFVH	Manhattan, Kansas	218.8	15									WJBI	Charlotte, N. C.	224	10
KFVI	Houston, Texas	240	10									WJBL	Red Bank, N. J.	218.8	250
KFVN	Welcome, Minn.	227	50									WJBM	Ypsilanti, Mich.	233	10
KFVR	Denver, Colo.	244	50									WJBN	Decatur, Ill.	270	500
KFVS	Cape Girardeau, Mo.	221	50									WJBO	Sycamore, Ill.	256	10
KFVW	San Diego, Calif.	240	500									WJBP	New Orleans, La.	268	100
KFVY	Albuquerque, N. Mex.	250	10									WJBR	Buffalo, N. Y.	218.8	50
KFWA	Ogden, Utah	261	500									WJBD	Lewisburg, Pa.	211.1	100
KFWB	Hollywood, Calif.	252	500									WJBS	Buffalo, N. Y.	218.8	50
KFWC	Upland, Calif.	211.1	50									WJBT	Moosheart, Ill.	302.8	500
KFWD	Arkadelphia, Ark.	266	500												

An Easily Constructed Crystal Receiver

By M. L. HARTMAN* and JOHN R. MEAGHER†

It is freely admitted that there is no detector that will give the results obtainable with a crystal. The receiver herein described is well worth the time spent on its construction.



IT IS believed that there would be many more people who would build sets employing crystal detectors, if it were possible to assure them that the receiver they took the trouble to build would give satisfactory results. The receiver described below has incorporated in it the best features of modern radio design, is inexpensive to construct, and the resulting signals have a good, clear tone.

This crystal receiver gives excellent volume for head-phone reception of broadcast stations within a 30-mile radius; and under the proper conditions it can reach out surprisingly, and has done so, picking up stations more than 300 miles distant. And this is not the record distance by any means.

Probably the best feature, the one that will be fully appreciated only after listening



Fig. 1. This is a rear view of a crystal receiver that is excellent for both volume and distant reception. Notice the simplicity of the layout.

to this type of set, is the pleasing purity of reproduction. When music is coming over the air, it sounds as music should—clear and enjoyable—and when speech is being received, the human voice is clear and natural. Few persons will dispute that, in this respect, a plain crystal receiver is better than any other.

EXPERIMENTAL WORK

In March, 1925, the writers conducted a series of tests to determine the most efficient circuit and arrangement of apparatus to use with the carborundum (silicon carbide) detector.

Direct comparisons were made between—

- (a) plain inductances of various shapes and sizes, etc.,
- (b) tuning circuits of different inductance, capacitance ratios, and
- (c) variometers of all modern styles.

To insure absolute constancy of received signal strength, a miniature broadcast transmitter was set up in a remote portion of the laboratory. It supplied modulated radio frequency energy of a constant value at three wave-lengths of 250, 350 and 450 meters.

Reception was accomplished with a single-wire aerial, approximately 100 feet over-all length. The average phone circuit current was less than 20 micro-amperes (.00002 amps), corresponding to the actual strength of signals received from the broadcast station WGR in Buffalo, about 22 miles away.

DESIGN OF TUNING SET

As a result of this work, a standard tuner design was evolved, which can scarcely be excelled for all-around efficiency. It is of the adjustable auto-coupled type, the degree of aerial coupling being controlled with a six-point switch. The circuit is shown in the diagram.

Tuning is accomplished with a variable condenser of low value; the inductance is large and wound with heavy wire.

The main features of the tuner are as follows:

1. The coupling-control switch makes it possible to adapt any size of aerial to the set, with a good match of their respective impedances at different wave-lengths. This results in greatest efficiency.

2. The auto-coupling, which eliminates the energy loss usual in inductive coupling, and the high rate of inductance to capacitance, provide greatest voltage variation for a given signal, so the volume is as great as possible.

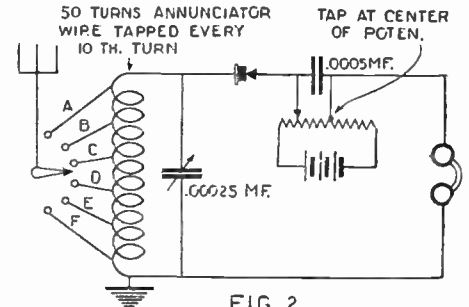

The circuit diagram of this receiver is very easily followed by the constructor and the circuit is one that should give good results.

3. The combined design, including adjustable auto-coupling, high tuning circuit ratio, low resistance and freedom from "dead ends," makes for "low loss," high efficiency, sensitivity and maximum receiving range.

4. When used with an electrically controlled carborundum detector or with any normally high-impedance crystal, the selectivity is better, considering volume, than any other arrangement we have been able to devise.

THE INDUCTANCE

The tuning or inductance coil is very simple, and there should be no difficulty in making this properly. It is designed to have low resistance and low distributed capacity. It is connected in such a way as to eliminate "dead end" turns. All of these tend to increase the efficiency.

The coil is wound on a stiff, but light, cardboard or bakelite form, approximately
(Continued on page 1362)

*Research Director, The Carborundum Co. †Radio Research Engineer, The Carborundum Co.

LIST OF BROADCAST STATIONS IN THE UNITED STATES

(Continued from page 1291)

Radio Call Letter	BROADCAST STA. Location	Wave (Meters)	Power (Watts)	Radio Call Letter	BROADCAST STA. Location	Wave (Meters)	Power (Watts)	Radio Call Letter	BROADCAST STA. Location	Wave (Meters)	Power (Watts)	Radio Call Letter	BROADCAST STA. Location	Wave (Meters)	Power (Watts)
WKAQ	San Juan, P. R.	340.7	500	WNAC	Boston, Mass.	230.2	500	WQAN	Scranton, Pa.	250	100	WSBF	St. Louis, Mo.	273	250
WKAR	East Lansing, Mich.	283.5	1000	WNAD	Norman, Okla.	251	250	WQAD	New York, N. Y.	360	100	WSBT	South Bend, Ind.	275	250
WKAV	Laconia, N. H.	224	50	WNAL	Omaha, Nebr.	258	50	WQJ	Chicago, Ill.	447.5	500	WSDA	New York, N. Y.	263	250
WKBB	Joliet, Ill.	214.2	100	WNAT	Philadelphia, Pa.	250	100	WRAF	Laporte, Ind.	224	100	WSKC	Bay City, Mich.	261	100
WKBE	Webster, Mass.	231	1000	WNAX	Yankton, S. Dak.	244	100	WRAC	Escanaba, Mich.	256	100	WSM	Nashville, Tenn.	282.8	1000
WKBG	Chicago, Ill.	215.7	100	WNBH	New Bedford, Mass.	248	250	WRAM	Galesburg, Ill.	244	100	WSMB	New Orleans, La.	319	500
WKRC	Cincinnati, Ohio	325.9	1000	WNJ	Newark, N. J.	252	150	WRAV	Yellow Springs, Ohio	263	100	WSMH	Ovosso, Mich.	240	20
WKY	Oklahoma City, Okla.	275	100	WNYC	New York, N. Y.	526	1000	WRAX	Reading, Pa.	238	10	WSMK	Duynon, Ohio	275	500
WLAL	Tulsa, Okla.	250	100	WOAI	San Antonio, Tex.	394.5	2000	WRAX	Gloucester City, N. J.	268	500	WSOE	Milwaukee, Wis.	246	500
WLAP	Louisville, Ky.	275	20	WOAN	Lawrenceburg, Tenn.	282.8	500	WRBC	Valparaiso, Ind.	278	50	WSRO	Hamilton, Ohio	252	100
WLB	Minneapolis, Minn.	278	500	WOAW	Omaha, Neb.	526	1000	WRCA	Washington, D. C.	468.5	1000	WSUI	Iowa City, Iowa	493.6	500
WLBL	Stevens Point, Wis.	278	500	WOAX	Trenton, N. J.	240	500	WRCD	Raleigh, N. C.	252	100	WTAB	Fall River, Mass.	266	100
WLIB	Elgin, Ill.	302.8	2500	WOC	Davenport, Iowa	183.6	5000	WREC	Coldwater, Miss.	254	10	WTAC	Johnstown, Pa.	268	100
WLIT	Philadelphia, Pa.	394.5	500	WOCL	Jamestown, N. Y.	275	15	WREO	Lansing, Mich.	285.5	500	WTAD	Carthage, Ill.	236	50
WLS	Crete, Ill.	344.6	1500	WODA	Paterson, N. J.	224	250	WRHM	Minneapolis, Minn.	252	50	WTAG	Worcester, Mass.	268	500
WLTS	Chicago, Ill.	258	100	WOI	Ames, Iowa	270	750	WRK	Hamilton, Ohio	270	100	WTAL	Toledo, Ohio	252	10
WLW	Harrison, Ohio	422.3	500-5000	WOK	Homewood, Ill.	217.3	500	WRM	Urban, Ill.	273	500	WTAM	Cleveland, Ohio	389.4	3500
WLWL	New York, N. Y.	288.2	1500	WOKD	New York, N. Y.	293	50	WRNY	Richmond Hill, N. Y.	236	100	WTAP	Cambridge, Ill.	242	50
WMAC	Cazenovia, N. Y.	275	100	WOO	Philadelphia, Pa.	508.2	500	WRNY	New York, N. Y.	258	500	WTAR	Osseo, Wis.	254	100
WMAF	Dartmouth, Mass.	410.9	1000	WOQ	Kansas City, Mo.	278	1000	WRR	Dallas, Tex.	246	500	WTAR	Norfolk, Va.	261	100
WMAK	Lockport, N. Y.	266	500	WORD	Batavia, Ill.	405.2	500	WRST	Bay Shore, N. Y.	215.7	250	WTAS	Elgin, Ill.	302.8	2500
WMAL	Washington, D. C.	212.6	15	WOS	Jefferson City, Mo.	440.9	500	WRVA	Richmond, Va.	256	1000	WTAW	College Station, Texas	270	500
WMAN	Columbus, Ohio	278	50	WOWL	New Orleans, La.	270	10	WSAI	Mason, Ohio	325.9	5000	WTAX	Streator, Ill.	231	50
WMAX	Chicago, Ill.	47.5	500	WOWO	Fort Wayne, Ind.	227	500	WSAJ	Grove City, Pa.	229	250	WTAX	Lambertville, N. J.	261	15
WMAY	St. Louis, Mo.	248	100	WPAK	Agricultural Col., N. Dak.	275	50	WSAN	Allentown, Pa.	229	100	WTIC	Hartford, Conn.	348.6	500
WMZ	Macon, Ga.	261	500	WPCC	Chicago, Ill.	258	500	WSAR	Fall River, Mass.	254	100	WWAD	Philadelphia, Pa.	250	250
WMBB	Chicago, Ill.	250	500	PGC	Atlantic City, N. J.	299.8	500	WSAU	Chesham, N. H.	229	10	WWAE	Plainfield, Ill.	242	500
WMBC	Detroit, Mich.	250.4	100	WPRC	Harrisburg, Pa.	215.7	100	WSAX	Chicago, Ill.	268	100	WWAO	Houghton, Mich.	263	250
WMBF	Miami Beach, Fla.	384.4	500	WPSC	State College, Penna.	261	500	WSAZ	Chicago, Ill.	268	100	WWGL	Richmond Hill, N. Y.	212.6	500
WMC	Memphis, Tenn.	499.7	500	WQAA	Parkesburg, Pa.	220	500	WSBJ	Pomeroy, Ohio	244	50	WWI	Dearborn, Mich.	266	500
WMDA	Hoboken, N. J.	340.7	500	WQAE	Springfield, Va.	246	50	WSB	Atlanta, Ga.	428.3	1000	WWJ	Detroit, Mich.	352.7	1000
WNA	Arlington, Va.	434.5	1000	WQAM	Miami, Fla.	263	100	WSBC	Chicago, Ill.	209.7	500	WWL	New Orleans, La.	275	100
WNAB	Boston, Mass.	250	100												

Construction of the Duodyne

By ASHUR VAN A. SOMMERS

The editor has received many requests for a constructional article on the popular Duodyne receiver. It is presented herewith. Mr. Sommers not only tells how the receiver may be built from parts designed specifically for it, but gives directions as well for making the duoformers from raw stock.

THE Duodyne circuit was designed to produce a tuned radio frequency receiver inherently balanced over the entire range of broadcast stations, and in which the balancing process would not sacrifice efficiency at some wave-lengths, as is the case with most receivers. For this reason a special type of coupling transformer is employed, which will be described later in the article. Aside from this feature, the circuit differs very little from that of any standard tuned radio frequency receiver; but this one point of difference is sufficient to place the Duodyne well in advance of the average receiver of its type.

Figure 4 is the schematic wiring diagram of the Duodyne circuit, using storage battery tubes. The duoformers are primarily designed for use with storage battery tubes; and it is recommended that they be used in this manner, whenever the use of a 6-volt storage battery is practical. The set has been designed to use a power tube in the last audio stage. The circuit has been so arranged that no changes in the wiring are necessary to change from one type of tube to the other.

substitute other parts for those shown, be sure to use high quality apparatus. The use of a poor audio frequency transformer or other inferior parts may affect the operation of the entire set. On the other hand, do not

radio frequency coupling transformers, which are the keynote of the success of this circuit. The complete duoformers, as shown at C, Fig. 5, may be purchased ready-made if the builder so desires. If not, they may be

Fig. 2. Plan view of the Duodyne. The parts numbered are: 1. Duoformers; 2. .0003 μ f. S.L.F. condensers; 3. R.F. amplifier sockets; 4. detector socket; 5. A.F. amplifier sockets; 6. A.F. transformers; 7. grid condenser and leak; 8. antenna series condenser; 9. a 1- μ f. by-pass condenser for the radio frequency tubes; 10. rheostat, 15-ohm; 11. rheostat, 6-ohm; 12. phone jack; 13. antenna switch; 14. binding post strip.

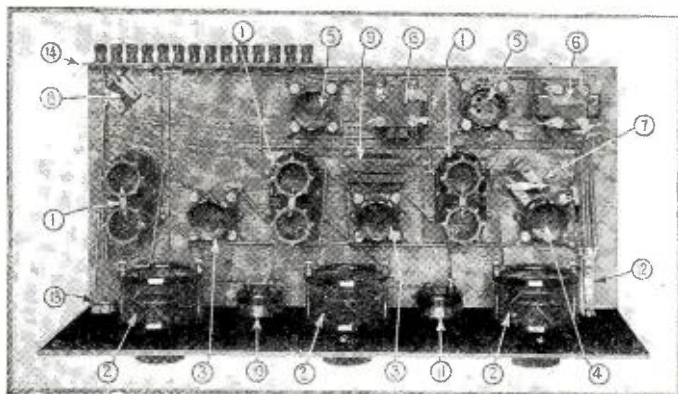
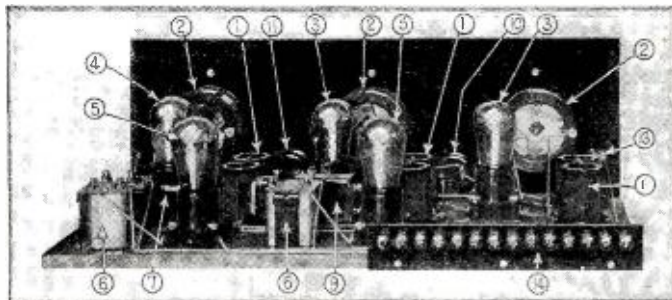

Fig. 3. Back view of the Duodyne receiver, with the tubes inserted. The numbers on this illustration are identical with those on Fig. 2 below, and the parts to which they refer may be ascertained in the caption of Fig. 2. Notice the very convenient arrangement of the binding post strip. Photos courtesy Camfield Radio Company.



feel it is necessary to duplicate the parts shown, if you have other parts on hand, or are unable to purchase the parts recommended.

Care should be taken that the condensers have a rated maximum capacity of at least

made at home in a somewhat simplified form. (See page 1375.)

Each of the duoformers is composed of two coils in the "binocular" arrangement which confines the field to a small area. Each coil is wound on a bakelite tube, 2 $\frac{3}{8}$ inches long and 1 $\frac{5}{8}$ inches in diameter. The home builder should procure six tubes of this size. The good mechanic can, if he so desires, cut away eight points in the wall of each tube, and make a low-loss coil form similar to the commercial type. Those who make the duoformers at home may use their ingenuity in improvising a form of mounting for the two coil sections.

One of the duoformers is an antenna coupler. The other two are interstage transformers. The antenna coupler has 68 turns of No. 24 D.S.C. wire on each form. Both coils are wound in the same direction, and the top leads are connected together. One coil is provided with taps, one at the twelfth turn from the bottom and the other at the twenty-fifth turn from the bottom. The end of the coil nearest the taps goes to the ground and negative filament bus connection: the other end to the grid of the first radio frequency tube. The antenna is connected to one of the taps; the length of the antenna determines which.

(Continued on page 1374)

GOOD PARTS MUST BE USED

To insure obtaining maximum efficiency in operation the instructions given for the construction of this set should be followed closely. When it is necessary or desirable to

.0003 μ f.; otherwise, the full range of broadcast wave-length may not be covered.

CONSTRUCTING THE DUOFORMERS

In Fig. 5 may be seen the duoformers, or

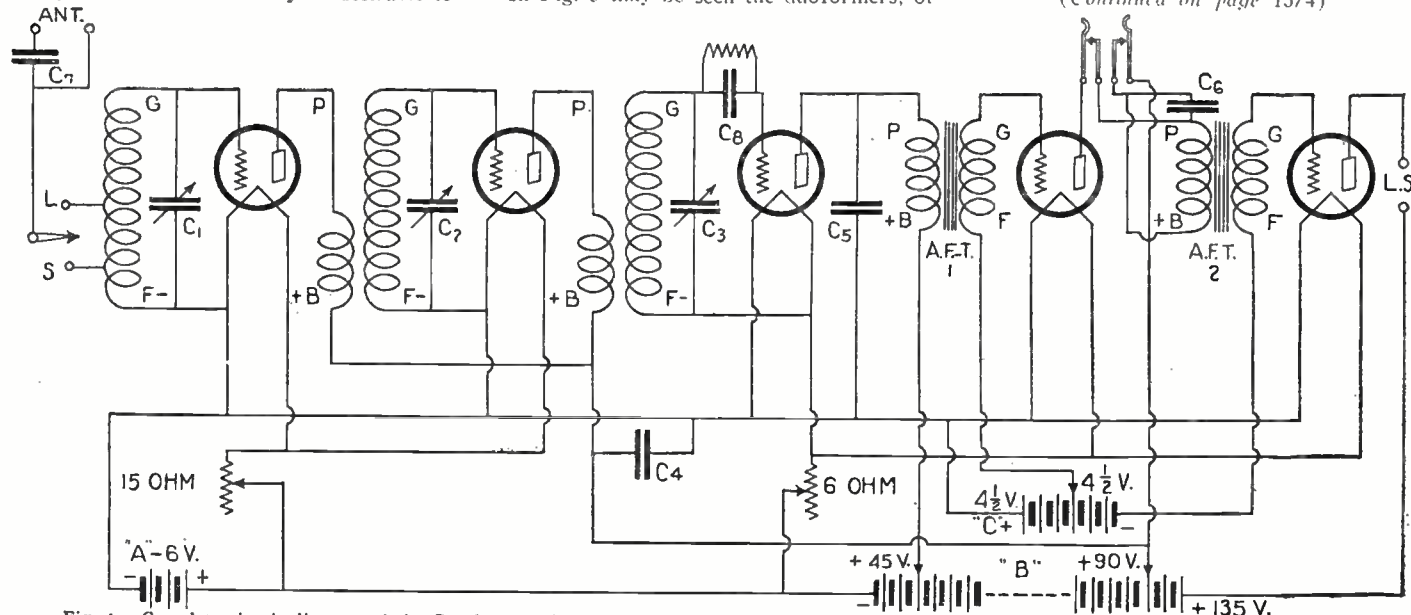

Fig. 4. Complete circuit diagram of the Duodyne receiver. At the upper left may be seen the antenna posts and switching device, allowing four possible adjustments for antennas of various sizes, and for various degrees of selectivity, as desired. The primaries of the two interstage radio frequency coupling transformers are composed of eight turns of No. 40 Advance resistance wire.

A Parlor Music Maker

By VOLNEY G. MATHISON

The receiver that is described in this article is one for the constructor to build as the ultimate, the one to be placed in the parlor and to be used when company is invited to listen-in.

BREATHES there a radio fan with soul so fervent that he never to himself has said: "Gee, I'm getting tired of all this drilling and soldering and screw-driving. I'm almost ready to shuffle off these coils and condensers and things; and if I could get the dope on a real good, nice-looking set to put in the parlor that it doesn't take a bootlegger's bankroll to buy the parts for—why, I'd build that and give my pliers and soldering-paste a rest."

If you have any such mutinous feeling as this lurking about you; if you find wiring and winding, building up and tearing down, holding your breath to catch distant call-letters through a cannonade of static and a chorus of squeals, all becoming stale, flat, and unprofitable; and if you are getting into the state of mind where you can sit down and listen to a good program all the way through without being afflicted with a hundred itches to grab the tuning-dials—then read on.

The receiver pictured herein is the outcome of several efforts to build a good, simple, low-priced instrument really worth putting in the parlor for musical purposes—and leaving there. The features especially aimed at were supremely fine quality of music, simplicity of operation, and tasteful appearance. Low cost, and the greatest possible ease of construction were also kept in view. These five requirements have been all worked out in this receiver to a quite successful extent.

A SIMPLE AMPLIFIER

Despite the immense amount of attention that has lately been focussed upon the resistance-coupled amplifier, many of the newer novices do not yet seem to have appreciated its simplicity and the marvellously fine results that it gives. In the receiver described herein, the inexperienced set-builder will find an opportunity to try out resistance amplification without having to go to much trouble or expense.

In the baseboard sketch (Fig. 1) we have, from left to right, the two filament rheostats (mounted on small bakelite shelf), antenna inductance and its tuning condenser, neutralizing condenser, radio-frequency and detector tube sockets, grid condenser and leak, three-circuit coupler unit with movable tickler-coil, and the resistance-coupled amplifier. The small fixed condenser attached to the right-hand end of the resistance amplifier is the regenerative by-pass connected in series with the tickler-coil, in the detector plate circuit. (See illustration.)

The filament current for the detector and the radio frequency tube is fed through bus-wires taken out from underneath the resistance-coupled amplifier; because "A" battery binding-posts are already found on the amplifier unit. Binding-posts are also provided on the amplifier for "B" battery con-

They are placed about 1 3/4 inches apart, and between them, under the bakelite strip, is mounted a .0001- μ f fixed condenser. By putting the antenna lead on the post nearest the rear edge of the baseboard, this condenser is placed in series with the aerial; and by shifting the antenna lead to the other post, it is cut out. This small, fixed condenser is essential when considerable selectivity is required; but in rural districts, where there are no nearby broadcast stations, it is sometimes preferable to eliminate it. When it is not used, the first condenser will be found to tune rather broadly.

CONSTRUCTION OF THE COILS

There are now several makes of inductance-coil sets on the market suitable for use in a receiver of this type; and it hardly pays to construct them by hand. Almost

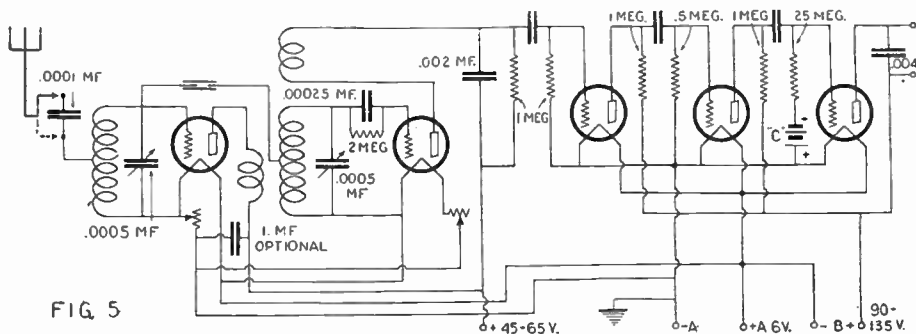

FIG. 5 The wiring diagram of the Parlor Music Maker is shown above, having one stage R.F., detector and three stages of resistance-coupled A.F. amplification.

nections; and from the binding-post for the detector plate battery, a bus-wire is run to the plate circuit of the radio-frequency tube; this tube, therefore, operates on the same voltage as the detector, as is shown in the wiring diagram. (See Fig. 5, above.)

The two binding-posts seen mounted on the end of the bakelite strip that supports the filament rheostats are both antenna posts.

any set of Roberts coils can also be adapted for use in this circuit. A defect of some of these coil sets is that they are not arranged to mount the inductances out behind the condensers, as has been done in this receiver. This construction is desirable; because it reduces the interference of the fields of the coils, and greatly makes for compactness.

Whatever coils are used, it is quite important to see to it that the primary coil of the three-circuit coupler is wound with No. 28, or preferably No. 30 wire, silk covered, and that it at least approximates the dimensions given farther on in this article. If it does not, a new primary coil had best be wound, as specified. A primary inductance wound of coarse wire gives capacity coupling to the secondary coil, instead of the desired inductive coupling; and quite surely kills the efficiency of the receiver. The foregoing applies similarly, but to a lesser extent, to the tickler-coil; this coil should also be wound of preferably no larger than No. 28 wire.

The builder may construct his own coil set, or remount a set of Roberts or other inductances on hand, by noting the arrangement in Fig. 2. At A is the drilled but unbent brass supporting bracket; B shows the bracket bent to shape; C is the rotating tickler-coil shaft; D represents a small piece of 1/8-inch bakelite which is bolted to the bottom of the brass bracket, and serves to support fibre pegs on which are placed the stationary primary and secondary coils; and E illustrates the complete assembly, with a tickler-coil peg 1/8-inch in diameter put in place, ready for coil. Two similar pegs for primary and secondary coils (omitted for clearness) are mounted over the two central holes in the small bakelite shelf, by drilling and tapping ends of pegs for 6/32 machine screws.

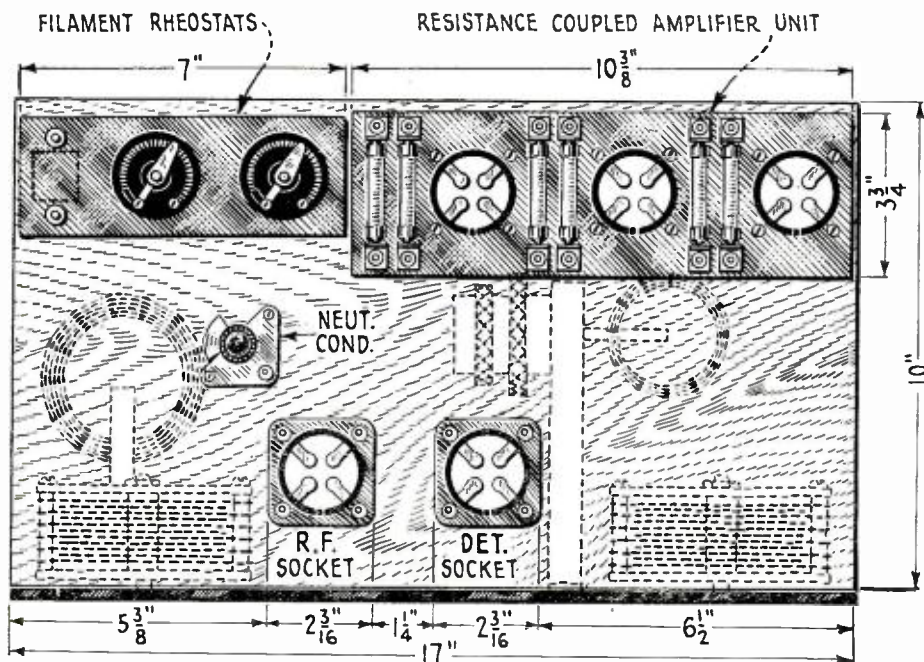
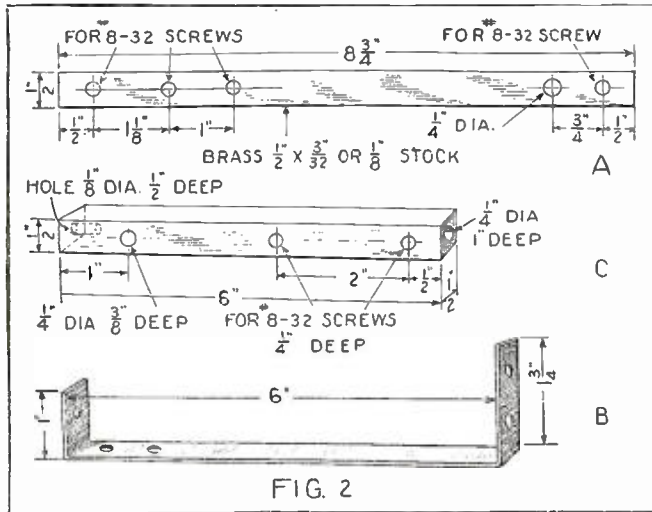

FIG. 1

Above is shown the baseboard layout of the Parlor Music Maker. Compare this with the illustrations on the opposite page.



On the left are shown detailed drawings for the construction of a coil holder. At A is shown the drilled, but unbent, bracket and at B is shown this bent in the proper shape. At C is shown the rotating tickler coil shaft. The shaft as mounted appears below.

In the general layout at E, Fig. 2, it will be noted that the piece of 1/4-inch round brass rod, pressed into the end of the heavy square rod and held with a set-screw, forms at once a bearing for the moving part and a connection for the front panel control-knob. The other end of the square rod is supported by the machine-screw passed through the rear end of the bracket and screwed firmly into it. The square rod should fit stiffly enough into the supporting bracket so that the tickler control will stay wherever it is set, without dropping down.

If convenient, the metal parts of the completed mounting should be nicked, as this will add much to the appearance of the set. This plating will usually cost about 45 cents. This coil-mounting device is not only quite easily constructed, but it connects directly to the panel, independently of the tuning-condenser, it supports the coils out in the rear of the condenser, and is exceedingly compact.

COIL-WINDING FORM

The inductances of this receiver are wound on a form of the kind shown in Fig. 3. This may consist of a piece of wood about 1 3/4 inches in diameter and an inch thick, drilled at equidistant points about its circumference with thirteen holes. In these are placed thirteen 1/4-inch pegs three or more inches in length. The wooden core may be turned on a lathe, or may be sawed from any conveniently obtainable piece of round wood or large spool. The pegs may be 30-penny iron spikes, or even a bunch of penny lead pencils. They should be fitted into the holes bored in the core, with just sufficient snugness to keep them from falling out. The core should be whittled or turned to a slight taper, to facilitate slipping the coils off after winding them.

The primary coil of the three-circuit coupler consists of 36 turns of No. 28 double silk-covered wire. Its outside end goes to the plate of the radio-frequency tube, and its inner end to the "B" battery. The tickler-coil has 28 turns of No. 28; its outside end is connected to the plate of the detector tube, and its inner end to the "B" battery and by-pass condenser.

Both the secondary coil and the separate antenna coil have 50 turns of No. 24 double silk-covered wire. The outside end of the secondary inductance goes to the grid-condenser of the detector tube, and, of course, to one side of the tuning-condenser. Its inner end goes to the A-plus filament, and to the other side of the tuning-condenser. The neutralizing tap is taken out of the secondary at the thirteenth turn from the inside.

The two ends of the separate antenna coil are shunted across its condenser, as is shown in the wiring diagram. It is tapped for the antenna connection at the 32nd turn, counting from the inside of the coil. The outside end of the antenna coil goes to the grid of

the radio-frequency tube, and its inner end to the A-minus, and ground.

The above-given number of turns for the secondary coil and the antenna coil are for use with .0005- μ f tuning condensers. For

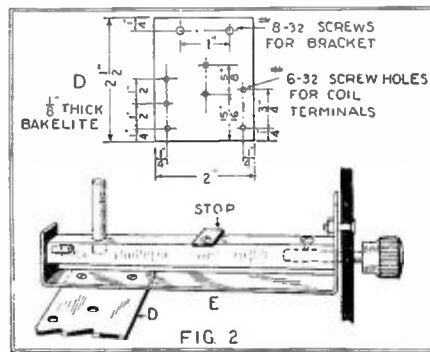

D is the bakelite strip with holes indicated; and at E is the assembly drawing.

use with .0035- μ f condensers, use coils of 62 turns each. In this case, the neutralizing tap on the secondary is taken out at the sixteenth turn from the inside; the aerial tap on the antenna coil remains unchanged;

that is, it is taken out at the 32nd turn from the inside, the same as is done when a 50-turn coil is used. No change is made in the primary or tickler coils.

All of the coils in this receiver are to be wound on a core 1 7/8 inches to 2 inches in diameter. The coils are wound by passing the magnet-wire in and out around each two pegs on the winding form. When the first turn has been taken around the core, the inner end of the wire should be well twisted around the part of the wire forming the turn; so that the coil will not afterwards unravel when it is pulled off the winding form. The winding should be done with clean, dry hands, and the wire must be pulled up as tightly and rigidly as possible. It is rather hard to make as good coils by hand as can be wound by machine; nevertheless, carefully wound home-made coils will work perfectly well. The outer end of the wire should be hooked into the completed coil, to keep it from unwinding. The pegs are then all withdrawn, and the coil is slipped off the core.

FINISHING THE COILS

Each coil, after being wound, must be immediately sewed with a needle and stout white thread. The thread is simply looped up and down through the small triangular-shaped interstices that will be found on both sides of the coil, after which it will be self-supporting and quite rigid. Sew all the way around each side of the coil, until the starting point is reached, where the two ends of the thread should be tied together. Be sure not to pass the sewing thread through any of the large diamond-shaped interstices of the coil, as this would only tend to pull it apart. A little collodion applied at the beginning and end of the winding will considerably aid the novice in making a neat coil; but this stuff should be used sparingly, as it is detrimental to the efficiency of the inductance units.

The coils are set up by simply slipping them over the ends of the fibre pegs on the mounting device that has been already described. The tickler-coil is connected into the circuit with flexible leads; and if any trouble is experienced with its slipping about, it may be rigidly secured to its mounting peg with sealing wax.

The antenna coil is mounted on a single
(Continued on page 1318)

Above is reproduced a photograph from the rear of the interior of the Parlor Music Maker. The two variable condensers employed are the straight-line frequency type, to insure ease in tuning. The resistance-coupled audio frequency amplifier is shown on the left of the baseboard. Below is shown the complete receiver in its cabinet, fit for any parlor.



A Piezo-Electric Loud Speaker

By R. F. SHROPSHIRE

This article describes another very interesting piece of apparatus for the experimenter's radio set. The actuating mechanism for the loud speaker is simply a Rochelle-salt crystal.



A GOOD many years ago, scientists discovered that in certain crystalline bodies there is a marked relationship between electrical and mechanical effects. This is termed "piezo-electricity," and has been defined as a study of the electrical phenomena produced when crystalline bodies are subjected to mechanical stresses, and of the mechanical deformation occurring as the result of applied electrical potentials.

In other words, if a piezo-electrically active crystal is subjected to an applied potential, there will be manifest a mechanical deformation. Conversely also, when such a crystal is subjected to mechanical forces which tend to deform it, there is a change of potential

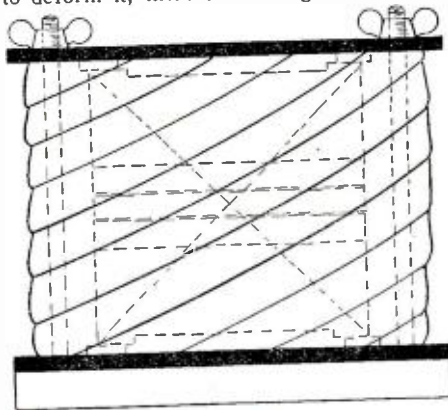

FIG. 4

A different type of speaker may be made by using two aluminum discs; the diaphragm being secured to their edges and twisted diagonally.

between its poles. The exact nature of that which occurs within a crystal is still a matter of conjecture, although the theory that the action is of a more or less electrostatic nature seems to be supported by the results of the experiments that have been made in this field.

One cause for this belief is the fact that the hysteresis loops for crystals are similar to those for iron. That and other properties of crystals have led scientists to believe that piezo-electricity and ferro-magnetism are closely linked. Suffice it to say, however, that whatever the cause of the various effects that manifest themselves, they are of such a nature that they readily lend themselves to many uses.

So far as the researches that have been made public have shown, there are only two classes of crystals which are piezo-electrically active. The first of these is the group in which there is an asymmetrical arrangement of the atoms in the organic molecules, which includes the tartrates, sugar, camphor, etc.; and the second is the group in which there is an asymmetrical arrange-

ment of the mineral molecules, such as in quartz, tourmaline and boracite. Quartz, tourmaline and the crystals of sodium potassium tartrate (better known as "Rochelle salt") have been the principal subjects of study. Of these, Rochelle salt shows the highest activity.

The particular activity in which we are most interested is that mechanical deformation which occurs as the result of applied

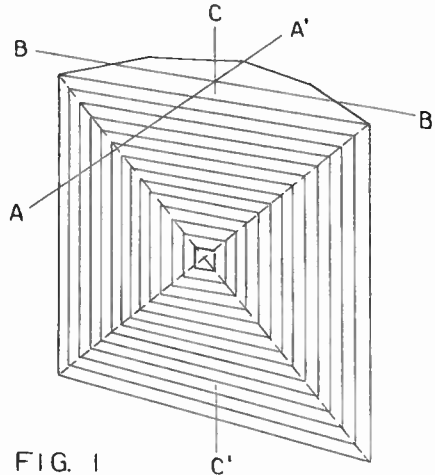

FIG. 1

The sketch shows a diagrammatic view of a Rochelle salt crystal. Note the axes C-C' and the "hour-glass" formation.

electrical potentials; and which manifests itself in the form of torsion about the main axis of crystallization. This is comparatively large, and has been calculated to be— 10^{-5} radians (2.06 seconds of arc) per applied volt

for a crystal approximately seven centimeters in length.

PREPARING A CRYSTAL

Although a method of growing crystals

of Rochelle salt has been previously described in RADIO NEWS (August, 1925, issue, page 233) it might be well to go briefly over the salient points in this process. First, a super-saturated solution of Rochelle salt is allowed to cool, with the resultant formation of a crop of "seed" crystals. From these, those are selected which have grown with their crystallographic axis horizontal, which are approximately one-half inch square, and which are free from flaws and other malformation.

One of the selected seeds is then immersed in a super-saturated growing solution of Rochelle salt, and allowed to "grow," or build up, until it has attained a size of

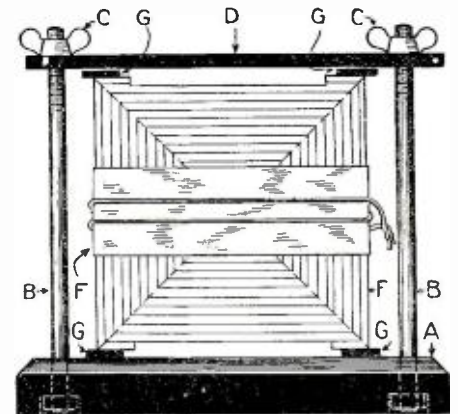

FIG. 2

The mounted crystal is here shown ready to be attached to the paper diaphragm (Fig. 3). See the text for legends of the letters.

approximately $2\frac{1}{2} \times 2\frac{1}{4}$ inches. It is then desiccated. This desiccation process is for the removal of the waters of crystallization, and is further aided by a subsequent heat treatment. The finally-prepared crystal is then ready for use.

It should be of about the dimensions mentioned above, and should exhibit a marked "hour-glass" formation. The latter is important. Fig. 1 shows a sketch of a crystal, and on it are indicated the axes, and the "hour-glass" formation.

This peculiar effect consists of stratifications perpendicular to the c-c' axis, and the remainder of the crystal structure, the stratification of which is ordinarily parallel to the axis. It is believed that the crystal molecules throughout these pyramidal regions are subjected to forces during growth, that tend to turn them in planes containing the principal axis, through 90 degrees.

In using these crystals, one connection is made to a metallic girdle surrounding the crystal, and which includes that section of the "hour-glass for-

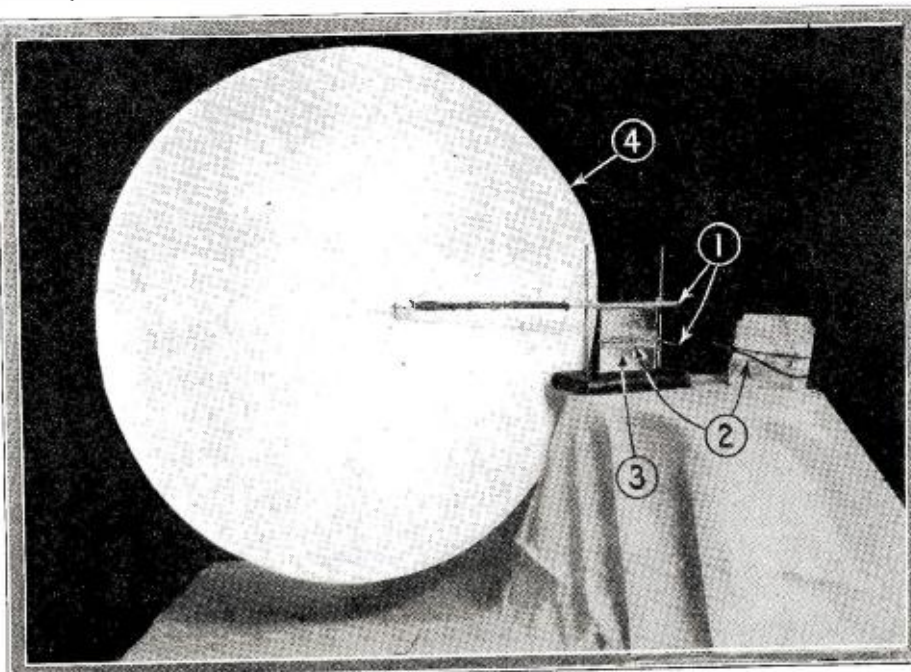

Fig. 3. This photograph shows a crystal loud speaker assembled. 1 shows the terminal connections; 2, the girdle; 3, the crystal and, 4, the paper cone.

(Continued on page 1320)

Something New In Wave Traps

By DONALD H. MENZEL and WINFIELD W. SALISBURY

The question of wave traps, or filters, is one that often causes the experimenter considerable trouble. It is not possible to say too much on this subject, and the present writers clearly outline several types of filters in general use. Certain important precautions in the use of filters or wave traps are given, neglect of which may go far in explaining why so many fans do not get results with their wave traps.

MANY amateurs have found the wave trap an unsatisfactory piece of apparatus. This is partly due to a misrepresentation of its possibilities, but the difficulties may usually be traced to improper design. It is often built of odds and ends of apparatus—cast-off condensers and coils—which should not be expected to work any better in the wave trap than in the receiver itself.

The common wave trap is probably fa-

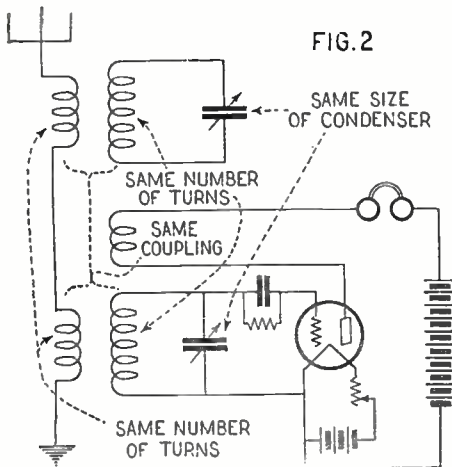

Fig. 2. A wave trap inductively coupled to the receiver is of little or no value in cutting out interference. When properly shielded, the conditions indicated above should be maintained.

miliar to every amateur who has tried to eliminate some undesirable interference from his radio receiver. Ordinarily it consists of two coils, one of which is shunted by a variable condenser and the other of which is inserted in the antenna circuit as shown in Fig. 1. Such a system is valuable only in eliminating interference which is sharply defined on one wave-length, such as the interference between two broadcast stations. It is especially useful in cutting out undesirable local programs.

To be effective, a wave trap must be made to fit the particular set for which it is designed. It will be of no value on a receiver in which the coils and wiring act as antennas. If a wave trap is necessary, the set with which it is to be used should be well shielded. A set in a metal case or one having a shielded panel works the best.

The three-circuit regenerative, the superheterodyne, or the neutrodyne, which employ an aperiodic antenna system, that is to say, an untuned antenna coil, may be fitted out

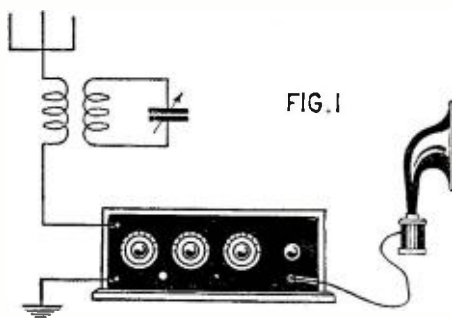

Fig. 1. The common form of wave trap is shown in this illustration, consisting of an oscillatory circuit coupled to the antenna.

with a wave trap most efficiently. The trap, for use with such a set, should be so designed that its antenna coil, secondary coil and condenser are exactly similar to the antenna coil, secondary coil, and condenser of the set. Care should be taken that none of the coils in the trap are inductively coupled to any coils of the set. It is also necessary to have the same type of coupling in each of the two circuits. This is shown in Fig. 2, which illustrates a three-circuit regenerative arranged with such a trap.

A properly designed wave trap will not affect the tuning of the set with which it is used except on the waves to which the trap is tuned. Low losses are just as important in the coils of the trap as they are in the coils of the set proper. Technically speaking, the antenna circuit will have a very high impedance to the frequency for which the trap is tuned and this impedance will be nearer and nearer to infinity as the resistance of the trap approaches nearer and nearer to zero. This shows the importance of low losses or low resistance in the wave trap. Such a trap, designed to fit the set, will greatly improve the selectivity of the set among local broadcast stations and even among distant ones where the wave-lengths come very close together.

THE LOW-PASS FILTER TRAP

Some other types of wave traps, or electric wave filters, as they are sometimes called,

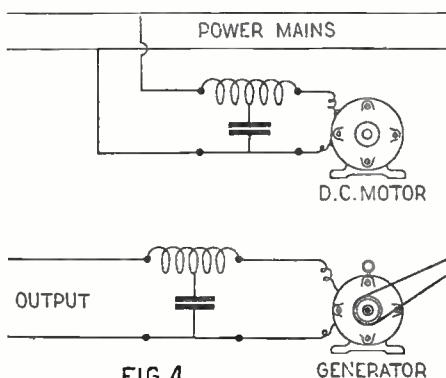

A low-pass filter connected to a motor or generator will kill the A.F. hum.

are also of use to the broadcast listeners. One of these is called the low-pass filter. It consists of a coil and condenser connected as shown in Fig. 3. The condenser should have a capacity in microfarads equal to the total inductance of the coil in henrys. If this device is connected in the supply-line of a direct current motor or the output line of a direct current generator, as shown in Fig. 4, it will eliminate any interference from this type of machinery. The coil may be made by a three-layer bank winding on a four-inch bakelite tube. It should consist of one hundred turns and be tapped in the middle. The condenser should be built up to .012 microfarads by connecting in shunt a number of smaller capacity fixed condensers. A system such as this will cut out, on any line, all frequencies higher than 30 kilocycles. It was used very successfully to eliminate interference which came from a telephone "trouble-tone" generator. This device will eliminate any trouble which is caused by

sparkling brushes in electrical machinery. It prevents the radio waves, which always accompany an electric spark, from passing out on the electric light and telephone lines, as they are made to do in wired wireless, and getting into all the radio receivers of the neighborhood. The coil described above allowed very pleasant reception over several

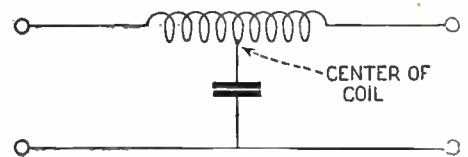
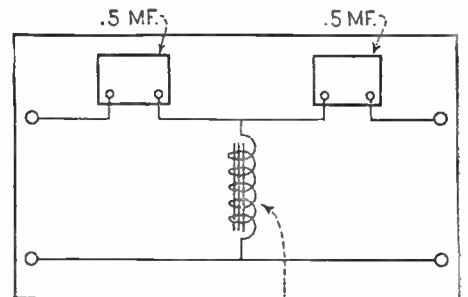

FIG. 3



.25 HENRY IRON CORE CHOKE

FIG. 6

Fig. 3, above, shows the fundamental arrangement of the low-pass filter, as shown in Fig. 4 connected to a motor or generator.

In Fig. 6 are given the average values for the condensers and coils of a high-pass filter that will generally fill the bill satisfactorily for amateur practice.

square blocks where no reception had been possible before.

Another type of wave trap which is not so familiar is the high-pass filter. It consists of a coil and two similar condensers connected in the antenna system of the set which it is to protect, as shown in Fig. 5. Its use is to eliminate the inductive effect of low frequency power lines which are in the neighborhood of the antenna. This, like the first one, may not work if the set itself is not well shielded. A tentative size of the coil and condenser for protection against noises from nearby 60-cycle power lines is given in Fig. 6. These wave traps, if properly constructed, will cut out, on a well-built receiver, almost every kind of interference except static.

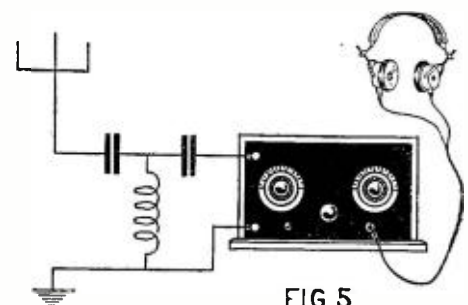

FIG. 5

Fig. 5. We have here the high-pass filter, shown connected to an ordinary radio receiver. This type of filter is not generally used, but it has its uses in eliminating certain kinds of interferences.

A Regenerative Loop Receiver

By G. C. B. ROWE

WHEN a dyed-in-the-wool radio fan sees in a magazine a circuit that he just has to build, generally his first thought is, "How much of the makin's can I find in the old junk box?" And if the answer happens to be that there is enough of the well-known makings available, in a short while a new receiver sees the light of day.

That is, of course, assuming that the circuit is new and interesting. Before any more of this article is read, let it be known that in this case the circuit is old; but it is one that has stood the test of time, and one that every fan, who has ever burnt his fingers on a soldering iron, has some time in his career built. It is a regenerative receiver. However, now is not the proper moment to turn over the page with an exclamation of disgust. The following paragraphs contain a description of a regenerative receiver for which *no coils are needed*.

NO COILS TO WIND!

Perhaps that last statement might be modified a bit by saying that all the inductances necessary are incorporated in the loop antenna; and there are necessary no salt or oatmeal boxes to be purloined from the family larder on which to wind 342½ turns of No. 6¾ wire. From a glance at the pictures of the set, it may be seen readily that the only apparatus mounted on the panel and baseboard are sockets for tubes, transformers, automatic filament controls, a straight-line frequency condenser and a filament-control jack. Nothing to build and most of the parts can be found, if not in the junk box, at least somewhere around the work-bench.

Also from the pictures an idea of the loop antenna may be gained. It will be seen that there is a small loop that can be revolved within the larger one. This may seem to be difficult of construction, but upon close inspection it will be found that anyone who knows the difference between a screwdriver and a monkey wrench should not find it particularly hard to put together. The outside loop functions exactly as though it had no baby brother inside it; that is, if it is turned from side to side, different stations may be tuned in and out without varying the condenser. The smaller loop acts as a tickler coil, as it is connected in the plate circuit of the detector tube.

THE CIRCUIT

As has been mentioned above, the circuit used in this receiver is one employing regeneration. The majority of circuits in which regeneration is used have an outside antenna as a pick-up medium. For the fan who lives in a locality which prohibits erection of such an antenna, and who wishes to experiment with regeneration, this circuit will be most welcome, as only a loop is needed.

The straight-line frequency condenser, which is shunted across the large loop, is of this type, in order to facilitate the separation of stations that broadcast on the lower wave-lengths. This condenser is mounted approximately in the center of the panel, to the right of it the filament control jack. It should be noticed that two transformers for the last stage (push-pull) are mounted at right-angles to the other transformer; not only for the conservation of space, but that there may be no interference between them in the matter of stray fields. The vacuum-tube sockets are of an unusual construction, in that the support which fits around the base of the tube is attached to the base at only one point, thereby reducing losses to a minimum, claims the manufacturer.

CONSTRUCTION OF REGENERATIVE LOOP

The two loops, comprising the antenna and tickler, are so constructed that they can be moved independently of each other. The

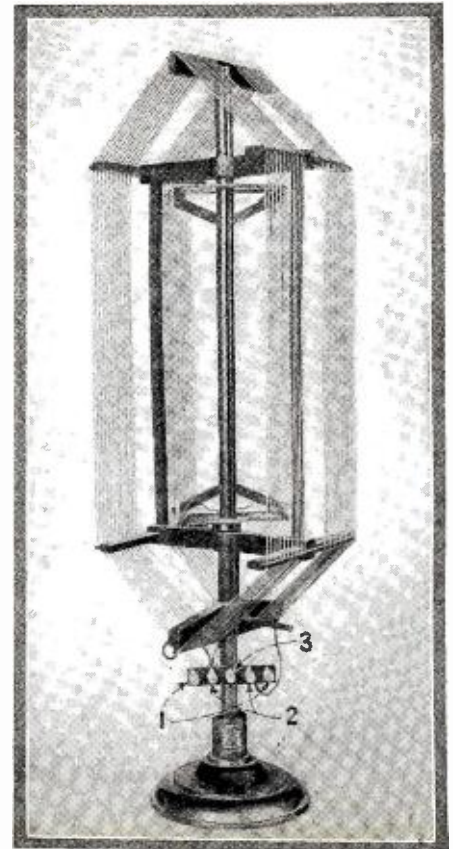

The terminals marked 1, are those for the outer loop, the center tap of which is brought to terminal 3. The inner loop terminates at 2. Photo by courtesy of Utt-Williams Electric Products Co.

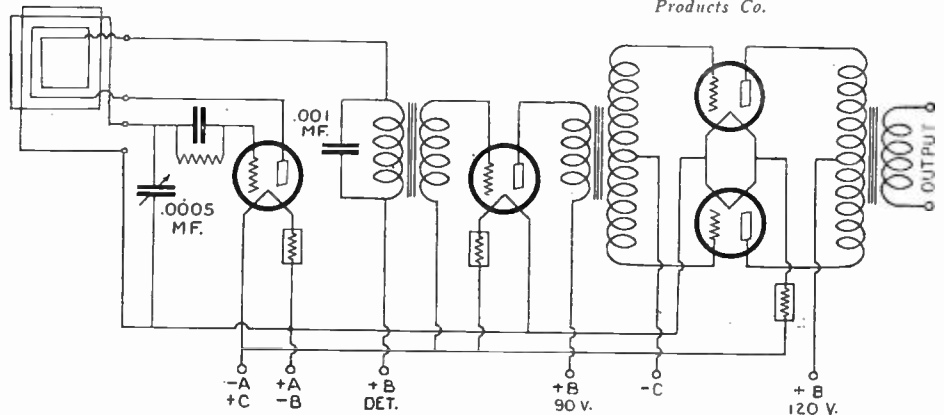

This diagram shows the simplicity of the regenerative circuit, as used with a regenerative loop antenna.

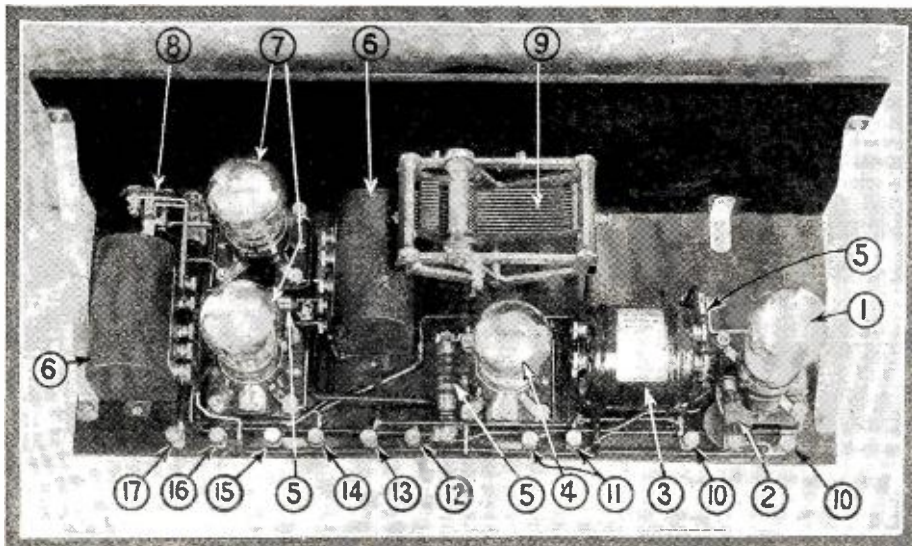

1, detector; 2, grid leak and condenser; 3, transformer for first stage A.F.; 4, tube for this stage; 5, automatic filament controls; 6, push-pull transformers; 7, tubes for push-pull stage; 8, filament control jack; 9, S.L.F. condenser. Binding posts as follows: 10, outer loop; 11, tickler loop; 12 + C; 13, - C; 14, + 22½ volts; 15, + 90 volts; 16, - "A"; 17, + "A" and - "B."

smaller loop is built on the rod, which is placed in a hole in the base of the system, and in this hole easily revolves. The outside loop rides on a shoulder of this same rod, and turns about it as an axis.

The outside loop has 24 turns, a tap leading to the center binding post being taken from the twelfth turn. The inner loop has 12 turns and is not tapped. The ends from the outer loop are brought out to the two outer binding posts on the terminal board shown beneath the loop; the second and fourth posts are attached to the inner loop.

The dimensions of the inner loop are 4¼ x 13 inches. The larger one is eight inches wide, the long stretch being 14¾ inches, and the four short stretches each 5½ inches. The angle between the ends is 90 degrees.

It must be borne in mind that these two loops must be built so that they may be moved independently of each other. This is because it must be possible to rotate the inner loop in order to control regeneration, without disturbing the setting of the larger
(Continued on page 1379)

Constructing A Real DX Receiver

By MARVIN S. OLSON

A really good receiver is a rarity these days, especially when one tries to build one along economical lines. The one described is a really good receiver, one which brings in a lot of DX and at the same time costs little to build, at least no more than any ordinary 3-tube set. The combination of regenerative detector and tuned radio frequency amplification is carefully worked out.

EVER since the advent of radio frequency amplification, radio authorities have wrangled over the problem of reconciling it with regeneration. In truth, there seems to be no end to the agreements and disagreements concerning the relative value of radio frequency amplification when used in conjunction with a regenerative detector. Perhaps, if radio men would supplant their superficial knowledge of this type of amplification with more actual experimental work and less theorizing, some of its problems could be solved, once and for all. Though it has been continually declared that R.F. amplification and regeneration cannot be used together with any degree of satisfaction, I beg to disagree with that statement. A one-step R.F. amplifier in connection with a regenerative detector and a one-step A. F. amplifier has been in use at station 9AAG for some time, and the results obtained on both amateur and broadcast wave-lengths have been most satisfactory.

unit or units. A noticeable increase in amplification will be secured by doing this. I shall not attempt to explain the reason for this; I merely offer it as a suggestion which can be applied to other receiving sets as well as the one in question. Try it and see!

CONSTRUCTION OF THE COILS

At this point it might be well to consider the construction of the coils used in the set. L1 and L2, comprising the feed-back arrangement, consist of an ordinary variocoupler. This can, of course, be either constructed or purchased. The following dimensions are given for the benefit of those fans who may desire to construct the coupler for broadcast reception. L2 consists of 50 turns of No. 16 D.C.C. wire wound on a cardboard tube four inches in diameter, and tapped every tenth turn. L1, the tickler coil, has 20 turns of No. 20 D.C.C. wire wound on a tube with a three-inch diameter. Thirty turns of No. 20 D.C.C. wire on a tube with a four-inch diameter

will be satisfactory for L3. This coil should be tapped every sixth turn. These coils may be wound in any form, such as stagger-wound, basket-weave, zig-zag, and others, if the constructor thinks he will obtain better results with these windings. In my opinion, the ordinary type of winding is equally efficient when properly wound—and left undoped. The radio frequency choke X is not always necessary. It consists of 250 turns of No. 28 D.C.C. wire on a tube with a three-inch diameter. Variable condensers C1 and C2 each have a maximum capacity of .0005 mfs. The rest of the diagram, I believe, is self-explanatory.

Next in order is the mounting of the apparatus. This is almost a matter of common sense, and can be summed up in two words: "DON'T CROWD." Keep the coils L3 and X well separated from each other and from the vario-coupler L1-L2. If possible, L3 should be mounted at right angles to L1-L2. If this is done, no trouble will be encountered with electro-magnetic action between the wrong circuits. Another thing: Do not mount the coils or condensers on a metal-shielded panel. There is positively no excuse for the use of metal shielding if the rotary plates of the condensers are grounded as shown in the diagram. The remainder of the mounting is a matter of individual taste.

Closely associated with the mounting is the wiring of the set. The rules of correct wiring are ancient history to most radio fans, but for the sake of safety, I will repeat them:

1. Run all leads as straight as possible.
2. Do not run long parallel leads.
3. Make the grid and plate circuit leads exceptionally short.
4. Separate the grid and plate circuit wires as far as you can.
5. Keep all wires at least one-half inch apart.
6. Solder all connections with resin-core solder.

By following these rules, you will not only be contributing to the efficiency of the set, but to the appearance as well.

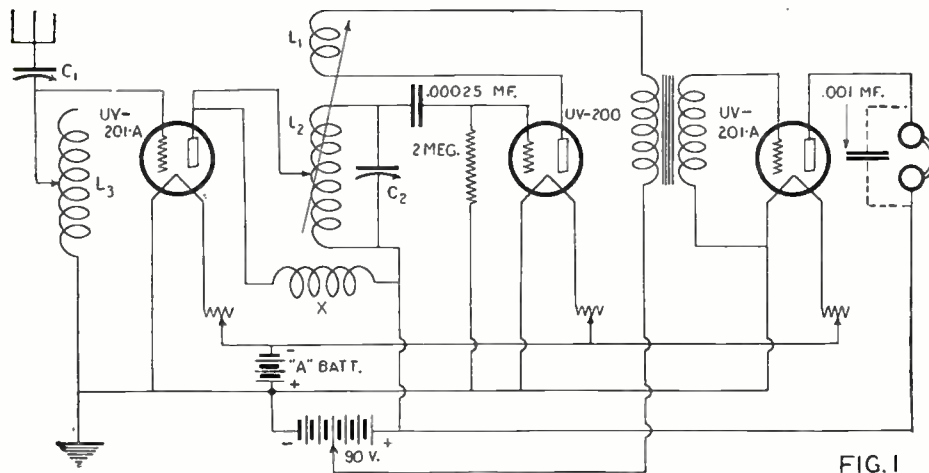

The complete circuit diagram of the receiver, consisting of one stage of tuned Radio Frequency amplification, Regenerative Detector, and one stage of Audio Frequency amplification.

The circuit is shown in Fig. 1. There is nothing unusual about it, except that the familiar potentiometer, "stabilizer," "losser," grid-biaser, or whatever you wish to call it, has been omitted. If the set is properly wired, the rhcoostat of the R.F. tube will prove an entirely satisfactory means of oscillation control. Merely turn down the filament of the R.F. tube and the oscillations will cease. Let me emphatically reiterate the necessity of using care in the wiring job. Failure to do so will result in a tendency of the R.F. amplifier to oscillate readily, and thus render the proper reception of broadcasting impossible.

It will be noticed that reactive-capacity coupling is used between the R.F. tube and the detector. This affords greater amplification and selectivity, because of the high peak value obtained when the amplifier is tuned to one wave-length. The use of broadly tuned coupling transformers between the stages of a R.F. amplifier always results in a loss of amplification and selectivity.

Now for a statement which I know will bring heaps of criticism upon me but, nevertheless, a statement which I know from experience to be true. The audio frequency amplifier should be placed at least half a foot away from the tuner R. F., and detector

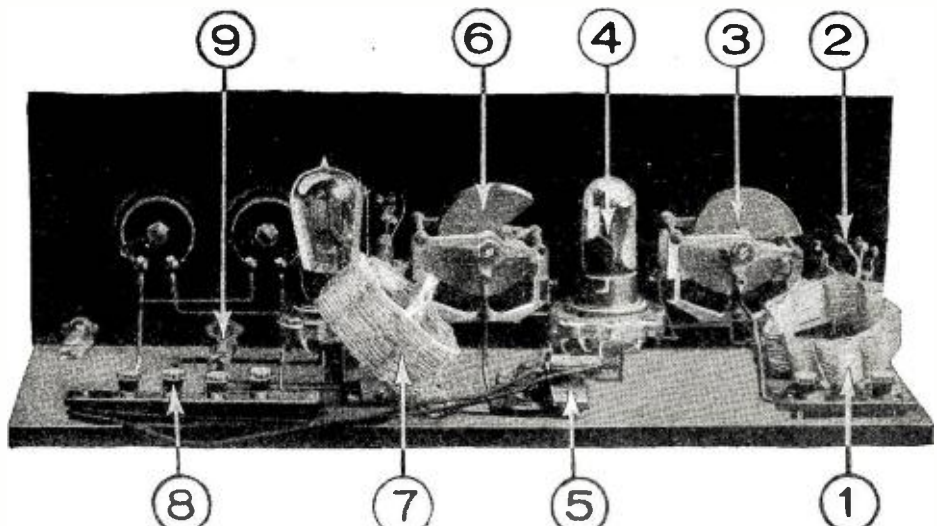

1, Antenna Coil; 2, R.F. Amplifier Tube; 3, Antenna Tuning Condenser; 4, Detector Tube; 5, Grid Leak and Grid Condenser; 6, Detector Tuning Condenser; 7, Interstage Coupling Coil and tickler coil; 8, Binding Posts; 9, By-Pass Condenser.

The Crystal Classified and Analyzed

By J. F. CARRIGAN, M. Sc., A. I. C.



The crystal detector has been used for a long time in receiving radio messages and concerts, but the average fan does not know that there are a great many kinds of minerals which will serve the purpose, some of them as well as galena. In this article the writer tells about many of the other minerals, and shows certain relations between their rectifying properties and their chemical compositions.

It is not 20 years since the first inorganic rectifier of high-frequency radio impulses was put to a practical use by General Dunwoody, of the United States Army. The property of unilateral conductivity upon which the rectifying action of all radio-sensitive minerals and crystals depends was first seriously considered and examined by the above-named experimenter in 1906. During the early summer months of that year Dunwoody produced his world-famous carborundum detector, a form of rectifying device which has now been granted an almost classical position in the annals of radio science.

GALENA

At the present time the amateur crystal enthusiast has a considerable number of rectifying minerals and crystalline materials to choose from. Although the most popular rectifier for general amateur reception at the present time is undoubtedly the ever-present galena, there is, nevertheless, quite a fair number of other minerals of both a natural and a synthetic variety which are capable of acting as very good rectifiers of radio impulses, provided they are employed under the necessary conditions.

It is rather a surprising fact, in view of the great popularity which has now overtaken the formerly despised crystal detector, that the number of minerals which has been added to the list of radio-sensitive materials within recent years is remarkably small. Indeed, all the natural mineral products which possess well-marked unilateral conducting properties seem to have been discovered very soon after the introduction of the carborundum detector to the radio world.

However, the purpose of this article is not to present a history of crystal rectification to the reader, but to put forward a number of facts concerning the chemical nature and composition of the more commonly employed rectifying substances which may be of some interest to the more serious-minded radio amateur.

Although the minerals which are now known to be endowed with rectifying properties to a greater or less degree are very considerable in number, they may, nevertheless, be classified, for all ordinary purposes, into not more than three or four different groups. Such a classification of min-

eral rectifiers which can be made is one which is founded upon a consideration of their intrinsic chemical composition only.

Adopting this method of classifying the crystals and minerals which are employed for the purpose of radio rectification, we may at once divide up all the more common substances of this description into three main groups or categories, viz., the elementary group of crystal rectifiers, the sulphide group and the oxide group. Others are very rare, and the reader may take it for granted that practically every specimen of radio-sensitive crystal or mineral which may come into his possession through the ordinary commercial channels may be relegated to one of the three main crystal groups mentioned above.

CHEMICAL COMPOSITION

Let us now deal for a short time with a consideration of the nature and properties of these three mineral groupings, and see how the rectifying powers of any given mineral or crystal are determined by its chemical nature and the grouping to which it properly belongs.

Most of the crystal rectifying substances which are in common use today are set forth in the accompanying table. This table indi-

TABLE SHOWING THE CHEMICAL COMPOSITION OF A NUMBER OF MINERAL RECTIFIERS			
Mineral or Rectifying Substance.	Chemical Composition.	Formula.	Class or Group.
Silicon	Element	Si	Elementary group of rectifiers.
Tellurium	"	Te	
Graphite	" (Carbon)	C	
Arsenic	"	As	
Antimony	"	Sb	Sulphide group. (Tellurides, selenides and arsenides may be included in this group.)
Molybdenite	Molybdenum sulphide	MoS ₂	
Galena	Lead sulphide	PbS	
Bornite	Double sulphide of copper and iron	Cu ₅ FeS ₄	
Bournonite	Double sulphide of lead, copper and antimony	Pb ₂ Cu ₆ Sb ₂ S ₈	
Stibnite	Antimony sulphide	Sb ₂ S ₃	
Mispickel	Sulphide of iron and arsenic	FeAsS	
Copper pyrites ..	Double sulphide of copper and iron	Cu ₂ Fe ₂ S ₃	
Iron pyrites	Iron sulphide	FeS ₂	
Marcasite	Similar to iron pyrites, but contains small percentage of arsenic		
Zincite	Impure zinc oxide	ZnO	Oxide group.
Cuprite	Copper oxide	Cu ₂ O	
Brookite	Titanium dioxide	TiO ₂	
Ilmenite	Oxide of titanium and iron	TiFeO ₆	
Tellurite	Tellurium dioxide	TeO ₂	
Magnetite	Magnetic iron oxide	Fe ₃ O ₄	
Psilomelane	Manganese oxides	Mn ₂ O ₃	
Pyrolusite	Manganese oxides	MnO ₂	
Cassiterite	Tin dioxide	SnO ₂	

eral rectifiers, of course, is based upon considerations of a chemical nature only. Other classifications of radio-sensitive minerals have been put forward from time to time, and these have been based upon the type of contact required for rectification, the direction of the current at the point of contact, the mechanism of the rectification which is believed to be carried out by these crystals, and upon many other considerations. However, the most concise classification of

each of the common crystal rectifiers, and in addition to this it will enable the reader to determine at a glance the group to which any particular rectifying crystal may belong.

LEAD SULPHIDES

It must, of course, be remembered that, when dealing with these minerals and crystals, we are not faced with absolutely pure chemical compounds. Galena, which is a natural sulphide of lead, and which belongs

(Continued on page 1316)

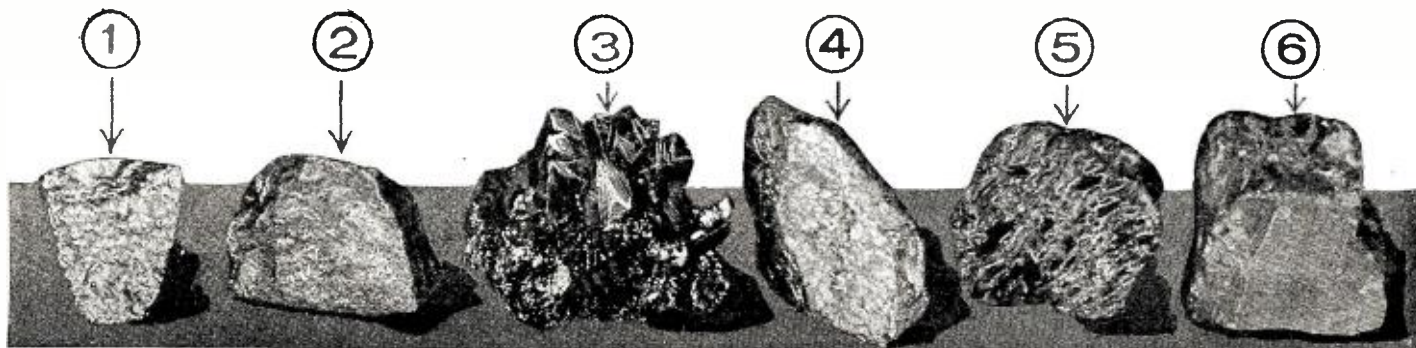

Various forms of crystals: 1, 2, silicon; 3, bornite; 4, chalcopyrite; 5, antimony; 6, iron pyrites.

The Loop Antenna

By LEON L. ADELMAN

TYPES OF COMMERCIAL LOOPS

- 1, Volumax (Scott & Fetzer); 2, Cage Antenna (Rogers' Research Labs.); 3, Aalco Loop (Aalco Radio Labs.); 4, Carter Loop; 5, Aero-loop (Uit-Williams Co.); 6, Fiat Loop (Radio Appliance Co.); 7,

- Deutsche Loop (Deutsche Co.); 8, Crescent Loop (Eclipse Radio Lab.); 9, Western Electric; 10, Supertenna (Super Tenna Co.)

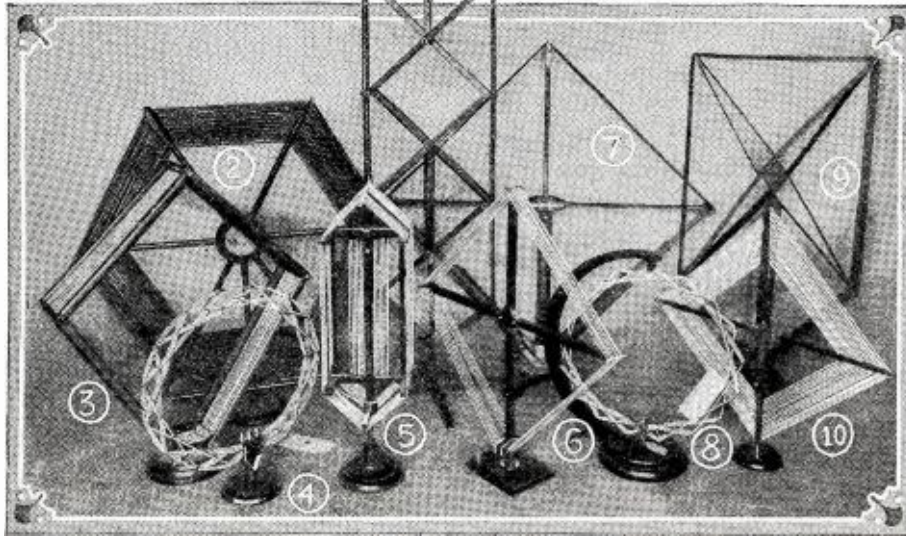

a fixed point in the path of the wave and must, therefore, be equal to the velocity of the wave divided by the wave-length. Expressed in terms of meters, 186,000 miles are equivalent to 300,000,000 meters. Thus:

$$\text{Frequency} = \frac{\text{Velocity}}{\text{Wave-length}}$$

and in the instance of a 600-meter wave used as an example, we have

$$F = \frac{300,000,000}{600} = 500 \text{ kc per second.}$$

TYPES OF LOOP ANTENNAS

There are two types of loop antennas, the pancake or spiral-wound loop and the solenoid or box type. There are many modifications of both kinds and these can be seen in the illustration of commercial loops.

Since the principle of the loop is that the total E.M.F. that can be generated in its windings depends upon the phase difference in the vertical wires, it can readily be understood that the best loop is one which has its vertical windings separated by one-half the wave-length. Maximum energy can thus be picked up, and the amount of this energy will be practically equal to the amount that can be picked up by a single wire antenna one wave-length long.

It is not practical, however, to have such gigantic loops for reception purposes. What is done is to bring down the size to limits which will allow of operation in a room. Thus, for the average loop, about ten turns of wire wound in a form, say one meter square, may have the same inductance as the theoretical half-wave loop, but is capable of receiving approximately but 3 to 5 per cent of the energy, inversely depending upon the wave-length-broadcast range.

So it can easily be seen that the loop appears to be a rather inefficient collector of radio wave energy. How, then, does one account for the very wonderful reception being accomplished daily by thousands who use loops instead of an outdoor antenna?

This is readily and most satisfactorily explained when—

The set used is a sensitive one. Radio frequency amplification is used. Regeneration is used. The loop is near or in a steel structure. The loop is in the neighborhood of a number of antennas.

Radiation takes place from a more powerful receiver in the vicinity.

The territory is free from "dead spots." Each condition in itself is a very important item and, in some cases, there may be present several contributing reasons for the

(Continued on page 1368)

THE early history of the development of the loop seems to be very much in obscurity. But whatever the truth about its origin and inception, we do know for a certainty that in the latter part of the nineteenth century Hertz used small loops in some of his famous experiments. One of the experiments showed that when a loop contained a spark gap and was held in certain positions in the neighborhood of apparatus radiating electromagnetic waves, a spark would pass between the spark balls, while if, on the other hand, the orientation of the loop were slightly changed, but the loop kept at the same mean distance from the source of radiation, the spark would no longer be produced.

EARLY HISTORY OF THE LOOP

This showed conclusively two things: first, that electric or electromagnetic waves were phenomena having definite wave motion in a given direction and, second, that the loop antenna or resonator, as it was then called, had directional properties.

It was not until 1905 that Round published an account of the directive properties of frame aerials, or more properly, loop antennas. From that time on, the loop has experienced more or less popularity with a public quite unacquainted with its characteristics.

This article has for its purpose mainly the design and use of a practical loop antenna for receiving, so that it is not proposed to go to any length into the theory of propagation of electromagnetic waves; for a discussion of this subject the reader is referred to the writer's article in the June, 1925, issue of RADIO NEWS, entitled "Theories of Radio Wave Propagation."

It is essential, however, that the reader have a clear perception or mental picture of an ether wave in order that he may understand the explanation of loop reception. The following hypothesis, accepted by scientists, is given as the most plausible explanation of electromagnetic wave phenomena:

ELECTROMAGNETIC WAVE PHENOMENA

Waves are propagated in straight lines; that is, between the transmitting station and a distant receiving station, the wave travels by the shortest path—on the arc of the "great circle," passing through both points. This wave consists of a system of electric and magnetic lines of force at right angles

to each other. The magnetic force is parallel to the earth's surface, but is at right angles to the direction of travel of the waves. The electric lines of force are also at right angles to the direction of travel of the waves, but are perpendicular to the ground. Further details of the phenomena of radio wave propagation can be gleaned from an article, entitled "What Are Radio Waves?" in the January issue of RADIO NEWS. For our purpose, it will be neces-

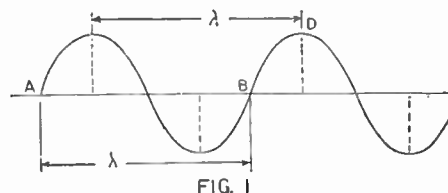

FIG. 1
The distance between two points where the forces comprising the wave are at a maximum in the same direction, is the wave-length.

sary to consider only the three factors of velocity, frequency and wave-length as represented by the accompanying diagram.

First, let us consider velocity. Electricity travels at the rate of 186,000 miles per second. This holds good regardless of whether the wave form is purely direct or whether the frequency lies between one cycle per second or the highest possible frequency to obtain. In other words, the speed of the electric current is always the same, no matter what the frequency may be.

Next comes wave-length. The wave-length of an electromagnetic wave is defined as the distance between two points where the forces comprising the wave are a maximum in the same direction. Thus, in Fig. 1, the wave-length would be measured by the distance AB.

In broadcasting, we encounter frequencies included between 200 and 600 meters, or from 1,500 to 500 kilocycles.

To receive this band of wave-lengths properly, it is essential that the loop have the correct number of turns of wire. In other words, the inductance of the loop must be such that when tuned by a suitable capacity, no difficulty will be encountered in covering the whole band.

The frequency is obtained from the number of times the successive wave crests pass

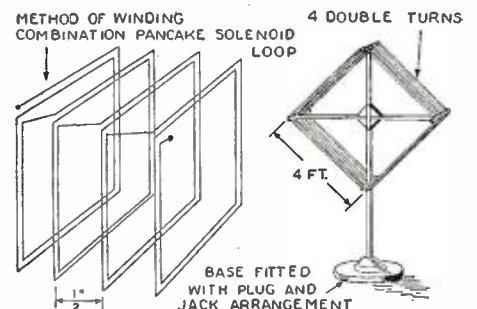

FIG. 3

Constructional details of an efficient loop. Use No. 22 D.C.C. wire.



Correspondence from Readers



In this department the readers air their views on many important questions of the day. Comment is invited and an attempt is made to give equal weight to both sides of a controversy regardless of the magazine's policy.

NEW RADIO FRATERNITY

Editor, RADIO NEWS:

For a number of years I have read every issue of RADIO NEWS carefully, for the good things between the covers. Your "Correspondence From Readers" has been of especial interest to me. Now I have a few remarks of my own.

I think your readers generally will appreciate your evident aim of impartiality regarding BCL's and amateurs. In the end, the two classes aren't so far apart in interest, and it's possible for either one to do the other a lot of good.

Once in a while, even out here in Oklahoma, somebody does something really worth while. A number of years ago, a body of radio bugs in the University of Oklahoma, at Norman, Oklahoma, got together and organized what they called the Norman Radio Research Club. That there was a good deal of interest among the members is evidenced by the fact that this organization became the Alpha Chapter of Alpha Sigma Delta in 1921, so far as I know the beginning of national, professional radio fraternities.

In 1924 the first additional chapter was admitted at Oklahoma Agricultural and Mechanical College. Later in that year, the third chapter was admitted at the Massachusetts Institute of Technology, commonly known as Boston Tech.

Beside a number of possible chapters in other states, petitions are now being considered from the University of Toronto, Canada; the University of Iowa; and Cornell at Ithaca, New York. I understand from fellow members that prospects are exceedingly good now for an increase in the number of chapters.

The fraternity was organized to remove the lack of any co-ordinating factor among collegiate radio men. A need for something to bring about co-operation and fellowship between them has long been felt.

The fraternity is incorporated in the states of Oklahoma and Massachusetts. In Oklahoma, at least, it is recognized as quite a power. The membership, while not large, includes some of the best-known scientists in the United States. Alumni of the Alpha Chapter alone are scattered well over the world, holding important positions, and doing some brass-pounding.

In order better to fit the needs of a fraternity undergoing such rapid expansion, it has been found advisable to revise the constitution several times, but the essentials of the thing, taken from the constitution, are, briefly: The government of the fraternity is vested in a Grand Council, which meets at least once every two years at some predetermined point. Local affairs are managed by the usual elective officers. Charters can be granted only to chapters in institutions where either M. Sc. or M. A. degrees with national recognition are conferred. Membership is open to male students of such institutions who possess a certain knowledge of radio and whose scholarship measures up to a certain standard. It is the aim of the fraternity to keep out of college politics, and antagonism between fraternities is not sanctioned. This leads to a body with higher ideals and with a greater ability for doing good. The fraternity has an official seal, and identifying pin. Wearers of this pin are recognized on our campus as radio men of some superiority.

If you can help the fraternity in its efforts to become better known, I am sure it

will be sincerely appreciated by those "who stay up nights talking across nations as people used to talk across fences."

HERBERT G. HOLLIS,
526 Sixth Avenue,
San Francisco, Calif.

THE REGENERATIVE INTERFLEX

Editor, RADIO NEWS:

Please accept my thanks for telling us how to make the Regenerative Interflex. It is certainly a good one. We, here in a poor-reception locality, with static a-plenty, have found the Interflex to be the quietest (no set noises) and sweetest-toned set ever, not like the usual regenerative sets. As for volume, it has proved equal to the four-tube Tuska superdyne and like circuits. Chicago and New York perform on our loud speaker nightly; the local stations cut out clear and clean, and we get Western and Texas stations right through them. Logged 34 stations first night (Sunday, December 13).

We are at present using the only crystal obtainable, the ten-cent-store variety. We notice, too, that the point of catwhisker operates set at almost any point of crystal; and even gives results (though poorer) on the metal the crystal is mounted in. Why it works, we don't know; in fact, we can't really figure out the Interflex operation itself, but the results are there, and that's all that really counts.

We used standard coupler, cut down tickler winding to 25 turns, so ours is a two-dial set and one rheo. We don't mind, as one alone tunes wave-length; and we seldom touch coupler or rheostat. We use our auto battery, plugging cable in at dash—same running underground to house.

A. FIESS,
R.F.D. 2, Sulphur Springs,
December 25, 1925. Tampa, Fla.

APPRECIATES INTERFLEX

Editor, RADIO NEWS:

The article on the Single-Control Regenerative Interflex, in your December issue, read so well that I decided to build one; and I wish to say the results were most gratifying. After balancing I was able to log 23 stations in one evening, with equal volume to my five-tube set, and with more clearness and stability.

H. C. WATTERS, JR.,
1111 Eighth Street,
Huntington, W. Va.
December 15, 1925.

HORRORS OF RADIO

Some time ago, Mr. Milton M. Schuman, of Baltimore, advertised for a stenographer with radio experience. One appeared who claimed to know all about radio matters, as her family had a set. The following is a verbatim copy of a letter as she transcribed it:

December 1, 1925.

Mr. Hugo Gernsback,
Editor of Radio News,
New York, City.

Dear Sir:

Regarding the data published in this issue, regarding your latest circuit, I wish to be enlarged on a few points which were not exact clear to me.

I have made the flexy former according to specifications and wish to ask if your tapped primary would be most efficient in the arial and ground circuit, also would it make any

difference weather the secondary of the copal goes to the wider side of the variable condenser.

I am using U. V. 201-A, with a 135 volt on the plate but cannot get any oscillations, and ask if you would suggest putting in a pentecioneter. It is necessary to mort the aureola frequency at right angles, and insert a tripole O-1 dubilani fixed condenser against this primary of the first stage?

I noticed wherein you asser at the connection on the carbarondum should be rejected for better reactions. Does this mean simply taking the crystal without tuning it aroud? Would it be just as efficient if reogatatet were used in place of the automatic amperites, I am using a exiode 120 ampier storage battery. Would I keep the specific gravity around 1280 degrees, and have the connections in series with the set and the fuse gote through a ballcot charger. I am using a 23 plat caropotec 23 plat variable condenser and find I am troubled with battery capacity, and ask if you suggest the pannel by shielding.

I am using Benjamin's suspension sockets to relieve violation but find some how the set will only operate the magnet-box on locals. I am using a 125ft. sever strand enameled covered airail.

with the 20 ft. lead in A. Broch and lighting arrester. I am using a fillcastset to control the films on the first amplifier, and find its operation is extremely critial, would you advise me moving any terms from the honeycomb coil.

Thanking you for this information, I remain,

Respectfully,

THE MERCURY DETECTOR

Editor, RADIO NEWS:

I noticed in your correspondence section a letter relating to the use of mercury as a rectifier in radio reception. Perhaps I can radiate a ray or two of light that will brighten the path of any experimenter thinking of playing with the elusive quick-silver.

There used to be advertised a "Barr Mercury Cup" detector just after the World War, in the latter days of amateur spark telegraphy. Whether or not these are obtainable now, I don't know. I do know that I was never affluent enough to purchase one then; although the glowing words in the ad attracted me and afflicted me with a bad case of covetousness. However, the inability to purchase never was an insuperable barrier to the real bug.

So, using a fuse end, one of the cartridge type, for my cup, and a safety pin with a wood screw for the adjustment, the mercury holder was made. This was back in 1920 or perhaps 1919. By spilling some mercury in class at school I angered the physics professor, but obtained the necessary mercury after chasing it all around the floor. This experiment was a failure, because the mercury ate the bottom out of my cup, which bottom was mainly solder. Also, the mercury amalgamated with everything in sight, including my ring, to the disgust of my maternal parent and the blacking of my finger.

Accidentally, I later got hold of a carbon cup electrolytic detector of 1913 vintage or earlier. This and a broken thermometer (accidental breakage, of course) resulted in another mercury detector, which worked with mediocre success. The main trouble was that the movable contact, generally being

(Continued on page 1354)

Awards of the \$50 Radio Wrinkle Contest

First Prize INTERCHANGEABLE INDUCTANCES

By CHARLES DOELLE

Almost all receivers, that are expected to cover a band of more than five or six hundred kilocycles, must be fitted with inductance switches or interchangeable coils. As the switching method is very inefficient, due to the losses in the unused portions of the inductances, as well as to their tendency to trap out certain frequencies, the interchangeable-coil idea is the best solution.

Many types of interchangeable coils, however, have no provision for more than two contacts. Others have sockets that are inefficient in themselves. All are more or less costly.

Interchangeable coils, made up in the fashion illustrated in the accompanying drawing, cost less than 50 cents apiece, when the total cost of the sockets and the interchangeable coils is averaged. This includes the price of the contact springs, bakelite tubing, and wire for coils for ordinary wave-lengths.

Referring to the drawing, the various contacts, A and B, are made from large paper fasteners. Six are required, as a rule. Six will give a better support, even when only four of them are used for contact. The details of both kinds of contact are given in the drawing. Notice especially that B is bowed out to make a spring contact that will always press against A.

The tubes, C and D, may be of any diameter convenient for the individual set; but should be made from thin-walled bakelite, celoron, or some similar substance. The walls need not be more than 1/8 inch in thickness. It is best to have them as thin as possible, from the point of view of efficiency. When 1/8-inch tubing is used, the socket, D, should have a diameter 1/4 inch greater than the coil tube, C. For thicker tubing, add to the 1/4-inch difference the additional thickness over 1/8 inch, doubled.

The contact elements are supported by rivets made from small brass brads, clipped

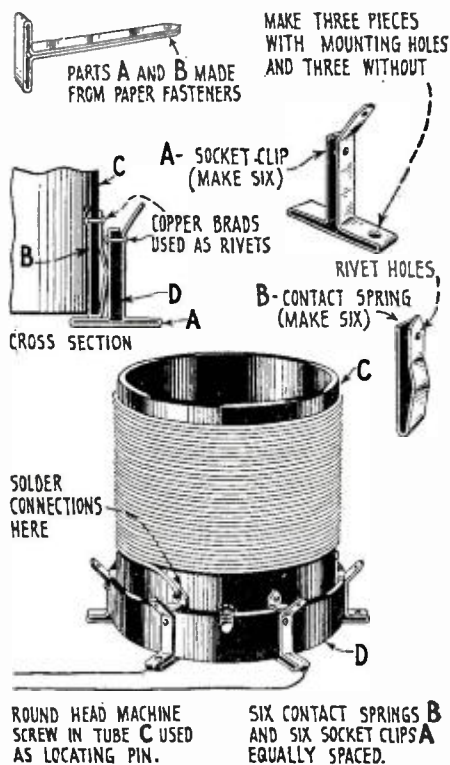

A method of constructing interchangeable inductances and the socket into which they fit is shown above. Ordinary paper fasteners make the very efficient contact members.

off about 1/8 inch from the head. A No. 33 drill should be used to make the holes for the rivets. A 1/4-inch machine screw is inserted into a threaded hole in the coil tube, and fits in a slot cut in the socket, thus keeping the contacts in alignment when the coil is inserted.

Prize Winners

First Prize \$25

INTERCHANGEABLE INDUCTANCES

By CHARLES DOELLE
395 Jenks St., St. Paul, Minn.

Second Prize \$15

AN IMPROVEMENT IN VERNIERS

By DANIEL PORTER
Greenwich, Connecticut.

Third Prize \$10

TANDEM CONNECTION FOR CONDENSERS

By ROY MARSHALL
19A Ft. Winfield Scott, San Francisco.

NOTE: The next list of prize winners will be published in the May issue.

Second Prize

AN IMPROVEMENT IN VERNIERS

By DANIEL PORTER

The purpose of any vernier is two-fold. First, it must aid in making a finer and more accurate adjustment. Second, it must be so situated that its operation causes no noticeable hand-capacity effect upon the instruments. Many verniers on broadcast receivers fall down on the latter requirement, and almost all do on the low-wave sets. Indeed, a movement of the body three feet from the set is sufficient to tune out a signal on two or three meters.

For this reason, any sensitive receiver, even if it is shielded, cannot be operated on low waves without a vernier that keeps the hands of the operator a foot or more from the condensers and coils. Yet such an instrument, in most cases, would make the set hopelessly bulky and awkward.

The detachable vernier handle shown in the accompanying illustration solves the problem nicely. In addition, it interferes in no way with large movements of the dial and is, therefore, a decided improvement over constant friction and geared verniers. In cases where a moderately broad wave is being received, the vernier may be used without its extension handle.

Referring to Fig. 1: (a) is a common rubber furniture foot; (b-b) are washers; (c) the supporting spring; (d) part of a brass bolt, threaded for two-thirds of its length, and drilled for the insertion of the pin in (a); (e) a large binding post knob; (f) a rod of insulating material one-half inch in diameter and about one foot long, and (g) a small knob with male thread insert.

Fig. 2 shows the manner in which the head of the knob (c) and the end of the shaft (f) are notched with a file to allow the former to be turned by the latter. The first verniers used by the writer were made like a screw-head and screwdriver; but the arrangement shown in the illustration proves much more satisfactory, as there is almost no tendency to slip.

In assembling the parts (d) is driven over the pin of (a) by tapping it with a light hammer; and when it is flush with the rub-

ber, the pin is bent over and clipped, if necessary, and a drop of solder applied to hold it in place. Curved spring washers may be used to give tension. The illustration shows two, but more may be necessary. Dimensions of most of the parts are omitted, as they will depend upon the type of dial, the parts on hand, etc.

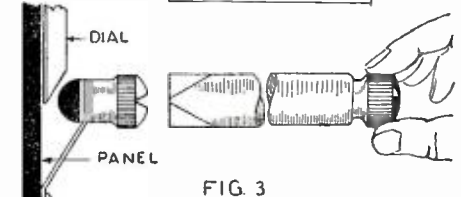
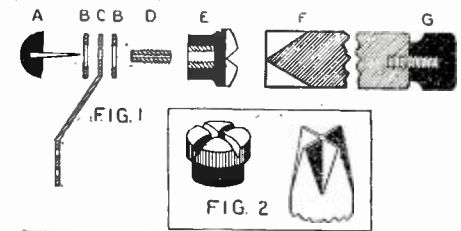

A vernier with a long, detachable handle will be welcomed by all who have trouble with hand capacitance. It will be found especially useful for very short wave work.

Note that when the vernier is not in use it does not touch the dial at all; but when the rod is inserted in the slots and pressed forward it is made to bear against the rim of the dial.

Contributed by Daniel Porter.

Third Prize

TANDEM CONNECTION FOR CONDENSERS

By ROY MARSHALL

A small strip of metal is bent as in the accompanying illustration, so that it is just long enough to clear the end plates of the condenser. This allows full clearance of condenser rotor plates, and prevents a short circuit of condenser at any position of rotor.

The first condenser is dismounted and the strip drilled to fit the shaft of the rotor. Remove the nut which holds the plates of the rotor, slip the strip of metal on shaft and set up lock nut of rotor securely. The adjustment of the condenser is not changed. If it is desired to use three condensers, the second is treated as above, after which the two or three condensers are mounted, either upon a solid strip of bakelite or hard wood, or upon two strips of metal, if the circuit in which the condensers are used permits of a common connection of the rotors. If the circuit will not permit of a common connection of the rotors, the metal strip which connects the condensers is cut and insulated as is clearly shown in the illustration.

Clamps for holding the condensers to the block are made by bending brass machine screws at right angles, and two or four used for each condenser as desired.

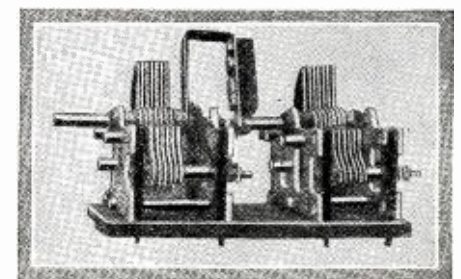

By means of a strip of metal and an optional piece of insulating material, condensers may be connected in tandem for uni-control. If the rotors are both grounded in the circuit the insulating block is omitted.

The connection is quite flexible and it is only necessary to line the condensers approximately.

After the condensers are wired in the circuit, a station about midway on the dials, that is, of about 350 meters wave-length, is tuned in to maximum signal strength; after which the strip of metal is soldered, or fastened by set screw, to the shaft of the second (and third) condenser. This setting gives very good reception over the entire wave-length range of the receiver, and a vernier dial is suggested, as the peak of reception is very critical.

A NEAT HOME-MADE COIL TERMINAL

I have always had quite a bit of trouble with the contacts of my home-made coils, until I hit on the plan of using small shoe eyelets and soldering lugs for terminals; and they have certainly solved the problem.

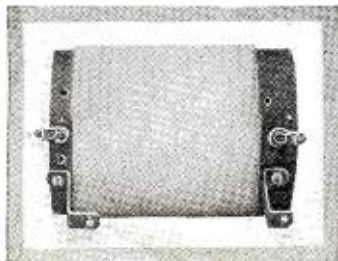

Shoe eyelets may be used as shown to form neat and efficient terminals for inductance coils.

The eyelets may be purchased from any shoe shop for about two or three cents a dozen. A No. 8 drill was used to ream the hole in the soldering lugs and drill the form. Any sharp instrument may be used to cut the eyelet at four or five places, after which it is bradded down. The whole makes a very neat and efficient terminal.

Contributed by Roy Marshall.

SOLDERING OUTDOOR WIRES

When installing lead-in and ground wires for a radio receiving set, it is often necessary to do some outdoor soldering. In cold, windy weather, it is a problem to keep the iron (so called) hot enough to do the work properly. An electric soldering iron with a long connection is not often available; and a brazing torch takes time to prepare and is inconvenient for use in the wind, as well as dangerous in certain places.

On several recent jobs I adopted the following method with entire success. I started the iron heating over the kitchen gas burner, as usual, and had a small pickle jar handy. After preparing the outside wires and applying the flux, I held the hot soldering iron

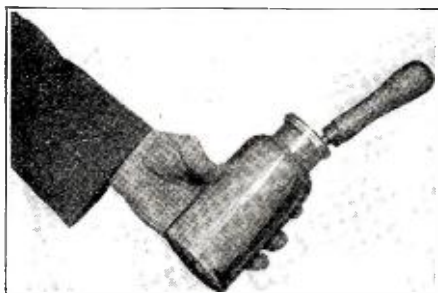

Those who have attempted to do outdoor soldering in cold weather will welcome this wrinkle. It consists of an asbestos lined bottle to keep the soldering copper warm.

inside the pickle jar and carried it out in the yard, where I found that it held the heat and did a perfect job of soldering. I suppose a container made of some substance that does not absorb heat easily, or an asbestos lining placed in the pickle jar would be even better.

Contributed by Ernest Leland Holcomb.

METHOD OF COIL-WINDING

Lately there have been many different types of coil-winding methods published, some using solid forms on which the wire is wound

and others that are so-called "wound on air." The coil-winding method below described is one of the latter type.

A round cardboard box that has a diameter of more than 3 inches is procured and the bottom is removed. The side of the box

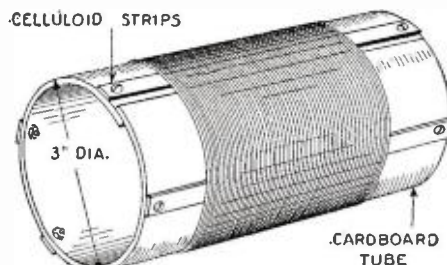

When it is desirable to cut down on coil expense, the above method of making a low-loss form may be used. Usually it will be found necessary to employ about twice as many celluloid strips as are shown in the drawing.

is slit lengthwise and overlapped until the diameter is exactly 3 inches. Four strips of celluloid $\frac{3}{8} \times \frac{1}{8} \times 6$ inches, near the ends of which have been drilled a $\frac{3}{16}$ -inch hole, are fastened on the outside of the prepared tube. The wire is then wound over these strips and fastened temporarily at each end of the box. When the winding is completed, apply either "airplane dope" or collodion to the winding along the celluloid strips. This secures the winding permanently to these strips which act as a form for the coil. When the "dope" is dry, the cardboard tube is squeezed and removed from inside the wire. It will be found that the result is a coil that is entirely self-supporting and built with a minimum of trouble.

Contributed by C. E. Berghom.

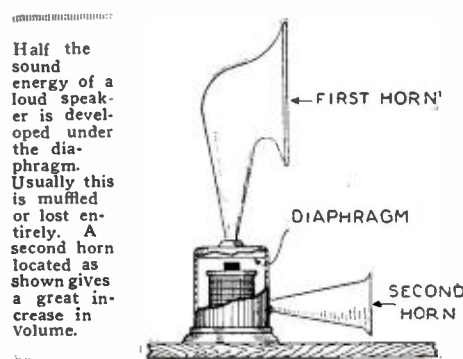

INCREASING THE SOUND ENERGY OF A LOUD SPEAKER

Excluding the cone types, very few loud speakers make use of the sound energy developed on both sides of the diaphragm. All of the common horn models make use of the energy from one side only. It has occurred to the writer that loud speakers of the latter type may be made to give nearly one hundred per cent. more output by the use of a second horn into which is directed the sound energy from within the base of the loud speaker.

The writer used a Western Electric phonograph unit from which the magnets were removed and a half-inch hole drilled in the side of the brass shell. The magnets and coils were then replaced. A plate of thin brass was cut to fit within the shell, and slotted to let the magnet ends come through. A semi-circular hole was also cut in the edge of the plate over the hole drilled in the side of the shell. A little brass strip was then cut to reach from the back of the shell to within about $\frac{1}{8}$ -inch from the front edge, and bent in a semi-circle to fit the hole in the plate. This was carefully soldered on the inside of the shell opposite the hole. The plate was placed on and carefully soldered to the shell around its edge. It should be pressed down a little at the edge in doing

this. Then solder the plate to the little tube and you have a means of conducting the sound from the back of the diaphragm out. A neck is soldered outside the hole, with an elbow if necessary, to lead to the horn. The writer is using two horns, one on the regular opening in front, and another on the extra opening, and gets almost equal volume from both. This scheme might be used on a rubber-case receiver by using wax to secure the plate, or the whole cavity might be filled with wax, but this would make it difficult to reach the coils or other parts in case of trouble. The idea might also be applied to other complete loud speakers.

I might say that this works to some extent without filling the cavity or covering it, but it is much improved by having this collecting chamber reduced.

Contributed by Paul W. Meradith.

A SMALL EMERGENCY CLAMP

One often wishes for three hands when soldering or doing other work on a small article that must be held fairly tight during the process. A vise often is too large and clumsy; and sometimes it is desirable

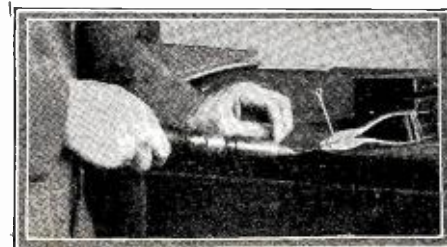

A quick-action clamp for holding small parts is of great assistance in soldering, and in many operations. A pair of pliers and a heavy rubber band are the only parts required to make such a clamp.

to be able to move the work for some reason. A small clamp is the best solution; yet frequently this is as difficult to use as a vise.

A small emergency clamp that is really handy may be made from a heavy rubber band and a pair of pliers, as shown in the accompanying drawing. Loop the band around the handles of the pliers several times. Tension may be adjusted by increasing or decreasing the number of turns of elastic.

Many uses for this device will suggest themselves at once, such as holding small wooden parts that are being glued, holding parts that are being soldered, and so forth.

Contributed by Paul E. Hoopes.

A HANDY WIRING DEVICE

Coil-winders, as a rule, are either so bulky and complicated that they are costly and hard to use, or else they are so simple that they have little advantage over the old method of doing it all by hand. The winder described below combines the best features of both types. It may be made up with almost no expense from parts that are to be found in all workshops, and is useful in winding almost any type of small coil.

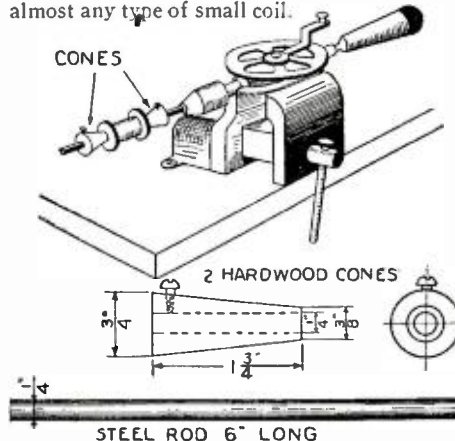

This illustration shows a handy jig for winding small coils rapidly. The writer gives as well a novel means of counting turns.

The winder consists of a double-frame drill (held in a bench vise as shown) and a coil-holder of special construction. The latter is made from a steel rod, 1/4 inch in diameter and 6 inches long, and two wooden cones, the dimensions of which are given in the accompanying sketch. These should be made, preferably, from birch or maple. Larger ones may be required by some experimenters; but this coil-winder is not suitable for coils of a diameter in excess of about two inches.

If transformer coils are being wound for use on a square core, truncated pyramids should be substituted for the cones. It would be well to mount the device sufficiently far along the table to allow the left hand, which guides the wire, to rest on that.

If it is desired to have an exact number of turns, as in a transformer coil, this can be determined readily by the ratio of gearing. For example:

Turns desired 3,000
Teeth, large gear 88
Teeth, small gear 24

The handle will have to be turned a number of times indicated by the formula 3,000 times 24, divided by 88. This gives 818 turns of the large handle as correct. The handle is far easier to count than the rapidly-revolving coil.

Contributed by Norman Lee.

EMERGENCY "SOCKET WRENCH"

It is customary to use a special form of socket wrench to place thumb nuts and binding post tops in inaccessible places in the radio set. As an emergency substitute a common pencil may be used, as shown in the accompanying illustration. The point of the pencil is merely pushed into the hole of the thumb nut until the latter sticks; it may then be placed upon the screw and given a turn or two to start it. When the pencil has been twirled a few times the point will be ejected automatically. The tightening may then be completed by reversing the pencil and pressing with the rubber end. This will give enough purchase to make a reasonably firm connection.

Contributed by Geo. W. Pope.

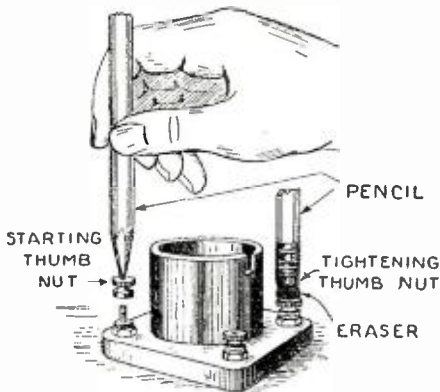

Inserting and fastening the thumb nuts on a socket is a ticklish business, especially when it is situated at the bottom of the set, or in some other inaccessible place. A common pencil may be used as an emergency socket wrench for the purpose.

CUTTING DOWN "B" BATTERY CONSUMPTION

When the same set is used alternately with a loud speaker and a head-set, a great saving may be made in "B" battery consumption by cutting down the voltage when the head-phones are used. Even though the set is used without the last stage of amplification, the steady drain of current for the other tubes is much greater with a high "B" battery voltage than with moderate voltage.

The switching arrangement shown in the

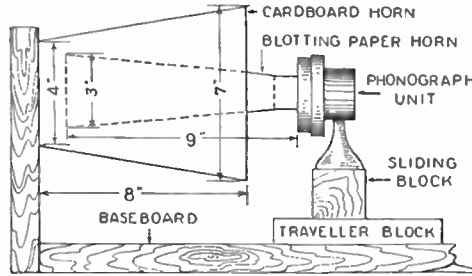

FIG. 1



FIG. 2

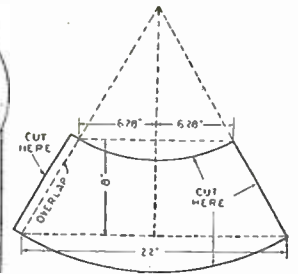
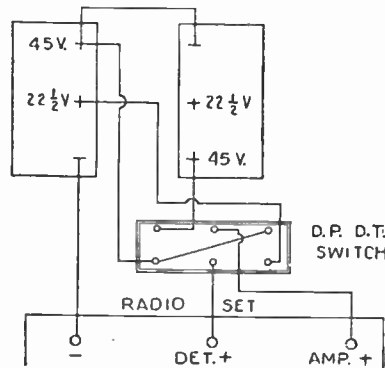

FIG. 3

The constructional details of an adjustable reflecting horn loud speaker are shown in the three figures above. The use of blotting paper and cardboard, respectively, for the inner and outer horns gives unusually good tonal qualities to this home-made instrument. While the volume of sound produced is not as great as in the straight rigid-horn types, the reproduction is more pleasing and accurate.

accompanying diagram allows the use of 90 volts on the amplifying tubes and 45 volts on the detector when the loud speaker is used; and 45 volts on the amplifiers and 22 1/2 on the detector for head-phone reception. Thus half of the battery is entirely out of the circuit, and the rest works at a greatly reduced current drain.

Contributed by D. S. Bergeron.



Those who have sets with no provision for cutting out audio frequency stages when powerful stations come through will welcome the scheme shown in this diagram. It provides for a simultaneous reduction of both amplifier and detector voltage, for use as a volume control; and prolongs greatly the life of the batteries.

A REFLECTING HORN LOUD SPEAKER

Some time ago a wrinkle was published in RADIO NEWS, telling how to construct a reflecting loud speaker with both compactness and improved tonal qualities. As the original model required a good deal of mechanical skill in its construction, the following directions are given for constructing the same type of speaker from simpler materials and in a simpler way.

Fig. 1 is a side view showing dimensions. The method of fastening the large cone to the back and the small cone to the unit is more or less up to the ingenuity of the individual. The writer fastened the large cone to the top of a tobacco can which happened to be of the right size, securing it with sealing wax. Any kind of cement designed for use with metal may be substituted. The small cone was tied around the projecting portion of the unit, and made rigid with sealing wax.

Fig. 2 shows the construction of the sliding block to which the unit is fastened. The sliding feature is very necessary, as it allows the horn to be adjusted for minimum resonance and maximum volume. In this adjustment lies the difference between an exceptionally good loud speaker and a punk one.

Fig. 3 shows the method of cutting the cones, from cardboard for the large one, and blotting paper for the small.

This horn may be constructed in a very short time by almost anyone, and its operation will surprise the user of the average loud speaker. The soft material from which

the inner cone is made prevents much of the distortion that comes from rigid horns.

Contributed by J. H. Congdon.

A NOVEL TUNING DEVICE

In order to maintain the proper relation between inductance and capacitance over a band of frequencies, it is necessary to vary both simultaneously. Here is shown a novel method of accomplishing this with but one instrument. A flat spiral coil is wound of spring metal, preferably of a copper composition, and of sufficient width to give a fairly high distributed capacitance between turns. The non-technical builder will have to use the trial-and-error method in choosing the right width and spacing for best results. Those who are mathematically inclined can calculate these factors to suit conditions.

To prevent mechanical vibration, the turns may be immersed in heavy transformer oil.

The outside turn of the variable spiral is made fast to a terminal at the top, while the inside turn is secured to a rotating shaft. The rotation of the dial attached to the shaft causes the spiral to wind or unwind, depending upon its counter-clockwise or clockwise direction of rotation. This varies the distance between the turns, which is the cause of simultaneous change in inductance and capacitance.

This method of tuning will be found very effective for short wave-lengths, on which exceedingly fine adjustment is necessary.

Contributed by Earl J. Pilkington.

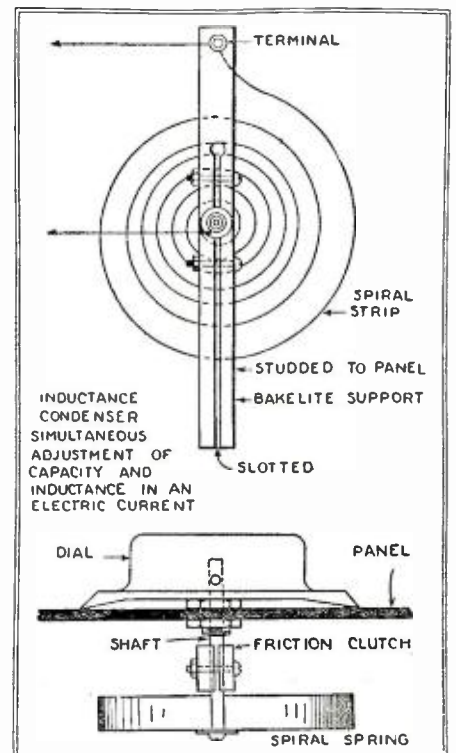

In some circuits it is very desirable to vary both inductance and capacitance at once, maintaining a fixed ratio. This shows a novel means of performing simultaneous variation.

-RADIOTICS-

CAMELS OR SWEET CAPS?

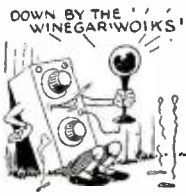

In the *Evening Bulletin*, Providence, R. I., of December 4, was an advertisement telling of a radio set having "A genuine mahogany SMOKING panel." We've got a hunch that our radio set has been out behind the barn shootin' a butt on the sly, thus accounting for some of the dizzy reception.

Contributed by Irving A. Sunderland.

FOR PORTABLE SETS

This from the *Daily Sketch*, London, England, of November 28: "Mr. Lee deForest, inventor of the THIN electrode valve." Our English cousins have been keeping something from us. Just think, tubes that must be made like a deck of cards. Why a 52-tube set would easily go in your pocket.



Contributed by J. E. Martin.

BUT LITTLE PITCHERS CAN



In the December issue of *Q. S. T.*, Hartford, Conn., occurs this gem: "and a G. E. 75-watt filament HEARING transformer." No, Oswald, we don't think these transformers can hear the filaments when they go out.

Contributed by William McCartney.

"HAIRY APE" STUFF

In the October 31 issue of the *Radio Digest* there is the following statement: "Gas pipes also have rubber and other INSULTING materials at the joints." Take our word for it, if some night our ground connections start hurling insults at us, we'll go down and beat up the local gas company.

Contributed by Wm. G. Mortimer.



THAT'S WHERE OUR MONEY GOES

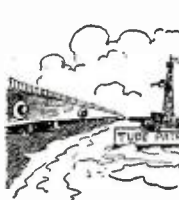

In the *Toledo Blade* of November 26 is the following news item: "The Navy Department is installing an 80,000-TUBE transmitter at the San Diego Naval Radio Station." We certainly would hate to live in the vicinity of San Diego with a station like this blating away every night.

Contributed by Harry W. Hankinson

'WAY, 'WAY BACK IN THE AGES DARK

Historical incident from the *Pittsburg Press*, of November 29: "Since 1293 International broadcasting has been carried on in an experimental way." Evidently the vanishing American and the Heathen Chinee had some method of communication that historians sure did miss.

Contributed by Paul Amtower



STRONG ARM STUFF



In the November 27 issue of the *Baltimore Evening Sun* was this statement: "But I have picked two stations OUT OF FLORIDA and some Chicago stations." Why on earth couldn't this fellow pick up a few of the undesirable stations and toss them nonchalantly in the middle of the Atlantic Ocean?

Contributed by David K. Roberts, Jr.

YOU MUST COME OVER

This from the *Columbus Sunday Dispatch* of December 6: "the POPULARITY of the terminals." The writer of the article in which this sentence appeared does not go into any detail of why terminals are popular. Perhaps in the wilds of Ohio they have some of the female of the species and maybe they're good lookin'.

Contributed by Robert Brierly.

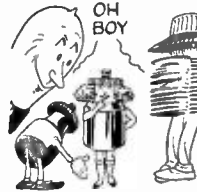

HOW ABOUT LICKER?



Gastronomic item from the *Chicago, Ill. Evening Post* of Nov. 25: "Every wire connection and piece of MEAL in a receiver contributes to the capacity effect, which has a strong influence on tuning." In other words, my son, keep the bloopers far, far away from the dining room table.

Contributed by C. F. Noe

RADIO VS. MEDICINE

Medical announcement in the *Kuickerbocker Press*, Albany, N. Y., of Nov. 27: "Dr. Lee deForest asserts his PATIENT will dispense with horn." We understood that the famous inventor was most versatile, but we were unaware that he was treating deaf people.

Contributed by Edw. J. Frank



IF you happen to see any humorous misprints in the press we shall be glad to have you clip them out and send to us. No RADIOTIC will be accepted unless the printed original giving the name of the newspaper or magazine is submitted with date and page on which it appeared. We will pay \$1.00 for each RADIOTIC accepted and printed here. A few humorous lines from each correspondent should accompany each RADIOTIC. The most humorous ones will be printed. Address all RADIOTICS to

Editor RADIOTIC DEPARTMENT, c/o Radio News.

ANY OTHER OFFERS?



Real estate (?) advertisement in the *Commercial Appeal* of Memphis, Tenn., of Nov. 8: "3 tube set in beautiful cabinet with tubes; \$35 cash GETS CALIFORNIA, CANADA AND MEXICO." Long ago we read that Manhattan Island was purchased for \$24, but we think this offer has that transaction tied to the mast and yelling for help.

Contributed by C. F. Walker.

WHATTA YUH THINK OF THAT?

Scientific advertisement in *Wireless*, London, England, of Nov. 14, stating that the product has "the lowest minimum capacity of any condenser manufactured. 6 1/2 MICRO-FARADS." By chowder, that's what we calls a hot-dawg condenser, but will someone please tell us what they use the thing for.

Contributed by John S. Marchant.



HERE COMES THE BRIDE



Matrimonial announcement from the *Rochester, N. Y. Evening Journal and Post Express* of Dec. 14: "Noise MARRIED radio reception last night." Yes, Grandpa, we knew that the two of 'em were playing around together for a long time, but we didn't know that they were even engaged. Well, we hope there will be a divorce soon in the interest of reception.

Contributed by Mrs. Arthur Hammer.

LARRY, TURN THE CRANK

From the *Standard Radio Catalog* we learn that there is for sale the "Branson Spec. TRAPPED Loop." In this cage, ladies and gents, we have the one and only wild loop in captivity. It was captured only after a terrific battle, in which 17 men were killed and injured. Its food consists of bolts with nuts for dessert.

Contributed by Melvin Johnson.



IS THIS A NEW PARISIAN STYLE?



Fashion note from the *Border Cities' Star*, Windsor, Canada, of Dec. 10: "A straight Line TUBE Dress, \$65." Just what the connection between this dress and radio is not revealed, but we suppose that the wearer can tune out any undesirable visitors or something like that.

Contributed by Everett M. Grant.

FIREMAN, SAVE ME CHEILD

Under the heading of "A Ground Substitute" the *Denver, Col., Post* of Dec. 6 has the following: "A FIRE FENCE often makes an excellent substitute for a ground." Did you know that, Oscar? You did? Well then, stand up and tell the children just what kind of a fence that is. We don't know.

Contributed by T. W. Beals.



THROW AWAY YOUR SET



From *Radio Merchandising*, July, 1925. "We have our own horn out in front and all day long IT CATCHES THE WAVES IN THE AIR AND REPRODUCES THEM IN CLEAR TONES." Pretty soft for that fellow, wad-daya say? No other tubes or things to bother about. Gosh, some guys have all the luck.

Contributed by S. L. DuBuclet.

WHY THIS IN LONDON?

The *Pittsburgh, Pa., Gazette-Times* of Dec. 13 in describing an English transmitter mentions "the WATER COLORED transmitting valves." We were unaware that England had to resort to such things as that, because we looked at John Bull as a gent who scorned Volsteadian ways.

Contributed by Carl H. Rauschenberg.



PAGING MR. LUTHER BURBANK



Horticultural item from the *Toronto, Canada, Daily Star* of Dec. 8. "With the use of a SELF-MADE 5-tubed neurodyne." Can any of the children tell us whether these sets grow on a bush or on a tree? Also is the seed from which they grow, the well-known "radio nut"?

Contributed by Edmund Daly.

NOW WE KNOW

First aid to balky sets from the *Randolph Radio Corp.* catalog is given when "ENNUNCIATOR wire" is advertised. Keep this a secret, but we are ordering a large supply of this wire for the times when our family bloopers refuse to perk. Wire that talks, sings and otherwise performs might while away a dull evening.

Contributed by George Phillips.



STANDARD HOOK-UPS

EVERY month we present here standard hook-ups which the Editors have tried out and which are known to give excellent results. This leaf has perforation marks on the left-hand margin and can be cut from the magazine and kept for further reference. These sheets can also be procured from us at the cost of 5c per sheet to pay for mailing charges. RADIO NEWS has also prepared a handsome heavy cardboard binder into which these sheets may be fastened. This binder will be sent to any address, prepaid on receipt of 20c. In time there will be enough sheets to make a good-sized volume containing all important hook-ups. Every year an alphabetical index will be published enumerating and classifying the various hook-ups.

Handy Reference Data for the Experimenter

THROTTLE-CONTROL 3-CIRCUIT SET

Circuit No. 143. Herewith is described a system of regeneration control that has distinct advantages over the conventional tickler method. It has been termed "throttle-condenser regeneration." In this circuit regeneration, instead of being controlled by the ordinary tickler coil of a three-circuit tuner, is controlled by a variable condenser, which is shunted across from the plate circuit of the detector tube to the filament circuit, and allows the straight or separate radio frequency currents to be fed back to the grid of the tube. The coil consists of an ordinary three-circuit tuner, having primary, secondary and tickler winding. Two variable condensers are necessary, one to control wave-lengths, the other to control regeneration.

C-1 has a capacity of .0005 μ f.; C-2, .00025 μ f. The secondary is wound on a 3-inch tube, with 45 turns of No. 22 D.C.C. wire. The primary consists of 10 turns of the same size wire, $\frac{1}{2}$ -inch below the secondary winding. The tickler coil is wound on a tube $2\frac{1}{4}$ inches in diameter with 30 turns of 24 D.C.C. This coil is placed within the secondary coil. The two-stage amplifier that is added to this set is of the conventional type.

If two audio frequency transformers of different ratios are used, a 5:1 ratio should be used in the first stage, and a 3:1 in the second stage. An additional fixed by-pass condenser may be necessary across the primary of the first audio transformer. The capacity of this condenser should be of .001 μ f.

SIX-SEVENTY-ONE RECEIVER

Circuit No. 149. One of the many circuits that has created a great deal of discussion at the recent radio show, is the Six-Seventy-One Receiver. The description and name of this receiving set was so unique as to create unusual interest. Its greatest fea-

ture is the fact that it employs only one dial for tuning.

Instead of the usual losses method (potentiometer method) of controlling oscillation in the radio frequency amplifier tube, a variable impedance element is inserted between the grid and the "B" plus of the radio frequency transformer, which acts as a radio frequency shunt, forcing the tube to operate at its most efficient point, i.e. just below the oscillation point.

In this manner the set is made to operate smoothly, that is, without squealing or howling, throughout the entire broadcast band and with equal efficiency on all frequencies.

cuit is .00035 μ f. The R.F. choke (L_1) consists of 200 turns of No. 28 D.C.C. wire wound on a one-inch tube. An iron core is placed in the center of the coil, which is wound on an ordinary wooden spool. Either this coil should be tapped at the 125th, 150th, 175th and 200th turns, or provision made for a variable iron core, which will also change the inductance value of the choke coil, and thereby allow the builder to neutralize efficiently or stop the oscillation of the receiver. C_1 has an approximate value of from 2 to 20 μ f., for which a small semi-variable condenser should be used.

Audio frequency transformers of high

An unusual regenerative receiver, employing a novel and efficient means of controlling regeneration, termed "throttle control." The variable condenser, C_2 , is the "throttle," which governs the R.F. feed-back to the detector-tube grid.

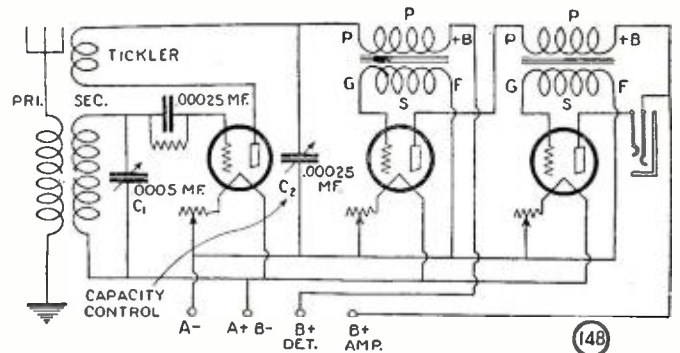

The construction on the radio frequency transformer is as follows:

Three coils, $2\frac{1}{2}$ inches in diameter and $2\frac{1}{2}$ inches in length, are necessary. The primary of each consists of eight turns of No. 36 D.C.C. wire, space wound; secondary, 26 turns of No. 26 D.C.C. wire wound over primary with slight air space between coils. This air space may be obtained by placing a sheet of Empire insulating cloth in between the primary and secondary winding. A triple condenser is used to tune all circuits simultaneously. The capacity of each condenser that is connected across a single cir-

efficiency should be used in the audio amplifier stages of this receiver. Along with the additional stage of resistance-coupled amplification, an unusually high degree of quality reproduction and remarkable sensitivity is obtained with this receiver.

The condenser marked X is of .00025 μ f, and used only when long antennas are employed. This condenser is short-circuited when the receiver is used with an antenna below 100 feet long, including lead-in.

The audio frequency transformers should not have a ratio exceeding 4 or $4\frac{1}{2}$ to 1; as otherwise distortion will usually result.

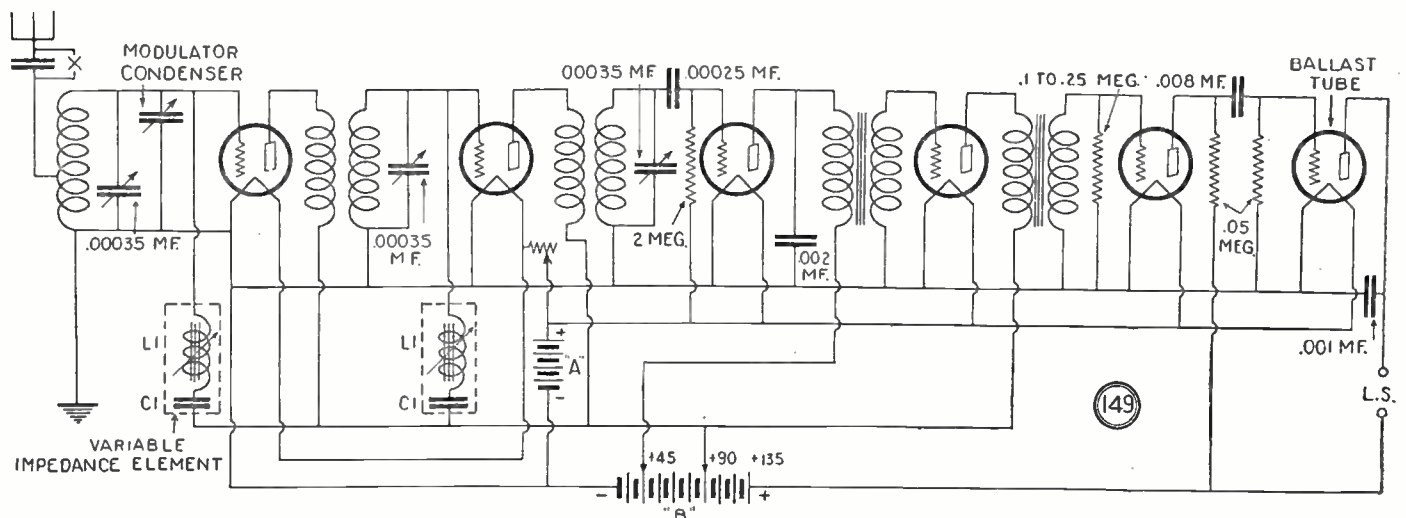

A six-tube receiver of unusual sensitivity, and extraordinarily high quality of reproduction, all obtained with only a single control. This receiver is so constructed that oscillation is prevented or eliminated.

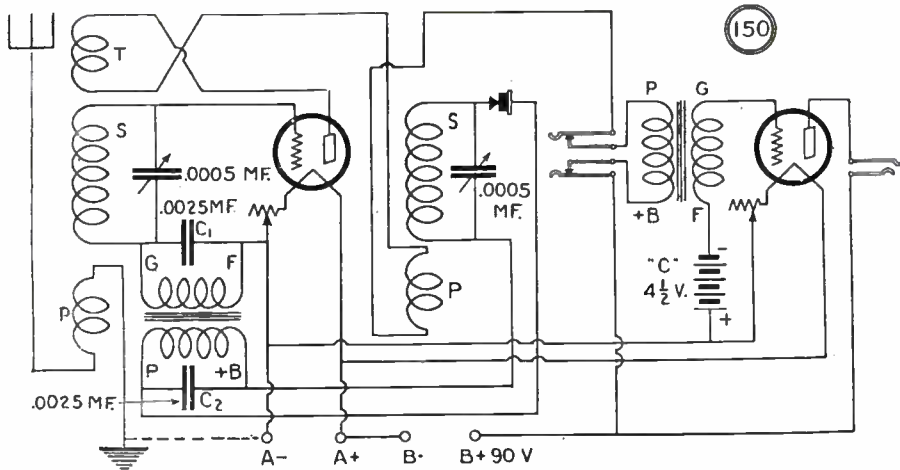

The famous and efficient Superdyne, modified, so that a crystal detector is used as the rectifier of radio impulses, resulting in improved tonal quality, and a stage of reflexed audio amplification to save the cost of an additional tube.

REFLEXED SUPERDYNE

Circuit No. 150. The Superdyne here-with shown is capable of giving extreme selectivity, due to the stage-tuned radio frequency amplification; remarkable quality in view of the fact that a crystal detector is used to rectify the radio frequency impulses; and loud speaker volume, due to the use of one stage of straight audio frequency amplification and one stage of reflexed audio frequency amplification.

The parts necessary for this receiver are as follows:

- 2 Low-loss tuners for broadcast waves, one with tickler and one without tickler.
- 2 Condensers of .0005 μ f., without extra vernier plates.
- 2 Rheostats, 6 ohms.
- 2 .0025 μ f. fixed condensers.
- 2 Sockets.
- 2 A.F. transformers, 3½:1 ratio.
- 1 Fixed crystal.
- 1 Panel, 7 x 21 inches.
- 3 Dials.
- 5 Binding posts.
- 2 Jacks, one double-, one single-circuit.
- 2 UV-201A or 301A tubes, batteries, speaker, cabinet, etc.

In building this set, any convenient layout may be adopted. An ordinary wooden base-board may be used. Keep all battery connections down near the base; and grid and plate leads at right angles to each other, and higher up and away from the battery connections. The connections going to the tickler are important and the builder should try reversing them for best results. The rotor ends of the variable condensers should be connected to the filament side of the coil. The "A" negative should be grounded, as indicated in the diagram, to see if this gives better results.

In operating the set, keep the condensers in step with each other, turning them very slowly, as tuning is very critical. Vernier dials are suggested. When the rotor is at right-angles to the stator, the set gives its greatest volume and selectivity. If oscillations occur in this position, turn the rotor a degree or two until the oscillations clear up and the signal comes through.

GREENE'S SELECTOR

Circuit No. 151. Greene's Improved Concert Selector is a receiver that is extremely popular in the New England States. Due to its extreme selectivity and extraordinary value, it has created a great deal of enthusiasm among New England set builders. An additional feature is that it works best on a short antenna, making it ideal for the dwellers in apartment houses, as well as suburbanites and commuters; although a long

aerial will not impair its efficiency. It is possible with this receiver to tune out a local broadcast station that may be in the vicinity of a few blocks.

Although this remarkable selectivity is extremely popular with the average builder of radio sets, who has encountered no end of interference trouble with other types of sets

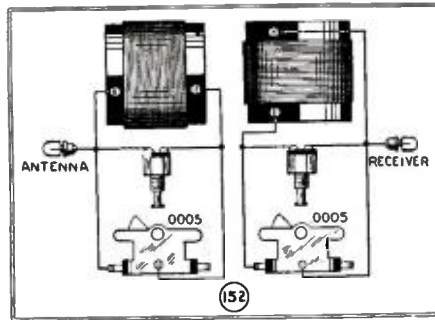

A wave trap that may be used in conjunction with any receiver to eliminate station interference. It is extremely simple both in construction and operation.

that he may have built, it is troublesome to the ordinary layman who has had no experience in the tuning of very selective receivers. However, this handicap may be easily overcome by some little practice in the tuning of this receiver.

It employs two variometers, discarded by so many amateurs in favor of the so-called low-loss coils.

Transformers and other units should be so mounted that all connections leading to these parts are of the shortest possible lengths. With a panel of the size given below and a deep baseboard, about 10 x 17, ample room for all parts, thereby permitting access for wiring and soldering, is possible.

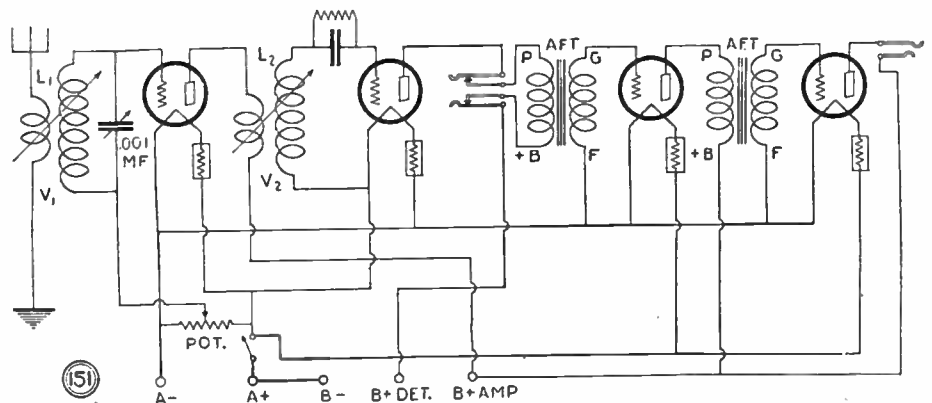

The popular New England circuit, "Greene's Selector," improved so that a considerable increase in efficiency is obtained. This circuit, when used in a well-constructed receiver, experiences no interference worth mentioning, even in close proximity to a broadcast station.

The stabilizer or potentiometer is used for controlling regeneration. The second variometer (V_2) is one of the means of obtaining various stations or wave-lengths, also giving the desired selectivity. The condenser is used for tuning-in various stations.

The other parts required in this receiver are as follows:

- 1 .001- μ f. variable condenser.
- 4 Sockets.
- 4 Amperites.
- 1 7 x 18 panel.
- 1 Grid-leak grid condenser.
- 1 Double-circuit jack.
- 1 Single-circuit jack.
- 1 400-ohm potentiometer.
- 2 Audio frequency transformers.
- Miscellaneous, such as binding posts, screws, etc.

A DOUBLE WAVE-TRAP

Circuit No. 152. Where the usual type of receiving sets is operating in the immediate vicinity of one or more powerful broadcast stations, it is generally impossible to "break through" for distant stations while these locals are on the air. The wave-trap illustrated is a simple and efficient means of reducing such interference. When the wave-trap is so adjusted as to be in resonance with the wave-length of the interference broadcast station, it offers to the energy of that station an almost infinitely high resistance or impedance. Consequently, this energy cannot get through to act upon the receiver; but other stations will not be hindered by this device, and act upon the receiver just as though the wave-trap were not there.

This device has these advantages:

- 1. Eliminating entirely, or in greater degree, interference from one or two local stations.
- 2. The design is such that both traps are sufficiently sharp that they will not affect the signal strength of other stations.
- 3. Separate shorting switches enable the operator to set the traps to the frequency of the interfering station; and thereafter cut out either or both stations at will, by merely closing or opening the proper switch.

The following parts are necessary for the constructing of this double wave-trap:

- 2 .0005 μ f. variable condensers.
- 2 4-inch lengths of bakelite, or hard rubber tubing 4 inches in diameter.
- 1 Pound of No. 18 D.C.C. wire.
- 1 Panel, 7 x 12 inches.
- 2 Ordinary battery switches.
- 2 Dials for the condensers.

Each coil in this wave-trap has 40 turns, and is mounted on the rear-end plate of each condenser, allowing at least an inch space between coil and condenser.

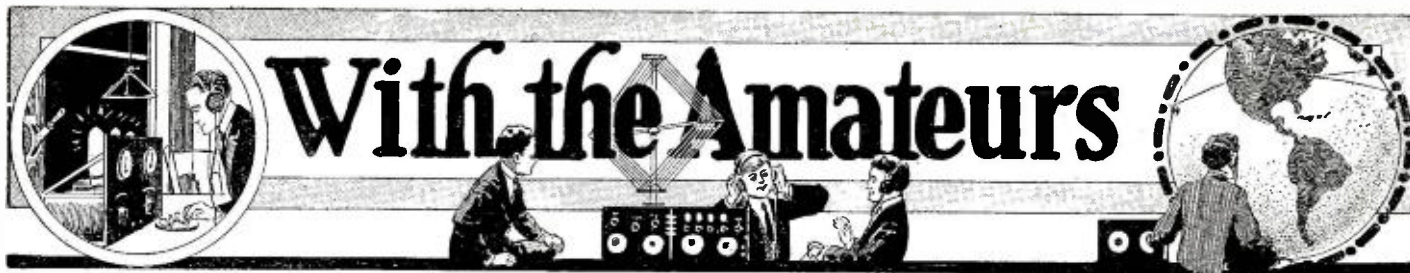

What Wave Shall We Work On?

BY JACK MILLIGRAM

ONLY a few short years ago it would have been not at all necessary to write an article of this type. At that time the hams were allowed to use only the band between 150 and 200 meters, approximately. I say *approximately* advisedly, because there were many that were out of that band. However, today we are allowed space in the ether on no fewer than six different bands. The question now arises, as to which one we should use to the exclusion of all others, or whether we should be as exclusive as this? Might we not be a little better off if we employed two or more of the different wave bands that are now assigned to ham work?

The answer is indeed *YES*—and a short review of the working qualities of the different ham bands will be of great assistance in determining just which we shall design our next transmitter to operate upon.

First, we have the old timer. On 150 to 200 meters we can operate with either C.W. or phone transmission, but, on the other hand, we have to observe quiet hours. Since these are from 8 to 10:30 p.m., local standard time, the operation on such a wave-band exclusively is detrimental to the advancement of amateur radio; and, therefore, we will hardly want to put our transmitter on this band, without the possibility of changing to others. However, there is one great thing about this highest of the wave bands. Local work is fine business here. This is in great contrast to some of the lower bands whose

characteristics will be mentioned later. With a low-powered set operating on about 175 meters, phone transmission can be used and we can have more than a little fun chewing the rag with other hams in the same city, county and state. On C.W. the same thing holds true. We can work locals with these, but DX is not so good. True, a few of the old-timers who have stuck to the high wave band have been, after the congestion cleared up, able to do some most creditable DX work. However, for consistent transmission of this nature, this high wave band is not at all desirable.

The next band that we will consider is 80 meters. It is rumored that we will soon be allowed to use phone on the upper end of this band; but if we are, we will have to observe quiet hours, just the same as we have to on the upper band. Even by the time this magazine reaches you, it may have been officially decided to allow the use of phone on waves between approximately 80 and 85 meters. At the time of writing, however, this is not permitted. The 80-meter band, so called, is mighty good in many respects. Working on it, locals can be communicated with quite consistently, and some wonderful DX can be done with comparatively low power. It is not at all hard to get a set to operate on this band, as the adjustments are not at all critical; and, in fact, the various principles of radio transmission that we learned when operating on the 150- to 200-meter band can readily be

applied to 80 meters. It is only necessary to make the inductances a little smaller, and possibly use smaller tuning condensers. The rest of the apparatus can be left as is and there is nothing at all tricky about getting a set to operate at its greatest efficiency on this band.

THE TEMPERAMENTAL 40 METERS

When, however, we consider the 40-meter band, we find that things are a lot different. Here the eccentricities of short-wave transmission begin to make themselves manifest; and we find that sometimes a set will work on 40 meters, whereas, with slightly different adjustments, it will positively refuse to perk. There is a lot to learn when one first places his transmitter on the 40-meter band, and some most surprising results will be noticed.

For instance, a perfectly good brute-force filter may be used and still the note may be as raw as the rawest of A.C. On the other hand, little filter, if any, may be employed and practically a pure DX note result. Do not, of course, take these as being established facts, because conditions vary so much on the 40-meter band that you are liable to find almost anything happening there. It is safe to say, however, that on this band a filter sometimes works and sometimes doesn't. Once it is set, however, it will usually keep right on working until the tuning of the set is changed.

On 40 meters we have to use a little different design on some of the apparatus. For instance, R.F. chokes should be long and thin, rather than short and fat. They should be space-wound, rather than solid wound, and must never be banked or wound in a honey-comb form. To do this will defeat the entire purpose of the chokes, particularly on the short waves.

The three remaining bands are the 20-, 5- and $\frac{3}{4}$ -meter ones. We will not consider them in our present discussion, because of the fact that, as yet, they are only in an experimental stage; and there is so little being done there in the line of traffic work that they can be practically disregarded at the present moment.

TAKE ADVANTAGE OF THREE BANDS

Now let us see what conclusions we can draw from the facts mentioned above, relative to the various wave bands. Obviously, we do not want to set our transmitter on the high wave band and employ this alone. To do so, virtually closes up our station for two and one-half hours every night, and all Sunday morning during local church services. We do not want to forsake this band entirely and, therefore, we should make provisions for changing over the transmitter from one of the short-wave bands to the highest, so that we can carry on local communication and use phone.

On the other hand, on 40 meters, it is almost impossible to work locals within a radius of 300 or 400 miles and, therefore, it would seem that a set so arranged that either the 40- or the 150- to 200-meter band could be used would be the ideal type. A

(Continued on page 1328)

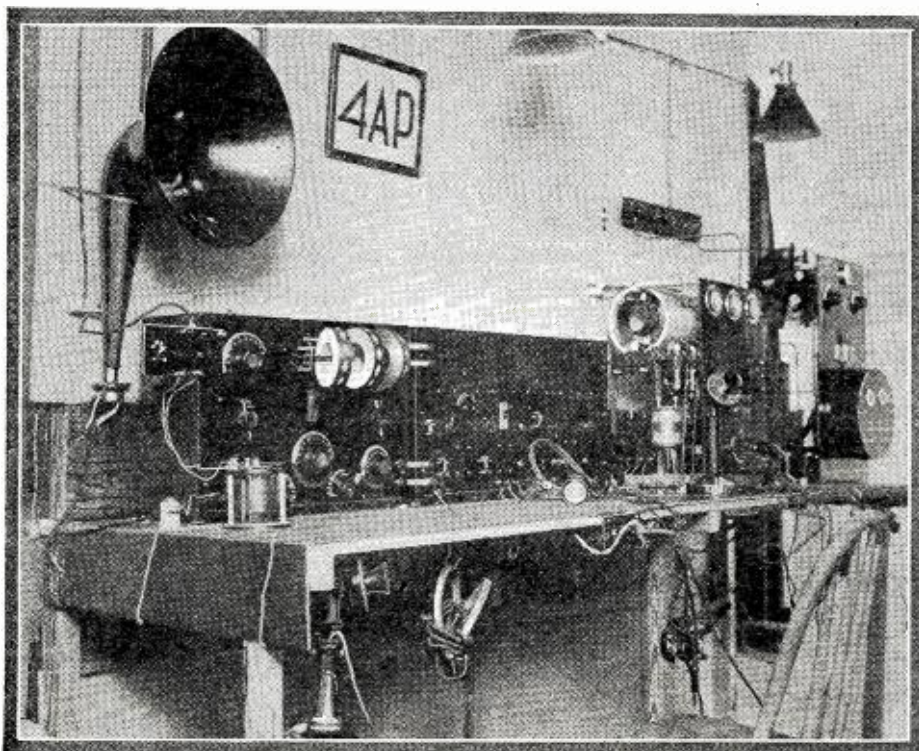

This view of a typical ham station shows one of the most complete and convenient layouts that we have seen for quite some time. Note how handy everything is to the operator; the tuner and the amplifier directly in front of him, the transmitter controls at his right hand, and at his left a telephone for forwarding local messages. We wish that there were more stations of this type in operation today.



**APPROVED
RADIO NEWS
LABORATORIES
1922**

RADIO NEWS LABORATORIES



RADIO manufacturers are invited to send to RADIO NEWS LABORATORIES, samples of their products for test. It does not matter whether or not they advertise in RADIO NEWS, the RADIO NEWS LABORATORIES being an independent organization, with the improvement of radio apparatus as its aim. If, after being tested, the instruments submitted prove to be built according to modern radio engineering practice, they will each be awarded a certificate of merit, and a "write-up" such as those given below will appear in this department of RADIO NEWS. If the apparatus does not pass the Laboratory tests, it will be returned to the manufacturers with suggestions for improvements. No "write-ups" sent by manufacturers are published on these pages, and only apparatus which has been tested by the Laboratories and found to be of good mechanical and electrical construction is described. Inasmuch as the service of the RADIO NEWS LABORATORIES is free to all manufacturers whether they are advertisers or not, it is necessary that all goods to be tested be forwarded prepaid, otherwise they cannot be accepted by the Laboratories. Apparatus ready for the market or already on the market will be tested for manufacturers, as heretofore, free of charge. Apparatus in process of development will be tested at a charge of \$2.00 per hour required to do the work. The Laboratories will be glad to furnish readers with technical information available on all material listed here on receipt of a stamped envelope. The Laboratories can furnish resistances of the various instruments, amplification curves of transformers, losses in condensers, etc., and other technical information. Address all communications and all parcels to RADIO NEWS LABORATORIES, 53 Park Place, New York City.

VARIABLE CONDENSER

This variable condenser was submitted to the RADIO NEWS LABORATORIES for test, by the Precise Manufacturing Company, Rochester, N. Y. It is of the low-loss type and compares very favorably with the ca-

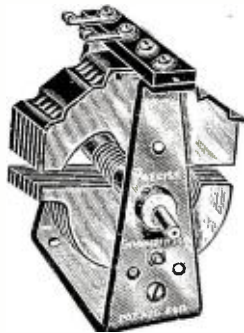

capacity stated by the manufacturer. It is of rigid construction and the stator plates are cut away in order to spread the dial readings of the stations operating on short wavelength.

AWARDED THE RADIO NEWS LABORATORIES CERTIFICATE OF MERIT NO. 1113.

"DIALOG"

The vernier shown here was submitted to the RADIO NEWS LABORATORIES for test, by the Walnut Electric Manufacturing Company, 1249 West Van Buren Street, Chicago,



Ill. It may be used on any receiving set, being of neat design and rigid construction. Stations received may be indicated on one side of the dial.

AWARDED THE RADIO NEWS LABORATORIES CERTIFICATE OF MERIT NO. 1148.

RESISTOFORMER KIT

The kit shown herewith was submitted to the RADIO NEWS LABORATORIES for test, by the Aerovox Wireless Corporation, 489 Broome Street, New York City. It may be used in the construction of any resistance-coupled amplifier, such an amplifier reproducing unusually clear and loud signals. The resistance and condensers were tested in the Labor-

atories and found to compare accurately with the values stated by the manufacturer.



AWARDED THE RADIO NEWS LABORATORIES CERTIFICATE OF MERIT NO. 1157.

"PREMAX" WRENCH SET

The small wrenches shown were submitted to the RADIO NEWS LAB-



ORATORIES for test, by the Niagara Metal Stamping Corporation, 245 Tenth Street, Niagara Falls, N. Y. They may be used in the construction of any radio receiver; various sizes are supplied to fit the various-sized nuts which are generally used in the construction of a set.

AWARDED THE RADIO NEWS LABORATORIES CERTIFICATE OF MERIT NO. 1144.

TOROIDAL TRANSFORMER

This transformer was submitted to the RADIO NEWS LABORATORIES for test, by Naxon Electrical Laboratories, 4526 Cottage Grove Avenue,



Chicago, Ill. It was tested in a tuned circuit of a receiving set and found to have the qualities ascribed to the Toroidal type of coil.

AWARDED THE RADIO NEWS LABORATORIES CERTIFICATE OF MERIT NO. 1150.

CONDENSERETTE

The condenserette shown in the illustration was submitted to the RADIO NEWS LABORATORIES for test, by Gardener & Hepburn, 2100 Washington Avenue, Philadelphia, Pa. This small variable condenser passed the required standards for this type of instrument, and may be used as a neutralizing condenser or oscillation control in various receiving circuits.



AWARDED THE RADIO NEWS LABORATORIES CERTIFICATE OF MERIT NO. 1149.

"HEX" HEAD CAP SCREW

This insulator was submitted to the RADIO NEWS LABORATORIES for test, by the William H. Pearl Co., 425 Harmon Street, Indianapolis, Ind. It is of glazed porcelain; has a fairly long wood-screw, thus enabling it to be used in brick walls; and also may be used as a "stand-off" insulator for both lead-in and outdoor ground.



AWARDED THE RADIO NEWS LABORATORIES CERTIFICATE OF MERIT NO. 1140.

RADIO CRYSTAL

This radio crystal, furnished by the National Efficiency Co., 3908



Holmes Street, Kansas City, Mo., to the RADIO NEWS LABORATORIES for test, was found to have an extraordinary sensitivity and reproduction factor.

AWARDED THE RADIO NEWS LABORATORIES CERTIFICATE OF MERIT NO. 1156.

TUBE-CIRCUIT TESTER

The tube-circuit tester shown in the illustration was furnished by



Robert A. Stevenson, 413 King Street, Lancaster, O., to the RADIO NEWS LABORATORIES for test. This tester was found to be of considerable aid in locating trouble in a radio receiver.

AWARDED THE RADIO NEWS LABORATORIES CERTIFICATE OF MERIT NO. 1132.

HOOK-UP POST

The binding post shown in the illustration was submitted to the



RADIO NEWS LABORATORIES for test, by C. E. Parker, Shidler, Okla. It is of unique construction, is very efficient and may be used in any radio receiving set.

AWARDED THE RADIO NEWS LABORATORIES CERTIFICATE OF MERIT NO. 1127.

"PERFECT TUBE"

The tube shown in the illustration was submitted to the RADIO NEWS LABORATORIES for test, by Gold Seal Products Co., 250 Park Avenue, New York City. This tube was found to be efficient in any type of



receiver and consumes 1/4 ampere of filament current. It fits an ordinary V.T. socket.

AWARDED THE RADIO NEWS LABORATORIES CERTIFICATE OF MERIT NO. 1129.

LOUD SPEAKER

This speaker was submitted to the RADIO NEWS LABORATORIES for test, by Homer P. Snyder Manufacturing Company, Little Falls, N. Y., and was approved, having conformed



with the standards of the laboratory as regards sensitivity, quality of reproduction, volume factor and neatness of design.

AWARDED THE RADIO NEWS LABORATORIES CERTIFICATE OF MERIT NO. 1142.

RADIO CEMENT

The radio cement shown in the illustration was submitted for test to the RADIO NEWS LABORATORIES, by the Phenix Aircraft Products Co.,



Williamsville, N. Y. This cement may be used for insulating or supporting material in various low-loss coils.

AWARDED THE RADIO NEWS LABORATORIES CERTIFICATE OF MERIT NO. 1135.

VACUUM TUBE

The vacuum tube shown in the illustration was submitted to the RADIO NEWS LABORATORIES for test, by the Sunlight Lamp Co., Newton



Falls, Ohio. This tube operates under the usual filament and plate voltages and proves satisfactory when used as a detector or amplifier.

AWARDED THE RADIO NEWS LABORATORIES CERTIFICATE OF MERIT NO. 1136.

JUNIOR LIGHTNING ARRESTER

The lightning arrester shown in



the illustration was submitted to the RADIO NEWS LABORATORIES for test, by the Ajax Electric Specialty Co., 1926 Chestnut Street, St. Louis, Mo. This lightning arrester has been found to pass the requirements of the Board of Fire Underwriters.

AWARDED THE RADIO NEWS LABORATORIES CERTIFICATE OF MERIT NO. 1161.

ANTENNA COUPLER

The antenna coupler shown was submitted to the RADIO NEWS LABORATORIES for test, by the A. J. Hill Manufacturing Company, Atlanta, Ga., and approved as conforming with the laboratory standards with regard to inductance value, construction, resistance of coil, etc. It may be used in conjunction with loop receivers where an antenna and ground are desired. Its outstanding feature is a dustproof case, which permits the coil to have a constant inductance value.

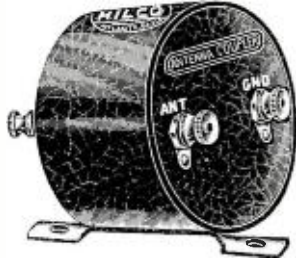

AWARDED THE RADIO NEWS LABORATORIES CERTIFICATE OF MERIT NO. 1151.

AUDIO TRANSFORMER

This audio frequency transformer was submitted to the RADIO NEWS



LABORATORIES for test, by the Samson Company, 832 Park Sq. Bldg., Boston, Mass. It was tried in an ordinary receiving set using audio amplification and found to give distortionless tones, with a high amplification factor.

AWARDED THE RADIO NEWS LABORATORIES CERTIFICATE OF MERIT NO. 1126.

"SUPERETTE RADIO HEAD-SET"

These head-phones were submitted to the RADIO NEWS LABORATORIES for



test, by the Newton Pressed Steel Manufacturing Company, 13 Hawthorne Street, Newton, Mass. They were found to conform with the standards imposed on telephone receivers as regards sensitivity, construction, appearance and qualities of reproduction.

AWARDED THE RADIO NEWS LABORATORIES CERTIFICATE OF MERIT NO. 1147.

ADJUSTABLE CRYSTAL DETECTOR

This crystal detector, shown in the illustration, was submitted to the RADIO NEWS LABORATORIES for test, by the United Metal Stamping and Radio Co., 410 East Pearl Street, Cincinnati, Ohio. It has an entirely different construction from the usual run of crystal detectors, and was

found to be of considerable aid in adjustment of crystal receivers.

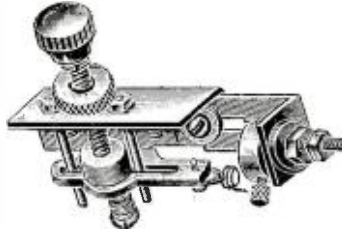

AWARDED THE RADIO NEWS LABORATORIES CERTIFICATE OF MERIT NO. 1145.

AMPLIFIER AND DETECTOR

This tube was submitted to the RADIO NEWS LABORATORY for test, by Titania Trading Corp., 105 West 40th Street, New York City. This tube was found to operate satisfactorily as a detector or amplifier in a broadcast receiver.



AWARDED THE RADIO NEWS LABORATORIES CERTIFICATE OF MERIT NO. 1047.

"CROSLY PUP"

The receiving set shown in the illustration was submitted to the RADIO NEWS LABORATORIES for test, by the Crosley Radio Corp., Cincinnati, Ohio. It has passed all of the standards required of a receiving set in regard to sensitivity and selectivity.



AWARDED THE RADIO NEWS LABORATORIES CERTIFICATE OF MERIT NO. 1131.

"GRIP-IT SOCKET WRENCH"

This socket wrench was submitted to the RADIO NEWS LABORATORIES for test, by the Sattler Tool Co., 126 Joralemon Street, Brooklyn, New York. This tool is of the socket wrench type, which may be used to tighten nuts of any shape. A long handle is supplied, so that the socket wrench may reach into corners where ordinary tools are ineffective.

AWARDED THE RADIO NEWS LABORATORIES CERTIFICATE OF MERIT NO. 1130.

PACENT SOCKET

The socket shown in the illustration was submitted for test to RADIO NEWS LABORATORIES by the Pacent

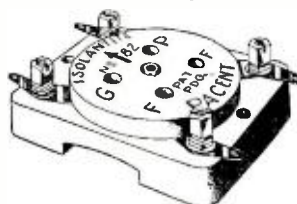

Electric Co., 91 Seventh Avenue, New York City. This socket is constructed on the low loss principle, being entirely made of isolantite. The prongs of the tube make firm

contact with the prongs of the socket in fact, the entire socket is built on sound engineering principle.

AWARDED THE RADIO NEWS LABORATORIES CERTIFICATE OF MERIT NO. 1124.

ELECTRAD FIXED CONDENSER

The condenser shown in the illustration was submitted for test, to the RADIO NEWS LABORATORIES by The Electrad, Inc., 428 Broadway, New York City. This fixed grid condenser is designed for use in the detector circuit of any radio receiver

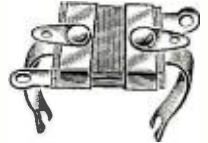

where a tube is employed. It has a grid leak mounting of spring metal and will be found to be very satisfactory.

AWARDED THE RADIO NEWS LABORATORIES CERTIFICATE OF MERIT NO. 1029.

ERLA VERNIER DIAL

The vernier dial shown in the illustration was submitted for test to the RADIO NEWS LABORATORIES, by the Electrical Research Laboratories, Inc., 2500 Cottage Grove Avenue, Chicago, Ill. This vernier dial may be used in conjunction with any receiver. It is of rigid and neat construction and has a fairly slow vernier motion with practically no backlash.



AWARDED THE RADIO NEWS LABORATORIES CERTIFICATE OF MERIT NO. 1117.

AIRGAP SOCKET

This socket was submitted for test to the RADIO NEWS LABORATORIES, by the Airgap Products Co., 376 High Street, Newark, N. J. This socket is of the low loss type, having very little metal, and part of the insulation is cut out between the grid and plate terminals to reduce leakage. It is of neat design, and recommended for use in a receiver where low loss is the prime consideration.



AWARDED THE RADIO NEWS LABORATORIES CERTIFICATE OF MERIT NO. 1056.

SOCKET ADAPTER

This socket adapter submitted to the RADIO NEWS LABORATORIES for test, by the Alden Mfg. Co., Springfield, Mass., is designed for use with



a VX- or CX-199 type tube to be used in the standard VT socket. It is of solid and unique construction.

AWARDED THE RADIO NEWS LABORATORIES CERTIFICATE OF MERIT NO. 1116.



Conducted by Joseph Bernsley

THIS Department is conducted for the benefit of our Radio Experimenters. We shall be glad to answer here questions for the benefit of all, but we can publish only such matter as is of sufficient interest to all.

1. This Department cannot answer more than three questions for each correspondent. Please make these questions brief.
2. Only one side of the sheet should be written upon; all matter should be typewritten or else written in ink. No attention paid to penciled matter.
3. Sketches, diagrams, etc., must be on separate sheets. This Department does not answer questions by mail free of charge.
4. Our Editors will be glad to answer any letter, at the rate of 25c for each question. If, however, questions entail considerable research work, intricate calculations, patent research, etc., a special charge will be made. Before we answer such questions, correspondents will be informed as to the price charge.

Mr. Bernsley answers radio questions from WRNY every Thursday at 8:30 P. M.

SLEEPER RX-1 RECEIVER

(2163) Mr. A. S. Emerson, Burlington, Vt., asks:

Q. 1. I have heard a good deal of the new Sleeper RX-1 Model Receiver. Can you confirm any of the reports as regards its sensitivity and over-all efficiency as a receiver? Also, can you furnish me with constructional details, providing this type of receiver is simple to build?

A. 1. The receiver you mention has aroused a great deal of discussion and interest here in New York City, especially in the radio sections of our various local newspapers. It is very simple and quiet-operating, these two characteristics making it an ideal receiver for the home. The circuit that is used in this receiver is of the conventional type, no "tricks" being incorporated; thus permitting the average builder with very little radio knowledge to build this set, without having to make any peculiar or intricate adjustment.

Another feature in its favor is that it is very inexpensive to build, the parts necessary being few, although necessarily of a high quality. The quality of reproduction obtained from this receiver is excellent, due to the stage of resistance-coupled amplification that follows the detector tube. This is a better scheme than the average system of resistance-coupled amplification, which usually follows a stage or two of transformer-coupled, because distortion from the output of the detector circuit is immediately corrected; whereas, when transformer-coupled amplification follows the detector output, the distortion is enhanced.

The parts necessary for this circuit are as follows:

- 2 .005- μ f. variable condensers, preferably of low-loss straight-line frequency type;
- 2 Coils, wound on a 3-inch tube, and consisting of 45 turns of No. 22 D.S.C.; one having placed within it a primary winding of 8 turns, on a 2 $\frac{1}{4}$ -inch tube (The other coil has a tap at the 35th turn);
- 1 .00025- μ f. grid condenser;
- 1 Two-megohm grid leak;
- 1 .01- μ f. condenser;
- 1 One-megohm grid leak;
- 4 Sockets;
- 1 25-ohm resistance;
- 1 4:1 transformer;
- 2 15-ohm rheostats;
- 1 10-ohm rheostat;
- 1 Single-circuit jack;
- Binding posts, etc.

The circuit diagram for this receiver is shown on this page. (Fig. 2163-A.)

"C" batteries are used in conjunction with this receiver to obtain the proper bias on the radio frequency tube and on the first audio tube. Flexible leads should be used where the "C" battery is connected, in this particular circuit, to one end

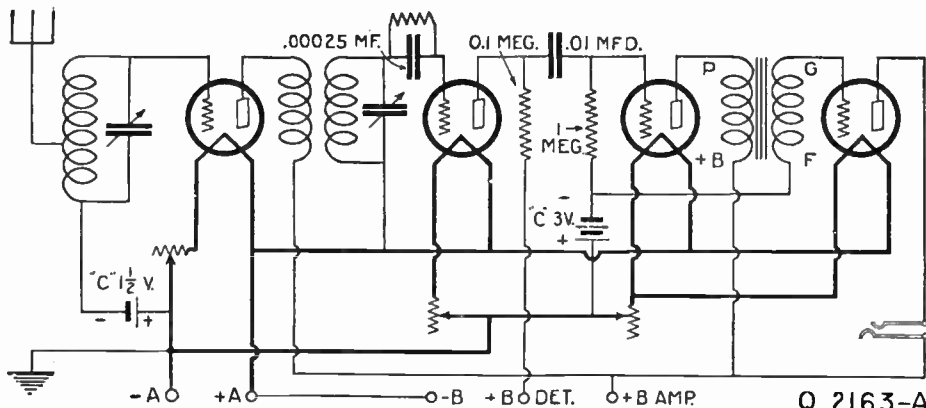

The Sleeper RX-1 Receiving Circuit. Inexpensive and simple to build, one wonders at the results obtained in regard to both sensitivity and quality, for the time and money spent. The stage of resistance-coupled amplification before the ordinary transformer-coupled stage, accounts for the set's unusual quality of reproduction.

audio amplifier. I am using, at present, a three-tube neutrodyne set in connection with a commercial two-stage transformer-coupled audio amplifier; and would like to substitute for this type of amplifier one of the resistance-coupled type to improve the tone of quality obtained. Any information you may give me in regards to this type of amplifier will be greatly appreciated.

A. 3. A resistance-coupled audio amplifier we

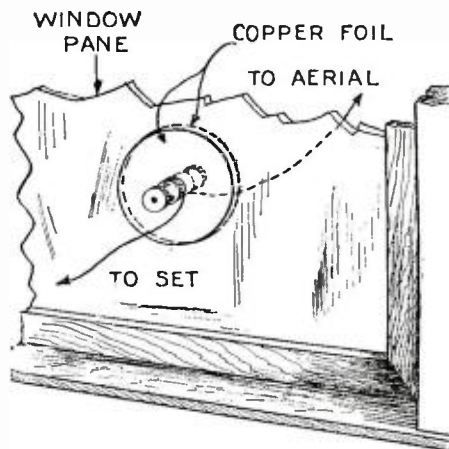

Q. 2163-B. An ingenious "stunt," permitting lead-in connection from an outside aerial to the receiving set, without window holes, porcelain tubes, etc.

CAPACITY LEAD-IN

Q. 2. What is a "capacity lead-in"?
A. 2. This is clearly shown in "2163-B" to be nothing but two circles of metal foil pasted on either side of a window glass. This forms a condenser of considerable capacity and makes it unnecessary to drill a hole through the window or wall. The signals may be said to "go right through the glass."

Copper foil is best. A connection binding post is soldered in the middle of each six-inch circle before fastening to the pane. Use heavy foil or light sheeting.

Because of the enormous amount of mail handled by this department, questions addressed to the "I Want to Know Department" and unaccompanied by the usual remittance of 25 cents per question cannot be answered by letter.

RESISTANCE-COUPLED AUDIO AMPLIFIER

Q. 3. Please give me details and constants used in the construction of a resistance-coupled

can recommend for use with any receiver is shown in Q. 2163-C.

An amplifier with the constants shown and efficiently built, will be capable of giving practically true reproduction; and will satisfy the most critical in regards to tone quality obtained. It is suggested that "B" batteries of the storage or dry type be used for supplying the "B" voltage to this amplifier. Most "B" eliminators on the market have some slight A.C. ripple or hum, unless the D.C. output is of an extremely high quality. We suggest that you stick to ordinary "B" batteries for use with this resistance amplifier, unless you are positive that the "B" eliminator you may wish to use is satisfactory.

TUNED RADIO FREQUENCY SET USING VARIOMETERS

(2164) Mr. R. S. Gillespie, Baltimore, Md., asks:

Q. 1. It seems that none of the popular radio publications are featuring any unusual circuits that contain the "obsoleter" (?) variometer. I have an old two-variometer and variocoupler set, which I used a few years ago for the reception of broadcast and amateur stations. I would like to incorporate the variometers in some sort of unusual five-tube circuit that will be capable of producing satisfactory results in regards to selectivity and sensitivity. Can you furnish me with a diagram of such a circuit? If additional parts are required, please mention them.

A. 1. Due to the entrance of various low-loss coils on the market, variometers have become somewhat obsolete. However, we are here showing a diagram, Fig. 1 (Q. 2164-A), of a five-tube circuit which employs variometers, with remarkable results possible. The circuit is exactly similar to that of the monophase, featured in this magazine some few months ago, except that we substitute for the complicated coils described in that article an ordinary, wooden, old-fashioned "contraption," without any resulting decrease in the efficiency of the receiver. The parts necessary for this circuit are as follows:

- 3 Large wooden variometers.
- 2 10-ohm rheostats.
- 1 Double-circuit jack.
- 3 Dials.

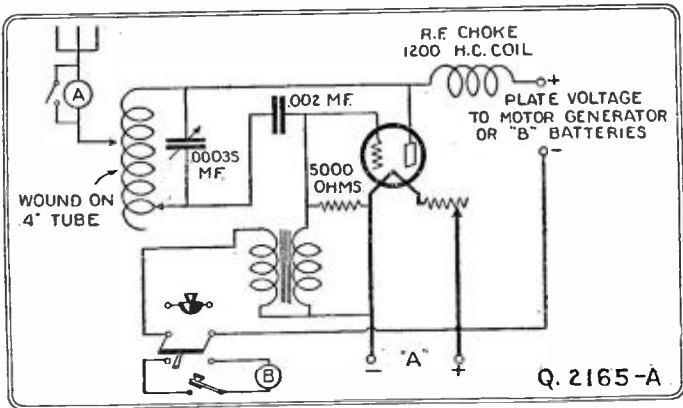

A five-watt phone and I.C.W. transmitter, which may be constructed by the average experimenter. It has a consistent radiophone range of about 20 miles. I.C.W. range of about 500 miles. "B" is a high-pitched buzzer, and the transformer shown is a modulation transformer, which may be a Ford spark coil whose vibrator has been "screwed down tight."

- 1 Microphone,
- 1 High-pitched buzzer,
- 1 Transmitting key,
- 1 Double-pole, double-throw switch.

The transmitting inductance can be constructed by the builder. It consists of 20 turns of No. 14 cotton-covered and enameled wire. This coil should be tapped every two turns after the tenth turn. A primary winding of five turns is wound on top of the secondary, with the same size wire.

When the switch is thrown in one position the transmitter is ready for radio phone transmission; in the other position it is used for code transmission. A motor generator or "B" batteries should be used to supply the plate voltage for the transmitting tube. About 350 volts is suggested, so that a reliable range of at least 25 miles may be covered. It is also suggested that a radiation ammeter be used in series with the antenna, to facilitate the adjustment of the transmitter. Maximum output from the transmitter occurs when the ammeter indicates its highest reading. An ordinary 6-volt flashlight lamp may be substituted for the radiation ammeter, maximum output being indicated by its brightest glow. A switch should be placed across the lamp, and short-circuited when the transmitter is being used for communication.

ELIMINATING STATION INTERFERENCE

Q. 2. I am bothered by constant interference of one particular local station which transmits with 1,500 watts of power. The transmitting station is within the immediate vicinity. Is there any selector or wave-trap circuit that you can give me, which will eliminate this interference? I am positive that the trouble is not in the receiving set, as neighbor friends with radio sets are experiencing the same difficulty.

A. 2. A filter or wave-trap which will eliminate the trouble you mention is shown in the next column. Its construction is fairly simple, having but two parts; although the adjustment of this filter is somewhat complicated. However, once adjusted, it needs no further handling or dial twisting.

The parts necessary for this wave-filter are as follows:

- 1 .001- μ f. variable condenser, low-loss type,
- 1 .0005- μ f. variable condenser, low-loss type,
- 1 Variable resistance, 0-25,000 ohms,
- 2 Bakelite tubes, 3-inch diameter, 4 1/2 inches long,
- 1/2 Pound No. 22 D.S.C. wire.

L₁ consists of 55 turns wound on one side of the tubes. L₂ is 45 turns wound on the remaining tube. L₃ is wound on top of L₂, but is separated by a sheet of empire cloth, or waxed paper, and has ten turns. C₁ is the .001- μ f. variable condenser and C₂ is the .0005- μ f. variable condenser. The theory of this wave-trap is as follows:

The incoming signal flows through cells L₁ and L₂. The circuit comprising L₁ and C₁ is tuned to the frequency of the interfering station, and the condenser is then set at that position. The circuit enclosing C₂ and L₃ is commonly termed an absorption circuit. The condenser of this circuit is rotated until the signal of the interfering station is heard at a minimum strength. The circuit, when in resonance with the interfering station, will absorb almost all of the energy received from that station. The energy is received from coil L₂, which is closely coupled to L₃. In this way, signals of other stations will be allowed to pass through, but that of the interfering station is dissipated in the absorption circuit. The resistance across L₁ and C₁ serves as a static-leak, the resistance being variable to obtain the best adjustment possible.

WHAT FARADS AND HENRYS ARE

(2166) Mr. F. C. Bossert, Houston, Texas, asks:

Q. 1. Among the various and numerous technical terms used in radio are the expressions microfarad and microhenry. I have referred to numerous books on these two terms and cannot seem to get a clear definition or conception of these two terms. I would be very grateful if you could explain them, possibly illustrate in some way, so that these two terms may become clear to me.

A. 1. Just as the gallon, pint, or gill is a unit of measurement to compare or measure liquids, and the inch, foot or yard a unit of measurement to compare or measure size or length, so the henry and farad are the units of measurement to compare various sizes of coils and condensers, respectively.

The unit of capacity is the farad. How large this unit is may be somewhat vaguely suggested to

our imagination by the fact that if everybody in the United States had 18 each of the so-called .0005-mfd. condensers (usually equal to 18 plates), the total capacity of the whole lot, connected in parallel, would be one farad. The question naturally arises in everybody's mind, why such a huge unit was ever chosen to begin with? A volt, the unit of potential, is a convenient size. An ampere, the unit of current, is convenient. An ohm is an easily-obtained quantity of resistance. These three are the basic units. Starting with these three, such a unit as a farad is a derived unit; that is, it follows as a matter of definition.

A condenser is fundamentally a dielectric with a conductive plate on each side of it. Connected to an electric source, the condenser is charged. The larger the charge, the greater the difference of potential between the two conductive plates; and the equation is that Q equals E times C, when Q is the charge, E is the potential, and C is a constant for any particular dielectric and arrangement of parts. C is a ratio of Q to E, and we call it the capacity.

The unit of capacity is the capacity of a condenser charged to a potential of one volt by a unit quantity of electricity. The name of a unit quantity of electricity is a coulomb, which is the charge transmitted in one second by a current of one ampere. Really, therefore, the farad is the ratio of the unit of charge to the unit of potential.

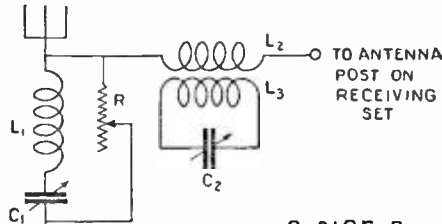

An exceedingly efficient wave-trap to eliminate that "local station" interference. The circuit is similar to that employed by broadcast stations to "eliminate their own" interference, thus enabling them to listen to other stations.

Like the unit of capacity, the unit of inductance is a tremendous unit. It is the henry. While in capacity we usually deal with the millionth part of a farad, in inductance we usually deal with the thousandth part of a henry, the millihenry; although in radio work the microhenry is not uncommon, because air-cored coils are much used.

The henry is also a derived unit and its size is due, not to design, but to force of circumstances. It is the inductance in a circuit when the electromotive force induced in the circuit is one volt, and the inducing current varies at the rate of one ampere per second. It, therefore, is derived from the unit of voltage and the unit of current.

Unfortunately, the formulas for inductances are subject to many correction factors, and are very elaborate. It is almost impossible to figure accurately the inductance of a coil without consideration of a multitude of factors, some of which cannot be known with accuracy. In general, the inductance is directly proportional to the length of the coil, the square of the mean diameter, and the square of the number of turns per unit of length; and in each case the inductance depends on the material of the core.

A core of iron gives much greater inductance than one of any other substance. Air and non-magnetic materials give minimum inductance.

Put simply, the larger the diameter the greater the inductance, and the gain is more rapid than simple proportion. A 4-inch coil diameter gives 16 times the inductance of a 1-inch coil. The number of turns per inch of length determines the inductance largely. Double the number of turns per inch, as by using finer wire, and you will get four times the inductance. The longer the coil the greater the inductance.

Various interesting and technical data and explanations may be obtained from the book "Morecroft's Principles of Radio"; and from the data sheets published in the various radio departments of the *Experimenter*, *Science and Invention*, *Radio Listeners' Guide and Call Book*, and *Radio Review*.

REMEDIES FOR INTERFERENCE

Q. 2. In my immediate vicinity there is a con-

stant electrical disturbance of some sort which bothers radio receiving sets in this location. Perhaps you can mention the various causes of such disturbances, and remedies, so that I may in some way familiarize myself concerning same and perhaps eliminate.

A. 2. An original review of causes and remedies would be somewhat too lengthy for this department, but some helpful suggestions may be found in the article on page 1286 of this issue, "Tracing Interference to Its Lair," which tells of the methods employed by the U. S. Bureau of Standards in detecting and combating interference.

WHY "A" AND "B" BATTERIES?

(2167). Mr. N. R. Sordeil, Charleston, South Carolina, asks:

Q. 1. In connecting up radio receivers, I have often heard the expressions "A" and "B" batteries, as applied to the various batteries that are connected to the receiving set; and have often wondered why there are two batteries necessary? Why the different expressions "A" and "B" are used? What the functions of each are? Why one has only 6 volts, whereas the other has at least 90? Perhaps you can clear up some of these difficulties.

A. 1. To explain why we have "A" and "B" batteries in a receiving set, the functions of each, and why one high-voltage and one low-voltage battery is used, it is necessary to go into an explanation of the principle of the vacuum tube as used for radio purposes. We will attempt to make this explanation as clear and non-technical as possible. For a technical and lengthy explanation of the evolution and functions of a vacuum tube, the reader is referred to the December, 1925, January and February, 1926, issues of *The Experimenter*; or to Morecroft's "Principles of Radio," or Van Der Bijl's "Thermionic Tubes."

Through the researches of scientists, such as Thomson, Richardson and Millikan, we know now that when certain metals are heated to incandescence, particles of matter are thrown off. These particles are called electrons and the theory explaining this phenomenon is called the "Electron Theory." Incidentally, these electrons are negative particles, and at present the smallest particles of matter known.

In 1904 Fleming (another scientist) was granted a patent on the device called a "Fleming valve," which consists of a filament-and-plate element enclosed in an evacuated glass vessel. In school, in the physics or science class, we learned that positive attracts negative, or vice versa, depending upon which has greater strength. Fleming inserted in this device a battery of high potential. The positive side of this battery was connected to the plate within the vessel, thus making the plate highly positive, thereby enabling it to attract the electrons which were thrown off by the heated filament. This device was of little practical use as far as radio (in those days called "wireless") was concerned, until 1906 when DeForest inserted the third element called the "grid," thereby making the most sensitive detector known.

Now to show how "A" and "B" batteries are concerned. The battery required to heat the filament to incandescence is called the "A" battery (probably because it is the first battery to be taken into consideration, or primary battery). The battery required to give the plate its positive potential is called the "B" battery. However, since the filament consumes an enormous amount of current compared to that used by the plate element of the tube, the battery necessary to heat the filament must have a high amperage capacity, ranging from 28 to 120 amperes, depending upon the number of tubes used in the receiving set, and the type of tubes. In the early days tubes were manufactured with filaments which required six volts and consumed about an ampere. At present, due to research and developments made by the General Electric engineers, we have radio tubes which operate from a dry cell or two, and consume only from .06 to 25 of an ampere.

The "plate" of the tube consumes very little current, as aforementioned but requires an extremely high potential, varying from 22 1/2 volts for a "soft" or detector tube, to 90 volts for the ordinary amplifier tube, and about 135 volts for a power-amplifier tube. Ordinary "B" batteries are constructed (consisting of a number of very small cells) so that, although their amperage capacity is very low, ranging from two to seven amperes (of total output) the voltage delivered is high because of the small cells, each delivering 1 1/2 volts, being connected in series.

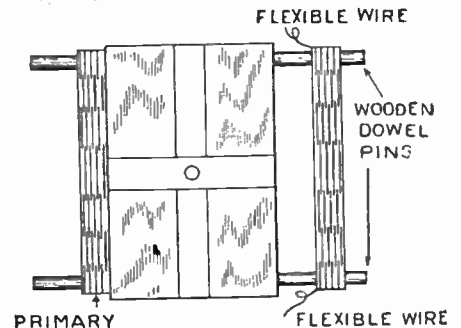

Q. 2164-A

Fig. 2. The method used for mounting the coils to the variometer for the modified Monophase circuit shown on previous page.

silent power

...from your lighting socket

THE most rigid specification set for the Duo-Rectron, the new RCA "B" battery eliminator, was that it be silent—hum-free. The hum of the 110 volt, 50 or 60 cycle line current has been filtered out by a special filter system. And the perfection of this system is guarded by minutest care in manufacture.



no more—no less. This means that whether you have a one tube set or a ten, you can depend on the Duo-Rectron

for the correct voltage, under any current drain, all the way up to 50 milliamperes.

The new rectifying tube, Radiotron UX-213, is built for long service—designed especially for this power unit.

In many important points the Duo-Rectron meets demands never met before.

Everything has been considered in the RCA Duo-Rectron—silent power, reserve power, economical power, constant power!

One new feature is a *voltage regulator*—a new tube that keeps plate voltages constant. The Duo-Rectron has taps for 22½, 45, 90 and even 135 volts. Hook up where you will, you get the voltage marked—

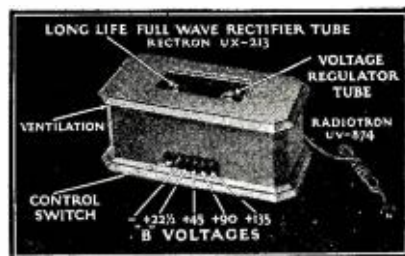

RCA Duo-Rectron, complete \$65

* * *
The RCA Uni-Rectron is a power amplifier for loudspeakers. Connect it with the first audio stage of any set and get super-power amplification from an A. C. socket. Price complete . . . \$105

RCA Duo-Rectron



RADIO CORPORATION OF AMERICA · NEW YORK · CHICAGO · SAN FRANCISCO

UNION RADIO TIP JACKS

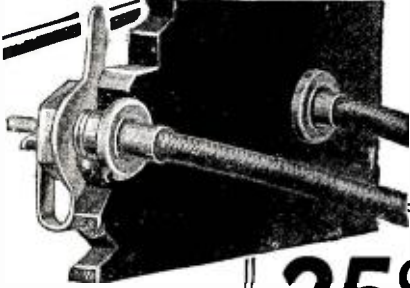

**25°
A PAIR**

Are Being Used As Standard Equipment In Many of the Finest Receivers

CONNECT your battery leads, aerials, ground and output wires to Union Radio Tip Jacks and get a quick, positive, steady connection. No parts to loosen—no parts to lose. Plug in and out at will. Neat in appearance, handy and far superior to all other forms of connections.

Firmly grip all wires from No. 11 to No. 24 B & S gauge. Three sizes for all panels. TYPE A (Standard) for 3/16" to 1/4" panels. TYPE B (Special) for panels, cabinet walls and partitions from 5/16" to 1/2" thick. TYPE C (Special) for panels up to 1/8" thick. HEAVILY NICKEL PLATED.

The Engineers and Designers of the **HAMMARLUND-ROBERTS RECEIVER**

Specify the Use of Union Radio Tip Jacks

for their convenience, and ease of connecting and disconnecting all the input lead wires. This compact, efficient and highly recognized receiver employs only the finest standard parts. Union Radio Tip Jacks are also used as standard equipment in many of the finest receivers on the market.

Other Guaranteed Union Products

VERNIER DIAL ADJUSTERS — Handy for finer tuning. Price 60c.



IDENTIFICATION TAGS — Hard, red fibre ovals with stamped designations. Thread them on your wires—they save time in tracing leads. COMPLETE SET OF 9 TAGS ONLY 10c.

Ask your dealer for Union Radio Tip Jacks and other guaranteed products or write to us for illustrated and descriptive circular "C."

TO ALL BRANCHES OF THE TRADE

Send for literature and samples of our reasonably priced Guaranteed Radio Products. Get details of our attractive proposition.

UNION RADIO CORPORATION
124 SUSSEX AVENUE, NEWARK, N.J.
NEW YORK OFFICE 116 WEST 32ND STREET

The Crystal Classified and Analyzed

(Continued from page 1300)

to the sulphide group of rectifiers, is never found naturally occurring in an absolutely pure state. Most of the galena crystals which are marketed at the present day contain other chemical compounds besides the basic lead sulphide. Traces of silver sulphide, arsenic sulphide, antimony sulphide, lead sulphate and carbonate, and a number of other compounds are always to be found in natural galena. Nevertheless, the basic constituent of natural galena is lead sulphide, and for this reason the mineral is placed in the sulphide group of rectifiers.

SILICON

The elementary group of rectifiers is not a very large one. It contains those elements which are set forth in the table, and also a number of special alloys which have been observed to possess slight, yet definite rectifying properties. Probably the best known rectifier belonging to this group is the element silicon, which is very widely distributed in nature.

Silicon occurs in a very large number of rocks, but for commercial purposes it is obtained from sand, this material being heated to a very high temperature in an electric furnace along with a number of other substances.

Silicon makes a very good rectifier. It is not quite so sensitive as galena, but it has the advantage over the latter mineral in that it retains its sensitivity over very long periods, and also that it is not generally sensitive to the effects of heat.

PERIKON

Tellurium and graphite (which is a form of carbon) are not generally used for purposes of rectification with metallic contacts. They are best employed as one of the elements of a perikon detector, tellurium giving especially good and efficient results when it is used in conjunction with zincite. Graphite is at its best when it is used in light contact with ordinary galena. Nevertheless, both these elements will rectify when they are used alone in contact with an ordinary piece of fine wire.

COMPOSITION OF "ITES" CRYSTAL

The sulphide group of rectifying minerals includes all the best known and the most widely used substances of this description. Galena is, of course, the most prominent member of this category, for this mineral, in a natural or a synthetic state, forms the basis of practically all the numerous proprietary crystal and rectifying substances. All the crystal "ites" are composed of galena in one form or another, and they give good results because, for ordinary short distance reception of telephony, galena is the most efficient mineral to use in a simple metallic contact detector. Furthermore, by incorporating small but definite traces of other mineral sulphides with galena, the sensitivity of the resulting product can be very considerably increased. Galena is the commonest and also the least expensive of all rectifying minerals, and this fact accounts in some respects for the many different forms and varieties of this material which are to be seen on the market today.

Molybdenite, stibnite and iron pyrites are simple sulphides like galena, but the remainder of the sulphide group of minerals consist of sulphides of more complex composition.

Take the well-known bornite, for instance. This mineral contains copper, iron and sulphur. It is a "double sulphide," not a mere mechanical mixture of copper and iron sulphides; but a definite chemical compound

containing copper, iron and sulphur in constant proportions.

SUB-MEMBERS

There are a number of rare minerals which can be employed as rectifiers and which, although they are not sulphides, are very much akin in chemical composition to the members of this group. Such minerals are the arsenides, tellurides and selenides of certain metals. That is to say, they consist of combinations of these metals with arsenic, tellurium and selenium, respectively. In chemical properties, however, they are very similar to the metallic sulphides and, therefore, they may be considered as sub-members of the sulphide group of rectifying minerals.

Hessite, for example, which is a naturally occurring telluride of silver, is an excellent rectifier when used in conjunction with zincite. Nagyagite, a telluride of gold and lead, gives still better results when used under the same conditions. Both these minerals, however, are extremely rare.

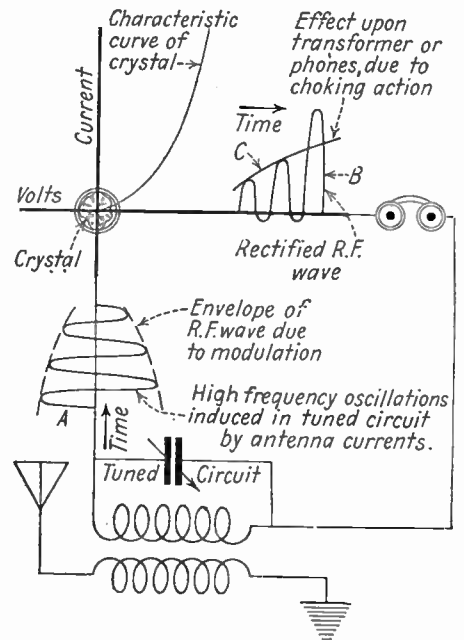

This diagram shows in a schematic way how rectification is accomplished by means of the crystal detector. The explanation is given on page 1318.

THE OXIDE GROUPS

Coming, finally, to the third group of crystal rectifiers—the oxide group—we notice that the best known member of this group is zincite, which is an impure oxide of zinc. Zinc oxide, in its pure state, is almost perfectly white in color, and the natural oxide of that metal, zincite, derives its characteristic ruby-red color from traces of manganese, which are always present in it to a greater or less extent.

If we include in the oxide category of rectifiers all the oxides which give only slight rectification, we shall find that this group of rectifiers is the largest of the three. Practically any metallic oxide is capable of functioning as a rectifier, provided it is used with a very light contact.

SYNTHETIC ZINCITE

With the exception of zincite, the members of the oxide group of rectifiers are not very much used for rectification purposes on account of the much greater superiority and ease of working of the materials comprising the sulphide group. Zincite, however, is a very important rectifier, and on account of this fact, successful attempts have been made to produce it artificially, with the result that "synthetic yellow oxide" is now rapidly gaining favor with many crystal experimenters as an effective substitute for the more expensive natural zincite.

Perhaps you, too, can cut your "B" battery costs in half. Just follow the chart. It gives you the secret of "B" battery economy.

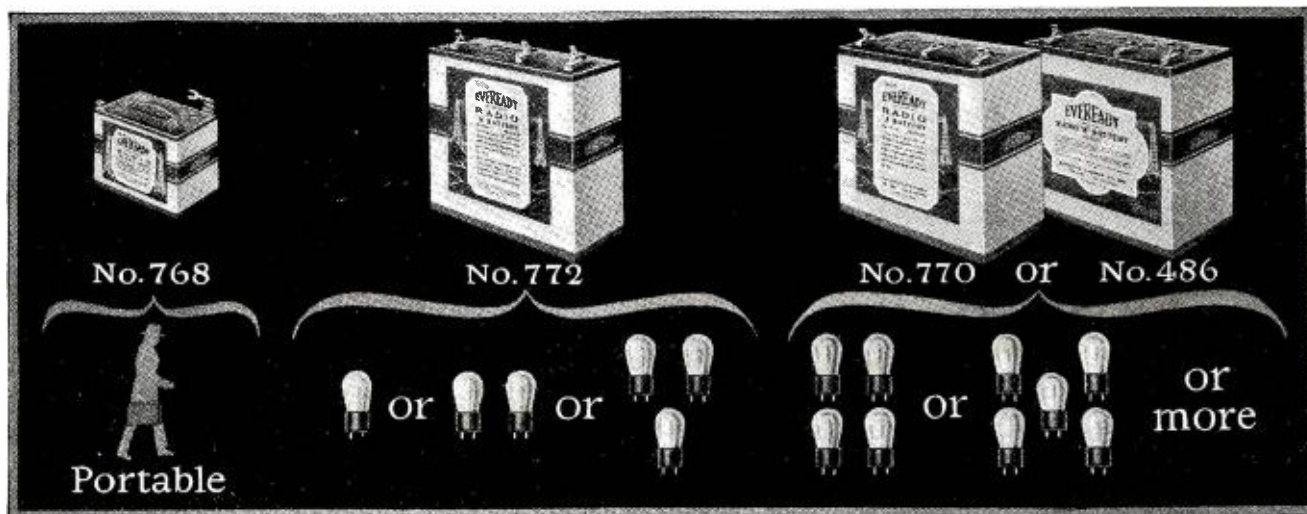

THOUSANDS of people have made the discovery that Eveready "B" Batteries, when used in the proper size and with a "C" battery*, are the most economical, reliable and satisfactory source of radio current.

On sets of one to three tubes, Eveready "B" Battery No. 772, used with a "C" battery, will last a year or longer, usually longer. On sets of four and five tubes either of the larger Heavy Duty Eveready Batteries No. 770 or No. 486, used with a "C" battery*, will last eight months or more.

These figures are based on the average use of receivers, which a country-wide survey has shown to be two hours daily throughout the year. If you listen longer, of course, your batteries will have a somewhat

*NOTE: In addition to the increased life which an Eveready "C" Battery gives to your "B" batteries, it will add a quality of reception unobtainable without it.

shorter life, and if you listen less, they will last just that much longer.

Here is the secret of "B" battery satisfaction and economy:

With sets of from 1 to 3 tubes, use Eveready No. 772.

With sets of 4 or more tubes, use either of the Heavy Duty Batteries, No. 770, or the even longer-lived Eveready Layerbilt No. 486.

Use a "C" battery on all but single tube sets.

Evereadys give you their remarkable service to the full when they are correctly matched in capacity to the demands made upon them by your receiver. It is wasteful to buy batteries that are too small. Follow the chart.

In addition to the batteries

illustrated, which fit practically all of the receivers in use, we also make a number of other types for special purposes. There is an Eveready Radio Battery for every radio use. To learn more about the entire Eveready line, write for the booklet, "Choosing and Using the Right Radio Batteries," which we will be glad to send you on request. This booklet also tells about the proper battery equipment for use with the new power tubes. There is an Eveready dealer nearby.

Manufactured and guaranteed by
NATIONAL CARBON CO., INC.
 New York San Francisco
 Canadian National Carbon Co., Limited
 Toronto, Ontario

Tuesday night means Eveready Hour
 —9 P. M., Eastern Standard Time,
 through the following stations:

- | | |
|------------------|---|
| WEAF—New York | WSAI—Cincinnati |
| WJAR—Providence | WEAR—Cleveland |
| WEEL—Boston | WWJ—Detroit |
| WTAG—Worcester | WGN—Chicago |
| WFI—Philadelphia | WOC—Davenport |
| WGR—Buffalo | WCCO—Minneapolis |
| WCAE—Pittsburgh | WCCO—St. Paul |
| | KSD—St. Louis |
| | KGO—San Francisco, 8 P. M. Pacific Coast Time |

EVEREADY
Radio Batteries
—they last longer—

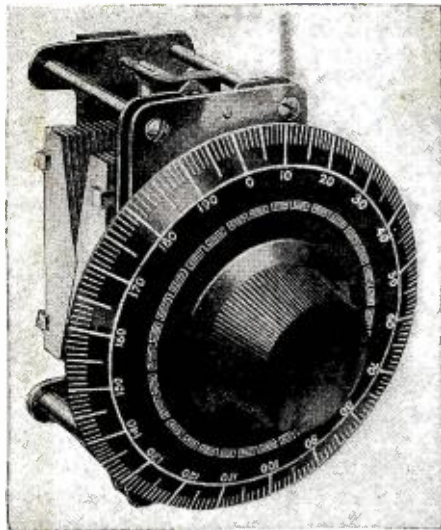

Greater Station Spread with 360° Dial

NEW Wade vernier dial, finished in beautiful black lacquer is a vital factor in the Wade tuning efficiency—Spreads stations over the entire 360° circumference and gives twice the space between stations for close tuning as rotor plate types of straight line frequency condensers using 180° dials. No more bunching of stations, none of the annoyance of overlapping stations.

By actual test the Wade condenser gives the lowest minimum capacity and wider tuning range. Covers the whole broadcast range and down below 200 meters.

No Body Capacity Effects

A separately grounded frame, insulated from both sets of plates, shields the condenser from all body capacity effects—an important feature, exclusively in Wade Condensers.

WADE TUNING UNIT Including Condenser and Dial

The Wade Tuning Unit consists of a Wade Condenser geared to a four-inch 360 degree vernier dial of 16 to 1 ratio. Finest possible control with no backlash. Prices below are for the complete unit.

Capacity .00125 mfd.	\$6.00
Capacity .00025 mfd.	6.25
Capacity .00035 mfd.	6.35
Capacity .0005 mfd.	6.50

At your dealer, otherwise send purchase price and you will be supplied postpaid.

Jobbers and dealers write for further information and opportunities in your locality.

THE VIKING TOOL AND MACHINE COMPANY, INC.

745-C 65th Street, Brooklyn, N. Y.

WADE

There are one or two rectifying minerals which have not been included in the above classification. Carborundum is the most prominent member of these. This material, however, cannot properly be termed a mineral, because it is not found in a natural state. Carborundum is essentially an artificial product.

Cerussite, another rarely used rectifier, is a carbonate of lead which is found naturally occurring in various parts of the world.

Before concluding this article, it may be well to explain the action of the crystal detector in a radio receiver. This may be done very simply and easily by means of the circuit diagram shown in the sketch on page 1316, which was worked out by Mr. Sylvan Harris of the *RADIO NEWS* staff.

This diagram shows a simple crystal hook-up in which the lines representing the wires have been used as the axes of the characteristic curve of the crystal. These two axes are drawn heavily, and represent the current through the crystal and the voltage impressed on it. The explanation is as follows:

The current induced in the antenna by the traveling radio wave induces a high frequency wave in the tuned circuit. This secondary current has the form shown at A on the diagram and the envelope (or dotted curves) represents the variations in amplitude due to the modulation at the transmitting station.

When this high frequency current passes through the detector it is rectified, due to the asymmetrical conductivity of the crystal, into the shape shown at B. In the curve A it is seen that there is just as much of the oscillation on one side of the axis as on the other. At B there is more of the curve above the axis than below, so that the average value of the current in the phones will have a distinct direction, and a finite value.

The phones, however, due to their high impedance to the high frequency oscillations, as well as the sluggishness of the diaphragm, cannot respond to each individual oscillation, so they respond to the average value of the curve B. In other words, the high frequency oscillations at A have been rectified by the crystal into the form B, which is then "choked" into the form C. The same thing happens when the phones are replaced by a transformer, when amplification follows detection.

It will be noted that there is a loss of energy in the crystal due to its resistance. This is shown by the difference in size between A and B. In vacuum tube rectifiers, there is an amplification, the losses being more than made up by the energy released from the "B" batteries.

A Parlor Music Maker

(Continued from page 1295)

fibre peg, $\frac{3}{8}$ inch in diameter and $1\frac{1}{2}$ inches long, which is drilled and tapped at one end for a 6/32-inch screw. This peg is screwed onto the end of a piece of stiff brass about $\frac{1}{2}$ inch wide and $1\frac{1}{2}$ inches long. By means of a second hole drilled into this piece of brass, about an inch away from the one for mounting the fibre peg, the entire antenna inductance unit may be very conveniently mounted under one of the end nuts of the first tuning condenser, as shown in the illustration.

AERIAL AND GROUND

There is no ground binding-post on the receiver in the picture; the ground connection is made to the negative post of the filament-lighting storage battery; thereby eliminating a wire. In the set, the antenna coil is then grounded through its being connected to the A—lead.

The antenna coil shown, by the way, has small flexible braided copper leads attached to it, which are taken directly to the two sides of the first tuning condenser and to the antenna connection. This eliminates the soldering of any bus-wires directly to the coil ends, which procedure always makes a rather unsightly job.

The .0001- μ f. fixed condenser for use in the aerial circuit does not appear in the photograph, because it is mounted underneath the bakelite strip supporting the filament rheostats and antenna binding-posts.

The neutralizer in this receiver is a three-plate condenser of rather large size for this purpose. The builder need not necessarily use one of this type; almost any midget condenser or standard neutralizing condenser may be employed; but the one that is used should be conveniently adjustable.

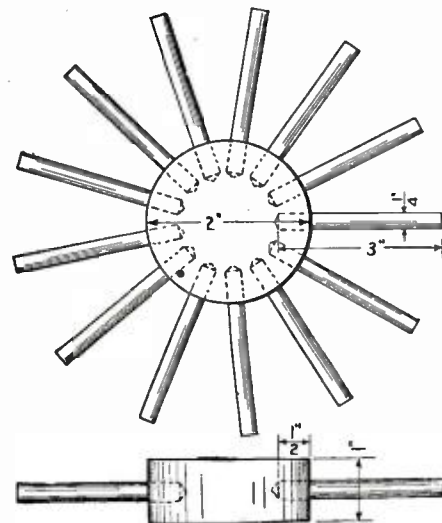

FIG. 3

Detail of simple coil-winding form, described on page 1295.

The following is a complete list of the parts required to build the receiver:

- 1 Panel, 7 x 18 x $\frac{1}{8}$ inches. (See Fig. 4.)
- 1 Baseboard, 10 x 17 $\frac{1}{2}$ x $\frac{1}{2}$ inches,
- 1 Bakelite sheet for baseboard (optional),
- 1 Bakelite strip, 7 x $\frac{1}{2}$ x $\frac{1}{8}$ inches,
- 2 Variable condensers, straight-line frequency, .0005 μ f.,
- 2 Vernier dials,
- 1 "A" battery switch,
- 1 Set of inductance coils and mountings (or build as in text),
- 2 Sockets for 201-A type tubes,
- 2 Rheostats, 20-ohm,
- 1 Neutralizing condenser,
- 2 Antenna binding-posts,
- 1 .0001- μ f. fixed condenser,
- 1 .00025- μ f. fixed condenser,
- 1 .002- μ f. fixed condenser,
- 1 .004- μ f. fixed condenser (for shunting across amplifier output),
- 1 1- μ f. by-pass condenser (optional),
- 1 Grid leak, 2 meg.,
- 1 Three-stage resistance amplifier, assembled, or in knocked-down kit (or corresponding units).

ADJUSTMENT OF SET

If, when testing out the newly-built set, the constructor finds that it has a tendency to oscillate or whistle, even with the tickler-coil turned down at right angles to the secondary coil, he should carefully adjust the neutralizing condenser, until oscillation ceases. If the set has a tendency to persist in oscillating, it indicates that too much filament voltage is being applied to the radio-frequency tube, and possibly to the detector tube. Cut in resistance on the filament



DON'T APOLOGIZE

WHAT a feeling that is,—isn't it? All the neighbors and the wife gathered round to hear you make good on that crack—that you got "MIAMI" last night. ¶ And you work and sweat and pray with a net result of many squaks, a few whistles and finally hear a few remarks, from your local broadcasting station ten miles away, for the relief of the suffering South Sea Islanders. It's awful. ¶ Good Tubes are the answer to many radio troubles—the great majority of the sets are good—the hookup in most cases is very simple—but you must rely on your tubes to do the work—and that's where Sylvania comes in. ¶ Sylvania Tubes are

Good Tubes—no higher in price—they are excelled by none in quality, performance and life. ¶ Try this better tube—it will please you as it has thousands of others—and amaze you, too, with the results you will get. At your dealers or write us direct.



Sylvania

Radio Tubes



SYLVANIA PRODUCTS COMPANY
EMPORIUM, PENNA.

"THERE'S A SYLVANIA FOR EVERY TUBE APPLICATION"

“and even the distant stations now come in loud and clear”

A UX Power Tube will increase volume and clarity in YOUR set, too!

REWIRING UNNECESSARY

NOTE: The UX-120 tube has been designed to increase volume and clarity in all dry battery sets. The UX-112 tube has been designed to increase volume and clarity in storage battery sets. To make it easy for you to secure the great benefits of the UX tubes without rewiring their sets, a complete line of Na-Ald Adapters and Connectorals have been manufactured.

Months of service have proved their efficiency. Below are given three very efficient and easily made applications of the new power tubes. For complete details covering all possible applications of the new tubes mail coupon at bottom of ad.

How to improve sets equipped with UV-199 tubes
To increase volume and clarity in sets using UV-199 tubes, use the UX-120 tube in the last stage. Easily fitted to the UV-199 socket with a Na-Ald No. 920 Connectorald which also provides cables for attaching necessary extra 45 volts B battery and 22½ volts C battery required for the UX tube. Price, \$1.25.

How to switch to dry batteries without sacrificing volume or quality

The combination of a UX-120 tube for the last stage with UX-199 tubes in the other sockets provides with dry cells, results previously obtained only with storage batteries. Fit UX-120 tube to the UV-201A Socket with Na-Ald Connectorald No. 120. Cables provided for attaching extra B and C batteries. Fit UX-199 tubes in all other sockets with Na-Ald No. 419-X Adapters. Price, No. 120 Connectorald, \$1.25; No. 419-X Adapters, 35c.

How to improve storage battery sets

Volume and clarity can be increased in storage battery sets by using the UX-112 tube in the last stage. Easily fitted to the UV-201A socket by means of the Na-Ald No. 112 Connectorald which provides cables for attaching necessary extra B and C batteries. Price, \$1.25. Mail coupon below for complete adapter information covering use of new tubes in all sets.

ALDEN MANUFACTURING COMPANY
Dept. K17 Springfield, Mass.

All Na-Ald Sockets, Dials and Adapters are protected by patents. Many patents pending.



ALDEN MFG. CO.,
Dept. K17, Springfield, Mass.

Please send me complete information on how to increase volume and clarity in any set by the use of the new tubes.

Name
Address
City State.....

rheostat of the radio-frequency tube, until the set becomes perfectly quiet at all settings of the tuning condensers.

Best results will always be obtained with the radio-frequency tube operating on rather low filament voltage, and with the neutralizing condenser adjusted to as low capacity as is found consistent with quiet operation. The detector tube should also be operated on moderate filament voltage.

The tickler-coil may be left turned down at right angles to the secondary, when receiving local stations; but when receiving a weak station, it should be brought up near the oscillating point. There is no substitute for this regenerative control, when fishing for distant stations.

It will be observed that no jacks have been used in this receiver. They seem a rather unnecessary complication on a parlor instrument. If an output jack is desired, however, it should be mounted on a small strip of bakelite screwed onto rear edge of the baseboard, placing the jack opposite and over the output binding-posts of the resistance-coupled amplifier. Then a hole of suit-

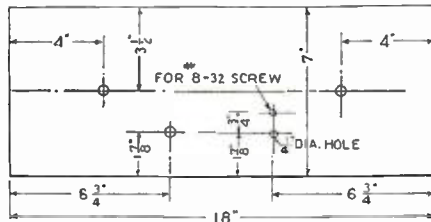

Panel lay-out of the Parlor Music Maker. Only center holes for condensers are indicated, as positions of others will depend on make of condensers used.

able size may be bored into the back of the cabinet, to enable the insertion of the speaker-plug into the jack.

LEAVE WELL ENOUGH ALONE

Without desiring to hold a brief in favor of any particular speaker, I wish that every person who builds this receiver could connect it to a good cone-type reproducer; for only then will the marvelous results obtainable with the resistance-coupled amplifier be most completely realized.

If, when operating this receiver, you find that your fingers seem to itch to lift up the cabinet-cover and turn the rheostats every minute or two, even after they have been properly adjusted, I recommend that you lie yourself forthwith to your workshop and hastily mount seven or eight old junked rheostats on a piece of scrapped panel, or on a piece of board knocked from the side of a soap box. This panel or board you may then set up on the table, beside the receiver—but without connecting to it in any way. Then you may relieve the itching of your fingers by turning all these rheostats violently back and forth. You may feel foolish doing this when company is present, in which case you are advised to hide the panel with the seven rheostats in your lap, under the latest radio magazine, or under a newspaper. But, of course, if this does not help, the only thing to do will be to mount the two receiver rheostats on the panel.

This is the kind of receiver that will please mother and sister, and possibly wifey; for there is nothing to do but pull out the battery switch and turn the two tuning dials together. The regenerative control is of no great importance in tuning in strong local stations; but I could not forego putting it on the panel, since it does not mar the appearance of the set; and, at the same time—this does not help, the only thing to do will enable you, when you are in the mood for it, to go right out after distant stations and pull them in with an amount of volume that is surprising.

A Piezo-Electric Loud Speaker

(Continued from page 1296)

mation,” the stratifications of which are parallel to the c-c’ axis. The other connection is made to the basal regions of the “hour-glass” formation through the metal parts of the mounting mechanism.

The girdle, referred to above, is usually a strip of tinfoil, which is wrapped about the middle of the crystal. Its width should be approximately one-third the length of the crystal, measured along the c-c’ axis. To this girdle is fastened a wire which serves as one connection to the crystal.

ARRANGING THE LOUD SPEAKER

In mounting the crystal for use as a loud speaker, a heavy base, two tie rods and nuts, and an arm are required. Fig. 2 shows a mounted crystal. A is a heavy metal base; B the tie rods; C the nuts for securing the tone arm D; E is the crystal, surrounded by the tinfoil girdle F, and supported by the lead cushions G.

The base should be as heavy as possible and the tie rods should be as light and as close together as the crystal will permit. The length of the tone arm can only be determined by experiment, and depends on the thickness of the material used. Using ⅛-inch brass, one inch wide, it has been found possible to fasten the diaphragm as far as six inches from the crystal. The lead cushions are used to prevent chipping of the crystal and to provide better adhesion between the crystal and the metal parts of the system.

It will be noted that the middle section of the crystal is partially cut away at the basal regions, between G-G. This is occasionally found necessary, in order to render more salient the “horns,” or corners, of the crystal.

CONSTRUCTING THE DIAPHRAGM

Fig. 3 shows a mounted crystal with diaphragm attached, at the outermost point of the tone arm. To make this diaphragm, a circle of paper (preferably 3-ply bristol board), about eighteen inches in diameter, is cut out. A 15-degree sector is next cut from the circle, and the two edges fastened together, thus forming a cone whose slope is about 15 degrees. A short piece of bus-bar is then secured at the apex of the cone, with a paste made from melted Rochelle salt.

It may be of interest to add that by melting Rochelle salt to a paste, and then permitting it to harden, a cement is formed that, in addition to having great strength, is easy to use, sets quickly, and is very useful around the laboratory.

The conical diaphragm is then secured by soldering the bus-bar to the tone arm. Due, as has already been said, to the effect of the thickness of the metal used in the tone arm, it may be necessary to try the diaphragm at various distances from the crystal, but it should operate best at a distance of from four to six inches.

NATURAL REPRODUCTION

It will be found that a loud speaker of this type will give more natural reproduction of both voice and music, than one actuated by a magnetic driving element. However, it has the disadvantage, from the standpoint of the average set, that an output transformer is necessary for its operation, because of the high internal impedance of the crystal. This impedance is not a constant, but depends on the size of the crystal and the degree of desiccation. It will be found that it is usually on the order of 100,000 ohms, at 1,000 cycles. The ordinary audio coupling transformer has a secondary impedance of about this value, so that it may be used as a means of coupling the output of a set to the crystal loud speaker.

To build good will, say: "Install Willards"

- Your customer will have better reception.
- He'll save money.
- He can charge his batteries at home.

WILLARD RADIO BATTERIES

Whatever set you sell to a customer, or whatever hook-up you suggest, you'll build good will by recommending reliable, full-powered, *rechargeable* batteries to furnish the power. Sell Willards! They'll do the same good job for your customers that they are doing in 204 leading broadcasting stations.

WILLARD STORAGE BATTERY CO.
CLEVELAND, OHIO

The Right Selling Plan for Radio Dealers

Your local Willard Service Station will act as your jobber on Willard Radio Batteries.

This means a quick source of supply of strictly fresh, well-charged batteries which you can turn over to your customers in the pink of condition.

No servicing problems for you. Your local Willard Service Station assumes the responsibility for service.

Months of operation have proved that this plan is effective, and profitable for all concerned.

Willard Radio Batteries are being advertised more extensively than ever.

Have your local Willard Service Station show you this advertising and explain the details of this practical plan for selling radio storage batteries. The advertisements are signed:

Sales and Service through-
The Willard Battery men
and their
Authorized Radio Dealers

Appropriate signs and window cards will identify you as an Authorized Dealer. Booklets and other valuable selling helps are also furnished.

Your Nearest Willard Service Station is Your Nearest Willard Jobber

(C)

-TEAR OUT-

Radio Institute of America
324 Broadway, New York City

Please send me full information about your Home Study Course of radio instruction.

I am interested in the complete course, including code instruction, which qualifies for the U. S. Gov't Commercial or Amateur Radio License.

I am interested in the technical course for radio dealers, jobbers and salesmen.

Name

Address

A Shortage of Trained Radio Men!

We can't supply trained radio operators to the shipping companies fast enough! Atlantic, Pacific—Gulf and Lakes—our graduates are sought everywhere.

You can't get better radio training than that offered by Radio Institute of America. Courses planned and supervised by RCA secure you your 1st Class Commercial Radio Operator's License. And an immediate position awaits every graduate.

Moreover you can study at home in spare time.

The coupon will bring you complete information.

RADIO INSTITUTE OF AMERICA

Formerly Marconi Institute
Established in 1909

324 Broadway, New York City

A SIMPLER CONSTRUCTION

For those whose facilities do not permit them to make the more elaborate device, the simpler form may be found to give good results. To make this, two circular discs of aluminum, approximately 3½ inches in diameter, are required. These are drilled in such a manner that tie rods can be used to hold the crystal between the discs. When the crystal is mounted in place, connections have been made to the poles, and a connection from the girdle has been brought out through an insulated bushing fastened in one of the end plates, a diaphragm is secured in place about the edges of the two discs. Then the diaphragm is twisted so that it is stretched in diagonal folds, and it is securely fastened by means of rings. Small adjustable embroidery rings may be used for this purpose. It will be found that varnishing the diaphragm will improve the tone and pitch. Fig. 4 shows a device of this type in its completed form.

The two forms of loud speakers that I have described are not the only two that it is possible to make. One of the remarkable features of these crystals is the great force that is obtained. On many occasions I have successfully used a laboratory bench as a diaphragm, by merely resting the tone arm of the crystal mechanism against it. Wooden partitions, windows, musical instruments (such as violins), in fact, anything that has a large vibratory surface, may be used as a diaphragm. The volume obtained, of course, depends on the activity of the crystal, the material used as a diaphragm, and the voltage applied.

Radio Forecasting and the Weather

(Continued from page 1256)

Following the checking up on the western stations, which were very satisfactory, the fight for the Florida stations by the writer was again resumed, but still without success. As is the custom, a re-canvass of all stations was made and checked. This was done several times through the evening.

Twice, while trying to reach for Florida, another station came in on the same wavelength, but it was found to be a Michigan station.

Finally, following a dozen attempts on Florida, about 1 o'clock in the morning, the announcer at Fulford-by-the-Sea, Fla., was heard as though he were many thousands of miles away. Following the announcement of the call letters and the name of the city, a musical program started, but soon faded out, and further attempts were futile. On account of the line of reception coming directly through the tropical hurricane, static areas were so severe that the broadcasting waves were greatly interfered with.

STATIC AND FADING BY TURNS

Following Wednesday night's southern receptive difficulty, conditions began to improve from the south, because of the diminishing tropical storm as it moved up the coast toward New England. In the meantime, western reception became more impaired as the storm from the west advanced over the broadcasting area, thus causing increasing fading.

To analyze the effects of the weather on reception, it has been proven by the writer that, as a storm advances on distant broadcast stations, fading is the result; the intensity of which depends on the severity and size of the area affected. The more severe the storm, the more pronounced will be the fading. The higher the temperature, the greater the interference will be from fading and static. The fading accompanies the oncoming low pressure until it gets near enough, depending on the volume of static waves, so that slight reports of individual

(Continued on page 1328)

G-S DETECTOR SILK-CORE



WHY IT IS BETTER!

Look at the Construction Judge for yourself!

The one adjustable detector-insuring strong signals. Will operate on any set designed for a crystal detector, regardless of tube capacity.

Guaranteed 100%

Ask your dealer, or write directly. PRICE \$2.00.

Manufactured by
G-S RADIO RESEARCH LAB.
1269 Cochran Ave. Los Angeles
National Distributors:

SCOTT SALES CO.,
439 So. San Pedro St.,
Los Angeles, Calif.

110

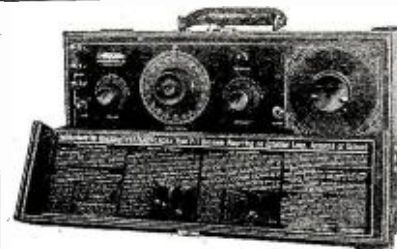

The Famous Truly Portable

TELMACO P-1 Receiver

Four Tubes Do the Work of Seven

The peer of portables in size, weight, ease of tuning, selectivity, distance, volume, workmanship and price. Aerial, loud speaker and batteries self contained. Complete with tubes and batteries. **\$125.00**
\$141.50. Receiver only

P-1 Kit Saves You Money!

Our offer of the Telmaco P-1 Receiver in kit form has met with enthusiastic reception. This contains all parts, as built by us, including case, drilled and engraved panel, and illustrated instructions. **\$80.00**
Complete kit

Ask your dealer or write us. Descriptive folder free.

Radio Division:

Telephone Maintenance Co.
20 So. Wells St. Dept. B Chicago, Ill.



Quality Radio Exclusively Established 1918

OHIO Motor Generator CHARGER

A real Motor Generator with no bulbs to break—no chemicals to renew—no contacts to burn or fuse. Charges in one-third the usual time or several batteries in parallel. Capacity 3 to 18 amps. at 6 to 10 volts. Also made up to 250 volts. Merely hook to light socket. Fully automatic. Lasts a lifetime.

SATISFACTION GUARANTEED OR MONEY BACK

THE OHIO ELECTRIC & CONTROLLER CO.
5907 MAURICE AVENUE - CLEVELAND, OHIO.

PATENTS

If you have an invention and desire to secure a patent, send for our Evidence of Invention Blank and free guide book. "HOW TO GET YOUR PATENT." Tells our Terms, Methods, etc. Send model or sketch and description of your invention for INSPECTION and INSTRUCTIONS.

No Charge for the Above Information

RANDOLPH & CO., Dept. 459 Washington, D. C.



for
finest reception

RAYTHEON

the result of five years of research and experiment, and the work goes on to maintain the standard already set. Ask your dealer to explain the meaning of Full Wave Rectification, No Filament, Reserve Power, and a sixty milliamperere rectifier for six dollars.

Progress comes not through a happy hit or miss process. In each link of the broadcast chain—from microphone to loud speaker—we realize the results of years of unremitting effort for something better. Today attention is focused on the elimination of the battery, that most unreliable and expensive source of electric power now in commercial use. That this should come about as a result of scientific research was to be expected. That it should make possible an added beauty of tonal reproduction gives further assurance of the permanency of the RAYTHEON rectifier in this field.

RAYTHEON B-eliminators or specially designed parts for home-built units are made and sold by these and other well-known manufacturers:

Acme Apparatus Co.
 All-American Radio Corp.
 Dongar Electric Mfg. Co.
 General Radio Co.
 Jefferson Electric Mfg. Co.

Mayolian Radio Corp.
 Modern Electric Mfg. Co.
 Thorardson Electric Mfg. Co.
 Tobe Deutschermann Co.
 Webster Co.

RAYTHEON MANUFACTURING COMPANY
CAMBRIDGE, MASSACHUSETTS

ACME

B-ELIMINATOR

*Gives Greater Distance, Greater Volume
and Better Quality*

with

No Noise
No Hum
No Distortion

Buy it Complete—or make it yourself

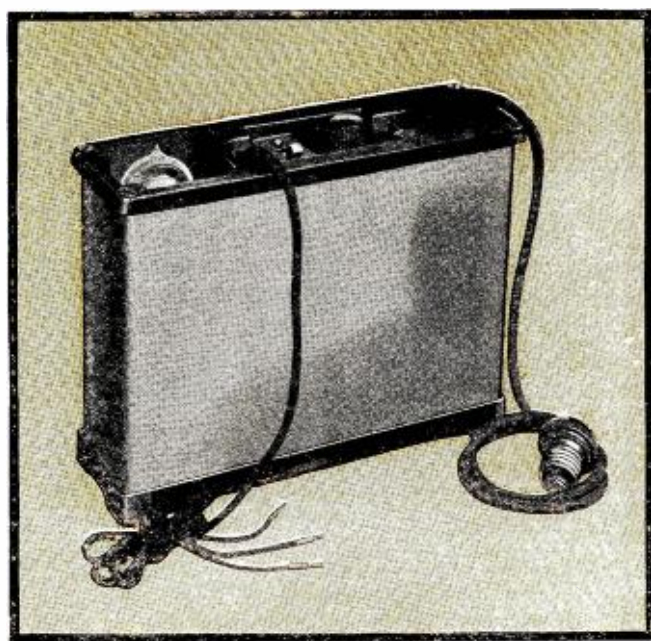

Illustration at right shows Acme B-Eliminator. Made in two types. Type E-1, (110 volts 60 Cycle), \$50. Type E-2, (110 volts, D.C.), \$20. For details, see text.

THE big job in finding a method of hooking up house electric current to replace "B" batteries in radio sets has not been to eliminate the hum. That was easy. The problem was to discover a way of overcoming the distortion.

Now, after two years of experimental and research work, we have won. The Acme "B"-Eliminator has no noise, no hum, no distortion.

You can guess the result. NO "B" batteries to quit cold when you need them most. You get permanent reception, better reception and higher voltage that is constant. There is nothing to wear out. The first cost is the last—and the current consumed is trifling.

Not only this, but the new Acme "B"-Eliminator has two voltages—100 and 150. It is highly effective on any set from 2 to 10 tubes. What is more, the detector voltage is 0 to 70.

The rectifier consists of an Acme Transformer and vacuum tube, with no filament to burn out. This rectifier (Raytheon) tube handles both sides of the wave and will last indefinitely.

The filter current so successfully smooths out the rectified pulses in current and voltage that a source of power is delivered of a better nature than batteries.

Better Quality

After all, how well you can hear, is the thing that really counts. To prevent blasting due to strong broadcasting overloading the tubes, high B and C voltages are required. High resistance in the B-supply existing in worn-down dry batteries and discharged storage batteries destroys quality because the voltage varies with different frequencies and volume of notes. The Acme "B"-Eliminator maintains its voltage at all times.

More Distance

High resistance in "B" sources prevents the operator from bringing his set to the most sensitive condition and often introduces squeals and high pitch

whistles. The Acme "B"-Eliminator keeps the set pepped up.

A Profitable Investment

An Acme "B"-Eliminator is an investment because it never needs replacement and the operating expense is about one cent for six hours. The Raytheon tube has no filament to burn out and will last for thousands of hours.

An Acme Development

This "B"-Eliminator using the Raytheon tube is an Acme Development and has required many months of research work. The E-1 "B"-Eliminator shown above was the first complete eliminator with Raytheon tube to appear on the market.

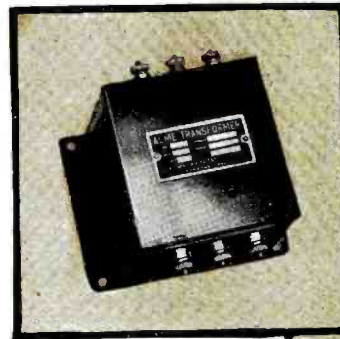
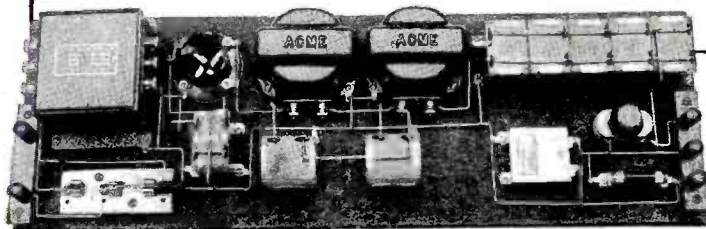
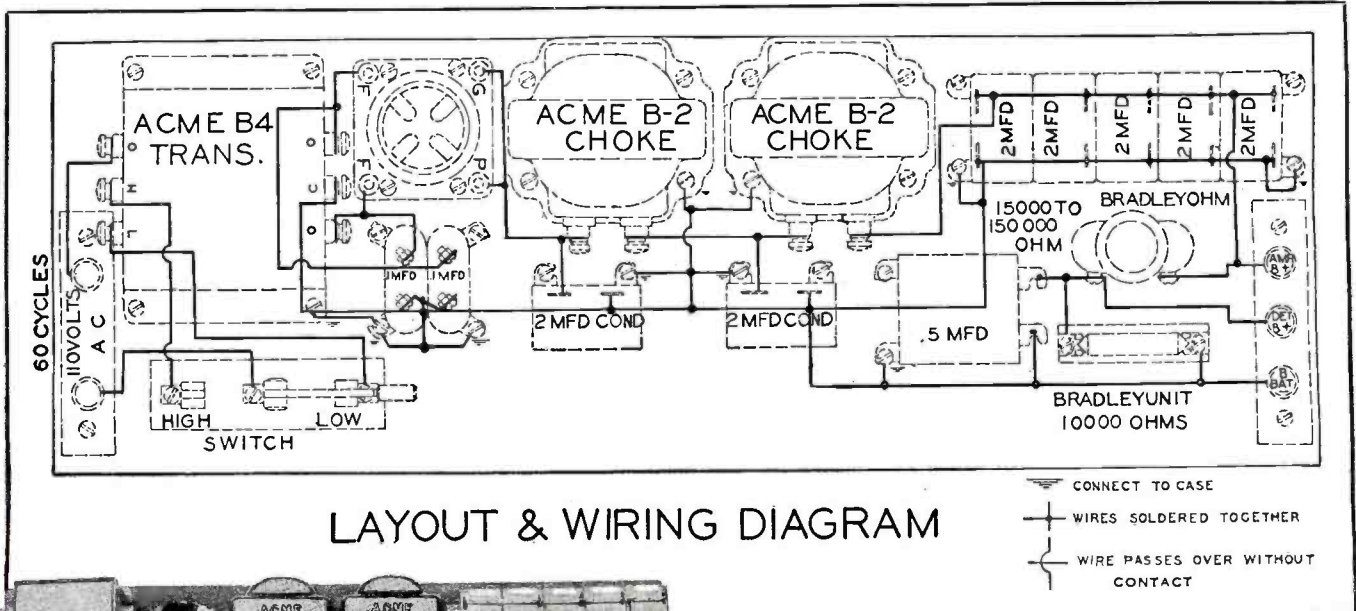

Acme B-4 Transformer \$7

Acme B-2 30 Henry Choke \$5

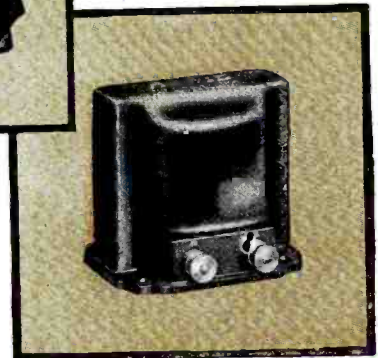

Those who prefer to assemble the Acme B-Eliminator themselves, can easily and successfully do so, simply by following a few simple instructions, using parts readily purchased in the open market. The parts required are as follows:

- | | |
|--------------------------------------|------------------------|
| 1 Acme B-4 Transformer...\$7.00 each | 1 Vacuum Tube socket |
| 2 Acme B-2 choke coils.... 5.00 each | 1 Bradley ohm variable |
| 1 Raytheon tube 6.00 each | 1 Bradley ohm |
| 14 mf. of condensers | 1 SPDT switch |
| 2 .1 mf. condensers | 5 binding posts |
| | 1 .5 mf. condenser |

All Acme Apparatus is guaranteed against defective workmanship and material.

The 11th edition of the 32-page booklet "Amplification without Distortion" tells the full story of this new Acme B-Eliminator. Send 10 cents for your copy; or for 25 cents we will also supply you with an actual size wiring diagram that will make the construction of your Acme B-Eliminator as easy as rolling off a log.

ACME APPARATUS COMPANY

Dept. K13, 37 Osborn Street

Cambridge, Mass.

ACME
for amplification

Send the coupon and 25 cents for this diagram and a copy of "Amplification without Distortion."

ACME APPARATUS COMPANY, Dept. K13, 37 Osborn St., Cambridge, Mass.

- Enclosed find 10 cents stamps or coin for my copy of the new 11th edition of "Amplification without Distortion."
- Enclosed find 25 cents stamps or coin for actual size working diagram for construction of Acme B-Eliminator, and copy of "Amplification without Distortion."

Name

Street

City State

Tested and approved by the Raytheon Mfg. Co. for use in the Raytheon "B" Eliminator

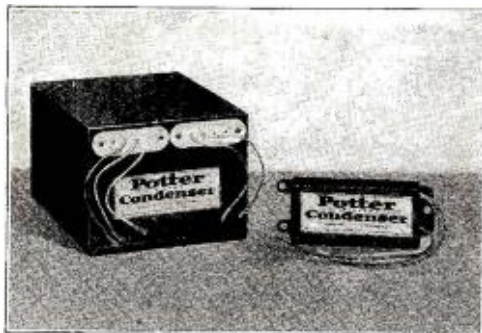

The Only Condensers specially designed for the Raytheon "B" Eliminator

These two Condenser Groups constitute complete condenser equipment for building the Raytheon "B" Eliminator. They are the only condensers specially designed in groups for this use. Specially developed to stand up under high voltages used with the Raytheon tube.

Both units are thoroughly tested to a breakdown voltage of not less than 1000 Volts D. C. The larger is the Filter Unit; the smaller is used across the secondary of the transformer. They eliminate all hum. Give continuous discharge service without leakage. Have extremely long life under continuous use. Cost little more than the cheapest condensers bought separately. At your Dealer's. If he cannot supply you, write to us.

No. 350 Raytheon Filter Unit—Tested 1000 Volts D. C.—Tapped 8 Mfds., 2 Mfds., 2 Mfds. and .5 Mfd.

No. 375 Same as 350, but tapped 6 Mfds., 2 Mfds., 2 Mfds. and .5 Mfd.

No. 385 Transformer Condenser Unit—Tested 1000 Volts D. C.

Potter
FILTER
Condensers
(An American-Made Product)

POTTER MANUFACTURING COMPANY, NORTH CHICAGO, ILLINOIS



TRANSFORMERS OF MERIT FOR 15 YEARS

Build Your Own "B" Eliminator

TRANSFORMERS using Raytheon Tubes and



Full Wave 509
List \$7.00

CHOKES



20 Henry 514
List \$5.00
RAYTHEON TUBES
List \$6.00

Up-to-date radio means clear, true reception, without hum and without B-Batteries. You will never go back to the old way once you have used the new and perfected type B-Power Supply with the Raytheon Tube and Dongan Transformers and Chokes.

Full instructions for building this remarkable B-Eliminator can be obtained from your dealer or direct from us at your request. Costs little to build, is an economy to use and will serve you for years.

Order from your dealer or send check or money order to us direct.

DONGAN ELECTRIC MFG. CO., 2977-3001 Franklin Street, Detroit, Mich.

The STANDARD RADIO TEXTBOOK

Wireless Course
in 20 Lessons

The Book Every Radio Beginner Needs

264 Pages of Radio—500 Illustrations.

Size 6x9 Inches—DeLuxe Binding.

Genuine Gold Stamped—Round Corners.

PRICE \$2.00

Experimenter Publishing Company, Inc., 53 Park Place, New York City

YOU know these circuits and the results they should bring. Kits purchased from Morison's do work. Morison makes no substitutions of inferior parts. You get exactly the same parts the designer of the set used in building his receiver.

COCKADAY LC-26

The newest Cockaday model. Described in December Popular Radio. Complete parts, including decorated drilled panel and mahogany or walnut cabinet\$77.90

Specified parts for the
SILVER SIX
The essential kit for
\$27.75

HAMMARLUND-ROBERTS

The combined engineering product of several leading parts manufacturers. Remarkable tone and distance ability. Complete certified parts\$60.80
Two-tone mahogany cabinet for this kit\$12.00

NEW

all the parts for the
**GENERAL RADIO
UNIVERSAL**
\$44.80

McLAUGHLIN SINGLE CONTROL SUPER-HETERODYNE

A very compact, easy to build, one-control super. Very sensitive and selective. Specified parts...\$113.30
D.T.W. Loop\$25.00
True Blue Tubesea. \$3.50

COMPLETE blueprint with every kit. Send to Morison's for hard to get parts for any circuit.

Write for complete information on our service to set builders and dealers.

C.O.D. Mail Orders promptly filled.

WHOLESALE RETAIL



15 East 40th Street, New York City



Where the Future of Radio Lies

A Finer Musical Tone Obtained by a More Perfect Reproduction of the Overtones

**Single Dial Tuning Which Is Absolutely Free from Verniers
or other Auxiliary Adjusters**

THE time is coming soon, is here now, when radio receivers will be bought like pianos for their tone quality and for ease of operation. All other considerations are minor.

Curiously enough, these two outstanding qualities in radio are closely linked together. You can not have a really beautiful tone in a complicated set. Every extra device or piece of wiring employed subtracts from or blurs the overtones. That is the nature of radio.

And why should radio sets be complicated? There is no other reason than the difficulty of designing a circuit which does not have

errors or discrepancies in it. Each one of such errors must be compensated for by some device. The more errors there are, the more devices must be employed to correct them.

Genius in radio design lies in avoiding error; not in compensating for it. It is always easier to do things in a complicated way. It takes skill to do them SIMPLY.

The double merit of the Pfanstiehl Overtone receiver lies in its utter simplicity. That is the secret of its tone quality and the secret of its single dial control. It also makes possible the clean swept beauty of its tuning panel. There are no extra knobs to clutter it.

For further details, address

PFANSTIEHL RADIO COMPANY, 11 South La Salle Street, Chicago, Ill.

Prices West of the Rockies Slightly Higher

Pfanstiehl

"OVERTONE" RECEIVER
Perfectly Reproducing the Overtones

TELEPHONE CABINET SPEAKER

Beautifully finished in Walnut, it stands 15 inches high and is only 3 1/4 inches deep.

\$32⁵⁰



Pleases the Eye, Ear and Purse

THE eye recognizes in Teletone a handsome piece of furniture, rich enough to harmonize with any decorative scheme. The ear appreciates Teletone's purity of tone, unusual volume, and unique freedom from distortion both in high and low registers. And, when eye and ear have come under Teletone's spell, no purse can resist its truly economical price appeal.

All wood construction—inside in Spruce—outside in Walnut—explains in part why Teletone makes any radio receiver sound better.

Fill in and mail coupon below, for illustrated booklet and the name of your nearest Teletone dealer, who will gladly demonstrate.

TELEPHONE CORPORATION
449 WEST 42nd STREET
NEW YORK CITY

TELEPHONE CORPORATION,
449 West 42nd St., New York.

Please send me, without obligation on my part, Teletone booklet and the name of your nearest dealer.

Name

Address

TELEPHONE Principle

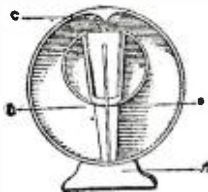

Based on Structure of Throat and Mouth

Note that a sound-wave coming from the sound producing unit "A" (the human vocal chords) is amplified through the orifice "B" (the human larynx) until it reaches the conducting area "C" (the back of the throat), whence it is again conducted to the point of greatest amplification "D" (the correctly formed and opened mouth of the singer).



static discharges become audible. This gets louder with the advancing storm until the center reaches the place of observation. Static areas vary in a low pressure center as to intensity, depending on the nature of the pressure distribution; that is, the area it covers, the lowness of the barometer, and the range and state of temperature in and near the center. With the passage of a "low," static discharges will be audible for a reasonable length of time following. The static waves, traveling in all directions from the point of discharge, naturally "flare back," as the writer terms it, over the territory from which the storm has just passed. With the increasing distance of the passing storm, the individual static reports diminish and are again replaced by fading in the same manner as was observed with the oncoming storm.

WESTERN STORM REPLACES SOUTHERN

At 8 a.m. Friday, December 4, the center of low pressure of the eastern storm was over the Atlantic Ocean, east of Cape May. The line of pronounced fading and static lay between Boston and the tip of the Florida peninsula, passing through Long Island and Cape Hatteras.

The western storm had advanced until its center lay between St. Louis and Kansas City. Heavy static and fading was experienced along a front corresponding to the line between St. Louis and Knoxville, in a lesser degree on the whole front between North Platte and Atlanta. Along the line from Winnipeg to Denver, stations came in clear and strong, while the same appeared to the eastward of the Oswego-Atlanta line, until the influence of the disappearing storm from the Gulf was felt.

LOCAL NATURE OF STATIC

There are times when static is very annoying, no matter what station the listener may dial for, and yet distant reception may be brought in very clearly between crashes and sputtering of static. When this condition exists, it is due to the static area being of a local character.

Radio reception is continually varying, as regards distance and quality. It is all due to weather conditions; and to forecast it, means the services of a skilled meteorologist.

What Wave Shall We Work On?

(Continued from page 1309)

very simple switching arrangement can be worked out to enable the operator to change from one band to the other, without the necessity of building two complete transmitters. The same oscillator, meters and power supply can be used on both bands, and it will only be necessary to change over the tuning inductances and condensers. If a switching arrangement is used, either set of inductances can be employed as desired, and it will not be necessary to retune every time the wave-length is to be changed.

A word must be said regarding the antenna to be used with a set of this nature. In the writer's opinion, the very best type to use would be an antenna and counterpoise system having a fundamental wave-length of approximately 130 meters. For working locals on phone and C.W. on 150 to 200 meters, the antenna circuit can be loaded up to the desired wave-length, or above it, and then cut down with a series antenna tuning condenser. The oscillator for the 40-meter transmitter can then be tuned to the desired wave, coupled to the antenna system, and the latter circuit tuned to a value equal to three times that of the oscillator circuit. The oscillator will then be driving the antenna at its third harmonic, and the results obtained are, more often than not, very surprising.

LEARN RADIO

Become a big-pay man in the greatest industry of all time. Quickly, easily and right at home, you can fit yourself for highest salary positions, or you can cash in on your spare time. The call is urgent for mechanics, operators, designers, inspectors. Unlimited, fascinating opportunities on land or sea.

I WILL TRAIN YOU AT HOME TO BE A RADIO EXPERT

Under my practical, easy to understand, instruction—you qualify in an amazingly short time. No previous experience is necessary. Every branch of radio becomes an open book to you. You learn how to design, construct, operate, repair, maintain and sell all forms of Radio apparatus. My methods are the latest and most modern in existence.

FREE Wonderful home construction tube receiving set of the latest design. **Write Today** "Radio Facts" **FREE**

A. G. Mohaupt, Radio Engineer. RADIO ASSOCIATION OF AMERICA, Dept. 5943 4513 Ravenswood Ave., Chicago



Insure your copy reaching you each month. Subscribe to Radio News—\$2.50 a year. Experimenter Publishing Co., 53 Park Place, New York City.

ATWATER KENT RADIO

"It is remarkable that anything so small can be so powerful. It's like hiding the Boston Symphony Orchestra in one of the upper drawers of my desk."
—WALLACE IRWIN

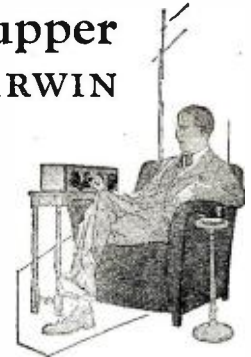

In the home of WALLACE IRWIN is the Atwater Kent Model 20 Compact and Model H Radio Speaker

The famous author of "The Japanese Schoolboy" and "The Golden Bed" might be expected to impale a whole set of facts with one unerring phrase. This he has done in writing to us about his Model 20 Compact. And note what else he says:

"I approach a radio set much as I approach an automobile. I don't know what goes on inside, or why. I only know that if you turn something on, something is supposed to happen.

"For that reason I am an ideal Atwater Kent addict. I don't even have to turn it on. My oldest boy, aged 8, does that for me, and produces such music as I am sure Beethoven at the age of 8 never even dared to tackle."

So simple that even a child's fingers are sufficient. So small and so beautiful that it *belongs*—never intrudes—in any room, in any home. Yet a full-powered, robust, complete five-tube set that meets all your demands in performance. That is the Model 20 Compact, as so many persons who could buy *any* radio set have found out.

Write for illustrated booklet telling the story of Atwater Kent Radio

ATWATER KENT MANUFACTURING CO.
A. Atwater Kent, President
4713 WISSAHICKON AVE. PHILADELPHIA, PA.

Prices slightly higher from the Rockies west, and in Canada.



Model 20 Compact, \$80

Hear the Atwater Kent Radio Artists every Sunday evening at 9:15 o'clock (Eastern Standard Time) through stations—

- | | |
|-------------------------------------|---------------------------|
| WEAF New York | WFI } . . . Philadelphia |
| WJAR Providence | WOO } . . . alternating |
| WEEL Boston | WCAE Pittsburgh |
| WCAF Washington | WGR Buffalo |
| WSAI Cincinnati | WOC Davenport |
| WCCO Minneapolis-St. Paul | WTAG Worcester |
| WEAR Cleveland | KSD St. Louis |
| | WWJ Detroit |
| | WLIB Chicago |



Radio Speaker Model H. \$32



With Tungar— an overnight charge for a dime!



It can't blow out Radiotrons if left hooked to set while charging

Does not disturb radioreception in neighborhood

It is complete—charges 2-4-6 volt "A" or 6-12 volt auto batteries, or 24-96 volt "B" batteries in series

Especially adaptable to permanent installation in cabinet with switch control.

Five ampere size \$28.00 (East of Rockies)

Two ampere size \$18.00 60 cycles - 110 volts

Merchandise Department
General Electric Company
Bridgeport, Connecticut

Two clips for your battery and a plug for your house current—that's all. And the steady, quiet Tungar charges your batteries overnight.

Just about a dime's worth of current and two minutes of work. So simple!

It's the no-fuss, easy-to-use charger—for all batteries.

Tungar
REG. U.S. PAT. OFF.
BATTERY CHARGER

Tungar—a registered trademark—is found only on the genuine. Look for it on the name plate.

GENERAL ELECTRIC

There are a good many amateur operators using a third harmonic transmission system at the present time, and they are more than pleased with it. They far prefer it to working an antenna at a point somewhere just below its fundamental. By using an antenna system of the type described, the installation of a two-wave transmitter will be far simpler than if two antennas are erected.

THE HAPPY MEDIUM

In the latter part of this discussion we have not considered the 80-meter band particularly. Here, let us say a word in favor of it. If you find it impossible, for some reason or other, to construct a two-wave transmitter of the type mentioned, by all means put the one that you do make on 80 meters. You will find that it has many of the advantages of 40, and most of those of the highest band. True, DX is not quite as easy to achieve on the 80-meter band, but still thousands of miles have been worked, using very low power, with the set tuned to somewhere between 76 and 84 meters. This band is not at all to be slighted when only one transmitter or no change-over system is to be employed; but as we mentioned above, it is far more satisfactory to operate on both the highest wave band and the 40-meter band. In this way we can do the type of work that we most desire, and do it consistently. There is no need to close down during quiet hours, because we can then throw over to 40 meters and work DX to our heart's content.

Let's hear some more from the boys who are working two-wave transmitters of this nature. We are sure that the work involved in constructing a transmitter of this type will be amply repaid by the results obtained.

CALLS HEARD

CLARENCE WOLF, JR.—3ABH

1521 North 16th Street, Philadelphia, Pa.
(Detector only, October 11 to November 29, 1925.)
1aai, laii, lajk, laze, (lawq), lbfq, lcaa, (lcbg), (lchl), lcjc, (lcot), lpi, lqv, (lui), (luu), (lzk), 2aav, (2acp), 2afv, (2afv), 2ahw, 2ajc, (2aje), 2akv, (2amk), 2amj, (2awq), 2bdi, (2bqp), 2bqq, 2bzz, 2ccl, (2cxl), (2cyh), 2av, 2bg, 2cp, (2cy), 2gp, (2ke), 2lm, (2ol), 4bg, 4he, 4og, (4tg), 4vo, 4wg, (4wq), 5akn, 5apq, 5atp, 5bx, 5acz, 5ahc, (5amb), (5anc), 5aom, 5asi, 5atc, (5aul), 5azu, (5bay), 5bbl, 5hoz, (5bpd), (5bro), 5cap, (5cas), (5cay), 5cjb, 5cjb, 5cmw, (5cta), 5cxp, 5dbn, (5dfo), (5dhh), (5dix), 5dln, 5dpe, 5dqz, (5eu), (5eq), 5gi, (5iz), (5lp), (5wv), 5aai, (5ami), (5aub), (5axb), 5bmm, 5bof, (5bv), (5cax), (5clw), 5cxl, 5dew, 5dgv, 5dht, 5dlh, (5dxy), 5dyl, (5ehg), (5eq), (5jo), 5kv, (5tv).
CANADIAN: (3co).
(AF2).
5o7. QRA of this station wanted.
QRK mi 30 watts cw? A card goes out for every one that comes in.

T. N. MONTGOMERY, SKERRIES, COUNTY DUBLIN, IRELAND

Calls Heard on 40-Meter Band (September 22 and 23, 1925):

UNITED STATES: 1aay, 1am, 1amf, 1bxy, 1ckp, 1nt, 1ana, 1gy, 1wr, 2cxl, 2gk, 3aqf, 3ccl, 3fa, 4rl, 4pr, 8es, 8sf.

PORTO RICO: 4sa, 4oi.

BRAZIL: iab, isp.

ARGENTINE: ch8, 4fg.

MISCELLANEOUS: h9br, ind, 3ca, wiz, wir.

U buie, pwn, conn.

All heard on two tubes.

Will be glad to hear from any of above. All cards sent promptly.

LIVIO G. MOREIRA, RUA PAULA GOMES 6, CURITYBA, SOUTH BRAZIL

During 14 days in August: 1aay, 1aci, 1aha, 1agh, 1arh, 1aw, 1bqi, 1bqt, 1ckp, 1cre, 1ox, 1pl, 1sl, 1vi, 1xg, 1wl, 2aef, 2afn, 2agb, 2bee, 2cft, 2cth, 2cty, 2fo, 2ha, 2wg, 2wr, 3buy, 3ff, 3jw, 3lu, 3nj, 3ot, 4ask, 4ha, 4tv, 5agn, 5nj, 5va, 5uk, 5aul, 5ben, 5djm, 5eg, 5sf, 5bbi, 5bht, 5xn.

ARGENTINE: bal, dh9, dm9, fa3, fg4.

BRAZIL: lab, lap, laq, mt.

CHILE: 2ld.

CANADA: lar.

HOLLAND: pcz.

MISCELLANEOUS: kdka, wgy (phone), nfk, wir, wiz, wqn, 8ct.

G6QB, 33 HAPRENDEN ROAD, WEST NORWOOD, S. E. 27, LONDON, ENGLAND

1aci, 1ahg, 1aiu, 1air, 1alt, 1ana, 1anq, 1arh, 1azd, 1ban, 1bhs, 1bqi, 1bs, 1ckp, 1cmx, 1cmf, 1fn, 1ga, 1jt, 1ka, 1kl, 1my, 1pl, 1zl, 1zt, 2aey, 2afn, 2ahm, 2aof, 2apn, 2axq, 2bbx, 2bj, 2bn, 2bqa, 2bui, 2caz, 2cpr, 2cth, 2cub, 2cyw, 2gk, 2gy, 2kr,



100 AMP. RADIO BATTERY

6 Volt Rubber Case

TWO-YEAR Written Guarantee by
THOMAS WITHERBEE

Storage Battery Pioneer for 28 Years.

Shipped direct from factory to you. No middlemen's profit—no delays—no grief.

Send No Money

This is an actual 100 amp. Radio Storage Battery honestly built of purest materials by real battery builders. Solid Rubber Compartment cases—not wood (non-leakable)—will outlast the battery itself. Lead coated carrying handle. Wing binding posts.

Will operate the average 5 tube radio set from three to four hours daily for a month to six weeks.

NO DEPOSIT or Advance Payment Required

Simply order—and we will ship by express and you can examine battery at your express office to your heart's content. If you agree with us that it's the biggest offer ever made—pay the expressman \$9.98 plus express charges. If you prefer to remit with order—deduct 50c. You run no risk as we replace any defective battery during two years.

THOMAS BATTERY CORP., 511 West 50th St., New York, N.Y.

BUILD THE Camfield DUODYNE!

Nothing like it has ever been known before!

It is a Five Tube Tuned Radio Frequency Circuit using a new and Highly Efficient system of preventing oscillations.

Sensitivity, Selectivity and Tone Quality—
combined to give results
never before obtainable!

Build it Yourself with Camfield Parts

at half the cost of a good five tube Receiving Set! The following Camfield Parts are essential for use in the Duodyne Circuit:

- 1 Type 22K Camfield Duoformer Kit. \$10.00
- 3 Type 886 Camfield Straight Line Variable Condensers, each \$6.00
- 5 Type 11 Camfield Bull Dog Grip Sockets, each \$.65

*Write Direct to the Home Office for
Complete FREE Descriptive Literature*

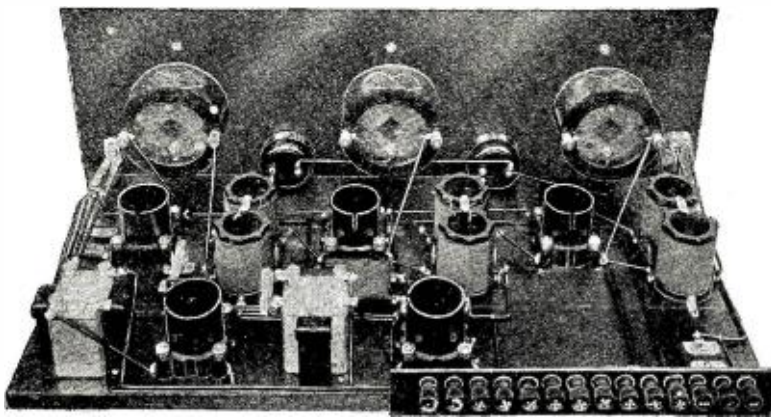

Rear Panel View, Showing Position of Parts and Wiring

telling all about the Duodyne Circuit and Camfield Parts, giving us the name of your radio dealer.

DEALERS: Our Sales Policies protect your profit and those of your jobber. Write us on your business letterhead for complete information about the Duodyne Circuit, Camfield Parts and Dealers' Prices, giving us the name of your jobber.

CAMFIELD RADIO MANUFACTURING CO.

Home Office
829 Harrison Street, Oakland, Calif.

Branch Office
1268 West 115th Street, Cleveland, Ohio

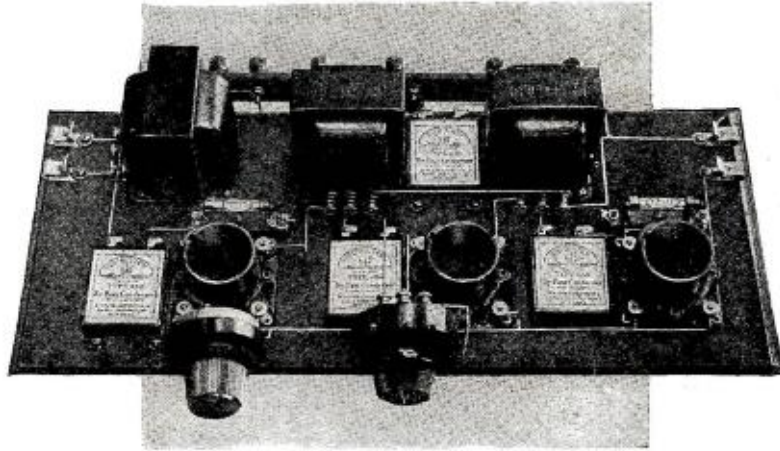

Distortionless Amplification

¶ In impedance coupled Amplifiers (which evenly amplify all the notes in the musical scale) as well as in most of the latest developments in audio amplification, fixed condensers and grid leaks are essential elements of the hook-up.

¶ Unless the accuracy and reliability of these parts is above question, the results from the unit will prove disappointing.

¶ The set-builder who uses *Dublier By-Pass Condensers* and the silent *Dublier Metaleak* in constructing this unit, works with the assurance that comes from the use of parts whose performance has been tested and guaranteed by the best known manufacturer of condensers in the world.

Dubilier

CONDENSER AND RADIO CORPORATION

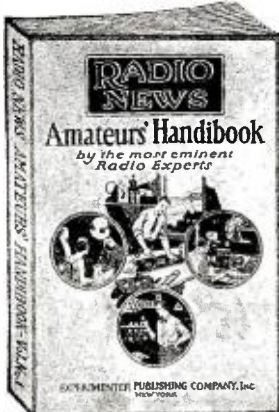

Price \$1.00

JUST THE BOOK YOU WANTED

"RadioNews"

AMATEUR'S HANDBOOK

Volume No. 1 (Fourth Printing)

Chock full of radio constructive and instructive articles from cover to cover. Written by foremost radio authorities, in plain everyday language which everyone can understand. Sections include articles on Receiving sets and Sundry Apparatus, Transmitters and Accessories, Radio Theory, Vacuum Tube Data, and Practical Hints for the Amateur. A book which also serves as a ready reference and should find a place in the library of every amateur. It contains 224 pages and over 375 illustrations, diagrams, and photographs, bound in a multi-colored heavy board. On sale at all leading radio stores. If your dealer can not supply you, send a dollar bill and the book will be forwarded to you postpaid.

EXPERIMENTER PUBLISHING CO., Inc.

53 Park Place, New York

2lu, 2wc, 2xaf, 3bpm, 3ca, 3cc, 3fa, 3jw, 3lz, 3xu, 3zo, 4fl, 4ja, 4ll, 4lv, 4oa, 4rl, 4rm, 4tr, 4tv, 4vl, 5in, 5nj, 5rz, 6bjj, 8avl, 8bf, 8bon, 8bzk, 8bzu, 8dke, 8don, 8eg, 8pk, 8pl, 8ry, 8sf, 9ek, 9xn, clab, cldm, cled, c2fo, bzlab, wap, wnp, nrll, a2cm, z2aq, z2xa, z4as, wqv, nkf.

A NEW QRA

Charles W. Hoff, L. Box 203, Clinton, N. Y., informs us that he is now operating station 8CGW on 40 meters, and will answer all QSLs promptly.

Tracing Interference to Its Lair

(Continued from page 1286)

power wires and by them are radiated out and are then picked up by radio receiving sets. The noise thus produced in a radio set may come from a disturbance which has traveled several miles along the electric power wires.

REMEDIES FOR LOCAL INTERFERENCE

"One remedy for such types of interference is to eliminate the spark. This is possible if the spark is an electrical leak and not necessary to the operation of the machine in which it occurs. Many very useful electrical machines, however, depend for their operation on the making and breaking of electrical circuits while they are carrying current and whenever this happens a spark is produced. It is impossible to eliminate these machines, so that it is necessary to make the spark of such nature or so to arrange the circuits that the radio frequency current is reduced or prevented from radiating.

"To prevent the radio frequency current produced by a spark from getting onto the lines connecting the sparking apparatus some form of filter circuit is necessary. A condenser (1 microfarad, more or less) connected across the sparking points will short-circuit a considerable amount of the radio frequency current, or a condenser connected from each side of the line to ground will serve the same purpose. A choke coil in each side of the line in addition to the condensers connected to ground forms a simple filter circuit which should prevent frequencies in the broadcast range from getting on the line. A high inductance (choke coil) or high resistance connected in each side of the line changes the characteristics of the circuit so as to reduce the amount of power radiated. If such a filter circuit is not effective or is impracticable, the apparatus may in some cases be surrounded by a solid metal sheet or wire screen which is thoroughly grounded. The screen should completely surround the apparatus. This may be difficult. For example, in shielding the ignition system of a gasoline engine the spark coils and all wires and other parts of the system must be enclosed in metal shields and these must be very well grounded.

"When any connections are made to the power line, in order to avoid fire and personal injury, only apparatus that is carefully tested as to voltage and current-carrying capacity should be used and the power company should be consulted before making the installation. Additions to the power lines should be made only by qualified persons.

TRACING THE SOURCE OF TROUBLE

"The first thing to do in tracing the source of trouble is to make sure that it is not in the receiving set itself. The next thing is to open the electric switch at the house meter; if the interfering noise is still heard in the radio set, the source is then known to be outside the house. It is then desirable to report the situation to the electric power company. Many of the companies have apparatus for the purpose of following up complaints of this kind. Usually a sensitive receiving set with a coil antenna is used to determine the direction from which the interference noise comes, and this outfit is taken

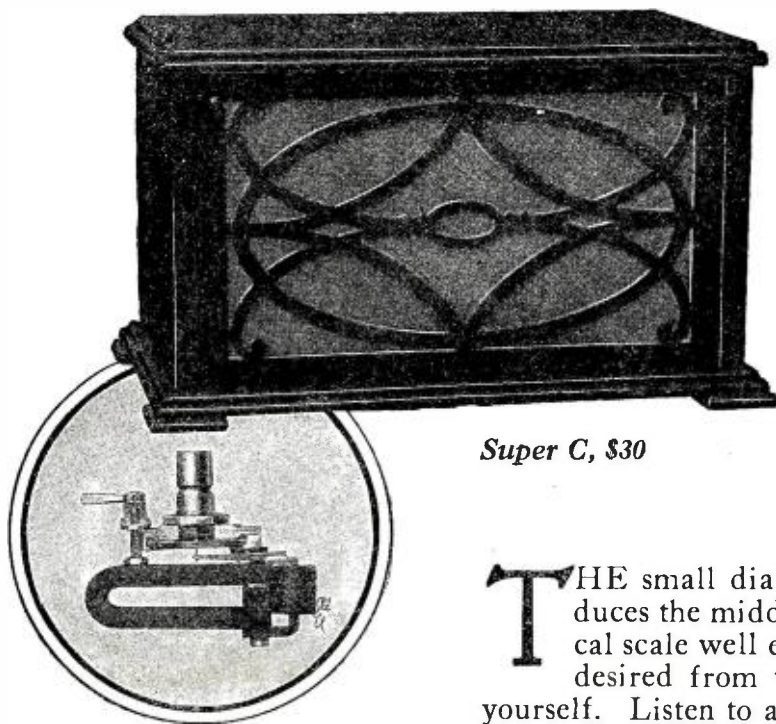

This Speaker has the **NEW VOICE!**

Super C, \$30

↑
**The New
SUPER
UNIT**

THE small diaphragm commonly used reproduces the middle and upper notes of the musical scale well enough, but it leaves much to be desired from the middle down. Verify this yourself. Listen to almost any speaker and you will be amazed at the muffled sound of the middle and lower registers of voice and instrument.

The Bristol Speaker is equipped with that latest discovery in tone reproduction, the SUPER-UNIT. This unit contains an unusually *large diaphragm* which brings in the full range of tones from deep bass to high treble.

The rumble of the tympani, the roll of the snare drum, the low tones of the viols, tuba, organ, saxophone and voice—notes you've never before heard in radio—notes which are even more vital in reproduced music than in an actual concert—are clearly and naturally audible.

The cabinet is highly polished mahogany, 17 x 10 x 10 $\frac{1}{4}$ inches in size, with long, freely vibrating sound chamber. The price is \$30. Ask your dealer for a demonstration, and at the same time

Send for Free Booklet

entitled, "How to Select Your Loud Speaker." It tells how to look for and find tone quality in a speaker.

BRISTOL SPEAKER

(AUDIOPHONE)

THE BRISTOL COMPANY, RADIO DIV. S, WATERBURY, CONN.

For 36 years makers of the highly sensitive and accurate Bristol's Recording Instruments

Send for this RADIO BOOK FREE

The World's Largest Exclusive Radio Mail Order House Will Send You This Wonderful Book FREE



1926 Catalog of Everything New in RADIO at a Big Saving

64 illustrated pages containing thousands of radio sets, semi-finished sets and radio kits of all styles, sizes and approved circuits at attractive prices. Beautiful models of the very latest designs and types. Elaborate console models with loud speakers built right into cabinets of genuine mahogany and walnut. **All Sets Guaranteed.** Coast to coast receiving range. Catalog also contains everything in radio supplies, including batteries, chargers, loud speakers, transformers, condensers, rheostats and any other parts you may want for improving your set or building a new one.

You must have our catalog no matter what set or kit you want. Our line is complete and includes all popular sets.

Our semi-finished sets come with all parts mounted on the panel and baseboard, ready for wiring.

No matter what you want in radio—anything from a one tube to an eight tube set, kit, or semi-finished sets—anything in parts or supplies—any radio data—it's in our wonderful catalog.

OUR GUARANTEE
Every article exactly as represented. Every article is tested before shipping. Complete satisfaction or money cheerfully refunded.

A Complete Manual of Radio. You Cannot Afford To Be Without This Book. It's FREE.

Our Catalog
Includes complete list of broadcasting stations and general information and facts about our free service division. Our radio engineers will help you solve all your radio problems. Send your name and address on a card or in a letter. We will send catalog FREE.

REMEMBER—WE ARE THE LARGEST EXCLUSIVE RADIO MAIL ORDER DEALERS IN THE WORLD AND CARRY THE BEST OF EVERYTHING IN RADIO. SEND FOR OUR CATALOG TODAY!

RANDOLPH RADIO-CORPORATION
The Largest Exclusive Radio Mail Order House in the World
159 N. Union Ave. Dept. 258 Chicago, Illinois

Pictures by Radio With the PHOTOTRON

The New, Sensitive, and Practical Alkali-Metal Photo-Electric Tube

Also for Radio—Movies—Pictures by Wire—Burglar Alarm and Electric Control Systems—Cardiograph Apparatus—Color and other Sorting Devices.

An interesting booklet on the remarkable PHOTOTRON yours for the writing.

PHOTON ELECTRIC CORPORATION
247 Park Ave., 1269 Cochran Ave.,
New York, N. Y. Los Angeles, Cal.

Build the Radio Broadcast UNIVERSAL Four Tube Receiver

ENDORSED by Radio Engineers as the best of over 200 circuits tested. Incorporates all the latest improvements in receiver design. . . . truly universal in wave-length range.

COMPLETE KIT of approved parts including drilled and engraved panel, baseboard, binding post strip, wire, etc. . . . \$46.50

WRITE for free booklet containing complete instructions and templates for building.

RADIO PARTS CO., LABS.
8 South Austin Boulevard Oak Park, Ill.

from place to place until the source is found. The location of such sources is often a very difficult and baffling undertaking. The trouble sometimes comes from a spark discharge over an insulator to ground, or between a pair of wires, or it may be that the wire is touching some object such as a tree, pole, guy wire, etc. Such a spark discharge is a loss of power to the operating company and a potential source of serious trouble and for these reasons the company is probably more interested in finding and eliminating this type of trouble than the radio listener. Large leaks and sparks may often be observed at night, especially in hot weather. However, sparks which are too small to be readily noticed may cause serious interference to radio reception.

"Where D.C. motors are in operation near a radio receiving set interference is sometimes caused, especially when the brushes on the motor are sparking badly. The sparking should be reduced as much as possible by cleaning the commutator and setting the brushes properly. The remaining interference is sometimes overcome by placing two condensers (about 2 microfarads each) in series across the power supply line and connecting their midpoint to a good ground system.

"Another source of interference is the ringing machine used in rural telephone exchanges. Telephone engineers can reduce or eliminate interference by connecting a filter between the machine and the ringing keys.

"Many cases of radio interference have been caused by electrical precipitators which are used to prevent smoke and noxious fumes or material from leaving the chimney. The precipitator operates by establishing inside the chimney a highly charged electric field of such a nature and direction that particles going up the chimney are charged and driven against the walls, where they stick. Precipitators cause interference for the reason that the high voltage used in their operation is obtained from a rectifier which produces sparks and generates radio frequency alternating current as well as the direct current which the precipitators need. If the precipitator is so designed and arranged that the distance between the rectifier and the chimney is only a few feet or if the entire apparatus, including all leads, is housed in a metal building there is usually no trouble. But if the rectifier is separated from the chimney, the wire which joins them forms a good antenna which will radiate and cause interference for 20 miles or more. Interference from these precipitators can be eliminated by placing a grounded wire screen entirely around these wires and thoroughly grounding the wire screen and the rectifier. If screening of the various parts is impracticable, damping resistances can be inserted at various points in the wire line which will reduce the amount of power radiated. Tuned

Station
WRNY
NEW YORK
258.5 Meters - 1160 kilocycles
is owned and operated by the
publishers of this magazine
Our Editors will talk to you
several times every week—
See your Newspaper
for details.
**TUNE IN ON
WRNY**

Insure your copy reaching you each month. Subscribe to Radio News—\$2.50 a year. Experimenter Publishing Co., 53 Park Place, N. Y. C.

FANSTEEL
Balkite
Radio Power Units

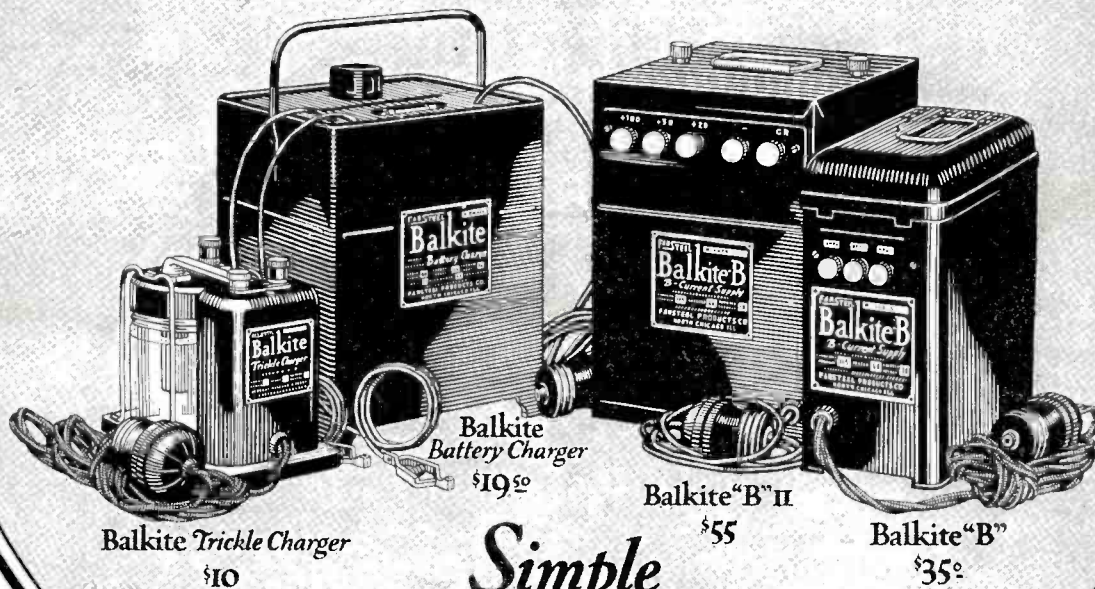

*Simple
 Entirely Noiseless
 Permanent*

Manufactured by FANSTEEL PRODUCTS COMPANY, Inc., North Chicago, Illinois



**Convert your present receiver into
 A LIGHT SOCKET SET
 with
 Balkite Radio Power Units**

Ask your Radio Dealer

Manufactured by FANSTEEL PRODUCTS COMPANY, Inc., North Chicago, Illinois

Sole Licensees in the United Kingdom:
 Messrs Radio Accessories Ltd., 9-13 Hythe Rd., Wellesden, London, N.W. 10



BENJAMIN
Straight
Line
Frequency
Condenser

Pick Your Stations Easily from the Crowded Ether Lanes

Increase your tuning range. Spread the broadcasting frequencies evenly over the entire sweep of the dials. The new Benjamin Straight Line Frequency Condensers give each station a wide, clear space for very easy tuning. The rotation is velvet-like in smoothness—compact construction—low loss—the accuracy of the workmanship is exceptional—the finish is dull silver. In three sizes: .00025 Mfd.; .00035 Mfd.; .0005 Mfd.

Benjamin Electric Mfg. Co.

247 W. 17th Street
New York

120-128 S. Sangamon Street
Chicago

448 Bryant Street
San Francisco

Manufactured in Canada by the Benjamin Electric Mfg. Co. of Canada, Ltd., Toronto, Ontario

Benjamin Cle-Ra-Tone Sockets stop tube noises by preventing the transmission of outside vibrations into microphonic disturbances. Four springs support the socket—"float" it above the base and absorb all shocks and jars. The new "Push" type Cle-Ra-Tone Sockets are for standard UX and WX Tubes.

Benjamin Tuned Radio Frequency Transformers improve tone, volume and selectivity. Low resistance. Low distributed capacity. Space wound, air core; double green silk insulation—the nearest approach to an all-air dielectric construction and the highest type of inductance possible. Put up singly and in sets of three.

Patented July 25, 1925; May 2, 1911

Patents Pending



LEARN THE CODE AT HOME

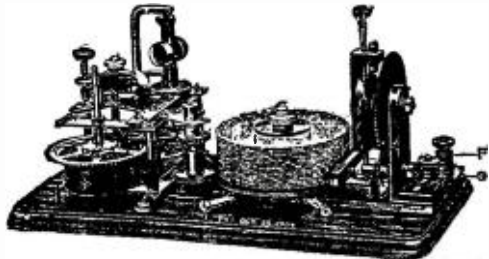

WITH THE OMNIGRAPH

THE OMNIGRAPH Automatic Transmitter will teach you both the Wireless and Morse Codes—right in your own home—quickly, easily and inexpensively. Connected with Buzzer, Buzzer and Phone or to Sounder. It will send you unlimited messages, at any speed, from 5 to 50 words a minute.

THE OMNIGRAPH is not an experiment. For more than 15 years, it has been sold all over the world with a money back guarantee. The OMNIGRAPH is used by several Depts. of the U.S. Govt.—in fact, the Dept. of Commerce uses the OMNIGRAPH to test all applicants applying for a Radio license. The OMNIGRAPH has been successfully adopted by the leading Universities, Colleges and Radio Schools.

Send for FREE Catalog describing three models. DO IT TODAY.

THE OMNIGRAPH MFG. CO., 15 HUDSON STREET, NEW YORK CITY

If you own a Radio Phone set and don't know the code—you are missing most of the fun



NO MORE LOOSE CONNECTIONS X-L PUSH POST

A binding post that really does excel, looks, action, service, and convenience. Push it down—insert wire—cannot jar loose from vibration. No screwing or danger of shearing off wires. Furnished attractively plated with soldering lug and necessary markings. Price Each 15 Cents
X-L RADIO LABORATORIES
2426 Lincoln Avenue Chicago

**Write Today For Our
64 Page Catalog of
RADIO BARGAINS
RANDOLPH RADIO CORP.
159 N. UNION AV. Dept. 2 CHICAGO, ILL.**

Insure your copy reaching you each month. Subscribe to Radio News—\$2.50 a year. Experimenter Publishing Co., 53 Park Place, N. Y. C.

circuits connected across the spark gap of the rectifier will assist by absorbing the radio frequency power."

"Interference"

(Continued from page 1257)

the next night to prove it. Dan climbed up on the roof and howled.

"Look," he wailed. "Just look!"

We looked. It was a pretty sight, the two wires stretched neatly between two wooden masts, fifteen feet above the roof.

"What's the trouble?" I inquired weakly.

"The roof! Just look at the roof! Man, it's tin!"

That seemed to explain it. If you have a tin roof under your aerial, you get static—rolls and rolls of it.

So we moved it—the aerial, I mean, not the roof. I almost broke my neck. I skinned my knees, I accumulated several holes in prominent parts of my trousers. We moved the antenna until it swung over nothing but an apartment-house-excuse for a back yard.

Then we went inside to hear the music.

The set oscillated as satisfactorily as before. That is, it made as much noise.

"Interference," pronounced Dan gravely. "You're near a power house."

It took me the rest of the evening to convince him that we were not. We were in a suburban apartment house locality, with a grocery store, butcher shop, delicatessen and other minor places of business in the neighborhood. The nearest garage was seven blocks away. A street car line passed six blocks from the house.

Dan peeked into every private garage in the neighborhood, looking for a battery charger of the vibrator type. He did not find any.

He came back, looked at the set and growled. He made funny faces at it. He removed all the tubes, cursed them individually, and put them back. But he remonstrated when I suggested dropping an axe into its gizzard.

"I'll get Hank Riggles," he decided. "Hank is an expert on interference. He built a super-het last month."

Hank agreed that interference was the trouble. The fact that there were no power lines of consequence, or any leaky transformers in the neighborhood, did not influence his judgment. "In fact," he told me, "it doesn't sound like a leaky transformer. It comes from a generator." He didn't say where the generator was.

Still, he was getting it down to a fine point. He was the first expert who could tell by the noise what caused it.

He brought over a static-eliminator, and hooked it in between the set and the antenna. It helped. It cut down the volume of the interference. But it didn't bring in any music. The only manner in which we could tell that any broadcasting was being done was by reading the programs in the papers. Occasionally, by expert manipulation of the dials, we caught faint echoes of alien sounds between the crashes of "interference." But it was not encouraging.

The next day Hank showed up with a "helix." It was a wooden frame criss-crossed with wires. By attaching the antenna wire at different points, Hank managed to diminish and increase the noise in the loud speaker at will. He finally arrived at the point of cheerfully discussing with me the matter of putting the set through the meat chopper.

"I've put up with you maniacs for over a week," declared the wife. "Another evening of this and I'll have such good grounds for divorce that it would be a shame to pass up the chance. Why don't you get the man who sold you the set to tell you the trouble?"

Hank sniffed.

"He only sold the set. It takes an expert to eliminate interference. That wouldn't do any good." He smiled encouragingly. "I'll

KARAS Parts Are Intended Only for the Few Who Demand Finest Quality and Workmanship

IT takes many manufacturers to supply the tremendous demand for condensers and transformers in this vast radio market of ours. If all home set builders were ready to pay the price which *real* quality commands, a big proportion of them would necessarily be disappointed—the Karas factory could not begin to take care of all. Karas parts are designed and built for the select few—you builders who want the utmost in quality, in quiet operation, in appearance. You who take pride in your workmanship—whose sets have that “professional” appearance which is the envy of all your radio friends.

Just as water quickly finds its level, so did Karas Harmonik Transformers and Orthometric Condensers quickly find the exclusive market for which they were intended.

The most skillful radio set builders the country over, discovered Karas Harmonik Transformers soon after they were placed on the market in 1924. When Karas Orthometric Condensers appeared a year later they were snapped up far too quickly for our own comfort. Perhaps it was because they were the first to meet the demand for a Straight Frequency Line tuning instrument. More likely it was because of the

Buy” is far greater than we first imagined. Our production has been greatly increased to provide for the growing numbers who demand Karas parts and will accept nothing else.

In many places, good dealers who wanted a stock of Karas products could not be supplied. If you are still unable to find them in your local stores, tell your dealer that we are now able to take care of his requirements. Or, if you wish to get Karas parts in the quickest possible time, we will be glad to send them to you direct.

However you buy Karas Harmonik Transformers or Orthometric Condensers, you do not run the least risk of their not performing up to your highest expectations. If there is the slightest cause for disappointment during a thirty days' test, you are invited to return the parts to the dealer from whom you bought them, or to us if you buy direct. Your money will be promptly refunded without question or quibble.

Karas Harmonik Transformers and Karas Orthometric Condensers are highly recommended by the Radio News technical staff for all of the circuits they design. Both products are specified for use in the Automatic Double Range Receiver described in this issue.



THE KARAS HARMONIK "ALL-STAGE" RATIO AUDIO FREQUENCY TRANSFORMER

Price \$7 each. Shipped direct where dealers cannot supply, cost plus a few cents postage paid to postman on receipt. Parcel post is prepaid where payment accompanies order. Our 30-day Money Back Guarantee applies, wherever and however purchased.

enviable reputation created the year before by Karas Harmonik Transformers. At any rate, it was months before we could fully supply the insistent, clamorous demand that came to us from all sides.

We begin to think now that the number of set builders who want the very "Best that Money Can

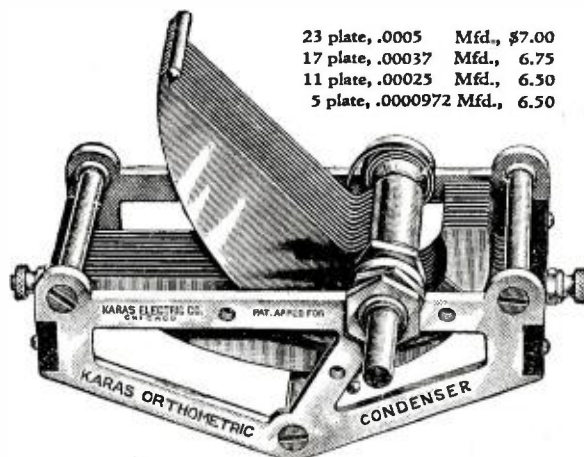

23 plate, .0005 Mfd., \$7.00
 17 plate, .00037 Mfd., 6.75
 11 plate, .00025 Mfd., 6.50
 5 plate, .0000972 Mfd., 6.50

THE KARAS ORTHOMETRIC (STRAIGHT FREQUENCY LINE) CONDENSER

Prices and sizes above. Shipped direct where dealers cannot supply. No money in advance. Pay the postman price plus a few cents postage. Or send cash with order and we prepay parcel post. 30-day Money Back Guarantee.

Karas radio parts are the pride of an organization that has been making precision electrical apparatus for more than thirty years. We believe we are making the finest transformers and condensers possible to produce and we are glad to back them up with this, the strongest guarantee we know how to write.

KARAS ELECTRIC COMPANY

FACTORY, 4040 N. ROCKWELL ST.
 OFFICE, 1023 ASSOCIATION BLDG.,
 CHICAGO, ILLINOIS

BARKELEW Lightning Arresters

LIGHTNING ARRESTER SWITCH

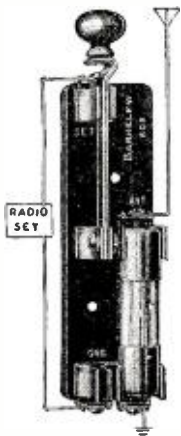

No. 602 Price \$2.50

OUR No. 602 Lightning Arrester Switch is universally recognized as the only device on the market which combines on one base all those functions essential for maximum protection.

The Vacuum tube arrester is permanently in the circuit from antenna to ground, ready to "spill" any overcharge. With the switch blade the antenna may be disconnected from the radio set and thrown directly on ground.

It meets not only the requirements but also the additional recommendations of the National Electric Code.

Our No. 606 Vacuum Tube Lightning Arrester is less expensive but it meets all the actual requirements of the National Electric Code.

Both are Approved by the Underwriters' Laboratories.

See our Radio Catalog at your Dealer. If he hasn't his copy, we have one for him.

LIGHTNING ARRESTER Vacuum Tube Type

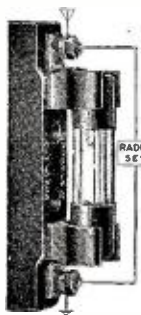

No 606 Price \$1.50

The Barkeley Electric Mfg., Co.
Middletown, Ohio, U. S. A.

NEW YORK, 157 Chambers St.
BOSTON, 31 Bedford St.
WASHINGTON, D. C., Mills Bldg.
ATLANTA, GA., 180 Spring St.

CHICAGO, 15 S. Clinton St.
DENVER, Denham Bldg.
MINNEAPOLIS, 1017 Lumber Ex.
SEATTLE, 1041 Sixth Ave. S.

SAN FRANCISCO, 75 Fremont St.
LOS ANGELES, 443 S. San Pedro St.
TORONTO, 20 Bloor St. W.
MONTREAL, 296 St. Paul St. W.

Hear Europe with the Universal Plio-6

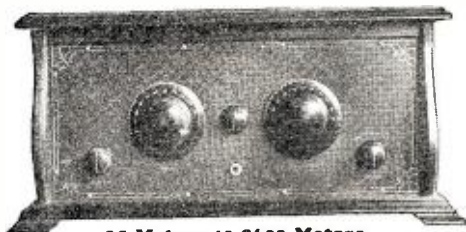

35 Meters to 3600 Meters

No Batteries

are required even to operate the powerful receiver pictured above, if you use the new laboratory type

Model A Power Unit

A new broadcast receiver representing the highest type of efficiency obtainable in point of extreme range, tremendous audibility and remarkable selectivity.

Maximum Efficiency — Inexpensive

Parts or Completely Constructed

Write for information today

NORDEN-HAUCK, Inc.
Engineers
1617 Chestnut Street, Philadelphia, Pa.

Amazing New Kind of Radio FREE to Ambu Trained Agents

Wonderful 6 Tube Radio Frequency Set gets All-Wave Coast to Coast Reception from 40 to 550 Meters. Shot Subpanel makes assembly quick and easy. We train you in Radio. Give FREE Demonstrator Set and appoint you as distributor.

Make \$60 to \$100 WEEKLY

This amazing Set in big demand—Sells for half store prices—You sell from free Demonstrator set and buy at wholesale prices. Hundreds making a fortune in Radio. Get free Plan today!

AMBU ENGINEERING INSTITUTE
2632 Prairie Avenue Div. 25C Chicago, Illinois

BUILDING A SET?

You must have rheostats of correct ohmage. Insist on the genuine



KLOSNER RHEOSTATS
Made by pioneer makers of the vernier. FREE.—Send for valuable Rheostat Chart and information on the care and operation of vacuum tubes. Mention dealer's name.

KLOSNER RADIO CORPORATION
1024 East 178th St. Rheostat Specialists, N. Y. C.

TO THE RADIO DEALER

Thousands of dealers sell RADIO NEWS over the counter because buyers come back each month for the new issue. It makes them steady callers. Are you selling your customers? For information address

DEPT. N. S.,

Experimenter Publishing Company,

53 Park Place, New York City.

bring Jack Feddles over tomorrow night. Jack is an expert. He'll find the trouble in a jiffy."

We went over to Bill's house, and Bill brought out the pinochle deck. He won four-bits, but my mind was off the game. We discussed "interference."

"The trouble with the set comes from outside," we finally decided. "Maybe some bird is using a massage vibrator in one of the apartments. We'll find it tomorrow."

"You bet we will!" agreed Hank. "Jack Feddles can locate a leak a mile away. You wait and see!"

Hank met me at the office with Jack. Jack had an apparatus for locating "interference" with him. A wire affair, with head phones. You carried it in your arms, with the phones on your ears, and it led you directly to the cause of the noise. Jack said it would.

He started wearing it about a block from the apartment. Several people looked at us queerly, but, with the aid of intent dignity, we escaped arrest.

Jack circled around the street, slowly, listening intently, and then smiled.

"I hear it!" he said.

We followed him on tiptoe, cagerly. We walked, and walked, and walked.

"Where is it?" we asked.

"Getting closer," said Jack.

He continued saying it for several blocks. After we had gone about a mile, I remembered that it was past dinner time. I felt it in my legs.

"Suppose you continue," I suggested. "If I'm not home soon, the little wife will be worried. You understand how it is."

"That's a good idea," agreed Hank. "I'll go with you. Jack can report after he has located the trouble. Hurry up, Jack. We'll wait for you at the house."

The Missis met me at the door. The expected frown was missing. In fact, she actually grinned at me!

"I'm late," I said.

"So's dinner," she answered. "I've been listening to the radio."

Clear, swinging strains of dance music floated to our ears from the inner room, sweet, and undisturbed by noise of any kind!

"What has happened?" I demanded. "Who has been monkeying with the set?"

"Good old Jack!" enthused Hank. "I knew he'd find the trouble!"

The wife laughed at us both.

"There was a screw loose in the diaphragm," she stated, "that probably came out when it was shipped. That made all the noise in the loud speaker. There wasn't anything wrong with the set—or any interference. If you had a set of head phones you would have discovered that the first thing!"

"In the loud speaker!" Hank and I exclaimed. "How do you know that?"

"Oh," she answered, "the man from the store came out this afternoon and fixed it. He told me all about it."

Just then the telephone rang. I answered. It was Jack Feddles.

"I've found the trouble," he cried, "down here at the car barns." The car barns were three miles away.

"They have a big generator here, and I think the brushes are worn," continued Jack. "As soon as they fix that your troubles will be over."

The best I could do was say "Thanks." Why spoil his fun?

"Anyway," said Bill, as he twisted the dials, trying to get Denver at an hour when it was off the air, "we'd have found the trouble ourselves if it hadn't been for interference!"

"Sure," agreed Hank. "Who would look for it in a loud speaker?"

The Missis didn't answer. She only smiled.

Years of experience are behind this radio battery

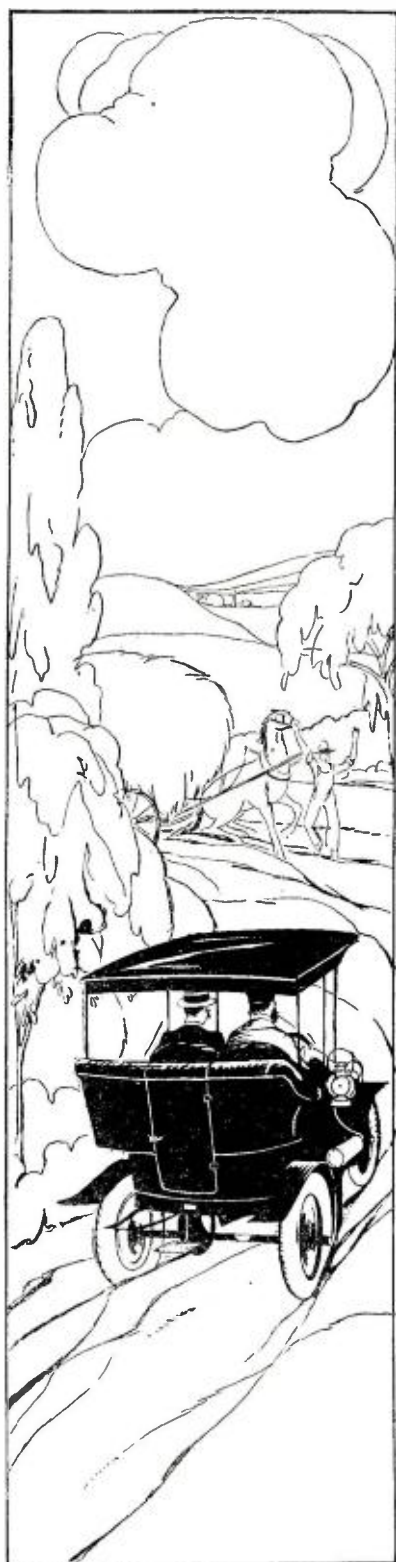

Twenty years ago, when the automotive industry was in its infancy, Prest-O-Lite gave the motor-car its first dependable eyes. Today Prest-O-Lite Batteries, for radio and motor-cars, are sold by millions in all parts of the world, and there is always a Prest-O-Lite or radio dealer service station within a few steps of your home.

Prest-O-Lite Radio Batteries were especially designed for radio in the world's largest electro-chemical laboratories. In engineering, materials and workmanship nobody offers more than Prest-O-Lite. Prest-O-Lite Storage Batteries deliver their rated ampere-hour capacity at full power, thus lengthening the time between recharging and assuring you good, clear reception.

The name Prest-O-Lite has always represented a product of highest grade, and a manufacturer with twenty years' successful manufacturing experience has a dollars-and-cents value to you. It is a guarantee that your money will be wisely expended.

Prest-O-Lite Batteries are attractively priced from \$4.75 up. It is no longer necessary to take a chance on batteries of unknown make.

THE PREST-O-LITE CO., INC.
INDIANAPOLIS, IND.

New York San Francisco

In Canada: Prest-O-Lite Company of Canada, Ltd.
Toronto, Ontario

Send for free booklet

"What every owner of a radio should know about storage batteries" is a little booklet which every radio fan will find interesting and helpful. It is crammed full of hints that will bring surprising radio results—and save you money. It's yours for the asking—without obligation.

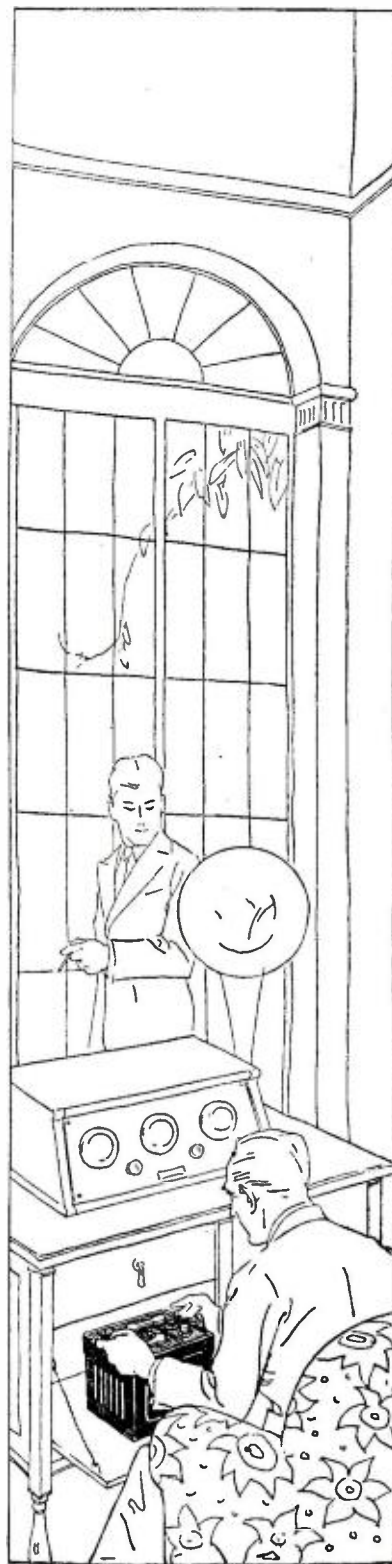

Designed especially for radio

Prest-O-Lite

STORAGE BATTERIES FOR
MOTOR-CARS AND RADIO





Two-In-One or One Alone

If your set needs a "booster", if it needs a loop, or both—if it isn't built for use with an antenna and you want to use it with one—in fact

AERO-LOOP

is just what you need—it does the thing you want it to do—thoroughly.

Get the facts. A 12-page booklet, illustrated, and showing the many uses of this wonderful "loop-within-a-loop," will be sent to you free, on request. It will tell you why Aero-Loop will increase distance and selectivity.

Better yet—go to your dealer—ask him to explain and demonstrate. Buy your Aero-Loop from him today. If he hasn't stocked them yet, we will ship direct to you, express prepaid on receipt of price—be sure to state the type of set you operate. Give us your dealer's name.

SCOTT SALES COMPANY

National Distributors

443 South San Pedro St.
Los Angeles, Calif.

MANUFACTURED BY
Utt-Williams Electrical Products Co.
Santa Ana, California

Beautifully finished in mahogany
Dimensions 30-in x 8 x 7 in.

Sells for **\$1250**



How Airplane Telephones are Shielded

(Continued from page 1277)

the super-heterodyne is extremely sensitive to electrical disturbances, it is practically necessary to have radio-ignition-shielding on the motors of airplanes in which this set is installed." The illustrations in this article indicate, in a lucid manner, the arrangement and operation of this ignition shielding system. While this method is not perfect, it seems to offer the best arrangement yet devised for suppressing airplane motor noises.

THE STANDARD AIRPLANE SET

The radio receiving set adopted for use on airplanes by the United States Air Service employs a conventional super-heterodyne circuit; the outfit, including a filament battery, weighing about twenty pounds. The equipment resolves itself into two separate units—the seven vacuum tubes with accompanying transformers, etc., mounted in the fuselage; and the tuning unit, which is mounted in the cockpit, readily accessible to the operator. The tuning unit contains the oscillator, as well as a condenser for tuning the grid element of this vacuum tube, and another condenser, in conjunction with a variometer, for tuning the antenna to different wave-lengths. The third control on this tuner is a filament rheostat.

The seven vacuum tubes employed in this receiver are known as type VT-5, using one-quarter of an ampere for the filaments and from 45 to 60 volts for the plate element. The functions of these vacuum tubes, when analyzed, are as follows: Oscillating tube in the tuning unit, first detector, three electron tubes for intermediate radio frequencies, second detector, and two stages of audio frequencies. The outfit in its entirety represents the most satisfactory facilities yet perfected for the reception of voice communication on aircraft in flight—both with respect to the sensitivity and selectivity of the radio receiver and in the system for screening extraneous noises from the receiving set.

Short Wave Work in 'IRAQ

(Continued from page 1271)

States, and signals were first exchanged with America through 1ABS and 1PL and 4OU. The U. S. A. is audible from 2100 G.M.T.—maximum signals being received at 0330 G.M.T.

Nova Scotia rapidly followed, and Major Borrett, C1DD, and C1AR came in very well, usually at dawn. The Hamilton Rice Expedition, 3,000 miles up the Amazon, was intercepted many times (SA WJS).

The only Russian on the air was 1FL, who is at Novogorod.

Aerial radiation on 100 watts was .9 amps. Reducing power tests were then tried with 5MO, 2LZ and 2NM, all of whom could read me R3 when I was using an input of 20 watts. It is interesting to note that while I was working on 100 watts to England, using a directly-coupled aerial circuit, the main stations only a quarter of a mile away (short- and long-wave aeriels running parallel) experienced no interference while using a 3-valve direct-coupled receiver and listening to the majority of the BBC stations on an auxiliary aerial.

Bournemouth and Newcastle were exceptionally good, but 5XX, despite its power, was not received so strong or consistently. KDKA, on 66 meters, was very useful for calibrating our short-wave receiver.

"WHERE IS MESOPOTAMIA?"

The situation has its humorous side, particularly in view of the fact that in giving



JEWELL TEST YOUR TUBES AT HOME



❑ Poor reception may be the result of one bad tube in your set. Do you know the condition of your tubes?

❑ By using a JEWELL JUNIOR TUBE-CHECKER—at home—you will always know whether your tubes are weak and just when to replace them.

❑ Send for our circular No. 735.

Jewell Electrical Instrument Co.
1650 Walnut St. - - - Chicago
26 years making good instruments

Pattern 107
JEWELL JUNIOR TUBE-CHECKER

Insure your copy reaching you each month. Subscribe to Radio News—
\$2.50 a year. Experimenter Publishing Co., 53 Park Place, N. Y. C.

A New Conception of Radio

*A
New Kind of Receiver
No Dials - No Panel
Built-in Loudspeaker*



*Ultra Simplicity ~
Tastefully Unobtrusive*

\$135

West of the Rocky Mts. \$140
In beautiful Console Model \$175
The Ultradyne, Model L-3, is a six-tube receiver employing the fundamental principles of the best circuits, greatly refined and marvelously simplified. No dials—no panel; just two inconspicuous levers which constitute a station-selector. Duco finished, two-toned mahogany cabinet.

Designed by R. E. Lecault, E. E., Chief Engineer of this Company, and formerly Radio Research Engineer with the French Signal Corps Research Laboratories.

To protect the public, Mr. Lecault's personal monogram seal (R. E. L.) is placed on the assembly lock bolts of all genuine ULTRADYNE Model L-3 Receivers. All Receivers are guaranteed so long as these seals remain unbroken.

This new kind of radio-musical instrument marks the mastery of technicalities to the point where the whole range of radio's resources are literally at your instant command.

The Ultradyne, Model L-3, supplants the usual "laboratory machine." It is a new artistic table-piece that makes the entrance of radio into the well-appointed home *unobtrusive, inconspicuous*. It represents the triumph of art over mere mechanics.

The Ultradyne Receiver is worthy of the place of honor in luxurious homes.

The Ultradyne Model L-3, fulfills everything that the critically-minded have demanded of radio. Why wait any longer, why deny yourself the infinite treasures of radio? The ideal has at last been attained!

Skepticism will vanish if you will let your local dealer demonstrate this new modern radio receiver.

Illustrated folder on request.

PHENIX RADIO CORPORATION, 114 EAST 25TH ST., NEW YORK

ULTRADYNE

MODEL L-3





12-Cell-24-Volt Storage "B" Battery

Positively given Free with each purchase of a WORLD "A" Storage Battery. You must send this ad with your order. World Storage "B" Batteries give you economy and performance unheard of before. They deliver unflinching power that is clear, pure and quiet. Tested and Approved by Leading Authorities.

Radiocast Station
W S B C

Set your Radio Dials at 210 meters for the 1000-watt World Storage Battery Station, WSBC, Chicago. On the air nightly, between 6:30 P. M. and 8:30 P. M. and 10:00 P. M. and 1:00 A. M., with intensely interesting programs for your approval and enjoyment.

You save 50%



WORLD "A" Batteries are famous for their guaranteed quality and service. Backed by years of successful manufacture—thousands of satisfied users. Built of finest materials possible to obtain from raw material producers of national reputation. Equipped with solid rubber one-piece containers, an insurance against acid, leakage and breakage. You save fifty per cent and get a



2-Yr. Guarantee Bond in Writing

with each Radio "A" and Auto Battery. WORLD Battery owners "tell their friends." That's our best proof of performance and is chiefly responsible for the tremendous growth of the Company. Compare these prices—then send your order in TODAY.

Solid Rubber Case Radio Batteries	Solid Rubber Case Auto Batteries
6-Volt, 100-Amperes . \$11.25	6-Volt, 11-Plate . . . \$11.25
6-Volt, 120-Amperes . 13.25	6-Volt, 13-Plate . . . 13.25
6-Volt, 140-Amperes . 14.00	12-Volt, 7-Plate . . . 16.00

SEND NO MONEY!

Just state battery wanted and we will ship day order is received, by Express, C. O. D., subject to your examination, on arrival. FREE "B" Battery is included.

EXTRA OFFER—Five per cent discount for cash in full with order. Buy NOW and get a guaranteed battery at fifty per cent saving to you.

WORLD BATTERY COMPANY
1219 S. Wabash Ave., Dept. 10, Chicago

World Batteries for Radio

AEROVOX
FIXED CONDENSERS



have won an enviable
Reputation
among the foremost radio experts.
~ there's a reason

*Tested and approved by M. I. T., Yale, Radio News, Popular Radio and Popular Science. Used by over 200 of America's leading set manufacturers.

Made in all capacities. Also manufacturers of Grid Leaks, Resistors, Resistofomers and Rheostats.

AEROVOX WIRELESS CORPORATION

Chicago Office: 53 W. Jackson Boulevard
Cincinnati: 304 Palace Theatre Building

493 Broome Street, New York City

HEATH
CONDENSERS
For Real Radio Reception

Write for Literature
HEATH RADIO & ELECTRIC MFG. CO.,
206 First St., Newark, N. J.

1926 CATALOG
JUST OUT!
SEND FOR YOUR COPY
RANDOLPH RADIO CORP.
159 N. UNION AV. Dept. 2 CHICAGO, ILL.

my QRA it never seemed to strike the average experimenter that Mosul was in the East, especially as its commercial call-sign began with a "G." The first gentleman to point out to me my obscurity was a well-known Swede (whose call-sign shall not be disclosed). The log read as follows:

Swede: QRA.
I: QRA MOSUL 'IRAQ.
Swede: Where is 'IRAQ?
I: MESOPOTAMIA, O.M.
Swede: Where is MESOPOTAMIA?
I (with motor humming and wondering what on earth to say on the spur of the moment): Near BAGHDAD (thinking he must know of the Thousand and One Nights).
Swede (after a pause): WHERE IS THAT?
I (in despair): Up the PERSIAN GULF.
Swede: R TKS FB (Fine Business) OK, etc.

Here is another incident; it was 3 A.M. with me; when a steady call came through on 90 meters. I replied, and the fingers on the key in England said GEOM UR VY OK, etc., and then the startling announcement. "I am in bed, O.M."

Thinking my co-optimist was in bed sick, I replied, "Not very ill, I hope?" "Oh, no," came the cheerful reply, "I've merely got a

40 Non-Technical Radio Articles

every month for the beginner, the layman and those who like radio from the non-technical side.

SCIENCE & INVENTION, which can be bought at any newsstand, contains the largest and most interesting section of radio articles of any non-radio magazine in existence.

Plenty of "How To Make It" radio articles and plenty of simplified hook-ups for the layman and experimenter. The radio section of SCIENCE & INVENTION is so good that many RADIO NEWS readers buy it solely for this feature.

List of Radio Articles
Appearing in the March
Issue of
"Science and Invention"

The Radio Constructor—How to Build a Four-Tube Tuned R. F. Set with Regeneration.

By A. P. Peck, Assoc. I. R. E.

A Novel Radio Cabinet.

By Dr. Ernest Bade.

Latest Broadcast News.

Radio Oracle—Radio Questions Answered.

Radio Wrinkles.

relay and the transmitter is downstairs." Such are the ways of the enthusiast.

23-METER WAVES EFFICIENT IN DAYLIGHT

The great problem that awaits solution is, on what wave can continuous day and night communication on low powers be carried on over distances of three thousand miles and over? As I have previously stated, 70, 80, 90 and 100 meters were all equally efficient with darkness at either one end or the other—but with daylight completely in between, signals fade right out on this wave-band. Quite recently daylight communication has been established between Mosul and G2LZ in the United Kingdom on 23 meters, but insufficient time has elapsed to enable me to prove that this is completely successful for the whole of the twenty-four hours.

That it will be on a wave-band slightly below 40 meters is my firm conviction, and perhaps before these words are in print, the efforts of the British experimenters will have proved it. When one comes to retrospect—what would we have thought five years ago of securing direct nightly com-

RADIO 'RITHMETIC



Multiply distance by adding a *RECTIGON*

A SIMPLE solution for so big a result! Want band music? Try KDKA. Jazz? Theatricals? Maybe you'll find it at WBZ, KYW or KFKX. What your local stations won't provide can be obtained easily from somewhere else.

How well you receive radio entertainment depends upon the condition of your batteries —and that's up to you. With a Westinghouse

Rectigon on the job both your "A" and "B" batteries can be kept fully alive to the greatest possibilities of your set.

And it's easy as can be. Just snap on the leads and turn on the current. There's no muss or fuss; no acids; no chemicals, and no noise. The Rectigon more than pays for itself within a short time.

WESTINGHOUSE ELECTRIC & MANUFACTURING COMPANY

SOUTH BEND, INDIANA

The Westinghouse Rectigon Battery Charger



© 1926, W. E. & M. Co.

No storage-battery radio is complete without a **RECTIGON.**

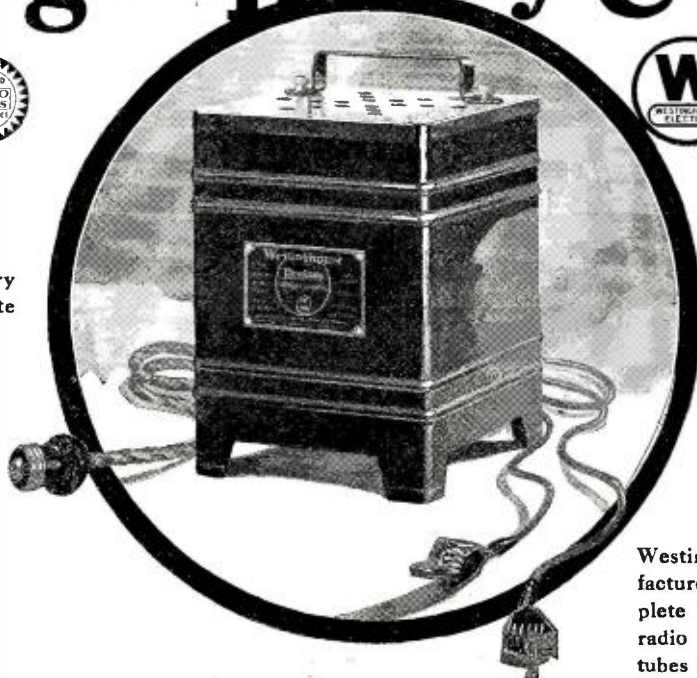

Westinghouse manufactures, also, a complete line of Micarta radio panels, Micarta tubes and instruments.



NAVY MODEL C-10 Super-Heterodyne

The Highest Class Receiver in the World

Wave length range 50-600 meters with removable Coils.
 Panel Dimensions 28 3/16 in. x 8 in. x 1/4 in.
 Only two major tuning adjustments.
 Total amplification almost 2,000,000 times.

No Batteries

are required even to operate the most powerful 10-tube receiver pictured above, if you use the new laboratory type

Model A Power Unit

A high powered 10-tube Broadcast Receiver capable of receiving over 3,000 miles under favorable conditions, and having a degree of selectivity far in advance of others.

We believe the Navy Model C-10 represents final superiority over any receiver now being manufactured or even contemplated for broadcast reception.

Attractive illustrated literature gladly mailed upon request. Write direct to

NORDEN-HAUCK, INC.

Engineers

1617 Chestnut Street, Philadelphia, Penna.

munication between England and Mesopotamia with stations whose aerials are scarcely visible and whose power and equipment could be installed in a telephone call-box?

WHAT AMERICANS HAVE HEARD HIM?

I attach a list of the American stations worked. My heartiest thanks go out to them all, as by their co-operation and help, a great deal of useful data has been obtained.

I have satisfied myself by experiments, that wave-lengths of the order of 70 to 100 meters follow the "Heaviside" layer, and are dependent upon the density of that medium as regards range. Below 70 meters, the waves appear to shoot off at a tangent, and stations coming in the effective "reflected" zone are in good communication. Experiments show that A and B could communicate over three thousand miles by day on 23 meters, but C and D, who were situated in a direct line between A and B at five hundred and fifteen hundred miles, respectively, could not hear A or B stations.

I would greatly appreciate any observations from U. S. A. experimenters who have heard any of my calls (GHH, GHH1, or M1DH).

AMERICAN STATIONS HEARD AND WORKED

1AAL, 1ABS*, 1BHM, 1CMP, 1KC, 1LW, 1AW, 1AO, 1PM*, 1BVS, 1ARY, 1YD, 1BY, 1QV, 1CRU, 1AUC, 1CRI, 1BZP, 1XU, 1AXN, 2CEE, 2KKP, 2CXW, 2AX, 2YT, 2WY, 2AG, 2GK, 2CBJ, 2BRC, 2AAN, 2AAA, 2CVJ, 2BGI, 2WIK, 2ANM, 3BCO, 3BUY, 3OQ, 3HH, 3CS, 3BNU, 3CJN, 3DHK, 3OY, 4IR, 4KE, 4XF, 4EQ, 4JE, 4OU*, 4JX, 4JY, 6CD, 6CSS, 6AK, 7OC, 9KR.

WPY, WPX, WPG, KDKA, Test ship LN.

Radio As An Ally to the Theatre

(Continued from page 1272)

questionably. It will not require a fight. It is not opposed by the West Coast Theatres, nor do I believe that there will be any serious opposition from showmen with the foresight and vision to look beyond the immediate present. The experiments and tests now being conducted are the steps leading to such an alliance. Once it is demonstrated that radio can be used in conjunction with the motion picture successfully, and the method made commercially practicable, there will be swift and certain co-operation between the two industries."

In the course of the evening I found Mr. Lesser to be somewhat different from the average theatrical magnate. His conversation showed that he has not only been keeping in close touch with radio improvements and progress, but is vitally interested in all inventions which have a bearing on the motion picture. At present he is financing an invention which he hopes will enable people to enter a theater at any time during the showing of the feature film, and pick up the trend of the story. And he is interested in a plan for the control of broadcast wave-lengths, so that programs may be received on specially tuned sets only.

"By doing this," he said, "interference will not only be eliminated to a great extent, but the programs will be rendered exclusively for the theatres receiving the service, and the attractions of the legitimate stage will be brought to those who would, by reason of location or circumstances, be unable to attend a metropolitan theatre. It will not represent competition, because a two-dimension moving picture synchronized with the actor's voice can never entirely take the place of the legitimate stage presentation. But it will bring the presentation to those who are unable to view the original, and



The Perfect Loud Speaker

YOUR PHONOGRAPH



For CHENEY AND PATHE PHONOGRAPHS



For BRUNSWICK PHONOGRAPHS

MILLIONS have been spent perfecting its acoustic properties. Every inflection of tone is accurately reproduced. Use it! Simply disconnect your present phonograph reproducer from the tone arm, attach a Cross Radio-Phonograph Adapter in its place, then—the loud speaking unit to the Adapter—that is all!

CROSS

RADIO-PHONOGRAPH ADAPTER

6 types fit any Phonograph

3 sizes of each type to fit any make of loud speaking unit.

WRITE FOR LITERATURE

CROSS GEAR & ENGINE COMPANY, Radio Division
 3250 Bellevue Avenue Detroit, Mich.

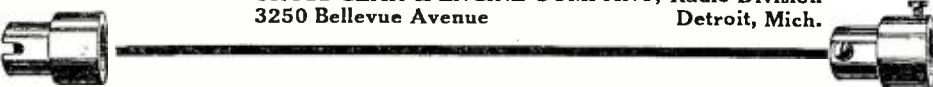

GEARS

All Kinds—Small

The most accurate made and prices reasonable. We carry a complete line of gears in stock for immediate shipment. Can also quote on special gears of all kinds. Send us your inquiries. Write for Catalogue 40 Chicago Stack Gear Works 105 South Jefferson St., Chicago

RADIO BARGAINS

FREE RADIO CATALOG & GUIDE of newest ideas, approved special hook-ups with illustrations. Tremendous savings on standard radio parts, sets, kits. Be sure to get this thrifty book before you buy. Wonderful? Unusual? You'll say so. Write letter or postal NOW. BARAWIK CO., 102-142 S. Canal St., CHICAGO, U.S.A.

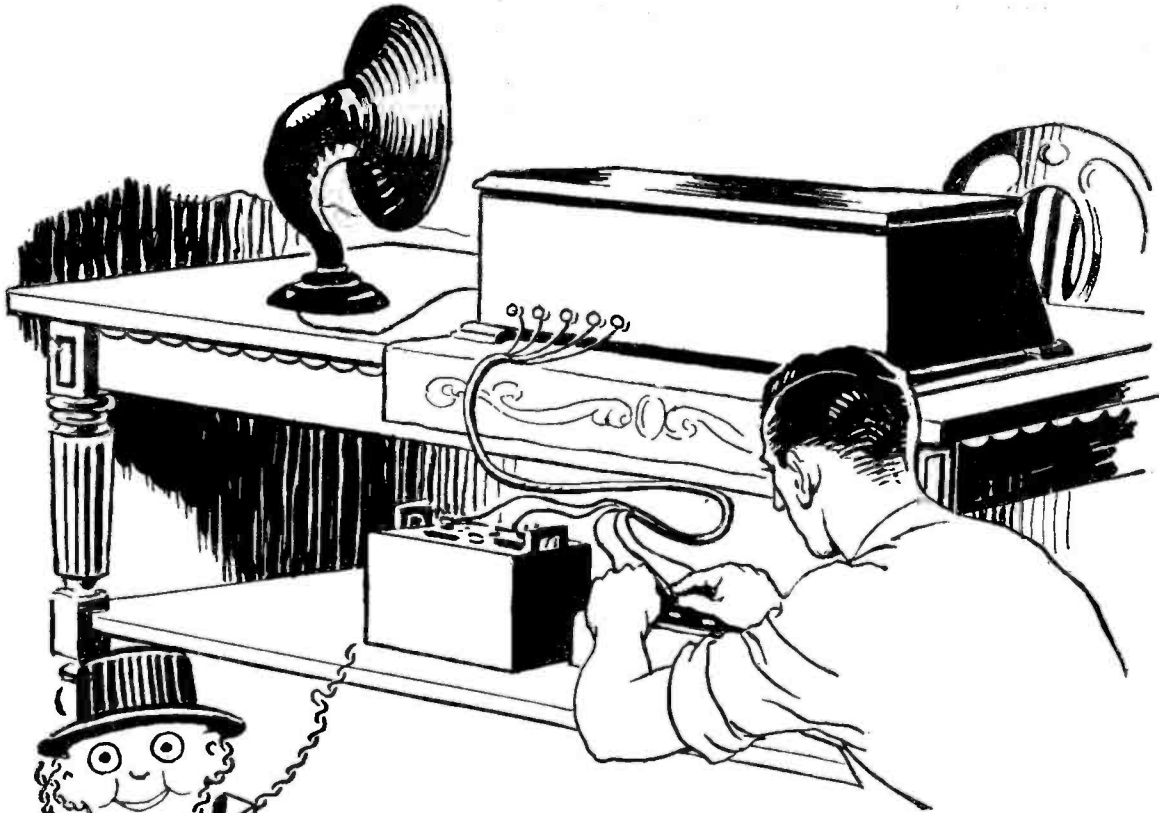

Easy to trace circuits with a Belden Battery Cord

A BELDEN Radio Battery Cord has five flexible rubber-covered cotton-insulated conductors, each identified by a separate color marking. There is no danger of short-circuits between A and B-batteries that are so costly in tubes.

Another thing! The Belden Radio Battery Cord takes the place of the messy tangle of wires usually found between a radio set and the batteries. It makes a neat, compact installation that greatly improves the appearance of any set.

One burned out tube will pay for many Belden Radio Battery Cords. Why not get your cord, now?

Look for the Belden Striped Carton

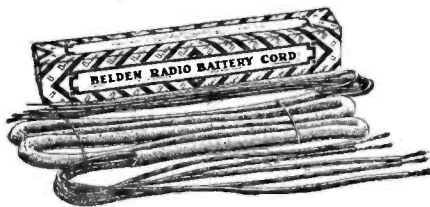

Mail the Coupon for Free Illustrated Booklet

BELDEN MANUFACTURING CO.
 2314K South Western Ave., Chicago

Please send me your booklet entitled "Helpful Hints for Radio Fans."

Name.....

Address.....

Belden

NATIONAL Tuning Units

Include the Time Tested

National Browning-Drake Transformer, National Condenser and National

Velvet Vernier Dial

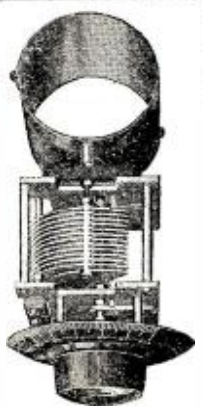

NATIONAL Tuning Unit BD1-A, comprising the Browning-Drake Inductance Coil and NATIONAL Condenser.

No units have given greater satisfaction to the home experimenter. And for these reasons:

- 1—sharper tuning
- 2—superb tonal quality
- 3—remarkable selectivity
- 4—ability to get distant stations
- 5—new straight line wave length condenser, permitting spread of stations over 180° on the dial.

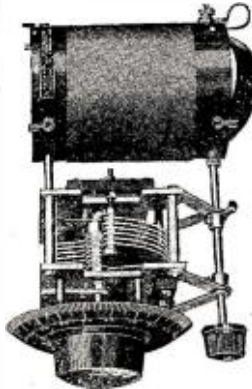

NATIONAL Tuning Unit BD2-A, comprising genuine Browning-Drake Transformer and NATIONAL Condenser.

Get The Genuine—Insist on NATIONALS

NATIONAL COMPANY, Inc.

W. A. READY, President

110 Brookline St.

Cambridge, Mass.

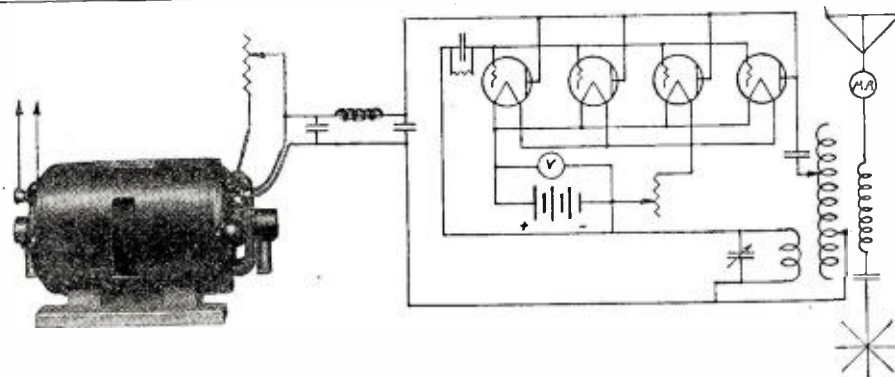

This is Item No. 8 furnishing Power Supply for 4/5 watters in the reversed feed back hook up. Item 8 can be furnished with either A.C. or D.C. motors, or as a separate generator. The machine is two bearing, wick oil, and its output is conservatively rated at 500 volts, 150 watts. It's a real little maximum miles per watt DX getter.

ELECTRIC SPECIALTY COMPANY

Manufacturers of Motors, Generators, Motor-Generator Sets, Dynamotors and Rotary Convertors for all radio purposes. Have you got your copy of Bulletin 237B and ESCO Filter Facts? If not, write for them.

TRADE "ESCO" MARK

211 South Street

Stamford, Conn.

EUREKA DIAL POINTERS
10c EACH
Polished Nickel or Gilt.
D-X Owl Pointer:10c
Nickel10c
Gold Plated15c
Samples for Stamps.
C. W. BUTTS, INC.
42 HEDDEN PLACE
EAST ORANGE, N. J.

FREE—Our 64-Page Catalogue. Filled With Radio Bargains. Write Today!

RANDOLPH RADIO CORP.
159 N. UNION AV. Dept. 2 CHICAGO, ILL.

because of unlimited scope of the camera, will bring also to an audience the combination of voice and action in scenes that could never be duplicated or presented on the legitimate stage.

"It means," he added, "greater entertainment for the public. That is the purpose of both industries—entertainment, educational as well as amusing or interesting—and eventually the radio and motion picture will accomplish together that which is impossible for either to do without the co-operation of the other."

Radio Beats the Ticker

(Continued from page 1263)

had been laughing at him ever since he started playing around with "that Kahn sylph"; and he knew that if he made this bet known to them the razzing would never cease.

But at the conclusion of the meal he and Alfred retired to their suite of rooms in the attic. They had chosen the attic deliberately, "in order to have sufficient room to live in," as they put it—which meant having any number of friends up to late suppers, amateur boxing parties, and, above all, so that Alfred would have plenty of floor space upon which to pile his wires, transformers, motors, inductances, and a seemingly endless collection of radio junk of one sort or another. They had taken over the old attic and made it into rooms for themselves.

Once they reached it and had securely closed the door, James told his tale. At the conclusion of it, Alfred could not restrain a long, low whistle.

"For the love of the Great Horn Spoon, boy, you certainly did make yourself a fine task! Of course, the whole point of the situation is to figure out some way to get the money so you can get yourself tied up to this Kahn sylph, am I right?"

"Only too right, me buck, only too right."

"Well, now, there's radio—"
"There you go! Do be sensible this time, for this is important. I don't mind when you try to cure corns or make the potatoes in the garden give three yields a year with radio, but, for Heaven's sake, don't drag radio into this."

"As a matter of fact, radio is the only way to help. Now, I have the germ of an idea—" And he paused very effectively. Effectively enough, in fact, to make James blurt out: "Well, let's have it."

"You remember when you were a kid, you used to work in that bucket shop in Fourteenth Street?"

"Yes. Well, what of it? Now don't be so foolish as to tell me that I ought to take what little money I have left and give those thievers a chance at it to try to win on the proverbial shoestring. It just can't be done, my boy."

"Oh, yes, it can—with radio."

"What do you mean, Solomon?"

"Well, it's this way. Listen closely while I spill the good news. First, bucket shops seldom actually buy the stock they gamble their patron's money on. They just take the margin bet. As everyone knows, the ticker tape is the thing that decides all bets. And the figure on that ticker tape is nothing but a report of the last sale price of the stock, bond, hay, grain, or what-not, in which the patrons are gambling. Right?"

"Yes."

"Very well. And you will remember further that those sales are made on the trading floor, and then a report of them is given to a man with an electric typewriter, who sends it to some undefined exchange room in one of the upper floors where it is sent out in turn on the ticker wire. Further, you will remember that the time required between the making of the sale and the placing of the quotation on the wire is between fifteen and forty minutes, depending on the

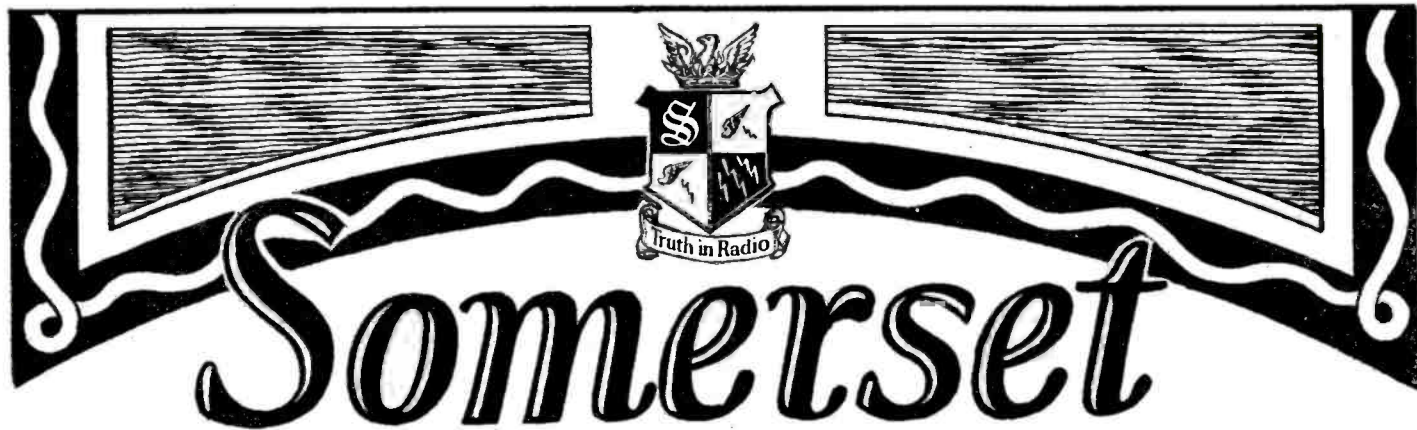

STANDISH MODEL 4-C



"TRUTH IN RADIO"

Synchronized, Single Master Control Gives Greatest Simplicity of Operation

Ever since SOMERSET Radio made its appearance two years ago, these beautiful sets have endeared themselves to the public on account of absence of extravagant claims.

SOMERSET Standish Model 4C achieves absolute simplicity in operation. One synchronized control takes care of all major tuning for local stations. A vernier control underneath the large dial is used only when listening to distant stations.

This is a 4-tube set entirely enclosed in an antique mahogany, two-tone, beautifully inlaid cabinet, with built-in Utah Loud Speaker, the best that money can buy. There is space for both "A" and "B" batteries in this large cabinet. Not just a cabinet, but a perfect piece of furni-

ture. The total size of the cabinet is 28½"x 13"x13½".

Storage batteries or dry cells can be used. Standish Model 4C operates from 200 to 600 meters. There is an automatic filament control, eliminating chances of burning tubes too brightly and does away with extra controls.

Straightline Frequency condensers of the latest type do away with crowding of the short-wave stations.

This receiver is the best and most pleasing model of the SOMERSET line of modern radio receivers. It is handsome, powerful, and practical throughout—built by men who have been in the radio business since 1908.

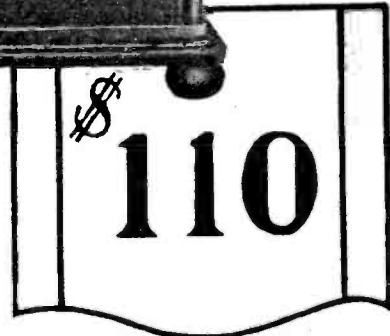

Special Dealer
FRANCHISE

Extra valuable dealer franchises for the SOMERSET line are still open to some dealers who are interested in the better model receivers that are ready for quick installing, backed by a liberal advertising campaign in your own territory. Write for complete plan. Wire for your territory or use this coupon, as we are closing all territory rapidly.

SOMERSET RADIO CORPORATION
113-119 Broadway Brooklyn, N. Y.

SOMERSET RADIO CORP.,
113-119 Broadway, Brooklyn, N. Y.

3-26

Gentlemen: Kindly send me at once details as to special Dealer franchise.

Name

Address

City, State

Right Resistance Meters

**Your Loud Speaker May Talk
But It Can't Tell You What's Wrong
In Your Set**

**STERLING POCKET METERS
ANSWER THESE QUESTIONS**

What Voltage should a NEW Dry B Battery Show?
How Long Can It Be USED With Satisfactory Results?
Should It Be Discarded When No Longer Serviceable in the Detector Circuit?
When Should Storage B Batteries Be Recharged?

Let the Sterling Meter find the kinks in your reception. These always ready, ever obliging testing instruments are doing their part for the upkeep of good radio. Get one and use it. Make sure it's a Sterling for Sterling Meters are "right resistance" Meters—a safeguard against overdraining the battery under test and really accurate in their readings!

If you care for good radio, give radio your care.

At All Good Dealers
A type for every requirement
\$1.00 to \$4.00

**THE STERLING
MANUFACTURING CO.**
Dept. V Cleveland, Ohio



Sterling

POCKET METERS

"tell the truth"

state of business. Now, on a busy day, there is a great lag between the sale and the arrival of the quotation on the tape, say, at the Fourteenth Street bucket shop. Do you begin to see my plan?"

"No, can't say that I do."
"You're forgetting radio."
"No, I'm not—I don't see very well how I can. Come on, give me the remainder of the plot."

"Well, briefly, here it is: That kid who was in college with you and who introduced you to the Kahn slyph is something or other in his father's broker's office, which is just across the street from the Exchange. He also has access to the floor of the Exchange. Now, if we can get him to jibe with our plans, the trick will be worked through the money of the bucketeers. We'll gamble on a perfectly safe thing. Joe Hamilton will go up with you and carry the apparatus which will be installed somewhere in the office of your friend's father. It will be one of the new short-wave sets which I have been building. Works on dry batteries and takes up just the room of a suitcase, and will easily keep in touch with me. At this end, I'll go rent an office in the immediate vicinity of the bucket shop and install that receiver, together with a small five-watt transmitter. I'll get mother to sew a loop in your coat; and I'll put a fixed crystal in circuit with it and a small phone unit you can carry in your hand. The chap downtown will signal the minute a sale is made, together with the price which will be sent to me via radio. It will be coded so that I can speak into the microphone of the five-watt set just as he gives me the name of the stock. You then step up and buy some of it on margin, of course. Ten minutes later, the new quotation from the Exchange will come in on the ticker, and you can sell, collecting a small profit. See?"

"Great idea, but how do you know that we can get all these offices, and how do you know that Joe will care to spend two months on the job?"

"That is up to you. You must put the thing over if you want the Kahn sy—"
"Don't you say it!"

* * * * *

Three days later the necessary arrangements had been completed. Alfred had put in a detector and two-step for receiving the signals in an office almost directly over the bucket shop, which was on the ground floor. He had also built up a five-watt transmitter on phone for retransmitting the quotations to James, who was to be in the bucket shop.

That evening they went down to the office and started the small phone transmitter—of course, Alfred just changed licenses to cover the portable station—to make a test of it. Alfred sat in the little cubbyhole of an office and counted slowly into the microphone of the transmitter, while James walked up and down the street in front of the office building. Two or three times a policeman looked at him as he walked slowly holding his left hand to his ear. He would go to the middle of the next block, stop suddenly, take a few steps backward and then forward, turn around and walk back again.

They found by the test that the signals could be heard easily with the crystal up to a block on either side of the transmitter. All was in readiness. The following morning would open the campaign.

The first thing James did upon his arrival at the shop was to open an account with the cashier with the remaining money he had. A steel stock was on a rampage, seemingly, from the number of times quotations for it were changed on the bulletin board. The card boy did little else than snap the cards in and out of the space under it.

James was almost scared the first time he hauled the little receiver very stealthily from his pocket and held it to his ear. He listened intently for a moment, there was all sorts of noise in the room which he had forgotten to figure on. He couldn't hear a thing. His heart came to his mouth—he

-it's in the TUBE

YOUR receiving set can be no better than its tubes. CeCo Tubes give maximum results in clarity of tone, rich volume and long life.

Our charted tests (results confirmed by laboratories of national reputation) PROVE CECO TUBES' SUPERIORITY—as detectors, as amplifiers.

Buy CeCo Tubes whether your set takes one tube or eight.

Now ready! CeCo Tubes with new type Long PRONG BASES. Also, power amplifier tubes, E (Dry Cell Type), F (Storage Battery), for last stage of Audio Frequency. Ask your radio dealer.

	"A"	"B"	"C"
Filament Volts.....	5.0	3.0	3.0
Filament Current.....	0.25	.08	.08
Plate Voltage	20 to 120	20 to 80	20 to 80

C. E. MFG. CO., INC.
702 Eddy Street Providence, R. I.



CECO
TUBES

PATENTS WRITE for our Four Guide Books and "RECORD OF INVENTION BLANK" before disclosing inventions. Send model or sketch and description of your invention for our INSPECTION and INSTRUCTIONS FREE. TERMS REASONABLE. Electrical and Radio Cases a specialty.

VICTOR J. EVANS & CO.
919 NINTH ST., WASHINGTON, D. C.

Free to Men Past 40

What is prostate gland disorder? Why does it come to two-thirds of all men past middle age? Why does it cause loss of vitality, sciatica, aching feet, back and legs? Amazing book, written by well known American scientist, answers these questions and tells how 20,000 men have found relief without drugs, surgery, lessons. Simply send name and address for copy, no obligation.

Address: The ELECTRO THERMAL CO., 6053 Main St., Steubenville, Ohio.
West Office: Dpt. 60-X, 711 Van Nuys Bldg., Los Angeles Cal.



BUILD YOUR OWN RADIO SET!

FREE

THIS VALUABLE 64-PAGE BOOK

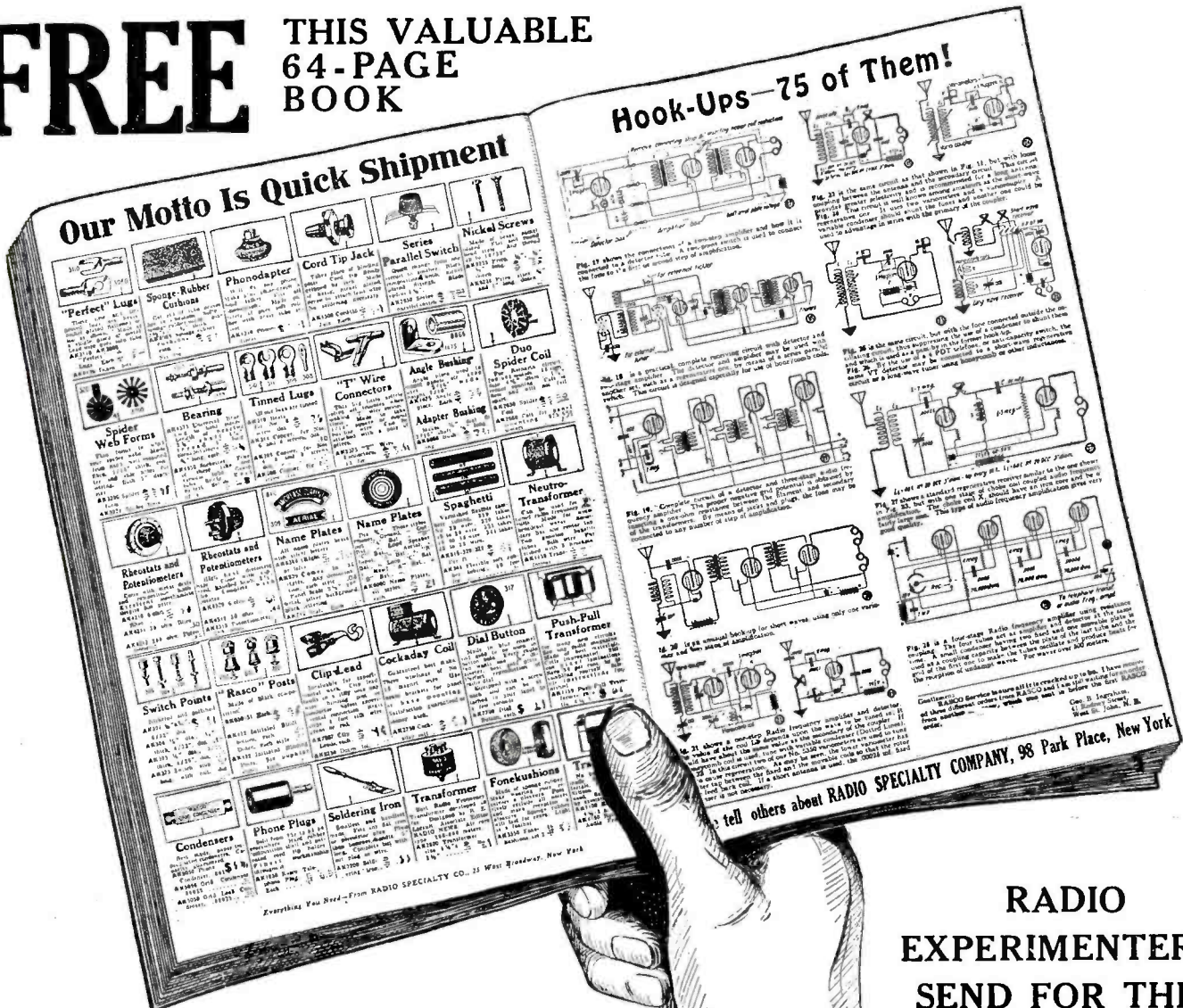

**NEW 1926 SPRING CATALOGUE
No. 16 JUST OUT
64 Pages—600 Illustrations**

Buy from Radio's oldest Mail Order House

THE NEW RASCO CATALOG No. 16

Contains the Following Hookups.

All Armstrong Circuits: These important circuits are explained clearly, all values having been given, leaving out nothing that could puzzle you. Just to name a few of the Vacuum Tube circuits: The V.T. as a detector and one-step amplifier; Super Regenerator; one-step radio frequency amplifier and detector; three-stage audio frequency amplifier; short wave regenerative circuits; 4-stage radio frequency amplifier; radio and audio frequency amplifier; inductively coupled amplifier; all Reflex Circuits.

This catalog is crammed full of small parts and radio findings, literally thousands of them. In addition there is much useful information contained herein.

WE are the oldest established, exclusive radio mail order house in the country. Our motto is "Quick Shipment." All orders are shipped within 24 hours. Quick, prompt, courteous service. We carry a larger variety of radio parts and findings than any other radio house in the country.

"RASCO HAS IT"

If you are in need of certain small radio parts that other radio and mail order houses do not bother to carry, get the Rasco parts catalog, and you will find them there, anything from a screw to copper ribbon and telephone diaphragms, as well as thou-

sands of other small radio findings. Just to mention a few:

Lugs, nuts, dials, vernier dials, jacks, plugs, every kind of knob, cords, panels, screws, sliders, washers, selenium, tin foil, switches, crystals, cap nuts, Litz wire, cord tips, brass rods, resistances, name plates, spring binding posts, switch parts, metal ribbon, carbon balls, binding posts, all types, switch points, switch levers, lock washers, carbon grains, ground clamps, metal pointers, insulated tubing, low melting metal, antenna connectors, bus bar wire, as well as thousands of others.

WE CARRY THE LARGEST VARIETY OF SMALL RADIO PARTS IN THE WORLD.

If you will paste this coupon on a post card and mail today, we will be pleased to send you our two Catalogues at once.

RADIO SPECIALTY CO.
98 Park Place New York City

RADIO SPECIALTY CO. R.N.-326
98 Park Place, New York.
You may send me, without charge or obligation, your NEW CATALOG No. 16. (Write on margin if you desire).

Name

Street

P. O. State

THE SILVER "SIX"

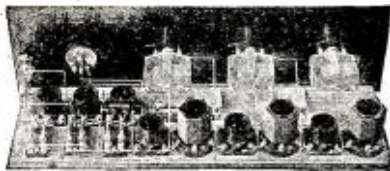

TYPE 600 KIT, includes all parts necessary to build the complete "SIX" \$53.00 TYPE 610 KIT, essentials only, including 3 condensers, 3 inductances and 3 inductance sockets\$27.75

SM Low Loss Inductances

All-Bakelite Low Loss Interchangeable Coils for 50-550 meters. These new coils may be used as excitators, antenna adapters and R V transformers in standard circuits. Price of all types, Each\$2.50 Sockets for any size Coils, Each\$1.00

SM 210 and 211 Transformers

Designed so that maximum amplification will be obtained at 60 Kilocycles. Both types in bakelite housings, hermetically sealed. No. 210 is iron-core type while No. 211 is of the air-core type supplied with measured tuning condenser. Each transformer is furnished with individual laboratory curve chart. Price: Both Types\$8.00 ea.

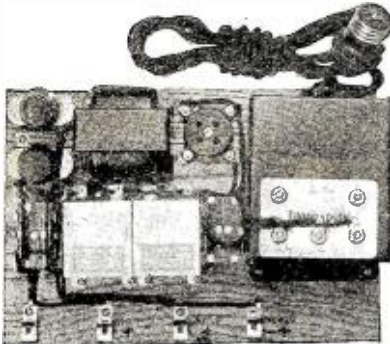

NEW S-M LONG WAVE COILS

SM Interchangeable Inductances are now available for European wavelengths. These coils are merely plugged in, in place of present sizes. No circuit changes necessary. Regular Type numbers apply.

FOR THE SILVER "SIX"

The following coils are needed for the foreign wavelengths:

550-1200 Meters	1200-1800 Meters
2-112 D Coils	2-112 E Coils
1-110 D Coil	1-110 E Coil

FOR THE SILVER SUPER

Described in Radio News of January these coils are needed:

550-1200 Meters	1200-1800 Meters
1-110 D Coil	1-110 E Coil
1-111 D Coil	1-111 E Coil

PRICE ANY TYPE NUMBER

D Range\$3.25 E Range\$3.50

Thordarson Power Transformer \$8.00

The Improved RAYTHEON-THORDARSON B-ELIMINATOR

The SM Type 650 Kit includes Thordarson transformer, choke, Tube condensers, genuine Raytheon tube, Bradleyohms and all necessary parts. Price \$34.

This eliminator will deliver from 20 to 200 volts at three different, adjustable voltages with maximum current of 50 milliamperes—more than enough for the largest receiver.

Send for Assembly Instruction by McMurdo Silver 10c

Circular on SM Products mailed on request.

SEE SM PRODUCTS AT YOUR DEALER'S

SILVER-MARSHALL, Inc. 116 S. WABASH AVE. CHICAGO

RADIO an Advertising Medium a new Suggestion

Advertising by radio broadcasting, of course, is in the very earliest stages of development.

If you are thinking about it and how to harness it, it will interest you to know that the Experimenter Publishing Company has organized a radio broadcast service department. It is under the direction of one of America's foremost service men who has spent years in a study of the new medium of tomorrow: radio broadcasting.

This department is at your service. Any accredited representative of a national or local advertiser, or of an advertising agency, is invited to correspond with this department without obligation of any kind. The service is maintained by this corporation without charge and contemplates the broadcast application as it effects the entire field of radio broadcast stations.

Write to the Experimenter Publishing Company, Radio Broadcast Advertising Service Department, 53 Park Place, New York, N. Y.

looked around and started for the door—he must reach Alfred and ask him to find the trouble. The crowd in front of the ticker and the stock board made it necessary for him to walk clear to the other side of the room in order to reach the exit.

And as he passed the center of the room under the beam the words of Alfred counting came clearly into the phone. James could hardly restrain a shout. It did work, after all.

Later, when he told Alfred about not being able to hear the signals except in the rear half of the room, Alfred laughed. They had both forgotten that half of the room had a metal ceiling!

Then the fun started. A steel stock was very active; so Alfred called his friend at the downtown transmitter and gave him the code that that was the stock to be traded in that day. James bought all he could on the smallest margin. That gave him a chance for a large profit. He would take a two-point rise and then pyramid his winnings for the next operation. Playing an absolutely sure thing and playing against a bucket shop left him with a feeling of elation. As soon as he had a start he would take out the capital and play only on his winnings, but he must have a start first. The steel stock was rising so rapidly that Alfred was kept busy getting him the word on the transactions. He pyramided before every new quotation. At the end of the day, when the market closed, he received a check from the cashier for \$871.23. As James and his brother went home at four o'clock they were unanimous that the day's work had not been so bad.

Back on the floor of the bucket shop things went as well as ever; the radio messages were beating the ticker consistently. By the end of the third day the owner of the shop began to notice James and ask him questions as to where he had learned to read the tape—which, in the parlance of stock operators, means the possession of an added sense, which allows the possessor of this wonderful quality to feel the trend of the price of a certain issue.

By the fourth day, the manager had begun to look askance at this new operator. He regarded him as a distinct liability, but was afraid to stop his play, for he put down the success of his work to beginner's luck.

Also, sitting behind a well-polished and heavily-glassed mahogany desk in the *sanctum sanctorum* of Kahn and Company, International Bankers, the president of that institution was chewing the end of a new Corona y Corona with a mouth that was distinctly vicious in its aspect. Mr. Kahn was contemplating with pleasure such visions as holding one James Michael Machilenny by the left heel while he, Mr. Kahn, lowered and raised him, Mr. Machilenny, slowly into a cauldron of very hot oil. For Mr. Kahn took a great interest in his depositors, both large and small. Particularly did he take an interest in them when their accounts were growing by about a thousand dollars a day; and, of course, his business acumen made it incumbent upon him to watch the doings of Mr. James Michael Machilenny to see whether that young man was really going to win his unique wager.

Mr. Kahn had really begun to worry ever so slightly about this young man who actually aspired to the hand of his daughter. He had put her infatuation for the boy down to childish enthusiasm, from which she would recover with ease, once the object of her affection was removed from sight.

But such was not the case. Every evening for the last five, when Kahn, senior, had sat down to a well-earned dinner, his daughter asked him, with the regularity of the twentieth century, as to the status of the Machilenny account.

As Kahn, senior, sat punishing the Corona y Corona in his well-upholstered chair, he made a decision, snap, just like that. He had a way of making decisions in the grand

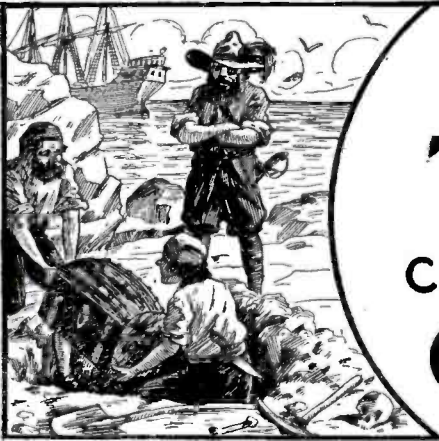

BURIED TREASURE

can still be found in

CHEMISTRY



Good Chemists Command High Salaries

and you can make yourself independent for life by unearthing one of chemistry's yet undiscovered secrets.



T. O'CONOR SLOANE.
A.B., A.M., LL.D., Ph.D.
Noted Instructor, Lecturer and Author. Formerly Treasurer American Chemical Society and a practical chemist with many well known achievements to his credit. Not only has Dr. Sloane taught chemistry for years but he was for many years, engaged in commercial chemistry work.

Do you remember how the tales of pirate gold used to fire your imagination and make you want to sail the uncharted seas in search of treasure and adventure? And then you would regret that such things were no longer done. But that is a mistake. They *are* done—today and everyday—not on desert islands, but in the chemical laboratories throughout your own country. Quietly, systematically, the chemist works. His work is difficult, but more adventurous than the blood-curdling deeds of the Spanish Main. Instead of meeting an early and violent death on some forgotten shore, he gathers wealth and honor through his invaluable contributions to humanity. Alfred Nobel, the Swedish chemist who invented dynamite, made so many millions that the income alone from his bequests provides five \$40,000 prizes every year for the advancement of science and peace. C. M. Hall, the chemist who discovered how to manufacture aluminum made millions through this discovery. F. G. Cottrell, who devised a valuable process for recovering the waste from flue gases, James Gayley, who showed how to save enormous losses in steel manufacture, L. H. Baekeland, who invented Bakelite—these are only a few of the men to whom fortunes have come through their chemical achievements.

What Some of Our Students Say of This Course:

I have not written since I received the big set. I can still say that it far exceeded my anticipations. Since I have been studying with your school I have been appointed chemist for the Scranton Coal Co. testing all the coal and ash by proximate analysis. The lessons are helping me wonderfully, and the interesting way in which they are written makes me wait patiently for each lesson.—**MORLAIS COUZENS.**

I wish to express my appreciation of your prompt reply to my letter and to the recommendation to the General Electric Co. I intend to start the student engineering course at the works. This is somewhat along electrical lines, but the fact that I had a recommendation from a reliable school no doubt had considerable influence in helping me to secure the job.—**H. VAN BENTHUSEN.**

So far I've been more than pleased with your course and am still doing nicely. I hope to be your honor graduate this year.—**J. M. NORKUS, III.**

I find your course excellent and your instruction, truthfully, the clearest and best assembled I have ever taken, and yours is the fifth one I've studied.—**JAMES J. KELLY.**

From the time I was having Chemistry it has never been thus explained to me as it is now. I am recommending you highly to my friends, and urging them to become members of such an organization.—**CHARLES BENJAMIN.**

I shall always recommend your school to my friends and let them know how sincere your lessons are.—**C. J. AMDAHL.**

I am more than pleased. You dig right in from the start. I am going to get somewhere with this course. I am so glad that I found you.—**A. A. CAMERON.**

I use your lessons constantly as I find it more thorough than most text books I can secure.—**WM. H. TIBBS.**

Thanking you for your lessons, which I find not only clear and concise, but wonderfully interesting. I am—**ROBT. H. TRAYLOR.**

I received employment in the Consolidated Gas. Co. I appreciate very much the good service of the school when a recommendation was asked for.—**JOSE DECKER.**

Now Is the Time to Study Chemistry



Not only are there boundless opportunities for amassing wealth in Chemistry, but the profession affords congenial employment at good salaries to hundreds of thousands who merely follow out its present applications. These applications are innumerable, touching intimately every business and every product in the world. The work of the chemist can hardly be called work at all. It is the keenest and most enjoyable kind of pleasure. The days in a chemical laboratory are filled with thrilling and delightful experimentation, with the alluring prospect of a discovery that may spell Fortune always at hand to spur your enthusiasm.

You Can Learn at Home

To qualify for this remarkable calling requires elaborate specialized training. Formerly it was necessary to attend a university for several years to acquire that training, but thanks to our highly perfected and thorough system of instruction, you can now stay at home, keep your position, and let us educate you in Chemistry during your spare time. Even with only common schooling you can take our course and equip yourself for immediate practical work in a chemical laboratory. Dr. Sloane gives every one of his students the same careful, personal supervision that made him celebrated throughout his long career as a college professor. Your instruction from the very beginning is made interesting and practical, and we supply you with apparatus and chemicals for performing the fascinating analyses and experimental work that plays such a large part in our method of teaching, and you are awarded the Institute's official diploma after you have satisfactorily completed the course.

CHEMICAL INSTITUTE OF NEW YORK
Home Extension Division 3
66-R—West Broadway
New York City

Experimental Equipment Furnished to Every Student

We give to every student without additional charge this chemical equipment, including forty-nine pieces of laboratory apparatus and supplies, and forty different chemicals and reagents. These comprise the apparatus and chemicals used for the experimental work of the course. The fitted heavy wooden box serves not only as a case for the outfit but also as a useful laboratory accessory for performing countless experiments.

Easy Monthly Payments

You don't have to have even the small price of the course to start. You can pay for it in small monthly amounts—so small that you won't feel them. The cost of our course is very low, and includes everything, even the chemistry outfit—there are no extras to buy with our course. Our plan of monthly payments places a chemical education within the reach of everyone. Write us and let us explain our plan in full—give us the opportunity of showing you how you can qualify for a highly trained technical position without even giving up your present employment.

Please send me at once, without any obligation on my part, your free Book "Opportunities for Chemists," and full particulars about the Experimental Equipment given to every student. Also please tell me about your plan of payment and your special 30 day offer.

Special 30 Day Offer

Besides furnishing the student with his Experimental Equipment, we are making an additional special offer for a short while only. You owe it to yourself to find out about it. Write today for full information and free book "Opportunities for Chemists." Send the coupon right now while it is fresh in your mind. Or just write your name and address on a postal and mail it to us. But whatever you do, act today before this offer is withdrawn.

CHEMICAL INSTITUTE OF NEW YORK, Inc.

HOME EXTENSION DIVISION 3

66-R—WEST BROADWAY NEW YORK CITY

DON'T WAIT—MAIL COUPON NOW!

NAME

ADDRESS

CITY STATE

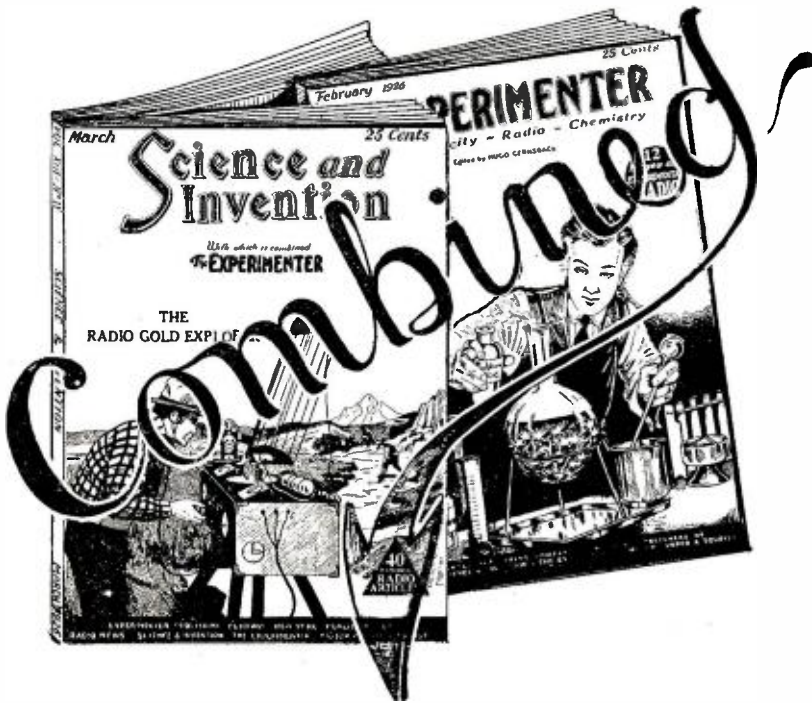

The EXPERIMENTER
is now combined with
SCIENCE and INVENTION
into a new and greater
SCIENCE and INVENTION.

These two great magazines are now ONE. The Bigger SCIENCE and INVENTION will carry, in complete form, all the best departments of the merged EXPERIMENTER.

This means more, useful, interesting material for your money than ever before. Not only all the great scientific achievements of the world but also all the experiments of value.

The Price of the New SCIENCE AND INVENTION Is Only 25c the Copy.

SOLD ON ALL NEWSSTANDS

EXPERIMENTER PUBLISHING CO., Inc.
53 Park Place New York, N. Y.

manner. He touched a button conveniently placed near one end of his desk and it was only a moment before there appeared, in one of the doors, the face of a very stern individual, evidently of Irish extraction.

"Mullins, come in and have a cigar."

"Yes, sir, thank you, and it's several days I've been without one of these," he said, rolling the Corona y Corona between his fingers. "And who is the culprit you would have me be getting now, Mr. Kahn?"

"Mullins, I've run up against a snag. I bet with an Irishman before I thought."

"And ye should know better, at your age, Mr. Kahn."

"But, Mullins, I want you to get me out of it." And then followed a full explanation of the whole silly business with fitting remarks by Mr. Kahn concerning the habits and characteristics of Irishmen generally and sad asides as to how he, Mr. Kahn, was a man of his word and was about to lose his daughter by his own foolishness.

Ten minutes later, Mullins, with another Corona y Corona in his pocket, started to checkmate the young man who was intent upon so rudely taking the banker's pearl of great price. As a start in the matter, he called up the Machilenny household and inquired where the son could be found. He was told the exact spot.

That, Mullins considered a good day's work. So he went home to enjoy a quiet afternoon playing baseball with his youngest.

The following morning, however, when he heard the buzzer ring in his little room, he started repenting, and continued repenting, as he walked up the steps toward Mr. Kahn's office.

"Damitall, why didn't you get that kid?" was the greeting he received.

"But, Mr. Kahn, a man can't be interfered with when he's playing the market. He needs all his attention to keep those bears and bulls from the door. Ye told me as much once yerself."

Then followed his information as to the Machilenny whereabouts.

"You go down there today and watch him. He's probably at work by now making another thousand."

"And it's the last one he needs," thought Mr. Kahn, as a clerk laid a memorandum on his desk upon which was penned the following inscription:

"Machilenny, \$8,791.13."

It was, frankly, too much, this young whipper-snapper making any such sum—and on the market, at that. But, of course, one cannot expect Mr. Kahn to keep absolutely abreast of the scientific times. That is, not until inventions become better paying propositions.

Mullins, being anxious to do a friend a good turn—and Mr. Kahn was his friend—set out immediately for Fourteenth Street. Arrived there, he looked carefully over the faces of the men in the place. There was no trouble at all in finding his man from the description given him. And he found him, sitting quietly in a chair in the rear half of the room.

"Now, I'll just take this youngster to the boss on the pretext that he wants to see him. Once I get him there, his blood'll be on the boss's head, for I will have done me duty and the kid will not have made the necessary money."

But, being experienced in his line, and having a few dollars in his pocket, and knowing the reputation of the Machilenny account at the House of Kahn, Mullins considered it good business to follow the doings of the lad with a few dollars of his own before taking him away; besides, it might be much better to wait until the close of business, there would be much more chance then of the lad coming with him. Mullins knew that Mr. Kahn could close the shop—at a moment's notice—by a few simple words. If he did not close it entirely, he could at least cause it to refuse the patronage of

Machilenny. So, being kind hearted, and needing a new overcoat, Mullins decided to let the boy have his play for the remainder of the day. That would be time enough to close down on him.

Machilenny had been playing the last two days on a motor stock to good effect. He had so much money on it, and was gambling so much daily, that his nerves were in frazzles. He did not even go to lunch. He had begun this morning by playing it for a rise and had posted \$500 for a margin. The stock, of course, had immediately taken the jump. The manager of the shop had been distinctly uncordial to him for the last three days. In fact, he had told him only yesterday that if his winnings continued for a couple more days, as they had in the past, he would refuse to take any more orders from him. And, besides, the manager said, James' habit of holding his hand to his left ear made him distinctly nervous. In fact, he went so far as to intimate that the gesture was seriously interfering with his sleep at night.

The manager was coming across the floor now. James knew that his time was up. No more winnings and just a little short. He was listening at that moment to a two-point rise in an oil company which was coming through the receiver. Quickly removing his hand he darted to the other side of the room and, by putting the crowd of investors between himself and the manager, reached the cashier and placed \$1,000 on the stock—his largest sum so far, and the limit set by the house on margin investments.

The manager felt his heart sink, but the cashier had handed James the slip before the manager reached him.

"That's all, young man," he said to James, and turning to the cashier said, "Joe, this man"—pointing to James—"is not investing with us any more. We cannot handle his business."

James was so busy he had lost account of the money he had in the bank. In two minutes the ticker told the story. James collected \$1,825, which was his gains, less commission to the house.

With the total check for his day's winnings, he almost fell out the door. He leaped up the steps to tell Alfred that it was all off, and to see how much money he lacked. There was at least a month left of the stipulated time: so he thought that he could earn enough to supplement it.

But as he was coming down the stairs to eat—he hadn't had lunch for three weeks for lack of time—Mullins laid his hand on his shoulder.

"Mr. Kahn wants to speak to you. Get in this cab," and he held open the door to a taxi.

James was too dazed to do anything else, and anyway, he had to deposit the checks.

At the bank, he made the deposit and asked for his balance. It was, to his momentary surprise, \$10,372.18.

"Now let's go see Mr. Kahn," he said, turning to Mullins, who was a bit grouchy because of the loss of the overcoat.

* * * *

Years after, when James Michael Machilenny had grown rather stout of paunch from too much work over a well-polished and heavily-glassed mahogany desk in the House of Kahn, the clerks would tell each new man who came into the employ of the bank how James got his position, because he walked straight into the old man's office and said, "Pay me." Of course, his rise was more rapid than usual, because he had later married old Kahn's daughter.

LUCKY HUSBAND

"Oh, Charley," sobs the young bride, "it's awful. I was . . . right in the middle of making a fine cake . . . and listening to the radio set . . . when the tubes burned out . . . and I couldn't hear the rest of the recipe. . . . What shall I do?"

Portland Oregonian.



Now Formica Offers Complete Panel Service!

FORMICA has improved its service to the American Radio manufacturer by offering completely decorated and finished front panels. The decorations are done in gold, silver and other colors by the Veri-Chrome process. They are by far the most handsome panels in use in radio today—and the panels with the most permanent finish and surface.

This service is now extended to those amateurs who wish to assemble certain well-known kits. In numerous instances the Formica Veri-Chromed panels is part of the kit offered by the manufacturer.

Dealers are supplying kit builders with the following complete Veri-Chromed Formica panels: Bremer Tully, Counterphase, Nameless and No. 1; two sizes of Best's Superheterodyne, 7 x 20 and 7 x 26; Browning Drake Four-tube National Receiver.

Formica panels in all the usual standard sizes are sold by most good dealers. Each panel is packed in a neat individual envelope.

Write for booklet "What Formica Is"

THE FORMICA INSULATION COMPANY
4618 Springrove Avenue
Cincinnati, O.



FORMICA

Made from Anhydrous Bakelite Resins
SHEETS TUBES RODS



It Says "STOP" and Lightning Won't Harm Your Set

The National Board of Fire Underwriters specify that an approved Radio Lightning Arrester *must* be used with all out-door aerial installations. Protection is easy. Insure your insurance and save your set with a WIRT LIGHTNING ARRESTER (listed as standard by the Underwriters Laboratories). The cost is a trifle.

The WIRT LIGHTNING ARRESTER is an approved air gap type, made of bakelite giving ample insulation, with brass terminals moulded in bakelite, far enough apart so that there is no leakage. A "petticoat" of bakelite shields the arrester from water and dust. Handsome and rigid. Lasts a lifetime. Easy to install. Full directions on box.

THE WIRT LIGHTNING ARRESTER IS LISTED AS STANDARD BY THE UNDERWRITERS LABORATORIES

Wirt Lightning Arrester...\$1.00
Wirt Insulator35

When you install your WIRTLIGHTNING ARRESTER get a WIRT INSULATOR and prevent leakage along your lead-in wires. It keeps the wire at the proper distance, provides perfect insulation, and prevents wear and tear on the wire by preventing sagging and swaying.

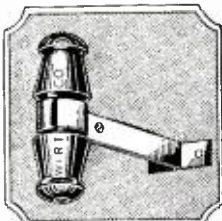

Sold by Leading Radio Dealers

WIRT COMPANY
PHILADELPHIA, PENNSYLVANIA
Makers of Dim-A-Lite



GEM TUBE

A Guaranteed Radio Tube
Within Reach of All

Every tube guaranteed. A tube for a dollar of \$3 value. A trial order will convince you as it has thousands of others. Send your orders at once.

Orders sent C.O.D. parcel post.
Type 401A
Type 400
Type 499
Type 499A
\$1.00
EACH

(with standard base)
Dealers, Write for Discounts

GEM TUBE CO.

Dept. N, 200 B'way, N. Y. City
220 So. State St., Chicago, Ill.
Lafayette Bldg., Detroit, Mich.

Insure your copy reaching you each month. Subscribe to RADIO NEWS—\$2.50 a year. Experimenter Publishing Co., 53 Park Place, N. Y. C.

Correspondence for Readers

(Continued from page 1302)

a metal spring, would almost certainly amalgamate and ruin itself and the mercury. The supply of thermometers ran out; the physics laboratory had no more mercury; so my experiments were stopped, while yet but imperfectly done. It wasn't much later that I managed to purchase an Audiotron, double filament and tubular, and fought all about any other type of detector than the vacuum tube.

At any rate, I found that the mercury detector was practical, though not how good. It is probable that the use of a carbon point and a carbon cup would result in a successful and satisfactory detector, although one which would probably be easily jarred out. A metal which failed to amalgamate with the mercury could be used as a point in it, of course, and perhaps with success. At any rate, any appreciable presence of another metal in the mercury results in a rapid depreciation of its value for rectification purposes.

I wish it were possible for me to obtain one of the old Barr detectors now; merely for a souvenir since experiments in that line are not of immediate interest, although there are, undoubtedly, a number of details yet to be learned about the performance of the mercury detector.

If there is any doubt about the business working, I hope that this will dispel it, as well as encourage experiment; since but small expense can be attached.

L. W. HATRY,
c/o The Hartford Times,
Hartford, Conn.

December 13, 1925.

A Radio Sounder and Interference Eliminator

(Continued from page 1284)

sets up a harmonic of the fundamental frequency of the wire; the first harmonic, in fact, with its node resting on the ridge of the diaphragm, and the maximum amplitude of vibration midway between the node and the extremities of the wire. When the vibration is reasonably active, this amplitude causes the wire to extend up and down as much as an eighth of an inch. (Pluck a violin string, by way of illustration, and note the distance it passes through in the plane of its motion.) If we place a contact over this point of the wire where it reaches its maximum amplitude, the contact will engage the wire and actuate a relay. We have now established a rather unique system with innumerable possibilities for radio control. The point might be better illustrated by asking the reader to consider a piano without the keys, with only the wires, each wire surmounting a receiver and bearing on the ridge of the diaphragm. Over each wire is a contact to engage the wire as it goes into motion. It is understood that the receivers are in multiple and connected to a radio receiving set.

Do you not see that from a distant point you have a control system which admits of as many missions as you have piano strings? The experiments at the university illustrated a very interesting phenomenon in connection with this particular phase of the system, perfectly logical, but somewhat hard to credit until tried. A composite musical note, consisting of different frequencies, such as a musical chord, was transmitted by radio, passed into a receiving set, and thrown into such a system as described. The musical chord sought out the various wires making up the chord and set them in vibration, all at the same time; hence, the device will act

PATENTS

To the Man with an Idea

I offer a comprehensive, experienced, efficient service for his prompt, legal protection and the development of his proposition. Send sketch, or model and description, for advice as to cost, search through prior United States patents, etc. Preliminary advice gladly furnished without charge. My experience and familiarity with various arts frequently enable me to accurately advise clients as to probable patentability before they go to any expense. Booklet of valuable information and form for properly disclosing your idea free on request. Write today.

RICHARD B. OWEN

PATENT LAWYER
2 Owen Building, Washington, D. C.
41A Park Row, New York City



YOU CAN SEE at a glance with an S. O. S. Hydrometer

the state of your
"A" Battery

No figures to read, no float to stick or break. The CHASLYN balls tell the story. Quickly—easily—you don't even have to remove the hydrometer from the battery. No need to spill acid or get it on your fingers. Small and compact, fits easily into battery compartment. You do not have to move battery.

Ask your dealer if he can't supply you, if not, write us enclosing price.

Sold the World over.



75c

Swim all three, charge fully.

Sinks the white, charge still right.

Sinks the green, charge is lean.

Sinks the red, charge is dead.

THE CHASLYN COMPANY
4617 Ravenswood Ave., Chicago



Radio Dealers

Don't
Overlook This Opportunity

Some Radio Dealers have overlooked the fact that their steady customers are the biggest buyers of Radio News in the country—and that they can simply and easily increase business by selling Radio News to them over the counter at a big profit.

For Information Address

EXPERIMENTER PUBLISHING CO.
53 Park Place, N. Y. C.
Dept. 2 R. D.

separately or compositely. It has also been found, that a number of different wires stretched on the same ridge respond separately or compositely.

It might be mentioned that, during many experiments, we used as a test against interference, a 1/4-kw. rotary spark set, operated within ten feet of the model, without noticeably disturbing its function.

This paper may be summarized by saying that this patent embraces the following possibilities: a means of increasing the ratio of signal strength over that of ordinary interference; a sounder emitting a loud and pleasing signal, and obviating the use of head-sets; the possibility of operators, during stand-by periods, or at night, putting their sets on call enunciators; and, finally, it opens up a field of development in radio control which depends on a very simple mechanical selector and differentiator.

In concluding, most hearty thanks are extended to Capt. James A. Code, Jr., for the facilities, in the way of research and development, so kindly placed at the writer's disposal, while he was conducting this research work at Ohio State University; to many friends among the student body, some of whom spent long vigils, oftentimes until the sun was up in the morning; and to Professor Caldwell, of the electrical engineering college, and Professor Blake, of the department of physics, without whose help and encouragement progress would have been extremely hard.

How Radio Tubes Are Evacuated

(Continued from page 1283)

volves the Gaede principle, with certain important improvements.

Fig. 5 shows the principle of construction of pumps of this kind. They consist of a drum set eccentrically inside a cylinder, so that the drum touches the cylinder at one point. One or more pairs of steel crossbars are set in slots in this drum and held apart by springs, or otherwise, so that, during rotation, they bear constantly against the inner wall of the cylinder. The air from the bulb being exhausted, expands continuously into the space N, and is swept along and out of the exhaust by the flapper bars. These pumps are sealed with oil. They are operated with motors and, when turning over at 200 to 400 R.P.M., they are rapid in action and effective in producing a vacuum as low as the vapor pressure of the oil. The best of these pumps will give a pressure of 1/1000-mm., or somewhat better. A 10-quart container can be pumped down to 2/1000-mm. in about ten minutes.

High-speed power-driven pumps of this pattern are heavy—perhaps 100 pounds in weight—and costly, listing at about \$250 to \$300. The cost lies largely in the careful machining of the parts necessary for efficient operation.

AN EFFICIENT SMALL PUMP

A simplification, and, in some respects, an improvement, of this design has been made by an American manufacturer, who has placed a complete small outfit, including pump and motor, on the market at \$85. Such an outfit is to be recommended to experimenters who wish to work to pressures around 1/1000-mm. For the evacuation of a large volume, this small pump is, naturally, slower than a larger one—40 minutes being required to bring a 10-quart container down to 2/1000 mm., and 90 minutes to bring it down to 1/1000 mm. The amateur experimenter, however, seldom deals with large volumes, nor is he seriously concerned over the amount of time taken up in his operations, provided this time is not unreasonably great.

The rotary oil-sealed air pumps represent the highest present development in the way

SAVE TIME AND MONEY

We have radio Tools of every description for every conceivable set building purpose

You will be astonished at the remarkable tools we have for your work and delighted at our low prices

NO. 202



COMBINATION PLIER

Combination Plier, Wire Cutter, Wire Former and Wrench. Drop forged, slender but exceptionally strong. 6 inches long. No. 202—Combination Plier, Wire Cutter, Wire Former and Wrench.....75c

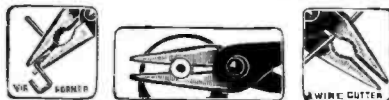

RADIO TOOL SET

This is the handiest set of tools ever made for Radio Work by the makers of the famous "YANKEE" Tools. It contains the following: 1 Ratchet Screw-driver, 6 1/2 in. long holding all attachments; 1 Blade, 5 1/2 x 3-16; 1 Blade, 3 1/2 x 1/8; 1 Blade 2 1/2 x 1/4; 1 Countersink; 2 Socket Wrenches for all small nuts; 1 Reamer to enlarge holes in panel from 1/8 to 1/2; 1 Wrench, one end 5-16" square or hex. for jack, other 1/2" hex., etc.

PRICE per set—No. 701.....\$3.00

NO. 701



SIDE CUTTING NIPPER, LAP JOINT

For cutting all kinds of wire. Jaws hardened and oil tempered. Natural steel finish with polished jaws. Length 6 inches.

PRICE—No. 201.....75c

NO. 201



CIRCLE CUTTER

Especially designed for the Radio Constructor. Made of the finest material and equipped with the highest grade high steel cutting bits. It does three things at once. It drills its own pilot, cuts out plug and puts bead or scroll around the hole in one operation. Cuts holes 3/4 to 4 in. in diam.

PRICE—No. 402.....\$3.00

Nos. 401 & 402



NO. 304

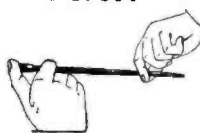

SCREW STARTER and DRIVER

Holds any screw by its slot with a firm grip, makes it easy to place and start screws in difficult places. Just the tool for the Radio Constructor. All parts heavily nicked and polished.

PRICE—No. 304.....\$1.00

NO. 800



ELECTRIC SOLDERING IRON

A perfect tool for Radio Work. Operates either on 110-volt A.C. or D.C. The heat element is of Nichrome, which prevents overheating and assures the desired even temperature. Size of Iron, 10 1/2 in. long. A 4-ft. cord and plug is furnished.

PRICE No. 800.....\$2.00

NO. 302

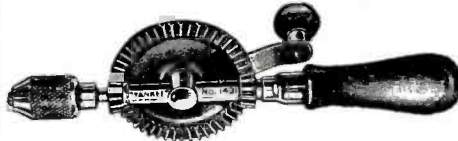

HAND DRILL

Especially designed for Radio Work by the makers of the famous "Yankee" Tools. A beautiful balanced, small, powerful drill with 4 to 1 ratio of gears for speed. Special chuck 9-32" capacity, to take largest drill, mostly furnished with drill or tool sets. Length over all, 9 1/2 in. Weight 1 1/2 lbs.

PRICE—No. 302.....\$2.75

Order all tools by order number. All goods are shipped free of transportation charges to all parts of the United States and possessions the same day as the order is received.

MONEY REFUND GUARANTEE

If you are not satisfied money will be refunded on return of goods.

THE RADIOGEM CORPORATION

66-R West Broadway

New York, N. Y.

Takes the MYSTERY out of RADIO!



100,000 SOLD
514 PAGES

Compiled by
HARRY F. DART, E.E.

Formerly with the
Western Electric
Co., and U. S.
Army Instructor of
Radio. Technically
edited by
F. H. DOANE.

BE A RADIO expert—it's easy for the 100,000 who own this compact, complete Radio Handbook. Written in good, plain, understandable language. Crammed full of facts, every one useful and important. Explains how receivers and transmitters work, how to build and operate them. Whatever you or your friends want to know, it's here. Will save you many times its small cost.

TELLS ALL ABOUT: Electrical terms and circuits, antennas, batteries, generators and motors, electron (vacuum) tubes, most receiving hook-ups, radio and audio frequency amplification, broadcast and commercial transmitters and receiving, super-regeneration, codes, license rules. Many other features.

Nothing else like it. Make this extraordinary book your radio library—just this one little giant is all you need. Everything in one index, under one cover, in one book, for one dollar. The biggest dollar's worth in radio today. Combines the knowledge of many expensive works. Buy this and save the difference.

Just mail the coupon with a dollar bill and your name and address, and this 514-page I. C. S. Radio Handbook will be sent to you by return mail. Note the other good books listed below at low prices.

INTERNATIONAL CORRESPONDENCE SCHOOLS

Box 8282-G, Scranton, Penna.

I enclose \$....., for which send me, post-paid, the Handbooks marked X, at \$1 each. It is understood that if I am not entirely satisfied I may return them within five days and you will refund my money.

RADIO HANDBOOK, 514 PAGES, \$1

- Automobile Handbook, 354 pages - - - \$1
- Electrical Handbook, 414 pages - - - \$1
- Chemistry Handbook, 348 pages - - - \$1
- Pharmacy Handbook, 324 pages - - - \$1
- Traffic Handbook, 386 pages - - - \$1
- Building Trades Handbook, 409 pages - - \$1
- Machine Shop Handbook, 335 pages - - \$1
- Salesman's Handbook, 352 pages - - - \$1
- Advertising Handbook, 445 pages - - - \$1
- Bookkeeper's Handbook, 302 pages - - - \$1
- Civil Engineer's Handbook, 411 pages - \$1
- Steam Engineer's Handbook, 298 pages - \$1

Name.....

Address.....

Enclose \$1.50 for each book if you want the Leatheroid binding. All of the above books can be had in this binding except the Traffic Handbook and the Building Trades Handbook.

RADIO RENCH

Five strong little wrenches and a handy screw-driver bring every nut and bolt on your radio. All held together by a patented device so none will be lost but easily detached for use.

Niagara Metal Stamping Corporation
Dpt. 601 Niagara Falls, N.Y.

Folder Free

PREMAX

RADIO BARGAINS

FREE RADIO CATALOG & GUIDE of newest ideas, approved special hook-ups with illustrations. Tremendous savings on standard radio parts, sets, kits. Be sure to get this thrifty book before you buy. Wonderful! Unusual! You'll say so! Write letter or postal NOW. BARAWIK CO., 102-142 S. Canal St., CHICAGO, U.S.A.

of pumps easily usable in shop work, and can be made to run effectively for hours with very little attention. They are limited, however, to the production of vacua which, in practice, are not generally better than 1/1000 mm.; and, to be truthful, are, under shop conditions, usually considerably worse than this.

In turning to the description of pumps of Classes 5, 6, 7 and 8, we come to what are more strictly "laboratory pumps." These pumps need skilled handling; but when so handled, are capable of producing the highest degree of vacuum which has ever been attained up to the present.

PRINCIPLE OF THE MERCURY PUMP

The "stationary" mercury pump of the Sprengel pattern was introduced many years ago, but has still its applications in the laboratory for work where speed is not necessary. The design is attractive to amateurs since it is simple and cheap.

Fig. 6 shows how easily one can be constructed from a funnel, F, a piece of rubber pipe and a long glass tube with a side entrance near the top. It is important that this long tube be considerably more than 30 inches from the side inlet to the bottom. The principle is easily understood. The flow of the mercury through the rubber pipe must be adjusted so that successive drops, filling the entire bore of the tube (the bore should be 1 to 2 mm.), and perhaps 4 to 5 cm. apart, fall continuously past the side entrance, A, to which the bulb to be exhausted is attached. These drops of mercury act as so many pistons, the air from the bulb expanding into the successive inter-spaces between the drops and being thus carried down and finally discharged through the mercury at the bottom. The mercury must be removed from the receptacle at the bottom and poured into the funnel at the top, as required.

FOR THE AMATEUR'S USE

Since a pump of this pattern may be used quite conveniently by an experimenter in exhausting a radio tube to any desired vacuum, it will be worth while to describe a special form devised by Guichard, in which no glass-blowing work is required. The Guichard pump can be put together for a very small sum of money, probably not more than three dollars. The principal expense is in the mercury necessary to operate it. Mercury, at the present time, costs about one dollar a pound.

The capillary tube, BD, of the Guichard pump (Fig. 7), ought to be 125 cm. long and of 1 to 2 mm. bore. It is shown in the figure curved up at the bottom, although this is not essential. At one side, near the top, is a small hole (H) through the side wall into the bore, through which the drops of mercury enter. The capillary passes through a rubber stopper, S, and has inverted over it a long glass tube, of perhaps 1 cm. diameter, which communicates at the top directly with the bulb to be evacuated. A third tube (T), of small bore, runs down at the side of the other two and all three are enclosed in the larger tube (M), which fits tightly over the rubber stopper. At the top is a funnel communicating with tube T through a rubber pipe provided with a pinch-cock. The receptacle, C, at the bottom, enables one to transfer the mercury from the bottom to the top without stopping the action of the pump.

To start the pump into action against full atmospheric pressure, it is necessary to bring the mercury level up to the hole, H. A considerable volume of mercury is, therefore, necessary, constituting an item of some expense. This design is thoroughly practical and will evacuate radio bulbs in a satisfactory manner. The design of Fig. 6 is faulty in that the rubber tube at the top is almost certain to allow air to leak in.

PRACTICAL OPERATION

Suppose now that we have one of these

SAVE 50%
Direct-from-Factory To You!



5-Tube T.R.F. Receiver

ORPHEUS "FIVE"

\$25.00
LESS ACCESSORIES

Designed and built especially for us by one of the largest Radio Manufacturers. Extremely Selective, wonderful tone quality, and a real distance getter.

Our Direct-To-User Selling Policy enables us to offer this Wonderful Receiver at a price never Equalled.

Quantity LIMITED — Order At Once and avoid disappointment.
Sent C.O.D. or on receipt of Money Order—express collect—to any part of U. S. or Canada.

UNITY COMPANY, Room 4108
Woolworth Bldg., New York

Burns

LOUD SPEAKER

Distinctive in design

Pyralin bell
Aluminum column

Volume—Clarity—Beauty
No. 205B—Polished black flare....\$22.50
No. 205D—Shell pyralin flare..... 25.00
No. 205P—Mother-of-pearl flare... 30.00
No. 100 —Phonograph unit..... 10.00

Manufacturers
American Electric
COMPANY
State and 64th Sts. Chicago, U. S. A.

22½ VOLT

unacid
everlasting
rechargeable

"B"
STORAGE
BATTERY

\$2.95

Includes
chemical



45 volts, \$5.25; 90 volts, \$10.00; 112½ volts, \$12.50; 135 volts, \$14.75; 157½ volts, \$16.80. Truly the biggest buy today. Easily charged on any current including 32 volt systems. Any special detector plate voltage had. Tested and approved by leading authorities such as Popular Radio laboratories. Over 3 years sold on a non-red tape 30-day trial offer with complete refund if not thoroughly satisfied. Further guaranteed 2 years. Knock-down kits at greater savings. Complete "Hawley" "B" Battery Charger \$2.75. Sample cell 35c. Order direct—send no money—simply pay the expressman cost on delivery. Or write for my free literature, testimonials and guarantee. Same day shipments.

B. HAWLEY SMITH
314 Washington Ave. Danbury, Conn.

pumps set up and wish to evacuate a radio bulb with it. It is not sufficient merely to stick the bulb on the outlet of the pump with a piece of rubber tubing and then go ahead. The evacuation must be carried out carefully and in a certain manner. First, the bulb must be provided with an outlet tube with a constriction, as shown in A (Fig. 8). This outlet tube and, also, the pump connection, must next be coated with a thin layer of sealing wax, by heating the glass gently in a blue gas flame—not in a smoky, yellow one—and then rubbing the stick of wax on it. Never heat the wax and rub it on the cold glass, as a connection so made will leak air between the wax and the glass. Next, the bulb should be sealed on the pump by gently warming the two tubes and working the wax together into a smooth sheath with wetted fingers. A suitable support must, of course, be supplied for the tube at this stage.

Now start the pump into action. Next, wrap the radio bulb, H, with a layer of asbestos paper, and wind about this a number of turns of No. 24 or 26 nickel wire, through which current from a 110-volt A.C. or D.C. circuit can be passed. The current will bring the wire up to a good temperature and heat all parts of the tube thoroughly, thus dislodging water vapor and other gases from the glass and metal parts. During this heating, a wad of cotton, wet with cold water, ought to be kept on the metal base of the tube—otherwise the base may fall off, due to softening of the cement. Heating during evacuation is essential to get good results. The heat may, of course, be applied with a gas burner, but the electrical method is the better. The heating ought to be kept up an hour or so, and the pump action for, perhaps, two hours.

During the second hour of pumping, battery leads ought to be brought up against the filament terminal stubs on the tube base, so that the filament glows brightly, a few seconds at a time, for an aggregate time of perhaps one minute. At the end of the second hour, bring a pointed blowpipe flame against the constriction in the bulb outlet, and heat carefully on all sides until the flame turns yellow. Then draw the bulb gently away, the pump still being in operation, and melt the film of glass down to form a neat globule on the tip of the bulb.

If these directions are followed, a thoroughly satisfactory vacuum will be obtained—excepting that mercury vapor at a low pressure will be present in it. This mercury vapor will do no harm in many uses to which the tube may be put, especially for detection. It is, in fact, not impossible that the detecting action might be improved thereby. The mercury can easily be eliminated during evacuation, if it is so desired, by the use of a freezing mixture, as we shall explain in our next article.

The description of pumps of Classes 6, 7 and 8, which are the types used in research laboratories for the production of the highest vacua, such as are needed in investigational work, must be deferred until next month. At that time we shall also describe how vacua can be improved, through the use of freezing mixture, solid absorbing agents and electric discharges.

SAVE THE FILAMENTS

It will probably be an old story to hear what dire results may come from trying to use the VT's in the radio receiver to light up the room or to illuminate the interior of the cabinet. The modern tubes are made to operate properly with but little illumination coming from the filaments. In fact, these tubes are known by the English as "dull emitters."

Nothing is gained by burning the filaments brightly; on the contrary, much may be lost. Remember that when the voltage on the filament of a tube is even as little as 10 per cent above the voltage it was designed for, the life of the tube may be cut in half.

It's Easy to Build A Powerful Set

Using the New and Improved **FRESHMAN "TRF" Low Loss Kit**



Straight Line Wave Length Condensers With Low Loss Self Balanced Coils

These are the identical units which have made the FRESHMAN MASTERPIECE factory built Receivers the World's Greatest Radio Sets **\$ 9.50**

Complete instructions for building this powerful five tube receiver, written in plain everyday English, together with actual size schematic wiring diagram are furnished with every FRESHMAN "TRF" Kit.

Sold by Authorized Freshman Dealers Only!

CHAS. FRESHMAN CO., INC. Freshman Building, New York 2626 W. Washington Blvd., Chicago



BLUEBIRD RADIO TUBES

—are powerful—sensitive for distance, give clear volume and long service.

GUARANTEED

to work in Radio Frequency, Neutrodyne, Super Heterodyne and Reflex.

WITH BAKELITE BASE

Type 401A All Standard Types
Type 400 \$2.00
Type 499
Type 412

Also 499A with Standard Base 202-5 Watt Transmitter \$3.00

When ordering mention types Shipped Parcel Post C.O.D.

BLUEBIRD TUBE CO.
200 Broadway Dept. N New York

5 in 1 Connector



Use 1 to 5 headsets on any Radio Set Binding Posts. Works while Loud Speaker is in operation.

Ask your Dealer, or 25c pair, postpaid, in United States.

JOBBERS, DEALERS PRICES ON REQUEST

SNOW & COMPANY

Dept. W. 149 Church Street New York

Protects

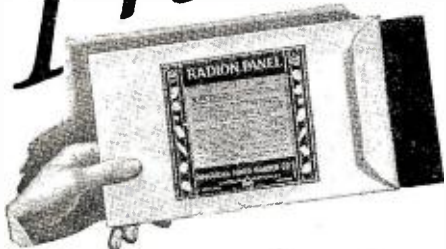

against leaks and losses

THE utmost possible protection against leaks and losses in the circuit is afforded by Radion—The Supreme Insulation.

Radion Panels reduce surface leakage and dielectric absorption to a minimum. Their beautiful surface finish adds to the attractiveness of any set. Radion Dials match their beauty of finish and help to get close tuning. Radion Sockets eliminate capacity effects.

Radio dealers have the complete line of Radion low-loss parts. Manufacturers will find it to their interest to write us for prices on moulded parts. Send for catalog.



No. 2 Radion Socket for new UX tubes, with collar adapter for old-type tubes. No. 4 same as No. 2, without collar adapter, for new UX tubes exclusively.

FREE Booklet, "Building Your Own Set," Mailed on request.

AMERICAN HARD RUBBER COMPANY
Dept. A15,
11 Mercer St.,
New York City

Chicago Office: Conway Building
Pacific Coast Agent: Goodyear Rubber Co., San Francisco-Portland

RADION

The Supreme Insulation.

Made to order exclusively for radio purposes

RADIO AGENTS WANTED

5 Tube Demonstrator FREE!

Earn \$25 to \$100 a week, part or full time. Everyone a prospect. Complete line standard sets and accessories, \$5.00 to \$90.00. Write today for illustrated catalog and exclusive selling plan for live dealers and community agents. 20TH CENTURY RADIO CO., 1001 Coca Cola Bldg., Kansas City, Mo.

DEALERS!

Complete stock of nationally known parts and accessories. Send for illustrated catalog and discount sheet.
Radio Exclusively Since 1921
CLARK & TILSON, Inc.
552 Seventh Ave. :: New York
The Nationally Known House

Insure your copy reaching you each month. Subscribe to RADIO NEWS—\$2.50 a year. Experimenter Publishing Co., 53 Park Pl., N.Y.C.

When Nations Listen In

(Continued from page 1266)

Shrew"; and the Richman dance orchestra—jazz and Shakespeare following each other. Radio is a faithful reflector of life.

It will be a long time before we forget the night Belle Bennett came to WRNY. She brought with her Vera Gordon, who was the mother in "Humoresque"; and told how this fine interpreter of Jewish character had helped her when she (Miss Bennett) was in distress. Then Miss Gordon paid a sincere and generous compliment to the younger woman. But the thing which followed was the dramatic sensation.

I asked Miss Bennett to try to put into words her climax scene in "Stella Dallas." She never tried it; but, suddenly, the inspiration came to her. She was the Irish woman who comes to the woman of her husband's choice, offering to divorce him that the lovers may have each other. She was the dignified, but kindly, rival; she was again asking her rival to take not only her husband, Stephen Dallas, but her own daughter, whom she loved, that the girl might be free to wed, and not tied down by such a mother as Stella. The listeners were in tears; and I doubt that anything more beautiful has ever been broadcast.

WOMEN'S CLUB ACTIVITIES

Turning to entirely different activities, I wish to say just one word of the club women's hour. Mrs. Edgar Cecil Melledge has done splendid work, and those who listen in on these events will hear the foremost women in every field of life.

Again the meeting place. The Bowery, Chinatown, fashionable Riverside Drive and Park Avenue, the Battery, Yorkville—all have been answering to their names in the roll call of WRNY's "Side Walks of New York," and all are getting better acquainted with one another.

Once more of the theatre. Stars of "The Enemy," "The Vortex," Channing Pollock, the playwright himself, and those whom I mentioned above, have all been with WRNY's big Broadway Revels.

And such novelties! Did you come backstage with us at "Twelve Miles Out" and hear the creaking of the boat, and the orders of the stage hands—or, on another night, were you with us backstage at "Earl Carroll's Vanities," where so many of the prettiest girls were? Or were you aboard when a phantom ship sailed out of a phantom port, and able-seamen enacted a sailing vessel leaving port, entering a storm and finding calm again?

Or when Homer Croy, Will Irwin, Joseph Auslander, Inez Haynes Irwin and Dorothy Scarborough held the WRNY Literary Round Table discussion? Every newspaper, it seemed, had a big story about it.

Of course, the popular music goes merrily on; and you can be sure of grand opera and concert numbers almost any time you tune in on WRNY.

I'll see you again next month.

Radio Experts Discuss Future Problems

(Continued from page 1255)

high-power broadcast stations, all using good programs, would suffice; and the elimination of an attempt to entertain on the part of the small, local stations, confining their work to reports and local news happenings, would greatly advance the radio art.

"Further—a very marked diminution in the amount of jazz, most of this second-rate jazz, which is now being broadcast, and an increase in the proportion of really good music worth listening to, would be a fine thing for radio and a long step forward in educating the American taste in good music."

Build the Set That Holds 4 World's Records



The receiver that brought in stations 6,000 to 8,000 miles distant with loud speaker volume night after night. All records fully verified.

Holds World's Records For

- (1) Longest distance ever received on a loop aerial—8,375 miles.
- (2) Most consistent reception of stations 6,000 to 8,000 miles distant—117 programs in three months.
- (3) Brought in 6 different stations in 2 1/4 hours—all over 6,000 miles.

PRICE

Complete Set of Parts.....\$89.00
(Includes all parts necessary to make an exact duplicate of this wonderful receiver, together with blue prints and complete building instructions.)

Story of development and proofs of records sent on receipt of stamped and addressed envelope.

Scott Radio Laboratories

39 S. Dearborn St. Chicago
Dealers and set builders write for discounts



THE SIMPLEST PRACTICAL RADIO SET MADE

\$1⁰⁰

The RADIOGEM

The simplest radio outfit made—yet as practical as the most expensive. A crystal receiving set that you can operate and enjoy even though you know absolutely nothing about radio. You receive the RADIOGEM unassembled, together with a clearly written instruction book, which shows you how to quickly and easily construct the set, using only your hands and a scissors. The outfit comprises all the necessary wire, contact points, detector mineral, tube on which to wind the coil, etc., etc. The instruction book explains simply and completely the principles of radio and its graphic illustrations make the assembling of the RADIOGEM real fun.

THE RADIOGEM CORP.
66-R W. Broadway New York City

PATENTS

S. GOLDSTEIN, Registered Patent & Trade Mark Atty. Formerly member examining corps U. S. Patent Office, Washington D.C.
1440 BROADWAY, N. Y. CITY. Tel. PENN 4287

NO FUNDAMENTAL CHANGES

Dr. J. H. Dellinger, of the Bureau of Standards, considers that radio has come to stay, and that the problems that confront the radio engineer are many and varied. He says:

"My general reaction to the present situation is one of pronounced optimism. I cannot help feeling that radio broadcasting has now arrived; that it is no longer a mere source of wonderment to the public, and that, on the technical side, radio can be considered as substantially stabilized.

"I must hasten to add that I have no thought whatsoever that we are at the end of progress, and even of very great progress. There will unquestionably be great advances in the character and quality of broadcasting, and great extensions of mitigation of the numerous annoyances and difficulties now besetting broadcast reception. Nevertheless, it is clear that there will be no changes in any wise comparable with the original rise of broadcasting itself. I believe this is generally recognized and that the many workers in this field now feel that they can go forward confidently to perfect the service which radio can render.

"As I have said, the technical problems in radio are numerous enough. I feel that none of them is outstanding, however; and that the means of solution are fairly well recognized for all of them. There are limited times and places where substantial perfection of radio service can now be found. Thousands of persons are now listening in their own homes to wonderful musical programs and nationally important subjects and events, with never a blemish of acoustic imperfection. The great problem of radio engineering and industry is to extend as rapidly as possible the areas and times in which this perfection is available.

OVERCOMING INTERFERENCE

"We shall probably never wholly rid ourselves of interference, but it is being steadily overcome. The increase of power which is going on in many stations is doing a great deal to overcome both the natural interference (static) and electrical interference from various sources. Campaigns of education are assisting greatly in the mitigation of interference from electrical apparatus and radiating receiving sets in different localities. The replacement of spark and other broadly-tuned transmitting apparatus by continuous-wave apparatus, and the holding of transmitting stations rigidly on their assigned frequencies, are bringing the solution of station interference.

"The problem of fading is still with us, but the great progress in interconnection of stations is bringing the superlative service rendered by local stations to wider and wider circles of listeners. My general feeling of gratification over the present situation arises from the fact that this is an era of widespread recognition of the inherent difficulties of radio and of substantial progress in eliminating them. A notable instance is the main result of the 1925 National Radio Conference; viz., the decision to limit the number of broadcast stations. With this principle recognized, it can be expected that much better progress can be made in the welding of the whole system of broadcast stations into a coherent group with the minimum possible amount of interference.

APPRECIATION OF THE ANNOUNCER

"The technical side of radio being in a satisfactory state of progress or actual achievement, the greatest problem now confronting radio is in what we might call the radio art as distinguished from the radio industry. More specifically, the place where the vital questions affecting the future of radio are now found, is in the radio programs. Electrical and mechanical instrumentalities having been provided with a high degree of perfection, what actual program material is going to be delivered to the public by those who control the stations?



Enjoy Radio at its BEST!!



S-L-F
Condenser
H-R Unit
3

"Hammarlund
Junior"
H-R Unit
2

H-R
Unit
4

RADIO reception depends on the harmonious working of many "little things." One poorly-designed part in a receiver may put the stamp of mediocrity on the entire outfit—it may be the one weak link which spoils the chain. Use Hammarlund Products and enjoy the perfections of fifteen years' experience.

Straight-Line-Frequency Condenser

This newest member of the Hammarlund Condenser family is rugged, compact and exceptionally effective in distributing stations equally over the dials. It has all the famous Hammarlund low-loss features and several new ones including Isolantite, insulation and one-hole mounting.

"Hammarlund, Jr." (Midget)

The most perfectly designed midget ever offered, having every feature of the larger models. It has many valuable uses in a receiver. Diagrams on request.

Space-Wound Coils

Hammarlund Space-Wound Coils have created a sensation. Here for the first time the famous solenoid coil is successfully anchored to a film of dielectric material and definitely spaced between turns, thus reducing distributed capacity and resistance to a minimum. They are approved for the new Hammarlund-Roberts Receiver and are made in various sizes and arrangements for other standard circuits. The Hammarlund-Roberts Units are illustrated here.



H-R
Unit
4

Hammarlund-Roberts Receiver

The composite ideal of ten leading radio engineers. A receiver that has won the plaudits of phans and experts throughout the country, because it makes only five tubes as sensitive and selective as a multi-tube super-heterodyne and delivers remarkable volume with beautiful tone quality. You can build it yourself from parts costing only \$60.80. Send 25 cents for complete, illustrated construction book.

HAMMARLUND MANUFACTURING CO.
424-438 W. 33rd Street, New York

H

For Better Radio

Hammarlund

PRECISION
PRODUCTS



PATENTS

C. L. PARKER
Formerly Member
Examining Corps,
U. S. Patent Office.
PATENT - LAWYER
McGill Bldg., Wash., D. C.

Patents, Trade Marks, Copyrights, Patent Litigation

Handbook for Inventors, "Protecting, Exploiting and Selling Inventions," sent upon request.

RADIO — BARGAINS

FREE RADIO CATALOG & GUIDE

of newest ideas, approved special hook-ups with illustrations. Tremendous savings on standard radio parts, sets, kits. Be sure to get this thrifty book before you buy. Wonderful! Unusual? You'll say so. Write letter or postal NOV. BARAWIK CO., 102-142 S. Canal St., CHICAGO, U.S.A.

RADIO PANELS OF GENUINE BAKELITE

Cut, drilled and engraved to order. Send rough sketch for estimate. Our New Catalog on Panels, Tubes and Rods—all of genuine Bakelite—mailed on request.

STARRETT MFG. CO.
520 S. GREEN ST. CHICAGO

A Laboratory Product



CRESCENT LAVITE RESISTANCES

for Distortionless Amplification
Insure distortionless amplification and a clarity of tone not obtained through any other resistances. All capacities 12,000 ohms and up. List price \$1.50. Special sizes to order. Write for full information.
Crescent Radio Supply Co., 1-5 Liberty St., Jamaica, N. Y.

Insure your copy reaching you each month. Subscribe to Radio News—\$2.50 a year.
Experimenter Publishing Co., 53 Park Place, N. Y. C.

AMPLION

**Product of
38 Years'
Experience**



**"Brings in instruments
lost in other speakers"**

"I have listened to many loud speakers, but never to any music which can compare with that reproduced by the Amplion. The sound is clear, sweet and well modulated. It brings in clearly instruments in bands and orchestras that were lost in other speakers. Through my Amplion I enjoy my radio to a degree I had never thought possible."

You will be as appreciative as this gentleman, once you hear your set through an Amplion. Creation of the originators and oldest makers of loud speaking devices—Alfred Graham & Co., London, England—The Amplion leads in popularity throughout the world.

Enjoy an Amplion demonstration at your dealer's. Six models, including phonograph units, equipped with cords and panel plugs, \$12 up. Write for the "Amplion Pedigree."

**THE AMPLION CORPORATION
OF AMERICA**

Suite S, 280 Madison Ave., New York City
Chicago Branch: 27-29 N. Morgan St.
Burndept of Canada, Ltd., Toronto

ARE YOU THE MAN

?

to be first in your town to sell and demonstrate POWEROLA, the famous 5 tube NO-BATTERY ELECTRIC LIGHT SOCKET RADIO RECEIVER (not an attachment), universal for D.C. or A.C. (100-115 v., 40-60 cycle), now sold and demonstrated thru THE NEW YORK EDISON CO., THE public utility companies and radio, electric and music dealers everywhere. Absolutely dependable, fully guaranteed, powerful, practical, perfect in performance. Tested and endorsed by Popular Radio, Radio Broadcast, Radio News, and all leading authorities and engineers of your local electric light company.

Are You the Man Who Sees Opportunities Ahead for Real Money Making?

"You, too, can make Powerola"

Send \$1.00 for wiring diagrams showing how to re-wire any old or new parts, battery sets, or radio circuits (one to eight tubes) and power apparatus used to operate satisfactorily from A.C. or D.C. Get in at once on wonderful and exclusive business. Thousands of homes are waiting for you now.

Write for literature, terms and prices at once.

POWEROLA RADIO CORP.
Dept. RN, 1845 Broadway, N. Y. City

"One aspect of this question is the commercialization of radio programs. I need not enlarge upon this as it has been done amply elsewhere. The solution probably is precisely that laid down in the resolutions on this subject by the Fourth National Radio Conference, which, in substance, merely call for intelligence in the working out of the problem. An incidental phase of this problem is the character of the announcements. Station managers have, perhaps, not realized to what an extent the words used by the announcers are, to the listener, just as much part of the program as the so-called program material. The psychological effects of announcements have not yet been fully examined and understood, and there seems to be no appreciation at all that some periods of silence during an evening's radio program are not wholly distasteful to the radio listeners.

"While I believe the radio program art is only at its beginning, I could not complete this statement without a tribute to its extraordinary power and value, even in this formative period. While the wonder and mystery of radio have now largely disappeared, as far as its physical instrumentalities are concerned, it seems the world can never marvel sufficiently over the actual service of enlightenment and joy which it offers freely to all men."

COST OF BROADCAST PROGRAMS

It is the opinion of Mr. Powel Crosley, Jr., president of the Crosley Radio Corporation, that the biggest problem that the industry has to face is that of broadcasting, and the improvement of the programs put on the air. Mr. Crosley said:

"If ten people identified with radio were asked, 'What is the biggest problem confronting the radio industry today?' probably nine of them would say, in general, 'Broadcasting.' That is the foundation upon which the radio industry is based. Without it, the manufacture of sets for popular consumption would never have been started. Without it, the set industry could not exist today.

"More specifically, broadcasting is one big problem, composed of three smaller ones and a host of little problems of minor importance. The three principal problems are: First, the elimination of interference, as now caused by the great number and proximity of broadcast stations; second, improvement of dependability of reception (that is, overcoming of static, fading, etc.); and third, improvement of the quality of programs. The last of these three introduces another question—that of the compensation of the broadcasting artists.

"Probably the first two of these problems will take care of themselves. As broadcasting becomes more costly, there will be fewer and fewer stations, and interference will be reduced; and as more and more powerful stations are built, reception difficulties (due to static, fading, and the like) will be largely eliminated. The third problem is, however, worthy of serious study.

"Improvement of programs necessitates obtaining better and better artists, and this makes ever more vital the question of where the funds shall come from to compensate this talent. Not many of us are prepared to make definite statements of our opinions as to how this problem should be solved. Different plans have been tried in different localities, with more or less success. In some countries, broadcasting is subsidized by the governments; in others, it is supported by taxation of the people; in our own United States, it has been, in the main, provided by radio manufacturers, schools, churches, etc., with the assistance of national advertisers. At the present time, it is difficult to choose the proper solution—but it is certain that broadcasters are going to find a solution necessary within a very short time."

REGULATION IN THE PUBLIC INTEREST

Radio as a public service is the main thought, in the opinion expressed by Major



ALL-AMERICAN
TRADE MARK

View of inside construction of the "Model R" (Rauland-Lyric-equipped) showing steel chassis and arrangement of parts.

**See it and hear it—
then you'll know
why we say—
Radio Built for
the Years to Come**

**WRITTEN
2-YEAR
GUARANTEE**



**Battery Prices
SMASHED!**

To Consumers Only
Here is a real battery quality, guaranteed to you at prices that will astound the entire battery-buying public. Order Direct From Factory. Put the Dealer's Profit in your own pocket. You actually save much more than half, and so that you can be convinced of true quality and performance, we give a **Written 2-Year Guarantee**. Here is your protection! No need to take a chance. Our battery is right—and the price is lowest ever made. Convince yourself. Read the prices!

Auto Batteries	Radio Batteries
6 Volt, 11 Plate, \$9.50	6 Volt, 100 Amp, \$9.50
6 Volt, 13 Plate, 11.50	6 Volt, 120 Amp, 11.50
12 Volt, 7 Plate, 13.00	6 Volt, 140 Amp, 13.00

Buy Direct—Send No Money
We ask no deposit. Simply send name and address and style wanted. Battery will be shipped same day we receive your order Express C.O.D. subject to your examination. Our guarantee accompanies each battery. We allow 5% discount for cash in full with order. You cannot lose! Send your order today—**NOW!**

ARROW BATTERY CO.
Dept. G, 1215 So. Wabash Ave., Chicago



Get the BIG PAY RADIO Job

I'LL SHOW YOU HOW

There are thousands more big pay fascinating radio positions open than there are men to fill them. I know what and where these real positions are—and I can qualify you, in a few weeks spare time, to fill one of these positions so you can earn **\$3,000 to \$10,000 a Year—Learn** I have successfully trained thousands of men in Electricity, Wireless and Radio for 15 years. You can make you a full-fledged radio expert quickly; a titled, big pay man. You will learn how to install and maintain transmitting and receiving apparatus, professional and amateur, land and sea. You will know Radio thoroughly—and will get the bigger money because of your better, broader, training.

BIG SET GIVEN! Send name and address for a full outline of my course and how to get the big A. R. E. Twin Superdon Experimental Set absolutely GIVEN. Write me personally! Irwin J. Mendels

AMERICAN RADIO ENGINEERS
1010 Heart Square, Dept. 207, Chicago

MAIL THIS COUPON

Irwin J. Mendels, American Radio Engineers,
Dept. 207 Heart Square, Chicago, U. S. A.
Send me your big catalog and full particulars of your complete course of training. Also tell me more about the A. R. E. Twin Superdon Long Distance Receiver and how I can get it free.

Name

Address

City

State

General C. McK. Saltzman, chief signal officer of the Army. General Saltzman said: "The most urgent problem confronting radio today is happily not related to the technicalities of the art itself. It is the problem of determining those phases of radio enterprise that are worthy of continued existence, further development, and continued public support.

"The increasing use of radio as a means of international and domestic telegraph correspondence, as an aid to aeronautical and marine navigation, automatic train control and other vital services, has made it imperative, for the present at least, to restrict all radio activities within definite limits in the ether. That all services within those limits may be assured of unrestricted development and technique, it becomes apparent that an effort should be made to eliminate those features of service and faulty technique which tend to retard rather than contribute to service and development of the art.

"Our annual National Radio Conferences, at which representatives of every agency interested in, or affected by, radio have met, have resulted in consideration and constructive recommendations toward the solution of this and other radio problems. Those recommendations, if given proper national, moral, and legal support, will be conducive to much improvement in radio."

What Happens in Vacuum Tubes

(Continued from page 1255)

the other the control electrode (Fig. 1). The photographs are taken directly along the filament axis, so that the front edge of the anode and control plate appear as straight strips, while the filament is concealed by the filament supports. In Fig. 2, the left dark strip is the front edge of the anode, the right that of the control plate. The thin hook in the center is the filament holder. In this case, the plate voltage was +130 volts and the control element potential 0 volts, referred to the negative terminal of the filament. A sharply outlined picture of the glow discharge is seen. From the shape of this glow discharge, we can deduce the paths of the electrons. In this first example, the significance of the glow discharge is considerably elucidated by the fact that the conditions of the above-mentioned theory of electron emission are here comparatively well satisfied. We have, then, the possibility of verifying the theory by observation.

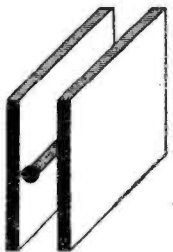

Fig. 1.

At the left is shown the arrangement of the elements of the vacuum tube used in this series of experiments. The filament of the tube is placed between two plates, one of which is the anode and the other the control electrode.

Actually we gain a deeper insight into vacuum tube phenomena than that afforded by the theory alone. The investigation, which presents no very great difficulty, but cannot be carried on without certain mathematical calculations, will not be continued here. It will be sufficient to add a few more illustrations to make these relations clearer.

Fig. 3 shows the same arrangement and voltage as Fig. 2; but is taken with a different lens, and without external illumination, so that reflection from the glass walls of the tube is reduced.

RESULTS OF VARYING VOLTAGES

Fig. 4 is the same tube as in Figs. 2 and 3 and at the same anode voltage, but with a

New "AMSCO" Products

The choice of Leading Radio Engineers

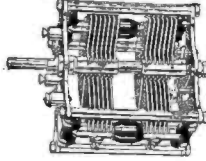

AMSCO SIAMESE CONDENSERS

Used by William H. Preiss in his "Straight 8" Receiver, R. E. Lacault in his "Ultra-dyne," L. M. Cockaday in his "L. C. 26" Receiver, and specified by Lester L. Jones for single control receivers.

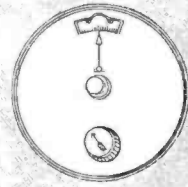

DE LUXE MODEL AMSCO VERNIER DIALS

Now finished in gold, silver, and jet. Free acting—forward or backward, fast or slow, without momentum or backlash. Gives finesse to fingers.

FOR STRAIGHT-LINE AMPLIFICATION



AMSCO RESISTANCE COUPLERS

The perfected instruments for straight-line amplification. All frequencies within the voice and music ranges, from the highest treble to the lowest bass, are augmented equally, giving true tone reproduction without distortion.

Investigate Amsco Resistance Couplers, Grid Gates and Resistors.

It Clicks into Contact

AMSCO UNIVERSAL SOCKET



All standard UX and CX radio tubes snap in with a click that assures positive contact.

Patented Amsco construction fully enclosed in genuine Bakelite. One hole mounting. They save space



AMSCO PRODUCTS, INC. Broome & Lafayette Sts., New York



ALMOST TOO GOOD TO BE TRUE X-L VARIO DENERS

INSTALL THEM IN YOUR SET AND LEAVE THEM SPEAK FOR THEMSELVES
Endorsed and Used by the Foremost Radio Engineers
MODEL N—Capacity range 1.5 to 20 micro-microfarads, for balance in Roberts two tube, Brownings-Drake, McMurdo Silver's Knockout, Neutrodyne and tuned radio frequency circuits. Price \$1.00
MODEL G—For the Cockaday circuit, filter and intermediate frequency tuning in super-heterodyne and positive grid bias in all sets.
G-1—.0002 to .0001 Mf. G-10—.0003 to .001 Mf.
G-5—.0001 to .0005 Mf.
Price each with Grid Leak Clips \$1.50
X-L RADIO LABS., 2426 Lincoln Avenue, Chicago

Rubber Covered Insulators



Neat and efficient. For antenna, ground and for lead in wires. Small screw starts readily and makes finished job. Great improvement over ordinary large, unsightly insulators. They keep the wires in place and out of the way. Packed 10 in a box, 25c at your dealers or direct from us.

CULVER-STEARN'S MFG. CO. Worcester, Mass., U. S. A.

Insure your copy reaching you each month. Subscribe to Radio News—\$2.50 a year
Experimenter Publishing Co., 53 Park Place, N. Y. C.

YOUR RADIO

if it has a loud speaker, either attached or built in, probably uses some type of

MILLER Amplifying Horn



The reason we say this is because of the well-known quality of the Miller Horn and the fact that we make *forty-one* different models, one of which is adapted to practically any radio on the market.

Miller Horns

whether they are straight, curved or folding, large or small, are all worked out on scientific principles as far as acoustics are concerned. Then they are built to endure, because, as they are moulded, they are accurate in size and their composition is such that they are inert, non-absorbing, unaffected by outside conditions — will not crack, split, dry up, swell or rattle. Surely, Mr. Manufacturer, we can supply your wants with one of our models — and at a competitive price.

The Miller Rubber Co.
of N. Y.
AKRON OHIO

FAHNESTOCK CLIPS



PRESS DOWN HERE

"Popular Wherever Radio Is Used."

FAHNESTOCK Connectors are used by nearly every manufacturer of standard radio sets and manufacturers of high grade "A" and "B" Batteries. FAHNESTOCK makes connectors for every radio purpose.

"THE IDEAL CONNECTOR"
Catalog sent upon request

FAHNESTOCK ELECTRIC COMPANY
Long Island City, New York



Print Your Own

Cards, Stationery, Circulars, Paper, etc. Save money. Print for others, big profit. Complete outfits \$3.85. Job press \$12, \$35, Rotary \$150. All easy, rules sent. Write for catalog presses type etc. THE PRESS CO., Y-72, Meriden, Conn.

small negative control element potential. The space filled by the electrons is, under these conditions, considerably smaller than in Figs. 2 and 3.

Fig. 5 is the same tube, but with an anode potential of only +10 volts and a control element potential of +35 volts. The result is that now the most of the charge passes, not to the anode, but to the control element.

Fig. 6 is a tube of the same dimensions as that used heretofore. But in this tube the anode as well as the control element are in grid form. The meshes are very small, compared with the surface and the distances. The anode potential is +62 volts, the control element potential is 0 volts. Fig. 7 shows the same lamp with an anode potential of +69 volts and a control electrode potential of -15 volts. Fig. 8 is the same lamp as in Figs. 6 and 7, with +62 volts and -25. These three pictures show effectively that the electrons, when, by virtue of the anode potential, they reach a certain velocity, and are not stopped by a massive anode plate, will continue in a straight line in their initial direction.

In this manner, every arrangement may be investigated by the application of most varied potentials to the individual electrodes. It is, therefore, not absolutely necessary to photograph every case. In many cases, personal observation will answer the purpose. It can be readily understood how much easier and more instructive is this method of studying various vacuum tubes than very complicated and only approximate theorizing

FURTHER POSSIBILITIES OF THIS METHOD

A further advantage of this method offers itself, in that more complicated phenomena than that of mere electron emission may be rendered observable; as, for instance, emissions of positive and negative ions, which are of great scientific value. There are such manifold things taking place in the vacuum tube that our knowledge of them is yet far from exhausted. It is surely to be hoped that it will be possible, by this method, to penetrate further into the unknown, or as yet uninvestigated, realms of science.

An Easily Constructed Crystal Receiver

(Continued from page 1292)

four inches in diameter and five inches long. An ordinary oatmeal container will be satisfactory. This should be cleaned, and the edges squared off with sandpaper. It may then be placed in a warm oven until it is thoroughly dry, and then coated lightly with good waterproof varnish. This will prevent moisture absorption, and make the form strong and rigid.

The coil is wound with annunciator wire, which is really admirable for the purpose. The wire, No. 18, is heavy enough to minimize resistance, and yet not so large as to introduce objectionable eddy-current losses. The two thick layers of paraffined cotton covering provide excellent insulation, and space the turns just the proper distance.

There are 50 turns of wire, with a tap at every tenth turn. The winding should be started, about half an inch from one edge, by fastening the wire end in two small holes drilled or punched for the purpose. A 12-inch lead should be allowed for connection. The 50 turns should be wound evenly and tightly. The end should be fastened in two more small holes, and a 12-inch lead for connection left, as at the start.

The tap leads are made with bare wire. Annunciator wire with its covering removed is good. Four 12-inch leads are required. Mark the tenth, twentieth, thirtieth and fortieth turns. At each of these, slip a small screwdriver under the turn and pry it up slightly above the others. Scrape off the insulation at the bulge so that about 1/4 inch

RAILROAD FARE

to Chicago included without extra charge if you enroll NOW!



LEARN IN CHICAGO

Electrical Center of the World.

All personal practical training.

ELECTRICITY

Pays \$60 to \$200 a Week to Properly-Trained Men!

Get into this great field of opportunities. There's real money in it for you. My big Electrical Course is the result of 27 years' experience.

Spend 12 Happy Weeks at COYNE

Here you get a Complete Electrical Training on big, modern apparatus in great shops. You don't need advanced education or experience. Expert instructors guide you at every step. **EARN WHILE YOU LEARN**—My Employment Dept. helps you get a job to earn part or all your expenses while learning, and assigns you to a good job when you graduate. Be sure to write today for BIG FREE BOOK and Special Offer of R. R. Fare.

COYNE ELECTRICAL SCHOOL

1300 W. Harrison St. Dept. 2943 Chicago, Ill.

Send this Coupon now for BIG FREE BOOK and DETAILS OF MY SPECIAL OFFER!

H. C. Lewis, Pres., Coyne Electrical School
1300 W. Harrison St., Dept. 2943, Chicago, Ill.
Dear H. C.—Send the Big FREE Book with its 151 actual photos of electrical scenes, also Special Offer of R. R. Fare.

Name _____

Address _____



"a new 5-Tube Set with all the power and none of the grief of the Supers" — so wrote Henry M. Neely, Editor of Radio in the Home, Philadelphia.

Get This Book

Write today for this big fascinating 32-page booklet which tells how you can build the truly amazing new QUADRAFORMER receiver. Based on a new radio principle, five tubes give remarkable results.

Enclose 10c and you'll have it by return mail

Gearhart-Schlueter Radio Corp'n
713 Voorman Avenue, Fresno, California

Special Library of Information
on

**RADIO PATENTS
and
TRADE MARKS**

JOHN B. BRADY

Patent Lawyer

Ourray Building Washington, D. C.

Cable address:
RADIOPAT

Telephone:
Main 4806

APEX VERNIER DIALS

ARE BEST ON ANY SET
ASK YOUR DEALER OR WRITE US
APEX ELEC. MFG. COMPANY, CHICAGO

of the wire is exposed. Then solder the leads to these bare sections.

When finished, there are six leads to the coil: (A) at the start, (B) at the tenth, (C) at the twentieth, (D) at the thirtieth, (E) at the fortieth and (F) at the end or fiftieth turn. (See diagram.)

The inductance has a value of approximately 172,000 cms. When shunted with a variable condenser of .00025 mfd. maximum capacity, the tuning range is, approximately, from 180 to 400 meters. The additional capacity of an average aerial results in an actual wave-length range of from about 200 to 550 meters.

THE DETECTOR UNIT

This set uses a carborundum detector unit, comprising a regular fixed carborundum detector and a potentiometer regulating biasing voltage for controlling the impedance of the detector. The potentiometer is of very high resistance and has a neutral tap, which automatically provides application to the detector of either a positive or negative voltage. In this way, the detector impedance may be made very high or very low, or set at some intermediate value that affords best reception. This adjustment, being made electrically through movement of the potentiometer knob, is positive and simple. If the detector impedance is low, it dampens the circuit and causes broad tuning; if it is high, it affects the tuned circuit only slightly and, consequently, permits the highest degree of selectivity. It may readily be seen that this regulation governs the selectivity of the set.

The unit has a carborundum detector, a built-in by-pass condenser, and clips for insertion of a small flashlight cell. The bias is adjustable over a positive and negative range. It is of the single-hole type suited for back-of-panel or table mounting, requiring only two connections, just as does an ordinary crystal detector.

ASSEMBLY AND WIRING

The panel of the set shown in Fig. 1 is of hard rubber or bakelite, seven inches high and ten inches long. Holes for the shafts of the switch, condenser and unit should be located along the center line of the panel; with the condenser in the middle, the unit spaced 3 3/4 inches to the right and the switch an equal distance to the left. This simple layout presents a very neat appearance.

After holes of the proper size are drilled, mount the apparatus as shown in the illustration. The coil should be attached firmly to the rear-end plate of the condenser with suitable brackets or screws. Bring the leads from taps A, B, C, D and E to the five contact points in the order named. The leads should be cut to the proper length and covered with insulating tubing to prevent short circuiting; and the ends should be soldered to the contacts. Care should be taken that the solder does not flow between and short adjacent contact points. Connect the end of F tap lead to the ground binding post. The lead should be insulated with cambric tubing.

Connect the ground binding post to one of the phone posts and make a connection between this lead and the rotary plate terminal of the variable condenser. Connect the aerial binding post to the switch lever. Connect tap contact "A" to the No. 1 binding post on the detector unit, and connect this lead to the stationary plate contact on the variable condenser. Finally, connect terminal No. 2 of the detector unit to the remaining phone binding post.

AERIAL AND GROUND INSTALLATION

The horizontal portion of the antenna should be as high above surrounding objects as possible, and should be at least 100 feet and preferably 150 feet long—even 200 feet is not too much. This will insure good, loud reception and the greatest range.

We recommend the use of a single No. 12 soft copper enamel-insulated wire for the aerial, lead-in, and ground connection.

THORDARSON

Super
TRANSFORMERS
Standard on majority of quality sets

In sets priced
as high as
\$2000
you'll find
Thordarsons!

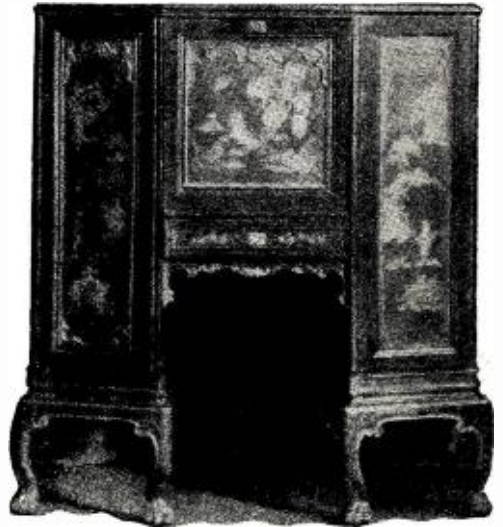

Is your radio set lacking in clearness and volume? To give it a tone quality comparable with that of the finest receiving instruments, replace the present audio frequency transformers with Thordarsons. Your dealer carries Thordarsons, identical with those used by nearly fifty leading manufacturers whose sets are priced as high as two thousand dollars each. Follow the lead of the leaders—amplify with Thordarsons. Write for interesting literature.



Types and Prices

Thordarson Super Audio Frequency Transformers, sub-panel or top mounting type: 2-1, \$5; 3 1/2-1, \$4; 6-1, \$4.50. Thordarson Power Amplifying Transformers, \$13 pair. Thordarson Interstage Power Amplifying Transformers, \$8 each. Thordarson Auto-formers, \$5 each. All Thordarsons are unconditionally guaranteed. If dealer cannot supply, order from us.

THORDARSON ELECTRIC MANUFACTURING CO.
Transformer Specialists since 1895
WORLD'S OLDEST AND LARGEST EXCLUSIVE TRANSFORMER MAKERS
Chicago, U.S.A.

ZENITH
KENNEDY
W.L.
Radiodyne
Planstiehl
Howard
Thermodyne
OZARKA
Deresnadyne
ADLER-ROYAL
MURDOCK
MU-RAD
Valleutone
LEICH
Silver-Marshall
GLOBE
Wokehawk
Newport
BUCKINGHAM
NUNN-LANDON
KUSTOMBILT and
many others
use Thordarsons

Also choice
of the
MacMillan
Arctic
Expedition

You Will Make a Big Mistake

If you buy a radio cabinet without first getting our free catalogue. Made in hardwood mahogany finish or solid black walnut. Choice of 7 1/2 or 10 inch depth same price. Full length piano hinge and lid support, both nickel plated. Baseboard free. Beautiful cabinets in rubbed finish. We sell Loud Speaker cabinets complete with grille and silk ready for your favorite unit.





The Southern Toy Company, Inc.
Dept. N
Hickory, North Carolina

Insure your copy reaching you each month. Subscribe to Radio News—\$2.50 a year. Experimenter Publishing Co., 53 Park Place, N. Y. C.

**SOLD AT ALL NEWSSTANDS
AND RADIO STORES**

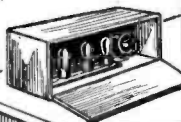

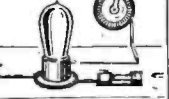
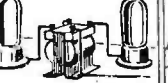
**25
CENTS**

<p>CHAPTERS Each of the six illustrations shown here represent the various general subjects covered by this handbook and illustrate its thoroughness.</p>	<p>GENERAL TROUBLES</p> 	<p>AERIAL TROUBLES</p> 	<p>TUNER FAULTS</p> 	<p>DETECTOR TROUBLES</p> 	<p>AMPLIFIER TROUBLES</p> 	<p>REPRODUCER TROUBLES</p> 
--	--	---	--	--	--	---

Trouble Finding and Correcting Simplified for Everyone

**68
Pages**
**200
Illustrations**
**Size
6 x 9 Inches**

Sold everywhere
on Newsstands
and Radio Dealers

No matter how much or how little you know of your radio receiver, this new "Radio Trouble Finder" book is going to be a big help.

It explains the common and special faults of all the standard receivers of today; tells how to recognize instantly, by various sounds, where the trouble lies and also gives special simple tests by which you can determine what is wrong with your receiver. Then for each particular fault there is explained the proper procedure for correcting it.

All troubles and their remedies are arranged in simple charts so that even the most inexperienced radio user will have no trouble in keeping his set at all times in first class condition.

All parts of the radio set are illustrated to show the layman how to proceed in correcting faults.

THE PRICE OF THIS BIG BOOK IS ONLY 25c. Everyone can afford a copy. Keep one around the house for any emergency. Order today by using the coupon below, enclosing 25c.

Published by The E. I. Company

Distributed by

The Conrad Co., Inc., 64 Church St., New York, N. Y.

CONRAD CO., INC.,
64 Church St., New York, N. Y.

Gentlemen:—I am enclosing 25c. Kindly forward at once one copy of "The Radio Trouble Finder."

Name

Address

City, State

EASY OPERATION

Turn the knob of the detector unit until the slider is at the neutral point of the resistance strip. Place the switch lever on the contact point "E" and slowly rotate the variable condenser between minimum and maximum; if no stations are heard, move the switch lever to point "D" and again rotate the condenser. If necessary, repeat this at each of the switch contacts. When a station is heard, center the condenser at the point of loudest response; then move the knob of the detector unit to the point where signals are strongest.

RESULTS

The finished set was tried in a number of homes in Niagara Falls, where receiving conditions are similar to those in the majority of cities—being neither very good nor very bad. WGR in Buffalo (22 miles) and WMAK in Lockport (20 miles) were received sufficiently loud to be heard plainly with the phones on the table. Other stations included KDKA, Pittsburgh (200 miles), WGY, Schenectady (250 miles), WBZ, Springfield, Mass. (325 miles), and several Chicago stations (450 miles). This was during April and May, 1925, so we have expectations of greater DX this winter.

The Manufacture of Modern Low-Loss Condensers

(Continued from page 1276)

The little perforated strip, which may be seen in front of the pile of rotor plates in Fig. 3, is forced over the projections at the end of this set of plates, and serves to hold them in alignment. This also is swedged into place.

After this part of the assembly is finished, the insulating bushings are inserted in their sockets, and the end plates and bearings are assembled. The small ball bearing that may be seen in the lower left-hand corner of the layout is an important feature in the bearing, as it keeps the shaft in permanent alignment.

PROCEDURE OF TESTING

When the assembly is complete, the condensers are sent to the testing department.

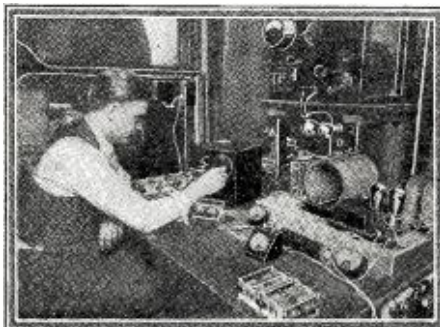

Fig. 4. An inspector testing condensers for efficiency and accuracy. A 10-watt oscillator is used in the tests.

Fig. 4 shows the inspector and the apparatus for determining the efficiency and the accuracy of the finished condenser. An oscillator employing two 5-watt tubes, and tuned to 600 meters, is coupled to a circuit in which the condenser is inserted. When the condenser is tuned to resonance, the amount of current flowing in the high frequency ammeter shows its efficiency. If the current is lower than normal, there is a leakage path somewhere in the condenser, and it is discarded. Similarly, the capacitance of the maximum and minimum settings is checked. This must be accurate to 1 per cent. before the condenser is passed.

Fig. 5 shows a second testing process, used for double or "Siamese" condensers. It is the duty of the inspector to check the

"I'LL TRY ANYTHING ONCE"

is heard quite frequently. No doubt it's an interesting habit—but the expense which follows is not always so pleasant.

The chance is usually in the other fellow's favor,— and the expense yours.

When you buy a B-T product you eliminate chance. You are sure of sound engineering and practical design.

Bremer-Tully know how to design enough things of merit that they don't have to paint glowing pictures of novelties. No B-T product is released unless it is superior,—nor is any B-T put on the market unless both Mr. Bremer and Mr. Tully feel that it fills a real need.

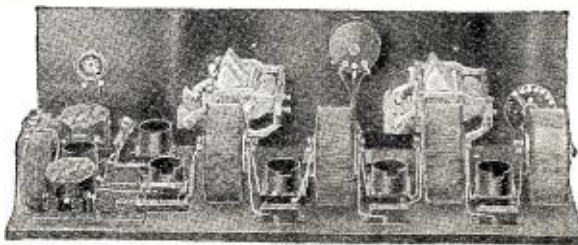

The B-T Counterphase

method of R.F. control is a proved success. A lot of last fall's novelties have run their race,—the COUNTERPHASE is just nicely warmed up,—and it's showed its heels to all of them.

Both the Counterphase Circuit and Torostyle Transformers used therein are covered by B-T patents. For 1, 2 or 3 stages of R.F. they are unequalled,—and no one has ever even intimated that any other wiring diagram begins to approach the 9-color scheme furnished with 5- and 6-tube kits.

B-T Audio Transformers

will be found wherever dealers carry the best. The quality is there,—and there is no distortion in the price. Insist on getting your money's worth.

B-T Condensers

are not only mechanically superior, but likewise possess an electrical efficiency that is unsurpassed. The wise fan chooses condensers from results, not advertising pictures,—you will find B-T's in his set.

Before you buy SOCKETS, DIALS, CHOKES, TUNERS, or any of the above just look over the B-T parts first,—and think for a moment what RADIO experience means in the design and manufacture of parts for RADIO use.

"Better Tuning" describes and illustrates B-T circuits. Sent for 10c. CIRCULARS FREE.

Bremer-Tully Mfg. Co., Chicago

HOMMEL DEALERS BENEFIT
FROM OUR SERVICE AND REPAIR DEPARTMENT
WHY NOT YOU?
WHOLESALE EXCLUSIVELY
LUDWIG HOMMEL & CO.
929 PENN AVENUE PITTSBURGH, PA.
Catalog 466 is free to dealers.

You must see our new 64-page Catalog before you buy anything in Radio. It's FREE. WRITE TODAY!
RANDOLPH RADIO CORP.
159 N. UNION AV. Dept. 2 CHICAGO, ILL.

U. S. TOOL S.L.F. CONDENSERS
work with a smoothness that prevents skipping by any station. Equally efficient under all conditions.
U. S. TOOL COMPANY, INC.
AMPERE, N. J.

YOU CAN GET
Greater reflex or crystal set reception if you use the
BROWNLIE VERNIER DETECTOR
\$2.00 At your dealer or Direct.
ROLAND BROWNLIE & CO.
20 Saunders St. Medford, Mass.

Insure your copy reaching you each month. Subscribe to Radio News—\$2.50 a year. Experimenter Publishing Co., 53 Park Place, N. Y. C.

A NEW Radio Product by WESTON

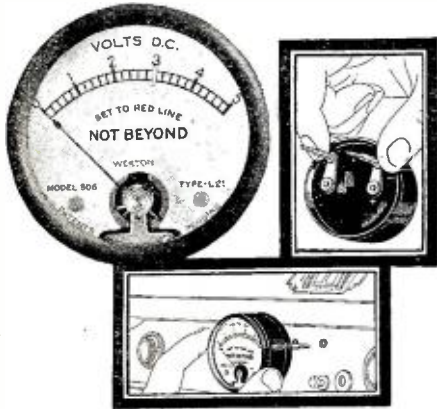

Pin-Jack Voltmeter

THREE famous makers, Radiola, Victor and Brunswick have provided their superheterodynes with pin-jacks for the reception of a Voltmeter.

The Weston Pin-Jack Voltmeter plugs directly into these pin-jacks as shown by the illustration.

No tools, no trouble, no adjustments, simply plug-in then turn the battery setting knob until the pointer of the voltmeter reaches the red mark on its dial. And there you have it! You are operating your set at three volts which is the critical tube filament voltage for the best reception.

You prolong the life of your tubes, you lengthen the use of your batteries, you get greater distance, better volume, clearer tone and get the real results of which your set is capable.

Think of it! This remarkable instrument will cost you only \$7.50.

90% of your radio troubles vanish by its use, responsible dealers everywhere will be glad to show it to you—or write us for full information.

WESTON
ELECTRICAL INSTRUMENT CORPORATION
173 Weston Ave., Newark, N. J.



7 BLUE PRINTS FREE

Send immediately for the seven copyrighted hook-up blueprints which have just been prepared by us for distribution to interested radio enthusiasts throughout the country. These are furnished absolutely free of charge to readers of Radio News making the request.

A. F. HENNINGER CORP.
4505 Ravenswood Ave. Chicago

RADIO BARGAINS

FREE RADIO CATALOG & GUIDE of newest ideas, approved special hook-ups with illustrations. Tremendous savings on standard radio parts, sets, kits. Be sure to get this thrifty book before you buy. Wonderful! Unusual! You'll say so. Write letter or postal NOW. BARAWIK CO., 162-142 S. Canal St., CHICAGO, U.S.A.

capacitances of both halves of the double unit, and to make sure that they read alike over the entire scale. They must check to within 1 per cent., at any setting, before they are passed. Minor adjustments to bring them into synchronism are made by bending slightly the free outside rotor plate of one of the condensers.

When the condensers have received the final OK they are deposited in numbered trays and sent to the packing department, ready for shipment to the wholesalers.

IMPROVEMENTS IN MANUFACTURE

It is interesting to note that, despite the apparently large number of parts appearing

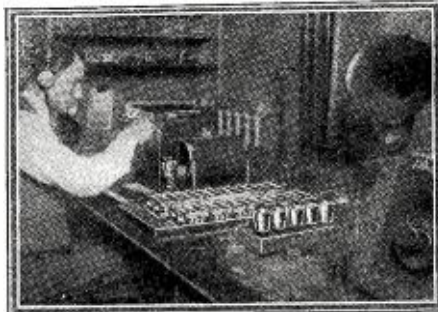

Fig. 5. This inspector is adjusting double, or "Siamese," condensers, so that their capacitances will be equal at any setting of the tuning dial.

in Fig. 3, a condenser of the same capacitance, produced under the manufacturing methods in vogue three or four years ago, would have from fifty to seventy-five per cent. more parts. The reduction is due to the use of milled rods to hold the plates in alignment, instead of the multitude of small washers formerly used to space them. The result is a neater, less complicated, and much more efficient job, both electrically and mechanically.

Precision methods allow, as well, a considerable reduction in the over-all size of the finished instrument, as the plates may be spaced at a smaller clearance than heretofore. In all the manufacturing processes outlined above, a maximum "tolerance," or error allowance, of 1/1000 of an inch is specified. Any part that varies from normal more than this amount is rejected.

The plant shown in these pictures is one of the largest of its kind. It uses 20,000 feet of floor space, most of which is required for the actual machining processes.

Controlling Power and Motion by Radio

(Continued from page 1281)

used instead of two, in order to set up various complex patterns of effective potential, thus allowing the greatest possible flexibility of control.

The useful range of a "ground" current device of this kind is restricted to a mile or two, and is considered seriously only for purposes of harbor defense.

HERTZIAN WAVES

Together with infra-red emanations, Hertzian waves form the most effective means of radio control of mechanisms, but they are subject to one serious drawback. Of all the methods that have been mentioned so far, radio control is the most subject to interference from enemy or other undesirable sources.

The real problem in the field of Hertzian-wave radiodynamics is to find a means of directing a beam of high enough power to minimize interference from chance or deliberate sources. So many stations are in operation at present that it is impossible to use a sensitive receiving device, without running the chance that any signal on the same wave-length will cause it to respond, as, for instance, by exploding a torpedo. A

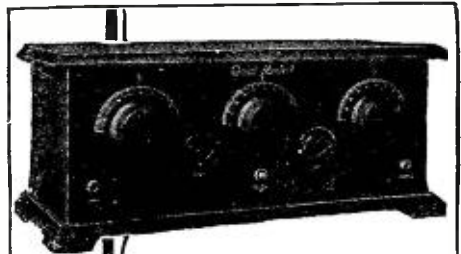

In 7 x 18" Beautiful Wooden Cabinet

It's a 5-Tube GOLD MEDAL TUNED RADIO FREQUENCY RECEIVER

Was \$60 without accessories

NOW \$25

without accessories

Satisfaction Guaranteed

Delivered free anywhere in the United States

GOLD MEDAL RADIO

1034 Longwood Avenue
New York City

Increase Your Earnings In Pleasant Work



G. H. Kolbe

Learn Radio At Home in Spare Time Courses for Radio Operators, Mechanics, Broadcasting, Dealers, at Home or School Write NOW for free booklet "Opportunities in Radio" Y. M. C. A. RADIO INSTITUTE 158 East 86th St., New York City

G. H. Kolbe, enjoys his job! He was Chief Radio Operator on the S.S. President Harding when the sensational rescue was made. He is another "Y" INSTITUTE graduate. Radio offers these opportunities to you, too!

MARKO

RADIO BATTERIES

are

ALWAYS DEPENDABLE

MARKO STORAGE BATTERY CO.
Brooklyn, New York

receiving unit that will not respond to strong static impulses, nor to chance signals from a nearby, high-power station, is an absolute necessity, unless a complicated signalling system is used. It is desirable, also, to have the controlling beam of waves so absolutely directional that they will not affect any ordinary receiving stations not in line with the beam. This makes it more difficult for an enemy to detect the operations of torpedo-directing stations, and adds to the surprise element.

A few years ago the old, messy and unreliable coherer was used as a detector in all Hertzian-wave radio dynamic work. Of late the vacuum-tube amplifier has made possible the use of much more reliable detecting devices; but we are again confronted with the problem of "jammed" ether. No longer is it necessary to find detectors sensitive enough. Our new problem is to make them sufficiently insensitive, and still reliable and positive in operation.

TRANSLATING APPARATUS

As has been pointed out earlier in this article, the transmission and reception of impulses is only half of the problem of radio-dynamics. The other half is the means of applying this received impulse to controlling the torpedo, or other mechanism. For example, we may wish to be able to start, stop, or reverse the propelling mechanism, to steer right, left, or straight ahead, to control lights, to ignite explosives at the proper moment, etc. These functions are usually carried out by an instrument called a selector. It may have any one of several forms, such as a rotary cam switch controlling several circuits, a progressive selector that will perform each of a series of operations always in the same order, etc.

For example, the steering may be controlled by means of iron plungers working in solenoids, as shown in Fig. 3. If the torpedo is to be steered to the right, a signal is sent out which causes the selector to close the local circuit of solenoid B. The current from the local battery then flows through the solenoid, pulling the armature inward and, in consequence, causing the rudder to move in the desired direction. The next impulse will break the circuit, and the spring will draw the rudder back to the straight-ahead position. Similar mechanisms may be devised to perform practically any desired function.

TYPES OF SELECTORS

Selectors are divided into two main classifications. The simplest are those which perform a certain set number of functions always in rotation. The more complicated forms allow the functions to be performed in any order, as needed. A rotary cam switch, similar to that shown in Fig. 4, is typical of the simpler selectors. In this case, in one complete revolution of the wheel of insulating material, the contact strip C closes the circuit of each pair of brushes successively. It takes six impulses for a complete revolution. Therefore, each function can be performed but once in a revolution and, in addition, each function must be performed once per revolution. Thus the speed and practicability of such a device is limited.

The foregoing type of selector requires nothing more than a series of single impulses, or dots, for its operation, and all of these are on a single wave-length (if Hertzian waves are used). The more complicated instantaneous selector may require more elaborate signals, and sometimes the use of several different wave-lengths. In the latter case, several separate tuned circuits are used in the receiver, and each works independently of the rest, closing its own relay and performing its one function.

If the simpler type of selector illustrated in Fig. 4 is used, it is possible to skip rapidly around the barrel of the switch without pausing for more than an instant at any one

Positive Performance Not an Experiment

CASE RADIO APPARATUS

Formerly Indiana Hyperdyne

IS IT not a pleasure to have that favorite orchestra or that particular concert just when you want it? Case Radio will give you performance without interference from other stations, or howls or squeals. It beautifully becomes any home, with Radio reception in fair weather or foul.

These sets are not just put together—they are manufactured complete, in our modern plant, constantly under the attention of Engineers.

Tuned Radio Frequency has stood the test of time and will give you positive reception. CASE sets employ this perfected circuit.

Hear this set—compare it with other sets, regardless of price, and you will agree that it is the best set to be had. Made in 6 styles—all moderately priced.

Description—Model 506

Is a perfectly logged 5-tube, long-distance, tuned Radio frequency set. Solid Mahogany Cabinet, with a 15° Sloping Crystal Lacquer Aluminum Panel, using 5 Vernier-controlled, silver pointers. Panel is marked in meters—see illustration.

Jobbers and Dealers—New catalogue inserts and electro-type proofs—just off the press.

Model 506—\$75.00 List

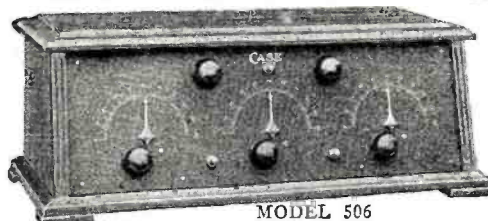

A full line of Radio Receivers — \$65.00 to \$200.00. Dealers—write us for the nearest distributor in your territory.

Indiana Manufacturing & Electric Co.

Factory and General Offices:

600 Case Block, - - - Marion, Indiana

RADIO APPARATUS and AUTOMOTIVE ACCESSORIES

100 Volt Storage "B" Battery for \$1000!

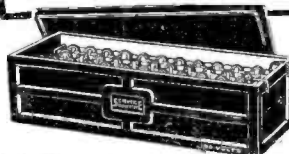

Everybody can now enjoy the benefits of Storage "B" Batteries—more power, quieter reception, greater economy. Rubber case prevents leakage or shorting. Easy to recharge. Will last for years with ordinary care.

SERVICE Rechargeable "B" Batteries
 in all-rubber cases 50 VOLT \$5.50
 100 \$10⁰⁰ 125 VOLT \$12.50

Prices in Canada 50 VOLT \$7.75
 100 VOLT \$14.⁵⁰ 125 VOLT \$17.⁰⁰

Service "A" Batteries
 Indestructible rubber case. Two year guarantee.
 6 volt. 100 amp. hr. \$14.00
 6 volt. 120 amp. hr. \$16.00

SERVICE Double-Duty CHARGER

Charges 6-volt "A" or Auto Batteries or up to 125 volts of "B" Battery IN SERIES. Noiseless in operation. Extremely economical. The height of convenience.



Complete with Bulb \$14.⁵⁰

SERVICE BATTERY CO. of Canada, 137 Roncesvalles Ave. Toronto, Ontario

SERVICE BATTERY CO.

704 East 102nd Street

Cleveland, Ohio

MYERS TUBES



Get Out of the Fog

Myers Tubes make an instantaneous improvement in the clarity, volume, distance and quality of reception from any Radio Set.

The Tube is the Voice of the Circuit

MYERS Tubes are real Radio Tubes—not modified incandescent lamps. They are made by pioneer Radio Tube designers, for Radio purposes exclusively. Compact, precisely correct, free from dead spaces and clumsy dimensions. Finest performance, finest appearance.

Special internal geometry gives highest mutual conductance and largest factor of amplification, resulting in maximum performance when used in either transformer, impedance or resistance coupled circuits.

Unbreakable in normal use. Double-end electrode supports. Absolutely non-microphonic. Perfectly uniform. No matching necessary.

Marvelous Clarity

Internationally preferred by amateurs and experts. Made with standard four prong base, or double-end, in types Myers 01A, Myers 01X, Myers 99, Myers 99X.

List price, any type \$2.50.

Fully protected by patents pending and issued in the United States and Foreign Countries.

At Your Dealers

Myers Radio Tube Corporation
Cleveland, Ohio



9 Circuits-1 Tuning Dial!

A Separate Circuit for each 40 Meter Wavelength Band. A single tuning dial, yet greater selectivity. Let our nearest dealer show you the great Kellogg.

KELLOGG WAVE MASTER

Or write for complete descriptive folder No. 1-C today.
KELLOGG SWITCHBOARD & SUPPLY COMPANY
1041 W. Adams Street :: :: Chicago, Ill.

64 Illustrated Pages of Radio Bargains!
Write for Catalog Today
RANDOLPH RADIO CORP.
159 N. UNION AV. Dept. 2 CHICAGO, ILL.

Insure your copy reaching you each month. Subscribe to RADIO NEWS—\$2.50 a year. Experimenter Publishing Co., 53 Park Place, N. Y. C.

contact; so the desired control may really be reached without going through all the other steps one at a time.

PROGRESS OF THE SCIENCE

Ten years ago radiodynamics was little more than a possibility, as far as practical application was concerned. Four or five years ago it had advanced to the status of an amusing and mystifying toy. Today it is being used in both the Army and the Navy to control movable targets, and for other similar purposes.

From our present point of view, there seems to be little possibility of anything other than a wartime usage for the science. What its future may be we cannot say, but it is to be hoped that the world-wide movement toward the substitution of machine power for man power will soon find a place for radiodynamics in everyday life.

Set Owner's Information

(Continued from page 1268)

tested all the connections, the trouble is, perhaps, in his tubes. After the vacuum tubes have been run about a year or so with hard usage they become inoperative. This is because there is, originally, a surface coating of thorium on the filaments of the tubes, and after a while this coating wears away. It is not necessary to throw away the tubes, as they can be repaired, or re-activated, at almost any radio store, for a very small sum.

The Loop Antenna

(Continued from page 1301)

excellent results being obtained with a loop. The first condition mentioned is the use of a sensitive set. Just what constitutes a sensitive receiver? A brief summary of the existing types of circuits will help us answer the question.

TYPES OF RADIO RECEIVERS

There are five distinct classes of receivers: non-regenerative, regenerative, radio frequency, super-regenerative and super-heterodyne. In the first class, the use of a loop is restricted to an extremely short radius from the broadcast station, since this type of set is neither sensitive nor selective. It is wholly inadvisable to use a loop with such a set.

The regenerative set includes the regenerative reflex and the greatest success can be obtained by using a loop instead of an aerial. Under the category of regenerative sets is included the use of inductive or capacitive feed-back in conjunction with a detector and one or more stages of audio frequency amplification. Only one thing can be said about using a loop with a set of this kind; and that is, when an inductive feed-back is employed, be careful not to allow the loop to get too near the tuning inductance, as excessive feed-back resulting in oscillation will be produced.

The use of a loop with a tuned radio frequency type of receiver has been condemned by some who have experienced poor results with the arrangement. But there is no reason for not being able to get just as good results with a loop as with an outdoor antenna on this kind of set. No matter whether the set be of the straight tuned radio frequency type, neutrodyne, superdyne or other modification, the loop can be successfully employed. By using proper care in preventing the loop from receiving energy from the field set up by the radio frequency transformers, the trouble is at once remedied. This can be done either by placing the loop

"78 STATIONS in 2 evenings on this indoor aerial!"

—writes a Michigan fan



Increased Selectivity—Sweeter Reception—

Everywhere this new scientifically designed antennae is breaking distance records. Coast to coast reception is common—much greater volume than outside aerials, many fans have told us.

Large Size Has 1000 Feet of Wire!

Type IXL EFFARSEE contains 1000 feet of copper wire, covered with parchment. Equipped with special fixed condensers. Much more efficient than unsightly outside wires that have been exposed to weather and corrosion. EFFARSEE can be used anywhere—can be hung on walls, used under rugs, in attics. Write for reception reports of enthusiastic users.

Type IXL (large) . . \$4.00
Type BXL (small) . . 2.50

At any radio dealer
—or write direct.



FISHWICK RADIO CO.

131 CENTRAL PARKWAY, CINCINNATI, O.

Vernon Room
MARCH MUSICALES
EVERY SATURDAY EVENING
February 27th to March 27th
FOURTH YEAR

Levitzi—Sparkes—Dadmun
Errolle—Claussen—Ballon
Peterson—Kindler—Davis
Giannini—Steschenko—Salzedo
Tibbert—Lennox—Jacobsen

CHALFONTE-HADDON HALL
ATLANTIC CITY

Details of these Musicales with hotel folder and rates on request

LEEDS AND LIPPINCOTT COMPANY

Insure your copy reaching you each month. Subscribe to RADIO NEWS—\$2.50 a year. Experimenter Publishing Co., 53 Park Pl., N.Y.C.

at a safe distance from the set or else by completely shielding the latter. Of course, the formality of dispensing with the first radio frequency transformer will have to be enacted and the loop directly connected to the grid of the first radio frequency tube. The more interstage regeneration which takes place, the better the selectivity, sensitivity and volume, but take care to keep the loop far away.

WRNY Broadcasts Christmas Greetings from Germany
(Continued from page 1261)

led over two "idlers" or pulleys at the front of the apparatus. Between these pulleys is mounted the electromagnet, 1. The driving motors are located near the floor, far enough away from the magnet to prevent them from introducing unwanted electromagnetic disturbances through sparking, etc. A motor is connected to each spool separately, in such way that the wire may be run in either direction and quickly wound up or unwound, as desired.

On the floor in front of the telegraphone is a box, 3, containing the amplifier, for magnifying the very weak currents induced by the magnetic wire to loud speaker strength. Steel piano wire, about No. 30, is used. The reproducing electromagnet has a diameter and length of about three-eighths of an inch, and a soft iron core of about 3/64-inch cross-section. This core has a groove in its outer end in which the piano wire runs. The magnet may be wound to a resistance of anywhere from 100 to 5,000 ohms, depending on the impedance of the



The condenser microphone, used in Germany, which consists of two metal discs 1/1000 of an inch apart, one of which is free to vibrate, setting up changes of potential in the circuit.

circuit in which it is to be placed. The piano wire is run over the magnet with a speed of about 100 yards a minute. The spools used in the apparatus shown hold five pounds of wire, and give a record of about 45 minutes. The voice currents to be recorded are put through the magnet. As the wire passes by, it is given a varying magnetization, corresponding to the fluctuations of the voice current.

If the magnet is disconnected from the input circuit, and the wire is again run through with the original velocity, the varying magnetic field of the wire will set up currents in the magnet winding corresponding to the original signals. These currents may be amplified and made to operate a loud speaker; or the amplifier may be connected to a broadcast transmitter, in which case the original speech and music will be put on the air, just as though it were being received for the first time from the microphone. The making of really good records is quite a delicate task, involving many circuit adjustments; but once they have been made, it is a simple matter to give a practically perfect reproduction of the original program at any time or place. Should it be desired to make a new record on this wire, the old one may be readily wiped out by simply passing the wire through a constant magnetic field, such as that of an ordinary permanent magnet.

WAX RECORDING

While the magnetic method of recording has the great advantage that the record may



\$35

4-volt model, \$35
6-volt model, \$40
Prices West of the Rockies slightly higher.
110-125 volt—
60 cycle A.C.
Balkite-equipped

At last!.. perfect "A" power

THE new Gould Unipower has taken the uncertainty out of "A" power—and banished forever the inconvenience and cost of renewing dry cells, or of charging a storage battery. *Automatically*, it delivers continuous, unfailing "A" power of the highest quality—and always at full voltage.

Unipower is a single compact "A" power unit that fits *inside*

most radio cabinets. It will last you for years—no tubes, bulbs, lamps or working parts that require replacement.

Only a few cents a month

Unipower automatically replenishes itself on a low trickle charge and with a minimum consumption of current. Ask your dealer for a free demonstration! The Gould Storage Battery Co., Inc., 250 Park Ave., New York.

Unipower
TRADE MARK

Off when it's on—On when it's off

BUILD STYLE INTO YOUR RADIO!

Send 10c in stamps or coin for 64-page illustrated booklet, "Making it Easy to Build Things of Wood" containing helpful information and describing Boice-Crane Circular Saws, Band Saws, Jig Saws, Lathes, Jointers and Drills.

Boice-Crane Junior Bench Saw

Does ripping, mitering, grooving, rabbeting, sanding, grinding and other operations with ease and accuracy. Special blades cut Bakelite. Saws 1 1/2" stock. Table 10 x 12". Driven by 1/4 to 1/3 h.p. motor attached to light socket. Sold on Money Back Guarantee.
W. B. & J. E. BOICE. Dept. 803-B. TOLEDO, OHIO



RADIO — BARGAINS

FREE RADIO CATALOG & GUIDE of newest ideas, approved special hook-ups with illustrations. Tremendous savings on standard radio parts, sets, kits. Be sure to get this thrifty book before you buy. Wonderful! Unusual? You'll say so. Write letter or postal NOW.
BARAWIK CO., 102-142 S. Canal St., CHICAGO, U.S.A.

PATENTS
DON'T LOSE YOUR RIGHTS
Before disclosing your invention to anyone send for free blank form "EVIDENCE OF CONCEPTION" to be signed and witnessed.
LANCASTER & ALLWINE
Reg. Pat. Attys. in U. S. and Canada
270 Ouray Bldg., Washington, D. C.
Originators of the form "Evidence of Conception"

SUPERADIO Receiver



Licensed under Reactodyne Agreement

A powerful 5-tube set of advanced design that must be seen and heard to be fully appreciated. A most sensational value, \$56.

SUPERADIO B-Battery Eliminator

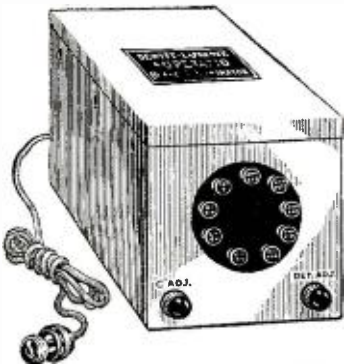

Operates any Receiver at top efficiency. Provided with taps for precise voltage adjustment as follows:

"R" Taps: Det.—4 to 35 volts variable; Amp.—45 volts; Amp.—67½ volts; Amp.—90 volts; Amp.—135 volts; "C"—Taps—1½ volts; 9 volts; 4 to 40 volts variable.

Type A for B and C. Batteries....\$35.00
Type B for B. Batteries.....\$25.00

DeWitt-LaFrance Co. Cambridge, Mass.

Boston Representative:

Martin, Hartley & DeWitt Sales Co.,
99 Bedford Street

Chicago Representative:

William A. Welty & Co., 36 S. State St.



SHORT LEADS!

SHORT LEADS—which improve, so much, the efficiency of any set—are made possible through the use of sub-panels mounted on **GARFIELD NON-METALLIC BRACKETS**. Made of **RADION**—the supreme insulation—wires can touch, run through or near them without danger of short circuits and without creating distributed capacities.

\$1.25 a pair

GARFIELD RADIO MFG. CORP.
Dept. B, 64 Vesey Street, New York

be quickly made anywhere, it has the disadvantage that the making of duplicate records, to be used anywhere and everywhere, is not quite a simple matter. Here the phonograph disc record has an unquestionable advantage at the present time. Such records are readily duplicated and may be run off wherever there is a phonograph. However, the quality of reproduction given by the old familiar disc record is not such as to be suitable for broadcasting. Indeed, the use of such records in high-class stations is forbidden in the United States by a ruling of the Department of Commerce. But, in the course of the past year, radio has come to the rescue of the phonograph and developed new and revolutionary methods of recording and reproduction.

THE CONDENSER MICROPHONE

The microphone itself consists essentially of nothing more than two metal discs separated by less than 1/1000 of an inch. These constitute the condenser. One of the discs is so mounted that it will vibrate with sound waves. The capacity of the condenser is thus altered, in accordance with the sound vibrations of speech or music. The condenser is charged to a potential of several hundred volts, by means of a battery connected to it through a high resistance. The vibrations of the free condenser plate set up minute changes of potential, which are impressed on a three-stage amplifier and thus magnified several thousand times. The condenser microphone gives very faithful reproduction of the highest and the lowest notes, and has a nearly straight-line frequency characteristic.

Now, this electric needle would not of itself produce a record in the wax corresponding exactly to the currents from the microphone. This is for the reason that
(Continued on page 1380)

Speech Currents in Radio-Phony

(Continued from page 1285)

be detected at a greater distance through the air than the former. If we set up an antenna or use a simple continuous circuit of another kind, and move it gradually from the adjacent radiating circuits, the lower frequency circuit will be inaudible at a point where the higher frequency is still audible. Finally, at another point and distance, both will be inaudible. This assumes that both carry the same effective power in either radiator.

TRANSMISSION

Now assuming the fact that we desire to transmit speech by means of one of these radiators, it is manifest that the one which radiates furthest will serve the desired end better than the other. Supposing that this chosen circuit is in the form of a large loop with an alternator of low power in series, we insert a microphone similar to the one originally mentioned. It will be found that the transmitted speech is unintelligible to an extreme.

Looking into the possibilities of higher frequency currents, the effects of which can be detected at still longer distances from the open radiator or antenna, we discover that as the frequency ascends, the speech becomes more intelligible until we reach a point where the frequency is such that both speech and the carrier frequency are inaudible at the receiving antenna or loop.

A question comes up as follows: Since the arbitrary average frequency of the voice is 800 cycles, why cannot we use an antenna whose period is 800 cycles, and thus gain the advantage of using a radiator which works best when worked near to its natural period, and radiate current at the frequency of the voice without having to resort to either inductive effects, such as originally

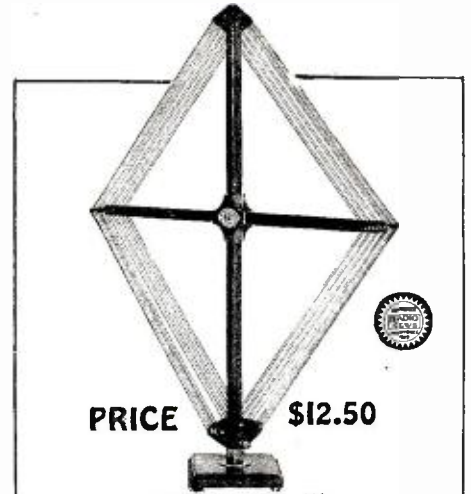

PRICE \$12.50

Patd. Oct. 27 1925

REMARKABLE EFFICIENCY

combined with unusual beauty

The FIAT is unusually selective and highly directional. Bank-winding and a unique arrangement of turns to reduce the distributed capacity, together with a novel folding feature which avoids tangled turns and insures taut wires at all times, are exclusive features in the FIAT LOOP.

The Browning-Drake receiver can be easily adapted for use with the FIAT LOOP. Results are amazing. Selectivity and tone quality will be greatly improved.

Write for illustrated literature of intense interest to any radio set owner. Standard Model is center tapped and tunes with .0005 M.F. Condenser.

Jobbers: Send today for attractive proposition.

RADIO APPLIANCE LABORATORY
4888 No. Clark St. Chicago, Ill.



\$3.65

C. O. D. MONEY-BACK GUARANTEE

OLD TUBES MADE GOOD AS NEW

This latest Laboratory product will recondition any old, run-down, even worthless tubes, as long as the filament still lights. Makes them good as new in few minutes time. Costs but few cents more than new tubes! Simple, efficient, practical. Big money-saver. Thousands in use. Why pay more. Operates on either A.C. or D.C.—110-120 Volts. Model No. 20 for UV201A (C301A, etc.) and all similar types. Model No. 10 for UV199 (C299, etc.) and all similar types. Order yours today.

SEND NO MONEY
You cannot lose! Act quick on this special short-time introductory price. Pay postman \$3.65 and postage, or we pay postage if you send cash with order. Be sure to state Model Number wanted. Full directions included. Our guarantee refund price protects you. Send now.

MACK LABORATORIES
724 Cass St. Chicago, Ill.

MACK RECONDITIONER

THE CURE FOR RUN-DOWN TUBES

5-TUBE SET = \$28 = LATEST DESIGN

This wonderful value made possible because practically everything is manufactured in our own factory. We supply chassis completely wired with cushioned sockets, S. L. F. Condensers, Vernier Dials, Low Loss Coils, no cabinet. Dimensions of set 7x18 inches. Latest design. Money refunded if unsatisfactory in 5 days. Remit cash. Money order or Express. Dealers write for special propositions.

DuKe Radio Co., 814 Market St., Chicago, Ill.

Insure your copy reaching you each month. Subscribe to **RADIO NEWS**—\$2.50 a year. Experimenter Publishing Co., 53 Park Place, N. Y. C.

used in the small circuits described before, or without resort to the use of current, the frequency of which is very high, this latter making necessary apparatus of complicated design in order to produce these higher frequencies?

We are back again to the original points gone over. Radiation depends upon the frequency to a great extent. Another point is that were we to erect an antenna whose natural period was close to 800 cycles, it would mean that the wave-length would approach 375,000 meters, which is a staggering quantity for an antenna. Supposing the longest wave now used in radio to be 25,000 meters, then to radiate at voice frequency we would require an antenna system fifteen times larger than the greatest in existence today. Then on the other hand, when we consider that although the average voice frequency may be said arbitrarily to be 800 cycles, nevertheless the voice carries vibrations tremendously greater and less than that figure, and also all voices are of absolutely different quality or pitch. It is seen that only those frequencies near 800 cycles would be strongly radiated while the other tones would be submerged or lost altogether.

PRACTICAL PROBLEMS

Besides, the erection of an antenna of the kind necessary would entail mile after mile of an enormous structure which in the end would be a failure in transmitting clear speech over only short distances. When we consider that in a grounded open radiator there is a potential node at the ground and a loop or maximum at the free end, then the voltages built up on an antenna of this kind would approach the tension of thunderbolts and require more insulation than that of a thousand smaller stations. Then it might be inadequate!

As far as we can see today, there is no possibility of transmitting speech over long distances without the aid of very high frequencies, which cause great electro-magnetic disturbances in the ether and dissipate large amounts of energy into space, which do not return in the collapse of the field, but go speeding on their way in the form of waves, carrying the spoken word of the city to the hamlet or to the solitary ocean carrier miles from land.

After all is said, we can compare the system of speech transmission by direct current over a wire to the radio system—which is really comparable, because in the first place the object in view and the result obtained is the same; that is, the carriage of speech across long distances.

\$1000 Prize Contest

(Continued from page 1258)

This is going to be a contest where the majority rules, not the minority. We do not want freak sets. No manufacturer would build them, and we do not think that the majority of the public would wish such a set. The prizes, therefore, will be awarded in the following manner:

After all the entries have come in, those that are nearest in similarity will be put together. The designs that show the greatest similarity in practically all details will determine the prize-winning type. There will, of course, be hundreds of near-duplications for that reason.

Let us say, for example, that 5,000 designs are received with a single-control dial, enclosed loop, and built-in loud speaker. This, then, would become the prize-winning type, because the majority want that kind of a set.

How, then, are the prizes going to be awarded? Under the rules and conditions published at the end of this article, it will be seen that the judges will choose the prize-winners in a very simple manner. They will

The Mystery Receiver

CHARLES LEUTZ'S LATEST EPIC

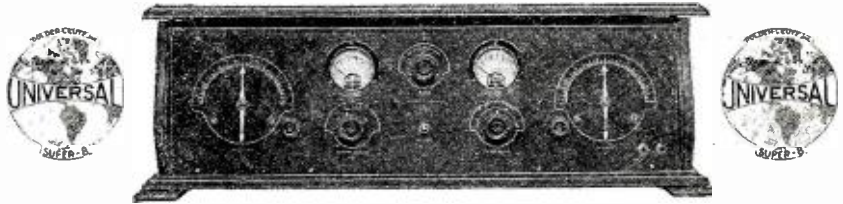

THE UNIVERSAL SUPER-8

LICENSED UNDER HOGAN PAT. 1,014,002

Tunes all Wavelengths from 35 Meters to 3600 Meters

The Universal Super 8, "The Mystery Receiver," is an improved design of the Universal Plio 6, but does not by any means supersede the Universal Plio 6, which is still continued and which is the leading broadcast receiver in its sphere. The Universal Super 8, however, is an advancement in that while it retains all the salient features of the Universal Plio 6, adds some new desirable features, making it the highest grade set possible to produce.

- (1) Meters are provided to read the battery voltages.
- (2) A special antenna coupling circuit is provided to reduce interference and static.
- (3) Geared verniers are provided on the tuning controls.
- (4) Metallic shieldings provided at points deemed advisable.
- (5) Seven tubes are used to give still greater volume and fine tone musical reproduction.
- (6) All the important component parts are encased in a metal container, and factory sealed to prevent any damage and to prevent competitors from copying the new features.
- (7) We believe it is impossible to trace the circuit and design by taking this receiver apart outside of our factory.

The exact function of the seven tubes of the Universal Super 8 is not revealed at this time as the manufacturers desire to keep all details a secret until full patent protection is afforded. Full operating instructions are supplied with each Universal Super 8, however. Patents are applied for covering some of the features of the Universal Super 8.

Either the old or the new type tubes are used in the Universal Super 8, and special provision is made for bias batteries, specified by some tube manufacturers.

Obviously this receiver will not be made on a large production scale, due to the time needed in building each one individually. Orders are now being taken on a custom-made basis as each set is laboratory tested in Long Island by an expert radio engineer to insure its perfection.

It is believed that the new design embodied in the Universal Super 8 gives the finest musical reproduction, tune, selectivity, audibility and maximum range that can be obtained by any receiver using seven tubes. Judging from the interest in our other multiple tube receivers, we believe the demand for this new design is going to tax our capacity the year around, and, as above stated, orders are now being taken in rotation. Prices quoted on application.

This receiver is not regenerative and is not a super-heterodyne.

WRITE OR WIRE

GOLDEN-LEUTZ INC.

VAMOS BUILDING

6th & Washington Sts., Long Island City, N. Y.

Cable "Experrato"

Free 3 Lessons

You can play the scale in an hour and play Jazz in a week on the

Buescher Saxophone

We give 3 free lessons with each new instrument. They start you. Teach yourself. It's great fun practicing because you learn so quickly. Even though you have failed with some other instrument, you can learn the Buescher Saxophone. And it will make you the most popular person in your set. 6 days' free trial in your own home, any instrument. No obligation. Easy terms if you decide to buy. Send now for beautiful free literature. A postal brings liberal proposition. Address:

Buescher Band Instrument Co. (In)
1227 Buescher Block Elkhart, Indiana



ACME

"B" Power Unit

No Noise or Hum. Operates on all types of sets. Sold on money-back guarantee. Write for circular.

The Sensation of the Year

THE ACME ELECTRIC & MFG. CO.
1344 Hamilton Ave. Cleveland, Ohio
Manufacturers of the Acme Charger

\$28.50 Complete East of Rockies
The Best by Test—

Insure your copy reaching you each month. Subscribe to Radio News—
\$2.50 a year. Experimenter Publishing Co., 53 Park Place, N. Y. C.

Two Great Radio Books In One

FIVE

Big sections each a complete Radio Book in itself.

1

HOOKUP REVIEW

Plenty of new and practical hook-ups, illustrated and explained in a constructional and non-technical manner. For the radio set builder and amateur.

2

RADIO ENCYCLOPEDIA

Every issue contains an instalment of S. Gernsback's Radio Encyclopedia. The first complete, authentic work of its kind. Valuable to everyone interested in radio.

3

RADIO PRESS DIGEST

New ideas in radio, radical improvements, etc. Altogether, this section is novel, interesting and keeps you in touch with radio from other countries.

4

CALL BOOK

This is a very valuable reference, a complete list of Broadcast and amateur stations, Canadian stations and foreign amateur and broadcast stations. The most complete list of its kind.

5

RADIO LISTENERS INFORMATION

This section gives many hints and ideas on the care and operation of a receiving set, together with practical information on radio from the listener's point of view.

50^c
PER
COPY

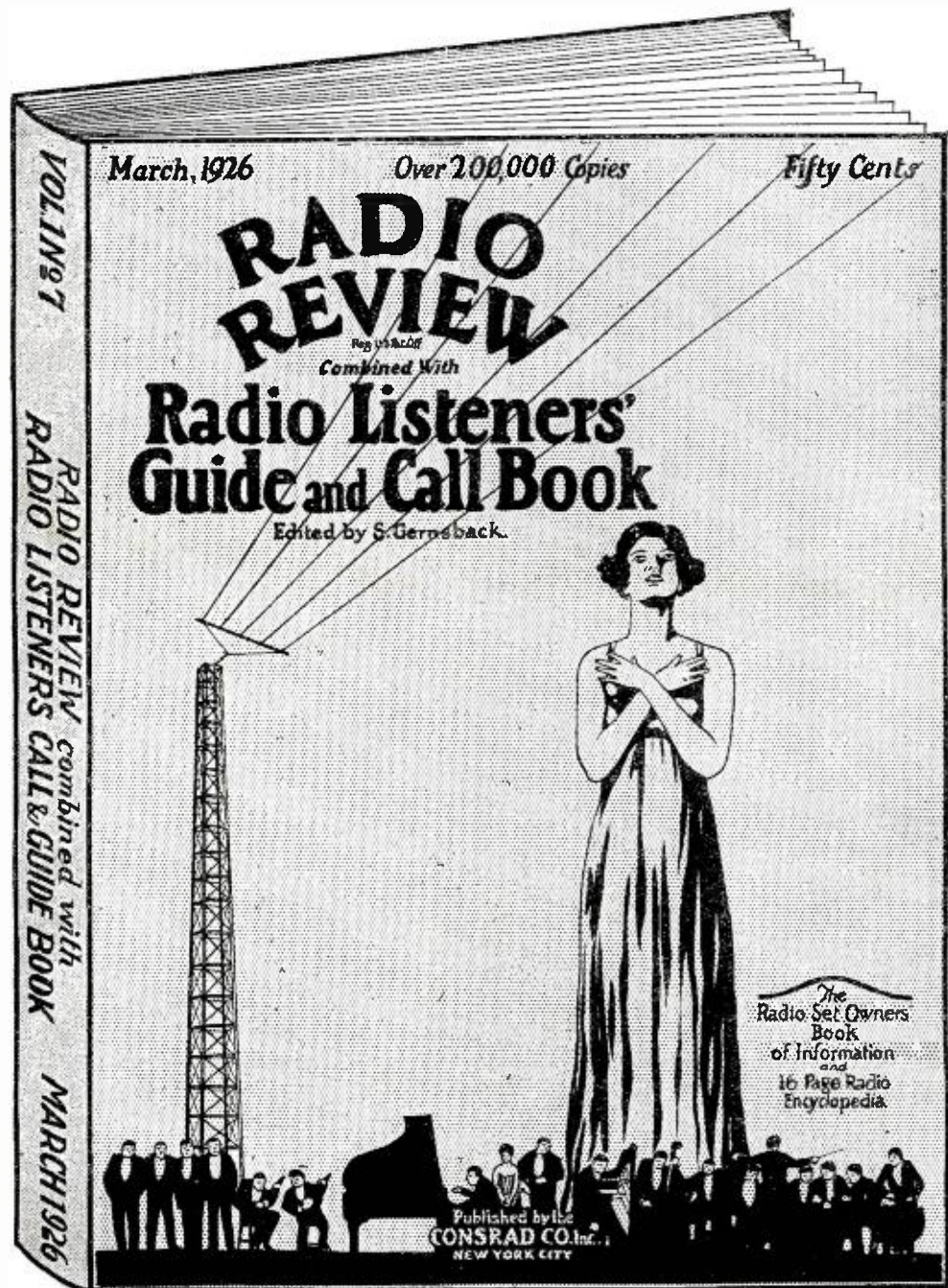

The Most Valuable Radio Book of its kind-for Beginners,
Broadcast Listeners and Amateurs

SOLD ON ALL NEWSSTANDS

Now the RADIO LISTENERS' GUIDE and CALL BOOK is combined with RADIO REVIEW and will be issued four times a year in one great complete volume.

Each issue of this great new book contains a complete digest of practical radio hook-ups culled from radio press throughout the world, S. Gernsback's well known radio encyclopedia, in installments, an international radio press digest of news and information, a complete accurate list of Broadcast station call letters, and a valuable section replete with information for the Broadcast listener.

Published in the large Magazine size, contains 200 pages and more than 300 illustrations ALL FOR 50c the COPY. Watch for the first issue on all newsstands and all radio stores beginning February 1st.

You will buy the biggest value in wealth of radio reference material ever printed for the radio broadcast listener, amateur or professional.

Published and Distributed by

The Consrad Co. Inc. 64 Church St. New York, N.Y.

judge according to the best reasons why the contestant, in his description, which must accompany all entries, thought such a set should be America's most popular one.

YOU MUST SEND A DRAWING

Neatness of design and originality in carrying out the drawing or design will, of course, count, but not 100 per cent. Note particularly, when sending in your entry, that it is necessary to accompany it with a drawing. You can sketch and draw right on the front cover design, if you care to do so. If you care to use the front cover design, and should you wish to make a console set, all you need to do is to cut out with a pair of scissors the set pictured there, and draw your console, if you are so inclined. The better way, however, is to draw the entire set yourself, from start to finish; and it is not at all necessary to make a fancy design, or paint the colors in oil. All that the judges require is a pen-and-ink drawing of the simplest sort, as the ones shown on page 1258. Just a skeleton design will do nicely; and such a design is likely to be a winner, just as much as the more elaborately finished one.

While the first prize will go to the best design of the majority-favored type, other prizes will go to those that show originality; for, you can never tell, somebody might create a revolutionary design that might be adopted by the entire industry. So, if you have original ideas, do not hesitate to send them in. Furthermore, if you have too many ideas, this need not bother you, because YOU CAN SEND IN AS MANY DESIGNS AS YOU DESIRE. There are no restrictions as to this.

SPECIAL PRIZES FOR WOMEN

The lady of the house must also have a voice in this contest. As a matter of fact—and of record—the idea of this prize contest originated with one of the fair sex: Mrs. Hugo Gernsback, the wife of the editor of RADIO NEWS. Radio sets today are made with the furniture idea uppermost in the minds of many set manufacturers. The reason is that the lady of the house must be pleased first. She demands a certain piece of furniture that will harmonize with other furniture in the room. Hence, radio sets are assuming more and more the looks of a beautiful piece of furniture, rather than keeping to the old orthodox idea of just a panel with a box and a lot of knobs, the whole to be put upon any old table.

With this idea in mind, the women of America are asked to submit their ideas as to radio furniture. Here, again, the first prize will be awarded to one of the majority sets. There will be thousands of designs from women designers, and out of these there will be a great number of similar sets. These will be judged for the best details, and the best letter accompanying the design.

It is hoped that, by combining the ideas of men and women contestants, this contest will bring forth a design that will be most acceptable, not only in America, but to the whole world.

READ CAREFULLY!

Please read carefully the following rules of the contest, which must be closely followed. Prize entries not adhering to the rules will be disregarded and thrown out from the contest:

(1) Anyone may enter this contest, with the exception of the employees of the Experimenter Publishing Company and their families.

(2) It is not necessary to draw the design upon the blank on the front cover of this magazine. The design may be traced or copied or drawn from imagination.

(3) Any style of radio set is eligible, whether sloping panel, straight panel, set without a table, console type, portable, etc. The set may be for aerial or for loop, with or without built-in loud speaker, as fancy dictates. Sets may have any kind of con-

THE BIG LITTLE THINGS OF RADIO



The DAVEN LEAKANDENSER—the new combination grid leak and grid condenser all in one! For any detector tube circuit.



The biggest of all the little things—THE DAVEN GRID LEAK. Made in 29 standard values from 2,500 ohms to 10,000,000 ohms.

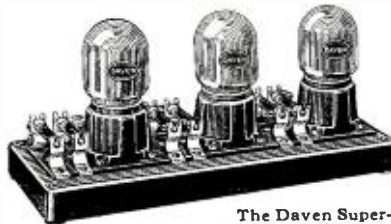

The Daven Super-Amplifier eliminates all hook-up labor. For those who prefer to assemble, the Type 3-K Kit is complete except for sockets. For 50% more volume use the new Daven Tubes Type MU-20 with the Daven Super-Amplifiers. Daven Power Tube Type MU-6—for the last stage of any set.



New Daven Special Type "A" Coupling Condenser increases volume with Resistance Coupled Amplification. Sold separately, also included in all Resistor-Couplers, Super-Amplifiers and kits.

Daven

VOLUME and QUALITY



As an owner of a radio set you should demand two things: (1) Volume on the weakest signal, (2) Tone quality that makes criticism impossible and excuses or qualifications unnecessary. Why sacrifice one for the other? Demand both. Today it is a simple matter to have both.

It is easy to get volume but there is only one way to get both quality and volume. Use Resistance Coupled Amplification in the audio end of your set. We have made this very simple by developing the Daven Super-Amplifier. Or, if you prefer self-assembly, couple up Daven precision-built resistances and mountings as contained in the 3-K Kit. Then you will hear radio at its best.

Three new Daven Products were announced this Fall. The Daven Leakandenser is a

Daven grid leak of permanent and constant value, combined with a grid condenser of fixed capacity, correct for all makes of detector tubes. Precision-built, simple, effective, uniform and very handsome. A pair of mounting clips included.

The new Daven High MU Tube Type MU-20, used with the Daven Super-Amplifier, is designed to give 50% more volume—6 volt, 1/4 ampere. The Daven Power Tube Type MU-6 is for use in the last or output stage of any set regardless of the method of amplification used—6 volt, 1/2 ampere.

The new Daven Special Type "A" Condensers are the latest development of Daven Engineers. Their use in Resistance Coupled Amplifiers gives you 50% more volume than ordinary condensers.

The Resistor Manual is the "A.B.C." of Resistance Coupled Amplification—a complete handbook for designers and builders. Send for it.

DAVEN PRODUCTS ARE SOLD ONLY BY GOOD DEALERS

"The Sine of Merit"

DAVEN RADIO CORPORATION

Resistor Specialists

NEWARK

Reg. U. S. Pat. Off.

NEW JERSEY



Clip this Coupon

DAVEN RADIO CORPORATION, 159 Summit Street, NEWARK, NEW JERSEY

Please send me the following on Resistance Coupled Amplification:—

[] Resistor Manual, 30c inc enclosed. (Check One) [] Complete Catalog (free)

Name _____

Address _____

To Dealers: May we have our nearest distributor communicate with you?

Stand This Handsome Radio Lamp Next to Your Receiver!

Base is an exact duplicate of broadcasting microphones, with shade of beautifully decorated papyrus. Socket connection on top of base. Novel—ornamental—decorative—a lamp every fan will want.

Also Furnished With Built-in Loud Speaker Unit

The Kodol Radio Lamp is also furnished with built-in loud speaker unit—sensitive—loud—clear.

Price with Speaker Unit.....\$26.00

Price without Speaker.....\$25

If your dealer cannot supply you we will ship direct on receipt of price.

THE KODEL RADIO CORPORATION
501 E. Pearl Street, Cincinnati, Ohio



Insure your copy reaching you each month. Subscribe to Radio News—\$2.50 a year
Experimenter Publishing Co., 53 Park Place, N. Y. C.



\$3.50
IN U. S.
(WITHOUT DRY CELL)

No. 32

Banish Detector Troubles with The Carborundum Stabilizing Detector Unit

By a turn of the knob on the stabilizer you adjust the detector impedance to best suit operating conditions.

You can materially reduce the detector circuit damping, thus giving increased selectivity—sharper tuning.

With this stabilizing unit you get the most efficient rectification—resulting in increased sensitivity—greater volume.

It's a simple device that solves all detector troubles.

Comes equipped with genuine, fixed Carborundum Detector. An ordinary flash-light cell for booster voltage completes the unit.

You can get the fixed, permanent Carborundum Detector alone for \$1.50
YOUR DEALER OR DIRECT
Send for Descriptive Circular Showing Hookups

THE CARBORUNDUM COMPANY
NIAGARA FALLS, N. Y.

New York Chicago Boston Philadelphia
Cleveland Detroit Cincinnati
Pittsburgh Milwaukee Grand Rapids



AGENTS
Big Money Quick!

COMBINATION KING RADIO WONDER

First combination tube and crystal set ever made. Turn of a switch and either tube or crystal works as desired, or both together. 1000 Miles or more on headphones—Loud speaker on Locals. Two complete sets in one for only \$10.95 retail. Get my wonderful money making plan and special price today.

Aerial Electric Co.
128-49 W. Kinzie St.
Chicago

You Want This Proposition - Write Today!

Insure your copy reaching you each month. Subscribe to RADIO NEWS — \$2.50 a year. Experimenter Publishing Co., 53 Park Pl., N.Y.C.

trol, whether by regular dial, vernier dial, dials behind the panel, or new vertical dials (such as used in the Radio Corporation and Grebe types, for instance).

(4) Any number of designs may be submitted by contestants.

(5) No design can be submitted in pencil drawing. It must be executed either in ink or india ink, water colors, oil colors, etc.

(6) A description of 100 words or less, stating your reason, why you think your particular design is best, must be PASTED on the back of the design. This description to be either typewritten or penned in ink. No penciled matter can be considered. Your name, and address must be included in this description, and do not forget to paste the letter on the back of the design. Descriptions or letters attached with pins or clips are ruled out.

(7) All designs must be sent in flat. Those received rolled will be rejected.

(8) This contest is NOT a technical one. The judges are not concerned with what is behind the panel. Thus, for instance, a single dial may control three or more condensers, but no technical description of what is behind the panel is wanted or can be included in the description. It is up to the set manufacturers to build sets according to the wishes of the American public.

(9) Where a concealed loop or concealed loud speaker would not show on the face of the drawing, it is desired that you include this in your written description of the set. If an unusual design is submitted, the location of the loop aerial or loud speaker can be indicated by dotted lines on the face of the drawing, or by indicating arrows, etc.

(10) It is permissible to use colors on the designs, if desired, although the judging of designs will not be affected thereby.

(11) In case of a tie, identical prize-winning answers being submitted by different contestants, identical prizes will be awarded to those tying for the prizes.

(12) Entries submitted in this contest cannot be returned to contestants.

(13) This prize contest closes April 20, 1926, at noon, which time all answers must have been received at this office. Announcement of the prize winners will be made in the July, 1926, issue of RADIO NEWS. Prizes will be paid upon publication of the July, 1926, issue.

Address all entries to Editor, *Ideal Radio Set Contest*, in care of RADIO NEWS, 53 Park Place, New York City.

RADIO SET DIRECTORY CORRECTION

Through a purely typographical error in the Radio Set Directory which was published in the November, 1925 number of RADIO NEWS, the price of the All-Amx Senior Receiver, manufactured by the All-American Radio Corp., of 2650 Coyne St., Chicago, was made to appear as \$4.00, instead of \$42. the real list price.

As this list was not published as an advertisement, the manufacturer, who had no part in making this error, is in no way responsible for it.

The Duodyne Circuit

(Continued from page 1293)

THE INTERSTAGE TRANSFORMERS

The two interstage transformers are identical. They are wound on the same type of forms as the antenna coupler. The primary winding consists of four turns of No. 40 Advance resistance wire on each coil. These turns are spaced widely (about 1/2 inch apart). The two windings are connected together at the top of the duoformer; the two free ends to the plate and "B" battery respectively. The secondary winding is laid on directly over the primary winding, and consists of 68 turns of No. 24 D.S.C. wire on each form. The two halves of the secondary are connected together at the top of the coil; the other ends to the grid filament of the tube. The end that goes to

"SUPER BOOSTER"

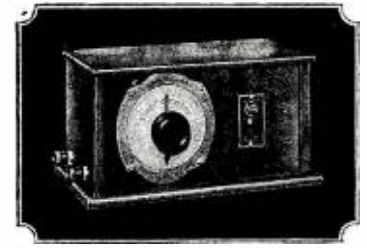

A Beautiful Mahogany Cabinet, 9x4x5.
Easily Attached to All Sets

Price \$12.00

Owners not satisfied with the operation of their Super-Heterodynes or loop sets will find the solution to their troubles in using this unit, because of its qualifying merits.

A greater range—added volume—increased selectivity—reduced static.

A minimum reduction of radiation in regenerative sets.

Material saving in battery and tube cost.

Owners of all types of set are reporting the remarkable benefits and pleasure the Super Booster is giving them.

Descriptive literature furnished on request. In writing us give description of your set, also the name of your dealer.

SUPER PRODUCTS MFG. CO.
918 1/2 South Vermont Ave.,
Los Angeles, Calif.

MUSIKTRON

RADIO TUBE

The Best Tube Made

No matter what you pay, you cannot buy a better tube than the famous Musiktron. Marvelous results can be secured from your Radio Set when you use Musiktron Tubes, for both detector and amplifier. Brilliant, clear tone and REAL DISTANCE. Made of extra quality materials to insure long life and heavy service. Regular type KH001A, type KH011 and type KH699 only \$1.50 each! Special Resistance coupled amplifier Tubes \$2.00. Power Tubes all types \$1.00. Absolute satisfaction or money refunded. Sent direct by mail, C.O.D. or you can send money, order with your order. We pay the postage. Send for yours today.

PRICE POST PAID
\$1.50

K. & H. ELECTRIC CO.
43 Commercial Street
NEWARK
New Jersey

Volume, Selectivity, Quality, Distance

THE **CRAYF** JR. CRYSTAL RECEIVER HAS THEM ALL

Thousands of Satisfied Users
\$12 complete--\$5.50 set alone

Sent prepaid anywhere in U. S. Send for free descriptive booklet and give us the name of your dealer.
CRAYN BROS. RADIO & MFG. CO.
2304 Telegraph Avenue, Oakland, Calif.



You Can SAVE

Send in your subscription to
— RADIO NEWS —

\$2.50 FOR 12 MONTHS

the grid is the one that is next to the "B" battery end of the primary coil.

The designers of the Duodyne circuit claim that this arrangement of high-resistance primary is a more efficient means of controlling oscillations than the usual method of introducing resistance into the grid circuit. In the plate circuit the primary resistance is in series with a resistance of nearly one hundred times greater magnitude, and has no appreciable effect upon the signal. In the grid circuit, on the other hand, such a resistance causes a great drop in efficiency.

CONSTRUCTION OF THE SET

The first operation in building the set is to drill the bakelite panel and binding post strip so that the parts may be arranged in the manner shown in Figs. 2 and 3.

Next, lay out the baseboard in accordance with Fig. 2, and screw all of the apparatus in place on it. Mount all of the apparatus on the panel, except the three variable condensers, and secure the panel to the baseboard. The condensers should not be mounted and connected in the circuit until all of the other wiring is finished. This is recommended because they might otherwise be in the way when running some of the wires.

Before proceeding with the actual wiring, Fig. 4 and the top and rear views in Fig. 2 and 3 should be studied very carefully.

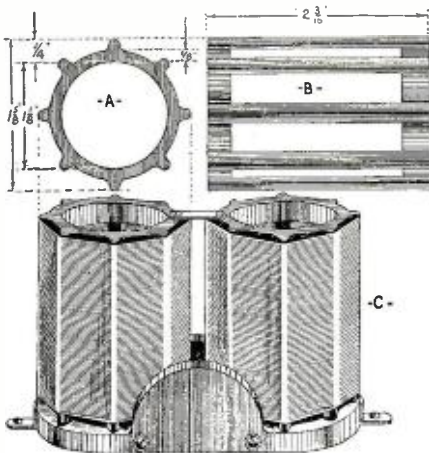

Fig. 5. The duoformers, which are the heart of the Duodyne circuit, may be bought complete, as shown at C; or may be wound on forms similar to A-B.

LIST OF PARTS

- 3 S.L.F. variable condensers, .0003 μ f.,
- 3 Duoformers,
- 5 Tube sockets,
- 2 Audio frequency amplifying transformers, 3 $\frac{1}{2}$ -to-1 ratio,
- 1 Rheostat, 6 ohm,
- 1 Rheostat, 15 ohm,
- 1 By-pass condenser, 1 μ f.,
- 2 Fixed condensers, .002 μ f.,
- 1 Fixed condenser, .00025 μ f.,
- 1 Grid condenser, .00025 μ f., with leak mounting,
- 1 Double circuit jack,
- 1 Single-pole double-throw antenna switch,
- 1 Grid leak, 2 megohm,
- 14 Binding posts,
- 1 Panel, 7x21x $\frac{1}{8}$ inches,
- 1 Small panel, 9 $\frac{3}{8}$ x1 $\frac{1}{2}$ x $\frac{1}{8}$ inches,
- 1 Baseboard, 9 $\frac{1}{2}$ x20x $\frac{1}{2}$ inches,
- 2 Feet No. 18 tinned copper wire,
- 20 Feet No. 9 black spaghetti tubing,
- 2 Feet resin core solder.

HOOKING UP THE SET

The set is now ready for test. Before any tubes have been inserted in the sockets, the batteries should be connected. Then turn on both rheostats, part way, and insert one tube. The filament should now light up to a dull glow. If it does, all is in order and the other tubes may be inserted. If it fails to light, or flashes up brightly, there is a mistake in the wiring; and it should be traced out and corrected before proceeding further.

A Scientific Instrument House of International reputation offers for the first time direct to the public an improved S.L.F. Variable Air Dielectric Condenser

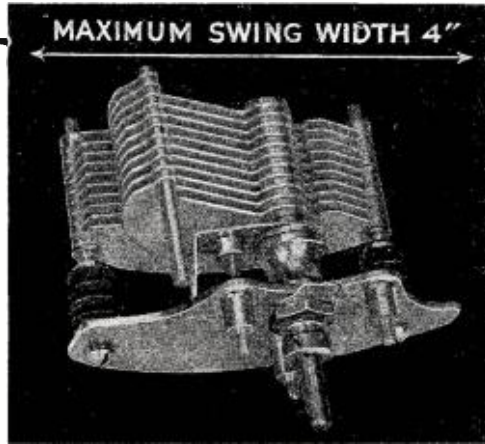

Made of the best materials obtainable, the highest grade of aluminum and the best grade of brass. Besides the materials used, the workmanship is that of instrument makers rather than ordinary mechanics and several features of decided merit are embodied in this Condenser, among them being the improved calibration curve.

The S. L. F. Condenser that takes no more room than old types

The popular "straight-line frequency" calibration gives too rapid a capacity variation near maximum capacity to permit convenient tuning for the longer-wave-lengths. This will be appreciated by radio fans, who appreciate the nicely balanced compromise, such as has been obtained by equal spacing of broadcasting stations and equal facilities of tuning over the entire frequency band. Its compactness is appreciated, due to the fact that most of the

present-day "straight-line frequency condensers" have narrow, pointed rotor plates of small area, which require a large number of plates and give rise to an extravagant rotor sweep, so as seriously to crowd the other parts of the set. In our Condenser the eccentric semi-circular plates, which gives the improved calibration curve, has a substantial area and only a moderate sweep.

Special Features

- Low Minimum Capacity, reaching down to 200 meters. Negligible Losses.
- Individually fitted bearings, allowing no side or end play.
- Highly developed crimping process insures good bonding between plates.
- All plates centered, due to rigid assembly and inspection tests.
- General sturdiness of construction and clean workmanship.
- Our enormous production for set manufacturers enables us to make this extremely fine price offer to the public.
- Sold only on a cash with order basis, money returned if you are not more than satisfied that they are exactly what you want and equalled electrically or mechanically.

Price \$2.75 each Set of three, \$8.00

Sent by paid parcel post anywhere in U. S. A.

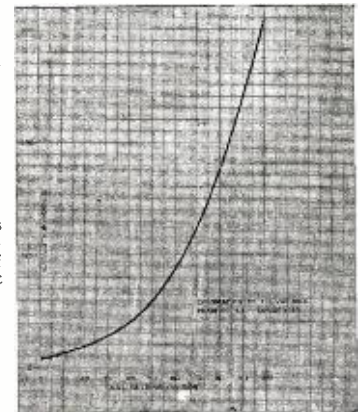

THOMPSON-LEVERING COMPANY—Radio Divison
353-357 NORTH 57th STREET PHILADELPHIA, PENNA.

Trade Mark Registered

1926 RADIO CATALOG & LOG BOOK

Get Our 1926 Beautiful Illustrated Catalog!

Which contains all latest STANDARD RADIO MERCHANDISE and up to date Log Book. It will pay you to buy from us. We carry one of the largest lines of Radio in the East. Don't miss the wonderful opportunity to participate in this Great Sale. Rush your request at once.

To cover the cost of mailing enclose 10c.

ECONOMY RADIO SALES COMPANY
288 6th Ave. Dept. F. New York
DEAL DIRECT AND SAVE REAL MONEY (No Dealers)

MURDOCK

You get perfect tone quality with **MURDOCK HEADPHONES**

Wm. J. Murdock Co.
Chelsea, Mass.

MURDOCK RADIO

Insure your copy reaching you each month. Subscribe to Radio News—\$2.50 a year. Experimenter Publishing Co., 53 Park Place, New York City.



\$2.75
C.O.D. **World**
Storage "B" Battery

12 Cells, 24 Volt units. Equipped with Solid Rubber Case, an insurance against acid and leakage. Extra heavy glass jars. Heavy rugged plates. Built with the same care and precision as the famous World Radio "A" Batteries.

Lasts Indefinitely— Pays for Itself

Economy and performance unheard of before! Recharged at a negligible cost. Delivers unflinching power that is clear, pure and quiet. Tube plate (B) voltage is best served by storage battery power. It is, above all, constant, unvarying, dependable and efficient. Radio tubes are far too critical to subject them to power less efficient than that coming from a good storage "B" battery. Your set demands the best!

Tested and Approved by Leading Authorities

The following qualified institutions of merit have tested and approved World Storage "B" Batteries: Radio News Laboratories, Popular Science Institute of Standards, Popular Radio Laboratories, Radio Broadcast Laboratories, Radio Age Laboratories, Lefax, Inc., and others equally important. You can depend on a tried and proven article when you decide on a World Storage "B" Battery. Thousands in use. Order yours today!

SEND NO MONEY

Just state number of batteries wanted and we will ship day order is received. Extra Offer: 4 batteries in series (96 volts), \$10.50. Pay expressman after examining batteries. 5 percent discount for cash with order. Save 50 percent—get a tried and proven battery of merit, by mailing your order in NOW!

WORLD BATTERY COMPANY
1219 So. Wabash Ave., Dept. 75 Chicago, Ill.
Makers of the Famous World Radio "A" Storage Battery
Prices: 6-volt, 100 Amp. \$11.85; 120 Amp. \$13.25; 140 Amp. \$14.60.
All equipped with Solid Rubber Cases.

World
STORAGE BATTERIES
Set your Radio Dial at 210
wavelengths for the new 1000
watt World Storage Battery
Station WIBC, Chicago.
Watch for announcements.
KDKA - WEAZ - WGN - WJS - KHJ - RGO - KFAT - WJY - KOP

NION FIXED-RIGID DETECTORS
\$1⁰⁰ — GUARANTEED —

Have built over 50 sets including 34 tube Grimes and used NION without a single failure. On straight Regenerative and R. F., I omit Grid Leak and connect 221-2 volts tap to crystal improving tone 100 per cent without affecting volume or distance. I have found no other so dependable. Sincerely, H. Peigh, 647 N. Lawndale, Chicago.

ATOMITE
TOP NOTCH
RECEPTION AT EVERY POINT GUARANTEED
50c At Your Dealers or by Post

KEYSTONE PRODUCTS CO.
304 Gardenia Ave., ROYAL OAK, MICH.

It is recommended that an antenna with a total length of one hundred feet, from its far end to the set itself, be used; and raised as high as possible, especially at the far end. It should be connected to the first antenna binding post on the set; if a longer antenna is used, the best results will probably be obtained by connecting it to the second antenna binding post on the set. After the set is in operation, the antenna should be tried on first one post and then the other; and then left on the post that gives the best results.

THE TUNING OF THE SET

The tuning of the Duodyne is similar to that of any five-tube Neutrodyne or tuned radio frequency set. Readings on the center and right-hand dials will be practically the same for any given station. The reading of the left-hand dial may be the same, or slightly above or below, depending upon the characteristics of the antenna and the position of the two-way switch on the lower left-hand corner of the panel. The position of this switch controls the relative selectivity and volume obtainable. When it is thrown to the right, the set will be more selective for cutting through the local stations, but will not have quite the volume on distant stations that it has when the switch is thrown to the left. On changing the position of this switch, the left-hand dial must be reset, to receive the same station. The position of any station will be slightly higher on the dial when the switch is thrown to the right.

By following the simple instructions set forth herein, anyone can build the Duodyne and be assured that results will be at least equal, and perhaps superior, to those obtainable from any five-tube tuned radio frequency set that might be purchased complete.

The Hidden Witness
(Continued from page 1262)

Mrs. Warren. I am sure what I saw was but a harmless flirtation—but I have come to warn you that there may be others who know your husband and will cause trouble. It is from the slander of these people I wish to protect you. As a friend of your husband, I claim this right when he is away.

MRS. WARREN: Thank you very much, Mr. Marshall, for telling me this—but the gentleman was someone I know before I was married—but he has been away for a long time—and I was—very—pleased—to—see him.

MR. MARSHALL: I am afraid you showed your pleasure in a very marked manner, in fact in such a manner that I am sure your husband would not approve.

MRS. WARREN: It was nothing at all, Mr. Marshall. Please don't say anything to Jack, because he will be very angry with me,—and I couldn't bear that.

MR. MARSHALL: I shall not think of telling him, but I have incurred a considerable expense in coming here to warn you, so I think it is only right that you should defray some of my expenses.

MRS. WARREN: Tell me how much it is and I will pay you now.

MR. MARSHALL: One thousand dollars.

MRS. WARREN (*horror-stricken*): One thousand!—but you must be joking, it can't have cost you that large amount!

MR. MARSHALL: Perhaps not, but it is going to cost you exactly that amount.

MRS. WARREN: I haven't anywhere near that amount in the house. If I had, I shouldn't dream of paying you such an exorbitant sum.

MR. MARSHALL: Mrs. Warren, this is a serious matter to me. If you are unable to pay me I have no other alternative but to apply to your husband for it. It is hardly necessary to point out that such an applica-

Adapto
RADIO CABINETS



Adapto Cabinets are constructed to accommodate every type of present day radio receivers. Loud Speaker horn built in—space for the accommodation of all batteries and equipment. Your choice, Mahogany or Walnut.
Write for illustrated circular showing various models and prices.

L. R. DONEHUE CO.
PERTH AMBOY, N. J.

To-day in every good set!

A turn of the Tuning Dial—that's all!

And presto! The AMPERITE self-adjusting rheostat control does the rest. Tones so clear, voices so distinct, volume so good, you simply are amazed. Tubes deliver as never before when under the seemingly magical influence of AMPERITE individual control. No guessing. Less wiring. Permits of any type or combination of tubes. Specified in all popular construction sets. Price, \$1.10.

There is an AMPERITE for every tube
Write for free hook-ups
Radiall Company
Dept. R. N.-3, 50 Franklin St., N. Y. City

AMPERITE
REG. U. S. PAT. OFF.
The "SELF-ADJUSTING" Rheostat

Insure your copy reaching you each month. Subscribe to RADIO NEWS — \$2.50 a year. EXPERIMENTER PUB. Co., 53 Park Pl, N. Y. City

tion would involve an explanation of how I incurred the expense.

MRS. WARREN: You mean—you will tell him?

MR. MARSHALL: Precisely my meaning, Mrs. Warren. I congratulate you on your perspicacity.

MRS. WARREN (*greatly agitated*): But that is blackmail.

MR. MARSHALL: I object to that term, consider it a payment for services rendered, but it can never be blackmail.

MRS. WARREN: I told you before I hadn't the money.

MR. MARSHALL: I see you are wearing some apparently valuable jewelry. You could sell that.

MRS. WARREN: I can't. Jack gave this to me, he would miss it directly if I sold it.

MR. MARSHALL: That has hardly anything to do with me, and as you will not take my advice there is nothing left for me but to inform your husband of your foolish escapade. Good morning, Mrs. Warren.

MRS. WARREN: Please wait a minute, don't go yet. I have some other jewelry which I can sell, if you will wait a day or two, and I will send you a check.

MR. MARSHALL: I am to old and experienced a man to be trapped with such a simple trick. However, I am willing to wait for the money. Today is Monday. If, by Thursday, I do not receive from you the sum of one thousand dollars—in small bills, please—I shall find it necessary to see Mr. Warren.

(*A door bell is heard ringing.*)

MRS. WARREN (*quickly*): That is my husband just returned. You won't say anything to him, will you, please?

MR. MARSHALL: Not if you promise to do as I desire.

(*Door opens.*)

MR. WARREN: Hello, May darling, pleased to have me back? (*A kiss.*) Oh, good evening, Mr. Marshall, I didn't notice you.

MRS. WARREN (*calmly, contrasting with her previous agitated manner*): Jack, Mr. Marshall came to see me to threaten that, if I didn't pay him one thousand dollars, he would tell you that he had seen me many times flirting with—my brother!

MR. MARSHALL: Eh? Mr. Warren. I assure you that Mrs. Warren is mistaken. Of course, I knew it was her brother, and I—er—jokingly remarked that if I had not been a friend of the family I might have put a wrong construction on the matter.

MR. WARREN: May, dear, did he try to blackmail you?

MRS. WARREN: Yes, Jack, he did. He is lying to you.

MR. MARSHALL: Mrs. Warren, I strongly object to you making such a statement about me. Mr. Warren, you know me better than to believe such a wicked untruth.

MR. WARREN: I would rather believe my wife. What explanation have you to make before I hand you over to the police?

MR. MARSHALL: If you charge me with blackmail, you will make a fool of yourself. In the law courts it will be my word against your wife's. I made sure when I entered the room that there was nobody to overhear our conversation.

MR. WARREN: So your conversation wouldn't bear overhearing? You made the same defense when Ross cornered you for the suicide of his brother.

MR. MARSHALL (*gasping*): Ah?

MR. WARREN: That hits you hard. You didn't know that the Ross brothers were very great friends of mine, in spite of their faults. Andrew and I knew that you blackmailed his brother till he went crazy, but we couldn't prove it. We swore then we would get you for it, and now we have got you—you rotten cad!

MR. MARSHALL (*again composed*): Mr. Warren, I am afraid you suffer from illusions; but, perhaps, your illusions take the form of witnesses to the conversation between your wife and myself.

A revolutionary step forward~



\$9.75

Complete, nothing else to buy.
Noiseless — no hum.
Delivers unlimited current to any receiving set, regardless of number of tubes.

FERBEND "B" ELIMINATOR

Now you can supply plate voltage to your Radio Set at a price scarcely higher than new "B" Batteries! Your electric light socket and the new *Ferbend "B" Eliminator* furnish the permanent means of efficient "B" current supply for any set. No need for you to pay more than \$9.75 or \$12.50 for a "B" battery eliminator for Ferbend guarantees theirs to be equal or superior to any on the market regardless of price. Our price was fixed with the interests of the radio buying public in mind. The result is efficient and permanent "B" current now placed

Delivers 100 volts to any set.
A. C. Model gives full Wave Rectification.
Cost of operation less than 50c a year.
Lasts indefinitely.
All parts are specially designed and manufactured by us for this purpose only.

FERBEND Wave Trap

This company also manufactures the famous Ferbend WAVE TRAP—the instrument which has been widely imitated but never equalled. It is the only original and genuine. See advertisement on page 1380.

Within Reach of All

The price of this remarkable new unit is spectacular in more ways than one. Besides saving you from \$15 to \$50 it is amazingly low considering the quality and superiority. Surely it marks a revolutionary step forward in radio. Equip your set NOW with this marvelous instrument, and be convinced.

Unconditionally Guaranteed
to be equal or superior to any eliminator on the market, regardless of price.



Ask your dealer, or send direct
Until nation-wide distribution is completed it is possible that your dealer hasn't stocked the *Ferbend "B" Battery Eliminator as yet*. So you will not have to wait, we will make shipment direct to you upon receipt of \$9.75, (A.C. Model, \$12.50) or C.O.D., if desired. Remember, superior results are guaranteed or your money back. Be one of the first to own and use the *Ferbend Maxim "B" Battery Eliminator. Use coupon NOW!*

FERBEND ELECTRIC CO.
425 W. Superior St. - Chicago, Illinois

FERBEND ELECTRIC CO.
425 West Superior St., Chicago

Send at once. I am enclosing \$9.75, \$12.50
 Send C. O. D. D. C. A. C.
 Send Literature.

Name.....
Address.....
City.....
State.....

RADIO - BARGAINS

FREE RADIO CATALOG & GUIDE of newest ideas, approved special hook-ups with illustrations. Tremendous savings on standard radio parts, sets, kits. Be sure to get this thrifty book before you buy. Wonderful! Unusual? You'll say so. Write letter or postal NOW. BARAWIK CO., 102-142 S. Canal St., CHICAGO, U.S.A.

Sylfan "RADIOMATES"
Receivers - Reproducers - Tubes
BAKER-SMITH CO., INC., San Francisco
Branches in Principal Cities

Authorized Cockaday Coil \$5.50
Precision Autodyne Coupler \$3.50

PRECISION COIL CO., Inc.
209 CENTRE ST. NEW YORK CITY
Specialists in the manufacture of all types of radio coils

LATEST WHOLESALE RADIO CATALOG

FREE Simply send name TODAY for big 64-page book explaining liberal proposition paying agents \$60 to \$100 a week, and how to get latest radio goods at wholesale. Live dealers and agents wanted.
Standard Radio Co., 1408 Walnut, Kansas City, Mo.

The New

RADIO NEWS

Sold on All Newsstands

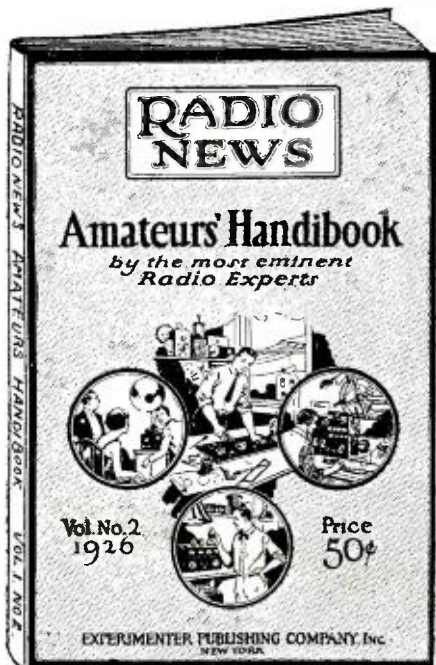

AMATEURS' HANDIBOOK
118 Hookups : Over 300 Illustrations

Any electrician will tell you that his Electrical Handbook is his most valuable reference—so also, the builder, the mason, the carpenter, all use a handy reference book no matter what the job may be. It is as important as the tools they use to work with. EVERY MAN SHOULD HAVE A RADIO HANDBOOK, the real, concise, yet comprehensive book on everything of reference value to anyone interested in radio whether he builds his own set or is engaged in professional radio activity.

All information for this book has been carefully culled from the pages of no less authority than Radio's Greatest Magazine, Radio News. Radio men in constant touch with all radio material have selected the most valuable articles.

The RADIO NEWS AMATEURS' HANDIBOOK contains a complete resume of every phase of radio. It is the first book of its kind, a veritable gold mine of radio information. Published in the large size 9 x 12 inches, contains 128 pages, illustrated.

New, Enlarged 2nd Edition
Size 9 by 12 inches

PRICE 50 CENTS THE COPY

Published and Distributed by

50c the Copy

The Experimenter Pub. Co., Inc.
53 Park Place, New York, N. Y.

1926 Will Be a Great Radio Year!

Save Money by Subscribing Now to RADIO NEWS

Everywhere in radio we find opportunities for development and improvement. 1926 will surely bring forth many novel devices for the standardizing and improvement of radio transmitting and receiving and perhaps many new devices for enlarging and broadening the sphere of radio to the people of the world.

RADIO NEWS is the medium that keeps thousands and thousands of radio fans in direct touch with what is going on every where in the industry. It is radio's greatest magazine written for every one who owns or uses a radio set whether he be a broadcast listener or professional radio engineer.

By subscribing to RADIO NEWS and using the coupon below a copy of RADIO NEWS will be mailed direct to your home for twelve months and you can save 50c over what you would have to pay if you bought your copy each month on the newsstand.

Fill out and mail this coupon today. Remember you can save 50c and have RADIO NEWS delivered to your home each month for twelve months, do not delay.

These 12 Departments are 12 Big Reasons Why More People Read RADIO NEWS Than Any Other Magazine

- | | |
|---------------------|-------------------------|
| General Articles | Radio News Laboratories |
| Radio Beginner | New Radio Patents |
| With the Amateurs | I Want to Know |
| Standard Hookups | Broadcast Stations |
| Radio Set Directory | Contests |
| International Radio | Readers Service |

Published and Distributed

by

Experimenter Pub. Co.
Inc.

53 Park Place, New York, N. Y.

USE THIS COUPON TO SAVE MONEY

Experimenter Pub. Co., Inc.,
53 Park Place, New York, N. Y.
Gentlemen:—Enclosed find \$2.50 for One Year's (12 months') Subscription to RADIO NEWS.

Name

Address

City, State

MR. WARREN: Well, would you call this an illusion?

(Up to the word "call," the speaker approaches the microphone. At the word "this," the noise of a curtain suspended from rings being drawn back is heard.)

MR. MARSHALL (alarmed): What's that?
MR. WARREN: That rather solid delusion is The Silent Witness—a microphone! The director of the radio station, WRNY, is also in the plot; he has supplied his listeners with ten minutes' entertainment and me with about a million witnesses! And, if it's necessary, I'll see that the lot are subpoenaed to get you convicted.

MR. MARSHALL (uneasy again): You are bluffing! What do you mean by WRNY? It means nothing to me! I am not interested in radio!

MR. WARREN: Well, for the last week, I have, unknown to you, been staying with Ross. After you had definitely made the appointment with my wife, I phoned to the radio station and the microphone was fixed behind the curtain there, ready for when you came. My wife, as you have discovered, was an excellent actress; and when I had heard enough on Ross's radio set, I came around—

MR. MARSHALL (greatly agitated): Switch the infernal thing off, and if you are a sportsman, give me a chance to get away! (The click of a lock is heard.) What are you locking the door for.

MR. WARREN: I'll switch the microphone off with pleasure, as I don't want any witnesses to what I'm going to do—er—say to you. After that, you can go to the devil. (Microphone is switched off.)
THE END.

A Regenerative Loop Receiver

(Continued from page 1298)

loop, which is set in the direction necessary to bring in a given station.

THE AUDIO FREQUENCY AMPLIFIER

The method of amplification used in this receiver is one that should give very excellent results, as there is one stage of transformer-coupled and one stage of push-pull amplification.



This illustration shows the dial for varying the condenser, and at the right the filament control jack.

In using push-pull amplification, it will be found that the unit operates more satisfactorily if there is used on the plates of the two tubes a higher voltage than is usual. In the illustrations there are shown only sufficient binding posts to supply 90 volts to the plates of all the amplifier tubes; but it would be an excellent thing for the constructor to add another binding post, in order to supply the two tubes of the push-pull amplifier with 120 volts. This could be placed at the extreme left side of the row of binding posts.

The tuning of this receiver is not at all difficult, as there are but two adjustments to make in bringing in a station. The condenser on the panel is set with the plates about half-way meshed; and then the larger of the two loops is slowly rotated until a station is heard. The condenser setting can be changed, if no station is picked up, until the familiar regenerative whistle is heard. Then the inside loop is turned until this whistle is eliminated, just as a tickler coil is used in the ordinary regenerative receiver. The large loop is then readjusted until maxi-

Kodel has Solved it! Perfect A and B power from your light socket!

No Hum - - - no distortion - - - all the power you want for any size set!

It took years to do it - - years of experiments, tests and trials. Now perfect A and B radio power from your light socket is an accomplished fact - - without hum or distortion - - without expensive replacements - - without acids or other harmful liquids - - constant uniform efficient reception on distant as well as local stations.

Kodel A-B Radio Power Units furnish 2, 4 or 6-volt filament current; 22½ to 150 volts to the plates - - more than enough power to supply any set. Operate 199, 201-A, and new power tubes. Kodel A-B Radio Power Units are

guaranteed to give you silent, efficient reception such as batteries were never capable of. You may purchase either Kodel-A-Power or Kodel-B-Power or both. Any good radio dealer can supply you.

Manufactured and guaranteed by
THE KODEL RADIO CORPORATION

501 East Pearl Street
Radio Receivers - Battery Chargers - Loud Speakers - Power Units
Cincinnati, Ohio

LIST PRICES (Tube Extra)

- *A' Power Unit \$40.00
- *B' Power Unit \$42.50
- *A-B' Power Unit \$82.50

Write for descriptive booklet—mailed Free



DEALERS: So certain are we that these new power units will amaze you by their performance that if you cannot secure them from your jobber, we will send one of each to you on ten days trial on receipt of nominal deposit. Write for details.

Kodel A & B Radio Power Units

RADIO TUBES

Repaired—Exchanged—Sold
\$1.25 Send broken or burned out tubes to us. We repair and return them good as new. \$1.25 each for common types. Or—we exchange one of your present tubes for another type, for your tube and \$1.25. All tubes scientifically evacuated to .000001 MM. Send no money. We ship C. O. D.

We Operate Our Own Laboratory
You are assured perfect tube performance with our repairs because we operate our own tube laboratory. Don't take chances. Send your tubes to us—one of the oldest high frequency laboratories in the country.
CHICAGO ELECTRIC DEVICES CO.,
70 E. 22nd Street, Dept. 33, Chicago, Ill
Established—1920

EVERYTHING IN RADIO
AT ATTRACTIVE PRICES
SETS OR PARTS
Mail order only
ALL RADIO COMPANY, 417 North Clark St., Chicago

RADIO CATALOG

Dealers! Send for new 1925-1926 Catalog. Contains nationally advertised high quality sets, kits and parts. Use your letterhead.
Western Radio Co. MFG.
134-136 W. Lake St. Chicago, Ill.

AMSCO PRODUCTS CO.
Broome & Lafayette Sts.,
New York, N. Y.
WRITE FOR OUR BOOKLET

CHELSEA

Super Five \$50.00

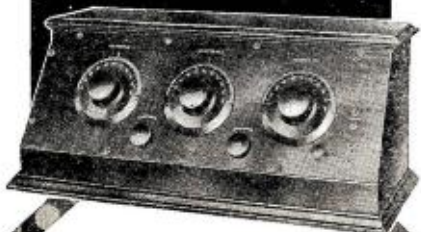

The Set You Can Afford to Own

THE new Chelsea offers the finest kind of service—consistently—regularly—without fuss or trouble.

Sweet, clear volume, and plenty of it, is obtained with but slight drain on the batteries and negligible wear on the tube filaments. Rugged bus-wiring, hand-soldered connections and a protective dust-proof, fool-proof inside panel are construction features insuring greater life and longer satisfaction. Fine mahogany piano-finish Cabinet with large over-size dials for positive selectivity which makes tuning a pleasure.

See this remarkable value at your dealer's or write for illustrated folders.

CHELSEA RADIO CO.
CHELSEA, MASS.

SEND FOR YOUR FREE COPY TESTED HOOK-UPS

Submitted By Users of Our

Wonderful transmitter Button for loud speakers. Amplification and experiments.

Price \$1.00 Postpaid with Instructions



K. Electric Co., 15 Park Row, New York

Immediate Shipment from Stock
HAVE MERCHANDISE WHEN YOU NEED IT
Catalog 466'S is free to dealers

WHOLESALE EXCLUSIVELY
LUDWIG HOMMEL & CO
929 PENN AVENUE PITTSBURGH, PA

mum signal strength is heard; which will perhaps necessitate a readjustment of the tickler loop.

This receiver, if built according to the specifications given above, should bring in local stations on the loud speaker with remarkable volume, and should give excellent DX reception on head-phones. UV- or UX-201A tubes can be used throughout; or, if it is desired, power tubes may be used in the stage of push-pull amplification. If more information is sought on the subject of amplifiers, there is a description covering all the different types in the November, 1925, issue of RADIO NEWS.

WRNY Broadcasts Christmas Greetings from Germany

(Continued from page 1370)

the needle working on the wax has a natural tendency to record some bands of tone frequencies more strongly than others. The microphone itself also shows the same inclination to a slight degree.

CORRECTING TENDENCY TO DISTORT

To correct these tendencies, which would otherwise manifest themselves as distortion in reproduction, the filter system is introduced, which causes the record to give a faithful copy of all sounds in their true proportion to one another; instead of greatly over-emphasizing a certain small band of frequencies, and leaving the very high and low notes out altogether, as is the case with the old acoustic recording methods.

A filter, correcting the frequencies, may be introduced also in the reproducing circuit to correct any faults introduced by the mechanism of the panatrope, or to reduce the slight "ground noise," or scratch, which is sometimes noticeable.

THE CHRISTMAS BROADCAST PROGRAM

The first speaker on the international program, broadcast by WRNY on Christmas afternoon, was Dr. Gustav Stresemann, Minister of Foreign Affairs of the German Republic.

"Since the world war, which plunged the European nations into misfortune came to an end, the efforts to repair the damage wrought have found firm support from the American people," said Dr. Stresemann. "We owe, therefore, to them our sincere gratitude. It is the strong and sound American nation which is suited, as hardly any other in the world, to build a firm foundation for future world-political development. May the American citizens regard it as their great task to be strong and wise furtherers of humanitarian ideals! We know how firmly these are implanted in the land of Washington. Therefore, we in Germany are ever interested in the cultural development of the United States; and the feeling of a common bond, which the ocean cannot sever, fills us in this hour.

"In contrast to America, young and strong, stands Europe, weary with civilization, and bleeding from a thousand wounds. Reconstruction can only take place through the co-operation of the nations, not in strife. Therefore the German people took the initiative which led to the treaties of Locarno; and we hope that these treaties may be the basis of a new era, in which the peoples of the world will understand one another, and in which national striving and development will serve humanity as a whole. We are convinced that our call for co-operation in the furtherance of peace will nowhere find a louder echo than in the United States. When we thus extend our hands to each other for a common effort, then, with God's help, will the coming year and coming developments bring a new day."

Dr. Stresemann's speech, like those which

Three "E" Straight Line Rheostat

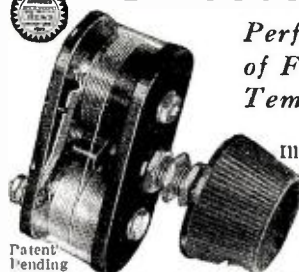

Perfect Control of Filament Temperature

6-15-30 Ohms
Illustration 1/2 Size

Master Engineering Precision and Skill now offer you the utmost in Rheostats.

Patent Pending

Designed and produced by one of the largest manufacturers of electrical power equipment. Used by those who demand the best results. Perfect Reception depends on a fine, smooth, dependable variation of filament temperature in the detector tube. For there is only one temperature at which efficient reception is obtained and this point is very critical.

The THREE "E" STRAIGHT LINE RHOESTAT finds this critical point as no other can. It gives straight line variation, runs smoothly, is absolutely NOISELESS and once set "stays put!" By all means secure this precision instrument at once. Ask your Dealer or order direct, giving us his name.

Price \$2.50—Postpaid

ELECTRICAL ENGINEERS EQUIPMENT CO.

Radio Division
708 W Madison St., Dept. 6,
Chicago, Ill.
Circulars on Request



The Aristocrat of Rheostats

Trade CHICAGO U.S.A. mark



The Traffic Cop of the Air

Add a Ferbend Wave Trap to your Radio Set and "Police" your reception. Regulate traffic! Guaranteed to tune out interfering station. Widely imitated, but never equalled. Not a "toy"—quality, material, workmanship equal to that of the finest receiving sets.

The original and only successful WAVE TRAP. Now in its fourth year. Sent postpaid upon receipt of \$8.50 or C.O.D. plus postage. Send for Free Booklet.

Ferbend Electric Co.
425 W. Superior St., Chicago.
See the new Ferbend "B" Eliminator announcement on page 1377.

U.S. Post Office, Billings, Mont.

Ferbend Electric Co. Gentlemen:

With my Fada Nautrotyne and Ferbend Wave Trap I received the address of Fred Coolidge from WOA/W Omaha, on a special wave length. Many fans tried to get it but failed. Also the base-ball World Series from WOA/W and K.M.A. Shenandoah, Iowa. Had W.E.A.P. New York, loud enough to carry across the street. Will put my Set and Wave Trap up against any in the city regardless of price.

(Signed)
J. A. Thompson,
Supt. of Mails.



FREE BLUEPRINTS

To Set Builders TO PROVE THE SELECTIVE AND SENSITIVE COMBINATIONS OBTAINABLE WITH

WERNER R.F. TRANSFORMERS

which cover the entire broadcasting wave range and have been used by the best radio engineers for the past two years. We will furnish a full size Blueprint of a selective 6 Tube Radio Loop receiver FREE if you order from us direct.

Werner R. F. and Audio Transformers are fully guaranteed and are tested on actual broadcast reproduction; also guaranteed damp and moisture proof and will give perfect reception in all climates.

RADIO FREQUENCY\$4.00

AUDIO FREQUENCY\$6.00

Both types for any standard vacuum tube

Werner Loop Antenna

Used with any type of loop receiver. Adjustable to a fine degree of clearness, can be folded or extended without tools. Approved by Popular Radio. Price Postpaid \$14. Send for free circuit diagram and descriptive literature.

Book containing nine up-to-date practical R. F. circuit diagrams and treatise on R. F. Amplification. Postpaid 25c.

Ask your Dealer for Werner Products.

WERNER RADIO MFG. CO.
204-206 Ninth St., Brooklyn, N. Y.

followed, was delivered in German, and translated to the listeners by the announcer of WRNY.

The solo, "Holy Night, Stilly Night," which followed, was sung by Cläre Dux, the famous soprano of the Berlin State Opera.

Dr. Hans Bredow, who, as State Secretary, exercises a supervision over German radio like that of Secretary Hoover in America, and for his enlightened efforts toward its upbuilding has been called "The Father of German Broadcasting," declared that the greatest significance of radio is its international aspect.

RADIO THE GREATEST EDUCATOR

"The primeval combat against the restrictions of time and space has entered a new stage," said Dr. Bredow. "Although crossing the ocean involved weeks of journey but a few decades ago, yet we have experienced the stupendous fact that the ocean was crossed in seventy hours by the Zeppelin. A far greater advance, however, has occurred in the distribution of news; it has become possible to broadcast over the entire world in the fraction of a second.

"This development has enabled us to consider the whole world as one vast auditorium, regardless of whether we are neighbors or antipodes. And the ethical idea of radio is crowned by the motto of its noble aim: 'Create new paths for human understanding.'

"Radio has been welcomed in Germany in a period of deepest social and economical distress, as a liberating marvel; and is considered here a cultural factor whose influence on the life of the people is beyond comprehension. For the first time since the discovery of printing by the German, Gutenberg, a new possibility has been created of the simultaneous transmission to countless numbers of intellectual wealth; and it is comprehensible that the spiritually-starving masses of humanity should storm their way to radio. Its mission is to awaken the good in people and satisfy their yearning for intellectual development. Every country becomes a great lecture room, through the radio, in which everyone—poor, rich, young or old—may find that which brings pleasure and profit.

A GUARANTOR OF WORLD PEACE

"But beyond the borders of countries radio will have importance. It will unite the nationalities into one great community, and through daily mutual experiences convey the conviction that they are all members of one great spiritual association. So can radio in the future contribute to the mutual understanding of nations, and perhaps serve the peace which humanity seeks. In this spirit the German radio friends extend heartiest Christmas greetings to all Americans."

The musical numbers following, "O Come All Ye Faithful," and a Christmas carol, were sung by Cornelis Bronsgeest, leading tenor of the Berlin opera, and impresario of the opera broadcasts of the Berlin stations.

Dr. Paul Loebe, president of the German Reichstag, who completed but recently a visit to the United States, spoke briefly in admiration of American energy and co-operation, and Dr. Hugo Eckener, who piloted the ZR-3, now the Los Angeles, across the Atlantic, referred to the warmth of the welcome he had then received, and expressed the hope that modern science will create a solidarity among the civilized nations stronger than nationalistic misunderstandings.

A duet by Miss Dux and Mr. Bronsgeest, "O Tannenbaum," (from whose simple air at least two of our states have taken their anthems) and selections of instrumental music ended the international program. At its close a brief explanation of the novel reproduction methods employed was given to the radio audience by Hugo Gernsback, editor of RADIO NEWS.

RADIO — BARGAINS

For Radio News Readers Barawik's 1926 Radio Guide

Any real radio bug will find Barawik's Radio Guide a gold-mine of information, for it presents, in concise form, the famous radio circuits you have read about. Besides, it illustrates and describes thousands of sets, kits, accessories and parts that are needed by every set builder, fan, novice or beginner. As a catalog and guide it is invaluable and it shows you how you can save huge sums in the very things you need, or it helps you to decide what set will best meet your needs and your pocket-book.

Shows Radio's Newest Creations

It shows the newest straightline condensers, low-loss coils, vernier dials, tubes, cone speakers, A and B current supply, batteries and everything from a crystal to the expensive complete console receiver—and one, two, three, five and eight tube sets—at startlingly low prices. Whether you just want supplies for your present set or desire a new set, here you can secure them at a guaranteed saving.

Get this Catalog Before You Spend Another Penny for Radio Supplies

Fill in the coupon now for your free copy or drop us a postal or letter. Do this before you spend another cent for anything in radio—now, while this announcement is before you. You'll be well repaid. Also please include name of radio fan or fans who would be interested.

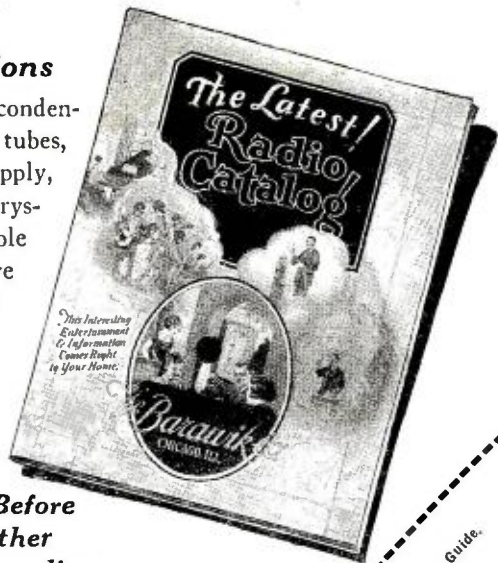

The Barawik Co.

102-142 So. Canal St., Chicago, U. S. A.

Send me my copy of your new Radio Catalog and Builder's Guide.

Name _____ Address _____ Friend _____ Address _____ Friend _____ Address _____

BARAWIK CO., 102-142 So. Canal St., Chicago, Ill.



CARTER New "IMP" Loop

Again Carter leads with a loop that is compact, sturdy, yet highly efficient. No possibility of loose wires breaking. Weighs one pound, diameter 16 inches. Taps provided for all loop circuits.

In Canada, Carter Radio Co., Limited—Toronto



See one at your dealers.
Write for illustrated folder.

Insure your copy reaching you each month. Subscribe to Radio News—
\$2.50 a year. Experimenter Publishing Co., 53 Park Place, N. Y. C.

OPPORTUNITY AD-LETS

Follow these advertisements every month. Reliable advertisers from all over the country offer their most attractive specials in these columns.

Classified advertising rate twenty-two cents a word for each insertion. Ten per cent discount for 6 issues, 20 per cent discount for 12 issues. Name and address must be included at the above rate. Cash should accompany all classified advertisements unless placed by an accredited advertising agency. No advertisement for less than 10 words accepted.

Objectionable or misleading advertisements not accepted. Advertisements for the May issue must reach us not later than March 1st.

CIRCULATION LARGER THAN THAT OF ANY OTHER RADIO PUBLICATION

EXPERIMENTER PUBLISHING CO., INC., 53 Park Place, New York, N. Y.

Agents Wanted

Big Money and fast sales. Every owner buys gold initials for his auto. You charge \$1.50; make \$1.25. Ten orders daily easy. Write for particulars and free samples. American Monogram Co., Dept. 133, East Orange, N. J.

Guaranteed Genuine Gold Leaf Letters anyone can put on store windows. Large profits. enormous demand. Free samples. Metallic Letter Co., 422 N. Clark, Chicago.

Bankrupt and Rummage Sales. Make \$50.00 daily. We start you, furnishing everything. Distributors, Dept. 213, 609 Division, Chicago.

Best seller—Jem Rubber Repair for tires and tubes; supersedes vulcanization at a saving of over 800 per cent.; put it on cold, it vulcanizes itself in two minutes and is guaranteed to last the life of the tire or tube; sets to every auto owner and accessory dealer. For particulars how to make big money and free sample, address Amazon Rubber Co., 204 Amazon Building, Philadelphia, Pa.

AGENTS: \$11.80 daily in advance (Send for sworn proof) Introducing New Insured Hosiery. 57 styles, 40 colors, guaranteed seven months. No capital or experience required. You simply take orders. We deliver and collect, (or you can deliver, suit yourself). Credit given. **PAY YOU DAILY**, monthly bonus besides. Spring line now ready. We furnish samples. Spare time will do. Macochee Textile Company, Card 4743, Cincinnati, Ohio.

District representatives. Marvelous opportunity selling Radiolette system of servicing batteries to battery stations, garages, auto and radio owners. Wonderful discovery. Free sample. Exclusive territory going rapidly. International Radiolette Co., St. Paul, Minn.

Agents—90c an hour to advertise and distribute samples to consumer. Write quick for territory and particulars. American Products Co., 5799 American Bldg., Cincinnati, Ohio.

Aviation

Boys—Get a three-foot model airplane free. Write to Aero Shop, 3050 Hurbit Ave., Detroit, Mich.

Business Opportunities

Free Book. Start little Mail Order Business. Pier, 990 Cortland Street, N. Y.

Responsible manufacturer wants competent men to manage office and salesmen. \$300 to \$1500 necessary; will allow expenses to Trenton if you qualify. Address Manager, 536 Forst Bldg., Trenton, N. J.

\$50 a week. Mail Order business. Booklet tells how. Sample and plan 25c. Outfit furnished you free. Bradford Co., Dept. E, Shawnee, Okla.

Electricity—Short day or evening courses in Electricity, Drafting, Engineering, and Architecture. In Chicago earn while you learn. Part Time positions pay expenses. Faculty of experts. Special short courses. Diplomas in 2 years. B. S. Degree in 5 years. Small classes, individual instruction. 23 year old institution with thousands of successful graduates. Enter any time. Employment bureau. Moderate tuition—monthly payments. New College building—all athletics. All details in 72 page "Blue Book." A copy will be sent to you free. Write today. Chicago Technical College, Dept. 27, 118 E. 26th St., Chicago, Ill.

Wanted—Building-Draftsman. Train at home, in spare time, to be a Building-Draftsman. Big demand means big salaries and steady work. Get into Building America's \$7,000,000,000 industry. Keep right on with your present work. We train you by mail. Free Trial Lesson and Blue Print plans to show you how easily and quickly you can learn. Get into the \$3,000 to \$10,000 salary class. Write for Free Lesson, Blue Prints and catalog. All free, no obligation. Chicago Technical College, Dept. 1685, 118 E. 26th St., Chicago, Ill.

Become a Builder. The World's Big Pay Field—Building. Be an estimator, superintendent, or spare a contracting business of your own. Train at home, in spare time, to earn \$5,000 to \$20,000 a year, or more. No matter what your job is now—there's a big opportunity for you. A virgin field with no overcrowding. Free book, "How to Read Blue Prints," actual Blue Print Plans and Catalog sent free. See how quickly and easily you will learn this fascinating big-pay profession. If you are earning less than \$75 a week, write us now. Send for free books and Blue Print Plans today! Chicago Technical School for Builders, Dept. 2773, 118 E. 26th St., Chicago, Ill.

To Sell the Radio Fone Lamp Loud Speaker. Latest radio reception reproducer. Write for sample outfit. Radio Film Supply, 1020 Forbest Street, Pittsburgh, Pa.

Sell Five Tube Radio Sets. Thirty days' free trial. Three sales weekly pays \$90 profit. Experience unnecessary. Direct Radio, 197-C 14th St., Milwaukee, Wis.

Chemistry

Learn Chemistry at Home. Dr. T. O'Connor Sloane, noted educator and scientific authority, will teach you. Our home study correspondence course fits you to take a position as chemist. See our full page ad on page 1351 of this issue. Chemical Institute of New York, 66 W. Broadway, New York City.

Educational

Used Correspondence School courses save over half. Bargain Catalogue 1000 courses free. Used courses bought. Students' Exchange, Dept. A, 47 West 42d St., New York.

Exchange

200-20,000 meter Receiver Radiotron \$25.00. Smith, 4416 Market, Philadelphia.

Help Wanted

Detectives Needed Everywhere. Travel. Experience unnecessary. Write, George Wagner, former Government Detective, 1968 Broadway, N. Y.

Qualify for \$150-\$300 railroad jobs. Fireman, Brakeman, Baggageman, Sleeping Car or Train Porter. 237 Railway Bureau, East St. Louis, Ill.

Steamship Positions—Europe, Orient; good pay; experience unnecessary, men, send self-addressed envelope for list, Box 30-A, Mount Vernon, N. Y.

Incorporations

Delaware Incorporator, Charters; Fees Small; forms. Chas. G. Guyer, 901 Orange St., Wilmington, Del.

Insects Wanted

Why not spend Spring, Summer and Fall gathering butterflies, insects? I buy hundreds of kinds for collections. Some worth \$1 to \$7 each. Simple outdoor work with my instructions, pictures, price-list. Send 10 cents (not stamps) for my illustrated Prospectus before sending butterflies. Mr. Sinclair, Dealer in Insects, Dept. 40, Box 1124 San Diego, Calif.

Instruction

Learn Chemistry at Home. Dr. T. O'Connor Sloane noted educator and scientific authority, will teach you. Our home study correspondence course fits you to take a position as chemist. See our full page ad on page 1351 of this issue. Chemical Institute of New York, 66 W. Broadway, New York City.

Miscellaneous

Skinderviken Transmitter Button. Free tested hook-ups. Loud Speakers. Experiments. K Electric Co., 2 Rector Street, New York City.

Every Autoist will buy Auto Mitten Dusters. 200 per cent Profit. Free Sample offer. National Fibre Droom Co., St. Louis, Mo.

Lightning Electrolyte. Charges storage batteries instantly. Gallon costs 50c, sells \$10.00. Make it yourself. Guaranteed formula \$5.00. Write for free circulars. Murphy, Chemist, Tulunga, Calif. Box-D.

Homeopathic and Brochemic preparations sent postpaid to all parts of the world. Manual and booklets free. Halsey Bros. Co., 643 St. Clair St., Chicago, Ill. Established 1855.

Motion Pictures

Films for Toy Machines. Hart—Mix-Chaplin. Complete stories 1000 feet \$3.50. Special 200 foot lengths \$1.50 postpaid. Big Boys list Free. Monarch Films, Department 3, Memphis, Tenn.

Motorcycles, Bicycles

Don't Buy a Bicycle Motor Attachment until you get our catalog and prices. Shaw Mfg. Co., Dept. 6, Galesburg, Kansas.

Musical

Play Piano by Ear. A Sound System. Write for Free booklet. You'll be glad you did! Boucher's Harmony Studio, 127 Metcalfe St., Ottawa, Can.

Old Coins

German Gov't Bond 5,000,000 Mk. 1924, \$1.50. 2,000,000 Mk Bond 1923, \$5.00. 500,000 Mk, Bill and Catalogue, 10c. Norman Shultz, Colorado Springs, Colo.

Old Money Wanted

\$2 to \$500 each paid for hundreds of Old or Odd Coins. Keep all old money, it may be very valuable. Send 10c for New Illustrated Coin Value Book, 428. Guaranteed Prices. Get posted. We pay Cash. Clarke Coin Company, 14 Street, LeRoy, N. Y.

Patent Attorneys

Inventors—Should write for our Free Guide Books and "Recad of Invention Blank" before disclosing inventions. Send model or sketch of your invention for our Free Inspection and Instructions. Radio, Electrical, Chemical, Mechanical and Trademark experts. Terms reasonable. Victor J. Evans & Co., 922 Ninth, Washington, D. C.

Patents. Send drawing or model for examination and report as to patentability. Advice and booklet free. Highest references. Best results. Promptness assured. Watson E. Coleman, Patent Lawyer, 644 G Street, N. W., Washington, D. C.

Patents—My fee in installments. Free personal advice. Frank T. Fuller, Washington, D. C.

Patents—Send for form "Evidence of Conception" to be signed and witnessed. Form, fee schedule, information free. Lancaster and Allwine, Registered Patent Attorneys in United States and Canada, 269 Ouray Bldg., Washington, D. C.

Inventors—who derive largest profits know and heed certain simple but vital facts before applying for patents. Our book "Patent-Sense gives those facts; free. Write Lacey & Lacey, 631 F St., Washington, D. C. Established 1869.

Patents

Inventions Commercialized. Patented or unpatented. Write Adam Fisher Mfg. Co., 278 Enright, St. Louis, Mo.

Personal

Lonesome—Join our club—make acquaintances everywhere. Big illustrated book with descriptions and photos, sent in plain wrapper for ten cents. Bonafide Co., Dept. 58, Kansas City, Mo.

Free to Radio Fans. For Rupture. The system embodied in Stuart's Plapapads has been successfully used by thousands since 1906, in the privacy of the homes, without hindrance from work, and at slight expense. Entirely different from Truss. No Straps, Buckles or Springs attached. Write for Free Test Plapapad. No charge now or ever. Address Plapapad Laboratories, 3713 Stuart Bldg., St. Louis, Mo.

BRANT
POWER

**Unfailing "B" Power
GUARANTEED
TWO YEARS**

Stops all worry about "B" Battery supply. Makes your set work better and more powerful—100 Volts and more. Clean, compact unit.

WRITE TODAY FOR OUR BIG CIRCULAR "R"

BRANT BATTERY CO.
1622 W. 16th St., Los Angeles, Cal.

**BIG CATALOG FREE
DISCOUNTS
TO RADIO DEALERS**

A lifetime opportunity is open for you as a radio dealer. Radio promises its biggest record-breaking season. Make the most of it by getting our new big catalog before you buy. Huge stocks of standard radio parts, sets, kits ready for quick shipment at lowest rock-bottom wholesale prices. Wonderful special offers on finest sets, tubes, batteries. Write for free copy NOW.

W. C. BRAUN COMPANY 34-35 S. Clinton St., Chicago, U. S. A.

**100
RADIO
HOOKUPS**

for 50c

A Practical, valuable Radio Book, selling by the thousands, used by beginners and amateurs alike.

Mailed Postpaid on receipt of 50 cents

THE CONSRAD COMPANY
64 Church St., New York, N. Y.

Printing Outfits and Supplies

Print your own cards, stationery, circulars, paper, etc. Complete outfits \$8.85; Job Presses \$12, \$35; Rotary \$150. Print for others, big profit. All easy, rules sent. Write for catalog presses, type, paper, etc. Press Company, A-1, Meriden, Conn.

Radio

Boys! Don't Overlook This. The "Rasco" Baby Detector. Greatest detector ever brought out with molded base. Fully adjustable. See former advertisements in this publication, or our catalog. Detector with Galena Crystal, complete 50c, the same detector with Radioite Crystal, 75c pre-paid. Send for yours today. Radio Specialty Company, 96-98 Park Place, New York City.

Attention!—50 Vacuum tube hook-ups. The greatest collection of vacuum tube circuits ever brought under two covers at such insignificant cost. These diagrams will be found in the great "Rasco" catalog, which contains raw materials and parts in a greater profusion than any other catalog. 1c in stamps, or coin, will bring the catalog to you. Radio Specialty Co., 96-98 Park Place, New York City.

Make Your "B" with Edison Elements. They last a lifetime. Pair 5 cents; welded, 7½ cents postpaid. Henry Chapelle, Woodburn, Ore.

Slightly Used Microphones \$1. 250 watt, 550 cycle motor-generators one unit motor 110 volts D.C. \$25. R.C.A 150 watt filament transformers \$4, UP1018 750 watt plate transformers \$12. TL1003 Oscillation \$5. Others, R. Wood, 38 Way Ave., Corona, New York.

Transmitting Sets & Tuners at your Savings. 20-600 Meters. Stamp for information. S. Strobel & Co., 3925 N. 6th St., Philadelphia, Pa.

Wonderful new grid-leak, adjustable from ½ megohm to 5 megohms, price 25c. Also adjustable resistances for resistance coupled amplifier, fits any condenser, no mounting needed, noiseless and moisture proof. 3 stages, per stage 75c, pre-paid, no condensers included. Also special resistances down to 1000 ohms 50c each. Spencer Mfg. Co., Aurora, Neb.

Assemble a Lifetime "B" Battery from my better Edison elements. With welded connections 7c pair. Sample cell from my complete battery 10c. Paul Mills, Woodburn, Ore.

Ivory Radio Panel. Grained white Ivorylite makes most beautiful set of all. Any size 3c sq. inch, 3/16 in. thick. Beautiful Ivorylite dials inlaid gold numerals \$1.35 ea. Knobs, 53c ea. Shipped anywhere prepaid or C.O.D. Write for free sample. Ivorylite Radio Panel Co., 3222 Avenue F, Dept. N, Fort Worth, Texas.

Build Famous BT Counterphase Six. Complete B. T. Kit including engraved Panel and Mahogany Cabinet \$65. Completely constructed sets \$90. J. Benson, Orchard Park, N.Y.

Atwater Kent Model 26 receiver, speaker, like new. Crasley Super Triodyne Unipower "B" Bulbrite "B" bargains. Write G. Simmons, Lake, New York.

Complete minus wiring Cockaday LC-26—\$75. West Pawlet, Vermont, Box 182.

Salesmen Wanted

A Salesman wanted in every town or city within 25 miles of a broadcasting station to sell Radiogen, the complete radio receiving set that retails for \$2.50. With Radiogen there is nothing else to buy—the outfit includes the Radiogen receiving apparatus, 1,000 ohm phone, and aerial outfit. The cheapest radio outfit on the market—yet as practical as the most expensive. Big money to the right men. Send \$2.00 for sample outfit. The Radiogen Corp., 86-R West Broadway, New York City.

Sell Five Tube Radio Sets. Thirty days free trial. Three sales weekly pays \$90.00 profit. Experience unnecessary. Direct Radio, 197C Fourteenth St., Milwaukee, Wis.

Scenery to Rent

Settings for Opera, Plays, Minstrels. Plush Drops. Address Anella Grain, Philadelphia.

Song Writers

Songwriters: Let me furnish the music for your songs, guaranteeing you absolute satisfaction. Copyrights secured. Submit your scripts for estimate and free advice. Walter W. Newcomer, 1674 Broadway, New York.

Stammering

Stop Stammering. All speech defects successfully corrected. Samuel Robbins, 399 Boylston St., Boston.

Telegraphy

Telegraphy—Both Morse and Wireless taught thoroughly. Big salaries. Wonderful opportunities. Expenses low; chance to earn part. School established fifty years. Catalog free. Dodge's Institute, Cour St., Valparaiso, Ind.

Wanted to Buy

Full Value Paid for Old Gold, Jewelry, Watches, Diamonds, crowns, bridges, dental gold, silver, platinum, gold or silver ore; magneto points, old false teeth. Packages returned if our offer is not satisfactory. United States Smelting Works (The Old Reliable) 39 So. State St., Dept. 18, Chicago, Ill.

How to Make Your Own

SPEECH AMPLIFIER

MICROPHONE Transmitter Buttons have been used for a number of years to make powerful sound transmitting elements. These very sensitive amplifiers offer every "Radio Fan" the means of building his own powerful speech amplifier. We offer herewith to the constructor these special Amplifier Units.

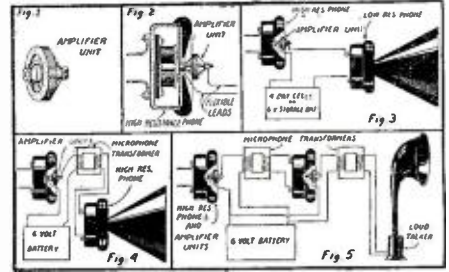

Fig. 1 shows the amplifier unit.

Fig. 2, shows how the unit is attached to a telephone receiver. The first procedure is to mount the unit on the diaphragm of a telephone receiver, which usually is a high resistance telephone, either 1,000 or 1,500 ohms.

Next we select the loud speaking telephone. If a low resistance telephone is available, it should have for maximum efficiency an impedance equal to the resistance of the amplifier unit, or about 10 ohms; it is connected up as shown in Figure 3. A 5 ohm telephone receiver is used in this circuit with a 6-volt storage battery.

Two telephones taken from a good double headset of 2,000 to 3,000 ohms which do not rattle on strong currents, are employed in Fig. 4, one at the receiving end, the other as loud talker. In this hook-up there is one instrument which must absolutely be used with this combination, the transformer. As stated before in connection with Fig. 3, the impedance of the telephone, if used in direct connection, should equal the resistance of the unit. But as the impedance of the telephone in Fig. 4 is much higher than the resistance of the unit, it may be 200 times as great, a transformer having a step-up ratio is used to match up the resistance of the unit with the impedance of the loud speaking telephone. In other words, the primary coil of the transformer should have an impedance (which is sometimes called "A. C. resistance") equal to the resistance of the unit, or about 10 ohms, and the secondary coil should have an impedance equal to the impedance of the high resistance telephone. This transformer may be purchased in any Radio Store and is called a microphone transformer or modulation transformer, designed primarily to use in radio transmitting sets. A 6-volt battery gives the best results. The current passing through the unit will vary from .1 to .25 ampere.

Fig. 5 shows a circuit for further increasing the volume of sound. This is simply two of the circuits, such as shown in Fig. 4, linked together. This arrangement is highly sensitive and the telephones on which the units are mounted should be packed in a box of cotton, as the slightest vibration or sound in the room will be picked up and heard in the loud talker. Any sensitive radio loud talker may be used in this particular circuit.

THESE and innumerable other interesting experiments are possible with these amplifiers. Every amateur should have at least one or two in his "Lab" or workshop. A four-page instruction pamphlet is sent with every unit.

SPECIALLY PRICED **85c** Per Unit
While they last
OR TWO FOR \$1.50

PRESS GUILD,
66-R W. Broadway, New York City, N. Y.

Enclosed find 85c—\$1.50 for which send me postpaid one—two amplifier units as advertised.

Name

Address

Town..... State.....

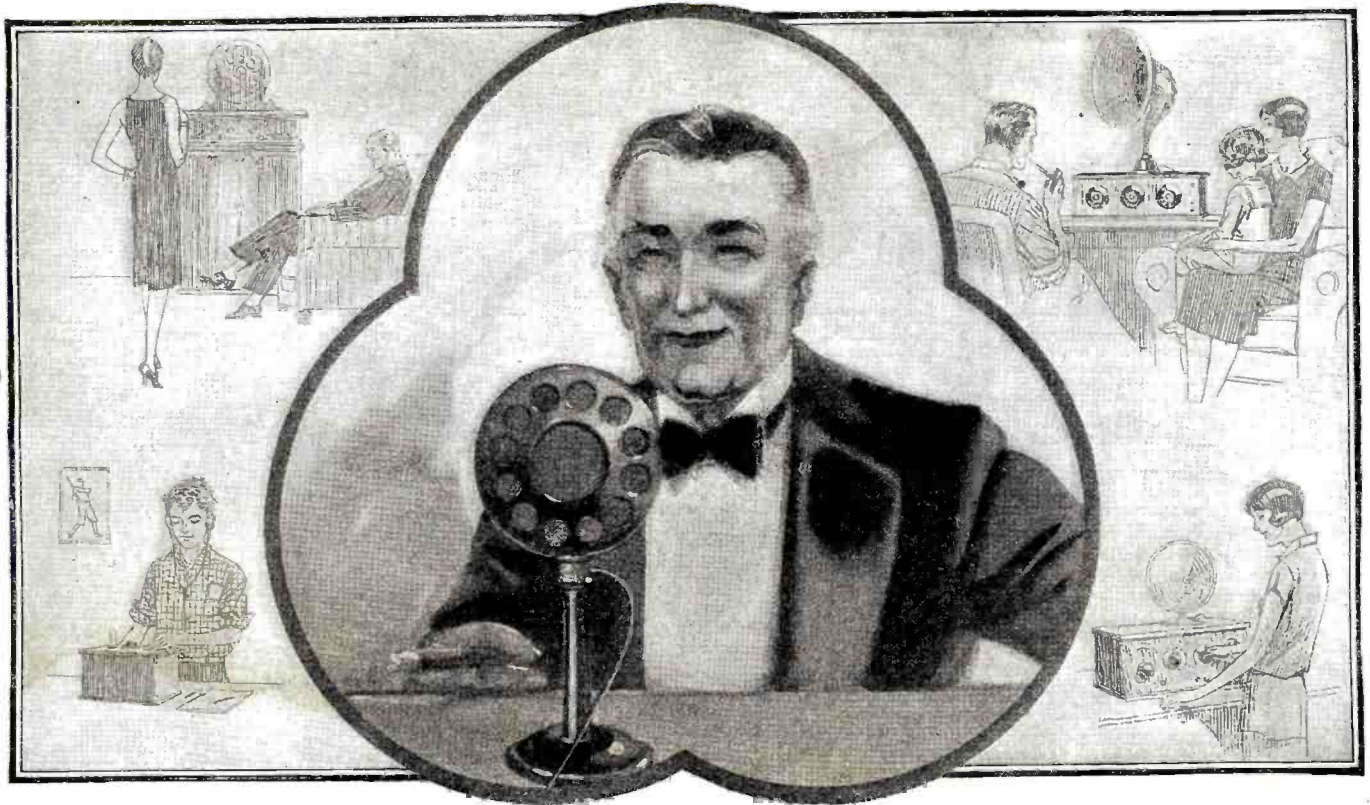

Great names become real folks

The President, the Secretary of Commerce, and scores of leaders in politics, science and industry are no longer mere "names". Through radio they speak direct to you. The very tones of their voices are known to millions.

In bringing Radio broadcast reception within the reach of everyone, Bakelite has had a major part. You will find it in receiving sets, speakers and accessories, for it improves both appearance and performance.

Bakelite is the most widely used material for panels, dials, knobs, tube bases and sockets, rheostats,

variable and fixed condensers and other parts requiring lasting insulation.

In speakers Bakelite is used for magnet spools, housings and diaphragms, as it is unaffected by temperature and atmospheric changes. Because of its resonance it is also used for speaker "bells" and "cones".

It is a fact that over 95% of radio set and parts manufacturers use Bakelite, for they know that its electrical properties, as well as its beauty of color and finish are permanent, unimpaired by time or service.



Shaw Insulator Co. Tube Socket



Daven Radio Corp. Resisto Coupler



Micamold Radio Corp. Grid Condenser and Leak



Carter Radio Co. Flat Plug

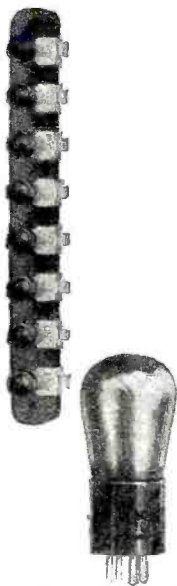

Conwey Electric Laboratories, Bakelite Base and Shaw Insulator Co. Binding Posts and mounting

Write for Booklet 24, a helpful guide when buying a radio set or parts.

BAKELITE CORPORATION
247 Park Avenue, New York, N. Y.
Chicago Office: 636 West 22d Street

BAKELITE

REGISTERED

U. S. PAT. OFF.



THE MATERIAL OF A THOUSAND USES

"The registered Trade Mark and Symbol shown above may be used only on products made from materials manufactured by Bakelite Corporation. Under the capital "B" is the numerical sign for infinity, or unlimited quantity. It symbolizes the infinite number of present and future uses of Bakelite Corporation's products."

PRINTED BY GILES PRINTING CO., LONG ISLAND CITY

The New

S.L.F. Bradleydenser

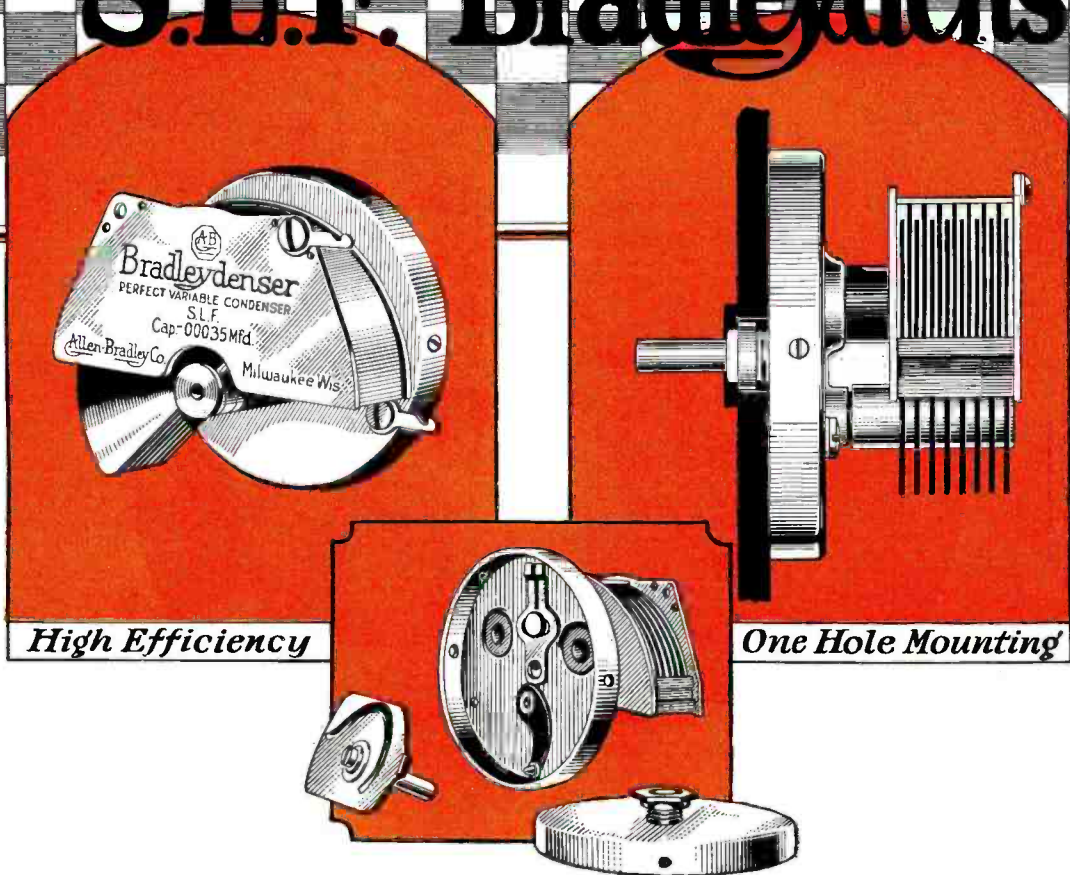

High Efficiency

One Hole Mounting

A Compact Straight-Line-Frequency Condenser

THE new S. L. F. Bradleydenser is the outcome of long, careful research in condenser design. It provides straight-line-frequency tuning over the entire circumference of a 360-degree dial. Stations are widely and evenly spaced over twice the dial-spacing of ordinary condensers. This unique control is obtained by using a special cam on the condenser shaft which provides the straight-line-frequency tuning now demanded by all set builders. The efficiency of the condenser is extremely high, due to the unique construction that practically eliminates insulating material in the condenser.

ANOTHER outstanding feature of the new S. L. F. Bradleydenser is the compact design which eliminates entirely the long eccentric rotor plates, ordinarily used with straight-line-frequency condensers. The Bradleydenser can be substituted for any condenser in a set without interfering with other parts on the panel. The one-hole mounting also simplifies installation. The S. L. F. Bradleydenser is the latest Allen-Bradley contribution to better radio. Be sure to bring your set up-to-date by getting a set of S. L. F. Bradleydensers from your nearest dealer.



OTHER Allen-Bradley Devices

Use the Bradleystat, Bradleyleak, Bradleyometer, and Bradleyohm in your next set. For resistance amplification, use the Bradleyunit Resistor.

Mail the Coupon

Allen-Bradley Company,
287 Greenfield Avenue,
Milwaukee, Wisconsin.

Please send us your latest literature on the new S. L. F. Bradleydenser and other items of the Allen-Bradley line.

Name

Address



The mark of quality whether you buy or build. Insist upon C-H radio products for highest efficiency in your new set.

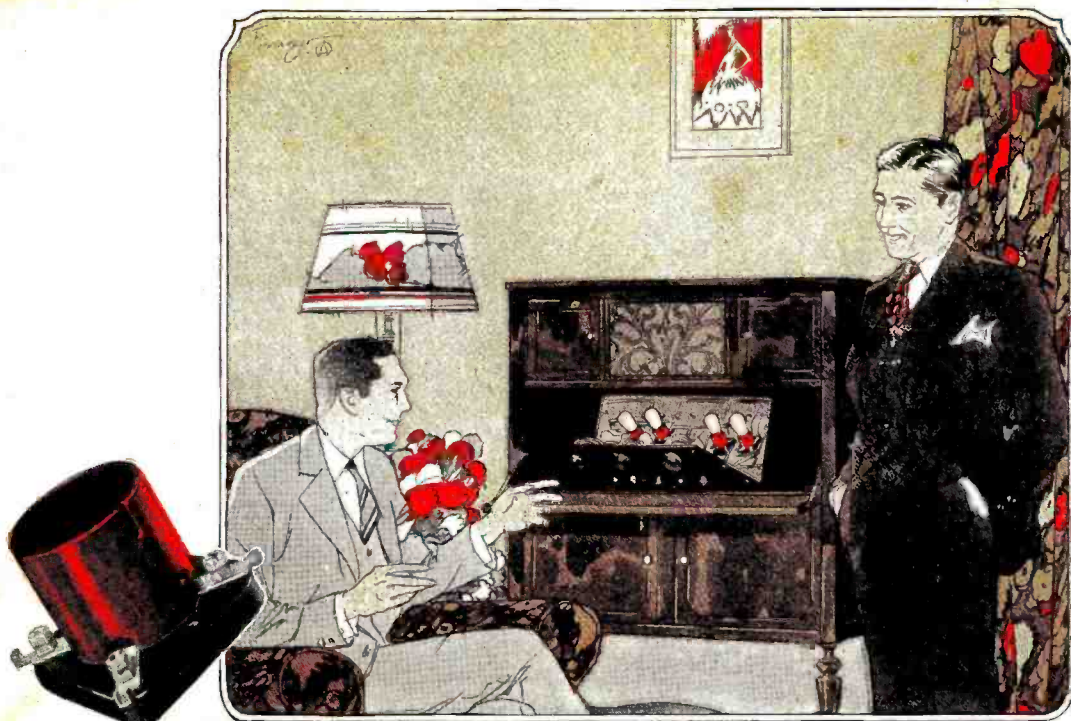

"That's Not Only a Beautiful Set, Fred; It Has Been Carefully Designed—Those Sockets Prove It!"

"YOU can always tell a carefully designed set by its parts"—any radio set manufacturer will tell you so.

A list of some of the prominent radio manufacturers using C-H products

Aeme Apparatus Co.
American Bosch Magneto Co.
Astral Radio Corporation
Boissier Radio Corporation
Chelsea Radio Co.
Crosley Radio Corporation
Dayton Fan & Motor Co.
Dictagraph Products Co.
Dubilier Condenser & Radio Corp.
Electrad, Inc.
Freed-Eisemann Radio Corp.
Garod Corporation
Giffill Bros., Inc.
Allen T. Hamscorn
Harding Mfg. Co.
Howard Radio Co.
The Keyport Laboratories
King Electric Mfg. Co.
Kodel Radio Corporation
LeMor Radio, Inc.
Magnus Electric & Radio Co.
Malone-Lemmon Laboratories
Glenn L. Martin Co.
Wm. J. Murdock
Newport Radio Co.
Pfanstiehl Mfg. Co.
Philadelphia Storage Battery Co.
Radio Master Corp. of America
The Radio Compak Co.
R. B. Radio Co.
Robbins Radio Co.
Signal Electric Co.
Silver-Marshall Co.
Simplex Radio Co.
R. E. Thompson Co., Inc.
J. S. Timmons
Workrite Mfg. Co.
Zenith Radio Co.

That's why you find so many sets on the market today with C-H sockets, rheostats and switches. For manufacturers know by careful testing the advantages that hundreds of thousands of radio fans have found in C-H features through years of "building their own."

C-H Low Loss Sockets, for instance, settle once and for all one of the most annoying of all set troubles—loose contacts at the tube prongs. In C-H sockets each tube prong is firmly held in the one piece, *silver-plated*, double grip contacts. Jarring of the set or corrosion cannot alter the perfect contact. They are easily wired and give a finished appearance to any set.

So whether you buy or build—look for the C-H trade mark. It is a guarantee of satisfaction.

THE CUTLER-HAMMER MFG. CO.

Member Radio Section, Associated Manufacturers of Electrical Supplies

MILWAUKEE, WISCONSIN



The New C-H UX Socket

for the new UX tubes. Same C-H one piece, low loss SILVER plated, double grip contacts as in the C-H original low loss socket with the ORANGE shell. Heat proof Thermoplax body—terminals cannot loosen under heat of soldering iron.

Spring washers under binding posts prevent loosening of hex nuts and assure tight connections. The hex nuts are slotted to permit tightening with screw driver or wrench

The lugs at the end of the contacts are designed for easy soldering and may be bent down for under wiring.

CUTLER-HAMMER

Buy Your Radio Parts by Name