

CIRCULATION LARGER THAN THAT OF ANY OTHER RADIO PUBLICATION

RADIO NEWS

REG. U.S. PAT. OFF.

25 Cents

AUGUST

Over 200 Illustrations

Edited by
HUGO GERNSBACK

\$20,000

**RADIO SHOWER
CONTEST**

*See Page
150*

RADIO'S GREATEST MAGAZINE

EXPERIMENTER PUBLISHING COMPANY, NEW YORK, PUBLISHERS OF

SCIENCE and INVENTION

THE EXPERIMENTER

MOTOR CAMPER & TOURIST

www.americanradiohistory.com

Cunningham RADIO TUBES

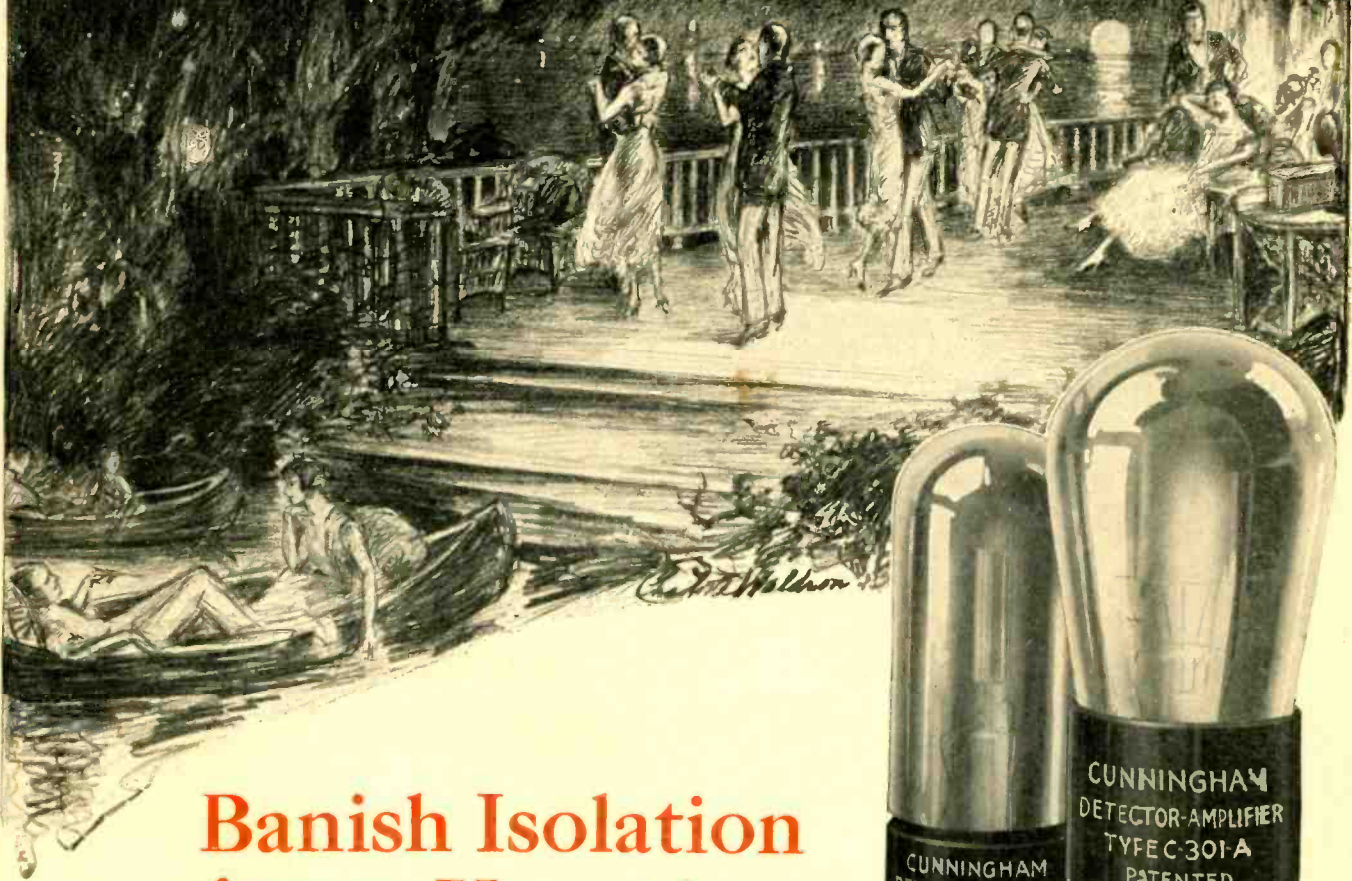

Banish Isolation from Vacation

TRANSLATE a mid-summer night's dream, a fairy fantasy, into the gay reality of dance—of song—of haunting melody.

In the back-country, among the towering, snow-capped peaks, over the placid summer sea, the ether is a-thrill with those same magic impulses that soar and dip above the city's crowded streets.

For real summer enjoyment you cannot do without radio. For full enjoyment of radio you cannot do without Cunningham Radio Tubes.

Home Office:
182 Second Street
San Francisco

C. J. Cunningham, Inc.

Chicago
New York

Patent Notice: Cunningham Tubes are covered by patents dated 2-18-12, 12-30-13, 10-23-17, 10-23-17, and others issued and pending.



*Since 1915—
Standard for
All Sets*

TYPES C301A, C300, C299,
C11, C12.

*In the Orange and Blue
Carton.*

Tower

Little Spitfire Loud Speaker

\$4.95

All Tower Loudspeakers equipped with adjustable units

Covers EVERY Chromatic in the Entire Scale

The high quality of Tower Radio Products needs no introduction to the MILLIONS now using Tower Scientific Headsets in every corner of the World.

Each Tower Loudspeaker—from the "Little Spitfire" to the beautiful "Tower Meistersinger" with its special duralumin horn and deep, full tone—is equipped with an adjustable unit that reproduces accurately every tone from the lowest note on the double bass to the highest tone on the piccolo.

On sale from Coast to Coast wherever good radio is sold.

There's a Tower Loudspeaker to fit YOUR particular pocketbook.

TOWER MFG. CORPORATION
98 BROOKLINE AVE. BOSTON, MASS.

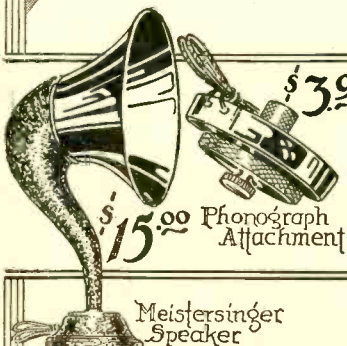

Meistersinger Speaker



Scientific Loudspeaker



WORLD'S GREATEST LOUDSPEAKER VALUES

RADIO NEWS

Published by EXPERIMENTER PUBLISHING COMPANY, INC.
 Publishers of "Radio News," "Science and Invention,"
 "The Experimenter" and "Motor Camper & Tourist."
 Editorial and General Offices: 53 Park Pl., New York City
 H. GERNSBACK, President. S. GERNSBACK, Treasurer
 R. W. DEMOTT, Secretary.
 MEMBER: AUDIT BUREAU OF CIRCULATIONS

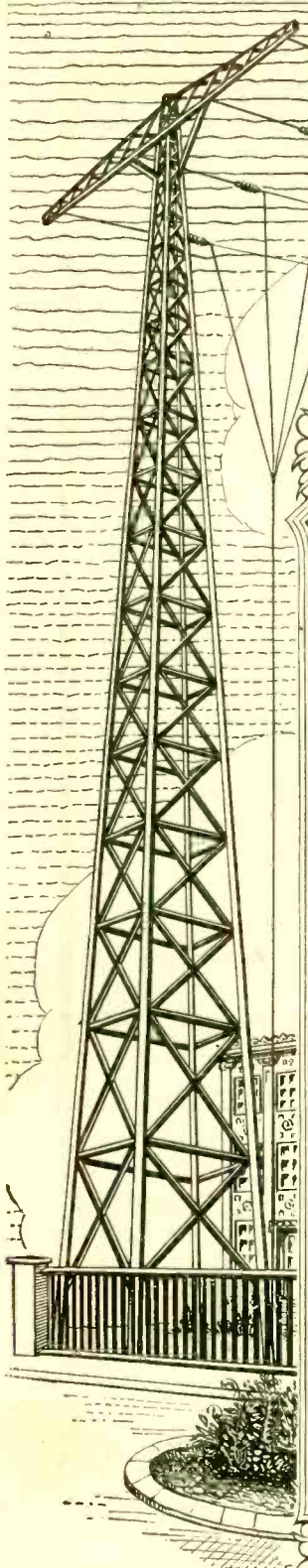

VOLUME 7

CONTENTS AUGUST, 1925

NUMBER 3

In Our Next Issue

The Interflex Circuit, the latest circuit invention of Mr. Hugo Gernsback, which is a non-radiating receiver giving good volume and excellent clarity. * * *

The latest in rectifiers. Mr. Joseph Riley has discovered among the manufacturers a new wrinkle in the use of alternating current for set supply. The new tube uses the asymmetrical conductivity in a Neon gas medium. * * *

More about the latest development in condensers—the straight-line frequency type. By Mr. Harris. The problems and worries of the use and manufacture of this type of instrument with various inductances will be cleared up. * * *

The RADIO NEWS Hylo Circuit by the staff of RADIO NEWS Laboratories. This circuit will admit tuning of all stations, from the shortest of the new assignments to the longest of the old ones, and at the same time circumvent undue crowding on the dial.

In This Issue

Editorial. By Hugo Gernsback	141	"Push-Button" Radio. By Brainard Foote	178
The Piezo Electric Oscillo- graph. By C. B. Bazzoni	142	A Ten-Cent Store Loud Speaker. By Jay Hollander	181
Listening In Across Canada. By Rose D. Meyer	144	History of Radio Inven- tions. By A. H. Morse	184
Radio and the Blind. By W. H. McDonald	146	Straight-Line Frequency Condensers. By Sylvan Harris	188
Putting WRNY on the Air. By Gilson V. Willetts	147	The Radio Beginner. By A. P. Peck	191
Up In the Air Over Aerials. By Edward C. Hubert	148	With the Amateurs—the Army and the Navy For- ever. By Jay Hollander	194
RADIO NEWS' Second Radio Shower Party	150	Radio Wrinkles	196
The Life and Work of Lee DeForest	152	Standard Hook-ups	197
The Inventions of Reginald A. Fessenden	156	Radiotics	199
The Listening Post. By Don C. Walk	159	New Radio Patents. By John B. Brady	200
Drink to Me Only With Thine Ears (A Story). By Robert Francis Smith	160	Correspondence From Read- ers	201
International Radio	169	RADIO NEWS Laboratories	202
Does Your Radio Set Jeop- ardize Your Insurance? By Ben B. Fosdick	160A	I Want to Know. By R. D. Washburne	204

Index to Advertisers 132

RADIO NEWS is published on the 10th of each preceding month. There are 12 numbers per year. Subscription price is \$2.50 a year in U. S. and possessions. Canada and foreign countries, \$5.00 a year. U. S. Coin as well as U. S. Stamps accepted (no foreign coins or stamps). Single copies, 25 cents each. A sample copy will be sent gratis on request. Checks and money orders should be drawn to order of EXPERIMENTER PUBLISHING CO., INC.

All communications and contributions to this journal should be addressed to Editor, RADIO NEWS, 53 Park Place, New York, N. Y. Unaccepted contributions cannot be returned unless full postage has been included. All accepted contributions are paid for on publication. A special rate is paid for novel experiments; good photographs accompanying them are highly desirable.

RADIO NEWS, Monthly. Entered as second class matter, July 12, 1921, at the Post Office at New York, N. Y., under the Act of March 3, 1879. Additional entry at Long Island City, N. Y., and San Francisco, Calif. Title registered U. S. Patent Office. Copyright, 1923, by E. P. Co., Inc., New York. The Experimenter Publishing Co., 53 Park Place, New York. The Contents of this magazine are copyrighted and must not be reproduced without giving full credit to the publication. Copyright in Germany. Reproduction of articles in Germany is reserved for Radio, Berlin 42.

New York City
General Advertising Dept.
53 Park Place

Western Advertising Representatives
Finucan & McClure
720 Cass St., Chicago, Ill.

Pacific Coast Advertising Representatives
A. J. Norris Hill Co.
Hearst Bldg., San Francisco, Calif.

New England Advertising Representative
T. F. Magrane, Park Square Buildings, Boston, Mass.

Kansas City Advertising Representative
George F. Dillon
Republic Building, Kansas City, Mo.

RADIO NEWS is for sale at all newsstands in the United States and Canada, also at The International News Co., Ltd., Bream's Building, London, E. C. 4, England, and at Brentano's, 37 Avenue de l'Opera, Paris.

HOW TO SUBSCRIBE FOR RADIO NEWS. Send your name, address and remittance to Experimenter Publishing Co., 53 Park Place, New York. Mention the name of the magazine you are ordering. We also publish SCIENCE AND INVENTION, the EXPERIMENTER and MOTOR CAMPER & TOURIST. Write clearly. RATES AND TERMS. The subscription rate for RADIO NEWS is \$2.50 per year (12 numbers). When remitting do so by check, money order, or registered letter if cash is enclosed. Avoid sending cash through the mail if possible. Subscriptions for less than one year are not accepted. Subscription may be made in combination with SCIENCE AND INVENTION or the EXPERIMENTER.

POSTAGE. We prepay postage in all parts of the United States, Mexico and island possessions. For foreign or Canadian subscriptions we require 50 cents in addition to the subscription price for additional postage charges.

CHANGE OF ADDRESS. Notify us as far in advance as possible. It requires several weeks to make an address change on our records. Always write clearly.

ON EXPIRATION of your subscription we enclose a renewal blank in our last number to you; we stop our delivery to you on expiration.

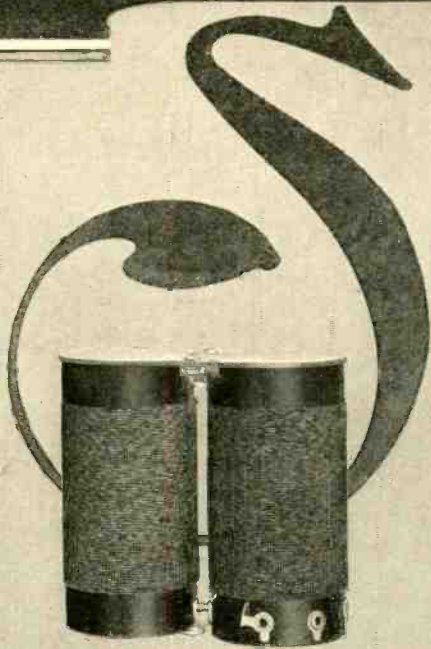

Binocular Coils

Selectivity

—the most important function of a radio set

Sensitivity—yes.

Clarity of tone—surely.

But *selectivity*—that is the true test of performance.

The extreme selectivity of the Grebe Synchronphase has been made possible by the *Binocular Coils* which, because they have no field, are unaffected by impulses from undesired stations. They keep the set automatically balanced against such interference.

These Binocular Coils are exclusively Grebe, as are also the *Grebe S-L-F* (straight line frequency) *Condensers* and *Grebe Volume Control* which are outstanding features of the Synchronphase.

Ask your dealer to demonstrate these features or write us

A.H. Grebe & Co., Inc., Van Wyck Blvd., Richmond Hill, N.Y.
Western Branch: 443 So. San Pedro St., Los Angeles, Cal.

The

GREBE

SYNCHROPHASE

— TRADE MARK —

This Company owns and operates stations WAHG, WBOQ; also mobile and marine low-wave re-broadcasting stations.



The true worth of a machine lies not in its appearance but in its performance.

Doctor Hu



All Grebe apparatus is covered by patents granted and pending.

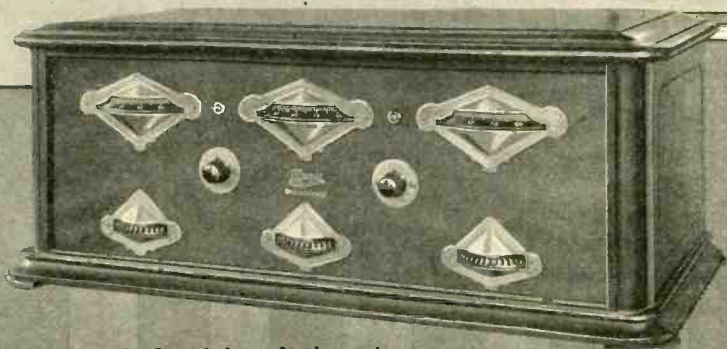

Also supplied with base for batteries

INDEX TO ADVERTISERS

A	Page	D	Page	I	Page	R	Page
Acme Apparatus Co.....	135	D. X. Instrument Co.....	248	International Correspondence		Radiall Co.	238
Aerovox Wireless Corp.....	253	Daven Radio Corp.....	234	Schools	228	Radio Association of America..	239
Alden Mfg. Co.....	228	Dayton Fan & Motor Co.....	230			Radio Corporation of America,	Back Cover
All-American Radio Corp.....	244	Diamond Electric Specialties		J		Radiogem Corp., The.....	217
Allen-Bradley Co.	256	Corp.	243	Jefferson Electric Mfg. Co..	226-245	Radio Industries Corp.....	234
Abco	244	Dietzen, Inc.	218	Jewell Electrical Instrument Co.	230	Radio Parts Co.....	241
American Bosch Magneto Corp.	212	Dongan Electric Mfg. Co.....	247	Jones Radio Mfg. Co., Jos. W.	249	Radio Specialty Co.,	138-139-212-218-228-237-241-248
American Electric Co.....	241	Dubilier Condenser & Radio		Karas Electric Co.....	207	Radio Units, Inc.....	245
American Hard Rubber Co.....	210	Corp.	237	Kellogg Switchboard & Supply		Radio World's Fair.....	231
American Radio Engineers.....	237	Duplex Condenser & Radio		Co.	214	Randolph & Co.....	255
American Radio Exposition....	243	Corp.	248	Kimley Electric Co., Inc.....	230	Rice & Hochster.....	233
Amplion Corporation of Amer-		E		Klosner Radio Corp.....	239	Richardson Radio, Inc.....	248
ica, The	244					Roice Tube Co.....	243
Amsco Products, Inc....	214-243-251	E. I. Co., The.....	216-224-240	L			
Andrews Radio Co.....	239	E-Z Toon Radio Co.....	228	Lancaster & Allwine.....	255	S	
Apco Mfg. Co.....	233	Eagle Radio Co.....	235			Saturn Mfg. & Sales Co., Inc.,	
Armley Radio Corp.....	251	Electrical-Engineers-Equipment-		M		The	220
Arrow Battery Co.....	220	Co.	251	M & M Co.....	241	Service Battery Co.....	247
Atwater Kent Mfg. Co.....	223	Electrical Research Laboratories	235	Marshall Electric Co.....	245	Shipman Ward Mfg. Co.....	242
Automatic Electrical Devices		Electric B. G. Products Co... 238		Mass. Radio School.....	248	Silver-Marshall	222
Co., The	243	Electric Service Supplies Co... 218		Midwest Radio Corp'n.....	222	Spaulding Fibre Co., Inc.....	230
B		Electric Specialty Co.....	239	Miller Rubber Company of		Starrett Mfg. Co.....	218
Bakelite Corp.	226	Elgin Radio Supply Co.....	245	N. Y., The.....	220	Sterling Mfg. Co., The.....	249
Barkeley Electric Mfg. Co.,		Elite Stationery Co.....	247	Mozart-Grand Co., The.....	244	Super-Booster Distributing Co.	226
The	218	Erie Fixture Supply Co.....	235	Murdock Co., Wm. J.....	220		
Bluebird Tube Co.....	248	Evans & Co., Victor J.....	255	Music Master Corp.....	221	T	
Bodine Electric Co.....	249	F		Mydar Radio Co.....	231	Telephone Maintenance Co.... 238	
Boice, W. B. & J. E.....	247	Fahnestock Electric Co.....	248			Thordarson Electric Mfg. Co... 242	
Brady, John B.....	255	Fansteel Products Co., Inc.... 213		N		Tork Co., N.	235
Brightson Laboratories, Inc.,		Ferbend Electric Co.....	253	Nagel Electric Co., The W. G. 224		Tower Mfg. Corp.....	129
Inside Back Cover		Firth Radio Corp.....	242	National Airphone Corp..... 233			
Bristol Co., The.....	212	Firmica Insulation Co., The.. 215		National Carbon Co., Inc..... 211		U	
Brooklyn Radio Exposition....	253	Freshman Co., Inc., Chas...214-242		National Radio Institute,		Uncle Sam Electric Co.....	242
Brownlie, Roland	235	Frost, Inc., Herbert H.....	214	The	208-216	U. S. Tool Co., Inc.....	249
C				O			
C. E. Mfg. Co.....	241	G		Oliver, Inc., Jas.....	230	V	
California Radio Minerals.....	220	Gem Tube Co.....	228	Omnigraph Mfg. Co., The.... 253		Valley Electric Co.....	224
Carter Radio Co.....	222	General Electric Co.....	233	Owen, Richard B.....	255	Vesco Radio Co.....	222
Chemical Institute of New		Gould Storage Battery Co..... 222		Ozarka, Inc.	140		
York, Inc.	229	Grebe & Co., Inc., A. H..... 131		P		W	
Chicago Electric Devices Co... 244				Paent Electric Co., Inc.,		Waage, A. H.....	238
Chicago Salvage Stock Stores.. 226				136-137-245		Wade Mfg. Co., Inc.....	212
Cleveland Engineering Labs.				Palmer School of Chiropractic,		Walbert Mfg. Co.....	218
Co., The	251			The	225	Washburn Burner Corp., The.. 244	
Collier & Son Co., P. F.....	242			Parker, C. L.....	255	Western Radio Mfg. Co.....	244
Conrad Co., Inc., The..232-250-255				Phenix Radio Corp.....	219	Weston Electrical Instrument	
Continental Fibre Co., The... 234				Corp.	230	World Battery Co.....	218-234
Coyne Electrical School.....	245						
Crescent Braid Co., Inc.....	238			XYZ			
Crescent Radio Supply Co... 226				X L Radio Laboratory.....	244		
Crosley Radio Corp., The. 209				Y. M. C. A. Radio Institute.. 220			
Cunningham, Inc., E. T.,				Zenith Radio Corp.....	133		
Inside Front Cover							

ZENITH

TRADE MARK REG.

RADIO

→ LONG DISTANCE ←
TRADE MARK REG.

Arctic Explorers Stake Their Lives on Zenith Radio —

Costs More
But Does More

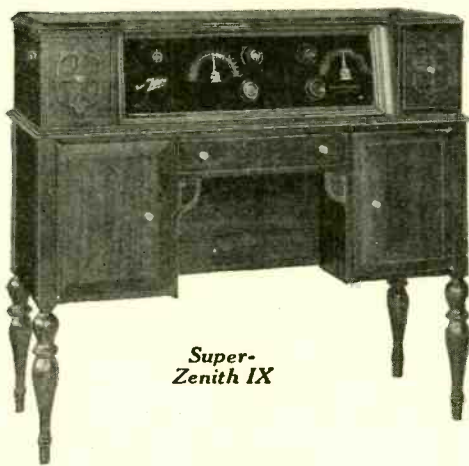

Super-Zenith IX

It is one thing to select a radio set for pleasure only—it is quite another to select a set which may be called upon most unexpectedly to save your life.

Alone in the Arctic—cut off from the nearest rescue post by hundreds of miles of ice and open water—men cannot run to the nearest radio shop for repairs. If transportation fails, *and radio does not work*, they are in the gravest peril.

This summer—across the million square miles of unexplored territory stretching between Alaska and the North Pole—MacMillan and his party of explorers will fly in three great navy planes. Each of these cruising airplanes is equipped with Zenith radio, as are the *Bowdoin* and the *Peary*, which will locate at Etah as their base. Between ships and airplanes messages will be sent and received.

When Arctic explorers of MacMillan's calibre stake their lives—repeatedly—on Zenith performance, one reason only can explain their choice—*Zenith has proved to be the best obtainable, at any price.*

Call this evening at your nearest Zenith dealer and let him prove it to you by a demonstration.

ZENITH RADIO CORPORATION
310 South Michigan Avenue, Chicago

THE complete Zenith line ranges in price from \$100 to \$475.

With either Zenith 3R or Zenith 4R, satisfactory reception over distances of 2,000 to 3,000 miles is readily accomplished, *using any ordinary loud speaker.* Models 3R and 4R licensed under Armstrong U. S. Patent No. 1,113,149. They are NON-RADIATING.

Zenith 4R - \$100
Zenith 3R - \$175

The new Super-Zenith is a six-tube set with a new, unique, and really different patented circuit, controlled exclusively by the Zenith Radio Corporation. It is NOT regenerative.

SUPER-ZENITH VII—Six tubes—2 stages tuned frequency amplification—detector and 3 stages audio frequency amplification. Installed in a beautifully finished cabinet of solid mahogany—44 1/2 inches long, 16 1/4 inches wide, 10 1/2 inches high. Compartments at either end for dry batteries. Price (exclusive of tubes and batteries)..... **\$240**

SUPER-ZENITH VIII—Same as VII except—console type. Price (exclusive of tubes and batteries)..... **\$260**

SUPER-ZENITH IX—Console model with additional compartments containing built-in Zenith loud speaker and generous storage battery space. Price (exclusive of tubes and batteries)..... **\$355**

SUPER-ZENITH X—Contains built-in, patented, Super-Zenith Duo-Loud Speakers (harmonically synchronized *twin* speakers and horns), designed to

reproduce both high and low pitch tones otherwise impossible with single-unit speakers. Price (exclusive of tubes and batteries) **\$475**

All Prices F. O. B. Factory

Zenith Radio Corporation

Dept. 8B

310 S. Michigan Avenue, Chicago, Illinois

Gentlemen:

Please send me illustrated literature about Zenith Radio.

Name.....

Address.....

RADIO NEWS READERS' BUREAU

Time and Postage Saver

IN every issue of RADIO NEWS you undoubtedly see numerous articles advertised about which you would like to have further information. To sit down and write an individual letter to each of these respective concerns, regarding the article on which you desire information, would be quite a task.

As a special service to our readers, we will write the letters for you, thus saving your time and money.

Just write the names of the products about which you want information, and to avoid error the addresses of the manufacturers, on the coupon below and mail it to us.

If the advertiser requires any money or stamps to be sent to pay the mailing charges on his catalogue or descriptive literature, please be sure to enclose the correct amount with the coupon.

We will transmit to the various advertisers your request for information on their products.

This service will appear regularly every month on this same page in RADIO NEWS.

If there is any Manufacturer not advertising in this month's issue of RADIO NEWS, from whom you would like to receive literature, write his name, address and the product in the special section of the coupon below.

TEAR ALONG THIS LINE

READERS' SERVICE BUREAU,
Experimenter Publishing Co., Inc., 53 Park Place, New York, N. Y.

RN-8-25

Please advise the firms listed below that I would like to receive detailed information on their product as advertised in the issue of RADIO NEWS.

 **DO NOT USE THIS COUPON FOR TECHNICAL QUESTIONS**

NAME	ADDRESS (Street — City — State)	List here specific article on which you wish literature.	If Catalogue of complete line is wanted, check in this column
.....
.....
.....
.....
.....
.....
.....
.....

Use this space if you desire information from a manufacturer whose advertisement does not appear in this month's issue.

NAME	ADDRESS (Street — City — State)	
.....
.....
.....

Your own name here

If you are dealer check here. Address

City State

Loud and clear entertainment *all summer*

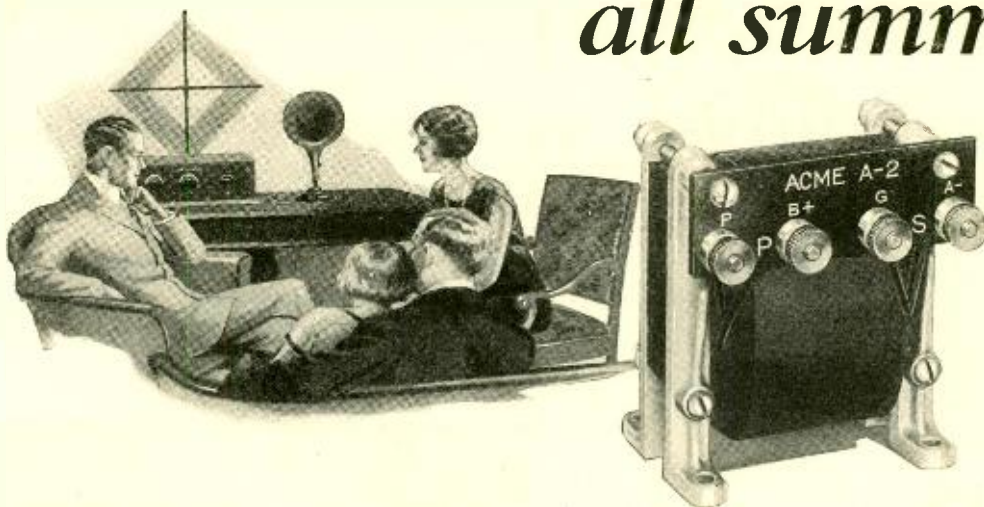

through ACME transformers

**Amplification
without
distortion**

**Enjoy your radio
in summer as
well as winter**

IN THE early days, automobiles were stored during the winter because the weather was too severe for them. Do you now have to store your radio during the summer or would you like to be able to enjoy your set all summer long? If you are not getting loud, clear radio, try Acme Transformers and note the difference. Why miss the pleasure of music during the season when it is most appealing?

The Acme A-2 Audio Amplifying Transformer is the result of 5 years of research and experimenting. It gives amplification without distortion to any set. Whether you have a neutrodyne, super-heterodyne, regenerative or reflex the addition of the Acme A-2 Audio Transformer will make it better.

Each transformer is tested and carries a guarantee tag. If you want Amplification without Distortion use Acme Transformers in the set you build and insist on them in the set you buy. (That's one of the big reasons why the Acmeflex Kitset gives such good results—it uses Acme Transformers.) Send for our 40-page booklet which explains how to get the best results by proper amplification and which also contains a number of valuable wiring diagrams. It will help you build a set. Mail the coupon with 10 cents.

ACME APPARATUS COMPANY,
Dept. K6, Cambridge, Mass.

Transformer and Radio Engineers and Manufacturers

ACME

~for amplification

ACME APPARATUS COMPANY,
Dept. K6, Cambridge, Mass.

Gentlemen: I am enclosing 10 cents (U. S. stamps or coin) for a copy of your book "Amplification without Distortion."

Name
Street
City..... State.....

Pacent Engineering

"DON'T IMPROVISE - PACENTIZE"



The last word in condenser design
Pacent *True Straight-Line*
Frequency Condenser

Condenser Advanced Features

- 1 True "Straight-Line" Frequency.
- 2 Negligible Losses.
- 3 Perfect Insulation—Isolantite—Properly Placed.
- 4 Special Brass Plates—Riveted and Soldered.
- 5 Rigid Channel Frame Construction.
- 6 Permanent Plate Alignment.
- 7 Extra Tie Bars.
- 8 Oversize, Dust Proof, Uni-Bearing.
- 9 Positive Enclosed Stop.
- 10 Practical, Adjustable One Hole Mounting.
- 11 Design Provides for Uni-Control Tandem Mounting.
- 12 Distinctive, Compact and Sturdy.

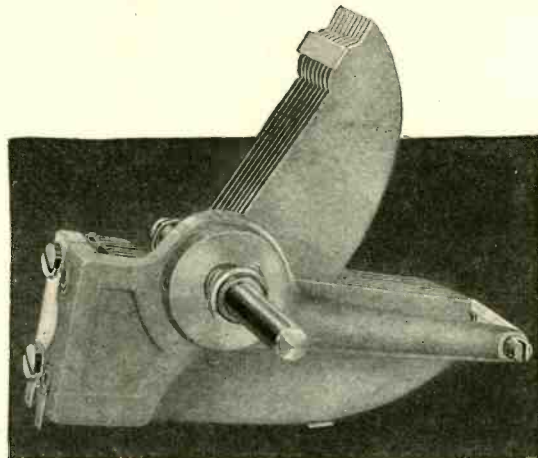

You have tried other "Straight-Line" Condensers. First there was the "Straight-Line" Capacity Condenser. Then the "Straight-Line" Wave Length Condenser was produced. Neither of them satisfactorily divided the stations equally on your dial. Now we announce the Pacent True "Straight-Line" Frequency Condenser. It makes possible the equi-spacing of stations—because stations are spaced according to *Frequencies*.

It is the result of a year's painstaking research and development by the Pacent Engineers, under the direction of L. G. Pacent. Many designs were brought forth, discussed, improved, and discarded. From out this process there was crystallized what we firmly consider the Last Word in Condensers.

A Real Engineering Feat—both Electrically and Mechanically—meeting all requirements of low loss design—grounded rotor in continuous connection with metal end-plate. Only two small pieces of ISOLANTITE—highest grade dielectric—are used, placed so that absorption losses are negligible. Plates permanently spaced and joined together with metal tie bars and riveted and soldered joints.

Simple and Practical one-hole mounting.

Two or three of these condensers can be mounted in tandem, with mono-control.

SUPPLIED IN ALL STANDARD CAPACITIES

Manufacturers - Dealers - Jobbers
WRITE OR WIRE FOR PARTICULARS

NEW FEATURES COMING →

PACENT ELECTRIC CO. 91 SEVENTH AVE, NEW YORK CITY
OFFICES :- CHICAGO - MINNEAPOLIS - BUFFALO - BOSTON - PHILA. - WASH. D.C. - PITTS. - SAN FRAN. - ST. LOUIS -

DON'T IMPROVISE - PACENTIZE™

Achievements



The last word in vernier dials
**Pacents Microvern—A
 Super Tuning Device**

Microvern Advanced Features

- 1 Most practical ratio—5 to 1.
- 2 Proper size— $\frac{1}{4}$ " diameter.
- 3 Absolutely noiseless in operation.
- 4 Positively no back-lash.
- 5 Exclusive "Radiofile" feature simplifies logging.
- 6 Direct reading in wavelength and frequency.
- 7 Easily and quickly mounted on any condenser.
- 8 Provides an electro-static shield.
- 9 Specially designed Bakelite Knob for ease in tuning.
- 10 Mechanism encased and dust proof.
- 11 Neat design—Improves appearance of any set.
- 12 Nothing to wear out.

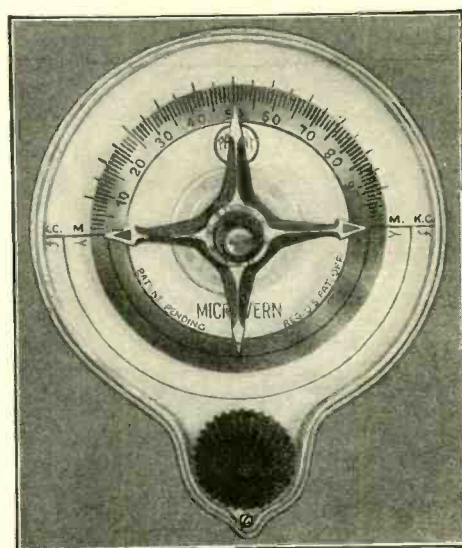

For use on sets being constructed or on existing sets, where there is real need for *sharp tuning*. While it will produce the best results in conjunction with Pacents Straight-Line Frequency Condenser, it will materially improve and simplify the tuning with any condenser. The ratio is five-to-one, which has been found by Pacents engineers to be the ideal ratio making for maximum speed of tuning consistent with delicate variations.

The Pacents Microvern is distinctive—totally different from any other vernier control in appearance and mechanical design alike. No gears are used. A special driving mechanism which is radically new. There is a velvety feel to the fluted knob as the operator proceeds to cut the Gordian knots of the ether. *No backlash* to cause delicate adjustments to be lost as hand is removed. The metal case, reinforced by beading around the face, completely encloses the mechanism.

A unique triple tuning feature is obtained by use of the exclusively Pacents Radiofile feature, which permits of permanent logging of stations by name, wave-length or frequency.

SUPPLIED IN SEVERAL FINISHES

Manufacturers - Dealers - Jobbers
 WRITE OR WIRE FOR PARTICULARS

Many New Pacents Radio Essentials
 WATCH FOR ANNOUNCEMENTS

PACENTS ELECTRIC CO. 91 SEVENTH AVE, NEW YORK CITY.
 JACKSONVILLE - DETROIT - CANADIAN (LICENSEE) R.H. WHITE RADIO CO. HAMILTON, ONTARIO

PRICES SLASHED FOR QUICK ACTION!

To get you started dealing with us, we have slashed the prices on these most popular two kits. But your order will have to be sent by August 31 when our regular catalog prices will again be in effect. Look at the list prices—then our low catalog prices—then see the big cut we have made to give you an inducement to order quick! Your chance to get the best kit at a *big saving!* Take it!

All of our Kits contain complete parts for receiver, including drilled and engraved Bakelite-Dilecto panel, finest, roomy mahogany finish cabinet, simple new-style blueprint and instructions, everything—

nothing more to buy. All parts highest grade—advertised, well-known, reliable, dependable—fully guaranteed by manufacturers and ourselves. Look at these brands. You cannot get better kits!

Our New Method of Wiring—Perfectly Simple—No Radio Knowledge Needed

No solder—No bare wires—No poor connections—No dissatisfaction.
No tools needed except a common screw-driver and common pliers.

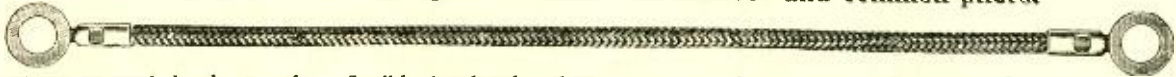

All connections are made by the use of our flexible, insulated eyeletted connecting wire in place of bus bar or wire, and solder. And in a fraction of the time usually required when using the old fashioned way. And when the job is done it is neat and your connections are tight.

4-Tube Roberts Knock-Out

Superior to most other sets REGARDLESS OF NUMBER OF TUBES!

Spl. \$43.49 Postpaid Kit KX 9215 Range 3500 Milse

Combines principles of Reflex, Neutralization, Tuned Radio Frequency, Regeneration (without blooming), and Push-Pull Amplification. Smooth-working—easily tuned—non-howling—non-squealing—non-reradiative. Guaranteed absolutely to give entire satisfaction.

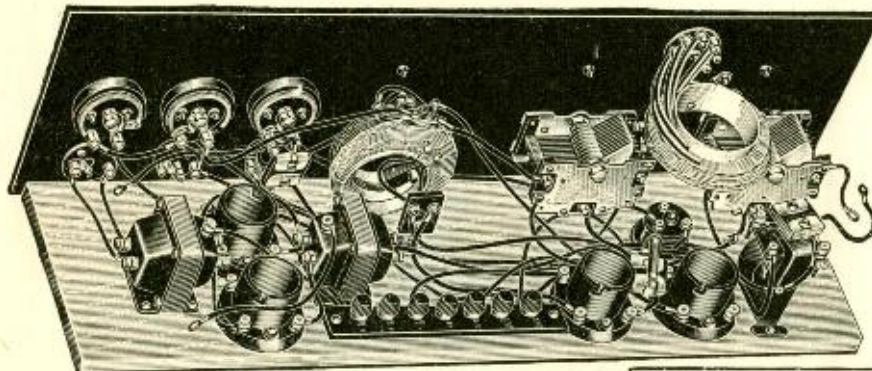

See what Doubleday, Page & Co., through Mr. Arthur H. Lynch, Editor of their magazine, "Radio Broadcast," say about the Radio Broadcast's sensational 4-Tube Knock-Out Set developed by Walter Van B. Roberts:
"Tube for tube, dollar for dollar, result for result, we will stack it up against any receiver for home construction ever described by any radio publication and gamble that it comes out winner."

MR. LYNCH ADDS—READ IT!

"It is the best we have ever seen—and we have seen and operated almost every type made and used during the past twelve years. It has pulled in forty-six stations on a loud speaker with two tubes, using an indoor antenna. Its signals have been heard through the air more than a quarter mile. It is not merely the best four-tube receiver, but the best by a very good margin."

CUSTOMERS PRAISE IT!

Receives Calif. from N. Y. on Two Tubes!

"I have followed the development of the Roberts circuit with results far beyond all expectations. I find it to be EXACTLY as efficient as described, although I was skeptical as to the unusual operation that it was said to have accomplished. I no longer have any doubts, for in the last week of August and to date in September, I have received KGO at least four times. On one of these occasions I received it on my Dictogrand loud speaker, using only two tubes! I have consistently received long distance, such as Dallas, Fort Worth, Auburn, La., Hastings, and Kansas City, in all about 65 stations, while just "fishing" locals, such as Pittsburgh,

Schenectady, New York City, Chicago, Boston, etc., it need not be mentioned, are perfect, even on occasions when I have used neither aerial nor ground. I am sure it was a lucky day when this set came to my attention." L. L. Clifford, 190 Second Street, Fulton, NEW YORK.

Selectivity Better than Eight tube Heterodyne

"Last week I constructed the four-tube Roberts Knock-Out set. I am more than pleased by its operation, its selectivity being better than my eight-tube super-heterodyne. On a poor night I was able to bring in WOS, WGN, WOC, WSAI, WBZ, and all at loud speaker intensity." Louis R. Jeffrey, 51 Newark Street, Hoboken, NEW JERSEY.

See What You Get—Best Quality

Fine 7x24x8 mahogany finish cabinet, drilled and engraved Bakelite-Dilecto panel, five-ply (laminated) baseboard, Sickles' Roberts' coils, 2 Hammarlund low loss variable condensers, 3 E-Z Toon vernier dials, Thordarson transformer, pair Modern push-pull transformers, 3 Patent rheostats, 4 Bell Bakelite low loss sockets, Improved single-circuit jack, Improved double-circuit jack, Cutler-Hammer inductance switch, Smillear filament switch, Electrad grid leak, Hilco grid condenser and mounting, 2 Hilco fixed condensers, Amplex grid-denser, 7 Aristocrat binding posts, binding post strip, complete set "No-Sod-er" connecting wires, hardware, blueprint and instruction sheet. You can assemble in only three hours or so.

List price, \$64.69; our regular catalog price, \$48.56—Special price to August 31, only \$43.49.

Special Features

Great volume.
Utmost clearness.
Sweetness of tone.
Highly selective.
Cheap to build.
Easy to operate.
Receives great distance.
Does not radiate or cause squealing in your neighbors' receivers.
Low cost of upkeep.
It offers a better combination of sensitivity, selectivity and quality for the total cost than any other circuit we have ever known.
The best 4-Tube set for home construction ever produced.

3-Tube LoLos \$26.49 Postpaid—Kit KX6996 Explorer—Spl. Range 1000 Miles on Loud Speaker

Stations Logged in 2 hours at New York City All on Loud Speaker

By one of the editors of "Radio News"

WJZ	73	65	N. Y. City
WEAF	86	77	N. Y. City
WFBH	65	21	N. Y. City
WFAM	55	18	St. Cloud, Minn.
WQAO	73	40	N. Y. City
WBBH	75	43	Chicago
WJY	72	52	N. Y. City
KDKA	70	32	E. Pittsburgh, Pa.
WTAS	67	25	Elgin, Ill.
WGBS	67	30	N. Y. City
WHN	72	39	N. Y. City
WJAX	88	48	Cleveland
WIT	75	83	Philadelphia, Pa.
KYW	78	93	Chicago
WOC	83	74	Davenport, Iowa

Positively a "hummer!" We have never tested an outfit at anywhere near our price more suitable for long distance broadcast reception. Contains a low loss 3-circuit tuner, a low loss condenser, low loss sockets, etc. Special Features: Sensitive—Selective—Clear reception—Simple to construct—Simple to operate—Dependable—Low loss design—Receives long distances—Great volume.

We Give You High-Class Parts

Fine 7x18x8 mahogany finish cabinet, drilled and engraved Bakelite-Dilecto panel, five-ply (laminated) baseboard, Gen-Win low loss coupler, Hammarlund low loss variable condenser, 2 Bell Bakelite dials, 2 Raseo verniers, 2 Patent A. F. transformers, 2 Patent rheostats, 3 Bell Bakelite low loss sockets, Improved single circuit jack, 2 Improved double circuit jacks, Smillear A battery filament switch, Hilco fixed grid condenser and mounting, Electrad grid leak, 7 Aristocrat moulded binding posts, binding post strip, complete set "No-Sod-er" connecting wires, hardware, blueprint and instruction sheet. You can assemble in only a couple of hours. List price for parts, \$37.84. Our catalog price, \$30.25. Special Price to August 31st, only \$26.49.

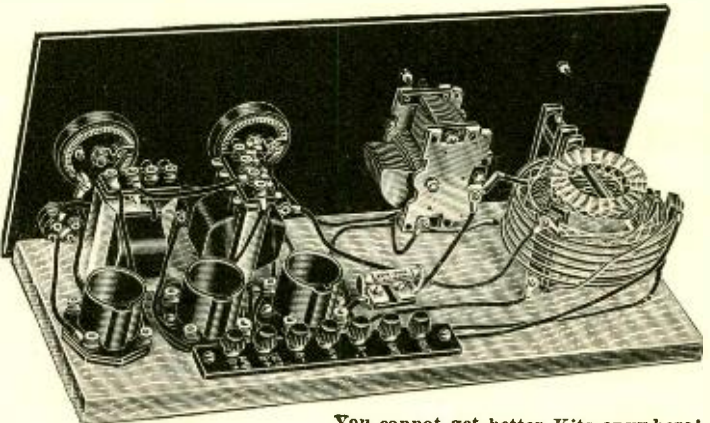

You cannot get better Kits anywhere!

This is a dandy! Order it!

BE SURE TO SEE THE OPPOSITE PAGE FOR NEW "RASCO" GOODS

ORDER DIRECT FROM THIS AD—ON APPROVAL
NO MONEY IN ADVANCE—SHIPPED ON APPROVAL—WE PAY TRANSPORTATION—24-HOUR SHIPMENT—SATISFACTION OR MONEY BACK
Send for CATALOG---36 pages, 7x10---FREE
Filled with big bargains in Kits, Parts and Accessories. Send today!

WE SHIP IN 24 HOURS Satisfaction Guaranteed

RADIO SPECIALTY CO., Kit Div. 679Q, 245A, Greenwich St., N.Y.

"BUILD YOUR OWN" WITH "RASCO" PARTS!

Buy from the Oldest and Original Exclusive Radio Parts House in the United States

We pay ALL transportation charges in U. S. ALL GOODS SENT PREPAID IN 24 HOURS

Order direct from this page.

SPECIAL PRICES FOR AUGUST

Money refunded if goods do not satisfy

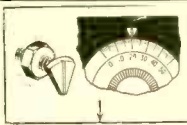

Dial Marker
The big little thing you have been waiting for. Just drill a hole in the panel and mount the marker above the dial. Nickel plated and polished. G7788 Dial Marker, three for\$1.10

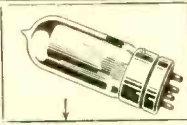

Vacuum Tubes Specially Priced
Only best make tubes carried in stock. Any tube replaced if defective, providing filament lights. G701A 5 v., .25 amp. \$1.65
G799 3 v., .06 amp. \$1.65
G72 1 1/2 v., .25 amp. \$1.65

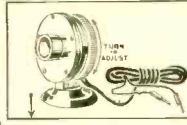

Melotone Loud Speaker
The greatest and most powerful loud speaker phonograph attachment made. If, after five days trial, you do not proclaim it the best and most powerful speaker return it for refund. G6699 Melotone...\$6.90

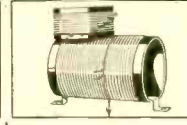

Cockaday Coil
Guaranteed best make. Three windings of No. 18 Magnet wire. Has brass brackets for panel or base mounting. Satisfaction guaranteed or money back. G2750 Cockaday coil \$1.50



Tapped "B" Batteries
We positively guarantee these batteries to be of long life. We carry only fresh stocks. All with taps. G2250 Sm. 2 1/2 v.\$0.65
G2251 Medium Navy size, 2 1/2 volt.1.20
G4500 Medium large size, 45 volt 2.30

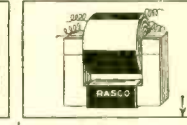

Audio Frequency Transformer
No better Transformer made. Highest class materials. Impregnated coils. Silicon steel stampings used. Save 50 per cent by assembling it yourself. G1100 Ratio 4 1/2-1..\$1.85
G1150 Ratio 6 1/2-1.. 1.85

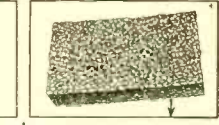

Sponge-Rubber Cushions
Get rid of tube noises due to vibration. Softest sponge rubber made. Size 2 1/2"x3", 3/8" thick. G8989 Sponge-rubber cushions, each\$1.12
Six for\$6.20

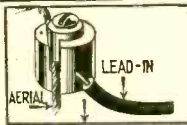

Antenna Connector
At last the solderless antenna connector, made entirely of brass in three pieces: clamps aerial and lead-in with vise-like grip, keeping perfect contact at all times. Dia. 3/4", height 1/2". G4244 Connector\$0.20

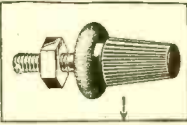

Rasco Vernier
Why use a vernier condenser when a vernier attachment will do anything and everything a vernier condenser accomplishes? Cleverest vernier made. Can be used with any dial. Soft rubber ring engages dial. Nothing to come apart. G1450 Vernier\$1.18

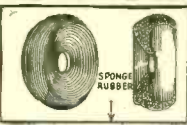

FONEKUSHIONS
Made of sponge rubber. Make wearing your receivers a pleasure. Positively exclude all noises and make reception a pleasure. Sponge rubber will last for years. Light as a feather. Sanitary. G3550 Fonekushions, set of two\$3.35



Dial Button
Made in blue enamel and gold, to be worn in button hole. Every radio fan wants one. 3/4" diameter, best gold plate. Perfect reproduction of radio dial. G7799 Dial Button. Each\$0.25

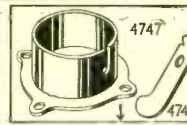

Vacuum Tube Shell
Nickel plated shell for the man who builds his own. 4 holes to attach to sub-base. Each shell comes complete with 4 phosphor bronze socket contacts. See illus. 4748. G4747 Vacuum Tube Shell and Contacts\$0.16

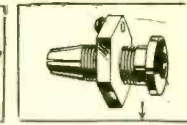

Cord Tip Jack
Takes place of binding posts. Cord tip firmly gripped by jack. Made of brass, nickel plated. Screw to attach lead wire. No soldering necessary. G1500 Cord tip jack. Each\$1.15

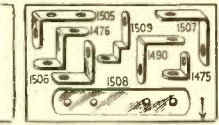

Brass Nickelated Brackets
All illustrations 1/4 size. G1505 Bracket, each \$0.05
G1507 Bracket, each .05
G1509 Bracket, each .04
G1476 Bracket, each .05
G1506 Bracket, each .05
G1490 Bracket, each .04
G1475 Bracket, each .03
G1508 Bracket, each .05



Three-Gang Socket
Aluminum shells, genuine heavy bachelite base, 3 brackets for mounting, 12 nickel binding posts. Length 7/4". G5995 3 gang socket \$1.50



Rasco 180° Variocoupler
Silk wire wound on bachelite tubes. Six taps. Wave length, 150 to 600 meters. For panel mounting. 1/2" shaft. Your money refunded if it is not all we claim. G3190 Variocoupler pre-paid \$1.50

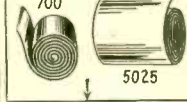

Copper Ribbon
.005" thick. G700 3/4" wide; G701 1/2" wide; G702 3-16" wide. All sizes per foot. \$0.01
Copper Foil
.001" thick. 4" wide. G5025 Copper Foil, per foot\$0.10
10-foot length\$1.00



Rasco Clip Leads
Invaluable for experimental work. Clip lead hooks in a jiffy onto any wire, binding post or conductor. Safest experimental connection. Brass clips, 1 foot silk wire, green or red. G7887 Clip Leads, ea. \$1.12
Dozen lot1.35



Radio Frequency Transformers
Best Radio Frequency Transformer developed so far. Designed by R. B. Lacault, Inventor of Ultra-dyne. Air core type. 200-600 meters. G2800 Transformer, size 1 1/2"x2 1/2"\$1.35



PUSH-PULL
Push Pull Transformer for many new circuits. See any radio magazine. Made of best materials. Silicon steel laminations. Save 50 per cent by assembling yourself. Simple instructions furnished. G1159 Push-Pull Transformer, ratio 6 1/2 to 1 \$3.40



Dielctrye Panels
Highest dielectric strength as per Bureau of Standards. Beautiful high finish. G7100 7x10x3-16"\$0.70
G7120 7x12x3-16"85
G7140 7x14x3-16"95
G7180 7x18x3-16" 1.25
G7210 7x21x3-16" 1.45
G7240 7x24x3-16" 1.65



Low Loss Tuner
Same type as used in our LOLOS EXPLORER. Tunes from 200 to 600 meters. Hard rubber insulation throughout. Silver plated primary. Secondary D. C. C. Tickler silk insulated wire. G2690 Tuner\$5.00



"T" Wire Connectors
This big little article solves all troubles when making "T" wire connections. Made to take 1/16" square or round bus-bar wire. Can be attached with a pair of pliers. G2975 "T" Wire Connectors, 12 for\$0.05

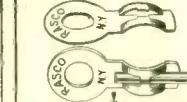

Nosolder Lugs
Finally, a real solderless lug is here. Soldering positively done away with. Takes square or round bus-bar, which it holds with a vise-like grip. Perfect connection. Just slide bus-bar into slip-grip. G3727 Lug, 25 for\$1.15



Low Loss Coil
Same type coil as used in Freshman and other Tuned Radio Frequency sets. D. C. wire, 200-500 wave length, 3" diameter, 1" wide, 5-16" thick. 4 connections, 2 primary, 2 secondary. G2629 Low Loss Coil \$7.00

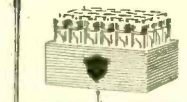

Storage "B" Battery
48 volts, 4 1/2 amp. hours. Buy storage "B" batteries by capacity, not by looks. Charge lasts one month. Rubber tops and vents, wooden tray. Sent Express Collect. G9848 Storage "B" Battery \$14.00

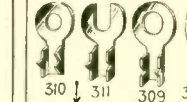

Tinned Nickel Lugs
All our lugs are tinned. G310 Brass Lugs for No. 8 screw, doz.\$1.10
G311 Copper Lugs for Nos. 6 and 8 screws, doz. \$1.10
G309 Copper Lugs for Nos. 4, 6 and 8 screws, doz. 10
G308 Copper Lugs for 6-32 screw, doz. 10



Formica Panels Clearance Sale
As we are discontinuing these particular sizes, this material is now offered at cost. All 3-16" thick. G352 9x12" each\$1.25
G354 6 1/2x9 1/2" each 1.60
G356 6x14" each 1.20
G357 6x4" each45



Phone Plugs
Sold from 50c to 75c everywhere. Hard rubber composition shell and patented cord tip holder. Finest workmanship throughout. G1030 Rasco Telephone Plug, Each\$0.35



Bakelite Socket
Octagon shape. Four nickel binding posts, phosphor bronze contact springs. Best brown bakelite. G6510 Bakelite socket \$4.00
G6500 Tube Socket. Made entirely of composition. Best made. Each\$0.35



Binding Post Name Plates
Dia. 3/4". These styles: Phones, Ground, Output, "A" Bat., "B" Bat., Loud Speaker, "C" Bat., Aerial, Input, "A" Bat., "B" Bat., Loop, "C" Bat., New! "A" Bat., "B" Bat. G6000 Name Plates, Dozen\$0.25



"Rasco" Posts
Made of black composition. G650-51 Each\$0.06
G202 Has nickel-plated bottom, each\$0.08
Dozen, each style.\$0.90
G122 Initialed Binding Posts. Six popular styles. Each\$0.06

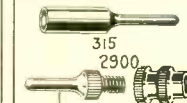

Cord Tips
Standard phone cord tips, nickel. G315 Each\$0.03
Separable Cord Tips
No solder required. Wire goes in ferrule. Shank holds it tight. Nickel plated. G2900 Each\$0.06



"Perfect" Lugs
These new and improved lugs are brass, nickel plated, flattened on top as shown. Made of a single piece of metal. Lead wire goes into tube. G3110, G3080 "Perfect" Lugs, Each\$0.02
Dozen Int. 20



Brass Rods
Sold in 6" lengths only. G8032 Rod 8-32" thread length\$0.08
G6032 Rod, 6-32" thread length\$0.03
G1425 Rod, plain, 1/4" round, length\$1.10
G3616 Rod, plain 3-16" round, length\$0.06

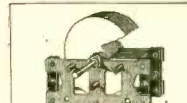

Panel Mounting Grounded Rotor Condensers
Positively no better condenser made. Lowest losses, all insulation hard rubber. Have binding posts, aluminum plates, rugged construction. Used by 9 big set manufacturers. G5113 13-plate\$1.10
G5123 23-plate 1.20
G5143 43-plate 1.30



Storage Batteries
Guaranteed for two years. Only NEW material used. Acid proof terminals. Patent vents. G2400 Two volt, 40 amp. hours\$3.90
G6440 Six volt, 40 amp. hours 7.25
G666 Six volt, 60 amp. hours 8.90
Shipped express collect.

New 1925 "Rasco" Catalog No. 12
CONTAINS 75 VACUUM TUBE HOOK-UPS, 300 ILLUSTRATIONS, 500 ARTICLES, NOW 100 PAGES

All Armstrong Circuits are explained clearly, all values having been given, leaving out nothing that could puzzle you.

Just to name a few of the circuits: The V.T. as a detector and one-step amplifier; all Armstrong circuits; one-step radio frequency amplifier and detector; three stage audio frequency amplifier; short wave regenerative circuits; 4-stage radio frequency amplifiers; radio and audio frequency amplifier; Inductively coupled amplifier; all Reflex Circuits.

FREE

A POSTAL CARD BRINGS IT



NEW Battery Lead Tags
Latest wrinkle, made in metal, nickel-plated, polished. Clamp tag on battery wire, and it won't come off. These five styles: "B" +, "B" + Det., "B" -, "A" +, and "A" -. G8830 Tags, set of 10 \$1.15

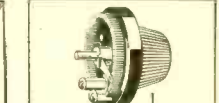

Rheostats and Potentiometers
High heat dielectric base. Come with tapered, knurled knob, 2 1/2" dia. Complete with pointer. G4310 0 ohm\$3.38
G4311 30 ohm44
G4312 Potentiometer 200 ohms65

RADIO SPECIALTY COMPANY, 98 Park Place, New York City
Factories: Brooklyn, N. Y. Elkridge, Md.

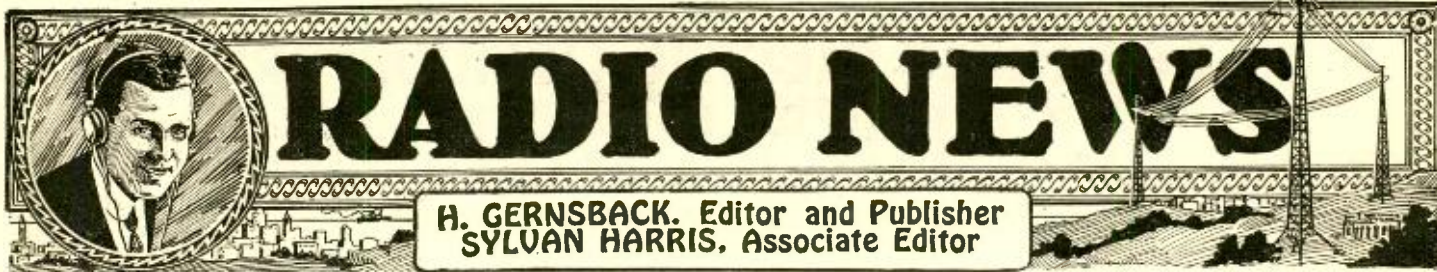

EDITORIAL AND GENERAL OFFICES, 53 PARK PLACE, NEW YORK

Vol. 7

AUGUST, 1925

No. 2

RADIO RECORDING

By HUGO GERNSBACK

RADIO enthusiasts are in for a new treat which is coming along rapidly. Very often when we listen in by radio to a great personality, a well-known opera singer, or a famous orchestra, we are wont to exclaim that radio, while a wonderful thing, is still more or less ephemeral. In recent years some well-meaning, but otherwise misguided people have condemned radio for just that reason. They will tell you glibly that, after all, there is nothing like the phonograph, because you can repeat the selection any time you wish, whereas with radio, if you get a really excellent offering, it has flitted into the past just when you enjoy it most.

These well-meaning people are in for a severe shock, because it is becoming more and more apparent every day that radio can beat the phonograph at its own game any time it wishes to do so. The writer has in his possession a record of a recent speech by President Coolidge. This record was made in New York, using an ordinary 4-tube radio set. Mr. Coolidge spoke from Washington, of course, while the speech was broadcast through a New York station. The man who made the record has a specially constructed little machine by which the radio loud speaker is attached to a recording device, through which agency the entire speech was recorded.

The writer understands that a number of companies are now busily engaged in bringing out recording machines which can be attached to any radio set, making it possible for even a layman to record any selection that is wanted, and so preserve it for future use. Nor will these recording devices be expensive. They will, in most cases, cost far less than a radio outfit itself, and provide a lot of new entertainment for the radio enthusiast.

This is of particular importance right now, when so many companies are going into the manufacture of radio sets having a phonograph as an adjunct. It will, therefore, be a simple matter to record your radio selection and then play it on the phonograph alongside.

The reader will now probably make the objection that the 12-inch record, which is the largest made, can hold only five minutes of entertainment. Smaller records, of course, are in proportion. What, then, will happen if the President of the United States, or some other famous man, gives a lecture that runs for twenty-five

minutes? Obviously, the phonograph disc is useless on such an occasion.

There is a more recent development which one concerns, taking cognizance of this fact, proposes to put upon the market. This is to be a photographic-phonographic device, similar in some ways to the DeForest Phonofilm. It is proposed to make a very narrow film, not more than one-quarter of an inch wide, rolled upon a reel. Such films could be bought at a low price.

The film is run through a small machine by means of a motor, while the incoming radio sound impulses are registered on the photographic film by means of a photo-electric cell. These films are good for a half-hour's run, while longer films can, of course, be made to run for an hour, if necessary.

A device of this kind naturally does not take up much room, nor is it expensive. The recording is easily done, even by a layman, and after the full record is finished the photographic roll is taken to your nearest drugstore and developed, just exactly as are the snapshots which you take with your Kodak. After the film comes back developed, it is run through the identical machine, by motor. The photo-electric cell is now used again in conjunction with your loud speaker. Every sound which originally came in through your radio set is held fast in the film, and can be reproduced a dozen or a thousand times, if necessary.

This method is much superior to the phonographic disc method. The latter has the disadvantage that the record must be made in soft material, such as zinc, wax, etc., and such a master record cannot be played many times before it begins to wear out. To be sure, matrices could be made from the original master record, but no layman would have the equipment to do this.

On the other hand, the photographic method is much better, because it has been proven that a photographic film on which sounds have been photographed can be run through the machine more than ten thousand times without acquiring any noticeable defects whatsoever. The reason is that no mechanical stylus is used on the photographic film, but rays of light instead, which do not affect the photographic film once it has been developed. We should, therefore, soon see in every house that has a first-class radio set, a radio recording device. It gives radio a new thrill and a permanency that it did not possess before.

The Piezo Electric Oscillograph

By C. B. Bazzoni*

Some of the most interesting experiments in electricity can be performed with an oscillograph. The construction of such an instrument is herein described.

THE general laws covering the flow of direct and of alternating electric currents in circuits, even of complicated design, have been known for so long a time that everyone interested in electricity is acquainted with them. The experimenter can thus predict with certainty the principal changes which will be produced in a given circuit by a current passing through it. The magnetic, the heating and the chemical effects are the most important and most easily observable results of current flow.

LITTLE KNOWN ELECTRICAL EFFECTS

On closer study it is found, however, that many minor electrical effects exist, such as the thermo-electric effects, the Seebeck, Thomson and Peltier effects, the Nernst, Ettinghausen, Hall and Leduc effects and so on, all of which are of interest although few are of great practical importance. Since most of these phenomena are unknown even by name to the amateur, a brief description of them may be of interest.

The *Seebeck phenomenon*, named, as are all the others, from its discoverer, is the ordinary thermo-electric effect. It is found that if, in a circuit made up of two different metals, the two metal junctions are kept at different temperatures a continuous although small current will flow. *Peltier's effect* is the reverse of Seebeck's. When a current flows through a junction of two different metals it heats them or cools them, depending on the direction of flow. *Thompson* found that a difference of potential exists between different parts of the same conductor when these parts are at different temperatures. *Hall* found that when a magnetic field is applied from above at right angles to a current-bearing wire a difference of electrical potential develops between the sides of the wire. *Nernst and Ettinghausen* showed that when two edges of a metal sheet are held at different temperatures and a magnetic field is applied at right angles to the sheet there will be produced a difference of potential between the edges of the sheet and also, conversely, that when a current is flowing through such a sheet set at right angles to a magnetic field a temperature difference appears between the edges of the sheet. *Leduc* found that, if the temperature varies in the direction of a magnetic field passing at right angles to a metal plate, a

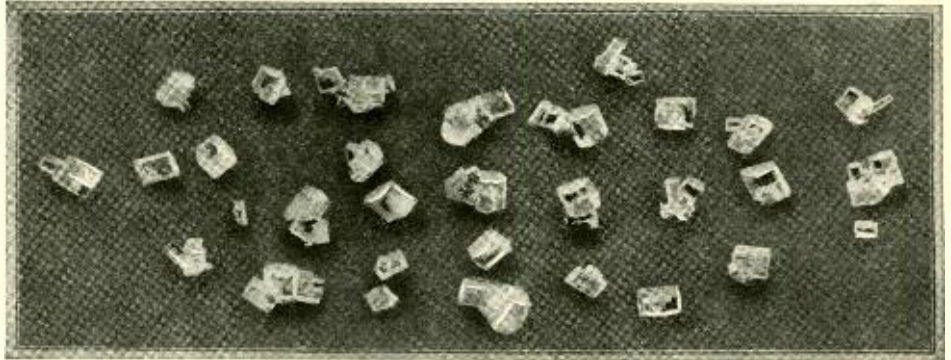

Actual size photograph of "seed crystals" of Rochelle salt grown by the instructions given below.

transverse difference of temperature will develop between the edges of the plate.

These "effects" are all small—Seebeck's being the only one which has been put to practical use up to the present time. It will be observed that all of these phenomena have to do with an interrelation of heat and of electricity and magnetism. Under the electron theory both heat effects and current effects are believed to be due to the atmosphere or cloud of free electrons existing in the interior of conducting bodies. This being the case, it is natural to expect that relations of the kind described ought to exist. Without going into detail it can be said that some of the phenomena referred to above are satisfactorily explained by the present-day theories and some are not. The Hall effect is found, for one, to be particularly difficult to explain in full. The "effects" mentioned are by no means all that have been discovered. A number of others, interesting and important, are associated with the passage of current through crystals.

CRYSTALLINE AND AMORPHOUS SUBSTANCES

We all know that matter in every form in which it occurs is made up of atoms having, on the average, a diameter of one one-hundred-millionth of an inch and, therefore, entirely too small to be perceived by any means at our disposal. There are in the known universe about ninety-two different kinds of atoms, each kind being characteristic of a particular chemical element. When these atoms combine in groups to form a chunk of matter they frequently show a preference for arranging themselves as if on a regular lattice-work, the atoms setting themselves at the joints of the lattice. This

comes about because of the regular nature of the forces acting between the different atoms. If this building-up process proceeds regularly, atom by atom, until a chunk big enough to be seen is formed, the chunk will

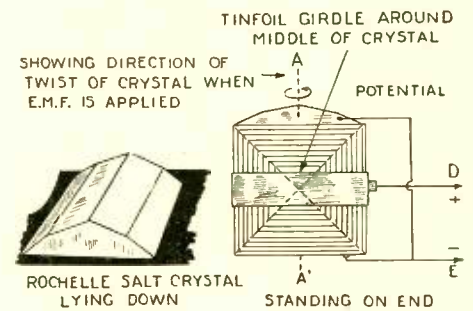

FIG. 1
The appearance of a Rochelle salt crystal. A good size for the oscillograph is approximately 2 by 1 1/4 inches.

be found to have a regular shape with sharp and definite edges and corners. The shapes themselves may be very various as obtained from different chemical compounds, as needle-shaped, cube-shaped, octahedron-shaped and so on, but for any one material the shape is always the same if the method of production is not changed. The usual way to bring about this slow building-up process is to dissolve the substance in a liquid and then slowly evaporate the liquid. The regular chunks of matter thus formed are called crystals. Modern physics has proved through the use of the X-rays that the atoms of all crystals are arranged in a perfectly regular and symmetrical manner, as if at the corners of a lattice-work, as mentioned above. The X-rays have also shown that nearly all forms of matter are crystalline, even though the crystals may be too small to be apparent. Substances which are entirely without a crystalline structure are said to be amorphous.

ELECTRICAL EFFECTS IN CRYSTALS

Crystals have been carefully studied by physicists not only as to their structure but also as to the way in which they react to heat, to light and to electricity and magnetism. Since we know how the atoms are arranged in the crystals it would seem that we have, in dealing with crystals, a better chance to explain what we observe in experiments than we have in dealing with ordinary solids about the interior structure of

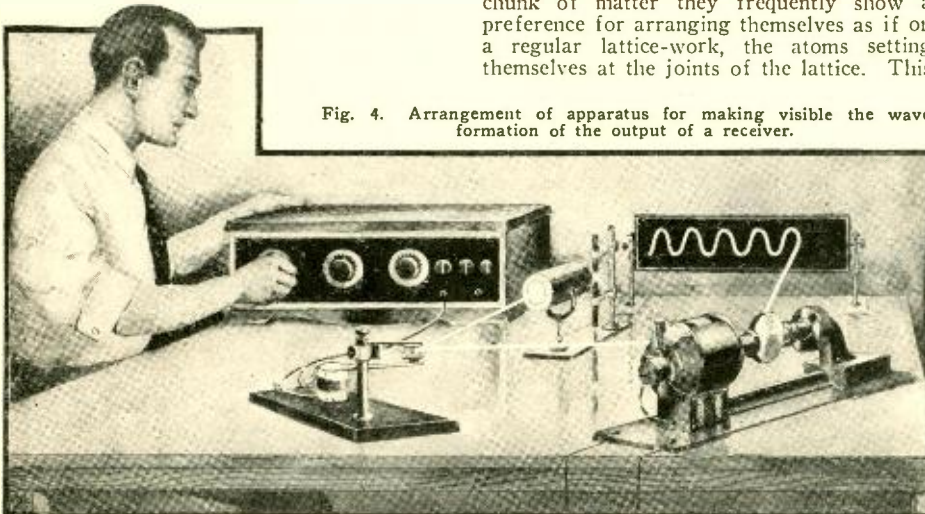
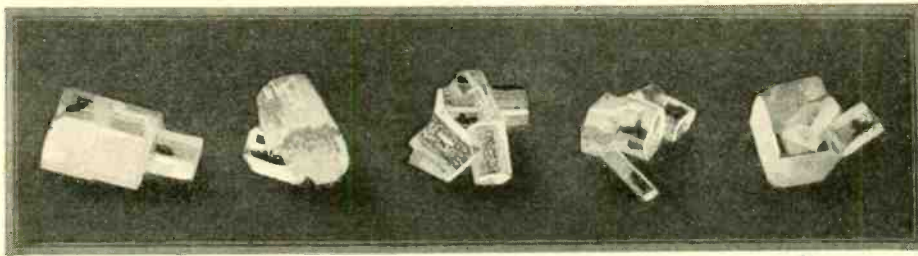

Fig. 4. Arrangement of apparatus for making visible the wave formation of the output of a receiver.

* Professor of Experimental Physics, University of Pennsylvania.



Some crystal groups of Rochelle salt which should be avoided. Crystal groups are useless as oscillographs.

which we know nothing. Work of this sort is being carried out at present in many university laboratories of physics so that we may hope in the near future to know a great deal more about these things than we do now. As to electrical effects in crystals there are two that I wish to mention in particular: first, the pyro-electric effect and, second, the piezo-electric effect.

PYRO-ELECTRICITY

As the prefix *pyro* indicates, this is a heat

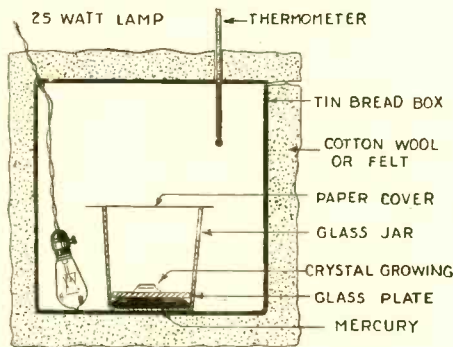

FIG. 2

To obtain well-shaped crystals it is necessary to keep a constant temperature, for which the above apparatus is used.

effect. It has been found that certain crystals exhibit electric charges when heated or cooled. This effect is marked in tourmaline—a semi-precious stone frequently used in jewelry. When a tourmaline crystal is heated, one end becomes positively charged and the other end negatively charged; when the crystal is cooling down after heating the charges are reversed. This effect can be shown in opaque crystals of tourmaline, which are not useful for jewels and which are, therefore, not expensive.

It is interesting to note that if the crystal be broken up, each part exhibits the effects above described. Even if powdered, the effect still persists. If the powder be heated on a glass plate its particles will stick together in chains as iron filings do in a magnetic field. Quartz and fluor spar, as well as many other crystals, show this pyro-electric effect. No practical use has been made of pyro-electricity up to the present.

THE PIEZO-ELECTRIC EFFECT

The prefix *piezo* of this somewhat formidable word indicates that the effect has to do with pressure. As a matter of fact, the piezo-electric phenomenon is found in the development of a difference of electrical potential between the ends and sides of a crystal when that crystal is compressed or stretched. This is not primarily a heat effect. As with pyro-electricity, piezo-electricity can be developed from a great variety of crystals, the details of the effect as to the amount and position of the charges developed being different in different crystals. The majority of experiments in piezo-electricity have been done with Rochelle salt, from which relatively large effects can be obtained and which is cheap and easy to prepare. Quartz crystals are more permanent and less breakable than Rochelle salt, but their piezo effect is

much smaller. For some special uses tourmaline is preferable to either quartz or Rochelle salt.

THE INVERSE PIEZO EFFECT

It has been shown that the inverse of the piezo effect also exists; that is, that if differences of potential are applied between the ends and the middle of suitably selected crystals a stretching or compressing force will be developed in the crystal which may show itself in a warping of the shape of the crystal. The direction of this twist or warp is shown in Fig. 1. The principal purpose of this article is to describe an instrument making use of the inverse piezo effect in measuring changes of electrical potential.

The twisting of the crystal about its axis due to the changes in the potential applied to it is nearly instantaneous, consequently the twistings and untwistings of such a crystal will follow very rapid alterations of potential such as we get in alternating current circuits. If the crystal be mounted so that its twisting can be readily observed, the arrangement can evidently be used to study the nature of the potential changes in such circuits. Instruments designed to do work of this kind are generally called "oscillographs." The piezo-electric oscillograph which we are to describe below was devised by Mr. C. E. Wynne-Williams of the University College of North Wales, Great Britain, and was first

publicly described by him in February of this year (1925).

OSCILLOGRAPHS

Oscillographs of several different types have been invented in the past and have been in use in laboratories for many years. It would clearly be very difficult to find out exactly what goes on in alternating current and radio circuits without such instruments. The two most usual kinds of oscillographs are the "hair-pin pattern oscillograph," suitable for alternating frequencies up to 5,000 per second, and the "cathode-ray oscillograph," suitable for frequencies up into the millions, that is, in the radio range. An instrument of the first kind costs, with necessary accessories, in the neighborhood of \$1,200. The second type costs complete about \$150. No ordinary amateur is, on account of these relatively high costs, likely to possess one of these useful instruments. The piezo-electric oscillograph, which within cer-

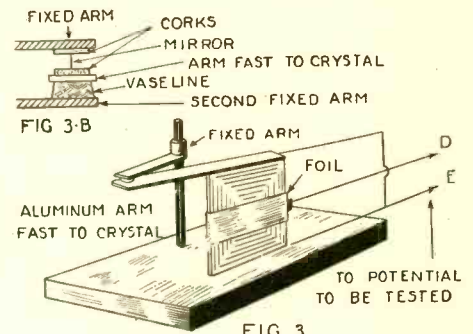
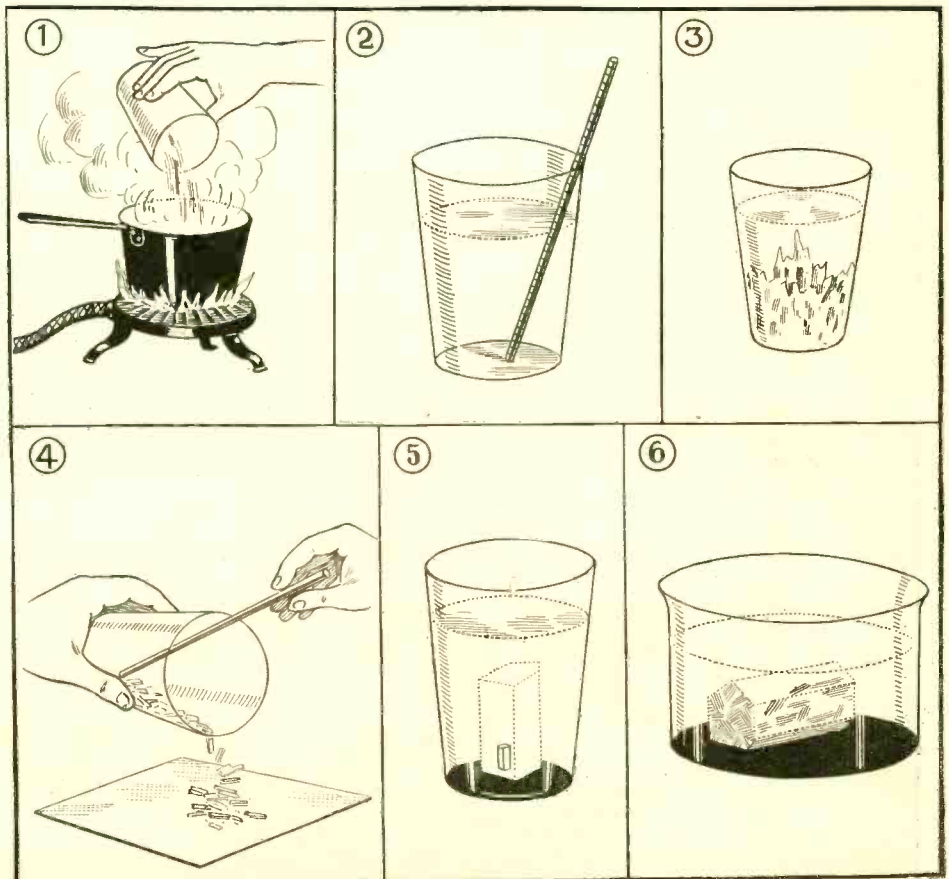

FIG 3 The appearance of the oscillograph, showing relative positions of its components. Fig. 3B. Device for damping.

tain limits will do the same work, can, however, be built for a very few dollars by anyone willing to spend the time necessary for the preparation of a suitable crystal. (Continued on page 233)



Method of growing Rochelle salt crystals. These figures show the routine of the process of forming the crystals. Great care must be taken to have the solution temperature and specific gravity just right.

Listening In Across Canada

By ROSE D. MEYER

For a year and a half the Canadian National Railways have been broadcasting programs of great merit. Here is the story of how it has been accomplished.

SINCE the very beginning of broadcasting, Canada has shown an extraordinary interest in and enthusiasm for radio, and she now ranks high among the countries of the world for her achievements in this field. Canada has already erected a chain of nine broadcast stations which, simultaneously operating, blanket the country, and is ambitiously endeavoring to be heard in Europe, although she is considerably further from the average European listener-in than the United States. On February 3, 1925, the first attempt was made, a special program broadcast from Moncton, New Brunswick, in an effort to reach radio fans in Great Britain and Ireland.

This initial entertainment, broadcast on a wave-length of 313 meters, was under the direct supervision of W. H. Swift, Jr., radio engineer, and the British Broadcasting Company co-operated by clearing the air in Great Britain at 11 o'clock, so that as many listeners-in as possible might receive the Moncton station. The musical program included selections characteristic of the Motherland, and concluded with an arrangement of Canadian airs, while bagpipe selections formed the *pièce de résistance* for the Scottish listeners.

The addresses of the evening were made by Sir Henry W. Thornton, Chairman and President and W. D. Robb, Vice-President of the Canadian National Railways, for Moncton is the ninth link in the great chain of radio broadcasting stations operated by this institution. One more link—Vancouver, B. C., which soon will be in operation—remains to be added, and the chain will be complete from the Atlantic to the Pacific.

A novel service was put into operation by this railroad during the visit of the Prince of Wales on his trip across Canada last fall. From the time of his arrival until his departure, arrangements were made so that he and the members of his household were kept informed by radio of affairs of the world

and given periodical entertainment from various broadcasting stations in Canada and the United States. However, the railroad did not depart from the standardized practice of the radio engineering department in the matter of programs on trains, so that passengers on regular schedule were able to enjoy the programs broadcast for the Prince's party in the same way and through the same types of instruments as were used on his special train.

To commemorate the first anniversary of the installation of radio as a definite part of the service furnished by this railroad, its executives, on December 28, 1924, sent New Year's greetings and good wishes via radio to the members of their staffs and employees in general. The actual broadcast took place in the Montreal studio, and it was from there that the executives spoke. Previously this station and that at Ottawa (the mother station) and Toronto had been "tied-in" by special telephonic circuits and the voices of the speakers carried by this means to the studios at Ottawa and Toronto. In these latter places the telephone circuits led into the amplifying instruments and voices and music were there re-broadcast from each station, forming the most important simultaneous broadcast yet performed in the Dominion. Copies of the New Year's messages and addresses had been forwarded to other radio stations of the system, which were read by announcers from Moncton, Winnipeg, Edmonton, Calgary and Saskatoon—Regina having been the only one of the chain of nine stations silent that night. Thus by means of the simultaneous and related broadcast, Canada was covered from coast to coast, and, in addition, vast audiences from the United States had an opportunity to listen-in.

RADIO ON TRAINS

The Canadian National was the first railway in the world to adopt radio as a part of its service, and it has played an important rôle in radio transmission, particularly on

train service. Radio experimentation of this system may be said to extend back to 1902, when Sir Ernest Rutherford, then a professor at McGill University, carried out successfully the transmission of signals by wireless to a moving train on the Grand Trunk Railway System between Toronto and Montreal—this system is now a part of the Canadian National Railways. This was the first occasion upon which wireless had been successfully transmitted to a moving train. However, it was not until the early summer

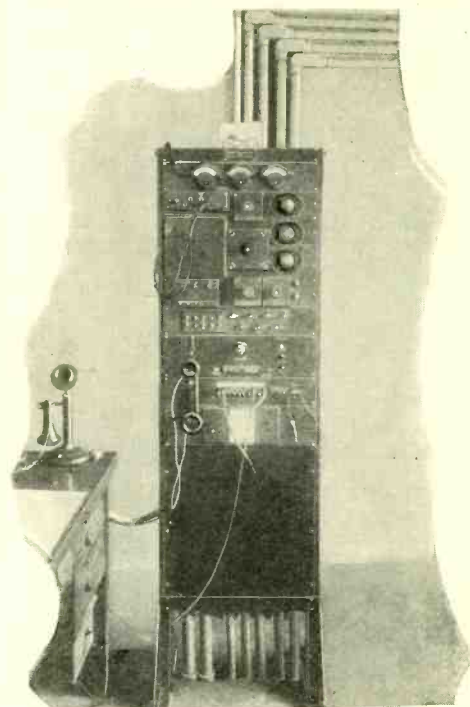

A transmitter of the Canadian National Railways.

of 1923 that radio really was adopted by this railroad.

Difficulty was encountered at first in securing the types of sets necessary for the successful reception of concerts on board a moving train. However, this has been overcome, and now radio receiving apparatus has been installed in the observation cars of all the company's trans-continental and international trains. The equipment used is a four-tube garod Neutrodyne receiving set in conjunction with a Northern Electric power amplifier and loud speaker. In case of unsatisfactory reception for loud speaker work, fourteen head-phones are conveniently arranged throughout each observation car; these cars are also equipped with collapsible aerials. An experienced radio operator accompanies each train, who tunes in on the programs, which are given twice daily.

The importance of radio in the fabric of civilization cannot be overestimated. It has, through some method of its own—just how we do not understand—assisted us in collecting together scattered waves of ether and coercing them to serve us in a great diversity of ways. The mystery and wonder of it attribute in a large measure to its fascination. Such thoughts were flitting through my mind after a thorough enjoyment of the radio entertainment provided from my seat in the observation car while traveling on this system from Winnipeg to Vancouver last summer. The broadcast had

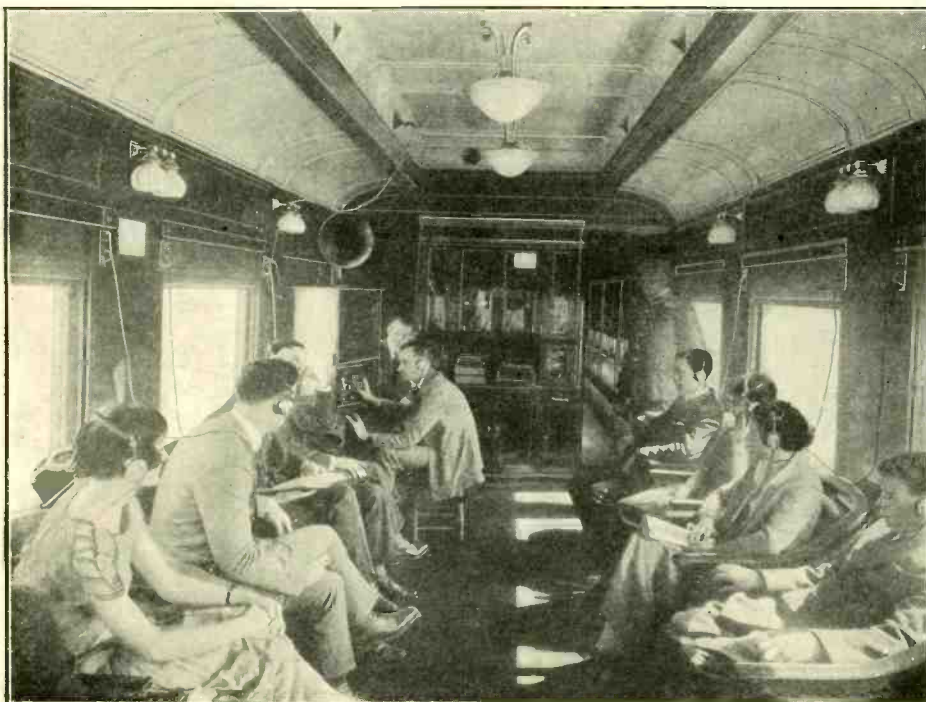

Listening to radio programs on a Canadian trans-continental train.

been from Ottawa. I was suddenly brought back to the world of reality with a sort of jolt by the words: "But how does the sound come into the train when it is going so fast? Where does it come from? Gee, I wish I could understand how it all works!"

So absorbed had I been in the program I had given no heed to the fact that the train had come to a stop at a small town in the prairie province of Saskatchewan. Near the platform a small group of farmer boys in khaki had gathered and were listening as if in a trance to the vocal selection being wafted to them. The metropolis and its gaiety in some of its finest phases are brought to them. We of the city have become so accustomed to the phenomena of this invention as to regard it as almost commonplace, but not until I had talked with some of the farmers of Western Canada did I fully realize what a blessing and boon the radio has come to be to the settlers of the sparsely populated districts of the prairie provinces. The dread of isolation, which has been such an obstacle to development, has been removed, and most of the farm houses in these provinces, so rich in potentialities, are now equipped with radio receiving sets. In the interesting old Indian reservation of Kitwanga, B. C., I saw two radio sets and one Ford car. Surely, the world do move.

PURPOSE OF RADIO CHAIN

In referring to the development of the radio service of the Canadian National, Mr. Swift, radio engineer, said: "The building of stations and the equipping of trains with receiving sets was only one feature of the work. There had to be a directing policy of real service, not merely to the company and its patrons, but to the country at large if it was to justify itself and to retain its popularity. And the broadcasting of music and features of entertainment is but part of this policy. The real thought behind it is the dissemination of information about the Dominion. Every program includes a short address with this end in view—information on its natural resources, its physical attractiveness, and its opportunities to the settler, capitalist, and the industrialist. The radio department is also co-operating with national welfare campaigns. By the use of radio, officials of the system are able to give per-

The antenna wires on the top of the observation car are supported by brackets that are collapsible.

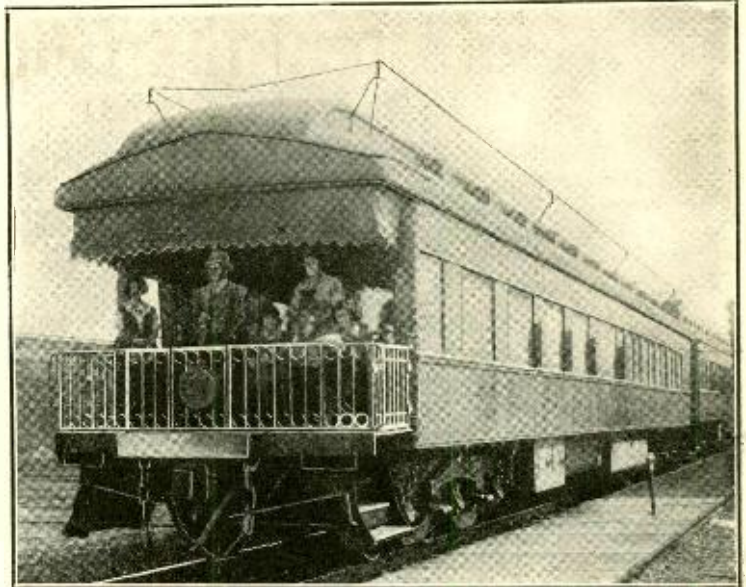

sonal messages to employees in their own homes, thus coming into direct contact with the men in a way that otherwise would be impossible. And there is another important result which cannot be omitted—it may be indirect, but that does not lessen its importance—radio has done an incalculable amount of good in keeping content those who have to live in sparsely settled districts of the north and west. Daily quotations from the grain and cattle markets are broadcast from Calgary, and each evening from one or more of the prairie stations the air holds entertainment for those who have the desire to listen—and their name is legion. The obstacle of distance thus has been overcome."

In July of last year the new call letters beginning "CNR" for all Canadian National programs went into effect. Officially the call is a four-letter one, the fourth being the initial letter of the city wherein the station is situated, for example—Ottawa's call letters are CNRO; Montreal, CNRM; Toronto, CNRT, etc. The letters "CNR" had been originally assigned for radio purposes to the Moroccan Government, but with the co-operation of the Federal Government, the

British Foreign Office and the French Government arrangements were made whereby Morocco agreed to relinquish these letters and substitute another call. Difficulty arose in the case of Moncton, where had this plan been carried out, the call letters would have clashed with those of Montreal. It was decided to name Moncton station CNRA, the "A" symbolizing the Atlantic region, of which Moncton is the headquarters.

This is but a brief résumé of the activities of the efforts of just one great organization to transform many aspects of contemporary existence through the medium of the radio.

When one considers the progress made in radio development within the past few years, not much flight of the imagination is needed to visualize broadcasting stations of such increased power and more completely developed re-broadcasting schemes as will enable programs to be heard simultaneously over large parts of the earth's surface. International broadcasting, which will link up the farthest corners of the world, is perhaps closer at hand than the general public imagines.

Radio Hazards

By CLARENCE U. PURSELL

DURING the past three or four years much has been said and written about radio in its various branches. A great deal of advice has been given regarding the proper set to buy, which circuit to use and methods of installation, insofar as the technical end is concerned. Little, however, has been brought to the attention of the public dealing with hazards which may be encountered either through ignorance or negligence and certain precautions that are necessary to the protection of life and property.

The use of the radio is of itself by no means a risk, and the radio fan can be assured that there is absolutely no danger in indulging in the pleasures and benefits of this timely art if a fair amount of common sense is used in the installation of the apparatus and especially the erection of the antenna. Only the other day a serious accident occurred in Waltham, Mass., while a young man was drawing an antenna wire across an electric light wire. The fact that the electric light wire was insulated did not matter as his antenna wire soon cut through the insulation, communicating the current to his body. The problem of the antenna installation has caused carelessness on the part of a great many fans throughout the coun-

try, and this faulty installation has been the cause of the greatest number of fatalities.

The following "Don'ts" are given for the benefit of those who would profit by the example of those who have been unfortunate enough to become involved in some needless mishap:

Don't run an antenna over or under any other wires carrying an electric current of any sort, whether these wires be high tension wires, service wires or telephone lines.

Don't attach an antenna to any pole or tower to which other wires are attached, or climb or attempt to climb such poles or towers for any purpose.

Don't run an antenna over or across any public highway.

Don't attach an antenna to any electric light, telephone or telegraph pole even though no other wires are attached thereto. If using an outside antenna, always comply with the regulations governing the installation of an approved lightning-arrester. Such a device is inexpensive and easily installed.

Don't borrow your neighbor's antenna by attaching your lead-in to the far end of his wire. You don't know what he is doing and besides antenna wire is cheap and serves the purpose far better than a lot of gall.

Don't attach your antenna wire to a kite. Don't use your telephone line for an antenna. Connection to an electric light socket is not encouraged nor recommended.

Remember that a high voltage "B" battery can cause considerable damage if carelessly handled. The insulation on the wiring must be sufficient for the voltage used. Care should be taken in the installation of a large capacity storage battery. Short circuits should be guarded against by proper wiring and insulation.

Remember that results can always be obtained from an inside antenna if the necessary precautions cannot be taken in the installation of the usual outdoor aerial. It is far better to sacrifice a little signal strength and distance reception than to take too much for granted and not even live to be sorry for it.

SIZZLING

BINKS: What do you know about it? I got Hades on the radio last night.

JINKS: Impossible.

BINKS: Well, I heard a frying sound in the loud speaker.

Contributed by Paul S. Powers.

Radio and the Blind

By W. H. McDONALD

RADIO NEWS takes pleasure in presenting this article to the radio public. Radio has proved a godsend to the blind, as it enables them to listen to events throughout the country as they occur, instead of having them read to them later on. For instance, when the recent race between the 20th Century Limited and Gar Wood's speed boat was broadcast from the airplane, Mr. McDonald followed the progress of the racers by radio from Albany to New York.

THE radio, in the extended use of which it is capable, has brought to many classes and groups of people a great field of pleasure, education and a widening of the intellect that cannot easily be estimated. Among these classes and groups is that of the blind.

Its adaption and peculiar fitness to aid the blind in the acquirement of education and useful knowledge has been recognized by the public in general and by the workers for the blind, and there is already a movement under way to provide radio sets for the

but he assured me that all four pointers on both dials were exactly alike and that the real pointer was only different in that it was gilded. I was discouraged somewhat, but I determined to use a blind person's methods entirely, and I examined the instrument carefully and found that there was a very distinct way in which I could tell the pointers—and at that very easily.

They were not exactly the same, though the difference is small, and although it escaped the eye of the onlooker, it could not evade the delicate touch of the blind. So



Mr. McDonald uses the touch system on the typewriter for correspondence so that tuning his radio receiver in the same way is comparatively easy.

I noticed that there are six small screws around the outer circumference of the dial that holds it in place. All the numbers on the dials are in the upper half of the circle. At the end of the horizontal diameter of the dial there is one of these screws, and there are two on the upper part of the circle, so I mentally divided the semi-circle into its 180 degrees. This brings the first screw at the beginning of the semi-circle at zero degrees, the second screw at 33 degrees, the third at 66 degrees, and the fourth at 100 degrees; the subdivisions are quite easy.

The control of the battery position is easy enough and does not require to be touched upon. All the other adjusting of the instrument is very easy and quickly attained.

A BLIND MAN'S INVENTION

In connection with this discussion of the benefits and advantages of radio for the blind, it might not be inopportune for me to describe briefly an idea for a machine which I have been trying for some time to develop and which would, I believe, prove to be as great a blessing to the blind as radio. I mean an invention which would, in some manner, permit the blind to read by sound.

I had often thought that there might be some method by which the blind might read from sound, and a few years ago I began to study the question, and thought out several ways in which it might be accomplished, such as by the use of perforated paper, some ink that would serve as a conductor of electricity, etc., but discarded them all as untenable. Then the peculiar properties of selenium came to my notice and, on reading up the subject as well as I could, I found that this was well adapted to my scheme, and

I gradually thought the whole thing out,
(Continued on page 228)



By feeling the position of the pointers with respect to the heads of several screws on the face of his radio receiver, Mr. McDonald can tune in stations by the "touch system" as easily as those who depend on the dial logging system.

people of the dark, and with the help of the newspapers of the country it is now possible for every blind person in the country to procure a radio set at a nominal cost.

It is entirely within the power of all blind persons to use the instrument fully as satisfactorily as their more fortunate friends, as there are no difficulties in the way that cannot be readily overcome by the blind.

I have been totally blind for thirty years, and I now sit up every night until far past midnight, when all the house is silent and dark, listening in until the last station says good-night; then I turn off the switch and reluctantly go to bed.

The instrument that I am using is the six-tube super-heterodyne, and I find it a very sensitive and reliable instrument.

HOW THIS BLIND MAN OPERATES HIS SET

I have had it about six months and up to a month ago it was always operated by a sighted person. Then I undertook to manipulate it myself, and now it is at least as easy for me, and possibly more so on account of my more carefully trained hearing, as for my sighted friends.

At first it seemed quite hopeless for me to find the different stations, and to use the dials as they should be used, but after a little perseverance it came to me very quickly. I had a talk with the agent who had provided the machine, and questioned him closely to find out if there were not some manner by which I could distinguish the difference between the hands on the dials,

far successful, I went at it in earnest, and now I can find a station as quickly as any one, and tune in more accurately than most operators.

In finding a station I take note only of the dial number on No. 1 dial, disregarding the number given for the other dial, and then get the right position for the No. 2 dial pointer by moving it a little to right or left of the number on dial No. 1. This simplifies the tuning very much.

The manner in which I find the numbers on dial No. 1 cost me some little thought to develop, as I wished to avoid putting any mark on the instrument or in any way using anything to indicate something to the blind, and so I use about the same method that I have used for years to tell time by my watch, which is by feeling the hands, and finding the time to the exact minute by the angle they make with each other.



Putting WRNY On the Air

By GILSON V. WILLETS, Chief Engineer, Station WRNY

Few people realize the enormity of the task of preparing a broadcast station for transmission. In the following article are related a few of the odd jobs.

THE average layman believes that all that is necessary to place a new broadcast station on the air is to buy a good transmitter, set it up in a room, have a couple of masts built, swing an antenna, and then have a big opening party, with notables present to welcome the radio audience.

The actual situation is quite the contrary. The setting up of the parts is the very least of the difficulties encountered, inasmuch as most of them are covered by circuit diagrams and engineering data. The erection of the masts always presents difficulties, as the antenna must be considered with regard to directional effect, absorption by surrounding structures, and the actual foundations for the masts themselves. Also the studio must be treated properly for acoustics, and various other things attended to, all of which are in routine of building a station.

The tuning of the station, however, involves three of the most complicated conditions confronting the modern radio engineer. The first is that of obtaining the wave-length specified by the Department of Commerce for that station. The second is balancing the oscillator and modulator circuits to insure a clear transmission. The third is the elimination of what is known as radio frequency pick-up—the worst bug-bear in a modern station.

The tuning of Station WRNY presented to its engineering staff and consulting associates one of the most complicated problems ever placed before a broadcast station personnel, inasmuch as the antenna has only one-third the length of the lead-in, and the lead-in is surrounded for more than one hundred feet of its length by three walls of the massive structure of the Roosevelt Hotel at 45th St. and Madison Ave., New York.

The first thing to be done after the set was fully hooked up was to adjust the oscillator circuit. To do this, if Heising modulation is used, it is necessary first to remove the modulator tubes and the speech input tubes, leaving the oscillator circuit free to swing itself.

Station WRNY is equipped with the latest device known to the world of radio engineering, called a harmonic suppressor, the effect of which is the elimination of the signals of WRNY from every frequency except that to which it has been assigned by the Government, which means, in fan language, that the station may be tuned in on only one setting of the dial. The tuning of the oscillator to a specified wave-length includes hundreds of changes of inductances, capacity and plate current. This took over a week of constant testing by the engineering staff, during which time the oscillator circuit had to be tuned to the proper frequency. Further, the harmonic suppressor had to be properly adjusted, and all these tested out with special precision instruments which measure currents so infinitesimal that only the finest of current-squared galvanometers would indicate them.

The Western Electric equipment used at WRNY is the very last word in engineering, and in order to get 100 per cent. efficiency from it, every adjustment had to be made with the idea in mind of passing the maximum current from one circuit to another. The result of this was that the oscillator circuit measured 7 amperes, the antenna circuit registered 65 amperes, and resonance was to be found throughout the transmitter. Thus far the work was accomplished by keeping the oscillator plate cur-

rent very low, but at this point the oscillator plate current is raised to its proper value, and the circuits are in true resonance throughout.

Now we are ready to balance the oscillator and modulator circuits, leaving the frequency dials on the transmitter locked. This is not so bad and only requires an hour's work.

With Heising modulation the transmitter functions so that when the modulator plate current rises, the oscillator plate current falls. To secure the best results when modulating at frequencies of ordinary voice transmission one figures a raise in modulated plate current of 100 per cent.

Station WRNY uses two 250-watt oscillators, and two 250-watt modulators, with one 50-watt input tube. These tubes take a filament current of 6.3 amperes each, and a plate voltage of 1600 volts. The tuning coils for the transmitter are wound with the very finest grade of imported Litzendrat wire, and the set is equipped throughout with specially constructed time-delay relays, which protect the big tubes from injury when starting up the set. Each one of these relays must be properly adjusted so that it will close its contacts at the proper moment. At this point, with the transmitter functioning properly, all meter readings correct, the tubes not overheating, and the wave-length checked correctly, we are ready to try the modulator carrier. The very instant that the microphone is thrown in, one notices that the modulator plate current takes a decided rise to about 400 milliamperes, and one hears at the receiving end a loud whistling noise. This means that the carrier wave from the antenna which has been propagated through space has been picked up by some unshielded part of the

speech input system, carried back through the transmitter, highly amplified by the amplifiers therein, and shot back again to the transmitter. If one should say "hello" in the microphones under these conditions, if it were possible to record the result at the receiving station, the result would be several thousand hello's within a ten-thousandth of a second.

This cannot be as there must be no energy from the antenna picked up on the speech input system and subsidiaries thereof. Immediately the operators will set about locating unshielded wires and then properly covering them, and grounding the shielding every few inches. In the erection of a broadcast station everything must be grounded or shielded, and the shielding is grounded, and the slightest oversight in this matter will mean that energy from the antenna will be picked up by the speech input system, and transmitted back to the transmitter and distort the wave, making it impossible to transmit voice or music.

The modulation of the set is first tested by an announcer who will count from one to ten, raising the volume each time he counts. When you hear an announcer at a new station counting from one to ten, and following it with "On one," or "On two," you will know that he is running the volume control, which is called by the broadcasters the "gain."

When everything had been tested out and the wave was stable, the United States radio inspector called at WRNY and, after a very careful inspection of the entire equipment, in which nothing was overlooked, he passed upon the installation. Next an application was sent to Washington for the official call signal which is WRNY. The station went on the air officially June 12th at 8 P. M.

Instructions for Using "Proof of Reception" Card

Remember that the station must be convinced that you have actually heard their broadcasting. Comments of the Announcer or the mention of some particular identifying incident that occurred during the number are, perhaps, the best proof of this. The exact time that a particular number began or ended or the sequence of numbers are other proofs.

Fill out all the blanks on the card and take care that your name and address are plainly written where they belong and that a dime is inserted. Then put the card in an envelope addressed to the broadcasting station you heard. A list of addresses of broadcasting stations is included in your ekko stamp album.

My Name _____ City _____ State _____
 Street and Number _____
 On _____ at _____ I heard your station _____
Date (Day and Month) Time (A. M. or P. M.) Call letters
 broadcasting the following: _____

Please send me one ekko stamp of your station. Enclosed find ten cents to cover cost of mailing and verifying.

Be sure your name and address are PLAINLY marked above.

© THE EKKO COMPANY 1925

(OVER)

The proof of the reception card and stamp of WRNY used in the Ekko stamp album. This means of proof of reception will be used by the RADIO NEWS broadcast station.

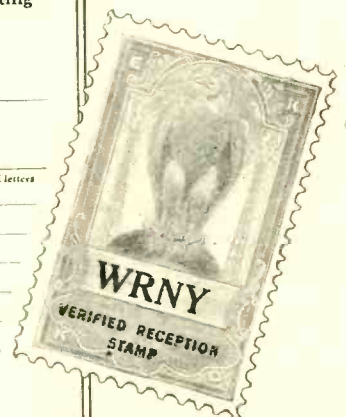

Up In the Air Over Aerials

By EDWARD C. HUBERT

Some experiences of an experimenter who has had "ripping" good fun putting up aerials.

I HAVE been putting up aerials for ten years. I have risked my lanky neck innumerable times climbing branchless trees, swaying masts and steep-sloping roofs. I have had dead twigs break beneath my pedestals—and saved myself by hanging on with my teeth, my belt, the seat of my pants or some other part of my anatomy. I have been marooned in trees while all of the most vicious dogs in the neighborhood growled, in expectation of a large, generous bite, as they parked themselves below me. I have had ponderous aerials nearly pull me out into "the great open spaces."

My dreams are haunted by terrifying memories of my bird-like existence. I am told that my dreams are not of the best Freudian standard. I fear that I have a serious aerial complex. Any night I can see myself wrestling with an over-sized, heavy-weight aerial at a dizzy height, and feel myself being thrown for a total loss of a hundred feet before I meet the earth. And after I volplane down, a huge porcelain insulator follows me and cracks me a hard one on the bald spot. I don't understand the fellow who wrote that song, "Why Don't My Dreams Come True?" He must have been a "glutton for punishment," as the phrase goes.

I have always had high ambitions about aerials. When I was new at the radio game, just a kid, I planned to tie a fifty-foot iron

pipe to the chimney on top of the house. A tremendous aerial that would make Marconi green with envy was to hang from the top of the mast. The "great idea" didn't make such a hit with some members of my family who happened to live in the house also. They didn't turn green with envy, but they did turn white with fear at the thought of a huge iron pipe and aerial tied to an old chimney. That aerial was never put up. It died on paper. As several other excellent ideas did!

But I did finally get an aerial up on the roof. (The mast was left on the ground.) I'll never forget the thrills and risk of putting up that aerial. There was no skylight, so I had to climb out of the attic window and crawl, flat on my stomach, up the hypotenuse of a forty-five degree angle. On paper the angle may not seem so steep, but on your stomach, fifty feet above the stone sidewalk, it seems like a straight angle, a reverse angle, or some new kind of angle devised just for your destruction.

I slipped once, on the way up and slid, like a glacier, down the roof till my feet met the rain gutter. I lay there several minutes, not daring to move. This was not cowardice, it was the instinct of self-preservation, so long dormant in me, asserting itself. Cowardice is being afraid to do something noble. There was nothing noble to do up there on the roof, and crawling around on

my stomach like an animal didn't make me feel noble either. I did try to picture myself as a martyr to the radio cause, with Marconi paying tribute at my bier. But I was interrupted from these pleasant thoughts by a comforting voice from below:

"Hey, young feller, be careful! You'll break your neck!" But being of a contrary nature I raised five fingers at him and climbed up to the top of the roof, without any casualty other than an embarrassing tear in a certain part of my wearing apparel.

I have since put up other aerials with ripping good success. But I am no more at home in the clouds than I am in the sea. I have been told that I am a poor fish. I also think that I am a poor bird.

Recently I doped out and built an aerial that was to be far superior to any others tried. I bought several dollars' worth of tinned copper wire, long, high-grade porcelain insulators and low-loss lead-in tubes. I bent stiff No. 10 galvanized iron wire into two-foot rings and built a jointless, low-loss, cage aerial of six wires. I was so careful, so precise about the smallest details! The aerial would be a world-beater!

Well, I picked a seventy-foot maple tree to climb and have not been the same man since. The careless, boyish smile has left my face, my hair has left my head. There is an expression of fear, worry, horror upon my once noble countenance and I have the nervous manner of an old man who has lived—and suffered—intensely.

But I am not looking for sympathy; I am trying to tell a story, and I may succeed. However, I have never seen, nor torn my pants on a tree like that awkward, topless maple. I have never climbed a tree that had the branches so inconveniently located and so unwilling to hold me. Bugs, ants and the stickiest of sap added to my discomfort and hindered my ascent. Words suitable to the circumstances only increased my anger and made me more uncomfortable.

When I finally reached the height of sixty-two feet I paused—"nor breath nor motion." I was afraid to move a muscle or an eyelash, lest I break the thin stem I had draped myself upon. I looked East, West, North and South and saw in the distance cities, countless housetops and towers, second only to my lofty perch in altitude. I looked down, far down, to the ground and then above me at the small twigs that completed the seventy-foot height and realized that I was in a very hazardous location!! Just about this time, all of the neighbors and "Calamity Janes" within twenty thousand meters assembled below to warn me, and to be on hand to say "I told you so!" if I fell and died a suitable, miserable death.

The comments and suggestions of this mob below me reminded me of a Yale cheering section chanting the Harvard funeral song. Being of a musical and morbid nature, I joined in the chorus and finally led the whole congregation in the singing of Chopin's "On To The Morgue." All were much inspired, even myself, the corpse.

Well, to make a wrong story short—I fooled the public, double-crossed them as 'twere, finished my lofty purpose and descended, under my own power. The aerial was finished and, of course, I thought the set worked ten times better than before.



"I slipped once on the way up and slid, like a glacier, down the roof until my feet met the rain gutter. I lay there several minutes, not daring to move."

But the funny thing about it is the strange way the set acted after a few days' operation on the new aerial. I had become accustomed to the new dial readings since hooking on the new aerial. But one night I noticed all the readings were several degrees higher. The volume was just about the same as before and I picked up WMBF, WEBH and several other DX stations, on two tubes. Apparently the set was working just about normal, except for the tuning. I grew suspicious of the new aerial and found that the lead had pulled itself loose from the lightning switch. I was mad, disgusted, through with radio for life!

How would you feel after risking your valuable life, flattening your pocketbook and tearing good pants to put up a low-loss, prize aerial—just to find out that the set works nearly as well on a twenty-foot wire from the set to the switch outside! The next aerial I build will be of the underground type. There is less chance of falling while building it and there may be some sensible, unvarying theory back of it that will at least give me a suspicion of its working characteristics. At present I know only my own "working characteristics," and as far as aerials are concerned I acknowledge no such trait of character. I was born a man, not a bird, with the privileges of life, safety and pursuit of happiness. I shall climb no more. I shall claim my privileges, until the day I go to a happy land where there is no climbing—and no aerials!

A Solution of the Broadcast Problem

By DONALD E. LEARNED

IT seems to me that the present separation of 10 kilocycles between broadcast stations is not sufficient. It is very noticeable lately that practically every station received in the earlier part of the evening is blurred. This blurring diminishes as the number of stations operating in proximity in the frequency scale diminishes.

The upper limit of audition is variously given as from 10 kilocycles to 45 kilocycles. If we assume it to be as low as 10 kilocycles, it would require a 20-kilocycle separation to prevent interference with the present styles of transmitting equipment. We know that it is possible to construct apparatus tuning so sharply that it will not receive sufficient side bands to reproduce the transmitted material properly. Consequently, a good receiver should gather a band of frequencies just sufficiently wide to reproduce the frequency components of these side bands, or the reproduction will be lacking in the necessary overtones which give to all sounds their distinguishing characteristics. With a receiver having such tuning ability, it is necessary that the received station be separated on at least one side from any station, by 20 kilocycles, to prevent interlocking of the side bands, and consequent distortion of the received material.

A little consideration will show that 10 kilocycles could not possibly separate two broadcast stations transmitting simultaneously, if 10 kilocycles is taken as the upper limit of audition. Let us assume two stations, "A" working on 1,000 kilocycles, and "B" on 1,010 kilocycles. Now suppose that "A" and "B" are both transmitting a 5-kilocycle tone. "A" will broadcast 995, 1,000 and 1,005 kilocycles. "B" will emit 1,005, 1,010 and 1,015 kilocycle waves. If we tune the receiver (having a 10-kilocycle band) so that the waves received are from 995 to 1,005, no interference will be experienced from "A" from "B," and the receiver will gather all available signal from station "A."

—and realized that I was in a very hazardous location! Just about this time, all the neighbors and "Calamity Jans" within twenty thousand meters assembled below to warn me, and to be on hand to say, 'I told you so' if I fell and died a suitable, miserable death."



Now if "B" increases its transmitted tone frequency ever so little, it will be received, since its side band, 1,005, will go lower in frequency and consequently invade the tuning channel of the receiver. Suppose that "B" transmits a tone of 5.5 kilocycles. The frequencies emitted will be 1,004.5, 1010 and 1,015.5. Clearly, the frequency 1,004.5 is within the tuning channel of the receiver. It corresponds to a tone of 4.5 as transmitted on 1,000 kilocycles and will be audible from the receiver. A 500-cycle beat-note will be heard, in addition.

But this interference is not limited to the reception of station "A." $1,004.5 + 1,005 = 2,009.5$. This last beat-note is radio frequency and contributes to the "radio fog," causing at the instant an interference with stations being received at that frequency.

We are not tuned right when our receiver is tuned to 995-1,005. Let station "A" now



WOP came in on a high wave.

transmit a tone 6 kilocycles. The receiver will not get it. (Station "A" is now broadcasting 994, 1,000 and 1,006.) And that is not all. If station "B" transmits a tone 9 kilocycles our receiver will pick up the 1,001 frequency, corresponding to a 1-kilocycle tone from "A," and reinforced by heterodyning "A's" carrier.

If "A" and "B" are both transmitting

jazz music, the problem becomes one formidable to a mathematician, and wonderful to hear. The reception of "A" becomes a matter of how many beat-notes (low frequency) "A" can transmit, for the ear to reconstruct at the receiver, rather than how faithfully the music is transmitted, for only a razor-sharp tuner can separate "A" from "B" above and from "C" below, and sharp tuning knocks the overtones.

The writer suggests: It is not wise to limit the tuning channel of a receiver to less than 10-kilocycle band. The elimination of about two-thirds of our Class B stations would solve the problem. No superpower will ever compete with a thunderstorm in the next state. All stations should stay on their assigned wave-length or frequency. One side band and the carrier wave should be filtered out at the transmitter, since it does no good to anyone, as long as the air is so crowded. And last but not least, the assignment of a definite wave-band to the Westinghouse Electric Co., and to the General Electric Co., containing not more than six channels for their exclusive use, said channels to be assigned three to each company, and to be assigned together in the frequency scale. (E.g., Westinghouse, 1,000, 1,020 and 1,040; General Electric, 1,060, 1,080 and 1,100.) The Western Electric Co. and the American Telephone & Telegraph Co. might be similarly assigned. Separate all stations operated by responsible concerns so that they alone would be responsible for any interference between themselves, and rescind the license of the station which gets within the other fellow's territory.

FICKLE JANE

Prof.—What's the gender of A.C. current?

Stude—Feminine, sir.

Prof.—By what sign is it feminine?

Stude—It changes its mind so often.

—Contributed by Jack Bront.

Radio News' Second Radio Shower Party

\$20,000 Worth of Radio Goods To Be Given Away August 3rd

On August 3, radio fans all over the country will be treated to a special event that will long be remembered. This date is set for the Second Radio Shower Party.

It will be remembered that the first Radio Shower was held during March, 1923, and the results were so good that RADIO NEWS decided to hold another similar party but on a much larger scale. In the 1923 Shower Party, \$5,000 worth of radio sets and apparatus were given away, and there were over 700 prizes, all told. The present Radio Shower will be very much larger and over \$20,000 worth of sets and apparatus will be given away. There will be a total of more than 1650 prizes.

The present Radio Shower is being given by the leading radio manufacturers of the entire industry. The party is conducted by RADIO NEWS in conjunction with its new broadcast station, WRNY, located at the Roosevelt Hotel. The wave-length of this station is 258.5 meters.

Promptly at 11 o'clock New York time (10 o'clock Eastern Standard time), on the evening of August 3, the Editor of RADIO NEWS, Mr. H. Gernsback, will give a radio lecture at WRNY. At the conclusion of this lecture he will ask ten questions, which questions will be found printed at the end of this article.

The contest itself will be rather simple. An unusual knowledge of radio will not be required to answer the questions.

There are five questions for regular broadcast listeners—that is, those who do not know much about radio technicalities, and then there are five questions which any radio fan or amateur, or, in fact, any one with a fair knowledge of radio, should have little trouble in answering.

You need answer only one set of five questions. If you are a broadcast listener, just answer the first group; if a radio fan or amateur, answer the second group—or, at your option, you may answer both sets of questions.

In order to make sure that the prizes only go to those who actually listen in to the lecture and to the questions asked over WRNY broadcast station, the questions are printed correctly in this issue of RADIO NEWS BUT ARE NOT PRINTED IN THEIR CORRECT ORDER. Each question as printed at the lower right-hand corner of this page has a little box printed before it. Therefore, when you are listening in on the evening of August 3, Mr. Gernsback will call off the questions and he will say: "Question No. 1—Question No. 2—" etc. It is up to the listener to put the correct number in each square. Unless this correct number is given, the reply will be thrown out of the contest. In other words, it is absolutely necessary, in order to compete, that you listen in to WRNY, in order to get the correct sequence of the questions.

There will be over 50 prizes for each district, as explained further on. These prizes will be given to the lucky winners in the various districts in the following manner:

The first prize will be the most expensive, or most elaborate, outfit. A list of these prizes is given at the end of this article. Other prizes will be given in the same fashion.

It should be understood that it is not necessary at all for any one competing to buy a copy of RADIO NEWS in order to study the questions or copy them. The questions will

be read by Mr. Gernsback at WRNY, twice in succession, slowly and distinctly, so that any listener can write them down. The announcer at WRNY, before the lecture starts, will advise listeners to obtain pencil and a pad, so that all may write down the questions. The rules of the contest will also be read by the announcer, to make sure that all listeners, whether they read RADIO NEWS or not, can participate in the contest.

- (2) New York, New Jersey and Delaware.
- (3) Pennsylvania, Maryland, Virginia and West Virginia.
- (4) Ohio, Indiana, Michigan, Illinois, Wisconsin and Kentucky.
- (5) Tennessee, North Carolina, South Carolina, Mississippi, Alabama, Georgia and Florida.
- (6) Minnesota, Iowa, Missouri, North Dakota, South Dakota, Nebraska, Kansas, Montana, Wyoming and Colorado.
- (7) Arkansas, Louisiana, Oklahoma, Texas and New Mexico.
- (8) Washington, Oregon, Idaho, California, Nevada, Utah and Arizona.
- (9) Dominion of Canada.
- (10) Mexico, Cuba, Panama Canal Zone and South America.
- (11) England, France, Spain and Mediterranean cities.
- (12) All other places not named, including the High Seas.

CONDITIONS OF THIS CONTEST

- (1) The contest is open to all radio enthusiasts everywhere, not only in the United States but in all foreign countries.
- (2) Every contestant must give the hour and minute that was given as the official time when the final question was broadcast. Mr. Gernsback will give this time at the end of the lecture.
- (3) Questions must be answered in the same order in which they are broadcast through WRNY.
- (4) The questions as printed in this issue of RADIO NEWS are correct BUT THEY ARE NOT PRINTED IN THE CORRECT ORDER. This makes it necessary to listen in to WRNY in order to win a prize.
- (5) Prizes will be awarded for the best and most correct answers. THE SHORTEST CORRECT ANSWERS WILL WIN THE PRIZES.
- (6) All answers must be addressed to Radio News Shower Contest, 53 Park Place,

All About the WRNY Radio Shower

THE Radio Shower Party is being conducted by 160 leading radio manufacturers of the United States, who are giving the radio listeners one of the greatest treats in the history of radio.

There will be over sixteen hundred and fifty prizes, totalling in value over \$20,000.

If you want to win a prize, all that is necessary for you to do is to listen in to RADIO NEWS Station WRNY, located on top of the Roosevelt Hotel, New York City, on the evening of August 3, 1925, at 11 P. M. (10 P. M. Eastern Standard Time.)

Mr. Hugo Gernsback, Editor of RADIO NEWS, will give a short radio talk, at the end of which he will ask you ten questions.

Answer these questions correctly and you will stand a good chance of getting one of these prizes.

There will be the greatest radio contest ever staged, and we advise you to familiarize yourself with the rules of the contest.

PRIZES

There will be given away \$20,000 worth of radio merchandise of every conceivable nature, donated by the entire radio industry to the RADIO SHOWER. The prizes will be sent direct by the manufacturers to the winners, immediately after the contest is closed. RADIO NEWS itself will send no prizes, with the exception of its own donated prizes of books and subscriptions.

The prizes are enumerated at the end of this article. There will be a different set of prizes for each of the 12 zones, as listed below. Each district, therefore, will have its own set of prizes (one special prize for the farthest reply).

ZONES

- (1) Maine, New Hampshire, Vermont, Massachusetts, Connecticut and Rhode Island.

PRIZE QUESTIONS

BROADCAST LISTENERS' QUESTIONS

- What do you think is the future of radio in the United States?
- What benefits do you derive from your radio outside of pleasure?
- What is your pet radio grievance?
- What interests you most in radio?
- How much money do you spend every year on radio?

RADIO FANS' AND RADIO AMATEURS' TECHNICAL QUESTIONS

- Explain regeneration in fifty words or less?
- What is the best circuit you know? Give diagram of same.
- What broadcast stations do you receive best—long-wave stations or short-wave stations? Give names of stations, with wave-length.
- State action of super-heterodyne in simple language, fifty words or less.
- Explain principle of straight line frequency condenser in fifty words or less.

TO BE FILLED IN BY ALL CONTESTANTS:

My correct local time at which the lecture from Station WRNY was finished was.....P. M.

My set consists of

I am a broadcast listener
 a radio amateur

(Place a cross (X) in square for correct information)

The air distance from my station to WRNY is.....miles.

This is to be cut out and sent in with your entry. If you do not wish to mutilate the magazine, copy this blank on another sheet of paper.

New York City, N. Y.

- (7) The date of mailing, as shown by the postmark, the simplicity of language used in answering, as well as brevity, legibility, etc., will be taken into consideration.
- (8) From this contest are excluded employees of the Experimenter Publishing Co., and their friends, as well as the members of the staff of Broadcast Station WRNY.
- (9) All replies must be mailed by midnight, August 5, 1925. No replies bearing a later postmark than August 5 will be considered.
- (10) All replies must be either typewritten or penned in ink. No pencil matter will be considered.
- (11) Results of the Radio Shower will be published in our November issue.

List Of Prizes Zone I

Maine, New Hampshire, Vermont, Massachusetts, Connecticut and Rhode Island

- 1—De Luxe Neutrodyne Radio Receiver Kit. Courtesy Workrite Mfg. Co.
- 2—Manhattan Junior Loud Speaker. Courtesy Manhattan Electric Co.
- 3—Grand Opera Speaker. Courtesy Radio Industries Corp.
- 4—Super Booster Wave Trap. Courtesy Super Booster Distributing Co.
- 5—Scientific Head-set. Courtesy Tower Mfg. Corp.
- 6—Ferbend Wave Trap. Courtesy Ferbend Electric Co.
- 7—23-Plate Plain Variable Condenser. Courtesy Hammarlund Mfg. Co.
- 8—Melotone Horn-type Speaker. Courtesy Radio Industries Corp.
- 9—3 Balloon Circloid Tuning Coils. Courtesy Electrical Research Laboratories. 3 Variable Condensers. Courtesy U. S. Tool Co.
- 10—2 Audio Transformers. Courtesy Halldorson Co.
- 11—1 Year's Subscription to RADIO NEWS, SCIENCE AND INVENTION, THE EXPERIMENTER, MOTOR CAMPER & TOURIST. Courtesy The Experimenter Pub. Co.
- 12—Head-set and Plug. Courtesy William J. Murdock Co.
- 13—Resistance-coupled Amplifier Kit. Courtesy Electrad, Inc.
- 14—13 Conrad Patterns. Courtesy Conrad Co.
- 15—Super Booster Wave Trap. Courtesy Super Booster Dist. Co.
- 16—1 Audio Transformer. Courtesy Acme Apparatus Co. Kant Blo Switch Tube Protector. Courtesy Clark and Tilson, Inc.
- 17—1 Year's Subscription to RADIO NEWS and THE EXPERIMENTER. Courtesy The Experimenter Pub. Co.
- 18—1 Wave Trap. Courtesy Ferbend Electric Co.
- 19—Conrad Library, fourteen books. Courtesy Conrad Co.
- 20—1 Lamp Socket Antenna. Courtesy Electrad, Inc. 1 Cushion V. T. Socket. Courtesy Illinois Radio Co. 1 Polyplug. Courtesy Polymet Mfg. Corp.
- 21—1 Year's Subscription to SCIENCE AND INVENTION and MOTOR CAMPER & TOURIST. Courtesy The Experimenter Pub. Co.
- 22—Ekko Stamp Album. Courtesy Ekko Co. 3 A-1 Wonder Crystals, 1 Glass-enclosed Detector, 1 package Catwhiskers. Courtesy California Radio Minerals.
- 23—1 Audio Transformer. Courtesy Acme Apparatus Co. 1 Ekko Stamp Album. Courtesy Ekko Co.
- 24—2 Vario-Densers, Model G. Courtesy X-L Radio Laboratories. 1 Aerial Lead-in Connector, 1 package Name-Plates. Courtesy Radio Specialty Co.
- 25—No-Dust Blower. Courtesy Peiffer and Co. Ekko Stamp Album. Courtesy The Ekko Co. 1 Rheostat. Courtesy Klosner Radio Corp. 4 V. G. Connectors. Courtesy Illinois Radio Co.
- 26—1 Year's Subscription to RADIO NEWS. Courtesy Experimenter Pub. Co.
- 27—Keystone Lightning Arrestor. Courtesy Electric Service Supplies Co. 1 Vernier Rheostat. Courtesy Klosner Radio Corp. Ekko Stamp Album. Courtesy The Ekko Co.
- 27A—1 Audio Transformer. Courtesy of the Halldorson Co.
- 28—Vernier Crystal Detector. Courtesy Roland Brownlee and Co. 2 Crystals. Courtesy Newman Stern and Co. "How and Why of Radio Apparatus." Courtesy Conrad Co.
- 29—1 Year's Subscription to SCIENCE AND INVENTION. Courtesy Experimenter Pub. Co. Ekko Stamp Album. Courtesy Ekko Co.
- 30—Kant Blo Switch. Courtesy Clark and Tilson, Inc. Jiffy Ribbon Antenna. Courtesy Apex Stamping Co. Two Bakelite Sockets. Courtesy Bell Mfg. Co. Ekko Stamp Album. Courtesy Ekko Co.
- 31—Radio Map of the United States. Courtesy

- Conrad Co. Ekko Stamp Album. Courtesy Ekko Co.
- 32—Bakelite Dial. Courtesy the American Hard Rubber Co. Jiffy Blow Torch and Soldering Outfit. Courtesy The Apex Stamping Co. 1 Polyplug. Courtesy Polymet Mfg. Co. Sixteen-in-One Radio Tool. Courtesy Radio Specialty Co.
- 33—1 Year's Subscription to THE EXPERIMENTER. Courtesy The Experimenter Pub. Co. 1 Ekko Stamp Album. Courtesy The Ekko Co.
- 34—2 Variodensers, model N. Courtesy X-L Radio Laboratories. Ekko Stamp Album. Courtesy the Ekko Co.
- 35—Set of Model C-10 Blue Prints for making receivers. Courtesy the Experimenters' Information Service, Inc. Ekko Stamp Album. Courtesy the Ekko Co.
- 36—2 Vernier attachments for dials. Courtesy the Radio Specialty Co. Polyplug. Courtesy the Polymet Mfg. Co.
- 37—1 Year's Subscription to MOTOR CAMPER AND TOURIST. Courtesy the Experimenter Publishing Co. Ekko Stamp Album. Courtesy the Ekko Co.
- 38—1 Plain Rheostat. Courtesy Klosner Radio Corp. Keystone Lightning Arrestor. Courtesy the Electric Service Supplies Co. Ekko Stamp Album. Courtesy the Ekko Co.
- 39—Lamp Socket Antenna. Courtesy Electrad, Inc. 2 Packages of Kester Solder. Courtesy Chicago Solder Co. Jiffy Blow Torch and Soldering Outfit. Courtesy Apex Stamping Co.
- 40—20 Radio Diagrams and Hook-ups. Courtesy the Conrad Co. 1 Ekko Stamp Album. Courtesy the Ekko Co.
- 41—1 Glass Enclosed Crystal Detector. 3 Wonder Crystals, 1 Package Catwhiskers. Courtesy California Radio Minerals. Aerial Lead-in Connector. Courtesy Radio Specialty Co.
- 42—1 Ekko Stamp Album. Courtesy the Ekko Co. 2 Four-inch Bakelite Dials. Courtesy Bell Mfg. Co. De-Tec-Tone Crystal Detector. Courtesy Pyramid Products Co. 2 Crystals. Courtesy Newman Stern Co.
- 43—1 Year's Subscription to RADIO NEWS. Courtesy the Experimenter Publishing Co.
- 44—1 Cushion V. T. Socket. Courtesy the Illinois Radio Co. 1 Ekko Stamp Album. Courtesy the Ekko Co. 1 Jiffy Ribbon Antenna. Courtesy the Apex Stamping Co. 4 V. G. Connectors. Courtesy the Illinois Radio Co.
- 45—Set of Model C-10 Blue Prints for making receivers. Courtesy the Experimenters' Information Service, Inc. Ekko Stamp Album. Courtesy the Ekko Co.
- 46—Vernier Crystal Detector. Courtesy Roland Brownlee and Co. 1 Ekko Stamp Album. Courtesy the Ekko Co. 1 Package of Catwhiskers. 1 Wonder Crystal. Courtesy California Radio Minerals.
- 47—Wireless Course in Twenty Lessons. Courtesy the Conrad Co.
- 48—1 Year's Subscription to SCIENCE AND INVENTION. Courtesy the Experimenter Pub. Co.
- 49—1 Rasco Crystal Detector. Courtesy the Radio Specialty Co. 1 Ekko Stamp Album. Courtesy the Ekko Co. Jiffy Ribbon Antenna. Courtesy the Apex Stamping Co. 1 Package of Catwhiskers. Courtesy California Radio Minerals.
- 50—2 Vario-Densers, Model N. Courtesy X-L Radio Laboratories. De-Tec-Tone Crystal Detector. Courtesy Pyramid Products Co. 2 Tested Crystals. Courtesy Newman Stern Co.
- 51—Radio Listeners' Guide and Call Book. Courtesy Conrad Co. Ekko Stamp Album. Courtesy Ekko Co.
- 52—Jiffy Ribbon Antenna. Courtesy Apex Stamping Co. Glass-enclosed Crystal Detector. 1 Wonder Crystal. 1 Package Catwhiskers. Courtesy California Radio Minerals.
- 52A—Genwin Three Circuit Tuner. Courtesy General Radio Winding Co.
- 53—Pilot Light Switch. Courtesy Yaxley Mfg. Co. 1 Set Lavite Resistances. Courtesy Crescent Radio Supply Co.
- 54—Shock Proof Phone Plug. Courtesy L. S. Brach Mfg. Co. Ekko Stamp Album. Courtesy Ekko Co.
- 55—1 Year's Subscription to THE EXPERIMENTER. Courtesy Experimenter Publishing Co.
- 56—S.P.D.T. Jack Switch, 1 Portable Jack. Courtesy Carter Radio Co. Ekko Stamp Album. Courtesy Ekko Co.
- 57—Four-Phone Plug. Courtesy Barkelew Electric Mfg. Co.
- 58—Tuway Plug, 1 Double Circuit Jack. Courtesy Carter Radio Co.
- 59—Two Packages of Kester Solder. Courtesy Chicago Solder Co. 2 Aerial Insulators. Courtesy American Hard Rubber Co.
- 60—Glass-enclosed Crystal Detector. 1 Package Catwhiskers. Courtesy California Radio Minerals. 2 Crystals. Courtesy Newman Stern Co.
- 61—1 Year's Subscription to MOTOR CAMPER & TOURIST. Courtesy Experimenter Pub. Co.
- 62—Jiffy Ribbon Antenna. Courtesy Apex Stamping Co. Ekko Stamp Album. Courtesy Ekko Co.
- 63—2 Crystals. Courtesy Newman Stern Co. 2 V. G. Connectors. Courtesy Illinois Connector Co. Ekko Stamp Album. Courtesy Ekko Co. 1 Package Catwhiskers. Courtesy California Radio Minerals.
- 64—Radio Log Book. Courtesy Conrad Co. Ekko Stamp Album. Courtesy Ekko Co.
- 65—Packet C. Courtesy Conrad Co.
- 66—Packet D. Courtesy Conrad Co.

Zone 2

New York, New Jersey and Delaware

- 1—Model 20 Radio Receiver. Courtesy Atwater-Kent Mfg. Co.
- 1A—Amplion Loud Speaker. Courtesy Amplion Corp. of America.
- 2—Balkite Battery Charger. Courtesy Fansteel Products Co.
- 3—Grand Opera Loud Speaker. Courtesy Radio Industries Corp.
- 4—Super Booster Wave Trap. Courtesy Super Booster Distributing Co.
- 5—Spitfire Head-set. Courtesy Tower Mfg. Co.
- 6—Ferbend Wave Trap. Courtesy Ferbend Electric Co.
- 7—23-Plate Plain Variable Condenser. Courtesy Hammarlund Mfg. Co.
- 8—Melotone Horn-type Speaker. Courtesy Radio Industries Corp.
- 9—3 Balloon Circloid Coils. Courtesy Electrical Research Laboratories. 3 Variable Condensers. Courtesy U. S. Tool Co.
- 10—2 Audio Transformers. Courtesy Halldorson Co.
- 11—1 Year's Subscription to RADIO NEWS, SCIENCE AND INVENTION, THE EXPERIMENTER, MOTOR CAMPER & TOURIST. Courtesy The Experimenter Pub. Co.
- 12—Head-set and Plug. Courtesy Wm. J. Murdock Co.
- 13—Resistance-coupled Amplifier Kit. Courtesy Electrad, Inc.
- 14—13 Conrad Constructional Patterns. Courtesy the Conrad Co.
- 15—Super Booster Wave Trap. Courtesy Super Booster Distributing Co.
- 16—Audio Transformer. Courtesy Acme Apparatus Co. Kant Blo Switch. Courtesy Clark and Tilson, Inc.
- 17—1 Year's Subscription to RADIO NEWS, THE EXPERIMENTER. Courtesy the Experimenter Pub. Co.
- 18—1 Wave Trap. Courtesy Ferbend Electric Co.
- 19—Conrad Library, fourteen books. Courtesy Conrad Co.
- 20—1 Lamp Socket Antenna. Courtesy Electrad, Inc. 1 Cushion V. T. Socket. Courtesy Illinois Radio Co. 1 Polyplug. Courtesy Polymet Mfg. Corp.
- 21—1 Year's Subscription to SCIENCE AND INVENTION and MOTOR CAMPER & TOURIST. Courtesy The Experimenter Pub. Co.
- 22—Ekko Stamp Album. Courtesy Ekko Co. 3 A-1 Wonder Crystals, 1 Glass-enclosed Detector, 1 package Catwhiskers. Courtesy California Radio Minerals.
- 23—1 Audio Transformer. Courtesy Acme Apparatus Co. 1 Ekko Stamp Album. Courtesy Ekko Co.
- 24—2 Vario-Densers, Model G. Courtesy X-L Radio Laboratories. 1 Aerial Lead-in Connector, 1 package Name-Plates. Courtesy Radio Specialty Co.
- 25—No-Dust Blower. Courtesy Peiffer and Co. Ekko Stamp Album. Courtesy The Ekko Co. 1 Rheostat. Courtesy Klosner Radio Corp. 4 V. G. Connectors. Courtesy Illinois Radio Co.
- 26—1 Year's Subscription to RADIO NEWS. Courtesy Experimenter Pub. Co.
- 27—Keystone Lightning Arrestor. Courtesy Electric Service Supplies Co. 1 Vernier Rheostat. Courtesy Klosner Radio Corp. Ekko Stamp Album. Courtesy The Ekko Co.
- 27A—1 Audio Transformer. Courtesy Halldorson Co.
- 28—Vernier Crystal Detector. Courtesy Roland Brownlee and Co. 2 Crystals. Courtesy Newman Stern and Co. "How and Why of Radio Apparatus." Courtesy Conrad Co.
- 29—1 Year's Subscription to SCIENCE AND INVENTION. Courtesy Experimenter Pub. Co. Ekko Stamp Album. Courtesy Ekko Co.
- 30—Kant Blo Switch. Courtesy Clark and Tilson, Inc. Jiffy Ribbon Antenna. Courtesy Apex Stamping Co. Two Bakelite Sockets. Courtesy Bell Mfg. Co. Ekko Stamp Album. Courtesy Ekko Co.
- 31—Radio Map of the United States. Courtesy Conrad Co. Ekko Stamp Album. Courtesy Ekko Co.
- 32—Bakelite Dial. Courtesy the American Hard Rubber Co. Jiffy Blow Torch and Soldering Outfit. Courtesy The Apex Stamping Co. 1 Polyplug. Courtesy Polymet Mfg. Co. Sixteen-in-One Radio Tool. Courtesy Radio Specialty Co.
- 33—1 Year's Subscription to THE EXPERIMENTER. Courtesy The Experimenter Pub. Co. 1 Ekko Stamp Album. Courtesy The Ekko Co.
- 34—2 Variodensers, model N. Courtesy X-L Radio Laboratories. Ekko Stamp Album. Courtesy the Ekko Co.
- 35—Set of Model C-10 Blue Prints for making receivers. Courtesy the Experimenters' Information Service, Inc. Ekko Stamp Album. Courtesy the Ekko Co.
- 36—2 Vernier attachments for dials. Courtesy the Radio Specialty Co. Polyplug. Courtesy the Polymet Mfg. Co.
- 37—1 Year's Subscription to MOTOR CAMPER AND TOURIST. Courtesy the Experimenter Pub. Co. Ekko Stamp Album. Courtesy the Ekko Co.
- 38—1 Plain Rheostat. Courtesy Klosner Radio Corp. Keystone Lightning Arrestor. Courtesy the Electric Service Supplies Co. Ekko Stamp Album. Courtesy the Ekko Co.
- 39—Lamp Socket Antenna. Courtesy Electrad, Inc. 2 Packages of Kester Solder. Courtesy Chicago

(Continued on page 206A)



The Life and Work of Lee De Forest



Dr. Seibt, the German radio engineer, who introduced the quenched spark gap to the United States.

PART X

ONE notable point in the history of the radio art as it has to do with the subject of this biography is the fact that not only did he give the United States and the world many of the most important developments in apparatus and technique of his own invention, but he developed any idea which seemed worthy of his notice. One of the most important instances of this is in connection with the introduction of the quenched spark system of telegraphy. In the early part of 1909 DeForest made a trip to Germany in connection with the demonstration and sale of some of his apparatus. While there, he met Dr. George Seibt, who was one of the foremost exponents of the quenched spark system.

Immediately seeing the advantages to be gained by the use of this method of transmission as opposed to the old open spark type of equipment, DeForest at once arranged to bring Dr. Seibt to America and put him in the laboratory of the DeForest company. This was done, and within six months from the time of his landing, the DeForest stations throughout the country were being equipped with the new apparatus.

Then the most surprising thing happened. The old records for long distance transmission began to be smashed right and left. At the experimental station in New York—the same station at the Metropolitan Life tower—traffic was started with the Chicago and Milwaukee stations, a thing which had never been done before with any degree of dependability.

Then, as always, there was the question of static—a bugbear which the industry has not yet been able to circumvent. But Dr. Seibt and Dr. DeForest, knowing that the

radio signals could be read much more easily if the note of the transmitted signal were of a high pitch, set about designing a five-hundred-cycle generator to go with the new quenched spark gap. This they did and before the end of the month had it in full operation. The results were astounding. Dr. Seibt, through his knowledge of the early development of the gap, understood its workings thoroughly and so designed a transmitter that the gap could be adjusted to give the clearest tone to the signal put on the air.

ARMY ADOPTS QUENCHED SPARK GAP

And then, following his usual custom, having perfected the new apparatus to a point where it was dependable, DeForest took a set to the War and Navy departments for a demonstration.

This was another policy which DeForest had always carried out from the very beginning of his career. Every time he developed a new invention or perfected a new system which might be of tactical or military value, he went immediately to the Government with it.

The results were fairly good. At first the Navy remained skeptical, even after DeForest had showed them beyond any doubt that it was almost twice as efficient as anything they had then in operation, and that the cost of installation and operation would pay for the apparatus in a short time, but the Army took to it with open arms. Shortly an order was forthcoming for the equipment of two Army transports, the *Beauford* and the *Dix*.

Both vessels were at that time in port. One, the *Beauford*, was in Seattle and the other was at San Francisco. As soon as the arrangements were completed, DeForest set out for the West coast with Seibt to install the apparatus on the boats.

And when the installations were completed and the stations put into operation, they set record marks which had never before been obtained. The *Dix* was copied in Honolulu from the West coast and the companion set worked Seattle regularly from her dock in San Francisco.

All during the time that the two experimenters had been installing the ship sets, they had been employing their spare moments in further perfecting the system. It was during a conference that DeForest was struck with the idea of employing the quenched spark for the generation of highly undamped waves to be used as a carrier for voice currents. And, as usual, as soon as he had the idea, he set about perfecting the necessary apparatus to give it a trial.

On the generators—the five-hundred-cycle type—the frequency was simply a pure, high-pitched note with one discharge across the gap for every half-cycle of the generator. However, when the gap was applied to a spark coil, the adjustment could be so made that there would be several discharges to each half-stroke of the interruptor, or half-cycle of current fed to the transformer. By this method a frequency of about 5,000 cycles was gained at antenna input which served very well as a carrier for speech currents. Of course, there was always the hiss of the carrier for the background, but the resultant message picked up was perfectly clear and distinguishable. There was very little harmonic mush created with the telephone, in spite of the fact that the microphone was put directly in the ground circuit of the antenna.

But the apparatus was designed primarily as an instrument for the transmission of voice frequencies—on the order of the intercommunicating apparatus which had been installed on Admiral Evans' fleet, so it was good for the purpose for which it was designed.

Simultaneous with the installation of the sets aboard the Army transports, the commercial shore stations of the DeForest company were swiftly changing over to the new type sets. All the stations along the shores of the Great Lakes—Milwaukee, Chicago, Detroit, Benton Harbor and Duluth—were becoming of some importance in the telegraphic field.

NEW YORK TO PHILADELPHIA SERVICE

At New York the company was fast establishing a direct service with Philadelphia. The New York station was a transmitter and receiver rigged up at the Metropolitan Life Tower, with the laboratory stations. As the traffic increased, it became harder to keep the traffic station segregated from

the experimental work and DeForest decided to move the station into the Wall Street district and so kill two birds with one stone, so to speak. So he rented the tower of the Manhattan Building at 42 Broadway, the same location where he had made his first tests for transmission across the Hudson some twelve years before.

On the previous occasion success had been prevented by the copper tower which sur-

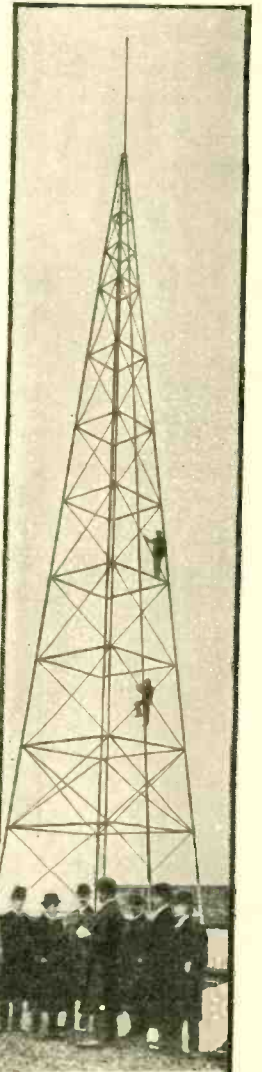

The DeForest company was the first to change from the use of pole masts to the type shown in this photograph.



WIRELESS TOWER
AT CLOSE RANGE
Antenna reaches up about
350 feet above street.

mounted the building; it absorbed most of the energy transmitted before it could affect the receiver. Now, with more power and the audion receiver, the same location worked the Philadelphia station—which was located on the Bellevue-Stratford Hotel—at all times without the slightest trouble.

Then another flash of the old days appeared. The United Wireless Corporation had its New York station just next door to the DeForest station on Broadway. In fact, a stone tossed off the building where the DeForest station was located would light flat in the center of the United aerial system.

As was the custom, when another station was getting too much of the available business, the station which was not faring so well followed the very simple expedient of placing the dictionary or some other large object on the key—and leaving.

The result is obvious. Anyone who has attempted even to listen to a broadcast program through code interference from a station close at hand can easily appreciate the disaster of trying to copy messages of a second code station through such noise.

And when it is remembered that the United station was next door to the DeForest station, the state of affairs becomes much worse.

But DeForest was not to be so hindered. He simply set about grounding the copper dome and then screened the operating room with chicken netting, which was, in turn, grounded. Then a third screen was put over the receiving apparatus and grounded. A coating of tin foil was wrapped around the phone cord and grounded. With this extreme arrangement and the sharpness of the quenched spark signal, traffic could be worked with ease. Of course, the loose coupler arrangement with an independent link circuit made up the tuner. This, in itself, gave the sharpest possible tuning. It must be remembered that this all occurred before the days of the wireless act of 1912, when there was no limit on the decrement of a station, nor any other rules as to the operation of a radio set.

In this way DeForest overcame another of the obstacles which confronted his putting radio onto a practical working basis. It seems almost unaccountable that real scientists, or for that matter, inventors, who were trying, ostensibly, to create a new method of communication should stoop to such petty business for the sake of competition. Where the utmost in co-operation was demanded for the sake of the young art, the opposition companies resorted rather to cutting the other fellow's throat than to the perfection of the apparatus and the establishment of the science on a firm basis in the economic scheme of the country. DeForest, however, did not stoop to the usual tactics and did not allow his operators to do it. It was more his interest in the problems at hand and his idealism for the science rather than any high moral attitude which caused this personal policy. Being entirely human, there were times when

One of the old-time quenched spark gaps for transmitting. Note the large cooling flanges and the compression screw in the end-plate.

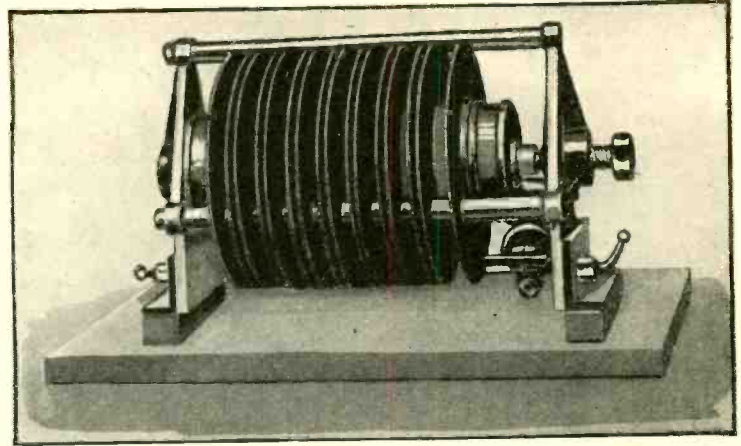

he could have wrung the necks of various and sundry operators of the United and Marconi systems. However, there was no time for the reeking of punishment and the desire passed.

DeFOREST COMPANY COLLAPSES

Fate plays us all dirty tricks at times and she gave DeForest a resounding whack on many occasions. The last big one came just about this time. The quenched spark system had been brought to high efficiency and the competing companies were forced to the most extreme measures to keep pace with the DeForest company. In fact, they were being outstripped at every turn.

But as had happened at two previous episodes, while he was just in sight of the goal, the hope of fulfillment was snatched away—for a time. When the technical affairs of the company were in the best possible shape, the financial management developed a sudden and serious lameness. The development was being carried on almost entirely by the sale of stock and bonds on the real equipment of the company. But there was pressure in the money market and the inevitable result was that the first places the pinch was felt was in the industries in which dividends were not on a pretty firm basis. With the DeForest company every cent which was being made was being put back into the operation of the stations and the improvement of the apparatus. No dividends were being paid, expansion was moving at the greatest possible speed. The result was easily to predict. As soon as the market tightened, no more bonds or stock could be sold to the public. The large houses clamped the doors of their safes and then the little fellows followed likewise and the crash came.

A perusal of the treasurer's notes showed that the company owed everybody and the sheriff his taxes. There was nothing to do. DeForest was always a scientist and not so much of a business man. Everyone else—in the classical language—got out from under and left DeForest without visible means of support. There was only one thing to be done—he had to close up shop and get a job.

His note-book entry covering the incident is extremely interesting. It could hardly be more concise. It follows:

"About this time, however, bad management and other difficulties on the part of some of the directors of the Radio Telephone Company brought an end to our plans. I therefore decided to remain in California and continue the development of several inventions, in which I was particularly interested, with the Federal Telegraph Com-

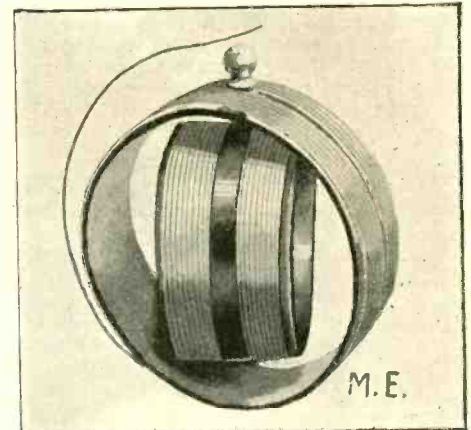

The father of the present-day variometer is shown in the above illustration.

pany. As a result of this connection three of my happiest and most useful years were spent in California. My work was chiefly experimental laboratory at Palo Alto, but the installation of receiving apparatus and various new devices in connection with the radio telegraph gave me opportunity to travel up and down the Pacific Coast and make observations on the reception of undamped wave telegraph signals which were exceedingly interesting."

The Federal Telegraph Company was an organization under the guidance of C. F. Elwell, started in the United States to take over the American patent rights to the Poulsen system of undamped wave telegraphy. Elwell had completed negotiations with the Dane and had brought his specifications to this country and started the operation of three or four high-powered arc stations.

The first duty to which DeForest was assigned after he made connection was the quantitative measurement of the radiation resistance of the various antenna systems which were being used. The Federal system proved to be an excellent one for long distance work and still remains one of the most satisfactory. At that time the first work on high-speed code was being done. The Danish system would work, provided it was carefully watched all the time the signals were being received. But the recording device used a very fine Einthoven wire in a strong magnetic field. The signals

(Continued on page 230)

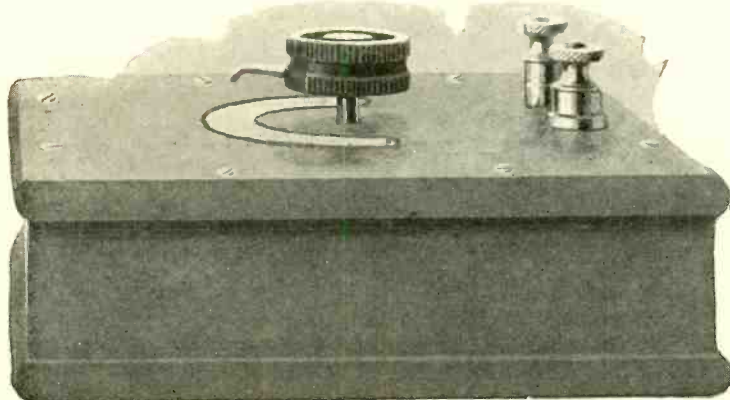

Here is a photograph of a standard variable condenser used in DeForest transmitters of the 1910 period. They were sometimes filled with oil to increase the capacity.

The Inventions of Reginald A. Fessenden

PART VIII

EDISON was just transferring his experimental work from the Lamp Works at Harrison, N. J., to the Edison Laboratory, which he was then constructing at Llewellyn Park, Orange, N. J., and where he still is. It consisted of a long three-story main building and four smaller buildings, as shown in the plans. Fig. 1 shows the first floor of the main building, the second and third floors are shown in Fig. 2. It was surrounded by a high fence and had only one entrance, guarded always by a watchman because on a number of occasions men from other companies had obtained entrance surreptitiously.

While all the experimenters and other employees worked under his direction and instructions, the salaries of some of them, employed on problems which the Edison Lighting Companies and the Edison Machine Works wished solved, were paid by these latter companies. The laboratory itself had been planned by Edison to be absolutely complete, to afford means of solving any problem which might come up or be presented to him without a moment's delay in obtaining any instrument or material which might be necessary for the work.

EDISON'S LIBRARY

After passing the gate and guard house and passing through the door A, one came into a hall from which opened the library which ran up two stories clear in the center and was surrounded by two stories of book stacks and mineral cases. The lower stacks were supposed to contain, and I believe did actually contain, complete sets of every scientific transaction and proceeding and publication which had been printed up to

Interior of the Edison chemical laboratory, showing Mr. John Dorr at the right.

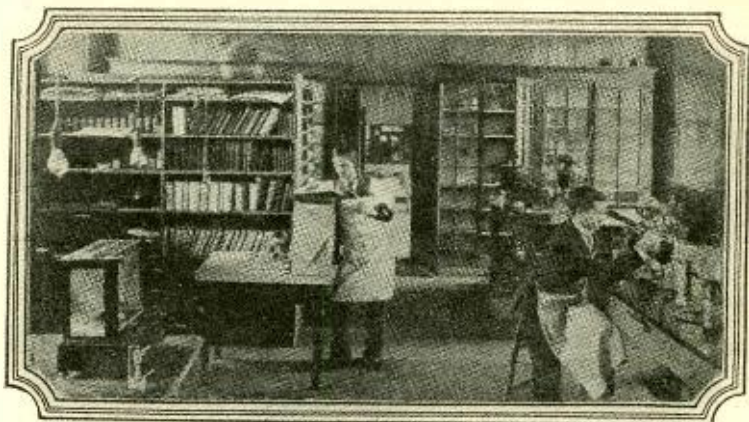

proceedings of the mathematics societies in the stacks below.

Between these gallery stacks were cases containing specimens of every known mineral, many of them extremely rare and extremely beautiful. The work of collecting and describing these, which took many years, was placed in the hands of Dr. Kunz, the famous expert of Tiffany's and author of several most important and magnificently illustrated treatises on precious stones whom I met again a few months ago, with the pleasing phantasy that he must have come across the philosopher's stone in his searches, for he had become a wealthy man and did not look a single day older than in 1886.

The clock over the fireplace and the library furniture were a Christmas present to Edison from his employees, in 1889, I think.

STORE ROOM

Opposite to the library, across the hall, was the store room. This contained all known organic and inorganic substances. A somewhat large statement, but for a number of years Edison had spent a part of his time going through encyclopedias of chemistry and technical dictionaries and making lists of substances, and these had all been ordered from manufacturers. Where they could not supply them, he sent out his own agents to obtain them. The stories of the man sent all round the world to obtain every known species of bamboo have been told elsewhere, and there were several such sets of agents, and a large number of missions. I can only say that I never needed any substance that I did not find there, and during the big blizzard of 1888, when Aylesworth and I were marooned in the laboratory, we fared fairly well on buckwheat cakes, maple syrup, stews of dried beef and pemmican, macaroni with olive oil, dried fruits, zwieback, coffee which we roasted and flavored with vanilla beans, and condensed milk.

MACHINE SHOP—HOW THE PHONOGRAPH WAS INVENTED

Batchelor, Edison's partner, took personal charge of the large machine shop. He was the, sometimes needed, conservative element of the combination. Once, when I had worked out some minor but troublesome details in a way which pleased Edison I took advantage of it to ask him how he had come to invent the phonograph. He told me that he had been working on one of his high-speed telegraph systems, in which the messages were embossed in dots and dashes on a strip of paper. The ordinary sending relays would not respond fast enough, "So,

after I had worked a while I thought, a telephone will respond to high-pitched notes, thousands of vibrations a second. I soldered a little steel point onto a telephone diaphragm and ran the strip underneath it. It worked, but when we came to very high speeds I noticed that the diaphragm gave out very queer sounds. I said to Batchelor, 'I bet if I ran a smooth piece of paper underneath that point and talked to the diaphragm it would record what I said and reproduce it when we ran the strip back again.' I had a cylinder made up and wrapped some tin foil around it instead of paper, and it worked all right." Batchelor had come up and was standing by as we talked. He said, "Yes. I never believed the thing would talk. I bet Edison \$25 that it wouldn't. I tell you I was scared when he began to turn the handle, and it began to say, 'Mary had a little lamb.'" Batchelor was always looking after Edison's interests and seeing that the work was put through on time and that there was no waste.

The work done there was mostly on street railways and ore milling, but one of the big lathes was once used in a rather interesting experiment. The minute traces of silica in the phonograph wax would soon dull the steel knives, so finally sapphires were used. These were off-colored stones and the cost per knife was not great. But the dealers, so soon as they found there was a demand, increased the price about ten times. Edison sent down samples of every kind of very hard stone to be tested out, and while they were grinding these up, decided to make sapphires artificially. The constituents were known, and they were melted together, but always there were minute bubbles in the fused product which spoiled the edges of the knives and could not be removed, even by melting in hydrogen and making the fusion very fluid. So a casing was built on the head of one of the large lathes like a circular trough with the opening facing toward the center, and filled with the right mixture and a big arc was placed so as to heat the mixture as it revolved. The idea was that the centrifugal force would separate the fused material from the bubbles as in the modern centrifugal milk separator. It worked after a fashion, for the inner surface of the fused material was quite transparent, though not of very uniform color, and further work would no doubt have given a good layer of sufficient thickness to make knives of. But the other line of work, *i.e.* that on the other kinds of stones, had disclosed the fact that knives made of Oriental jade would do as well or better. A third line, fusing quartz in the arc, pulling it out

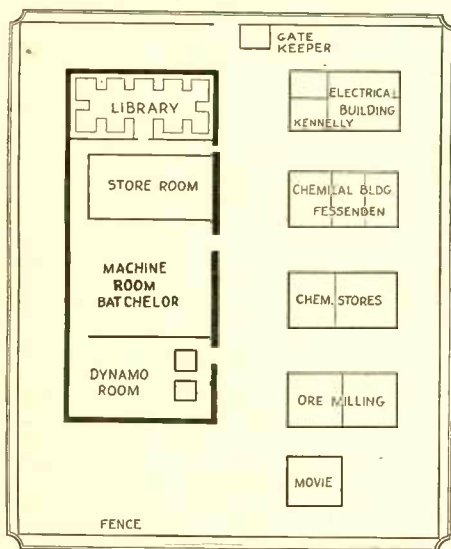

A plan view of the Edison laboratory.

that date, and all sets were kept up, the latter numbers being found on small tables in the alcoves adjoining the bound volumes.

The upper set of stacks, or gallery stacks, contained so far as possible all books of any importance which had been written about electricity, chemistry, mechanics, engineering, mining and physics, and what would elsewhere have been considered fairly complete libraries in many other subjects. Perhaps its only weakness on the physical side was in mathematics, but this was more than made up for by the complete sets of

into rods about 1/32-inch diameter and holding the rods in the arc or oxy-hydrogen flame till a small bead formed on the end, gave him the reproducing points. So the experiments on artificial sapphires were dropped. Two or three years later Boys drew out long fine threads of quartz, for galvanometer suspensions and for his splendid work on the determination of the gravitational constant, by fastening one end of a quartz rod to an arrow and shooting it away when the middle of the rod was softened by the heat. And for the last fifteen years the Silica Syndicate in England has been

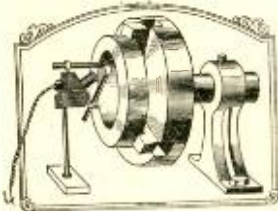

Centrifugal furnace for the making of artificial sapphires, devised by Edison in his early experimental days.

making fine transparent quartz ware; but Edison was the first to fuse and form quartz articles.

The engine and boiler room completed the first floor of the main building.

EDISON'S BEDROOM

A description of this comes very near the famous chapter headed "Snakes in Iceland" and consisting of the words "There are none." But not quite. In those years Edison and three or four of his assistants worked night and day a good part of the time. I think it fair to say 25 per cent. This was because there were always problems coming up which had to be solved very quickly if there were not to be large financial losses. It was real work during these periods, the meals consisting of a sandwich and a cup of coffee and the only opportunities for sleep being when the work was halted for a few minutes, at most half an hour, for the completion of some necessary apparatus or of some chemical reaction. Under such conditions one can sleep anywhere; one machinist disappeared in the middle of some job and was finally located asleep on top of a crane where if he had moved he would have been killed. Edison and Aylesworth and the Otts were able to take these cat-naps sitting in a chair but I found I got more rest per minute on the asphalt floor (which for some reason is much more comfortable than a wooden one) with a volume of Watts' Dictionary for a pillow and the soothing sizzle of an arc lamp overhead.

To come to the bedroom. It was originally intended as a drafting room. But success in inventing consists largely in almost infinite knowledge of and careful working out of almost innumerable details, and the only way I know to use a draughtman is to give him the first sketches dimensioned as completely as possible, and then when he has pencilled up the apparatus, come 'round and correct it and supply the main details; then when these are drawn, correct again and add others, till completed. Personally I think this is the best way of working out inventions and that draughtmen are invaluable, as it is much cheaper to correct on the draughting board than in the shop.

Edison could not, in those years, spare the hours for this so the room was vacant for a long time. Then Batchelor, who was worried about Edison's working such prolonged periods, put a canvas cot in the room. Edison would not use it. Finally one Thursday morning, when we had been working especially hard since the Monday morning and had finally got what he wanted, he succumbed; but, always very considerate for others, his conscience apparently troubled him at enjoying all this luxury by himself. "Fezzy," he called out as I was passing. "Yes, Mr. Edison." "Come on in here, there's a table in here." Tables I never did

like, for one reason I am six feet two inches long and hang over; as it happened, there was something I had to attend to in the chemical laboratory before calling it a day, and this served as an imperative excuse for leaving him in his solitary Capua.

Next to this was the room where I did most of my work on certain special problems, mainly on carbon filaments. The next room was where Edison did most of his work, and where Fred Ott had his precision lathe.

MOVING AND TALKING PICTURES

Next was Dickson, the son of a well-known English painter. He was an expert photographer and was, when Edison invented the moving pictures, about 1887, placed in charge of that work.

This was a case of pioneering work from the ground up as there was nothing to start with. Edison had first to get a suitable optical system. Then he had to get photographic film made up in long strips. Holes were punched in the edges of these, for feeding them, and various intermittent motions, as is the practice at the present day, were tried. But Edison was always after perfection, he wanted something with absolutely no flicker, so he finally abandoned the intermittent motions for the time and decided on making the light instantaneous and running the film continuously. For the light he used a large battery of condensers discharging across a spark gap geared to the toothed wheel used to feed the film, and this gave good results as the spark was high in ultraviolet light. The reproducing was done in the same way, by running the negative through in place of the photographic film.

Edison's original idea was that all movies should also be talking, and this was easily accomplished by attaching the film-feeding gear to a phonograph; and the first movie taken was of the office boy whistling and talking and singing and dancing a clog. It was taken and reproduced in the little shed marked "Movies" in the plant. It came out very well, absolutely no flicker and perfect synchronism between sound and motion, and though, of course, DeForest's method of making the sound record photographically on the edge of the film is a great improvement, this first movie of Edison's was a truly remarkable achievement. Many years later, about 1907, in the course of some other work, I found that sufficient focusable in-

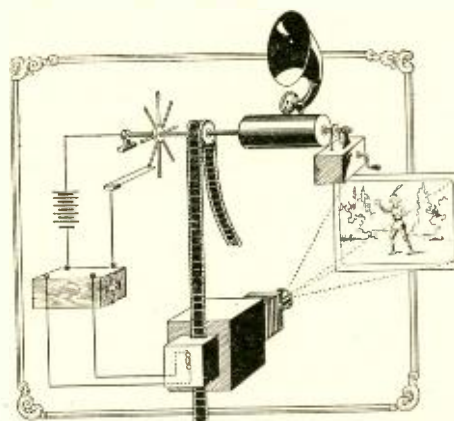

A schematic arrangement of the first talking movie devised by Edison. Note the synchronous interrupter mounted on the shaft of the phonograph cylinder.

stantaneous spark illumination could be got by discharging compressed air condensers across an arc in compressed gas, and later, through nitrogen-filled tungsten lamps kept at a low red by continuous current.

THE OTTS

Across the hall was John Ott's room. He was Edison's right-hand man in all design of fine mechanical apparatus, and made the final drawings for these, when there were any. His brother Fred was an especially

skillful machinist. He worked in room E.

Next came the Phonograph Doll room. A company had been formed by some Philadelphia capitalists to place the phonograph on the market and they went into things on altogether too large a scale, overlooking the fact that the market had to be made. Edison did not like this, and I remember his expression (and expressions) when one day his secretary, Tate, told him they were proposing to form a million-dollar company to make dresses for the phonograph dolls. But the financiers were in control. They made a big failure of it, which Edison later retrieved and turned into a big success, showing he was a financial as well as an inventive genius. The testing of these dolls, which went on day and night, hundreds of them repeating their childish verses in their little tinny voices, used to annoy me considerably when trying to think out some difficult problem in my room across the hall.

Next to this came the precision room, P. R.

AYLESWORTH, GLADSTONE, FORCE

On the third floor, above the library, was the room where the phonograph records were made, where we sometimes stopped in for a few moments in the intervals of work to hear some famous pianist or singer.

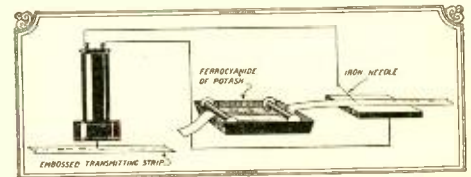

High-speed telegraph which gave rise to Edison's invention of the phonograph.

The room marked Aylesworth was where Aylesworth, the inventor, later, of Condensite, worked on compounds for making the phonograph cylinders. His investigations must have covered nearly 100,000 substances, compounds and mixtures, for he was engaged at it for more than twenty-five years.

Gladstone, in the next room, was on the zinc and copper oxide cell for running phonograph motors, for at that time there was substantially no electric lighting anywhere except the preliminary installations in lower New York and in Brockton, Mass. Edison finally developed this cell into a really good primary battery, but his own nickel-iron storage battery and the development, at other hands, of the lead peroxide cell so limited its field that it disappeared, as did also the zinc sulphate current meter, which was also worked out to a success at this time, but later supplanted by Elihu Thomson's rotating dynamometer current and watt meters.

The next room was occupied by Joe Force, a skilled glass-blower. His work at this time had to do with a machine for making incandescent lamps, which Edison was developing. At that time the lamps were being sold for a dollar each and cost more than that to make, so they were sold at a loss in order to make sales for the central station equipment. To add to our troubles, the glass-workers, believing they had a monopoly, refused to take on any apprentices or to work during the summer months and demanded, and had to be given, twice the old wages, still further adding to the loss on the sales of lamps. So some cheaper method of manufacture was imperative, and Edison finally evolved a machine which made the lamps for 15 cents, so they could be sold at a profit for 25 cents. Without this machine electric lighting would have been retarded for years, as before it was finished it was costing over \$1.50 to make each lamp.

Glass in those days was not very good, cracking easily, and most glass-blowers drank rather heavily as the alcoholic vapor in the breath was supposed to prevent this. That the amount of alcohol was not inconsiderable was shown one day during a test on Edison's

"Tasimeter," a device for measuring very minute quantities of radiant heat, for example, of the corona during an eclipse. In this a bent strip of paper, covered on one side with lampblack and shellac, pressed against a carbon button and when the radiant energy heated the shellacked side and softened it, the pressure on the carbon button was reduced, the resistance increased, and the spot of light from a galvanometer in series with the button, moved over a scale. One of the old-time gas-blowers came into the room. The spot of light danced off the scale. It was found that it took only five or six seconds for his breath to diffuse across the room and soften the shellac enough to give a big indication.

Force was almost a total abstainer and for that or other reasons had so much trouble during the annealing of his work that his own vocabulary was inadequate. So he had the storekeeper, who had a fine command of language, fill a 15-minute cylinder competent to all occasions. The first time I met him he was leaning back, a peaceful look on his face, and listening to a phonograph which was making very uncomplimentary remarks about the quality of Corning glass. He taught me how to blow complicated apparatus, which often came in extremely useful later.

Last came the Pump Room for exhausting lamps.

KENNELLY

Dr. Kennelly, now professor of electrical engineering at Harvard, was then Edison's chief electrician and occupied the Electrical Building. Though we had charge of different lines of Edison's work, we did quite a little scientific work, some of which I will mention later, and read mathematics together. I had a copy of J. J. Thomson's "Dynamics Applied to Physics and Chemistry" and Kennelly got one too, which we used to read during the lunch hour. Edison came in one day looking for us and when we got back we found at the top of the page where the book had been left open, and which had a lot of quadruple integrals, a sentence in Edison's handwriting:

"This inscription was found written over the top of the door of an ancient Aztec lunatic asylum."

But though Edison sometimes made fun of our mathematics, he was himself a natural born mathematician, like Faraday, and when, a little before, the mathematicians he had employed had failed to obtain a rational solution of the problem of the size of the neutral in a three-wire system, he had solved it himself, and his solution stands today.

CHEMICAL LABORATORY

When I reported at the laboratory a few days before the end of 1886 to Batchelor I found they were not ready for the dynamo development work, and the engine room and electrical building were not even wired. I asked Batchelor what I should do and he told me to wire up the electrical building. This was not exactly what I had been engaged to do, but I have always held that everyone should work with his hands as well as with his head, and that manual work was really a rather interesting and agreeable form of physical exercise, provided that there were facilities for a good shower afterward. So I set to work, and Kennelly joined me, and we made a good workmanlike job of it, as I had the satisfaction of noting on looking it over some dozen years later. When it was finished I asked Batchelor what next. He said there would not be anything for some time and that I had better go back to Schenectady. I saw Edison next morning



Mr. Charles Batchelor

Mr. John Dorr

Professor A. E. Kennelly

at his house and explained the situation. He said, "Do you know anything about chemistry?" I said, "No." He said, "Then I want you to be a chemist. I have had a lot of chemists. I had one whose name was all through Watts' Dictionary. But none of them get results. I want you to take it up. You can start in helping Cousins."

This time the answer had been the right one.

INVENTIONS OF NON-INFLAMMABLE ORGANIC COMPOUNDS

Edison took me in to Cousins. "We are having trouble with fires from electric light wires, and the Machine Works wants a fire-proof insulation. What they want is something which is as good an insulator as glass, but as flexible as India rubber; not affected by acids or alkalis or oils; and fireproof, and"—his face relaxed for an instant—"it must not cost more than 15 cents a pound." He told Cousins to start by mixing some of every chemical, in alphabetical order, which was on the shelves of the chemical building, with linseed oil, and record in our note books how it stood a Bunsen flame. When I got down to antimony trichloride, that mixture did not burn and I reported to Cousins. But of all the rest of the list there was only one that behaved similarly, chloride of tin, and that not so well. Cousins thought that the traces of water in the oil had decomposed the chlorides and that the hydrochloric acid vapor had smothered the flame. That night I read up on combustion and on oils and elementary organic chemistry, and came to the conclusion that combustion started first with the hydrogen atoms of the oil. Then I reasoned that if some other atom could be substituted for the hydrogen, and one which had very slight affinity for oxygen, we would get a substitution compound which was non-inflammable, but physically very much like the original inflamma-

ble hydrocarbon. Then I decided that this was what had taken place with the antimony trichloride, *i.e.*, that a chlorine substitution compound had been formed.

Next morning I told Cousins this, but he stuck to his original theory, then and in making his report to Edison, I, of course, saying nothing, as he was my chief. But he was a thoroughly honorable gentleman, and when he had finished he said, "But Fessenden here has a theory that the chlorine has gone in and taken the place of the hydrogen in the oil, and that that is why it will not burn." Edison asked me to explain, then said to keep on along the line we were working, but to try out the substitution theory. (This was always his method; he would never be led away from any line he had laid out, because of apparent success in a side line, until he had followed the original line to the end.)

Cousins said, "You know I want to get into the telegraphy work. Why don't you let Fessenden handle this job and let me work at the high-speed system?" Edison agreed, so I got my first step.

The only substitution compounds which had been investigated at that time were crystallizable ones, and this was exactly what we did not want. "The chemists won't look at a thing unless it crystallizes," said Edison one day. "The chemistry of the future is the chemistry of the colloids." So my work was entirely experimental and largely at first empirical. Thousands of organic compounds were chlorine-substituted and the chemical laboratory was always filled with a yellow fog, which impressed visitors so much that an illustrated interview with Edison at his laboratory, which appeared in the *New York Herald* somewhere in 1887, contains a sketch of Mr. Edison introducing me as "the man with the platinum lungs." Edison noticed that the men in the chemical building never suffered from influenza during epidemics, and attributed this to the chlorine gas. I think he mentioned this in the interview referred to.

The final result was a compound which was non-inflammable; a good insulator; not attacked by any except concentrated acids or alkalis, and not at all by oil; slightly but sufficiently elastic; and reasonably cheap. Also as a by-product, the substitution organic compounds afterward known as the halowaxes and the use of tetrachloride of carbon, "Pyrene," for extinguishing fires where water could not be used.

Meantime, always under his instructions, so that I finally got to understand his methods pretty well and seldom needed to bother him about details, I did a number of minor pieces of work which pleased him. One was to get a coating for iron armature laminations which would be a good insulator and tough, but occupy little space; which problem I solved by rusting the iron in every possible way and then finding a non-melting film which gave toughness to the rust. (I cannot, of course, give formulas, the work being done under Edison's direction and his property.) Another was a method of making rail bonds. Edison had built a stretch of street railway near the laboratory to work at 20 volts D.C. using one rail as feeder and the other as return. Good joints were essential, made by casting babbitt around the rail ends and fish plates after these had been ground on the spot by a motor-driven emery wheel. This was a very slow operation, so Edison said, "Fessenden, cannot you get up some chemical way of doing this?" I had noticed, in the course of some other work, that antimony pentachloride would remove

(Continued on page 237)

—The Listening Post—

Being a digest of the odd, interesting, more human side of America's greatest indoor sport. A treatise on the fads and foibles and general effect of Radio on civilization.

Conducted by Don C. Walk

OF course, there is the consolation that Los Angeles is a good place to go in the winter months, but it seems a pity that such good music, such good cheer, should recede to unavailable distances in the good old summertime. KFI is getting further

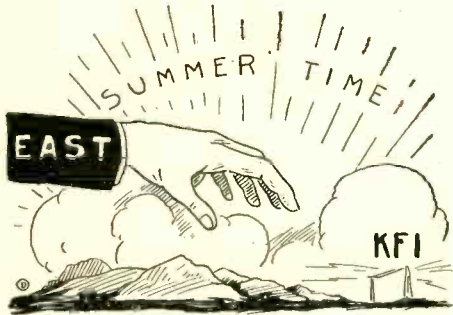

and further away as the summer advances. I must confess that KFI's lure holds me at the set until the world about me is asleep, and there is no sound except the crackle of Rocky Mountain static, and the dim and misty tinkle of distant music. Disheartened, I await the summer night when there will be nothing but the static left!

Atta boy, Quin Ryan! This popular radio announcer—he is director of WGN—is pioneering a daring innovation at this Chicago station. "No more names!" asserts Quin, meaning that WGN will not burden the air and bore its listeners with the dreary monotony of long lists of names of those who write, wire or telephone approval of programs. And I'll wager that WGN's correspondence does not dwindle one iota!

Music Week was fittingly observed by its newest exponent, Radio. I call to mind special Music Week programs from WGY, WLW, WEA, WGN, KSD, KOA and many others. Those sceptical of the power of radio to provide interesting, genuine music must have been convinced, if they chanced to listen in on any of the scores of stations which broadcast programs arranged especially for this national observance.

In the South, particularly, has the spread of radio broadcasting been rapid and healthy. With such fine stations as WSB, Atlanta; WFAA, Dallas; WBAP, Fort Worth; WOAI, San Antonio; KFRU, Bristow, and most recently, the



splendid WSMB, New Orleans, waves from which penetrate the northern fastness with amazing clarity and tone, the South yields nothing to the North in the matter of splendid programs, splendidly broadcast. To WSMB, New Orleans, we extend the hand of welcome.

WSAI, Cincinnati's transmitter, seems to withstand all effort of experts to remedy its defective modulation. This station has had trouble for months with its modulation, and although some improvement is noted in recent weeks, it is still far from the standard its splendid volume merits. WSAI's programs, also, have always been of a high standard, and I sincerely hope that its transmitting difficulties will soon be smoothed out.

If any criticism at all is to be leveled at the dinner concerts broadcast from numerous stations, let it be relative to their day-in-and-day-out sameness. One comes to expect certain selections with the soup, others with the entrée and still others with the meats, salads, and so on. I suggest for the attention of fans at large the manner in which WLW, Cincinnati, avoids commonplaces in the matter of its dinner concerts. At this station diversity seems to be the goal, and this is reflected in its early evening broadcasting.

A few nights ago I listened to a recital by a violin choir from a well-known Middle West station. The music came through with fine modulation, and I settled down to an hour of solid entertainment. At 9:31 o'clock, the announcer began to read telegrams and credit other correspondents with telephone calls. He consumed just exactly seven minutes, the last two of which I doggedly stayed with him for the mere purpose of finding out how long he would clog the air with that sort of drivel. He smashed a fine program to smithereens for me, to please the comparative few who had wired or telephoned. I wondered how many more thousands had tuned him out in disgust before he finished.

This same station thirty minutes later sprang an innovation by permitting the individual members of the choir—they were all girls—to announce their names and cities of residence. This was pleasant, and a unique departure from the beaten path.

Two sterling musical events remain with me over the last few weeks of broadcasting. It is with a feeling of real regret that I listened to the last of a series of delightful programs from KDKA, Pittsburgh, under the general heading of "Reveries of a Theatre-goer." In this series, songs and instrumental numbers of hallowed memory were revived and broadcast by a well-balanced orchestra and a quartet of exceptionally good voices. It seems to me there should be more of this type of material in the air. The other event was the dedication of the magnificent new pipe organ at WLW, Cincinnati, a ceremony which was graced by a fine program of organ, orchestral and song numbers.

The staff of WLW, Cincinnati is to be congratulated upon the acquisition of this instrument, which came over with singularly clear modulation, when one

considers it was its first appearance, so to speak, on the air.

I like the way the Gypsy Stringed Orchestra signs off at WEA, New York, and its collaborating stations. Here is a musical organization, while I am on the subject, which has done more than its share of demonstrating what radio entertainment can be. After its regular hour on the air, this orchestra signs off by having the music of its last offering gradually dwindle away to nothing. I would like to know how this effect is obtained.

BEG PARDON!



have no sympathy for the reviewer who veils himself under the moss-grown, editorial "we."

Speaking of music, does everyone agree with me that the quality of orchestral music now broadcast is far ahead of that of even a year ago? Of course, even then there were a few organizations on the air of real musical ability, but it seems to me there are so many more now than there were then. There are to be heard, it is true, many which are not up to standard. It is not difficult, however, to tune away from such, and get on the wave of a station which requires a high standard of effort from its musical organizations—and sticks to it.

I call to mind the Gypsies, the Capitol Theatre Grand Orchestra, the Oriole Orchestra, Meyer Davis' organizations, Vincent Lopez and his several groups, Paul Whiteman's Collegiates and many, many others.

JAZZ or CLASSICS



I am watching with a great deal of interest—and some apprehension—the result of a unique vote now being polled by the announcers at WHO, Des Moines. Jazz or the classics is the big question at this station, as this is being written. WHO has asked for a vote on the subject, following a series of organ recitals which are evenly divided into these two classes of offerings. What will the decision be?

Drink to Me Only with Thine Ears

By ROBERT FRANCIS SMITH

MARRIAGE is like a second-hand vacuum tube—it may work, but if it doesn't, you can't get a refund.

That's my predicament, and boy, I'm telling you, I means it! The wife has just changed her mind.

Not that it's at all unusual—oh, pardon me, I'm Joe Hammerstein, vaudeville dancer, pleased to meetcha, and the button-sewer is Doris, mentioned above—except that this particular mental alteration sorta conflicts with my plans, which again ain't unusual. I'll be clearer.

It's the tail end of the summer season, and we're getting the most outa the few weeks left before we'll have to pull our stakes away from Brightmere-on-the-Deep and do our song-and-dance out over the circuits. That is, I says we will.

Doris, it seems, ain't got her scandal files complete, and don't wanta leave for a while. That part would suit me, except that I likes

to eat and hear broadcasts, and try to do those things on credit!

"Joe," says Doris, "what say this year we lay offa vaudeville?"

"Ain't you the cutest little jigger, though," I remarks, sarcastic. "How do you suppose I'm gonna pay for that new eight-tube set I got in on approval?"

"Sell it, if necessary," smiles Doris.

"Well, what's the idea—got a bid for a production engagement?"

Doris shakes her abbreviated locks. "No, dear," she coos. "Last night I dreamed all about it."

I grunts. "Spill it," I requests. "I'm agreeable to staying in the East, but what on? My reputation?"

"Impossible," says the apron-stringer. "Here's the opus: Why not get up a new supper club, with ourselves as hosts and entertainers?"

"Field's too crowded," I replies, although I'm interested. "Every vacant garret is a hang-out for a set of Charleston addicts."

My little one puts her arms around my neck. "Oh, Joe, dear, couldn't we try? I just couldn't bear going out West again, especially if we're gonna take the troupe along, like we did last season."

When a man's own wife can vamp him, something's wrong. I'm sorta half-way in favor of the project, but there's numerous objections.

"In the first place, the original cost," I states. "Then, there's the danger of being closed up any minute by the booze-chasers. You know these Broadway birds just naturally gotta carry something along to stimulate them, and the liquor dicks is live and busy nowdays."

"Whoops!" yelps Doris, sudden. "Stimulant!"

"Whatinell?" I exclaims.

"Oh, Joe, you're a darling!" gurgles my Fifth Avenue model. "I know!"

"Thanks," I says. "What do you know, and can you prove it?"

"Stimulant!" chirps Doris. "Joe, we can give them a stimulant, and never get pinched."

I'm sarcastic. "Whoops!" I mimics. "Get a patent on it."

But Doris ain't to be damped. "Listen," she commands. "Why not let Jerry rig up a café full of his queer devices, together with his newest radio inventions, and call the place the Q. R. M. Club?"

Once again in my life I takes off my hat to a woman.

"Darling," I murmurs, "often I think you really got sense."

Doris only smiles, joyous. Then I strikes a snag.

"Maybe The Master won't want to do it," I cautions. "You recall the cunning little flop he staged at the Colossus last fall? It's sorta got him set against the theatre."

That makes Doris think. "I'd forgotten that," she admits. "But can't you fix it up with Jerry so's he won't have to show up? You know how to get around him."

"Me?" I inquires. "Say, getting around The Master when he don't want to be got around is like trying to fit an undersized bathing suit onto a mosquito with a pipe-wrench. If Jerry says no, he means Certainly Not."

The Master, by the way, is Mister Gerard Lawson, our millionaire friend, capitalistic by inheritance, scientific by choice, and what a choice! He's young, tender, fond of radio and don't know a Joe Miller from a Will Rogers.

"Aw, go on, Joe, ask him!" pleads Doris. "He can't do no more'n say nothing doing."

So finally I sets off across lots to The Master's. Being an old friend, fellow ether-bound and brother Elk, I don't hesitate but runs upstairs leading to the miniature inferno he calls his laboratory. This same is situated on top of a big-time garage, and consists of several innocent-looking rooms. The rooms is innocent, but the contents! However, I sticks my dome through the doorway and yodels my greetings.

"Hello, Jerry," I says, snappy and to the point. "Howsa ol' boy?"

"Oh, hello, Joe," he comes back, and I sees he's feeling as good as he can feel. "What's the news?"

"Oh, nothing," I says, preferring to let the subject on my mind dry out a little before ironing. I sits down on a packing box and takes a slant around the joint. It's familiar, me spending most of my spare time there, but there's always some half-finished do-funny that I ain't lamped before. At present Jerry's working on one. If curiosity killed a cat, my nine lives is a thing of the remote past.

"Well, what's it today?" I inquires, genial. "How many souls 've been saved since last I trod these here boards?"

The Master sees I means to be funny, so he smiles. "Oh, last night I figured out a

(Continued on page 216)



"Wanta bet on it?"
The officer is a good sport. "All right, boy, I'll bet you your freedom against a box of Havana Ropes that he's pickled."

Does Your Radio Set Jeopardize Your Insurance?

By BEN B. BOSTICK

Is your receiver properly installed? This article gives excellent precautions to observe.

THIS is an interview with R. B. Shepard of the National Board of Fire Underwriters in which the few simple precautions which the ordinary set owner must follow in order to have his installation pass muster with the insurance inspector are detailed. Mr. Shepard is in charge of the Laboratory of the Fire Underwriters. He speaks as follows:

"We are always being told of the extreme importance of little things, so often in fact that we are constantly growing more and more lax on account of this very retelling.

"Every one knows that the National Board of Fire Underwriters has a code which must be adhered to if the fire insurance is to remain in force. And most people know that

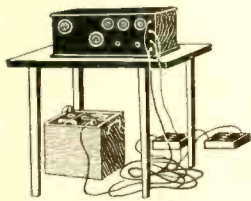

How not to have battery wires around a radio receiver.

there is a specific section of this code devoted to radio installations. Yet, how many sets are installed with the idea of making them pass the rules of the underwriters? To find the answer it is only necessary to pass down the street some morning and count the number of aerials with lead-ins not equipped with grounding switches or lightning protectors.

"The whole point is this: If the underwriters' code is not adhered to, there is a very great possibility that the insurance on the building in which the offending set is installed may be voided at any time. And worse yet, the insurance company might very logically refuse to pay a part or all of the contract in case of fire of undetermined origin. They would be upheld in any court if the installation could be proven faulty or not according to code, if the fire started in the same part of the house as the set.

"So does it not behoove the householder or property owner to see to it that all radio sets are installed according to the code of underwriters? And more paradoxical yet is the fact that the rules require only a few simple precautions and add not more than a few dollars to the complete price of the installed outfit. Why are sets installed at the very small saving effected by disregarding these rules when, at the same time, results from it may entail infinitely greater losses in jeopardized insurance? And if an inspector finds it, he will immediately order the cancellation of the insurance and not vali-



Obviously this is not the shortest possible path from the set to ground.

date the contract until the rules have been complied with.

THE UNDERWRITERS' RULES

"The rules, briefly, which affect the ordinary broadcast receiver are about four. The first has to do with the installation of lightning protectors in the aerial and ground circuit; the second with the type of ground employed for the operation of the set and the protective ground for the lightning arrestor; the third takes into consideration the wiring of the storage and 'B' batteries and the fourth the position and type of lead-in.

"The first rule is that any antenna anywhere shall be connected to an approved type protective device and to ground. This rule holds for both antenna and counterpoise. If the latter is used, it is to be considered as an antenna and treated as such.

"The 'approved' in the last paragraph means that the lightning arrestor must be approved by the National Board of Fire Underwriters Laboratories. The cartons in which these little instruments are packed usually have a notation on them to the effect that they are passed by this body. However, since the approved type rarely costs more than a type which does not carry this annotation, it might be a profitable point for the purchaser to look for himself and see that the instrument he is getting has the approval.

"The underwriters also recommend that a separate switch be employed to disconnect the set entirely from the antenna while it is not in use. This is not demanded but has been found to be desirable in practice. Sometimes such a switch will save the set owner a burned-out transformer or other damage to the set.

"It must be understood too, that the ground required for the protective device is not necessarily the same which is used for the operation of the set. In fact, the rules specifically state that the ground conductor from the protective device should 'run in as straight a line to the ground as possible.' Of course, if your regular ground used with the set is connected to the cut-off under the kitchen sink, and the lead to it goes from the front room, under Willie's bed and then takes a tack across the path of the dining-table, it is hardly running as straight to the ground as possible.

"In the hypothetical case just stated, it might be well to mention that the logical procedure is to drive a six-foot length of pipe into the ground beneath the window where the aerial lead enters and connect the ground side of the protective device to it. This serves perfectly well as long as the pipe is at least an inch in diameter and six feet or more in length. The connection may be made with an approved ground clamp. Here it is best to ask the dealer whether the clamp is approved or not—some of them are not.

THE "LIGHTNING PROTECTOR"

"And here it might be well to mention that though the little device is very often called a 'lightning protector' in the trade and among its users, it is never called that in the Underwriters' Code. The underwriters are engineers and know the vagaries of lightning. And knowing them so well, they never expect it to follow a No. 14 wire.

"They know further that an antenna does not increase the lightning hazard on a building. If anything it decreases this cause for worry since it, by nature, if properly

grounded, tends to reduce the electrical pressure between the charged atmosphere and the earth. The protective device is primarily to protect the set against damage by extra heavy static discharges and like contingencies.

"The strength which this phenomenon sometimes attains may be judged from the experience of commercial operators. Many of them will tell you of experiences during which static was so strong as to cause small sparks to jump between the stator and rotor plates of the variable condensers. What this would do the ordinary set probably would not be serious. The underwriters, however, work on the principle that an ounce of prevention is worth a pound of cure. They

It is recommended to have a switch for disconnecting the antenna entirely from the set.



wish to protect the entire contents of houses from damage.

"Aerials are seldom constructed out of smaller wire than No. 14, therefore nothing will be said about this rule. Make your antenna out of no less than No. 14 copper wire and see that all joints are soldered or made with approved splicing devices.

"As to lead-in insulators, that is another question. The rules say: 'Each lead-in conductor shall enter the building through a non-combustible, non-absorptive, insulating bushing slanting upward toward the inside, or by an approved device designed to give the necessary protection.'

"This eliminates several of the trick type of lead-in strips and devices now on the

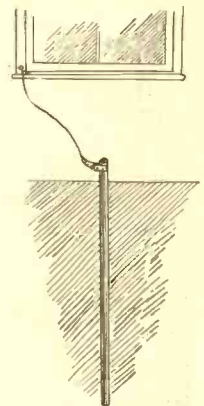

An excellent ground connection is six feet of one-inch pipe driven into the ground as close as possible to the house. The ground wire is attached by an approved ground-clamp.

market. Before installing one of them see that the stamp 'Approved by the National Board of Fire Underwriters' appears on it.

"Of course, after the campaigns for safe aerials which have been carried on by this and other publications, it is hardly necessary to mention the fact that aerials should not be installed in the neighborhood of lighting mains, trolley or feeder wires. This rule is specifically stated in the code.

DANGERS IN WIRING

"Inside the house, none of the wires leading to the set should be placed nearer than six inches to any conductor carrying house-lighting potentials. This should be carefully considered by those who use storage battery chargers and have them installed in the proximity of the set.

"This applies to lead-in and ground wires as well.

"Within the house all leads should be made fast in a 'workmanlike manner' and should not come closer than the above measurement to light and power wires. This raises quite a problem in sets employing house-lighting circuits for antenna and power supply. There have as yet been no absolute general rules made covering such installations, so the only criterion upon which the purchaser may rest is the passage of the set by the laboratory of the underwriters.

"This same applies to the use of various condenser devices which are manufactured

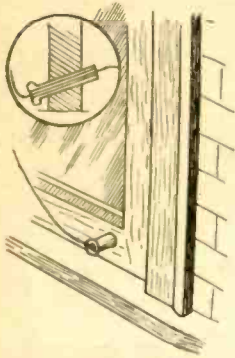

The lead-in insulator should always be installed so it points upward to the inside.

to be placed into the light socket for using the light mains as a collective agency for receiving sets. Here again the purchaser must rely upon the little stamp for protection.

"To many, this seems a great deal like quibbling, but the fact remains that the insurance companies and the courts take the word of this body of engineers pretty much as law. Of course, the underwriters work hand in hand with the Institute of Radio Engineers and the Institute of Electrical Engineers, so their code is primarily one for the safety of the installation rather than a method for helping the insurance companies avoid responsibility.

"There are several provisions of importance to be considered in connection with the filament leads and the placement of the storage batteries, both "A" and "B" types. The code requires that all batteries be supported upon 'non-combustible, non-absorptive insulators, such as glass or highly glazed porcelain.'

"All wiring from them must conform to the general wiring code found in the code which applies to regular house installations

under the head of Open Wiring. This means that all connections shall be made with rubber-insulated wire (this is a special provision of the radio section of the code) and that all wires shall have a separation of at least three inches from each other and a separation of at least one-half inch from the surface wired over. This also prohibits the use of staples in holding the wire in place. All supports for wires shall be of approved non-combustible material, the design of which is passed by the board.

"The moral of the last paragraph is that storage battery wires—or any battery wires, for that matter—should *not* be laid loosely around the radio set. There might be such a thing as a temporary installation for two or three months, but when the same set is used in the same place and with the same attachments for more than a couple of months, it should be considered a permanent installation and wired according to rules. The temporary idea, however, does not release the set owner from the possibility of having his insurance called.

NEW RULING ON STORAGE BATTERIES

"The rules are going to be changed for storage batteries in the fall—and chiefly on account of the fact that so many sets are

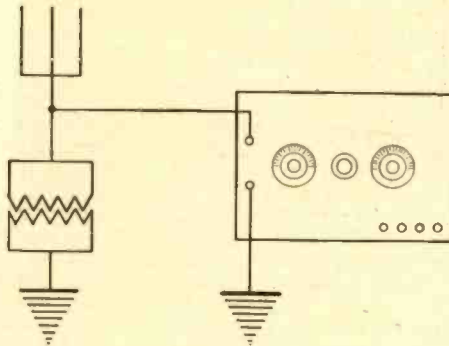

The simplest lightning protector installation is designated above.

installed with the wires to the batteries in any way they happen to fall. Too many experimenters have installed sets by the very simple process of setting the cabinet on one corner of the table, installing the batteries on the floor beneath and then connecting the batteries with the cabinet and the aerial and ground without the slightest regard for the position of the interconnecting wires. So next fall a circuit-breaker, rated at not more than fifteen amperes, must be included in

the storage battery leads. This last rule has been drawn up by the engineers of the board and will be submitted to the full board in the next couple of months.

"The chances are all for its passing.

"The rules and advice given above deal with problems of the industry as it exists today. Constantly there are new devices being perfected for the market, and the laboratory of the Board, at 109 Leonard Street, New York City, with its staff of engineers and the advice of the other engineering bodies of the country, are constantly working with the investigators and designers so that the completed device will have the least possible hazard to the user and the property upon which it is installed.

"Some of these problems facing the

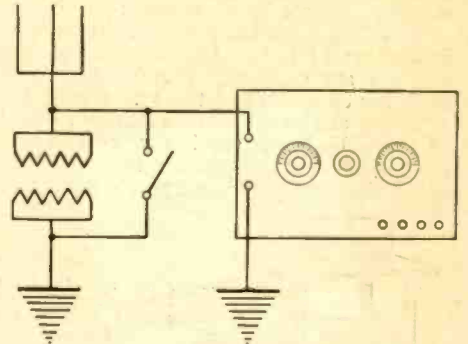

The position of the lightning arrester in the aerial lead is shown in the above hook-up. Note the grounding switch.

Laboratory at the present time are in connection with the recently introduced varieties of vacuum tubes with their filaments heated from the house-wiring lines. No general practice has been developed here as yet, and the Board is following the principle of passing each individual design rather than falling back on general rules. Up to the present there have been about three systems devised for furnishing 'B' battery potential from the house current.

"I hope this interview will show the public the ideas underlying the operation of the Board of Underwriters and enlist its help and co-operation. Too often there is the idea that the Board is a bunch of high-binders operated exclusively for the purpose of making the individual purchase useless gimcracks. If this article serves to correct this notion, it will help all along the line."

Medium-Sized Sets and Medium Distance

THE craze for long-distance reception is gradually dying out, except among new fans, according to an experienced listener and broadcaster of the West. He advocates medium-sized sets, suggesting that, by tuning in on stations nearer home, we will get less interference and just as good programs.

When a man or a boy gets his first set, be it a crystal or single tube, he begins to reach out a thousand miles or so, expecting to hear something fine, but all he gets at that distance, usually, is static and, perhaps, very weak signals, according to Ernest V. Wright, the expert quoted. Finding that he cannot pick up distant stations satisfactorily, he trades in his set toward a larger one. Then, with the first word or note from some far-away broadcaster, he gets the fever for hearing something still farther away, until he joins the ranks of the "super or ultra sets."

Multi-tube sets are too expensive for some fans to maintain. There are eight tubes to burn out instead of two or three, a whole

array of batteries to recharge or replace every so often, and what does he get in return? No better music or oratory than he can get from the nearest large city station. Therefore, unless he is wealthy, he soon finds out that a three-tube set will bring in all the entertainment he wishes, either by phones or loud speaker. Then comes the change and perhaps sanity.

Medium-sized sets are now said to be selling ten to one of the multi-tube affairs. This fan says he is tired of trying to get distance stuff which comes in badly. Consequently, he has decided to listen to stations he can get well and be contented. He plans to get rid of his five-tube set and purchase a good three-tube outfit. Distance in radio, he says, is something like using a telescope.

From Los Angeles he can get Chicago, Salt Lake, Denver and Kansas City stations, but the distance away is all that makes them more interesting than those near home. Now he is determined to listen in on the home and medium distant stations and leave long-distance alone.

Isn't this a pretty good idea? Those who live in New York have as good programs available as there are in Los Angeles or Chicago, and *vice versa*, so why not patronize home, or at least, neighboring stations and talent, picking up programs which come in clearer and much stronger?

DUTCH POLICE MAKES REQUEST

Some days ago a special committee was appointed in Holland to study the question of whether radio can be of any service to the police in a small country such as ours.

The committee will be glad to hear the opinion of you and of your readers on this matter. It will be glad, too, to be informed about the results already obtained and the methods used in America by police broadcasting.

May I take the liberty to beg you to insert this request of the aforesaid committee in your columns? Any answers to these questions should be mailed to my address.

LEO COHEN.

Amsterdam, Holland.

First Annual Portable Radio Set Directory

By HUGO GERNSBACK

A Complete List of Portable Radio Receiving Sets of American Manufacture with Complete Data on Each Set.

RADIO NEWS takes pleasure in presenting, this month, its First Annual Portable Radio Set Directory. This is a companion directory to the First Annual Radio Set Directory published in our March, 1925, issue. We believe that this directory is complete and represents all of the portable radio sets manufactured in the United States at the present time.



This year is the first one in which manufacturers have contributed a good selection of sets to the industry. There are, in fact, twenty-two of them represented, which should prove sufficient for all purposes.

Inasmuch as the size and weight of portable sets are important considerations, this information has been added wherever available. With close to 600 radio broadcast stations operating throughout

the length and breadth of the land, and a great number of these with increased power, it is now possible to enjoy radio programs no matter where you are located, or where you travel, whether you go on a motor camping trip, whether you go into the wilds of the forest, or into the most inaccessible places.

It goes without saying that portable sets are also very popular in homes where it is often necessary to transport an outfit from room to room, particularly in apartments where space is at a premium. There is also a huge demand springing up for portable sets for hospitals and hotels.

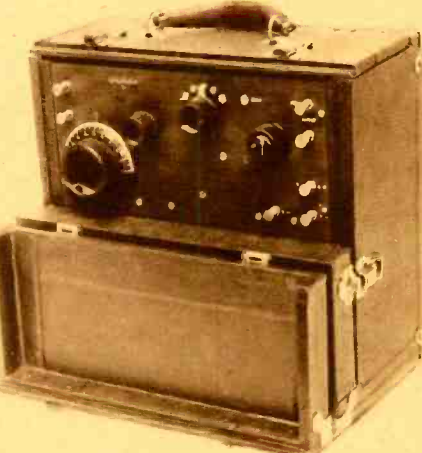
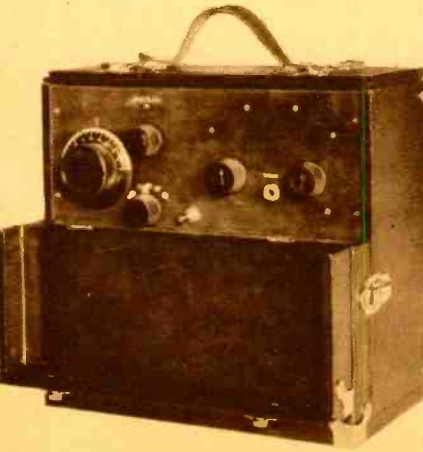
One New York hotel, the Roosevelt, in which RADIO NEWS' Station WRNY is located, provides its guests, upon application, with portable sets.

	<p>TRADE NAME: American Apparatus Co., Portable MODEL: CN-7 TYPE: Regenerative WEIGHT AND SIZE: 15 lbs., 7½ x 10½ x 8½ inches TUBES: Two 199 type BATTERIES: Dry cell CONTROLS: Two ANTENNA: Outdoor PRICE: \$20, without accessories MANUFACTURER'S NAME: American Apparatus Co.</p> <hr/> <p>TRADE NAME: Kennedy MODEL: III TYPE: Single circuit WEIGHT AND SIZE: 24 lbs., 13 x 14 x 8 inches TUBES: Three BATTERIES: Dry cell CONTROLS: Two ANTENNA: Outdoor PRICE: \$75, without accessories MANUFACTURER'S NAME: Colin B. Kennedy Corp.</p>	
	<p>TRADE NAME: Crosley 50-Portable MODEL: 50-Portable TYPE: Regenerative TUBES: One BATTERIES: Dry CONTROLS: Three ANTENNA: Outdoor PRICE: \$16, less accessories MANUFACTURER'S NAME: Crosley Radio Corporation</p> <hr/> <p>TRADE NAME: Crosley 51-Portable MODEL: 51-Portable TYPE: Regenerative TUBES: Two BATTERIES: Dry CONTROLS: Three ANTENNA: Outdoor PRICE: \$23.50, less accessories MANUFACTURER'S NAME: Crosley Radio Corporation</p>	
	<p>TRADE NAME: Crosley 52-Portable MODEL: 52-Portable TYPE: Regenerative TUBES: Three BATTERIES: Dry CONTROLS: Three ANTENNA: Outdoor PRICE: \$35, less accessories MANUFACTURER'S NAME: Crosley Radio Corporation</p> <hr/> <p>TRADE NAME: Superiorflex MODEL: P.3-S TYPE: Reflex WEIGHT AND SIZE: 39 lbs., 20 x 9½ x 12¼ inches TUBES: Three BATTERIES: Dry or wet CONTROL: Single ANTENNA: Short outdoor PRICE: \$150, including antenna and ground MANUFACTURER'S NAME: Electrical Research and Manufacturing Company</p>	

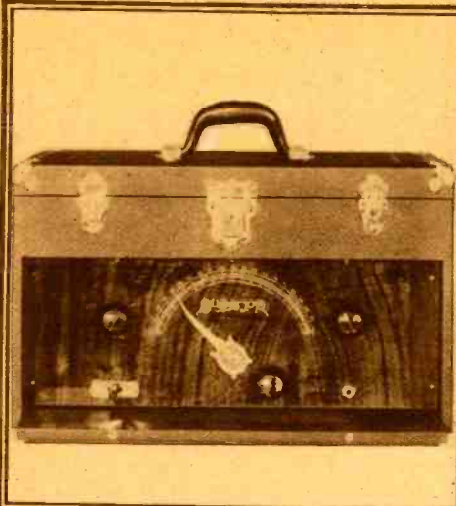

TRADE NAME: Superiorflex
MODEL: P3
TYPE: Reflex
WEIGHT AND SIZE: 34 lbs., 20 x 9½ x 12¼ inches
TUBES: Three
BATTERY: Dry or wet
CONTROL: Single
ANTENNA: Antenna and ground furnished.
PRICE: \$125, less accessories
MANUFACTURER'S NAME: Electrical Research and Manufacturing Company

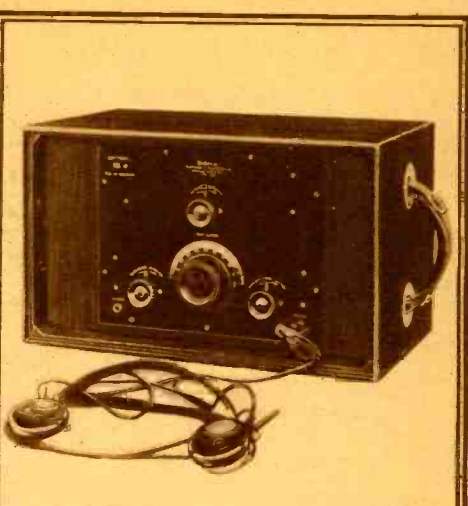

TRADE NAME: Federal
MODEL: 102 Portable
TYPE: One radio, detector and two audio
TUBES: Four
BATTERIES: Dry cell
CONTROLS: Four
ANTENNA: Outdoor
PRICE: \$140, without accessories
MANUFACTURER'S NAME: Federal Telephone and Telegraph Company

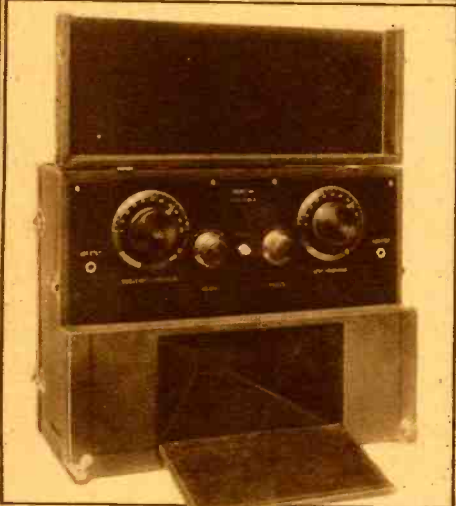

TRADE NAME: Haynes-Griffin
TYPE: Super-heterodyne
WEIGHT AND SIZE: 44 lbs., 21 x 8½ x 17¼ inches
TUBES: Eight
BATTERIES: Dry
CONTROLS: Two
ANTENNA: Loop
PRICE: \$100, less accessories
MANUFACTURER'S NAME: Haynes-Griffin Radio Service, Inc.



TRADE NAME: Hetrola Portable
MODEL: R-199-P
TYPE: Super-heterodyne
WEIGHT AND SIZE: 35 lbs., 18½ x 14½ x 8½ inches
TUBES: Seven
BATTERIES: Dry
CONTROLS: Two
ANTENNA: Loop or outdoor
PRICE: \$165, without accessories
MANUFACTURER'S NAME: Hetrola Radio Company, Ltd.

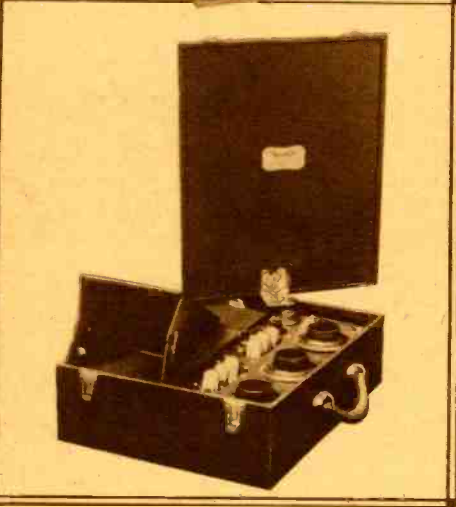

TRADE NAME: Karryadio
TYPE: Tuned radio frequency
WEIGHT AND DIMENSIONS: 29 lbs., 18½ x 14¼ x 5¼ inches
TUBES: Six, 199 type
CONTROLS: Three
BATTERIES: Dry cells
ANTENNA: Loop
PRICE: Case, loop and collapsible loud speaker, \$15. Complete with set installed, \$75
MANUFACTURER'S NAME: Armley Radio Corp.

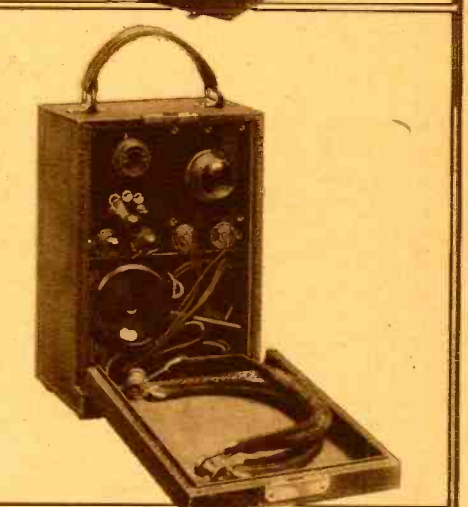

TRADE NAME: Kodol Portable
MODEL: P-11
TYPE: Kodol circuit
WEIGHT AND SIZE: 3 lbs., 6¼ x 9 x 5 inches
TUBES: One
BATTERIES: Dry cell
CONTROLS: One
ANTENNA: Outside standard
PRICE: \$16, less accessories
MANUFACTURER'S NAME: Kodol Radio Corporation



TRADE NAME: Kodol Portable
MODEL: P-14
TYPE: Kodol circuit
WEIGHT AND SIZE: 28 lbs., 14½ x 13¼ x 10¼ inches
TUBES: Four
BATTERIES: Dry cell
CONTROLS: Two
ANTENNA: Outside standard
PRICE: \$50, with built-in loud speaker but without accessories
MANUFACTURER'S NAME: Kodol Radio Corporation

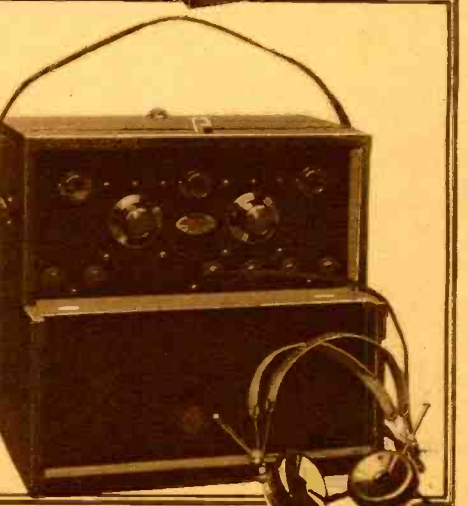

TRADE NAME: Kodol Portable
MODEL: P-12
TYPE: Kodol circuit
WEIGHT AND SIZE: 6 lbs., 10 x 7½ x 9 inches
TUBES: Two
BATTERIES: Dry cell
CONTROLS: One
ANTENNA: Outside standard
PRICE: \$22.50, less accessories
MANUFACTURER'S NAME: Kodol Radio Corporation



TRADE NAME: Radio Masterpiece
 MODEL: P. L. 103
 TYPE: Built-in loud speaker and loop
 TUBES: Six
 BATTERIES: Storage or dry cell
 CONTROLS: Two
 ANTENNA: Loop, furnished
 PRICE: \$160, without accessories
 MANUFACTURER'S NAME: Lytton, Inc



TRADE NAME: Nyaccoflex
 MODEL: R. P. 1
 TYPE: Reflex in case with phonograph
 TUBES: Two
 BATTERIES: Dry cell
 CONTROLS: Two
 ANTENNA: Outdoor
 PRICE: \$65, without accessories
 MANUFACTURER'S NAME: New York Album and Card Company



TRADE NAME: Operadio
 MODEL: 1925
 TYPE: Tuned radio frequency
 WEIGHT AND SIZE: 41 lbs., 17 x 9 x 12 inches
 TUBES: Six
 BATTERIES: Dry cell
 CONTROLS: Two
 ANTENNA: Loop
 PRICE: \$189, including tubes, batteries, loud speaker and loop
 MANUFACTURER'S NAME: The Operadio Corporation



TRADE NAME: Radiola
 MODEL: 26
 TYPE: Super-heterodyne
 WEIGHT AND SIZE: 40 lbs., 13 x 14 1/4 x 9 1/2 inches
 TUBES: Six 199
 BATTERIES: Dry cell
 CONTROLS: Two
 ANTENNA: Loop
 PRICE: \$225, with loud speaker, tubes and loop
 MANUFACTURER'S NAME: Radio Corporation of America

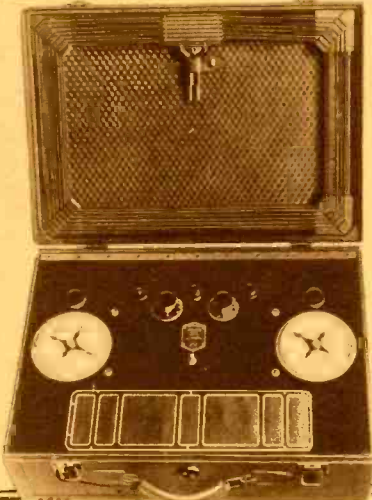
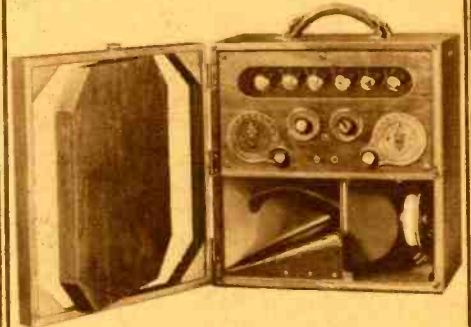

TRADE NAME: Radiola
 MODEL: Second harmonic super-heterodyne.
 TYPE: Radiola 24
 WEIGHT AND SIZE: 40 lbs., 21 1/2 x 15 x 7 1/2 inches
 TUBES: Six U. V. 199
 BATTERIES: Dry cell
 CONTROLS: Three
 ANTENNA: Loop
 PRICE: \$195, including tubes, loop and built-in loud speaker
 MANUFACTURER'S NAME: Radio Corporation of America



TRADE NAME: Standard
 MODEL: Portable
 TYPE: One-stage radio, detector and two audio
 WEIGHT AND SIZE: 35 lbs., 16 x 9 x 11 inches
 TUBES: Four
 BATTERIES: Dry
 CONTROLS: Two
 ANTENNA: Loop
 PRICE: \$75, less accessories
 MANUFACTURER'S NAME: Standard Radio Company

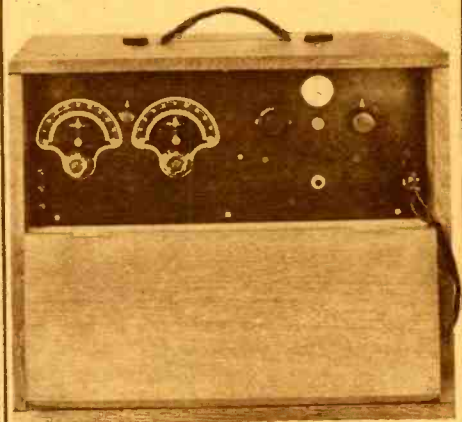

TRADE NAME: Telmaco Portable
 MODEL: P-1
 TYPE: Reflex
 WEIGHT AND SIZE: 26 lbs., 8 x 10 x 18 inches
 TUBES: Four
 BATTERIES: Dry cell
 CONTROLS: Two
 ANTENNA: Loop or antenna
 PRICE: \$125, with loop and loud speaker; \$143.50 complete, with tubes and batteries
 MANUFACTURER'S NAME: Telephone Maintenance Company



TRADE NAME: Wells Bear-Cat
 MODEL: 500
 TYPE: Radio frequency
 WEIGHT AND SIZE: 36 1/2 lbs., 19 x 15 x 9 1/2 inches
 TUBES: Five
 BATTERIES: Dry cell
 CONTROLS: Three
 ANTENNA: Antenna and ground on reel in case
 PRICE: \$110 including antenna, ground and built-in loud speaker
 MANUFACTURER'S NAME: Wells Radio Manufacturing Company



Radio In New York Police Department

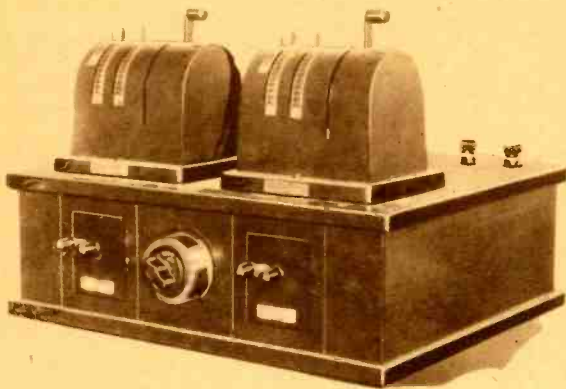

SELECTIVE SIGNALING DEVICE. The levers in this signaling device are set at different points indicated by numbers and letters, thus automatically signaling station houses or police booths by radio, through station WNYC. © Fotograms.



IN THE STATION HOUSE. When a station house is signaled, a light flashes and a bell rings in the receiving set, which is tuned only to the wave-length of WNYC. © Fotograms.

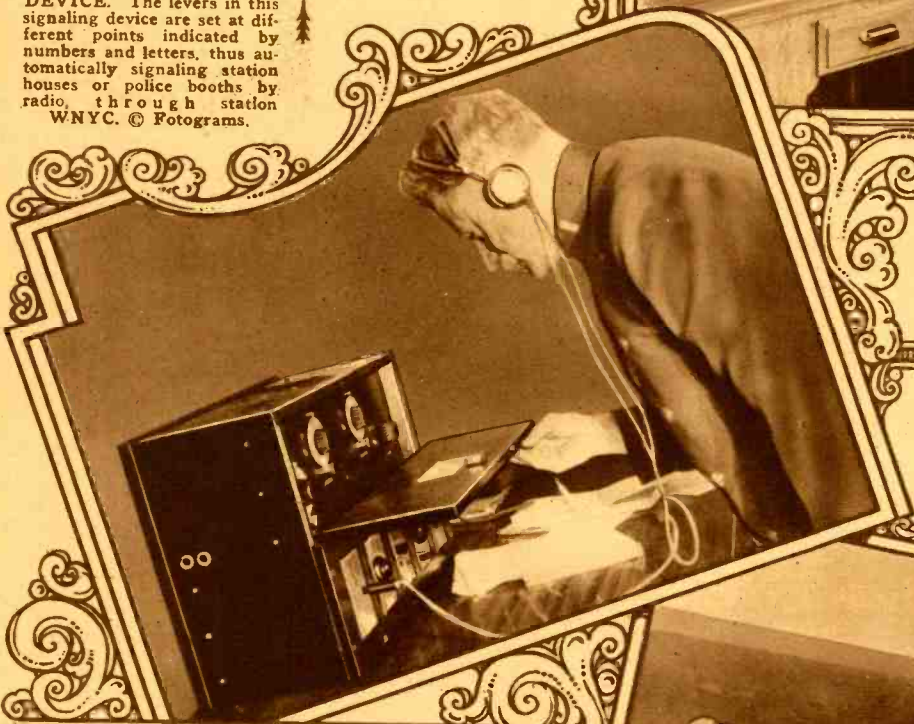

SETTING THE SIGNALING DEVICE. When headquarters desires to broadcast an alarm, it can call any one station, any group of stations or all the stations in the network by this little device. After the signal has been sent, the message is broadcast through the city's station, WNYC. © Fotograms.

THE INTERIOR OF A RECEIVER. The dials are locked in the position for receiving on 526 meters, the wave-length of WNYC, and the front lid is locked, so that the set is ready at all times for emergencies. © Fotograms.



RECEIVING A CALL IN A POLICE BOOTH. The method of radio signaling is a great time-saver in informing the outlying districts of the committing of a crime, as it takes but a very few minutes to broadcast to the whole city complete details and orders. In this manner thefts of automobiles can be reported almost instantly and outlets of the city can be watched, making the chance of escape very small. © Fotograms.



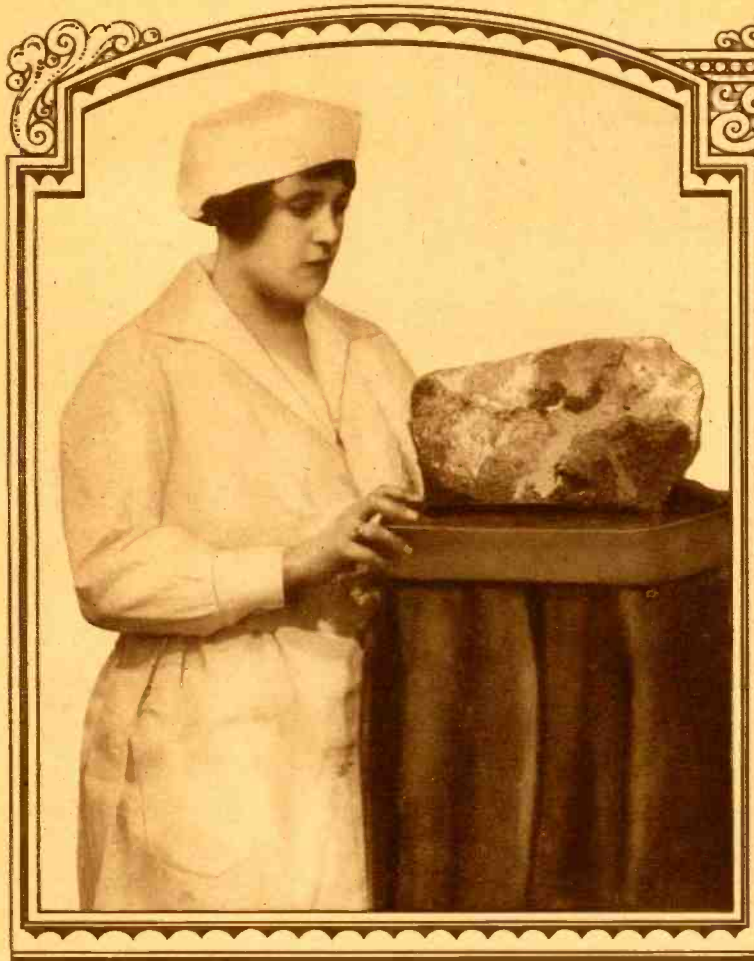

ONE OF THE BIGGEST CRYSTALS IN THE WORLD. This midite crystal, which is said to be one of the world's largest, was exhibited at the English Radio Show at Hull. © Underwood & Underwood.

GIANT VACUUM TUBE. This large tube was exhibited at the Radio Show in Hull, England. How would you like to have a receiver with four or five tubes like this one in it? © Underwood & Underwood.

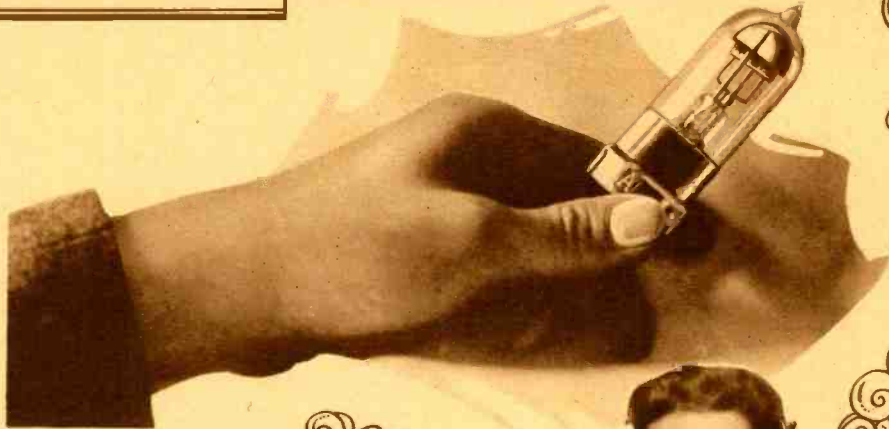

A SMALL EDITION OF THE GIANT TUBE. Here is a regulation size vacuum tube made by the English company which produced the large one shown above. Some idea of the size of the latter can be obtained by comparing the one on the right and the man's hand with the tube in the picture above.

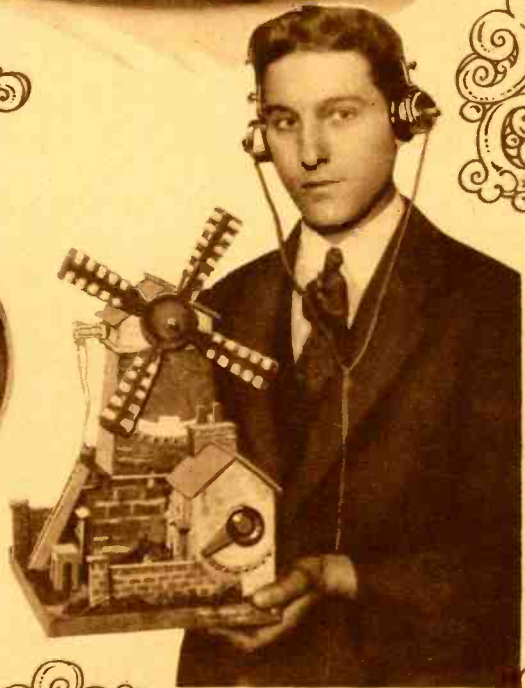
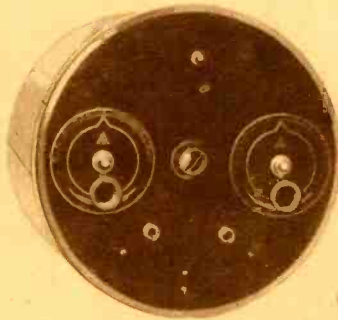
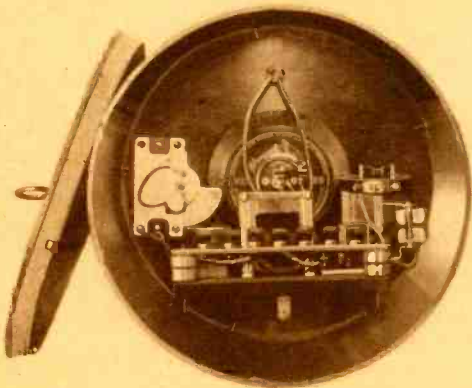

RADIO PANELS MADE FROM OLD PHONOGRAPH RECORDS. The above receiver was built on a discarded phonograph record and a round shipping box. The record is a good insulator and will prove satisfactory in every way. The set shown above is a portable outfit, there being sufficient space in the box for the necessary batteries. © Kadel & Herbert.

CRYSTAL SET IN MINIATURE WINDMILL. A receiver that attracted a great deal of attention at the Radio Show in Hull was the small set shown on the right, made by an English amateur.

WRNY'S Masts

FASTENING GUY WIRE SHACKLES TO MAST. One of the workmen is seen placing in position the shackles to which are attached the guy wires supporting the mast. Anyone who has ever erected an antenna mast will realize the importance of this operation.

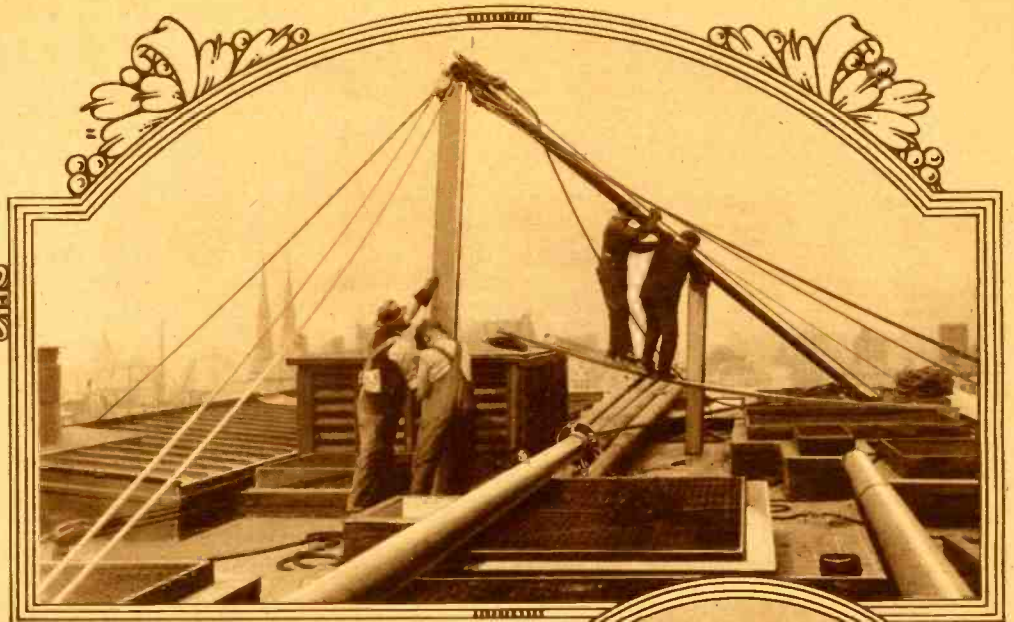

RAISING A SECTION OF THE MAST. Four of the workmen on the roof of the Roosevelt Hotel are placing one of the masts in position, while other workmen are manning the ropes that raise the mast.



PLACING THE CROSS-ARM ON ONE OF THE MASTS. Two of the workmen, high above Madison Ave., are securing the antenna supports to one of the masts. The guy wires may be seen, attached to the mast at three different points.

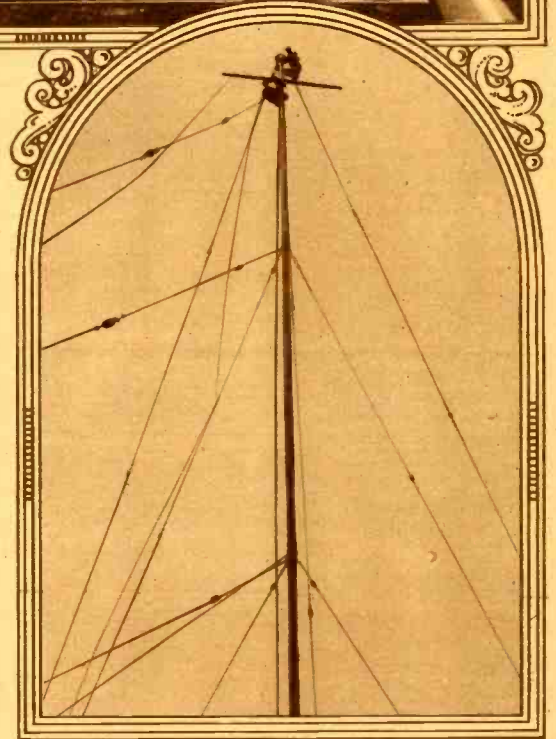

THE TWO MASTS OF WRNY. One of the masts is in position and the first section of the other being secured by guy wires which the workman is attaching to the shackles.

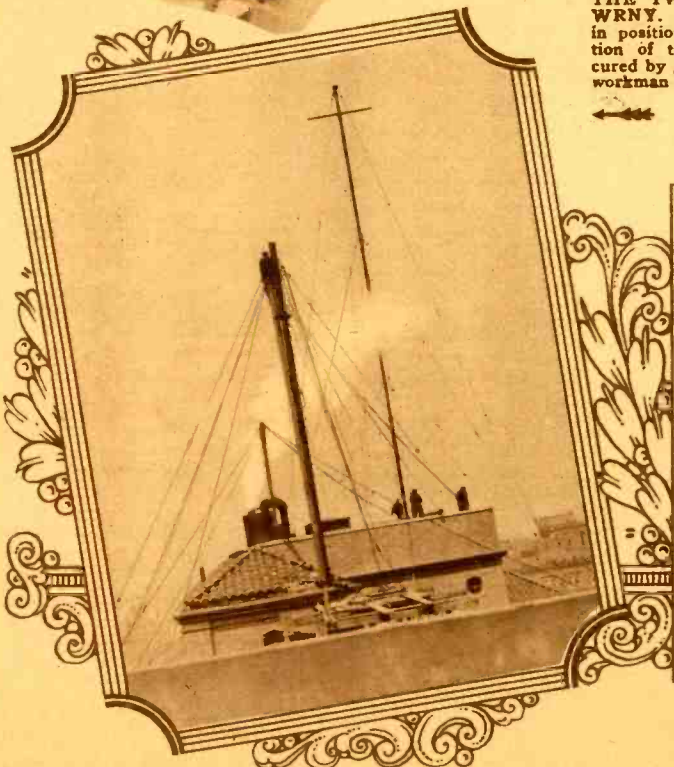

ATOP THE ROOSEVELT HOTEL. The view that a bird would have if he perched on one of the WRNY masts. In the background may be seen the sky-line of New York, and in the foreground a section of one of the masts.

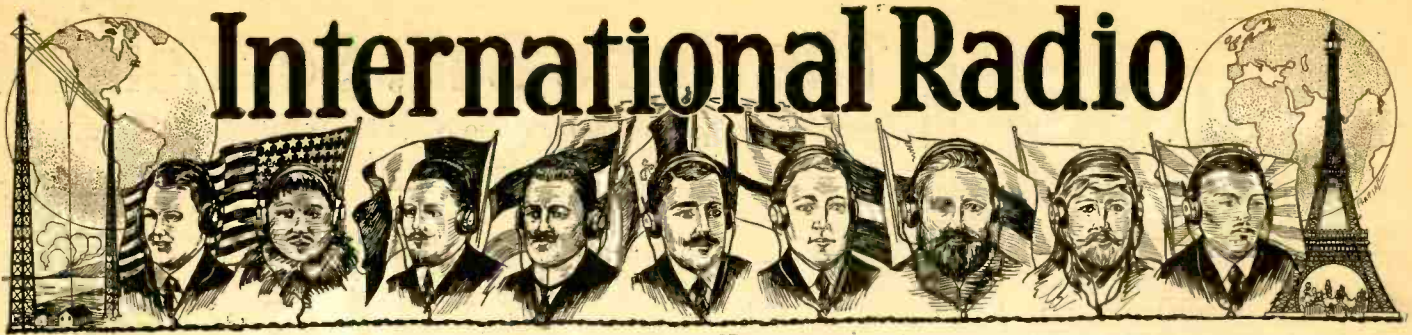

SOUTH AMERICA

Radio Developments

The world leadership of the United States in the development of the radio art and industry has won for our manufacturers and engineers a dominant position in the radio affairs of South America, where the greater percentage of the total business is carried on by Americans.

Broadcasting in South America is at present chiefly confined to the few large cities, and the schedules are well interspersed with phonographic music. However, in Buenos Aires excellent broadcasting is given the people during the operatic season, when the opera is put on the air direct from the Teatro Colon.

It is interesting to compare the "radio coverage" in the countries of Chile, Argentina and Brazil, with that of the United States. Here one station serves an area of roughly 6,000 square miles, while in South America one station serves more than 300,000 square miles. From the figures it is obvious that the South American broadcasting service is wholly inadequate, even though large sections are not extensively populated. This is doubtless the reason that the interest in radio matters is somewhat below par. As far as the Argentine is concerned, the city of Buenos Aires is about the only one where broadcasting has become a factor sufficiently important to be recognized. In Brazil and Peru the interest is less marked than in Argentine, Rio de Janeiro being the only city served by powerful stations.



BRAZIL

Internationally Built Radio Station

Every leading radio nation in the world will have a part in the construction of the radio station which will soon be erected in Brazil, not far from Rio de Janeiro.

That is, the station will be put up by an Internationale of Associated Companies. The towers will be erected by Telefunken of Germany, the antenna by the Radio Corporation of America, the transmitting apparatus will be furnished by the British Marconi Company and the generators by the French Compagnie Générale de Telephonie sans Fil. This new station will be built along the same lines as the French super-power station at Ste-Assise.

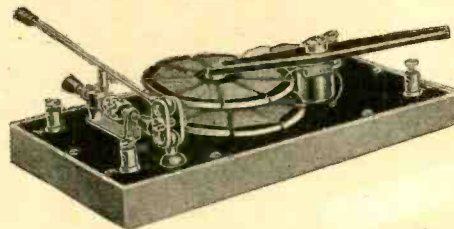

The crystal detector shown in the accompanying photograph has been recently put on the market by an English concern. The unique method of varying the coupling between the spider-web coils and the long handle on the adjustment of the crystal detector are new developments.

is made the fan has to advise the dealer where he is planning to install his set, giving antenna installation plans and other data. The cost of sets in Japan runs from \$12 up to \$150.

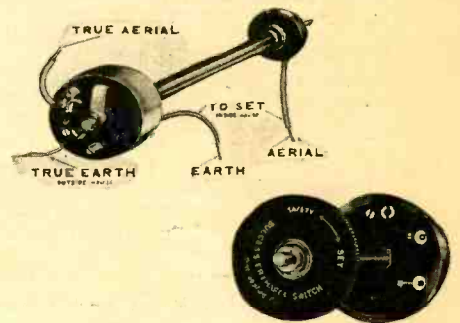

An English safety switch for grounding the antenna without bringing the antenna lead-in inside the house. The switch is operated from within the house. With this arrangement there is no danger of lightning entering the building since, when the switch is turned to safety, the antenna is directly grounded.



SWITZERLAND

International Broadcast Union

There has recently been formed an International Broadcast Union having headquarters in Geneva, which has for its members organizations and societies that broadcast programs. It is hoped that the Union will be able to further the co-operation between the different broadcasting enterprises in Europe, and if it succeeds in this, it is proposed to extend the membership to broadcasters in other continents.



JAPAN

Japan Goes on the Air

On March 1 the first Japanese broadcaster went on the air at Tokyo. This station is owned by a local broadcasting association and will carry the usual type of broadcast program. Another station is proposed at Osaka. Both of these stations are reported to be equipped for 750 watts power. About 50 more applications are said to be on file.

Of course the broadcasts will be in Japanese, and the power limit is 1.5 k.w., but it is anticipated that American DX fans, especially those on the Pacific Coast, will strive to pick up these Far Eastern transmitters, whose initial call letter is "J." The specific calls have not been reported.

Already the Japanese government has received over 800 applications for licenses to operate receiving sets. The government is seeing to it that only reliable and non-radiating sets are used; local manufacturers and importers must submit sample sets to the officials handling radio for approval before they can be placed on sale. Distributors of radio apparatus must also be responsible for the collection of the annual fee of 2 yen levied on listeners by the government and also the charges made by the broadcasting association for service. When a purchase



GERMANY

Going Pretty Far

Apart from the ordinary fee collected by the authorities in Neustadt, the following scale of taxes is levied on the radio listeners: 5 marks for local permit, 5 marks for testing the receiver and 1 mark per annum for use of ether situated directly above town property.



ENGLAND

Radio and Theatres Reconciled

The theatres have withdrawn the ban against broadcasting dramatic productions, and the British Broadcasting Company has agreed not to broadcast more than twenty-five theatrical pieces a year. The full terms of the agreement are as yet unknown.

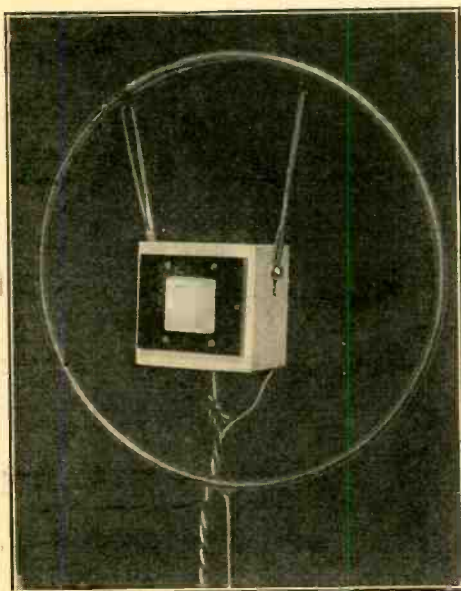

One of the greatest advances of the year in radio has occurred in Berlin, where the marble-block microphone shown in the accompanying illustration was invented by Eugen Reiss. Marble is used to eliminate undesirable oscillations that are common in other microphones. Instead of the carbon powder that is usual in microphones, there is employed here a finely powdered crystal substance, the formula of which is a secret.

A few of the receivers entered in the Home-Built Set Contest.

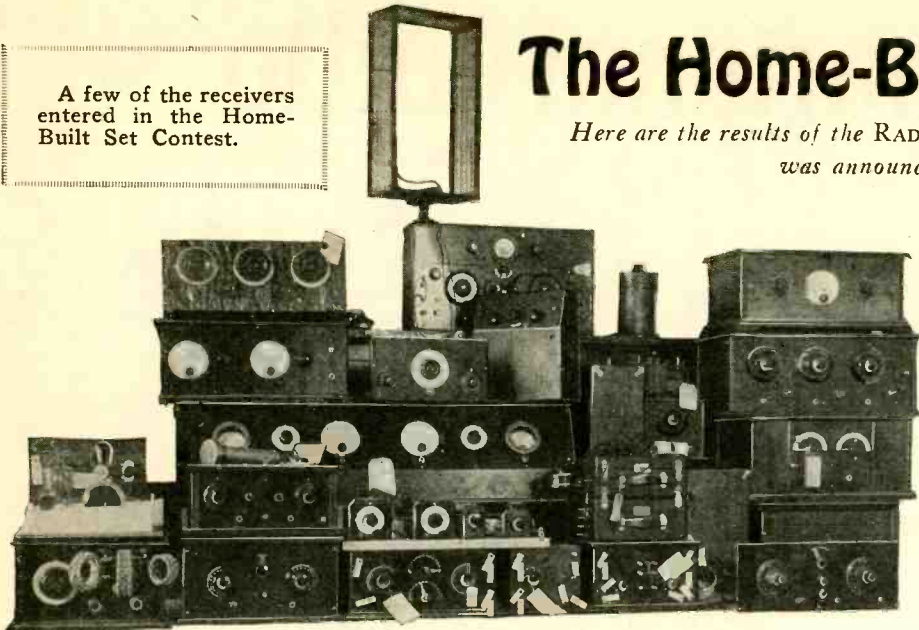

The Home-Built Set Contest

Here are the results of the RADIO NEWS Home-Built Set Contest which was announced in the May issue.

unfair to pit a super-heterodyne against a simple crystal set, so every receiver was judged according to its own class. All the crystal sets were tested and compared with each other, without any thought of comparing them with a receiver having four or five tubes. Then were tested the single-tube sets, and then the sets were divided into classes according to the number of the tubes employed. Also it would have been unfair to put a reflex circuit using two or three tubes against a set in which the tubes were utilized but once, so all reflex receivers were put in a class by themselves, as were the super-heterodynes.

The judges, who were the Editorial Staff and Laboratory Staff of RADIO NEWS, having Mr. Hugo Gernsback, the Editor of RADIO NEWS, as their Chairman, first tested a receiver as to its performance, which was decided as being the first logical step to take, for if a radio receiver will not func-

THE results of the Home-Built Set Contest were indeed gratifying to the Editor of RADIO NEWS, both in number of entries and the over-all quality of the apparatus that was submitted. The standard was very high, so high in fact that a great deal of difficulty was experienced in making decisions.

In the sets submitted practically every type of hook-up known to the art was employed. There were representatives of every sort from the most complete of super-heterodynes to the simplest of crystal affairs! And throughout the whole range, the workmanship, selection of parts and the layout of the apparatus was all that could be desired. An accompanying photograph will give some idea of the number of receivers and the labor and care represented in their construction and design.

FACTORS IN JUDGING

Naturally, it would be unfair to give each of these factors an equal value in the selection of prizes, so the rules of the contest read: "Novelty shall be rated at 10 per cent.; design, 20 per cent.; workmanship, 20 per cent. and results and efficiency, 50 per cent." These values were followed out in the judging of the contest. For example, if a set that was rated high in the first three of the factors did not have as good a performance record as some other set that had not the neatness of workmanship or some other item, but received a higher rating in its performance, the two sets had an almost equal rating.

Another thing that was considered in the selection of prizes was the difference in type of receivers. Obviously, it would be most

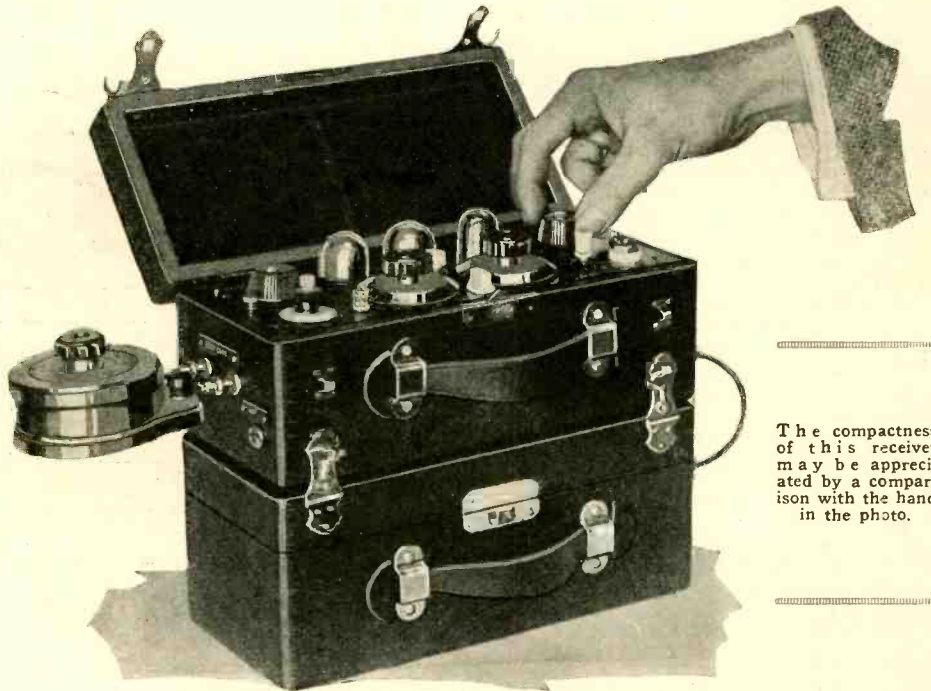

The compactness of this receiver may be appreciated by a comparison with the hand in the photo.

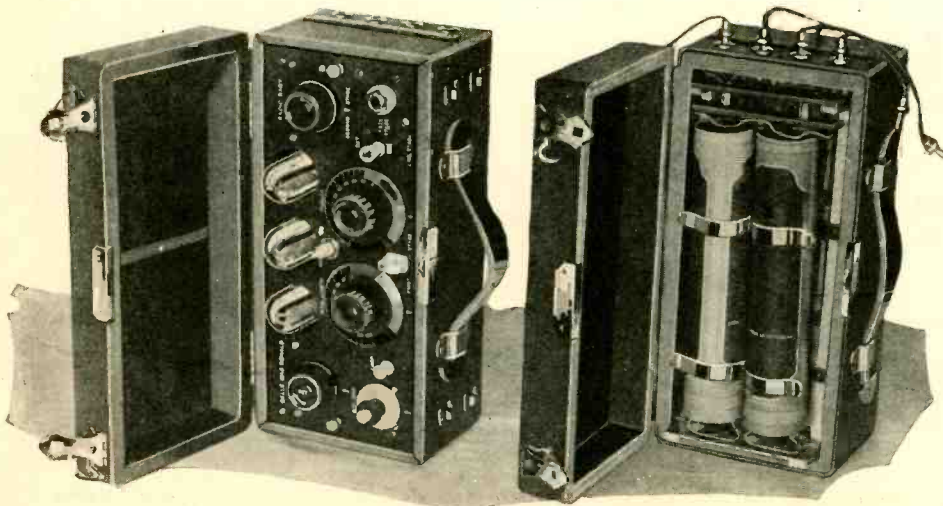

The first prize receiver and the battery case, showing how the batteries are clipped in.

WINNERS OF THE \$500 HOME-BUILT SET CONTEST

- First Prize \$200—R. V. MacDonald, 957 Albany St., Schenectady, N. Y.
- Second Prize \$100—Allen S. Hitch, Whitewater, Wis.
- Third Prize \$75—Sidney Kasindorf, 910 Home St., Bronx, New York City.
- Fourth Prize \$50—J. Howard Bennett, 709 W. 170th St., New York City.
- Fifth Prize, \$35—W. A. Knight, Columbus, Ohio.
- Sixth Prize, \$25—S. G. Waite, Jr., 4525 9th St., N. W., Washington, D. C.
- Seventh Prize \$15—John B. Cook, 408 Woodlawn Ave., Buffalo, N. Y.



R. V. MacDonald, who received the first prize.

When there were more than one of a certain class of receivers which had approximately the same rating in the performance tests, each was inspected as to the three remaining divisions of the general test, as has been already mentioned above. The workmanship being the next most important item to be considered, the wiring and arrangement of the apparatus was taken under consideration. Here the fact was brought out with startling clarity that most of the sets that gave more than average results in performance were carefully wired and the apparatus arranged exceptionally neatly, proving beyond a doubt that if you want a set to do real worth-while work for you, it is necessary that a corresponding amount of care be taken in its general construction.

Then were considered the design of the circuit and general layout of the cabinet and the novelty of any innovations that the constructor had incorporated in the receiver. Naturally, such items as these were not worthy of receiving as high a rating as the performance and workmanship, so the judges took these under consideration last of all.

THE FIRST-PRIZE SET

The receiver that was awarded the first prize of two hundred dollars was designed and constructed by Mr. R. V. MacDonald of Schenectady, N. Y. Photographs and a diagram of connections of this set will be found elsewhere in this article. Mr. MacDonald calls his receiver "a miniature receiver," but we have seen many fully grown ones that were in no manner as efficient.

The receiver unit is mounted in a case 9½ inches long, 4¼ inches wide, and 4¼ inches high, over all. Dimensions of unit without case are 9¼ inches long, 3¾ inches wide and 2½ inches deep. Three UV-199 tubes are used, one as detector and two as transformer-coupled audio amplifiers.

The tuner consists of a variometer across the antenna and ground, which tunes the grid circuit of the detector tube. Regeneration is obtained by means of a plate variometer which feeds back energy to the grid circuit through the tube itself, and also by an inductive coupling to several turns, which are carried from the ground end of the grid variometer close to the stator of the plate variometer.

One telephone jack is used, which is connected to a toggle-switch in such a way that phones or loud speaker may be connected either to the output of the detector tube or to the first or second amplifier stage simply by moving the handle of the toggle-switch to its three positions, as marked on panel. Operation of switch is fully shown in the diagram.

The antenna series condenser is a small 22-plate condenser with vernier and self-contained short switch. The 22 plates occupy a space of 1⅛ x ½ x ½ inches and the maximum capacity is .00017 mf. With this condenser the set tunes from 220 to 495 meters, with the condenser shorted, the set tunes from 400 to 750 meters.

For use with loop for local reception only,

tion properly, even though it is a masterpiece of the cabinet-maker's art, what use is it? In the case of crystal sets and those having one vacuum tube, ear-phone reception of local stations was attempted. If the set was selective and received the "locals" with fair volume it was given a chance on the loud speaker. When a set had at least two stages of audio frequency amplification it was assumed that it should receive the local stations on a loud speaker, so ear-phones were not used.

In the first part of the performance test, it was determined whether the set would separate the local stations, this being considered a good test of a set's selectivity, as there is a wide band of wave-lengths represented in and about New York City. If this test was passed satisfactorily then the set was tried for sensitivity. As it would be unfair to expect all sets to bring in DX with loud-speaker volume, phones were first employed in this part of the test, and if the reception proved satisfactory then the loud speaker was substituted.

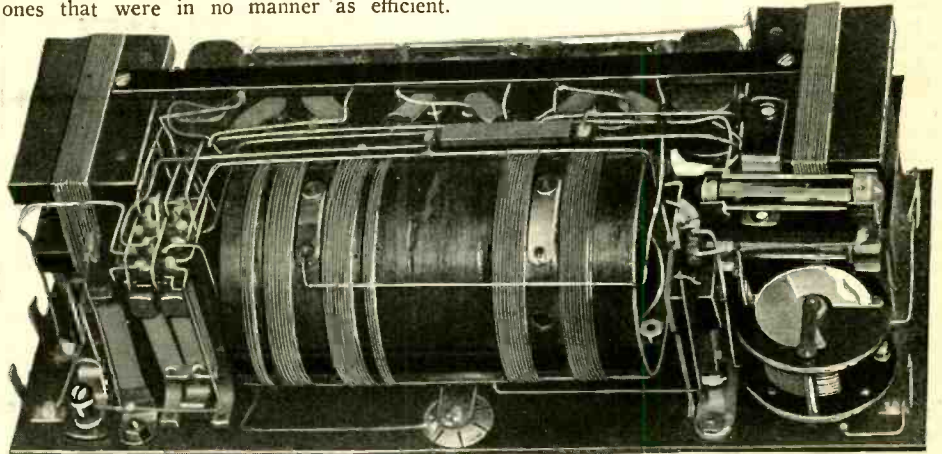

Interior view of the first prize receiver. Note the small variable condenser.

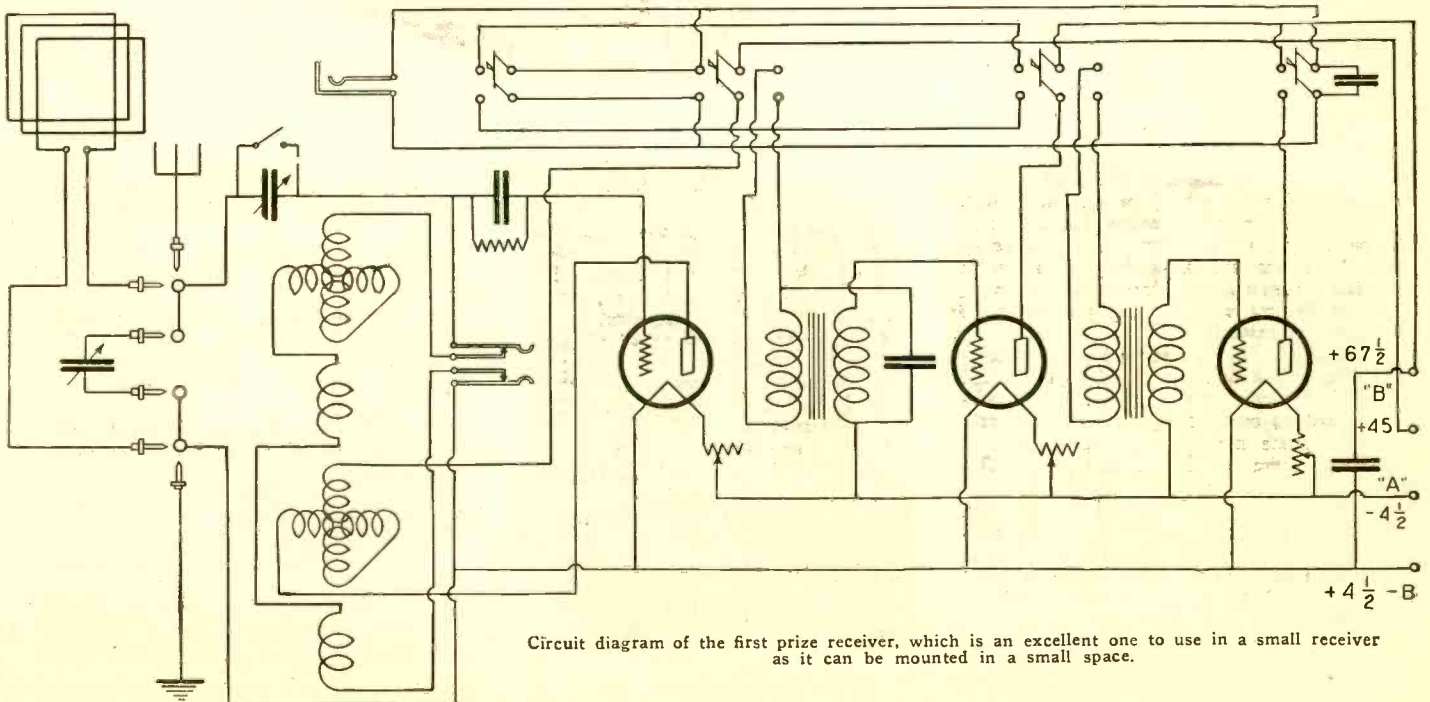

Circuit diagram of the first prize receiver, which is an excellent one to use in a small receiver as it can be mounted in a small space.



Allen S. Hitch, whose set, shown below, won second prize.

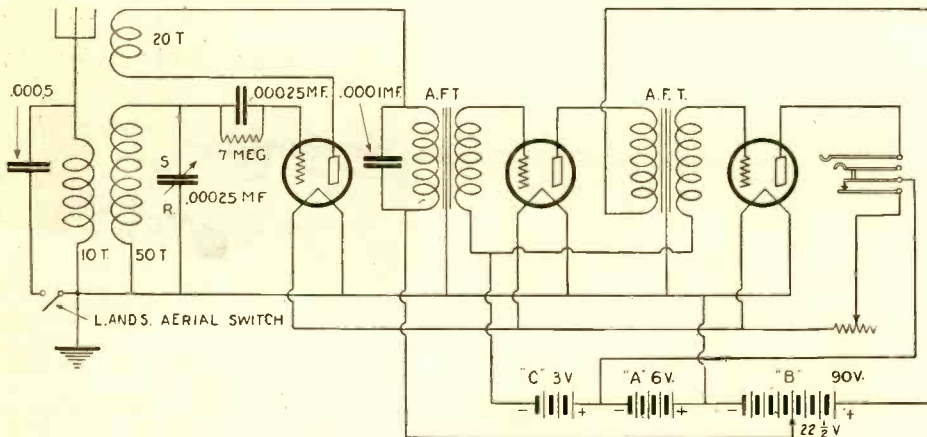

Diagram of Mr. Hitch's receiver, which is remarkable for its selectivity and volume.

a D.P.S.T. jack switch is provided to disconnect the antenna tuning circuit.

This receiver and parts are entirely home-made, with the exception of two filament rheostats, the engraving and the containing cases.

The set was designed and built to fit the cases. This required all parts to be specially built to fit the small space. The upper section contains the receiver, which is detachable from the lower portable battery section consisting of three 22½-volt "B" batteries and two 3-cell flashlight batteries in parallel. Battery connections are made to the receiver with short wire jumpers with plugs. Flashlight batteries are mounted in clips and can be changed instantly by opening the cover of the lower section. These batteries are used only for portable work. A special four-prong plug attachment with binding posts is used for external batteries.

The Radiola circuit was used in this receiver because it is better adapted to the small space; long distance reception has been obtained just as consistently as on larger sets with the same number of tubes—including programs from PWX (Cuba) and KOA (Denver).

To work the set, the special antenna and ground leads must be attached and the filament switch turned on; then the receiver is ready for use. For use with a loop (for local reception only), the antenna and ground leads are connected to the loop, and the external loop condenser, furnished with the set, is inserted in the jacks marked "loop condenser." The series antenna condenser is placed in the

shorting position, as indicated by the red arrow on the dial. The switch marked "loop" is pulled up; this disconnects the antenna tuning circuit, leaving the plate variometer in the circuit.

SECOND-PRIZE SET

The winner of the second prize, which amounted to one hundred dollars, was Allen S. Hitch of Whitewater, Wis. His description of the set that he submitted to the contest follows:

"The set I have submitted as coming nearest meeting these requirements is a three-tube regenerative, using a single tuning control, a volume control, and a tube control. The latter may be set at the proper place when the set is first placed in operation and thereafter left alone. Therefore, there are only two active controls. A single output jack is used and it is a single-circuit, filament-control type. Merely inserting the loud speaker plug places the set in operation, and removing the plug shuts it off.

"The station selector, or tuning control is an Ultra-Vernier, which greatly simplifies tuning. A pencil record of the stations may be made on the dial, and thereafter simply turning the finder to the pencil mark will locate the desired station at once.

"The volume, or regeneration, is controlled by a small dial which requires but slight ad-

in or-out a fixed condenser to adapt the set to a long or short aerial.

"Tube control is by a single rheostat, 201A or 301A tubes being recommended throughout.

"Examination of the circuit diagram will disclose a contraction of the three-circuit tuner, the entire tuning and regeneration system being embodied in a specially wound variocoupler and a .00025 variable condenser.

"The variocoupler is of standard design with 3½-inch stator and 3-inch rotor and 90-degree coupling, with the regular windings removed and the special windings put in their place. The primary is aperiodic and is made by winding ten turns of No. 22 D.C.C. wire on the 3½-inch tube. A tap is then taken and the winding continued as the secondary. This is made by bank-winding 33 turns, and then winding 17 turns in single layer. The rotor which acts as the tickler has twenty turns of bank-winding.

"Since jacks are not provided for the detector or first step the wiring is greatly simplified and losses materially reduced. This also makes for a more symmetrical design.

"The horizontal placing of the audio frequency transformers reduces the length of the grid and plate leads as well as adding to the efficiency of the design.

"The provision for use with or without the "C" battery is novel, yet simplicity itself. The grid return terminals of the A.F. transformers are connected and a Fahnestock connector fastened to one of them. One end of a piece of flexible covered wire is then soldered to the negative "A" battery lead, the other end left free so that it may be clipped into the Fahnestock connector if a "C" battery is not desired, or connected to the positive terminal of the "C" battery and another wire connected from the negative "C" battery to the Fahnestock clip when such grid bias is desirable."

Possibly neither of the prize-winning sets described above will appeal to some of our readers, who may have special problems to consider or special inclinations toward a certain type of set. In the next issue of RADIO NEWS, however, will appear several more prize-winning sets with descriptions and detailed instructions for building. All of these sets have been thoroughly tested in the RADIO NEWS LABORATORIES, and found to be exceptional, so that the constructor of any of them may be sure to find that they will give exceedingly good results when properly built.

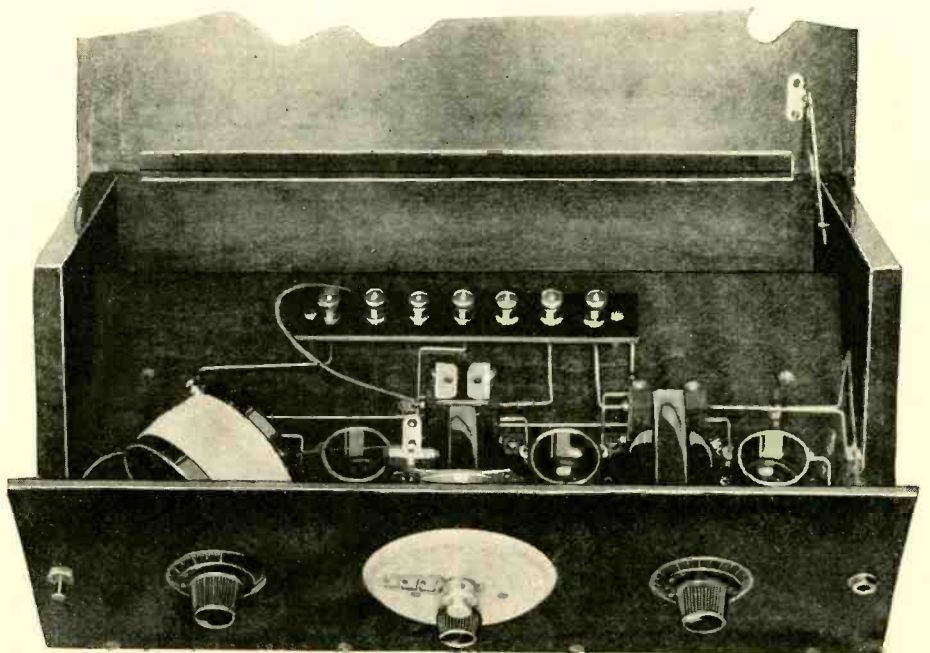

Panel and interior view of the receiver that was awarded the second prize.

A Really Portable Set

By the Staff of Radio News Laboratory

This receiver, developed in the RADIO NEWS Laboratories, is recommended to any fan who wants a really portable set.

THERE have been various and sundry portable and not so portable sets for summer use. The chief trouble with most of them is that the designers and engineers consider anything portable that takes up less space than a soap box and may be transported with a car with less engine strength than a Mack truck.

And, again, most of them are built in such a fashion as to be barely efficient enough to pass muster in the show room, since the chief controlling idea seems to be to build a super-heterodyne in less than the number of square inches usually allotted to a detector and two audio frequency transformers.

When the RADIO NEWS Laboratories started on its design, it first of all selected a hook-up which would give a fair degree of volume and selectivity, be of extreme simplicity in operation and, above all, be rugged and light. The results may be seen in the accompanying photographs.

Our experience in the past with the crowding of stations at the lower end of the dial readings has taught us a good lesson, and since at last the straight-line frequency condenser is available, it was thought very desirable to use this type of condenser in the set. It is clearly shown in the photographs and the diagrams. The condenser is the same one that is pictured in the article by Sylvan Harris on the straight-line frequency condenser, in this issue of RADIO NEWS.

For maximum sensitivity and volume with the least number of tubes consistent with a portable outfit, a reflex circuit was selected as the proper type to be employed. Here there may be a healthy howl raised by those initiated into the operation of this particular principle. However, a glance at the drawings will show that the arrangement of the apparatus and the method of wiring have been carefully thought out, with stability as the chief idea.

The use of aperiodic radio frequency transformers is, of course, for good reason. A portable set should be as simple and as stable as possible. Tuned stages would add

hopelessly to the complications to be dealt with, therefore such a circuit was not used. The loss of efficiency in the set as compared with tuned stages is not sufficient to pay for the added difficulties encountered.

In constructing the set, the first step is to prepare the baseboard. It is cut from half-inch stock, 7½ inches wide and 21 inches long. Two such boards are needed. One serves as the battery compartment bottom and the other as the base for the mounting of the instruments.

After the baseboard is cut, the panel is drilled and the variable condenser, the jack and the potentiometer-rheostat mounted. It will be found best to leave the mounting of the loud speaker until last, since the business of wiring will be greatly expedited thereby. After the sockets, the condenser and the resistances have been connected as in the drawing, the radio frequency transformers and the audio transformers may be installed.

After all connections are made to these units, the by-pass condensers and the crystal detector are put into the circuit.

The main tuning condenser, which is placed across the loop, should have a maximum capacity of at least .0005 mfd. The by-pass condensers across the secondaries of the audio frequency transformers are all of the fixed mica type and have a capacity of 0.00025 mfd. The third transformer does not have a by-pass condenser in the set shown in the photographs. The transformer used in the present instance had sufficient distributed capacity in the windings to pass the radio frequency. The builder may find, however, that he needs one for the best functioning of the set. Its use may be determined only by trying the set with and without it.

The next point of importance is the crystal detector, which is of the fixed type. In the set described, carborundum was employed. The characteristics of this crystal are so well known as to need no discussion. For constant and acceptable operation under the most adverse conditions it cannot

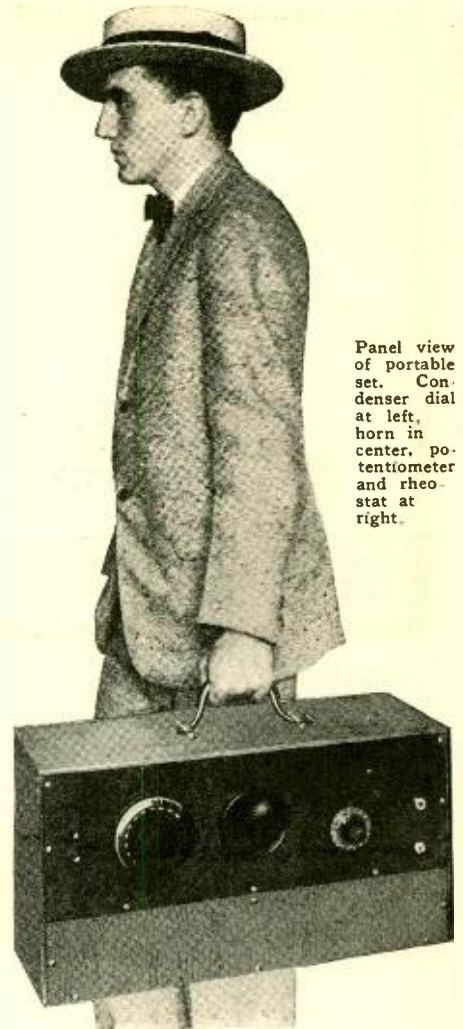

Panel view of portable set. Condenser dial at left, horn in center, potentiometer and rheostat at right.

be beaten. Its ruggedness surpasses that of all other crystal rectifiers.

The last step in the assembly of parts is the mounting of the loud speaker. It consists of an ordinary unit attached to a small Radion horn. A covering of some sort may be placed over the opening of the horn, but this is not necessary.

The horn is held in place with a brass angle-iron bend, fitting snugly around it and protruding through the panel.

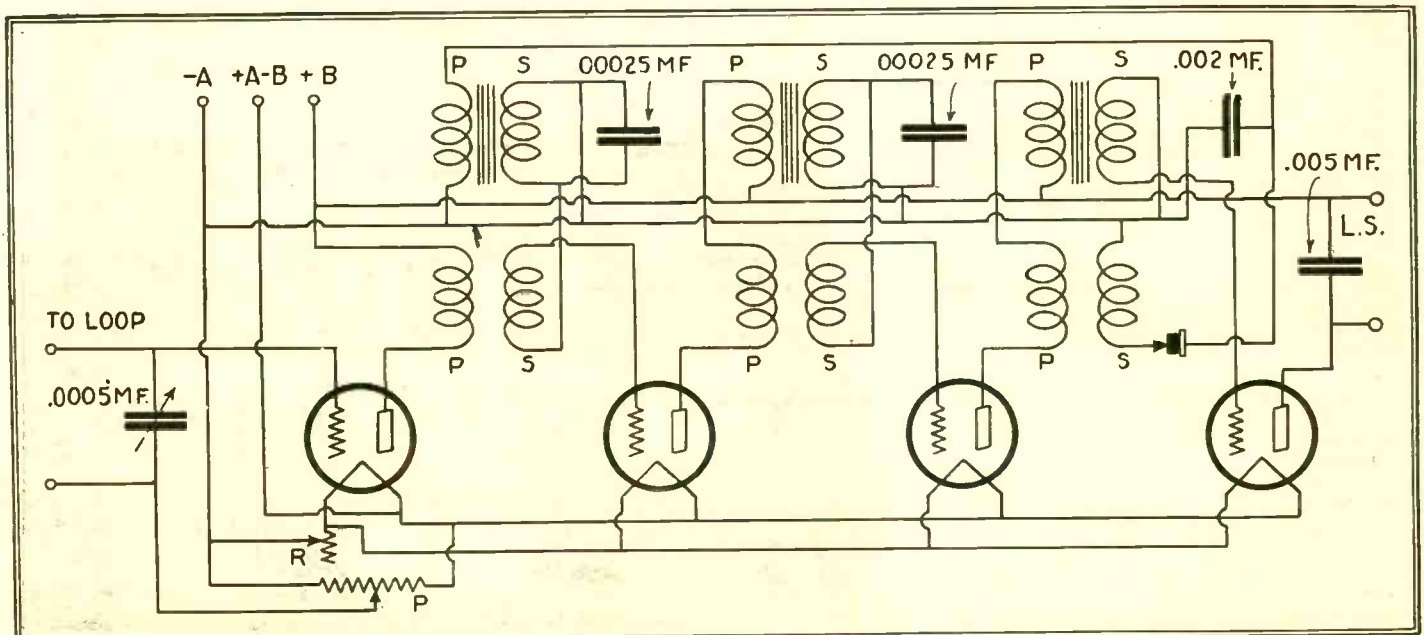

Reflex circuit diagram of the four-tube portable receiver, using crystal detector.

After the assembly of the parts is completed, the battery case should be constructed. This necessitates two bits of 3/4-inch finished stock 8 x 3 1/2 inches. These are placed flush with the ends of the baseboards, with the front setting half an inch inside the front line of the baseboards.

Then the paneling for the case is put on. The best material to use for this is three-ply, veneered stock, three-eighths of an inch in thickness. The two end-plates measure 8 1/4 x 11 inches. The front panel, which fits under the regular panel, measures 21 x 4 inches.

The panel and the end-plates are held together with brass angles and machine screws. The rear forms the loop.

The rear piece is 11 1/2 x 21 1/2 inches, while the top is 8 1/2 x 22. The loop is built in the larger piece. It consists simply of twenty turns of flexible wire cable wound on tacks driven into the board. Two leads

are taken from the loop to the binding posts on the front of the panel. The top and bottom are fastened with a running hinge, so that they may be placed over the set for protective covering. The handle, which may be of leather, is attached to the center of the top piece. A set of hooks or latches are placed on the two pieces in order to hold them to the remainder of the set.

The tuning of the set is the simplest possible. The loop is connected and the filament rheostats turned up. The variable condenser is then varied until the signal comes in when the potentiometer is adjusted for the greatest intensity of signal. There are actually only two controls on the set. It is light, compact, rugged and—truly a portable set.

The operation of the set meets all the requirements that one could impose. It is very selective, both on account of the potentiometer control, and of the use of the

straight-line frequency condenser. There is absolutely no crowding of the stations at the low dial readings, and it is a very easy matter to tune exactly to the peak of any wave.

The volume of the output of the receiver is likewise very satisfactory, as is the quality, and this set represents about the best type that an experimenter could build for portable use, other than, perhaps, a super-heterodyne, which, as a rule, would cost considerably more to construct than this one.

The range of the set is from 550 meters to 220 meters, which includes the total range of the present broadcasting wave-lengths. If it is desired to go to the shorter wave-lengths, as will be necessary in the near future, all that is necessary is to provide a tap on the loop. This has been done in this set, the tap on the loop being controlled by the two-point switch on the panel.

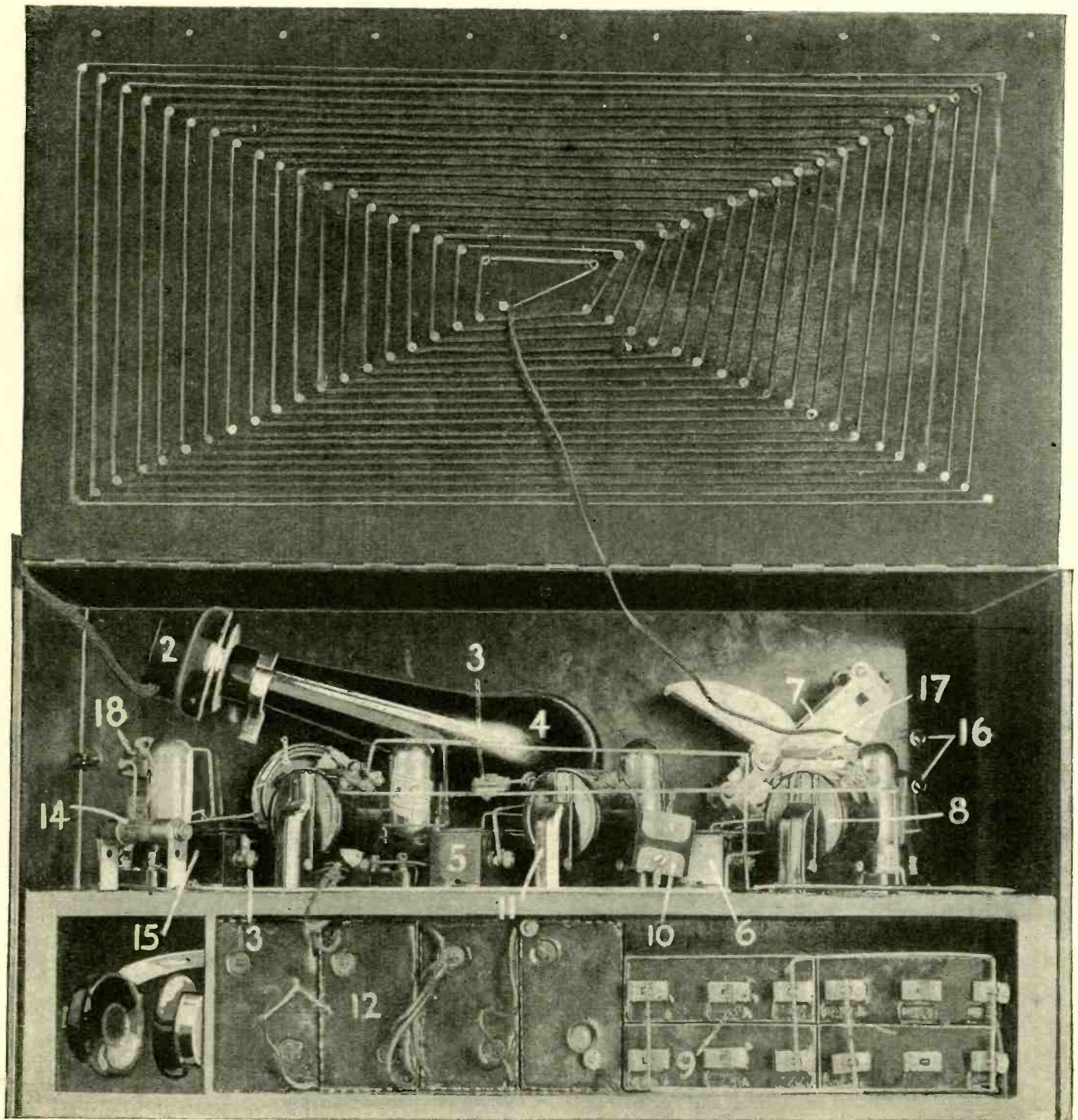

Interior of the portable receiver. The numbers on the instruments correspond to those on the opposite page.

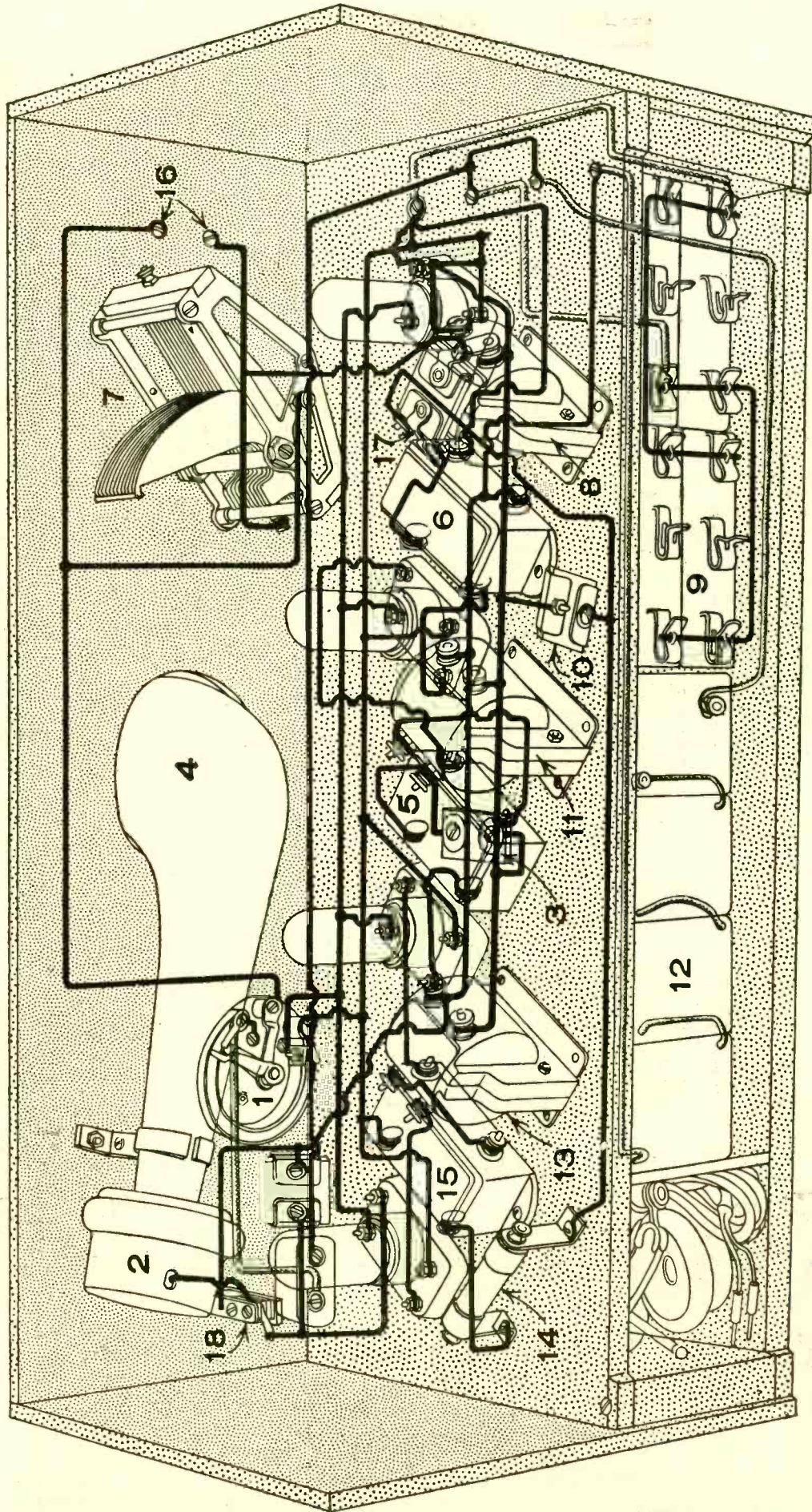

PERSPECTIVE LAYOUT OF PORTABLE SET

1. Combined potentiometer and rheostat, 400 and 30 ohms, respectively. 2. Loud speaker unit. 3. By-pass condenser. 4. Horn. 5 and 6. R.F. transformers. 7. Straight-line frequency condenser. 8. A.F. transformer. 9. A.F. transformer. 10. By-pass condenser. 11. A.F. transformer. 12. "A," batteries. 13. A.F. transformer. 14. Crystal detector. 15. R.F. transformer. 16. Loop binding posts. 17. By-pass condenser. 18. Phone jack.

"Push-Button" Radio

By BRAINARD FOOTE



The experimenter who enjoys building novel sets should be greatly interested in this method of selective switching by remote controls.



IF you're an avid DX fan don't bother with this. But if you happen to be one of those inexhaustible experimenters who like to tackle new stunts and thrive on novel accomplishments, here's an idea that may appeal to you.

Have you ever thought of the possibility of a radio outfit whereby a light touch upon the proper button brings forth entertainment from the desired broadcasting station? A set, furthermore, so constructed that all of the electrical apparatus necessary to actual reception, together with the storage and "B" batteries, is relegated to the attic, empty room or vacant closet? Where the living-room is fitted up with nothing more formidable or unsightly than a small row of push-buttons and a loud speaker?

HOW WE DO IT

One man made a remote control set by having one tuning dial run by a reversible electric motor. This takes as much skill as adjusting the dial by hand, if not more, and it isn't easy to tell just where the dial is set. The arrangement which seemed more certain to me involves a row of magnets and a separate tuning system for each of the local stations that would be cut into circuit by the proper magnet and push-button. Inasmuch as distant stations aren't wanted, there is little use for radio frequency amplification. The set then incorporates a simple regenerative detector and two stages of audio frequency amplification.

Fig. 1 gives a general view of the outfit. At the left end of the baseboard the magnetic controller and contacts may be seen. Next come the coil and the individual condensers and finally the three tubes and the audio transformers. A fixed coupler is employed, with a tap for the antenna and a plate winding through which regeneration is obtained. The primary of the first audio transformer acts as a radio frequency choke, the feed-back being adjusted by a fixed coil and adjustable capacities for each station.

THE CIRCUIT

Connections appear in Fig. 3, except those for the push-buttons and magnets. The audio frequency portion of the set is of the customary type, using two transformers. Coils L-1 and L-2 may be wound on the same length of tubing—a cardboard cylinder about 4 inches long and 3 inches in diameter serving nicely. L-1 consists of 45 turns of

wire in the neighborhood of No. 24 in size, preferably double-covered. L-2 is started with a 1/8-inch gap between the coils, and has 20 turns of wire. The tap for the antenna connection will depend upon the size of the antenna and its capacity. It is placed near enough to the filament or ground end of coil L-1 to provide good volume without interference among the local stations to be received. Usually, the tap goes at the tenth turn, or less, if interference is encountered.

The tuning condenser C-1 and the regeneration condenser C-2 are similar. These are seen beneath the coil in Fig. 1. Two pieces of wood, about 3/8 of an inch thick and measuring 10 by 2 1/4 inches, form the clamps by which the plates are fastened. There are two fixed plates in each condenser, cut 10 by 2 1/4 inches also. For separators, pieces of photographic film are the most satisfactory. A discarded roll may be obtained from any photo store. Four sheets measuring 10 by 2 1/4 inches are cut from it. The plates may be of thin zinc, aluminum or brass—the thinner, the better. Holes are drilled with No. 27 drill for three No. 6 wood screws that are to hold the condensers to the baseboard or table on which the set may be assembled. One screw is placed at the center and one at each end. In assembling the condenser, one of the 10 by 2 1/4 metal plates is laid on the table first, then one of the film sheets, next the other film sheet and finally the second metal sheet. The wood strip goes on top to clamp them together. For connections, lugs may be left extending from each plate as it is cut, or lengths of magnet wire may be soldered to the plates.

THE ADJUSTABLE PLATES

The condensers, as explained so far, have two stator plates each, but no movable plates. There are to be enough movable plates to provide one for each local station. Since reception of the New York stations was the factor controlling the construction of the set illustrated, it was first necessary to know what stations were received with good volume with a three-tube regenerator at the location in mind. These proved to be as follows:

No. 1 WNYC, No. 2 WAAF, No. 3 WJZ, No. 4 WOR and WJY, No. 5 WHN, No. 6 WGBS and WAHG. No. 7 WFBH and WBBR, No. 8 WAAM.

Station WMCA was included in the list at first, but it was finally omitted because the

interference from WHN was too strong. This accounts for the fact that, although nine controller magnets are shown in the photo, but eight are considered in the construction. Eight will probably be sufficient for most locations, as there are usually one or two "poor stations" for every listener in the metropolitan area. Some stations operate jointly on the same wave-length, making it necessary to have but one contact magnet for both.

Each station is tuned separately by its own fixed condenser, the stator or fixed plate of which is common to all of the condensers. These plates have just been described. The adjustable plates vary in size from a mere narrow strip, perhaps 1 inch by 1/8 inch for the shortest wave-length of WAAM, to a sheet 1 1/2 by 2 inches for WNYC, the longest wave-length. The wide range of capacities obtained in so small a space is due to the closeness of the plates—a few thousandths of an inch representing the separation given by the photographic film. A length of magnet wire is soldered to each plate or fastened to it by a short machine screw and nut, and the capacity regulation is made by sliding the plate in and out with the fingers or a pair of pliers. The capacity of the body does not seriously interfere with this adjustment because the adjustable plate is connected to the filament side of the circuit. It is best to push the plate in between the fixed plates to almost the proper point, and then obtain the final setting by using a piece of bakelite rod or wooden stick as a lever. The regeneration condenser is adjusted in a similar way, just below the "squealing" point. The actual width of the plate is best determined while the set is in operation, the plates being made narrower with a pair of shears. The screws clamping the condensers should be set up until the movable plate is gripped firmly, but may still be slid in and out. Before these movable plates can be made, however, it is necessary to build the controller.

THE MAGNETS

If eight stations are chosen for the push-button set, sixteen magnets will be needed. One-half pound of No. 26 double-covered wire will be more than sufficient. For the magnet cores, 16 iron stove-bolts with flat heads are employed, these being 1/4 of an inch in diameter and about 2 1/2 inches in length. The thread should run nearly to the head and two nuts are needed with every bolt. A hand-drill capable of holding a 3/4-inch drill in its chuck will expedite the winding. It may be clamped in a vise, the wire measured off and guided back and forth with one hand while the drill handle is turned with the other. Forty feet of the magnet wire suffice. One wrap of friction tape is placed on the bolt first and two or three wraps on the finished winding. The coil is placed next to the head of the bolt and should be about one inch in length. It is not necessary to "layer-wind" the magnet. In actual use, the coils become warm if the current is permitted to flow for several minutes, but since these magnets are but for use limited to two or three seconds at the most, this factor is of little consequence. Fig. 4 illustrates the magnets and their mounting.

The framework for the magnets is made of four wooden blocks. The inside measurement should be about 3 by 10 inches and

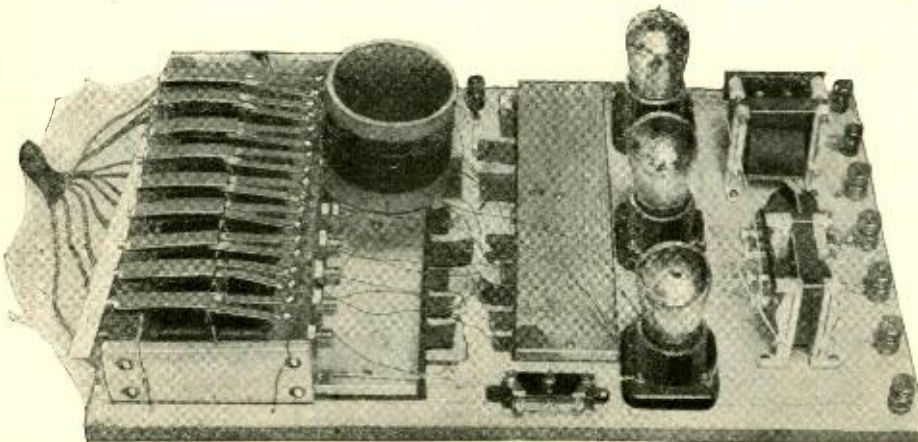

Fig. 1. At the left are the magnetic controllers and contacts, with the cable leading to the remote control board. The coil is above the board that holds in place the individual condensers.

the height about 2 inches. The magnets are mounted in a row, eight to each side-piece of the frame, on the horizontal center line and about one inch apart. They should be opposite, since one is to pull an armature to the "on" position and the other to pull it back to the "off" setting. The space "d" should be about 3/16 inch, this being adjusted after the connections are made and ready to test. The armatures are cut from a sheet of galvanized iron about No. 26 in gauge, each being 5/8 of an inch in width and 2 1/4 inches long. Pencil marks 1/4 of an inch from each end indicate points where the armatures are bent. The axis for the armatures is a length of heavy galvanized iron wire (No. 12 will do) held in holes in the end-pieces of the frame. A piece of this wire can be employed to bend the end of the armature, as shown in Fig. 4. The first bend for this end may be made by clamping the armature in the vise with the wire and the finishing bend may be done with a pair of pliers. The upper end is bent to an angle, as illustrated.

The springs are cut from very thin sheet phosphor bronze. The sheet used in the set described was 10 thousandths of an inch in thickness. Springs A and B are one-half an inch wide and the end of spring B is bent nearly at right angles, so that a movement of the armature to the left will raise it and permit it to rest on top of the armature. Springs C and D are 1/4 of an inch wide, and are in line with each other, as seen from the side. Moving the armature to the left thus closes four contacts at once. To improve the contact, the ends of the contact springs may be silver-plated electrically, or all contact points may be tinned with the soldering iron. The latter method will require a little sandpapering now and then to improve the conductivity. The magnets are individually adjusted so that the motion is as short as possible. The springs are held by short wood screws, and are bent by lifting or depressing with the fingers. The magnet positions are easily changed by loosening the nuts and re-adjusting them. The armatures must not grip the axles too tightly, and a few drops of oil on the sloping top of the armature and at the axle will improve the operation. The armatures are spaced by stringing two or three 8/32 nuts on the wire between them. To attach the controller

frame to the baseboard, two screws may be introduced from beneath the base. Should the "off" magnets operate sluggishly, two dry cells in series may be put in at point "X," Fig 5.

MAGNET CONNECTIONS

The "off" magnets operate in unison, through a series-parallel arrangement. Thus a single "off" button serves to turn off the set and detune a given station. The push-button may be of the "flush" type, mounted in a row of holes of suitable diameter drilled in a hard-wood block. The buttons are made in a simple manner from a length of 1/4-inch bakelite rod. Nine holes are drilled in a neatly planed and sandpapered oak block about 2 by 7 inches and 1 inch thick. The holes for the buttons are located 3/4 of an inch apart. Fibre washers having 1/4-inch holes encircle the buttons, being glued in position. The ends of the buttons are filed down slightly and sandpapered to move freely in the washers.

The bottom of the block is hollowed out with a chisel, 1 1/2 by 6 1/2 inches. Nine short contact springs are fastened in with small wood screws, with their ends projecting over the holes directly under the buttons. A common contact plate is screwed in position also, in such a manner that a push on any button brings its spring into contact with the common plate.

Next a suitable location for the receiving set, batteries and aerial and ground leads is chosen. Then the proper point for the control buttons and the loud speaker is selected. The push-button block is most convenient for use when it rests on the living-room or library table. A piece of felt may cover the bottom. Twelve connecting wires are needed, for which from two to four pounds of bell wire will be necessary, depending upon the distance to be covered. These wires are cut to the measured length and bunched into a "cable." Strong black thread or twine serves to tie the wires together and they may be taped where they are visible in the room. The wires can be run through a hole in the floor and thence to the destination via the cellar ceiling, or it may be more convenient to run them along the baseboard of the room.

Fig. 5 gives the connections for the cable

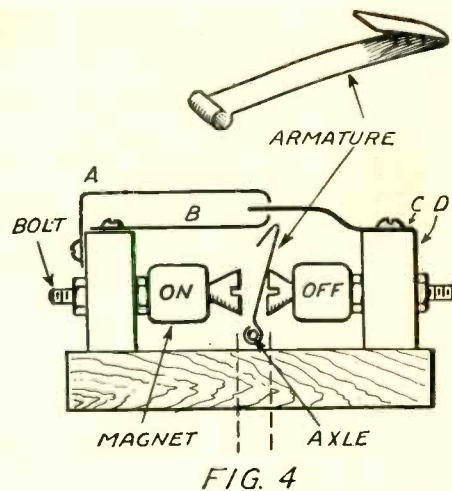

FIG. 4

The details of the switch for tuning in stations by pressing a button.

and controller systems. A battery and voltmeter or battery and lamp are used to "test out" the various wires, and to do this, it is convenient to bring the push-button end of the cable into the receiving room and leave it there while adjusting the controller. The loud speaker wires are put on first and then the negative "A" battery wire to the common plate or common posts of the push-button block. Next the "off" button No. 9 is connected and the "off" action of the armatures tested. One push of the "off" button should pull all of the armatures back into the "off" position. In practice, only one at a time will be set to "on," however. The individual "on" contacts are connected next, it being advisable to arrange the controller contacts and push-buttons in the order of station wave-lengths. This is followed in the figure.

Before attempting to tune the station, it is extremely important to make certain that there are no short circuits anywhere—as between the magnet windings and their cores—and that all contact springs open and close as they should when the proper buttons are manipulated. The connections of Fig. 3 do not include the magnet and push-button connections, but are those for the tuning and

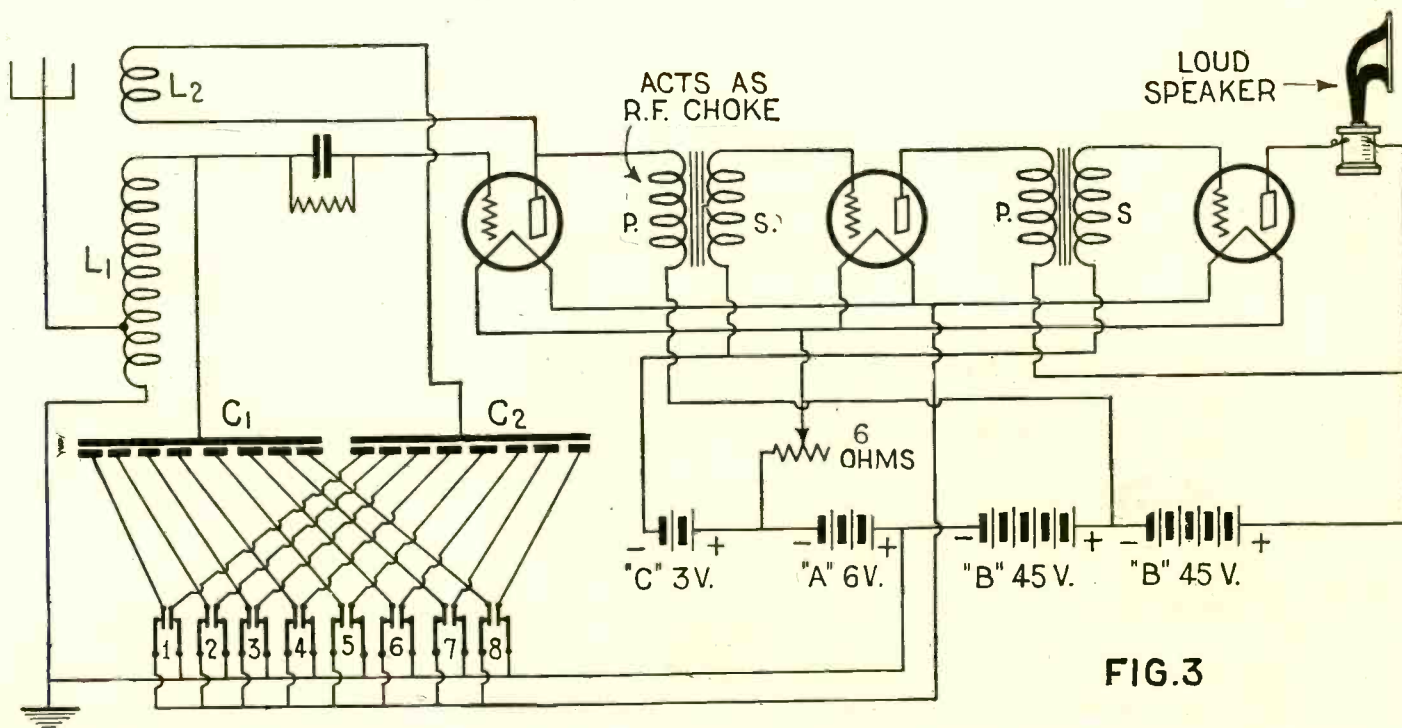

FIG. 3

The circuit diagram of the "push-button" radio receiver. In the lower left-hand corner of the diagram may be seen the wiring for the magnetic switches.

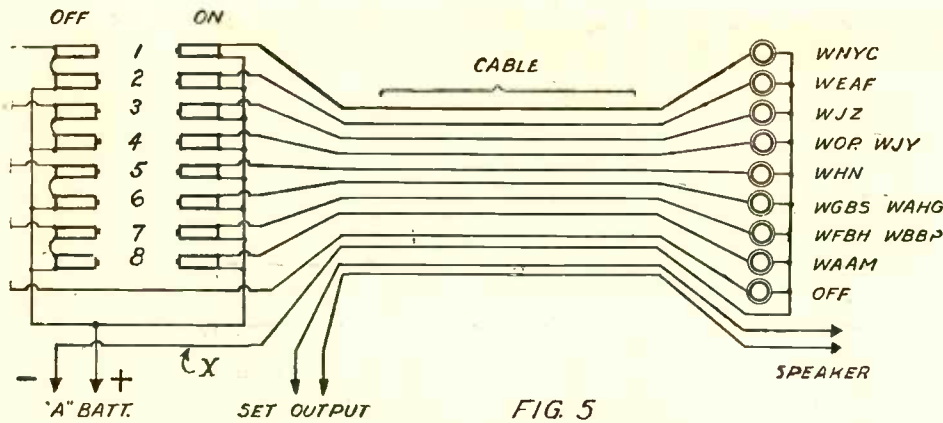

FIG. 5

How the switches and the push-buttons are connected. The connecting wires may be made into a cable.

amplifying circuits exclusively. The condenser contacts of the controller are shown side by side, whereas they really would appear one behind the other in a side view.

TUNING UP

The late afternoon and evening is the best time for adjustment of the individual condensers, since the stations will be in operation. Starting with the station of shortest wave-length, the corresponding button is pushed to bring the armature into position and close the contacts. This lights the tubes and makes contact to the proper condenser springs. The condenser strip for this station, in this case WAAM of Newark, may have to be very small—a strip about half inch wide being used at the start. It is then “pared down” with the shears until it may be pushed nearly all the way in be-

tween the two fixed plates of the tuning condenser for correct tuning. Meanwhile, the regeneration condenser is set for good sensitivity without actual oscillation. When the circuits are very close to oscillation, the capacity of the hand may interfere, and it is for this reason that a stick is helpful in making the final touches on tuning and regeneration.

When the first station is tuned so that it may be switched on and off at will, the next one is adjusted for similarly. As the wave-length increases, it will be necessary to use larger sheets of metal for the movable plate of the condenser. In each case, the minimum possible width is employed, so as to allow plenty of room for those of still longer wave-length. Trouble will probably be experienced first with some of the contacts, but this can be corrected by bend-

ing the springs so that no short circuits occur. The circuit used is such that no harm will result should a “short” occur between the plates of the regeneration condenser. The 45-volt “B” battery will be connected across the primary of the first audio transformer and a loud click will be heard in the speaker should this happen.

OTHER APPLICATIONS

Listeners in centers like Chicago, Philadelphia, Boston, San Francisco, etc., where three to ten broadcasters are on the air, may easily adapt the suggestions of this article to their own needs. For each station to be received, two magnets are required and a set of contacting springs. As for the push-buttons, there's one per station and one additional button whereby the set is turned off. In a city where there are only three or four main stations, as in Philadelphia, for instance, the listener may provide one or two extra contacts and magnets for the best DX stations. On favorable nights, these stations can be received. The fact that two local stations often divide up the time on the same wave-length simplifies matters a good deal. In Philadelphia there are WOO and WIP on the same wave-length and WLIT and WFI also. In New York we have WOR and WJY, WAHG and WGBS, and WBBR and WFBH in dual operation.

In closing, let's sum up once more the principal advantages of push-button radio:

1. Every station accurately tuned, ready to be heard.
2. Quick and simple action in transferring from one to the other.
3. Elimination of unsightly wires and apparatus from living-room.
4. Absence of radiation, caused ordinarily by carelessness or inexperience in tuning.

Selective Signaling for New York Police Department

By E. TOUSLEY

IN the very near future the Police Department of New York City will apply an old radio principle in a new manner to increase the efficiency of informing its different units of a crime. This principle, that has been used on railroads for some time, is selective signaling, but instead of using wires, as was formerly done, radio is now employed. Police Headquarters will be able to call any particular station, any group of stations or all the stations in the network by setting the selector switches and broadcasting the orders through the radio station WNYC, which is operated and owned by New York City.

For transmission the apparatus includes a selector key, which is an electro-mechanical device for sending the code call of the particular station which it is desired to signal, and an audio frequency oscillator which is connected to the transmitter at WNYC. The system was designed for efficient operation at the transmitting frequency of WNYC, which is 570 kilocycles, or 526 meters.

The operation of calling each station resembles that by which a train dispatcher calls the various tower-men along his telephone line. Levers in a small box on the sending operator's table are set to the number of the station wanted, and a corresponding number of pulses of 3,000-cycle alternating current are sent into the radio transmitter. This modulates the radio carrier wave like other frequencies in the audible range, and any listener to WNYC's program will hear, at intervals, a series of high-pitched tones; this means that a police alarm is going out.

The radio receiver is of a comparatively simple type. An unusual feature is that

there is no tuning adjustment accessible, as the sets are designed for use at one frequency and all necessary adjustments are made within the set at the time of installation and then locked.

When in its normal adjustment the regular program from WNYC may be received at any time, but when a signal is to be sent the other broadcasting must cease. The proper code impulses are then transmitted and the called station, or stations, are summoned by a red light or bell. When the call is answered, the operator disconnects the bell and light by pressing a button.

The receiving circuit uses no batteries, being arranged for operating from the 110-volt lighting supply. Sets are designed for both alternating and direct current, as there are both kinds of current supply in the city. Apparatus used at the receiving points includes a receiver, four vacuum tubes, sensitive relays, a modified form of the selector switch and a signaling device, either bell or light. One important feature of this set is the use of a relay whose magnetic circuit is made of permalloy, the new alloy, first used commercially in the New York-Azores cable.

The receiving apparatus is contained in a portable case about the size of an ordinary suit-case. The exterior shows only a jack for the plug of the head-set cord, a red signal lamp and its associated switch and a green lamp with switch. The green lamp is lighted constantly when the power is on, to indicate that the set is in order to receive signals.

Operation of the set is complicated. The special relay with the permalloy magnetic circuit is the first to operate. When the transmitter current is modulated by the

3,000-cycle tone in accordance with the impulse of the selector key, the plate current of the rectifier tube is increased to an amount sufficient to operate this relay. The alternate operation and release of this relay automatically closes intermittently a circuit which causes the successive operation of the other relays and steps the contacts of the selector around until they are in the proper position to complete the local alarm circuit. The selector used is capable of responding to any of 253 code calls. Each selector is adjusted to respond to three different signals—one, the individual call of the station; another for the group of stations to which it belongs; and a third, the general call for all stations.

This system of visual or audible signals does away with the necessity of having an operator wearing a head-set constantly when he is on watch. It requires no change after the initial adjustment. Such a system as is planned for New York will be of inestimable value to metropolitan areas. In a few seconds after an alarm is given, a cordon of police stations surrounding the city may be instructed, or one or more stations may be warned in the event that a bridge or railroad station is to be watched. Thus, in a very short time after the committing of a crime all the forces of a city may be warned and all avenues of escape closed.

A SERIOUS CASE

Fred: “That radio of yours sounds as if it had bronchitis.”

Radio Fan: “I'm afraid it has, it's always blowing out its tubes and wheezing through its loud speaker.”

Contributed by John R. Evans.

A Ten-Cent Store Loud Speaker

By JAY HOLLANDER

Many engineers are agreed that the cone type loud speaker gives the most perfect reproduction attained so far in any device.

EVER since the appearance on the market last season of the cone type loud speaker with paper diaphragm, it has taken the premier place among such apparatus and has proved to be the best reproducer of speech and music to put in an appearance on the radio market.

But the price of the commercial types is pretty high, high enough, in fact, to make them almost out of the reach of the ordinary fan. For some time the writer con-

is out of the question, however, and for the smaller sizes we must depend upon the formation of harmonics for the reproduction of the very low notes.

Back again to the construction. After the strip of brass has been cut, it is rolled into as nearly a perfect circle as possible. The ends are connected by soldering a small piece under them.

The supports are then made for the phone unit. These consist of three or four heavy wires, soldered to the under side of the ring and run in toward the center where they are again soldered to a second brass ring much like the first, except that its diameter is such as to fit snugly around the case of the unit to be used.

This second ring need not have its ends soldered together, but it may have a jumper fixed around the rear and equipped with a set screw for adjusting the tension of the diaphragm. The writer tried this idea on his first speaker, but found it unnecessary for good operation.

The cone is then made. If the diameter of one foot is being adhered to, the cone must be $8\frac{1}{4}$ inches in radius. This gives the completed cone a pitch of about four inches, deep enough for practice. After the circle is cut, another circle is marked with a radius one inch less; this marks off the point at which the paper is to be folded over the brass ring. Now, on this dotted line measure a distance across a chord of $7\frac{1}{4}$ inches. This marks the points at which the paper is to be cut to form the cone. Lines are drawn through these points to the center and then the paper is cut along them.

For fastening the paper to the brass ring, small V's are cut in the edge about every thirty degrees around the circumference from the edge of the paper to the dotted line, which is one inch closer to the center. A large number of very small V's will give better results than a small number of big ones, so do not be afraid of cutting the V's.

The writer used an extra good grade of photo-mounter paste to stick the paper to the brass ring, and it served its purpose excellently. Shellac, however, is better. Some trouble may be experienced with this operation, but a few trials will give a good idea of the best paste to employ.

Following the completion of the speaker

thus far, the next point is the installation of the connecting rod between the cone and the unit which is to be employed. A piece of bus bar will serve admirably, if there is not an available piece of brass rod around the work-bench. The matter of attaching it to the diaphragm of the phone is very simple. Be careful that a good, tight connection is made but that, at the same time, the area covered by the connection is as small as possible. That is to say, see to it that the solder used covers as little of the diaphragm space as possible.

The attachment to the cone is not quite so simple a matter. The writer used two small brass cones two inches in diameter, one on the outside of the apex of the paper

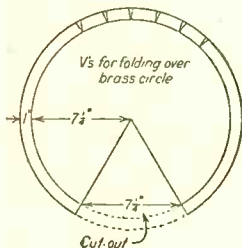

The layout of the paper cone which forms the vibrating member of speaker.

templated the problem of getting together sufficient cash to buy one of these units, and finally, having discovered that such was almost impossible, decided to build one as the only possible way in which he might get the desired purity of tone from his radio set. (He has, of course, a resistance-coupled audio amplifier on a super-het.)

Having purchased a great deal of his radio supplies at the five-and-dime, he was wandering over near the radio counter one day, dreaming of the cone loud speaker, when he was hit by the great idea. Here it is: On that counter is a lamp shade; here is a candlestick; there's a lot of drawing paper at home and an old receiver—ergo, the great corporation won't get thirty "bucks" out of me and I'll still have a cone loud speaker.

Here is how the trick is turned.

The lamp shade gave the idea, the remainder was simple. The details follow. First secure a piece of heavy brass sheeting and cut a strip one inch wide and about 37 inches long—this dimension is for a cone about 12 inches in diameter, which is a good size. For perfect reproduction, any smaller size will not give the best results. As a matter of fact, if absolutely perfect reproduction is desired, the cone would have to be at least eight feet in diameter. This

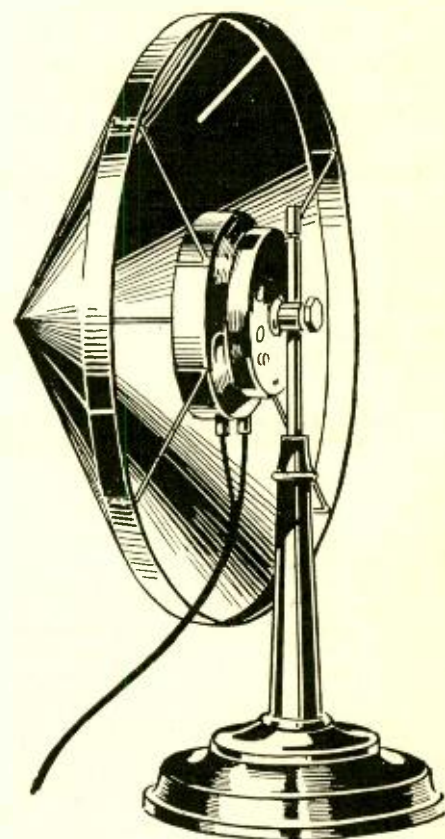

Above is a clear schematic constructional diagram of the loud speaker.

cone and the other on the inside. Then the connecting rod was attached to these cones with a suitable threaded end by means of nuts.

Those who do not care to spend the necessary time to make the other pair of cones and the threaded rod may use the bus bar and a bit of well-spread sealing wax. The end of the bus bar may be bent to lie flat on the outside of the cone. Then the attachment is made firm by dipping about two inches of the surface of the cone into melted sealing wax. A little practice will enable the builder to swing the cone into the wax so that a most workmanlike job results. The final touch is added by placing a few drops of the wax on the inside of the apex of the cone where the wire comes through.

Now for the unit. The second brass ring was made to fit snugly around the outside of the receiver case. The receiver slips

(Continued on page 212)

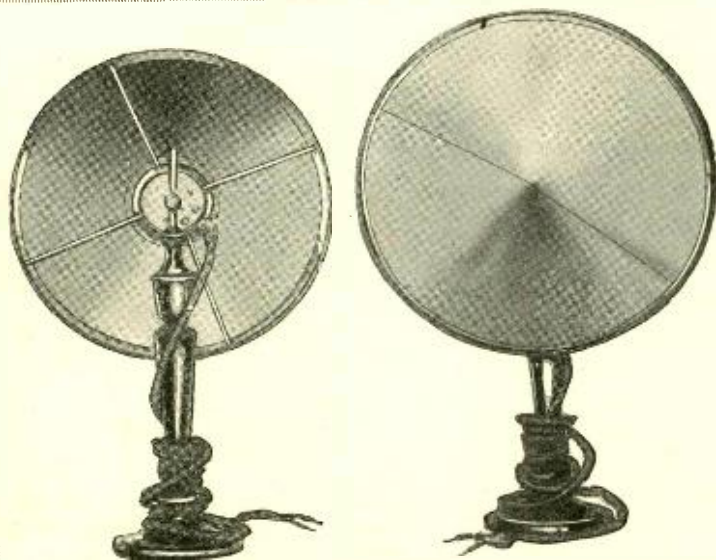

The completed loud speaker mounted on a candle stick. The total cost of the parts used in the construction of this speaker is well under \$5.00.

How to Make Basket-Weave Coils

Do you have difficulty in winding coils? We suggest the method below as a remedy.

THE basket-weave method of winding coils is becoming increasingly popular with the amateur who makes his own coils, especially for short-wave work where a coil should be practically self-supporting so as to include a minimum of dielectric in its field.

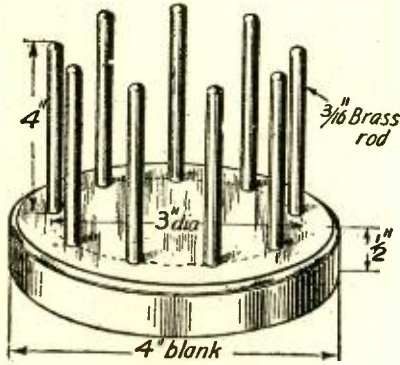

Fig. 1. Illustrating the base and arrangement of the spokes.

CONSTRUCTION

The writer, requiring a coil of this description for a Tropadyne adaptor that was described in *Wireless Weekly* for November 26, 1924, made up a special former for the job, which has since proved exceedingly useful whenever a coil has been wanted.

It should be mentioned here that the former described needs a 2 and a 4B.A. tap and die and the appropriate drills for its construction, but for the benefit of those who do not possess these tools an alternative method will be given at the end of this article.

The base is made of 1/2-inch brass, a blank 4 inches in diameter being obtained from one of the large metal merchants, though it could probably have been only 3/8 of an inch or 1/4 of an inch thick without detriment to the finished former—which is shown in Fig. 1. The centre of the blank was found and a 3-inch circle scribed on one surface. This circle was divided into nine equal parts and a center punch mark made at

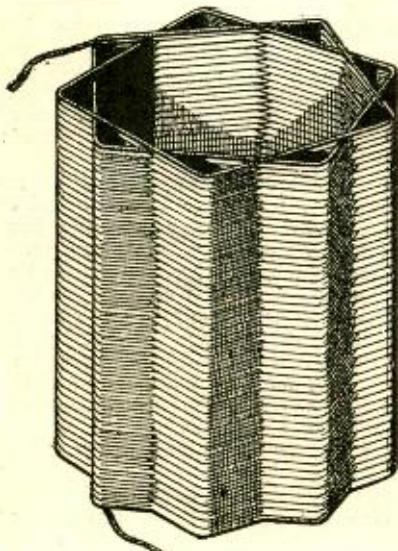

Fig. 2. The appearance of a single-weave coil wound on the former described.

each division line. The division of the circumference into any number of equal parts is easily done by multiplying the diameter by 22/7 and dividing the resulting figure by the number of divisions required. This figure will not be quite accurate, but any slight inaccuracy can easily be corrected by "trial and error."

BRASS RODS

A hole was drilled at each of the punch marks, a 2B.A. tapping drill being used. After this the holes were tapped out 2B.A., and the complete base was filed smooth and polished with sand-paper. The top edge had a groove cut in it on a friend's lathe just to finish it off and a coat of lacquer applied.

Next a length of 3/16 brass rod was obtained and 9 four-inch lengths cut from it. One end of each of these lengths was rounded off with a file and a little over one-quarter of an inch of the other end was screwed with a 2B.A. die. It was now merely necessary to screw the rods into place in order to be able to make basket-weave coils. The single-weave coil is the most usual and is shown in Fig. 2. But double- and triple-weave coils can be made if desired, and form interesting variations from an experimental point of

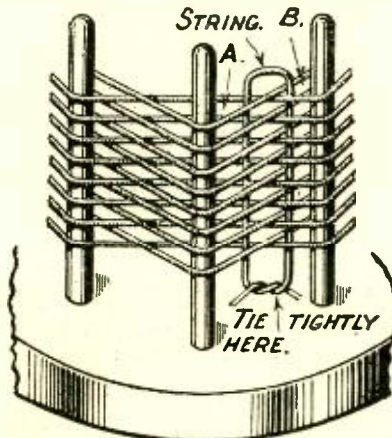

Fig. 3. The coil is self-supporting and secured with string.

view, as well as allowing more turns of wire to be accommodated on a winding of given length.

It was also intended to wind special chokes for fifteen-meter reception; these, of course, need to be much smaller than those generally used, and so another circle, one inch in diameter, was scribed inside the first one. This was divided into seven parts and 4B.A. tapping holes were drilled, the pegs were made, of course, from 4B.A. rod. These pegs were made only two inches long but the same amount was screwed at one end of each. The chokes made on this former consisted of thirty turns of No. 24 S.W.G. D.C.C. copper wire.

The method of making these basket-weave coils self-supporting is shown in Fig. 3. First lift the coil so as to leave a space of 1/2 inch to 1 inch between the bottom of the coil and the base of the former. This can be done with a strip of metal beveled off at one end and inserted between the base and the bottom turn, or by means of a special lifting plate shown in Fig. 5. Next a piece of thin string or twine is slipped down the space, as shown at A, on one side of the crossing of the wires between the pegs and the other end slipped down the space B on the other

side. The ends of the twine are now tightly tied to pull the winding together, and then knotted. After the crossings have thus been tied, it will be found that the coil can be slipped off the former as a unit and will be quite self-supporting.

MOUNTING

There are various methods of mounting these coils, but what is probably the simplest

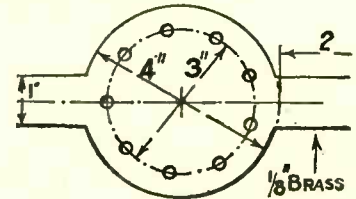

Fig. 5. The "lifter," for raising the coil off the base before fastening.

is shown in Fig. 4. A is a piece of wood or ebonite cut down to slip into one of the spaces of the coil, as at B. About 1/2-inch is allowed at either end, by which the piece of wood or ebonite can be fixed to either the panel, some instrument, or the baseboard of the receiver.

Coils made on this former will be found to be very efficient and give a good tuning range on account of their low self-capacity, while for low-loss tuners they are undoubtedly one of the best types to use on short-wave work.

If the constructor does not happen to have the necessary tools for drilling and tapping the base and threading the ends of the brass pegs, another means of making the former is as follows: Drill the nine holes required in an inch-thick hardwood base with a drill which is a trifle smaller than the brass rod used for the pegs, and having cut these, drive them into the holes with a hammer until they are quite firm. As long as fairly light gauge wire is used in winding the coils, and undue tension is not put on the wire while winding, this will prove quite a satisfactory alternative. If too great a tension is applied to the wire the tops of the pegs will be pulled out of the vertical, and not only will the coils be conical, but after several turns have been wound the pegs will tend to become loose in their holes.

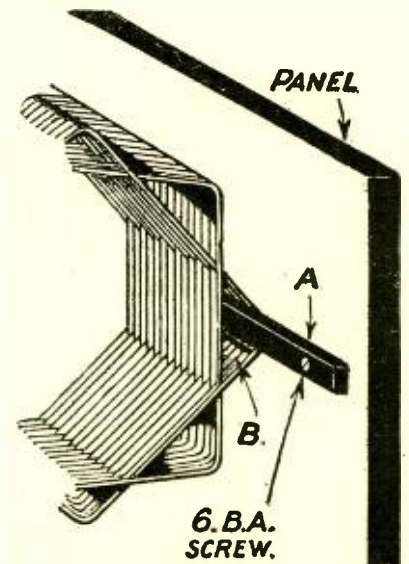

Fig. 4. A suggested method by which the coil may be mounted.

Super-Power

An Interview With J. H. Doellinger

REPORTED BY S. R. WINTERS

Here is an official interview with the Radio Section Director of the U. S. Bureau of Standards on the question of super-power broadcasting.

WITH approximately a dozen broadcasting stations appreciably increasing their consumption of power this summer—super-power stations, so-called—fear is entertained that this liberal use of electric energy may cause additional interference in radio reception.

"Is this anticipation well founded?" I inquired of Dr. J. H. Doellinger, Chief of the Radio Laboratory of the Bureau of Standards and President of the Institute of Radio Engineers.

"While there are real problems, which merit very careful attention, involved in the establishment of high-power broadcasting stations, there need be no fear that such stations will interfere seriously with the smaller stations nor displace them, provided (and Dr. Doellinger strongly emphasized this word *provided*) some very simple principles are followed," replied Dr. Doellinger, who has made a thorough study of this subject. Then I requested that he stipulate the simple requirements under which super-power broadcasting stations would necessarily have to operate in order to obviate the creation of interference.

"In the first place," outlined the President of the Institute of Radio Engineers, "proper frequency separation must be observed. If a new class of specially high-power stations is established, it must be assigned such frequencies as will minimize interference. One proposal to this end contemplates assigning them frequencies at or beyond one end of the present broadcasting frequency band. In the second place, such stations should be separated from others, not only in frequency, but also geographically.

"It is merely necessary that the field intensity with which the waves from such a station reach any large body of listeners shall not be materially in excess of the intensity from the more ordinary broadcasting stations. This will be readily attained if the broadcasting stations of specially high power are kept out of the cities. Many one-half kilowatt stations are now located in the midst of large cities. Supposing such a station to be three miles from the average listener in the city, the average interference in that city will be the same as that caused by a 10-kilowatt station located about 20 miles out."

At this point the Chief of the Radio Laboratory of the Bureau of Standards indicated to the writer that the powerful broadcasting stations recently built have observed this basic principle, namely, the operation of their transmitting establishments at points removed from congested areas. For instance, the first super-power station to be built, that erected by the Crosley Radio Corporation, is located in the country. It is a number of miles removed from the city limits of Cincinnati and is remotely controlled by a land wire from a studio at the latter point. WLW is a 5,000-watt station, whereas the ordinary broadcasting station consumes 500 watts or less.

Dr. Doellinger pointed out that among the marvels of radio is the really very minute power used, in comparison with the service which it renders. The 500 watts used by the ordinary broadcasting stations is the same amount of power as is used by an ordinary electric flat-iron or toaster. It is almost impossible for most persons to believe this, but it is true. The marvel is not dimin-

ished by the further fact that, of this relatively small power, only one-billionth part is received in the receiving set of the average listener.

"The questions involved in higher power are of immediate interest," emphasized Dr. Doellinger, in continuing his outline of this fundamental problem. "We face on the one hand the fact that the nearby local stations are the most satisfactory from the standpoint of technical quality of reception and low cost of receiving apparatus, and on the other hand the fact that the higher the power used at a station, the greater is the territory that can be served by a single station and the more economically practicable it becomes to interconnect stations for the simultaneous broadcasting of nationally important material. A number of considerations should guide thought upon the problem thus presented. Since the most satisfactory quality of reception is obtained when the incoming signal is relatively strong, the person interested primarily in radio broadcasting as an actual service, the delivery to him of agreeable entertainment and important news and instruction, is served best at the present time by the local stations. There still are, on the other hand, a large number of people who derive their chief satisfaction from radio through the thrill of listening to broadcasting from great distances. The satisfying of this interest must and will continue, through the operation of many stations of about the power and location of present stations.

"It must be recognized, however, that all

long-distance reception is necessarily subject to the interruptions and disturbances from atmospheric discharges and electrical interference. There is always a certain amount of random electrical disturbance in the atmosphere, and to insure radio reception of high quality not vitiated in part by these disturbances it is necessary that the received signal have an intensity above a certain minimum value. It is, therefore, not the power of the transmitting station nor the sensitivity of the receiving set which gives the limit to genuine quality reception, but rather the general level of intensity of atmospheric disturbances.

"All of the vast engineering and amateur effort to make more sensitive sets can henceforth be considered as being spent for the benefit of the radio listener who desires to hear distant stations rather than for the listener who desires to secure reception of high quality. The needs of the latter class are, on the other hand, vitally dependent on the general planning of the system of broadcasting stations. The reason why the local stations give technically superior quality and satisfactory reception is simply because they deliver a radio wave to the receiving antenna of an intensity greater than that of the atmospheric disturbance. In order to deliver a signal of the same intensity to a larger number of people or a larger territory it is necessary to use higher power in the transmitting station. This train of thought explains the evolution in the furnishing of broadcast service which has brought us to the present use of increased power."

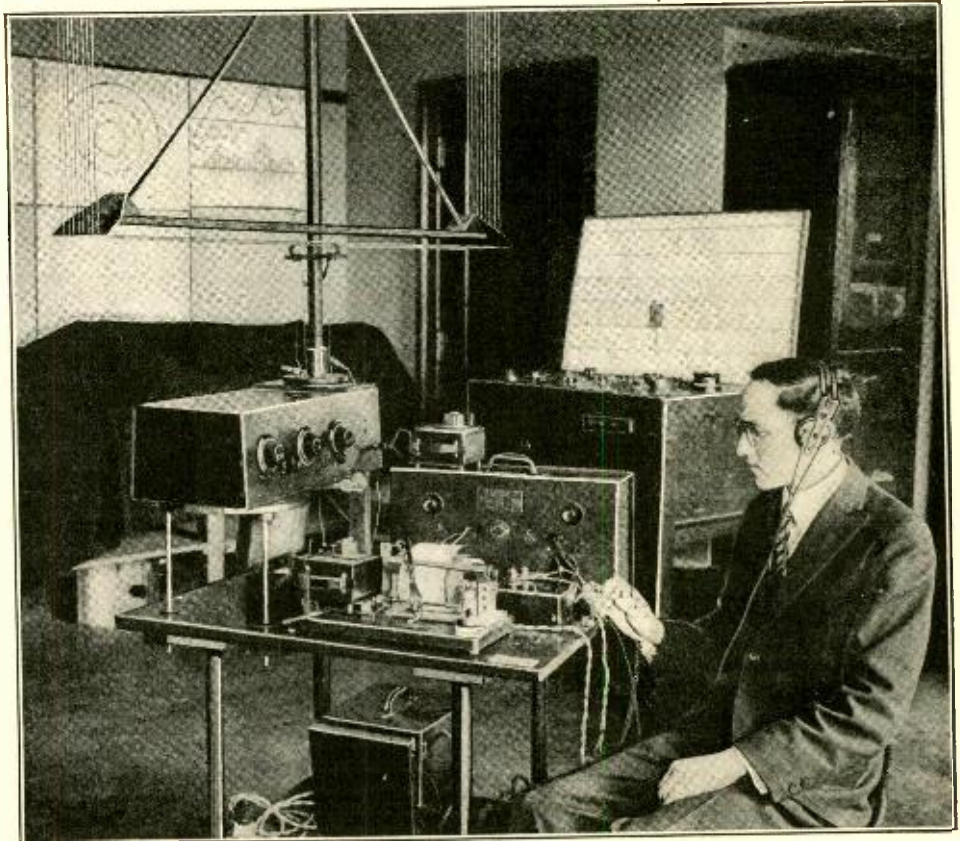

E. Z. Stowell of the Radio Laboratory of the Bureau of Standards, measuring the field intensity or strength of broadcast stations.

History of Radio Inventions

By A. H. MORSE, A.M.I.E.E., Member I.R.E.*

PART IV

BEAM signalling will undoubtedly find extended use, and being presumably free from vital patent restrictions, is sure of rapid development, particularly for short distances. It will be especially useful for conversation between ships in sight of each other, at sea, for aids-to-navigation purposes; and possibly in land warfare.

It has already been proposed to use as a conductor or aerial a beam of waves of the frequency of ultra-violet light, and such a beam may come to be utilized to guide a carrier wave. (Br. Pat. 124,833 to J. Hettlinger.)

"So, Engineers, observe a Wave
Hath smaller Waves that on him ride,
And these have smaller Waves to ride 'em,
And so proceed *ad infinitum*."

So one may paraphrase Dean Swift and epitomize the technique of radio-telephony.

The triode, as we know it, will undoubtedly undergo considerable evolution. DeForest and others have proposed various forms of hot cathodes, and it may be that an arc will come to be used as a cathode in the larger-powered triodes of the future; in fact, this is suggested in the specification of DeForest's British Patent 5,258/06. On the other hand, it has been suggested that the hot cathode may some day be dispensed with.

There is very much work for the research engineer of the future in discovering the hidden causes of the many known phenomena, and for him, as for most of his predecessors, success is likely to be its own reward.

We have yet to learn why radio waves persistently ignore certain spots in their great-circle path to others more distant, where they arrive with no abnormal attenuation. Cases are too numerous and too well known to be worth citing. It seems hardly reasonable to suppose that a "Heaviside Layer" or any other celestial reflector is suf-

could be accounted for by a variation of wave-length due to the equivalent of winds in the ether, just as the pitch of the whistle of a passing locomotive will vary with the growth and decay of the speed (and frequency) of the sound waves, as their source

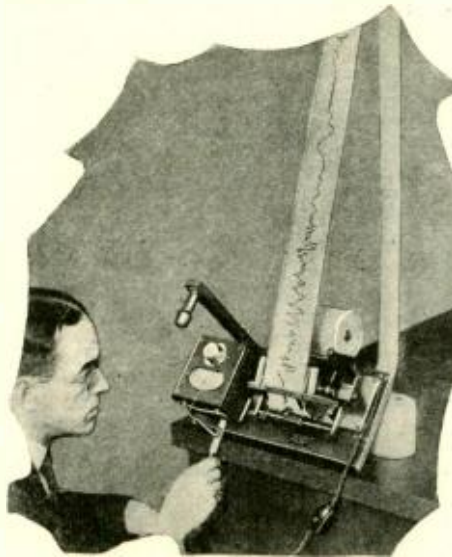

Fading is, with static, one of the difficulties in radio reception which is still to be overcome by our engineers.

approaches and recedes; but there is no proof that fading is so caused. According to Fleming, "No experiments yet (1921) devised have enabled us to determine any motion of this hypothetical ether relatively to the earth or any other moving matter," and he quotes Professor Eddington as declaring that "the ether must now be regarded as an idle hypothesis unsupported by experiment and giving explanations of nothing."

If one may not postulate ethereal winds, a reflecting layer, or even an ether, there is only the "passing shadow" theory to ac-

able. In fact, in the near future, there will probably be an "antipodean" station in every country—almost certainly in every continent. The receiving component of each will be equipped with a number of vertically plane-polarized and "sense" selective aerials, arranged radially about the operating house; so that regardless of the direction of approach, or the phase of the incoming waves, their energy may be summated in the received signal. In short, it is not unlikely that the most dependable, really long distance communication of the future will be effected between stations that are approximately "poles apart."

ANTIPODEAN BROADCASTS

Obviously, transmitting stations of such relative location would be of the "broadcasting" kind, as any attempt to use directional transmission would tend to the sacrifice of the special value of broadcasting for such communication. Moreover, for highest efficiency, a directional transmitter would require to be continuously oriented.

There is not yet any ground for supposing that "beam" transmission will ever be practicable or useful for antipodean or even long-distance communications, but there is good reason to suppose that the high-powered long-wave transmitter of the future will be supplemented by a short-wave comparatively low-powered transmitter for auxiliary night communication, particularly where the route of communication has a diurnal all-dark period. It is perhaps not sufficiently well remembered that no two spots on the earth's surface are more than 12,500 statute miles apart; or that two broadcast stations of this range, and suitably disposed, could sweep the earth.

It may transpire that on account of the uniformity of conditions of light, long-distance wireless services will tend to be restricted to longitudinal routes.

The wave-lengths allocated to broadcasting and amateurs have proved so efficient for night communication that an attempt may be made to reclaim them for commercial telegraph purposes during the night hours—say from midnight to 6 A. M.; especially is this likely since the very long waves now in use for telegraphy tend to impose a limitation upon the speed of transmission. According to recent reports, the allocation of a band of short waves to commercial radio-telegraphy seems now to have been definitely decided upon.

It is unlikely that there will be any wide application of radio-telephony to public service beyond broadcasting. The average broadcasting station occupies as much of the ether as would accommodate ten radio-telegraph stations—possibly more; and the ether is already becoming congested. The suppression of the carrier wave and one of the side-bands would effect an economy of the ether of about 50 percent (and also of transmitting energy), but stations operating under such economical conditions would be unintelligible on the broadcast receivers now generally in use.

In the near future, broadcasting of local urban interest only will probably be effected over existing wire (lighting or telephone) systems, and so kept out of the ether. Stations broadcasting entertainment, etc., of wider interest, will probably extend their present practice of "tying-in" or broadcasting the same program simultaneously from several stations, with a resultant improvement in the quality of program.

Already it is possible to set up an audio-frequency electrostatic field, so that a person may listen to a broadcast program by



One of the most important future advances in radio is bound to be the further development of television. Here is shown C. Francis Jenkins with his television apparatus.

ficiently stable, as regards position and plane, to work consistently for the benefit or otherwise of certain spots.

FADING

We do not know the cause of fading. It

*Late Supt. Dom. DeForest Wireless Telegraph Co. and United Wireless Telegraph Co.; Engineer, Marconi's Wireless Telegraph Co.; Wireless Adviser, Indo-European Telegraph Co.; Managing Director, Marconi Wireless Telegraph Company of Canada.

count for fading unaccompanied by, freak reception, but when fading alternates with freaking, the cause would seem to be transient interference and co-operation of direct and diffracted waves, which inevitably bespeaks a layer.

Given adequate power, there is every reason now to believe that dependable, if not continuous, communication by radio-telegraphy may be effected between any two points on the earth's surface; and that between relatively antipodean stations, communication should be particularly depend-

means of a pair of head-telephones having no fixed attachment, and may even hear the program in any part of a room. (Br. Pat. Application 16,442, 25th June, 1923, Hale and Lyle.) This device may come into extensive use in private houses, hotels, restaurants, ships and trains, where loud speakers are not desired. The electrostatic field is set up by a conducting grid which may be in the form of a mat under a carpet, the metal lathing of a ceiling, or the spring of a bed or chair, connected to one terminal of an audio-frequency amplifier, the other terminal of which is connected to earth or a suitably disposed counterpoise or second grid.

When the loud speaker is more nearly perfected, there is no doubt that it will be used in hotels and ocean liners to make orchestral music available in a number of public rooms. For instance, on a liner the orchestra that plays for the first class passengers will be made audible to those of the second and third class.

For the last twenty years or so, the ultimate authority on radio matters has been vested in a league of nations—if one may borrow a term—with headquarters at Berne in Switzerland. For the use of this body a common language had to be adopted and, according to precedent, French was chosen. Obviously, therefore, radio has long been a factor in social evolution in the broadcast sense, and to-day the practice of broadcasting opens up further new and wonderful opportunities in this direction. To realize what a great opportunity radio now affords to people of good sense and goodwill, one has only to consider that one station in Europe may provide instruction and entertainment for people of twenty different races, tongues and religious prejudices. What an opportunity also for the advocates of Volapuk, Ilo, Esperanto, or other lingua franca!

AUTOMATIC RECEIVERS

At the moment the radio and shipping worlds most urgently await an automatic distress call receiver. It must be one that is acceptable to all nations, and that will not necessitate expensive or intricate gear at the transmitting station. If it should appear advisable, there is no doubt that the international distress call signal would be modified or materially changed to suit any practicable device. The question presumably now awaits the universal adoption of continuous-wave transmitters aboard ship, or the next International Conference.

In the author's opinion, the ultimate distress call will be made up of signals of two or three different notes or wave train frequencies, used either simultaneously or successively. In such case, the automatic receiver will consist of two or three tone-selective switch-closing elements, inoperable by anything but the distress-call and self-resetting.

Comparing the old and the new: At the left is a station of ten years ago and at right a station of today.

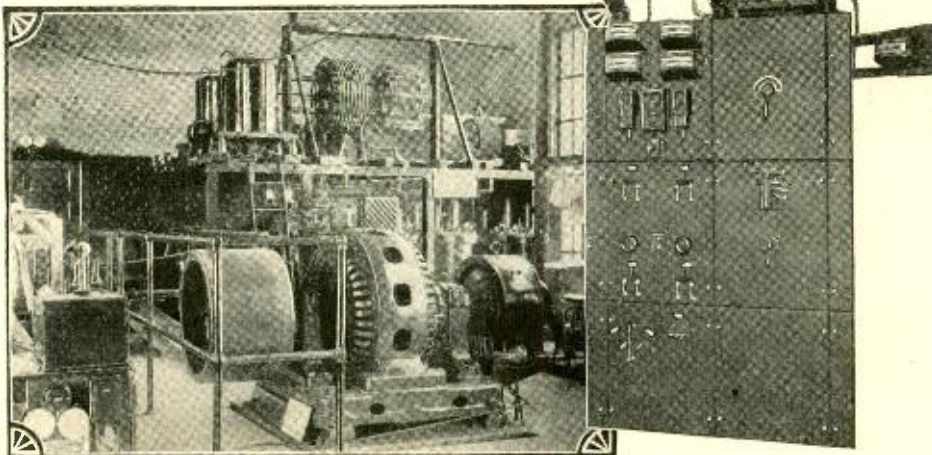

As an alternative or additional measure, a special wave may be allotted exclusively to distress-calls, particularly in busy areas, and a definite number of suitably located listening stations established to stand by permanently on that wave. Each of such "distress" listening stations will be equipped with direction-finding gear, so that the distress-call may be confined to the ship's call letters or any other signal on the prescribed wave.

If such a scheme were adopted, shipboard transmitters would have to be designed to provide instantaneous change-over to the "distress" wave, and for maximum efficiency thereon. Ships unfurnished with operators would be permanently tuned to the "distress" wave, and would be provided with code-wheels or other suitable automatic transmitters and explicit directions for their use.

Upon receipt of a distress-call, the distressed ship's position having been located by means of cross-bearings, the controlling coast stations would be notified immediately to suspend all traffic on the commercial waves until definite arrangements had been made for the assistance of the distressed ship; meantime, certain extra ship or coast stations would stand by on the "distress" wave.

It may be found desirable to have ships' distress radio transmitters tied into simultaneously operating submarine sound transmitters, so that (if she were equipped with apparatus to measure the difference in transit time of the two signals) an approaching ship could calculate the distance of the signal source. That such a method has often been proposed may be gathered from a reference to the specifications of the following British Patents: 12,124/99 to C. F. Kelway (Ether and Air); 10,082/09 to J. Schiessler; 25,318/10 to E. F. Cassel; 4,352/14 to A. Stchensnovitch; 7,452/15 to F. L. Sawyer; and 146,125/19 to R. L. Williams.

One very gratifying thought for those who have been associated with radio for the last two decades or so is that it is now practically impossible to lie about it. Of course, there will continue to be exaggerated claims and wild statements when, in the opinion of some of those concerned, occasion arises. For instance, it is doubtful that the fetish that radio will supplant conductor systems of telegraphy and telephony will be allowed to die. The astonishing thing is that, even in the days of radio's greatest limitations, anyone ever thought it necessary to embellish the facts.

SHORT WAVES

The potentialities of short-wave radio appear to be very great in a limited sphere. In the autumn of 1918, the author proposed to the British Air Board that the ignition systems of aircraft should be used for pur-

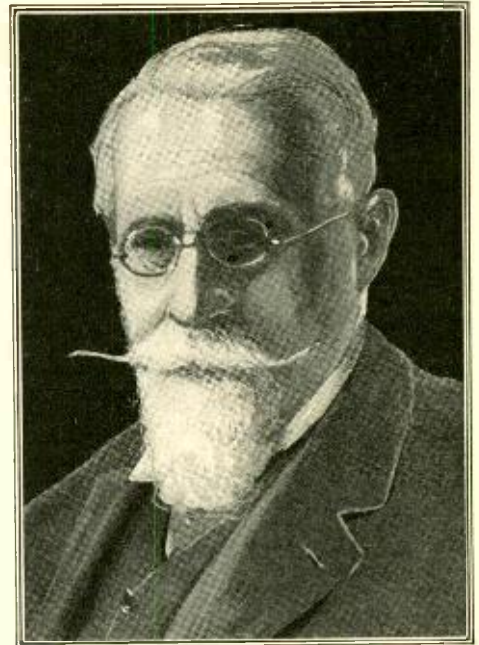

Sir William Crookes, whose pioneer work in conduction through vacuums still remains of great importance.

poses of telegraphic identification. To this end, every aircraft was to have a three- or four-letter identification signal—like a ship—and be provided with a rotatable code-wheel in series with the engine ignition system. This code-wheel would have appropriate conducting and insulating segments, and would be normally short-circuited. Upon receipt of a prearranged signal from below—preferably a visible signal—the airman would rotate his code-wheel and thereby signal his identity in two ways, by Hertzian, and air, or sound, waves. This matter is brought to mind now by a perusal of C. S. Franklin's report on his experiments with short waves, in which he states that the interference he experienced emanated mainly from the ignition systems of motor boats and motor cars.

Marconi suggests that by the use of very short waves it may be possible for a ship to discover its distance from a signal source, because of the great consistency of the attenuation of these waves over sea. It is not recorded that experiments have been made with a view to discovering whether or not this attenuation varies with sunlight conditions, although it is known that there is a very great difference between the daylight and dark attenuation of short waves of the order used in broadcasting.

It has also been suggested recently that short-wave radio beams may be used between ship and ship as an aid to navigation in fog, and it is possible that with the instrumentalities now available, something along the lines proposed by A. N. Hovland to this end, in 1901, may be put into effect. (Br. Pat. 19,170/01.) (See also the following British Patent specifications: 15,569/03 Ladd; 19,878/06 DeForest; 27,938/06 DeForest; 18,632/12 Hienicke and Jasper.)

It has been shown that in radio particularly there is often a great distinction between an invention and the means to carry it out; and it is probably true that a number of inventions of great potential merit have gone into the discard, merely for the lack of means (instrumentalities) to put them into effect. We have seen what the triode has done for radio receivers, amplifiers, beam and other transmitters and direction-finders. May it not be that it is capable of doing as much for some of the pre-radio systems of telegraphy without wires? If some of these systems could be resuscitated, they might now be used to supplant

(Continued on page 210)

A Short-Wave Adapter for Broadcast Receivers

By CLYDE J. FITCH

Following along the line of shorter waves for broadcasting as announced in the June issue of RADIO NEWS, an adapter for short waves is herewith presented.

SHORT waves are becoming more and more popular. It is safe to predict that within a few months many broadcast stations will be transmitting on wave-lengths too low to be received on the present broadcast receivers. The present receivers have a tuning range of about 200 to 600 meters. There are nearly 600 broadcast stations in the United States, all operating within this range, which is now so crowded that considerable interference results. In order to relieve the situation, it is proposed to reduce the broadcast wave-length band to 150 meters or lower, instead of 200 meters, and thereby make room for the many new stations which are bound to spring up this fall. This means that the present broadcast receivers will not be able to tune down to the 150-meter stations unless radical changes are made. It is the purpose of this article to describe a very simple unit, easily constructed by the average broadcast listener, that will enable him to receive the short waves on his present set without making any changes.

The unit is very inexpensive. Almost all of the parts in the broadcast receiver are made use of without changes. It may be used with any type of broadcast receiver, including the super-heterodyne, but this article will describe its use mainly with a 5-tube, tuned radio frequency set, because this is the most popular broadcast receiver in this country.

The short-wave adapter is of the same general construction as the standard single-tube short-wave regenerative receiver with tickler feed-back. It may be designed to cover any of the amateur wave-length bands. Those who are interested in amateur telegraphy and who now own a broadcast receiver would do well to build this adapter. The following parts are required, practically all of which are standard:

- 1 7" x 10" Panel.
- 1 6½" x 9" Baseboard.
- 1 Short-wave tuning condenser, .00025 mfd.
- 1 Short-wave tuner.
- 1 Standard vacuum tube socket.
- 1 Grid condenser and grid leak.
- 4 Binding Posts.
- 1 Burned-out UV-201A tube.
- 1 7" Cabinet.
- 10 Feet bus-bar wire.

The illustrations show the simplicity of the device. Fig. 1 shows the circuit diagram, which is merely a regenerative cir-

cuit designed to receive the short-wave stations. The antenna A is that used for broadcast reception, and is merely disconnected from the broadcast receiver and connected to the adapter. L is the primary, L₁ the secondary, and L₂ the tickler of the short-wave tuner. There are many short-wave tuners now on the market designed for amateur reception, any of which may be used. Diagrams are usually furnished with the tuners and the connections are marked, so there is little chance of mak-

of an old, burned-out, standard vacuum tube, such as the UV-201A. The base is removed from the tube by heating it, which softens the cement. The solder should be removed from the tube-prongs first.

A wooden plug is turned out to fit inside the metal base, as shown. It is glued in place, but before gluing the three-conductor flexible cord must be connected to the socket prongs.

At the right of Fig. 3 is shown the bottom view of the tube base with the filament prongs marked F, F, the plate prong P, and the grid prong G. These are shown with relation to the pin that holds the tube in the socket. The prongs F, F, P, are the only ones used and are shown in black. The wires in the three-conductor cord are soldered to these three prongs. The wires should be of different colors or should have markers so the other ends can be correctly connected to the three binding posts marked F, F, P on the adapter.

The panel is drilled to suit the short-wave tuner and condenser purchased. Templates are furnished with the instruments to facilitate drilling. As the drilling of different makes of apparatus is different, no dimensions are given. Four binding posts are mounted on the panel or, if the builder prefers, he may mount them on a bakelite strip in the rear.

After you have screwed the panel to the baseboard and mounted the instruments, they should be connected according to Fig. 1, which shows the working diagram. About 10 feet of bus-bar wire will be required. The adapter may then be placed in a 7 x 10 radio cabinet, as shown in Fig. 2.

HOW TO USE THE ADAPTER

Now that the adapter is finished, the builder no doubt wonders how to place it into service. This is very simple. The dia-

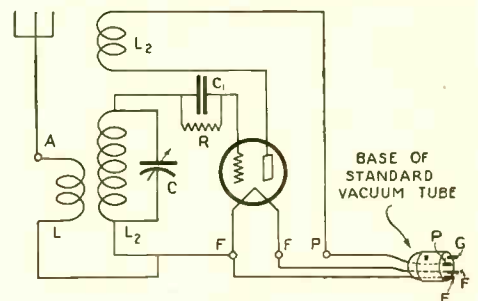

FIG. 1
The wiring diagram of the short-wave adapter is a simple three-circuit tuner.



ing an error in building and wiring the adapter.

C is the short-wave tuning condenser. It should, of course, be of good and stable mechanical construction. A variable condenser with a maximum capacity of .00025 mfd. will be found suitable. The grounded rotor type is preferable, as the rotor side can be grounded or connected to the filament circuit, as shown, so as to eliminate body capacity effects. A straight-line wave-length condenser is preferable, although a straight-line capacity one will suffice.

C₁ is a .00025 mfd. fixed grid condenser and R is a 1 to 3 megohm grid leak. F, F, and P are binding posts connected to a flexible three-conductor cord terminating in the base of a burned-out vacuum tube, shown in detail in Fig. 3.

THE PLUG CONNECTOR

To connect the adapter to the broadcast set a special plug is required. The plug is shown in Fig. 3. It is made from the base

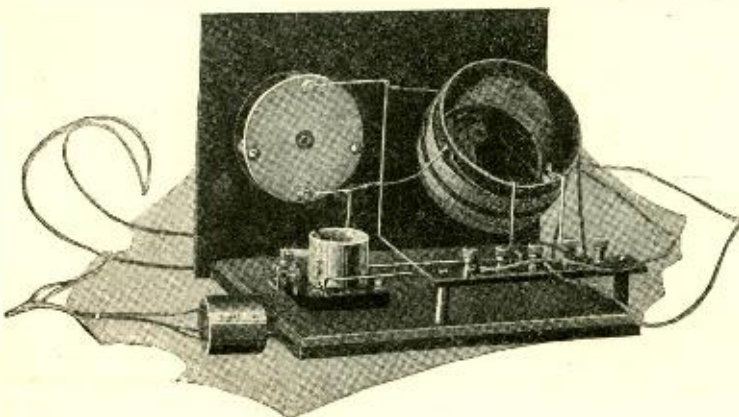

The arrangement of the apparatus in the adapter for short waves. Note the base of a vacuum tube used as a connector.

gram of connections is shown in Fig. 2. First, try out the broadcast receiver, and be sure that it is in good working condition with the loud speaker plugged in on the second stage of audio amplification. Second, disconnect the antenna from the broadcast receiver and connect it to the antenna post A of the adapter. Third, remove the detector tube from the broadcast receiver and place it in the socket of the adapter. Fourth and last, insert the special plug connector with the three-conductor cord in the detector socket of the broadcast receiver. Short-wave stations may then be tuned in on the adapter and heard in the loud speaker.

The operation of the apparatus is simple. By inserting the special plug into the detector socket of the broadcast set, we supply "A" battery current for the adapter tube

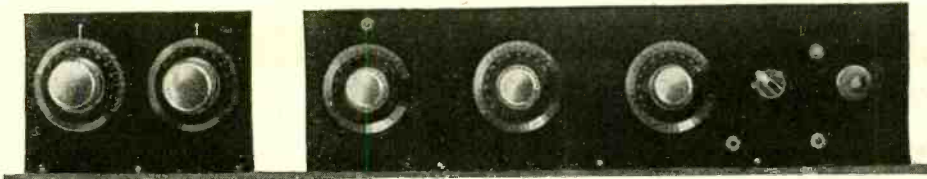

Panel view of the short-wave adapter and a standard receiver. Only the dials of the adapter are used in tuning the combined sets.

through the leads marked F, F. "B" battery current is supplied through the lead marked P. The two-stage amplifier in the

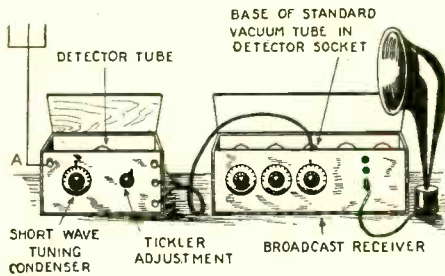

FIG 2

How the adapter is connected to the detector tube socket of the broadcast receiver.

broadcast receiver amplifies the short-wave stations received on the adapter. The de-

tor rheostat on the broadcast receiver controls the filament current of the tube in the adapter. The tuning dials on the broadcast receiver are not in use, all tuning being done on the condenser in the adapter. The radio frequency amplifier tubes in the broadcast receiver may be turned out, as they are not in use.

This gives us a detector and two-stage audio amplifier. Head-phones may be plugged into the detector or first-stage audio amplifier jack of the broadcast set when using the adapter. No ground connection is used on the adapter because the adapter is grounded through the filament connections of the broadcast receiver.

It seems needless to say that this adapter is designed for use with sets employing standard 6-volt storage battery tubes, such as the UV-201A or C-301A. For use with a broadcast set employing dry cell tubes, a dry cell tube socket should be placed in the

adapter instead of a standard socket, and the connection plug should be made from the base of a dry cell tube base.

When used with a super-heterodyne, the second detector should be removed from the super and placed in the adapter, and the plug placed in the empty detector socket of the super. If a loop aerial only is used with the super, it should be removed and one binding post of the loop should be connected to the antenna post of the adapter. This will give fairly good results. An outdoor aerial is preferable. This adapter can-

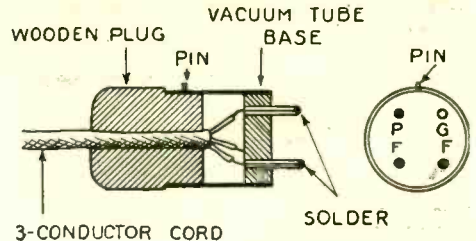

FIG. 3

How a vacuum tube base may be made into a connector for the short-wave adapter.

not be used with broadcast sets employing crystal detectors. If no ground is employed on the broadcast receiver, the filament circuit should be grounded.

Solutions Will Not Charge Storage Batteries

By JOSEPH RILEY



One of the most mistreated parts of a radio receiving set is the storage battery. This report from the Bureau of Standards on "fake charging solutions" is well worth remembering, as some of the solutions harm the batteries.



THE "Wets" of radio land, who prefer to use storage batteries on the filaments, and perhaps the plates, of their tubes, will be interested in what practically constitutes an exposé by the Bureau of Standards of "fake" charging solutions.

An official bureau statement says: "Changing the solution in a storage battery does not charge it," and continues as follows:

An investigation was recently made at the Bureau of Standards of certain solutions which were said to charge batteries instantly, or in a short time as compared with the usual process. These tests have shown that batteries containing these solutions, contrary to the claims made for them, behave in accordance with well-established laws of electro-chemistry.

Analysis revealed these solutions to contain 38 to 42 per cent. of sulphuric acid, which is about the amount in the ordinary electrolyte of an automobile battery when charged. In some of them were found also significant amounts of sodium or magnesium as well as coloring matter. The sodium may have been added as soda, lye, or Glauber salts; the magnesium as Epsom salts. The use of sodium sulphate (Glauber salts) in batteries is an old story. It was suggested more than 35 years ago, but various authorities since that time have stated that such material is without beneficial effect. This has been confirmed by the Bureau's recent experiments, which show the rate of sulphation of plates to be unaffected by even 4 to 5 per cent. of Epsom salts or Glauber salts.

Comparison was made between batteries containing these solutions and similar batteries containing electrolyte of sulphuric acid of equivalent strength. No essential differences were shown in the charging, the voltage, the efficiency or the temperature. When a battery is said to be charged it is understood that the battery is fully charged.

A battery which is almost completely discharged may have nearly the same voltage as one that is charged. In this condition it may be able to operate the starter of an automobile, but this fact cannot be taken as evidence that the battery is fully charged. It takes as long to fully charge a battery containing one of these solutions as to charge a similar battery containing the ordinary electrolyte.

The indiscriminate addition of these solutions to a battery is not advisable, although in some cases no great harm may be done. If the solution is used to replace the electrolyte of a completely discharged battery, as is usually the case, the battery may be spurred on to give a little more current, because the plates retain a surplus of active material. When the battery is recharged by an electric current the specific gravity will rise much too high. This is because the acid formed at the plates by the charging current is added to the acid already present in the solution. In the Bureau's experiments it rose to 1.365. This is not desirable because the local action or self-discharge within the battery is materially increased. A battery containing one of these solutions lost 47 per cent. of its charge in four weeks, as compared with 8 per cent. which was lost by a similar battery with the ordinary solution. Batteries containing solutions of higher than normal specific gravity often give less capacity at high rates of discharge, as when cranking the engine of an automobile, depending upon the behavior of the negative plates. The higher the specific gravity of the electrolyte the more injurious is the action upon the separators. It is a well-recognized principle in battery operation that acid should be added only to replace that which may have been spilled, or, in rare instances, to adjust the specific gravity to the required standard after the completion of a full charge.

Although the materials and coloring matter, considered individually, may be harmless, the disadvantages in using such solutions more than offset any temporary gain. The usual electrolyte of pure sulphuric acid and water, adjusted to the proper specific gravity at the completion of a full charge, is believed to be the best.

HIGH SCHOOL TEACHER SAYS RADIO SPOILS STUDY

Walter F. Downey, Headmaster of the English High School, Boston, says the radio ranks with the movies, automobiles and dance halls as a distraction from study. Many failures have been traced directly to the installation of a radio set in the pupil's home, he says. First, the boy spends the two or three hours necessary for his homework in listening to a concert. He appears in school the next morning with a radio "alibi." Second, he goes without sleep in order to get a distant station, and his school-work naturally suffers for it.

"With the exception of honor students," says Mr. Downey, "nearly every pupil in the school has been affected by the radio distraction. To my mind, the radio is like bringing the moving picture into the home, except that the radio may be said to be never in itself objectionable. It is bound to create a division of interests in the student's mind.

"I would not ask parents to deny themselves the pleasure of owning a radio, but I would advise them to keep their radios under lock and key while their children are supposed to be studying and under lock and key while their children are supposed to be sleeping. It is the only way to limit the harm that it is causing to the pupils' scholarship."—N. Y. Times.

Straight-Line Frequency Condensers

By SYLVAN HARRIS

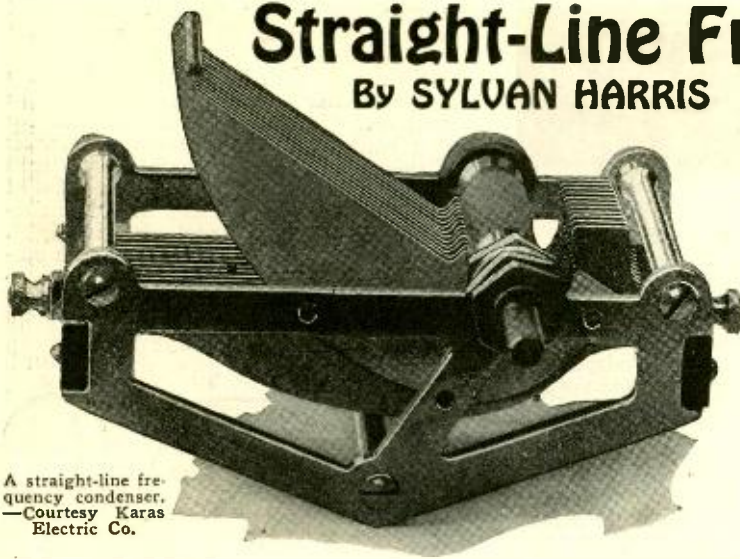

A straight-line frequency condenser.—Courtesy Karas Electric Co.

THE advantages of a straight-line frequency condenser are strikingly illustrated in the dials shown on these pages. For simplicity's sake, we have shown two sets of dials, the first one indicating how the frequency is spaced around the dial, and the other how the wave-length is spaced on the dial. The latter set of dials is shown for the purpose of helping the reader to orient himself, as most radio fans are not accustomed to thinking in terms of kilocycles.

It should be kept in mind that the straight-line frequency condenser deals solely with frequency, and has nothing to do with the wave-length. It becomes important for the future to accustom ourselves to the thought of frequency, because this is a fundamental idea, while the idea of wave-length is secondary. It is unfortunate that the radio fraternity has become so accustomed to the wave-length conception.—EDITOR.

CONDENSERS have once again come into the spotlight. It seems that their lustre will never be dimmed. First it was because of the enormous losses that people thought they found in them; later it was because of the infinitesimal losses that people thought they found in them; and now it is because people have found that the shape of the plates in them seriously affect their comfort of mind and the convenience of tuning their radio receivers.

We will say nothing here about the losses. These have already been treated in detail in this journal. We will confine ourselves here to a study of the effect of the shape of condenser plates. The plates in variable air condensers have heretofore generally been circular, more for simplicity of mechanical construction than for any other reason. Attempts have also been made, from time to time, to place on the market the sliding plate condensers. In fact, this was probably the earliest of continuously variable air condensers. These have not proved satisfactory until of late, as the mechanical design has only recently been much improved and the need for the straight-line type of condenser has just begun to be felt.

With regard to the variation of capacity to the setting of the condenser dial, there are three important shapes of condenser plates. These shapes are such that:

- (1) The variation of capacity with dial setting is linear.
- (2) The variation of wave-length of the tuned circuit with dial setting is linear.
- (3) The variation of frequency of the tuned circuit with dial setting is linear.

Each of these types has its advantages and disadvantages, and we will endeavor, as far as possible, to study them in parallel order, so that the merits and drawbacks may be easily recognized.

The curve of capacity of the circular plate condenser is shown in Fig. 1. This is a straight line throughout, excepting for the small portion at the bottom. The reason why the curve rounds off at the bottom is apparent in Fig. 2. The rotor plates are not in mesh with the stator plates over their whole radius until the rotor has been turned a little, generally about 10 divisions on the dial. Even when the plates are totally out of mesh, as shown in Fig. 3, the capacity

between the terminals of the condenser is not zero, for there is a certain capacity existing between the edges of the two sets of plates and between the shaft and the stator plates.

The curve can be regarded as a straight line, however, over its major portion, and from this it follows that equal motions of the dial will produce equal changes of capacity.

When the condenser is used in a tuning circuit with a fixed inductance, however, the variation of wave-length or frequency of the circuit with the setting of the dial is not linear. The relation of the wave-length and frequency to the dial setting is shown in Fig. 4, which has been computed from the equations

$$\lambda = 1884 \sqrt{LC} \text{ and } f = \frac{159.3}{\sqrt{LC}}$$

in which λ is the wave-length in meters, f is the frequency in kilocycles, L is the inductance of the coil in microhenries and C is the capacity of the condenser at any setting in microfarads, assuming ordinary values of inductance and capacity.

There is a very significant point in connection with these curves. That is, that when we tune on the low dial settings—below about 40 on the dial—the curves become very steep, and small changes in the dial setting cause very great changes in the wave-length or frequency. When the broadcasting stations are assigned channels separated by equal frequency intervals (10 kilocycles), it is evident that there will be a great many stations crowded together at the low dial settings. This is the situation today, as everyone is aware; this subject was taken up in detail in RADIO NEWS of June by W. B. Arvin, page 2206.

In their efforts to help relieve this crowded situation, designers of condensers have turned their attention to condenser plates of shapes other than circular. The first of these that became popular was the straight-

IT is doubtful if there has been anything during the past few years that has been awaited with such expectancy as the straight-line frequency condenser. This condenser has become the most important necessity in radio of which we know today.

In the present type condenser all of the low-wave stations bunch on the one side of the dial in such a manner that it is impossible to separate them. All this has been done away with in the straight-line frequency condenser, which has just now arrived.

We believe RADIO NEWS is the first to show an actual condenser of this type. One of these, with a capacity of .0005, is shown on this page.

It becomes a real pleasure to tune with such an instrument. In one night's experience we logged quite a number of broadcast stations of the shorter wave-lengths which we had never heard before.—Editor.

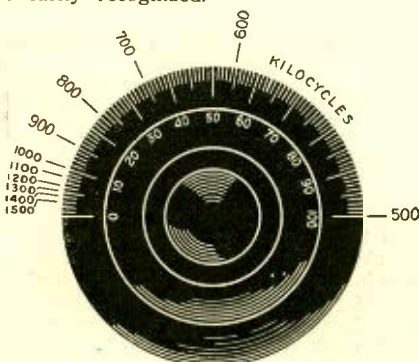

There is considerable crowding on the circular plate condenser.

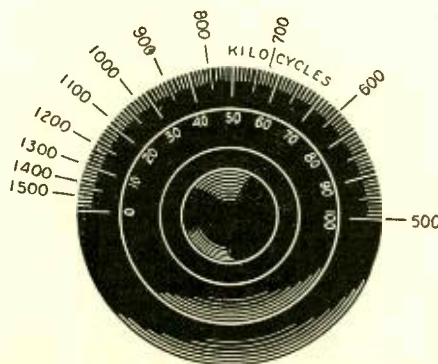

On the straight-line wave-length condenser there is less crowding.

On the left is shown the frequency distribution for a circular plate condenser with the stations crowded at the lower end. Above, less crowding is shown, for the straight-line wave-length condenser, and to the right, for the straight-line frequency condenser, there is no crowding.

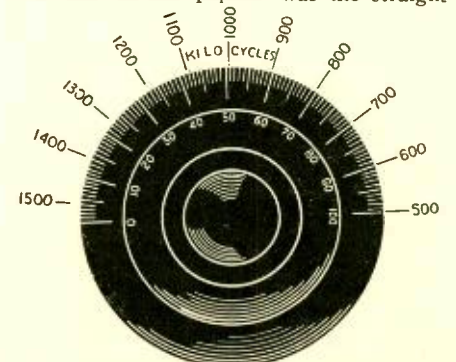

All crowding is eliminated on the straight-line frequency condenser.

line wave-length type, which gives a straight-line calibration when dial setting is plotted against the wave-length. Such a curve is shown in Fig. 5; it has been drawn to include the wave-lengths from 600 to 200 meters. In other words, since we require a straight line from 600 meters at 100 on the dial to 200 meters at 10 on the dial (remember, the plates do not begin to mesh properly until about 10 on the dial is reached), we have simply drawn a straight line between these two points.

Now, if the assignment of transmission channels were made at equal wave-length intervals, say 10 or 20 meters apart, the straight-line wave-length condenser would solve the problem. But the channels are not assigned this way, since it is necessary for them to have a certain minimum frequency separation to take care of the sidebands which arise in modulating the carrier wave. That is, since transmission of voice

range as the other condensers, *vis.*, 600 to 200 between dial readings of 100 and 10. We will not worry about whether such a condenser is possible or not at present; this will be discussed later on. At any rate, to show the desirability of a condenser that will give a straight-line calibration of frequency against dial settings, we have simply drawn the straight line between the limits of the other curves.

The figure shows very plainly that the straight-line wave-length condenser is a trifle better than the straight-line capacity condenser in a way of relieving the crowding, but that it does not completely solve the problem. There will still be some crowding at the low dial settings, while the stations at the higher dial settings will still be somewhat spread out.

The straight-line frequency condenser, as we have represented it, will solve the problem properly. The frequency varies in proportion to the dial setting, and the frequency difference over equal portions of the dial will always be the same, no matter whether it is at the lower or the higher end of the dial. The slope of the curve is less at the low dial settings and greater at the high settings, indicating that at low dial settings the crowding will be less, and at the high settings the spreading out will be less than in the other two types.

Now let us learn how the capacity must vary with the setting of the dial in these three types of condensers. Incidentally, it must be noted that the dials used with the straight-line frequency condensers must be calibrated backward; that is, in the other two types, when we are considering wave-length, an increase of capacity means an increase of wave-length, so that the dial is marked 100 when the plates are entirely *in mesh*. When considering frequency, however, this is highest when the capacity is least, so we must mark our dial 100 when the plates are entirely *out of mesh*.

The variation of capacity with the dial setting can be studied from the formulas

$$\lambda = 1884 \sqrt{LC} = K\sqrt{C}$$

and

$$f = \frac{159.3}{\sqrt{LC}} = \frac{K}{\sqrt{C}}$$

in which the quantities are in the same units as explained before. We will assume the inductance to be constant, and do the tuning only by varying the capacity of the condensers. K is a constant obtained by combining the numerical parts of the equations with the constant inductance.

We then have the three laws for the three types of condenser which make these straight-line condensers:

- (a) For the circular type, C is proportional to D.
- (b) For the straight-line wave-length type, C is proportional to D².
- (c) For the straight-line frequency type, C is proportional to 1/D².

Thus, if D² is substituted for \sqrt{C} in the equation for λ , we shall have $\lambda = K'D$. Likewise, if we substitute 1/D² for \sqrt{C} in

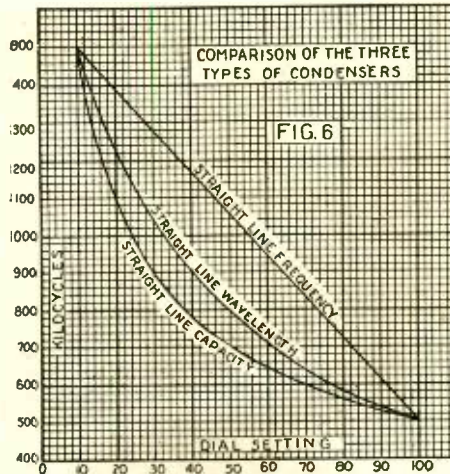

The relative advantages of the three types of condensers are here shown very clearly.

the equation for f, we shall have $f = K'D$. Both of these resulting relations are linear equations. D represents the dial setting.

Knowing the laws expressed by (a), (b) and (c) given above, it is easy for us to study how the capacity must vary with the dial setting. We shall consider the range of dial readings to extend only from 10 to 100, for reasons that have been explained before. There is an additional reason for doing this: if we should take zero for the dial setting and substitute this in the relation $C \propto 1/D^2$ (the sign \propto means "proportional to"), we shall have $C \propto \frac{1}{0}$, which is an indeterminate number generally expressed as "infinity."

To show the relative variation of capacity in the three types of condensers, we have assumed the capacity at 10 on the dial of the straight-line capacity and wave-length condensers equal to unity. At 100 on the dial, the capacity of the circular plate condenser will then be 10 and that of the straight-line wave-length condenser 100. In other words, whereas the capacity ratio of the circular condenser can satisfactorily be 10 to 1, the ratio for the *straight-line wave-length* condenser must be 100 to 1. That is, if the capacity at 100 on the dial is 0.0005 microfarad, the minimum capacity will have to be 0.000005 microfarad to preserve the square law (or the straight-line calibration) over the whole dial. There are on the market at present several very satisfactory straight-line wave-length condensers.

The reader must remember that the curves of Fig. 7 represent *relative* values and not actual values; thus, the capacity of the straight-line capacity condenser at a dial reading of 50 must be *five* times the capacity it has at a dial setting of 10; the straight-line wave-length condenser must have a capacity at 50 on the dial of *twenty-five* times its capacity at a dial setting of 10; this is also true of the straight-line frequency condenser.

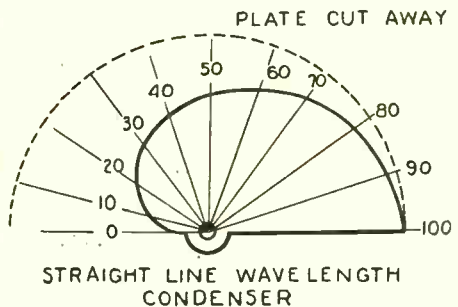

FIG. 8

A considerable amount of material is cut from the circular plate to form the straight-line type.

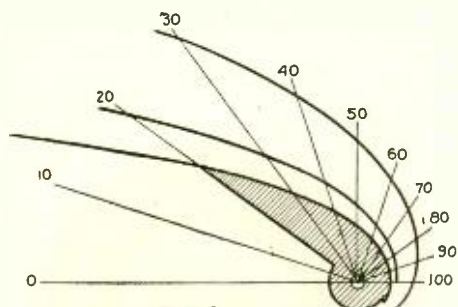

FIG. 9

The straight-line frequency plates are taken from the mathematical curves, as shown.

or musical sounds requires a frequency band of at least 10 kilocycles to prevent interference or overlapping, if the assignment were made at equal intervals of wave-length, at the short wave-lengths the frequency separation would not be sufficient, while at the longer wave-lengths it would be more than sufficient. This is the reason why the assignments are made in frequencies.

To show the effect, the corresponding frequency curve has been plotted in Fig. 5. This has been obtained merely by taking the wave-length of points on the curve and dividing this into 300,000 to obtain the corresponding frequency. In other words,

$$f = \frac{300,000}{\lambda}$$

in which f is the frequency in kilocycles and λ is the wave-length in meters. It will be noted that although there is still crowding at the low dial settings with this type of condenser, the crowding is not as bad as it is with the circular plate condenser. See Fig. 6.

In Fig. 6 the frequency calibrations of the three types of condenser have been plotted together for the sake of comparison. The straight-line frequency condenser in Fig. 6 has been assumed to have the same

The stator and rotor of the condenser pictured on the preceding page are here shown separately.

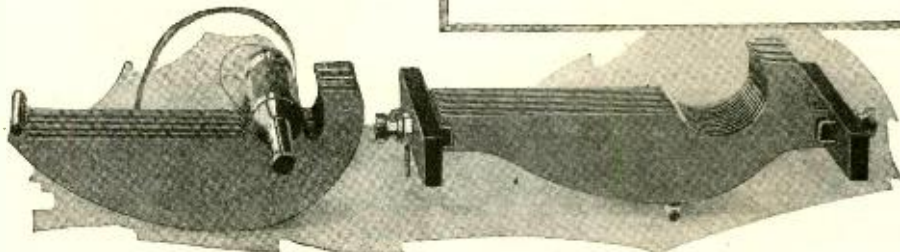

It will be noted that the straight-line frequency curve increases as the dial setting becomes lower. This is in accordance with our statements above to the effect that when the plates of this condenser are entirely *out of mesh* and the capacity is least, the frequency is highest.

To be able to visualize more easily the difficulties which attend the design of the straight-line frequency condenser, we have reversed the reading of the latter and have made it read in the same direction as the others. The dial readings are shown at the top of Fig. 7. We have then re-plotted the

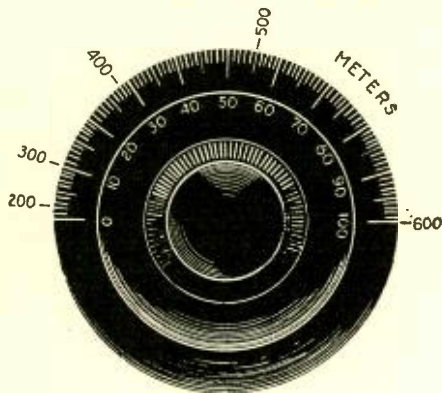

Wave-length distribution of the circular plate condenser.

curve, giving us the broken line curve of Fig. 7.

It will be noted that below about 70 on the dial, the ratio of capacity of the condenser at any setting to the capacity at 10 on the dial is much less than either the straight-line capacity or straight-line wavelength types. This means that the plates at the low dial settings (remember, we have temporarily reversed the dial) must be cut away considerably. After about 70 on the dial, however, the capacity must increase at an enormous rate. This is shown by the steepness of the curve, and the abruptness with which it turns upward. This is what

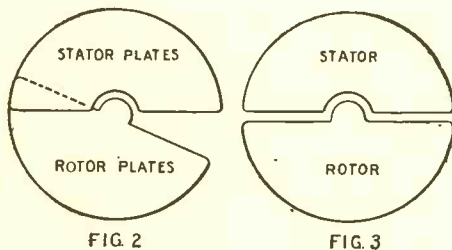

In a circular condenser the plates are not fully in mesh until about 10 on the dial.

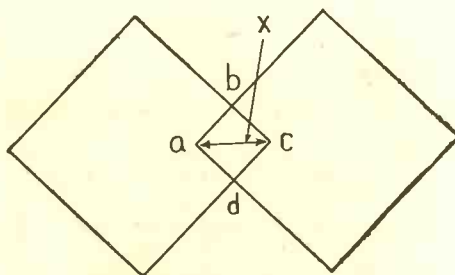

FIG. 8(a)

Rectangular plate straight-line wave-length condenser.

makes it a difficult matter to construct straight-line frequency condensers so as to have the usual capacities and yet not to

occupy too much space in the radio receiver. This will be brought out more clearly as we proceed.

Everyone is familiar with the circular shape of the straight-line capacity plates. These are shown in Figs. 2 and 3. The shape of the plates of the straight-line wave-length condenser is shown in Fig. 8. This, as is the shape of the plates of the straight-line frequency condenser, is a mathematical curve, the equation for which is

$$r = \sqrt{4aD}$$

in which r is the radius, or the distance of the plate edge from the center, D is the dial setting, and a is a constant, which depends on the units we use in making the computations. This is just the simple plate shape, without considering the cut-out section where the rotor shaft passes through. If this is taken into account, the formula becomes

$$r = \sqrt{4aD + r_2^2}$$

where r_2 is the radius of the cut-out.

To consider one of the practical problems that arise in designing these straight-line wave-length condensers, suppose we take a circular plate as in the ordinary condenser, and cut out the straight-line shape from

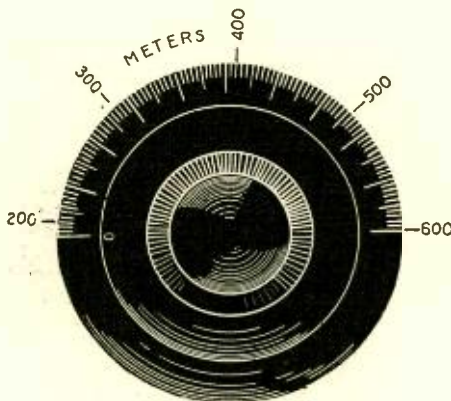

Wave-length distribution of straight-line wave-length condenser.

it. We have to keep the maximum radius the same, or else we should have to build our condenser larger. This also means that the plates will be mounted eccentrically.

The amount that it is necessary to cut out of the circular plate is indicated in Fig. 8 where the circular plate has been sketched in. Obviously, it will require a greater number of plates in the straight-line condenser to give the same capacity as we have in the circular condenser, assuming that we keep the same spacing between the plates. Otherwise, we shall have to be satisfied with condensers of smaller capacity.

The straight-line wave-length law also applies to condensers of square plates, as shown in Fig 8 (a). The overlapping area of the plates, and hence the capacity of the condenser, is proportional to the square of the distance x , through which the movable plates are moved. This follows from the geometric law that the area of a square (abcd) is proportional to the square of the diagonal (x).

The same situation is true of the straight-line frequency condenser. The formula for the shape of the plates is

$$r = \sqrt{\frac{4a}{D}}$$

if we neglect the cut-out section. If we take this into consideration, the formula becomes

$$r = \sqrt{\frac{4a}{D} + r_2^2}$$

where r_2 is the cut-out radius. This formula is very interesting for several reasons.

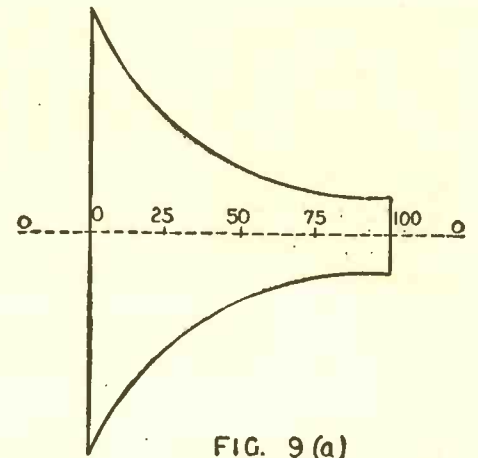
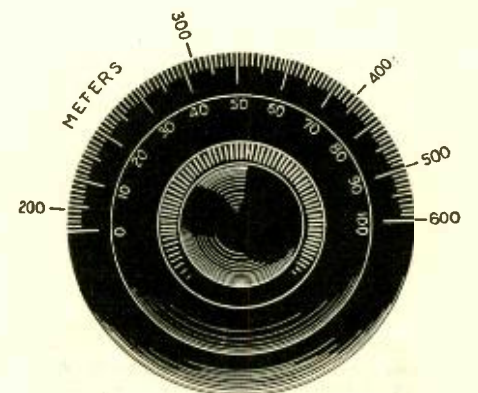

FIG. 9(a)

Sliding-plate straight-line frequency condenser.

Suppose we give a certain value to r_2 , the cut-out radius, say $\frac{3}{8}$ of an inch, and then try to calculate the radius. We shall have to start calculating from 100 on the dial, because, as we have said before, when we use zero for the dial setting, we get an indeterminate number. Furthermore, as we decrease the dial setting D , the value of r , the radius, will increase indefinitely; in fact, it increases enormously, and we never get back to the zero dial setting. This has been indicated in the curves of Fig. 9, which the writer has calculated.

In all these curves a cut-out radius of $\frac{3}{8}$ of an inch has been assumed, and three different radii have been assumed at 100 on the dial, *viz.*, $\frac{3}{4}$, $\frac{1}{2}$, $\frac{1}{8}$ of an inch. The difficulties attending the design of straight-line frequency condensers are instantly apparent. We can obtain a straight-line shape



Wave-length distribution of straight-line frequency condenser.

easily enough by using any portion of these curves that we fancy, as is illustrated by the heavy lines drawn in Fig. 9. But the trouble is that if we wish to keep the radius of the plates within the usual limits, we shall have to use a great many plates. For instance, in the plate shape shown in Fig. 9, the maximum radius of $2\frac{1}{2}$ inches, which would make a pretty large condenser, and yet the area of the plate is only about one-half the area of a semi-circular plate $1\frac{1}{2}$ inches in radius.

However, if we wanted to use this plate, we could do so, and it would give us a straight-line frequency curve if we had the necessary minimum capacity. We should, however, have to squeeze in our dial calibration, so that, instead of reading from 100 to 20 on the dial, as indicated in Fig. 9, the complete rotation of the plate will be from 100 to zero on the dial. This will

(Continued on page 208)



The Radio Beginner

What Instruments Should I Buy?

By A. P. PECK

NOW that summer time is fully upon us and radio reception is not as good as one might wish it to be, other things have somewhat replaced radio in our daily activities. This time of the year, however, is the one in which he who is mechanically inclined and interested in radio should begin to think about the fine days and nights of reception that will soon be with us with the coming of the cooler days and nights less shot with static. If we make our plans now for the building of a set of some new type for next fall, we shall then get a start on the radio season and shall be able to use our new set to its greatest advantage as soon as the better reception weather starts in. Possibly some of us have an idea safely tucked away in some corner of that particular part of our brain which houses our radio thoughts, said idea taking the form of some new type of radio set which we wish to construct. Now is the time to make plans for that set and start the construction of it. You can do the work at your leisure and not be rushed with the thought that the set must be finished at once and placed into immediate operation. You can, therefore, take time to carefully consider the purchase of the various parts to be used in the set and arrange the mechanical layout in the best possible manner.

THE ANTENNA SYSTEM

In connection with this line of work, let us start at the beginning of the set and work on through. In this way we can cover everything from aerial to phones. The antenna system, as the aerial and ground combined are known, will receive first attention. Pos-

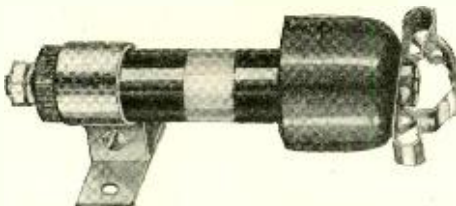

Fig. 1. This type of lightning protector, in which there is no switch, is an excellent arrangement because it eliminates the human element.

sibly your aerial has by this time become corroded or the joints may be bad. This is not a desirable condition, as it interferes with good reception. If the wire is weak, replace it with new material. If the wire seems to be still in good condition, the joints can be resoldered. If new wire is installed, it may be advisable to use enameled copper wire. Many authorities on radio reception claim that this wire is best for aerials. In any event, however, the joints should be perfect in order to insure the best results.

The lightning protective device is the next item to be considered. This may take the form of either a lightning arrester, such as shown in Fig. 1, or a large single-pole, double-throw switch. The former is to be recommended and some type approved by the

Board of Underwriters should be installed. A switch is sometimes considered to be somewhat better protection, but then we have to consider the fallibility of the human element. Often the switch is left open just at a time when it should be closed. This can never happen with a lightning arrester. The device is always in the circuit and always ready for operation.

Ground clamps of the cheap variety are to be shunned. The best of devices of this nature are not costly and a few pennies saved here are nothing gained. Obtain a clamp that will give a good firm grip on the pipe and which, at the same time, will hold the ground wire solidly in contact. There are

Fig. 4. When buying a condenser having this type of insulation, apply the test for "mud" insulation, as described below.

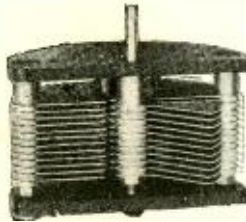

so many of these devices on the market that no further details will be necessary. Only be sure that the one you purchase is made entirely of copper or brass. Thin sheet iron is poor, as it will inevitably rust and result in a poor connection.

The insulation of the antenna system should also be considered in buying new radio parts. The insulators at the ends of the antenna wires or wire, as the case may be, should be of as good a type as you can consistently afford. In the cheaper grades of insulators, glazed porcelain are the best. Do not allow yourself to be inveigled into the purchase of unglazed or porous insulators. Devices of this type are almost worse than no insulators at all. If you cannot get glazed porcelain, obtain an 18-inch length of 1-inch square, dry hard-wood and thoroughly boil it in paraffin. This, however, is to be used only in case suitable cheap insulators cannot be obtained. In the higher-priced insulators, probably the type that should be considered as the best, is that made of glass. Good, strong, glass insulators are just about the best you can possibly put into your aerial and if you employ them, you need not worry further.

COILS

Coils, or inductances, as they are sometimes termed, are to be found in every existing type of radio set. These take many forms, but in the sets in use today, there are only a few types which may as yet be seriously considered. Under the heading of coils come various instruments, such as radio frequency transformers and couplers or variocouplers. The usual type of radio frequency transformer looks somewhat like the primary of a variocoupler or three-circuit tuner. A standard type of the latter is illustrated in Fig. 2. Other radio frequency transformers take the form of audio fre-

quency types only. All of them are good, but in the type first mentioned the most important point to watch is the insulation. If the coils comprising the transformer are wound on a solid tube, this tube should have very thin walls. The wire should be of a medium size and should be well insulated. However, skeleton forms for supporting the windings are somewhat superior to solid forms. One type is, as mentioned above, the same as the primary or the three-circuit tuner shown in Fig. 2. Glass rods set in holes in two bakelite rings support the windings. Thus, good insulation is provided and at the same time there is little dielectric or insulating material, which causes a deleterious effect, near the coil. These radio frequency transformers which we are now discussing are to be used in connection with a variable condenser across the larger winding. This forms a circuit which is known as a tuned, radio frequency, amplifying circuit and gives very sharp tuning results. Other types of transformers which do not require variable condensers enable the constructor to build smaller and more compact sets, but care must be exercised in the selection of these transformers. Be sure that the manufacturer guarantees the instruments to cover the complete band of wave-lengths occupied by broadcast stations. Many of the cheaper, fixed radio frequency transformers, as these types are called, will work only over a comparatively small band of wave-lengths and a set constructed with them will give very inferior results. With a combination of this nature only certain broadcasting stations can be received with any degree of satisfaction. This type of transformer is rather passé now, as it was developed when all broadcasting stations were on nearly the same wave-lengths. With the band spread out from approximately 200 to 550 meters, better designed transformers become necessary and the tuned, radio frequency transformers are to be recommended above all. They make a more flexible receiving set, which will give the builder much greater satisfaction.

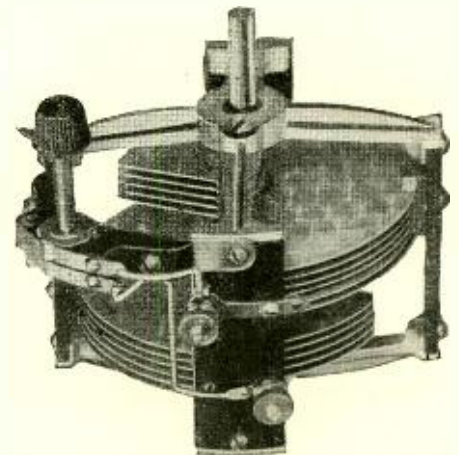

Fig. 3. Strips of hard rubber are used as insulation between the two sets of plates, reducing resistance as much as possible.

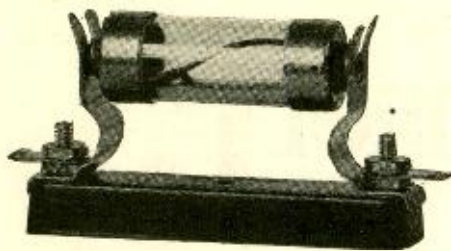

Fig. 5. A new type of grid leak that depends for the variation of its resistance on the bent wire immersed in a liquid.

We now come to the subject of three-circuit couplers. Several years ago, the variocoupler was the recognized tuning instrument, but this has lately been replaced by the so-called three-circuit tuner. This device is not unlike the old variocoupler in appearance, but instead of having but two windings, one on the stator and the other on the rotor, it is equipped with three—two on the stator and the usual rotor winding. In using a coupler of this type in the circuit recommended by the manufacturer, much greater selectivity is obtained than was possible with the old type of two-winding variocouplers and, furthermore, a set using the new type in a feed-back circuit does not tend to radiate nor cause interference with nearby receiving stations. Thus, the congestion of the air, which is a serious problem today, is avoided. Many other couplers of a similar nature are made today and the remarks above pertaining to tuned radio frequency transformers apply to these couplers. There is one other type of coupler that is worthy of mention. This consists of a skeleton framework supporting a basket-wound, cylindrical coil which comprises the secondary of the coupler. Over the skeleton frame and the secondary is wound a six-turn coil of silver-plated wire. This coil is used as the primary. This instrument is also provided with a flat, pancake type of rotor, wound in a novel type of basket-weave coil.

CONDENSERS

Of late, the low-loss craze in condensers has assumed tremendous proportions. Just what constitutes a low-loss condenser is a mooted question among many of those well versed in radio theory and practice. At one time it was said that a bakelite end-plate condenser was not satisfactory and was causing great losses in receiving sets. This led to a rush on the part of the buying public to those condensers employing metal end-plates. The result was that in some cases slightly better results were obtained, but often the change was for the worse, inasmuch as the influence of a poorly designed metal end-plate condenser on a circuit is far worse than the effect of any instrument with

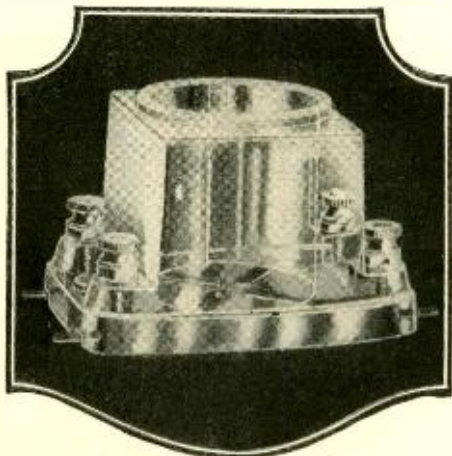

Fig. 7. This tube socket of moulded glass eliminates any difficulties that might arise from "mud" insulation.

bakelite plates could ever be. The manufacturers soon realized this and have settled down to more or less standardized types of condensers. Some use well designed metal end-plates or spiders, such as shown in Fig. 3, whereas others use solid insulating plates, as in Fig. 4. The one thing to watch in any condenser is the insulation between the rotary and stationary plates. Bakelite or hard rubber are both good. In the condenser shown in Fig. 3, the strips separating the end spiders are composed of hard rubber and the insulation in this condenser is just about as perfect as can be desired. In the condenser shown in Fig. 4, the plates supporting the rotary section are themselves of an insulating nature. Bakelite or hard rubber are both good here. The thing to watch in the purchase of a condenser, if you contemplate buying one with solid end-plates, is that you do not get stuck with what is known as "mud" insulation. A very simple and quite conclusive test for this material is to hold the condenser in your hand and, pressing rather firmly on a corner of the insulating plate, draw that corner across a sheet of paper or cardboard. "Mud" insulation will immediately make itself apparent by virtue of the fact that it will leave a smudged mark on the clean surface. Bakelite and hard rubber will merely make an indentation in the surface, but will leave no trace which indicates that some of the material has been rubbed off

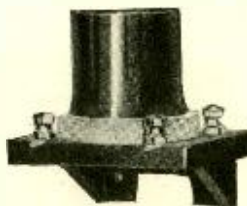

Fig. 8. A sponge rubber cushion is built in this type of socket to absorb any shocks that might reach the tube elements and cause annoying noises.

in the process. You can safely depend upon condensers with solid end-plates as these plates are not of "mud," contrary to the loudly expressed opinions of many experts.

The writer holds no brief for any condenser manufacturer and is not trying to knock so-called low-loss condensers. Many of them are excellent in construction. Only let us reiterate that you should avoid all insulation in condensers which is not either bakelite, celeron, radion, glass or glazed porcelain. One or two condensers have recently appeared on the market using the two latter mentioned substances for insulation. The average constructor will probably not notice any difference in a set when it contains condensers insulated by any one of the above mentioned materials.

FIXED CONDENSERS

One important part of a radio receiving set that is usually neglected in construction is the fixed condenser. There are usually one or more of these little instruments in every set. When you go to buy the particular capacities that are designated by the article which you are following in the construction of your set, do not be content to pay only a few cents for some unknown type of condenser that is insulated with paraffin paper. Rather spend a little more money and purchase good condensers—you will be repaid in the end. Fixed condensers can cause more trouble in a set and that trouble is harder to find than anything else. Buy a reputable make of condenser which is provided with mica insulation. The condenser should be well pressed together and it should be impossible to notice any compression between the sides of the condenser when it is pressed between the fingers. If the condenser gives slightly when you apply this test, it shows that the capacity also changes slightly and a condenser of this nature will never give satisfactory results.

Those instruments sealed between heavy sheets of insulating material, those molded in a composition case and those enclosed by a compressed brass tube are perfectly safe to use and are about the best that you can buy. Select one or the other of this type and you can rest assured that any trouble you may find with your set will probably not be located in the condensers. All the above remarks apply to grid and by-pass condensers located anywhere in the ordinary receiving set.

GRID LEAKS

Another source of great trouble to radio constructors is the grid leak in the detector circuit. Here again the purchaser should be most careful in choosing this little unit. It is inexpensive in any of its forms, but just the same it requires a good deal of consid-

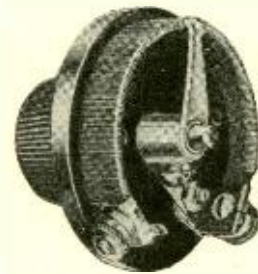

Fig. 10. Only the best of insulating materials should be used in this type of rheostat, as others might tend to soften when heated and cause uneven operation.

eration. Most of the very cheap grid leaks are turned out in rapid production and suffer accordingly. The writer has tested many leaks of the same make which were marked with various resistances from 1/2 to 5 megohms. Most of them had a resistance of about 3 megohms. Thus, it is shown that you cannot always go by the markings on the cheapest of these instruments. Well known and widely advertised leaks are very reliable and you need not hesitate to purchase them. Several variable leaks are on the market today, but many of them have their drawbacks. Those that use a contact scraping along a resistance surface soon scrape that resistance away and cause a change in the maximum and minimum range of the instrument. However, those variable grid leaks which depend upon the compression and release of carbon or graphite or a similar conducting material are usually very satisfactory. A grid condenser that will fit across the leak terminals, as shown in Fig. 6, may be purchased with this leak. Thus two units are combined. Here two piles of small graphite disks are compressed or released according to the direction in which the control knob is turned. Therefore, the resistance of the instrument is, of course, changed in a like proportion. Using a leak of this nature in any radio receiving set enables the

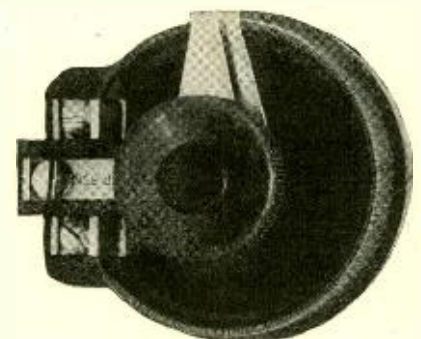

Fig. 11. In choosing a potentiometer the same precautions should be observed as in buying a rheostat.

operator to determine exactly what resistance the particular detector tube in use requires. After this position is once located, it is not necessary to change the resistance of the leak again until the detector tube is changed. Therefore, an instrument of this nature is a valuable asset to any receiver.

Another very good type of leak which has recently appeared on the market and which appears to have promising qualities is illustrated in Fig. 5. Here a small quantity of high resistance conducting liquid is sealed in a glass tube and a peculiarly shaped wire is suspended between one metal end and an insulating ring. This wire is so shaped that, as the small cylinder is turned, more or less of the wire dips into the solution and the amount of solution in the circuit is thereby changed. Of course, this effects a change in resistance and, as mentioned above, the leak can be set at the best value for the detector tube.

TUBES

The same may be said of tubes as in connection with batteries. They are so standardized that there is little, if any, choice. So-called "bootleg" or "independent" tubes are very often satisfactory in operation, but cannot always be relied upon. In any event, the purchase of almost any tube, even of standard manufacture, is somewhat of a gamble and you should see to it that your dealer really tests your purchase, preferably in a radio receiving set that is actually in operation. Do not be satisfied only to see that the filament lights. Frequently tubes in which the filament will light absolutely refuse to operate. *Hear* your tube in operation before you purchase it.

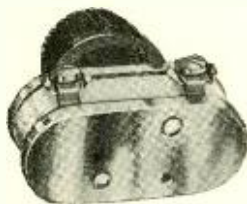
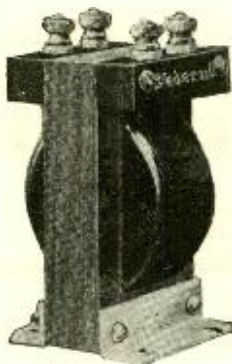

Fig. 9. A type of rheostat that allows an infinitely fine adjustment of the filament currents.

The receptacles which hold the tubes, or sockets as they are usually called, should be quite carefully selected. A "mud" insulated socket may cause considerable trouble in a set. Often under the influence of the heat of the tube, sockets made up of this material melt somewhat and close around the base of the tube so that it sometimes becomes impossible to remove it. Sometimes the softening of a socket of this nature acts in the opposite direction. The socket swells outward and the tube will not be held in firm contact with the prongs. Therefore, purchase sockets made either of molded bakelite and so stamped, or made with a bakelite ring at the base and a metal shell. "Mud," to which we have referred several times in this article, is an inferior insulating compound made to imitate bakelite in appearance. It is usually composed of some resinous material which melts at a very low temperature. Tar is also present in some of these compositions.

A third good type of socket is made of molded glass, into which are set the four springs which make contact with the prongs on the base of the tubes. Such a socket is illustrated in Fig. 7. Another point to watch in the purchase of a socket is that the springs or flat metal strips in the base really deserve the name of "springs." They should be of material which will allow itself to be bent into some position other than the original, but which upon release will return to the original form. In this way we are assured that the springs will always make contact with the four little prongs on the base of the tube. Lately many types of freak contacts in sockets have been placed on the market. A few seconds' study of them will satisfy the purchaser as to whether or not the prongs make good contact. This is their purpose in life and is the only thing that really counts in their construction. Another excellent all-around type of socket is illustrated in Fig. 8. This socket is provided with a cushion which absorbs vibrations or shocks and prevents them from reaching the filaments of the tubes. Thus, the annoying sounds often heard in the loud speaker or



A good, standard type of audio frequency transformer is shown at the left.

phones when a set is jarred are greatly reduced and usually eliminated. This is an important feature.

Summarizing sockets, let us say that you should make sure that the shell itself is of good bakelite or metal, that the springs make good contact and are well insulated.

RHEOSTATS

Since all vacuum tubes are slightly different in characteristics and require a rather critical control of the filament current which is supplied by the "A" battery, rheostats or controlling devices are necessary. Several fixed instruments of this nature are for sale and are quite satisfactory in amplifiers. However, in detector circuits, a continuously adjustable resistance is quite necessary and, in fact, almost indispensable. One of the smoothest rheostats that is for sale today is shown in Fig. 9. This instrument operates on a principle similar to the variable grid leak shown in Fig. 6, and allows absolutely smooth and stepless control of the current. Of course, other rheostats are also good and one of the finest types of wire-wound rheostats is shown in Fig. 10. Here a length of resistance wire is wound on a segment and an arm traveling over the surface of the wire throws resistance into or out of the circuit, thereby controlling the filament current. In purchasing a wire-wound rheostat, if you do not desire the compression type shown in Fig. 9, see to it that the wire is smoothly and evenly wound on the segment and that the arm makes firm contact all the way around. See that the arm is quite springy in action so that it will always keep this firm contact. Also see that the base of the instrument is not of mud as this material will, as mentioned above, soften under heat and possibly allow the resistance coil to get out of alignment, whereupon the consequent operation will be rendered rough or impossible.

An instrument which greatly resembles a rheostat in construction and operation, but which has a much higher electrical resistance and which acts in a different manner in a set is the potentiometer, frequently used in radio frequency circuits for controlling the grids of the tubes. Such an instrument is illustrated in Fig. 11. Potentiometers using the carbon compression principle may also be purchased. The type shown in Fig. 11 consists of fine, high-resistance wire, wound on a segment as in the case of a rheostat and controlled by an arm. In selecting one of these instruments, observe the precautions mentioned for rheostats.

AUDIO FREQUENCY TRANSFORMERS

When purchasing an audio frequency transformer, as in the case of any other instrument, select a standard, widely advertised make. Transformers which are large physically are usually good and can be trusted. Such dimensions show that the wire comprising the coils is of a comparatively large size and that the core is generous. All these features affect the operation of the transformers and an instrument such as that described would generally give good amplification with little distortion. Avoid transformers in which the cores are loose or composed of heavy laminations or strips of

steel. Such points denote poor workmanship in manufacture and always tend to cause suspicion. If the leads or wires from the coils to the binding posts are exposed, see that they are of a substantial nature and cannot be easily damaged. However, if the entire transformer is enclosed in a case, you can usually depend upon the connections being solid and mechanically correct.

Jacks and switches which are used in various amplifiers and other parts of sets to change from one circuit to another, or from one part of a certain circuit to another part, require attention. In purchasing, avoid fibre insulation between the springs of jacks. Hard rubber strips are far superior and should be looked upon with favor. Also be sure that the flat strips in the jack or switch, as the case may be, are springy and capable of retaining their position. In the case of jacks, also make sure that the contact points are of a generous size and long enough to make perfect contact with each other. Thus, and thus only, can the correct operation be obtained. Switch bases should be of hard rubber or porcelain and, in any event, the contact between the moving and stationary parts of the switch should be perfect. Where two metals rub firmly against each other, you can usually be sure that the contact is as nearly perfect as it is possible to get.

Phones and loud speakers may be selected at the dealers. Decide upon the price that you wish to pay for either of these two



Fig. 6. A carbon pile grid leak of this nature allows the adjustment of the resistance to be made to a very fine degree.

units and ask the dealer to give you a demonstration of all of those which he has in stock and which are within your price limit. Notice the quality of tone delivered as well as the volume, and make your own selection. Phones or loud speakers which deliver very good quality should be shown preference to those which deliver volume but little quality. Your own judgment can aid you further along this line than hundreds of written words.

The panel and sub-panels, or binding post strips, are a vital part in the construction of a set. A poor panel will cause an otherwise well constructed set to give inferior results. Bakelite, celeron and radion are always reliable for use in this connection. Compositions employing fibre or pressed paper and cardboard should be avoided. They change their electrical characteristics under the influence of weather and, therefore, are not reliable.

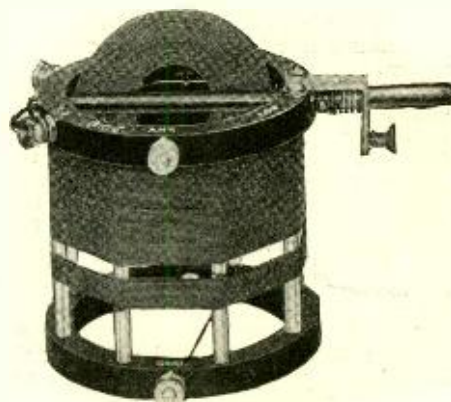

Fig. 2. Coils wound on a frame like the above, which has hard rubber rings in which are embedded glass rods, are excellent if the wire is not too fine.



The Army and The Navy Forever

By JAY HOLLANDER

WITH the summer military training camp season again full upon us, there arises the ever important question: Why do not more of the hams give a little co-operation to the tops and pettys in O. D. and blue? It's hard to argue the question in peace time, since most of the hams have had enough actual experience with the military to avoid it as they would the inevitable cooties it usually brings in its train.

But the main point, the text of this particular sermon, is that it would redound to the good of the fraternity in the end, as well as give our old Uncle of the income tax and the rum row chasers a bit more security in event of a riot like the late unpleasantness near the Marne.

Now that the broadcasters have decided

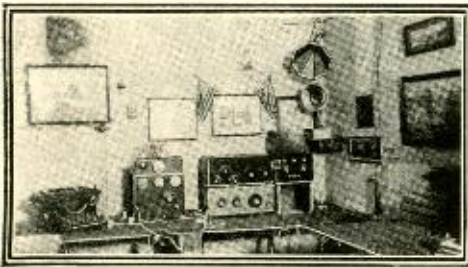

2LA, The New York station of Robert L. Fischer, rated at 10 watts.

to do their stuff a little lower in the scale, it is inevitable, like the flowers that bloom in the spring, that sooner or later, the hams are going to be pushed down the very last notch in the available frequencies. And when this is done, we suppose it will be up to 1XAM to show us how to work at negative frequencies or else use the heat waves generated by the old faithful in the basement as a carrier.

But these hard times are a few years off at least. So while there are still a few bright and shining hours, why not prepare a scheme which will work as a sort of automatic lobby with the gents who pass the amendments that take our liberties and our money?

Not that these bozos are not perfectly honest and working for the good of the country; in fact, quite the contrary. The point is that they must be convinced that amateur radio is for the good of the country. Ergo, the second fact follows. From time immemorial—about a couple of decades ago, when big business discovered that it needed a good bit of representation in Washington—it has been the custom of Congressmen and Senators to let the various lobbies do their thinking for them.

This may be a very good plan, and the hams have a nice lobby all fixed up and greased—oscillating, so to speak—for them if they but take advantage of it. We speak, brethren, of the Army and the Navy.

Just the other day, one of these gents who gets a weekly pay check from the Sig-

nal Corps approached us with the cork out and inquired if we wanted a good vacation with all expenses paid. We knew instinctively that there was a catch in it somewhere and so set about finding the red herring. It happened that this halt-march feller wanted us to sign up with the military as a reserve something or other and take our hard-earned two weeks at a training camp.

Now, the cork was out, but the smell was decidedly not reassuring, so we decided to talk philosophy instead of business. The sergeant feller was impressed with the situation of the broadcasters going down and, being a good ham himself, had a few misgivings as to the result in the end. He repeated our idea that the old furnace would have to do its stuff as an oscillator if the boys found it as profitable to bunk the ether with bad sopranos in 1935 as they do in the present *anno domini*.

But he was a back-slapping go-getter before he became a back-stepping go-and-get-it. He had a scheme whereby the silk hats under the golden dome could be convinced, once and for all, of the value of ham radio.

This is the lay: The Army and Navy will be absolutely dependent upon radio in the next fight, if any. Things have come to such a pass in the business of killing the other fellow in wholesale lots that it is impossible to carry on a respectable trade in blood and iron if there is not a company of radio men for every four companies of anything else.

The second point in this syllogism is that you can make a top kick (provided the material is hard-boiled in the first place) in a couple of weeks. But when it comes to reading the da-ditditdit, it takes several months and a little gray matter to start with.

Therefore, if the Army and the Navy have a whole flock of well-trained men upon whom they can call at a moment's notice, it means that they will be able to organize an effective resistance at a moment's no-

tice. . . . Gee! Ain't we important! Hot dog!

Now the point is this: If the Army and the Navy are dependent upon the hams and have them on the list in some form or other, these boys are not going to stand for the mere silk hats mistreating them in favor of a few broadcasters. The whole question then resolves itself into one of finding the best method of getting the boys on the list without entailing any extra amount of the beef and beans prepared by K. P.'s. Is it not so?

Now the Sunday school teacher always tells about Daniel in the fiery furnace and then shows you the No Smoking signs. So, therefore, do we point to the fact that the brethren must send in a few letters or something telling how this little problem may be solved. Would it not be possible to enlist the hams under the various branches of the service and then set aside two or three nights a month when strictly military business could be handled by relays? It seems that something of the sort could be arranged.

This would not only be greatly to the benefit of the branches of service involved, but it would be the very best sort of training for the amateurs themselves. Of course, any evening now down around the twenty and forty band, there may be heard any number of messages with the prefix, NRRL, which will easily attest to the help the hams are already rendering the Navy. The trouble is that it is all being done unofficially and therefore no official notice may be taken of it.

If this work could be managed through a reserve branch of the service, mention of it would be made in all the reports made, and finally the Congressmen and Senators—the gents of the silkers—would become so accustomed to it that they would gradually come to believe that an organization carry-

Mr. H. C. Colburn is an ambitious amateur. On 6XBY and 6UR with 50 watts he does amateur work. On KFUU he is a broadcaster. He's an old-timer—see below. This station is at San Leandro, Calif.

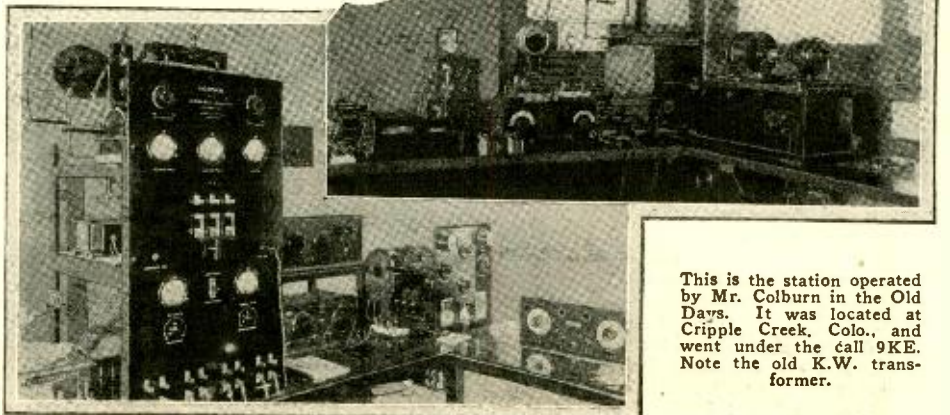

This is the station operated by Mr. Colburn in the Old Days. It was located at Cripple Creek, Colo., and went under the call 9KE. Note the old K.W. transmitter.

ing on so much good work must necessarily be protected. This is simply a subtle form of propaganda, but it is one, I trow, which will work with the greatest efficiency.

Further, if the men of blood and steel habitually fall back on the work of the hams, they will sooner or later begin considering them a part and parcel of the service and so give them the greatest possible consideration when they begin their yearly campaign for appropriations, etc.

This is as it should be, since a great deal of the new practices in the art which have proved so profitable to the commercial and military are primarily the work of the great and glorious Fraternity of Brass-Pounders. Why not make all their work semi-official, thereby also giving them much in added facilities for more quickly bringing the promising ideas to practicable use?

The greatest drawback to the whole scheme is, of course, that no logical plan has been worked out whereby the amateur may retain his liberty—that is, freedom from the military life—and at the same time be a member of some reserve organization. The writer has it on good authority that those in charge of the Signal Corps division will welcome suggestions as to how this great army of men may be brought effectively into service. Why do not some of the bright boys do their stuff in originating a plan which would be workable?

And just remember, as a parting shot, that one of the best ways to insure the future of the ham and at the same time one of the best methods of improving his present status and obtaining for him a wider flexibility in his chosen field, is to get the authorities actually and officially behind him. Selah.

HAMS PLEASE NOTE

The operators aboard the U.S.S. Pillsbury, destroyer, division 43 with the Asiatic Fleet, have a ten-watt transmitter under the call NUQG. They are now stationed in Amoy, China, and are anxious to establish communication with amateurs in the U. S. Word comes from them that many U stations would like, if possible, to establish a two-way contact. Address all communications to O. T. Cooper, U.S.S. Pillsbury, Asiatic station, care of postmaster, Seattle, Wash.

THE MONTH'S NEW CROP OF QRA's:

8DJX—Frederick Coath, South Ridge West, Ashtabula, Ohio. 5 watts, CW fone. All crds answd.

9SJ—Edward Reid, 325 East 57th St., Chicago, Ill. All reports appreciated and answered.

Station 9CFG at Atwood, Ill., the husky transmitter of E. Dale Nout, which he operates in conjunction with the physics department of the local high school. The old machine has two four-watt perkers and the same thing for modulation.

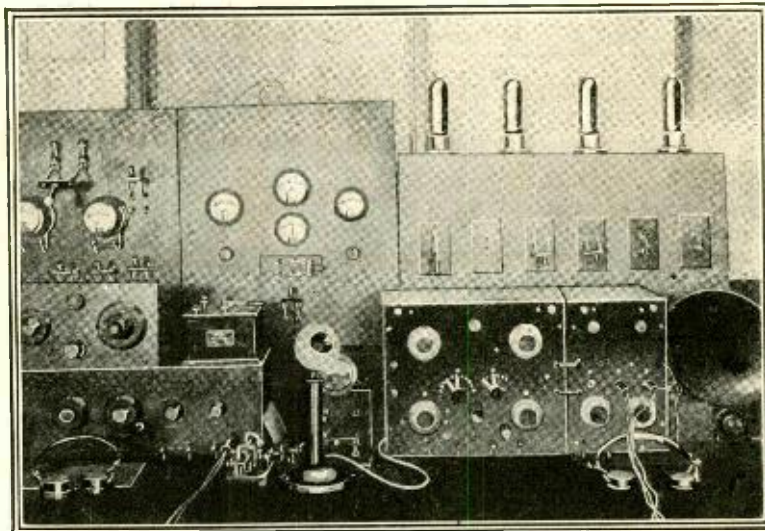

4AAD—J. H. Shaw, 206 Murphy Ave., Atlanta, Ga. 5 watts, CW. All crds answd same day.

Reassigned—9ECA, Leo W. Knaust, Box 343, Granby, Mo. 5 watts, 80 meters and 40 meters. All crds answd. QSL's appreciated.

2LR—G. L. Graveson, 266 46th St., Brooklyn, N. Y. All cards answered promptly.

9BVV—Edward G. Hackstock, 204 First St., Menasha, Wis. Pse QSL a crd. All crds answerd same day.

8CRK—Peter Gramba, 548 Glenwood Ave., Ambridge, Pa. 5 watts, CW and phone. All crds answd.

8DDU—Francis "Ed" Orcutt, 32 Madison Ave., Ashtabula, Ohio. ICW, CW es fone. Pse QSL QRK? mi sigs on 80 es 176λ.

8COZ—George W. F. Brendel, Box 46, Fennville, Mich. 5 watts, CW es fone. All cards recd here are QSL'ed.

8AJL—Howard Hull, Box 244, Fennville, Mich. 5 watts CW es fone. All crds QSL'ed QRK 8AJL?

9EEM—Reassigned to M. F. Ellinger, 228 Prospect St., Menasha, Wis. All crds answered.

1RG—Ernesto Montu, Bellagio, Lake Como, Italy. Hartly 100 watts. Transmit

on Sunday, G.M.T. 1400 on 10 meters, 1500 on 20 meters and 700 and 600 on 45 meters.

CALLS HEARD

W. F. B. SHAW, ENGLAND
AMERICAN: 1aaw, 1abf, 1af, 1aou, 1aqq, 1axn, 1axt, 1azr, 1bdx, 1bhm, 1bb, 1bzf, 1ckp, 1cri, 1cx, 1eb, 1ef, 1lw, 1pl, 1py, 1vj, 1xz, 1zt, 2ag, 2blm, 2bm, 2brc, 2by, 2chk, 2cjb, 2cuk, 2cpd, 2cvj, 2cxw, 1eq, 2gk, 2ld, 2wb, 2xi, 2xk, 3bkl, 3bta, 3chg, 3cjn, 3cmr, 3hg, 3hj, 3oq, 4fm, 4tj, 4ut, 4xe, 4xx, 8adg.

CANADIAN: 1ar, 1eb, 1ed.
 Hrd. on one tube. Will QSL all crds.

C. KOERNER, 2CEP, 20 MURRAY PLACE, STAPLETON, N. Y. C., U. S. A.
 g-(2cc), (2jf), qra?, 2ki, 2kg, 2kw, (2lz), 2nb, 2nm, 2od, 2sz, 5pz, 5rz, (5sz), 6gh, (6nf), f-8ab, 8ct, n-oba, oll, d-7ec, i-1mt, q-2lc, m-1aa, naval-neg, nekz, nerl, nkl, nrg.
 QRK mi ten watts? All crds welcum es QSL ed.

ALEXANDER D. MACPHERSON, JR., BOYD ROAD, NUNDAH, QUEENSLAND, AUSTRALIA
U. S. A.: 2acp, 2bgi, 5lr, 5ok, 5ox, 5ux, 6apt, 6weaf, 6cso, 6jy, 6agw, 6css, 6ut, 6vt, 6chs, 7czy, 7gq, 7iw, 7gq, 8cbp, 9bcw, 9rw, kel, kgo.
CANADA: 5ba.

8BRB, APOLLO, PA. Single Tube—40 Meters
 1afn, 1ajg, 1arc, 1arh, 1asa, 1aum, 1aww, 1axa, 1blp, 1bs, 1bv1, 1ckp, 1cw, 1sl, 1sm, 1ut, 1vd, 4bs, 4cu, 4cv, 4du, 4kb, 4pu, 4sc, 5tm, 5adh, 5agz, 5aih, 5ail, 5ais, 5ajh, 5amw, 5asv, 5atv, 5co, 5gm, 5pv, 5uk, 6aad, 6agk, 6awt, 6bin, 6bgz, 6bh, 6bmp, 6bni, 6cc, 6clp, 6clr, 6cpl, 6ese, 6crp, 6cto, 6dgz, 6im, 6im, 6jp, 6km, 6no, 6ts, 6ut, 6vc, 6vw, 6xap, (62b or 62oc), 7abf, 7ay, 7gb, 7gj, 7mf, 7nt, 7ux, 7rl, 7ya, 7zu, 9xi, 9xn, 9zt, nrll, kjt, wiz.
CANADIAN: 2eq, 5tk.
MEXICO: 1k.
FRANCE: 8ss.
BELGIUM: 3ad.
ENGLAND: 1dj.
 QRK? crd to any above requesting.

CHAS. DRESCHER, 1169 EAST 145TH ST., CLEVELAND, OHIO

U. S.: 1aao, (1afo), (1af), 1agl, 1alw, 1apk, 1asf, (1atq), (1bqi), 1cab, (1cpc), 1oq, 1qe, (2agp), 2aif, (2alc), (2ams), (2bkl), 2by, 2cel, 2clg, (2cnp), 2ctf, 2cqz, 2cul, (2kf), 2sz, (3aal), 3ajd, 3as, (3ash), (3bau), 3bnu, 3bqp, (3cey), 3ckh, 3qi, 3qt, 3rs, (4bk), (4bl), 4gx, (4tw), (4ua), (4uc), 5afb, (5afd), (5afu), 5ajj, 5and, 5aom, (5aqq), (5avn), (5aw), (5bb), (5ek), 5lr, 5ls, (5jv), 5oq, (5ny), (5ms), (5rg), 5se, 5uv, 5xa, 5wy, (6af?), (6awb), (6aww), 6bcp, 6bh, 6bik, (6bip), 6bir, 6bur, 6buw, 6cbb, 6cgw, (6chl), (6crs), 6cto, 6ea, 6eb, 6km, 6of, (6wp), 6wt, (7adm), 7af, 7afo, 7afir, (7ec), (7gr), (7lr), 7ly, 7mp, (7nh), 7us, 7zf, (9abw), 9ach, (9ad), 9aha, (9air), (9ajj), 9aim, (9auc), (9axb), (9abw), (9be), (9bht), 9bmi, 9buk, (9bpy), (9buk), (9bw), 9bwu, (9cfs), 9ckl, (9cjo), (9co), 9col, 9cuo), (9cv), (9cxc), (9deo), 9dly, (9doa), 9dkc, 9dil, 9dvi, 9dwx, (9dwz), 9dxn, 9dyt, 9ees, 9eib, (9elb), (9la), 9mm, 9np, (9pn), (9nv), 9th, 9um, 9zd, 9zw.

CANADIAN: 1ei, 2au, (2be), (3ms), (3ti), 3xi, (3zd), .cr, (5bz), (5ef), (5go), 5hc.
MEXICAN: (1aa), 1af, 1k, 1n, 1x.
ENGLISH: 2mk, 2kx, 2nm, 5ka.
CUBAN: 2mk.
SOUTH AMERICA: wjs.
BELGIAN: 3ad.
UNIDENTIFIED: wycj, hp.
 Would appreciate reports from anyone hearing my signals. Will gladly qsl.

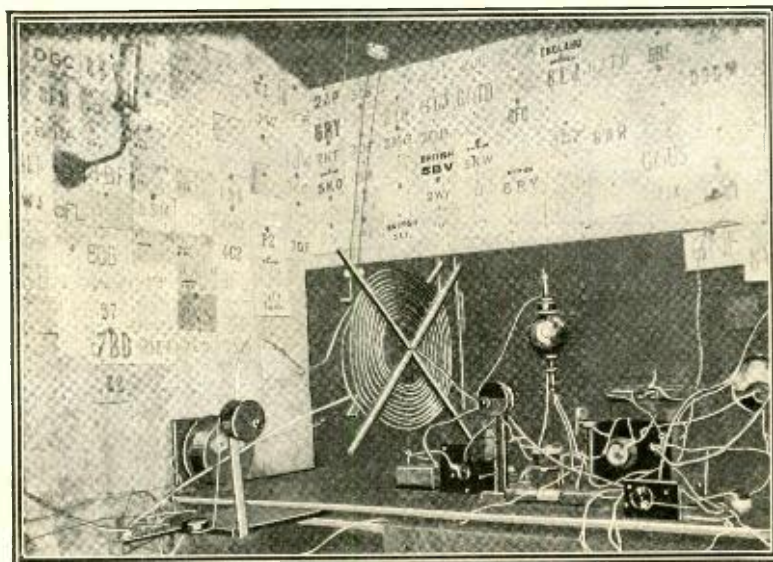

G6NF is one of the English brethren, Alfred D. Gay of 49 Mornlaw Road, London. The transmitter must put its punch into the air since this station has been handling considerable traffic with U. S. since November of last year.

Radio Wrinkles

HOW TO LAY OUT YOUR PANELS

The writer has been somewhat surprised in looking over the many published directions for building various radio sets to note that, while considerable attention is often given to the proper lay-out of the different pieces of apparatus on the panel, and sometimes exact dimensions are given for drilling the holes and placing the instruments, no directions are given as to the best method of transposing these dimensions to the panel in hand or for the care of the panel while the drilling is being done.

Anyone who has tried the old method of clamping or pasting a piece of paper to the face of the panel and drawing the lay-out on this paper before drilling knows how hard it is to do a good job in this manner because the paper tends to become loose if pasted on and is sure to bulge and sag at different spots if clamps are used. In addition to this, the clamps are in the way during the drilling and are likely to slip and throw the holes out of alignment, as well as to mar the highly polished surfaces.

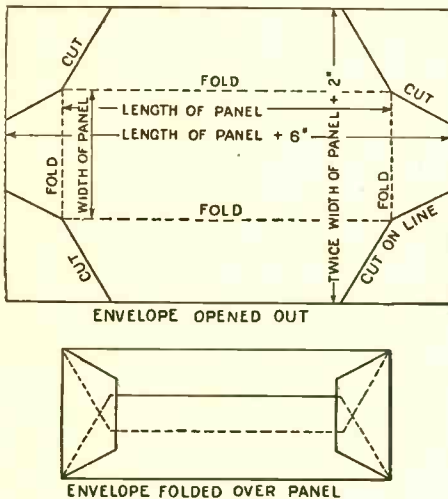

A panel-drilling template that will not slip out of position.

The following method has been used for some time by the writer and has proved highly satisfactory: A piece of tough wrapping paper is secured and cut as shown in the diagram. This paper should be twice the width of the panel plus two inches in one dimension and as long as the panel plus six inches in the other. The corners are then cut out as shown and the edges and ends creased along the dotted lines.

The paper should next be laid out flat on a smooth surface and rubbed evenly with a damp cloth until the entire paper shows damp on the opposite side. The panel should now be placed face down in the center of the paper and the two edges lapped over and glued. The ends should then be folded down and glued over the folded edges, thus forming a closely fitting envelope around the panel.

The covered panel is now placed in the sunshine or close to a warm stove or radiator and allowed to dry. When wet, the paper expands a considerable amount, and being placed over the panel in that condition, it will gradually shrink as it dries and so become stretched as tight as a drum across the panel.

The desired panel lay-out can now be drawn on the smooth side of the paper and the holes to be drilled can be marked and center punched. There is no danger of the paper slipping and the panel is protected on both sides until all machine work has

been done. Then the paper can be torn off and the panel will emerge in perfect condition.

Contributed by H. J. Nethken.

RADIO "B" BATTERY CABINET

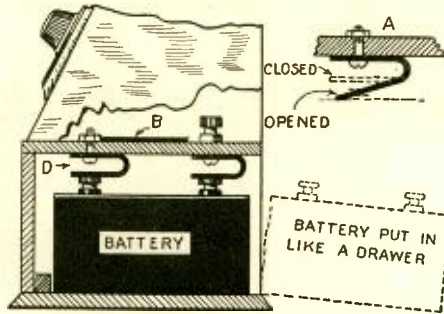

An excellent method for disposing of the "B" batteries.

This novel radio "B" battery cabinet is designed for the set owner who desires neatness and efficiency.

It is constructed to eliminate unsightly wires and makes the removal and replacement of "B" batteries a very simple matter, somewhat similar to the changing of the batteries in a flashlight.

The battery is inserted from the rear and pushed all the way in, contact being made by spring brass clips.

A connection is made for the 22½-volt in the front of the cabinet and is brought to the rear by a brass strip. Connections can be made by bus bar to the set from these posts. The cabinet shown in the sketch is designed to take a 7x18 panel, but a larger one can be made.

The interior measurements for the battery compartments are as follows: Length of each compartment, 8¼ inches; depth, 6½ inches, and height, 4 inches. Spring contacts are 3x1 inch, bent in the center. Perfect connections can be made and the danger of short circuits and improper hooking up of the batteries is entirely eliminated.

Contributed by Joseph J. Dargo, Jr.

A CLOSED CIRCUIT JACK AND PLUG

Nearly every object around the house has more or less use in a radio set and here is a use for the clothes-pin. Procure a clothes-pin of the type that is illustrated in the

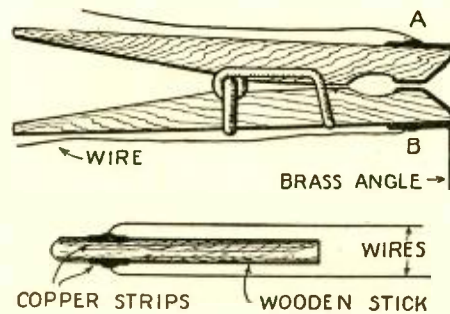

If a jack and plug are needed for an experimental set these are easy to make.

sketch and bend around the ends A and B strips of thin copper for contacts. As the jaws of the pin are normally in a closed position, these contacts will normally be closed. Lead wires are soldered at the points A and B. The plug is made from a wooden rod that fits snugly between the jaws of

the clothes-pin. On this rod are fastened two contacts to which are soldered the phone leads. This jack and plug are easy to construct and should prove of value to the experimenter.

Contributed by Ellis Elder.

VARIABLE RESISTANCE COUPLING

No two sets operate on the same value of resistances when using the resistance-coupled type of audio frequency amplification. The resistances should be adapted to the characteristics of the tubes used, the aging of the tubes, and the changing voltage of the "B" battery.

Variable resistances may be made so as to occupy very little room. Nearly all commercially made variable resistances are so made that it is awkward to mount them. Fig. 1 indicates a room-saving method. Use a base of hard rubber or bakelite 2x1¼x ⅝ inches, which is slit in two places about three-fourths of the length of the block. The resistance element (See diagram) is made by dipping a strip of cardboard in waterproof India ink. The resistances are usually arranged in pairs, one of the resistances making contact with the plate and "B" plus supply, the other making a connection from the grid of the amplifying tube to the filament. Sliders are made from sheet brass and electrically connected to the contacts at one end of the resistances by a soldered flex-

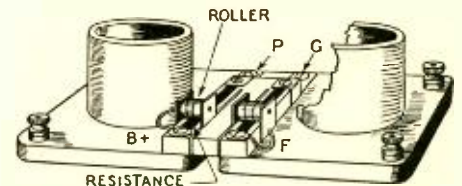

ible wire. Be sure that the flexible wires are well insulated. Roller contacts on the India ink resistance insure that the ink will not be scraped off or injured. These rollers are made by mounting about four of the ordinary spacing washers, from commercial variable condensers, on a ⅝-inch brass bar. Be certain that the pressure of the rollers on the resistance strip is firm and secure.

The figure shows how this unit may be placed between two tube sockets in such a manner as to conserve space, and save wiring all but one lead (to the "B" plus supply). Long binding post bolts are substituted for the short ones usually found in commercial tube sockets, and the variable resistance unit and the fixed condenser are bound to the socket terminals with the same bolts.

Contributed by Adelbert Ford.

CONSTRUCTING A LOOP ANTENNA

The actual construction of a loop antenna, also known as a coil antenna, is a very simple matter. The main difficulty in the problem is to find out what the dimensions of the loop should be and how many turns of wire should be used on it. The question also arises as to what size of wire will be best.

The question as to the wire size will be answered first. It is generally conceded that to obtain the lowest possible resistance in a coil, No. 16 wire should be used. This holds true in the case of a loop also, but it is possible to use larger wire on account of the spacing of the turns. There is little gained by this, however, so that No. 16 wire is probably the best size to use.

STANDARD HOOK-UPS

EVERY month we present here standard hook-ups which the Editors have tried out and which are known to give excellent results. This leaf has perforation marks on the left-hand margin and can be cut from the magazine and kept for further reference. These sheets can also be procured from us at the cost of 5c per sheet to pay for mailing charges.
 RADIO NEWS has also prepared a handsome heavy cardboard binder into which these sheets may be fastened. This binder will be sent to any address, prepaid on receipt of 20c. In time there will be enough sheets to make a good-sized volume containing all important hook-ups. Every year an alphabetical index will be published enumerating and classifying the various hook-ups.

Handy Reference Data for the Experimenter

RESISTANCE AND IMPEDANCE COUPLED RECEIVER

Circuit No. 109. Resistance coupled amplifiers at wave-lengths below 600 meters give rather mediocre results, but if a tuned circuit is used instead of the usual grid leaks, much better results are obtained. Such a circuit is shown in Fig. 109. The resistances should be variable so that they may be adjusted to prevent oscillation of the circuit at any wave-length.

The antenna and secondary coils are wound on a 3-inch bakelite or hard rubber tube. The secondary of 50 turns of No. 24 D.C.C. wire is first wound on the tube and over this is wound the 15 turns that form the primary. The two coils that are in the plate circuits of the radio frequency amplifier tubes are 50 turns of the same size wire wound also on 3-inch tubes. The blocking condensers of .0005 mfd. and .00025 mfd. in the plate circuits of the first two tubes should be tested before being installed, for, if they are shorted, the plate voltage will be introduced into the filament circuit, and the tubes blown out.

There is not shown in the diagram any form of audio frequency amplification, but this is placed after the detector in the conventional manner. Type UV201-A or C301-A tubes should be employed.

a standard type of transformer is installed, as transformers are more or less difficult to construct. The first R.F. transformer, R1, has a primary winding of 33 turns and the secondary has 105 turns, wound with No. 26 wire. The windings are of the "pie" type and the mean diameter is 1 1/4 inches. Two

have a ratio of 4 to 1 and A2 has a ratio of 5 to 1. The panel may be about 15 inches long and the depth of the cabinet about 8 inches. There is a crystal employed for rectification instead of a tube, because of its many well-known advantages.

The three stages of audio frequency am-

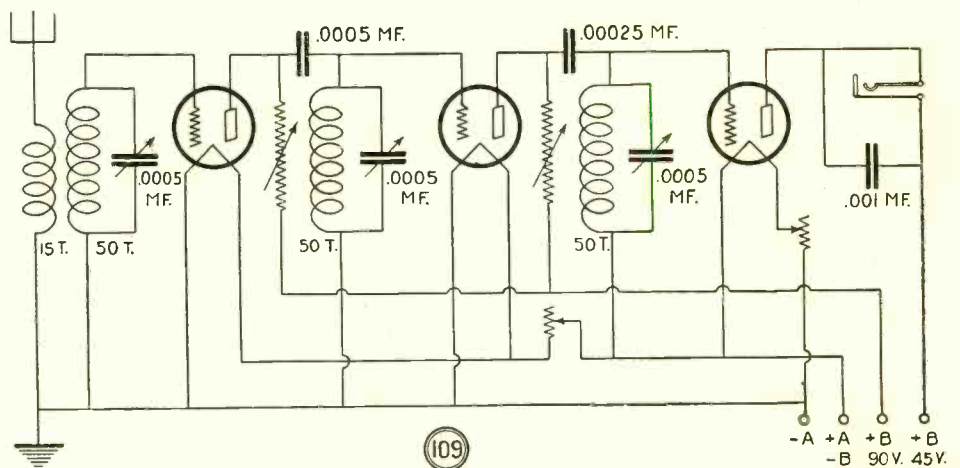

Three-tube receiver using variable resistances to prevent oscillations.

THE PRIEST FIVE-TUBE REFLEX

Circuit No. 110. This reflex receiver has a sensitivity determined by the utilization of three stages of radio frequency amplification, one of which is tuned in order to give a high degree of selectivity. This selectivity is increased by the use of a loop antenna.

The radio frequency transformers can be home-made, if desired, and the specifications are given below, but it is recommended that

of the pie windings are in the primary and three in the secondary, and there is also a little iron used in the core. R2 has 75 turns on the primary and 400 turns in the secondary, wound with No. 34 wire, the mean diameter of the coils being about 3/4 inches. R3 is also wound with No. 34 wire and has the same diameter. There are 225 turns on the primary and 330 turns on the secondary. Each of these transformers has a little more iron in the core than the preceding one. The audio frequency transformers A1 and A3

are used to get enough volume; it is possible to use as many as three stages because of the staggered characteristics and the balancing and opposing of the stray fields of the transformer systems. In the commercial receiver there is a grounded metal panel used; the lowest connection line in the accompanying diagram represents this grounded panel. UV201-A or C301-A types of tubes are recommended for use in this receiver.

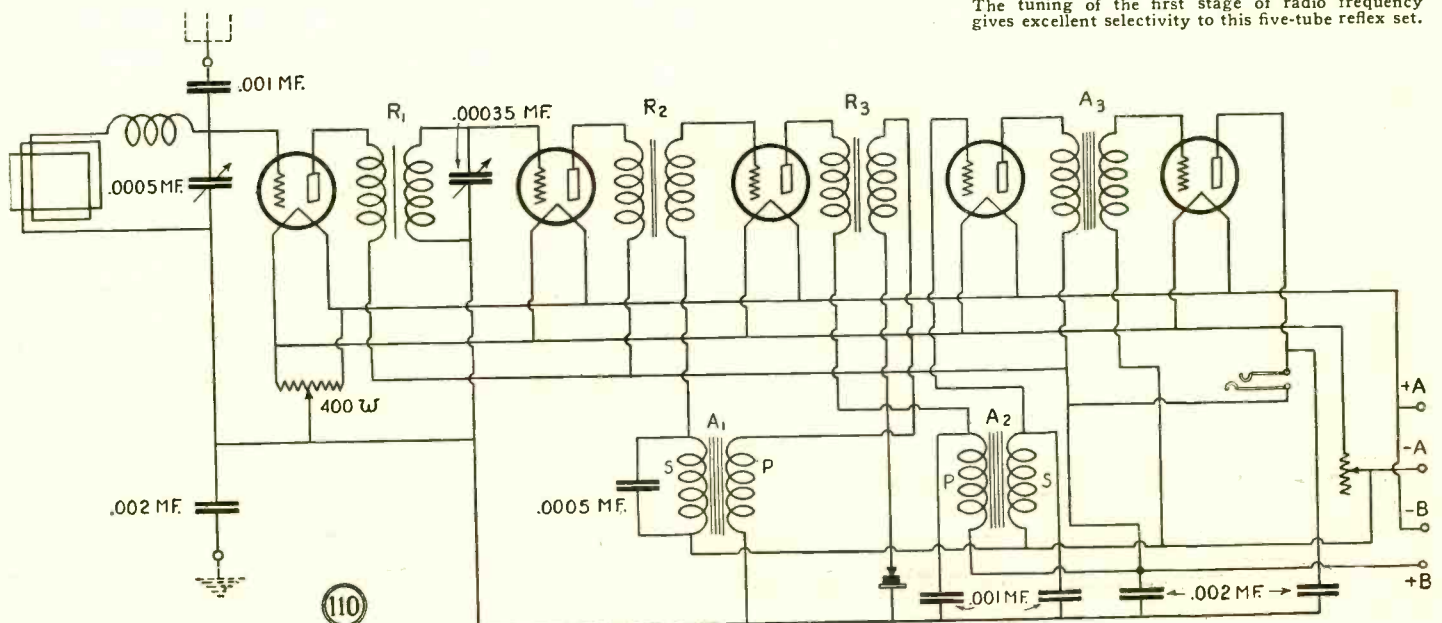

The tuning of the first stage of radio frequency gives excellent selectivity to this five-tube reflex set.

- Radiotics -

EASIER SAID THAN DONE

The *Evening Post Radio Magazine*, of Chicago, Ill., on April 23 had the following head: "Lumbermen's Dinner to be PUT ON THE AIR." We really consider this to be an unique manner in which to serve a dinner, but the *Chicago Post* does not tell us how the diners are going to stop the viands in their wild flight through space.



Contributed by C. F. Noe.

THE MUSIC WILL BE SWEETER

In the May, 1925, issue of the *Experimenter Magazine*, in an article about the erection of an antenna, there is mention made of a lead-in that is new to most of us. "In such a case the lead-in should also be in CAKE form." Doubtless, this is to insure the sweetening of any sour notes that may be transmitted.

Contributed by Morris Pool.



NOTHING BUT THE TRUTH

In the *Los Angeles (Cal.) Daily Times* of April 30 we find the following advertisement: "For Sale—New Radiola Super Het. It's terrible! Will trade for side-saddle or 100 lbs. of goat's milk." Whoever the person is that seems so anxious to rid himself of his set, we will hand him one thing, viz.: he sure believes that the truth will out.



Contributed by L. K. Mack.

SOME ARE STUCK UP

In the *San Antonio (Texas) Light* for April 28 we find the announcement that from Station WRC there will sing "the Maryland U-GLUEE CLUB." We often marvelled at the sticking power of some tenors and the way they cling lovingly to certain notes. There's the reason!

Contributed by T. C. Rumney.



FOR FUNERAL MUSIC ONLY?

In the *Chicago (Ill.) Daily News* of April 30 there is an article headed: "Gets DX on BURIAL ANTENNA." This is a custom that has been handed down apparently from the first Americans, the Indians, who were accustomed to bury with the departed brave his favorite weapons. Like the well-known brook, radio must go on forever.

Contributed by H. R. Arnold.



NEW UNIT OF CURRENT MEASUREMENT

Radio Magazine of Australia in the Feb. 18 issue ran an advertisement about DeForest tubes that "—take 3 volts at .06 of an AMPLION Filament." Down below the equator they sure do things backwards. Imagine having a loud speaker in a vacuum tube! It is to laugh.

Contributed by T. M. Fuery.

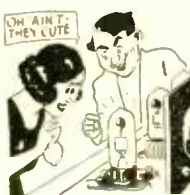

NEW TEST FOR TUBES

From the catalog of the Wholesale Radio Service Company, 9 Church St., New York City, we learn that in a set are used "FIRE-TESTED Cunningham tubes." We believe that the way the tubes are tested is that they are fired from the top of a tall building and if they bounce several times without breaking they are marked O. K.

Contributed by J. Schott.



HOW LONG IS THIS RECEIVER?

The *Detroit News* of April 26 has an article concerning some questions that a set-owner should ask himself. One of the questions is: "Are you using CAR in tuning your receiver?" There are some sets that we have tried to tune when we needed two or three more hands, but we have yet to meet a set of such a length that it was necessary to use a car in going from one dial to another.

Contributed by Albert Everett.

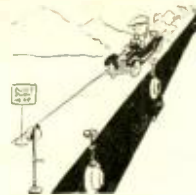

HOW TO IMPROVE RECEPTION

In the September issue of *Radio* there is a short note about the care of headphones. In part it reads: "Keep a GOOD WATCH on the diaphragms of the headphones." However, it is not specified whether the watch is to be an Ingersoll or a Waltham and for just what the watch is to be used. Maybe it's to supply those extra hands the set tuner so often needs.

Contributed by H. G. Akins.



HERE'S YOUR CHANCE

In the *Denver (Col.) Post* of May 10 is this advertisement: "Exchange your burned-out tubes for \$1.75." That is what we call big-hearted in every sense of the word. And confidentially, we'll whisper in your ear that we are already collecting the "dead ones" so we can cash in on this offer.

Contributed by Chas. Bloedorn, Jr.



TUBES, TUBES EVERYWHERE

The following advertisement was found in the *Battle Creek (Mich.) Enquirer* of April 26: "For Sale—Three-tube radio, with three-TUBE AERIAL. G. and B. batteries." No wonder they wanted to dispose of such an outfit. We find it hard enough to keep tubes operating in a set without bothering about them in the antenna, too. Nice job changing tubes on a snowy night, eh?

Contributed by L. Anderson.



QUITE A TRICK

In the March issue of *Popular Science* is an article about the construction of a receiver that says in part: "The receiver should squeal when the cat-whisker is not in contact with the crystal, and should disappear when the whisker makes contact." This is evidently a set for the magician; he would be the only one who could find the set after its disappearance.

Contributed by Bernard Parr.



NOT SO GOOD FOR THE TUBES

On Feb. 21 the *Telegram-Mail* of New York carried an advertisement that read: "Panels and TUBES cut to order while you wait." This must be another one of those much advertised steps forward, if they can sell pieces of tubes.

Contributed by Herbert White.



A NEW RADIO TITLE

In the *New York Sunday World* of April 26 we see the article, "Transmission Underground Proves Success," by H. G. Silbersdorff, A.M.I.K.E." Evidently Mr. Silbersdorff has spoken over the "Mike" so often that he has found it necessary to add a new radio title to his name. We recommend it heartily to all broadcasters.

Contributed by H. Gernsback.



IN DAYS OF OLD

The April 11 issue of the *Literary Digest* contained this enlightening advertisement: "—official list of broadcasting stations as of February 11, 1024." And they try to tell us that radio is still in long dresses! "Sir Launcelot du Lac will now broadcast how he overcame right valiantly all the Sir Knights of Camelot!"

Contributed by John M. Reed.



RADIO'S LATEST ACHIEVEMENT

In the *New Castle (Pa.) News* of April 20 there appears an advertisement reading: "MAGNAVOX SEEDS that grow." Flowers! Garden! Field! All we have to do now is to plant a field with these seeds and have a new loud speaker every day. At least, we can have a loud speaker in every room.

Contributed by John J. Ryczak.



BELIEVE IT OR NOT

On March 28 the *Radio Evening Public Ledger* of Philadelphia advertised that the U. S. Tube Exchange "built sets with OR WITHOUT MATERIAL. You should see and hear them." And then they say that Philadelphia is a slow town. We think somebody lied.

Contributed by John McMurray.



New Radio Patents



By JOHN B. BRADY*

(Patent No. 1,528,047, Frank Conrad. Filed March 15, 1922; issued March 3, 1925. Assigned to Westinghouse Electric & Manufacturing Company.)

Radio telephone system having a modulating system particularly adapted for high-power operation. The modulation system employs a thermionic tube which is so associated with energy-absorbing circuits that only relatively small

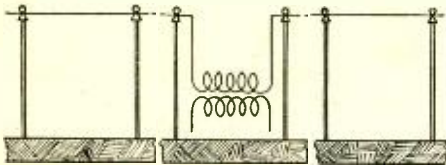

amounts of energy are dissipated in the modulator tube itself, the larger portion thereof being dissipated in the absorbing circuit. A pair of parallel connected valves are arranged in the transmitting circuit and modifications of the frequency of the impressed radio frequency currents cause opposite variations in the power absorbed by the respective circuits.

(Patent No. 1,533,278, J. Slepian. Filed November 20, 1920; issued April 14, 1925. Assigned to Westinghouse Electric & Manufacturing Co.)

Plate circuit excitation for an electron tube system in which multiphase alternating current is used for exciting the plate filament circuit. A polyphase source of electro-motive force is included

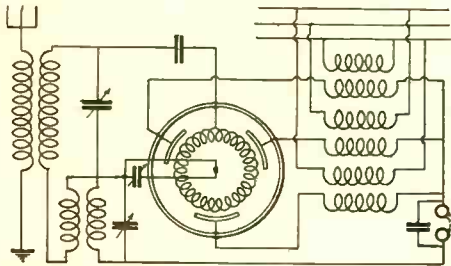

in the plate filament circuit to produce a flow of current therein similar to that produced by the direct current electro-motive force method of plate excitation. A rotating electrostatic field is thus produced within a closed vessel, which field may be controlled for further controlling energy in the output circuit of the electron tube.

(Patent No. 1,532,367, R. A. Weagant. Filed February 7, 1919; issued April 7, 1925. Assigned to Radio Corporation of America.)

Method and apparatus for radio signaling for reducing the effect of static disturbances. An antenna system comprising pairs of collectors is provided in which static energy may be suc-

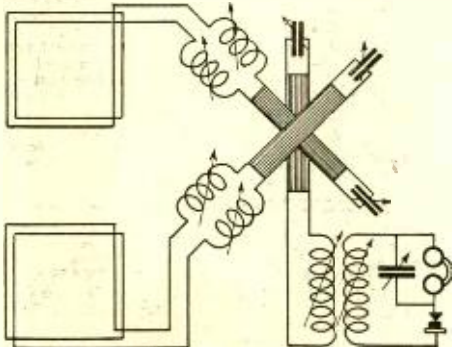

sively received while signaling energy is simultaneously received from substantially the same general direction. The relative differences of phase between the resulting currents is utilized to select the desired current.

(Patent No. 1,530,660, W. F. Friedman. Filed July 26, 1922; issued March 24, 1925.)

Printing telegraph system for effecting simultaneous transmission and reception of a plurality of code signal impulses representing the individual elements of the message characters that are to be transmitted. The object of the invention is to reduce the time necessary for the transmission of printed messages by telegraph. A set of generators of radio frequency oscillations at different radio frequencies is provided. A single modulation frequency is employed for telegraphically modulating the oscillations. A set of make-and-break keys are arranged to control the modulating or non-modulating of the oscillations. The keys are operated simultaneously and permutatively to correspond to the permutations of a plural unit signaling code representing message characters. The receiving station sets of receiver

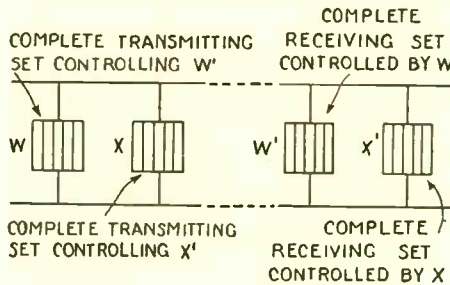

ing instruments are arranged to isolate the respective oscillations, detect the same, and control relay circuits which are operated permutatively to actuate a printing mechanism reproducing the transmitted messages.

(Patent No. 1,534,160, S. Cohen. Filed February 17, 1925; issued April 21, 1925.)

Condenser, in which the rotor plates are mounted on a ball-bearing member with the rotatable shaft journaled in a spring chuck secured in one of the end plates forming the condenser frame. The condenser is designed for high elec-

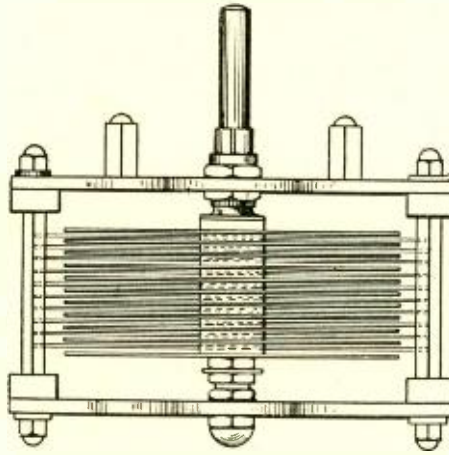

trical efficiency and high dielectric characteristics. The frame of the condenser and the rotor plates are of the same electrical potential.

(Patent No. 1,535,082, E. F. W. Alexanderson. Filed September 28, 1920; issued April 21, 1925. Assigned to General Electric Company, New York.)

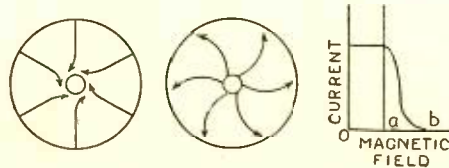

Electron discharge device, in which an elongated anode is disposed within an evacuated en-

velope with a filamentary cathode symmetrically spaced around the anode. A magnetic field is generated substantially parallel to the axis of the cathode. By controlling the magnetic field, the electron emission from the cathode is controlled to effect variations between the anode and cathode circuit.

(Patent No. 1,534,373, H. Fischer. Filed October 25, 1922; issued April 21, 1925. Assigned to C. Brandes, Inc.)

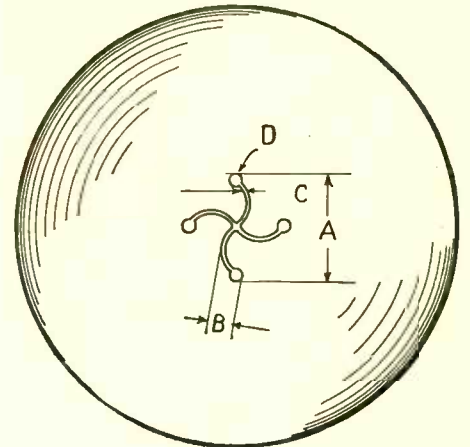

Diaphragm for telephone receivers, consisting of a pair of super-imposed members forming an air chamber therebetween, in which one of the members has an F-shaped slot therein. The object of the invention is to provide a diaphragm structure which will faithfully reproduce all of the tones of the musical scale. The patent covers an electro-magnetic sound-reproducing mechanism having a base made up of a plurality of stamped metal parts. The invention is particularly adapted for quantity production of electro-magnetic sound reproducers.

(Patent No. 1,530,988, H. W. Everitt. Filed November 6, 1920; issued March 24, 1925. Assigned to Western Electric Company, Inc., New York.)

Testing vacuum tubes and measuring the operational constants of electron discharge tubes. The constants which it is desired to measure are one or more of the following: Amplification factor U O, which is the ratio of the amplified current from the output circuit of the tube to the potential applied to the input; cathode-anode, impedance R_p, i. e., the internal output circuit impedance of the tube; and the mutual conductance $\frac{U O}{R_p}$.

By the present invention the constants of the tube can be read directly from dials which operate the different parts of the testing apparatus.

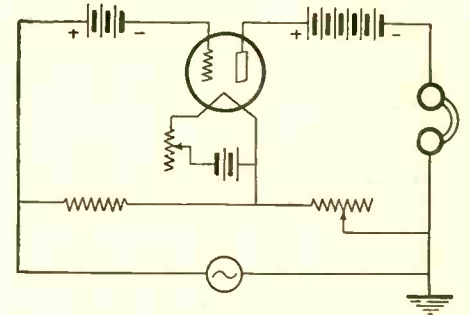

An adjustable balancing resistance is provided, connected in circuit with the electron tube tested. The resistance is calibrated in terms of the impedance of the space discharge path between two of the electrodes of the tube. When proper readings are obtained on meters in the tube circuits, the tube constants may be determined from the dial settings.

*Patent Attorney, Ouray Building, Washington, D. C.

Correspondence from Readers

MENTAL RADIO

Editor, RADIO NEWS:

In Mr. Gernsback's editorial, "Mental Radio," April RADIO NEWS, you describe a state of affairs that you consider unexplainable and improbable. If at any time experiences such as these had been yours, radio with its stages of amplification would become mere amateurishness compared to it, and maybe—or maybe not—you would have gone after it as the newest of new inventions.

A year or so ago, Dr. Conan Doyle was reported to have conversed with the spirits of those departed. My regret was sincere, for in my estimation the creator of the imperturbable Holmes had fallen into the wiles of the Yogis. When, however, a young woman came to me in mental distress and reported that she had heard voices live with modulation and resonance, saying something real to her, I listened attentively and questioned minutely and then told her, in a superior manner, that she was talking through her hat—that such things were delusions. This suffering young woman was shortly afterward brought before a psychopathic board and in psychic parlance "canned." If I had been more charitable or had had the good fortune to have read your "Mental Radio," I would have advised her to put a heterodyne oscillator under her pillow.

You say that a number of these cases have come to you and although you claim that they have heard nothing, it is my opinion that they have actually had sound waves impressed on their tympana. Unfortunately, I cannot account for the "why" or explain its insidiousness, so that my opinion is gratuitous and based on evidence that is discredited by others, as well.

I have heard and do hear these voices, and since I am unable to get any co-operation in solving their meaning, I have relegated the whole subject to the junk heap of medieval propaganda of some sort or other, which exploits the gullibility of human nature. I have presented a few of these facts to doctors, lawyers and to laymen, and the answer has been a bland perplexity at my ignorance. At most, it is an hallucination, poppy-cock of my own fabrication and other trivialities of that sort, but at the same time all are tremendously interested in how I react to these non-existent phenomena. No, there is no relief to be had except by remote controlling and that by all sorts and conditions of people, psychopaths, neuropaths, osteopaths, allopaths via homeo-diatetic-opaths and so on, all mixed together, or in single dosage, while the voices go right on talking hieroglyphics just the same.

After commenting, in one instance, on the remarkableness of this invention, I was asked, "What are you going to do about it?" Nothing whatsoever. What does one do about yesterday's newspapers, prohibition, bootleggers, politics, greed, stupidity, cancer, famine, poverty, etc.? They have come to stay.

If these voices are heard by some, why do not all hear them? Probably many have heard and accepted them along with the wars of the Medes and Persians or, in the absence of their own volition, have accepted them as their guide. The number, however, is probably in the minority and has been created by an unnatural environment which has forced them to evolve a psychic basis of their own; or they may be individuals who, on trying to accommodate themselves to artificial systems, have failed to understand any of them and are totally lost in the maze of arbitrary mandates. In that state of

super-stimulation, some senses become more acute than others and hearing may be one of them. To cite again my own instance, when the slam-banging began and every muscle was wracked by a sudden jar, my hearing became painfully acute and the voices got in and have stayed in for over fifteen years—the first thing in the morning until the last thing at night. Your instances of hearing them on elevated trains are probably correct. I hear them there also and in the open spaces as well. In a room where people are talking I hear them over all and so plainly that I wonder others do not likewise. That they do not is evidenced by the fact that I have noted this when with those who are oblivious of the existence of this phenomenon. I do not think there is anything spiritual or self-generated about it. It is the result of continued stimulation and concentration. A musician will hear sounds that the unaccustomed ear does not hear or does not distinguish. How the sounds are propagated is probably not beyond the scope of technical research and may be one of the confiscated patents of the German War Office adopted by the United States in conducting a sort of internecine warfare.

A remarkable omission in the recital of your cases is that none of them suspected that what they themselves said might be heard by others than those to whom they were speaking. For a time, scraps of my conversation were retailed to me, but as that activity did not last long I did not have the opportunity to check up on it with any definite results. I assume, however, that anything that I say anywhere at any time and to anyone in particular is decidedly not *entre nous*.

My reasons for writing you are as follows:

1. If this warfare in civil life is a branch of governmental strategy and is to be kept dark, why should your magazine with its large circulation bring it to notice?

2. If it is to be brought out into the open, wouldn't it be better to give it a hearing without stoutly denying its possible existence at the outset?

3. If it is decided that it does not exist, what disposal is to be made of the morons who become involved in its meshes? I was entirely unable to give any assistance to the young woman who told me that she was called a harlot and was frantic about it.

4. What I hear is equally good and at times exceeds goodness by becoming remarkable bits of psychoanalysis. For all that, I think it an incumbrance upon society, and if it ever permeates the financial world so that every legal document becomes a public property when voiced or read aloud, the people of the nation will find that they have only added to the complexities of existence in a way that will not enhance their welfare nor add to their ease of mind. What we need is less bone-headed propaganda and more brains to preserve the integrity of man's individuality and health. At the present rate of evolution in that direction, we will not have it for a million years to come.

GEORGE W. WIENHOEBER.

791 Bryant Ave., Winnetka, Ill.

(Of several hundred letters received referring to "Mental Radio," the above letter is the most intelligent as well as constructive we have seen as yet. Here is a man who seems to know what he is talking about, and, more interesting than all else, he knows radio, and approaches the matter with an open mind. We should very much like to have the pleasure of interviewing the correspondent and giving him a test in RADIO NEWS LABORATORIES for the benefit of all.

We extend to Mr. Wienhoeber an invitation to our Laboratories, and shall be glad to make available to him all modern scientific facilities, if he cares to submit to such a test.—EDITOR.)

MASTERS AND SEA-GOING OPS NOTE

Editor, RADIO NEWS:

I have read in several of the past issues of your magazine of the controversy between masters and radio operators about conditions on board ship.

As I intend to become a commercial operator soon, I should like to communicate with several masters and sea-going operators in order to become acquainted with all the duties of an operator.

Might I request that, for this purpose, my letter be printed in your Correspondence from Readers column?

FRED HANTELMAN,
c/o J. F. Bradford,
Burlington, Wash.

AN ADMIRER FROM PORTO RICO

Editor, RADIO NEWS:

Thanks for the publication of my last letter. I'm glad to say that the number of letters has increased from 217 to 307—most of them from New Zealand, Australia, Ireland, Canada, Philippine Islands and Panama.

Let me use a few lines now to tell you how I like RADIO NEWS. I have stopped buying other radio magazines, not because they are not good, but because I find RADIO NEWS sufficient to increase the knowledge of the radio reader and experimenter.

Radiospectfully yours,

ERNESTO DIAZ,
Box 224,
Caguas, Porto Rico.

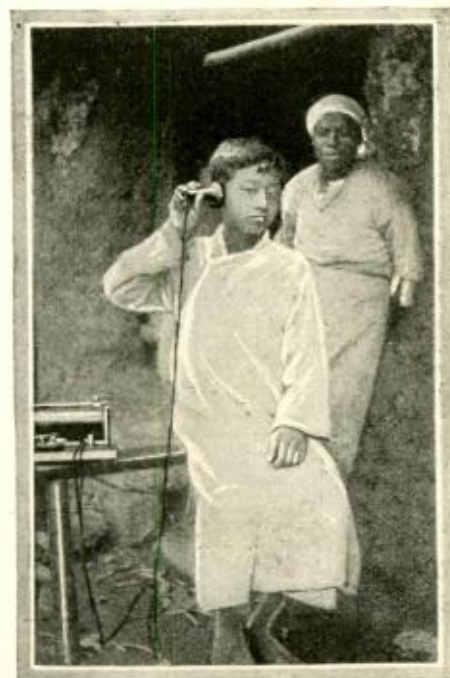

Even in the far interior of China, radio has its enthusiasts despite the various obstacles, the Foreign Relations Committee and the "Open Door" policy.



**APPROVED
RADIO NEWS
LABORATORIES
1922**

RADIO NEWS LABORATORIES



RADIO manufacturers are invited to send to RADIO NEWS LABORATORIES, samples of their products for test. It does not matter whether or not they advertise in RADIO NEWS, the RADIO NEWS LABORATORIES being an independent organization, with the improvement of radio apparatus as its aim. If, after being tested, the instruments submitted prove to be built according to modern radio engineering practice, they will each be awarded a certificate of merit, and a "write-up" such as those given below will appear in this department of RADIO NEWS. If the apparatus does not pass the Laboratory tests, it will be returned to the manufacturers with suggestions for improvements. No "write-ups" sent by manufacturers are published on these pages, and only apparatus which has been tested by the Laboratories and found to be of good mechanical and electrical construction is described. Inasmuch as the service of the RADIO NEWS LABORATORIES is free to all manufacturers whether they are advertisers or not, it is necessary that all goods to be tested be forwarded prepaid, otherwise they cannot be accepted by the Laboratories. Apparatus ready for the market or already on the market will be tested for manufacturers, as heretofore, free of charge. Apparatus in process of development will be tested at a charge of \$2.00 per hour required to do the work. The Laboratories will be glad to furnish readers with technical information available on all material listed here on receipt of a stamped envelope. The Laboratories can furnish resistances of the various instruments, amplification curves of transformers, losses in condensers, etc., and other technical information. Address all communications and all parcels to RADIO NEWS LABORATORIES, 53 Park Place, New York City.

SERIES PARALLEL SWITCH
The series-parallel switch shown in the illustration was submitted for

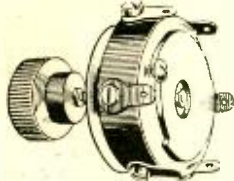

test by the Bretwood, Ltd., 12 London Mews, Maple St., London, England. This switch operates very satisfactorily in connection with multi-range sets when a change of condenser from the series to the parallel connection is required in the antenna system.

AWARDED THE RADIO NEWS LABORATORIES CERTIFICATE OF MERIT NO. 828.

ARION VACUUM TUBE

This vacuum tube is made to operate according to the usual filament ratings and under the usual plate filaments. It operates satisfactorily



as detector or amplifier and has a voltage amplification of approximately 7½. Submitted to the RADIO NEWS LABORATORIES for test by the Electric Sales Company, 140 Halsey Street, Newark, N. J.

AWARDED THE RADIO NEWS LABORATORIES CERTIFICATE OF MERIT NO. 805.

BRETWOOD VARIABLE GRID LEAK

This grid leak, made by the Bretwood Company, Ltd., 18 Maple St., London, England, is a very admirable piece of work. It has a total variation and resistance from 300,000 ohms to 10 megohms continuously variable and maintains its adjustment at all settings.

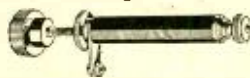

AWARDED THE RADIO NEWS LABORATORIES CERTIFICATE OF MERIT NO. 780.

FRANCE SUPERCHARGER

The France Supercharger consists of a transformer and tungar rectifier installed in a metal base. It is used for charging both "A" and "B" storage batteries. A five-ampere bulb is used. It operates from

the 60-cycle lighting circuit and by means of the flexible lead connections and clips, it is easily connected to the storage battery. The advantages of this type of charger are its silent operation and reliability. It was found to give excellent service. Manufactured by the France Mfg. Co., Berea Road and West 104th Street, Cleveland, Ohio.

AWARDED THE RADIO NEWS LABORATORIES CERTIFICATE OF MERIT NO. 669.

FEDERAL TRANSFORMERS

This audio frequency transformer, submitted to the RADIO NEWS LAB-

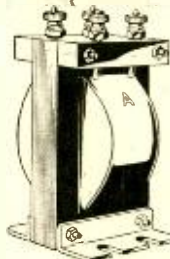

ORATORIES for test by the Federal Telephone & Telegraph Company, Buffalo, N. Y., shows a very flat characteristic and affords faithful reproduction in audio frequency amplifiers. It is totally encased in metal, thereby eliminating interstage coupling, and is very ruggedly built.

AWARDED THE RADIO NEWS LABORATORIES CERTIFICATE OF MERIT NO. 798.

"CE CO" RADIO VACUUM TUBE

This electron tube, furnished to the RADIO NEWS LABORATORIES by



the Providence Distributing Company, 625 Westminster St., Providence, R. I., is made to operate under a filament voltage of 5 and has a filament rating of .25 of an ampere. Operates satisfactorily under the usual voltages as an amplifier or detector. It has an approximate amplification factor of 7.

AWARDED THE RADIO NEWS LABORATORIES CERTIFICATE OF MERIT NO. 804.

AIRTRON VACUUM TUBE

This electron tube, furnished to the RADIO NEWS LABORATORIES by H & H Radio Company, is made

to operate on a filament current of .25 of an ampere. It oper-



ates satisfactorily as an amplifier, having 90 volts on the plate and an amplification factor of approximately 9. It will also operate satisfactorily as a detector with 45 volts on the plate.

AWARDED THE RADIO NEWS LABORATORIES CERTIFICATE OF MERIT NO. 803.

LOCK SWITCH

The lock switch shown in the illustration, submitted by the Chas. Fisher Spring Co., 88-90 Walker Street, New York City, presents an attractive appearance on the panel

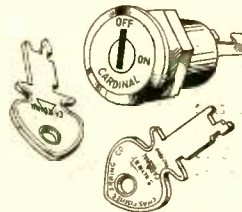

and prevents the set from being tampered with in the absence of the owner.

AWARDED THE RADIO NEWS LABORATORIES CERTIFICATE OF MERIT NO. 841.

CLEVELAND STORAGE "B" BATTERY

This battery furnished the RADIO NEWS LABORATORIES for test by the Cleveland Engineering Laboratories, 2104 Superior Viaduct, N. W., Cleveland, Ohio, is of the usual construction, containing 12 storage



cells, giving a total voltage of 24 volts. It can be satisfactorily charged and discharged in the usual way and operates quietly and satisfactorily as a source of plate voltage for radio receivers.

AWARDED THE RADIO NEWS LABORATORIES CERTIFICATE OF MERIT NO. 743.

"PERFECTO" SOLDERING FLUID

This soldering fluid, furnished the

RADIO NEWS LABORATORIES by the Fifth Radio Corp., 25 Beaver Street, N. Y. C., will operate satisfactorily in all cases where soldering is required in radio receivers.

AWARDED THE RADIO NEWS LABORATORIES CERTIFICATE OF MERIT NO. 806.

CARDINAL JACKS

These jacks were submitted to the RADIO NEWS LABORATORIES by the



Chas. Fisher Spring Co., 88-90 Walker Street, New York City. They are illustrated in the picture. These jacks operate satisfactorily in radio sets.

AWARDED THE RADIO NEWS LABORATORIES CERTIFICATE OF MERIT NO. 840.

WIRE NUTS

This wire nut, submitted by the Cork Company, 8 West 40th Street, New York City, furnishes a very satisfactory means for connecting two wires. The bared ends of the wires are inserted into the nut, which is then turned, the nut forming its own thread on the copper wires. The joint made is very good and very secure.

AWARDED THE RADIO NEWS LABORATORIES CERTIFICATE OF MERIT NO. 883.

REACHIT WRENCH

This wrench, supplied to the RADIO NEWS LABORATORIES by the Kaufman and Clough Co., 413 East 13th Street, Wilmington, Del., is a very handy tool to have around the radio laboratory. Screws in inaccessible places can be reached and moved with this wrench, without danger of their being dropped.



AWARDED THE RADIO NEWS LABORATORIES CERTIFICATE OF MERIT NO. 848.

CARBORUNDUM FIXED DETECTOR

This fixed detector, submitted to the RADIO NEWS LABORATORIES for test by the Carborundum Company, Niagara Falls, N. Y., is a very sensitive fixed detector and will operate satisfactorily in all sets requiring crystal detectors. It is very ruggedly built, requires no adjustment or batteries and maintains its sensitivity under all ordinary conditions.



AWARDED THE RADIO NEWS LABORATORIES CERTIFICATE OF MERIT NO. 797.

BRETWOOD VALVE-HOLDER

This valve-holder, manufactured by the Bretwood, Ltd., 12 London Mews, Maple Street, London, England, operates very satisfactorily with the English type of valve.



AWARDED THE RADIO NEWS LABORATORIES CERTIFICATE OF MERIT NO. 837.

PREMIER EXTENSION CORD

This extension cord, furnished the RADIO NEWS LABORATORIES for test by the Crescent Braid Company, Providence, R. I., is shown in the sketch. It is equipped with the Universal plug for quick adjustment.

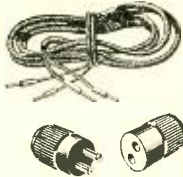

AWARDED THE RADIO NEWS LABORATORIES CERTIFICATE OF MERIT NO. 812.

GEN-ERAL TUNER

This three-circuit tuner, submitted to the RADIO NEWS LABORATORIES for test, by the General Manufacturing Co., 7637 South Shore Drive, Chicago, Ill., operates very satisfactorily in three-circuit tuners. It consists of a secondary and secondary

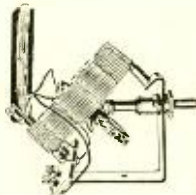

tickler and primary, the latter tube being variable in coupling. The terminal strip is divided with markings for connections in the set.

AWARDED THE RADIO NEWS LABORATORIES CERTIFICATE OF MERIT NO. 825.

VARIOHM

This variable grid leak, furnished to the RADIO NEWS LABORATORIES for test by Electrad, Inc., 428 Broadway, New York City, operates very satisfactorily in radio receiving sets,

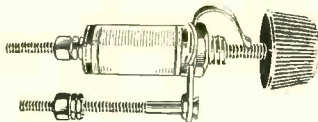

having a rated range of 1/4 to 30 megohms.

AWARDED THE RADIO NEWS LABORATORIES CERTIFICATE OF MERIT NO. 836.

BRAID FOR A LOOP

This braid, shown in the illustration, submitted by the A. H. Rice Company of Pittsfield, Mass., makes



a very satisfactory loop for broadcast reception.

AWARDED THE RADIO NEWS LABORATORIES CERTIFICATE OF MERIT NO. 818.

TECHNICELL

This storage "B" battery, submitted to the RADIO NEWS LABORATORIES by the American Storage Battery Co., 326 Newbury St., Boston, Mass., is of the usual acid type and has a terminal voltage of two volts. It operates satisfactorily in numbers for great voltage supply or for lighting low current consumption tubes.

AWARDED THE RADIO NEWS LABORATORIES CERTIFICATE OF MERIT NO. 712.

ERLA POTENTIOMETER

This potentiometer, submitted by the Electrical Research Laboratories, 2500 Cottage Grove Ave., Chicago, Ill., to the RADIO NEWS LABORATORIES for test is very well made. It is constructed very rigidly and has a resistance of 400 ohms. It is wound with high resistance wire and contact is made with this wire by means of a light spring so that excess wearing will not occur with continued use.

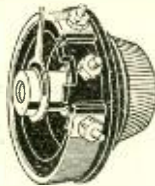

AWARDED THE RADIO NEWS LABORATORIES CERTIFICATE OF MERIT NO. 790.

ENDURANCE "B" BATTERY

This "B" battery, supplied to the RADIO NEWS LABORATORIES by the Gray Electro-Chemical Laboratories, Inc., 9-11 West 20th Street, Bay-



onne, N. J., is shown in the illustration. It is of the lead plate type and has a terminal voltage of 100 volts. It is very well made, presents a pleasing appearance and is easy to keep clean and in order.

AWARDED THE RADIO NEWS LABORATORIES CERTIFICATE OF MERIT NO. 849.

CRYSTAL DETECTOR

This device was submitted to the RADIO NEWS LABORATORIES for test by the Tuerk Manufacturing Co., 561 W. Washington St., Chicago,

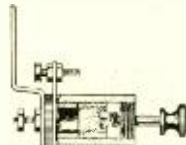

Ill. The crystal holder is shown in the illustration and operates very satisfactorily with any of the ordinary types of crystal.

AWARDED THE RADIO NEWS LABORATORIES CERTIFICATE OF MERIT NO. 826.

PAIR TELEPHONE CORDS

Submitted by the Crescent Braid Company, of Providence, R. I., to the RADIO NEWS LABORATORIES for test. These telephone cords are shown in the illustration.



AWARDED THE RADIO NEWS LABORATORIES CERTIFICATE OF MERIT NO. 814.

AIRADER CRYSTAL DETECTOR

This detector was submitted to the RADIO NEWS LABORATORIES for test, by Bernard's Radio Co., 11 Twelfth Street, Providence, R. I. The crystal holder is shown in the illustration



tion and operates very satisfactorily with any of the ordinary types of crystals.

AWARDED THE RADIO NEWS LABORATORIES CERTIFICATE OF MERIT NO. 827.

RADIO FREQUENCY TRANSFORMER

Submitted by the Rauland Mfg. Company, 2650 Coyne Street, Chi-



cago, Ill., to the RADIO NEWS LABORATORIES for test. This transformer is of the untuned type and operates very satisfactorily in radio frequency circuits and also in reflex circuits in portable sets.

AWARDED THE RADIO NEWS LABORATORIES CERTIFICATE OF MERIT NO. 817.

THOROLA LOW-LOSS DOUGHNUT COIL

This coil was submitted to the RADIO NEWS LABORATORIES for test,



by the Reichmann Company, 1725 West 74th St., Chicago, Ill. This coil operates very satisfactorily in radio receivers. It is made to operate with a .0005 condenser to cover the broadcast range.

AWARDED THE RADIO NEWS LABORATORIES CERTIFICATE OF MERIT NO. 824.

ERLA FIXED CRYSTAL DETECTOR

This fixed crystal detector submitted to the RADIO NEWS LABORA-



TORIES by the Electrical Research Laboratories, Inc., 2500 Cottage Grove Avenue, Chicago, Ill., operates very satisfactorily in all sets requiring a fixed crystal. Its sensitivity is very good.

AWARDED THE RADIO NEWS LABORATORIES CERTIFICATE OF MERIT NO. 845.

EUREKA DIAL POINTERS

The dial pointer, furnished by the C. W. Butts Co., 42 Hedden Place,



East Orange, N. J., to the RADIO NEWS LABORATORIES for test, is pictured in the illustration. This dial pointer presents an attractive appearance on the panel.

AWARDED THE RADIO NEWS LABORATORIES CERTIFICATE OF MERIT NO. 829.

"A" BATTERY

The "A" battery, pictured in the illustration, was submitted by the



Kellman Electric Co., Rochester, N. Y. This is a well-made battery of the storage type, having a terminal voltage of 6 volts. It operates very satisfactorily and will stand a heavy discharge without damage.

AWARDED THE RADIO NEWS LABORATORIES CERTIFICATE OF MERIT NO. 846.

BARKELEW LIGHTNING ARRESTER

The Barkelew lightning arrester No. 602 consists of a spark gap in

a rarified gas chamber mounted on a porcelain base. A switch is provided also on this base, as the illustration shows. The No. 606 lightning arrester is similar to the No. 602 except that it has no switch. Both of these arresters are of very good construction and are highly recommended for use with the ordinary outdoor aerial. Manufactured by Barkelew Electric Co., Middletown, Ohio.

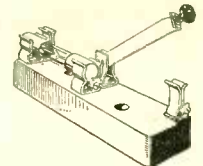

AWARDED THE RADIO NEWS LABORATORIES CERTIFICATES OF MERIT NOS. 683 AND 684.

X-L RADIO CRYSTAL SET

The crystal set submitted by the X-L Radio Corporation, of 1623 S. Vermont St., Los Angeles, Calif., to the RADIO NEWS LABORATORIES for test is a multi-control crystal set. Connections are made to the antenna and phones on the top of the box, where the tuning dial and crystal detector are also located.

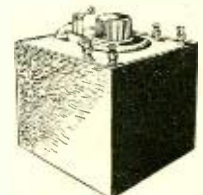

AWARDED THE RADIO NEWS LABORATORIES CERTIFICATE OF MERIT NO. 823.

NEUTROFLEX TRANSFORMER

Submitted to the RADIO NEWS LABORATORIES for test by the C. D. Tanner Company, 528 W. Washington St., Los Angeles, Calif. This is a radio frequency transformer made



for tuning with the variable condenser. Operates satisfactorily over the present range of wave-lengths.

AWARDED THE RADIO NEWS LABORATORIES CERTIFICATE OF MERIT NO. 816.

FIXED KRYSTAL DETECTOR

This crystal detector, shown in the illustration, was submitted to the



RADIO NEWS LABORATORIES by C. E. & H. T. Hargraves, Lakewood, R. I. It operates very satisfactorily in all circuits requiring a fixed detector.

AWARDED THE RADIO NEWS LABORATORIES CERTIFICATE OF MERIT NO. 831.

SUPER MICRO JACK

This jack was submitted by the H. W. Burns Co., 672 Broadway,

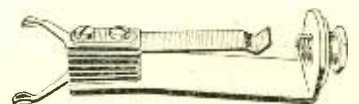

Brooklyn, N. Y., to the RADIO NEWS LABORATORIES for test. It is well made and operates satisfactorily in receivers.

AWARDED THE RADIO NEWS LABORATORIES CERTIFICATE OF MERIT NO. 832.



Conducted by R. D. Washburne

THIS Department is conducted for the benefit of our Radio Experimenters. We shall be glad to answer here questions for the benefit of all, but we can publish only such matter as is of sufficient interest to all.

1. This Department cannot answer more than three questions for each correspondent. Please make these questions brief.
2. Only one side of the sheet should be written upon; all matter should be typewritten or else written in ink. No attention paid to penciled matter.
3. Sketches, diagrams, etc., must be on separate sheets. This Department does not answer questions by mail free of charge.
4. Our Editors will be glad to answer any letter, at the rate of 25c for each question. If, however, questions entail considerable research work, intricate calculations, patent research, etc., a special charge will be made. Before we answer such questions, correspondents will be informed as to the price charge.

PICTURE DIAGRAM

(2131) Mr. John W. Smith, New York City, says:

Q. 1. Please show the picture diagram of a reflex receiver having only one tube.

A. 1. We are showing the circuit below. The crystal detector is shown connected to a center tap on the second radio frequency transformer secondary. The object of this is to increase selectivity. The dotted line indicates how one side of the radio frequency transformer secondary may be connected to "A" minus. This connection sometimes improves reception considerably, strong capacity effect being noted until this connection is made.

All coils are wound in the same direction, with any convenient size of wire. Three-inch tubes may be used. If larger tubes are used, less turns are required; if smaller, more turns. Although the spacing between the 12 (and 15) turn primary and the 50-turn secondary looks large, the spacing of a single turn of wire will probably be found quite sufficient. A greater spacing will considerably sharpen the tuning, but also decrease the volume. This reduction is most noticeable when receiving signals from distant stations. Enamel, cotton or silk may be used as wire insulation, the latter two being preferable.

The potentiometer controls amplification (regeneration).

Any good audio frequency transformer may be used. Those of high ratio are not desirable in regular sets, but in reflex receivers high ratio transformers seem to be desirable, rather than otherwise. The UV-712 transformer (of which there are two types) was originally designed for high amplification of spark signals. (That is, one type was.) In regular broadcast receivers considerable distortion results when these are used. This circuit may be used with these audio frequency transformers with quite excellent results.

Different tubes and different audio frequency transformers (and different placing of apparatus) require different "by-pass" condenser (that is, the condensers connected to the primary and to the secondary windings of the audio frequency transformer) values. Other values than those shown should be tried and the result noted.

This is an extremely efficient circuit for the reception of local stations. Tone quality is very good. If the radio frequency coils are not crowded together, selectivity should be quite sufficient for all ordinary needs.

Although an adjustable crystal detector is shown, one of the fixed variety may be used. A dozen different minerals should be tried. At least two different "detector stands" should be tried.

The size of the "A" battery used will depend upon the tube used and the tube selected is a matter of personal like and dislike. A regular "storage battery tube" will give best results. You

are fairly safe in buying a tube that will oscillate.

Q. 2. Is a loud speaker any good when made by clamping a pair of head-phones on the horn? Some of the loud speakers of this type require only a single unit.

A. 2. Head-phones are not designed for adequate handling of the strong currents necessary for proper loud speaker operation. There are many "units" obtainable that may be incorporated in some of the various types of horns. These units are entirely satisfactory for loud speakers.

A pair of head-phones designed to be really sensitive to weak signals will rattle greatly if forced to operate for even "moderate" loud speaker volume. Although not recommended, a simple expedient that permits of loud speaker operation with most head-phones (with the exception of the Brown and the Baldwin brands) is the raising of the diaphragm from the pole-pieces. It is the touching of the diaphragm against the pole-pieces which causes the rattle. Sometimes merely reversing the diaphragm, so that the inside now becomes the outside, is sufficient to stop the rattle. A thin paper washer, one-eighth inch wide and with an outside diameter equal to the diaphragm diameter, may be used to raise the diaphragm slightly from the pole-pieces, a sufficient number of washers being used to prevent the rattling.

Another thing. Some head-phones are wound with wire much finer than that used in other makes of receivers. The wire is large enough for ordinary signal strength, but is insufficient when taxed by the output of a 2-stage audio frequency amplifier. The result is a burn-out which renders the phones useless until repaired.

Q. 3. Where is it possible to purchase a book or construction blueprints for making an inexpensive, one-tube regenerative set?

A. 3. Our Book Department will be glad to furnish "How to Build a Low-Loss Receiver" (which is a packet containing blueprints and all details for making a one-tube regenerative receiver), or "How to Make a One-Tube Regenerative Set." The latter is a 64-page booklet. Prices will be supplied upon application.

INTERFERENCE

(2132) Mr. W. E. Grough, New York City, asks:

Q. 1. What method should be followed in eliminating interference due to a telephone-ringing machine?

A. 1. High mica usually causes excessive sparking at the commutator of the ringing machine. The result is often the radiation of a high frequency current which causes considerable interference at radio receiving stations. Turning down the commutator is the best remedy for this trouble.

We are showing a diagram of a filter. This

is sometimes required. It should be connected as close as possible to the ringing machine. Condensers "C" are each of 2 mf. capacity. Inductances "L" are each the No. 5-AA Retardation Coil, obtainable from the Western Electric Company. This coil has an extremely low resistance to the ringing current, which is usually of only 16 cycles. To currents of radio frequency, however, the resistance is very high. The direct current resistance of this unit, with both coils in series (the 5-AA Retardation Coil has two windings which may be connected in series or parallel) is only about 75 ohms. The voltage of a ringing machine output is extremely high, in the neighborhood of 100 to 110 volts, but the current is very small. A 75-ohm receiver may be used in place of the Retard Coils if these are not available, two receivers being used, one in place of each of the No. 5-AA coils.

Q. 2. Please show how a two-coil coupler and

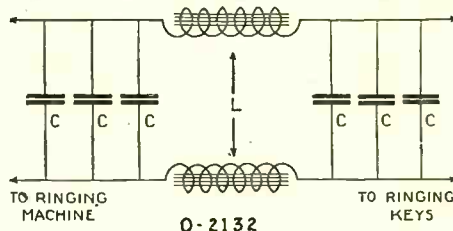

Q-2132 Telephone ringers often cause interfering sounds similar to those caused by lightning. The purpose of this circuit is to eliminate this interference.

a potentiometer can be used in the enclosed diagram.

A. 2. Diagram 2132-A shows how this is done. The stator may consist of 50 turns of No. 24 D.C.C. wire wound on a three-inch tube. This winding is tapped every five turns, making ten taps in all. The tickler may consist of about 20 turns of the same wire wound on a rotating tube about 2 1/4 inches or 2 1/2 inches in diameter. A regular variocoupler tapped in the regular "units and tens" manner may also be used.

The potentiometer makes it possible to bias the grid either negatively or positively. The former grid bias polarity is desirable for local reception, quality being best with a negative bias. A positive bias is better for extreme sensitivity. Excellent results are claimed for this circuit.

Q. 3. How many turns of wire are there in the Binocular coils used in the Synchronphase receiver?

A. 3. Complete construction data on these coils is contained in the article, "The Latest in Tuned Radio Frequency," by Arthur Reed. This two-page article, starting on page 1876 of the April, 1925, issue of Radio News, describes the Synchronphase receiver in considerable detail. The schematic circuit of this receiver cannot be furnished at this time in greater detail than that shown.

NEUTRODYNES

(2133) Mr. N. J. King, Boston, Mass., says: Q. 1. Please list the trade names of the Neutrodynes licensed under the Hazeltine patents.

- A. 1. The following 14 Neutrodyne receivers are licensed under these patents:
- | | |
|----------------|-------------------|
| Amrad | Howard |
| Carloyd | King-Hinners |
| Fagle | Murdock |
| Fada | Stromberg-Carlson |
| Freed-Eisemann | R. E. Thompson |
| Garod | Ware |
| Gilfillan | Workrite |

Further information relating to these receivers may be obtained by writing to the Advertising Department of this magazine.

Q. 2. How can my Neutrodyne be adjusted so as to shift the dial readings further forward? KSD is received at about 120 on the dial. Would like to receive this station at about 195 on the dial.

A. 2. Changing the capacity or changing the inductance will control the wave-length. If it

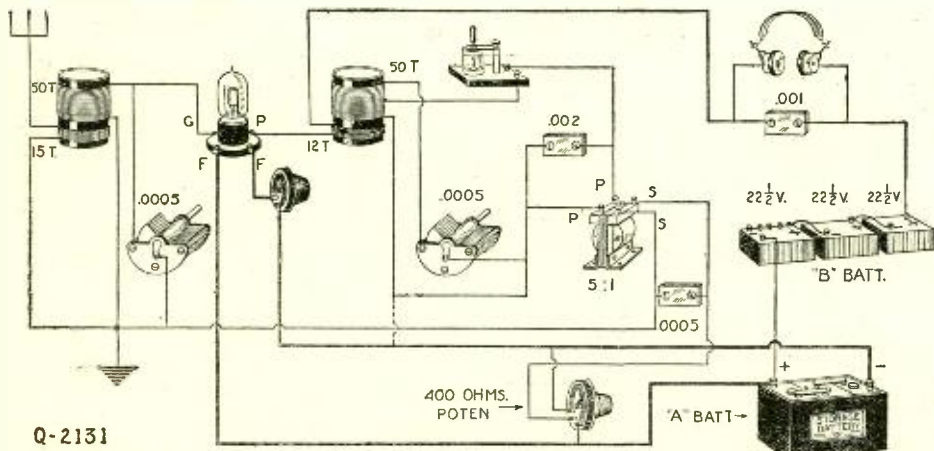

Q-2131

This month we are showing an efficient 1-tube reflex circuit. Good quality and range are promised to constructors who build this set with care. An adjustable detector may be used, but fixed ones are now obtainable.

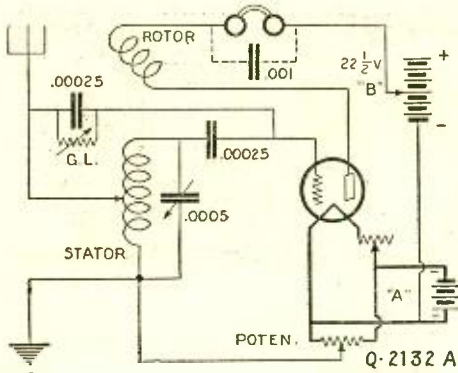

One of the variations of the single-circuit receiver. There should be no difficulty in making this operate in a satisfactory manner.

is not convenient to change the variable condensers to others having a lower maximum capacity, you may reduce the number of turns of the secondaries of the neutroformers. If the secondary windings are changed and difficulty is experienced in neutralizing the set, it may be necessary to reduce the number of turns in the neutroformer primaries.

Since you do not state the capacities of the variable condensers used, or the constants of the neutroformers, we cannot furnish specific information.

Q. 3. Why is it that a Neutrodyne constructed with standard parts does not neutralize when using UV-199 tubes? The neutrotons have no effect and the circuit will not oscillate.

A. 3. The neutroformers you are using were designed to operate best when standard six-volt storage battery tubes are used. Since the circuit will not oscillate when dry cell tubes are used, on account of the low internal capacity of these tubes, it becomes necessary either to increase the number of turns in the primaries of the neutroformers or else to connect a very small condenser across the grid and plate terminals of the radio frequency tubes. Neutrotons will probably be found satisfactory in this capacity. Do not forget to install the detector plate circuit by-pass condenser that connects across the head-phones, or across head-phones and "B" battery; it causes a big increase in signal strength and the circuit will oscillate more easily.

MICROPHONES

(2134) Mr. Eugene Moussean, Basin, Wyo., asks:

Q. 1. What is the highest radio station in the world?

A. 1. We understand the recently opened station on the Pic-du-Midi Mountain, in the Upper Pyrenees, near the Spanish border, is the highest station in the world. It is located 9,439 feet above sea level.

Q. 2. Can the very small "B" batteries of the size called "Signal Corps" be used in a super-heterodyne?

A. 2. These batteries have such a short life that they should be used in a portable receiver only. Larger batteries should be used in permanent installations.

Q. 3. How can microphone currents be amplified by a vacuum tube?

A. 3. Picture diagram numbered Q. 2134 shows how this is done. The microphone requires a high current at a very low voltage. The vacuum tube requires a high voltage but a very low current. The "modulation transformer" serves to adapt the microphone circuit to the requirements of the vacuum tube circuit.

Any firm selling transmitting apparatus will have this form of transformer, which has a low resistance primary (about 25 ohms) and a high resistance secondary (about 1,000 ohms). An ordinary Ford spark-coil is often quite suitable. A regular telephone transmitter may be used instead of the microphone, but it will not be as sensitive. Several telephone companies manufacture hand transmitters and microphones.

While the regular "A" battery used to supply the tube is shown as supplying the necessary microphone current, it may be necessary to have a different microphone current supply, depending upon the constants of the microphone used.

The regular 2-stage audio frequency amplifier of your radio set may be used. The modulation transformer may be used in place of the first audio frequency transformer; or the set may be left connected up in the regular way and then the microphone made up as a separate unit. When it is desired to use the microphone, it is only necessary to connect the secondary of the modulation transformer to the secondary of the first audio frequency transformer. Since one side of the modulation transformer and one side (the filament side) of the audio transformer may always be connected, it then becomes necessary only to have a regular push-pull switch to connect the remaining two transformer posts, in order to use the microphone. The microphone may also be connected directly across the primary of the first audio frequency transformer.

Those who are hard of hearing will find the system explained in the diagram marked Q. 2134 a great improvement over a microphone used

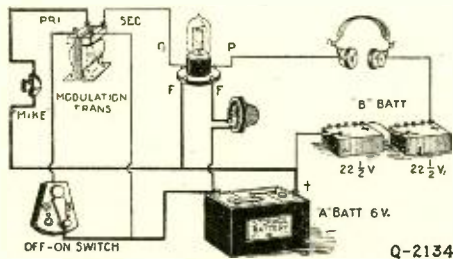

Amplifying voice currents. This illustrates the principle involved in telephone "repeaters."

alone, in the customary manner. The ordinary microphone connection uses only a small battery, the receiver and the microphone. It is usual for this combination to be very noisy, particularly when the battery is new. This is due to an overloading of the microphone. This overloading is prevented by using the tube amplifier shown. The microphone is operated with much less battery current, eliminating the loud, rushing sound usually present. In addition, quality is very greatly improved and greater volume is obtainable.

If the microphone is used with the 2-stage amplifier of a regular set, as described above, the exceptionally high amplification resulting may cause the loud speaker output to feed into the microphone, resulting in a "reflexing" of the audio sounds that builds up until a loud, continuous howl is heard. This may be prevented or reduced in one or more of several ways. The howl will stop if the microphone is moved to another room. Try reducing the tube filament current. Mount the microphone in a framework in such a way that the entire "mike" is suspended by springs. Rubber bands fastened to the "mike" and to the framework will afford the necessary spring suspension. The microphone may be suspended in a metal box open at one end, the box being grounded. This is an improvement over the plain

framework mounting mentioned above. The microphone should not touch the metal at any point.

VERNIER DIAL RATIOS

(2135) Mr. Henry Wells, Jr., New York City, asks:

Q. 1. What are the ratios of the vernier dials and condensers now available, exclusive of those having independently controlled condenser plates?

A. 1. We submit the following:

Vernier Dials	Reduction Ratio
Pico	12:1
Velvet Vernier (National)	6:1
Apex	12:1
Micro-Dial (Jewett)	50:1
Accuratune (Mydar)	80:1
Branston	10:1
Kellogg (cam action)	25:1
Remler	12:1
Eztoon (Butler)	80:1
Ultra-vernier (Phoenix)	20:1
Sensory	76:1
A. C. H. (on 3-inch dial)	156:1
A. C. H. (on 4-inch dial)	215:1
Uni-vernier	12:1
Verni-Dial (Erla)	14:1
General Radio (on 2 3/4-inch dial)	5:1
General Radio (on 4-inch dial)	8:1
Stasco	110:1

Vernier Condensers	Reduction Ratio
Acme	8:1
Remler	165:1
Signal	3:1
Barrett & Paden	10:1
National	6:1
Bruno	10:1
Ustoolco	9:1
General Radio (4-inch dial)	8:1
Mesco	12:1
Nelslide	2:1
Wade	32:1
Hammarlund (cam action)	25:1

These ratios are calculated on a full circle, 360° turn of the main dial.

Q. 2. How is it possible to sustain the vibrations of a tuning fork without employing the usual system of a contact on one side of one of the tines and an electro-magnet on one side of the other?

A. 2. Eccles and Jordan have patented the system shown in the accompanying diagram.

The note generated is determined mainly by the natural period of the tuning fork. This note is of practically constant frequency. The output is (nearly) sinusoidal.

Electro-magnets A-1 and B-1 may be ordinary 75-ohm head-phone electro-magnets, for experimental construction and test.

"B" may be about 45 to 60 volts. If the WD-12 type tube shown is used, the customary single dry cell or single storage cell is used, as "A."

Any audio frequency transformer may be used. Movement of one tine induces current in grid coil A-1. This causes a momentary plate current change which causes plate magnet B-1 to attract (or repel) the other tine, sustaining vibration at the natural period of the tuning fork.

Radio amateurs should investigate the possibilities of this application of the vacuum tube, in connection with transmission.

Note this: At Northolt, England, such a tuning fork arrangement has been successfully used as a modulator, at radio frequency, in a "constant current" transmitter that proved more efficient than the "master oscillator" system! In this particular instance the tuning fork was adjusted for a natural period of 1,963.6 cycles per second. It was possible to use the 22nd harmonic of this frequency! This harmonic has a frequency of 43,200 cycles and is, therefore, well within the

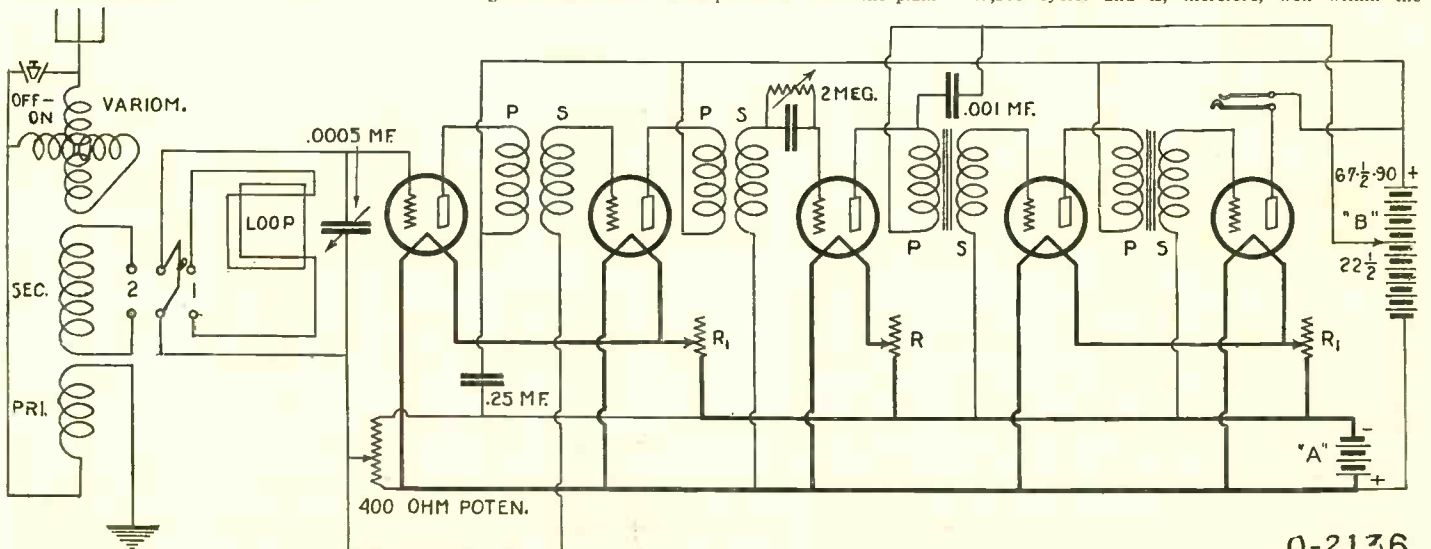

A 2-dial radio frequency set. Either a loop aerial or a regular aerial and ground may be used. For good operation over the entire broadcast wave-length range it will be necessary to use a good make of radio frequency transformer. Dry cell tubes may be used.

Q-2136

super-audible frequency range. By the use of a negative bias, instead of the positive bias shown, full advantage was taken of the asymmetrical action of the vacuum tube, resulting in the production of a relatively strong oscillation on this unusually far-removed harmonic. The antenna current at Northolt is 100 amperes.

To produce audio frequency oscillations in a vacuum tube circuit has formerly required large values of inductance and capacity. The result was a bulky unit. By selection of proper values it should be possible to produce an audio oscillator having a wide frequency range, slight bulk and a reasonably small amplitude variation.

5-TUBE SET

(2136) Mr. Richard Walters, Shanghai, China, asks:

Q. 1. Please show a switching arrangement connected to the 5-tube radio frequency circuit shown in the "Standard Hook-Ups" department of the March, 1925, issue of RADIO NEWS, circuit No. 84.

I wish to be able to use either an outside aerial and ground, or a loop. A variometer and a 2-coil variocoupler are available.

A. 1. This circuit will be found below. The usual 2-coil coupler, having about 10 to 15 turns on the primary and about 50 turns on the 3-inch tube secondary may be used.

The variometer should not be in inductive relation to the coupler. With the variometer short-circuited, you are using the so-called aperiodic antenna system. With the variometer in use, you are using the tuned antenna system.

The loop aerial will require between 90 and 110 feet of wire. This may be stranded or solid wire, No. 14 B. & S. gauge is a good size. It may be wound in the "flat spiral" (over-grown spiderweb coil) fashion, or on a box frame, like a direction-finding loop.

Ballantine vario-transformers may be used with excellent results. Any other make of transformers may also be used. The vario-transformers would have to be mounted in some accessible manner, as it is necessary to adjust these as different stations are tuned in. The vario-transformer has a variable primary operated and connected like a variometer. The secondary is made in the same manner.

Head-phones may be connected to the detector output by just touching the phone tips to the primary posts of the first audio frequency transformer.

The make and ratio of the audio frequency transformers are optional. We would recommend audio transformers of low ratio, when the detector is preceded by one or more stages of radio frequency amplification.

Phone-plug losses are often quite high at radio frequencies. Consequently, it is not advisable to use a phone-plug to connect the loop to the set; use two binding posts. The two loop leads should be loose, not together.

Q. 2. Please publish in your columns a diagram of connections for a long-range honeycomb set for Morse reception, using only one valve.

A. 2. The Ultra-audion regenerative circuit has been found exceptionally efficient for the reception of long-wave stations. The Ultra-audion circuit shown in the "I Want to Know" department of the December, 1924, issue of RADIO NEWS (picture diagram) may be used for the reception of broadcast programs transmitted on the longer wavelengths, and the signals of long-wave code transmitting stations.

If desired, the single stage of audio frequency amplification shown may be omitted, leaving the one-tube circuit requested.

You referred to the code signals as "Morse." This code is practically unused in radio, except in "line" transmission. "Continental," or "Con-

tinental Morse," as it is sometimes called, is the code used in radio work. There are no "spaced letters" in this code. That is, letters having a space as an integral part of the letter.

Q. 3. Is it possible for the "B" battery to cause a sound like that of "static"? If the answer is in the affirmative, is there any easy way of testing for the trouble?

A. 3. A run-down "B" battery may cause crackling sounds that cannot be distinguished from some forms of static due to an electrified condi-

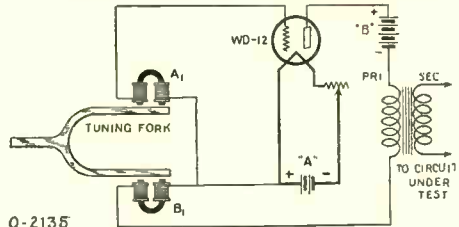

Q-2135

Maintaining constant vibration of a tuning fork, by means of a vacuum tube. An application of the device is described.

tion of the air. You do not state whether you are using one or more tubes. If yours is a single-tube set, the first substitution method will not apply.

If you have two 45-volt "B" battery units, it is probable that only one is causing the trouble. Therefore, try one of the two batteries. In that case, the set will be operating on only 45 volts plate potential, but the crackling sounds will be heard just the same, if the poor battery is connected into the circuit in place of the perfect battery.

A second, and sometimes not convenient, substitution method is to try a new "B" battery in place of the one, or ones, in the set.

If the voltage of the battery is determined by a high-resistance voltmeter, the needle will fluctuate if there are one or more defective cells. A poor battery will usually have an extremely low voltage reading.

If a pair of head-phones (really good phones should not be used for this test) are connected across the "B" battery, with a grid leak of high resistance in series, crackling is practically absent when the battery is good. A perfect grid leak is absolutely essential.

TUBE DATA

(2137) Mr. Alan Henry Edmonton, Altoona, Can., says:

Q. 1. Please state the temperatures at which the standard vacuum tube filaments operate.

A. 1. The heat of standard tube filaments, when operated at the normal, rated value, is shown in the following table:

UV-199	—1950°	absolute Centigrade
UV-201A	—1950°	absolute Centigrade
UV-200	—2450°	absolute Centigrade
UV-201	—2450°	absolute Centigrade
UV-202	—2600°	absolute Centigrade
WD-11	—1098°	absolute Centigrade
WD-12	—1098°	absolute Centigrade

To reduce the temperatures from absolute Centigrade to Centigrade, subtract 273°.

Q. 2. What are the constants of the Cunningham 250-watt tube with the "A" filament?

A. 2. The same as the 250-watt, C-304 tube, except for the filament consumption. The constants of the C-304A tube are:

Filament Terminal Voltage11 volts
Filament Supply Voltage12 volts

Filament Current3.85 amperes
(As against 14.75 amperes for the C-304 tube.)	
Normal Plate Voltage2,000 volts
Normal Plate Current200 milliamperes (2,000 volts, zero grid.)
Amplification Constant25
Mutual Conductance5,000 mhos.
Conductance is the reciprocal of resistance. Its unit is the mho. or "reciprocal ohm."	

ERRATA

(2138) Mr. J. La Salle Poyvais, Montreal, Que., Can., asks:

Q. 1. The list of Signal Audibilities, published in the "I Want to Know" department of the May, 1925, issue of RADIO NEWS (answering question 2114) does not check up with the list shown in another magazine, issue of the same month. Which list is in error?

A. 1. We regret that the list of audibilities shown was not correct. The list should be as follows:

SIGNAL AUDIBILITIES

- R1—Faint signals, just audible.
- R2—Weak signals, barely readable.
- R3—Weak signals, but readable.
- R4—Fair signals, easily readable.
- R5—Moderately strong signals.
- R6—Strong signals.
- R7—Good, strong head-phone signals. Would be readable through heavy QRN and QRM.
- R8—Very strong signals. Medium loud speaker volume.
- R9—Extremely strong signals, strong loud speaker volume.

Q. 2. In the June, 1925, issue, page 2269, appears the statement (answering question 2118 [Garod Neutrodyne]), "Neutroformers N-2 and N-3 each have four one one-half turn primaries." What should be the correct wording of this?

A. 2. This part of the answer should have read: "Four and one-half turn primaries."

Q. 3. Question 2129 and the accompanying answers are missing from the July, 1925, issue. Why did this occur?

A. 3. Limited space did not permit printing the following submitted by Mr. H. J. Reynolds, Atlanta, Ga.: Q. 1. Is the UV-200 tube a detector or an amplifier? A. 1. This (and the C-300) is the best detector and the worst amplifier of the tubes now available. Q. 2. How is a Neutrodyne different from any other set? A. 2. It will not "oscillate." This effect (neutralization) is automatic on all wave-lengths.

Q. 4. Should the Roberts Reflex (Q. 2120, June, 1925) be grounded?

A. 4. Yes. Ground "A" minus.

EXPERIMENTERS' CIRCUIT

(2139) Mr. Thomas E. Martin, Michigan City, Ind., asks:

Q. 1. I have about 100 feet of No. 12 German silver wire. Would this make as good an antenna as copper, or has it too much resistance?

A. 1. The resistance is much too high. Use copper for your aerial.

Q. 2. Does it make any difference how long the leads in a set are?

A. 2. All leads should be short. It is imperative that grid and plate leads (particularly the grid leads) be reduced to the shortest possible length, if best results are desired.

Q. 3. Would the enclosed circuit function satisfactorily with an outside aerial?

A. 3. We are showing this diagram with a few modifications that we believe will improve the operation of the circuit.

(Continued on page 214)

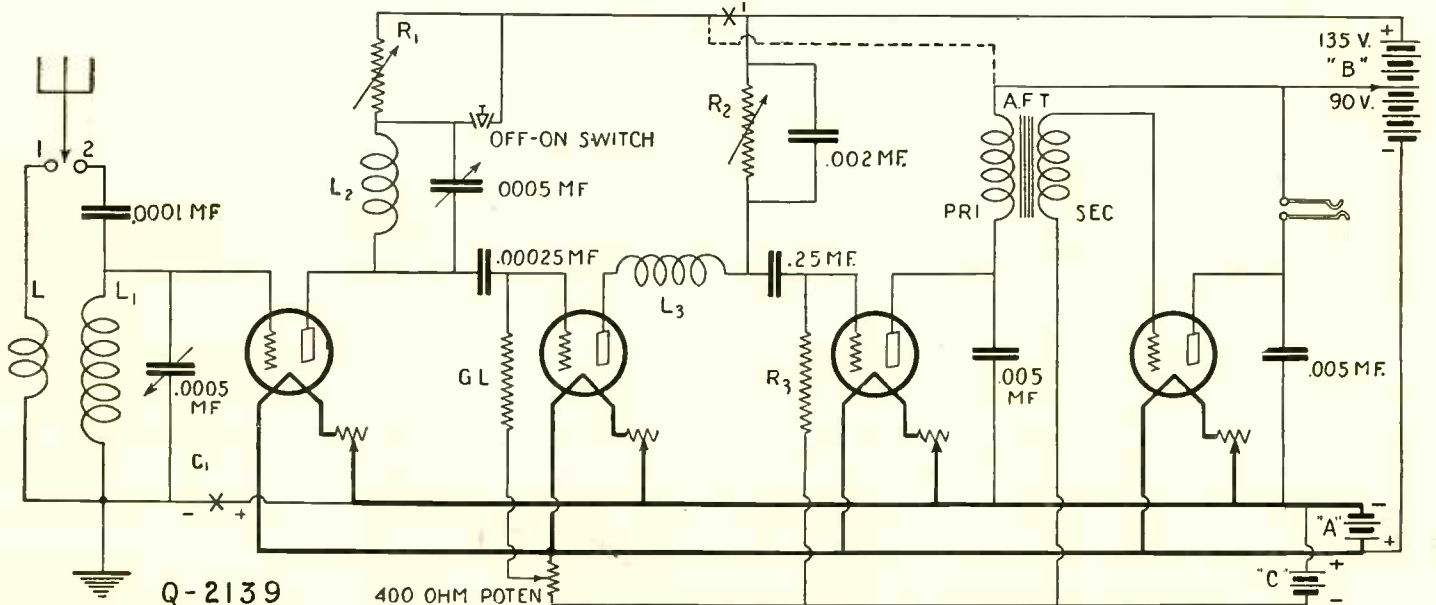

Q-2139

How an efficient receiver may be wired, using one fixed coupler, one variocoupler, two variable condensers and two variable plate resistors, in addition to the customary equipment. Coils L2 and L3 are in inductive relation to one another.

(Continued from page 151)

- Solder Co. Jiffy Blow Torch and Soldering Outfit. Courtesy Apex Stamping Co.
- 40—20 Radio Diagrams and Hook-ups. Courtesy the Conrad Co. 1 Ekko Stamp Album. Courtesy the Ekko Co.
- 41—1 Glass Enclosed Crystal Detector. 3 Wonder Crystals, 1 Package Catwhiskers. Courtesy California Radio Minerals. Aerial Lead-in Connector. Courtesy Radio Specialty Co.
- 42—1 Ekko Stamp Album. Courtesy the Ekko Co. 2 Four-inch Bakelite Dials. Courtesy Bell Mfg. Co. De-Tec-Tone Crystal Detector. Courtesy Pyramid Products Co. 2 Crystals. Courtesy Newman Stern Co.
- 43—1 Year's Subscription to RADIO NEWS. Courtesy the Experimenter Publishing Co.
- 44—1 Cushion V. T. Socket. Courtesy the Illinois Radio Co. 1 Ekko Stamp Album. Courtesy the Ekko Co. 1 Jiffy Ribbon Antenna. Courtesy the Apex Stamping Co. 4 V. G. Connectors. Courtesy the Illinois Radio Co.
- 45—Set of Model C-10 Blue Prints for making receivers. Courtesy the Experimenters' Information Service, Inc. Ekko Stamp Album. Courtesy the Ekko Co.
- 46—Vernier Crystal Detector. Courtesy Roland Brownlee and Co. 1 Ekko Stamp Album. Courtesy the Ekko Co. 1 Package of Catwhiskers. 1 Wonder Crystal. Courtesy California Radio Minerals.
- 47—Wireless Course in Twenty Lessons. Courtesy the Conrad Co.
- 48—1 Year's Subscription to SCIENCE AND INVENTION. Courtesy the Experimenter Pub. Co.
- 49—1 Rasco Crystal Detector. Courtesy the Radio Specialty Co. 1 Ekko Stamp Album. Courtesy the Ekko Co. Jiffy Ribbon Antenna. Courtesy the Apex Stamping Co. 1 Package of Catwhiskers. Courtesy California Radio Minerals.
- 50—2 Vario-Densers, Model N. Courtesy X-L Radio Laboratories. De-Tec-Tone Crystal Detector. Courtesy Pyramid Products Co. 2 Tested Crystals. Courtesy Newman Stern Co.
- 51—Radio Listeners' Guide and Call Book. Courtesy Conrad Co. Ekko Stamp Album. Courtesy Ekko Co.
- 52—Jiffy Ribbon Antenna. Courtesy Apex Stamping Co. Glass-enclosed Crystal Detector. 1 Wonder Crystal. 1 Package Catwhiskers. Courtesy California Radio Minerals.
- 52A—Genwin Three Circuit Tuner. Courtesy General Radio Winding Co.
- 53—1 Pilot Light Switch. Courtesy Yaxley Mfg. Co. 1 Set Lavite Resistances. Courtesy Crescent Radio Supply Co.
- 54—1 Shock Proof Phone Plug. Courtesy L. S. Brach Mfg. Co. 1 Ekko Stamp Album. Courtesy Ekko Co.
- 55—1 Year's Subscription to THE EXPERIMENTER. Courtesy the Experimenter Publishing Co.
- 56—Single Pole Double Throw Jack Switch, 1 Portable Jack. Courtesy Carter Radio Co. Ekko Stamp Album. Courtesy Ekko Co.
- 57—Tuway Plug, 1 Double Circuit Jack. Courtesy Carter Radio Co.
- 58—2 Packages Kester Solder. Courtesy Chicago Solder Co. 2 Aerial Insulators. Courtesy American Hard Rubber Co.
- 59—Glass-enclosed Crystal Detector. 1 Package Catwhiskers. Courtesy California Radio Minerals. 2 Tested Crystals. Courtesy Newman Stern Co.
- 60—1 Year's Subscription to MOTOR CAMPER & TOURIST. Courtesy Experimenter Pub. Co.
- 61—Jiffy Ribbon Antenna. Courtesy Apex Stamping Co. Ekko Stamp Album. Courtesy Ekko Co.
- 62—2 Tested Crystals. Courtesy Newman Stern Co. 2 V. G. Connectors. Courtesy Illinois Radio Co. 1 Package Catwhiskers. Courtesy California Radio Minerals.
- 63—Radio Log Book. Courtesy Conrad Co. Ekko Stamp Album. Courtesy Ekko Co.
- 64—Packet C. Courtesy Conrad Co.
- 65—Packet D. Courtesy Conrad Co.
- 66—1 Package Catwhiskers. Courtesy California Radio Minerals. Ekko Stamp Album. Courtesy Ekko Co.
- 12—Head-set and Plug. Courtesy Wm. J. Murdock Co.
- 13—Resistance-coupled Amplifier Kit. Courtesy Electrad, Inc.
- 14—13 Conrad Patterns. Courtesy Conrad Co.
- 15—Super Booster Wave Trap. Courtesy Super Booster Dist. Co.
- 16—1 Audio Transformer. Courtesy Acme Apparatus Co. Kant Blo Switch Tube Protector. Courtesy Clark and Tilson, Inc.
- 17—1 Year's Subscription to RADIO NEWS and THE EXPERIMENTER. Courtesy The Experimenter Pub. Co.
- 18—1 Wave Trap. Courtesy Ferhend Electric Co.
- 19—Conrad Library, fourteen books. Courtesy Conrad Co.
- 20—1 Lamp Socket Antenna. Courtesy Electrad, Inc. 1 Cushion V. T. Socket. Courtesy Illinois Radio Co. 1 Polyplug. Courtesy Polymet Mfg. Corp.
- 21—1 Year's Subscription to SCIENCE AND INVENTION and MOTOR CAMPER & TOURIST. Courtesy The Experimenter Pub. Co.
- 22—Ekko Stamp Album. Courtesy Ekko Co. 3 A-1 Wonder Crystals. 1 Glass-enclosed Detector, 1 package Catwhiskers. Courtesy California Radio Minerals.
- 23—1 Audio Transformer. Courtesy Acme Apparatus Co. 1 Ekko Stamp Album. Courtesy Ekko Co.
- 24—2 Vario-Densers, Model G. Courtesy X-L Radio Laboratories. 1 Aerial Lead-in Connector, 1 package Name-Plates. Courtesy Radio Specialty Co.
- 25—No-Dust Blower. Courtesy Peiffer and Co. Ekko Stamp Album. Courtesy The Ekko Co. 1 Rheostat. Courtesy Klosner Radio Corp. 4 V. G. Connectors. Courtesy Illinois Radio Co.
- 26—1 Year's Subscription to RADIO NEWS. Courtesy Experimenter Pub. Co.
- 27—Keystone Lightning Arrestor. Courtesy Electric Service Supplies Co. 1 Vernier Rheostat. Courtesy Klosner Radio Corp. Ekko Stamp Album. Courtesy The Ekko Co.
- 27A—1 Audio Transformer. Courtesy Halldorson Co.
- 28—Vernier Crystal Detector. Courtesy Roland Brownlee and Co. 2 Crystals. Courtesy Newman Stern and Co. "How and Why of Radio Apparatus." Courtesy Conrad Co.
- 29—1 Year's Subscription to SCIENCE AND INVENTION. Courtesy Experimenter Pub. Co. Ekko Stamp Album. Courtesy Ekko Co.
- 30—Kant Blo Switch. Courtesy Clark and Tilson, Inc. Jiffy Ribbon Antenna. Courtesy Apex Stamping Co. Two Bakelite Sockets. Courtesy Bell Mfg. Co. Ekko Stamp Album. Courtesy Ekko Co.
- 31—Radio Map of the United States. Courtesy Conrad Co. Ekko Stamp Album. Courtesy Ekko Co.
- 32—Bakelite Dial. Courtesy the American Hard Rubber Co. Jiffy Blow Torch and Soldering Outfit. Courtesy the Apex Stamping Co. 1 Polyplug. Courtesy Polymet Mfg. Co. Sixteen-in-One Radio Tool. Courtesy Radio Specialty Co.
- 33—1 Year's Subscription to THE EXPERIMENTER. Courtesy The Experimenter Pub. Co. 1 Ekko Stamp Album. Courtesy The Ekko Co.
- 34—2 Vario-Densers, Model N. Courtesy X-L Radio Laboratories. Ekko Stamp Album. Courtesy the Ekko Co.
- 35—Set of Model C-10 Blue Prints for making receivers. Courtesy the Experimenters' Information Service, Inc. Ekko Stamp Album. Courtesy the Ekko Co.
- 36—2 Vernier attachments for dials. Courtesy the Radio Specialty Co. Polyplug. Courtesy the Polymet Mfg. Co.
- 37—1 Year's Subscription to MOTOR CAMPER AND TOURIST. Courtesy the Experimenter Pub. Co. Ekko Stamp Album. Courtesy Ekko Co.
- 38—1 Plain Rheostat. Courtesy Klosner Radio Corp. Keystone Lightning Arrestor. Courtesy the Electric Service Supplies Co. Ekko Stamp Album. Courtesy the Ekko Co.
- 39—Lamp Socket Antenna. Courtesy Electrad, Inc. 2 Packages of Kester Solder. Courtesy Chicago Solder Co. Jiffy Blow Torch and Soldering Outfit. Courtesy Apex Stamping Co.
- 40—20 Radio Diagrams and Hook-ups. Courtesy the Conrad Co. 1 Ekko Stamp Album. Courtesy the Ekko Co.
- 41—1 Glass Enclosed Crystal Detector. 3 Wonder Crystals, 1 Package Catwhiskers. Courtesy California Radio Minerals. Aerial Lead-in Connector. Courtesy Radio Specialty Co.
- 42—1 Ekko Stamp Album. Courtesy the Ekko Co. 2 Four-inch Bakelite Dials. Courtesy Bell Mfg. Co. De-Tec-Tone Crystal Detector. Courtesy Pyramid Products Co. 2 Crystals. Courtesy Newman Stern Co.
- 43—1 Year's Subscription to RADIO NEWS. Courtesy the Experimenter Publishing Co.
- 44—1 Cushion V. T. Socket. Courtesy the Illinois Radio Co. 1 Ekko Stamp Album. Courtesy the Ekko Co. 1 Jiffy Ribbon Antenna. Courtesy the Apex Stamping Co. 4 V. G. Connectors. Courtesy the Illinois Radio Co.
- 45—Set of Model C-10 Blue Prints for making receivers. Courtesy the Experimenters' Information Service, Inc. Ekko Stamp Album. Courtesy the Ekko Co.
- 46—Vernier Crystal Detector. Courtesy Roland Brownlee and Co. 1 Ekko Stamp Album. Courtesy the Ekko Co. 1 Package of Catwhiskers. 1 Wonder Crystal. Courtesy California Radio Minerals.
- 47—Wireless Course in Twenty Lessons. Courtesy the Conrad Co.
- 48—1 Year's Subscription to SCIENCE AND INVENTION. Courtesy the Experimenter Pub. Co.
- 49—1 Rasco Crystal Detector. Courtesy the Radio Specialty Co. 1 Ekko Stamp Album. Courtesy the Ekko Co. Jiffy Ribbon Antenna. Courtesy the Apex Stamping Co. 1 Package of Catwhiskers. Courtesy California Radio Minerals.
- 50—2 Vario-Densers, Model N. Courtesy X-L Radio Laboratories. De-Tec-Tone Crystal Detector. Courtesy Pyramid Products Co. 2 Tested Crystals. Courtesy Newman Stern Co.
- 51—Radio Listeners' Guide and Call Book. Courtesy Conrad Co. Ekko Stamp Album. Courtesy Ekko Co.
- 52—Jiffy Ribbon Antenna. Courtesy Apex Stamping Co. Glass-enclosed Crystal Detector. 1 Wonder Crystal. 1 Package Catwhiskers. Courtesy California Radio Minerals.
- 52A—Genwin Three Circuit Tuner. Courtesy General Radio Winding Co.
- 53—1 Pilot Light Switch. Courtesy Yaxley Mfg. Co. 1 Set Lavite Resistances. Courtesy Crescent Radio Supply Co.
- 54—1 Shock Proof Phone Plug. Courtesy L. S. Brach Mfg. Co. 1 Ekko Stamp Album. Courtesy Ekko Co.
- 55—1 Year's Subscription to THE EXPERIMENTER. Courtesy the Experimenter Publishing Co.
- 56—Single Pole Double Throw Jack Switch, 1 Portable Jack. Courtesy Carter Radio Co. Ekko Stamp Album. Courtesy Ekko Co.
- 57—Tuway Plug, 1 Double Circuit Jack. Courtesy Carter Radio Co.
- 58—2 Packages Kester Solder. Courtesy Chicago Solder Co. 2 Aerial Insulators. Courtesy American Hard Rubber Co.
- 59—Glass-enclosed Crystal Detector. 1 Package Catwhiskers. Courtesy California Radio Minerals. 2 Tested Crystals. Courtesy Newman Stern Co.
- 60—1 Year's Subscription to MOTOR CAMPER & TOURIST. Courtesy Experimenter Pub. Co.
- 61—Jiffy Ribbon Antenna. Courtesy Apex Stamping Co. Ekko Stamp Album. Courtesy Ekko Co.
- 62—2 Tested Crystals. Courtesy Newman Stern Co. 2 V. G. Connectors. Courtesy Illinois Radio Co. 1 Package Catwhiskers. Courtesy California Radio Minerals.
- 63—Radio Log Book. Courtesy Conrad Co. Ekko Stamp Album. Courtesy Ekko Co.
- 64—Packet C. Courtesy Conrad Co.
- 65—Packet D. Courtesy Conrad Co.
- 66—1 Package Catwhiskers. Courtesy California Radio Minerals. Ekko Stamp Album. Courtesy Ekko Co.

Zone 3

Pennsylvania, Maryland, Virginia and West Virginia

- 1—Freshman Masterpiece, Model 5-F-2. Courtesy Chas. Freshman Co.
- 1A—All-Amaz, Jr. Radio Receiver Kit. Courtesy All-American Radio Corp.
- 2—Balkite "B" Current Supply. Courtesy Fansteel Products Co.
- 3—Grand Opera Loud Speaker. Courtesy Radio Industries Corp.
- 4—Super Booster Wave Trap. Courtesy Super Booster Distributing Co.
- 5—Scientific Loud Speaker. Courtesy Tower Mfg. Co.
- 6—Ferbend Wave Trap. Courtesy Ferhend Electric Co.
- 7—23-Plate Plain Variable Condenser. Courtesy Hammarlund Mfg. Co.
- 8—Melotone Horn-type Loud Speaker. Courtesy Radio Industries Corp.
- 9—3 Balloon Circloids Coils. Courtesy Electrical Research Laboratories. 3 Variable Condensers. Courtesy U. S. Tool Company.
- 10—2 Audio Transformers. Courtesy Halldorson Company.
- 11—1 Year's Subscription to RADIO NEWS, SCIENCE AND INVENTION, THE EXPERIMENTER, MOTOR CAMPER & TOURIST. Courtesy The Experimenter Pub. Co.
- 1—Penetrola. Courtesy Walbert Mfg. Co.
- 1A—All-Amaz Sr., Radio Receiver Kit. Courtesy All-American Radio Corp.
- 2—Victoreen Super-heterodyne Kit. Courtesy Victoreen Radio, Inc.
- 3—Grand Opera Loud Speaker. Courtesy Radio Industries Corp.
- 4—Super Booster Wave Trap. Courtesy Super Booster Distributing Co.
- 5—Spitfire Loud Speaker. Courtesy Tower Mfg. Co.
- 6—Ferbend Wave Trap. Courtesy Ferhend Electric Co.
- 7—23-Plate Plain Variable Condenser. Courtesy Hammarlund Mfg. Co.
- 8—Melotone Horn-type Loud Speaker. Courtesy Radio Industries Corp.
- 9—3 Balloon Circloid Coils. Courtesy Electrical Research Laboratories. 3 Variable Condensers. Courtesy U. S. Tool Co.
- 10—2 Audio Transformers. Courtesy Halldorson Co.
- 11—1 Year's Subscription to RADIO NEWS, SCIENCE AND INVENTION, THE EXPERIMENTER, MOTOR CAMPER & TOURIST. Courtesy The Experimenter Pub. Co.
- 12—Head-set and Plug. Courtesy William J. Murdock Co.
- 13—Resistance-coupled Amplifier Kit. Courtesy Electrad, Inc.
- 14—13 Conrad Patterns. Courtesy Conrad Co.
- 15—Super Booster Wave Trap. Courtesy Super Booster Distributing Co.
- 16—1 Audio Transformer. Courtesy Acme Apparatus Co. Kant Blo Switch. Courtesy Clark and Tilson, Inc.
- 17—1 Year's Subscription to RADIO NEWS, THE EXPERIMENTER. Courtesy the Experimenter Pub. Co.
- 18—Ferbend Wave Trap. Courtesy Ferhend Electric Co.
- 19—Conrad Library of Fourteen Books. Courtesy Conrad Co.
- 20—Lamp Socket Antenna. Courtesy Electrad, Inc. Cushion V. T. Socket. Courtesy Illinois Radio Co. Polyplug. Courtesy Polymet Mfg. Co.
- 21—1 Year's Subscription to SCIENCE AND INVENTION and MOTOR CAMPER & TOURIST. Courtesy The Experimenter Pub. Co.
- 22—Ekko Stamp Album. Courtesy Ekko Co. 3 A-1 Wonder Crystals, 1 Glass-enclosed Detector, 1 package Catwhiskers. Courtesy California Radio Minerals.
- 23—1 Audio Transformer. Courtesy Acme Apparatus Co. 1 Ekko Stamp Album. Courtesy Ekko Co.
- 24—2 Vario-Densers, Model G. Courtesy X-L Radio Laboratories. 1 Aerial Lead-in Connector, 1 package Name-Plates. Courtesy Radio Specialty Co.
- 25—No-Dust Blower. Courtesy Peiffer and Co. Ekko Stamp Album. Courtesy The Ekko Co.

Zone 4

Ohio, Indiana, Michigan, Illinois, Wisconsin and Kentucky

- 1—Penetrola. Courtesy Walbert Mfg. Co.
- 1A—All-Amaz Sr., Radio Receiver Kit. Courtesy All-American Radio Corp.
- 2—Victoreen Super-heterodyne Kit. Courtesy Victoreen Radio, Inc.
- 3—Grand Opera Loud Speaker. Courtesy Radio Industries Corp.
- 4—Super Booster Wave Trap. Courtesy Super Booster Distributing Co.
- 5—Spitfire Loud Speaker. Courtesy Tower Mfg. Co.
- 6—Ferbend Wave Trap. Courtesy Ferhend Electric Co.
- 7—23-Plate Plain Variable Condenser. Courtesy Hammarlund Mfg. Co.
- 8—Melotone Horn-type Loud Speaker. Courtesy Radio Industries Corp.
- 9—3 Balloon Circloid Coils. Courtesy Electrical Research Laboratories. 3 Variable Condensers. Courtesy U. S. Tool Co.
- 10—2 Audio Transformers. Courtesy Halldorson Co.
- 11—1 Year's Subscription to RADIO NEWS, SCIENCE AND INVENTION, THE EXPERIMENTER, MOTOR CAMPER & TOURIST. Courtesy The Experimenter Pub. Co.
- 12—Head-set and Plug. Courtesy William J. Murdock Co.
- 13—Resistance-coupled Amplifier Kit. Courtesy Electrad, Inc.
- 14—13 Conrad Patterns. Courtesy Conrad Co.
- 15—Super Booster Wave Trap. Courtesy Super Booster Distributing Co.
- 16—1 Audio Transformer. Courtesy Acme Apparatus Co. Kant Blo Switch. Courtesy Clark and Tilson, Inc.
- 17—1 Year's Subscription to RADIO NEWS, THE EXPERIMENTER. Courtesy the Experimenter Pub. Co.
- 18—Ferbend Wave Trap. Courtesy Ferhend Electric Co.
- 19—Conrad Library of Fourteen Books. Courtesy Conrad Co.
- 20—Lamp Socket Antenna. Courtesy Electrad, Inc. Cushion V. T. Socket. Courtesy Illinois Radio Co. Polyplug. Courtesy Polymet Mfg. Co.
- 21—1 Year's Subscription to SCIENCE AND INVENTION and MOTOR CAMPER & TOURIST. Courtesy The Experimenter Pub. Co.
- 22—Ekko Stamp Album. Courtesy Ekko Co. 3 A-1 Wonder Crystals, 1 Glass-enclosed Detector, 1 package Catwhiskers. Courtesy California Radio Minerals.
- 23—1 Audio Transformer. Courtesy Acme Apparatus Co. 1 Ekko Stamp Album. Courtesy Ekko Co.
- 24—2 Vario-Densers, Model G. Courtesy X-L Radio Laboratories. 1 Aerial Lead-in Connector, 1 package Name-Plates. Courtesy Radio Specialty Co.
- 25—No-Dust Blower. Courtesy Peiffer and Co. Ekko Stamp Album. Courtesy The Ekko Co.

- 26—1 Year's Subscription to RADIO NEWS. Courtesy Experimenter Pub. Co.
- 27—Keystone Lightning Arrestor. Courtesy Electric Service Supplies Co. 1 Vernier Rheostat. Courtesy Klosner Radio Corp. Ekko Stamp Album. Courtesy The Ekko Co.
- 27A—1 Audio Transformer. Courtesy Halldorson Co.
- 28—Vernier Crystal Detector. Courtesy Roland Brownlee and Co. 2 Crystals. Courtesy Newman Stern and Co. "How and Why of Radio Apparatus." Courtesy Consrad Co.
- 29—1 Year's Subscription to SCIENCE AND INVENTION. Courtesy Experimenter Pub. Co. Ekko Stamp Album. Courtesy Ekko Co.
- 30—Kant Blo Switch. Courtesy Clark and Tilson, Inc. Jiffy Ribbon Antenna. Courtesy Apex Stamping Co. Two Bakelite Sockets. Courtesy Bell Mfg. Co. Ekko Stamp Album. Courtesy Ekko Co.
- 31—Radio Map of the United States. Courtesy Consrad Co. Ekko Stamp Album. Courtesy Ekko Co.
- 32—Bakelite Dial. Courtesy the American Hard Rubber Co. Jiffy Blow Torch and Soldering Outfit. Courtesy the Apex Stamping Co. 1 Polyplug. Courtesy Polymet Mfg. Co. Sixteen-in-One Radio Tool. Courtesy Radio Specialty Co.
- 33—1 Year's Subscription to THE EXPERIMENTER. Courtesy The Experimenter Pub. Co. 1 Ekko Stamp Album. Courtesy The Ekko Co.
- 34—2 Vario-Densers, Model N. Courtesy X-L Radio Laboratories. Ekko Stamp Album. Courtesy the Ekko Co.
- 35—Set of Model C-10 Blue Prints for making receivers. Courtesy the Experimenters' Information Service, Inc. Ekko Stamp Album. Courtesy the Ekko Co.
- 36—2 Vernier attachments for dials. Courtesy the Radio Specialty Co. Polyplug. Courtesy the Polymet Mfg. Co.
- 37—1 Year's Subscription to MOTOR CAMPER AND TOURIST. Courtesy the Experimenter Publishing Co. Ekko Stamp Album. Courtesy the Ekko Co.
- 38—1 Plain Rheostat. Courtesy Klosner Radio Corp. Keystone Lightning Arrestor. Courtesy the Electric Service Supplies Co. Ekko Stamp Album. Courtesy the Ekko Co.
- 39—Lamp Socket Antenna. Courtesy Electrad, Inc. 2 Packages of Kester Solder. Courtesy Chicago Solder Co. Jiffy Blow Torch and Soldering Outfit. Courtesy Apex Stamping Co.
- 40—20 Radio Diagrams and Hook-ups. Courtesy the Consrad Co. 1 Ekko Stamp Album. Courtesy the Ekko Co.
- 41—1 Glass Enclosed Crystal Detector. 3 Wonder Crystals, 1 Package Catwhiskers. Courtesy California Radio Minerals. Aerial Lead-in Connector. Courtesy Radio Specialty Co.
- 42—1 Ekko Stamp Album. Courtesy the Ekko Co. 2 Four-inch Bakelite Dials. Courtesy Bell Mfg. Co. De-Tec-Tone Crystal Detector. Courtesy Pyramid Products Co. 2 Crystals. Courtesy Newman Stern Co.
- 43—1 Year's Subscription to RADIO NEWS. Courtesy the Experimenter Publishing Co.
- 44—1 Cushion V. T. Socket. Courtesy the Illinois Radio Co. 1 Ekko Stamp Album. Courtesy the Ekko Co. 1 Jiffy Ribbon Antenna. Courtesy the Apex Stamping Co. 4 V. G. Connectors. Courtesy the Illinois Radio Co.
- 45—Set of Model C-10 Blue Prints for making receivers. Courtesy the Experimenters' Information Service, Inc. Ekko Stamp Album. Courtesy the Ekko Co.
- 46—Vernier Crystal Detector. Courtesy Roland Brownlee and Co. 1 Ekko Stamp Album. Courtesy the Ekko Co. 1 Package of Catwhiskers. 1 Wonder Crystal. Courtesy California Radio Minerals.
- 47—Wireless Course in Twenty Lessons. Courtesy the Consrad Co.
- 48—1 Year's Subscription to SCIENCE AND INVENTION. Courtesy the Experimenter Pub. Co.
- 49—1 Rasco Crystal Detector. Courtesy the Radio Specialty Co. 1 Ekko Stamp Album. Courtesy the Ekko Co. Jiffy Ribbon Antenna. Courtesy the Apex Stamping Co. 1 Package of Catwhiskers. Courtesy California Radio Minerals.
- 50—2 Vario-Densers, Model N. Courtesy X-L Radio Laboratories. De-Tec-Tone Crystal Detector. Courtesy Pyramid Products Co. 2 Tested Crystals. Courtesy Newman Stern Co.
- 51—Radio Listeners' Guide and Call Book. Courtesy Consrad Co. Ekko Stamp Album. Courtesy Ekko Co.
- 52—Jiffy Ribbon Antenna. Courtesy Apex Stamping Co. Glass-enclosed Crystal Detector. 1 Wonder Crystal. 1 Package Catwhiskers. Courtesy California Radio Minerals.
- 52A—Genwin Three Circuit Tuner. Courtesy General Radio Winding Co.
- 53—1 Pilot Light Switch. Courtesy Yaxley Mfg. Co. 1 Imp Jack and Plug. Courtesy Carter Radio Co.
- 54—1 Shock Proof Phone Plug. Courtesy L. S. Brach Mfg. Co. 1 Ekko Stamp Album. Courtesy Ekko Co.
- 55—1 Year's Subscription to THE EXPERIMENTER. Courtesy Experimenter Publishing Co.
- 56—Single Pole Double Throw Jack Switch, 1 Portable Jack. Courtesy Carter Radio Co. Ekko Stamp Album. Courtesy Ekko Co.
- 57—Tuway Plug, Double Circuit Jack. Courtesy Carter Radio Co.
- 58—2 Packages Kester Solder. Courtesy Chicago Solder Co. Jiffy Ribbon Antenna. Courtesy Apex Stamping Co.
- 59—Glass-enclosed Crystal Detector. 1 Package Catwhiskers. Courtesy California Radio Minerals. 2 Tested Crystals. Courtesy Newman Stern Co.
- 60—Receptacle Jack. Courtesy Carter Radio Co. Ekko Stamp Album. Courtesy Ekko Co.
- 61—1 Year's Subscription to MOTOR CAMPER & TOURIST. Courtesy Experimenter Pub. Co.
- 62—Oneway Plug. Courtesy Carter Radio Co. 1 Package Kester Solder. Courtesy Chicago Solder Co.
- 63—Radio Log Book. Courtesy Consrad Co. Ekko Stamp Album. Courtesy Ekko Co.
- 64—Packet C. Courtesy Consrad Co.
- 65—Packet D. Courtesy Consrad Co.
- 66—1 Package Kester Solder. Courtesy Chicago Solder Co. 1 Package Catwhiskers. Courtesy California Radio Minerals. Ekko Stamp Album. Courtesy Ekko Co.

- whiskers. Courtesy California Radio Minerals.
- 2 Tested Crystals. Courtesy Newman Stern Co.
- 60—Receptacle Jack. Courtesy Carter Radio Co. Ekko Stamp Album. Courtesy Ekko Co.
- 61—1 Year's Subscription to MOTOR CAMPER & TOURIST. Courtesy Experimenter Pub. Co.
- 62—Oneway Plug. Courtesy Carter Radio Co. 1 Package Kester Solder. Courtesy Chicago Solder Co.
- 63—Radio Log Book. Courtesy Consrad Co. Ekko Stamp Album. Courtesy Ekko Co.
- 64—Packet C. Courtesy Consrad Co.
- 65—Packet D. Courtesy Consrad Co.
- 66—1 Package Kester Solder. Courtesy Chicago Solder Co. 1 Package Catwhiskers. Courtesy California Radio Minerals. Ekko Stamp Album. Courtesy Ekko Co.

Zone 5

Tennessee, North Carolina, Mississippi, Alabama, Georgia and Florida

- 1—Victoreen Super-heterodyne Kit. Courtesy Victoreen Radio, Inc.
- 1A—All-Amx Jr. Radio Receiver Kit. Courtesy All-American Radio Corp.
- 2—Manhattan Junior Loud Speaker. Courtesy Manhattan Electric Co.
- 3—Grand Opera Loud Speaker. Courtesy Radio Industries Corp.
- 4—Super Booster Wave Trap. Courtesy Super Booster Distributing Co.
- 5—Meistersinger Loud Speaker. Courtesy Tower Mfg. Co.
- 6—Ferbend Wave Trap. Courtesy Ferbend Electric Co.
- 7—23-Plate Plain Variable Condenser. Courtesy Hammarlund Mfg. Co.
- 8—Melotone Horn-type Loud Speaker. Courtesy Radio Industries Corp.
- 9—2 Audio Transformers. Courtesy Halldorson Co.
- 10—1 Loop Aerial. Courtesy Carter Radio Co.
- 11—1 Year's Subscription to RADIO NEWS, SCIENCE AND INVENTION, THE EXPERIMENTER, MOTOR CAMPER & TOURIST. Courtesy The Experimenter Pub. Co.
- 12—Head-set and Plug. Courtesy Wm. J. Murdock Co.
- 13—Resistance-coupled Amplifier Kit. Courtesy Electrad, Inc.
- 14—13 Consrad Patterns. Courtesy Consrad Co.
- 15—Super Booster Wave Trap. Courtesy Super Booster Dist. Co.
- 16—1 Audio Transformer. Courtesy Acme Apparatus Co. Kant Blo Switch Tube Protector. Courtesy Clark and Tilson, Inc.
- 17—1 Year's Subscription to RADIO NEWS and THE EXPERIMENTER. Courtesy The Experimenter Pub. Co.
- 18—1 Wave Trap. Courtesy Ferbend Electric Co.
- 19—Consrad Library, fourteen books. Courtesy Consrad Co.
- 20—1 Lamp Socket Antenna. Courtesy Electrad, Inc. 1 Cushion V. T. Socket. Courtesy Illinois Radio Co. 1 Polyplug. Courtesy Polymet Mfg. Corp.
- 21—1 Year's Subscription to SCIENCE AND INVENTION and MOTOR CAMPER & TOURIST. Courtesy The Experimenter Pub. Co.
- 22—Ekko Stamp Album. Courtesy Ekko Co. 3 A-1 Wonder Crystals, 1 Glass-enclosed Detector, 1 package Catwhiskers. Courtesy California Radio Minerals.
- 23—1 Audio Transformer. Courtesy Acme Apparatus Co. 1 Ekko Stamp Album. Courtesy Ekko Co.
- 24—2 Vario-Densers, Model G. Courtesy X-L Radio Laboratories. 1 Aerial Lead-in Connector. 1 package Name-Plates. Courtesy Radio Specialty Co.
- 25—No-Dust Blower. Courtesy Peiffer and Co. Ekko Stamp Album. Courtesy The Ekko Co. 1 Rheostat. Courtesy Klosner Radio Corp. 4 V. G. Connectors. Courtesy Illinois Radio Co.
- 26—1 Year's Subscription to RADIO NEWS. Courtesy Experimenter Pub. Co.
- 27—Keystone Lightning Arrestor. Courtesy Electric Service Supplies Co. 1 Vernier Rheostat. Courtesy Klosner Radio Corp. Ekko Stamp Album. Courtesy The Ekko Co.
- 27A—1 Audio Transformer. Courtesy Halldorson Co.
- 28—Vernier Crystal Detector. Courtesy Roland Brownlee and Co. 2 Crystals. Courtesy Newman Stern and Co. "How and Why of Radio Apparatus." Courtesy Consrad Co.
- 29—1 Year's Subscription to SCIENCE AND INVENTION. Courtesy Experimenter Pub. Co. Ekko Stamp Album. Courtesy Ekko Co.
- 30—Kant Blo Switch. Courtesy Clark and Tilson, Inc. Jiffy Ribbon Antenna. Courtesy Apex Stamping Co. Two Bakelite Sockets. Courtesy Bell Mfg. Co. Ekko Stamp Album. Courtesy Ekko Co.
- 31—Radio Map of the United States. Courtesy Consrad Co. Ekko Stamp Album. Courtesy Ekko Co.
- 32—Bakelite Dial. Courtesy the American Hard Rubber Co. Jiffy Blow Torch and Soldering Outfit. Courtesy the Apex Stamping Co. 1 Polyplug. Courtesy Polymet Mfg. Co. Sixteen-in-One Radio Tool. Courtesy Radio Specialty Co.
- 33—1 Year's Subscription to THE EXPERIMENTER. Courtesy The Experimenter Pub. Co. 1 Ekko Stamp Album. Courtesy The Ekko Co.
- 34—2 Vario-Densers, Model N. Courtesy X-L Radio Laboratories. Ekko Stamp Album. Courtesy the Ekko Co.
- 35—Set of Model C-10 Blue Prints for making receivers. Courtesy the Experimenters' Information Service, Inc. Ekko Stamp Album. Courtesy the Ekko Co.

- ceivers. Courtesy the Experimenters' Information Service, Inc. Ekko Stamp Album. Courtesy the Ekko Co.
- 36—2 Vernier attachments for dials. Courtesy the Radio Specialty Co. Polyplug. Courtesy the Polymet Mfg. Co.
- 37—1 Year's Subscription to MOTOR CAMPER AND TOURIST. Courtesy the Experimenter Publishing Co. Ekko Stamp Album. Courtesy the Ekko Co.
- 38—1 Plain Rheostat. Courtesy Klosner Radio Corp. Keystone Lightning Arrestor. Courtesy the Electric Service Supplies Co. Ekko Stamp Album. Courtesy the Ekko Co.
- 39—Lamp Socket Antenna. Courtesy Electrad, Inc. 2 Packages of Kester Solder. Courtesy Chicago Solder Co. Jiffy Blow Torch and Soldering Outfit. Courtesy Apex Stamping Co.
- 40—20 Radio Diagrams and Hook-ups. Courtesy the Consrad Co. 1 Ekko Stamp Album. Courtesy the Ekko Co.
- 41—1 Glass Enclosed Crystal Detector. 3 Wonder Crystals, 1 Package Catwhiskers. Courtesy California Radio Minerals. Aerial Lead-in Connector. Courtesy Radio Specialty Co.
- 42—1 Ekko Stamp Album. Courtesy the Ekko Co. 2 Four-inch Bakelite Dials. Courtesy Bell Mfg. Co. De-Tec-Tone Crystal Detector. Courtesy Pyramid Products Co. 2 Crystals. Courtesy Newman Stern Co.
- 43—1 Year's Subscription to RADIO NEWS. Courtesy the Experimenter Publishing Co.
- 44—1 Cushion V. T. Socket. Courtesy the Illinois Radio Co. 1 Ekko Stamp Album. Courtesy the Ekko Co. 1 Jiffy Ribbon Antenna. Courtesy the Apex Stamping Co. 4 V. G. Connectors. Courtesy the Illinois Radio Co.
- 45—Set of Model C-10 Blue Prints for making receivers. Courtesy the Experimenters' Information Service, Inc. Ekko Stamp Album. Courtesy the Ekko Co.
- 46—Vernier Crystal Detector. Courtesy Roland Brownlee and Co. 1 Ekko Stamp Album. Courtesy the Ekko Co. 1 Package of Catwhiskers. 1 Wonder Crystal. Courtesy California Radio Minerals.
- 47—Wireless Course in Twenty Lessons. Courtesy the Consrad Co.
- 48—1 Year's Subscription to SCIENCE AND INVENTION. Courtesy the Experimenter Pub. Co.
- 49—1 Rasco Crystal Detector. Courtesy the Radio Specialty Co. 1 Ekko Stamp Album. Courtesy the Ekko Co. Jiffy Ribbon Antenna. Courtesy the Apex Stamping Co. 1 Package of Catwhiskers. Courtesy California Radio Minerals.
- 50—2 Vario-Densers, Model N. Courtesy X-L Radio Laboratories. De-Tec-Tone Crystal Detector. Courtesy Pyramid Products Co. 2 Tested Crystals. Courtesy Newman Stern Co.
- 51—Radio Listeners' Guide and Call Book. Courtesy Consrad Co. Ekko Stamp Album. Courtesy Ekko Co.
- 52—Jiffy Ribbon Antenna. Courtesy Apex Stamping Co. Glass-enclosed Crystal Detector. 1 Wonder Crystal. 1 Package Catwhiskers. Courtesy California Radio Minerals.
- 52A—Genwin Three Circuit Tuner. Courtesy General Radio Winding Co.
- 53—1 Pilot Light Switch. Courtesy Yaxley Mfg. Co. 1 Imp Jack Plug. Courtesy Carter Radio Co.
- 54—1 Shock Proof Phone Plug. Courtesy L. S. Brach Mfg. Co. 1 Ekko Stamp Album. Courtesy Ekko Co.
- 55—1 Year's Subscription to THE EXPERIMENTER. Courtesy Experimenter Publishing Co.
- 56—Single Pole Double Throw Jack Switch, 1 Portable Jack. Courtesy Carter Radio Co. Ekko Stamp Album. Courtesy Ekko Co.
- 57—Tuway Plug, Double Circuit Jack. Courtesy Carter Radio Co.
- 58—2 Packages Kester Solder. Courtesy Chicago Solder Co. Jiffy Ribbon Antenna. Courtesy Apex Stamping Co.
- 59—Glass-enclosed Crystal Detector, 1 Package Catwhiskers. Courtesy California Radio Minerals. 2 Tested Crystals. Courtesy Newman Stern Co.
- 60—Receptacle Jack. Courtesy Carter Radio Co. Ekko Stamp Album. Courtesy Ekko Co.
- 61—1 Year's Subscription to MOTOR CAMPER & TOURIST. Courtesy Experimenter Pub. Co.
- 62—Oneway Plug. Courtesy Carter Radio Co. 1 Package Kester Solder. Courtesy Chicago Solder Co.
- 63—Radio Log Book. Courtesy Consrad Co. Ekko Stamp Album. Courtesy Ekko Co.
- 64—Packet C. Courtesy Consrad Co.
- 65—Packet D. Courtesy Consrad Co.
- 66—1 Package Kester Solder. Courtesy Chicago Solder Co. 1 Package Catwhiskers. Courtesy California Radio Minerals. Ekko Stamp Album. Courtesy Ekko Co.

Zone 6

Minnesota, Iowa, Missouri, North Dakota, South Dakota, Nebraska, Kansas, Montana, Wyoming and Colorado

- 1—Victoreen Super-heterodyne Kit. Courtesy Victoreen Radio, Inc.
- 2—Manhattan Junior Loud Speaker. Courtesy Manhattan Electric Co.
- 3—A.C. Super Ducon Battery Charger. Courtesy Dubilier Condenser and Radio Corp.
- 4—Grand Opera Loud Speaker. Courtesy Radio Industries Corp.
- 5—Super Booster Wave Trap. Courtesy Super Booster Distributing Co.

(Continued on page 238)

Where does KDKA come in on YOUR dial?

Remember! There are 52 stations that have to come in below KDKA on your dial

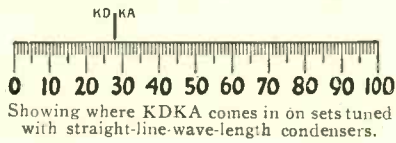
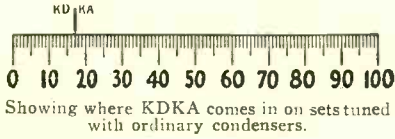

Don't overlook the audio end of your new set.
KARAS HARMONIK TRANSFORMERS
—the sensation of the 1924-25 radio season—
give you beautiful, true amplification.

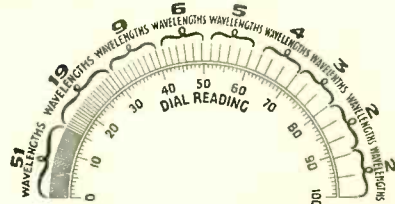

Ordinary Condenser Arrangement of Wavelengths
Ordinary straight capacity condensers crowd 70 of the 100 wave lengths into the first 30 points of the dial.

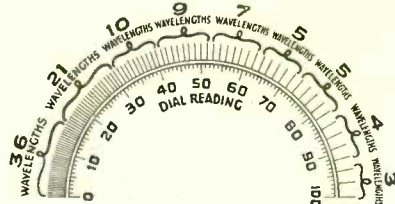

Straight Line Wavelength Condenser Arrangement
With straight-line-wave length condensers 57 of the 100 wave lengths are crowded into the first 30 points of the dial.

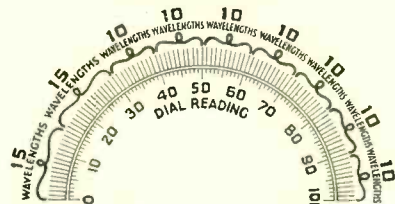

KARAS ORTHOMETRIC CONDENSER Arrangement of Wavelengths on Dial

Illustrating the equal distribution of allotted wave lengths over the entire dial range, when Karas Orthometric Condensers are used.

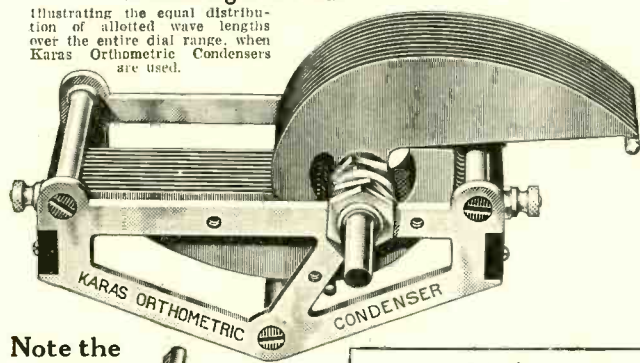

Note the Long Eccentric Plates

Made in 3 sizes
23 plates, .0005 capacity, price.....\$7.00
17 plates, .00037 capacity, price..... 6.75
11 plates, .00025 capacity, price..... 6.50

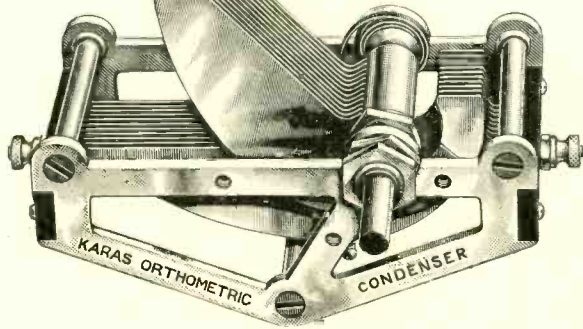

HERE is an interesting experience told by a skilled operator after he had tuned his "super" with Karas Orthometric Condensers for the first time:

"In spite of my confidence in your statements regarding Karas Orthometric Condensers, I couldn't help but look for KDKA around 17, where I had always received that station. When they were not there, I gradually crept up to 53, where you said they would be. Sure enough, there they were at 52, clearer and better than I had ever had them before. But with KDKA as high as 52, I began to wonder if KYW and KSD would come in at all on my dials. So I went after them and, sure enough, got KSD at 95. Am I tickled with my new condensers? Well, I should say I am—they give a NEW kick to 'fishing'."

A. W. NASON, 160 N. LaSalle St., Chicago, Ill.

KARAS Orthometric Condensers

Entirely eliminate crowding of stations
On any part of the dial

All adjoining wave lengths are separated by equal distances on the dial. Each point on the dial from 1 to 100 corresponds to one of the 100 allotted wave lengths, between 200 and 600 meters, separated from adjoining wave lengths by 10 kilocycles. Thus Karas Orthometric Condensers make your set conform to the station arrangement fixed by the government—by which every wave length is separated from adjacent wave lengths by an equal interval—10 kilocycles.

This clean cut separation of stations insures clearer, better reception than you have ever known because you receive all the side bands without interference from adjoining stations—interference that is unavoidable with old types of condensers which crowd low wave length stations so confusingly close together.

The Karas Orthometric stands absolutely alone! It is the first and only condenser of its type on the market—an eccentric condenser scientifically designed specially for broadcast receiving sets—not a relic of wireless days, out of step with new conditions.

Think of it! With the ordinary condenser, half of all the 100 allotted wave lengths are jammed into the first 15 points of your dial—even with the straight-line-wave-length condenser, the first 50 wave lengths are crowded into the lower 25 points of your dial. But with Karas Orthometrics, there is absolutely no crowding. The 100 allotted wave lengths are evenly distributed over your entire dial, every point on your dial corresponding accurately to one distinct wave length. No crowding anywhere! Wide, even distribution over the entire range.

Gets Low Power Stations Never Heard Before

Low power. Class A stations all broadcast on low wave lengths, corresponding to low dial settings—where ordinary condensers have so high a resistance that the weak signal cannot get through. Karas Orthometric design has changed all that. Due to their scientific design throughout, resistance at low settings is reduced to a negligible minimum. Weak stations you never heard before come in with satisfactory volume. And due to the marked eccentric shape of the plates, high wave stations will tune in much sharper than you have ever experienced.

The Karas Orthometric is a "job" that will delight the eye of the mechanical critic. It is made entirely of brass—frame and plates all die stamped—plates, patent leveled and entirely bridged to insure permanent rigidity and alignment. Every joint throughout is soldered. Grounded frame and rotor, with stator plates supported on hard rubber insulation. Tapered adjustable cone bearings, spring copper pigtail connection, automatic stops—in short, a condenser that is both theoretically and mechanically perfect.

Never forget that your condenser is your vital tuning instrument. It determines the tuning characteristics of your set.

Of course you will want Karas Orthometrics. It will pay you to wait for them. Deliveries start August 15th. But it will take some time to supply all dealers and jobbers. Applications will be taken care of in the order received. Individual builders, living in the smaller cities, wishing to be assured of prompt supply, are advised to place their orders immediately for shipment, Aug. 15th.

KARAS ELECTRIC COMPANY, Dept. C594
4038 N. Rockwell St., Chicago

USE THIS COUPON

KARAS ELECTRIC CO., Dept. C594,
4038 N. Rockwell St., Chicago.

Enter my advance order for.....Karas
Orthometric Condensers for shipment on or about
Aug. 15th, subject to your money-back guarantee.

Inclosed find \$..... in payment.

(State size desired).....

Name

Address

Positively Guaranteed

—not with the usual meaningless guarantee of "material and workmanship"

—but a guarantee of Complete satisfaction or your money back.



**EARN
\$50 to \$200
A WEEK!**

Become a Radio Expert

THIS is the time to get into Radio—the new, fast growing, uncrowded profession. Stop working long hours for small pay at work that is drudgery. Men from all walks of life are taking advantage of the big opportunities now open in this wonderful new industry. Salaries of \$100 a week—and more—not at all uncommon!

Learn at Home

You can train for this "big money" field right in your own home—in spare time. No matter how little you know about electricity or Radio, the National Radio Institute—the largest and oldest home-study Radio school in the world—established 1914—can quickly make you an expert through a marvelous method of practical instruction—which includes all necessary parts for building up-to-date receiving sets.

Big Demand Now

Almost every day we get urgent calls for our graduates. The big jobs hunt you when you are a Radio expert. Radio offers you more money than you ever dreamed possible—a chance to travel or to take any one of the many Radio positions all around you at home. Offers you a glorious future!

Send for FREE Book

Write today for free book "Rich Rewards in Radio." Tells all about this great new money-making field—and describes our amazing practical method which trains you for the bigger paying jobs in Radio. No obligation. Mail coupon now

National Radio Institute
Dept. 13KB, Washington, D. C.



The National Radio Institute,
Dept. 13KB, Washington, D. C.

I am interested in Radio as a profession. You may send me, free and without obligation, your interesting book, "Rich Rewards in Radio," all information about your spare time, home-study plan and about your free employment service. Also, the details of your Special Offer.

Name..... Age.....
Street.....
City..... State.....

Straight-Line Frequency Condensers

(Continued from page 190)

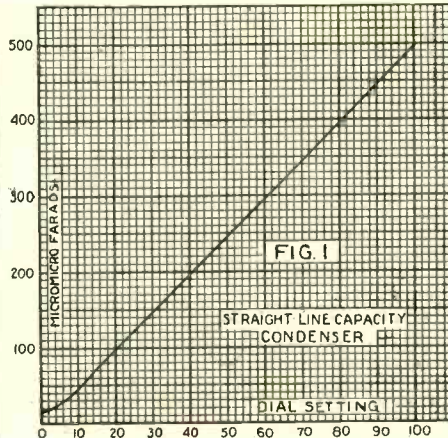

Capacity calibration curve of circular-plate condenser.

have no effect on the straight-line characteristic of the condenser.

It is also possible to build a condenser of square or rectangular plates which will give a straight-line frequency calibration. The shape of the plates required in this type of condenser is shown in Fig. 9 and the equation of the curve with respect to the line 0-0 is

$$y = \frac{3a}{x^2} + y_0$$

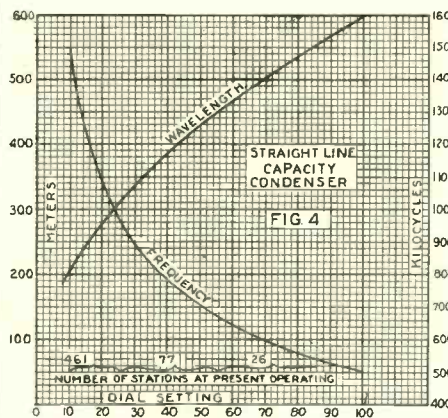

How the stations are crowded at the low end of the circular-plate condenser.

in which y is the height of the curve from the line 0-0, x is the distance along 0-0 and a and y₀ are constants. The curve may be duplicated on either side of 0-0 as has been done in Fig. 9a, if we so desire, to enable us to reduce the number of plates.

But this particular shape of straight-line condenser does not solve the problem any more than does the shape shown in Fig. 9. It is open to the same objections; the plate must be so cut away at the small ends, and must increase at such a rapid rate toward the large end that to obtain this rapid increase, and at the same time obtain the required maximum capacity of the condenser the dimensions of the condenser must become inordinately large.

Up to the present time no one has written of any way in which to overcome these inherent difficulties in the design of straight-line frequency condensers. There is, however, an expedient that might be used, which the writer may tell about some time later.

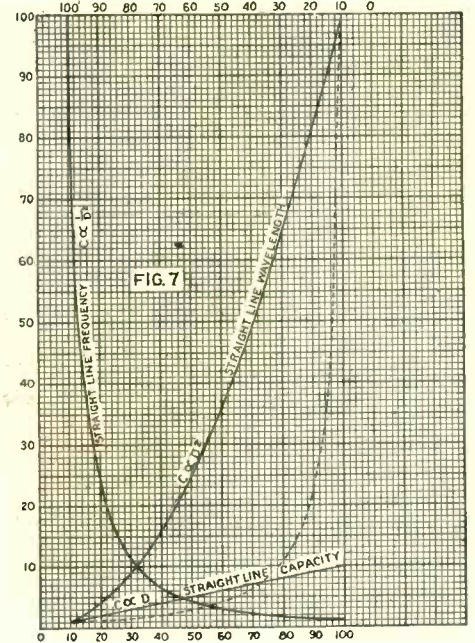

The vertical axis shows the ratio of capacity at any dial setting (indicated on the horizontal axis) to the capacity at 10 on the dial.

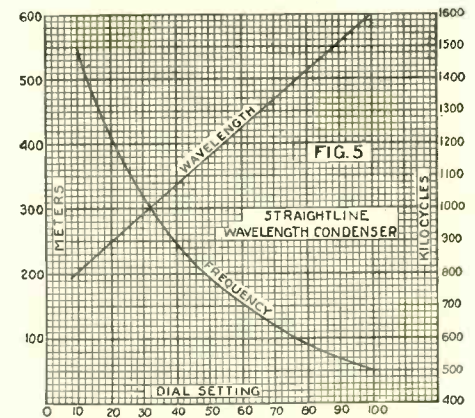

This curve is less steep than the one in Fig. 4, indicating that the stations are not so crowded.

For the present, however, it seems that we will have to be content with straight-line frequency condensers of small capacity, say 0.0002 microfarad, if we wish them to have low minimum capacities. Or, if we wish maximum capacities as high as, say 0.0005 microfarad, we shall have to be content with high minimum capacities.

The straight-line frequency condenser has to be designed to have a certain minimum capacity. This minimum capacity cannot be zero for the inverse-square law which must apply in straight-line frequency condensers requires a definite rate of variation of capacity from the lowest to the highest, or from the minimum to the maximum.

A TONE CONTROL NEEDED

Student: Why have the birth control "anti's" started to wage war on loud speakers?

Freshie: I suppose facts of reproduction are being made too public.

The Wonder of Radio!



Crosley owns and operates station WLW, Cincinnati, the first remotely controlled super-power broadcasting station

CROSLEY 50 One tube set



2-Tube Crosley 51

Same as wonderful Crosley 50 with additional tube amplifier. Local and nearby stations on loud-speaker always and distance up to 1500 miles under average conditions. Much greater range with head phones.

Special Sloping Front 2-Tube Crosley 51
Same as Model 51, with cabinet holding all dry A and B batteries. \$23.50.

2-Tube Crosley 51 Portable

The Crosley 51 in a black leatherette case, with nickel trimmings. Space for batteries. \$23.50.

Crosley Musicone

A marvelous new development of loud-speaking principles. Diffusion of sound creates perfect reproduction of all tones. \$17.50.



3-Tube Crosley 52

A larger set for those who want greater reception range on the loud-speaker. Operates on three tubes, using wet or dry batteries. Consistent loud-speaker range 1500 miles or more.

Special Sloping Front 3-Tube Crosley 52
Cabinet contains dry A and B batteries. Same efficient detection and reception as regular 52. \$35.

3-Tube Crosley 52 Portable

Same as other 52 models, but in a black leatherette case. Easily carried. All batteries inside. \$35.

Prices quoted above do not include accessories. Add 10 per cent west of Rocky Mountains.

Crosley, the world's largest manufacturer of radio receiving sets, offers radio's wonder—the Crosley Model 50, one-tube genuine Armstrong regenerative receiver at \$14.50. With tube, phones, batteries, antenna wire complete, less than \$25.

This momentous announcement means that every home in America can at last have the enjoyment and the entertainment of high class radio—the thrill of long distance reception as well as local—on the basis of real economy.

This Crosley 50 is the latest refinement and perfection of the set which brought MacMillan's North Pole messages in to Leonard Weeks, at Minot, N. D., when all others failed though they cost ten times as much.

This is the set which gets the stations from coast to coast; which gives you more for your money by far, because it is the genuine Armstrong circuit, built by Crosley.

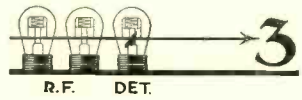

This little diagram shows three tubes using the ordinary radio frequency and detector circuit. Signals pass straight through the three tubes without extraordinary increase in their strength. The tube value therefore is three.



But Crosley's Armstrong regenerative set, with one tube, passes the signals several times through the single tube, each time increasing their strength and giving you much more than the three-

tube ordinary circuit, or a tube value of 3+.

That is why the Crosley one-tube set is so much more satisfactory and efficient.

Already, with this perfected Crosley 50, Andie Edmondson, at Stella, Mo., heard 2BD, Aberdeen, Scotland; Paul J. Hall, at Osceola, Neb., heard 2LO, London, England; Eugene Barnhouse, at Brookfield, Mo., hears Winnipeg and Montreal, Can., and Springfield, Mass.; James Gordon, at Fremont, Neb., hears them from coast to coast, from Canada to Texas, even picking up 10-watt KFNG at Coldwater, Miss., and 100-watt WFBL, at Syracuse, N. Y.; Mrs. J. E. Martin, at East Palestine, Ohio, hears KGO, Oakland, Calif.; O. W. Bryant, at Sunset, Tex., gets Hollywood, Calif., 1425 miles; Crosley Station WLW, Cincinnati, 1094 miles; Pittsburgh, Pa., 1361 miles.

Get your Crosley 50 now and learn that fine radio is not costly and difficult, but low-priced, simple, easy and reliable. A Crosley dealer is near by.

Crosley manufactures receiving sets which are licensed under Armstrong U. S. Patent No. 1,113,149, and priced from \$14.50 to \$65, without accessories.

The Crosley Radio Corporation
F. Noel Crosley, Jr., President
822 Sassafras Street, Cincinnati

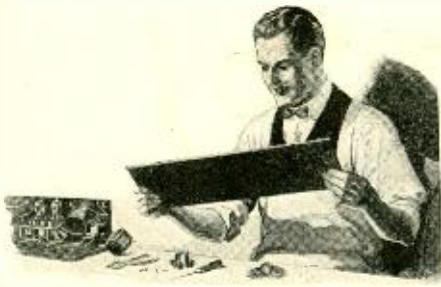

Developed by engineers for radio only

Why this special panel material gives better results

IN the early days of radio development, our engineers realized that ordinary insulation good enough for a hundred other uses was not good enough for radio. So they developed Radion—a super-panel material designed for radio use exclusively.

There is nothing quite like Radion. It has, by test, highest insulation characteristics. It has a high-polished finish which keeps out dirt and moisture, guarding against short circuits that often reduce good reception.

Radion is the easiest material to cut, drill and saw. 18 stock sizes, black and Mahoganite. Sold universally. Ask for it by name.

Send for booklet "Building Your Own Set"

For 10 cents we will send you our booklet, "Building Your Own Set," giving wiring diagrams, front and rear views, lists of parts and directions for building the most popular circuits. Use coupon.

AMERICAN HARD RUBBER COMPANY
Dept. A8, 11 Mercer St.,
New York City
Chicago Office: Conway Building
Pacific Coast Agent: Goodyear Rubber Co.,
San Francisco, Portland

RADION

The Supreme Insulation

PANELS

Dials, Sockets, Binding Post Panels, etc.



AMERICAN HARD RUBBER CO.,
Dept. A8, 11 Mercer St., New York City.
Please send me your booklet, "Building Your Own Set," for which I enclose 10 cents (stamps or coin).

Name
Address
City State

History of Radio Inventions

(Continued from page 185)

the present short-distance radio services, and so be the means of relieving the ether of its growing congestion.

There seems always to be a "last West" beckoning the radio engineer with a taste and aptitude for pioneer work. It will certainly be a good thing when his technique is available to the healing profession, for it is doubtful that electro-cautery, electro-diathermy and perhaps also radiography have yet been developed to the limit of the possibilities attainable by the more general application of the triode, and fuller recourse to the data available in the radio research laboratory.

It may yet be possible to project vortex ethereal rings, and thereby secure some results not yet foreseen.

CHAPTER IV

THE POULSEN ARC

By reason of its extreme simplicity, the Poulsen arc still has a wide application as a generator of radio frequency currents of high power and comparatively low frequency. Unfortunately, however, the radiations are encumbered with "mush" and harmonics, which must be eliminated if the arc is to be an important factor in the future.

Here again the invention was old before it found much application, but in this case the delay was probably due in large measure to the east wind of interested criticism.

The refinements of the arc are very largely due to the energy and genius of C. F. Elwell who, by the way, had the unique distinction, during the Great War, of being commissioned by the Italian Government to build a long-distance Poulsen station in the neighborhood of Rome: a work that he carried out so successfully that he was made a Knight of Cross of the Crown of Italy. The Federal Telegraph Company of San Francisco is also responsible for much development and practical application of the arc.

As late as December, 1921, the British Wireless Telegraphy Commission recommended the installation of arcs in three of the stations of the proposed Imperial Chain, not because they were thought to be more efficient than the triode, but because of the advantage of their simplicity in view of the isolation of the proposed stations.

CHAPTER V

BROADCASTING

"And the night shall be filled with music,
And the cares that infest the day
Shall fold their tents, like the Arabs,
And as silently steal away."

—Longfellow.

The paramount question of the moment is the control of broadcasting. There is the makings of a local broadcast receiver in almost any scrap heap; therefore there need be no limitation of the public enjoyment of the radio program.

Anyone who has considered the almost complete prostitution of the motion picture as an educational force, and its unhappy effect on the youth of today, cannot fail to appreciate the vital importance of directing to better ends the almost equally potent force of radio.

There are indications that radio's potentialities for insidious propaganda are already appreciated, and the only safe course seems to lie in Government control, particularly where there is representative democratic government, as in Great Britain and the

United States. What could support this latter contention better than the fact that the British administration is even now engaged in an attempt to capture and broadcast the song of the nightingale?

To the slum child of today, the nightingale means about as much as the Phoenix, the Liver or the Dodo; but tomorrow he may be familiar not only with the songs of our birds, but, through a purged cinema, with their appearance and surroundings. If so, the next generation will undoubtedly be the better for it.

It cannot be too widely known that practically all the benefits of broadcast reception may be enjoyed by the use of equipment which need involve no patented invention, and need cost no more than a few dollars, even when well made and attractively finished. It is only natural that companies owning costly patents should endeavor to cultivate a public demand for equipment involving their use, and which can be sold at non-competitive prices; but the fact remains that perfect short-range reception is accomplished with the simplest apparatus.

There is, or should be, no serious disadvantage in being limited to the nearby station or stations; in fact, the local programs are increasingly likely to be of special local interest and may yet be indispensable. It is likely, therefore, that "broadcasters" of the future will settle themselves into two classes, which may respectively be termed "stunters" and "utilitarians." The former will demand equipment whereby they may attain the greatest distances, and will be less concerned with economy and simplicity; while the latter will want merely the most dependable and simple apparatus that will enable them to enjoy the local program. The former class will probably bear about the same numerical ratio to the latter, as do racing motorists to those who motor merely for purposes of transportation or pleasure.

STANDARD APPARATUS

If the foregoing premises are correct, there will be a large and increasing demand for simple, dependable, patent-free equipment. Such equipment should be designed to operate on a single-wire aerial of definite length, so that the purchaser is not required to experiment. Preferably, it should be fitted with a readily demountable "cat-whiskerless" crystal detector, and a "variometer" tuning coil. The latter should be designed for minimum self-capacity, to which end it should preferably have a cylindrical stator. Such a set, with an aerial of reasonable elevation or clearance, should give dependable results and permit of the use of several pairs of telephones, up to six or eight miles from a broadcasting station. Moreover, an audio-frequency amplifier could be added, should the user require more volume—say for a loud speaker.

For slightly longer distances and greater selectivity, there should be a good market for a two-circuit "loose-coupler," with secondary calibrated in wave-lengths and preferably having both capacity and inductance variable. The reason for the latter is that it enables the ratio "capacity to inductance" to be varied to supply the most satisfactory signal voltage to the detector; but obviously the calibration would have to be predicted upon the fixed position of one of the variables. Provision could readily be made for the use of any type of detector, and for the addition of regeneration, and apart from the latter no patent need be involved.

The effect that broadcasting may have upon the press is still uncertain. It is claimed that since only the bare facts of the news may be broadcast, the effect will be to stimulate the demand for newspapers. The author was once discussing this question with two Canadian newspaper editors who held this view. By way of illustration, one said: "Suppose today the news is broadcast

EVEREADY HOUR
EVERY TUESDAY AT 8 P. M.
(Eastern Standard Time)

For real radio enjoyment, tune in the "Eveready Group," Broadcast through

WEAF	New York	WEAR	Cleveland
WJAR	Providence	WSAI	Cincinnati
WEEI	Boston	WWJ	Detroit
WFI	Philadelphia	WCCO	Minneapolis
WGR	Buffalo	WOC	St. Paul
WCAE	Pittsburgh		Davenport

Eveready
 Columbia
 Ignitor
 "A"
 Battery
 The
 proven
 dry cell
 for all
 radio
 dry cell
 tubes
 1½
 volts

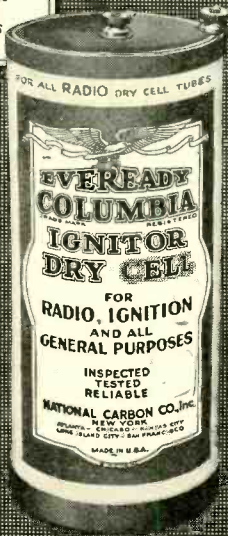

No. 767
 45-volt
 Large
 Horizontal
 Price
 \$3.75
 With
 variable
 taps



No. 772
 45-volt
 Large
 Vertical
 Price
 \$3.75

PREFERRED

It is no accident that more Eveready Radio Batteries are purchased by the radio public than any other radio battery made.

Such complete and voluntary endorsement can lead to but one conclusion—for best reception and longest life, Eveready Radio Batteries lead the field.

You can prove this for yourself by hooking Eveready Radio Batteries to your set. You will find that they deliver a steady, vigorous stream of power that lasts longer. It is Eveready economy that has created such an overwhelming preference for Evereadys. For every radio use there is a correct, long-lasting Eveready Radio Battery. There is an Eveready dealer nearby.

Manufactured and guaranteed by

NATIONAL CARBON COMPANY, Inc.
 New York San Francisco
 Canadian National Carbon Co., Limited, Toronto, Ontario

EVEREADY Radio Batteries

- they last longer



Registration applied for

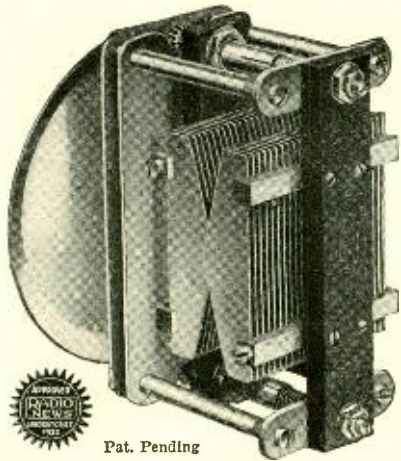

Pat. Pending



Eliminates Body Capacity

SPECIAL design eliminates body capacity effects for all time. The frame forms a shield about the plates, so efficient that Wade condensers may be used in the most sensitive circuits. This design is exclusively a Wade development and so vital in tuning efficiency that it's destined to change the entire phase of condenser construction.



Simplifies Close Tuning

UNIQUE design of plates and their angular operation assures straight line wave length—spreads all stations evenly over the dial. Any station can be quickly located, once a given station of known wave length is recorded. Special 360° dial, supplied with all Wade condensers, spreads the scale and gives more tuning range between stations.



SQUARE LAW
CONDENSER AND DIAL

All sizes, complete with 4-inch vernier dial, for:

- Short wave .000125 mfd.\$7.50
 - Tuned Radio Frequency, .00025 mfd. 7.75
 - Super-Heterodynes .0005 mfd. 8.00
- At your dealers, otherwise send purchase price and you will be supplied postpaid.

Wade Manufacturing Company, Inc.
1819-A Broadway New York City



that so-and-so has been murdered," mentioning the name of a famous British politician then in office; whereupon, giving way to political prejudice, the other remarked: "and a nice day for it, too." The first speaker went on to say that, in his opinion, everyone would want to buy tomorrow's paper to get the details, and he was probably right. It is certain that the broadcasting of parliamentary procedure will not find favor. To have to listen to it is one of the most trying ordeals of parliamentary life, and to do so gratuitously would be to throw away one's natural advantage, which reminds one of Gladstone's comment when he saw a member of Parliament using an ear trumpet.

The following U. S. Patents are claimed, by those who are interested, to be more or less vital to an efficient broadcasting station in America:

879532	Feb. 18, 1908,	DeForest
1129942	Mar. 2, 1915,	Arnold
1129943	Mar. 2, 1915,	Arnold
1137315	Apl. 27, 1915,	Heising
1201270	Oct. 17, 1916,	DeForest
1201272	Oct. 17, 1916,	DeForest
1218195	Mar. 6, 1917,	Logwood
1231764	July 3, 1917,	Lowenstein
Re. 14380	Oct. 23, 1917,	Colpitts
1314252	Aug. 26, 1919,	DeForest
1329283	Jan. 27, 1920,	Arnold
1349252	Aug. 10, 1920,	Arnold
1377405	May 10, 1921,	DeForest
1442146	Jan. 16, 1923,	Heising
1442147	Jan. 16, 1923,	Heising
1452032	Apl. 17, 1923,	Farrington.

A Ten-Cent Store Loud Speaker

(Continued from page 181)

into this and the diaphragm with the extension installed. Remember that if the connections to the cone and to the diaphragm are not made at absolute right angles, trouble in plenty is liable to result. The sounds of the Philharmonic Symphony coming through will resemble nothing so much as a hurdy-gurdy around the corner if the angles are not right.

But for argument's sake, let's assume that they are as they should be and go ahead with the discussion. If the second stage of the amplifier is husky, the cone will not help any in the matter of clarity of reproduction if the phone is used as is. The chances are that the diaphragm will constantly rebut itself against the pole pieces of the magnets, giving a nice, metallic twang. This is corrected by the installation of a couple of thin shims of copper or brass placed between the edge of the diaphragm and its bearing around the receiver case.

The thinnest possible metal sheet should be used for this purpose. If there is some old shielding material around the house, it will come in handy. Cut two or three circles from it just to fit on the edge of the receiver case where the diaphragm rests. A few trials will give the proper number of them to be employed. Keep the diaphragm as close to the pole pieces as possible, so long as it does not strike when the town's prize prima donna takes her high C.

Now for the finishing touches. In the dime store mentioned in the first paragraph, at the lamp counter, will be found a great assortment of decorative ribbons which are ordinarily used to bind the edges of home-made lamp shades. A little of this will cover the edge of the brass circle where the paper cone was pasted to it. This enhances the appearance of the completed instrument several per cent., making it look even more like the thirty dollars saved.

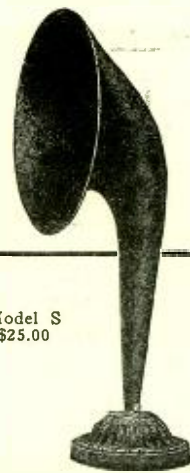

Model S
\$25.00

That Very Natural Tone

of the Bristol Loud Speaker is not due to chance, but to a long-time experience in the manufacture of finely-adjusted scientific instruments.

For over 36 years The Bristol Company has been manufacturing Bristol's Recording Instruments—which measure and record the minute changes in heat, cold, humidity, electrical current, and numerous other properties.

That this experience and factory fitness is reflected in the sweet tone of the Bristol Loud Speaker is a very natural thing.

BRISTOL AUDIOPHONE LOUD SPEAKER

For \$25 and \$30 you can get a Bristol Speaker; and there are others as low as \$12.50. Ask your dealer to send one out. Write us for Folder No. 3022-S, telling why the Bristol is such a delight to the ear.

THE BRISTOL COMPANY
Waterbury, Conn.



Go Into Business for Yourself! Be Your Own Boss!

Free Book Tells How

Send today for our Kit Catalog, 36 pages, 7x10. Contains bargain offers of best 38 radio receiver kits. Explains how to make money building sets for friends and neighbors. You can do it! Write for Book Now.
RADIO SPECIALTY COMPANY
Kit Div. 679N, 245A, Greenwich St., New York

WAIT FOR ANNOUNCEMENT OF BOSCH RADIO APPARATUS
American Bosch Magneto Corporation
Main Office and Works: Springfield, Mass.
Branches: New York, Chicago, Detroit, San Francisco

Balkite Battery Charger.
Charges 6-volt "A" storage
batteries.

Price \$19.50
West of Rockies, \$20
In Canada, \$27.50

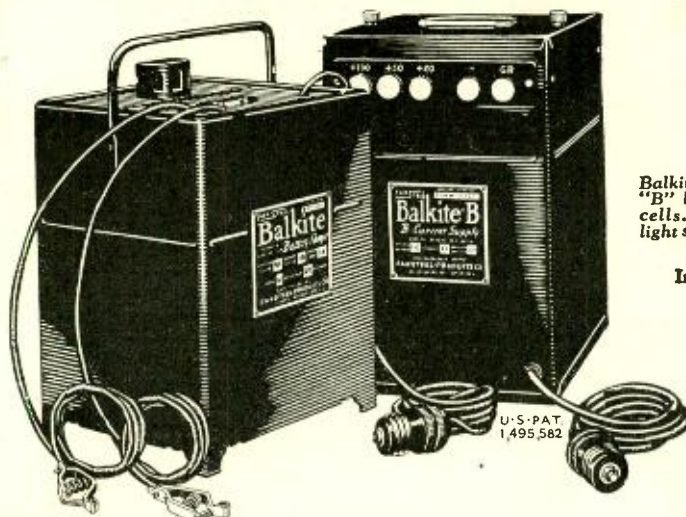

Balkite "B"—replaces
"B" batteries and dry
cells. Operates from
light socket.

Price \$55
In Canada, \$75

Balkite Radio Power Units

*give your set greater clarity,
distance and volume*

Your radio set will perform consistently only if your power supply is un failing. Balkite Radio Power Units provide a convenient power supply that furnishes a constant, uniform voltage to both "A" and "B" circuits. The Balkite Charger keeps your "A" storage battery charged and operating at full efficiency. Balkite "B" replaces both "B" storage batteries and dry cells, and supplies plate current from the light socket.

The Balkite Battery Charger

and Balkite "B" are based on the same principle. Both are entirely noiseless in operation, have no moving parts or bulbs, have nothing to adjust, break or get out of order. They do not create disturbances in either your set or your neighbor's, require practically no attention, and can be put in operation at any time by merely connecting to the light socket. Their current consumption is very low. Both are guaranteed to give satisfaction.

Sold by leading radio dealers everywhere

FANSTEEL
Balkite *Radio Power Units*

BALKITE BATTERY CHARGER—BALKITE "B" PLATE CURRENT SUPPLY

Manufactured by FANSTEEL PRODUCTS COMPANY, Inc., North Chicago, Ill.

This 48 Page Book tells all about FROST-RADIO Your Copy FREE!



WE want every reader of Radio News who has not yet received his copy to write for one of our 48-page catalogs of **FROST-RADIO** products.

It illustrates this only complete line of high quality radio parts and accessories, explains care and operation of **FROST-FONES** and **FROST-RADIO** parts, and contains a wealth of interesting information about the newest and best in radio. Write for your copy of this book today. Sent upon request to every reader of Radio News.

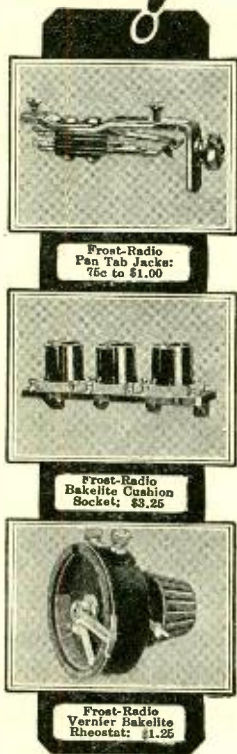

Use FROST-RADIO Parts and Accessories in Your Popular Mechanics' Circuit

To insure conformity to the original design of the famous Popular Mechanics' Circuit you should select from your dealer's store the **FROST-RADIO** items incorporated in this great hook-up. Some of these are illustrated above—others you will find are pictured and described in the **FROST-RADIO** Catalog. All of these items are of the superb quality which led to their being selected by Popular Mechanics for their circuit.

MEMBER **RMA** In writing for catalog, please address our main office in Chicago, and write to Dept. 10F508

HERBERT H. FROST, Inc.
314-324 West Superior Street, CHICAGO
NEW YORK CITY CLEVELAND
KANSAS CITY LOS ANGELES
Export Office: 314 West Superior Street, Chicago

If the cone itself was made from a good grade of hardware wrapping paper, the completed unit will look very well. The paper must be fairly heavy for best results, but still not so thick as to create an excessive load on the diaphragm of the unit. The hardware paper serves admirably. The writer used an old piece of drawing paper with an original water color on it.

The completed unit was then attached to a candlestick purchased in the same dime store, as shown in the photograph. This can be accomplished in a number of ways and is left to the ingenuity of the builder.

The strap may be put behind the unit and equipped with a set-screw for adjustment of the tension of the diaphragm and may improve the operation of the speaker considerably. However, the writer found it unnecessary in his case.

And here a word must be said about units generally and their adaptation to the cone type speaker. At first glance, the sceptic is prone to say: "What is the use of putting a cone reproducer onto the ordinary telephone receiver? Where is the advantage? The diaphragm which has to do the original vibrating is still just as small as ever, the cone is simply doing duty as a horn."

True, but the cone does not give the harmonics of the horn and its natural period is far below the usual range found in speech and music, so that if the receiver diaphragm vibrates with fair accuracy, the cone will produce it a great deal more perfectly than the horn.

But to get at the heart of the problem, let us turn our attention to the reproducing unit. The writer at the present time is investigating the adaptation of the mica type unit to the cone unit. It works somewhat better than the standard iron type, but still has a tendency to smear over the complicated frequencies, such as those created by an orchestra or a stringed quartet. For the human voice, it seems nearly perfect.

Some years ago an eminent experimenter attempted to use a varnished silk diaphragm. Some experimenter could do the art a great service by finding the proper method—cheaply—of supporting the iron armature in front of the pole pieces, so that it could be attached to the cone in such a manner that the cone would do all the changing of electrical energy into sound.

This is a field which will amply repay the experimenter who makes success. It is much behind the remainder of the science in its development and therefore needs more attention and so holds more room for the inventor.

I Want to Know

(Continued from page 206)

With the aerial switch on point 1, the coupling is aperiodic and inductive. With the connection to point 2, the coupling is capacitative and semi-tuned.

Resistance R1 and R2 are the usual type of variable plate resistors variable between 10,000 and 100,000 ohms. With R1 shorted by means of the off-on switch, it will be necessary to use a lower "B" battery potential, since it is not necessary to have a 135-volt plate potential to overcome the resistance of a plate resistor. The connection is indicated by the dotted line, the previous connection being broken at "X1."

The tendency of the first radio frequency tube circuit to oscillate is considerably reduced by connecting "C" battery C1 as shown. A "lower loss" connection would be that indicated by "X." "G. L." is two megohms. "R3," one-half to two megohms. The voltage of battery "C" may be about four and one-half volts. "C1" need be only one and one-half to three volts.

Coils L and L1 are in fixed inductive relation and may be made exactly the same as the radio frequency coil (with the 15-turn primary), shown in picture diagram Q. 2131.

Coils L2 and L3 are in variable inductive relation. Secondary stator coil L2 may consist of about 50 turns of No. 24 D.C.C. wire wound on a 3-inch tube. Rotor L3 may consist of about

Clarity and Tone Range

with Kellogg Transformers

The reproductions of the highest tones as well as those of the lower extreme of the scale, with faithful, pure quality, is essentially the spirit of Kellogg Transformer design.

The Kellogg radio frequency transformer is of the low loss type, having many important features. It will operate at all wave lengths with .00035 to .0005 variable condensers. For best results, use the Kellogg .0005 low loss variable condenser. Kellogg R. F. Transformers at all dealers—\$2.35.

Kellogg audio frequency transformers give greater volume with clearer reproduction, due to the high quality materials and expert workmanship used in the Kellogg process of manufacture. Kellogg audio frequency transformers are made in both shielded and unshielded types ranging in price from \$3.50 to \$4.50.

Kellogg transformers can be obtained at all radio dealers.

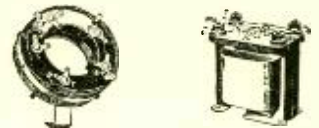

Kellogg Switchboard & Supply Company

1066 W. Adams Street
Chicago, Illinois

The Five Tube Set which startled the World!

FRESHMAN MASTERPIECE

The Greatest Value Ever Offered in A Radio Receiving Set
At Authorized Dealers Only

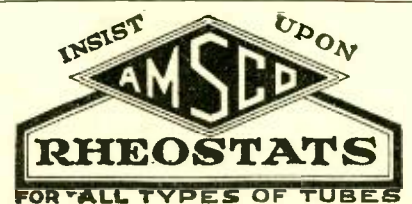

FREE MONEY

in extra profits if you enjoy our discounts. Dealers write for them now. Also for a copy of the Salespeaker.

HUDSON-ROSS—116 S. Wells St. Chicago

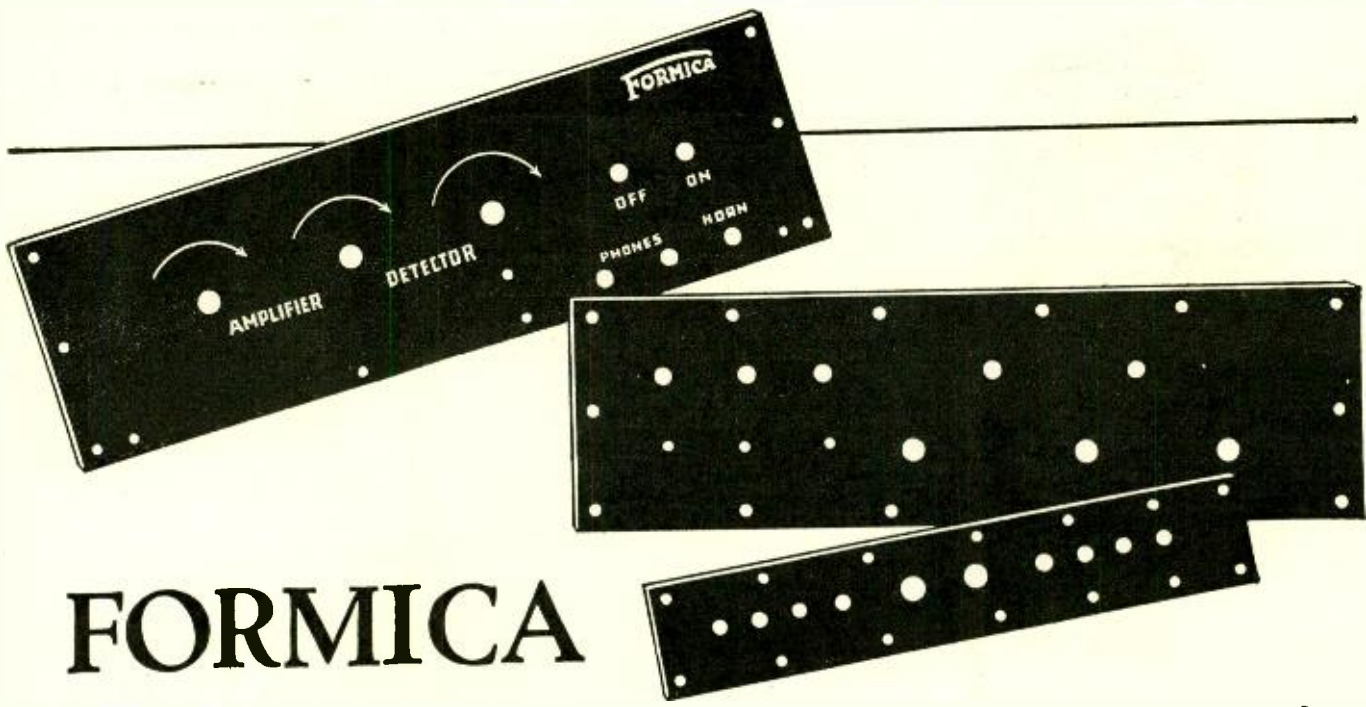

FORMICA

means permanent good performance!

WATCH out for the reaction against cheaply constructed radio sets. Every dealer has felt it on parts at one time or another. And radio sets cannot be built cheaper and cheaper without running into it.

Formica panels and base panels are a sure indication of quality in a radio set — of an intention on the part of the manufacturer to build for permanence and lasting good performance.

Formica base panels shorten and simplify the wiring and make the job a hundred times neater. Many sets built for real quality will have both front and base panels this year.

The better finish, greater uniformity, and greater freedom from warping that is characteristic of Formica have made it the preferred insulation of more than 125 leading set makers.

Dealers and jobbers find it the best known and most popular line of radio panels.

THE FORMICA INSULATION COMPANY

4618 Spring Grove Ave., Cincinnati, Ohio

Sales Offices

50 Church Street.....	New York, N. Y.	1026 Second Avenue.....	Minneapolis, Minn.
9 South Clinton St.....	Chicago, Ill.	725 Bulletin Bldg.....	Philadelphia, Pa.
516 Caxton Bldg.....	Cleveland, Ohio	708 Title Building.....	Baltimore, Md.
327 Cutler Bldg.....	Rochester, N. Y.	585 Mission Street.....	San Francisco, Cal.
422 First Avenue.....	Pittsburg, Pa.	419 Ohio Building.....	Toledo, Ohio
6 Beacon Street.....	Boston, Mass.	309 Plymouth Bldg.....	New Haven, Conn.
55 Calle Obispo.....	Habana, Cuba	Whitney Central Bldg.....	New Orleans, La.



FORMICA

Made from Anhydrous Bakelite Resins
SHEETS TUBES RODS

Hear the Formica Orchestra over WLW every Tuesday evening from 9 to 10 Central Standard Time.



Earn \$50 to \$250 a Week As Radio Expert

If you are making less than \$50 a week—if you want to jump quickly into the Big Pay Class—in the world's fastest growing industry—get into Radio NOW. Coupon below brings full information—it is your Ticket to Success.

Big jobs are open for trained men everywhere. We receive calls regularly for Radio experts. Radio manufacturers, dealers, broadcasting and receiving stations, railroad and steamship companies, government departments need Radio Experts NOW. Pay is big. Thousands now make \$50 to \$250 a week in Radio.

Easy to Learn at Home

The National Radio Institute (America's largest and oldest Home Study Radio School) will train you at home, in your spare time, to become a Certified Radio Expert. No red tape—no long drawn out delays. In a few short months by the famous National Radio Institute tested method you can become the Radio expert of your own town or wherever you wish to locate.

Men Land Big Jobs

Letters from our students prove that N. R. I. training, plus our Employment Service puts our graduates in the Big Pay Jobs where real money is made. See what these National Radio Institute men say:

Makes \$50 to \$80 a Week More

Your course leads so much further ahead than practical electricity that there is nothing left to say. Since I took your course I have earned from \$50 to \$80 a week more.

Preston Fowler, Gordon, Nebraska.



Increases Pay 160%

I was just receiving \$3.00 per 8 hours when I enrolled with N. R. I., and now I am receiving \$1.00 an hour more (160% increase). That is where N. R. I. put me. The course has been worth \$2500 a year to me and in another year it will be worth \$2500 a year. While taking the course I did assembling, repairing and installing and made about \$900. This made my course pay for itself many times even before I graduated. The N. R. I. is the Right Way.

Andrew M. Shurie, Latrobe, Pa.



Up-to-date Receiving Sets Given with Course

National Radio Institute training is practical training—not merely text books, but real work on real parts and receiving sets furnished free to you. You learn to design—build—repair—install and operate your own sets—it is like A, B, C.

Special Offer—Act Quick

The coupon below brings you the most Amazing Book on Radio ever written. It tells you how to turn a pastime into a Gold Mine. Important. We have a Special Limited Offer for those who act quickly. Mail the coupon NOW.

NATIONAL RADIO INSTITUTE
Dept. 513KB Washington, D. C.

FREE BOOK
tells how

Rich Rewards
In Radio

NATIONAL RADIO INSTITUTE
Dept. 513KB, Washington, D. C.

Please send me without the slightest obligation your Free Book, "Rich Rewards in Radio," and full details of your special Free Employment Service. Please write plainly.

Name..... Age.....
Address.....
City..... State.....

12 turns of the same size wire, wound on a 2½-inch tube. Coils L2 and L3 must not be in inductive relation to coils L1 and L2. Coils L2 and L3 may comprise a regular 2-coil variocoupler.

Drink to Me Only With Thine Ears

(Continued from page 160)

technicality on this device, and am merely putting it to a test."

I smiles. "Interesting," I admits. "If it ain't committing a breach of anything, what is it?"

"A device which I believe will, in a short time, do away with the necessity for prohibition."

"Do tell!" I exclaims. "What's the plan—gonna kill them all off?"

"No, no," replies Jerry, patient. "That would be utterly illogical. You see, my experience as a revenue officer has taught me that though an ounce of prevention may be worth a pound of cure, yet when the prevention is out of the question, the cure is the only hope. I have effected what may, in a sense, be termed a cure, although in another way it is merely a harmless continuance of the habit."

"Yo' all says words, big boy, but they don' mean nuffin," I remarks. "Have you found a substitute for the cup that hurrahs?"

The Master nods. "I have a device, electrical, which will produce the same effect as alcoholic intoxication without so much as even offending one nerve in the human system, let alone harming any other part or organ. It is entirely safe and sane."

"Glorious!" I cheers. "Go on."

"Some persons might call it a shock, which is it, primarily. I prefer to term it a gradual electrical anæsthetic. The effect of the device upon the human system is in one way akin to that of ether, except that there is no danger whatsoever from the electricity. When taken, it slowly overcomes the mind, and if continued for a great length of time will very nearly produce that effect known as catalepsy, or suspended animation. The result on a would-be drunk is precisely the same as that produced by alcohol. This morning I tested it on half a dozen confirmed liquor addicts, and they have sworn it to be better than any whiskey, because it leaves no after-effect, or 'hang-over,' as they call it. By taking a 'drink' with this machine, you are timed for a certain period, anything up to six hours. At the end of that time, or within fifteen minutes on either side of it, the awakening comes, without pain, and leaving the mind fully conscious of anything that may have been said or done during the preceding six hours."

I admits his greatness. "How does it work?" I asks, eager.

The Master smiles. "My device accomplishes this feat by utilizing one of the most elemental, vital and perhaps little-known facts connected with human existence. The whole scheme of this life, Joe, is based on vibration."

"Vibration?"

"Yes. Every object vibrates at a certain rate. The average human vibrates between 250 and 500 cycles, as we term it. With my machine I simply lower the rate of vibration. For example, take a man whose rate is 300 cycles. By reducing this to 150 I produce that stage of intoxication which I understand is termed 'three sheets in the wind.' From there down to 50 cycles, and the subject is dead drunk, unable to move. It isn't at all necessary to determine each subject's rate before experimenting. With small practice, one can tell merely by observing the patient's face just when the de-

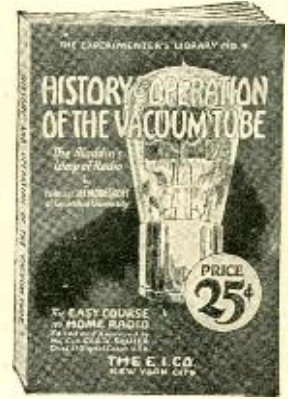

By
PROF. J. H. MORECROFT

The Fundamentals of the Vacuum Tube

How it was invented, developed and its modern function in the radio receiver.

This book serves an interesting study of the fundamental principles, historical evolution, and practical application of the vacuum tube as used in radio apparatus of every description. Since the vacuum tube is one of the most important parts in the modern radio set, and has been largely responsible for making present-day radio entertainment possible, this book has been entirely devoted to the subject of that one particular instrument. It is written in simple everyday language with all technical terms thoroughly explained so as to make matters easily understood by everyone.

The book contains chapters on the phenomena of vacuum tubes in general; the operation of vacuum tubes as detectors and amplifiers; and the junction of the vacuum tube used in various transmitting and receiving circuits, etc., etc.

52 pages printed in legible type; 24 illustrations and diagrams; bound in two-color cover; size 5½ x 7½ inches.

Sold by all
Reliable Radio and News Dealers

OR ORDER DIRECT

PRICE 25¢ PREPAID

E.I. Company

CONSRAD COMPANY, Inc.

Selling Agents

233 Fulton St., New York

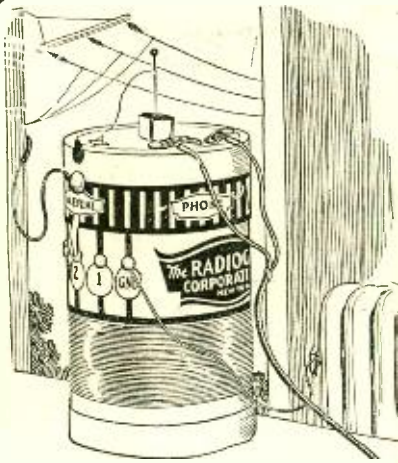

The Simplest Practical Radio Set Made

\$ **1**⁰⁰

The **RADIOGEM**

The simplest radio outfit made—yet as practical as the most expensive. A crystal receiving set that you can operate and enjoy even though you know absolutely nothing about radio. You receive the RADIOGEM unassembled, together with a clearly written instruction book, which shows you how to quickly and easily construct the set, using only your hands and a scissors. The outfit comprises all the necessary wire, contact points, detector mineral, tube on which to wind the coil, etc., etc. The instruction book explains simply and completely the principles of radio and its graphic illustrations make the assembling of the RADIOGEM real fun.

AERIAL OUTFIT

Complete aerial outfit for the RADIOGEM, consisting of 100 ft. of standard copper aerial wire and two special porcelain insulators. Price50c.

Radiogem - - - \$1.00

Aerial Outfit - - - .50

Radiogem and Aerial

Outfit - - - 2.50

RAGEMCO

Radio Headquarters for the Finest and BEST Radio Tools

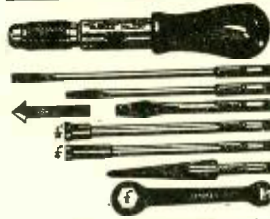

RADIO TOOLSET

This is the handiest set of tools ever made for Radio Work by the makers of the famous "YANKEE" Tools. It contains the following: 1 Ratchet Screw-driver, 6 1/2 in. Blade, 5/16 x 3-10; 1 Blade, 3 1/2 x 1/8; 1 Blade 2 1/2 x 1/4; 1 Countersink; 2 Socket Wrenches for all small nuts; 1 Reamer to enlarge holes in panel from 1/8 x 1/2; 1 Wrench, one end 5-16" square or hex. for Jack, other 1/2" hex., etc.
PRICE per set—No. 701.....\$3.00



HAND DRILL

The hardwood handle is hollow to store drills. Iron frame, nickel-plated parts, ball bearing three jawed chuck holding and centering accurately round shank drills from 0 to 3-16. Length of drill, 12 inches.
PRICE—No. 303\$2.25



WIREBENDING TOOL

For making eyes, loops, bends, and offsets on Bus Bar wire. With this device any Radio Constructor can wire his set to compare favorably with any factory made set. Easier to use and more accurate than pliers. Full directions in box. Made of heavy steel, blued and finished.
PRICE—No. 203\$1.00

CIRCLE CUTTER



Especially designed for the Radio Constructor. Made of the finest material and equipped with the highest grade high steel cutting bits. It does three things at once. It drills its own pilot, cuts out plug and puts bead or scroll around the hole in one operation. (Cuts holes 1/4 to 4 in. in diam.)
PRICE—No. 402\$3.00
401. Same tool but smaller and not fitted with bead or scroll in one operation.
PRICE—No. 401\$2.00

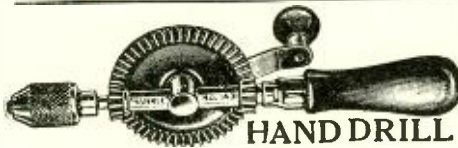

HAND DRILL

Especially designed for Radio Work by the makers of the famous "Yankee" Tools. A beautiful balanced, small, powerful drill with 4 to 1 ratio of gears for speed. Special chuck 9-32" capacity, to take largest drill, mostly furnished with drill or tool sets. Length over all, 9 1/2 in. Weight 1 1/2 lbs.
PRICE—No. 302\$2.75



Three-in-One Nut Wrench. Consists of handle with hollow stem 6 inches in length and three interchangeable sockets fitting popular sizes of nuts. The hexagon sockets grip the nut solidly.
PRICE per set—No. 301.....65c



Side Cutting Nipper, Lap Joint. For cutting all kinds of wire. Jaws hardened and oil tempered. Natural steel finish with polished jaws. Length 6 inches.
PRICE—No. 20175c

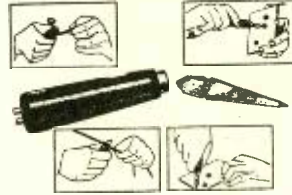

RADIO HANDI-TOOL

Bends Bus Bar or wire strips and scrapes wire, bores and reams holes, etc. Tool consists of 4 in. black japanned handle, to which is attached wire bending device, with nickeled ferrule and 3 in. long two sided reamer.
PRICE—No. 70250c



TOOL CHEST

Set consists of "LOCK-GUID" master handle, 5" long, black Rubberoid finish with steel chuck, nickel plated, buffed and with the following 9 tools: Saw, bradawl, large screwdriver, file, scratch awl, gimlet, reamer, chisel, small screwdriver. Each tool of fine steel, drop forged tempered, hardened, and nicely finished. Set comes in leatheroid box with tray.
PRICE—No. 703\$1.85

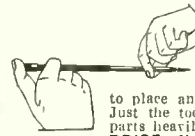

SCREW STARTER and DRIVER

Holds any screw by its slot with a firm grip, makes it easy to place and start screws in difficult places. Just the tool for the Radio Constructor. All parts heavily nickeled and polished.
PRICE—No. 304\$1.00

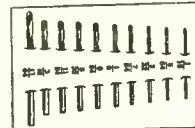

RADIO DRILL SET

Composed of 10 straight shank twist drills, fitting all hand and breast drills. The selection of these drills has been especially made for Radio Constructors and consists of the following sizes: 1-16, 5-64, 3-32, 7-64, 1/8, 9-64, 5-32, 11-64, 3-16, 17-64. Drills are mounted on white Holland Linen with sizes clearly marked.
PRICE—No. 305\$1.25

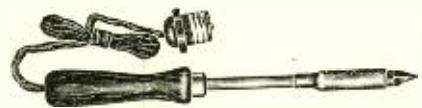

ELECTRIC SOLDERING IRON

A perfect tool for Radio Work. Operates either on 110-volt A.C. or D.C. The heat element is of Nichrome, which prevents overheating and assures the desired even temperature. Size of Iron, 10 1/2 in. long. A 4-ft. cord and plug is furnished.
PRICE—No. 800\$2.00



Combination Plier, Wire Cutter, Wire Former and Wrench. Drop forged, slender but exceptionally strong. 6 in. long.
PRICE—No. 20275c

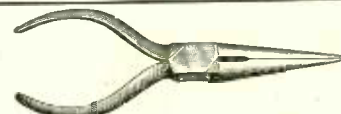

Long Sharp Nose, Side Cutting Pliers. Just the pliers for the radio constructor. Bends and cuts all kinds of soft wire. Nose 1 1/2 inches long, black body, polished jaws. Length 5 1/2 inches.
PRICE—No. 20075c

Order all tools by order number. All goods are shipped free of transportation charges to all parts of the United States and possessions the same day as the order is received.

MONEY REFUND GUARANTEE

If you are not satisfied money will be refunded on return of goods.

The RADIOGEM CORP., 66-R W. Broadway, New York

ULTRA-LOWLOSS CONDENSER

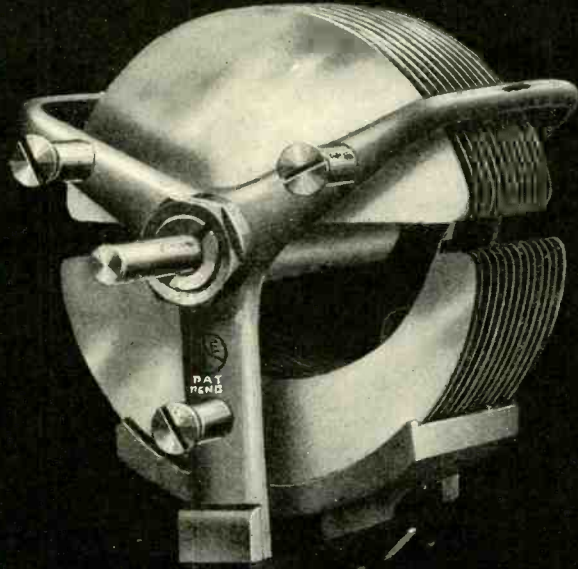

CAP. .0005 mfd.

\$5.00

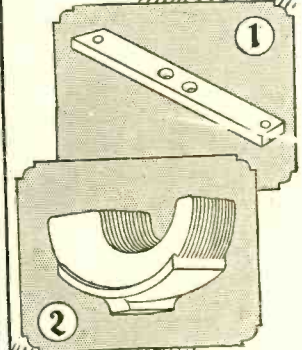
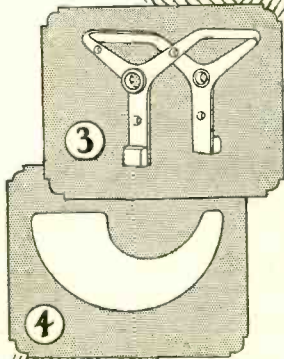

Unusual Features Increase Receiving Efficiency

IN less than six months the Ultra-Lowloss Condenser has proved its right to leadership by greatly simplified design, greater tuning efficiency, and radically different operating results—not only in the eyes of scientific and engineering men, but with the buying public as well.

These are the predominating Ultra-Lowloss features: (1) Single insulation strip reduces leakage losses materially, (2) Monoblock mounting with plates cast into block reduces series resistance and assures positive contact, (3) Minimum of metal of high resistance material in the field and frame reduces eddy current losses, (4) Cutlass Stator Plates produce a straight line wavelength curve—separating stations evenly over the dial. Each degree on a 100 degree scale dial represents approximately $3\frac{1}{2}$ meters over the broadcast wavelength range.

This even separation applies to both high and low wavelengths! Simplifies tuning materially!

The Ultra-Lowloss Condenser is a recent development of R. E. Lacault, E.E., originator of the famous Ultradyné Receiver.

Design of Lowloss Coils furnished free with each Condenser for amateur and broadcast wavelengths showing which will function most efficiently with the Condenser.

At your Dealer's. Otherwise, send purchase price and you will be supplied postpaid.

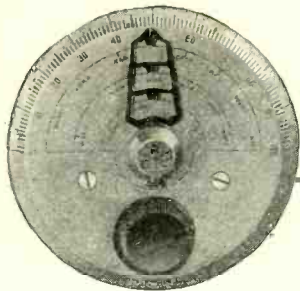

Simplifies radio tuning. Pencil record a station on the dial—thereafter simply turn the finder to your pencil mark to get that instantly. Easy—quick to mount. Eliminates fumbling, guessing. Furnished clockwise or anti-clockwise in gold or silver finish. Gear ratio 20 to 1. Silver \$2.50. In gold finish, \$3.50.

ULTRA-VERNIER
TUNING CONTROL



R. E. Lacault

To manufacturers
who wish to improve
their sets

I will gladly consult with any manufacturer regarding the application of this condenser to his circuit for obtaining best possible efficiency.

ULTRA-LOWLOSS CONDENSER

Write for Descriptive Folder.

PHENIX RADIO CORP., 114 East 25th St., N. Y.



Miller AMPLIFYING HORNS

37 Different Models
Others In Process of Development

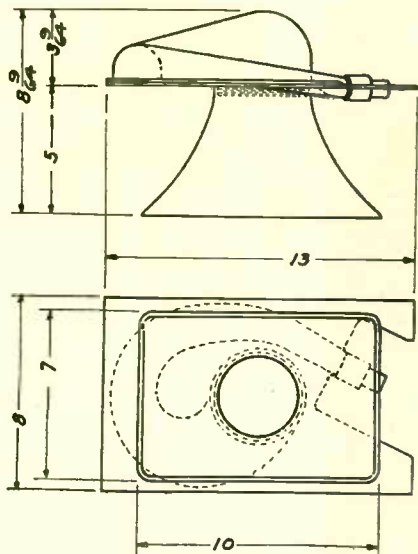

A Miller Horn for Every Radio Purpose

The Miller line of radio horns consists of 37 different models. Because the composition of which they are made is inert, horn distortion and vibration are practically eliminated. Each horn has been very carefully designed by competent engineers with a view of getting the maximum volume and quality of output.

We can meet your horn requirements with a high quality product at a competitive price. Our unexcelled service will enable you to take advantage of every possible sale. Write for prices and full details.

The Miller Rubber Co.
Akron of N. Y. Ohio

Radio Instruction

Practical training for Radio Operators, Radio Mechanics, and Radio Dealers.

Send for 36 page booklet
"Radio for Ambitious Men"

Resident and Home Study Courses.

Y. M. C. A. RADIO INSTITUTE
158 East 86th St., New York City

The SATURN
Perfect Jack and Automatic Plug.
Your order filled by mail promptly.
Every article absolutely guaranteed.
The SATURN Mfg. & Sales Co., Inc.
48 Beekman St.
New York, N. Y.
Dept. R. N.
Write for Literature

"It works, Joe!" he exclaims. "It works!"

"What does?" I inquire.

Jerry don't explain, but tells me to put on a single head-set he offers me, and listen to a program. I does, knowing when to ask and when not to, and now is when not to.

"Now taste this."

I does. "Grapejuice," I says.

"Are you sure?"

"Certainly."

"Now listen to the music being broadcasted from the transmitter in the next room. Take an occasional sip."

I sips. Nothing happens. I takes a few more sips. I begins to feel a bit hazy. I likes the sensation. I sips some more. When I comes to I remembers The Master's having tapped me with a cane, or something. I takes a coupla deep breaths.

"Pre-war stuff!" I exclaims. "What'd you put in that Bryan-boozie?"

The Master's surprised. "Why, nothing. Just grapejuice."

"Grapejuice, my eye!" I yelps. "What gave me that cute little jag?"

"My radio intoxicicator!" almost howls The Master.

I lets what passes for my brains rest a moment. "Your what?"

"You recall my device for producing harmless intoxication? I devised a means of controlling the vibrations by radio. The grapejuice was pure—it was the radio that made you drunk."

"Save me, Susie!" I yelps.

Jerry laughs. "The whole thing came through the head-set in the form of gentle, harmless, vibrating waves which lulled you into a semi-comatose condition. The grapejuice was merely a 'prop,' as you stage folks say."

I lets that vibrate a while. "Say, Jerry," I inquires, "couldn't we use this in our club?"

Here's where The Master almost laughs outright. "That, Joe, is the whole proposition," he smiles. "I am a law-abiding citizen, and have neither the desire nor the intention to hinder the law. For that matter, as you know, I am an officer myself. But devices of this nature are bound to be subject to considerable skepticism. If I were to endeavor to arrange with the authorities for a test I should be boo-hoed before I could even state the principle upon which my apparatus operates. So you see I intend using the club as a means of demonstrating my radio intoxicicator where there will be no doubt as to its ability."

I'm puzzled. "But why radio?" I asks.

"A disguise," answers Jerry. "The machine producing this intoxication is, as you can see, very cumbersome, and quite difficult to manipulate. Also, it bears no resemblance to a radio; even I should find trouble in convincing a revenue officer of its identity. And again, the device would be hard to hide, and in the event of a raid the apparatus would be easily found. By combining a broadcast program with these vibrating waves—which cannot be detected without suitable devices—the danger of discovery would be eliminated."

"Brilliant," I admits, sarcastic. "But won't all the listeners get lit? Won't they, huh?"

"As I just said, it is impossible to receive these special waves without my filter hooked across between the aerial and ground. I made exhaustive tests this morning, and am convinced no harm can result."

So a few days later we goes to New York to get the club ready for the grand opening. The place is one of the larger type, with a dance-floor in the center and a balcony on three sides. There's thirty tables, seating a hundred guests. Each place at the tables is equipped with a single head-set, all of which are connected to a central

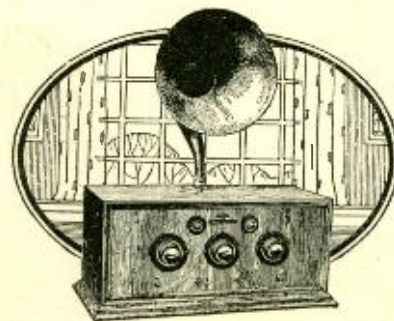

Hear the Murdock Neutrodyne

COMPARE the Murdock Five Tube Neutrodyne for the quality of its tone; for the beauty of its cabinet; and for its reasonable \$100. price!

There is space in the cabinet for the "B" batteries. The only accessories necessary are batteries and tubes. A "Murdock" set is backed by twenty years of successful experience in making radio apparatus.

\$100.

with built-in
Loudspeaker

\$92.50
without

WM. J. MURDOCK CO.
Dept. A6, Washington Ave.
Chelsea, Mass.

MURDOCK NEUTRODYNE

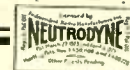

WRITTEN 2-YEAR GUARANTEE

ARROW BATTERY

Battery Prices SMASHED!

To Consumers Only
Here is a real battery quality guaranteed to you at prices that will astound the entire battery-buying public. Order Direct From Factory. Put the Dealer's Profit in your own pocket. You actually save much more than half, and so that you can be convinced of true quality and performance, we give a *Written 2-Year Guarantee*. Here is your protection! No need to take a chance. Our battery is right—and the price is lowest ever made. Convince yourself. Read the prices!

Auto Batteries	Radio Batteries
6 Volt, 11 Plate, \$9.50	6 Volt, 100 Amp, \$9.50
6 Volt, 13 Plate, 11.50	6 Volt, 120 Amp, 11.50
12 Volt, 7 Plate, 13.00	6 Volt, 140 Amp, 13.00

Buy Direct—Send No Money
We ask no deposit. Simply send name and address and style wanted. Battery will be shipped same day we receive your order Express C.O.D. subject to your examination on arrival. Our guarantee accompanies each battery. We allow 5% discount for cash in full with order. You cannot lose! Send your order today—NOW!

ARROW BATTERY CO.
Dept. 6
Wabash Ave., Chicago

Tested and Approved—POPULAR RADIO Trade Mark

A-1 SPECIAL CATWHISKERS

Twenty-five Cents Package of Ten

Reg. U.S. Pat. Off.
Two Cent Postage Stamp brings FREE SAMPLE

CALIFORNIA RADIO MINERALS
HARRY GRANT, JR.
904 Oak Grove Ave., Burlingame, Calif.

AERO-COILS Amaze All Who Try Them

Far more selective! Their lower high frequency and circuit resistance losses and smaller capacity losses enable them to tune into resonance "on a knife's edge!" Far more powerful! Because they use the energy ordinarily wasted! At your dealers or direct. \$3.50 each or \$10.50 for 3 with brackets.

Henninger Radio Mfg. Company
1772 Wilson Ave. Dept. 36 Chicago

Music Master

Resonant Wood Insures
Natural Tone Quality

—evolution

A series of receivers designed to provide powers of radio reception equal to the capacities of Music Master Reproducer.

*The Musical Instrument of Radio
—there IS no substitute*



Type 215
Six-Tube Special Music Master
Circuit. Built-in Music Master
Reproducer. Very selective, long
range, and splendid tone quality.
Solid mahogany cabinet in
brown mahogany art-satin finish.

Price \$215

- MODEL VI \$30
14" Wood Bell
- MODEL VII \$35
21" Wood Bell

AT LAST—radio reception incorporating the demonstrated results of latest radio research, and combining in one superb radio ensemble the proved principles of Music Master Radio Reproduction.

Audition will prove MUSIC MASTER'S outstanding powers of long range and high selectivity, its clarity and volume, and above all, its supreme Tone Quality based on MUSIC MASTER Reproducer as a vital element of the ensemble.

(Prices of all models slightly higher in Canada)

Canadian
Prices
Slightly
Higher

Sold by authorized distributors and by Registered Dealers everywhere.
Call on your MUSIC MASTER dealer—today. See MUSIC MASTER
—hear—compare—before you buy ANY radio set.

Six Models
\$60 to \$400
Guaranteed
Unconditionally

Music Master Corporation

Makers and Distributors of High-Grade Radio Apparatus

128-130 N. Tenth Street

Chicago New York PHILADELPHIA Pittsburgh Montreal

Canadian Factory: Kitchener, Ontario

Merchants of standing desirous of profiting by Music Master prestige and reputation are invited to communicate with Music Master Corporation

Music Master RADIO PRODUCTS

For Better Radio

The New

Hammarlund

SPACE-WOUND

COIL



NOW you are offered a REAL Low-Loss Coil—a fit companion to the famous Hammarlund Low-Loss Condenser.

The solenoid (spiral-wound) coil has long been favored over other types for its greater inductance value per given number of turns.

But it has been impracticable, heretofore, to wind such a coil without introducing heavy dielectric losses and high distributed capacity between turns.

In the new Hammarlund Space-wound Coil these difficulties have been overcome. The supporting form is a mere film of special, transparent composition of high dielectric quality. As the wire is firmly anchored in the dielectric and cannot warp out of place, any spacing between turns is possible, thus lowering distributed capacity to a desirable minimum, avoiding possible short circuits and greatly lowering resistance.

Hammarlund Space-wound Coils are light, strong and wonderfully efficient—so efficient that the laboratory of Columbia University rates them as having the lowest losses of any coil they have ever tested.

Made in all sizes for all purposes. Inquiries from radio manufacturers are especially invited.

Hammarlund Manufacturing Co.
424-438 W. 33rd St., New York



ON ONE TUBE

BIG FREE BOOKLET tells the story. California users of **CROSS COUNTRY CIRCUIT** hear Atlantic Coast, Canada, Mexico, Cuba and Hawaii. Our new plan makes this set easiest and cheapest to build. One hour puts in operation. One tuning control. No soldering. Any Novice can do it. **BOOKLET FREE** or complete Instructions 25c.

Vesco Radio Co., BOX RN-117
9-825 OAKLAND, CALIF.

Insure your copy reaching you each month. Subscribe to **RADIO NEWS**—\$2.50 a year. Experimenter Publishing Co., 53 Park Pl., N.Y.C.

switchboard. By dint of a little fast work under the midnight oil, The Master's built one of the largest multiplex radio receivers I've even seen. Anyway, you can bring in about seventy-five different stations on it, all at the same time, the idea being to let each patron pick his own station. We gets out a double menu; one side for physical sustenance, the other for mental, the latter being a list of seventy-five large radio stations, changed nightly, of which each patron may take his pick.

"You see," says The Master, "while we could have each customer give his order through a phone to central, it would require too many operators. As long as the radio intoxicator is to be a secret, no one but we three must know of its existence. Therefore, each patron will write on a slip provided for the purpose his order, both for food and radio. So, while he dines, he may hear whatever he chooses. And Joe, while you're at it, you'd better list the evening's program with each station, in order that the customers may have some idea of what they'll receive."

I does, along with a lot of other things. Then Doris speaks up.

"What'll we do about the scofflaws?" she asks. "How'll that be worked?"

"Joe will have the word passed around amongst those whom he knows that in order to get a drink one must ask for Station QRM. That will be my station, and in order to evade detection I shan't sign my call letters except once every half hour, on the minute. Joe, at the switchboard, will watch the clock, and one minute on either side of the allotted time he will cut off all head-sets that may be on my program. Thus no 'drinker,' after regaining consciousness, will be able to remember what station he was listening to, in the event an investigation leads to that angle."

Oh, the boy ain't leaving no fingerprints. I'll say, and he keeps following himself up with better ones.

"Joe, at the switchboard, will time each number for six minutes, which is a sufficient average for most people. As you see, our switchboard is located in a niche in the wall, and is screened in with muslin, with practically no lights behind it. Thus Joe will be able to see all the diners without their seeing him."

"Joe will?" I repeats. "Say, I gotta dance sometimes. You know I'm doing a double Apache with Doris that takes five minutes, besides a coupla honorary clogs. Who's gonna mind the board then?"

"Simple," says the brains of the gang. "Just put a notation on the menu to the effect that no broadcasts will be transmitted during any stage entertainment. And, in case they call for the manager, Doris can tune in as well as any of us."

"Sure," admits that cutie. "Oh, we'll goal 'em, that's all!"

"And remember, watch and be certain that each individual is served with the grapejuice before turning on the program. Otherwise they'll suspect something."

He's a great man. "But who'll operate your devices?" I asks.

"I'll have Pete Bradford come down and do it," he says. "You know Pete?"

I groans. "Do I?" I repeats. "That guy that's been begging me to take him on the stage? Know him! Cantcha get anybody else?"

"I'm afraid not," says The Master. "But Pete'll do it for you."

"Sure he will," soothes Doris. "Never mind."

Pete Bradford once won third prize in an amateur contest in Harper's Ferry, or some place. Anyway, he thinks every minute he's offa Broadway he's cheating the big time. He's mildly clever, and will do nice enough in The Master's rôle, provided he don't get nosy. Jerry promises to see

SM

SUPER-AUTODYNE

TRADE MARK



New!

A Perfected Super-Het

Not content with a seven-tube super-heterodyne, which has become the standard of comparison with radio engineers and editors, McMurdo Silver, Assoc., I.R.E., has developed "The Super-Autodyne," a 6-tube receiver that will out-perform average 7- and 8-tube sets. Read the description of this remarkable achievement in the July "Radio Broadcast." Plans and instructions for building, 50c. Or send for "The Why of the Super-Autodyne"—it's free!

Dealers—Send for Catalog

Silver-Marshall

116 S. Wabash Ave.
Chicago, Ill.

3 TUBE LOUD SPEAKING



only \$29.50

FULLY GUARANTEED

LONG DISTANCE RADIO

Users everywhere report Miraco Tuned Radio Frequency sets get programs coast to coast; super-form sets 3 times as costly. Send for proof they are radio's most amazing values. One tube guaranteed, completely assembled long distance outfit, only \$14.35. Three tube (above), \$29.50. Five tube \$75

SEND POSTAL TODAY for latest bulletin and special offer. It will interest you.

MIDWEST RADIO CORP'N
Pioneer Builders of Sets
404-P E. 6th St., Cincinnati, Ohio

AGENTS DEALERS
Our proposition's a winner. Write.

MIRACO RADIO GETS 'EM COAST TO COAST

CARTER

New Loop Aerial

Pat. 3-24-25



Small and compact, without sacrificing efficiency. Nothing to equal it for use with portable super-heterodyne. Send for illustrated folder.

\$15

Any dealer can supply.

In Canada, Carter Radio Co., Limited, Toronto.

Carter Radio Co.
700 S. HAMILTON AVENUE
CHICAGO, ILL., U.S.A.

Operate your radio from your lamp socket with a

Gould UNIPOWER Battery

for complete information address

GOULD STORAGE BATTERY CO.
250 Park Avenue New York

ATWATER KENT RADIO

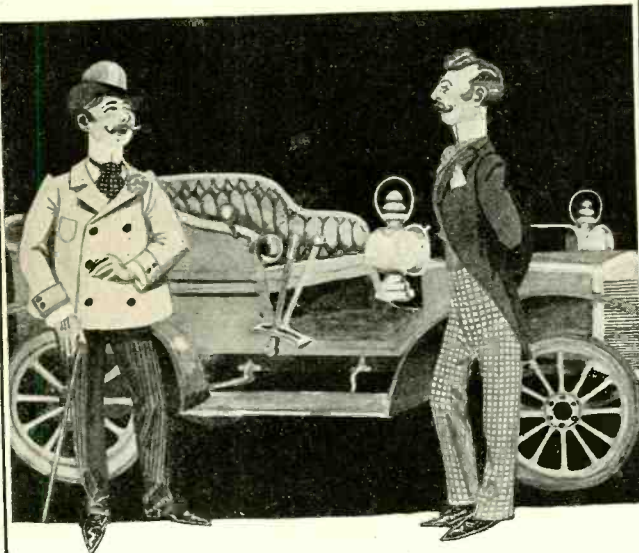

"How fast will it go?"

IN THE early days of automobiles, people asked just one question: "How fast will it go?"

As time went on, people assumed that a good automobile would make good speed. They looked for an all-round car, that would run swiftly *and* smoothly *and* silently *and* economically.

We are still in the early days of radio. People are still inclined to ask: "How much distance will it get?"

It is time to assume that a good radio will get good distance, to look for an all-round set that will get distance *and* tone *and* volume *and* selectivity *and* clear reception.

Every Atwater Kent Radio Receiving Set and Radio Speaker is that kind. It sacrifices no one quality to over-emphasize another.

The Atwater Kent is the radio of today — and tomorrow. It is the all-round radio.

ATWATER KENT MFG. CO.

A. Atwater Kent, President
PHILADELPHIA · PENNSYLVANIA

Hear the Atwater Kent Radio Artists every Thursday evening at 9 o'clock (eastern daylight time) through stations — W E A F New York; W J A R Providence; W E E I Boston; W F I Philadelphia; W C A E Pittsburgh; W G R Buffalo; W E A R Cleveland; W W J Detroit; W C C O Minneapolis-St. Paul; W O C Davenport; W S A I Cincinnati.



Model R, \$12



Model H, \$22



Model 12, \$100



Model 19, \$60



Model 20, \$80

Prices slightly higher from the Rockies west, and in Canada



Model L, \$17



Model M, \$23



Model 10, \$80



Model 20 Compact, \$80



Model 24, \$100

Prices slightly higher from the Rockies west, and in Canada

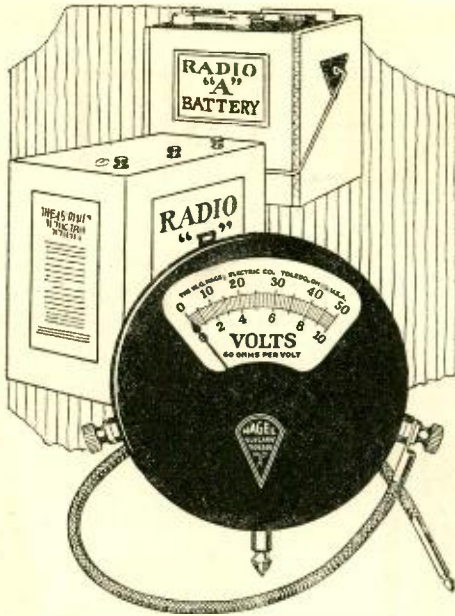

Accuracy and Safety!

Money spent for a cheap voltmeter means more money spent for batteries. 60 ohms per volt—Nagel standard of resistance—is a protection against battery drainage. No. 23 (pictured above), in addition to its use as a "B" battery instrument, is being used extensively for "A" battery testing in place of hydrometers. See your dealer or write The W. G. Nagel Electric Company, 512 Hamilton Street, Toledo, Ohio, makers of the well-known Nagel automobile measuring instruments.

NAGEL

Manufacturers of
DRY CELL TESTERS · AMMETERS
HIGH-RESISTANCE VOLTMETERS
and VOLTAMMETERS · BAKELITE
HOT MOULDED INSULATIONS

Valley Battery Chargers



The Charger With
Ten Points of Superiority

Mfgd. by Valley Electric Co.,
 St. Louis, Mo. Sold by
 Radio Dealers Everywhere.

Authorized Cockaday Coil \$5.50
 Precision Autodyne Coupler \$3.50

PRECISION COIL CO., Inc.
 209 CENTRE ST., NEW YORK CITY

Specialists in the manufacture of all types
 of radio coils

that Pete behaves, so I gives in. But I ain't comfortable.

Saturday night we're to open, and the joint is dressed to kill. The waiters and attendants are dolled up as sea-going operators, and the atmosphere suggests radio from every nook and corner. In the afternoon we rehearses the bill, acts, radio intoxicator and all, and she's perfect. Even Pete behaves, and minds his business.

That evening the doors open. I've done some heavy advertising on the boards and in the papers, and the crowd's all there. Immediately I regrets that supper clubs ain't designed after the hearty lines of the Madison Square Garden. We're filled up within fifteen minutes, everybody admiring and wondering what's what. By each table, with the menu, is a card stating that there's a lot of radio surprises due, so please keep your head-sets on at all times, and other bunk. There's a squad of whiskey-smellers present, an extra portion at my special request. They'd have been there, anyway, and a request gets publicity. For half an hour there's nothing unusual doing. The bunch dances, and an act or two goes on. Then comes intermission, and I gets the first order for Station QRM.

The order says Seat 52, so I plugs Seat 52 onto Jerry's station and watches. It works! Then the gang gets wise, or thinks they are, and orders for Station QRM comes thick and fast. A popular combination order is the DX Special, consisting of a chicken sandwich, Station QRM, and the house cat. What's the cat for? Why, to eat the sandwich, of course.

We does our act to a soused audience, and then I goes back to the switchboard. You see, we've a coupla attendants to go around and tap the drunks with wands, in order to clear the way for a new crowd or more orders from the same bunch, and I'm just about to give the order to that effect, when the chief of the champagne-chasers tells me I'm under arrest.

"Why, what for?" I comes back, innocent. "Funny guy, ain't you," replies the big boy.

"Why, not necessarily," I answers, smooth. "What's the charge?"

"Don't kid me, son," says the officer. "What about this booze?"

"Why, there's no booze here," I assures him. "If you find any, oblige us and throw it out. You know we're trying to run a dry establishment."

The officer laughs. "Yes, you are," he says. "Look at this guy. Only had two drinks, and he's gone already."

"Why don't you taste his stuff?" I inquires. "Seems to me like you'd oughta done that long ago."

"We're just waiting to get a complete case against you," he says. "But what gets me is your request for extra men. You must be dippy."

"Why don't you taste it?" I repeats. The officer does. The expression on his face would be a wow on the small time.

"Grapejuice!" he snorts. Then he and his assistants sample the rest. More grapejuice!

Finally the chief gets another idea. "You've doped it, eh?" he asks, suspicious. "We'll see. Jim, take this to the city chemist and have it analyzed immediately."

It's an hour before Jim returns. His face gives him away.

"Pure juice, chief," he mutters. "Hell!" grunts the chief. "Say, what's it all about? Where are they getting it?"

"Why, chief, they're not drunk."

"The devil they ain't!" yelps the chief. "Being funny again?"

"No," I contradicts. "See that fellow over there, for instance. The tall guy with the drugstore blonde?"

"Yeh—what about him?"

"Is he drunk?"

100 RADIO HOOKUPS

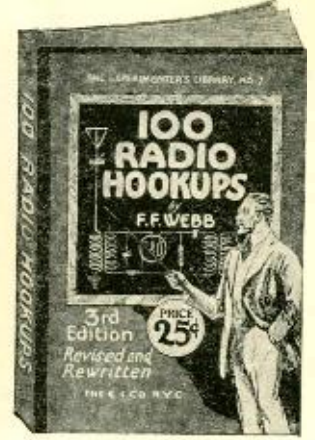

3rd Edition

Completely revised
 rewritten and
 enlarged.

16 Pages of the
 Latest Hook-ups Added

The most complete, practical and up-to-date radio hook-ups book obtainable. Revised and brought up to the minute by one of the foremost radio engineers in the industry.

Contains only practical, efficient hook-ups. Crystal sets, one tube sets, reflex, regenerative, radio frequency, and super circuits.

Gives complete wiring diagrams and full instructions on each and every set so that nothing further is needed in the way of patterns or diagrams.

One of the finest books to have on hand at all times for reference as to the various types of hook-ups and the most practical way of constructing each. Send for or buy a copy today.

All Orders Filled
 Within 24 Hours
 You Can Obtain a Copy
 at All Reliable Radio
 and Newsdealers

PRICE
25¢

Prepaid

E.I. Company
 CONSRAD COMPANY, Inc.
 Selling Agents
 233 Fulton St., New York

Get This Amazing Book—Its FREE

THIS MINUTE—mail the coupon printed below so that you may receive this book from the Institution that has made this famous station, WOC, possible.

The book explains clearly, and without the usual propoganda what has been termed "the greatest health science of this age."

Why Don't You Study Chiropractic

CHIROPRACTIC is the philosophy, science and art of things natural, and a system of adjusting the subluxated vertebrae of the spinal column, by hand, for the restoration of health.

This institution stands pre-eminently first as the originator of the highly developed ideas and principles of Chiropractic. The Palmer School of Chiropractic has long since proved its right to undisputed leadership in this most remarkable discovery, the greatest boon to mankind.

Your education, under our careful tutelage, will constitute the biggest factor in your subsequent progress. Once we have thoroughly equipped you as a finished graduate, your diploma will be evidence of competence, which the public has come to demand from chiropractors.

P. S. C. diploma stands primarily for four very important essentials: (1) The most thorough training offered today in Chiropractic; (2) An absolute adherence to a fixed standard in grades and attendance; (3) A technical education that has eminently fitted the graduate for a full life of ever-increasing prosperity; and (4) The absolute assurance and the mastering skill to care for the sick, with the whole world a field for operations. No wonder the general public is learning to insist on a P. S. C. diploma in selecting its chiropractor.

When you send for the above mentioned free book also indicate on the coupon that you desire to receive our big FREE Chiropractic book.

The Palmer School of Chiropractic

Chiropractic Fountain Head

Davenport, Iowa, U.S.A.

"Where the West Begins"

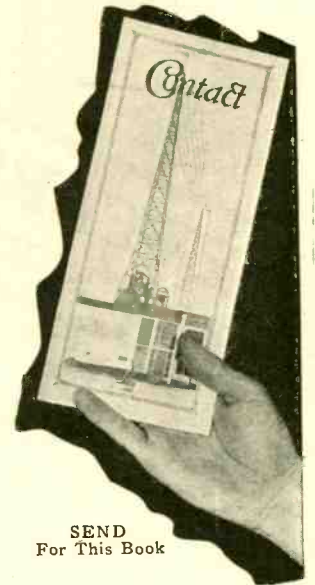

SEND For This Book

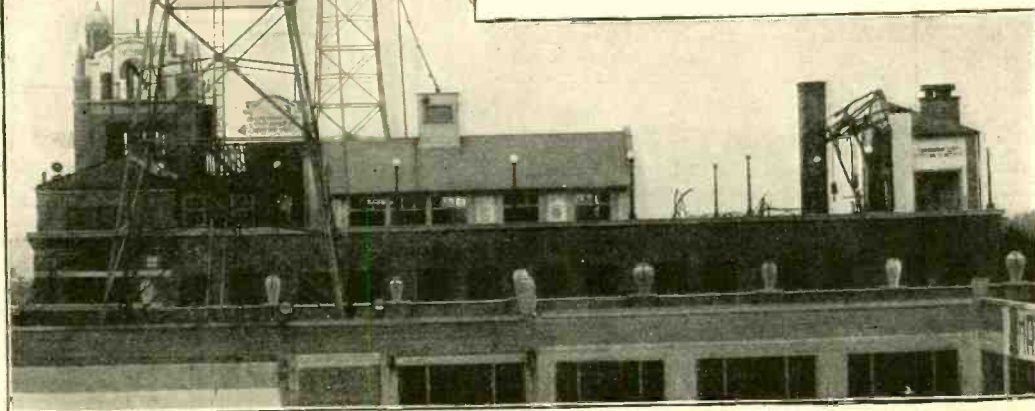
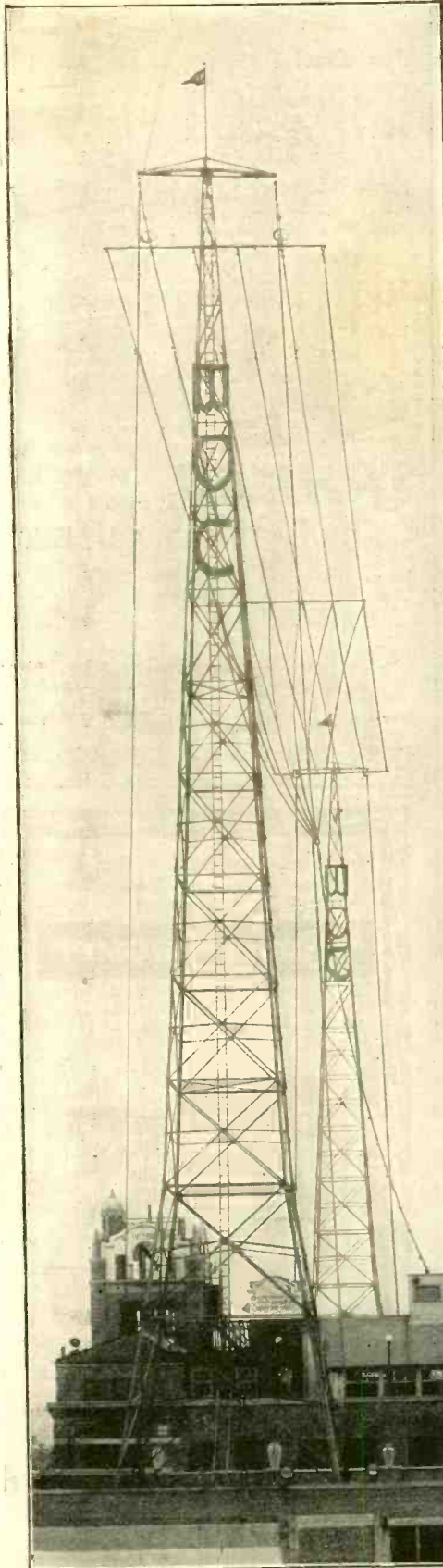

THE PALMER SCHOOL OF CHIROPRACTIC, Davenport, Iowa.

Send me without obligation the following booklets:

- Contact
- P. S. C. Announcement

Name

Address

City

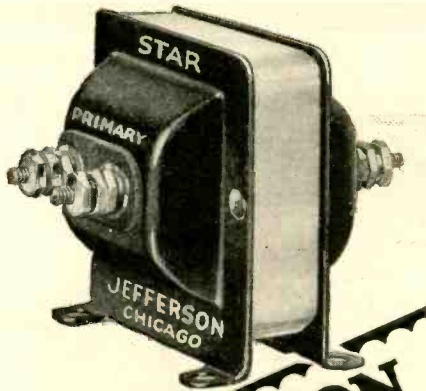

JEFFERSON TRANSFORMERS Clear!

That's the one word that means most in radio reception at this season. Jefferson Transformers do more than their share in making for clarity in audio amplification.

Jefferson Transformers are made by the largest manufacturers of small transformers in the world. The knowledge of design contributed by the best brains of the industry goes into Jefferson Transformers. They are better—many thousands of radioists prove it to their satisfaction every time they twirl a dial.

Jefferson Electric Manufacturing Co.

501 So. Green St. Chicago, Ill.

Makers of Jefferson Radio Tube Rejuvenators, Radio, Bell Ringing and Toy Transformers; Jefferson Spark Coils for



Automobile, Stationary and Marine Engines; Jefferson Oil Burner Ignition Coils and Transformers

A Laboratory Product



CRESCENT LAVITE RESISTANCES
for Distortionless Amplification

12,000, 48,000, 50,000, 100,000 Ohms. List \$1.50 each. Special Sizes to Order \$2.50 each. Dealers write for discounts. When Better Resistances are made they will be Crescents.

Crescent Radio Supply Co., 1-5 Liberty St., Jamaica, N. Y.

BAKELITE

Insulated Condensers give lasting satisfaction. Write for Booklet 24.



BAKELITE CORPORATION
247 Park Avenue, New York, N. Y.
Chicago Office: 636 West 22nd St.

Insure your copy reaching you each month. Subscribe to RADIO NEWS — \$2.50 a year. Experimenter Publishing Co., 53 Park Pl., N.Y.C.

The chief grins. "Keep on kidding me and see where you'll land. Of course he's drunk."

"Wanta bet on it?"

The officer is a good sport. "All right, boy, I'll bet you your freedom against a box of Havana Ropes that he's pickled."

I walks over and idly taps him with the wand.

"Get up, my man," I says.

The tall guy comes to, fully conscious. The chief gasps.

"What is this—a madhouse? Have you hypnotized him?"

He's a lot closer to the truth than he thinks, but I don't say nothing. I taps a few more, and they all comes to.

"I suppose none of 'em is drunk?" says the chief, his face flushed.

"Of course not," I says, sending the assistants to tap the others. "They're only kidding you."

"Hell!" remarks the chief. "Do you think you can trifle with the law?"

Then a new angle opens. For upon questioning, each drunk not only admits having been soused, but furthermore, swears to it!

The dry squad can't find a drop of Canadian toilet water so they gives up the search and just watches. The crowds comes and goes, getting drunk and becoming sober. In this way you can handle two or three times as many people as with real booze, and it's safer—so far. I'm watching Pete Bradford. He's got The Master's old Martian costume, and is wowing those that're sober. Really, he's clever enough, and I feels easier.

When closing time comes and we're over for the day, business is great. We've cleaned up.

We'll be the talk of Broadway!" chirps Doris.

We are. The morning papers has it all.

PROHIBITION SQUAD MAKES RECORD HAUL; PRISONERS INSIST THEY NEVER TOOK DRINK; PRODUCE AFFIDAVITS TO PROVE STATEMENTS

Dry Squad Fills City Jails To Overflowing; 10,634 Drunks Insist They Never Drank; Say They Were Listening In On Radio Concerts At Last Reckoning

Is the radio driving us insane? This is the question propounded by the Chief of Police this morning, when he found a list of nearly 11,000 persons charged with drunkenness, the majority of whom testified that they had been overcome while listening to the radio. The greater portion of the violators were persons of small means. One hundred sixty-three of them produced affidavits to prove themselves to be abstainers. Others were examined by physicians, who reported no trace of alcohol in their systems.

A peculiar demonstration was witnessed at the Q. R. M. Club, a supper cabaret opened last night, a feature of which was radio music through individual head-sets. At this place the manager brought alleged drunks to consciousness by tapping them with a cane. The oddity of this affair has brought with it the possibility of an extensive investigation, coupled with experiments by scientists to determine any possible causes of this phenomenon. At this hour no theories have been advanced. The management of the Q. R. M. Club will be called to testify this morning.

"We're sunk!" I groans.

Just then The Master breaks in. I falls on him like a ton of concrete.

"Didn't you say an ordinary set wouldn't receive these waves?" I asks.

Jerry's face is pale. "J-Joe," he stammers.

"I forgot to make any tests with my crystal receiver! This morning I discovered that galena itself is the best filter in the world!"

I rests that. "And I worried over Pete!" I wails. "We're in for it!"

"Not necessarily," says Jerry. "That is, no more than any other station. You see, these vibrating waves have no length, but come in on any scale. No matter what station they were listening to, they received

The LARGEST RADIO STORES in AMERICA

Hook-ups!
All the latest and best kits in our new **RADIO CATALOG**

FREE

THE HOUSE OF QUALITY AND SERVICE
RADIO CATALOG
CHICAGO
1925

Just Out! Our new 1925 96-page Radio Catalog including all the best and latest Kits, Parts and Accessories. Write for your FREE copy today!

Save Money! Here's a typical bargain from our catalog—hundreds of others like this:

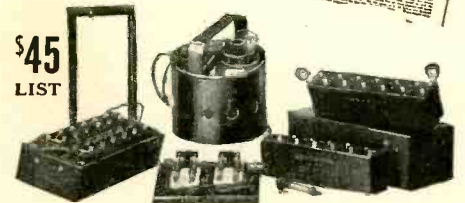

PHILCO CHARGER and 96-Volt "B" BATTERY OUTFIT

Includes: 2 Philco Storage "B" Battery Units in mahogany case, of 48 volts each, Hydrometer, Panel Switch and Philco Charger, Brand new, fully guaranteed. Special Price. **\$19.50**

Mail Orders Filled Promptly
CHICAGO SALVAGE STOCK STORES
Please Address Dept. R.N. 6

509 South State Street, CHICAGO, ILL.

In Broad Daylight You Can Get Stations 1,000 to 2,000 Miles Away With the Air of

The Super-Booster

It greatly increases distance and volume, sharpens selectivity and doubles the life of batteries and tubes. Effective with Super-Heterodyne or other loop-antenna set.

Beautiful mahogany cabinet, 9" x 4 1/2" x 5". Placed on top of set. No batteries or tubes. No connections to the set. Eliminates interference and increases the life of tubes and batteries. Makes ANY set more selective.

Price \$12, delivered anywhere in U. S. Sent C. O. D. or on receipt of money order.

DEALERS WRITE SUPER-BOOSTER DISTRIBUTING CO.
2528 W. Seventh St., Los Angeles

Insure your copy reaching you each month. Subscribe to RADIO NEWS—\$2.50 a year. Experimenter Publishing Co., 53 Park Place, New York City.

America's Greatest Radio Parts Manufacturer

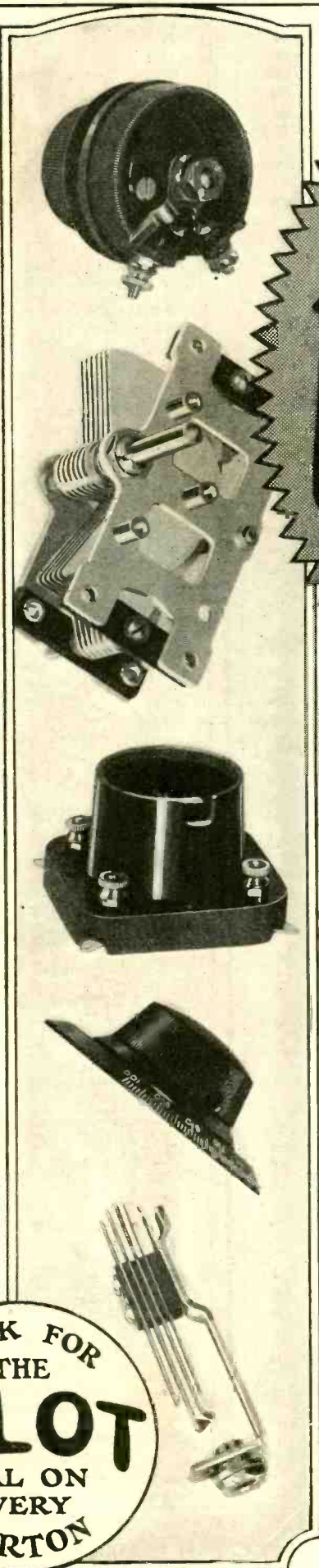

Ask for
PILOT
PARTS

Millions Use Pilot Parts *Radio's Standards*

Pilot Parts are created by the head and founder of the gigantic Pilot organization who has been actively engaged in the manufacture of Radio products since 1908. Being one of the pioneers of Radio and "wireless" he can appreciate the peculiar requirements of the experimenter and maintain at all times a low retail price. This is why Pilot Parts are marketed through the great syndicate chain stores throughout the country.

When a new unit is added to the Pilot Parts line, the entire engineering involved is examined in the Pilot Radio Research Laboratory and a design evolved by mathematical calculations that correctly relates all factors. For this work all modern standard radio testing instruments are used and many special instruments designed and built in the laboratory which cannot be bought in the market.

After a model has successfully passed the gruelling tests of the engineering staff and is approved by the head of the Pilot system, it is passed along to the great Pilot factory.

This organization is unique in that nothing enters it but RAW materials, every part being completely fabricated here. The turned metal parts are produced by a great gang of automatic screw machines, flat metal parts are punched out by special ultra-modern high speed automatic presses, while bakelite parts begin as powder and emerge from a battery of electric moulding machines in perfect conformation to the original design. Assembly of the various perfected units is by hand by skilled workers and rigid inspection is maintained at all times.

Pilot Parts are positive assurance of Radio Success. They are sold everywhere. Ask for them by the Pilot name.

Pilot Electric Company

323 Berry Street

Brooklyn, N. Y.

LOOK FOR
THE
PILOT
SEAL ON
EVERY
CARTON

Takes the MYSTERY out of RADIO!



100,000 SOLD
514 PAGES

Compiled by
HARRY F. DART, E.E.

Formerly with the Western Electric Co., and U. S. Army Instructor of Radio. Technically edited by F. H. DOANE.

BE A RADIO expert—it's easy for the 100,000 who own this compact, complete Radio Handbook. Written in good, plain, understandable language. Crammed full of facts, every one useful and important. Explains how receivers and transmitters work, how to build and operate them. Whatever you or your friends want to know, it's here. Will save you many times its small cost.

TELLS ALL ABOUT: Electrical terms and circuits, antennas, batteries, generators and motors, electron (vacuum) tubes, most receiving hook-ups, radio and audio frequency amplification, broadcast and commercial transmitters and receiving, super-regeneration, codes, license rules. Many other features.

Nothing else like it. Make this extraordinary book your radio library—just this one little giant is all you need. Everything in one index, under one cover, in one book, for one dollar. The biggest dollar's worth in radio today. Combines the knowledge of many expensive works. Buy this and save the difference.

Just mail the coupon with a dollar bill and your name and address, and this 514-page I. C. S. Radio Handbook will be sent to you by return mail. Note the other good books listed below at low prices.

INTERNATIONAL CORRESPONDENCE SCHOOLS Box 8280-F, Scranton, Penna.

I enclose \$..... for which send me, post-paid, the Handbooks marked X, at \$1 each. It is understood that if I am not entirely satisfied I may return them within five days and you will refund my money.

- RADIO HANDBOOK, 514 PAGES, \$1
- Automobile Handbook, 354 pages - - - \$1
- Electrical Handbook, 414 pages - - - \$1
- Chemistry Handbook, 348 pages - - - \$1
- Pharmacy Handbook, 324 pages - - - \$1
- Traffic Handbook, 386 pages - - - \$1
- Building Trades Handbook, 409 pages - - \$1
- Machine Shop Handbook, 335 pages - - \$1
- Salesman's Handbook, 352 pages - - - \$1
- Advertising Handbook, 445 pages - - - \$1
- Bookkeeper's Handbook, 302 pages - - - \$1
- Civil Engineer's Handbook, 411 pages - \$1
- Steam Engineer's Handbook, 298 pages - \$1

Name.....

Address.....

Enclose \$1.50 for each book if you want the Leatheroid binding. All of the above books can be had in this binding except the Traffic Handbook and the Building Trades Handbook.

IMPROVE Your Summer Tuning with E-Z-TOON

E-Z-TOON dials will improve the tuning of any radio set. Replace your old dials with E-Z-TOON and marvel at the simplicity of tuning—takes but a moment to install—a fine smooth 80 to 1 Vernier adjustment. 3 in. dials, Black, \$2; Mahogany, \$2.20. 4 in. Black, \$2.25; Mahog. \$2.45. 2 in. non-Vernier dials for rheostats, switches, etc., Black, 40c; Mahog. 46c. If your dealer cannot supply, write us.

E-Z-TOON RADIO COMPANY
3234 W. Washington St., Indianapolis, Ind.
"The Key to Simplified Tuning"

Insure your copy reaching you each month. Subscribe to Radio News—\$2.50 a year. Experimenter Publishing Co., 53 Park Place, N. Y. C.

the waves. That accounts for the large number of poor people arraigned. They were crystal-set users, and wandered off in a dazed condition after receiving the vibrations."

"One more thing," I says. "What'll we do at court?"

Give him credit, The Master's the emergency kid. "Simply say that you don't know—you just used the stick to wake them up, and that's all you can say. They may not believe you, but they can't prove anything."

We're investigated by so many professors I'm goofy, but Jerry's knowledge saves us. That night the Q. R. M. Club is running, sans the radio intoxicator. The free ad in the papers does the business; it's worse than the opening night. I'm happy, and so's Doris, but The Master is dejected.

"Fool that I am!" mutters Jerry, discouraged. "I've been so engrossed in tube work I'd completely forgotten that people still use crystal sets!"

"Cheer up," comforts Doris. "We ain't been found out."

The Master groans. "But my radio intoxicator! I'll never be able to demonstrate it without incriminating myself in last night's affair. I'm ruined!"

The poor boy's only got about eleven millions left, so I commiserates with him. But he ain't to be cheered.

That night, as we're leaving, Jerry stumbles against a table and knocks over a small hand mirror. It crashes to the floor and breaks into pieces.

"Oh!" laments The Master. "Now I've seven years bad luck coming to me!"

"You needn't worry," replies Doris, snappy. "That's back pay!"

The Blind and the Radio

(Continued from page 146)

and found it filled every phase of utility and was practicable. I discovered that I could have the books printed in an ordinary press and that they would be very little larger than the ordinary printed book and, of course, very much reduced in price, size and cost. There has already been some things done along these lines, notably the invention of Dr. Fournier, and that of Prof. Brown, formerly of the University of Iowa, with whom I have been in correspondence. The result of Dr. Fournier's invention along this line appeared in an instrument which was made by Strand & Company, of Glasgow, Scotland. One of the machines was brought to this country and it was found that the blind could read ordinary printed books by sound, but the machine was very expensive, costing six hundred dollars, and was so delicate in construction as to require an expert electrician to keep it in order, and so it would be almost useless to the blind. With my machine it would be necessary to print the matter in telegraphy and the instrument would be devoid of all delicate mechanism and would cost but a few dollars.

However, in the meantime, let us content ourselves with the radio receiver. It is often nearly as instructive and usually fully as entertaining as a book, and, in addition, it is extremely easy for the blind to operate. In fact, as I become more accustomed to the use of my radio set, I am astonished myself at the ease with which it can be managed by a blind person. A short time ago, early in the morning, I listened in to the entire progress of the race of the motorboat against the time of the Twentieth Century train from Albany to New York, and I got every word that was

Here's a customer for you!

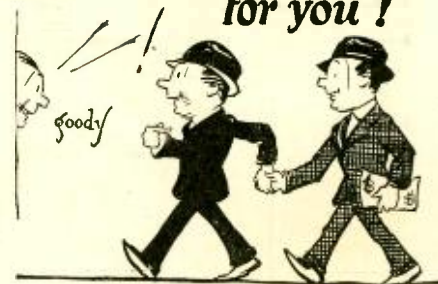

Hommel's policy of referring customers to their local dealers means additional sales and real money profit to them.

We make the co-operation between our dealers and ourselves as close and as tangible as is possible.

Your name could just as well be on our dealer list and you could profit like all Hommel dealers are profiting.

Our illustrated Encyclopedia of Radio Apparatus 266-S is free to dealers.

WHOLESALE
LUDWIGHOMMEL & CO
929 PENN AVENUE
PITTSBURGH, PA.

Radio Receiver KITS Catalog FREE

Send To-day

YOU Need This Book

Your Own Kit Without Money Go Into Business For Yourself Book Explains How

7x10 ins. 36 Pages

Contains offers of large number of unequalled Radio Receiver Kits of one to eight tubes, which you can build in from one to several hours by the aid of our new "NO-SOD-ER" SYSTEM which goes away with bus bar and solder. Use only screwdriver and pliers. Please see big ad., page 158

No money in advance—goods sent on approval—we pay transportation—satisfaction or money back.

RADIO SPECIALTY COMPANY
Kit Div., 679K, 245A Greenwich Street, New York City

GEM TUBE

A Guaranteed Radio Tube Within Reach of All

Every tube guaranteed. A tube for a dollar at \$3 value. A trial order will convince you as it has thousands of others. Send your orders at once.

Orders sent C.O.D. parcel post.

Type.....401A	\$1.00
Type.....400	
Type.....489	
Type.....499A	

(with standard base)

Dealers, Write for Discounts

GEM TUBE CO.
Dept. N, 200 B'way N. Y. City
220 So. State St., Chicago, Ill.
Lafayette Bldg., Detroit, Mich.

NA-ALD

Na-ald DeLuxe Sockets are the only ones with these three exclusive features—lowest loss, lowest capacity and positive side-scraping contact. Send for booklet and laboratory test. Alden Manufacturing Company, Dept. K12, Springfield, Mass.

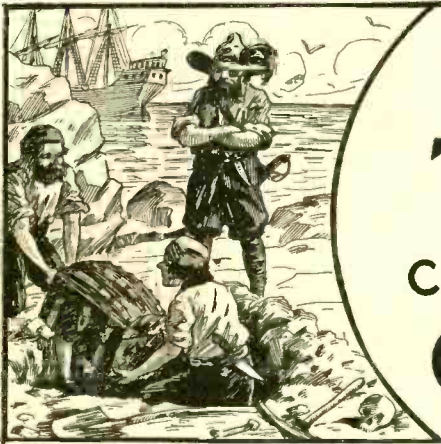

BURIED TREASURE

can still be found in

CHEMISTRY



Good Chemists Command High Salaries

and you can make yourself independent for life by unearthing one of chemistry's yet undiscovered secrets.



T. O'CONNOR SLOANE.
A.B., A.M., LL.D., Ph.D.
Noted Instructor, Lecturer and Author. Formerly Treasurer American Chemical Society and a practical chemist with many well known achievements to his credit. Not only has Dr. Sloane taught chemistry for years but he was for many years, engaged in commercial chemistry work.

Do you remember how the tales of pirate gold used to fire your imagination and make you want to sail the uncharted seas in search of treasure and adventure? And then you would regret that such things were no longer done. But that is a mistake. They *are* done—today and everyday—not on desert islands, but in the chemical laboratories throughout your own country. Quietly, systematically, the chemist works. His work is difficult, but more adventurous than the blood-curdling deeds of the Spanish Main. Instead of meeting an early and violent death on some forgotten shore, he gathers wealth and honor through his invaluable contributions to humanity. Alfred Nobel, the Swedish chemist who invented dynamite, made so many millions that the income alone from his bequests provides five \$40,000 prizes every year for the advancement of science and peace. C. M. Hall, the chemist who discovered how to manufacture aluminum made millions through this discovery. F. G. Cottrell, who devised a valuable process for recovering the waste from flue gases, James Gayley, who showed how to save enormous losses in steel manufacture, L. H. Baekeland, who invented Bakelite—these are only a few of the men to whom fortunes have come through their chemical achievements.

What Some of Our Students Say of This Course:

I have not written since I received the big set. I can still say that it far exceeded my anticipations. Since I have been studying with your school I have been appointed chemist for the Scranton Coal Co. testing all the coal and ash by proximate analysis. The lessons are helping me wonderfully, and the interesting way in which they are written makes me wait patiently for each lesson.—MORLAIS COUZENS.

I wish to express my appreciation of your prompt reply to my letter and to the recommendation to the General Electric Co. I intend to start the student engineering course at the works. This is somewhat along electrical lines, but the fact that I had a recommendation from a reliable school no doubt had considerable influence in helping me to secure the job.—H. VAN BENTHUYSEN.

So far I've been more than pleased with your course and am still doing nicely. I hope to be your honor graduate this year.—J. M. NORRIS, JR.

I find your course excellent and your instruction, truthfully, the clearest and best assembled I have ever taken, and yours is the fifth one I've studied.—JAMES J. KELLY.

From the time I was having Chemistry it has never been thus explained to me as it is now. I am recommending you highly to my friends, and urging them to become members of such an organization.—CHARLES RENJAMIN.

I shall always recommend your school to my friends and let them know how simple your lessons are.—C. J. AMDAHL.

I am more than pleased. You dig right in from the start. I am going to get somewhere with this course. I am so glad that I found you.—A. A. CAMERON.

I use your lessons constantly as I find it more thorough than most text books I can secure.—WM. H. TIBBS.

Thanking you for your lessons, which I find not only clear and concise, but wonderfully interesting, I am—ROBERT H. TRAYLOR.

I received employment in the Consolidated Gas Co. I appreciate very much the good service of the school when a recommendation was asked for.—JOS. DECKER.

Now Is the Time to Study Chemistry

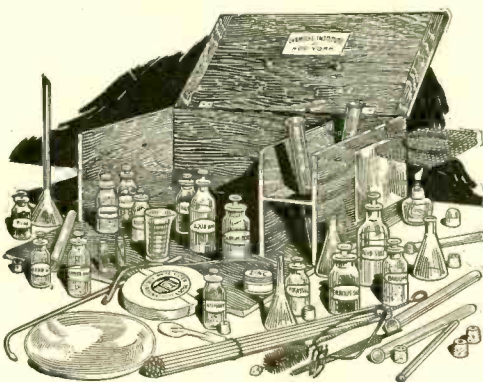

Not only are there boundless opportunities for amassing wealth in Chemistry, but the profession affords consoling employment at good salaries to hundreds of thousands who merely follow out its present applications. These applications are innumerable, touching intimately every business and every product in the world. The work of the chemist can hardly be called work at all. It is the keenest and most enjoyable kind of pleasure. The days in a chemical laboratory are filled with thrilling and delightful experimentation, with the alluring prospect of a discovery that may spell Fortune always at hand to spur your enthusiasm.

You Can Learn at Home

To qualify for this remarkable calling requires elaborate specialized training. Formerly it was necessary to attend a university for several years to acquire that training, but thanks to our highly perfected and thorough system of instruction, you can now stay at home, keep your position, and let us educate you in Chemistry during your spare time. Even with only common schooling you can take our course and equip yourself for immediate practical work in a chemical laboratory. Dr. Sloane gives every one of his students the same careful, personal supervision that made him celebrated throughout his long career as a college professor. Your instruction from the very beginning is made interesting and practical, and we supply you with apparatus and chemicals for performing the fascinating analyses and experimental work that plays such a large part in our method of teaching, and you are awarded the Institute's official diploma after you have satisfactorily completed the course.

Easy Monthly Payments

You don't have to have even the small price of the course to start. You can pay for it in small monthly amounts—so small that you won't feel them. The cost of our course is very low, and includes everything, even the chemistry outfit—there are no extras to buy with our course. Our plan of monthly payments places a chemical education within the reach of everyone. Write us and let us explain our plan in full—give us the opportunity of showing you how you can qualify for a highly trained technical position without even giving up your present employment.

Special 30 Day Offer

Besides furnishing the student with his Experimental Equipment, we are making an additional special offer for a short while only. You owe it to yourself to find out about it. Write today for full information and free book "Opportunities for Chemists." Send the coupon right now while it is fresh in your mind. Or just write your name and address on a postal and mail it to us. But whatever you do, act today before this offer is withdrawn.
DON'T WAIT—MAIL COUPON NOW!

Experimental Equipment Furnished to Every Student

We give to every student without additional charge this chemical equipment, including forty-nine pieces of laboratory apparatus and supplies, and forty different chemicals and reagents. These comprise the apparatus and chemicals used for the experimental work of the course. The fitted heavy wooden box serves not only as a case for the outfit but also as a useful laboratory accessory for performing countless experiments.

CHEMICAL INSTITUTE OF NEW YORK, Inc.

HOME EXTENSION DIVISION 8
66-R—WEST BROADWAY NEW YORK CITY

CHEMICAL INSTITUTE OF NEW YORK
Home Extension Division 8
66-R—West Broadway
New York City

Please send me at once, without any obligation on my part, your free Book "Opportunities for Chemists," and full particulars about the Experimental Equipment given to every student. Also please tell me about your plan of payment and your special 30 day offer.

NAME

ADDRESS

CITY.....
R. N., Aug. '25

STATE.....



If You Really Want Radio Pleasure

IT'S unfair to any set, however costly or perfect, to expect it to maintain its reputation and return your investment of interest and money—without the most careful operation.

Protect your tubes with a Weston Model 301 Filament Voltmeter or a Model 489 Table Voltmeter, and use your batteries with a complete knowledge of their condition. By doing so you assure clear tone and good volume at the same time.

Added to these indispensable instruments is the Weston Radio Plug for the fastest known change from headset to loudspeaker.

Write for the famous free booklet "Weston Radio Instruments."

Weston Electrical Instrument Corporation
173 Weston Ave., Newark, N. J.



Day-Fan RADIO
A Year Ahead
The set with the air telephone directory
The Dayton Fan & Motor Company
DAYTON, OHIO

Spaulding BAKELITE RADIO PANELS
SPAULDING FIBRE COMPANY INC.
TONAWANDA, N.Y.

Insure your copy reaching you each month. Subscribe to RADIO NEWS — \$2.50 a year. Experimenter Publishing Co., 53 Park Pl., N.Y.C.

sent out by Captain McClellan for, although words were accompanied by the roar and heavy rumble of the 400-horsepower engine of the airplane, I could easily differentiate between the awful racket and his words, and did not lose any of them.

He spoke slowly and clearly to produce the best possible result, and supplemented his talk with a wireless message, which, being an old Western Union operator, I could distinguish as plainly as I ever did from a telegraph instrument on my desk in an office. He was by no means sure that he could be heard by the radio listeners, or even by the expert listeners at WGY and WJZ, who were doing the work. The roar of the engine was, of course, very great, but it was a steady, uniform roar, and the words were much more readily understood, I think, on that account, for with the rattle and unevenness of the static interference, which is sometimes so great on the radio, I do not think that I would have been so fortunate as to understand Captain McClellan very well.

The same evening I heard with great clearness and pleasure Verdi's wonderful composition, the opera, "Aida." The entire substance and delightful music of the four acts and all the descriptions given by the announcer were plain and distinct. So, way up here in Utica, where Grand Opera is so rare, I had the pleasure of hearing a great professional troupe of singers render one of the best musical productions of all time.

And this is but one instance of the pleasure which radio can afford to the blind. It is, indeed, the greatest boon which has ever been bestowed on them, to make their dark days more like the days of other people. The benefit, profit and pleasure which it is capable of affording to the sightless cannot be measured by any standard that would show its full value.

Life and Work of Lee DeForest

(Continued from page 155)

were passed through it and its vibration was caught by a moving strip of sensitized film. The system—as so many are—was beautiful in theory but hardly so good in practice. The wire was so fine that repairs had to be made with the aid of a microscope. A good, healthy sneeze anywhere in the operating room would break it and just an ordinary jolt of summer static would fuse it.

DeForest set about designing another system for recording the incoming signals.

It was only a couple of days after he was assigned to this new work that he was sent out on an installation job for a new transmitter and receiver. The Federal company was now building sets in sizes up to forty kilowatts and already had a circuit established from San Francisco to Honolulu. This was a successful undertaking and the company was more or less busy with orders for installations which were coming in every day.

RECOGNITION OF "FADING"

It was on this installation that DeForest first segregated the knowledge that there was such a thing as fading, and definitely put it into the dictionary of the radio engineer. Up until this occasion no mention had been made of such a phenomenon. How all the engineers who had been in intimate connection with the art for a number of years could have failed to notice it he confessed not to know. One reason for noticing it was that the receiver worked as soon as it was connected to the antenna and that, at first, the signals came in strong and then gradually began to fade out. DeForest put his hand over on

KIC-O
"B" ELIMINATOR
SIMPLICITY
PERMANENT
ALKALINE STORAGE
BATTERY RECEPTION

KIC-O MULTI-POWER UNITS operate from your lighting line and eliminate the replacing of dry cell "B" batteries... usually saving their cost in the first six to twelve months of service on Neutrodyne and Super Heterodyne sets.

Its RECHARGER is attached to back.

Guaranteed Two Years PRICES MULTI-POWER UNITS (Complete)
150 volt P. U. \$43.50
100 volt P. U. \$35.00
100 volt C. U. \$32.50

P over — E conomy — P erformance
Unexcelled for better Radio. Backed by years of research. Write NOW for SPECIAL FREE TRIAL OFFER!
DEALERS! EVERYBODY!

Kimley Electric Company, Inc.
2665 Main Street Buffalo, N. Y.

JEWELL

"A" and "B" Battery Voltmeter

7½ and 150 Volts
No. 57 \$10.50

Test your batteries often and avoid much of your radio trouble. Add to life of your tubes.

Ask your dealer for a Jewell 15-A Radio Catalog.

Jewell Electrical Instrument Co.
1650 Walnut St., Chicago
"25 Years Making Instruments"

Will You Wear This Suit?

Show it to your friends and neighbors as a sample of our fine quality, hand-tailored All-Wool Suits, guaranteed \$40 values at amazing low price of \$23.50, take their orders, keep handsome profit for yourself and send orders to us.

Agents Making BIG MONEY
\$3.00 to \$5.00 an hour in spare time, \$75 to \$150 a week for full time. We supply handsome Swatch Line Outfit, large size samples and all latest styles in elegant Leather Case. Positively finest selling outfit ever furnished salesmen. Write for yours at once, pick out your suit and get started making The Big Money right away. Address Dept. 128.

JAMES OLIVER, Inc.
848 W. Adams Street Chicago
Write name and address below and mail at once.

Name.....
St. and No..... R. F. D..... Box.....
Town..... State.....

the condenser dial in the hope of retuning the set, thinking that temporarily it had gone out of resonance due to the shifting of some piece of apparatus. As soon as his hand reached the proximity of the dial the signal came back. But while he was still thinking about this happening, the signal again began to fade out. DeForest, thinking that there was some difficulty in the receiver itself, set about repairing the trouble. He looked through the set and gave it a thorough examination, carefully noting the condition of each part. The set proved to be in perfect condition and DeForest went to dinner with a great problem on his mind. Dependable communication could not be established if the incoming signals were going to play pranks like those to which he had just been listening. He went back and tried reception with another set. The same result was apparent.

Then there came the great idea. There could be only one explanation of the behavior of the set. There was some uncontrollable condition in the atmosphere or the ether which was causing the signals to swing in that manner. It was *fading*. He prepared a paper for the I. R. E. which set forth for the first time the idea of interference between two portions of the original wave-train due to refraction or reflection of that portion which took the upper course through the atmosphere upon some body of vapor, or heated or ionized air. This explanation of fading is today generally recognized as the correct one. It must be borne in mind that this phenomenon was discovered only thirteen years ago last month.

When he returned to the laboratory the problem of constructing the high-speed transmitter and receiver was still before him. The Danish apparatus was too hopelessly delicate for commercial work, so DeForest followed his usual method of attack by throwing the whole thing out of his con-

sciousness and starting along an entirely new track for the solution of the problem. The engineers of the company had been attempting to stabilize the system then in use for at least two years and had failed miserably.

The system was one which was simply too impractical to consider for dependability and commercial installation.

DeForest went back a couple of years in his experience and remembered the telegraphone which had been patented for the reproduction of dictation. This little device was, in fine, nothing more than a fine steel piano wire running in the field of an electro-magnet. Any audio frequency sound which passed through the magnet would create a definite field in the structure of the wire, and when the wire, in turn, was passed through the field of a coil it acted as the field of a generator and set up feeble currents in the wire of the magnets. These impressions could be retained for years. They were permanent until wiped off with a magnet. DeForest got together the necessary parts and constructed a telegraphone. He brought the signals from the ticker to the actuating magnet of the instrument and ran the piano wire through very swiftly. The high speed signals were implanted on the wire. Then, at leisure, the operator could rewind the wire and run it through the reproducer more slowly while he copied the message. Then the wire could be cleaned of its impressions by being wiped with a magnet and used again. The scheme worked most beautifully. The only trouble was that the signals from the ticker were so weak that an entirely different problem was raised when the operator tried to read the commercial signals.

INVENTION OF AUDION TUBE

And as has so often been quoted, "Necessity is the mother of invention," and this little problem caused DeForest to give to the world



Essential
for summer tuning

In summer, when static is apt to prove most active, the uncanny precision of the Accuratune, geared for coarse or fine tuning on an 80 to 1 ratio, is particularly appreciated. It tunes in stations clearly and strongly, and tunes out interference effectively, all as a matter of course.

MYDAR RADIO CO.
7 CAMPBELL ST., NEWARK, N.J.

ACCURATUNE
REGISTERED GEARLESS GIGI U.S. PAT. OFF.

1925

RADIO WORLD'S FAIR

258 th. Field Artillery Armory

NEW YORK CITY

SEPTEMBER

MONDAY TO SATURDAY

14th to 19th

Entire Exposition on Ground Floor

U. J. Herrmann and James F. Kerr, *Directors*

Business Offices: 1500 Times Bldg., New York

127 N. Dearborn St., Chicago

Official
Show
R.M.A.

A Great Manufacturers' Exposition which will be attended by the Principal Radio Jobbers and Dealers of the Universe

Official
Show
R.M.A.

Some Popular 1925 Standard Models

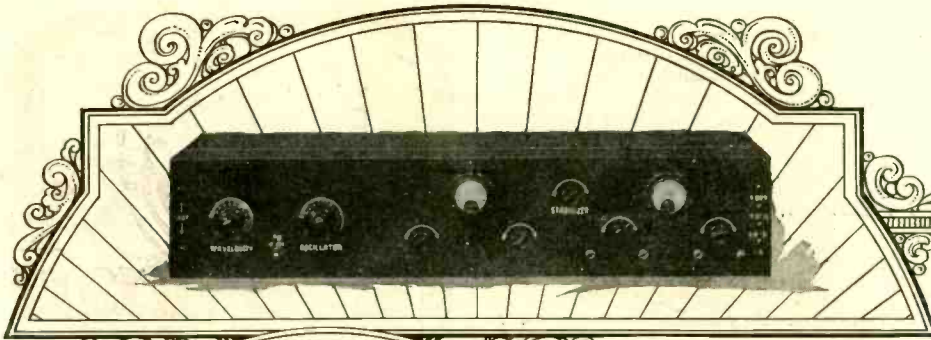

The superheterodyne—a late model. This is a type of circuit very popular with long distance fans and those who require good volume. Employs eight tubes and is easy to construct at home.



R. E. Lacault, A.M. I.R.E., the well-known radio engineer, designed and developed the "Ultradyné" shown above. It is a six tube receiver with splendid power, easy to wire and construct. The latest in 1925 radio models.

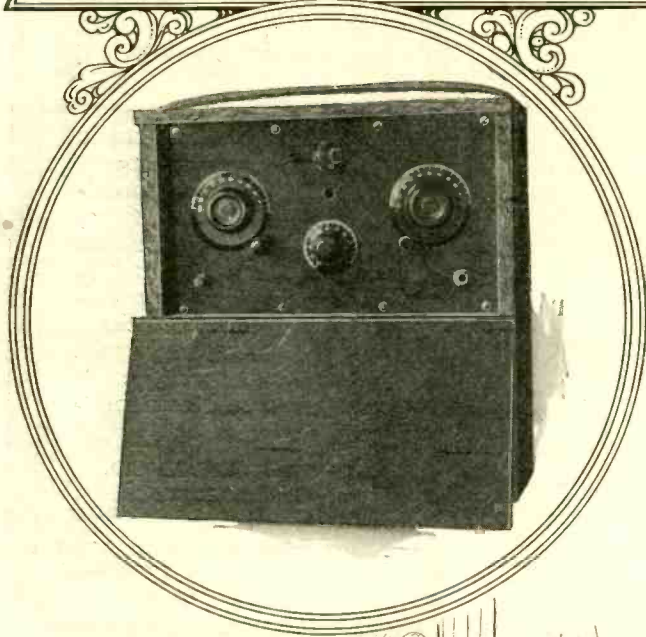

Here is something novel yet very popular in high powered radio receivers—the Tropadyne. Six tubes, equipped with tropaformers, operates from loop and reproduces beautifully.

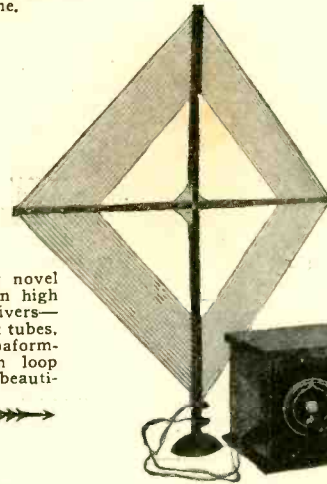

The popularity of the portable is spreading daily—that's because they have been perfected for 1925. Above is one of the season's most successful models, neat, light and easily carried.

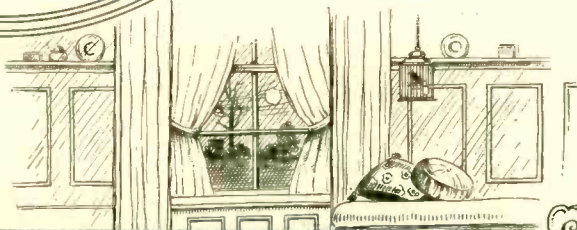

THE seven model receivers shown on this page represent perhaps the most select array of efficient, low cost, radio receivers on the market today. In fact, every one of them is so compact and complete that it can be built right at home with a few small tools and a few evenings' work.

Now is the time to select the receiver you want and start building.

There are complete instruction booklets and full size blueprints on all receivers on this page. Price 50c each. You can obtain them at all radio stores or by writing direct to

The Conrad Company, Inc.
233 Fulton St., New York, N. Y.

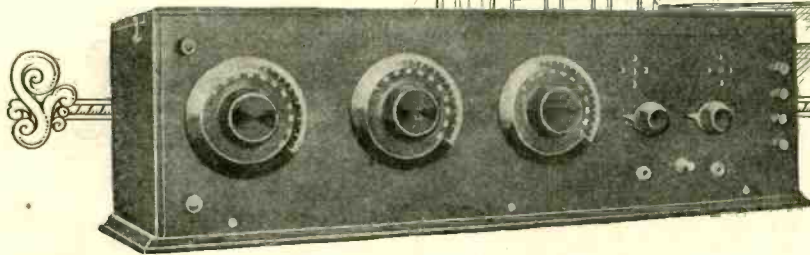

Countless thousands of radio fans throughout the country are Neutrodyne boosters. It is the 1925 ultimate in perfect reproducing radio receivers.

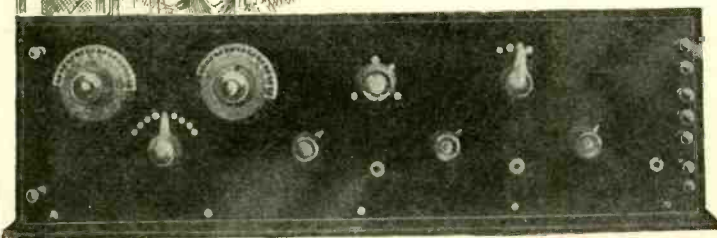

Lawrence M. Cockaday, one of the best known radio engineers, is responsible for the five tube Cockaday receiver shown above. It is replete with the recent radio improvements and is extremely compact.

And lastly, here's one of the famous low-loss receivers of recent design that is built entirely along the lines of current conservation. It is an ideal outfit for the man who would like to build a thoroughly satisfactory receiver for home use.

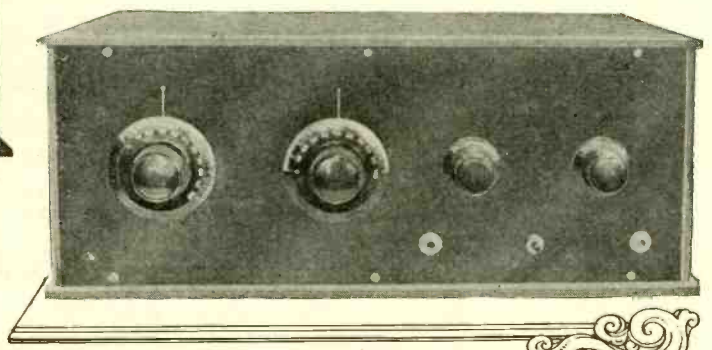

of DeForest's final rise above the bludgeonings of chance.

The Piezo Electric Oscillograph

(Continued from page 143)

Let us now consider in detail the proper way to prepare a crystal for this purpose and the proper way in which to rig up and use the crystal, once it is prepared.

PREPARATION OF THE CRYSTAL

Good-sized crystals of Rochelle salt suitable for piezo work can be grown by any careful amateur, but to avoid discouragement it ought to be understood at the start that real care and considerable patience are, excepting in the case of a lucky accident, certain to be necessary. In the first place, buy *one pound of Rochelle salt, chemically pure and crystallized*. This should be obtained in a sealed bottle from or through a druggist or chemical house. The cost will be about seventy-five cents. Buy also a quart or gallon bottle of *distilled water*, such as is used to refill automobile storage batteries. The cost of the water should not exceed twenty-five cents. Dissolve the whole of the Rochelle salt in about 10 or 12 ounces of warm distilled water in a clean glass vessel about six inches in diameter and about eight inches high, taking care at this and all subsequent stages to prevent the entrance of dust, small floating fluff or hairs and other foreign material. If this solution is too "strong" it will crystallize at once on cooling to room temperature, forming a mass of irregular crystals useless for piezo work. The strength must be adjusted so that crystals just begin to form at about room temperature. This critical adjustment may, by chance, be reached at once, but more likely it will take considerable time and experimentation. If the solution proves too strong add water; if too weak heat or boil to evaporate some of the water. The water may be measured in a graduate marked in ounces, such as is used in photographic work.

Next, put a few tablespoonfuls of the solution into a saucer or flat dish and let it evaporate *quickly* in a draught of air or in a warm place. A considerable number of small crystals will thus be formed. These are called "seed crystals." Select a few of these seeds, perhaps an eighth of an inch long, which have formed on a flat part of the saucer and which have a shape flat on the bottom and arched on the top like those shown in the sketch in Fig. 1. These seeds are to be used as centers for growing larger crystals such as we need for our oscillograph.

Now cut a square of flat window glass of such size that it will rest easily in the jar at the bottom of your salt solution. Clean this sheet, warm it and introduce it carefully into the solution. Next drop a selected seed crystal into the middle of this plate and set the jar in a place free from vibrations and disturbances where the temperature is steady. Level the jar with slips of paper under it until the glass plate is horizontal. Cover it with a sheet of paper and leave it strictly alone. If the strength of the solution is correct for the room temperature, if the temperature remains constant at the right value and if no dust has got into the jar the seed crystal will begin to grow within a few hours. After 18 to 24 hours it will have grown to a length of about two inches, which is long enough. Naturally the three "ifs" mentioned may cause trouble but, as I have said, any careful worker will certainly be successful in crystal growing after a few trials and adjustments to fit his particular facilities.

The dust trouble can be eliminated by filtering the solution hot before introducing



KEEP reception clear!

Keep it clear. Keep it loud—with all the volume your set should have. Keep the battery at top notch—fully charged—peppy.

The Tungar charges your storage battery overnight while you sleep—and at a cost of hardly more than five cents. It's easy! Just two clips—and a plug for the house current. Or you can make a permanent connection, and just throw a switch. Keep your set at its best all the time—with a Tungar.



The Tungar is a G-E product, developed in the great Research Laboratories of General Electric.

The New Model Tungar charges radio A and B storage batteries, and auto batteries. Two ampere size (East of the Rockies) . . . \$18.00

60 cycles—110 volts

Tungar

Reg. U. S. PAT. OFF.

BATTERY CHARGER

Tungar—a registered trademark—is found only on the genuine. Look for it on the name plate.

Merchandise Division

General Electric Company, Bridgeport, Conn.

GENERAL ELECTRIC

National Airphone Corp.
MANUFACTURERS OF
Somerset—the Ultimate in
Radio Frequency Receivers
18 Hudson Street — New York City

Reflectone

THE QUIET LOUD SPEAKER WITH THE GIANT VOICE

Registered

Only 5 Inches High—\$8.00

RICE & HOCHSTER
134 Washington Place New York City

SALESPEAKER

is the name of the most interesting radio bulletin published. If you are a dealer, we will mail you a copy, on request.

HUDSON-ROSS—116 S. Wells St.
Chicago

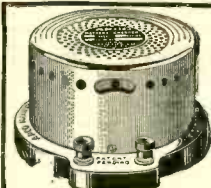

Sleep Tight

Sleep tight when you turn on an APCO "A" Battery Charger at night for it's not only noiseless but absolutely dependable.

APCO Mfg. Co.
Radio Division
Providence, R. I.

Insure your copy reaching you each month. Subscribe to Radio News—\$2.50 a year. Experimenter Publishing Co., 53 Park Place, N. Y. C.

LOOK HERE FOR THE RED STRIPE

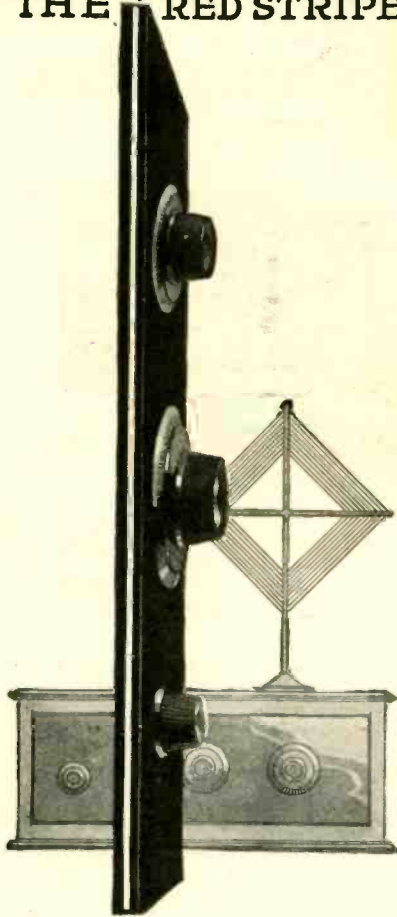

Used by the United States Navy and Signal Corps for over nine years. Dilecto is the strongest, safest radio panel that can be made. Look for the identifying "Red Stripe" that sets apart Dilecto from its imitators.

THE CONTINENTAL FIBRE CO.
FACTORY: NEWARK, DELAWARE

Service on Dilecto, also Conter, Conite, and Vulcanized Fibre, from:

- | | |
|----------------------------------|---------------------------------|
| NEW YORK
250 Park Ave. | SAN FRANCISCO
75 Fremont St. |
| CHICAGO
Wrigley Bldg. | SEATTLE
1041 6th Ave. So. |
| PITTSBURGH
Farmers Bank Bldg. | LOS ANGELES
307 So. Hill St. |

Offices and Agents Throughout the World

Dilecto
(distinguished by its red stripe)

"RICO" HEADSETS AND RUBBER CUSHIONS—MELOPHONE LOUD SPEAKER—TROPAPFORMERS (TUNABLE FOR LONG WAVE CIRCUITS)—AND THE FAMOUS RICO-DYNE FIVE TUBE SET—AT THE BETTER DEALER'S SHOP, OR WRITE DIRECT.

MANUFACTURED BY
RADIO INDUSTRIES CORP.
131 DUANE STREET
NEW YORK CITY, N. U. S.

To the Radio Dealer

Let us explain how you can make the sale of our publications a worth while, well paying part of your business. Write now and prepare for the Fall and Winter trade.

Experimenter Publishing Company

53 Park Place New York City

it into the crystallizing jar. The necessary constancy in temperature can be better assured by putting the jar, during the crystallizing process, into a tin biscuit or bread box which has been wrapped with several layers of cotton batting or hair felt tied on with strings. The trouble of leveling the glass plate can be avoided by pouring into the glass jar enough mercury to float the plate, if mercury is available. These ideas are embodied in the drawing of Fig. 2. Crystals as large as 3 by 2 inches can be grown by this method but the larger the crystal the more likely are flaws and twin crystal effects to develop. The experimenter ought to be satisfied with crystals two inches by one and a half inches approximately. When these crystals are removed from the glass plate they will be found to exhibit a peculiar structure on the under face, as shown in Fig. 1. The crystal looks like four pyramids with their tips together. Fig. 1 shows in a general way what the crystal ought to look like. The crystal, after removal from the solution, ought to be dried carefully by keeping it at about 100 degrees Fahrenheit for three or four days. The sensitiveness of the crystal when used in the oscillograph is found to depend on the dryness. Sensitivity can also be increased by soaking the crystal in absolute grain alcohol for 18 hours or so immediately after removal from the crystallizing jar and before drying. However, under present conditions, some people have difficulty in obtaining grain alcohol.

ELECTRICAL CONNECTIONS

Now, as has been indicated in Fig. 1, a twist is produced between the top and bottom ends of a Rochelle crystal of the shape shown when one terminal of a voltage supply is connected to the top and bottom surfaces and the other end of the voltage supply is connected to a girdle around the middle of the crystal, midway between the top and the bottom.

These electrical connections are made of tin foil cut to the proper shape and laid on with shellac. Tabs are left sticking out for connection to the potential wires. The girdle around the middle should cover about one-half the height of the crystal. After the shellac has been put on, the crystal must be again dried. We are now ready to assemble the complete instrument.

THE COMPLETE INSTRUMENT

The crystal may be mounted on a small board, as shown in Fig. 3. Fasten the crystal down with shellac and tin foil pads. A light arm of sheet aluminum, bent into girder form to give it rigidity, is next attached to the top of the crystal, as shown. The overall length of this arm is something more than twice the length of the crystal. Face the upper side of the end of the arm with a thin layer of cork. Another similar arm, faced with cork on its lower side, is arranged to slide on a post set behind the crystal, as shown in the figure. When this second arm is brought down over the arm attached to the crystal and a small piece of thin mirror, perhaps 1/16 of an inch square, is clamped between the two cork surfaces with its face vertical and parallel to the flat face of the crystal, the oscillograph is complete.

OPERATION OF THE INSTRUMENT

If now an electrical potential is applied between the wires D and E—if for example a 90-volt "B" battery is connected to these wires—the crystal will warp around its vertical axis and the little mirror will be tilted. If a beam of light is reflected from this mirror onto the opposite wall of the room the spot of light will move up or down when the potential is applied, thus showing the warp. If the crystal is a good one—there is quite a variation among crystals—150 volts applied between D and E ought to move the spot of light 1/2 to 3/4 of an inch

The
DAVEN SUPER AMPLIFIER

will give to your receiver ample volume of wonderful quality. Completely assembled, easy to attach, low "B" Battery consumption.

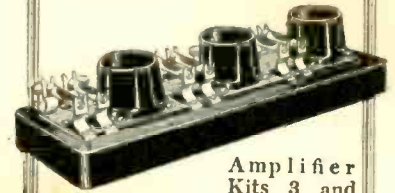

Amplifier Kits 3 and 4 stages.

The Resistor Manual at your Dealer 25 cents. Post-paid 35 cents.

The Son of Mont
DAVEN RADIO CORPORATION
"Resistor Specialists"
NEWARK, N. J.



\$3.50 each

RADIO Storage "B" Battery

12 Cells 24 Volts Lasts Indefinitely—Pays for Itself

Economy and performance unheard of before. Recharged at a negligible cost. Approved and listed as Standard by leading Radio Authorities, including Pop. Radio Laboratories, Pop. Sci. Inst., Standards, Radio News Lab., Lefax, Inc. and other important institutions. Equipped with Solid Rubber Case, an insurance against acid and leakage. Extra heavy glass jars. Heavy rugged plates. Order yours today!

SEND NO MONEY Just state number of batteries wanted and we will ship day order is received. Extra Offer: 4 batteries in series (96 volts) \$13. Pay expressman after examining batteries. 5 per cent discount for cash with order. Mail your order now!

WORLD BATTERY COMPANY
1219 So. Wabash Ave., Dept. 75 Chicago, Ill.
Makers of the Famous World Radio "A" Storage Battery
Prices: 6-v., 100 Amp. \$11.25; 120 Amp. \$13.25; 140 Amp. \$14.00. All equipped with Solid Rubber Case.

World FOR STORAGE BATTERIES RADIO

Young Men— Turn Your Spare Hours Into Money!

Earn big profits, prizes and awards selling RADIO NEWS, SCIENCE & INVENTION, The EXPERIMENTER and MOTOR CAMPER & TOURIST in your neighborhood. We train you as our salesmen and pay you liberally for your time. Write at once and we will help you get started.

M. BRIDWELL.

THE EXPERIMENTER PUBLISHING CO.
53 Park Place, New York City

on a screen three feet from the mirror. If a 60-cycle alternating potential is used, such as can be obtained from any ordinary wall socket, the spot will move up and down over a small range sixty times a second. The spot will then look to the eye merely like a line of light.

TO PRODUCE VOLTAGE CURVES

If this line be made to travel over a fixed screen or if a screen be moved across the line, a curve will be produced which will show how the e.m.f. varies during its cycle. The first method, that of moving the line across the screen, must be used in order to render the wave-forms directly visible to the eye. For this purpose a concave mirror, about 2 inches in diameter and of 18 inches radius of curvature, is mounted on a vertical spindle fixed so that it can be rotated at any desired speed by hand or, better, by an electric motor. The beam of light, after reflection from the oscillograph mirror, is made to fall on this rotating mirror and is thence thrown on the screen or wall. The movement of the rotating mirror throws the spot of light across the screen so that it no longer moves up and down in the same place but progressively across the screen, producing a wave-form, as pictured in Fig. 4. When the speed of the mirror is properly adjusted so that the spot of light travels over the same path on successive passages across the screen, a permanent wave-form will appear on the screen, where it can be studied in detail.

USES FOR THE OSCILLOGRAPH

Once this device is set up with its rotating mirror and a screen, a long series of interesting studies can be made. First the wave-form of the e.m.f. in the lighting circuit can be seen. A curve like Fig. 5A will result. Next an oscillating three-electrode tube circuit can be set up, as recently described by me in these columns, to give a frequency of about 500 cycles a second—as evidenced by a good musical tone in the telephones.

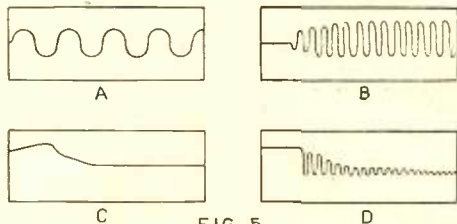

FIG 5
Appearance of some waves made visible by the Rochelle salt crystal oscillograph.

Leads taken to the oscillograph crystal from the plate and filament terminals of the oscillating tube will produce a figure on the screen like Fig. 5B. The way in which the crystal responds to a suddenly applied voltage can also be seen, merely by throwing the potential switch quickly. When the crystal is fresh an effect like Fig. 5C will probably be obtained, but when the crystal is several weeks old the effect may be more like D. When this second stage is reached a little damping of the motion of the crystal will improve performance. For this purpose another metal arm sliding on the post at the rear of the board can be brought up to within 1/16 inch of the oscillograph arm from below and a small drop of vaseline placed between the two arms (see Fig. 3B).

Now for the limitations of the instrument. If voltages greater than 1,000 are applied to the crystal it is liable to break down electrically and become useless.

The actual twist of the crystal is small, being for an average size crystal about one ten-thousandth of a radian (57.296 degrees) for an applied voltage of 200. This sensitivity, compared to that of a hair-pin type oscillograph, is very small but for the purpose in hand it is sufficient.

Build this phenomenal new radio in 45 minutes

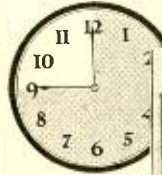

The revolutionary Erla Circlloid-Five Factory-Built Kit—as you receive it.

Price \$49.50

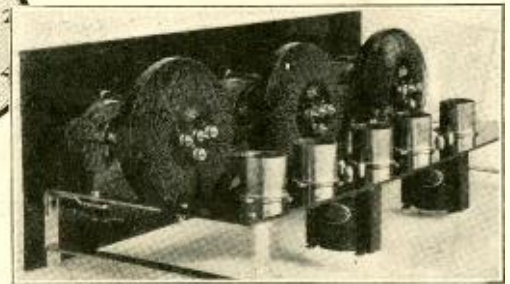

This new type kit is factory assembled. Ready cut, flexible, solderless leads make it ridiculously easy to wire. Amazing new inductance principle brings results hardly thought possible. Send for book, *Better Radio Reception*.

Now anyone can build the finest of receivers in only a few minutes. No more wire bending or soldering. Merely attach a few ready cut, flexible eyeleted leads and the job is done. The finished set is unsurpassed even by the costliest factory-built receiver.

But most amazing is the new inductance principle incorporated in this last word in kits—called the Erla Circlloid principle of amplification.

Four vital improvements result from this great discovery, which are not found in ordinary sets.

1. **Greater Distance:** Erla * Balloon * Circlloids have no external field, consequently do not affect adjacent coils or wiring circuits. This enables concentration of proportionately higher amplification in each stage, with materially increased sensitivity and range.

2. **More Volume:** Increased radio frequency amplification made possible by Erla Balloon Circlloids gives concert volume to distant signals inaudible with receivers of conventional type.

3. **Increased Selectivity:** Erla Balloon Circlloids have no pick-up quality of their own. Hence only signals flowing in the antenna circuit are amplified. Static is greatly reduced for this reason.

4. **Improved Tone Quality:** The self-enclosed field of Erla Balloon Circlloids eliminates stray feed-backs between coils and consequently does away with mashing of signals and distortion. Tone is crystal clear and perfectly lifelike.

Write for free information on kit—also book

See how 45 minutes of fun will give you the newest and most nearly perfected set known to radio science. Easy as A-B-C to finish. Examine it at any Erla dealer's, or send the coupon for full information, illustrations and diagrams free. Also ask for remarkable new book, "Better Radio Reception," describing the sensational new Circlloid principle. Enclose 10c for mailing and postage on book.

ELECTRICAL RESEARCH LABORATORIES
2520 Cottage Grove Ave., Chicago
* Trade Mark Registered.

ELECTRICAL RESEARCH LABORATORIES,

2520 Cottage Grove Ave., Chicago, U. S. A.

Send me free information on kit. Enclose 10c for postage for book, "Better Radio Reception."



This sign identifies authorized Erla distributors. All are equipped to give complete radio service.

Name
Address
City State

Dealers Exclusive franchises are available to high class dealers in localities still open. Write or wire immediately.

The EAGLE Neutrodyne RECEIVER
is "King of The Air"
Write for literature.

Wire-Nuts for joining
radio antenna and lead-in wires in one minute without solder, tape or tools.
Many other uses. A million perfect joints have already been made with these new Wire-Nuts.
Listed by Underwriters' Laboratories. Booklet free. Ask your dealer for Wire-Nuts.
We will send 3 Wire-Nuts post paid on receipt of 25c.
N. YORK COMPANY, 8 W. 40th St., New York

YOU CAN GET
Greater reflex or crystal set reception if you use the
BROWNLIE VERNIER DETECTOR
\$2.00 At your dealer or Direct.
ROLAND BROWNLIE & CO.
20 Saunders St. Medford, Mass.

"Lighting Fixtures"
READY TO HANG
(Direct from Manufacturer)
Completely wired including glassware
Send for new Catalogue No. 27
(Just reduced prices)
Special Proposition to Dealers
ERIE FIXTURE SUPPLY CO.
STATION R ERIE, PA.

Insure your copy reaching you each month. Subscribe to Radio News—\$2.50 a year. Experimenter Publishing Co., 53 Park Place, N. Y. C.

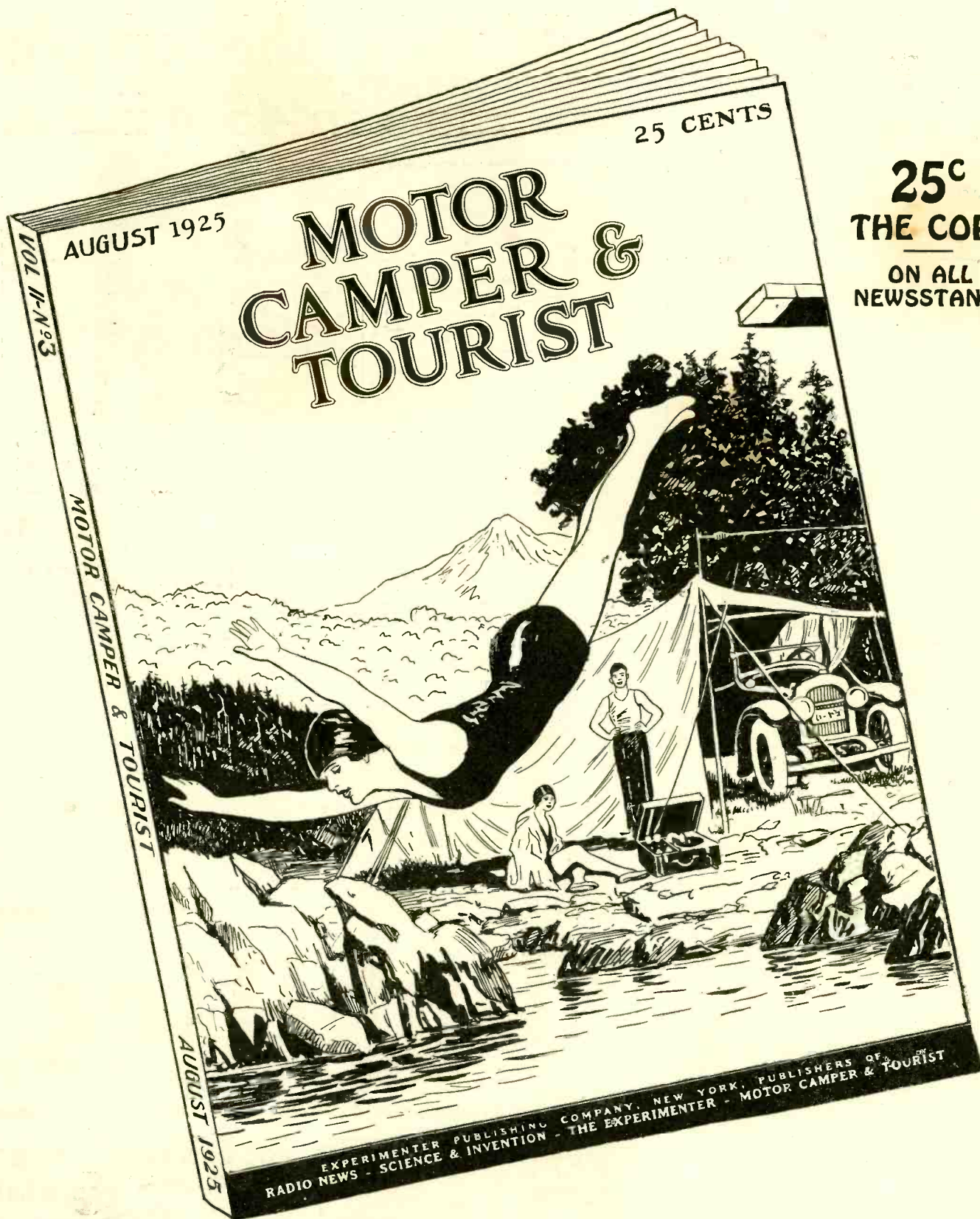

25^c
THE COPY
 ON ALL
 NEWSSTANDS

THE GREATEST VACATION OF THEM ALL
 A Motor Trip through our National Parks with MOTOR CAMPER & TOURIST
 as your guide

The National Parks and Forests of the United States offer a vacation motor trip that is beyond compare. Nowhere else in the country is there such magnificent scenery or as well preserved tracts of forest and mountain lands, even the natural wild life has been preserved in many places.

The August issue of MOTOR CAMPER & TOURIST has a very helpful guide to these splendid vacation lands. Buy a copy today before you make a final selection for your vacation tour. MOTOR CAMPER & TOURIST is sold at all radio and newsdealers.

GERMOTT PUBLISHING CO., Owners

Licensed Publishers—EXPERIMENTER PUBLISHING COMPANY, Inc., 53 Park Place, New York, N. Y.

Finally, to get striking results, a bright source of light should be used to furnish the beam which falls on the oscillograph mirror. An arc lamp with a screen with a pin hole in it in front of the crater of the arc is best. Crystals prepared as described have natural frequencies of 3,000 to 5,000 cycles. Because of natural resonance the crystals will not give a true picture of an applied e.m.f. having a frequency much above 1,000.

The cathode-ray oscillograph still remains the only instrument suitable for investigations in the high frequency range.

The Inventions of Reginald A. Fessenden

(Continued from page 158)

the heaviest and most tenacious rust almost instantly, leaving a thin film of antimony on the surface of the iron; and I knew that sodium amalgam would dissolve the antimony and give an amalgamated iron surface which would take the hot babbitt. So this gave a method by which the rails could be bonded as fast as the other part of the work could proceed.

Another time he came in and said, "Fessenden, we have just two weeks to get out a structureless carbon filament. They have obtained an injunction in Pennsylvania against our using the bamboo filament on the claim that it infringes the old Sawyer-Mann paper filament." He laid out a line, which I followed out, he working along with me as the matter was so urgent. It was during this job that a very characteristic thing happened. The substance (a new organic compound) which we had finally decided to use, dissolved in chloroform but this evaporated when the filaments were squirted, leaving them in powder form so they could not be carbonized. I had put into several hundred small tumblers small quantities of different fluids and some of the substance. Only one dissolved it, oil of birch. Edison, who had been looking after another part of the work, came into the room. We had been working for three or four days and nights continuously, hardly taking time to eat a sandwich and drink a cup of coffee. I told him the result and speculated a little on the reason why that one particular oil should be a solvent. Edison listened for a bit, chewing his cigar. "Well, Fezzy," and his eyes twinkled. "I guess what we need is more tumblers." And, of course, he was right. It was what Pythagoras might have said if he had been an inventor.

The good luck I had had in catching on to his methods and following out his instructions pleased him. One day an interview appeared in a New York paper in which he said, "I can take a Yankee boy and a china mug and he will get more results than all the German chemists put together." Which probably referred to Aylesworth and myself. A few days later he said, "Fessenden, you will take charge of the chemical laboratory in future." I said, "Why, is W. leaving? He is a much better chemist than I am," which was a fact, and I liked W. very much. "Yes, he is a fine chemist, but he does not get results and he has another place which will suit him better.

So I was now head chemist of the Edison Laboratory. Other lines of work were added, mostly connected with ore milling and refining the Sudbury copper-nickel deposits. There was also a good deal of analytical work. My chief assistant was John Dorr, who joined me direct from school, and has since become a very eminent mining engineer and the inventor of many mining processes. We were just beginning to get results with the Sudbury ores by a process of Bessermerizing which I had worked out when Edison went to Europe, to the Paris Exposition. Before he went I asked him if I could take up work on the lines of Hertz's experiments, which had recently been published. He said yes, but to wait till he came back.

He had hardly got back when, owing to financial difficulties and the reorganization of the Edison Companies, substantially the whole laboratory was shut down.

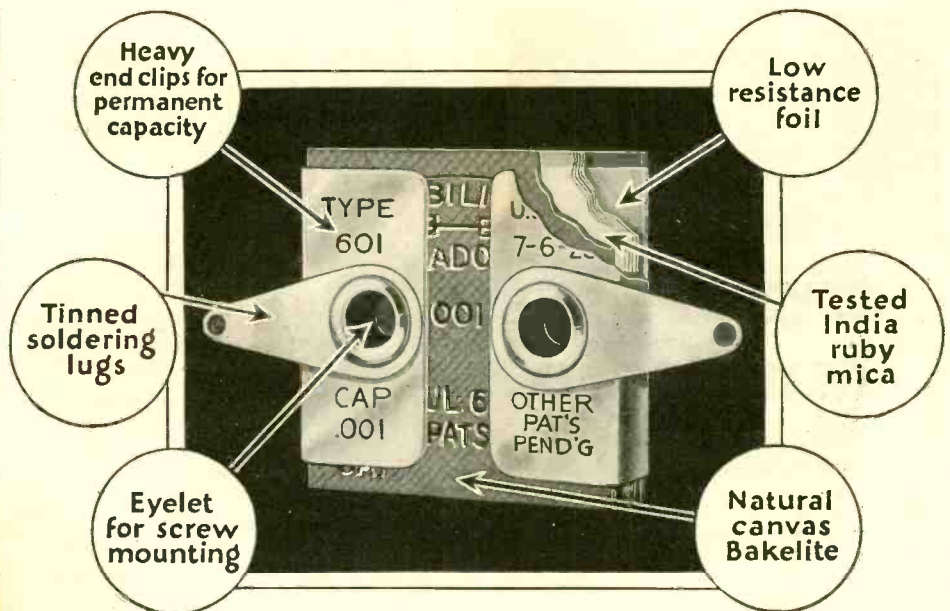

What makes for efficiency in fixed condensers?

This diagram indicates the efficient details of construction that have made Micadons the standard* fixed condensers of radio.

Dubilier engineers have developed these standard condensers of accurate and permanent capacity. Micadons are known the world over —and are used in 90% of all radio sets.

*Standard—anything recognized as correct by common consent . . . of a high degree of excellence.—Webster

Dubilier

CONDENSER AND RADIO CORPORATION

Be A RADIO EXPERT

EARN \$50 to \$200 a Week

Send for my big FREE RADIO BOOK right now! See how many wonderful money making opportunities are waiting for you as a Trained Expert in the liveliest, fastest growing Big Pay field in the world—RADIO!

Free Book *Send for it*

Superdon Radio Set FREE

Long distance, super-powerful selective radio set FREE to every student who acts now! No cent extra charge!

Write Today for full particulars and proof that you can succeed quickly in the big pay business of Radio; also how to get the wonderful Twin Superdon set without cost. Write at once—Now! No obligation.

I. J. Mendela, American Radio Engineers
646 N. Michigan Ave., Dept. 96 Chicago

RADIO KIT Catalog

FREE You Need It! SEND TODAY!

TELLS HOW to assemble your own radio set without the bus-bar-and-solder nuisance. HOW to get your own radio kit and accessories without charge. HOW to go into business for yourself and build sets our easy "No-Sod-er" way for your friends and neighbors. Everything Explained. Contains offers of kits for large number of the best radio receivers, at lowest prices. Highest quality parts. (Please see our big ad., page 138)

Goods Shipped on Approval—No Money in Advance—Quick Shipment—We Pay the Transportation—Satisfaction or Money Back

RADIO SPECIALTY COMPANY

Kit Div., 679L, 245A Greenwich St., New York City

Insure your copy reaching you each month. Subscribe to Radio News—\$2.50 a year. Experimenter Publishing Co., 53 Park Place, N. Y. C.

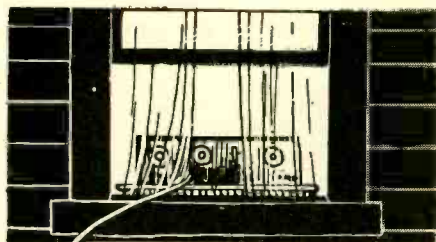

Extend Your Radio Season!

Take your loud speaker on the porch for those mid-summer night radio programs.

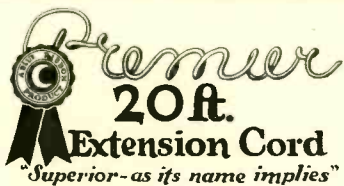

Through a PREMIER Cord you get full volume, utmost clarity and radio enjoyment where you want it. It's tightly braided for long wear. Will not break, kink or fade.

Complete with Universal plug,.....\$1.75
At your dealer's
—or write us.

CRESCENT BRAID CO., Inc.
Makers of Extension Cords and Battery Cables for Radios
Providence, R. I.

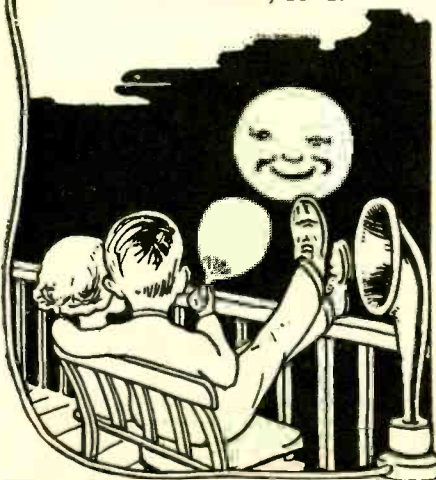

LOW LOSS TUN-A-FAR

THE NEW RADIO SENSATION GETS WONDERFUL DISTANCE
Marvelous Selectivity, Beautiful Tone and Tremendous Volume

B-ELIMINATOR KIT

Price \$20.00

FREE Diagram for One Knob Hook-up with Each Coil.
A. H. WAAGE 6 Reade St., New York, N. Y.



HEATH CONDENSERS

For Real Radio Reception

Write for Literature

HEATH RADIO & ELECTRIC MFG. CO.,
206 First St., Newark, N. J.

A Wonderful New Field for the EXPERIMENTER AND INVENTOR
The amplification of Radio by light rays. Booklet describing simple and practical experiments, price 50c prepaid.
ELECTRIC B. G. PRODUCTS CO.
Ithaca, Michigan

Radio News' Second Radio Shower Party

(Continued from page 206B)

- 6—Ferbend Wave Trap. Courtesy Ferbend Electric Co.
- 7—23-Plate Plain Variable Condenser. Courtesy Hammarlund Mfg. Co.
- 8—Melotone Horn-type Loud Speaker. Courtesy Radio Industries Corp.
- 9—2 Audio Transformers. Courtesy Halderson Co.
- 10—1 Phonograph Attachment. Courtesy Tower Mfg. Co.
- 11—1 Year's Subscription to RADIO NEWS, SCIENCE AND INVENTION, THE EXPERIMENTER, MOTOR CAMPER & TOURIST. Courtesy The Experimenter Pub. Co.
- 12—Head-Set and Plug. Courtesy Wm. J. Murdock Co.
- 13—Resistance-coupled Amplifier Kit. Courtesy Electrad, Inc.
- 14—13 Consrad Patterns. Courtesy Consrad Co.
- 15—Super Booster Wave Trap. Courtesy Super Booster Dist. Co.
- 16—1 Audio Transformer. Courtesy Acme Apparatus Co. Kant Blo Switch Tube Protector. Courtesy Clark and Tilson, Inc.
- 17—1 Year's Subscription to RADIO NEWS and THE EXPERIMENTER. Courtesy The Experimenter Pub. Co.
- 18—1 Wave Trap. Courtesy Ferbend Electric Co.
- 19—Consrad Library, fourteen books. Courtesy Consrad Co.
- 20—1 Lamp Socket Antenna. Courtesy Electrad, Inc. 1 Cushion V. T. Socket. Courtesy Illinois Radio Co. 1 Polyplug. Courtesy Polymet Mfg. Corp.
- 21—1 Year's Subscription to SCIENCE AND INVENTION and MOTOR CAMPER & TOURIST. Courtesy The Experimenter Pub. Co.
- 22—Ekko Stamp Album. Courtesy Ekko Co. 3 A-1 Wonder Crystals, 1 Glass-enclosed Detector, 1 package Catwhiskers. Courtesy California Radio Minerals.
- 23—1 Audio Transformer. Courtesy Acme Apparatus Co. 1 Ekko Stamp Album. Courtesy Ekko Co.
- 24—2 Vario-Densers, Model G. Courtesy X-L Radio Laboratories. 1 Aerial Lead-in Connector, 1 package Name-Plates. Courtesy Radio Specialty Co.
- 25—No-Dust Blower. Courtesy Peiffer and Co. Ekko Stamp Album. Courtesy The Ekko Co. 1 Rheostat. Courtesy Klosner Radio Corp. 4 V. G. Connectors. Courtesy Illinois Radio Co.
- 26—1 Year's Subscription to RADIO NEWS. Courtesy Experimenter Pub. Co.
- 27—Keystone Lightning Arrester. Courtesy Electric Service Supplies Co. 1 Vernier Rheostat. Courtesy Klosner Radio Corp. Ekko Stamp Album. Courtesy The Ekko Co.
- 27A—1 Audio Transformer. Courtesy of the Halderson Co.
- 28—Vernier Crystal Detector. Courtesy Roland Brownlee and Co. 2 Crystals. Courtesy Newman Stern and Co. "How and Why of Radio Apparatus." Courtesy Consrad Co.
- 29—1 Year's Subscription to SCIENCE AND INVENTION. Courtesy Experimenter Pub. Co. Ekko Stamp Album. Courtesy Ekko Co.
- 30—Kant Blo Switch. Courtesy Clark and Tilson, Inc. Jiffy Ribbon Antenna. Courtesy Apex Stamping Co. Two Bakelite Sockets. Courtesy Bell Mfg. Co. Ekko Stamp Album. Courtesy Ekko Co.
- 31—Radio Map of the United States. Courtesy Consrad Co. Ekko Stamp Album. Courtesy Ekko Co.
- 32—Bakelite Dial. Courtesy the American Hard Rubber Co. Jiffy Blow Torch and Soldering Outfit. Courtesy the Apex Stamping Co. 1 Polyplug. Courtesy Polymet Mfg. Co. Sixteen-in-One Radio Tool. Courtesy Radio Specialty Co.
- 33—1 Year's Subscription to THE EXPERIMENTER. Courtesy The Experimenter Pub. Co. 1 Ekko Stamp Album. Courtesy the Ekko Co.
- 34—2 Vario-Densers, Model N. Courtesy X-L Radio Laboratories. Ekko Stamp Album. Courtesy the Ekko Co.
- 35—Set of Model C-10 Blue Prints for making receivers. Courtesy the Experimenters' Information Service, Inc. Ekko Stamp Album. Courtesy the Ekko Co.
- 36—2 Vernier attachments for dials. Courtesy the Radio Specialty Co. Polyplug. Courtesy the Polymet Mfg. Co.
- 37—1 Year's Subscription to MOTOR CAMPER AND TOURIST. Courtesy the Experimenter Pub. Co. Ekko Stamp Album. Courtesy Ekko Co.
- 38—1 Plain Rheostat. Courtesy Klosner Radio Corp. Keystone Lightning Arrester. Courtesy the Electric Service Supplies Co. Ekko Stamp Album. Courtesy the Ekko Co.
- 39—Lamp Socket Antenna. Courtesy Electrad, Inc.

Obsolete

Take the "GUESS" Out of Tube Control

\$ 1.10 Everywhere

with

Amperite automatically controls tube current, eliminates hand rheostats, filament meters, guessing and all tube worry. Simplifies wiring, tuning and operation. Permits the use of any type of tube or any combination of tubes. Tested and used by more than 50 set manufacturers and in every popular construction set.

RADIALL COMPANY
Dept. RN-13 50 Franklin St., New York City

Write for **FREE** Hook-ups

AMPERITE

REG. U. S. PAT. OFF.

The "SELF-ADJUSTING" Rheostat

The Famous Truly Portable

TELMACO P-1 Receiver

Four Tubes Do the Work of Seven

The peer of portables in size, weight, ease of tuning, selectivity, distance, volume, workmanship and price. Aerial, loud speaker and batteries self contained. Complete with tubes and batteries, **\$125.00** \$148.50. Receiver only

P-1 Kit Saves You Money!

Our offer of the Telmaco P-1 Receiver in kit form has met with enthusiastic reception. This contains all parts, as built by us, including case, drilled and engraved panel, and illustrated instructions. **\$80.00** Complete kit

Ask your dealer or write us. Descriptive folder free.

Radio Division:
Telephone Maintenance Co.
20 So. Wells St. Dept. B Chicago, Ill.

TELMACO

Quality Radio Exclusively ♡ Established 1918

Young Men—

Turn Your Spare Hours Into Money

Earn big profits, prizes, and awards selling **RADIO NEWS, SCIENCE & INVENTION, THE EXPERIMENTER, and MOTOR CAMPER & TOURIST** in your neighborhood. We train you as our salesman and pay you liberally for your time. Write at once and we will help you get started.

M. BRIDWELL.

THE EXPERIMENTER PUBLISHING COMPANY

53 Park Place, New York, N. Y.

- 2 Packages of Kester Solder. Courtesy Chicago Solder Co. Jiffy Blow Torch and Soldering Outfit. Courtesy Apex Stamping Co.
- 40—20 Radio Diagrams and Hook-ups. Courtesy the Conrad Co. 1 Ekko Stamp Album. Courtesy the Ekko Co.
- 41—1 Glass Enclosed Crystal Detector. 3 Wonder Crystals, 1 Package Catwhiskers. Courtesy California Radio Minerals. Aerial Lead-in Connector. Courtesy Radio Specialty Co.
- 42—1 Ekko Stamp Album. Courtesy the Ekko Co. 2 Four-inch Bakelite Dials. Courtesy Bell Mfg. Co. De-Tec-Tone Crystal Detector. Courtesy Pyramid Products Co. 2 Crystals. Courtesy Newman Stern Co.
- 43—1 Year's Subscription to RADIO NEWS. Courtesy the Experimenter Publishing Co.
- 44—1 Cushion V. T. Socket. Courtesy the Illinois Radio Co. 1 Ekko Stamp Album. Courtesy the Ekko Co. 1 Jiffy Ribbon Antenna. Courtesy the Apex Stamping Co. 4 V. G. Connectors. Courtesy the Illinois Radio Co.
- 45—Set of Model C-10 Blue Prints for making receivers. Courtesy the Experimenters' Information Service, Inc. Ekko Stamp Album. Courtesy the Ekko Co.
- 46—Vernier Crystal Detector. Courtesy Roland Brownlee and Co. 1 Ekko Stamp Album. Courtesy the Ekko Co. 1 Package of Catwhiskers. 1 Wonder Crystal. Courtesy California Radio Minerals.
- 47—Wireless Course in Twenty Lessons! Courtesy the Conrad Co.
- 48—1 Year's Subscription to SCIENCE AND INVENTION. Courtesy the Experimenter Pub. Co.
- 49—1 Rasco Crystal Detector. Courtesy the Radio Specialty Co. 1 Ekko Stamp Album. Courtesy the Ekko Co. Jiffy Ribbon Antenna. Courtesy the Apex Stamping Co. 1 Package of Catwhiskers. Courtesy California Radio Minerals.
- 50—2 Vario-Densers. Model N. Courtesy X-L Radio Laboratories. De-Tec-Tone Crystal Detector. Courtesy Pyramid Products Co. 2 Tested Crystals. Courtesy Newman Stern Co.
- 51—Radio Listeners' Guide and Call Book. Courtesy Conrad Co. Ekko Stamp Album. Courtesy Ekko Co.
- 52—Jiffy Ribbon Antenna. Courtesy Apex Stamping Co. Glass-enclosed Crystal Detector. 1 Wonder Crystal. 1 Package Catwhiskers. Courtesy California Radio Minerals.
- 52A—Genwin Three Circuit Tuner. Courtesy General Radio Winding Co.
- 53—1 Pilot Light Switch. Courtesy Yaxley Mfg. Co. 1 Imp Jack and Plug. Courtesy Carter Radio Co.
- 54—1 Shock Proof Phone Plug. Courtesy L. S. Braeh Mfg. Co. 1 Ekko Stamp Album. Courtesy Ekko Co.
- 55—1 Year's Subscription to THE EXPERIMENTER. Courtesy Experimenter Publishing Co.
- 56—Single Pole Double Throw Jack Switch. 1 Portable Jack. Courtesy Carter Radio Co. Ekko Stamp Album. Courtesy Ekko Co.
- 57—Tuway Plug. Double Circuit Jack. Courtesy Carter Radio Co.
- 58—2 Packages Kester Solder. Courtesy Chicago Solder Co. Four-Phone Post for Radiola III. Courtesy Barkeley Electric Mfg. Co.
- 59—Glass-enclosed Crystal Detector, 1 Package Catwhiskers. Courtesy California Radio Minerals. 2 Tested Crystals. Courtesy Newman Stern Co.
- 60—Receptacle Jack. Courtesy Carter Radio Co. Ekko Stamp Album. Courtesy Ekko Co.
- 61—1 Year's Subscription to MOTOR CAMPER & TOURIST. Courtesy Experimenter Pub. Co.
- 62—Oneway Plug. Courtesy Carter Radio Co. 1 Package Kester Solder. Courtesy Chicago Solder Co.
- 63—Radio Log Book. Courtesy Conrad Co. Ekko Stamp Album. Courtesy Ekko Co.
- 64—Packet C. Courtesy Conrad Co.
- 65—Packet D. Courtesy Conrad Co.
- 66—1 Package Kester Solder. Courtesy Chicago Solder Co. Ekko Stamp Album. Courtesy Ekko Co. 1 Package Catwhiskers. Courtesy California Radio Minerals.

Zone 7

Arkansas, Louisiana, Oklahoma, Texas and New Mexico

- 1—Victoreen Super-heterodyne Receiver Kit. Courtesy Victoreen Radio, Inc.
- 2—Manhattan Jr. Loud Speaker. Courtesy Manhattan Electric Co. Ekko Stamp Album. Courtesy the Ekko Co.
- 3—Grand Opera Loud Speaker. Courtesy Radio Industries Corp.
- 4—Super Booster Wave Trap. Courtesy Booster Distributing Co. 1 23-Plate Variable Condenser. Courtesy General Radio Co.
- 5—1 23-Plate Vernier Variable Condenser. Courtesy Hammarlund Mfg. Co. Ekko Stamp Album. Courtesy the Ekko Co.
- 6—Melotone Horn-type Loud Speaker. Courtesy Radio Industries Corp.
- 7—Ferbend Wave Trap. Courtesy Ferbend Electric Co. Ekko Stamp Album. Courtesy the Ekko Co.
- 8—2 Audio Transformers. Courtesy Halldorson Co. Ekko Stamp Album. Courtesy the Ekko Co.
- 9—1 Year's Subscription to RADIO NEWS, SCIENCE AND INVENTION, THE EXPERIMENTER, MOTOR CAMPER & TOURIST. Courtesy the Experimenter Publishing Co.
- 10—2 45-Volt "B" Batteries. Courtesy Diamond Electric Specialties.

—at the end, the middle, and around the earth

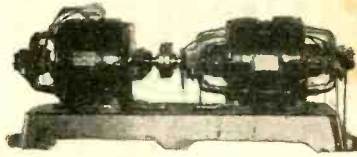

"ESCO" in the Arctic

In selecting "ESCO" Motor-Generators for the MacMillan Expedition to the Arctic this summer, Commander E. F. MacDonald, Jr., of the Zenith Company, writes: "We have settled definitely on yours, after having considered all various Motor-Generators available."

"ESCO" supplied the expedition with two Motor-Generator sets, motors 32 volt, 2 HP, generators 2000 volt, 1000 watt. These were of a new design with distributed field windings—and they were in transit three weeks from receipt of order!

"ESCO" on the Equator



Captain Stevens, aerial photographer for Dr. A. Hamilton Rice's expedition to unexplored regions in the tropical Jungle North of the Amazon River basin in Brazil, said: "Altho working with portable apparatus and in the heart of the world's greatest forest, a record was made in exchanging the first wireless messages to pass directly from South America to England and back again. Long-wave communication was carried on between the expedition and Manaus and short-wave communication to many parts of the world, including New York, San Francisco, London, Rio Janeiro and New Zealand. The signals were reported as very strong, both in New York and London." The A. Hamilton Rice expedition was equipped with "ESCO" Dynamotors.

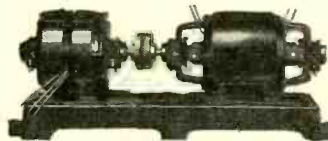

"ESCO" spans the Antipodes

WAHG announced that a cablegram had been received from St. George Barlow in Australia saying that the Locomotive Bell, the Nassau Club Orchestra, and the singing of Walter J. Neff had been heard in Melbourne and that WAHG would receive a silver trophy for its sending feat. At about the same time it was announced, Loyd Jacquet, American representative at the International Amateur Radio Convention, now in Paris, cabled that the Richmond Hill entertainment had been heard there. These messages from Australia and Paris showed that WAHG had covered a span of 15,000 miles.

WAHG was using a standard "ESCO" Item 20.

"ESCO" is the pioneer in designing, developing and producing Generators, Motor-Generators, Dynamotors and Rotary Converters for all Radio Purposes.

HOW CAN "ESCO" SERVE YOU?

ELECTRIC SPECIALTY COMPANY

TRADE "ESCO" MARK

211 South St.

Stamford, Conn.

LEARN RADIO

Become a big-pay man in the greatest industry of all time. Quickly, easily and right at home, you can fit yourself for highest salary positions, or you can cash in on your spare time. The call is urgent for mechanics, operators, designers, inspectors. Unlimited, fascinating opportunities on land or sea.

I WILL TRAIN YOU AT HOME TO BE A RADIO EXPERT

Under my practical, easy to understand, instruction—you qualify in an amazingly short time. No previous experience is necessary. Every branch of radio becomes an open book to you. You learn how to design, construct, operate, repair, maintain and sell all forms of Radio apparatus. My methods are the latest and most modern in existence.

FREE Wonderful home construction tube receiving set of the latest design. Write Today "Radio Facts" FREE

A. G. Mohaupt, Radio Engineer, RADIO ASSOCIATION OF AMERICA, Dept. 1584513 Ravenswood Ave., Chicago

BUILDING A SET?

You must have rheostats of correct ohmage. Insist on the genuine

KLOSNER RHEOSTATS

Made by pioneer makers of the vernier. FREE.—Send for valuable Rheostat Chart and information on the care and operation of vacuum tubes. Mention dealer's name.

KLOSNER RADIO CORPORATION

1024 East 178th St. Rheostat Specialists, N. Y. C.

Andrews

Deresnadyne

DE-RES-NA-DINE PATENTS PENDING

Radio Receiving Set

ANDREWS RADIO CO.

Tribune Tower Chicago

The SUPER-HETERODYNE

USE THIS BLANK TO ORDER

Just clip out this coupon, check the patterns or books you want and mail it to us with full remittance.

The Consrad Co., Inc.
233 Fulton St., New York, N. Y.

Gentlemen: I have checked below the patterns and books I desire. Enclosed find \$....., the full price. Kindly send me the items checked postpaid.

Consrad Patterns—50c each

- No. 2. How to Make a Two-Stage Amplifier.
- No. 4. How to Make a Reinartz Receiver.
- No. 5. How to Make a Reflex Receiver.
- No. 6. How to Make a Cockaday Receiver.
- No. 7. How to Make a Neutrodyne Receiver.
- No. 8. How to Make the Autoplex Receiver.
- No. 9. How to Make the S. T. 100 Receiver.
- No. 10. How to Make the Ultradyne Receiver.
- No. 11. How to Make a Five Tube Cockaday Receiver.
- No. 12. How to Make a Portable Receiver.
- No. 13. How to Make a Harkness Receiver.
- No. 14. How to Make the Original Genuine Super-Heterodyne. List \$1.00.
- No. 15. How to Make a Low Loss Receiver.
- No. 16. How to Make a Tropadyne Superadio.
- A. Radio Map of the U. S. on Cloth.
- B. 20 Radio Diagrams and Hook-ups. New Edition.
- C. All About Aerials and Their Construction.
- D. Radio Amateurs Practical Design Data.

Radio Books—25c each

- No. 1. Tips for the Radio Constructor.
- No. 2. How to Make Practical Radio Receivers.
- No. 3. Radio Questions Answered.
- No. 4. Radio Frequency Amplification.
- No. 5. Loud Talkers and How to Build Them.
- No. 6. How to Tune Your Radio Set.
- No. 7. One Hundred Radio Hook-ups. New Edition.
- No. 8. All About Radio Parts.
- No. 9. History and Operations of Vacuum Tubes.
- No. 10. The Neutrodyne and All About It.
- No. 11. How Radio is Received.
- No. 12. How to Locate Troubles in Your Radio Set.
- No. 13. Reflex Radio Receivers.
- No. 14. The Super-Heterodyne Theory and Construction.

Special Books

- Radio News Amateurs' Handibook.....\$1.00
- Radio Log Book..... .50
- Wireless Course in 20 Lessons—Leather Binding 2.00
- The Radio Instructor..... 1.00
- The Radio Listeners' Guide & Call Book..... .35
- The Radio Review, 35c the copy.....\$2.50 the year

Name

Address

City State.....

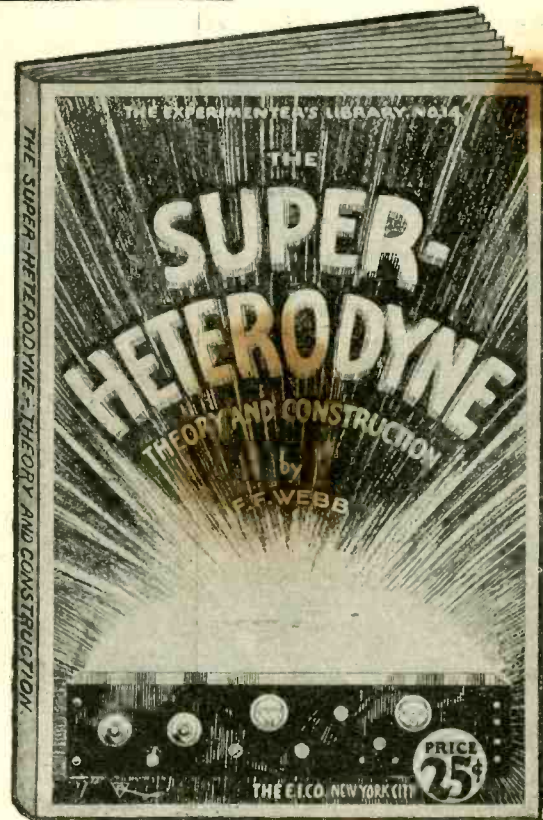

Here's the finest, most complete book of data and information ever compiled on the Standard Super-Heterodyne.

This is the big book of instruction and information on the various standard "supers" in common use today; a complete, up-to-the-minute, impartial 64-page book covering all the builder or user of this type of set might want to know. The Super-Heterodyne is written by a radio authority who not only has years of trade and practical experience but is constantly designing modern radio apparatus. It is a handy useful size, 5½ x 7½ inches, printed clearly, profusely illustrated, easy to read and bound with a handsome two color cover.

This is the very latest of the complete library of Experimenters Handbooks on radio, a list of which is printed on this page. These books are complete practical guides to almost every important phase of radio transmission and reception.

The famous Consrad patterns are also listed on this coupon for your convenience. They are radio's finest patterns for the building of the most successful standard receivers.

You can get any of these books or patterns at your radio or news dealer or direct from us by using the coupon attached to this page.

The CONSRAD COMPANY

Sole distributors to the E. I. COMPANY
233 Fulton St. New York, N. Y.

- 11—1 Filament Lock Switch, 1 Univernier Dial, 1 Safety Rim Socket; 1 Panelite. Courtesy Walbert Mfg. Co.
- 12—Head-set and Plug. Courtesy Wm. J. Murdock Co.
- 13—Resistance Coupled Amplifier Kit. Courtesy Electrad, Inc. Ekko Stamp Album. Courtesy the Ekko Co.
- 14—13 Consrad Patterns. Courtesy Consrad Co.
- 15—Super Booster Wave Trap. Courtesy Super Booster Dist. Co. Ekko Stamp Album. Courtesy The Ekko Co.
- 16—1 Audio Transformer. Courtesy Acme Apparatus Co. 1 Kant Blo Switch. Courtesy Clark and Tilson, Inc.
- 17—1 Year's Subscription to RADIO NEWS. Courtesy The Experimenter Pub. Co.
- 18—Ferbend Wave Trap. Courtesy Ferbend Electric Co.
- 19—Consrad Library, 14 Books. Courtesy Consrad Co.
- 20—Lamp Socket Antenna. Courtesy Electrad Co. Cushion V. T. Socket. Courtesy Illinois Radio Co.
- 21—1 Year's Subscription to SCIENCE AND INVENTION, MOTOR CAMPER & TOURIST. Courtesy Experimenter Pub. Co.
- 22—Ekko Stamp Album. Courtesy The Ekko Co. 3 A-1 Wonder Crystals. 1 Glass-enclosed Crystal Detector, 1 Package Catwhiskers. Courtesy California Radio Minerals.
- 23—1 Audio Transformer. Courtesy Acme Apparatus Co. 1 Ekko Stamp Album. Courtesy Ekko Co.
- 24—2 Vario-Densers, Model G. Courtesy X-L Radio Laboratories. 1 Aerial Lead-in Connector, 1 package Name-Plates. Courtesy Radio Specialty Co.
- 25—No-Dust Blower. Courtesy Peiffer and Co. Ekko Stamp Album. Courtesy The Ekko Co. 1 Rheostat. Courtesy Klosner Radio Corp. 4 V. G. Connectors. Courtesy Illinois Radio Co.
- 26—1 Year's Subscription to RADIO NEWS. Courtesy Experimenter Pub. Co.
- 27—Keystone Lightning Arrester. Courtesy Electric Service Supplies Co. 1 Vernier Rheostat. Courtesy Klosner Radio Corp. Ekko Stamp Album. Courtesy The Ekko Co.
- 27A—1 Audio Transformer. Courtesy of the Hall-dorson Co.
- 28—Vernier Crystal Detector. Courtesy Roland Brownlee and Co. 2 Crystals. Courtesy Newman Stern and Co. "How and Why of Radio Apparatus." Courtesy Consrad Co.
- 29—1 Year's Subscription to SCIENCE AND INVENTION. Courtesy Experimenter Pub. Co. Ekko Stamp Album. Courtesy Ekko Co.
- 30—Kant Blo Switch. Courtesy Clark and Tilson, Inc. Jiffy Ribbon Antenna. Courtesy Apex Stamping Co. Two Bakelite Sockets. Courtesy Bell Mfg. Co. Ekko Stamp Album. Courtesy Ekko Co.
- 31—Radio Map of the United States. Courtesy Consrad Co. Ekko Stamp Album. Courtesy Ekko Co.
- 32—Bakelite Dial. Courtesy the American Hard Rubber Co. Jiffy Blow Torch and Soldering Outfit. Courtesy The Apex Stamping Co. 1 Polyplug. Courtesy Polymet Mfg. Co. Sixteen-in-One Radio Tool. Courtesy Radio Specialty Co.
- 33—1 Year's Subscription to THE EXPERIMENTER. Courtesy The Experimenter Pub. Co. 1 Ekko Stamp Album. Courtesy The Ekko Co.
- 34—2 Vario-Densers, Model N. Courtesy X-L Radio Laboratories. Ekko Stamp Album. Courtesy the Ekko Co.
- 35—Set of Model C-10 Blue Prints for making receivers. Courtesy the Experimenters' Information Service, Inc. Ekko Stamp Album. Courtesy the Ekko Co.
- 36—2 Vernier attachments for dials. Courtesy the Radio Specialty Co. Polyplug. Courtesy the Polymet Mfg. Co.
- 37—1 Year's Subscription to MOTOR CAMPER AND TOURIST. Courtesy the Experimenter Pub. Co. Ekko Stamp Album. Courtesy Ekko Co.
- 38—1 Plain Rheostat. Courtesy Klosner Radio Corp. Keystone Lightning Arrester. Courtesy the Electric Service Supplies Co. Ekko Stamp Album. Courtesy the Ekko Co.
- 39—Lamp Socket Antenna. Courtesy Electrad, Inc. 2 Packages of Kester Solder. Courtesy Chicago Solder Co. Jiffy Blow Torch and Soldering Outfit. Courtesy Apex Stamping Co.
- 40—20 Radio Diagrams and Hook-ups. Courtesy the Consrad Co. 1 Ekko Stamp Album. Courtesy the Ekko Co.
- 41—1 Glass Enclosed Crystal Detector. 3 Wonder Crystals. 1 Package Catwhiskers. Courtesy California Radio Minerals. Aerial Lead-in Connector. Courtesy Radio Specialty Co.
- 42—1 Ekko Stamp Album. Courtesy the Ekko Co. 2 Four-inch Bakelite Dials. Courtesy Bell Mfg. Co. De-Tec-Tone Crystal Detector. Courtesy Pyramid Products Co. 2 Crystals. Courtesy Newman Stern Co.
- 43—1 Year's Subscription to RADIO NEWS. Courtesy the Experimenter Publishing Co.
- 44—1 Cushion V. T. Socket. Courtesy the Illinois Radio Co. 1 Ekko Stamp Album. Courtesy the Ekko Co. 1 Jiffy Ribbon Antenna. Courtesy the Apex Stamping Co. 4 V. G. Connectors. Courtesy the Illinois Radio Co.
- 45—Set of Model C-10 Blue Prints for making receivers. Courtesy the Experimenters' Information Service, Inc. Ekko Stamp Album. Courtesy the Ekko Co.
- 46—Vernier Crystal Detector. Courtesy Roland

This Catalog is for YOU

Explains what you want to know

About new revolutionary way of assembling your radio set from one of our kits—no solder, no bus bar, no poor connections, no waste of time, no skill required, no dissatisfaction, no tools needed except common screwdriver and pliers. Even a boy can quickly assemble a complicated kit.

SEND Today!



You Need This Book!

"No-Sod-er"
MAKES SET-BUILDING EASY
(Trade Mark Reg. U. S. Pat. Off.)

All connections are made by the use of our flexible, insulated eyeletted connecting wire in place of bus bar or wire, and solder. And in a fraction of the time usually required when using the old fashioned way. And when the job is done it is neat and your connections are tight. Makes set-building a pleasure.

This Free Book Tells

—HOW TO ASSEMBLE YOUR OWN SET without the bus-bar-and-solder nuisance. —HOW TO GET YOUR OWN KIT and Accessories without Charge. —HOW TO GO INTO BUSINESS for Yourself and Make Money Building Sets for your Friends and Neighbors.

Book contains 36 pages
7x10 inches

packed full of the most useful and interesting matter ever put into a radio catalog.

Tells about the Marvels of Radio—How it Helps All and Brightens Every Home—Gives List of Broadcasting Stations—Specimen Programs—And How Programs are Made Up—Answers the Questions, "What Set Shall I Buy," and How Much to Pay—Describes "No-Sod-er" Wiring System—Explains How to Get Your Own Radio Outfit Without Money—How to Save \$65.00 in Five Hours—How to Make Money by Going into Business for Yourself and Building Sets for Others—Tells Where Orders are Awaiting You—Where and How You Can Transact Your Business—Contains Detailed Descriptions and Finest Illustration of Large and Small Sets—Lowest Prices—Lists Full Line of Radio Parts and Accessories—Expresses Our Fair, Easy, Liberal, Golden-Rule Plan of Doing Business. You Need It.

COODS SENT ON APPROVAL—
NO MONEY IN ADVANCE—
QUICK SHIPMENT—
WE PAY TRANSPORTATION—
Satisfaction or Money Back
SEE BIG ADVT., PAGE 138

Radio Specialty Co.
Div. 679M, 245A Greenwich St., N. Y. City

MAIL THIS COUPON NOW

RADIO SPECIALTY COMPANY,
Kit Div. 679M, 245A Greenwich St., New York
You may send me your Kit Catalog No. 14 if without charge or obligation.

Name.....
Street.....
P. O. State.....

M & M INSULATORS



Wall Insulators 60c Each



Made of hard rubber with brass center. 4" Lead in Insulator 50c; 10" Lead in Insulator, 80c; 20" Lead in Insulator for thick walls, \$1.50. Send for our big catalog of auto supplies and radio parts, sets and supplies.

Jobbers and Dealers Write for our special proposition, including attractive display board.

THE M & M CO., 500 Prospect Avenue, Cleveland, Ohio

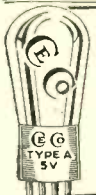

CECO Tipless Radio Tubes

Excellent Detectors and Amplifiers. A Quality Product. Approved by Leading Authorities.

C. E. MFG. CO., Providence, R. I.



PLIODYNE-6

One of the most selective receivers on the market—Consistent range of 1500-3000 miles. Two stages radio frequency detector, and three stages of balanced audio amplification. Beautiful Fabrikoid-covered Cabinet.

Price Without Accessories..... \$60.00
RADIO PARTS CO., Labs., 8 S. AUSTIN BLVD., OAK PARK, ILL.

P W X

is easy to get with the right kind of set. Profits are easy to get with the right kind of goods. Dealers write for facts.

HUDSON-ROSS—116 S. Wells St. Chicago

Burns

PERFECT REPRODUCER
Tone loud and pleasing. Hand-some material and design.
Black—\$22.50 Shell—\$25.00
AMERICAN ELECTRIC CO.
State and 64th Sts. Chicago



ZENITH
KENNEDY
Radiodyne
THERMIODYNE
ULTRADYNE
MURDOCK
AZARKA
Pfanstiehl
MICHIGAN
Deresnadyne
MALONE LEMON
MASTER RADIO
ADLER-ROYAL
Howard
Pathé
HARTMAN
AUDIOLA
EAGLE
GLOBE AND
MANY OTHERS USE

THORDARSON
Super
AMPLIFYING TRANSFORMERS
Standard on the majority of quality sets
 Follow the lead of the leaders. Build or replace with Thordarsons.

TYPES AND PRICES
 Thordarson "Super" Audio Frequency Transformers (sub-panel or standard type) are to be had in three ratios: 2-1, \$5; 3 1/2-1, \$4; 6-1, \$4.50. Thordarsons Power Amplifying Transformers are \$13 the pair. Thordarson Interstage Power Amplifying Transformer, \$8. All Thordarsons are unconditionally guaranteed. Dealers everywhere. Write for latest hook-up bulletins—free.

THORDARSON ELECTRIC MANUFACTURING CO
Transformer specialists since 1895
WORLDS OLDEST AND LARGEST EXCLUSIVE TRANSFORMER MAKERS
 Chicago, U.S.A.

\$3 DOWN Brings you a Genuine **UNDERWOOD** TYPEWRITER

10 DAYS FREE TRIAL Your \$3.00 unconditionally returned if at end of 10 days you are not satisfied with this late model UNDERWOOD typewriter rebuilt by the famous Shipman Ward process.

GREAT PRICE SAVING Direct to you from the largest typewriter factory in the world by our money saving methods.

EASY MONTHLY PAYMENTS So small that you will not notice it while you enjoy the use of this wonderful machine.

FREE BOOK OF FACTS Explaining Shipman Ward's wonderful system of rebuilding typewriters and also valuable information about the typewriter industry both instructive and entertaining.

Act Today! Mail Coupon

5 Year Guarantee

Shipman Ward Mfg. Company
 1195 Shipman Building
 Wrontrose & Ravenswood Aves., Chicago

Please send me free copy of your book of facts, explaining bargain offer.

Name.....
 St. and No.....
 City..... State.....

- Brownlee and Co. 1 Ekko Stamp Album. Courtesy the Ekko Co. 1 Package of Catwhiskers. 1 Wonder Crystal. Courtesy California Radio Minerals.
- 47—Wireless Course in Twenty Lessons. Courtesy the Consrad Co.
- 48—1 Year's Subscription to SCIENCE AND INVENTION. Courtesy the Experimenter Pub. Co.
- 49—1 Rasco Crystal Detector. Courtesy the Radio Specialty Co. 1 Ekko Stamp Album. Courtesy the Ekko Co. Jiffy Ribbon Antenna. Courtesy the Apex Stamping Co. 1 Package of Catwhiskers. Courtesy California Radio Minerals.
- 50—2 Vario-Densers, Model N. Courtesy X-L Radio Laboratories. De-Tec-Tone Crystal Detector. Courtesy Pyramid Products Co. 2 Tested Crystals. Courtesy Newman Stern Co.
- 51—Radio Listeners' Guide and Call Book. Courtesy Consrad Co. Ekko Stamp Album. Courtesy Ekko Co.
- 52—Jiffy Ribbon Antenna. Courtesy Apex Stamping Co. Glass-enclosed Crystal Detector. 1 Wonder Crystal. 1 Package Catwhiskers. Courtesy California Radio Minerals.
- 52A—Genwin Three Circuit Tuner. Courtesy General Radio Winding Co.
- 53—Storm King Arrester. Courtesy the L. S. Brach Mfg. Co.
- 54—1 Imp Jack and Plug. Courtesy the Carter Radio Co.
- 55—Mahogany Panel 7x24. Courtesy the American Hard Rubber Co. 1 Ekko Stamp Album. Courtesy the Ekko Co.
- 55—1 Year's Subscription to THE EXPERIMENTER. Courtesy the Experimenter Pub. Co.
- 57—S.P.D.T. Jack Switch, 1 Portable Jack. Courtesy the Carter Radio Co. 1 Ekko Stamp Album. Courtesy the Ekko Co.
- 58—Horn with No. 1 Cap. Courtesy the American Hard Rubber Co.
- 59—1 20-Ohm Rheostat. Courtesy the Carter Radio Co. One Ekko Stamp Album. Courtesy the Ekko Co.
- 60—Glass-enclosed Crystal Detector, 1 package Catwhiskers. Courtesy California Radio Minerals. 2 Crystals. Courtesy the Newman Stern Co.
- 61—Ekko Stamp Alum. Courtesy the Ekko Co. 1 Imp Lock Switch. Courtesy the Carter Radio Co.
- 62—1 Year's Subscription to MOTOR CAMPER & TOURIST. Courtesy the Experimenter Pub. Co.
- 63—Oneway Plug. Courtesy the Carter Radio Co. 2 packages Kester Solder. Courtesy the Chicago Solder Co.
- 64—1 Radio Log Book. Courtesy the Consrad Co.
- 65—Ekko Stamp Album. Courtesy the Ekko Co.
- 66—Packet C. Courtesy the Consrad Co.
- 67—Packet D. Courtesy the Consrad Co.

Zone 8

- Washington, Oregon, Idaho, California, Utah and Arizona
- 1—Zenith Radio Receiver. Courtesy Zenith Radio Corp.
- 2—Multi-Duty Super Charger. Courtesy France Mfg. Co.
- 3—Grand Opera Loud Speaker. Courtesy Radio Industries Corp.
- 4—Super Booster Wave Trap. Courtesy Super Booster Distributing Co. 1 23-Plate Variable Condenser. Courtesy General Radio Co.
- 5—23-Plate Vernier Variable Condenser. Courtesy Hammarlund Mfg. Co. Ekko Stamp Album. Courtesy Ekko Co.
- 6—Melotone Horn Type Loud Speaker. Courtesy Radio Industries Corp.
- 7—Wave Trap. Courtesy Ferbend Electric Co. Ekko Stamp Album. Courtesy Ekko Co.
- 8—2 Audio Transformers. Courtesy Halldorson Co. Ekko Stamp Album. Courtesy Ekko Co.
- 9—1 Year's Subscription to RADIO NEWS, SCIENCE AND INVENTION, THE EXPERIMENTER, MOTOR CAMPER & TOURIST. Courtesy Experimenter Pub. Co.
- 10—2 45-Volt Batteries. Courtesy Diamond Electric Specialties.
- 11—1 Filament Lock Switch, 1 Univernier Dial, 1 Safety Rim Socket, 1 Panelite. Courtesy Walbert Mfg. Co.
- 12—Headset and Plug. Courtesy Wm. J. Murdock Co.
- 13—Resistance Coupled Amplifier Kit. Courtesy Electrad, Inc.
- 14—13 Consrad Patterns. Courtesy Consrad Co.
- 15—Super Booster Wave Trap. Courtesy Super Booster Distributing Co. Ekko Stamp Album. Courtesy Ekko Co.
- 16—Audio Transformer. Courtesy Acme Apparatus Co. 1 Kant Blo Switch. Courtesy Clark & Tilson, Inc.
- 17—1 Year's Subscription to RADIO NEWS and THE EXPERIMENTER. Courtesy Experimenter Pub. Co.
- 18—Wave Trap. Courtesy Ferbend Electric Co.
- 19—Consrad Library, 14 Books. Courtesy Consrad Co.
- 20—Lamp Socket Antenna. Courtesy Electrad, Inc. Cushion VT Socket. Courtesy Illinois Radio Co. 1 Polyplug. Courtesy Polymet Mfg. Co.
- 21—1 Year's Subscription to SCIENCE AND INVENTION and MOTOR CAMPER & TOURIST. Courtesy Experimenter Pub. Co.
- 22—Ekko Stamp Album. Courtesy Ekko Co. 3 Wonder Crystals. 1 Glass Crystal Detector. 1 package Catwhiskers. Courtesy California Radio Minerals.
- 23—Audio Transformer. Courtesy Acme Apparatus Co. Ekko Stamp Album. Courtesy Ekko Co.
- 24—2 Vario-Densers. Model G. X-L Radio Lab-

ANTENELLA
No Aerial or Antenna Needed
The Complete Efficient and Economical Aerial



Why pay \$10 Only \$1.25 or more to have an aerial spoil the appearance of your home? Antenella eliminates all unsightly wiring, lightning arresters, etc., and precludes the possibility of dangerous grounding on a power line. It also stops "canary bird" re-radiation from nearby oscillating sets interfering.

ANTENELLA
 Is not only a real distance getter, but also overcomes troublesome static.

Sold by Authorized Freshman Dealers Only

Chas. Freshman Co. Inc.
Radio Receivers and Parts
FRESHMAN BUILDING
 240-248 WEST 40TH ST—NEW YORK, N.Y.

NEW LOW WAVE LOW LOSS UNCLE SAM COIL



Size **2 7/8 x 2 1/2 in.**
 Tunes from 35 to 150 meters with a .0005 mfd. condenser.

Ask your dealer or send us four cents in stamps for wiring diagrams in which this unit can be used.

FREE

UNCLE SAM ELEC. CO.
 211 E. Sixth St. Plainfield, N. J.

Get this great new **MAP of THE AIR**

A MARVELQUS new way to chart your radio exploits—a beautiful Air Map, printed in three colors, with every station clearly marked and Time zones outlined! Size 28 x 34 inches.

There's no limit to the useful and amusing ways you can use Collier's new Radio Map of the U. S. and Canada. With its help—

You can find out INSTANTLY how far away any station is

If you use a directional aerial, you can point the loop exactly toward the station you want to get. The map also outlines the radio districts, and gives an alphabetical list of all stations and their operators.

Thousands have already been sold. Get yours today! At your news-stand or radio dealer's, only twenty-five cents—or just mail a quarter to us.

P. F. COLLIER & SON COMPANY
 264 Park Avenue New York City

RADIO FANS
 For positive results use **"PERFECTO"** SOLDERING FLUID
Your Dealer or Send Us 25c for a Bottle
FIRTH RADIO CORP.
 25 Beaver St., New York City

- oratories. 1 Aerial Lead-in Connector, 1 package Name Plates. Courtesy Radio Specialty Co.
- 25—No-Dust Blowers. Courtesy Peiffer & Co. Ekko Stamp Album. Courtesy Ekko Co. 1 Rheostat. Courtesy Klosner Radio Corp. 4 VG Connectors. Illinois Radio Co.
- 26—1 Year's Subscription to RADIO NEWS. Courtesy Experimenter Pub. Co. Ekko Stamp Album. Courtesy Ekko Co.
- 27—Keystone Lightning Arrester. Courtesy Electric Service Supplies Co. Vernier Rheostat. Courtesy Klosner Radio Corp.
- 28—Vernier Crystal Detector. Courtesy Roland Brownlee and Co. 2 Crystals. Courtesy Newman Stern and Co. "How and Why of Radio Apparatus." Courtesy Conrad Co.
- 29—1 Year's Subscription to SCIENCE AND INVENTION. Courtesy Experimenter Pub. Co. Ekko Stamp Album. Courtesy Ekko Co.
- 30—Kant Bio Switch. Courtesy Clark and Tilson, Inc. Jiffy Ribbon Antenna. Courtesy Apex Stamping Co. Two Bakelite Sockets. Courtesy Bell Mfg. Co. Ekko Stamp Album. Courtesy Ekko Co.
- 31—Radio Map of the United States. Courtesy Conrad Co. Ekko Stamp Album. Courtesy Ekko Co.
- 32—Bakelite Dial. Courtesy the American Hard Rubber Co. Jiffy Blow Torch and Soldering Outfit. Courtesy The Apex Stamping Co. 1 Polyplug. Courtesy Polymet Mfg. Co. Sixteen-in-One Radio Tool. Courtesy Radio Specialty Co.
- 33—1 Year's Subscription to THE EXPERIMENTER. Courtesy The Experimenter Pub. Co. 1 Ekko Stamp Album. Courtesy The Ekko Co.
- 34—2 Vario-Densers, Model N. Courtesy X-L Radio Laboratories. Ekko Stamp Album. Courtesy the Ekko Co.
- 35—Set of Model C-10 Blue Prints for making receivers. Courtesy the Experimenters' Information Service, Inc. Ekko Stamp Album. Courtesy the Ekko Co.
- 36—2 Vernier attachments for dials. Courtesy the Radio Specialty Co. Polyplug. Courtesy the Polymet Mfg. Co.
- 37—1 Year's Subscription to MOTOR CAMPER AND TOURIST. Courtesy the Experimenter Pub. Co. Ekko Stamp Album. Courtesy Ekko Co.
- 38—1 Plain Rheostat. Courtesy Klosner Radio Corp. Keystone Lightning Arrester. Courtesy the Electric Service Supplies Co. Ekko Stamp Album. Courtesy the Ekko Co.
- 39—Lamp Socket Antenna. Courtesy Electrad, Inc. 2 Packages of Kester Solder. Courtesy Chicago Solder Co. Jiffy Blow Torch and Soldering Outfit. Courtesy Apex Stamping Co.
- 40—20 Radio Diagrams and Hook-ups. Courtesy the Conrad Co. 1 Ekko Stamp Album. Courtesy the Ekko Co.
- 41—1 Glass Enclosed Crystal Detector. 3 Wonder Crystals, 1 Package Catwhiskers. Courtesy California Radio Minerals. Aerial Lead-in Connector. Courtesy Radio Specialty Co.
- 42—1 Ekko Stamp Album. Courtesy the Ekko Co. 2 Four-inch Bakelite Dials. Courtesy Bell Mfg. Co. De-Tec-Tone Crystal Detector. Courtesy Pyramid Products Co. 2 Crystals. Courtesy Newman Stern Co.
- 43—1 Year's Subscription to RADIO NEWS. Courtesy the Experimenter Publishing Co.
- 44—1 Cushion V. T. Socket. Courtesy the Illinois Radio Co. 1 Ekko Stamp Album. Courtesy the Ekko Co. 1 Jiffy Ribbon Antenna. Courtesy the Apex Stamping Co. 4 V. G. Connectors. Courtesy the Illinois Radio Co.
- 45—Set of Model C-10 Blue Prints for making receivers. Courtesy the Experimenters' Information Service, Inc. Ekko Stamp Album. Courtesy the Ekko Co.
- 46—Vernier Crystal Detector. Courtesy Roland Brownlee and Co. 1 Ekko Stamp Album. Courtesy the Ekko Co. 1 Package of Catwhiskers. 1 Wonder Crystal. Courtesy California Radio Minerals.
- 47—Wireless Course in Twenty Lessons. Courtesy the Conrad Co.
- 48—1 Year's Subscription to SCIENCE AND INVENTION. Courtesy the Experimenter Pub. Co.
- 49—1 Rasco Crystal Detector. Courtesy the Radio Specialty Co. 1 Ekko Stamp Album. Courtesy the Ekko Co. Jiffy Ribbon Antenna. Courtesy the Apex Stamping Co. 1 Package of Catwhiskers. Courtesy California Radio Minerals.
- 50—2 Vario-Densers, Model N. Courtesy X-L Radio Laboratories. De-Tec-Tone Crystal Detector. Courtesy Pyramid Products Co. 2 Tested Crystals. Courtesy Newman Stern Co.
- 51—Radio Listeners' Guide and Call Book. Courtesy Conrad Co. Ekko Stamp Album. Courtesy Ekko Co.
- 52—Jiffy Ribbon Antenna. Courtesy Apex Stamping Co. Glass-enclosed Crystal Detector. 1 Wonder Crystal. 1 Package Catwhiskers. Courtesy California Radio Minerals.
- 52A—Genwin Three Circuit Tuner. Courtesy General Radio Winding Co.
- 53—1 Pilot Light Switch. Courtesy Yaxley Mfg. Co.
- 54—Imp Jack and Imp Plug. Courtesy Carter Radio Co.
- 55—100 Feet Celatsite Wire. Courtesy Acme Wire Co. Ekko Stamp Album. Courtesy Ekko Co.
- 56—1 Year's Subscription to THE EXPERIMENTER. Courtesy Experimenter Pub. Co.
- 57—1 Storm Guard Arrester. Courtesy L. S. Brach Mfg. Co. Ekko Stamp Album. Courtesy Ekko Co.
- 58—Lightning Arrester Switch. Courtesy Barlew Electric Mfg. Co.

GRAND CENTRAL PALACE

4th Annual

NATIONAL RADIO EXPOSITION

Grand Central Palace, New York

September 12th - 19th incl.

—the fourth successive national exposition representing all the leading manufacturers of the radio industry;

—the only great radio exposition of 1925 to be held in the metropolitan center of New York,

—the greatest spectacle of the year in the scientific, industrial and business progress of radio!

Business Office
AMERICAN RADIO EXPOSITION CO.
522 Fifth Avenue, New York

HAROLD BOLSTER, Director
J. C. JOHNSON, General Manager

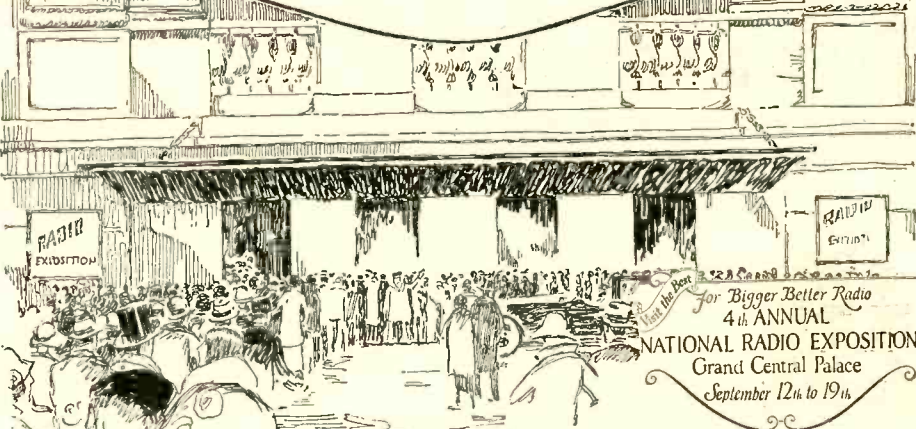

for Bigger Better Radio
4th ANNUAL
NATIONAL RADIO EXPOSITION
Grand Central Palace
September 12th to 19th

"I have found that the Diamond will outwear any other battery made."
—Mr. J. Hovey, Durhamville, N. Y.

Radio "B"

BATTERIES

DIAMOND ELECTRIC SPECIALTIES CORP.

103 South Orange Avenue, Newark, N. J.
Dealers, Jobbers—Write for Proposition

ROICE RADIO TUBES

"Royalty of Radio Tubes"
Produce clear volume—highly sensitive for distance reception.

EVERY TUBE GUARANTEED

to work in Radio Frequency, Reflex, Neutrodyne, Super-Heterodyne.

ALL TYPES **\$2.00**

Also 499A with Standard Base \$2.06
202-5 Watt Transmitter \$3.00

Shipped Parcel Post C. O. D.
When Ordering Mention Types.

ROICE TUBE CO.

21 Norwood St., Dept. N, Newark, N. J.



GOLD SEAL HOMCHARGER

The World's Most Popular Battery Charger
Write for Booklet

THE AUTOMATIC ELECTRICAL DEVICES CO.
121 West Third Street Cincinnati, Ohio

INSIST UPON

AMSCO

POTENTIOMETERS

Most Dependable Made

Insure your copy reaching you each month. Subscribe to Radio News—
\$2.50 a year. Experimenter Publishing Co., 53 Park Place, N. Y. C.

AMPLION

The World's Standard Loud Speaker

Alfred Graham & Co.
London, England
Patentees



\$13.50
AND UP

SHOULD NOT the originators and world's oldest makers of loud speakers—*thirty years' experience!*—rightfully be expected to create the world's finest loud speaker? The Amplion is their creation. To hear radio over The Amplion—in comparison—is all you need do to understand why, the world over, it has become the leading reproducer. Write for literature and dealer's name.

THE AMPLION CORPORATION OF AMERICA
Executive Offices: Suite W
280 Madison Ave., New York City
Canadian Distributors:
Burndept of Canada, Ltd., Toronto

BUILD AN ALL WAVE RECEIVER

LISTEN TO KDKA ON 64 Meters



WASHBURN INTERCHANGEABLE COIL TUNED RADIO FREQUENCY KIT
40 to 180 Meters

KIT NO. 2-100 to 300 Meters
KIT NO. 3-224 to 555 Meters

INTERCHANGEABLE COILS

Each kit contains three matched low loss Interchangeable coils; complete diagram and wiring instructions for building five tube tuned Radio frequency set. Interchangeable coils are mounted in Bakelite buses designed for use in standard tube sockets. Kit No. 1—10 to 180 meters, \$7.00; kit No. 2—100 to 300 meters, \$8.00; kit No. 3, 224 to 555 meters, \$9.00.

THE WASHBURN BURNER CORP.
Kokomo Indiana

TUBES REPAIRED

Burned Out Filament or Broken Bulb—Send Us the Tube.

All Work Done in Our Own Laboratory

We are not agents but own and operate a fully equipped tube factory manned by experienced tube experts. Our work is, therefore, superior and you are certain of satisfaction. We guarantee to return genuine element to you. New glass bulb put on in every instance, insuring correct vacuum and proper "hardness" for the type of tube. Tubes returned parcel post C.O.D. Send yours in today.

\$1.50

CHICAGO ELECTRIC DEVICES COMPANY
Established 1920. 70 E. 22nd St., Dept. 26, Chicago

- 59—20-Ohm Rheostat. Courtesy Carter Radio Co. Ekko Stamp Album. Courtesy Ekko Co.
- 60—Glass-enclosed Crystal Detector, 1 package Catwhiskers. Courtesy California Radio Minerals. 2 Crystals. Courtesy Newman Stern Co.
- 61—Ekko Stamp Album. Courtesy Ekko Co. Imp Lock Switch. Courtesy Carter Radio Co.
- 62—1 Year's Subscription to MOTOR CAMPER & TOURIST. Courtesy Experimenter Pub. Co.
- 63—Oneway Plug. Courtesy Carter Radio Co. 2 packages Kester Solder. Courtesy Chicago Solder Co.
- 64—Radio Log Book. Courtesy Consrad Co. Ekko Stamp Album. Courtesy Ekko Co.
- 65—Packet C. Courtesy Consrad Co.
- 66—Packet D. Courtesy Consrad Co.

Zone 9

Dominion of Canada

- 1—Deresnadyne Type M Receiver. Courtesy Andrews Radio Co.
- 1A—Model M Loud Speaker. Courtesy Atwater-Kent Mfg. Co.
- 2—Balkite Battery Charger. Courtesy Fansteel Products Co.
- 3—Grand Opera Loud Speaker. Courtesy Radio Industries Corp.
- 4—Super Booster Wave Trap. Courtesy Super Booster Dist. Co. 1 23-Plate Variable Condenser. Courtesy General Radio Co.
- 5—1 23-Plate Variable Condenser. Courtesy Hammarlund Mfg. Co. Ekko Stamp Album. Courtesy The Ekko Co.
- 6—Melotone Horn Type Loud Speaker. Courtesy Radio Industries Corp.
- 7—Ferbend Wave Trap. Courtesy Ferbend Electric Co. Ekko Stamp Album. Courtesy The Ekko Co.
- 8—2 Audio Transformers. Courtesy Halldorson Co. Ekko Stamp Album. Courtesy Ekko Co.
- 9—1 Year's Subscription to RADIO NEWS, THE EXPERIMENTER, SCIENCE AND INVENTION, MOTOR CAMPER & TOURIST. Courtesy Experimenter Publishing Co.
- 10—2 45-Volt "B" Batteries. Courtesy Diamond Electric Specialties.
- 11—1 Filament Lock Switch, 1 Univermier Dial, 1 Safety Rim Socket, 1 Panelite. Courtesy Walbert Mfg. Co.
- 12—Headset and Plug. Courtesy Wm. J. Murdock Co.
- 13—Resistance Coupled Amplifier Kit. Courtesy The Electrad Co.
- 14—13 Consrad Patterns. Courtesy Consrad Co.
- 15—Super Booster Wave Trap. Courtesy Super Booster Dist. Co. Ekko Stamp Album. Courtesy The Ekko Co.
- 16—1 Audio Transformer. Courtesy Acme Apparatus Co. 1 Kant Bio Switch. Courtesy Clark and Tilson, Inc.
- 17—1 Year's Subscription to RADIO NEWS, THE EXPERIMENTER. Courtesy Experimenter Pub. Co.
- 18—Ferbend Wave Trap. Courtesy Ferbend Electric Co.
- 19—Consrad Library of 14 Books. Courtesy Consrad Co.
- 20—Lamp Socket Antenna. Courtesy The Electrad Co. Cushion V. T. Socket. Courtesy Illinois Radio Co. 1 Polyplug. Courtesy Polymet Mfg. Corp.
- 21—1 Year's Subscription to SCIENCE AND INVENTION, MOTOR CAMPER & TOURIST. Courtesy Experimenter Pub. Co.
- 22—Ekko Stamp Album. Courtesy The Ekko Co. 3 A-1 Wonder Crystals, 1 Glass-enclosed Crystal Detector, 1 package Catwhiskers. Courtesy California Radio Minerals.
- 23—1 Audio Transformer. Courtesy Acme Apparatus Co. 1 Ekko Stamp Album. Courtesy Ekko Co.
- 24—2 Vario-Densers, Model G. Courtesy X-L Radio Laboratories. 1 Aerial Lead-in Connector, 1 Package Name-Plates. Courtesy Radio Specialty Co.
- 25—No-Dust Blower. Courtesy Peiffer and Co. Ekko Stamp Album. Courtesy The Ekko Co. 1 Rheostat. Courtesy Klosner Radio Corp. 4 V. G. Connectors. Courtesy Illinois Radio Co.
- 26—1 Year's Subscription to RADIO NEWS. Courtesy Experimenter Pub. Co.
- 27—Keystone Lightning Arrester. Courtesy Electric Service Supplies Co. 1 Vernier Rheostat. Courtesy Klosner Radio Corp. Ekko Stamp Album. Courtesy The Ekko Co.
- 27A-1 Audio Transformer. Courtesy of the Halldorson Co.
- 28—Vernier Crystal Detector. Courtesy Roland Brownlee and Co. 2 Crystals. Courtesy Newman Stern and Co. "How and Why of Radio Apparatus." Courtesy Consrad Co.
- 29—1 Year's Subscription to SCIENCE AND INVENTION. Courtesy Experimenter Pub. Co. Ekko Stamp Album. Courtesy Ekko Co.
- 30—Kant Bio Switch. Courtesy Clark and Tilson, Inc. Jiffy Ribbon Antenna. Courtesy Apex Stamping Co. Two Bakelite Sockets. Courtesy Bell Mfg. Co. Ekko Stamp Album. Courtesy Ekko Co.
- 31—Radio Map of the United States. Courtesy Consrad Co. Ekko Stamp Album. Courtesy Ekko Co.
- 32—Bakelite Dial. Courtesy the American Hard Rubber Co. Jiffy Blow Torch and Soldering Outfit. Courtesy The Apex Stamping Co. 1 Polyplug. Courtesy Polymet Mfg. Co. Sixteen-in-One Radio Tool. Courtesy Radio Specialty Co.

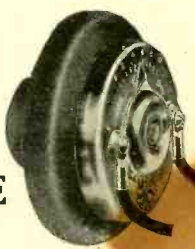

TYPE B **PRICE \$6**

THE SUCCESS or failure of your radio apparatus for 1925-6 season (the greatest in radio history) will depend more on the loudspeaker unit than any other single component.

May we tell you why, also why our products will bring you all the results you are hoping for?

THE MOZART-GRAND CO.
MANUFACTURING FINE RADIO APPARATUS
At 235-49 ELIZABETH AVE.
NEWARK N.J. U.S.A.



FOR GREATER DISTANCE, VOLUME AND CLARITY USE

X-L VARIO DENSERS

Endorsed and Used by the Foremost Radio Engineers of the Country

MODEL N—Capacity range 1.8 to 20 micro-microfarads, for balance in Roberts two tube, Browning-Drake, McMurdo Silver's Knockout, Neutrodyne and tuned radio frequency circuits. Price \$1.00

MODEL G—Two capacity ranges, .00016 to .00035 and .0003 to .0015 Microfarads, for the Cockaday circuit, filter and intermediate frequency tuning in super-heterodyne and positive grid bias in all sets. Price \$1.50

X-L RADIO LABORATORIES
2425 Lincoln Ave. CHICAGO
If your dealer cannot supply you write direct

ALL-AMERICAN
TRADE MARK

Largest Selling Transformers in the World

CAN YOU SELL?

We have a high-grade radio accessory and want to get in touch with men who have the selling instinct. We can prove that our "B" battery and rectifier, all in one case, is better than any other similar combination on the market, far superior to the best "B" battery eliminator. It is built on the past experience of a manufacturer old in the business, and is guaranteed to give satisfaction. This is something to be sold as a side line to users and dealers. Jobbers' accounts not solicited. If willing to work on strictly commission basis with full protection as to territory, address

ABCO, 2055 N. Racine Avenue, Chicago, Ill.

FREE Big catalog containing hundreds of bargains in standard radio sets, kits and parts. Write today.

WESTERN RADIO MFG. CO.
138 W. Lake St. Dept. 3-7 Chicago

Insure your copy reaching you each month. Subscribe to RADIO NEWS—\$2.50 a year. Experimenter Publishing Co., 53 Park Pl., N.Y.C.

- 33—1 Year's Subscription to THE EXPERIMENTER. Courtesy The Experimenter Pub. Co. 1 Ekko Stamp Album. Courtesy The Ekko Co.
- 34—2 Variodensers, model N. Courtesy X-L Radio Laboratories. Ekko Stamp Album. Courtesy the Ekko Co.
- 35—Set of Model C-10 Blue Prints for making receivers. Courtesy the Experimenters' Information Service, Inc. Ekko Stamp Album. Courtesy the Ekko Co.
- 36—2 Vernier attachments for dials. Courtesy the Radio Specialty Co. Polyplug. Courtesy the Polymer Mfg. Co.
- 37—1 Year's Subscription to MOTOR CAMPER AND TOURIST. Courtesy the Experimenter Publishing Co. Ekko Stamp Album. Courtesy the Ekko Co.
- 38—1 Plain Rheostat. Courtesy Klosner Radio Corp. Keystone Lightning Arrestor. Courtesy the Electric Service Supplies Co. Ekko Stamp Album. Courtesy the Ekko Co.
- 39—Lamp Socket Antenna. Courtesy Electrad, Inc. 2 Packages of Kester Solder. Courtesy Chicago Solder Co. Jiffy Blow Torch and Soldering Outfit. Courtesy Apex Stamping Co.
- 40—20 Radio Diagrams and Hook-ups. Courtesy the Consrad Co. 1 Ekko Stamp Album. Courtesy the Ekko Co.
- 41—1 Glass Enclosed Crystal Detector. 3 Wonder Crystals, 1 Package Catwhiskers. Courtesy California Radio Minerals. Aerial Lead-in Connector. Courtesy Radio Specialty Co.
- 42—1 Ekko Stamp Album. Courtesy the Ekko Co. 2 Four-inch Bakelite Dials. Courtesy Bell Mfg. Co. De-Tec-Tone Crystal Detector. Courtesy Pyramid Products Co. 2 Crystals. Courtesy Newman Stern Co.
- 43—1 Year's Subscription to RADIO NEWS. Courtesy the Experimenter Publishing Co.
- 44—1 Cushion V. T. Socket. Courtesy the Illinois Radio Co. 1 Ekko Stamp Album. Courtesy the Ekko Co. 1 Jiffy Ribbon Antenna. Courtesy the Apex Stamping Co. 4 V. G. Connectors. Courtesy the Illinois Radio Co.
- 45—Set of Model C-10 Blue Prints for making receivers. Courtesy the Experimenters' Information Service, Inc. Ekko Stamp Album. Courtesy the Ekko Co.
- 46—Vernier Crystal Detector. Courtesy Roland Brownlee and Co. 1 Ekko Stamp Album. Courtesy the Ekko Co. 1 Package of Catwhiskers. 1 Wonder Crystal. Courtesy California Radio Minerals.
- 47—Wireless Course in Twenty Lessons. Courtesy the Consrad Co.
- 48—1 Year's Subscription to SCIENCE AND INVENTION. Courtesy the Experimenter Pub. Co.
- 49—1 Rasco Crystal Detector. Courtesy the Radio Specialty Co. 1 Ekko Stamp Album. Courtesy the Ekko Co. Jiffy Ribbon Antenna. Courtesy the Apex Stamping Co. 1 Package of Catwhiskers. Courtesy California Radio Minerals.
- 50—2 Vario-Densers, Model N. Courtesy X-L Radio Laboratories. De-Tec-Tone Crystal Detector. Courtesy Pyramid Products Co. 2 Tested Crystals. Courtesy Newman Stern Co.
- 51—Radio Listeners' Guide and Call Book. Courtesy Consrad Co. Ekko Stamp Album. Courtesy Ekko Co.
- 52—Jiffy Ribbon Antenna. Courtesy Apex Stamping Co. Glass-enclosed Crystal Detector. 1 Wonder Crystal. 1 Package Catwhiskers. Courtesy California Radio Minerals.
- 52A—Genwin Three Circuit Tuner. Courtesy General Radio Winding Co.
- 53—Pilot Light Switch. Courtesy the Yaxley Mfg. Co.
- 54—1 Imp. Jack Switch, 1 Imp. Plug. Courtesy Carter Radio Co.
- 55—1 Mahogany Panel, 7x24. Courtesy the American Hard Rubber Co.
- 56—1 Year's Subscription to THE EXPERIMENTER. Courtesy The Experimenter Publishing Co.
- 57—S.P.D.T. Jack Switch, 1 Portable Jack. Courtesy The Carter Radio Co. 1 Ekko Stamp Album. Courtesy The Ekko Co.
- 58—Tuway Plug, 1 Double Circuit Jack. Courtesy The Carter Radio Co.
- 59—20-Ohm Rheostat. Courtesy The Carter Radio Co. 1 Ekko Stamp Album. Courtesy The Ekko Co.
- 60—Glass-enclosed Crystal Detector, 1 package of Catwhiskers. Courtesy California Radio Minerals. 2 Crystals. Courtesy The Newman Stern Co.
- 61—1 Ekko Stamp Album. Courtesy The Ekko Co. Imp Lock Switch. Courtesy The Carter Radio Co.
- 62—1 Year's Subscription to MOTOR CAMPER & TOURIST. Courtesy The Experimenter Publishing Co.
- 63—One-way Plug. Courtesy The Carter Radio Co. 2 packages Kester Solder. Courtesy The Chicago Solder Co.
- 64—1 Radio Log Book. Courtesy The Consrad Co.
- 65—1 Ekko Stamp Album. Courtesy The Ekko Co.
- 66—Packet C. Courtesy The Consrad Co.
- 67—Packet D. Courtesy The Consrad Co.

Zone 10

Mexico, Cuba, Panama, Canal Zone and South America

- 1—6-Tube Master Reflex Receiver. Courtesy Billmore Radio Co.
- 1A—All-Amx Jr. Radio Receiver Kit. Courtesy All-American Radio Corp.
- 2—Manhattan Jr. Loud Speaker. Courtesy Manhattan Electric Company.

**For Good Summer
Radio Reception use
JEFFERSON
TUBE REJUVENATOR
keeps tubes like NEW!**

DON'T blame the weather for all summer radio troubles. . . . How are the tubes? All tubes, remember, grow weak with use—especially in summer when operated at higher voltage. Bring them back to full efficiency—right in your own home—with the Jefferson Tube Rejuvenator! Takes only 10 minutes; attach to a convenient electric light socket. Completely restores paralyzed or exhausted tubes. Used once a month, it **DOUBLES** and **TREBLES** the life of tubes! Quickly pays for itself in saving of tubes and batteries. A home rejuvenator for tubes is just as essential to satisfactory radio reception as a charger for storage batteries. Jefferson Rejuvenator takes large or small tubes—201-A, 301-A, UV-199, C-299. Fully guaranteed. At leading stores selling radio supplies. If your dealer can't supply you, send \$7.50 to



For HOME Use



Patent Pending

JEFFERSON ELECTRIC MFG. CO.
501 So. Green St., Chicago, Ill.

Makers of Jefferson Radio, Bell Ringing and Toy Transformers; Jefferson Spark Coils for Automobile, Stationary and Marine Engines; Jefferson Oil Burner Ignition Coils and Transformers.

\$7.50
\$10 in Canada



For Best Results with your new
A C Circuit
use the famous **Pacent Audioformer**

Approved and recommended by McCullough. Perfectly designed for this circuit. High amplification with no single high peak or distortion. Beautifully finished in satin nickel. Ratio 3 1/2 to 1. Binding posts permit short leads. Price \$5.
(Note: Leading authorities on the A C Circuit recommend Pacent Jacks.)



The Famous Pacent Audioformer

Don't Improvize—**PACENTIZE**

Pacent
RADIO ESSENTIALS

Write for interesting free catalog

Pacent Electric Company, Inc. - 91 Seventh Ave., New York

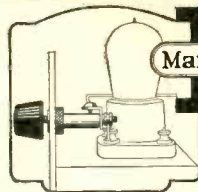

Marshall-stat
Price \$1.50

THE IDEAL RADIO RHEOSTAT
Mfgd. by Marshall Electric Co.,
3235 Locust Boul., St. Louis, Mo.

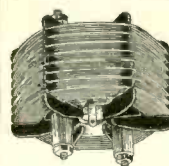

THE ANDREWS PADDLEWHEEL COIL

A low-loss inductance. Improves tone quality and increases signal strength and selectivity. Price, with bracket \$3.00
RADIO UNITS, INC.
1300 First Ave., Maywood, Ill.

Learn ELECTRICITY
in Great Shops of **COYNE**

All practical, personal training. No hooks or useless theory. You don't need education or experience. Earn while you learn. Electrical Experts Earn \$60 to \$200 a week. Complete course in 3 months. Send for Big FREE BOOK of 151 electrical photos. Ask about 2 Big Special FREE Courses.
COYNE ELECTRICAL SCHOOL
1300-10 W. Harrison Street, Chicago
Dept. C-594

Ask for Special Free R.R. Fare Offer NOW

FREE Send your name and address with a stamp for the complete working drawings of the famous
ELGIN SUPER-REINARTZ

This is the set that has heard the many European stations—the set of unequalled selectivity and clarity.
ELGIN RADIO SUPPLY CO.
Dept. C, 207 E. Chicago St. Elgin, Ill.

August Issue
Now on all News-stands
25c. the Copy

12
Pages of
EXPERIMENTAL
RADIO



Radio Features For August

THE IDEAL "A" AND "B" BATTERY CHARGING PANEL

Every radio experimenter who intends to do any work along Radio lines should have one of these practicable handy charging panels for his batteries. For this reason, THE EXPERIMENTER tells you how to build one in this August issue.

HOW TO RECEIVE TIME SIGNALS

For those radio listeners who wish to receive accurate time signals, THE EXPERIMENTER shows how to build a loading coil for your receiving set which will increase the wave-length and make possible the reception of government signals.

A SURE FIRE FIVE METER OSCILLATOR

If you have not already built one, this EXPERIMENTER five-meter oscillator is going to help you in your work. This set is complete and very compact, neat and accurate.

A THREE STEP, TRANSFORMER COUPLED, AUDIO FREQUENCY AMPLIFIER ACHIEVED

Do not fail to read this article in THE EXPERIMENTER. Here is something original, novel and well worth knowing.

The Radiotonscope—A New Experimental Idea

The most interesting and ingenious machine called the Radiotonscope is described in the August issue of THE EXPERIMENTER. This experimental machine gives a visual representation of radio in a multitude of marvelous color patterns.

Through a very simple arrangement each and every note of music or fluctuation of the voice over the radio produces a different color pattern

on this machine, yet the instrument itself is remarkably simple and can be constructed at home.

Besides many radio articles, THE EXPERIMENTER is full of the most novel and interesting developments of the present day. It will afford you many days of interesting activity through the reading and building of these novel machines. Ask your news or radio dealer for a copy today.

GERMOTT PUBLISHING CO., Owners

Licensed Publishers—EXPERIMENTER PUBLISHING CO., Inc., 53 Park Place, New York, N. Y.

- 3—Grand Opera Loud Speaker. Courtesy Radio Industries Corp.
- 4—Super Booster Wave Trap. Courtesy Super Booster Distributing Co.
- 5—23-Plate Vernier Condenser. Courtesy Hammarlund Mfg. Company.
- 6—Melotone Horn-type Loud Speaker. Courtesy Radio Industries Corp.
- 7—Ferbend Wave Trap. Courtesy Ferbend Electric Co.
- 8—2 Audio Transformers. Courtesy Halldorson Co.
- 9—1 Year's Subscription to RADIO NEWS, SCIENCE AND INVENTION, THE EXPERIMENTER, MOTOR CAMPER & TOURIST. Courtesy The Experimenter Pub. Co.
- 10—2 45-Volt Batteries. Courtesy Diamond Electric Specialties.
- 11—Filament Lock-switch, Univernier, Safety-rim Socket, Panelite. Walbert Mfg. Co.
- 12—Head-set and Plug. Courtesy Wm. J. Murdock Co.
- 13—Resistance-coupled Amplifier Kit. Courtesy Electrad, Inc.
- 14—13 Conrad Patterns. Courtesy Conrad Co.
- 15—Super Booster Wave Trap. Courtesy Super Booster Dist. Co.
- 16—1 Audio Transformer. Courtesy Acme Apparatus Co. Kant Blo Switch Tube Protector. Courtesy Clark and Tilson, Inc.
- 17—1 Year's Subscription to RADIO NEWS and THE EXPERIMENTER. Courtesy The Experimenter Pub. Co.
- 18—1 Wave Trap. Courtesy Ferbend Electric Co.
- 19—Conrad Library, fourteen books. Courtesy Conrad Co.
- 20—1 Lamp Socket Antenna. Courtesy Electrad, Inc. 1 Cushion V. T. Socket. Courtesy Illinois Radio Co. 1 Polyplug. Courtesy Polymet Mfg. Corp.
- 21—1 Year's Subscription to SCIENCE AND INVENTION and MOTOR CAMPER & TOURIST. Courtesy The Experimenter Pub. Co.
- 22—Ekko Stamp Album. Courtesy Ekko Co. 3 A-1 Wonder Crystals, 1 Glass-enclosed Detector, 1 package Catwhiskers. Courtesy California Radio Minerals.
- 23—1 Audio Transformer. Courtesy Acme Apparatus Co. 1 Ekko Stamp Album. Courtesy Ekko Co.
- 24—2 Vario-Densers, Model G. Courtesy X-L Radio Laboratories. 1 Aerial Lead-in Connector, 1 package Name-Plates. Courtesy Radio Specialty Co.
- 25—No-Dust Blower. Courtesy Peiffer and Co. Ekko Stamp Album. Courtesy The Ekko Co. 1 Rheostat. Courtesy Klosner Radio Corp. 4 V. G. Connectors. Courtesy Illinois Radio Co.
- 26—1 Year's Subscription to RADIO NEWS. Courtesy Experimenter Pub. Co.
- 27—Keystone Lightning Arrester. Courtesy Electric Service Supplies Co. 1 Vernier Rheostat. Courtesy Klosner Radio Corp. Ekko Stamp Album. Courtesy The Ekko Co.
- 27A—1 Audio Transformer. Courtesy Halldorson Co.
- 28—Vernier Crystal Detector. Courtesy Roland Brownlee and Co. 2 Crystals. Courtesy Newman Stern and Co. "How and Why of Radio Apparatus." Courtesy Conrad Co.
- 29—1 Year's Subscription to SCIENCE AND INVENTION. Courtesy Experimenter Pub. Co. Ekko Stamp Album. Courtesy Ekko Co.
- 30—Kant Blo Switch. Courtesy Clark and Tilson, Inc. Jiffy Ribbon Antenna. Courtesy Apex Stamping Co. Two Bakelite Sockets. Courtesy Bell Mfg. Co. Ekko Stamp Album. Courtesy Ekko Co.
- 31—Radio Map of the United States. Courtesy Conrad Co. Ekko Stamp Album. Courtesy Ekko Co.
- 32—Bakelite Dial. Courtesy the American Hard Rubber Co. Jiffy Blow Torch and Soldering Outfit. Courtesy The Apex Stamping Co. 1 Polyplug. Courtesy Polymet Mfg. Co. Sixteen-in-One Radio Tool. Courtesy Radio Specialty Co.
- 33—1 Year's Subscription to THE EXPERIMENTER. Courtesy The Experimenter Pub. Co. 1 Ekko Stamp Album. Courtesy The Ekko Co.
- 34—2 Vario-Densers, Model N. Courtesy X-L Radio Laboratories. Ekko Stamp Album. Courtesy the Ekko Co.
- 35—Set of Model C-10 Blue Prints for making receivers. Courtesy the Experimenters' Information Service, Inc. Ekko Stamp Album. Courtesy the Ekko Co.
- 36—2 Vernier attachments for dials. Courtesy the Radio Specialty Co. Polyplug. Courtesy the Polymet Mfg. Co.
- 37—1 Year's Subscription to MOTOR CAMPER AND TOURIST. Courtesy the Experimenter Publishing Co. Ekko Stamp Album. Courtesy the Ekko Co.
- 38—1 Plain Rheostat. Courtesy Klosner Radio Corp. Keystone Lightning Arrester. Courtesy the Electric Service Supplies Co. Ekko Stamp Album. Courtesy the Ekko Co.
- 39—Lamp Socket Antenna. Courtesy Electrad, Inc. 2 Packages of Kester Solder. Courtesy Chicago Solder Co. Jiffy Blow Torch and Soldering Outfit. Courtesy Apex Stamping Co.
- 40—20 Radio Diagrams and Hook-ups. Courtesy the Conrad Co. 1 Ekko Stamp Album. Courtesy the Ekko Co.
- 41—1 Glass Enclosed Crystal Detector. 3 Wonder Crystals. 1 Package Catwhiskers. Courtesy California Radio Minerals. Aerial Lead-in Connector. Courtesy Radio Specialty Co.
- 42—1 Ekko Stamp Album. Courtesy the Ekko Co. 2 Four-inch Bakelite Dials. Courtesy Bell Mfg.



Type B-^{AC} Tube Transformer



\$6.00 List



Type N Voltmeter
List Prices
0-7 volts, \$1.75; 0-50 volts, \$1.75; 0-100 volts, \$2.00
Four other types for Set Manufacturers and Jobbers.

Set Manufacturers!
Special Prices on Request



Type CSB Unmounted Transformer
37 other Types for Set Manufacturers and Jobbers.

DONGAN ELECTRIC MANUFACTURING CO.
2983 Franklin Street, Detroit, Mich.
Transformers of Merit for 15 Years

100 Volt Storage "B" Battery for \$10.00!



Service "A" Batteries
Indestructible rubber case. Two year guarantee.
6 volt. \$14.00
80-100 amp. hr. \$16.00

Everybody can now enjoy the benefits of Storage "B" Batteries—more power, quieter reception, greater economy. Rubber case prevents leakage or shorting. Easy to recharge. Will last for years with ordinary care.

SERVICE Rechargeable "B" Batteries
—in all-rubber cases—

100 VOLTS	\$10.00	50 VOLT	\$5.50
		125 VOLT	\$12.50

SERVICE BATTERY CO.
704 East 102nd Street Cleveland, Ohio

SERVICE Double-Duty CHARGER
Charges 6-volt "A" or Auto Batteries or up to 125 volts of "B" Battery IN SERIES. Noiseless in operation. Extremely economical. The height of convenience.



Complete with Bulb \$14.50

Prices in Canada

50 VOLT	\$7.75	100 VOLT	\$14.50	125 VOLT	\$17.00
---------	---------------	----------	----------------	----------	----------------

SERVICE BATTERY CO. of Canada, 137 Roncesvalles Ave. Toronto, Ontario

PERSONAL STATIONERY

200 SHEETS and 100 ENVELOPES \$1.00

Printed with your Name and Address

Clear, white bond paper, with envelopes to match. Your name and address printed in beautiful, rich blue ink, on both paper and envelopes, and sent to you postpaid for only \$1.00. (West of Mississippi river and outside of U. S. \$1.10.) If inconvenient to send the money, we will ship C. O. D. Money returned if you are not more than satisfied. Order today. Write name and address plainly.

AGENTS MAKE BIG MONEY taking orders for us. Write us today for our agent's proposition.

ELITE STATIONERY COMPANY Smethport, Pa.
7056 Main Street

Buy Now Pay Later

It's Easy to Build Things

Do ripping, mitring, grooving, tenoning, rabbeting and other operations with speed and accuracy on the

BOICE-CRANE JUNIOR SAW

Build radio cabinets, furniture, toys, novelties, etc., with this compact, practical machine. All metal construction. Attaches to light socket. Sold with or without motor and base. A quality machine at low price.

Write for complete information on Boice-Crane Bench Saws, Jointers, Band Saws and Motors.



W. B. & J. E. Boice, Dept. 808-A Toledo, O.

TO THE RADIO DEALER

Let us explain how you can make the sale of our publications a worth while, well paying part of your business. Write now and prepare for the Fall and Winter trade.

EXPERIMENTER PUBLISHING COMPANY, 53 PARK PLACE, NEW YORK CITY

DUPLIX CONDENSERS



"None better made," Conform to Bureau of Standards specifications for lowest losses. Automatic bearing take-up and rugged construction assure permanent alignment. All capacities—plain, vernier. Fully guaranteed.

DUPLIX STANDARD

Duplex Matched Condensers Afford Uniform Dial Settings

Always Read Alike  Only One Number to Log

Or eliminate logging — Dial by call letters or wave lengths. Specially tested and guaranteed. Matched, packed and sealed, to remain unopened until used.

Literature on request

DUPLIX CONDENSER & RADIO CORP.
52 Flatbush Ave. Extension, Brooklyn, N.Y.

Lack some of the refinements of the Duplex Standard but are "best at the price." Ideal for portables. All capacities—plain and vernier.

DUPLIX JUNIOR

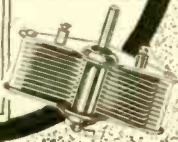

RICHARDSON 5 Power

A five-tube, tuned radio frequency set equalized on all wave lengths to give great power, distance and volume. Consider its performance, its appearance and its price. No wonder it is making radio history wherever it is demonstrated.



\$65

At Better Radio Stores Everywhere

RICHARDSON RADIO, Inc.
128 University Place, New York City

FAHNESTOCK CLIPS

The Perfect Radio Connectors—Are Used



By manufacturers of standard sets and parts and makers of wet Battery and exclusive on Eveready Dry Batteries. Their Sure Patented Grip is recognized universally by enthusiastic users.

Reg. U.S. Patent Office

FAHNESTOCK ELECTRIC COMPANY
Long Island City

- Co. De-Tec-Tone Crystal Detector. Courtesy Pyramid Products Co. 2 Crystals. Courtesy Newman Stern Co.
- 43—1 Year's Subscription to RADIO NEWS. Courtesy the Experimenter Publishing Co.
 - 44—1 Cushion V. T. Socket. Courtesy the Illinois Radio Co. 1 Ekko Stamp Album. Courtesy the Ekko Co. 1 Jiffy Ribbon Antenna. Courtesy the Apex Stamping Co. 4 V. G. Connectors. Courtesy the Illinois Radio Co.
 - 45—Set of Model C-10 Blue Prints for making receivers. Courtesy the Experimenters' Information Service, Inc. Ekko Stamp Album. Courtesy the Ekko Co.
 - 46—Vernier Crystal Detector. Courtesy Roland Brownlee and Co. 1 Ekko Stamp Album. Courtesy the Ekko Co. 1 Package of Catwhiskers. 1 Wonder Crystal. Courtesy California Radio Minerals.
 - 47—Wireless Course in Twenty Lessons. Courtesy the Conrad Co.
 - 48—1 Year's Subscription to SCIENCE AND INVENTION. Courtesy the Experimenter Pub. Co.
 - 49—1 Rasco Crystal Detector. Courtesy the Radio Specialty Co. 1 Ekko Stamp Album. Courtesy the Ekko Co. 1 Jiffy Ribbon Antenna. Courtesy the Apex Stamping Co. 1 Package of Catwhiskers. Courtesy California Radio Minerals.
 - 50—2 Vario-Densers, Model N. Courtesy X-L Radio Laboratories. De-Tec-Tone Crystal Detector. Courtesy Pyramid Products Co. 2 Tested Crystals. Courtesy Newman Stern Co.
 - 51—Radio Listeners' Guide and Call Book. Courtesy Conrad Co. Ekko Stamp Album. Courtesy Ekko Co.
 - 52—Jiffy Ribbon Antenna. Courtesy Apex Stamping Co. Glass-enclosed Crystal Detector. 1 Wonder Crystal. 1 Package Catwhiskers. Courtesy California Radio Minerals.
 - 52A—Genwin Three Circuit Tuner. Courtesy General Radio Winding Co.
 - 53—Pilot Light Switch. Courtesy Yaxley Mfg. Co.
 - 54—Antenna Selector Switch for Radiola III. Courtesy Barkeley Electric Mfg. Co. 1 Ekko Stamp Album. Courtesy Ekko Co.
 - 55—Bakelite Panel 7x18 in. Courtesy American Hard Rubber Co.
 - 56—1 Year's subscription to THE EXPERIMENTER. Courtesy Experimenter Pub. Co.
 - 57—Single-pole Double-throw Jack Switch. 1 Portable Jack. Courtesy Carter Radio Co. 1 Ekko Stamp Album. Courtesy Ekko Co.
 - 58—Tuway Plug, 1 Double-circuit Jack. Courtesy Carter Radio Co.
 - 59—1 20-Ohm Rheostat. Courtesy Carter Radio Co. 1 Ekko Stamp Album. Courtesy Ekko Co.
 - 60—1 Glass-enclosed Crystal Detector. 1 Package Catwhiskers. Courtesy California Radio Minerals. 2 Crystals. Courtesy Newman Stern Co.
 - 61—Ekko Stamp Album. Courtesy Ekko Co. Lock-switch. Courtesy Carter Radio Co.
 - 62—1 Year's Subscription to MOTOR CAMPER & TOURIST. Courtesy Experimenter Pub. Co.
 - 63—One-way Plug. Courtesy Carter Radio Co. 2 Packages of Kester Solder. Courtesy Chicago Solder Co.
 - 64—1 Radio Log Book. Courtesy Conrad Co.
 - 65—1 Ekko Stamp Album. Courtesy Ekko Co.
 - 66—Packet C. Courtesy Conrad Co.
 - 67—Packet D. Courtesy Conrad Co.

Zone 11

- England, France, Spain and Mediterranean Cities
- 1—Model MW Miraco Radio Receiver. Courtesy Midwest Radio Corp.
 - 1A—All-Amaz Sr. Radio Receiver Kit. Courtesy All-American Radio Corp.
 - 2—Manhattan Jr. Loud Speaker. Courtesy Manhattan Electric Co.
 - 3—Grand Opera Loud Speaker. Courtesy Radio Industries Corp.
 - 4—Super Booster Wave Trap. Courtesy Super Booster Distributing Co.
 - 5—23-Plate Vernier Variable Condenser. Courtesy Hammarlund Mfg. Co.
 - 6—Melotone Horn-type Loud Speaker. Courtesy Radio Industries Corp.
 - 7—Wave Trap. Courtesy Ferbend Electric Co.
 - 8—2 Audio Transformers. Courtesy Halldorson Co.
 - 9—1 Year's Subscription to RADIO NEWS, SCIENCE AND INVENTION, THE EXPERIMENTER, MOTOR CAMPER & TOURIST. Courtesy The Experimenter Pub. Co.
 - 10—2 45-Volt Batteries. Courtesy Diamond Electric Specialties.
 - 11—Filament Lock-switch, Univeraier Dial, Safety Rim Socket, Panelite. Courtesy Walbert Mfg. Co.
 - 12—Head-set and Plug. Courtesy Wm. J. Murdoch Co.
 - 13—Resistance-coupled Amplifier Kit. Courtesy Electrad, Inc.
 - 14—13 Conrad Patterns. Courtesy Conrad Co.
 - 15—Super Booster Wave Trap. Courtesy Super Booster Dist. Co.
 - 16—1 Audio Transformer. Courtesy Acme Apparatus Co. Kant Blo Switch Tube Protector. Courtesy Clark and Tilson, Inc.
 - 17—1 Year's Subscription to RADIO NEWS and THE EXPERIMENTER. Courtesy The Experimenter Pub. Co.
 - 18—1 Wave Trap. Courtesy Ferbend Electric Co.
 - 19—Conrad Library, fourteen books. Courtesy Conrad Co.

EARN \$35 to \$50 Weekly

SAVE \$1000 a Year

After short course in RADIO LICENSES a specialty. Instruction in all branches. FALL term begins SEPT. 14th. Positions secured for graduates.

Send for Sample Code Lessons. **FREE** FREE Scholarships for a few lucky ones. FREE catalogue and full details from

Mass. Radio School

18 Boylston Street

Boston, Mass.

(C. II IYS—40 to 200 meters.)

Take This Book—Free

Send Today!

36 Pages 7x10



Explains Easy Way of Assembling

Contains offers of Kits for a large number of best radio receivers, and accessories. Lowest prices. Highest quality. Shipped on approval — No money in advance — Transportation paid — Satisfaction Guaranteed. (See big ad, page 138).

YOU Need this Book

RADIO SPECIALTY COMPANY
Kit Div. 6790, 245A Greenwich Street, New York City

BLUEBIRD RADIO TUBES



—are powerful—sensitive for distance. Give clear volume and long service.

GUARANTEED

to work in Radio Frequency, Neutrodyne, Super Heterodyne and Reflex.

WITH BAKELITE BASE

ALL STANDARD TYPES **\$2.00**

Also 499-A with Standard Base \$2.00 202-5 Watt Transmitter \$3.00

When Ordering Mention Types

BLUEBIRD TUBE CO.
200 Broadway, Dept. N, New York

Shipped Parcel Post C.O.D.

for Improved Reception—

—build with KIL-KO-PARTS
Cut down interference and get stations you never heard before through scientific tube tuning. Booklet on Improved Reception sent for 2c stamp. Write Dept. RN-825.

D X INSTRUMENT CO. Harrisburg, Pa.

FIL-KO-PARTS

- 20—1 Lamp Socket Antenna. Courtesy Electrad, Inc. 1 Cushion V. T. Socket. Courtesy Illinois Radio Co. 1 Polyplug. Courtesy Polymet Mfg. Corp.
- 21—1 Year's Subscription to SCIENCE AND INVENTION and MOTOR CAMPER & TOURIST Courtesy The Experimenter Pub. Co.
- 22—Ekko Stamp Album. Courtesy Ekko Co. 3 A-1 Wonder Crystals, 1 Glass-enclosed Detector, 1 package Catwhiskers. Courtesy California Radio Minerals.
- 23—1 Audio Transformer. Courtesy Acme Apparatus Co. 1 Ekko Stamp Album. Courtesy Ekko Co.
- 24—2 Vario-Densers, Model G. Courtesy X-L Radio Laboratories. 1 Aerial Lead-in Connector, 1 package Name-Plates. Courtesy Radio Specialty Co.
- 25—No-Dust Blower. Courtesy Peiffer and Co. Ekko Stamp Album. Courtesy The Ekko Co. 1 Rheostat. Courtesy Klosner Radio Corp. 4 V. G. Connectors. Courtesy Illinois Radio Co.
- 26—1 Year's Subscription to RADIO NEWS. Courtesy Experimenter Pub. Co.
- 27—Keystone Lightning Arrester. Courtesy Electric Service Supplies Co. 1 Vernier Rheostat Courtesy Klosner Radio Corp. Ekko Stamp Album. Courtesy The Ekko Co.
- 27A—1 Audio Transformer. Courtesy Halldorson Co.
- 28—Vernier Crystal Detector. Courtesy Roland Brownlee and Co. 2 Crystals. Courtesy Newman Stern and Co. "How and Why of Radio Apparatus." Courtesy Conrad Co.
- 29—1 Year's Subscription to SCIENCE AND INVENTION. Courtesy Experimenter Pub. Co. Ekko Stamp Album. Courtesy Ekko Co.
- 30—Kant Blo Switch. Courtesy Clark and Tilson, Inc. Jiffy Ribbon Antenna Courtesy Apex Stamping Co. Two Bakelite Sockets. Courtesy Bell Mfg. Co. Ekko Stamp Album. Courtesy Ekko Co.
- 31—Radio Map of the United States. Courtesy Conrad Co. Ekko Stamp Album. Courtesy Ekko Co.
- 32—Bakelite Dial. Courtesy the American Hard Rubber Co. Jiffy Blow Torch and Soldering Outfit. Courtesy The Apex Stamping Co. 1 Polyplug. Courtesy Polymet Mfg. Co. Sixteen-in-One Radio Tool. Courtesy Radio Specialty Co.
- 33—1 Year's Subscription to THE EXPERIMENTER. Courtesy The Experimenter Pub. Co. 1 Ekko Stamp Album. Courtesy The Ekko Co.
- 34—2 Vario-Densers, Model N. Courtesy X-L Radio Laboratories. Ekko Stamp Album. Courtesy the Ekko Co.
- 35—Set of Model C-10 Blue Prints for making receivers. Courtesy the Experimenters' Information Service, Inc. Ekko Stamp Album. Courtesy the Ekko Co.
- 36—2 Vernier attachments for dials. Courtesy the Radio Specialty Co. Polyplug. Courtesy the Polymet Mfg. Co.
- 37—1 Year's Subscription to MOTOR CAMPER AND TOURIST. Courtesy the Experimenter Publishing Co. Ekko Stamp Album. Courtesy the Ekko Co.
- 38—1 Plain Rheostat. Courtesy Klosner Radio Corp. Keystone Lightning Arrester. Courtesy the Electric Service Supplies Co. Ekko Stamp Album. Courtesy the Ekko Co.
- 39—Lamp Socket Antenna. Courtesy Electrad, Inc. 2 Packages of Kester Solder. Courtesy Chicago Solder Co. Jiffy Blow Torch and Soldering Outfit. Courtesy Apex Stamping Co.
- 40—20 Radio Diagrams and Hook-ups. Courtesy the Conrad Co. 1 Ekko Stamp Album. Courtesy the Ekko Co.
- 41—1 Glass Enclosed Crystal Detector. 3 Wonder Crystals, 1 Package Catwhiskers. Courtesy California Radio Minerals. Aerial Lead-in Connector. Courtesy Radio Specialty Co.
- 42—1 Ekko Stamp Album. Courtesy the Ekko Co. 2 Four-inch Bakelite Dials. Courtesy Bell Mfg. Co. De-Tec-Tone Crystal Detector. Courtesy Pyramid Products Co. 2 Crystals. Courtesy Newman Stern Co.
- 43—1 Year's Subscription to RADIO NEWS. Courtesy the Experimenter Publishing Co.
- 44—1 Cushion V. T. Socket. Courtesy the Illinois Radio Co. 1 Ekko Stamp Album. Courtesy the Ekko Co. 1 Jiffy Ribbon Antenna. Courtesy the Apex Stamping Co. 4 V. G. Connectors. Courtesy the Illinois Radio Co.
- 45—Set of Model C-10 Blue Prints for making receivers. Courtesy the Experimenters' Information Service, Inc. Ekko Stamp Album. Courtesy the Ekko Co.
- 46—Vernier Crystal Detector. Courtesy Roland Brownlee and Co. 1 Ekko Stamp Album. Courtesy the Ekko Co. 1 Package of Catwhiskers. 1 Wonder Crystal. Courtesy California Radio Minerals.
- 47—Wireless Course in Twenty Lessons. Courtesy the Conrad Co.
- 48—1 Year's Subscription to SCIENCE AND INVENTION. Courtesy the Experimenter Pub. Co.
- 49—1 Raseo Crystal Detector. Courtesy the Radio Specialty Co. 1 Ekko Stamp Album. Courtesy the Ekko Co. Jiffy Ribbon Antenna. Courtesy the Apex Stamping Co. 1 Package of Catwhiskers. Courtesy California Radio Minerals.
- 50—2 Vario-Densers, Model N. Courtesy X-L Radio Laboratories. De-Tec-Tone Crystal Detector. Courtesy Pyramid Products Co. 2 Tested Crystals. Courtesy Newman Stern Co.
- 51—Radio Listeners' Guide and Call Book. Courtesy Conrad Co. Ekko Stamp Album. Courtesy Ekko Co.

JUST ONE LAZY TUBE MAY BE TO BLAME FOR LACK OF VOLUME OR FAILURE TO GET DISTANT STATIONS!

This Simple Tube Tester Quickly Reveals Many Troubles Which Might Otherwise Take You Hours To Find.

If your set isn't giving you volume, if it sounds "scratchy" or unmusical, if you can't get distant stations—don't blame the weather or some part of the set, for nine times out of ten your trouble is *tubes*.

The success or failure of any set often hinges on the quality of ONE tube. This tube may "glow" like the others and still be a poor amplifier. Some tubes deteriorate faster than others. A tube that is good today may be poor tomorrow.

The only way to know true conditions is to check the tubes with a scientific instrument. The Sterling Home Tube Tester will show you in less than half a minute whether a tube is good, fair or poor.

Act now—the sooner you get your Sterling Tube Tester the sooner your troubles vanish.

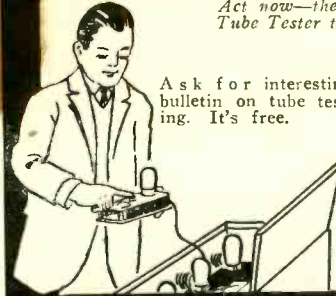

Ask for interesting bulletin on tube testing. It's free.



MORE THAN A TUBE TESTER

Not only for testing the quality of tubes but for locating such troubles as poor spring contacts in tube sockets, open "A" Battery wiring circuit, open circuit between "B" Battery and socket, open circuit in transformer primary, filament of tube deactivated—the Sterling Tube Tester is invaluable.

Sterling

HOME TUBE TESTER

The Sterling Manufacturing Co.
2831-53 Prospect Ave., Dept. H, Cleveland, Ohio

Perfect Precision in Every Part!

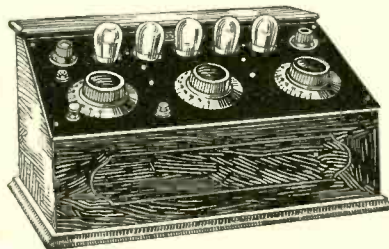

THAT is the secret of better radio reception—the reason for Jones superiority.

JOS. W. JONES J-75 SET

5-Tube Radio Frequency Receiver; plain black dials and trim. Price, without tubes, batteries, headphones or aerial equipment ... **\$75**

JOS. W. JONES

TRADE MARK

The product of 28 years' experience in the design and manufacture of precision instruments and parts. Not a trick circuit, but the time-

tested principle of Tuned Radio Frequency PLUS perfect precision in design, construction and co-ordination of parts.

Built of the Famous Jones Precision Parts.

Write NOW for literature and full particulars of these Standardized, Precision-Made Radio Receivers

JOS. W. JONES RADIO MFG. CO., 40-46 West 25th Street, New York

Branch Offices: Philadelphia — Boston — Chicago

BODINE BASKET-WEAVE LOOP AERIAL

Gives winter reception with no reduction in distance. Folding Loop. Ask your dealer.

BODINE ELECTRIC CO.
2250 West Ohio Street Chicago, Ill.

ASK YOUR DEALER About NEW TYPES of U. S. TOOL CONDENSERS

U. S. TOOL COMPANY, INC.
Ampere, New Jersey

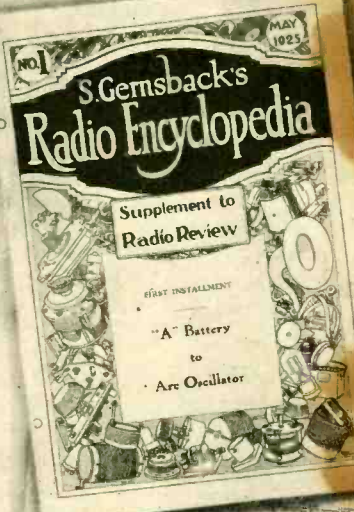

RADIO REVIEW

Reg. U.S. Pat. Off.

A Digest of the Latest Radio Hookups

The Newest Thing in Radio Literature

A complete 100 page illustrated magazine containing hookups and constructional Radio articles, gleaned from the entire radio press the world over.

Large magazine size 9 x 12 inches, printed on fine paper and profusely illustrated.

IN EVERY ISSUE A 16 PAGE SUPPLEMENT OF ONE INSTALLMENT OF S. GERNSBACK'S RADIO ENCYCLOPEDIA

This real Encyclopedia of Radio explains every word used in Radio, by means of photographs, drawings, charts or tables. (Some sample pages are shown in this advertisement). This supplement is arranged in loose-leaf form.

35c the copy on all Newsstands and Radio Stores.

Subscription price \$3.50 for 12 issues.

Published by

THE CONSRAD CO., Inc.
233 Fulton St., New York, N.Y.

THE CONSRAD CO., Inc.,
233 Fulton Street, New York.

Enclosed find \$3.50, for which enter my subscription to RADIO REVIEW for 12 issues.

Name

Street

Town

State

- 52—Jiffy Ribbon Antenna. Courtesy Apex Stamping Co. Glass-enclosed Crystal Detector. 1 Wonder Crystal, 1 Package Catwhiskers. Courtesy California Radio Minerals.
- 52A—Genwin Three Circuit Tuner. Courtesy General Radio Winding Co.
- 53—Pilot Light Switch. Courtesy the Yaxley Mfg. Co.
- 54—Lightning Arrester. Courtesy the Berkeley Electric Mfg. Co.
- 55—Bakelite Panel, 7x18 inches. Courtesy American Hard Rubber Co.
- 56—1 Year's Subscription to THE EXPERIMENTER. Courtesy the Experimenter Publishing Co.
- 57—Single-pole Double-throw Jack Switch. 1 Portable Jack. Courtesy Carter Radio Co.
- 58—Ekko Stamp Album. Courtesy Ekko Co.
- 58—Tuway Plug, 1 Double Circuit Jack. Courtesy Carter Radio Co.
- 59—2 Packages Kester Solder. Courtesy the Chicago Solder Co.
- 60—Glass-enclosed Crystal Detector. 1 Package catwhiskers. Courtesy California Radio Minerals. 2 Crystals. Courtesy Newman Stern Co.
- 61—1 Ekko Stamp Album. Courtesy Ekko Co. 1 Lock Switch. Courtesy Carter Radio Co.
- 62—1 Year's Subscription to MOTOR CAMPER & TOURIST. Courtesy Experimenter Pub. Co.
- 63—Oneway Plug. Courtesy Carter Radio Co. 2 Packages Kester Solder. Courtesy Chicago Solder Co.
- 64—Radio Log Book. Courtesy Conrad Co.
- 65—1 Ekko Stamp Album. Courtesy Ekko Co.
- 66—Packet C. Courtesy Conrad Co.
- 67—Packet D. Courtesy Conrad Co.

Zone 12

All other places not named, including the High Seas

- 1—K. H. Erla 5-Tube Radio Receiver Kit. Courtesy Electrical Research Laboratories.
- 1A—All-Amax Sr. Radio Receiver Kit. Courtesy All-American Radio Corp.
- 2—Grand Opera Loud Speaker. Courtesy Radio Industries Corp.
- 3—Miracle Crystal Set. Courtesy Uncle Al's Radio Shop.
- 4—Super Booster Wave Trap. Courtesy Super Booster Distributing Co.
- 5—23-Plate Vernier Condenser. Courtesy Hammarlund Mfg. Co.
- 6—Melotone Horn-type Speaker. Courtesy Radio Industries Corp.
- 7—Wave Trap. Courtesy Ferhend Electric Co.
- 8—2 Audio Transformers. Courtesy Halldorson Co.
- 9—1 Year's Subscription to RADIO NEWS, SCIENCE AND INVENTION, THE EXPERIMENTER, MOTOR CAMPER & TOURIST. Courtesy The Experimenter Pub. Co.
- 10—2 45-Volt Batteries. Courtesy Diamond Electric Specialties.
- 11—Filament Lockswitch, Univermier. Safety Rim Socket, Panelite. Courtesy Walbert Mfg. Co.
- 12—Head-set and Plug. Courtesy Wm. J. Murdock Co.
- 13—Resistance-coupled Amplifier Kit. Courtesy Electrad, Inc.
- 14—13 Conrad Patterns. Courtesy Conrad Co.
- 15—Super Booster Wave Trap. Courtesy Super Booster Dist. Co.
- 16—1 Audio Transformer. Courtesy Acme Apparatus Co. Kant Bio Switch Tube Protector. Courtesy Clark and Tilson, Inc.
- 17—1 Year's Subscription to RADIO NEWS and THE EXPERIMENTER. Courtesy The Experimenter Pub. Co.
- 18—1 Wave Trap. Courtesy Ferhend Electric Co.
- 19—Conrad Library, fourteen books. Courtesy Conrad Co.
- 20—1 Lamp Socket Antenna. Courtesy Electrad, Inc. 1 Cushion V. T. Socket. Courtesy Illinois Radio Co. 1 Polyplug. Courtesy Polymet Mfg. Corp.
- 21—1 Year's Subscription to SCIENCE AND INVENTION and MOTOR CAMPER & TOURIST. Courtesy The Experimenter Pub. Co.
- 22—Ekko Stamp Album. Courtesy Ekko Co. 3 A-1 Wonder Crystals, 1 Glass-enclosed Detector, 1 package Catwhiskers. Courtesy California Radio Minerals.
- 23—1 Audio Transformer. Courtesy Acme Apparatus Co. 1 Ekko Stamp Album. Courtesy Ekko Co.
- 24—2 Vario-Densers, Model G. Courtesy X-L Radio Laboratories. 1 Aerial Lead-in Connector. 1 package Name-Plates. Courtesy Radio Specialty Co.
- 25—No-Dust Blower. Courtesy Peiffer and Co. Ekko Stamp Album. Courtesy The Ekko Co. 1 Rheostat. Courtesy Klosner Radio Corp. 4 V. G. Connectors. Courtesy Illinois Radio Co.
- 26—1 Year's Subscription to RADIO NEWS. Courtesy Experimenter Pub. Co.
- 27—Keystone Lightning Arrester. Courtesy Electric Service Supplies Co. 1 Vernier Rheostat. Courtesy Klosner Radio Corp. Ekko Stamp Album. Courtesy The Ekko Co.
- 27A—1 Audio Transformer. Courtesy of the Halldorson Co.
- 28—Vernier Crystal Detector. Courtesy Roland Brownlee and Co. 2 Crystals. Courtesy Newman Stern and Co. "How and Why of Radio Apparatus." Courtesy Conrad Co.
- 29—1 Year's Subscription to SCIENCE AND INVENTION. Courtesy Experimenter Pub. Co. Ekko Stamp Album. Courtesy Ekko Co.

USE THIS ON YOUR DETECTOR the New

Three "E" Straight Line Rheostat

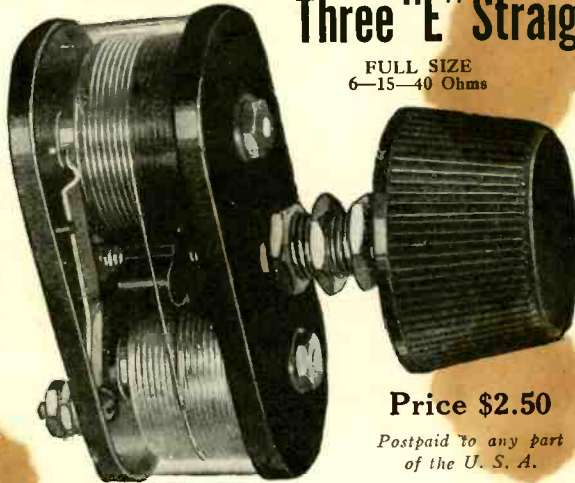

FULL SIZE
6-15-40 Ohms

Runs smoothly
Has no slider on wire
Ensures best reception
Outstanding design
Straight line variation
The ideal filament control
Absolutely NOISELESS
The Aristocrat of Rheostats

Price \$2.50

Postpaid to any part
of the U. S. A.

If your dealer does not
handle our Rheostat send
your Money Order to us
and we will supply you.

Patent Pending



Look for our TRADE MARK

Radio Division

ELECTRICAL-ENGINEERS-EQUIPMENT-CO.

708 W. Madison St.

Chicago, Ill.



NOW FOR LITTLE COST YOU CAN OWN A REAL PORTABLE

Karryadio

The ideal Portable Radio Case with Pivoting Loop-cover and Collapsible Horn—designed for a 18" by 7" standard panel—makes building a portable easy

GREATEST VALUE EVER OFFERED PORTABLE SET BUILDERS. THE THREE ESSENTIAL PORTABLE REQUISITES FOR THE PRICE OF ONE.

Price \$15

Pivoting Loop-Cover—is the only correct solution of the loop problem for a portable set. The loop in a portable radio must be directional, so that the different stations can be easily tuned in—it must also be ready for instant operation. With the Karryadio pivoting cover loop there is no waiting to assemble a loop on top of your set. The loop is center tapped, thus giving you a wide choice of circuits to build in the case.

Collapsible Horn—allows you to have space for real size batteries and yet keeps your radio really portable. When closed the horn occupies a space only about one inch thick—opened, it measures six inches square, giving wonderful volume.

Standard Panel—take a standard 18" by 7" panel. Build a reflex, superheterodyne, or any good loop circuit—place it in this case and you have an entirely self-contained radio ready for use at any time.

ARMLEY RADIO CORPORATION, 68-70 Fleet Street, Jersey, N. J.
At your Dealer's otherwise send purchase price and you will be supplied without further charge.



Pats. Pending

Write today.



STORAD

SUPER CAPACITY BATTERIES

Because Storads have high capacity and are built to give reliable long life service on modern multi-tube sets they are sure "trouble killers" and are the ideal batteries for "B" circuit power.

Equip your set with Storads.

Ask your dealer or write direct for information.

Distributors' territory is still available.

The Cleveland Engineering Laboratories Co., 2126 Superior Viaduct, N. W., Cleveland, Ohio.

THE LATEST

parts and sets are always featured in our Salespeaker. If you are a live-wire dealer, write for your copy, now.

HUDSON-ROSS—116 S. Wells St.
Chicago

INSIST UPON



AIR CONDENSERS
VERNIER & VARIABLE

The New Radio Stamp Fad

Here is the DX Radio Stamp Album just like the ones we owned in our youth, in which were placed the rare stamps of the countries of the world. Some were hard to get, some couldn't be purchased for love or money; but the fun of the hobby was the seeking of rare stamps and the eventual possession. So it will be with the DX Radio Stamp Album. There will probably be some stamps you will

never be able to own, but there will be many you will be proud to have and be able to show to other radio enthusiasts. It's an interesting game. Below the Album is shown the "Proof of Reception Cards" of which a generous supply is furnished with each Album. A dime placed in the hole in the card and sent to the station you heard brings back a stamp for your Album.



You can get this handsome Stamp Album *FREE*

This beautiful EKKO Stamp Album, illustrated above, will be given away absolutely free with a subscription to any one of our four magazines: "Radio News," "Science and Invention," "The Experimenter," "Motor Camper and Tourist."

Don't pass up the opportunity to get this valuable premium. With this album, you can keep through the means of beautiful engraved stamps, a certified record of every broadcast station you have heard on your radio set. Your friends will enjoy seeing it.

The album consists of 96 pages, size 9 x 12 and is bound in extra heavy stiff cover.

With the Album is furnished a large Cram's comprehensive radio map of the United States and Canada; a supply of "Proof of Reception Cards" and also some stickers. The Album contains a list of broadcast stations of the United States and Canada with wave-lengths and columns for recording dial setting, a table of stations arranged according to wave-lengths and a section for log records.

We have acquired 1,000 of these Albums especially for our subscribers. The coupon on this page filled out and mailed to us with \$2.50 will entitle you to a twelve months' subscription to any one of our four magazines and one of these EKKO Stamp Albums free.

EXPERIMENTER PUBLISHING CO., INC., 53 Park Place, New York, N. Y.

Gentlemen: I have decided to take advantage of your special offer. I am enclosing \$2.50 for 1 year's subscription to () "Radio News," () "Science and Invention," () "The Experimenter," () "Motor Camper and Tourist" and one EKKO Stamp Album which you will send me free. (Mark to which magazine you wish to subscribe)

NAME CITY
ADDRESS STATE

DON'T FAIL TO USE THIS COUPON

- 30—Kant Blo Switch. Courtesy Clark and Tilson, Inc. Jiffy Ribbon Antenna. Courtesy Apex Stamping Co. Two Bakelite Sockets. Courtesy Bell Mfg. Co. Ekko Stamp Album. Courtesy Ekko Co.
- 31—Radio Map of the United States. Courtesy Consrad Co. Ekko Stamp Album. Courtesy Ekko Co.
- 32—Bakelite Dial. Courtesy the American Hard Rubber Co. Jiffy Blow Torch and Soldering Outfit. Courtesy The Apex Stamping Co. 1 Polyplug. Courtesy Polymet Mfg. Co. Sixteen-in-One Radio Tool. Courtesy Radio Specialty Co.
- 33—1 Year's Subscription to THE EXPERIMENTER. Courtesy The Experimenter Pub. Co. 1 Ekko Stamp Album. Courtesy The Ekko Co.
- 34—2 Vario-Densers, Model N. Courtesy X-L Radio Laboratories. Ekko Stamp Album. Courtesy the Ekko Co.
- 35—Set of Model C-10 Blue Prints for making receivers. Courtesy the Experimenters' Information Service, Inc. Ekko Stamp Album. Courtesy the Ekko Co.
- 36—2 Vernier attachments for dials. Courtesy the Radio Specialty Co. Polyplug. Courtesy the Polymet Mfg. Co.
- 37—1 Year's Subscription to MOTOR CAMPER AND TOURIST. Courtesy the Experimenter Pub. Co. Ekko Stamp Album. Courtesy Ekko Co.
- 38—1 Plain Rheostat. Courtesy Klosner Radio Corp. Keystone Lightning Arrestor. Courtesy the Electric Service Supplies Co. Ekko Stamp Album. Courtesy the Ekko Co.
- 39—Lamp Socket Antenna. Courtesy Electrad, Inc. 2 Packages of Kester Solder. Courtesy Chicago Solder Co. Jiffy Blow Torch and Soldering Outfit. Courtesy Apex Stamping Co.
- 40—20 Radio Diagrams and Hook-ups. Courtesy the Consrad Co. 1 Ekko Stamp Album. Courtesy the Ekko Co.
- 41—1 Glass Enclosed Crystal Detector. 3 Wonder Crystals, 1 Package Catwhiskers. Courtesy California Radio Minerals. Aerial Lead-in Connector. Courtesy Radio Specialty Co.
- 42—1 Ekko Stamp Album. Courtesy the Ekko Co. 2 Four-inch Bakelite Dials. Courtesy Bell Mfg. Co. De-Tec-Tone Crystal Detector. Courtesy Pyramid Products Co. 2 Crystals. Courtesy Newman Stern Co.
- 43—1 Year's Subscription to RADIO NEWS. Courtesy the Experimenter Publishing Co.
- 44—1 Cushion V. T. Socket. Courtesy the Illinois Radio Co. 1 Ekko Stamp Album. Courtesy the Ekko Co. 1 Jiffy Ribbon Antenna. Courtesy the Apex Stamping Co. 4 V. G. Connectors. Courtesy the Illinois Radio Co.
- 45—Set of Model C-10 Blue Prints for making receivers. Courtesy the Experimenters' Information Service, Inc. Ekko Stamp Album. Courtesy the Ekko Co.
- 46—Vernier Crystal Detector. Courtesy Roland Brownlee and Co. 1 Ekko Stamp Album. Courtesy the Ekko Co. 1 Package of Catwhiskers. 1 Wonder Crystal. Courtesy California Radio Minerals.
- 47—Wireless Course in Twenty Lessons. Courtesy the Consrad Co.
- 48—1 Year's Subscription to SCIENCE AND INVENTION. Courtesy the Experimenter Pub. Co.
- 49—1 Rasco Crystal Detector. Courtesy the Radio Specialty Co. 1 Ekko Stamp Album. Courtesy the Ekko Co. Jiffy Ribbon Antenna. Courtesy the Apex Stamping Co. 1 Package of Catwhiskers. Courtesy California Radio Minerals.
- 50—2 Vario-Densers, Model N. Courtesy X-L Radio Laboratories. De-Tec-Tone Crystal Detector. Courtesy Pyramid Products Co. 2 Tested Crystals. Courtesy Newman Stern Co.
- 51—Radio Listeners' Guide and Call Book. Courtesy Consrad Co. Ekko Stamp Album. Courtesy Ekko Co.
- 52—Jiffy Ribbon Antenna. Courtesy Apex Stamping Co. Glass-enclosed Crystal Detector. 1 Wonder Crystal. 1 Package Catwhiskers. Courtesy California Radio Minerals.
- 52A—Genwin Three Circuit Tuner. Courtesy General Radio Winding Co.
- 53—Storm King Arrestor. Courtesy L. S. Brach Mfg. Co.
- 54—1 Imp Jack, 1 Imp Plug. Courtesy Carter Radio Co.
- 55—100 Feet Stranded Antenna Wire. Courtesy Acme Wire Co. Ekko Stamp Album. Courtesy Ekko Co.
- 56—1 Year's Subscription to THE EXPERIMENTER. Courtesy Experimenter Publishing Co.
- 57—1 Storm Guard Arrestor. Courtesy L. S. Brach Mfg. Co. Ekko Stamp Album. Courtesy Ekko Co.
- 58—Tuway Plug, Double Circuit Jack. Courtesy Carter Radio Co.
- 59—20-Ohm Rheostat. Courtesy Carter Radio Co. Ekko Stamp Album. Courtesy Ekko Co.
- 60—Glass-enclosed Crystal Detector. 1 Package Catwhiskers. Courtesy California Radio Minerals. 2 Tested Crystals. Courtesy Newman Stern Co.
- 61—Receptacle Jack. Courtesy Carter Radio Co. Ekko Stamp Album. Courtesy Ekko Co.
- 62—1 Year's Subscription to MOTOR CAMPER & TOURIST. Courtesy Experimenter Pub. Co.
- 63—Oneway Plug. Courtesy Carter Radio Co. 1 Package Kester Solder. Courtesy Chicago Solder Co.
- 64—Radio Log Book. Courtesy Consrad Co. Ekko Stamp Album. Courtesy Ekko Co.
- 65—Packet C. Courtesy Consrad Co.
- 66—Packet D. Courtesy Consrad Co.



AEROVOX Tested
 Fixed Mica or By-Pass
 Condensers are made in all capacities; also Fixed Mica Condensers with grid mountings. The testing laboratories of Radio News, Popular Radio and Professor Wheeler of Yale have enthusiastically endorsed them. Prominent set manufacturers throughout the country depend on them. Why shouldn't you have the best?

How can your set deliver maximum results unless the small parts are scientifically right? AEROVOX is your insurance of quality. If it is fixed or by-pass condensers or grid-leaks—use AEROVOX and you make sure of perfection.



Write for particulars of our complete line including Resistofomers and Rheostats.

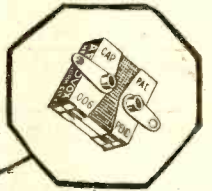

AEROVOX WIRELESS CORP.
 493 Broome St., New York City

Reserve Space Now!

**BROOKLYN
 RADIO EXPOSITION**

October 17th to 24th, 1925

to be held at

23rd Regiment Armory

Bedford and Atlantic Avenues

For space and rates apply to

STEPHEN T. ROGERS, Managing Director

Phone, Triangle 4126 1 to 7 DeKALB AVE., BROOKLYN, N. Y.

LEARN THE CODE AT HOME

WITH OMNIGRAPH

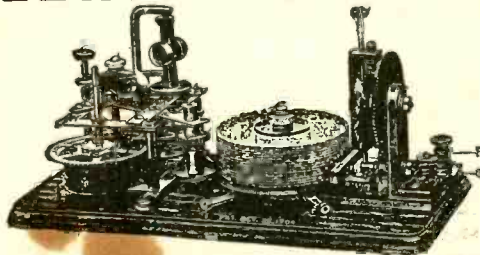

THE OMNIGRAPH Automatic Transmitter will teach you both the Wireless and Morse Codes—right in your own home—quickly, easily and inexpensively. Connected with Buzzer, Buzzer and Phone or to Sounder, it will send you unlimited messages, at any speed, from 5 to 50 words a minute.

THE OMNIGRAPH is not an experiment. For more than 15 years, it has been sold all over the world with a money back guarantee. The OMNIGRAPH is used by several Dpts. of the U.S. Govt.—in fact, the Dept. of Commerce uses the OMNIGRAPH to test all applicants applying for a Radio license. The OMNIGRAPH has been successfully adopted by the leading Universities, Colleges and Radio Schools

Send for FREE Catalog describing three models. DO IT TODAY.

THE OMNIGRAPH MFG. CO., 15 HUDSON STREET, NEW YORK CITY

If you own a Radio Phone set and don't know the code—you are missing most of the fun

**Build Your Own
 RADIO RECEIVER
 and Save Money.
 Revolutionary Method!**

SEND FOR BIG KIT CATALOG and learn how. (See big advt. on page 138.) Radio Specialty Co., Div. 679P, 245A, Greenwich St., N. Y.

**The Traffic Cop
 of the Air**



Add a Ferbend Wave Trap to your Radio Set and "Police" your reception. Regulate traffic. Guaranteed to tune out any interfering station. Widely imitated but never equalled. The original and only successful WAVE TRAP. Now in its third year. Sent Postpaid upon receipt of \$8.50 or C. O. D. plus postage. Send for Free Booklet

FERBEND ELECTRIC CO.
 25 E. So. Water St. Chicago

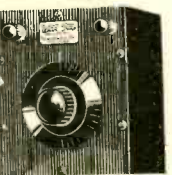

OPPORTUNITY AD-LETS

Follow these advertisements every month. Reliable advertisers from all over the country offer their most attractive specials in these columns.

Classified advertising rate twenty-two cents a word for each insertion. Ten per cent discount for 6 issues, 20 per cent discount for 12 issues. Name and address must be included at the above rate. Cash should accompany all classified advertisements unless placed by an accredited advertising agency. No advertisement for less than 10 words accepted.

Objectionable or misleading advertisements not accepted. Advertisements for the October issue must reach us not later than August 1st.

CIRCULATION LARGER THAN THAT OF ANY OTHER RADIO PUBLICATION

EXPERIMENTER PUBLISHING CO., INC., 53 Park Place, New York, N. Y.

Agents Wanted

Agents Wanted in every city and town to sell standard radio apparatus. Attractive discounts given. If interested write us at once stating age and radio experience. Wilmington Electrical Specialty Co., Inc., 405 Delaware Ave., Wilmington, Delaware.

Big Money and fast sales. Every owner buys gold initials for his auto. You charge \$1.50; make \$1.35. Ten orders daily easy. Write for particulars and free samples. American Monogram Co., Dept. 133, East Orange, N. J.

Guaranteed Genuine Gold Leaf Letters anyone can put on store windows. Large profits, enormous demand. Free samples. Metallic Letter Co., 422 N. Clark, Chicago.

Can You Sell? All-wool, union made, tailored-to-measure suits for \$19.75. Universal Tailors, 1899 Bedford Street, Boston.

Big money and fast sales, every owner buys gold initials for his auto. You charge \$1.50 make \$1.44. Ten orders daily easy. Samples and information free. World Monogram Co., Dept. 27, Newark, N. J.

Agents—Write for free Samples. Sell Madison "Better-Made" Shirts for large Manufacturer direct to wearer. No capital or experience required. Many earn \$100 weekly and bonus. Madison Mfrs., 501 Broadway, New York.

Excellent opportunity for Radio Phans in each County as our representative. Good Pay. Pleasant Work. No investment or deposit required. Be first. Immediately. Write for Proof. Manager, P. O. Box 131, Davenport, Iowa.

Business Opportunities

Make \$100 Weekly in Spare Time. Sell what the public wants—long distance radio receiving sets. Two sales weekly pays \$100 profit. No big investment, no canvassing. Sharpe of Colorado made \$955 in one month. Representatives wanted at once. This plan is sweeping the country—write today before your county is gone. Ozarka, 813 Washington Blvd., Chicago.

Advertise, hundred magazines, three issues, 10c word. Pennell Company, Covington, Kentucky.

Import your own goods. Big German export magazine published in English offers thousands of bargains in latest novelties. Sample copy, 50c. Opportunity for obtaining profitable agencies. J. Abca Specialty Co., 263 Fifth Ave., New York City.

Chemistry

Learn Chemistry at home. Dr. T. O'Connor Sloane, noted educator and scientific authority will teach you. Our home study correspondence course fits you to take a position as chemist. See our full page ad on page 229 of this issue. Chemical Institute of New York, 66 W. Broadway, New York City.

Educational

Used Correspondence School courses save over half. Bargain catalogue 1000 courses free. Used courses bought. Students' Exchange, Dept. A, 47 West 42d St., New York.

For Advertisers

24 Words—355 Rural Weeklies \$14.20. Admeyer, 4112-R Hartford, St. Louis.

For Inventors

New Ideas Wanted. Well known Radio Manufacturer whose products are nationally advertised and sold everywhere wants new Radio device to sell. Will pay outright or royalty for idea or invention which is really new and salable. Address: Mr. R. F. Devine, Room 1101, 116 West 32nd St., New York, N. Y.

For Rent

For Rent—Store or Department. 100% Richmond, Virginia, 100% For a live radio firm will rent a department or store. Each situated in the heart of the best retail shopping center, surrounded by our leading department stores and women's specialty shops and chain stores. Long lease, reasonable rent. Immediate possession. On one of the heaviest traffic bearing blocks in the city. For full particulars write. Gordon E. Strause, Broad at Seventh, Richmond, Virginia.

Games and Entertainment

Magic Trick Cards that are absolutely guaranteed. Free samples. Write me today. C. D. Blankenship, Adrian, W. Va.

Help Wanted

Earn \$25 weekly, spare time, writing for newspapers, magazines. Experience unnecessary. Copyright book free. Press Syndicate, 972, St. Louis, Mo.

Men to build radio sets in spare time. Leon Lambert, 595-H Kaufman Bldg., Wichita, Kansas.

Detectives needed everywhere; large salaries; free particulars; write National Headquarters, 188 East 19th, New York.

Instruction

Learn Chemistry at Home. Dr. T. O'Connor Sloane, noted educator and scientific authority, will teach you. Our home study correspondence course fits you to take a position as chemist. See our full page ad on page 229 of this issue. Chemical Institute of New York, 66 W. Broadway, New York City.

Miscellaneous

Beautiful registered bull pups cheap. Bulldogs, 501 Rockwood, Dallas, Texas.

Knitter supplies Fair Isle Jumpers Sports Coats. Genuine Shetland Wool hand-knit, natural or Jazz. \$19 post paid cash with order. Mrs. Cluness, 1 Braewick Road, Lerwick, Shetland, Scotland.

Jazz orchestra chording. Tenor or regular banjo. Clay, 1521 E. 86th, Cleveland, Ohio.

Pecan-Orange Groves "On the Gulf" \$10 monthly. Guaranteed Care. Soon produce \$500 yearly. Suburban Orchards, Dept. R, Biloxi, Mississippi.

Special! Manufacturer's direct sale of guaranteed 10 karat solid gold cufflinks only \$2.50 postpaid while they last. Eliminating dealers saves half. Illustrated circular free. Theander Novelty Co., 246 Fulton Street, Brooklyn, N. Y.

Learn How to Solder all kinds of metals. Send 50c coin and address of three friends for this copyright book, Twenty Years of Soldering Experience. Tinner, Box 1134, Scottsbluff, Nebraska.

German gentleman, great Radio enthusiast, desires regular correspondence with foreign gentlemen for exchange of experiences and opinion and new inventions. Leopold Patz, Delsnitz 1, Vogtland, Saxony.

Movie Films, 1000 ft. reels. Complete stories, \$2.50 each; shipped anywhere on receipt of remittance with order. Independent Films, 177 Golden Gate Ave., San Francisco, Calif.

Motorcycles, Bicycles

Don't Buy a Bicycle Motor Attachment until you get our catalog and prices. Shaw Mfg. Co., Dept. 6, Galesburg, Kansas.

Old Money Wanted

\$2 to \$500 each paid for hundreds of Old or Odd Coins. Keep all old money, it may be very valuable. Send 10c for New Illustrated Coin Value Book 48c. Guaranteed Prices. Get posted. We pay Cash. Clarke Coin Company, 14 Street, LeRoy, N. Y.

Patent Attorneys

Inventors—Should write for our Free Guide Books and "Record of Invention Blank" before disclosing inventions. Send model or sketch of your invention for our Free Inspection and Instructions. Radio, Electrical, Chemical, Mechanical and Trademark experts. Terms reasonable. Victor J. Evans & Co., 922 Ninth, Washington, D. C.

Patents. Send drawing or model for examination and report as to patentability. Advice and booklet free. Highest references. Best results. Promptness assured. Watson E. Coleman, Patent Lawyer, 844 G Street, N. W., Washington, D. C.

Patents—Send for form "Evidence of Conception" to be signed and witnessed. Form, fee schedule, information free. Lancaster and Allwine, Registered Patent Attorneys in United States and Canada, 269 Ouray Bldg., Washington, D. C.

Patent Attorneys (Continued)

Patents for inventions. Long experience, highest grade work, rates reasonable, best references. Advice as to patentability. Wm. Ashley Kelly, 41 Park Row, New York.

Patent-Sense—As one of the oldest Patent firms in America we give inventors, at lowest consistent charge, a service noted for results, evidenced by many well-known Patents of extraordinary value. Book, Patent-Sense, free. Lacey & Lacey, 631 F St., Washington, D. C. Estab. 1869.

Patents

Inventions Commercialized. Patented or unpatented. Write Adam Fisher Mfg. Co., 278 Enright, St. Louis, Mo.

Personal

Lonely Hearts—Exchange letters; make interesting new friends in our jolly club. Era Moore, Box 908, Jacksonville, Florida. Enclose stamp.

Exchange Cheery Letters with new friends. Write Betty Lee Inc., Box 820 City Hall Station, New York City. Stamp appreciated.

Lonesome—Join our club—make acquaintances everywhere. Big illustrated book with descriptions and photos, sent in plain wrapper for ten cents. Bonafide Co., Dept. 58, Kansas City, Mo.

Lonesome: Make friends everywhere through our Club. Write Eva Burchard, Box 75, Portland, Oregon, for particulars.

Printing Outfits and Supplies

Print your own cards, stationery, circulars, paper, etc. Complete outfits \$8.85; Job Presses \$12, \$35; Rotary \$150. Print for others, big profit. All easy, rules sent. Write for catalog presses, type, paper, etc. Press Company, A-13, Meriden, Conn.

Radio

Boys! Don't Overlook This. The "Rasco" Baby Detector. Greatest detector ever brought out with molded base. Fully adjustable. See former advertisements in this publication, or our catalog. Detector with Galea Crystal, complete 50c, the same detector with Radiocite Crystal, 75c pre-paid. Send for yours today. Radio Specialty Company, 96-98 Park Place, New York City.

Ivory Radio Panel: Grained white "Ivorylite" makes most beautiful set of all. Guaranteed satisfactory. Any size 3-10" thick sent prepaid 3c per square inch. Sample free. F. P. Hutton, Dept. N, 614 Main St., Fort Worth, Texas.

Attention!—50 Vacuum tube hook-ups. The greatest collection of vacuum tube circuits ever brought under two covers at such insignificant cost. These diagrams will be found in the great "Rasco" catalog, which contains raw materials and parts in a greater profusion than any other catalog. 15c in stamps, or coin, will bring the catalog to you. Radio Specialty Co., 96-98 Park Place, New York City.

Edison Elements 5c per pair. Co-operative Merchandise Co., Chelsea, Mass.

2650 Miles Distance with one tube. Any Novice understands our simplified instructions. Big free booklet tells the story. Vesco Radio Co., Box 117RN, Oakland, Calif.

Elleite Super Radio Receiver. No Tubes, A or B Batteries. Operates Speaker, Clarity, Distance. Write Elleite Radio Co., Box 135, Buffalo, N. Y.

McWilliams super-sensitive selenium cells are excellent for voice modulation and experiments with the amplification of Radio by light rays. Hook up for Radio furnished free with each cell. Electric Bean Grator Products Co., Ithaca, Michigan.

200,000 satisfied customers hear distant stations on Lambert Crystal Sets. Copyrighted plans \$1.00. Complete kit and plans \$5.00. Leon Lambert, 595, Wichita, Kansas.

20% Discount on Sets, Kits, Accessories. Write. \$97.00. Special Libradyne parts with cabinet \$77.60 Pre-paid. Ray Radio Supply, Box 317, Sandusky, Ohio.

Radio Hospital. Specialists in Neutrodyne and Superheterodynes. Dept. 2, Abilene, Kansas.

Bargains—Several loud speakers, also two receiving sets, all new and A-1 condition. Write for details. Carlisle Benjamin, Clyde, N. Y.

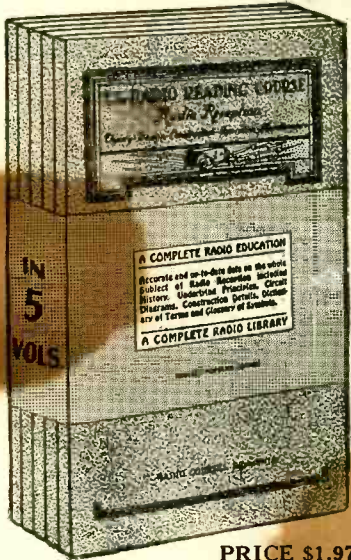

PRICE \$1.97

A RADIO EDUCATION

IN 5 VOLUMES

Theory, Design, Construction,
Operation and Maintenance

LEARN AT HOME

These five component parts of a complete Radio Instruction Course are outlined in five volumes that contain not merely the essentials as so many books do, but more, they contain all that any modern up-to-the-minute textbook on any subject would cover. They are in themselves a COMPLETE radio education teaching every possible portion of Radio science.

Size of each book 6 by 9 inches, handsomely bound and illustrated with charts, diagrams, descriptions of equipment, etc.

SEND NO MONEY for these books. Just forward your name and address. We send you the books at once. On receipt of same you pay the postman \$1.97 plus a few cents postage and then they are yours.

Distributed by

The Conrad Co.

233 Fulton St., New York, N. Y.

Salesmen Wanted

The Clothing Industry is the second largest business in the country. Men have made fortunes in it. So can you if you go into it right. We'll put you into it right without one penny of expense to you, supply everything you need to get into the business and clear from \$100.00 to \$200.00 a week, right from the start. This is a wonderful opportunity for the right man—but he must be "right." He must be honest, dependable, able and willing to sell, and above all, he must be willing to work hard for success. If you are such a man, we want to hear from you. Let's get together. You start by addressing Dept. 714, Goodwear Chicago, Inc., 844 West Adams Street, Chicago.

Skat Sales Agents Wanted. All or Part Time for Skat Hand Soap, Metal Polish, etc. Strictly Commission. The Skat Company, Hartford, Conn.

A Salesman wanted in every town or city within 25 miles of a broadcasting station to sell Radiogem, the complete radio receiving set that retails for \$23.50. With Radiogem there is nothing else to buy—the outfit includes the Radiogem receiving apparatus, 1,000 ohm phone, and aerial outfit. The cheapest radio outfit on the market—yet as practical as the most expensive. Big money to the right men. Send \$2.00 for sample outfit. The Radiogem Corp., 66-R West Broadway, New York City.

Clothing Sensation. New Line of men's clothes. All-wool suits and top-coats all at one low price of \$23.50. Nothing higher. We pay biggest commissions cash with order, supply finest selling outfit and give powerful cooperation. Three to six orders a day gives you income of \$80.00 to \$125.00 a week. We have men who earn even more and can prove it. If you're looking for a real proposition and a money maker, write us. Clothing experience isn't necessary. If you're honest, earnest and willing to work, we'll train you. Write at once to Dept. 513, William C. Bartlett, Inc., 850 W. Adams St., Chicago.

Profitable Side Line—Wanted, salesmen in all principal cities, United States, to sell Craftsman Condensers to Radio jobbers and dealers. Plenty of backing from house. Newspaper advertising if you reach quota in territory. Liberal commission. Felt & Kimmell Company, Bluffton, Ohio.

Scenery to Rent

Settings for Opera, Plays, Minstrels. Plush Drops. Address Amelia Grain, Philadelphia.

Song Writers

Songwriters: Let me furnish the music for your songs, guaranteeing you absolute satisfaction. Copyrights secured. Submit your scripts for estimate and free advice. Walter W. Newcomer, 1674 Broadway, New York.

Telegraphy

Telegraphy—Both Morse and Wireless taught thoroughly. Big salaries. Wonderful opportunities. Expenses low; chance to earn part. School established fifty years. Catalog free. Dodge's Institute, Cour St., Valparaiso, Ind.

Wanted to Buy

Full Value Paid for Old Gold, Jewelry, Watches, Diamonds, crowns, bridges, dental gold, silver, platinum, gold or silver ore; magneto points, old false teeth. Packages returned if our offer is not satisfactory. United States Smelting Works (The Old Reliable) 39 So. State St., Dept. 16, Chicago, Ill.

To the RADIO DEALER

Let us explain how you can make the sale of our publications a worth while, well paying part of your business. Write now and prepare for the Fall and Winter trade.

**EXPERIMENTER
PUBLISHING CO.**

53 Park Place, New York City

PATENTS

To the Man with an Idea

I offer a comprehensive, experienced, efficient service for his prompt, legal protection and the development of his proposition. Sends sketch, or model and description, for advice as to cost, search through prior United States patents, etc. Preliminary advice gladly furnished without charge. My experience and familiarity with various arts frequently enable me to accurately advise clients as to probable patentability before they go to any expense. Booklet of valuable information and form for properly disclosing your idea free on request. Write today.

RICHARD B. OWEN
PATENT LAWYER
2 Owen Building, Washington, D. C.
41A Park Row, New York City

Special Library of Information
on
RADIO PATENTS
and
TRADE MARKS

JOHN B. BRADY
Patent Lawyer
Ouray Building Washington, D. C.

Cable address: RADIOPAT Telephone: Main 4806

PATENTS

WRITE for our Four Guide Books and "RECORD OF INVENTION BLANK" before disclosing inventions. Send model or sketch and description of your invention for our INSPECTION and INSTRUCTIONS FREE. TERMS REASONABLE. Electrical and Radio Cases a specialty.

VICTOR J. EVANS & CO.
919 NINTH ST., WASHINGTON, D. C.

PATENTS

If you have an invention and desire to secure a patent, send for our Evidence of Invention Blank and free guide book. "HOW TO GET YOUR PATENT." Tells our Terms, Methods, etc. Send model or sketch and description of your invention for INSPECTION and INSTRUCTIONS. No Charge for the Above Information

RANDOLPH & CO., Dept. 459 Washington, D. C.

PATENTS

C. L. PARKER
Formerly Member
Examining Corps,
U. S. Patent Office.
PATENT - LAWYER
McGill Bldg., Wash., D. C.

Patents, Trade Marks, Copyrights, Patent Litigation
Handbook for Inventors, "Protecting, Exploiting and Selling Inventions," sent upon request.

PATENTS

DON'T LOSE YOUR RIGHTS
Before disclosing your invention to anyone send for free blank form "EVIDENCE OF CONCEPTION" to be signed and witnessed. LANCASTER & ALLWINE Reg. Pat. Attys. in U. S. and Canada 270 Ouray Bldg., Washington, D. C. Originators of the form "Evidence of Conception"

Bradleystat

PERFECT FILAMENT CONTROL
The result of more than twenty years' research and experience in the manufacture of graphite disc rheostats for radio, mines, mills, etc.

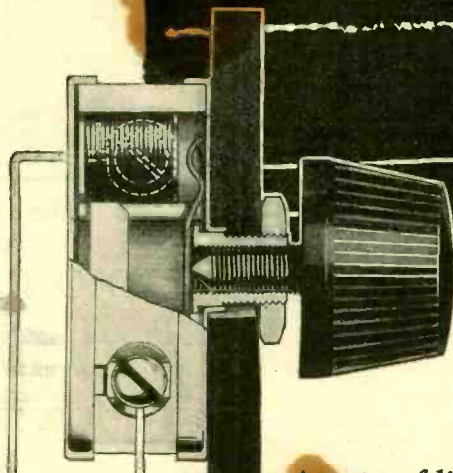
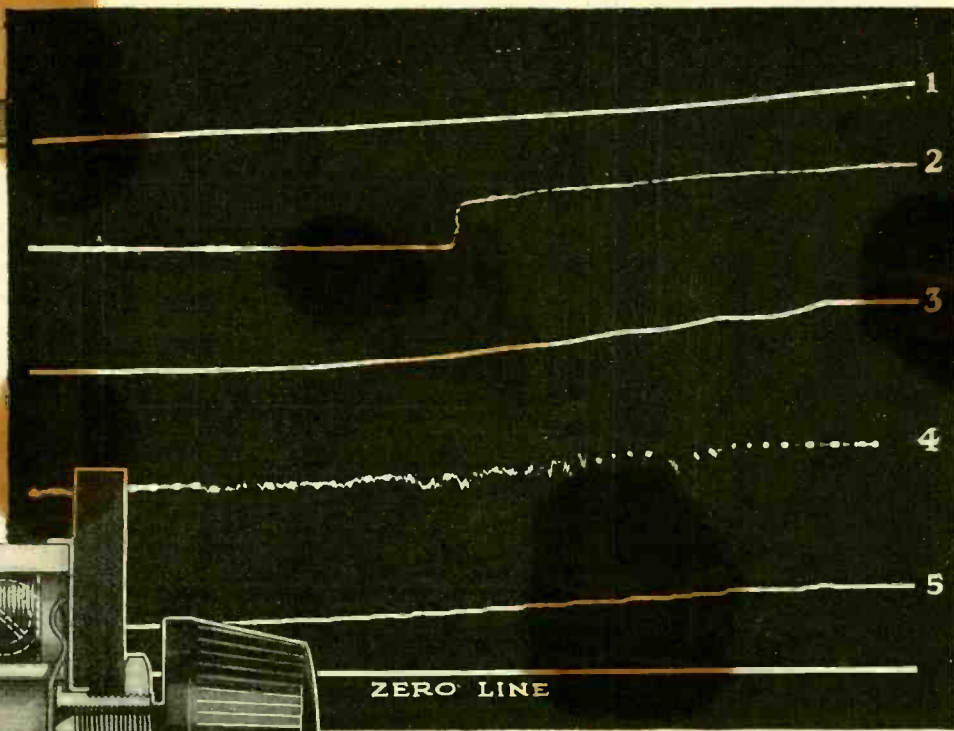

Use the same Bradleystat for ALL Radio Tubes without changing connections.

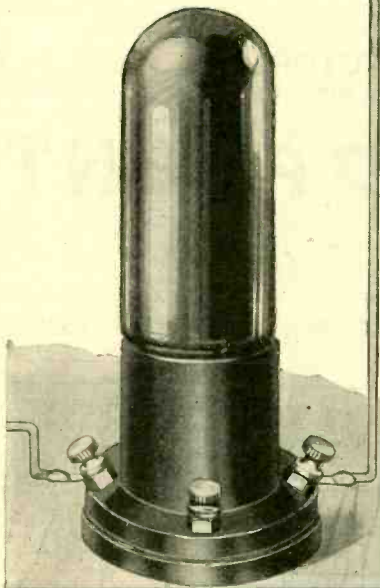

Only Graphite Discs provide noiseless filament control

A spot of light, silently guided by an automatic electric oscillograph, traced the above curves on a moving photographic film. The test, made at the University of Wisconsin, was impersonal and impartial. The result, however, proves beyond a doubt the superiority of the Bradleystat for radio filament control.

The first line (No. 1) shows the silent, stepless variation produced by the Bradleystat. The following curves (Nos. 2, 3, 4, and 5) were produced by other types of rheostats, some using loose powder instead of graphite discs. See the scratchy, noisy control. Every jog in the white lines means a distracting noise in the loud-speaker.

Is it any wonder that Bradleystats are being substituted for ordinary rheostats by thousands of set owners? Try one, yourself, and hear the difference!

Mail the Coupon for Literature

Allen-Bradley Co.
Electric Controlling Apparatus

287 Greenfield Ave.



Milwaukee, Wis.

Mfrs. of graphite disc rheostats for over twenty years.

Allen-Bradley Co.
287 Greenfield Ave., Milwaukee, Wis.
Please send me your latest literature on the Allen-Bradley line of radio devices.

Name.....
Address.....



Interchangeable, Noiseless Long Lived Radio Tubes

BRIGHTSON True Blue Radio Tubes differ from all others. They are designed by radio engineers who are authorities. They are made of materials heretofore considered too costly for commercial radio tube use by selected skilled workers, then rigidly inspected before being allowed to leave the laboratory. No other tubes are comparable to Brightson Radio Tubes.

The lowest loss tubes because of their solid silver contacts and non-conductive colored bakelite bases, Brightson Tubes are also the clearest toned because of their rigid, non-microphonic construction and high degree of vacuum. They give crystal clear reproduction. Their special filament material lasts two to three times longer than the standard.

Storage Battery Operation with Large or Small Sockets

Whether your set has 3-volt sockets or 6-volt sockets Brightson Tubes enable you to enjoy all the economy, volume, distance and trouble-freedom only 6-volt storage battery operation gives. The Standard Type fit 6-volt sockets; the Power-Plus Type fit 3-volt sockets, giving 6-volt

results with less drain on B batteries than with ordinary dry cell tubes. They greatly increase the range, volume and smooth operation of all sets equipped for 3-volt dry cell tubes and can be used in 6-volt sockets with adapters. Both types are safety cased singly or in sets.

60 Day Guarantee 10 Day Return Privilege

Unless Brightson Tubes do all that you expect of them you need not keep them. You can return them for refund within 10 days. If they develop any defect of manufacture in 60 days you may return them for replacement.

If your dealer does not stock Brightson True Blue Tubes, mail your check or money order to the nearest representative listed below.

Price \$3.50. Formerly \$6.

Dealers — Write Our Nearest Representative

Wm. C. Oakes, #32 Park Square Bldg., Boston, Mass.
R. G. Newland, 50 N. 11th St., Philadelphia, Pa.
Yahr & Lange, 207 East Water St., Milwaukee, Wis.
A. G. Schultz, 2831 Gratiot Ave., Detroit, Mich.
Triad Sales Co., Trust Co. of N. J. Bldg., Jersey City, N. J.
G. J. Seedman Automotive & Radio Co., Inc., Bedford Ave. at Madison St., Brooklyn, N. Y.

BRIGHTSON LABORATORIES, Inc., Waldorf-Astoria Hotel
16 West 34th Street, New York





UV-201-A



UV-200



UV-199



WD-11



WD-12



Vital to every radio fan

In a radio set, it is the tube that detects the sound—that amplifies the sound—that determines in large part the quality and volume of the sound. Therefore the tube—intricate of mechanism and delicate to make—is the vital spot in every set. And it always pays to be sure you use genuine Radiotrons—made with experienced precision.

Build any circuit—simple or complex. Buy any set, plain or fancy, simply boxed or elaborately cased. But give it every chance to achieve its best—with genuine Radiotrons. Be just as careful when you replace tubes, too. Always see for yourself that each one bears the identifying marks of a Radiotron: The word Radiotron and the RCA mark.

Radio Corporation of America

Chicago

New York

San Francisco

Radiotron

REG. U.S. PAT. OFF.

PRODUCED ONLY BY RCA

