

CIRCULATION OF THIS ISSUE OVER 225,000 COPIES

NEWS 1320
AMRAD 1363

RADIO NEWS

REG. U.S. PAT. OFF.

25 Cents
January

1923

Over 175 Illustrations

Edited by H. GERNSBACK

RADIO CONTROLLED
CLOCK
SEE PAGE 1260



THE 100% WIRELESS MAGAZINE

CIRCULATION LARGER THAN ANY OTHER RADIO PUBLICATION

Cunningham TUBES



Assure Clearest Broadcast Reception

Nationally known for Super-sensitive Detector Action and Distortionless Amplification, Cunningham tubes are ideal for use in your home receiving set.

The results obtained from the best radio sets depend largely upon the vacuum tubes used. Cunningham Detector Tubes insure clear reception—maximum signal strength and an absolutely quiet receiver in the absence of incoming signals.

Cunningham Distortionless Amplifier Tubes perform a great service. In making possible the reception of distant stations and the use of loud speaking telephones, these tubes bring into your home the music of great concerts and the singing of famous artists, aiding in the cultivation of the musical side of home life.

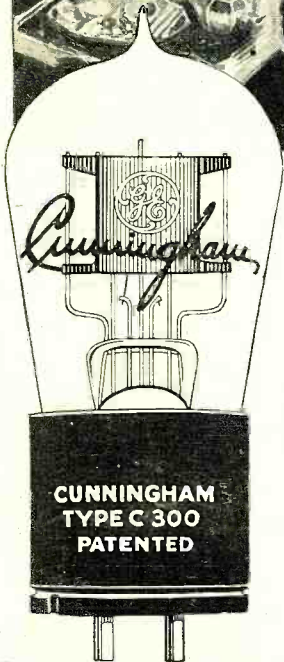

The trade mark GE is the guarantee of these quality tubes. Each tube is built to most rigid specifications.

TYPE C-300
Super-Sensitive
DETECTOR
\$5.00

Amplifies
as it
Detects

TYPE C-301
Distortionless
AMPLIFIER
\$6.50

Patent Notice Cunningham tubes are covered by patents dated 11-7-05, 1-15-07, 2-18-08 and others issued and pending. Licensed only for amateur or experimental uses in radio communication. Any other use will be an infringement.

E. J. Cunningham

Home Office:
248 First Street
San Francisco, Calif.

Eastern Representative:
154 WestLake St.
Chicago, Illinois

— for cottage or skyscraper!

SOMEWHERE handy to you there is now, or soon will be, a radio dealer who can show you radio sets so supremely simple anyone can operate them, so compact they are adapted for use in any location from the tiniest cottage to the tallest skyscraper, so efficient that broadcasted programs may be received from stations both far and near with perfect ease and clearness. He is the *A-P dealer*, handling the *A-P quality line*. Two remarkable sets from the A-P line are shown below—

The Oard Phantom Receptor

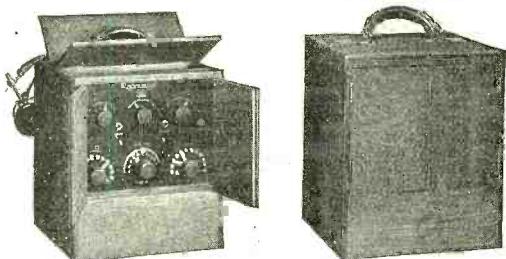

An A-P set so simple, compact, and complete within itself it can be used successfully in *any location* by *any person* who desires to receive radio programs or communications. *It requires neither aerial nor ground connection.* Efficient over both short and long distances. Highly selective.

Type AR-2 Receiver Detector and two-stage Amplifier

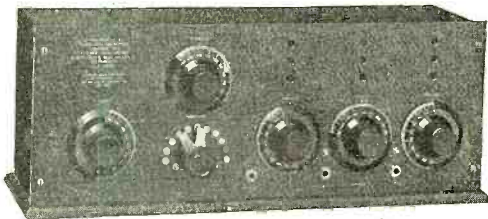

A beautiful regenerative set complete in a single cabinet. Combines ease of operation with marked sensitiveness and selectivity in action. Wave length 175 to 2,000 meters.

Licensed under Armstrong U. S. Patent No. 1,113,149, Oct. 6, 1914, for Amateur and Experimental Use Only.

Ask any A-P Dealer to demonstrate to you the remarkable features of these sets.

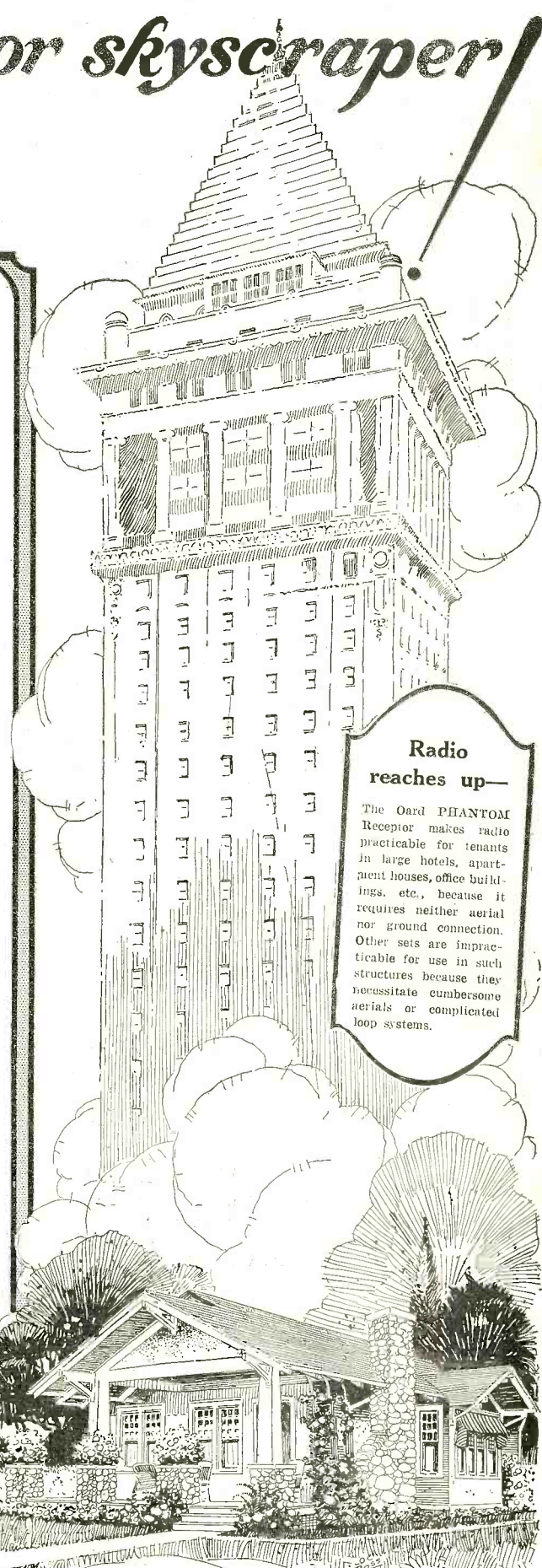

Radio reaches up—
The Oard PHANTOM Receptor makes radio practicable for tenants in large hotels, apartment houses, office buildings, etc., because it requires neither aerial nor ground connection. Other sets are impracticable for use in such structures because they necessitate cumbersome aerials or complicated loop systems.



If there is no A-P Dealer near you, write for a copy of Bulletin N-4, and with your own name and address send us also the name and address of the radio dealer you favor.

Atlantic-Pacific Radio Supplies Co.
646 Mission St. — San Francisco, Cal.

RADIO NEWS

CONTENTS

VOL. 4

FOR JANUARY

No. 7

Page	Page		
Editorial.....By H. Gernsback	1257	Some Practical Points in Amplifier Operation By Bernard Steinmetz	1277
Wireless Telephony for Coast and Harbor Services.....By Maurice E. Pelgrims	1258	Selectivity.....By Prof. W. Palmer Powers	1278
Radio in the National Guard By Herbert H. Foster	1259	Capacitive Coupling for Long Wave Regen- eration.....By John F. Bront	1278
A Radio Controlled Clock..By Lucien Fournier	1260	Radio Head Sets.....By Jesse Marsten	1279
Radio Telephone Receiving Set Installed in Capitol.....By S. R. Winters	1261	National Radio Week.....	1280
The Chicago Radio Show.....By Roscoe Smith	1262	A Novel Radio Desk.....	1282
KDYL at Salt Lake City.....	1262	My Trip in the Electron Bottle..By L. Hectron	1282
The Marconi Radio Bell By Maurice E. Pelgrims	1263	Who's Who in Radio..Dr. Louis Winslow Austin	1285
Broadcasting to the Neighbors By Herbert Warren Dodge	1263	Super-Regenerative Contest.....	1285
How Market Reports Are Made....By J. Farrell	1264	With the Amateurs.....	1286
Radio in Japan.....By E. G. Osborn	1264	Some Real DX Work...By Thomas A. Marshall	1289
Static is Greatest Obstacle in Radio By S. R. Winters	1265	A Modified Multiple Tuner By Bertram W. Downs	1289
The New Schmidt H. F. Alternator a Rival of the Vacuum Tube.....By Dr. K. Wirtz	1266	An Input Transformer for Telephone and Modu- lated C. W.....By D. R. Clemons	1290
Dr. Lee de Forest Speaks..By H. Winfield Secor	1267	Practical Hints on Mast Construction By John F. Bront	1291
Mr. Murchison's Radio Party By Ellis Parker Butler	1268	A C. W. Oscillator for Measurement Purposes By L. R. Felder	1292
The A. C. Line as a Source of Current for the Vacuum Tubes.....	1270	A Handy Portable Set By Arthur Paulson and Sidney Y. White	1293
Those Other Worlds...By Douglas A. Graham	1271	A Study of Different Types of Coupling Used in Radio.....By Louis Frank	1293
A New Radio Loud-Speaker....By Beryl Dill	1271	A Mechanical Radio Relay...By John F. Bront	1294
Use of High Power Vacuum Tubes By Dr. Irving Langmuir	1272	Back Panel Honeycomb Coil Mounting.....	1294
Radio with the Public Utility Companies By George J. Gropp	1274	An Efficient Short Wave Set..By H. S. Potter	1295
A Selective Long-Wave Receiver By Marius Thouvais	1275	Awards of the \$50 Radio Wrinkle Contest.....	1296
The Static Question.....By Ray Dio	1275	Useful Hints for Amateur Constructors.....	1297
The Electro-Static Loud Speaker By Michel Adam	1276	Radio News Laboratories.....	1298
Market Reports via Radio and Wire By John F. Bront	1277	Correspondence From Readers.....	1300
Index to Advertisers	1426	Radio Humor	1301
		Club Gossip	1302
		With the Sea-Going Op's	1303
		Radio Digest	1304
		I-Want-To-Know	1305

RADIO NEWS is published on the 25th of each month. There are 12 numbers per year. Subscription price is \$2.50 a year in U. S. and possessions. Canada and foreign countries, \$3.00 a year. U. S. coin as well as U. S. Stamps accepted (no foreign coins or stamps). Single copies, 25 cents each. A sample copy will be sent gratis on request. Checks and money orders should be drawn to order of EXPERIMENTER PUBLISHING CO., INC. If you should change your address notify us promptly, in order that copies be not miscarried or lost. No copies sent after expiration.

All communications and contributions to this journal should be addressed to Editor, RADIO NEWS, 512 Jamaica Avenue, Jamaica, New York; or 53 Park Place, New York, N. Y. Unaccepted contributions cannot be returned unless full postage has been included. All accepted contributions

General Advertising Dept., 53 Park Place, New York City. Western Advertising Representatives, Finucan & McClure, 720 Cass Street, Chicago, Ill. Kansas City Representative, Geo. F. Dillon, Republic Bldg., Kansas City, Mo. Pacific Coast Advertising Representatives, A. J. Norris Hill Co., Hearst Bldg., San Francisco, Cal.

Published by EXPERIMENTER PUBLISHING CO., INC.,
Publishers of "Radio News," "Science and Invention" and "Practical Electrics."
Publication Office: Jamaica, N. Y. Editorial and General Offices: 53 Park Place, New York City
H. GERNSBACK, President S. GERNSBACK, Treasurer R. W. DEMOTT, Secretary

are paid for on publication. A special rate is paid for novel experiments; good photographs accompanying them are highly desirable.

RADIO NEWS Monthly. Entered as second-class matter at the Post Office at Jamaica, N. Y., under the act of March 3, 1897. Title registered U. S. Patent Office. Copyright, 1921, by E. P. Co., Inc., New York. The Experimenter Publishing Co., 53 Park Place, N. Y. The contents of this magazine are copyrighted and must not be reproduced without giving full credit to the publication.

RADIO NEWS is for sale at all newsstands in the United States and Canada; also at The International News Co., Ltd., Bream's Building, London E. C. 4, England, and at Brentano's, 37 Avenue de l'Opera, Paris.

Western Advertising Representatives, Finucan & McClure, 720 Cass Street, Chicago, Ill. Kansas City Representative, Geo. F. Dillon, Republic Bldg., Kansas City, Mo. Pacific Coast Advertising Representatives, A. J. Norris Hill Co., Hearst Bldg., San Francisco, Cal.

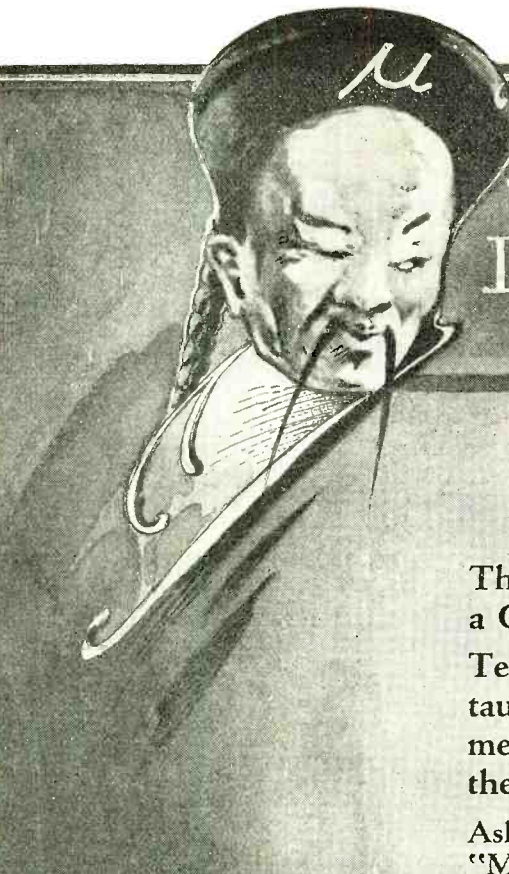

"He is rich," said Confucius, "who knows when he has enough!"
Would you find the richest man?
Look for the owner of a
Grebe Receiver.

Doctor Mu.

The whole world is at your fireside when you own a Grebe Receiver.

Ten years of radio manufacturing experience has taught us the importance of simplicity. Recommended by most good dealers because they know the shortcomings of ordinary apparatus.

Ask your dealer for a demonstration. Get your copy of "Musings of Dr. Mu"—the story of the development of the Perfect Receiver.

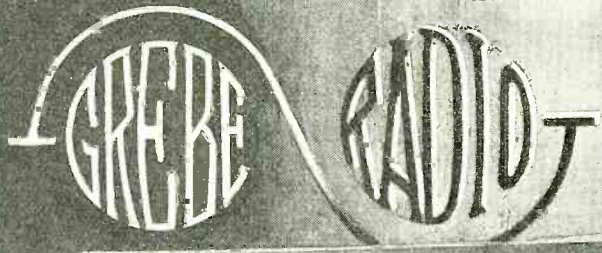

A. H. GREBE & CO., Inc.
Richmond Hill, N. Y.

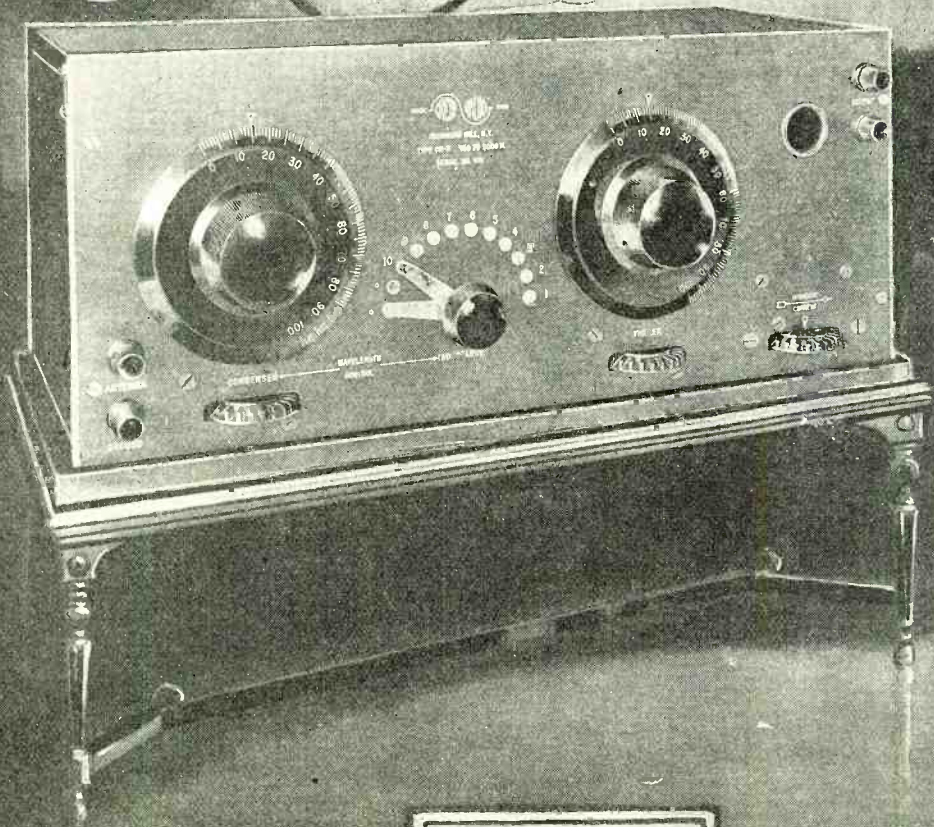

Licensed under Armstrong
U. S. Pat. No. 1113149

your hands can make a RADIO PHONE CRYSTAL SET

—at a fraction of what one would cost
made up!

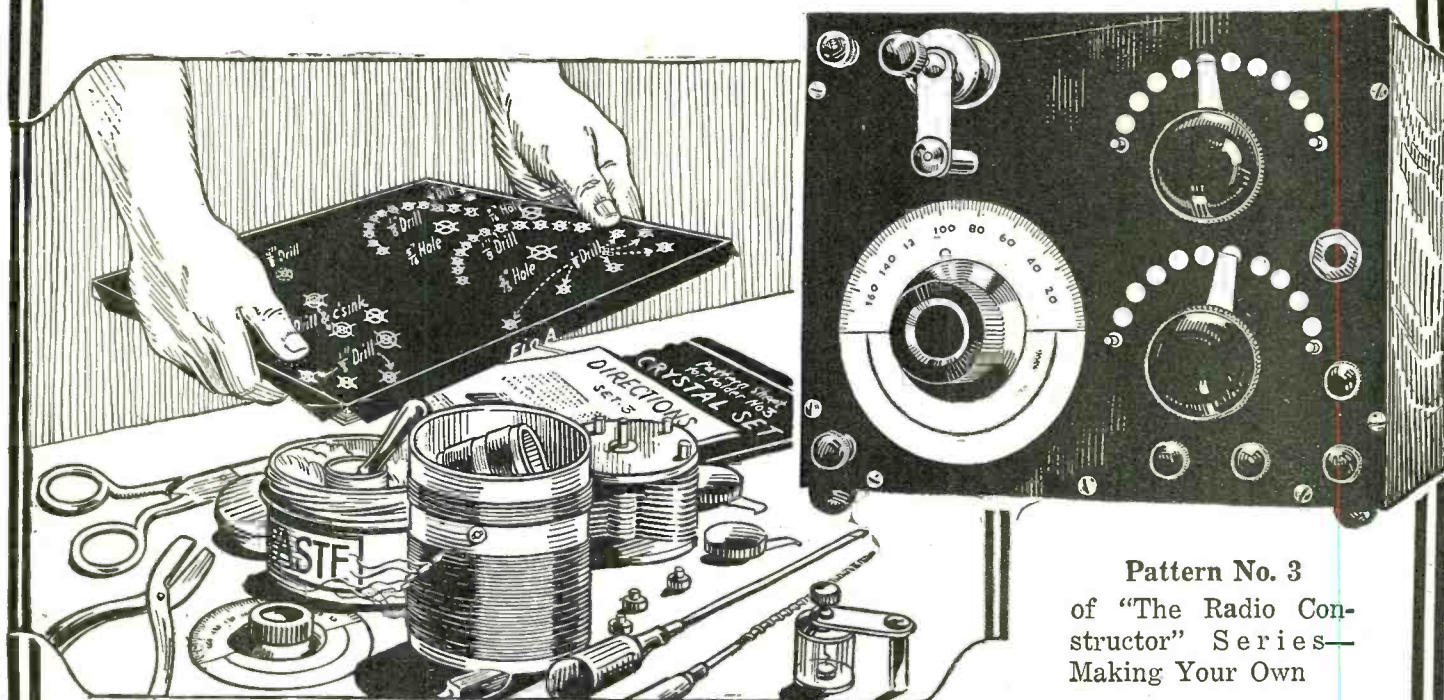

Pattern No. 3
of "The Radio Con-
structor" Series—
Making Your Own

PATTERN NO. 3: HOW TO MAKE A RADIO PHONE CRYSTAL SET

Our Complete Instructions and Blue Prints Are Designed For Those Without Technical Knowledge

No Machine Shop or Heavy Tools

You can build this splendid, reliable radio phone crystal set quite easily without a machine shop, or the use of any heavy tools. These patterns will make a handsome looking instrument with all the improvements to be found in the expensive, ready-made apparatus.

Only Standard Parts Used

One of the foremost radio engineers has constructed this set for us, especially for the amateur, and he has used only standard parts that may be procured from any supply house, and that are lowest in price.

Pattern No. 3

Complete radio phone crystal set, which, when completed and hooked to aerial, phone and ground, is ready for action! You receive a Four-Page illustrated Direction-Pamphlet Size 8½x11½ inches. One Blue-Print Pattern, Size 16x22 inches. All Contained in a Heavy Two-Color Printed Envelope, 9x12 inches.

Every Pattern is Full Size

Take for instance the pattern for the panel. It is printed on heavy blue-print paper exactly the size of the panel to be used. The position of the holes and other markings are exact, so that all you have to do is to paste the pattern on top of your panel by means of ordinary library paste, and when dry drill right through the pattern wherever the marks are located.

As Simple to Make as to Read

All the fun of building your own without any of the hardship. In this set of patterns we do not merely give you pictures of how the apparatus looks, and mere diagrams, but each and every pattern supplied is full size. This does away with all fussing and calculating, as we have done all the laying out in our own shop, and you need not worry that the final instrument does not come out right.

50^c

ORDER FROM YOUR DEALER—or direct from us

CONSOLIDATED RADIO CALL BOOK CO., Inc.
PUBLISHERS

98 Park Place

NEW YORK CITY

REMLER

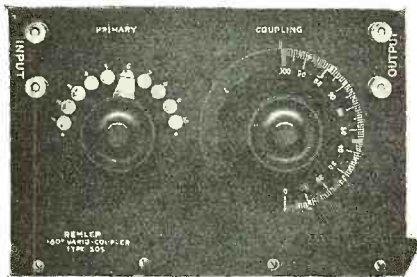

Remler Type 505 Panel Mounted Vario-Coupler Price \$12.00

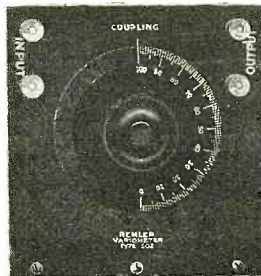

Remler Type 502 Panel Mounted Variometer Price \$10.50

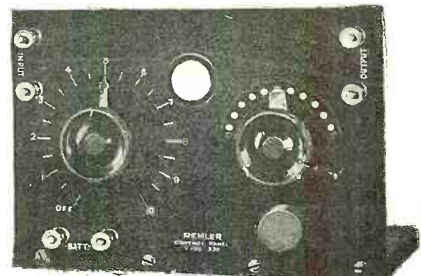

Remler Type 330 Detector Panel Price \$8.50

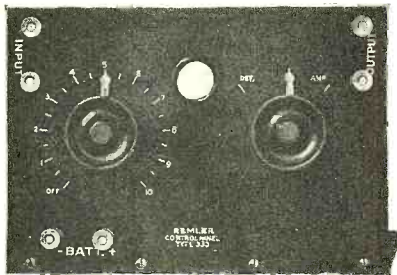

Remler Type 333 Amplifier Panel less transformer Price \$9.00

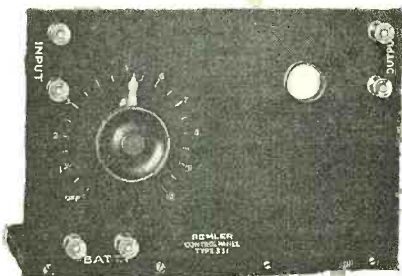

Remler Type 331 Amplifier Panel less transformer Price \$6.00

Remler Panels Make An Ideal, Economical Receiving Set

In placing these panels on the market Remler has put a high quality receiving set within the financial reach of everyone.

When designing these Remler panel-units, Remler engineers combined every point necessary for efficiency in receiving, together with special features of construction for the convenience of the user. No process of manufacturing that would make these panels efficient in operation, beautiful and uniform in appearance has been neglected. Each panel is a complete unit mounted on a hardwood base for table use but so designed that any number of panels may be easily mounted in a single cabinet.

Remler standard parts are used exclusively in their assembly—hence it is possible, by using combinations of Remler panel units, to obtain a complete receiving set, using the same circuit employed in the most expensive receiving set on the market, at only a fraction of the cost.

You can Start with only three panels:

A complete and efficient receiving set for local work is obtained by connecting together Remler panels types 505-502 and 330. For long distance receptions other panels may be added one at a time to suit the convenience of the owner until the most complete and efficient circuit possible is obtained. The cost is nominal.

The diagram below shows five Remler panels connected to form a complete inductively coupled receiving set and two-stage Amplifier.

Send 10c for new Remler 40-page catalog giving prices and complete descriptions of every Remler article.

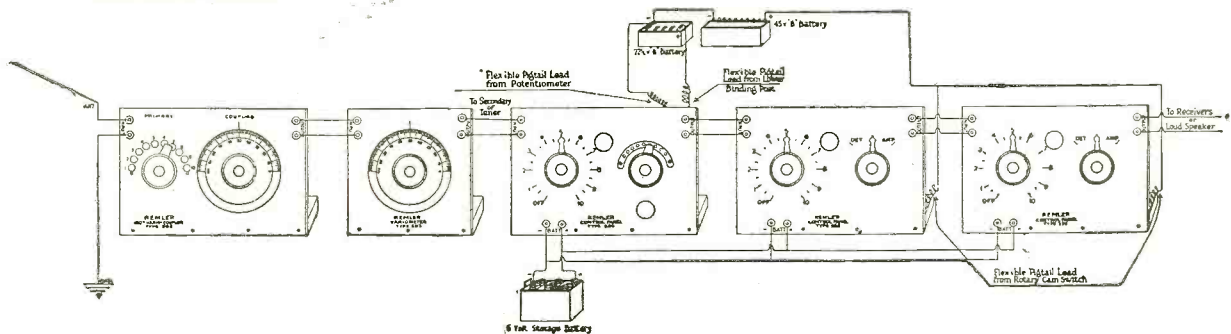

The Remler Technical Bureau is at your Service. Address your problems to Dept. N

REMLER RADIO MFG. COMPANY

FACTORY AND HOME OFFICE
248 FIRST STREET
SAN FRANCISCO, CALIF.

EASTERN SALES OFFICE
154 W. LAKE STREET
CHICAGO, ILLINOIS

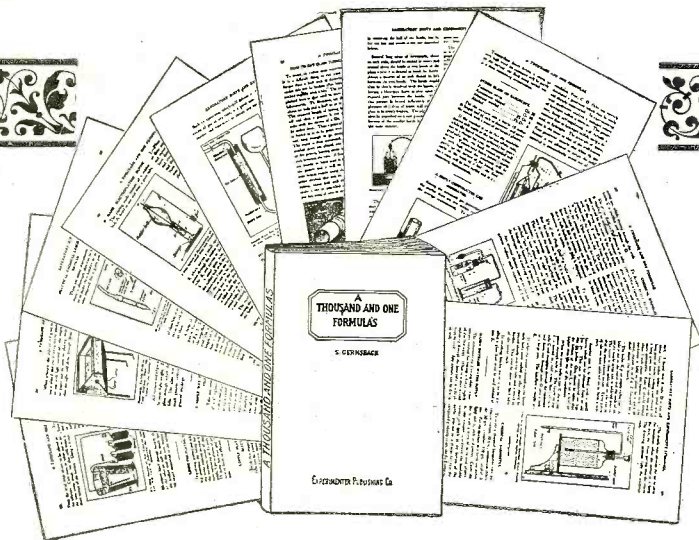

A Thousand and One Formulas

By S. Gernsback

A Laboratory Hand Book for the Experimenter and for Everyone who wishes to "do things."

A Book brimful with very important and priceless information. The recipes and formulas are classified in such a manner as to be available quickly, without long research.

Invaluable for Students, Engineers, Physicians, Experimenters, etc.

Here are some of the chapter headings:
Cements and Glues; Composition of All Kinds; Glass and Glassworking; Inks; Leather Polishes; Metal-craft; Perfumery; Soaps and Extracts; Photography; Blue Print and other Paper; Plating; Pyrotechny; Polishes and Stains; Varnishes and Paints; Various Cleaning Formulas; Wood-craft; Chemical Laboratory Hints and Experiments; Mechanical Laboratory Hints and Experiments; Electrical Laboratory Hints and Experiments.

There are a score of tables and hundreds of illustrations and Diagrams. It contains 160 pages. The paper has been especially selected to stand rough handling in laboratories.

Size, 6 x 9 inches.
Cloth bound in Vellum de Luxe, stiff covers, hand-sewed, gold stamped, each **\$1.75**

This Wonderful Volume of Formulas—You Sould Have It In Your Home

Every Radio Enthusiast Should Have These Books:

Wireless Course in 20 Lessons

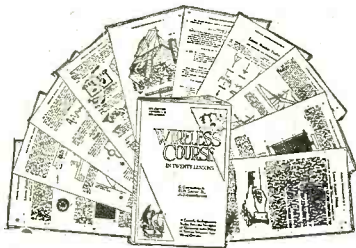

By S. Gernsback, A. Lescarboura and H. W. Secor, E.E. (11th Edition)

A course that tells you everything you wish to know about "wireless," starting lesson No. 1 by explaining the Principles of Electricity. By simple, easy stages, this wonderful Course takes you into "Wireless" by the use of simple language so skillfully used that you understand every word. There is a lesson devoted to Theory and Mathematics. The last lesson is devoted to a history of Wireless. This Course has been considerably revised in order that it meet many important changes which have occurred in Radio Telegraphy and Telephony within recent years.

Size of book is 7 x 10 1/4 inches, 160 pages, 350 illustrations, 30 tables.
Cloth bound in Vellum de Luxe, stiff covers, hand-sewed, gold stamped, each **\$1.75**
Same book, limp binding, colored cover.....\$0.75

Experimental Electricity Course in 20 Lessons

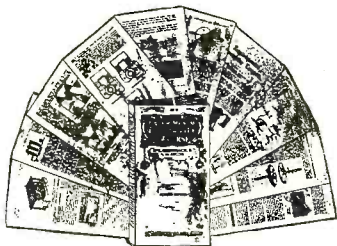

By S. Gernsback and H. W. Secor, E.E.

Every phase of experimental electricity is treated comprehensively in plain English. New Experiments are described and explained and nearly every application of Electricity in modern life is given in simple language.

A masterpiece. Explains every electrical device from a push button and bell to the biggest generator made. Worth its weight in gold for the man who wishes to know about electricity, and to the experimenter it is still more valuable because of its many facts, tables, etc.

The Best Electrical Text-Book on the Market. Size of Book is 6 x 9 inches.

The book contains 123 pages, and more than 400 illustrations.
Cloth bound, stiff covers, hand-sewed, green and black stamped, each **\$1.25**

The How and Why of Radio Apparatus

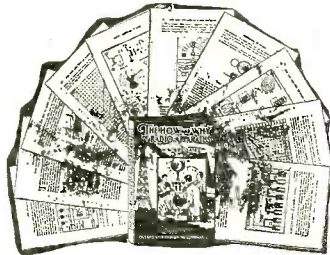

By H. W. Secor, E.E.

This newest book on radio matters fills a distinct gap in wireless literature. While the treatment is made as understandable and as free from mathematics as possible, it at the same time incorporates a wealth of technique and instruction for the Radio Amateur—the Radio Operator—the Installation and Designing Expert—as well as teachers and students of the subject in general.

A very broad field has been covered by the author, giving a great amount of information not found in other text-books. If you are engaged in any branch of the Radio or allied arts you will surely need this latest contribution to radio literature.

This newest of Radio Work has 160 pages, 6 x 9 inches. Hundreds of illustrations and tables. Cloth bound in Vellum de Luxe, stiff covers, hand-sewed, gold stamped, each **\$1.75**

You'll Need These Three "Little Wonder" Radio Books:

How to Make Wireless Receiving Apparatus



The 20 radio constructors who wrote the book know how articles should be made from simple materials.

Only modern apparatus is described, such as Receiving set without aerial or ground, magnetic detector, wireless relay, wireless lecture set, etc., etc. Book has 100 pages, each 5x7 inches, 90 illustrations, many full pages, paper bound, in two colors.

Price 35 Cents

How to Make Wireless Sending Apparatus



Contains information on how to make 30 different pieces of wireless sending apparatus from materials, easily obtained.

Tells How to Make an Experimental Arc Set, Speaking Arc, Quenched Gap, 1/4 K.W. Transformer, Oscillation Transformer, Photo Phone, etc., etc.

Book has 100 pages (size, 7 x 5 inches), 88 illustrations, paper cover printed in two colors.

Price 35 Cents

Design and Construction of Audion Amplifying Transformers



Radio and Audio Frequency Type

This book will be of great interest to all radio amateurs. The transformers have never before been described in print. The possessor of vacuum tubes cannot afford to do without this book. It will enable him to build the necessary amplifying transformers very readily. The book is printed on good paper and has an attractive cover in two colors. Paper bound. Size, 5 inches by 7 inches. Contains many illustrations, diagrams and working data.

Price 25 Cents

DEALERS—Ask for wholesale discount

EXPERIMENTER PUBLISHING CO., Inc. - 53 Park Place, New York

HERBERT H. FROST, Inc.

154 WEST LAKE STREET, CHICAGO, ILLINOIS.

FROST-FONES

Super-Inspected Quality Fones and Radio Parts



The best radio set that can be built is at the mercy of the receivers. They *must* be sensitive or you can't get satisfying results.

Frost-Fones—the world's favorites—are built as precisely as a delicate watch. Every Frost-Fone is specially inspected to insure sensitivity and permanent strength. Frost-Fones excel for hearing local broadcasting stations or distance work.

Quantity production under the most effective factory methods explains why Frost Quality Fones may be had at so low a price.

Frost Radio Plugs, Jacks, Extension Cords, Microphones, Tuning Coils and Receiving Transformers are made with the same attention to detail that has made Frost-Fones the nation's head-set. They are used by thousands of discriminating radio enthusiasts.

America's leading jobbers and dealers sell Frost-Radio Equipment. Save money and insure satisfaction by insisting on Frost-Radio

HERBERT H. FROST, Inc.
154 West Lake Street, Chicago, Illinois

FROST
No. 162
2000-Ohm Set
\$5.00



FONES
No. 163
3000-Ohm Set
\$6.00

No. 137 Frost-Radio Cord Tip Plug, \$1.25

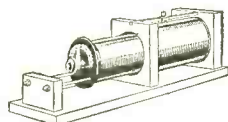

No. 400 Frost-Radio Receiving Transformers, \$8.50

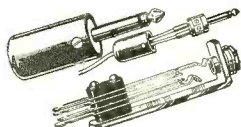

No. 131 Frost-Radio Double Circuit Jack, 90c

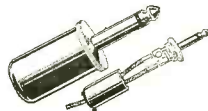

No. 139 Frost-Radio Cord Tip Plug, 60c



No. 138 Frost-Radio Multi-Phone Plug, \$2.50



Frost-Radio Extension Cord, \$3.00 and up



Better Radio Results at Lower Cost

THE results obtained from any radio outfit—home made or factory built—depend largely on the units employed. Cheaply constructed electrical apparatus **cannot** give best results.

After twelve successful years building electrical units the Briggs & Stratton Company have acquired an invaluable knowledge of electrical design which now expresses itself in the construction and workmanship of every unit in the Basco Line of radio equipment.

"Better Radio Results at Lower Cost" tells briefly what these many years of experience mean to you. Insure yourself against failures—insure top-notch results by building your outfit on a foundation of real result-getting radio units—the Basco Line.

Insist on Basco parts—ask your dealer for them. If he can't supply you, write us direct and we will see that your order is properly filled.

Besides articles shown and listed here, we also make switches, contact points, stop posts, binding posts and bezels.

Jobbers and dealers! Write for free catalog and details of our attractive selling proposition.

BASCO Radio Frequency Transformer. Efficient over wave band of 200 to 600 meters. Employs non-capacity winding—double silk-covered wire—no enamel. Maximum transfer of energy. Windings encased in fibre. Mountings and binding posts silver plated. **List price..... \$5.00**

BASCO Radio Receivers. Super-sensitive—natural voice pitch—no scratching. Light weight aluminum case—solid horseshoe type magnet—no laminations. Diaphragm set to thousandths-of-an-inch accuracy from magnet poles. Clean-cut, rugged design. Comfortable on ears. 2000 and 3000 ohms, list prices respectively.... **\$6.00 and \$7.50**

BASCO Vernier and Plain Rheostats. Vernier adjusts to 1-150 of an ohm. None better for detector. Smooth, positive contact always. One hole only for panel installation. Coils rigidly inset in heat-resisting fibre—no shifting possible. Metal parts heavily nicked. **List price, Vernier Rheostat \$1.25 Plain Rheostat 85¢**

BASCO Crystal Detector Set. Complete for instant hook-up to aerial, ground and phones. No batteries. Simple and sturdy. One dial to adjust. Sensitive tested crystal enclosed in glass. Simple cat whisker adjustment. Maximum crystal-set range. Metal parts solid brass. Bakelite composition panel. Mahogany finished cabinet 8"x6½"x6". **List price \$12.00**

BASCO 11 to 43 Plate Air Condensers. Sturdy—compact. Heavy plates, accurately spaced—no chance of touching. Two screw holes for easy mounting. Without dial, list prices:

13 plate.....\$4.25	17 plate.....\$3.60
23 plate..... 3.75	11 plate..... 3.45

BASCO Tube Socket. Black oxidized tube holder. Bakelite base. Strong—good looking. Sure-contact springs. Nicked binding posts. **An exceptional buy at 50¢**

BASCO Moulded Composition Dial. Graduated 180° and 100 divisions. 3 inches diameter, 1¼ inch knob. High lustre black—white inlaid figures. Accurately trued brass bushing for ¼-inch shaft. **List price..... 50¢**

Briggs & Stratton Co.
Milwaukee PRODUCT Wisconsin



RADIO NEWS

H. GERNSBACK—Editor and Publisher
ROBERT E. LACAULT—Associate Editor

EDITORIAL AND GENERAL OFFICES, 53 PARK PLACE, NEW YORK

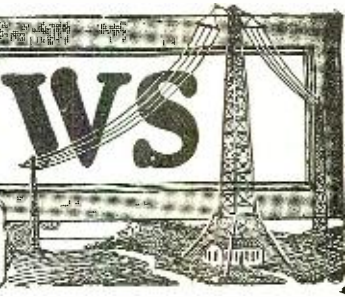

Vol. 4

JANUARY, 1923

No. 7

Outfits vs. Parts

WE have often heard the remark from business men not thoroughly versed in radio matters that the radio business should not be different from any other. We were told that soon radio outfits would become standardized, the same as the phonograph and the motion picture industries.

Statements such as these, coming from big business men, were taken at their face value, even by radio people who should have known better.

To the business man, the situation looked simple. You have several hundred or a thousand broadcasting stations, and you have 100,000,000 people or more anxious to listen to entertainment and whatnot; therefore, the simple object would be to perfect outfits in such a way that they could be sold like phonographs, or Ford cars, after everything had become standardized, which, in the minds of these business men, would put the radio industry on a solid footing.

Now nothing could be more erroneous. The radio business is decidedly not like the phonograph business, nor like the automobile industry, nor the motion picture industry. The trouble with our well-meaning, but misinformed, business people is that radio has no precedents, and must be treated entirely different, as the following will explain.

To our minds, radio can never become standardized in any way whatsoever, for the simple reason that the new art has too many ramifications. If it were only a matter of listening to 360 or 400 meters broadcast, perhaps radio could become standardized, but the truth is that radio is much bigger than this. The broadcast element is only one phase. Outside of the broadcasting stations, we have the spark and C. W. stations, amateur stations, etc. These operate on waves anywhere from 200 to 6,000 meters.

Next, outside of transmitting intelligence, be it by radio telegraph, or by radio telephone, we have several other phases. One is, for instance, transmitting pictures, photographs and the like by radio waves. Another one is radio telemechanics; that is, moving and operating machines or apparatus at a distance, a thing that has nothing to do with radio communication at all. Scientists are working overtime now and are approaching the solution of radio television, a thing every scientist considers can be done today, and will be accomplished during the next 10 years. We could go on and mention many more phases, but these will do to explain why radio can never become standardized. Quite the contrary. The more we know about it, the less apt shall we be to standardize it.

Naturally not every one (and this is particularly the case with private individuals) would want to have an outfit of that sort, nor would he have any use for it, but that is only half the story. The important part is that radio is in its infancy and is continually changing, some changes coming overnight. What was an excellent radio outfit two years ago is antiquated today. What is new tomorrow will be scrapped two years hence. Furthermore, every time our broadcasting stations make a change in their wave-lengths, chaos reigns in radiodom. For instance, a few months ago, in order to clear up the radio situation, the Department of Commerce decided to allow certain stations to broadcast at 400 meters, the others remaining at 360. Immediately there was an upheaval, for the reason that very few outfits could tune out one or the other set of stations. While this does not hold true so much with outfits employing vacuum tubes, it remains true of nearly all present-day crystal outfits, most of which were designed with a single circuit, with which it is impossible to tune out one or the other broadcasting station, with the result that when two stations operate at one time the listener will hear both, he being unable to separate the two.

This means that manufacturers must make changes in order to obtain sharper tuning. This means adding attachments to present outfits, or scrapping them and putting new ones in place.

If tomorrow the Department of Commerce will make another

change, and add still another wave-length, or, perhaps, allow some stations to send at, let us say, 380 meters, the chaos, for the time being, will be even worse; or if a new wave-length of 500 meters should be adopted, it would have the same effect, because many outfits would not be able, without additional attachments, to receive this wave-length.

On the other hand, even the novice, who was not interested in radio when he bought the outfit, is apt to turn into an amateur sooner or later. The thing fascinates him, particularly if, as surely will happen, he receives dots and dashes and wonders what they are. There will come a time, for the great percentage of the listeners, when sooner or later they will want to learn code, and once they have become educated to that point, the radio novice and the radio "fan" will have become the "dyed-in-the-wool" radio amateurs. Besides receiving broadcast, they will wish to listen to the big Government stations, to amateur stations, to Hawaii, and then to Europe, and further, if they can.

Now, then, the average stock outfit is not built for this traffic. Pretty soon after having become converted to code, our budding amateur will begin to frequent radio stores and he will invest all his spare money in parts.

And this is the reason why, at the present time, and indeed during the past summer, when no radio outfit could be sold at all, there was brisk demand for radio parts of every description. As a matter of fact, the new Armstrong Super-Regenerative Circuit, which made its appearance during the summer, was a God-send to the radio industry, because it stimulated the sale of Condensers, Variometers, Variocouplers, Choke Coils, High Resistances, and Vacuum Tubes to a very marked extent.

The man who owns a phonograph invests his money in new records, while the man who owns a radio outfit soon begins investing his money in radio parts. In many cases, unless he is not mechanically or electrically inclined, he will not use his "boughten" outfit at all, but will try to assemble his own, the fascination of this sort of thing being tremendous. Most any one can buy an outfit, but it takes ingenuity to assemble one with your own hands and brain, and receive stations that are thousands of miles away. This is truly fascinating, much more so than listening to broadcast entertainment alone.

All of this is said with no idea of discouraging people from buying complete outfits. Nothing could be further from our minds or intentions. The novice should, by all means, buy a simple outfit, which is the best possible thing he can do in order to familiarize himself with the art. Once the outfit has fulfilled its mission, then, if the owner is so inclined, he can go in for the parts to his heart's content, but to the man not electrically and mechanically inclined we would say do not buy parts, because he would probably make a mess of it and become discouraged. He should start with the outfit by all means.

It would be interesting if some one could get statistics of 10,000 owners who started with a radio outfit. We are inclined to think that a very large percentage of these become radio amateurs in time, which, of course, is as it should be. Nothing could be more desirable; nothing could be better for the art.

There is much to be learned from experimenting with radio, and not too much of it can be done. The more people who experiment in radio, the better for all concerned. There are many things to be learned, and we are still ignorant of many. Take, for instance, the standing puzzle, why it is possible in some cases, with a tuning coil, a "chunk" of Galena and a pair of phones, to receive broadcast over a range of 600 miles regularly, when the average distance is not more than 25 miles.

Radio is in an experimental stage, and we hope that it will always remain so as it is precisely this phase that makes it so fascinating.

H. GERNSBACK.

Wireless Telephony for Coast and Harbor Services

By Maurice E. Pelgrims

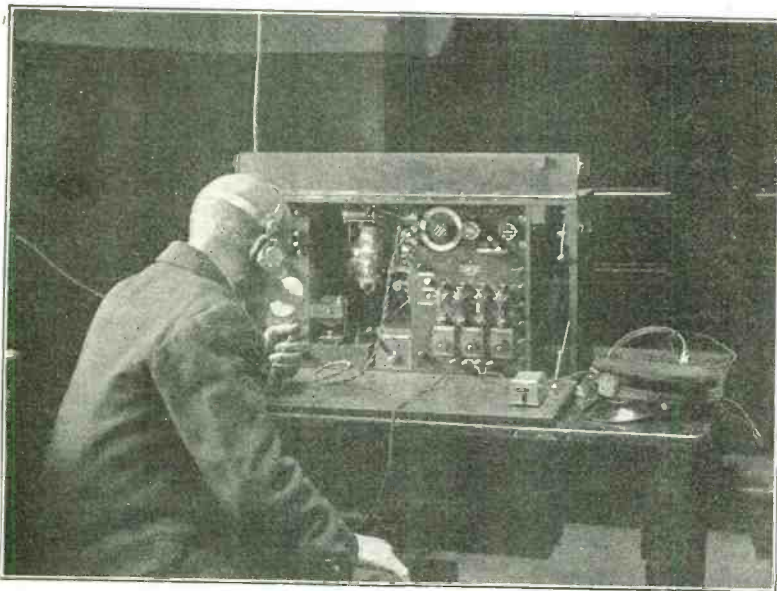

The Dock Office Installation. This Radio-telephone Set Is Equipped with an Automatic Call System, Making It as Practical as an Ordinary Telephone.

Dock Office. Power is obtained from a small motor-generator set, consisting of a double-output generator, coupled to a 3/4-h.p. electric motor wound to suit the local supply. The generator supplies current for working the transmitter and simultaneously charging the filament battery when required.

The aerial system consists of a twin-wire inverted L arrangement, the horizontal portion being 60' in length with a 40' downlead, use being made of existing pillars, chimneys, etc., for its support. An efficient earth connection has been obtained by fixing four copper gauze nets on the roof of the building.

A further important feature of this installation is the addition of a calling device, known as the Marconi "Wireless Bell," which enables either station to call up the other without the necessity for a continuous watch being kept.

The service inaugurated at Liverpool has proved a great success, the stations being regularly used by the Mersey Docks and Harbor Board for the purpose of obtaining accurate and reliable information regarding weather and movements of shipping.

The system is of the greatest assistance to owners of small coasters and tugboats, in that the latest information regarding the presence and approach of these vessels is always obtainable from the Dock office. Docking arrangements are quickly and easily made through the medium of the lightship and the results transmitted back within a very short space of time.

THE necessity for a simple and efficient means of inter-communication between points separated by a short distance over sea, as for instance between a lighthouse or lightship and a corresponding shore station, will readily be admitted. In a large number of such cases, owing to considerations of expense, limited accommodation, or both, skilled operators cannot be employed, and frequently no supply of electrical power is available. The use under these circumstances of self-contained wireless telephone sets capable of being used by non-technical people, considerably simplifies the problem under review.

The Marconi Company's Y series of Wireless Telephone-Telegraph Sets have been proved by experience to be highly suitable for the above purposes.

This series comprises a number of different types of sets graded according to the power required and giving guaranteed ranges of from 8 to 140 miles, according to the type of transmitter and aerial system employed. A large diversity of types of plants is, therefore, possible to suit the requirements of individual cases. Particulars of these are given in the company's pamphlets on the Y series.

THE LIVERPOOL BAR LIGHTSHIP INSTALLATION

A highly successful installation of this type is in operation at Liverpool between the Bar Lightship and the offices of the Mersey Docks and Harbor Board. The distance between these two points is approximately 15 miles, and the type of set installed at each is the YB.1. This transmitter requires a power input of rather less than 100 watts and has a guaranteed range of 30 miles under all conditions.

The installation on the Bar Lightship is under the care of the captain, who claims to have only a very limited elec-

trical knowledge and who gained sufficient information and practice during the short time taken by the Marconi Company's engineers in the fitting up and testing of the installation, to enable him to operate it successfully.

The necessary power is derived from a battery of 24 nickel-iron-alkaline accumulators, for the charging of which a small dynamo has been installed.

These cells are mechanically very

strong and can withstand short-circuiting or rough usage without injury.

The battery supplies current to the low tension side of a double-wound machine, the high-tension winding of which feeds the anode circuit of the transmitting valve. This generator is only running when the set is actually transmitting, the starting and stopping being concurrent with the operation of the send-receive switch. The aerial is of the twin-wire inverted U type, suspended from the two masts of the vessel.

The Liverpool Shore Installation is fitted in a room on the top floor of the

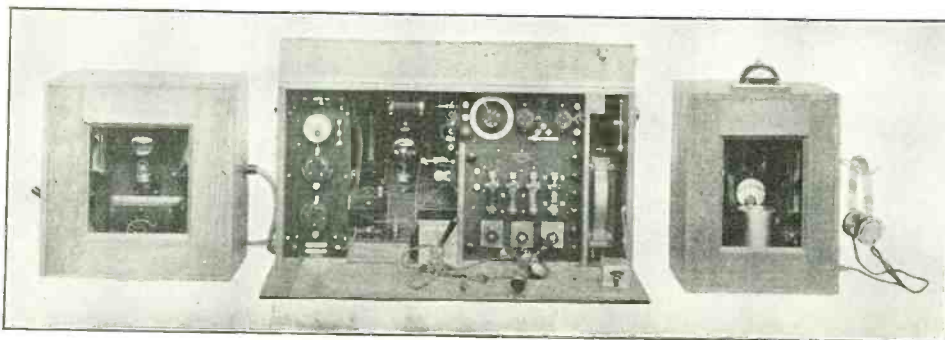

Left: Wireless Bell Call Transmitter. Center: 100-Watt Portable Telephone-telegraph Station. Right: Wireless Bell Call Receiver.

OTHER USEFUL APPLICATIONS

For use on lighthouses this means of communication is unequaled, while for vessels fitted with direction finding apparatus the location of a lightship or lightship is of far greater assistance to the navigator than the location of shore stations.

Further, apart from the employment of such sets for purposes directly analogous to the Liverpool service above de-

(Continued on page 1346)

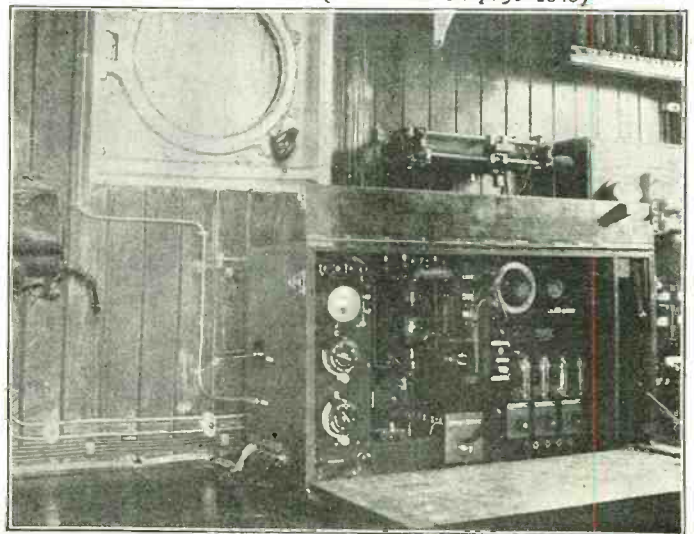

The Lightship Installation.

Radio in the National Guard

By HERBERT H. FOSTER*

AS strange as it may seem, the practice of radio, which is now being carried on in the United States Army and National Guard on a broad scale, is comparatively new. During the recent war, the Naval forces used the new method of communication with broad effect; in fact, it was one of the big factors that made possible many of the Naval coups and did more than any one thing to assure the safety of our troop transports. In the army the use of radio was negligible, especially in the forward areas where its practice would have overcome many obstacles.

In the writer's experience, first with an Infantry Regiment and later as a gunner in the Field Artillery, both branches of the arms that were greatly dependent upon communication for their effect and welfare, telephone communication was used almost exclusively. The work of establishing this communication was extremely hazardous and oft-times, in running one short line, many men "went West." The burst of one shell in the right place would often put a whole wire system out of business and make it necessary for the linemen to again offer themselves as targets for the enemy snipers.

It was often said during the war that one-half the army was continually looking for the other half. This is only a slight exaggeration. Broken communication isolated many units that would not have been isolated had they been equipped with portable radio sets such as are commonly used now. The famous "Lost Battalion" was not the only battalion that found itself almost entirely isolated from its flank supports, and in almost every instance the isolation might have been traced directly to lack of proper communication.

The mobility, reliability and efficiency of radio were well proven to military experts during the war and upon their recommendation, each Infantry Regiment will now have as part of its organization a complete communication unit with a personnel of highly trained radio operators and sufficient portable equipment to keep the lines of communica-

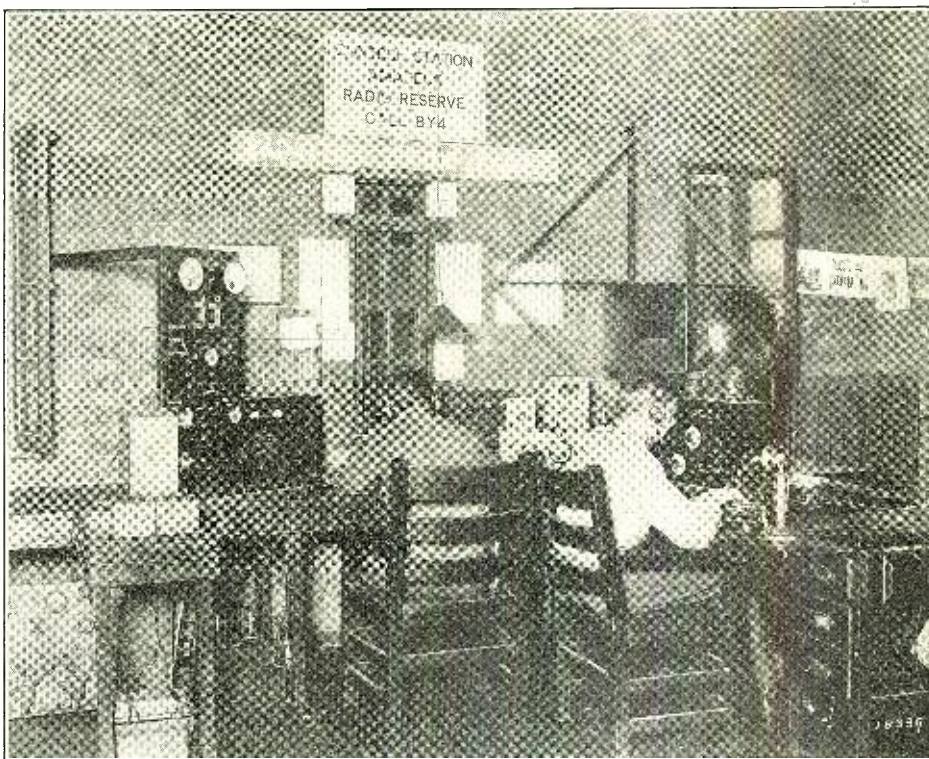

The Main Transmitting and Receiving Station of the 71st Infantry, N. Y. N. G. From this Station Communication is Established with the Field Units.

tion open, even under the most adverse conditions.

Aside from its use in wartime, this new organization will have considerable effect in an emergency as each National Guard armory will have a transmitting and receiving station, each part of a network that will cover the entire country.

Although apparatus has not yet been issued by the Government, many of the National Guard Regiments, with their usual ardor and zeal, have installed their own equipments.

The Seventy-first Infantry, N. Y. N. G., of New York City, has installed a complete apparatus for sending and receiving, and as BY4, is one of the first links in the great chain of military communication.

The apparatus was installed and built almost entirely by the men of the regiment, under the guidance of Lieutenant Grant Layng, who during the war served as a radio specialist with the Signal Corps.

For field work a portable transmitting set is used that can be used both ways on the low wave-length of 70 meters. A loop aerial of tubular construction is used, that may be folded into a very compact space. Rapid communication may be maintained by the use of a break-in system that makes unnecessary the use of a send-receive switch. The set operates on four volts.

Another unit of the field equipment is a transmitting set which operates on an aerial 3' high and 150' long. A 10-volt battery is used for the source of power. The set is designed especially for use in the forward areas, a feature of it being the low visibility of its single wire aerial.

The central illustration shows the permanent station that has been installed in the armory of the Seventy-first Infantry. Two aeri-als are used and duplex operation is possible; the transmitting operator is shown in the center and the receiving operator on the right.

There are two transmitting sets, one with two 50-watt tubes for phone, C.W. or I.C.W. operation, with a wave-length of from 250 to 500 meters; the other consists of two 5-watt tubes with a wave range of from 500 to 1,100 meters. The normal transmitting wave-length of the station, registered as BY4, is 250 meters and it has been reported as heard at many points east of the Mississippi.

There are three separate receiving sets for short, medium and long waves, also a power amplifier and loud-speaking equipment of the most modern design. A feature of the station is that it is operated solely with storage batteries, both for transmitting and receiving, thereby making it mobile and independent of wired power.

Beside its function in the National Guard net, the station is the control of the Amateur National Reserve net, which is an organization of amateurs throughout the United States creating an emergency system of communication with all important centers.

Another peace-time value of radio in the National Guard has been its effect upon recruiting the regiments up to their authorized strength. Since the inauguration of radio as a part of the regular training in the Seventy-first In-

(Continued on page 1346)



One of the Complete Field Sets by Means of Which Company Intercommunication is Made Practicable. Note the Loop Aerial.

*71st Infantry, N. Y. N. G.

A Radio Controlled Clock

By LUCIEN FOURNIER

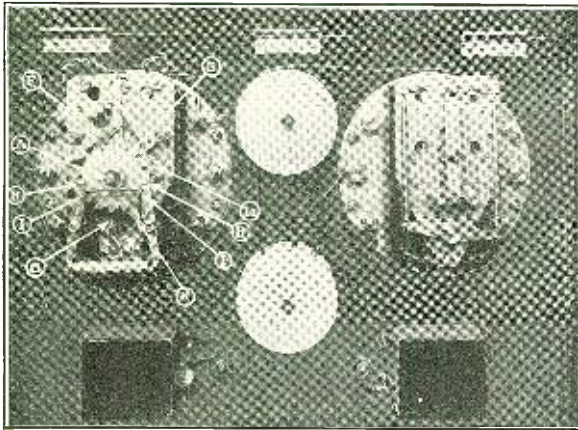

On the left are shown the radio control relay and the delayed action relay. On the right is an inside view of the radio and audio frequency amplifiers connected to the loop aerial which may be seen above and on the right of the clock in the lower picture. The front door of the clock is made of glass so as to show the mechanism working when the time signals are sent. This unique clock is installed in a French railroad station in Paris and is set to the correct time by the signals sent from the Eiffel tower every morning.

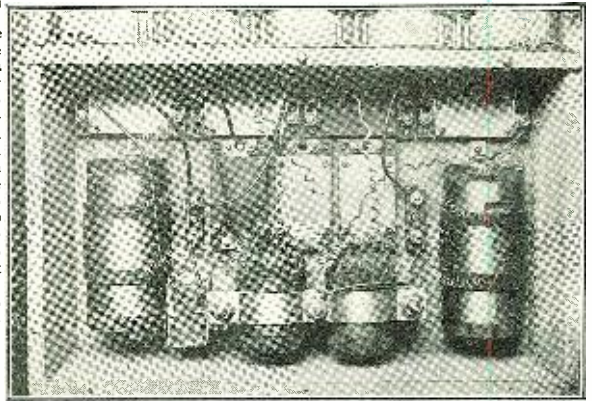

WHETHER a practical type of radio controlled clock could be built or not was asked by General Ferrié, Chief of the Signal Corps of the French Army, to one engineer of Brillié Frère Works who has succeeded in designing such a clock. The clock which is shown in the photographs, as well as on the front cover of this magazine, was installed in a railway station in Paris a few months ago and ever since is functioning perfectly without anybody attending to it. Every day, when the Eiffel Tower station sends the time signals, a dash lasting five seconds is sent by the radio station and this signal sets the clock to the proper time automatically. Not only is this particular clock set to the proper time, but several others which are already installed and are being installed in other public places as well.

The diagram of connections which is published herewith will help make clear the explanation on the functioning of this unique clock. A loop aerial, K, and a condenser constitute the receiving circuit. Since the current picked up by the loop is too weak to operate a relay, it is first amplified at radio frequency then at audio frequency so as to obtain a sufficient amount of energy to operate the relay. The relay



The first relay, RS, is a very sensitive one. In the photograph may be seen the armature oscillating between the two stopping-pins; it is adjusted by means of two springs mounted on a pendulum which is inclined toward the right or left in order to help the closing of the working contacts. The second relay is constituted by a coil with a movable core which is lifted up slowly when the current flows through the coil. This core falls suddenly as soon as the current is shut off. If the current flowing through the coil lasts less than five seconds, the core falls before it has reached the blade fixed above the relay and no current is sent in the second circuit. When the five-second signals are received, the core pushes the blade against the stopping-pins and the current operates the electro-magnet, E.

In order to prevent any signals which might last five seconds to operate the clock, another relay is connected in the circuit which is operated at the same time as the amplifier. These two apparatus are operated automatically by the clock itself which closes a contact a few seconds before the

(Continued on page 1324)

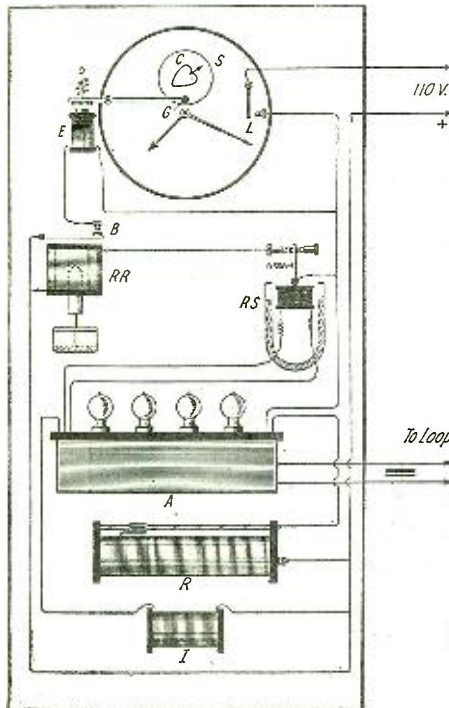

Diagrammatical view of the mechanism of the automatic clock.

RS, is equipped with a finger and the coil is supplied from the 110 volts, D. C. main. When the dash lasting five seconds is sent, the relay, RS, sends during five seconds, a current of 110 volts to the second relay, RR, which being of the delayed action type does not close the circuit before five seconds after it is energized. Any shorter signal has no effect upon this relay so that no signal can accidentally close the circuit. A dash sent in code at the normal speed lasts about one second maximum.

When the relay, RR, closes the circuit after five seconds, a 110 volt current goes through the adjusting electro-magnet, E. The armature of this electro-magnet is then attracted and brings a little wheel in contact with a heart-shaped cam, C, mounted on the shaft of the second hand. The pressure produces rotation of the cam until the little wheel falls into the notch, S, and adjusts this hand to the proper number of seconds.

We shall now consider a few constructional details which will help the reader to understand the functioning of this clock.

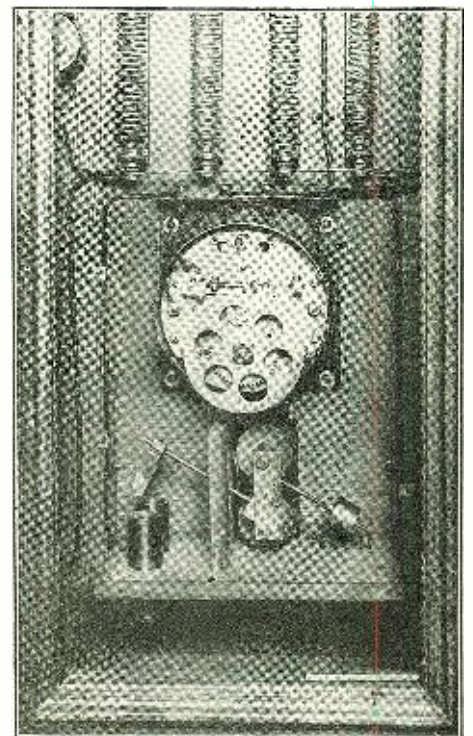

This mercury interrupter is closed one minute before the time signals are sent, and closes all the control circuits.

Heard But Not Seen

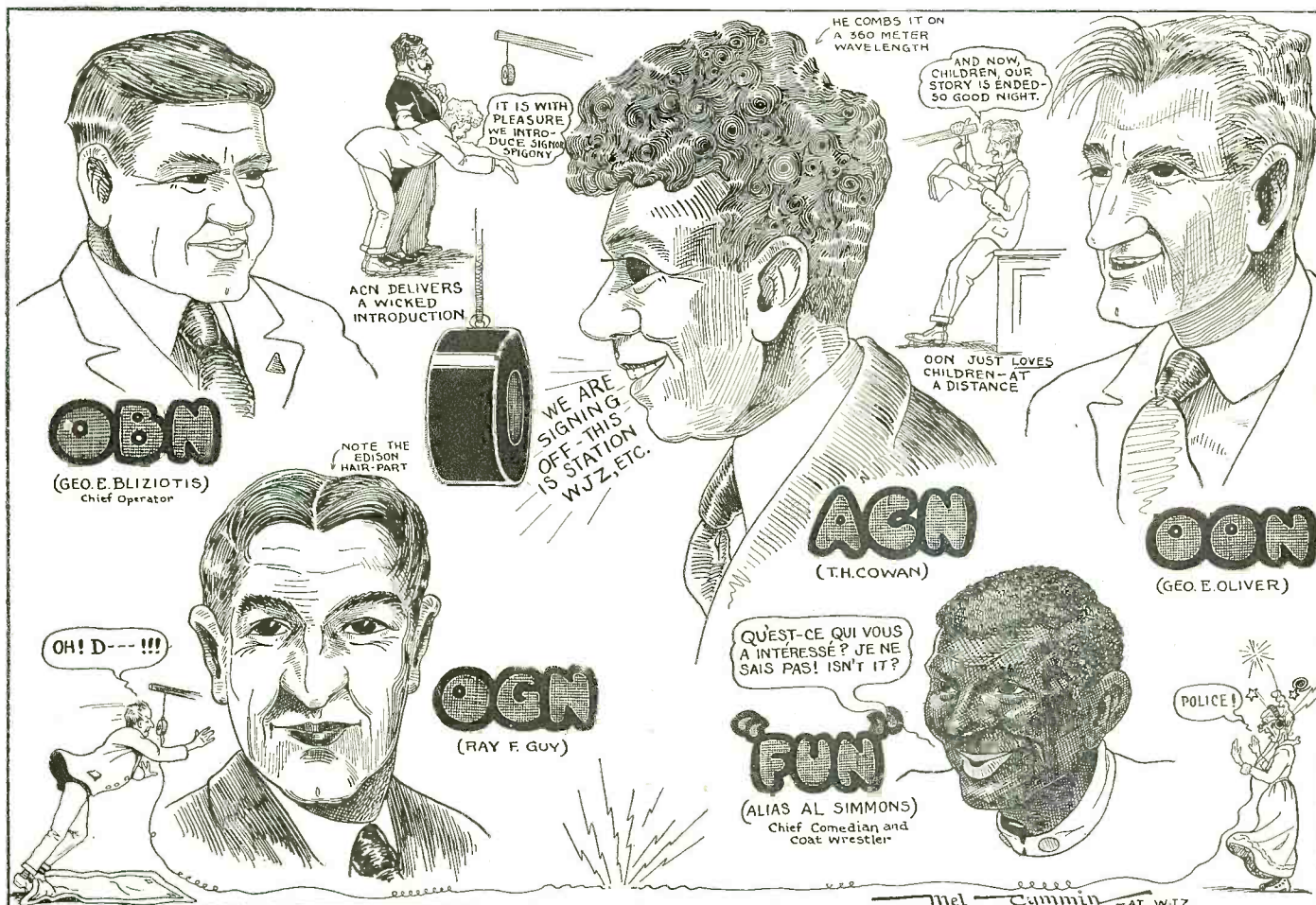

Broadcast Fans! Meet Our Invisible Friends; the Supervising Force of Station WJZ. Mr. Bliziotis, Mr. Oliver and Mr. Guy are in Charge of the Operation and Maintenance of the Transmitting Apparatus. They Are All Old Time Operators. Of Special Interest is the Picture of Mr. Cowan, Whose Voice We Are All Acquainted With. Mr. Cowan Placed the Artistic Touch to the Old Station. One glance at His Hair Convinces Us That It Was Well Done and Appreciated by the Star Visitors. The Popular Opinion Is That Mr. Cowan Is Some Sort of a Phonograph, but We Assure You That He Is Human. To Those Who May Think His Work "Soft" We Wish to Say That "Forethought" Is Necessary for This Kind of Work.

Radio-Telephone Receiving Set Installed in Capitol

By S. R. Winters

REPRESENTATIVE Louis T. McFadden of Pennsylvania, chairman of the Banking and Currency Committee of the House of Representatives, is accorded the singular distinction of being the first member of Congress to permanently install a radio-telephone receiving set in his office. The latter being located in the Capitol, where the sessions of the House of Representatives and the Senate are held, gives a dignified atmosphere to this wireless receiving outfit. The office, Room No. 60, of this Pennsylvania Congressman is located between the rotunda and stately hall in the Capitol.

The photograph shows Representative McFadden copying the market reports being transmitted by "WWX," the radio-telephone sending station of the United States Post Office Department. As indicated by the illustration, the receiving apparatus is of the more expensive design and its effective range

for the reception of speech and music is not limited to local broadcasting stations. Pittsburgh, Newark, Schenectady, and other remote points are within audible

range of this wireless equipment. The loop and cabinet are so handsomely constructed that they easily harmonize with expensive office furniture. The loop antenna, of course, serves the purpose of an overhead or towering antenna, the latter installation quite naturally being prohibited on the Capitol.



Representative Louis T. McFadden of Pennsylvania and His Radio Telephone Receiving Set. This Outfit Is Extremely Sensitive and Its Effective Range of Reception Is Not Limited to Local Broadcasting Stations.

The Banking and Currency Committee is one of the most important committees in Congress. All legislation affecting banking and currency is referred to this Committee. It was this Committee, under chairmanship of Carter Glass that framed and piloted the now famous Federal Reserve Act through the House of Representatives.

The radio-telephone receiving set can be made useful as well as novel if properly applied. Other than the reception of crop and market reports, current events, and forms of entertainment, financial information may be heard when disseminated from New York and other centers.

The Chicago Radio Show

By ROSCOE SMITH

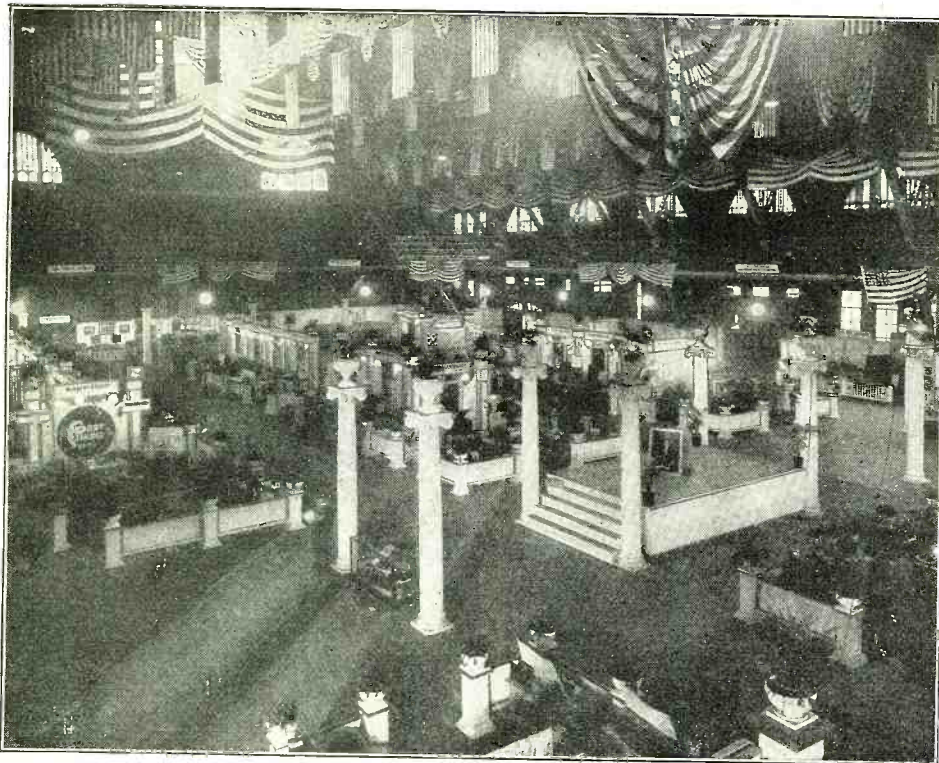

Central View of the Chicago Radio Show. The Center Platform Was Used for Demonstration Purposes. The Exhibitors Were Strictly Manufacturers.

THE Chicago Radio Show, both national and international in its scope, the first radio show to be held in the West at which the exhibitors

were strictly manufacturers, and also the first show to receive endorsement by the National Radio Chamber of Commerce and by the radio division of the

National Electrical Manufacturers, opened its doors at the Coliseum Saturday, October 14, for a week's exposition and proved to be a commercial Radio show of genuine value and interest to the industry as a whole. Internationally known as a trade center, offering enormous floor space on the street level, no better place could have been selected by the managing directors who are alive to the fact that the radio market has stabilized appreciably and the buying public is gradually reaching what is viewed as a receptive attitude. It was primarily a manufacturers show. The dealer, jobber and manufacturer were given an opportunity to combine efforts in taking steps toward gaining more constructive publicity for radio products and stimulating the educational possibilities in the field. The show opened just as the public interest in radio broadcasting was reawakening. In many instances the state of uncertainty as to broadcasting has been relieved by betterment in quality and diffusion of variety, making possible for the owners of modern receiving sets a choice of a wide range of subjects.

The architectural scheme for equipment of the booths and miniature buildings was new and novel and were placed in superb settings with two-thirds of the floor devoted to aisle space.

The show proved to be a great get-together convention for all the radio enthusiasts. Dealers and jobbers from every section of the mid-west met eastern and western manufacturers, and these meetings with the important functions of the National Radio Chamber of Commerce, with its representatives on

(Continued on page 1352)

KDYL at Salt Lake City

ON August 28, the *Telegram's* new broadcasting station was opened. It is conveniently situated atop the Newhouse Hotel. Ira Karr, engineer and operator in charge, worked for months getting everything ready, and designed a special transmitter.

With the new transmitter it was possible to broadcast much farther than formerly and messages can now be heard over a great radius as has been proven by the great number of cards and letters received from distant listeners who enjoy the programs.

Following is Mr. Karr's technical description of the new KDYL station:

The Radiating System.

The antenna proper consists of 10 conductors of 7-22 copper wire arranged as a cage. The hoops are of copper band and are 18" in diameter. One of these hoops is placed every 15'. The antenna is insulated at either end by four electrose insulators in series. The lead in cage is taken off at the exact center and also consists of a 10-wire cage. This is brought down directly to the electrose bushing which leads to the transmitter in the station. The antenna is supported 45' above the roof of the Newhouse hotel by two steel masts making the total height above ground slightly over 240' and is 150' long.

The counterpoise system is support-

(Continued on page 1348)

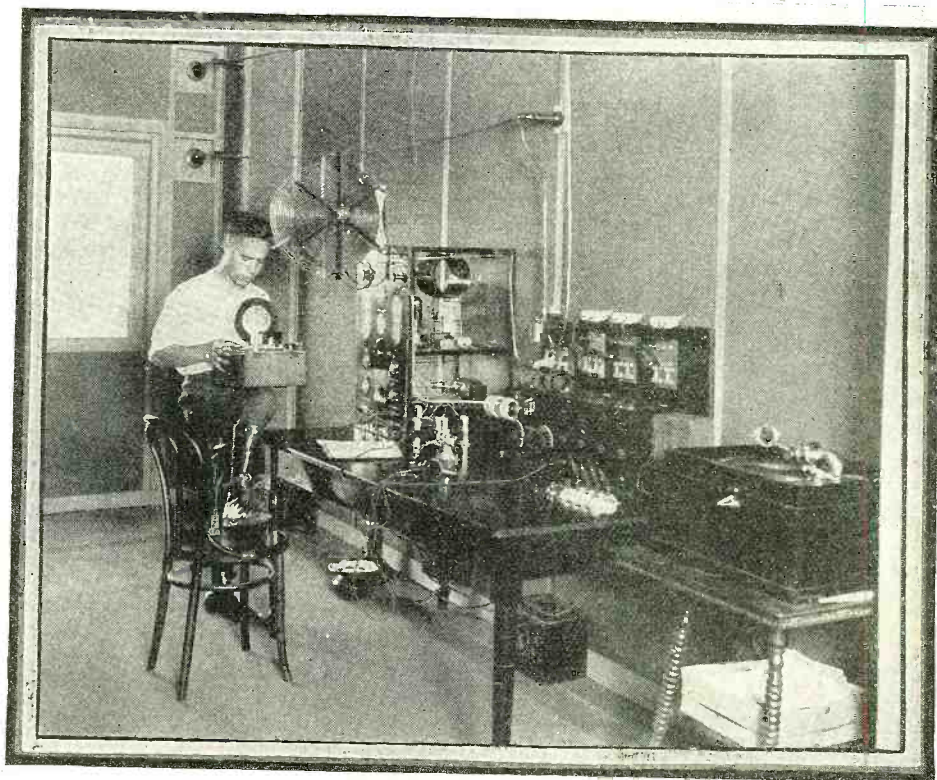

Operating Room of the Telegram's New Broadcasting Station. It Has a Normal Output of 100 Watts. The Receiving Set May Be Seen on the Right.

The Marconi Radio Bell

By MAURICE E. PELGRIMS

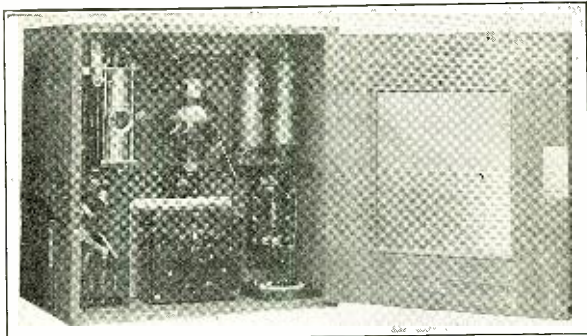

Marconi Call Transmitter, Used in Conjunction with the Main Transmitter. Pulling Down Handle on Left Places Set in Operation.

HITHERTO one of the greatest obstacles to a more extended use of the wireless telephone has been the necessity for maintaining a continuous watch at the instruments during those periods when communication is expected or desired, means being lacking whereby, as in ordinary telephone practice, a station could be "rung up."

This problem has been solved by the introduction of the Marconi Wireless Bell, which is an automatic device operated by a distant transmitter, and performs in a simple and efficient manner the same function as that of a call bell on the ordinary land line system.

It has been designed so that each instrument is not sensitive to any signals except those actually intended to operate it, and in addition it enables every wireless set with which it is incorporated to call up as many as five different stations on the same wave-length

even in congested areas. Furthermore, an additional adjustment enables still other stations on different wave-lengths to be called up, these being selected as quickly and efficiently as the first five.

The device is intended for use in conjunction with the YB or YC types of portable and semi-portable installations (see article in the April-May issue of RADIO NEWS and one of the illustrations shows apparatus installed in connection with a YBI set.

The principle is to transmit a signal of definite duration on a specific wave-length, this signal being produced by modulating the outgoing wave at a steady low frequency note. This note is varied by a five-point "frequency changing" switch, thus providing the means of calling up any of the first five stations previously referred to, five calls being in a like manner obtainable on each wave-length within the range of the main transmitter by means of the "frequency changing" switch.

It will thus be seen that by combinations of wave-length and frequency changes, an almost infinite number of calls is available to intergroup wireless stations.

The "call transmitter" is fitted in a teak box, as shown in the photograph, and forms a self-contained unit, comprising a valve and its oscillatory circuit, with the addition of a fixed resistance to cut down the high tension sup-

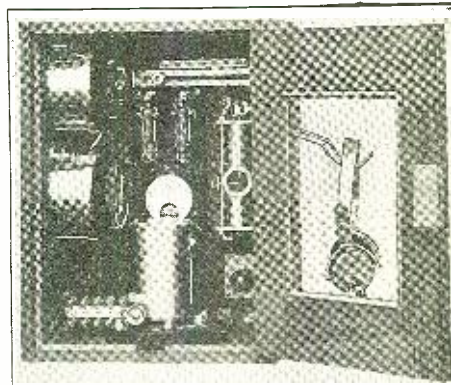

Marconi Call Receiver, Employed With Main Receiver. Signals Pass Through a Galvanometer and Two Relays to a Bell.

ply if necessary. The valve circuit produces low frequency oscillations, the frequency being varied by adjusting in five steps the value of the capacity, which is made up of a series of five condensers each led to a point on the switch. This arrangement is connected to the high-tension supply of the oscillating valve of the main transmitter, and thus the outgoing oscillations are modulated at a frequency determined by the control of the low frequency valve. The call apparatus is set in motion by pulling down the handle seen on the illustration, the handle being held in this position by an electro-magnet. The circuit of the latter passes through a dashpot, so arranged as to start moving when the signal commences, i.e., when the handle is actuated, and to complete

(Continued on page 1360)

Broadcasting to the Neighbors

By Herbert Warren Dodge



SAN FRANCISCO has again come forward with something new. Broadcasting radio telephone music to the neighbors! Using a Colin B. Kennedy type 110 Universal Receiver in conjunction with a two-step amplifier manufactured by the same concern, and a Magnavox, William R. Larzelere, Jr., of 1458 24th Avenue, provides the neighbors within 20 blocks with musical selections and announcements

People Within a Radius of 20 Blocks Are Provided With Concerts from this Receiver. Two Stages of Amplification and a Magnavox Are Used.

received from the numerous broadcasting stations around San Francisco Bay.

Mr. Larzelere, an amateur and commercial operator and former member of the Institute of Radio Engineers, has the receiving apparatus installed in the living room of his residence, and by simply placing the Magnavox in an open window he amuses dozens of people with grand opera, jazz, baseball re-

sults and other interesting broadcasts sent out from Rock Ridge, The Examiner, the Daily News, Hale Brothers', the Emporium, the Fairmont Hotel, and stations as far away as 100 miles from San Francisco.

With an antenna barely 20' in height and 200' long, phonograph music from Seattle has been heard 200' from the instruments. Using the same aerial nearly all the high powered long-distance arc and spark stations in the world have been copied on this set.

An added feature to Larzelere's apparatus is a tone amplifier, an accessory perfected by him. Consisting of two 5-watt tubes and amplifying transformers, the instrument is connected to the Magnavox with the resultant elimination of static and other atmospheric disturbances. In the reception of radio telephone music the tone amplifier not only prevents distortion, but smooths out the incoming sounds, entirely suppressing foreign noises.

According to Mr. Larzelere, this instrument is directly responsible for the amplitude of the received signals, the people in the district experiencing no difficulty in hearing every word of the speaker.

A 60-watt, 350-volt generator supplying the necessary power for the Magnavox completes the installation of this wonderful set.

Seven blocks from Mr. Larzelere's home the Shrine Hospital for crippled children is being erected, and during the

(Continued on page 1364)

How Market Reports Are Made

By J. FARRELL



One of the Branch Receiving Stations Which Figures in the Handling of the Daily Market Reports.

IN the wheat fields of Kansas, the pastures of the live stock country, the cotton fields of Georgia, the corn fields of Iowa, the fruit orchards of California—every place where crops or live stock are produced—thousands of pairs of eyes are continually watching for Uncle Sam the

size and condition of farm products. In the leading market centers thousands of other pairs of eyes are counting supplies and listening in on market deals. To bring together all this information and present the complete picture the same day, everywhere throughout the country, is a big job

—a practically impossible job before the advent of radio.

The story of the radio market news service of the United States Department of Agriculture has already been told in these pages. The story of how that market information is gathered is equally interesting. To prepare a daily national view of agriculture is the combined work of more than 250,000 crop and market experts, so that when you listen in on the radio market news, you are figuratively hearing the voices of nearly a quarter of a million people. Most of these men, particularly the crop reporters, are voluntary workers and receive no pay.

Practically every railroad station agent in the United States from whose station farm products are shipped, and officials of other transportation agencies, are active co-operators. Through these officials the Department of Agriculture knows from day to day the supplies of products moving to market. Thousands of produce firms, creameries, shipping associations and other organizations concerned with farm products also keep the Department informed of their activities. Reporters in the leading produce and live stock markets are paid employees.

At a recent meeting of the General Assembly of the International Institute of Agriculture at Rome, made up of delegates from the principal countries of the world, it was freely conceded that the United States Department of Agriculture has developed the most complete and accurate system of gathering agricultural statistics ever devised. The work of crop estimating is so systematized and safeguarded that no one in or out of the department can know what a given crop report will be until the estimate is completed a few minutes before its release, and in

(Continued on page 1338)

Radio in Japan

By E. G. Osborn

IT was in Seattle that two Japanese friends of mine—men well known on the Pacific Coast and in their home country, mooted the idea that radio broadcasting would be permitted in Japan, eventually if not soon. Having been in the newspaper business in Japan from 1914 to 1918, and having a close acquaintance with officialdom in that country, I shook my head in doubt. Visions of the inexplicable barriers set up by the Japanese Government against the least indication of a private firm or individual having anything to do with the communication services rose before me, and memories of my own experiences in trying to glean information for newspaper articles describing the big wireless stations at Funabashi, Choshi and Iwaki forced me to think that not for many years would the Japanese officials allow the common people to get in on the mysteries of radio.

I remembered, too, the experiences of a young American in Kobe in 1916. Being an amateur enthusiast, he had installed an unpretentious receiving set in the attic of his residence near the Tor Hotel in that city. Carefully concealed among the trees of his garden he strung a two-wire aerial, and he spent several months at his hobby listening in to the ship stations about the port. One

(Continued on page 1342)

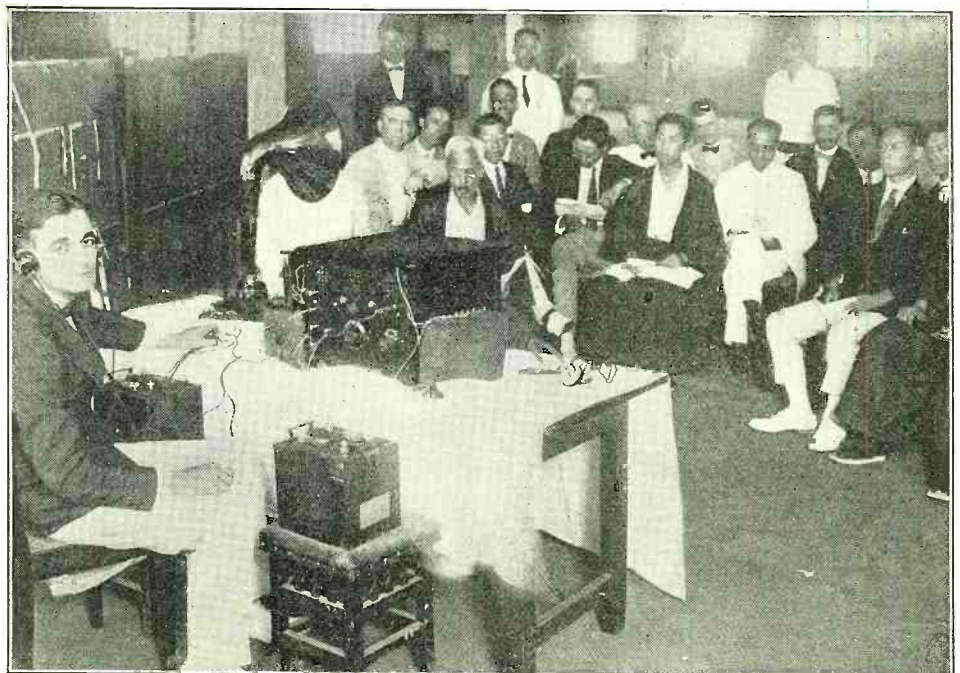

The First Public Demonstration of Radio in Japan on Sept. 6. The Picture Shows a Group of Newspaper Men and Officials Listening to Records by Miura, Tamaki and Other Japanese Artists sent from a Transmitter Five Miles Away. The Journalists Had to be Taken to the Transmitting Station Before They Would be Thoroughly Convinced that a Phonograph was Not Concealed Under the Table.

Static Is Greatest Obstacle in Radio

An Interview with Dr. L. W. Austin, Director of the Radio Research Laboratory of the U. S. Navy

By S. R. WINTERS

AS soon as possible an exhaustive study should be made of the prevailing directions and intensity of atmospheric disturbances in all parts of the world, since the future of long-distance wireless telegraphy depends upon the control of this menace to radio signals," said Dr. L. W. Austin, head of the radio research laboratory of the United States Navy Department, in the course of an exclusive interview upon his return from a three-months' tour of European countries. He was chairman of the American delegation at the meeting of the International Union of Scientific Radio Telegraphy, held at Brussels, an organization devoted to a study of scientific problems of wireless telegraphy.

A recorder in the form of a rotating loop has been devised and installed in England for the purpose of denoting daily and seasonable shifts of these disturbances. Such instruments, used at a number of stations, it is believed will eventually indicate certain points as sources of annoyances, popularly or derisively known by radio amateurs as "static." The intensity of atmospheric disturbances in the United States, in the opinion of Doctor Austin, will preclude the use of this form of apparatus in determining the direction from which this bane of radio telegraphy and radio telephony comes. However, Doctor Austin, while conducting purely scientific investigation near Goat Island, California, made the notable discovery that atmospheric disturbances possess sharp directional characteristics in this neighborhood. He is hopeful that the fruits of these observations will afford the key for an intelligent study of "static" the obstacle retarding the progress of wireless telegraphy and telephony. The discovery resulted in the establishment of continuous wireless communications between the Philippines and California, as well as affording a striking example of the value of purely scientific investigations.

Doctor Austin has systematically outlined the problems relating to atmospheric disturbances. While, he stated to this writer that these annoyances are not as troublesome in European countries as in the United States, he favors systematic daily observations on the intensity of atmospheric disturbances at a large number of points in all parts of the globe. If feasible, the intensity should be measured in terms of electric voltage on the antenna, expressed in volts per meter height. Recording apparatus should be designed for making these determinations automatically. When centers of atmospheric disturbances are identified, Doctor Austin suggests that meteorological and electrical conditions prevailing be carefully analyzed with the view of making known the causes producing these disturbances. These world-wide observations should be made simultaneously, thus identifying the type of disturbance, if possible. Finally he would settle the question of the direction of the crashing type of "static." When this information has been assem-

bled from widely scattering points of the earth, comparisons can be made between atmospheric disturbances and other natural phenomena; solar activity, the earth's electrical and magnetic phenomena, and those of seismology and volcanology.

Atmospheric disturbances are classified, with respect to the sounds when the telephones are held to the ears, as clicks, hissing, rumbling, and crashing. The rumbling type is most prevalent and authorities believe this form of distracting noise to be comprised of strongly damped electrical-wave trains or of untuned single pulses. To quote Doctor Austin: "That this type of disturbance has sometimes a certain amount of tuning is shown by the fact that the individual discharges are not heard simultaneously at different wave lengths but it is believed that the discharges are so

discovered in 1920. Mexico, too, the seat of other exported troubles in the States, is also believed to be the cause of difficulties that mar clear reception of radio-telegraph and telephone messages throughout the eastern section of the United States. Then, too, cities with their large number of chimneys discharging heated gases are sources of rumbling disturbances in the transmission of wireless communications. The ascending currents of heated air and thunder clouds, although the latter are disassociated from visible lightning flashes, are held responsible for the clicks in telephone receivers heard at moderate distances. Rumbling noises originate from land areas, it is believed, since seafaring vessels are comparatively free from this annoyance. The intensities of rumbling disturbances appear to bear a relation to the seasonal variations in the altitude of the path of the sun. Observations in Africa support this conclusion.

Crashes are another form of annoyance in wireless transmission traceable to "static." Evidence fails to show that this type of noise in the telephone receivers has directional characteristics. Yet, observations indicate that such occurrences take place at the same time at wireless stations far removed from each other; for instance at San Francisco and Honolulu. Solar outbursts have been blamed for these crashing noises, although proof is lacking to support this theory. Radio operators claim that crashes are of an untuned character, since individual occurrences are noted at the same time on widely varying wave lengths. When atmospheric disturbances possess directional characteristics and come from a point of the compass at variance from that of the wireless signals, it is frequently possible to eliminate "static" and make for clearer reception. This is done by use of uni-directional receiving instruments. A notable example is that of the Cavite, and Goat Island radio-telegraph stations whereby constant communication is maintained between California and Philippine Islands, more than 6,000 miles apart. However, a peculiar condition favors the Pacific Coast. And, probably in other portions of the United States secondary centers of disturbances are to be encountered, such as clouds and mountains in proximity to the receiving stations. These conditions are likely to establish annoyances coming from a number of directions simultaneously.

Doctor Austin, who is an international authority on long-distance wireless communication, was asked to name the most powerful radio-telegraph station in the world. He instantly cited the one at Bordeaux, France, erected by the United States Navy Department during the World War, which he rated as capable of radiating 85,000 meter-amperes. The latter term of measurement signifies the number of antenna amperes multiplied by the effective height of the antenna in meters. The newly-built French radio-telegraph station at Sainte-Assise is equipped at present with a radiating

(Continued on page 1413)

ANNOUNCEMENT

BEGINNING with our February issue, we shall publish a series of articles by Dr. A. J. Fleming, M.A., D.Sc., F.R.S., entitled: "ELECTRONS, ELECTRIC WAVES and RADIO TELEPHONY."

Dr. Fleming requires no introduction to readers of this journal. He is today the greatest living English authority on all radio matters. His book, "PRINCIPLES OF ELECTRIC WAVE TELEGRAPHY AND TELEPHONY," is a classic, and is considered as probably the greatest volume on radio ever compiled.

These articles, for which RADIO NEWS has secured the sole American rights, are without a doubt, the most important that have been published in a long time, and we are quite certain that all of our readers, whether they be scientists, amateurs, or novices, will look forward with great anticipation toward these articles from this master of Radio.

EDITOR.

numerous that since they occur at different frequencies, they form a kind of disturbance spectrum and thus appear in the receiving apparatus at every wave length to which the antenna may be tuned. While nothing is definitely known as to the exact nature of the source of the rumbling disturbances, it is believed that they are probably produced in the upper atmosphere by electrical readjustments. The resulting electrical waves expand in a more or less spherical manner until the lower portions of the wave front strike the earth when they spread out guided by the earth and move off with a wave front which soon becomes practically vertical, exactly like the electrical waves start from the transmitter of an airplane."

The investigations of Doctor Austin indicate that powerful rumbling electrical disturbances originate in definite centers frequently seeming to lie above mountainous regions. Observations made along the coast of Oregon and Washington, for instance, suggest that a major portion of these annoyances to wireless transmission came from the direction of Mount Ranier. Well-defined centers of disturbances have also been identified in the mountains to the rear of San Francisco and San Diego. These points from which "static" originates appear to be constant in position and their activities have not relaxed since first

The New Schmidt High Frequency Alternator A Rival of the Vacuum Tube

By Dr. K. Wirtz

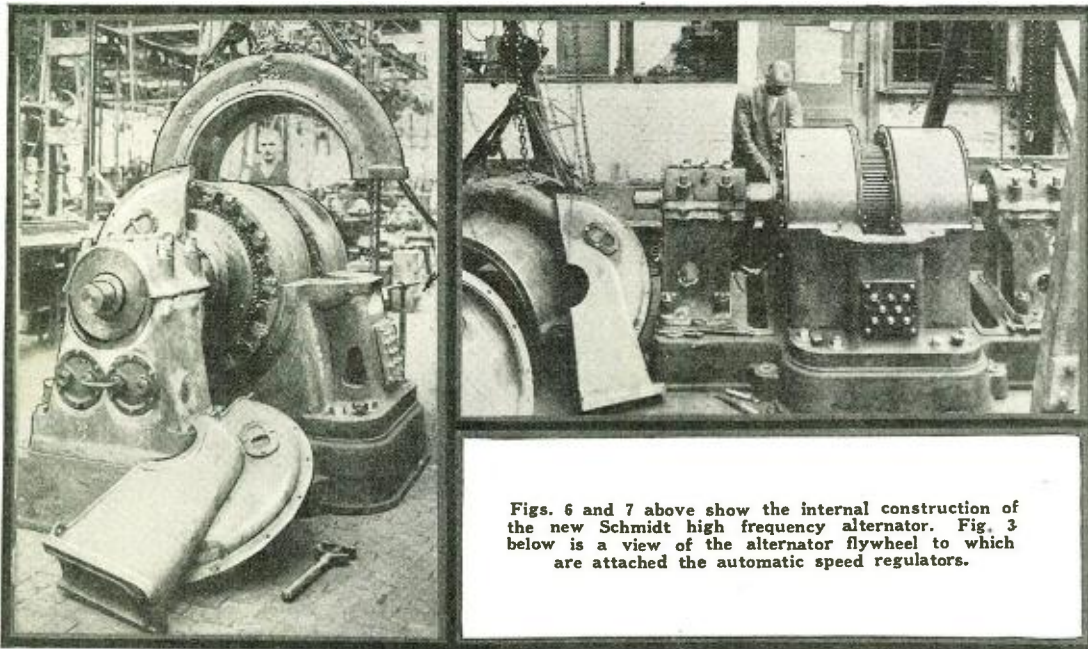

Figs. 6 and 7 above show the internal construction of the new Schmidt high frequency alternator. Fig. 3 below is a view of the alternator flywheel to which are attached the automatic speed regulators.

WHILE in the Goldschmidt machine and the installation of the Wireless Telegraph Co. used in Nauen, a repeated changing of the fundamental frequency of the high-frequency current used for sending is obtained, Schmidt has succeeded with a single transformer, in one step, and without direct current magnetizations to reach this frequency. The hook-up is shown in Fig. 1. An alternating current machine *M* of average frequency, say 6,000 cycles, works in series with a condenser *C*₁ on the windings of the frequency transformer. *C*₁ is of such a capacity that the circuits of the machine are in resonance with the fundamental frequency impressed by the

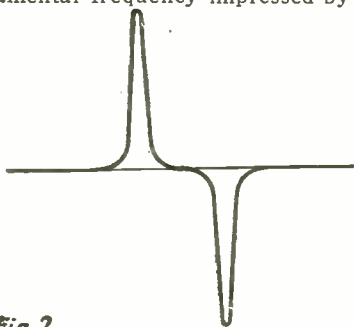
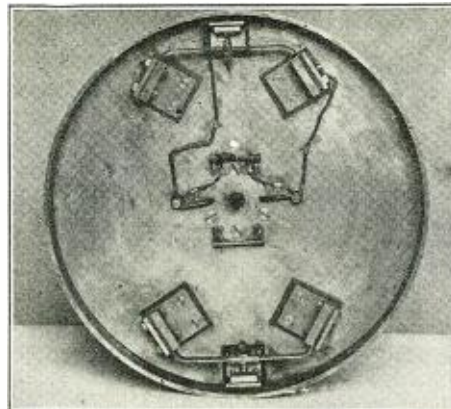

Fig. 2

A graphic representation of the high frequency current produced by the Schmidt alternator.

alternating current machine. The high-frequency circuit is connected directly to this winding, that is to say, between the points *a* and *b*, and it consists of a coil with self-induction *L*-2 and a variable condenser *C*-2.

By appropriate proportioning of the transformer and an adequate generator current, that is, by a complete saturation of the transformer coil, a distorted potential curve results between the points *a* and *b*, which at the limit give single pointed peaks adjoining each other, and separated by considerable spaces. According to the choice of tuning in the secondary circuit, currents of a multiple of the frequency of the machine are directly obtained. The sec-



ondary is inductively coupled with the antenna in which, for keying a choke coil, *D*, is connected according to Pungs. It consists of two separate ring-shaped iron cores, made of sheet iron .07 mm. thick, which, in the diagram in Fig. 1, is seen to carry two high-frequency windings *ww*, and a direct-current winding, *wg*, the load winding.

The two high-frequency windings, *ww*, are so connected that the magnetic field that is developed in the direct-current winding, *wg*, is in opposition, increases in strength and consequently no high-frequency potential is induced in *wg*, whereas the field of force developed by the direct-current-frequency windings. If the key is pressed, the iron is magnetically saturated. The coefficient of self-induction and also the resistance of the high-frequency windings are re-

Detailed construction is here shown of the iron core choke coil and the high frequency transformer symbolized in the circuit of Fig. 1.

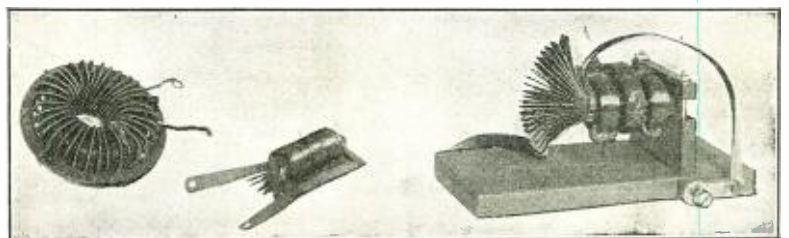

duced. during intervals between pressings of the key; therefore by releasing the key, the coefficient of self-induction and the loss of resistance by the coil are great. The antenna is in tune with the sending waves, while the key is pressed; that is to say, the direct current excitation of the coil is connected in. By releasing the key the result is that in consequence of the great self-induction, not only a detuning but also at the same time the resistance of the high-frequency coil increases so that the antenna current, by the opening of the key, falls to zero. If the apparatus is to be used for wireless telephony, one has only to replace the key by a microphone. For the same purpose one places in parallel with the direct current winding, *wg*, along with an iron choke coil, a second source of direct current which serves for pre-magnetization of the coil *D*. By speaking into the microphone the changes of the coefficient of induction, and of the resistance of the high-frequency windings within the straight line portion of the curve *u*, remain, which represent the relation existing between the heavy current on one side and the microphone current on the other side.

The field and the armature windings are placed on the stationary portion of the machine, just as in the Alexanderson alternator. The rotating portion consists of cast steel body with no winding, fitted on circumference with

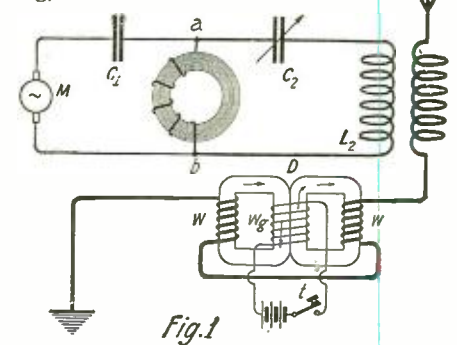

The circuit used in conjunction with the high frequency alternator.

series of teeth, whose interspaces are not filled with unmagnetic metal, as they are in the Alexanderson machine.

Special care must be taken in the building of the transformers in order to make the loss of iron as little as possible. (Continued on page 1388)

Dr. Lee de Forest Speaks

An Authorized Interview
By H. Winfield Secor

DR. LEE DE FOREST, the well-known American radio engineer, father of the three-electrode tube known as the Audion, and one of the world's pioneers with regard to the invention of various radio, telegraphic and telephonic apparatus, recently returned from Europe. In a recent interview, at which the Editor and the writer were present, a number of very interesting disclosures were made concerning the present status of the audion or three electrode vacuum tube, and several other points of interest, particularly to radio men.

As the Fleming patent on the vacuum tube used as a detector and amplifier or rectifier, expired a few weeks ago, we asked Dr. de Forest several questions concerning the three electrode vacuum tube. Dr. de Forest then disclosed at length some interesting phases of the relative merits of the Fleming patent, with respect to his invention of the three electrode tube. "In a contemporary radio publication a short time ago, appeared an article by an eminent expert, Professor J. H. Morecroft, of Columbia University, who stated that my principal contribution to the radio art consisted in placing a third electrode in a Fleming valve," said Dr. de Forest. "That is entirely wrong, and only states half of the fact, for the principal desideratum with regard to my invention of the audion was not only that I placed a third electrode in a so-called Fleming valve or tube containing simply a filament and the plate, but I also first brought into play what is now commonly called a 'B' battery of high potential, and which battery was caused to trigger off its energy through the receivers whenever an incoming signal charged the grid or third electrode, which I a little later added. It was the addition of the combined action of this third electrode or grid placed between the filament and the plate, together with the B battery that gave the remarkable results which were found in the laboratory when experimenting with the audion. It is impossible to make a hard two electrode tube, containing simply a filament and plate, as in the original Fleming valve, to oscillate or do anything else useful which my three electrode valve or audion accomplished."

"Now that the British-owned monopoly which the Fleming patent on the useless two-electrode rectifying detector has been lifted from the backs of the American Radio public," said Dr. de Forest, "my company will at once enter into active competition with the Radio Corporation, which finally obtained the Fleming rights from the Marconi company."

It is the irony of fate, coupled to judicial decisions past all analysis, that not until within two years of the expiration of his own Audion, three-electrode and amplifier patents, Dr. de Forest, the inventor of this device which has completely revolutionized the radio and telephone art as well, is permitted to manufacture, use and sell his own invention!

One will have to search far in the history of patent law to find a more flagrant case of injustice than this chapter which has now closed with the expiration of the Fleming two-electrode Edison valve patent.

We asked Dr. de Forest what he thought of the inventions of Major Armstrong, with respect to what is commonly now known as the Armstrong regenerative or Feed-back circuits, and what he thought of them with respect to his early invention of

a circuit which accomplishes similar results, and known as the Ultra-audion hook-up. Dr. de Forest said:

"The crux of the whole matter with respect to the Armstrong regenerative or feed-back circuits and the de Forest-Logwood ultra-audion circuit, simmers down to the point that in all of Armstrong's circuits there is a coupling of the plate filament circuit with the grid filament circuit by some form of coupling transformer or its equivalent. It is well to point out what is perhaps an entirely new fact to many students of radio, that it is not necessary in the ultra-audion circuit to have any coupling between the grid and plate filament circuits. There is here in fact only *one* oscillating circuit and that is the entirely novel grid plate circuit. This fact I have demonstrated time and again, as it was also demonstrated by a noted radio investigator, Dr. Frederick Holbom during my recent stay in Germany, where I developed my new talking motion pictures. To prove that the ultra-audion circuit would oscillate without

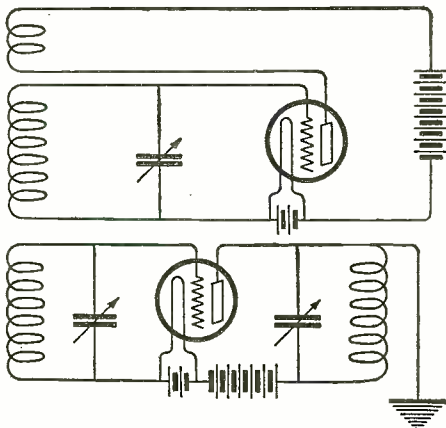

These two circuits show the difference between the Armstrong feed back and the Ultra Audion as outlined by Dr. De Forest

any oscillation whatever in the plate filament circuits as is the case in all the Armstrong arrangements, that it is not necessary for this condition to exist in our arrangement of the apparatus, a proposition which the court would not accede, the plate of the audion may be grounded. This grounding of the plate was also noted by the German investigator. The only thing necessary so that the audion will oscillate in the ultra audion hook-up, is to have an inductance and a capacity in the grid plate circuits, so that this single oscillating circuit can be tuned to the proper resonance. Moreover, in Kuhn circuits as used in Germany the inductance in the grid filament and plate filament circuits are placed about 3' apart, and at right angles to each other, so that there is no inductive relation between them through the air, as one might surmise if this relation was not specifically stated. The coupling here is entirely within the bulb itself. In the present so-called regenerative circuits used by many radio experimenters, where a variometer or adjustable inductance is placed in the grid or plate circuits, there may or may not be an inductive relation between the two variometers, according to how far apart they are, and the position of the one with respect to the other. If they are placed so as to act one on the other, we have an effect as described, and working according to the theories of Major Armstrong, but if they are separated sufficiently, and placed so as not to act on one another inductively, or

else properly shielded, then we do not have an inductive relation between the grid and the plate circuit, but we then have the Kuhn circuit. In other words, if you arranged the circuit so that you could properly tune the grid and plate circuits you could make the tube oscillate, as I have done in my early experiments years ago. But this so-called Kuhn circuit effect must not be confused with the ultra-audion single oscillating circuit."

Asked about the present status of radio in Germany, where Dr. de Forest has been carrying on experiments with his talking movies for the past year, he said that there were several interesting new developments in the commercial radio field, but with regard to amateur radio, there was practically nothing doing at all.

Among several other questions which Dr. de Forest was asked, was as to whether or not he still believed in the propagation of radio waves around the earth by ether waves in contradistinction to the Tesla theory, that the free ether wave has little to do with long distance radio, and that it is practically the ground conduction current which carries the radio impulses to the distant station. Several of the apparently incontrovertible claims of Dr. Tesla were cited to support the latter's theories with regard to the ground wave propagation of radio impulses, but Dr. de Forest firmly believes that we are not going to throw overboard the ether wave explanation of radio transmission as easily as one might think.

"It is all very true as you say," said Dr. de Forest, "that even as difficult a problem as that explaining why an airplane that has no connection to the ground can transmit and receive radio messages perfectly, can be explained by the Tesla hypothesis, on the basis of a capacity or condenser action, but if I grant you that point, then I will ask you why it is that the well-known directive effects are obtained with different types of antennae depending upon the direction in which they point, and on several other factors? It does not seem reasonable to me that if the propagation takes place solely by conduction through the ground, that such a small, charged wire system as the antenna, when considered in respect to the great distance over which the wave travels, would permit this antenna to so effect the direction in which the waves travel farthest." Dr. de Forest was referring to the well-known directive effects of the inverted L antenna, and other types, the inverted L aerial transmitting or receiving much more efficiently in a direction opposite to that in which the free end points, as all radio experts know, and particularly to the directive effects of a small receiving loop high above the earth in an aeroplane.

"I believe," said Dr. de Forest further "that we always have present the ether wave, or call it what you will, as it glides around the earth to the distant receiving station, each wave being accompanied by its complementary ground wave, the latter being electro-magnetic and the former electrostatic energy."

Dr. de Forest was asked whether he believed that the theory of the Heaviside layer still held true and that, as several experts have previously held, long distance radio transmission was, or is accomplished by successive reflections of the waves radiated from an antenna, and in this way caused eventually to reach the antenna of the receiving station possibly one-quarter or half way around the world.

(Continued on Page 1427)

Mr. Murchison's Radio Party

By Ellis Parker Butler



MR. ELLIS PARKER BUTLER

FOR two weeks after Mr. Murchison installed his radio receiving set he and his wife did nothing after dinner but sit in the parlor and listen to it. For one week they used ear-phones, but at the end of the week Mr. Murchison decided that it was a shame to have all the pleasures of WJZ, WOR and the other programs and not share them, and he bought a large horn-like arrangement by using which any number of persons could sit at the far side of the room and hear everything very well indeed. It was a great success.

This addition to Mr. Murchison's radio gave him full and happy evenings for one week, for he had become a true radio enthusiast and his days were merely hours that he had to pass somehow until the time came to go home and enjoy radio. He bought the best radio magazines he could find, and twelve books on radio, and he read them all and learned a tremendous lot he had never even imagined about radio. Although he had paid quite a large sum of money—for him—for his ready made set, he was so excited about radio that he set about building a set himself, and he nearly drove his wife crazy trying to explain what sounded to her like utter nonsense about why a high-power reverse action transforms the antenna generator into an edgewise inductance—which means nothing at all.

By the end of the week Mr. Murchison was such an enthusiastic radio builder that he told Mrs. Murchison he was going to take his boughten set apart to see what was in it, and he even kept Teena—the kitchen maid—from her work while he told her about indoor antennae and variocouplers. It was clear to Mrs. Murchison that unless something was done to bring Mr. Murchison back to the same pleasure of listening to the programs of the broadcasting stations he would soon be like Mr. Brownlee, who was so interested in building better and better amateur sets that he did nothing else and never completed one sufficiently to hear anything with it. Mr. Brownlee was indeed a radio enthusiast. He had become such an enthusiast that he could talk nothing and think nothing but

radio, and whenever he pulled his hand out of his pocket he shed screwdrivers and crystals and wire and insulators by the quart.

It was for this reason that Mrs. Murchison conceived the idea of having a radio party and, to her joy, Mr. Murchison welcomed the idea with enthusiasm.

"Great!" he exclaimed. "I'd just like to show some of these back-numbers here in Westcote what radio really is! We'll have a dinner—a swell dinner—and after dinner we will go into the parlor and we'll show 'em! And as for class—think of giving the first radio party in Westcote! It will make you, my dear; it will simply make you!"

"I thought of that, too," said Mrs. Murchison; "It should not, to say the least, hurt my social standing. I thought of inviting Mrs. Bimberry, dear."

Mrs. Bimberry was the social dictator of Westcote; she was the society queen. She was also large. Mrs. Bimberry had for years been reducing, banting, starving and dieting and she still grew larger and larger. She hated it and she hated everyone who referred to her size or looked as if she was thinking of it. Mrs. Murchison greatly desired the favor of Mrs. Bimberry's social smiles and in the depths of her heart Mrs. Murchison had a wily little plan. One of the broadcasting stations was sending out "reduce to music" programs every evening, and Mrs. Murchison felt that if Mrs. Bimberry heard the "reduce to music" number over the radio, and was pleased with the idea and

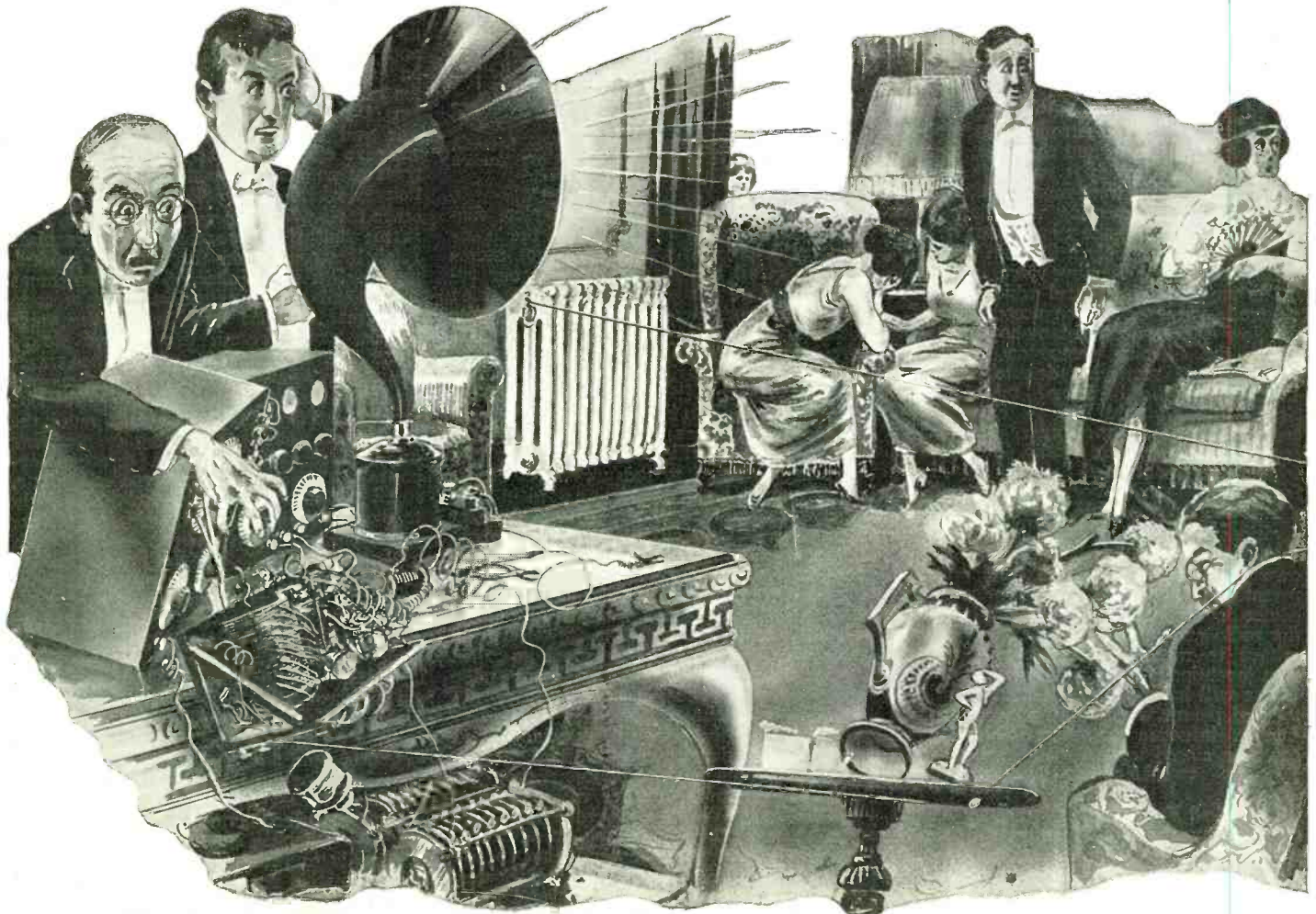

For a Moment the Queen of Westcote Society Stood on One Leg, Her Arms Stretched Out Before Her and One Leg Extended

bought a radio outfit and reduced herself to music because of it, Mrs. Bimberry would feel everlastingly grateful to Mrs. Murchison and would be her friend forever.

The dinner part of Mrs. Murchison's radio party was a great success. Not only were Mr. and Mrs. Bimberry present, but also Mr. and Mrs. Claygull and Mr. and Mrs. Brownlee. At the last moment Mr. Murchison had insisted that Brownlee be asked, for Murchison was an extremely nervous little man and as the time for the party approached he became panic-stricken lest his radio set should not work. He wanted Brownlee on hand in case there was any hitch in the program. Brownlee could certainly find what was the matter with the radio outfit if it did not work properly.

The dinner was excellent and all were very merry and talked nothing but radio, and after dinner Mrs. Murchison proudly led the way into the parlor and seated her guests in a semi-circle after they had examined the radio outfit and exclaimed over it.

"Ah!" said Mr. Murchison, glancing at his watch when all were seated. "We are just in time. The program is just beginning. Now you will see how simple this wonderful invention is. You see here three dials. I turn one, and I turn the next, and I turn the third, and from many miles away comes the—the—"

He had turned the dials, but nothing happened.

"Perhaps Central has not given you the right connection," puffed Mrs. Bimberry, who had eaten too much—as usual—and felt a trifle cross.

Mr. Brownlee, who with difficulty had made himself sit at all, now jumped up and went to the table.

"Let me tune her up, Murchison," he said. "I know all about this game. You

see, folks, I turn this dial to light the amplifier, and this one to find the wavelength and this to—to—to—"

Nothing happened. Mr. Brownlee and Mr. Murchison, quarreling in low tones pushed each other aside and turned dials this way and that way, but nothing at all happened.

"What in thunder did you do to this thing?" Brownlee demanded, and Mrs.

pose it makes any difference if the wires you had stretched to the barn are gone?"

"What!" cried Mr. Murchison. "My word, Mary! Do you mean to tell me—"

"Now, please, Henry," begged Mrs. Murchison. "There are guests present, please remember. Of course those wires are gone! I certainly did not know those wires were necessary, did I? You distinctly told Teena—I'm sure I heard you—that the wires out there were no longer necessary. So when they fell down this afternoon I gave them to a little boy who asked for them."

"Well, of all the idiotic—" Mr. Murchison began, but Mrs. Bimberry interrupted him.

"Well, Jane," he said to Mrs. Bimberry, "I guess we might as well be going; there doesn't seem to be any radio radiating here this evening. I told you—"

"Now, wait; please wait!" exclaimed Mr. Murchison distractedly. "Don't get mad, Bimberry. Don't blame me for this! I did happen to say that out-door aerials were no longer necessary, but I did not mean they were not necessary for us. It's a nice state of things when a woman picks up your slightest word and gives your antenna to the first red headed boy that comes along—"

"He was not red headed!" exclaimed Mrs. Murchison. "And if you feel called upon to say mean things to me, Henry Murchison, you might wait until a time when—"

(Continued on page 1384)

WE are pleased to announce that, beginning with this issue and for the year to come, Mr. Ellis Parker Butler will write radio stories exclusively for RADIO NEWS.

Mr. Butler does not need much introduction. He is, without question, one of the greatest living American humorists, his works having been translated into many different languages.

Mr. Butler has turned out a great quantity of literature during the past 15 years, his best known work being, of course, "Pigs Is Pigs," then "Philo Gubb, the Correspondence School Detective," "The Incubator Baby," "Mike Flannery," etc., etc.

The discovery that this eminent writer is a radio "fan" of some importance will be hailed with delight by every one of our readers. Mr. Butler knows the foibles of the radio amateur well, and he has a keen insight into his mentality. His first story proves this contention, and we congratulate our readers on the new treat, and we know they will laugh and smile with "Pigs Is Pigs" Butler for the next 12 months. —Editor.

Murchison tried to hide the annoyance she felt by asking Mrs. Bimberry, in her sweetest voice, if the coal situation wasn't just too pitiful.

"Get a move on, Murchison; get a move on!" urged Mr. Bimberry. "I've got a date at the club if this thing isn't going to pan out."

"Oh! I'm sure it will," said Mrs. Murchison sweetly, and then, to Mr. Murchison: "Henry, dear, do you sup-



Toward the Top of the Radiator to Which She was Wired Like a High Art Nature Dancer Hopping on One Leg.

The A. C. Line as a Source of Current for the Vacuum Tubes

By R. Barthelemy

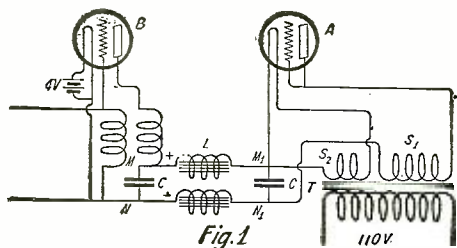

Fig. 1
The Alternating Current is Rectified by the Tube "A" and Fed to the Plate of Tube "B". The Winding S₂ Supplies Current for the Filament of the Rectifier Tube.

ONE of the drawbacks of the vacuum tube sets is the use of storage batteries for lighting the filaments and dry cells to furnish the necessary high tension for the plates of the tubes. With the increasing popularity of radio and the great number of receiving sets now in use, the possibility would be desirable of using the current from the light line to supply the radio receiver in the home. A great many attempts have been made along this line; some have tried to use the current from the D. C. line to supply both filaments and plates, others have tried the more difficult problem of utilizing the A. C. for the same purpose. Since 1919, Mr. Valette has used a system which permits the use of A. C. for the plates. Several radio frequency amplifiers of both three and four tubes were installed and successfully operated. Fig. 1 shows the circuit which comprises a small transformer, T, and a rectifying tube which is of the standard type, A. The step-down transformer has two secondary windings, S₁ and S₂, furnishing the filament current for the rectifying tube and the plate current for the amplifying tube. A filter system composed of iron choke coils and condensers of the proper values, smooth out the hum and furnish current which is sufficiently constant to prevent any noise being heard in the telephone receivers. This was the first successful system utilized. In 1919, we had taken a patent in the name of the "Societe Independante de T. S. F." on a system to light the filament of the tubes

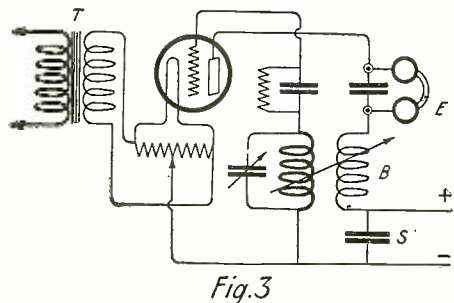

Fig. 3
This Circuit Incorporates the Potentiometer Method of Decreasing the Hum, Together with a Filter System in the Grid Circuit.

with A. C. In order to reduce to a minimum the noise caused by the A. C., the return from the circuit is made not to one leg of the filament, but to a center tap taken on a potentiometer or similar sys-

tem. As shown in Fig. 2, the center tap may also be taken on the secondary winding of the transformer supplying the filament current. Some time later, M. Moye, described his ingenious system consisting of the use of a crystal detector for rectification after the signals have been amplified through a radio frequency amplifier supplied entirely by A. C. These circuits were described in recent issues of the RADIO NEWS. Quite a few amateurs have built and used some amplifiers supplied from the light line and found that fair results could be obtained. We say fair results because when a vacuum tube receiver is entirely supplied with A. C. it becomes difficult to get maximum amplification by the feed-back system, because, when the tickler is turned, the noise increases in a great proportion as one reaches the point where the oscillations start. When regeneration is maximum, one notices a low frequency modulation of the signals received and also the hum caused by the machine which increases in intensity to such an extent that signals are almost inaudible. Therefore, in order to receive the signals, especially telephony without any trouble or interference caused by

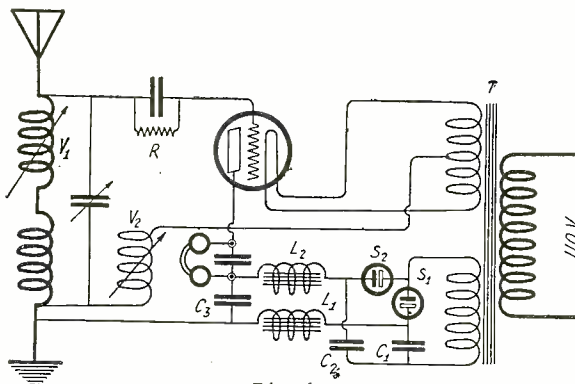

Fig. 4
In This Circuit A.C. is Used for Both Filament and Plate Supply. The Supply for the Plate is First Rectified and then Smoothed Out by Condenser and Chokes.

the supply, it is necessary to operate the tubes with a low degree of efficiency, since it is not possible to increase the feed-back action very much. This is, of course, a solution, but not the best.

Recently, the Societe Ducretet, during some researches carried out along this line, found that it was possible to secure very good operation from A.C. by means of a special tube which will be described later. They noticed that when an ordinary vacuum tube was connected in such a circuit as Fig. 3, some noise was still noticeable in the telephones. Since there is no low frequency induction in such a system, the source of the trouble was found to be caused by the variation of temperature of the filament during one cycle. If, in such a set, the feed-back coil is brought closer to the grid coil, increasing the regenerative effect, a strong roar becomes audible. It is caused by the variation of temperature of the filament, which is amplified in the same proportion as the signals but is, of course, very much stronger. It is well-known that the temperature of the filament acts upon the stability of the tube and upon its point of oscillation. If the

temperature of the filament is kept sufficiently low, little trouble is experienced, but if it is increased up to a certain limit, it happens that when the temperature becomes maximum at the peak of a cycle, oscillation starts and produces a heterodyne effect which is difficult to overcome. The noise heard in the telephones corresponds to a signal covered by strong I. C. W.

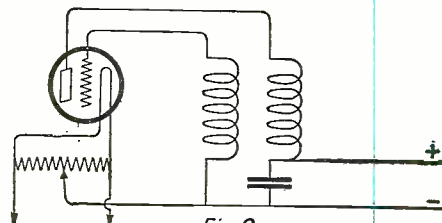

Fig. 2
This Circuit was Found Practical in Using A.C. Filament Lighting. The A.C. Hum is Decreased to a Considerable Degree.

After observing this, the experimenters tried several tubes with two filaments supplied by A. C. and various frequencies. A tube was even tried with two-phase current, and high frequency currents were also tried in an endeavor to reduce the noise. However, the best solution found so far consists in the use of a tube, the filament of which is of a sufficient size to remain practically at the same temperature during the interval between the peaks of the cycles.

With such a tube, no more low frequency noise is heard, but only an extremely faint buzz which is absolutely negligible and which does not cause any trouble even when receiving long distance stations, the signals of which are of a low audibility. It permits also a turning of the feed-back coil so as to obtain maximum regeneration without having the trouble previously mentioned.

Thanks to these tubes, it has been possible to design a receiver entirely supplied with A. C. The circuit is shown in Fig. 4. As may be seen, it is a very simple receiver, designed for popular use, for the reception of broadcasting stations, only those two controls being required. The set itself is composed of two units, one containing the receiver proper with the tube, and the other containing the transformer, filter system and two small electrolytic rectifier cells. Such a receiving set will soon be on the

(Continued on page 1412)

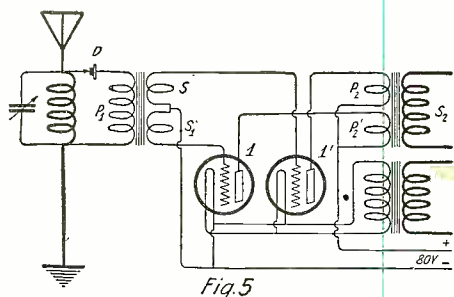

Fig. 5
The Incoming Signals are Rectified by a Crystal Detector and Amplified by the Two Tubes. A.C. is Used for Filament and Plate Supply.

Those Other Worlds

By DOUGLAS A. GRAHAM

AUDIO Amplification! Yesterday—the mystery of deep-eyed savants. Today—a familiar term to every school boy. Tomorrow—"optio" amplification! Why not?

Science has long known that we live in an infinitesimal world bounded by our five very limited senses. We hear a little, but only a small fraction of the known musical scale. We see a little, but not far or much without the aid of science. We smell, taste and feel a little but how much we do not really know.

And now comes the practical development and general use of radio communication with rapid progress in the understanding and control of unseen forces far beyond the natural range of our physical sensibilities. Has the door been unlocked? We have speculated much. Perhaps we can now change from speculation to proven theory and bring many things out of the obscurity of ignorance into the bright light of scientific knowledge. Let us consider a little.

Prior to the seventeenth century man had to depend on his unaided eyesight to guide him in his travels and his investigations of the phenomena of nature. Then came the telescope and his physical vision was greatly broadened. He began to realize that his country and, later, his world were only small parts of an immense universe. This led to the development of other sight-aiding instruments until today he can look through the human body and watch its organs in operation; an achievement far beyond the imaginative possibilities of the days of Gallileo. And all this came from the study and understanding of the nature of light which was found to be simply a certain kind of wave like disturbance in what is called the ether.

The next one of the human senses which rallied the scientists to its aid was that of hearing. Sound, too, was studied and found to be a disturbance, not of the ether but of the air, and also traveling in the form of waves. It was soon found that the human ear could per-

ceive only a very small range of these sound waves and that a musical scale existed infinitely greater than mortals had yet appreciated. We have all read of the Music of the fairies and the Angels and most of us have treated it as fancy. But is it? No two people are just alike. Some can see farther and hear better than others. Scientists can produce sounds we cannot hear. Perhaps there are other sources of music and speech that we cannot hear and is it not reasonable to assume that the ears of some mortals may be able to detect these sounds or that a means will some day be found to enable all of us to hear them?

Then again we have the phenomena of mental telepathy, mind reading, hypno-

yond a reasonable doubt that human understanding is as yet very limited and that there are forces, sounds and perhaps whole worlds outside our own limited mental horizon but which surround us in our daily life.

Scientists formerly have made a clear distinction between force and matter and have held that matter could be divided only into its smallest unit which man called the atom. Now the atom has been analyzed and found to be made up of still smaller parts which they call electrons. And electrons are units of force. It is reported that a boy experimenter has recently succeeded in sending milk by radio. This probably was some newspaper joke. A joke today, yes—but 50 years hence? Probably an everyday occurrence. Electric current which creates the electro-

magnetic waves of radio communication, is made up of electrons or small units of force or energy. Milk is matter which can be divided into molecules, atoms and finally into electrons. Apparently, therefore, milk is made up of the same units as electricity; it is only a difference in the way it is assembled. Oxygen combines with air and makes rust—a solid. It combines with nitrogen and makes air—a gas. Or it may combine with hydrogen and form water—a liquid. The element is the same in each case. It appears, therefore, that matter is not matter at all but

force like electricity, sound or light. So it would seem that both science and our own personal experience and reason bring us to the inevitable conclusion that this generation has learned only enough to realize how little we really know and that there is a missing key to "those other worlds" which, when found, will open up possibilities heretofore considered as entirely in the realm of unprovable belief.

But how are the recent developments of radio related to these interesting but somewhat mysterious facts. To consider
(Continued on page 1407)

IN publishing Mr. Graham's article the editors disclaim all responsibility for the thoughts expressed therein in view of their rather revolutionary nature. At the same time the editors feel that there is a tremendous interest in the ideas expressed by Mr. Graham and who knows but that at a future date some of these ideas may be worked out? It is fascinating to contemplate all the new worlds that the Vacuum Tube will open up to us and it is indeed opening them up every day.

EDITOR.

tism, mental or Christian healing, clairvoyance, clairaudience, spiritualistic communication and materialization and many others. The principles underlying all of these have their supporters and all of them are backed by testimony which is hard to reject completely. You may be a believer in one and a scoffer at the others but you can neither prove your own claims to the world nor absolutely disprove the claims of the others. You may *disbelieve* all of them but you cannot *laugh* at all of them. And, if you are a thinking man you will have to admit that it has been demonstrated be-

A New Radio Loud-Speaker

By Beryl Dill

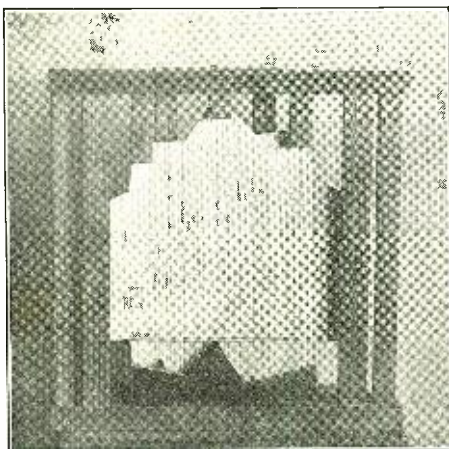

Front View, Showing the Leaf-Shaped Spruce Round Board. It Is 10 Inches in Diameter.

WHEN the radio craze first swept the country, everyone listened to the concerts and broadcasted material by means of the ordinary telephone receivers. This, however, soon lost its first favor and the question soon became that of some device whereby the sound could be heard by all within a room. This gave rise to the loud-talker, the use of phonographs and other devices for amplification. All save the most ardent radio fans, however, have found that none of these devices have been pleasing, the tones being usually harsh and grating.

R. H. Marriott, expert radio aide of the Puget Sound Naval Station, has solved the question of a pleasant toned radio receiving set in his home and his device is so much finer than the usual horns, sound chambers metal and dia-

(Continued on page 1409)

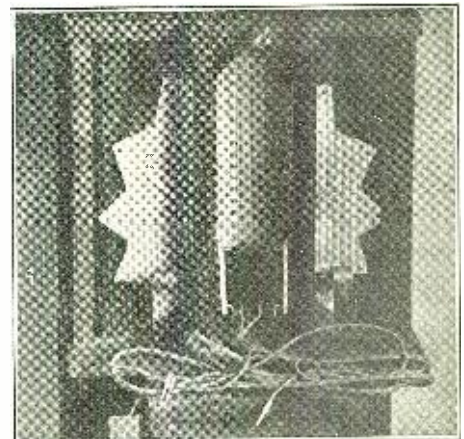

Rear View of the Loudspeaker. An Iron Armature is Fastened to the Lower part of the Round Board.

Use of High-Power Vacuum Tubes

By Dr. IRVING LANGMUIR

Assistant Director Research Laboratory, General Electric Company

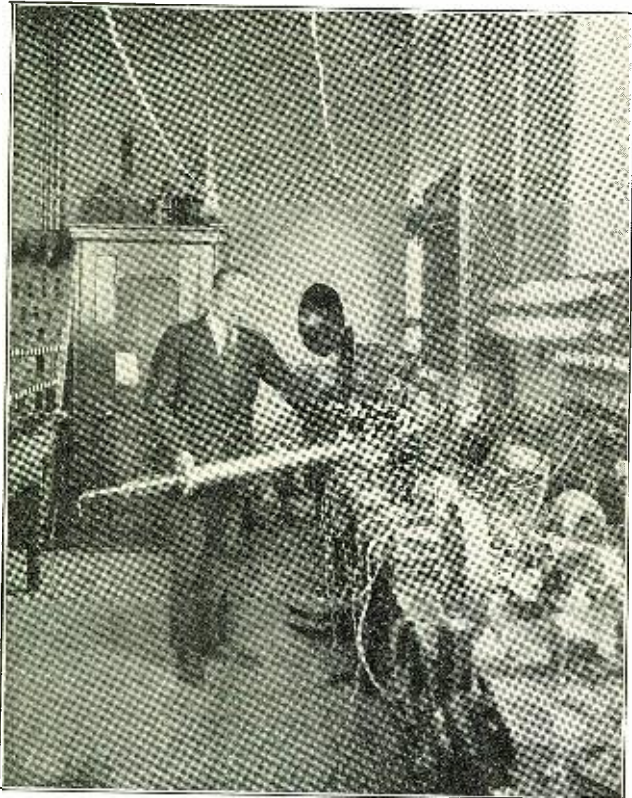

Fig. 4. One of the 1,000-kw. Magnetrons Recently Developed. The Filament of This Tube Is 0.4" in Diameter and 22" Long. It Is Excited by a Current of 1,800 Amperes at 10,000 Cycles.

THE recent tests at rocky Point, L. I., using 20-kw. pliotrons as a source of radio-frequency power have demonstrated the practical operation of high-power vacuum tubes. The Alexanderson Multiple-tuned antenna was used, supplied by high-frequency current from six 20-kw. pliotrons running in parallel, and during a sixteen-hour test signals were transmitted to Nauen, Germany, and came in from there. These signals were in addition to those usually transmitted with the Alexanderson alternator.

The tubes used in this test, like the ordinary vacuum tubes used for receiving radio signals, contain three electrodes, the filament, the grid and the plate, and to this extent they incorporate the principle first brought forward by de Forest. By the use of a very high vacuum and by special features of construction, ionization, due to a gas residue is brought down to negligible value, and in this way it has been possible to develop pliotrons capable of operating at higher and higher powers. The present 20-kw. tube marks simply one step in this development. The original de Forest audion operated with currents of at most a few milliamperes and at voltages of 30 or 40, so that the power which could be controlled was about 0.1 watt or 0.2 watt. By using the new principle of a pure electron discharge, independent of gas ionization, it was possible to develop tubes for transmitting purposes. Those were used widely

during the war for small radio-telegraph and radio telephone sets. Gradually tubes of 50 watts and 200 watt; were developed, using tungsten filaments as cathodes and with plates of metallic molybdenum capable of operating at such high temperatures that they could dissipate by radiation relatively large amounts of power. During the last few years tubes of this type of 1 kw. and 5 kw. capacity have been developed. The molybdenum anodes in these larger tubes are of cylindrical form and operate at high temperatures so that they can radiate the heat through the transparent glass wall of the bulb.

In going to larger powers it becomes difficult to make an anode of sufficient size to radiate to energy dissipated, and therefore resort has been made to water-cooling the anode. In this way the glass bulb was avoided entirely except as a means of insulating the leads connecting the electrodes to other external circuits.

The anode instead of being inside of the tube, is made to be the envelope of the tube. This introduces several new problems, for it is necessary to make a vacuum-tight seal between the cylindrical anode of relatively large diameter and the glass tube through which the leads are brought. Furthermore, new problems arise in connection with maintaining sufficiently high vacuum in a metal container in which large amounts of energy are being dissipated. These and other similiar problems have been worked out largely as a result of several years' work on the part of W. C. White and H. P. Nolte.

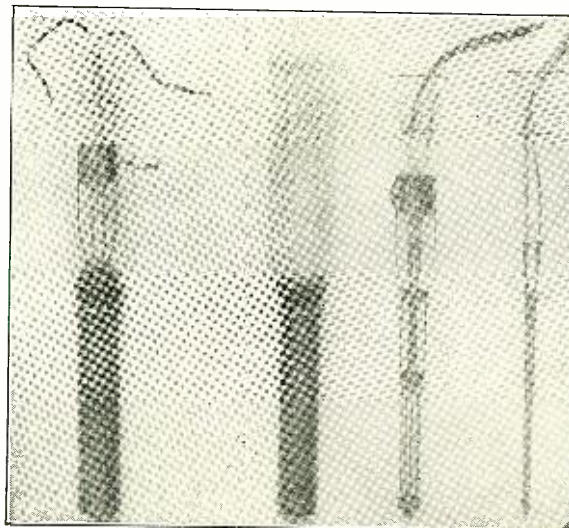

Fig. 2. Interior Construction of the 20-kw. Tube. The Filament Is Made of Tungsten and Consumes 1 kw.

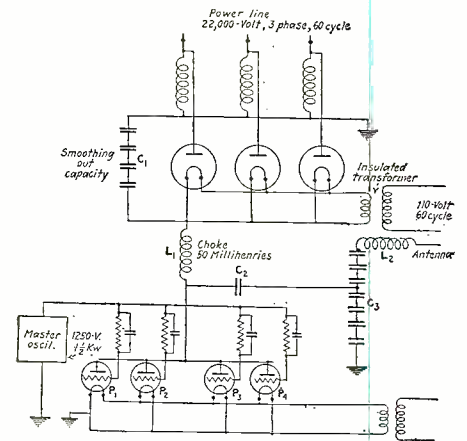

Fig. 3. The Circuit Used in the Recent Tests. The Power Is Supplied from a Three-Phase 60-Cycle, 22,000-Volt Line.

Fig. 1 is a photograph of the outside of the 20-kw. tube, which has already been manufactured in relatively large numbers and is commonly known by the type number UV207. It is seen that the lower part of the tube consists of a copper cylinder of about 1.9 in. outside diameter and about 8 in. long. This is sealed to a large glass tube of about 2.75 in. diameter by means of a conical thin-metal portion consisting of copper-covered nickel steel, this material acting as a substitute for the very expensive platinum which might otherwise be used. The upper glass portion of the tube is about 10 in. long and serves merely to support and insulate the filament leads from the grid and anode.

Fig. 2 is a photograph illustrating the interior construction of the tube. The cathode is a heavy tungsten filament of about 0.04 in. diameter bent in the form of a "W" supported on stout tungsten rods. It requires about 50 amp. heating current at about 20 volts, thus consuming about 1 kw. The plate or anode operates at about 15,000 volts direct current with respect to the cathode. The outside of the plate cylinder is directly in contact with running water supplied at the rate of about 2 gal. to 3 gal. per minute.

Because of the possibility of dissipating a large amount of power from the water-cooled anode it is possible to make this anode relatively smaller—in fact, much smaller than is used in the 5-kw. tube. This aids greatly in overcoming the space-charge effect which is a feature limiting the efficiency of electron tubes. These 20-kw. tubes have therefore a rather higher efficiency than the low-power tubes with molybdenum anodes. In the production of radio-frequency power these tubes give an output of 20 kw. in an antenna with a plate efficiency of 75 per cent, the filament loss of 1 kw. reducing the overall efficiency to about 70 per cent. This is by no means the limit of the efficiency that these tubes can give. If used for lower frequency, considerable higher efficiencies may be obtained.

The particular set-up used in



Tungsten filament of the 1,000-kw. Magnetron. Note its size in comparison with that of the electric light. This filament consumes 20 kw.

the recent tests is illustrated in the diagram of Fig. 3. The power is supplied from a three-phase, 60-cycle, 22,000-volt line. Each phase is grounded through a reactor and is also connected to the anode of a water-cooled kenotron. These kenotrons are constructed just like the 20-kw. pliotrons except that the grid is omitted. The filaments of the kenotrons are excited by an insulated filament transformer fed from 110-volt, 60-cycle current. In the recent Rocky Point tests carried out by co-operation between E. F. W. Alexanderson, C. W. Hansell of the Radio Corporation of America, W. R. G. Baker of the radio department of the General Electric Company and H. J. Nolte and W. C. White of the research laboratory, three kenotrons were used for rectifying the alternating current supplied. The power from the kenotron outfit was smoothed out by a capacity C1, shown in the diagram. This direct-current power supply was further smoothed out by the choke coil L1, or 50 millihenries. This direct-current power, ranging from 10,000 volts to 15,000 volts, was then applied to the plates of six pliotrons operating in parallel. The grids of these pliotrons were excited by a master oscillator giving about 1,250 volts and capable of delivering about 1.5 kw. of high-frequency power. The grids were operated in parallel, each grid being provided with a grid leak and grid condenser. The connection to the antenna from the plate circuit was made by means of the condenser C2, which was tapped into the antenna circuit at a point in a series of condensers C3, connecting the antenna with the ground. The antenna itself was connected to the condensers C3 through the tuning coil L. The antenna was of the multiple-tuned type which has been described by Alexanderson.

In the tests recently made where signals were transmitted to Nauen the antenna current was about 310 amp., which is about one-half that used ordinarily with the Alexanderson alternator. No particular effort was made to obtain the full output of the tubes in these tests, and undoubtedly more than twice as much power will soon be obtained from a similar number of tubes. The tests have demonstrated on a larger scale what we have already known from laboratory studies of individual tubes, that these tubes are capable of thoroughly satisfactory operation with an output of about 20 kw. The filament design is conservative, so that the life of the tubes

should average several thousand hours in actual operation.

The practical utilization for radio purposes of these 20-kw. tubes marks merely a step in the application of the basic principle of the pliotron. Since 1912, when this development was first begun, the energy controlled by the three electrode tubes has been increased from the 0.1 watt or 0.2 watt of the original audion up to more than 20,000 watts, an increase of more than a hundred-thousandfold.

This has been accomplished as the result of a careful study of the fundamental principles involved in the conduction of electricity through high vacuum. The writer's own work in this field was published in 1918 in the *Physical Review*,* and the first work in applying this principle in the construction of vacuum tubes was described before the Institute of Radio Engineers in 1915.†

Larger tubes than those rated at 20 kw. are being constructed. A 100-kw. tube of nearly the same type as the present 20-kw tube is now being developed by W. C. White and H. J. Nolte and promises to be fully as successful as the present tube, in addition to having the advantage of somewhat higher efficiency.

Another quite different type of tube, involving the principle of magnetic control proposed by Dr. A. W. Hull and called by him the magnetron, has been constructed by J. H. Payne. This tube, photograph of which is shown in Fig. 4, consists essentially of a water cooled cylindrical anode 30" long and 1 3/4" in diameter. In the axis of the anode is a tungsten filament 0.4" in diameter and 22" long. This filament is excited by current of 1,800 amp. at 10,000 cycles, the filament excitation requiring about 20 kw. The magnetic field produced by

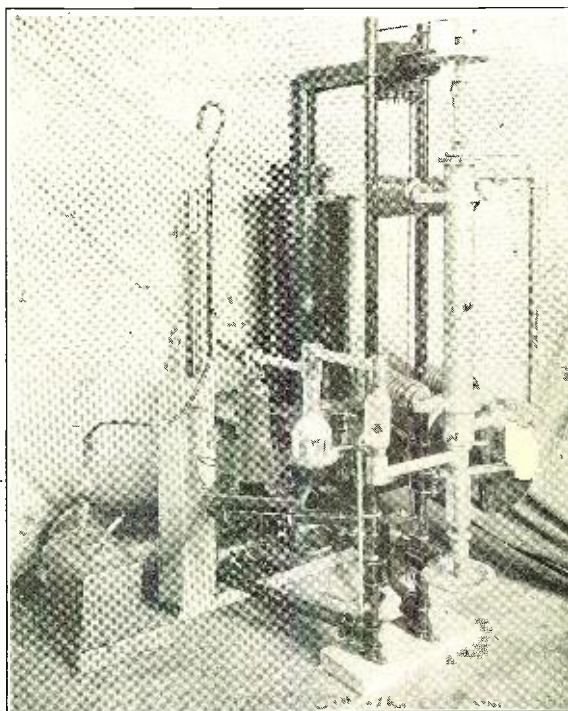

The Space Taken Up by This 1,000-kw. Tube Is Very Small Compared to That Required by a High-Frequency Alternator of the Same Capacity.

this large heating current is sufficient to "cut off" the electron current from the cathode to the anode during a portion of each half cycle of the current passing through the cathode, this action taking the place of that of the grid in the three-electrode tube. The electron current to the cathode is thus interrupted 20,000 times per second. By the use of properly tuned circuits this can be used for the production of high-frequency power for radio or any other purpose. The particular type shown in Fig. 4 will supply 1,000 kw. of 20,000-cycle power at an efficiency of 70 per cent, operating with an anode voltage of 20,000 volts direct current.

For radio purposes efficiencies of 70 and 80 per cent are eminently satisfactory, but for other engineering purposes they are not so high as would be generally desired. Another line of development is therefore in progress, viz., the production of tubes of higher efficiency as well as tubes of larger output.

The energy loss in heating the filament can be reduced to one-tenth, or even less than one-twentieth, of that necessary with a pure tungsten cathode by employing a "thoriated" tungsten filament under special conditions which have been the subject of study during the last few years.

The advantage of the thoriated filament is due to an absorbed film of metallic thorium on the surface of the filament, this film consisting of a single layer of atoms. The thorium as fast as it evaporates off the surface is supplied by diffusion from the interior of the filament. In utilizing this effect a particularly high degree of vacuum is desirable, or at least the presence of those gases must be avoided which would oxidize or otherwise combine with the very thin film of thorium. For this purpose the vapors of various reducing materials, such as magnesium, or alkali metals, such as potassium substances containing carbon have been used. Very successful results have been obtained in adopting this thorium filament in power tubes. At present the necessity of using this more efficient cathode is not very pressing, but with a future demand for high effi-

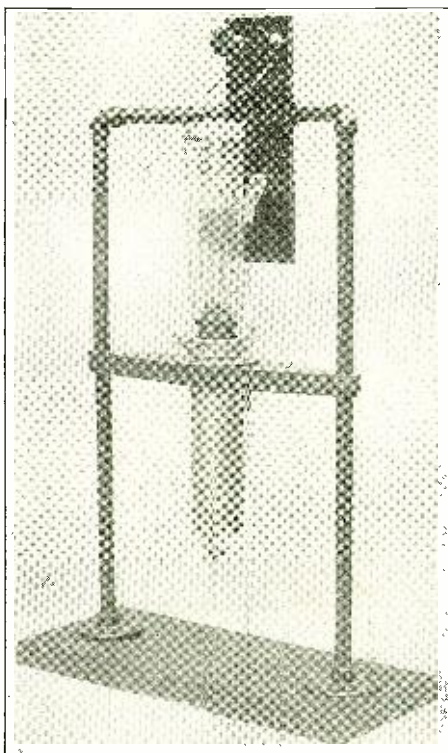

Fig. 1. Outside View of the 20-kw. Tube Which Has Already Been Manufactured in Large Quantities. It Is Known as the U. V. 207.

*Physical Review, Vol. II, page 450, 1913.

†Proceedings of Institute of Radio Engineers, September, 1915.

(Continued on page 1412)

Radio with the Public Utility Companies

By GEORGE J. GROPP

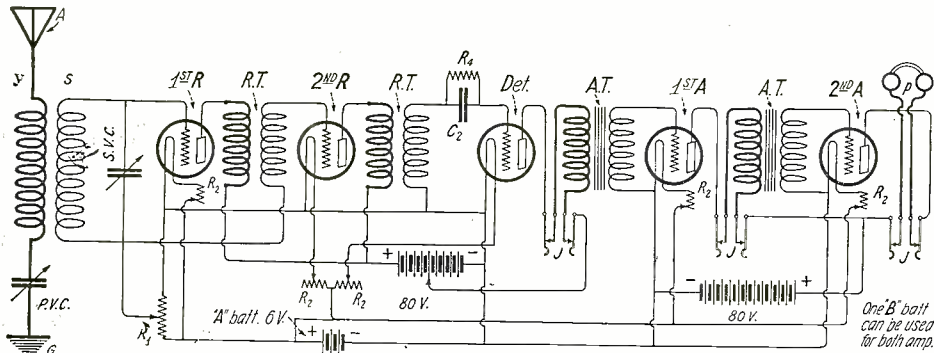

Fig. 1. This receiver consisting of two stages of radio frequency amplification, detector and two stages of audio frequency amplification gave very good results using the lighting line as an aerial.

EVER since Major General Squier announced his invention of "Wired Wireless," public utility companies have been experimenting with radio for use in their service lines. In the past four months The Richmond Light & Railroad Co. of Staten Island, New York, has done much radio research work on the uses that radio can be put to by a public utility company.

The first thing tried was wireless telephony, using lighting service wires as an antenna. A wire was fastened from the aerial post of the receiving set to one of the lighting service wires (the non-grounded side). One side of the line is grounded, therefore, a fixed condenser of .002 mfd. was inserted between the aerial post of the receiving set and the lighting service wire. This scheme met with success. In some instances the audibility of the music was as good on the lighting service wires, as it was on a one-wire aerial 110' long and 100' high. It was found that location of lighting service wires made a difference in the reception of signals. Service wires in high buildings and buildings with few outlets were found to give best results. These results were all obtained on vacuum tube sets, but could not be obtained with a crystal set. Among the receiving sets used were a Westinghouse Sr., Westinghouse Regenerative Receiver and Two-step Amplifier, a home-made regenerative receiver using variometers with three steps of audio frequency amplification and a Magnavox could be heard two blocks away. We notified consumers about the results by newspaper advertising and also helped them to attach their sets to the lighting service wires. This service was appreciated.

The next thing to be tried was the receipt of wireless telephone messages from a broadcasting station more than one hundred miles away and retransmit this broadcast on the same wave-length over a transmitting set which was attached to the lighting service wires. In this way consumers could enjoy concerts from distant broadcasting stations on a small vacuum tube set. The set with which we receive the broadcasts is a regular honeycomb receiving set with two steps of radio frequency, detector with two steps of audio frequency amplification. The hook-up is shown in Fig. 1. This set was used on the lighting service wires a loop aerial 4' square and two wire aeriels, one 80' long, the other 100' long, and each 100' high. The latter gave the best results. Some stations were receiving with the two aeriels parallel. The location of the aeriels was

ideal, being strung from a high smoke-stack to two derricks.

The transmitter is a 10-watt radio telephone transmitter using absorption modulation. The panel measures 15" square while the receiving panel is 15"x30". The panels are made of asbestos and coated with black switchboard lacquer

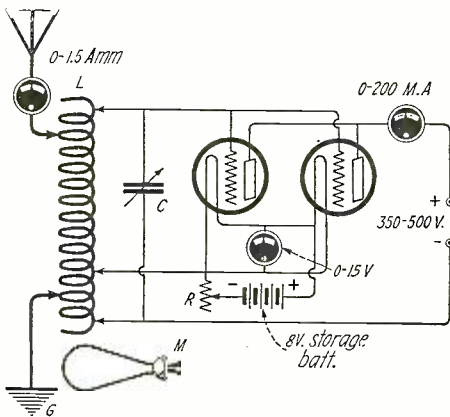

Fig. 2. The circuit of the 10 watt radio telephone transmitter is shown above. Absorption modulation is used.

which gives it the appearance of bakelite. The diagram of the transmitter is shown in Fig. 2. The high voltage for the plates of the tubes is obtained from the trolley service. The voltage is brought down by inserting a lamp bank.

It was decided to try working a receiving set with the alternating current supply for use as "B" battery and "A" battery. A special transformer was built to give one winding of 300 volts and two windings of 8 volts each. After many

transformer troubles, one was made to stand up. A UV-202 was used as a rectifier, which answered the purpose. A rectified voltage between 40 and 120 volts was obtainable by varying the filament brilliancy. When first tried, a loud hum was noticeable. After making adjustments on the potentiometers, "C" battery and putting in a 10-microfarad condenser, the hum was smoothed out. There was but a slight hum, but it was not objectionable. This is the kind of set people are looking for. In this way the public utility company can serve to its consumers its "A" and "B" battery source. More data will be available in the near future regarding results obtained with these sets. Advertising could be transmitted over the lighting service wires which would prove to be a bigger and better way than any now used. Also, portable sets could be made for linemen for communicating along the lines. The lighting service is supplied with all overhead wiring. The future of radio in the public utility company lies in the hands of the radio research worker. It is in the experimental stage and the possibilities in which radio can be used by public utility companies are unlimited.

NATIONAL BROADCASTER'S BUREAU

Revival of public interest in radio and a consequent boom in the industry was the consensus of opinion of Radio Broadcasters of the country, who met at the Hotel Sherman, Chicago, October 16, to organize a National Broadcasters' Bureau for the protection of their interests.

The gathering of radio men was somewhat startled by the straight-from-the-shoulder announcement of George S. Walker, president of the Western Radio Corporation, of Denver, who also operates Broadcasting station, WFAF, that 5,000 radio dealers are on the verge of bankruptcy and that something must be done to readjust conditions in the industry to save this small army of business men from the loss of their investment.

This statement aroused the conferees to a realization of the situation in the industry and brought out an expression of belief that the first of the year would see a renewed interest in radio by the public and the movement of radio supplies from the dealers' shelves. Mr.

(Continued on page 1324)

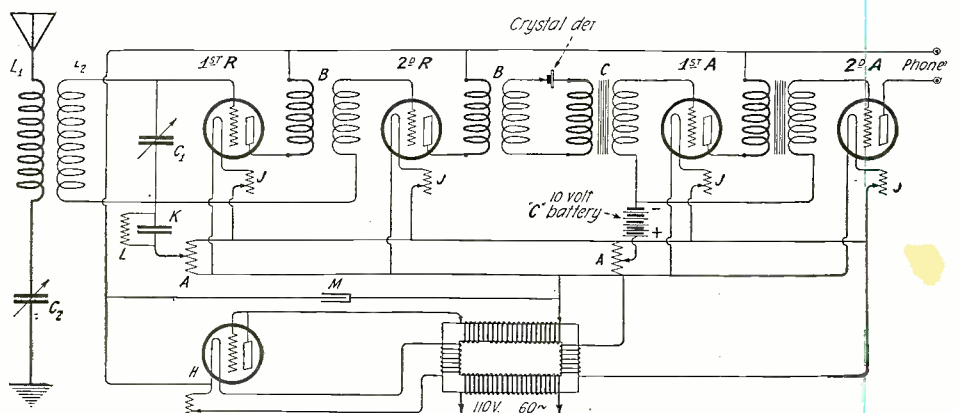

Fig. 3. Alternating current was successfully used in supplying the plates and filaments of the amplifier tubes. A crystal detector was used for rectifying the incoming signal energy.

A Selective Long-Wave Receiver

By MARIUS THOUVAIS

WHEN receiving continuous waves, which are sent at a frequency far beyond the limits of audibility, it is necessary to have a local oscillator at the receiving station interfering with the incoming waves so as to make them audible by producing beats at a musical frequency. The local oscillations can be produced either by a separate low-power oscillator, (Heterodyne), or by the receiving circuit itself when the detector is a vacuum tube (Autodyne). This latter method (Armstrong's regenerative receiver) is used in most receiving sets as it is simpler than using a separate heterodyne, and, at the same time, is somewhat more efficient on account of the amplification of the regenerative effect, which, while it reduces grid damping, increases the sharpness of resonance, thus giving a greater sensitivity.

It is clearly evident that with either method, in order to get the beats at a musical or audible frequency the wave-length of the local oscillator must be slightly different from that of the transmitting station. This is all right when using a separate oscillator, as the proper receiving circuit remains tuned to the exact wave-length being received, but it is not so when the interfering oscillations are

A Receiving Set Employing Both the Autodyne and Heterodyne method for Continuous Wave Reception. In this Combination, the Regenerative Effect is Retained and the Advantage of the Heterodyne Incorporated.

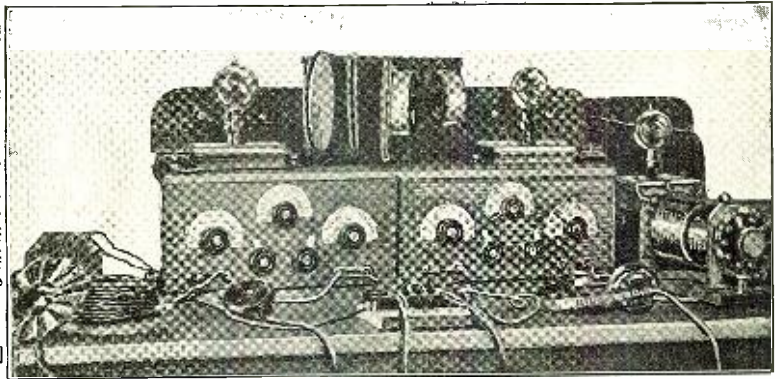

is exceedingly small, as every one knows it is less than 0.5 per cent up to 1,000 meters, and it is, therefore, negligible. This mistuning increases quickly with the W-L, and when we reach long waves the detuning becomes so great (it increases up to 6 per cent about 1,000 meters for 15,000 meter-waves) as to cause a considerable loss of efficiency. If we consider the sharpness of resonance of C.W. and of audion receivers, such a mistuning

of coming back to the separate heterodyne. However, when relinquishing the autodyne method we at the same time lose full benefit of regeneration and it is astonishing that so few experimenters realize the great advantage that can be gained by using both autodyne and heterodyne at the same time.

The writer used this method for a long time at his own receiving station and found it extremely effective for all long-wave stations and particularly for American ones. The photograph, Fig. 1, shows the appearance of the set, which consists of two similar wooden boxes; the first one is the long wave regenerative receiver and the second is the heterodyne unit. If we use the usual ready-made heterodyne it is necessary to use separate plate and filament batteries for each of the two tubes, but with the special hook-up, Fig. 2, the same batteries can be satisfactorily used for the two circuits, the autodyne receiver and the C.W. oscillator at the same time. It is well to point out that the waves produced by the heterodyne need not be strong and a low-consumption bulb can be used with quite good results.

It requires extremely fine adjustments to get the best of such a combination; after having tried the receiver and the heterodyne separately and optionally calibrated both, the whole circuit may be tried in the following manner: First, tune the receiving circuit as approximately as possible on the W.L. of the station it is desired to listen to, leaving reaction coil far enough from tuning (Continued on page 1386)

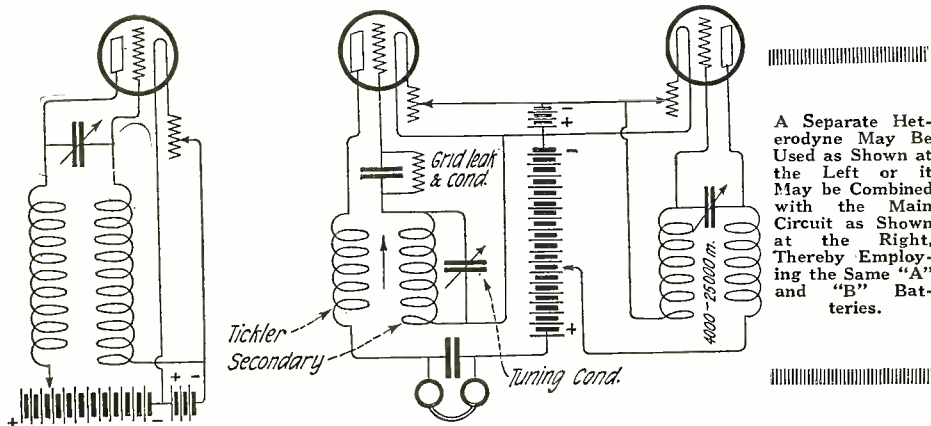

A Separate Heterodyne May Be Used as Shown at the Left or it May be Combined with the Main Circuit as Shown at the Right, Thereby Employing the Same "A" and "B" Batteries.

produced through the receiving circuit itself and here the receiver can no longer be exactly tuned on the incoming signals. However, when receiving short waves the detuning necessary to get a musical pitch in the phones

can no longer be accepted. The fact is too well known to need further comment and quite a lot of experimenters have pointed out the inefficiency of autodyne receivers for long C.W. and have shown the necessity

The Static Question

By Ray Dio

STATIC is emphatically a misnomer! Static, according to Webster "pertaining to bodies at rest or in equilibrium", means that we do not hear any STATIC in our wireless receivers, but merely the discharge of static electricity which has accumulated to the point where the potential permits it to bridge a certain gap of resistance and thereby create what I term Static waves.

Is this in any way different from our present laboratory methods? We simply charge a condenser until its potential reaches a point where a certain resistance (between the gap electrodes) is broken down. Do we call this STATIC ELECTRICITY? No! Well, then why refer to the waves generated by natural effects STATIC? Was not our electricity while storing in the condenser actually static electricity? Yes!

The whole trouble with the static situation and the reason why we SHALL NEVER TOTALLY ELIMINATE STATIC FROM OUR WIRELESS SYSTEMS is that we have actually reproduced the static discharge and created waves with apparatus similar to the methods employed by mother nature. AND NOW, FOOLS THAT WE ARE, WE STRIVE IN VAIN TO ELIMINATE THE WAVES WE ARE REPRODUCING. IT IS JUST AS EASY TO DEVISE A PERPETUAL MOTION MACHINE WHICH WILL GENERATE POWER. If you care to amuse yourself—try either one. It will satisfy your curiosity.

To reduce interference from static waves is a very easy matter, and the theory I propound regarding the way in which it is accomplished should be clear to every reader.

Every wave, whether it be that generated by nature or by one of our transmitting devices, comprises two well defined components, i. e., 1. The electro-magnetic component and, 2. The electro-static component. This is clearly depicted in Fig. 1.

(Continued on page 1387)

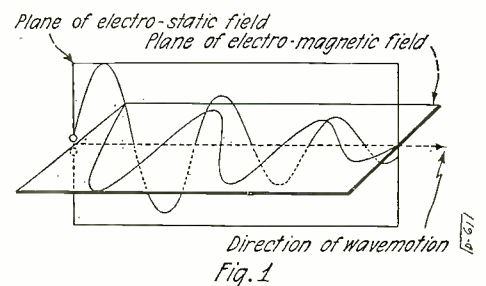

Fig. 1

The Electro-static Field and Electro-Magnetic Field Are Propagated at Right Angles to Each Other.

WIRELESS WAVE		TABLE 2		STATIC WAVE	
Electromagnetic Component	Electrostatic Component	Electromagnetic Component	Electrostatic Component	Electromagnetic Component	Electrostatic Component
60%	40%	40%	60%	60%	40%

The Electro-Static Loud Speaker

By MICHEL ADAM

THE principle of the electro-static telephone was given about fifty years ago by Doctor Gray. This principle may easily be demonstrated by means of a simple experiment. An induction coil, the vibrator of which buzzes at a musical frequency,

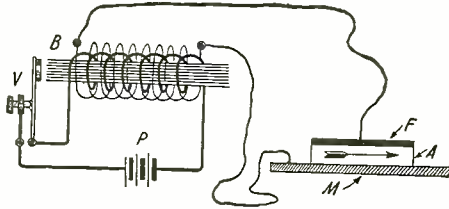

Set-up Used by Dr. Gray in His First Experiments: A, Piece of Slate; M, Metallic Plate; F, Metallic Sheet; B, Spark Coil.

has one end of its secondary circuit connected to a metallic plate, while the other end is held in the hand of the operator who applies his other hand to the metallic plate. Under these conditions, it will be noticed that the surface of contact between the operator's hand and the metallic plate reproduces the sound of the vibrator. A few remarks regarding this experiment will not be amiss. The secondary tension of the coil must be rather low as the current passes through the operator's body. It is, therefore, recommended to use only in the primary circuit of the coil, a low voltage such as that produced by one or two dry cells. It is also necessary that the hand of the operator be thoroughly dry, otherwise he must only touch the metallic plate with his nails. It will be noticed that during the experiment, the pressure of the operator's hand upon the metallic plate will be increased in spite of his will when the current passes through his body.

The same results may be obtained by replacing the finger by a small piece of slate, A, Fig. 1; one surface is thoroughly dry and in contact with the metallic plate, M. On the other side of the slate another electrode of large surface, which may be a thin metallic plate, is applied against the other side of the slate which should be wet. It may be noticed, again, that when the current passes through this outfit, the slate will stick against the metallic plate and that the sound of the vibrator reproduced in this system increases in volume as the speed of motion of the slate upon the plate increases; it practically ceases when the slate is at rest. The experiment may be more easily carried out by using instead of the metallic plate a cylinder which rotates while rubbing against the slate. The phenomenon demonstrated by the experiment just described, appears only under the influence of rather high tension and low current. They are of an electro-static nature.

It is well known that two electric charges of different names, i. e., positive and nega-

tive, attract each other. If we apply this phenomenon to a condenser which may be composed of two parallel armatures separated by a dielectric sheet, the armatures are charged equally of opposite signs, the value of which is proportional to the capacity of the condenser.

These electric charges attract each other with a strength proportional to the square of the tension applied; to the square of the surface of the armatures, and inversely proportional to the fourth power of the distance between the armatures, see Fig. 2.

Suppose, for instance, that the condenser used is charged with a tension of 300 volts and has two armatures of 10 square centimeters, separated by a distance of one millimeter; according to the nature of the dielectrics interposed between the armatures the attraction will be about 0.7 kilogram for air, 3.5 kilograms for mica and 7 kilograms for glass. It will be noted also that the attractive power is the same, regardless of the polarity of its plate, as shown in Fig. 3. In this diagram it may be seen that as long as one armature is charged, whether with the potential, $+V$ or $-V$, the charges are equal. This result is easy to explain, as the armatures are of the same size and the attraction merely depends upon the sign of the elec-

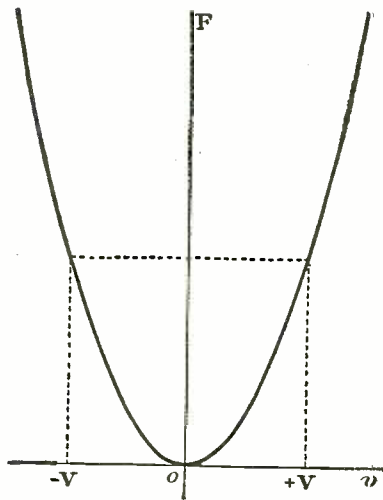

Variation of the Attractive Force "F" in Relation to the Tension "V" Across the Condenser.

tric charges. Another point which may be noted is, if the attraction increases rapidly as the tension or the surface of the armature is increased, it becomes much stronger as the distance between the armatures is decreased. This last point leads to the reduction of the thickness of dielectric, but the practical limit is soon reached, determined by the rigidity of the dielectric material.

ELECTRO-STATIC TELEPHONE WITH LIQUID DIELECTRIC

This principle was applied a few years ago in a type of telephone with a liquid dielectric. The condenser was constituted in the following manner. One of the armatures was a metallic cylinder, part of which was immersed in oil, see Fig. 4. Upon the cylinder was applied and stretched a metallic ribbon, L, held in place at one end by a spring, R, and at the other by a screw fixed in the center of the diaphragm, D. In this system, when the cylinder rotates, the thin layer of oil covers the surface and constitutes a dielectric between the ribbon and the cylinder. The system thus composed is a rotating condenser. If a tension is applied across this condenser, for instance, by

means of a transformer, T, the attracting force, as was explained previously, causes the ribbon to stick on the cylinder which therefore tends to pull it. However, since the ribbon is held in place, it goes back to its position as soon as the condenser is discharged. By referring to the diagram, it will be seen that the various charges of

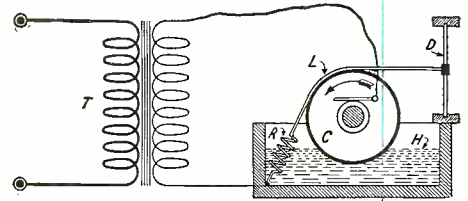

Details of the Electro-Static Telephone Having a Layer of Oil as the Dielectric.

the condenser produce a pulling effect of variable strength upon the diaphragm, D, which in vibrating, reproduces the sound transmitted.

It should be noted that the attraction of the armatures is sufficient only when a rather high tension is applied to the condenser, making it necessary to use some step-up transformers. It is also necessary, in order that the system be practical, that the motions of the diaphragm correspond exactly to those of the microphone. This is not possible when the variation of current produced by the microphone is directly applied to the condenser, for the attracting forces are proportional to the square of the difference of the potential applied. It is, therefore, necessary to make this device work, to superimpose these variations to a fixed tension, the amplitude of which is considerably greater. Under these conditions, variation v of the total tension, which is always in the same direction, produces variation f of the attracting force F .

Such a device may be used as a loud-speaker if the diaphragm is of suitable size, and if the attracting forces are sufficient, and also as a recorder when a pen is mounted, as shown in Fig. 6; the vibration of the diaphragm being transmitted to the pen transcribing the signals into a wavy line upon a strip of paper passing under it.

ELECTRO-STATIC TELEPHONE WITH SEMI-DIELECTRIC

This new apparatus recently invented permits much greater effects to be obtained than are possible with the first electro-static telephone described. The principle of functioning is determined by a peculiar operation of semi-imperfect dielectrics, which was shown in the experiments carried out by Doctor Gray and especially developed by the work of two Danish scientists, Messrs. Johnson and Rahbeck. The imperfect dielectrics are those which may be classified as dielectrics as well as conductors. When a piece of such a dielectric is connected in an electric circuit it produces a very high resistance,

(Continued on page 1415)

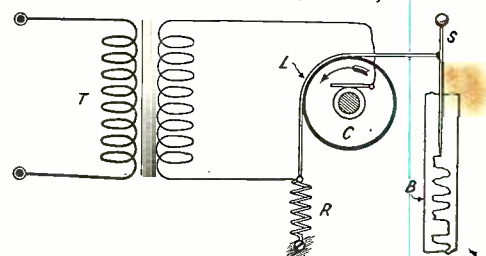

Using an Electro-Static Telephone as a Recorder.

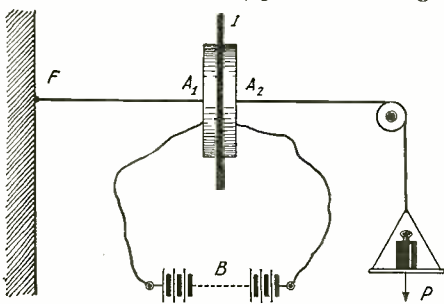

Showing the Attraction Developed Between the Armature of a Charged Condenser. I, Dielectric; A1 and A2, Armatures; B, Battery; P, Weight

Market Reports via Radio and Wire

By JOHN F. BRONT

RECEPTION of market and weather reports by radio, and their subsequent transmission over the telephone by speech and by buzzer, is becoming the vogue in some districts where there are a number of outlying components of a community surrounding a central point where a broadcast radio receiving station is located. In this manner the amateur station possessing the necessary radio receiving station may receive the reports through the air, and then transmit them to individuals having no radio installation. This procedure gives the valuable reports to those who would be unable to receive them otherwise, unless specially carried by hand.

Without special training, it is rather difficult for the average person to receive and accurately transcribe reports sent by voice over the phone, except when sent very slowly by the spoken word, and many repetitions are then necessary to enable the listener to transcribe the reports accurately. Especially in rural communities where the grounded line telephones are noisy and inefficient, and generally unsatisfactory, speech transmission except over short distances is difficult. In rural communities, too, the average person has not the aural sensitiveness to quickly and accurately grasp a spoken mass of figures and names sent in rapid succession, because their ears are usually accustomed to other sounds more in keeping with their daily tasks.

In localities where persons are more accustomed to the telephone, such as that of the regular phone companies using standard equipment, the transmission of radio received market and weather reports is more easily accomplished. In the far outlying districts, such as those points in the west and central portions of the country where there are no regular telephone services and the communication of the district may be carried on by means of the much used barbwire fence lines, or perhaps no phone connections of any description, the transmission of weather and market reports is a difficult task, without the possession by the individual of a radio receiver.

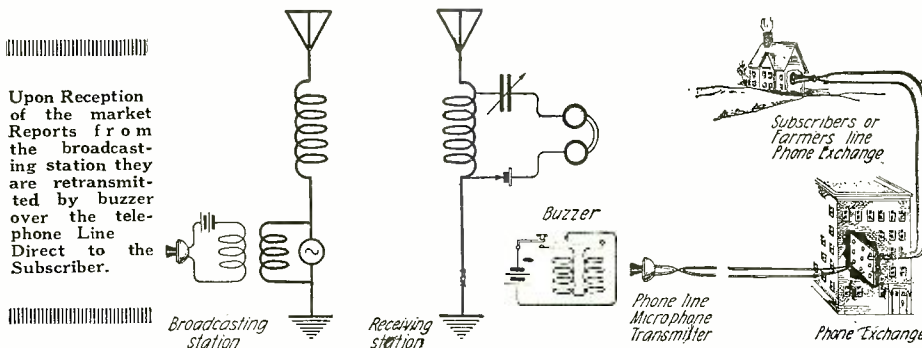

In the case that connection with the local farmers' lines is available at the switchboard of the standard phone companies, there is a ready means of transmitting the market and weather reports from a central radio receiving station by means of the buzzer. The latter is placed either in actual mounting contact with the microphone of the telephone at the radio receiving station, or in close relation with it so that its vibrations will effect the line current, and connections plugged through from the standard phone lines to the farmers'

lines, where the lads may copy the code over the noisiest (barbwire fence) lines in existence, if they are trained in receiving at a medium or low rate of speed. In practice the reports may be sent over the lines at a high rate of speed for the more advanced copiers, part of the transmission being really copied by the less trained operators and then the matter sent at a low rate of speed for the less trained receivers.

A real practical application of this radio (buzzer) telephone line scheme is shown in the work of a Canadian coast station. There the city office of the radio company is situated in the center of the city. The radio station lies outside of town on the water's edge. All the traffic is received at the station from ships and land stations by radio, then put on the wire by the use of a buzzer attached directly to the microphone of the telephone connection instruments. The operator calls the city office, changes over to buzzer and sends in the traffic at a high rate of speed. The clerk in the city who is also an operator copies the messages directly on the typewriter, ready for distribution to the addressees. The telephone connection is a necessary adjunct to the station anyway, and the company has adopted this scheme to gain full benefit from the wire connection, to facilitate their handling of business, and at the same time save the expense of a leased private wire for Morse operation or the construction of their own individual line, which would cost thousands of dollars.

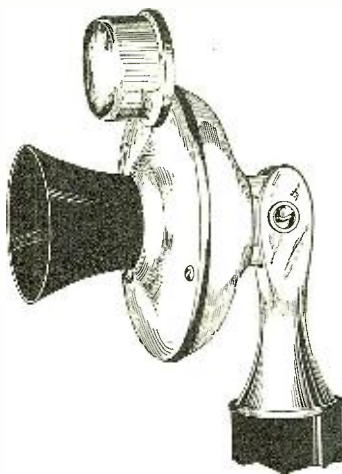

By Mounting the Buzzer on the Microphone, Its Vibrations Will Effect the Telephone Line Currents.

Some Practical Points in Amplifier Operation

By Bernard Steinmetz

THE amateur or novice frequently stumbles across a phenomenon which interferes with the operation of his set. This is especially the case when he is operating a regenerative set and amplifier, as regenerative effects make their appearance in amplifiers and give rise to such annoying disturbances as howling. A discussion of some of these things may not be amiss, therefore, and may be of help to those struggling with the strange manifestations of a sensitive receiver.

About the greatest nuisances that the novice has to contend with are the strange noises which he hears in the phones when adjusting his receiver. Assuming that he is not using an amplifier (the amplifier will be discussed later) these noises will generally be found to be caused by starting and stopping of oscillations which is due to incorrect values of grid condenser and leak.

While the receiver is in the oscillating state the grid has an average negative potential, which must be given a path for leaking off or else it will block the passage of the plate current. This leakage path is provided by the grid leak and the rate at which the negative charge on this leaks off depends upon the value of the grid condenser and leak. If the leak has too high a resistance, the charge leaks off too slowly, with the result that oscillations stop. During the period that the oscillations have ceased, the leakage still continues until the grid potential has again assumed a value permitting oscillations. Oscillations then commence until the above performance is repeated. This starting and stopping of oscillations may take place at an audible rate and results in the peculiar noise generally heard in the phones. The rate at which this takes place is what determines the pitch of the noise heard. The rate of starting and stopping

of oscillations is determined by the time constant of the grid condenser and leak combinations. The greater the values of resistance and capacity, the lower will be the pitch, and vice versa. By varying the values of leak and condenser, the note can be varied from individual clicks widely separated to a continuous high shrill note and even beyond to the inaudible stage. From this it will appear that it is best to use a variable grid condenser and leak and adjust these values until proper operation is secured. This is much more preferable than using a fixed condenser and leak, since each tube requires certain values for maximum efficiency, and these can best be secured by trial.

Frequently it will be found that the above tube noises can be traced to too tight a tickler coupling, and since feedback coupling varies with the wavelength used, it often happens that when

(Continued on page 1380)

Selectivity

By W. PALMER POWERS

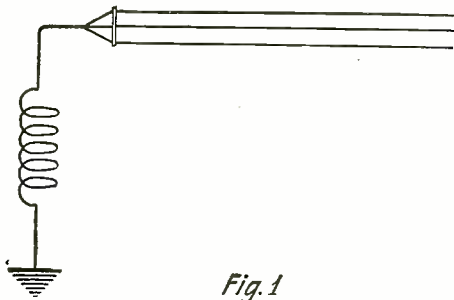

Fig. 1

Simple Form of Antenna Circuit, the effective Resistance of Which, However, is Quite Complex.

SELECTIVITY is without doubt the most desired characteristic of the receiving apparatus today. With the number of broadcasting stations rapidly increasing, the situation confronting those who desire to enjoy radio receiving is rapidly becoming alarming. A few months ago, when broadcasting first attracted the public, almost any sort of device was acceptable as a receiver. Today, as a result of this, there are thousands who, having purchased these cheaper receivers, are now compelled to give up in disgust because of the many broadcasting stations operating nearby on the same, or slightly different, wavelength. It is indeed unfortunate that the short-range receivers are as a rule the receivers to lack selectivity. Thousands of crystal sets were sold for use within 20 miles of the broadcasting station. They were expected to receive signals (and some of them did), but selectivity was an item of little consideration. In fact, some made remarkable claims as to the possibility of receiving simultaneously signals from two stations. Selectivity is vital in any receiver because without it satisfactory operation is impossible. Distance cannot be obtained if local interference is present. Selectivity is most difficult to obtain when the interference is strong. This us-

ually means that the receiver is near the source and, therefore, like thousands of others, it is quite likely to be one of the cheaper non-selective receivers. It is the purpose of this article to discuss a method which in many cases may be used to improve the selectivity of these simple sets. The discussion will be purposely confined to the simple circuit because it is the circuit which gives the least selectivity, and at the same time it is the circuit which has met with the greatest demand because of its low cost.

THE PROCESS OF TUNING

The process of tuning or adjusting a circuit to receive a certain signal is simply the manipulation of the circuit

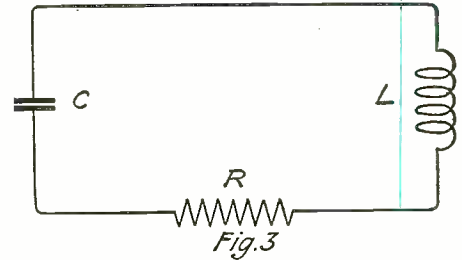

The Simple Circuit Shown in Fig. 1 Is Approximately Represented by the Above Circuit.

so as to reduce the opposition in the circuit (for the particular signal) to a minimum. In order to exclude a signal, we must establish an opposition in the circuit. The selective receiver is the receiver which reduces to a minimum the opposition for the desired signal, and at the same time, establishes considerable opposition for the undesired signal.

NATURE OF OPPOSITION

A radio wave as it passes through the receiving antenna, generates in the antenna a certain electric pressure. This pressure, operating on the antenna circuit, will cause a corresponding current to flow. The magnitude of the current will, of course, depend upon the opposition encountered in the circuit. Just as water flowing through a pipe meets opposition in the form of pipe-line resistance and certain back-pressures, we find that the feeble electric currents in the antenna circuit are obstructed by actual resistance of the system and by certain counter-electric pressures.

ANTENNA RESISTANCE

The effective resistance of a simple circuit (Fig. 1) is quite complex, being composed of the actual resistance of the wire plus terms which include the effect of ground losses, losses in the system and losses in structures under the influence of the system. The resistance of an antenna is, therefore, dependent upon the installation conditions, and one

(Continued on page 1352)

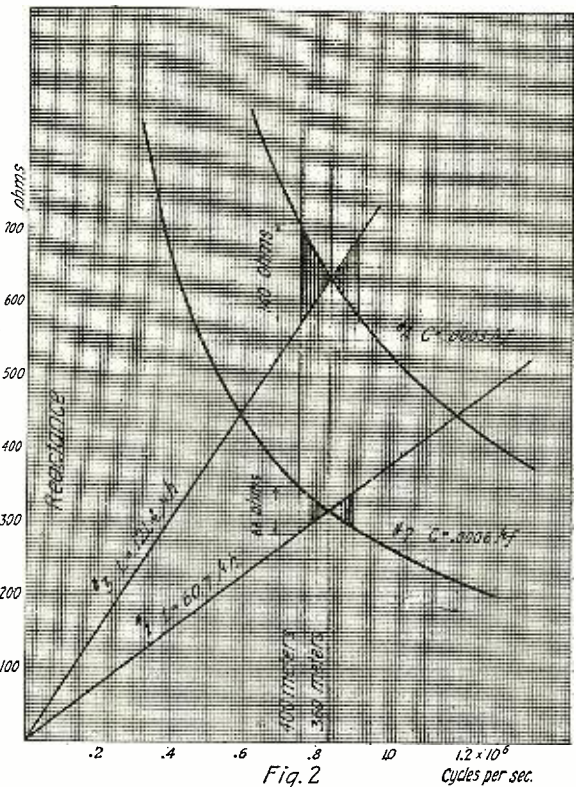

Fig. 2

Curves Designating the Reactance of a Circuit in Relation to Various Frequencies. Shaded Portions Denote the Effective (total) Reactance.

Capacitive Coupling for Long Wave Regeneration

By John F. Bront

IT is usual for the average radio experimenter to follow the beaten path in the construction of a receiver which will function satisfactorily on both the shorter as well as the longer waves. The short-wave adjustments bring in the broadcasting programs below 600 meters, and the longer waves carry the signals from high powered domestic and foreign stations to the listener. Some of the wave-lengths of many of these long distance stations are above 10,000 meters and it is usual that the experimenter employs the inductive coupling to obtain beat notes on these wave-lengths, as well as for those of higher frequencies and, therefore, lower wave-lengths. It is definitely demonstrated that the tickler or inductive coupling between the grid and the plate circuits functions very well on the shorter waves. The variometer coupling, or rather tuning

scheme, is well applicable for best results on the extremely low waves, yet it is really no more nor less than an adaptation taken from the inductive loose coupled plate and grid system of obtaining results which in this case is the

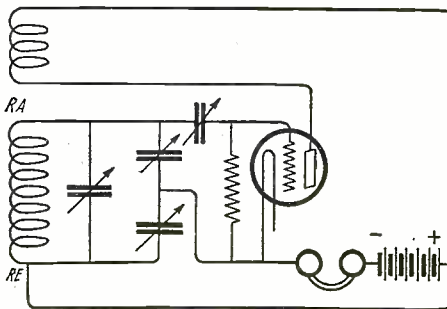

A Circuit Employing Tickler Feed Back and Capacitive Coupling.

beat note. The effect is the same in the end.

Capacitive coupling between the plate and the grid is not much employed in amateur receivers, and it is deplorable that for the longer waves it has been foregone in order to use the tickler scheme. The advantage of the capacitive coupling especially on the longer waves is that it appears more stable and the result in the audibility of the received signal is most satisfactory. Another item is that it is quite flexible and easy to adjust, the ease of adjustment progressing as the frequencies of the received waves grow in a downward direction. That is the longer the wave the better the capacitive regenerative scheme will work and the less critical the settings of the capacity or capacities employed for the coupling. One reason

(Continued on page 1356)

Radio Head Sets

By JESSE MARSTEN

DURING the past six months there have come into being almost one hundred different manufacturers of radio headsets, and as is to be expected, some are good and some not so good. The internal construction of most of the head sets, with exception of a few minor mechanical design modifications, are alike. They are all rated by their ohmage, 2,000 or 3,000, or whatever

heralded as a great "radio improvement," and will be talked up by the manufacturer of the head set to the exclusion of such prime essentials as the sensitivity of the telephones. It is amusing to listen to the average salesman tell his selling points—how wonderfully light this headband is, how well the ear caps fit the ear, how beautiful the head set looks, the highly polished nickel plated metalware—and then gloss over or forget entirely such trivial matters as the sensitivity and performance of the phone.

Those experienced in radio are able to separate the chaff from the wheat, but the average lay enthusiast is not, and so is often taken in by such talk as given above. It might, therefore, be timely to give here in a brief and limited way an outline of the simple theory of the telephone receiver to show what factors determine its sensitivity; to explain wherein lies the significance of the resistance of the phones; to discuss design features of the head set and what goes to make a good head set.

The theory and operation of the radio head set is the same as that of the telephone receiver used in wire telephony. The construction is somewhat different from that used in telephone booths and desk stand telephones, but is practically the same as the one used by the central station operator. Fig. 1 shows schematically the construction

net coils CC. These are generally wound on a bobbin first, and then slipped over the pole pieces. Resting on the top of the watch case container and just over the pole pieces is the telephone diaphragm D, which is generally of soft iron or tin, shellacked on one side and enameled on the other. The internal parts are then completely enclosed by means of the ear cap E which screws onto the containing case.

The action of the telephone receiver may be simply explained as follows: When there is no current flowing through the magnet coils CC, the magnets MM

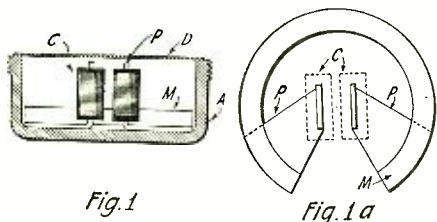

Fig. 1

Fig. 1a

The Internal Construction of the Receiver Is Shown in Fig. 1 and Fig. 1a.

the case may be, from which very little can be told as to the quality of the phones.

Before this period there was just a handful of reputable head set manufacturers and their claims could be relied upon. In that stage of the development of the radio art when only crystal sets were in vogue and radio communication had to be maintained between stations, good head sets were a necessity. Good head sets were, therefore, produced. But with the advent of the boom and the appearance of carloads of miscellaneous junk on the market, many head set manufacturers were content to put their O. K. on telephones which gave a loud signal when tested in back of a regenerative receiver with a two-stage amplifier a couple of miles away from a powerful broadcasting station. It is not surprising, therefore, that bad head sets were produced, since even bad telephones will give a fair signal under such conditions.

It is safe to say that a number of the new makers of head sets are not really familiar with the theory and design of telephones, in fact had never before manufactured telephone equipment requiring electrical design. They were perhaps good tool and die makers. They had presses which were standing idle. Coil winding machines were easy to make. Steel, wire, fibre, etc., were procurable. There was an unprecedented demand for head sets; hence they made telephones. It is as though one who had the tools for, and experience in, slaughtering cattle, felt himself qualified to perform surgical operations on human beings.

A good deal of what passes for radio and electrical design is very often nothing more than small mechanical changes or variations in standard approved apparatus. Illustrations of this contention are so numerous and obvious to those familiar with radio apparatus that mention of this is almost unnecessary. Thus a new headband for telephone or a novel method of connecting the telephone cords to the magnet coil windings will be

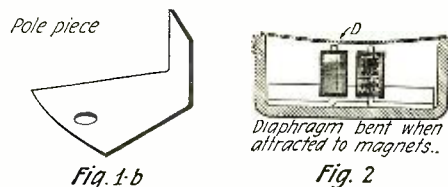

Design of the Soft Iron Pole Piece. Fig. 2 Designates the Influence on the Diaphragm When a Current Traverses the Magnet Coils.

exert a certain force upon the diaphragm D, thus attracting it to the pole pieces. In this condition the diaphragm is, therefore, slightly bent as in Fig. 2, (usually called "dished" position). When a current flows through the coils a magnetic field is set up, due to this current. When the current flows through the coils in one direction its magnetic field adds to the field of the magnet MM and hence the diaphragm is attracted with a greater force than originally. When the current reverses its direction through the coils, its magnetic field opposes that due to the magnet MM, and hence the diaphragm is attracted with less force than originally which is equivalent to a repulsion from its original position. Furthermore, the amount of this attraction or repulsion depends upon the strength of the current flowing through the coils. In this way a to and fro vibratory motion is imparted to the diaphragm, this vibratory motion being in harmony with the variations of the current flowing through the coils. But the variations in the current are simply electrical reproductions of the transmitted sound, be it signal or speech. Hence the vibratory motion of the diaphragm will result in the reproduction of the original sound.

The amplitude, through which the diaphragm vibrates, determines the loudness of the signal; the greater the amplitude the louder is the signal. As implied in the previous paragraph this amplitude depends upon the force with which the diaphragm is attracted to the magnet pole pieces. Without going into the mathematics of the problem, we may say that analysis shows that this force depends directly upon two factors: one, the strength of the permanent magnets MM; and two, the strength of the magnetic field created by the current flowing through the coils CC.

1. Strength of permanent magnets. The sensitivity of the telephones increases with the strength of the magnets MM. Hence magnets are made as strong as possible. (Continued on page 1326)

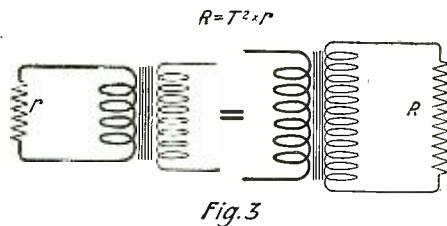

Fig. 3

A Resistance in the Low Tension Winding of the Transformer Is Equivalent to the Same Resistance Multiplied by the Square of the Transformer Ratio When Transferred.

(internal) of the average telephone receiver. The container is generally of the so-called watchcase type, that is, a shallow cup made of moulded insulation or of such non-magnetic metal as aluminum. Fastened to the base of the container is a permanent magnet MM—shown in detail in Fig. 1 (a)—this is usually circular in shape. To each pole of this permanent magnet there is attached a soft iron pole shoe, the general design of which is shown in Fig. 1 (b). Due to the magnetic influence of the permanent magnet MM the pole shoes PP are also magnetized, one pole shoe being a North Pole, the other a South Pole. Around these poles pieces are wound the receiver mag-

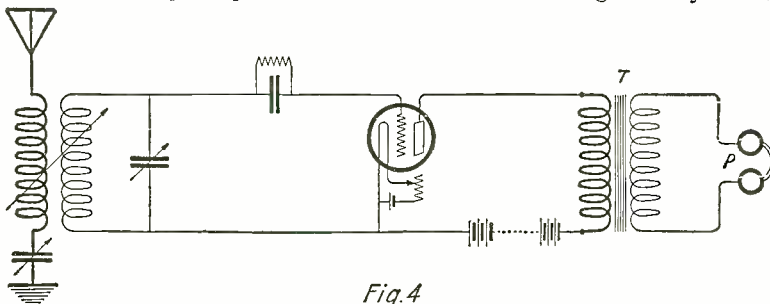

Fig. 4

A Vacuum Tube Receiving Circuit Incorporating a Step-Down Transformer in Conjunction with a Pair of Low Resistance Phones as Described in this Article.

National Radio Week

A preliminary announcement of *National Radio Week* appeared in the December issue of RADIO NEWS.

Recently at a luncheon given at the Bankers Club in New York, all the editors of the most important radio publications met and discussed ways and means of getting the public better acquainted with Radio. It was decided that a *National Radio Week* should be held during the week of December 23 to December 30. The suggestion met with the instant approval of all concerned, as it is appreciated by every one connected with the radio industry that something should be done to have the public at large more interested in Radio than they have been before.

Methods of doing this were discussed, with the following results: During *National Radio Week* every radio enthusiast should talk, think and dream of nothing but Radio. He should make it his business to acquaint all his non-radio friends with the great art.

der to awaken the lethargic public. Among these stunts mentioned were the following:

In the first place, it should be understood that *National Radio Week* is a national affair, and it has nothing whatsoever to do with any local center. It must be for the whole country. For that reason, it was realized that if, for instance, a great artist, such as Paderewski, should play, let us say at WJZ station, Newark, N. J., only a small percentage of the country at large would be able to listen in. Mr. Gernsback, for that reason, made the suggestion that the greatest artists, speakers, statesmen, etc., should be induced to speak during *National Radio Week* from a certain station, such as WJZ, at Newark, N. J. The entertainment, whatever its nature, should then be

It is appreciated that at the present writing there are some difficulties in thus relaying by radio concerts, speeches, music, etc., due to the modulation troubles that have not been overcome so far, but that the idea is at least feasible is best shown by the fact that nearly all of our large broadcasting centers are now retransmitting Government Time Signals which come in at a wave-length of above 2,500, retransmitting these signals at a wave-length of either 360 or 400 meters. Of course, the difficulties in re-transmitting spark signals are not so great as for the spoken word, but our best engineering talent is working overtime to solve the problem, and it will not be many months before President Harding, or any other great official, talking from Washington or elsewhere, will be heard simultaneously all over the country by relayed broadcast.

Another idea suggested by Mr. Gernsback was transmission off the roar of

BOOST NATIONAL RADIO WEEK

Everyone who owns a radio set, be it large or small, has a duty to perform. He should invite his friends to come to his house and listen to his set. If his set is not in order, he should invite his acquaintances to go with him to visit a friend who is known to have a good set. If every radio amateur, every radio "fan," every radio novice, would do this regularly, during *National Radio Week*, it would produce a result that even the most sceptical are not able to foresee. Today only one man out of twenty-five really knows about radio. Not one out of a hundred has been able to listen to a good radio set in the home. Of course, most of the population have heard loud-speakers in front of stores and have probably become discouraged on account of this. It is up to the radio enthusiast to correct this impression, and let his friends listen to real radio concerts, so that even the most sceptical will become converts to the art of Radio.

It makes no difference whether you are a "dyed-in-the-wool" amateur or a novice. The novice will wish to convert his friends to the radio telephone and broadcast, while the radio amateur if he really wishes to do something for the great art, will wish to convert his friends to code or at least explain to them the workings of his set, and show them what it is all about. The trouble with the amateur is that he keeps all the good knowledge to himself, and is, as a rule, not ready to impart the information to an outsider. All of this, of course, is wrong.

During the meeting before mentioned, Mr. H. Gernsback made the suggestion that in order to make *National Radio Week* a truly great affair, it would be necessary to do some real stunts, in or-

relayed to other broadcasting stations and retransmitted from these simultaneously. In other words, if Paderewski were playing in Newark, his music would be broadcasted from Pittsburgh, San Francisco, in fact from every broadcasting station at the same time. This is a thing that has never been accomplished before. It can be done by two methods: First, by relaying the entertainment by land lines from the center of distribution, or else Newark, N. J., could transmit the entertainment by radio at a higher wave-length, then all the other broadcasting stations, equipped with first-class receivers would retransmit the entertainment by radio.

THE TALKING NEWSPAPER

A recent development, showing how an ordinary newspaper can be made to talk loudly and distinctly so that it can be heard all over the room, is described in the January issue of SCIENCE AND INVENTION Magazine.

Niagara Falls, this to be retransmitted from all the stations so that the entire country could listen to the mighty voice of Niagara.

At the time this was written a number of great artists had already declared their willingness to help make *National Radio Week* a success, and there is no question that the first *National Radio Week* will go over big.

RADIO NEWS has prepared a beautiful three-color postal card, which is reproduced herewith, we are sorry to say, in one color only. It is executed in red, yellow and blue, and is a very striking work of art. No advertisement appears on the face whatsoever. These postal cards, for which there has been a tremendous call since we advertised them in the December issue of RADIO NEWS are to be sent to a friend or friends. If this issue gets into your hands before *National Radio Week* is over, we invite you to send for any number of these, within reasonable quantities. The cards will be sent to you free. All you have to do is write your name on the back, asking your friends or acquaintances to come over to your station at a certain time of the day. Then demonstrate your outfit to the non-radio men, and it is hoped you will make them converts.

If you wish to help the radio industry along, you might give the names of your callers to your favorite local radio dealer who, in turn, may work up the prospects and, it is to be hoped, sell them good sets that your friends will enjoy.

If every one of you radio enthusiasts would succeed in getting only one convert to radio during *National Radio Week*, this would be one of the best deeds imaginable.



Radio News has prepared a beautiful three-color postal card reproduced herewith. It is executed in red, yellow and blue and is very striking. No advertisement appears on the face whatever. Boost the first "National Radio Week" and make it a success. Get some of these cards and send them to your friends. They are free.

RADIO PICTORIAL

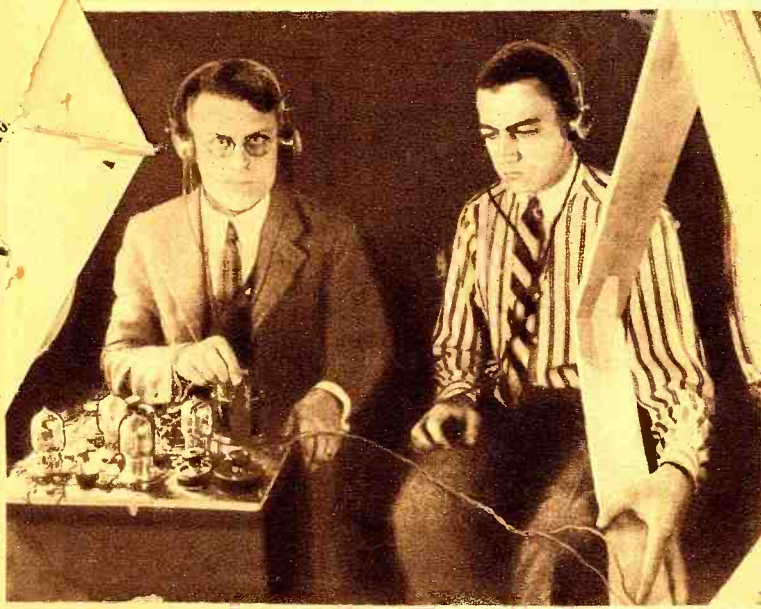

The Radio Room on an Aeromarine Flying Boat is Shown Above, with the Operator Listening In. Note the Loop Aerial. In the Upper Right-hand Corner is a View of the Rear Cabin on the Flying Machine in Which Are Installed the Apparatus. These Photographs Were Taken on Board the "Buckeye," Operating Between the U. S., Cuba and the West Indies. (c) Central News Photo Service

On the Right is Mme. Tettrazzini, Famous Opera Star, Who Recently Visited the Wireless Exhibition in London, and Was So Much Interested in Radio that She Purchased the Set Shown Here. From Her Expression She Evidently is Enjoying Something. (c) International News



Broadcasting is Everywhere; This is Shown by the Temporary Station Put Up by the Navy at the Polo Grounds, N. Y. City, Which is Pictured in the Lower Left-hand Corner. This was used to Send the Sailors Aboard Ship the Results of the Maryland-Delaware Football Game, a Feature of Navy Day. (c) U & U

Below is Shown How Time Signals are Re-transmitted from WJZ. The Arlington Signals are Picked Up by the Long-Wave Receiver on the Table and Made Audible Through the Loud Speakers Above. The Microphone of the Broadcasting Station is Then Placed Near and the Signals Go Out Again on 360 Meters. (c) K & H



A Novel Radio Desk



These two views of a Novel Type of Radio Desk Show How the Tuner, Amplifiers and Charging Panel are Mounted in a Stylish Cabinet. The Loud Speaker is Inside and the Horn Opens on the Side. Note the Doors of the Tone Chamber in the Lower View.

(c) Boston Photo News

A new Radio Desk has been perfected by a Boston man, that seems adapted to the homes of those who never have the time or inclination to bother with mechanics of any sort, especially the work of wiring and "hooking up" a radio receiving set. The new class of radio fans will be the women and the people who have fine living rooms that they do not want marred with an unsightly lot of wires and heavy acid batteries.

By means of switches and dials for readings, any child or woman without the slightest mechanical knowledge can handle the apparatus as easily as a phonograph and get perfect results in reception.

All wires are concealed in cables that run through the back of the panel. Only two outlets are used in the back, one for the loop or outside antenna and the other for the ground wire, leading



to the cellar. Once these are connected up the owner does not have to trouble further about connections. An ordinary plug for charging the "A" battery connected with the regular electric light current, which in most modern houses has a baseboard outlet for electric stoves, lamps or household electric machinery. There are no exposed wires. All wiring is complete within the panel.

Charging of the "A" battery is effected through an automatic transformer that steps down the current to the relatively low voltage required for battery charging and shuts off the current when the battery is fully charged. A filament is used in the panel, registering the amperage used by the tubes as well as registering the amperes drawn by the speaker amplifier. A left-hand thumb switch gives the amperes that

(Continued on page 1380)

My Trip in the Electron Bottle

By L. Hectron

LAST night, while listening to the program from WJZ, I was observing my vacuum tube and thinking how wonderful it was to have the music coming from the air transformed into audible sounds through the little lamp burning before me. I decided to find out more about it and how it was working, so I took a book, when the concert was over, and started to read how the vacuum tube works. At first it seemed simple, but the more I read the more complicated it seemed and I found myself, at about 12:30 P. M., plunging into electrons, positives, negatives, grids, plates, etc. The whole thing seemed to be mixed up and I stopped reading and tried to understand exactly the meaning of all this.

Suddenly the light in the room grew dimmer and I felt tired; all I remember is that two men came into the room. They were equipped with what appeared to be diving suits and funny outfits that looked like the gas-masks that we used to wear during the war. Without a word, one of the men gave me a similar outfit and helped me to put it on. Later,

I found that this was some special apparatus such as that used by the divers to obtain air while under the water. Then, before I could realize what was happening, I found myself in a tremendously big glass bulb. I could hear a hissing sound, but could not see anything around me! One of the men then touched me on the shoulder and pointing upward showed me the strangest spectacle I have ever seen.

On the left was a big luminous rod, as brilliant as the sun, from which could be seen small white bullets flying in space like drops of rain. On the right was a large, flat metallic plate which the small bullets were hitting. In the space between the luminous rod and the large metallic plate was what looked like a big pipe of zig-zag shape supported from the top. This, too, was vibrating and I could see the small white balls disappear as they touched the pipe. They seemed to melt one instant and to be repulsed the next, and at the same time, there arose a fog all around the luminous rod and the rain of the small balls upon the plate decreased in intensity. It was, indeed, a strange sight.

For a time, I observed what looked like a regular bombardment of a big tin plate by a million or so machine-guns attached to the luminous rod; then turning toward one of my companions, I pointed upward asking him for an explanation. Without a word, he took from his pocket a little book and opening it, pointed to a paragraph. This is what I read: "The filament, when connected to a source of current, becomes hot and emits in the surrounding space some electrons. These electrons, which are negatively charged, are, of course, attracted by the plate which is positively charged by means of a high tension battery. The grid or third element in the tube is interposed between the filaments and the plate, acting as a shutter which may be closed and will consequently stop the electrons midway, preventing them from reaching the plate. When the grid is itself positive, it acts as do the plates, that is, it attracts the electrons. However, the surface of the wire composing the grid is small in

(Continued on page 1383)

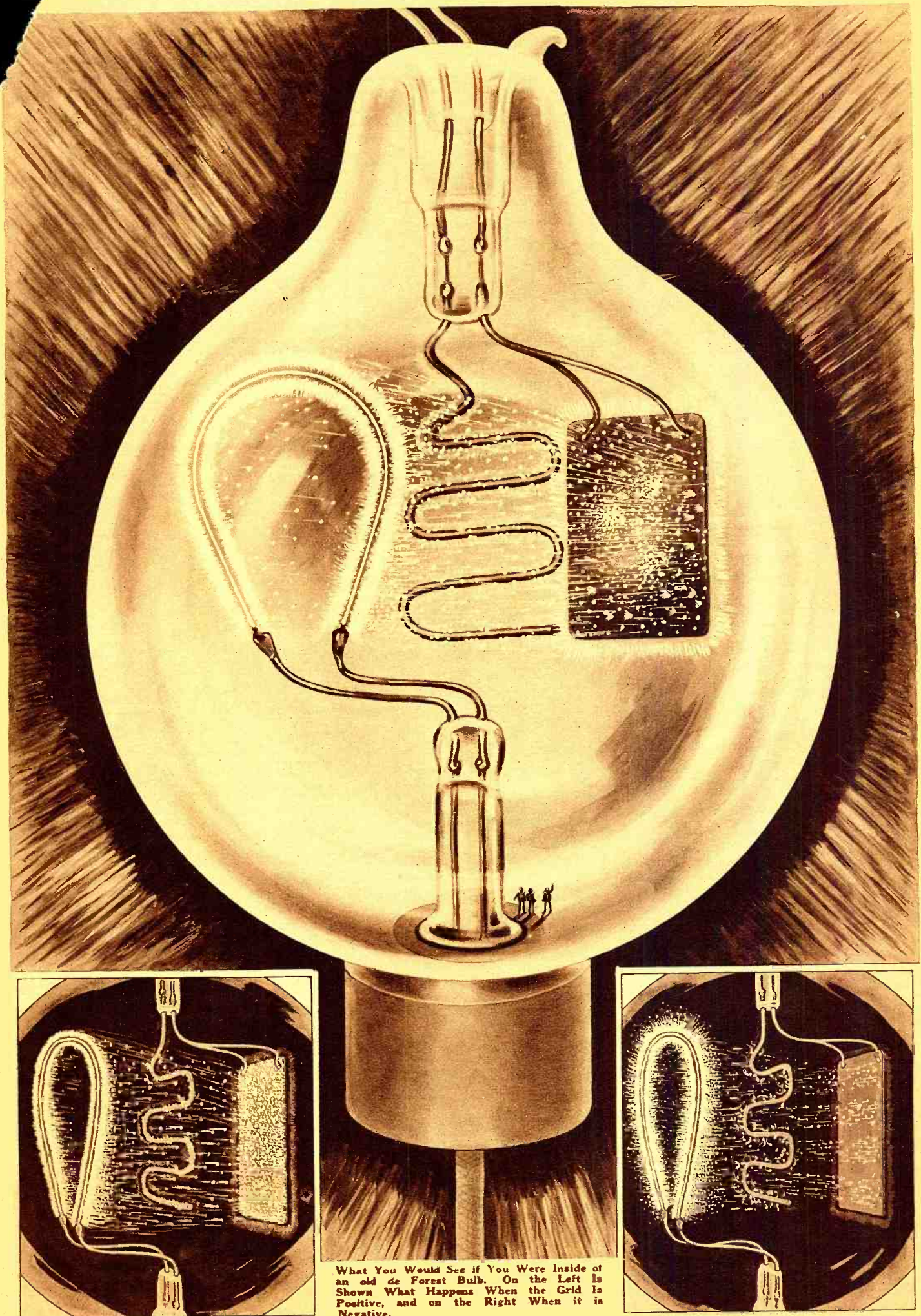

What You Would See if You Were Inside of an old de Forest Bulb. On the Left is Shown What Happens When the Grid is Positive, and on the Right When it is Negative.

Radio Pictorial

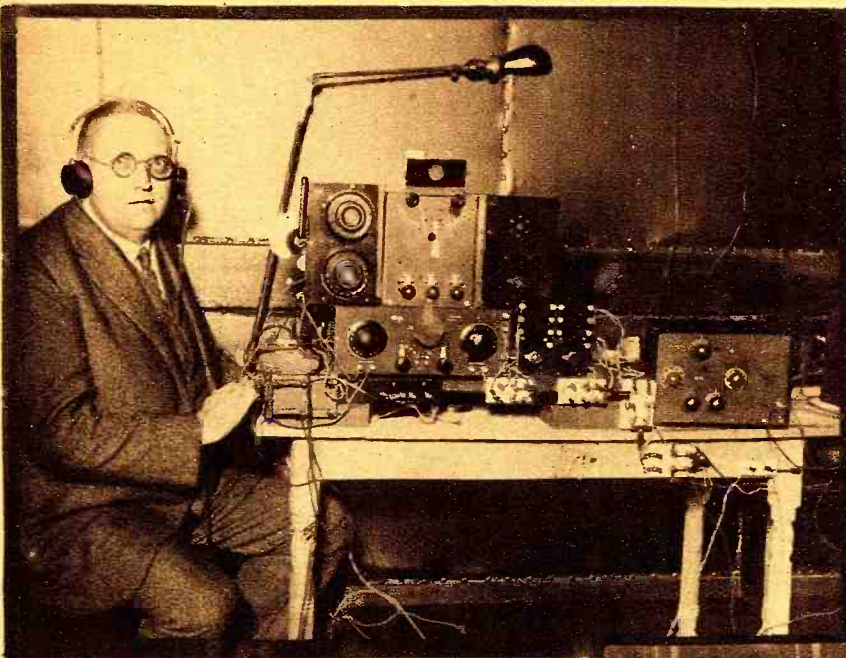

Just Recently Major Armstrong Started the World With His Regenerative Receiver. Dr. Franklin Leroy Satterlee, Noted X-Ray Specialist, Now Makes Public His Discovery on a Non-Regenerative Set Making One Detector Bulb Do the Work of Two Stages of Radio Frequency. It is Claimed With This Set that a Greater Receiving Range is Made than Heretofore Accomplished. This is the Set that Strongly Interested Gen. Squier, Chief Signal Officer of the United States, Who Said he Would Give but 15 Minutes to Test this Receiver, and Actually Gave Three Hours.

The Photo on the Left Shows Dr. Satterlee Comparing the Large Radio Sets with the Small One-Bulb Set on the Extreme Right, His New Invention, Embodying the Same Principles as the Large Set.

Few Users of the Vacuum Tubes Realize Just How Much Work is Involved in the Manufacture of These Tubes, and How Radio Engineers are Constantly Experimenting and Doing Research Work with a View to Improving Them. The Photo Below Shows Mr. Shu S. Man, Graduate of the Hong Kong University of China, Plotting the Characteristics of Vacuum Tubes at Columbia College, N. Y.

(c) K. & H.

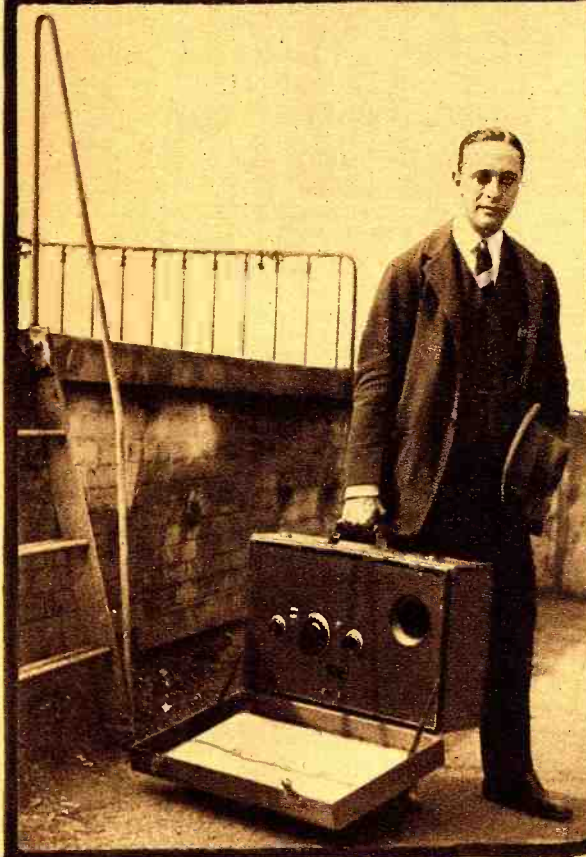

Above is the Latest Innovation, a Portable Radio Outfit, Including Loop, Batteries and Loud Speaker. It Can Be Operated Anywhere—on the street, in a Motor Car, on a Boat or in Any Building.

(c) Photo News.

While the Fordham University Station Was Designed Primarily for Relay Work Between the Various Colleges, It Has Proved so Successful that it Now Broadcasts Football Games Within a Radius of Many Miles. The Station Operates on 230 Meters and Uses Two to Four UV-233 Tubes.

(c) K. & H.

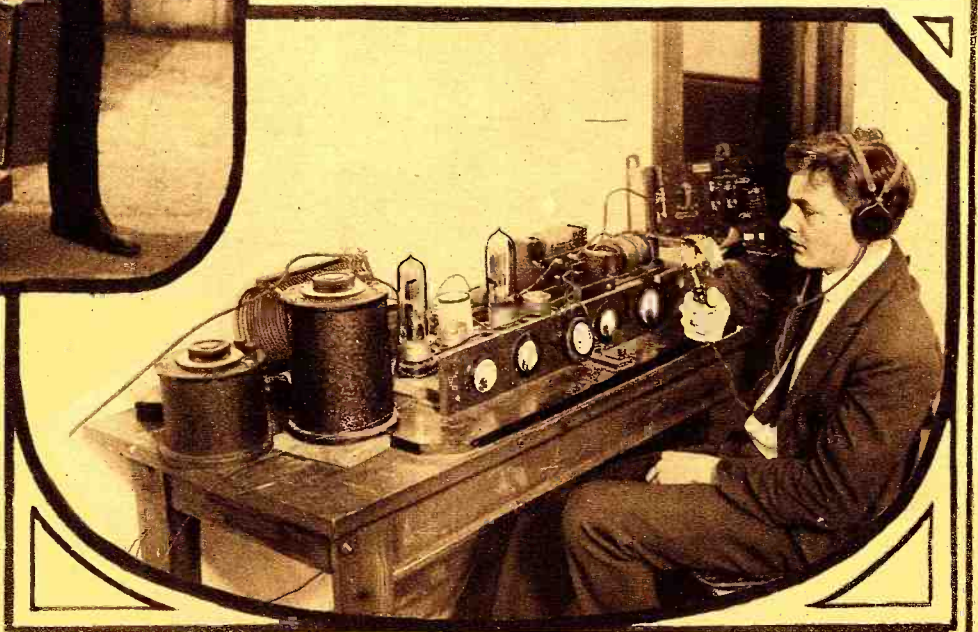
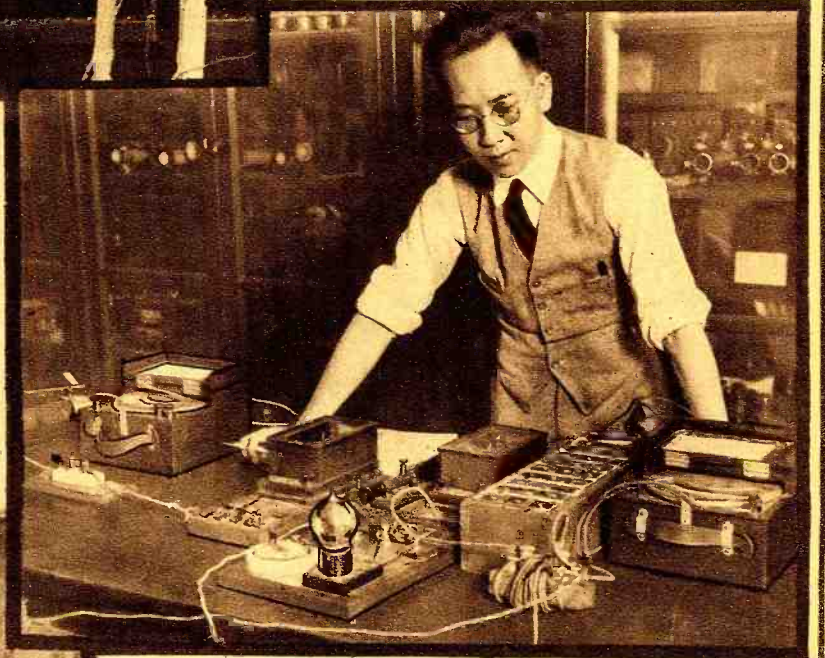

Who's Who in Radio

Dr. LOUIS WINSLOW AUSTIN

DR. AUSTIN was born at Orwell, Vermont, on October 30, 1867. After studying at Middlebury College, in 1889 he went abroad and became a student at the Universities of Strassburg and Berlin in 1889 and 1890, and obtained the degree of Ph.D. After being a fellow of Clark University for two years, he was Assistant Professor of Physics at the University of Wisconsin. He was later on the staff of the Physikalisch Technische Reichenstalt at Berlin. Since 1904, Dr. Austin has been connected with the United States Bureau of Standards and was appointed Head of the United States Naval Research Laboratory in 1908.

Since his appointment to this responsible position, the Laboratory has, under his direction, developed several new things. Among these may be mentioned the newest types of radio compass for use on ships and on coasts, some radio-control systems which were used during the maneuver to direct the old battleship, Iowa, used as target. During the war several new types of apparatus for submarines and airplanes have been developed by the staff of the Research Laboratory, all this work being done without much publicity for the men who deserve much credit for their continuous and hard work.



DR. LOUIS WINSLOW AUSTIN

Dr. Austin made noteworthy contributions to the art and is still actively engaged in research work. His work in Physics includes physical experiments, research in elasticity in metals, magnetostriction, discharge of electricity through gases and specific heat of gases at high temperature. In radio, his work has been concentrated primarily on the causes and sources of atmospheric disturbances. He carried out some lengthy experiments on quantitative high frequency measurements and on the efficiency of high power stations. From his work, in conjunction with that of Dr. Cohen, was produced the well-known Austin-Cohen formula.

Dr. Austin was the United States delegate to the Radio-Telegraphic Conference in London in 1912 and also to the International Technical Radio Conference in Paris in 1921. He wrote several papers and contributed extensively to the American, German and English Engineering journals. He is a fellow of the Institute of Radio Engineers of which he was president in 1914; he is also a member of the Washington Academy of Science, of the American Physical Society, National Research Council, Franklin Institute, Société Française de Physique and Deutsche Physikalische Gesellschaft.

Super-Regenerative Contest

SO far, the super-regenerative circuit, in spite of much experimentation, is not yet in favor among the amateurs. This is due mainly to the fact that it is rather ticklish to adjust and that experimenters who have tried it were not equipped with the necessary experience or patience required to make such a set function properly. In order to help those who would like to experiment with it, we are opening this contest and hope to receive several good and practical suggestions which, when published, will be useful to the amateur and novice for the construction of a set to receive broadcast and C. W. signals. If you have a set built, which works properly, send us a description of it with good photographs and the results you have obtained with it. There will be two contests in one; that is, one prize will be awarded for the best set for broadcast reception and the other for the most efficient super-regenerative circuit for C. W. reception, because as you know the requirements are different in these two cases.

In order to prove that the set entered in the contest works, it is required that a statement be sent with the entry signed by two persons who have had an opportunity to listen to signals received on the set. This is necessary, as we know of several cases where sets were built that did not give any results in the hands of their owners. This contest is open to all and the results will be published in RADIO NEWS. It is necessary

that at least two views of the set be furnished, not smaller than 4"x6", together with a description and complete data on the circuit used. The prize will be awarded to the simplest and most efficient outfit which may be, of course, of any of the types described by Major Armstrong in his paper, but remember

\$180 in Prizes

- 2 first prizes of \$50.00 each
- 2 second prizes of \$25.00 each
- 2 third prizes of \$15.00 each

"the simpler, the better" and the greater the chance to win a prize. If possible, in the description, the name of the manufacturer of each part should be given so that the sets will be described fully and may be duplicated by others in order to obtain exactly the same results. Much has been said and written about the super-regenerative circuit, but we know of some instances where very good results were obtained with sets of a different design not hitherto published. This is what we want for the benefit of all.

From the very nature of this contest, we are quite certain that it will not only

bring out the very best in the way of the American radio amateurs' ingenuity, but that it will help to advance the art.

Rules For the Contest

The super-regenerative set, to be eligible, must be of any type that works. Mere ideas or patent descriptions as well as commercial radio outfits are strictly excluded from this contest which is only for individuals. Where standard instruments such as condensers, tubes, etc., are used, the make of such instruments must be stated. A good diagram of the connections well executed in ink should be furnished with the description, which should be written on one side of the paper only. If the judges have any doubts as to the practicability of the receiver, they reserve the right to inspect and test the set. Insured express transportation will be paid by us both ways. The instruments will be returned promptly to their owners. More than one description may be entered by the contestants. A written statement signed by two persons who have listened in on the set is also requested. The contest is open to everyone, radio clubs included, except manufacturers of radio apparatus. All the prizes will be paid upon publication. This contest closes in New York, January 30 and the first prize winning article will appear in the March 1923 issue.

Address all manuscripts, photographs, etc.: Editor, Super-Regenerative Contest, care of this publication.

Announcement

Due to the large number of contributions received for the "Who Will Save the Amateur" contest, it has been necessary to postpone results until the judges can give each manuscript just consideration. The first prize winning manuscript will appear in the February issue.



THIS Department is open to all readers. It matters not whether subscribers or not. All photos are judged for best arrangement and efficiency of the apparatus, neatness of connections and general appearance. In order to increase the interest in this department, we prefer to publish photographs of stations that are accompanied by pictures of the owners.

We prefer dark photos to light ones. The prize winning pictures must be on prints not smaller than 5" x 7". We cannot reproduce pictures smaller than 3½" x 3½". All pictures must bear name and address written in ink on the back. A letter of not less than 100 words giving full description of the station, aerial equipment, etc., must accompany the picture.

PRIZES: One monthly first prize of \$5.00. All other pictures published will be paid for at the rate of \$2.00.

W. E. Dobbins, Jr.'s Station 4AP At ATLANTA, GA.

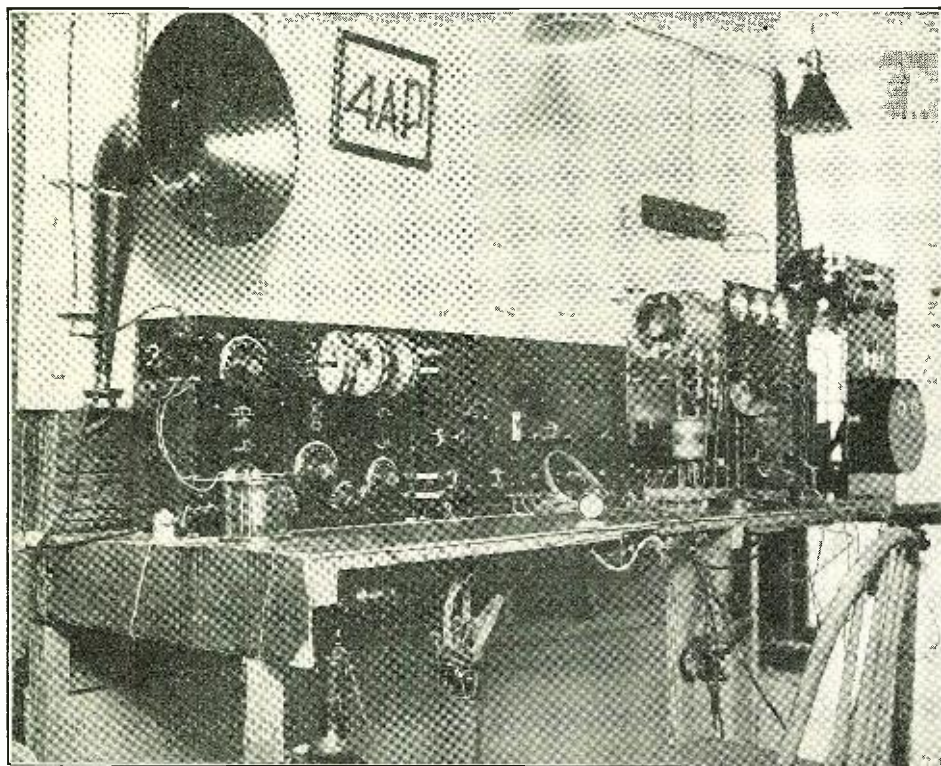

Mr. Dobbins' Station Is Certainly Laid Out Well and Its Neat Appearance Suggests System and Order. The Receiving Set and Amplifying Unit Are Seen on the Left; followed by a 20-Watt C. W. and Phone Set. At the Extreme Right Is the 1-K. W. Spark Transmitter.

HEREWITH is a photo of station 4AP.

The aerial system is composed of a six-wire cage, 70' high at one end, 20' high at the other and 65' long with a 15' cage lead in. This aerial is used for transmitting only. A 150' single wire is used for ordinary reception and a 300'

single wire for long-wave work. A loop is used successfully for broadcasting and amateur reception up to about 400 miles.

At the extreme right of the photo is a one-K. W. panel type spark set, composed of an Acme transformer, Dubilier condenser, variable speed rotary quenched spark gap, an oscillation transformer and radiation am-

meter. The tuning and coupling of the O. T. is adjustable by the dials mounted on front, while the spark may be observed through Ruby windows in front of gap housing. Radiation is about 6½ amps. at 200 miles.

Next is a 20-watt C. W. phone set, which is equipped for buzzer modulation or chopper. It is powered through a 200-watt transformer with a 20-jar rectifier made of pint jars with pure cast. lead and aluminum plates and Borax solution. Four electrolytic condensers and Acme chokes in the filter system eliminate practically any A. C. hum. All batteries, transformers, jars, etc., are behind the wall which is built out from the wall of the room and hides all unnecessary wires. With 500 V. on the plates and drawing 200 M. A., a radiation of two amperes on voice and three amperes on C. W. is obtained.

At the left are two cabinets composing the receiving set. The first contains a three-circuit variometer set, two condensers with verniers and a honeycomb coil mounting. The anticap switch throws from variometers to honeycombs, while the two series parallel switches take care of the condensers and plates. The large cabinet contains two steps of radio frequency using G. E. transformers, detector, and two steps of audio amplification. A Magnavox horn with a Western Electric makes an ideal loud speaker, and a wave trap makes it possible to work other stations through almost continual local broadcasting.

The operation of the set as a whole has been very satisfactory. Transmission up to 1,500 miles has been obtained. Trans-Atlantics come in loud enough to use the loud speaker, and nearly every broadcasting station and a bunch of amateurs, eight from the six and seventh districts, have been logged.

W. E. DOBBINS, JR.,
Radio 4AP.

5FT Reports Some DX

JUST a word to you and all the fellow hams of the Old U. S. A. We (my partner and I) are down here with the Shreveport Mining & Development Company, investigating one of their claims.

When we found that we would be down here at least eight or ten months, we immediately proceeded to rig up a radio set. The final result was and is a two variometer and coupler, single tube regenerative receiver. This set has more than given satisfaction, but farther it has accomplished

some unlooked for feats. The first night that it was installed we logged the following C. W. stations, 5AE, 5SK, 5ZA, 9ANQ and 8ZZ, all being logged within a period of some ten minutes. The next night we logged 5SM, 5XAD, 5ZA, 6AJH, 9APH and 5XD. After that they came thick and fast and we think nothing of logging 10 to 12 stations every night. Every time 5ZA or 6AJH operates we hear them so loud that we can almost lay the phones on the table and read them

by plugging in the detector alone.

The equipment used in the set is as follows: Winkler couplers and variometers, Klosner rheostat, Remler socket, Burgess batteries, Western Electric phones, Western Electric VT-1 tube, formica panel, all connected with a straight regenerative hook-up with two switch arms of 13 taps on the coupler, and with 45 volts on the plate.

As yet we have no transmitter, mainly

(Continued on page 1417)

Clayton R. Gerst's Station

at Cleveland, Ohio

I AM enclosing a flash-light photo of my radio set. It was built by me and is complete in every detail. Many improvements have been made since the photo was taken but I will give a description of the set as it was at that time.

On the left is the transmitter, a 10-watt outfit using either voice, I.C.W. or C.W. The frame work is angle steel and the panel formica. Radio Corporation parts were used throughout and it is giving very fine results. Kenotron tubes are used for rectification. There is no hum and the modulation is perfect. This phone has not yet been thoroughly tested, so I can not as yet claim any great distance records.

In the center is a cabinet containing the 120 A. H. storage battery, charger, fuses, etc. This cabinet has a cover which is quickly attached to prevent the noise of the charger while in operation. I use a Homecharger, which gives good results. Above the storage battery cabinet is the "B" battery box which contains six "B" batteries. There is another cabinet of "B" batteries under the table which does not show in the pic-

A Station Particularly Neat in Appearance, and Showing Evidence of Precise Workmanship. On the Extreme Left is a 10-Watt Tube Transmitter, Using Either Phone, I. C. W. or C. W.

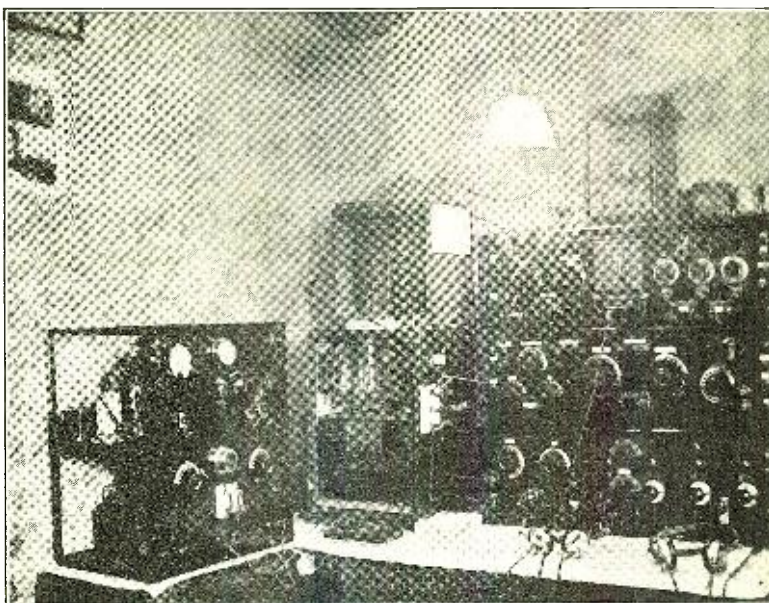

ture. These are used on the radio frequency amplifier.

The cabinets on the right are all for receiving. The one on the bottom, left, is the tuner used in connection with the radio frequency amplifier cabinet shown on the bottom, right. This is a three-step

and does not show very well in the photo.

The long cabinet in the center is a short wave tuner. It contains a variocoupler with units and tens taps, grid and plate variometers, each variometer

(Continued on page 1425)

Something New to Try

HEREWITH is a photograph of a little receiver and its hook-up which I have just completed, and which I thought might be of interest to some of your readers. It is compact, simple to operate and has a unique loop hook-up. The panel is 6"x14" and contains the complete tuner, detector and two stages of amplification.

The only difference between this and the general circuit used is the insertion of a small loop in the plate circuit. In reality this is not a loop hook-up, but demonstrates to me the truth of the ground circuit theory.

I will quote from a letter received from Mr. A. Victor Boyd, 210 N. Broad St., Philadelphia, Pa., who says, "Have just given it a try-out and it is my honest opinion that it is the BEST hook-up for popular use today. It is NOT a loop circuit in the true sense of the word, but it IS the finest and most economical GROUND receiving set outside of the new Armstrong 'Super' circuit. The loop has little or no directional effects, also fairly nearby stations can be received with your circuit on a 3" or 4"

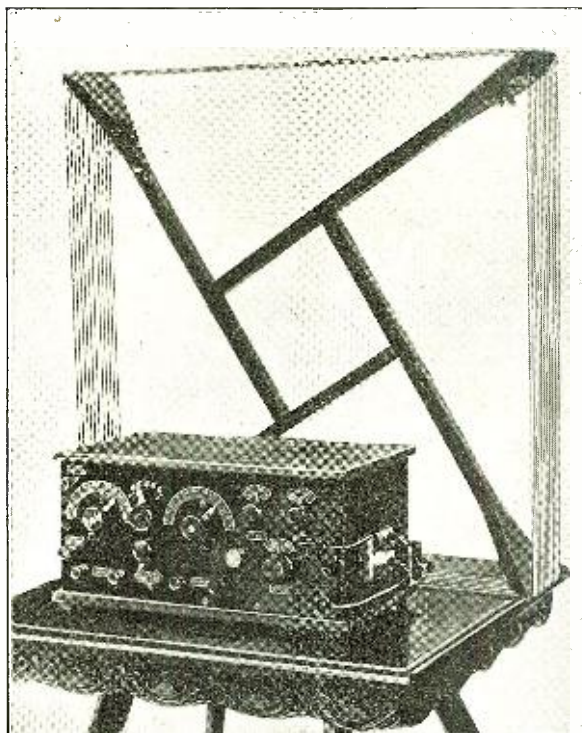

coil with very little loss of strength."

I get clear reception with this little set 500 miles, using a 3' loop, which I believe to be a loop record on such an outfit.

—Contributed by E. E. WAITS.

SEND IN YOUR CALLS HEARD LIST

There has been recently quite a discussion regarding the policy of RADIO NEWS: Some of the readers, the real "hams," claim that it has turned into a broadcast magazine. This is not the case, as we devote quite some space each month to articles of interest to the real amateurs, which articles are most of the time, too technical for the novice. To show the "gang" that we are not a broadcast magazine and that we take their requests into consideration, we shall devote in each issue some space to calls heard. We, therefore, invite you to send us a list of the stations you heard, typewritten if possible, or else sufficiently readable to prevent mistakes.

Preferably, the calls should be arranged alphabetically for each district. To distinguish the stations that have been worked they should be put in parenthesis and, according to the rules now in use, the C. W. stations should be mentioned in a separate list, both spark and C. W. lists covering the period from the first of each month to the first of the following. The lists should reach us by the 10th of the month for publication in the following issue.

ALTERNATING CURRENT FOR FILAMENT LIGHTING

I have read several times in various radio magazines, experiences of those who tried alternating current for filament lighting, and general opinion seems to be that satisfac-

(Continued on page 1405)

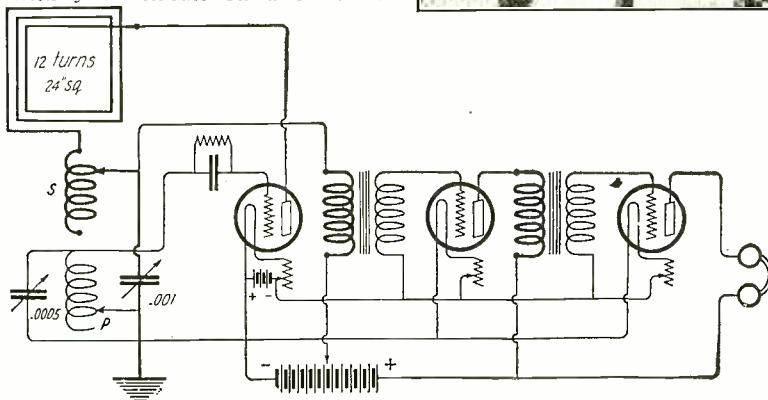

A Radical Type of Receiver Employing a Loop Aerial in the Tube Plate Circuit. The Circuit Used is Shown at the Left.

With the Amateurs

ANCIENT HISTORY

In going through some junk to-day I discovered the accompanying pictures, and thought perhaps they would interest you and the gang. This was one of the doctor's early experimental stations with a 1 K.W. spark and electrolytic receiver. We worked Cleveland, Detroit, Chicago, Ottawa and 42 Broadway, N. Y.

Have wondered what became of Horton, Wallace, Brown, Bucher, Cornish and the rest of the "gang."

Many interesting things occurred at BV, including hunger, when we were snowed in.

The doctor never saw this picture but I believe he would recognize it.

ALAN CHAPMAN (C.N.)
Box 1206, Orlando, Fla.

THE BIG STICK

We received from one of our readers in San Antonio, Texas, the following report clipped from the San Antonio, Texas, *Evening News*. As you shall see by reading these regulations, they police the ether themselves in that district. The only point that we cannot understand is why were not the amateurs represented at the meeting? They were invited, they did not go, but somebody should have been there:

NEW SCHEDULE FOR CONCERTS DECIDED UPON

FRIDAY NIGHT IS DESIGNATED AS SILENT NIGHT EVERY WEEK HEREAFTER.

Complete changes in the schedules of all broadcasting stations; designation of Friday nights as "silent nights"; discontinuance of broadcasting from DM-7, Brooks, Field, and scores of other developments were the result of an enthusiastic meeting of operators in the editorial rooms of the *Evening News*.

The new plan designates certain specified periods when amateur operators may transmit messages in "code." The *Evening News* notified amateurs to be present, but the amateurs failed to send a representative.

"The best interest of all concerned is the big object of this meeting," one operator said. "We know that 99 out of 100 persons with radio receiving sets want music, news and other spoken matter and not a lot of dots and dashes."

With this keynote, the schedule was prepared within a few minutes so that not only a definite period is set aside when all broadcasting stations, C.W. and spark, stations and any kind of transmitting apparatus in the vicinity of San Antonio will be SILENT. A sharp lookout is to be kept from now on and any person who hears a spark set in operation during the hours set aside for broadcasting stations should notify the *Evening News* Radio Editor.

The *Evening News* Radio Editor intends to follow up until every transmitting set is silent whenever broadcasting is being heard, either from local sending stations or from distant stations. It is a violation of the Federal

law punishable by penitentiary sentence for a person not licensed to transmit or send any kind of signals into the air. Everything possible should be done to halt this practice.

An example will be made of the first person caught transmitting during silent night or any other night when broadcasting stations are in operation. His license will be taken away; his sending set will be dismantled and he will be prosecuted to the limit of the law.

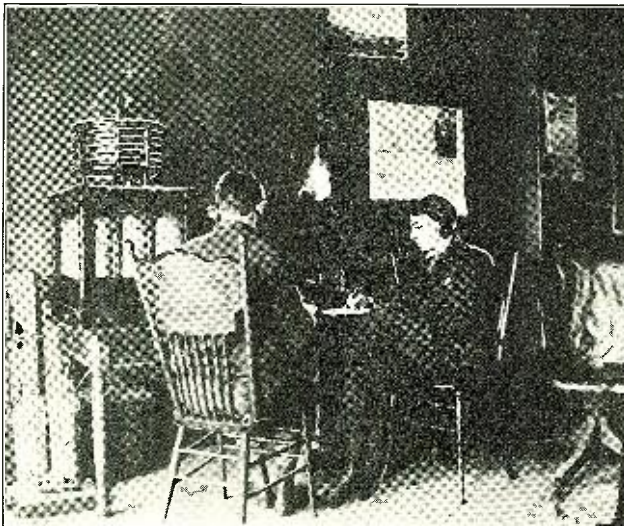
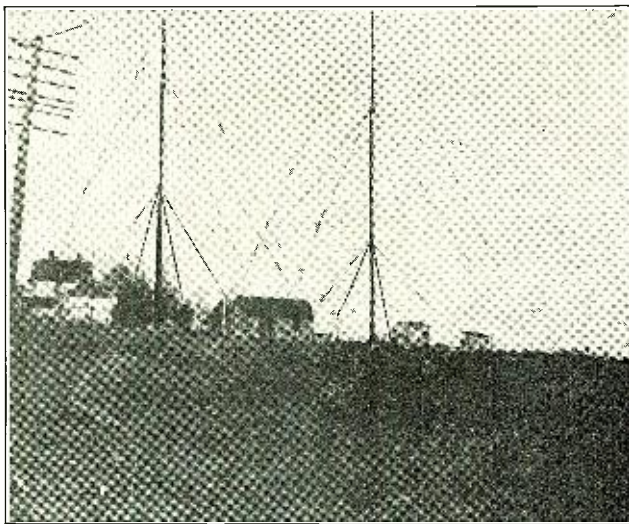

Two Heretofore Unpublished Photographs of One of Dr. de Forest's Early Experimental Stations. The Operators are None Other Than Mr. A. Chapman (left) and Mr. E. E. Bucher, Well Known Today in the Radio Engineering Field But Still Fervent Amateurs.

THE VOLUNTARY LID

(We have just received the following from the A. R. R. L.)

As a result of experience through the past year of broadcasting, we have a definite program to recommend for amateur consideration. There have been many unjustified complaints against amateur QRM and of course where amateurs in cities have hogged the air all evening there have been justifiable complaints. Most of us have realized that broadcasting was capable of becoming a powerful force for good in our country, of tremendous social, economical and educational value, and have known that meant the passing of the old days when we could pound brass from supper-time on and the ushering in of a new era when the air had to be shared. As we have pointed

out previously, many of us have gone so far in the business of sharing that we have almost been afraid to operate at any time, and amateur radio has suffered for the lack of a definite plan. On the other hand there are uninformed novice listeners who object to amateur transmission at any hour of night, and again the need for a recognized scheme has been shown. This we now offer.

Broadcasting is admittedly an institution of the early evening hours. That is the time that quiet air should prevail, when the greatest good can be done for the greatest number. When should we open up our stations for transmission? The Board has considered that question and has decided upon 10:30 p. m. as the proper time. We're regretfully obliged to conclude, fellows, that the time is here when we should voluntarily keep our transmitters silent during the early evening hours if their operation interferes with listening. This means that in all congested communities amateur stations should be quiet between the hours of 7 p. m. and 10:30 p. m. This is no new thing for most of us—we've been doing it already—but it makes a recognized principle of amateur work.

We urge amateurs and clubs to get together with the listening-in element in their community and have an understanding on the subject. Acceptance of this plan on the part of the amateurs means that they recognize the rights of the listeners to hear their concerts undisturbed and that they will keep quiet between these hours. Acceptance of this plan by the novice listeners means that they recognize the rights of us amateurs to transmit and carry on our useful work and that they will not complain against the "meaningless buzzes" when the lid goes off at 10:30. This plan was proposed at a meeting of all radio people in Rochester recently and was adopted as a solution of the local difficulty. We may well call it "the Rochester Plan."

Whenever a community gets together and agrees upon such a plan, we feel that it should become as law and that the mere possession of a transmitting license should not entitle an amateur to go contrary to the sentiment of all his fellows. It is our view that such operation unless justified by an emergency or official tests, would be deliberate and malicious interference within the meaning of the federal radio law, and we believe the Department of Commerce will agree with us. On the other hand, in localities where this plan is adopted and quiet air is maintained between 7 and 10:30 p. m., we will expect amateur transmission to proceed without complaint after 10:30, and the A. R. R. L. will protect with every resource at its command the right of any of its members to so transmit if unjustly accused while legally operating in such a community.

Now we have a working plan. Let us adopt it, fellow amateurs. This puts an important duty of self-policing on the shoulders of our affiliated clubs and we are depending upon them to handle the

(Continued on page 1403)

Some Real DX Work

By THOMAS A. MARSHALL

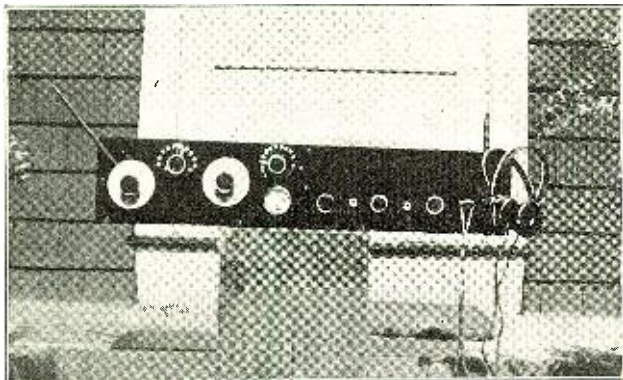

Front and Rear View of the Receiving Set Responsible for the Remarkable Records Listed. It Was Installed in Honolulu.

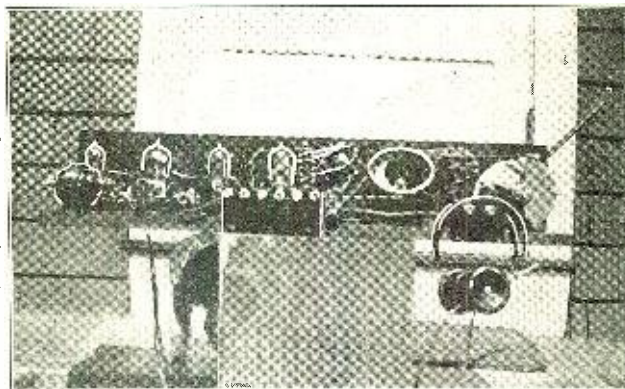

WHERE is the amateur who sits in front of the glowing audion, the glistening switch contact points, fancy dials, and engraved symbols, without getting excellent results? You have evidently been misled by some fancy hock-up. Every radio enthusiast vies for results. The air is full of amateur stations which you should be able to copy. They are there, radio fan, and if you are not logging 6ASJ, Oakland, Cal., and 4BX, Wilmington, N. C., your receiver, audion and amplifier are the "bunk."

I am going to tell you of one of those nights I spent at Honolulu, Hawaii, some 2,100 miles south-southwest of San Francisco, hunting for American amateurs. My log records many long-distance captures which would bring any radio fan a pleasing thrill. It was one of those snappy nights when I felt like twisting the knobs and playing the game until the "6" stations faded away into daylight.

A light reflection, a La Marquise fag, and a look at the sun gliding downward over the hills on the westward coast of Oahu, caused me to step lively for the radio shack. The pencil sharpener was put into operation and in a few minutes all the pencils were sharpened and ready to jot

down some new DX work. I dusted off the old log book, carefully turned to a clean page, donned the "baldies" and started the electrons to doing the bombarding act.

5PX, Fort Worth, Texas, some 4,000 miles away, whistled with feats of marvelous signals. A slight change of tickler coupling, and here was 9UU, Chicago, Ill., telling 5NU, Frost, Texas, to repeat a message. Another shift of the tickler and there was 9DPL, Kansas, City, Mo., sending a message to 5PX, Fort Worth, Texas, which was logged. "Some night for radio," I proclaimed to a contemporary who was guarding 375 meters for special amateur stations. A slight change in "B" battery value, tap on the vernier handle

and the effect was marvelous. 9DPL, Chicago, Ill., got an OK from 5PX, Fort Worth, Texas, for number one message. 9DPL sent another message to 5PX, which I intercepted and logged. 5PX flashes back "Address again, please." The address was quickly repeated, and the two amateurs bade each other good night with an exchange of best regards. There was 9APH, Chicago, Ill., chirping away. 8BSS, Baldwinville, N. Y., calling 4BX, Wilmington, N. C. 9DSM, Omaha, Neb., was percolating away. Then came 4BQ, Rome Ga., whose shrill continuous wave signals were whistling with a message to 8BWA, Akron, O., which was logged. Then 6BJY, San Diego, Cal., came rolling in with a loud signal. A slight change of the condenser, and here is 4BX, Wilmington, N. C., some 5,000 miles away, calling forth that signal "CQ" to all concerned. I rose up from my chair, snatched the amateur call directory from the shelf and scanned down the four-line column. "Extolling results!" I shouted. "Where is that man Paul Godley?" "His records have been shattered." I had reached an extreme point on the Atlantic Coast. Could it be true? Yes, because his signals were readable and were fairly clear.

(Continued on page 1364)

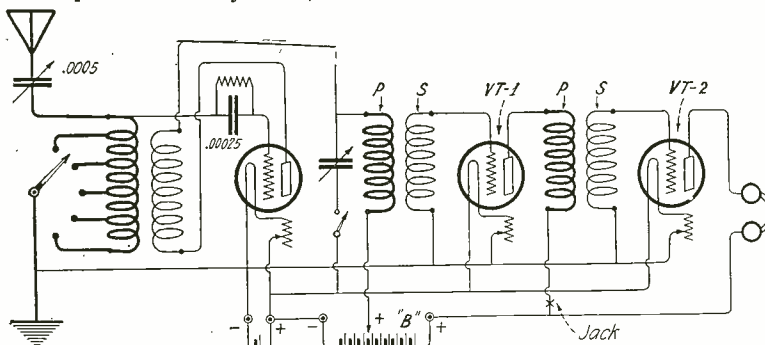

Fig. 2

Here is the Circuit Used in the Above Receiver. Tickler Feedback and a Two-Stage Audio Frequency Amplifier are Employed.

A Modified Multiple Tuner

By Bertram W. Downs

THE set here described is absolutely the "last word" in regenerative tuners. It is a modification of the old Marconi "multiple tuner," which was at one time the standard equipment in the old Marconi ship and shore commercial stations.

Besides eliminating one adjustment, the secondary coupling, this set has the advantage of bringing in louder signals than the standard, three-circuit regenerator, and at the same time being more selective. How these results are made possible will be explained below.

Referring to the diagram, it will be seen that this tuner possesses an untuned intermediate circuit which transfers the energy from the primary to the secondary coils. This circuit consists of two and one-half turns of heavy stranded wire (Litzendraht or several strands of lamp cord will serve admir-

ably) about the primary and secondary coils. The efficiency of this circuit depends upon reducing the resistance of

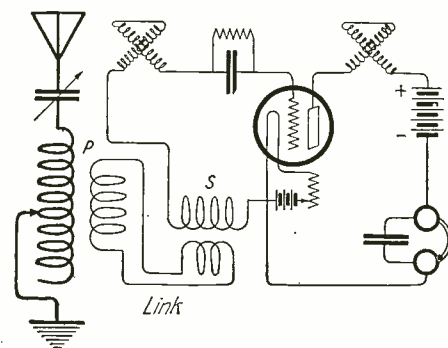

The Addition of the Multiple Tuned Circuit to the Three-Circuit Regenerative Receiver Allows for Greater Signal Strength and Selectivity.

this intermediate section to as near zero as possible.

The primary and secondary are mounted at right angles to each other, so that the only transfer of energy will be through the intermediate closed circuit.

The functioning of this circuit is as follows: In transferring the energy from the primary to the secondary the character of the wave is changed from one of a given decrement to that of a relatively lower decrement—that is, a "broad" wave becomes "sharp" in the secondary circuit, due to the negligible damping of the intermediate link circuit. This, of course, means that less interference will be experienced from stations whose wave-lengths are nearly the same.

For best results the link circuit coils should be wound about the part of the

(Continued on page 1379)

An Input Transformer for Telephone and Modulated C. W.

By D. R. Clemons

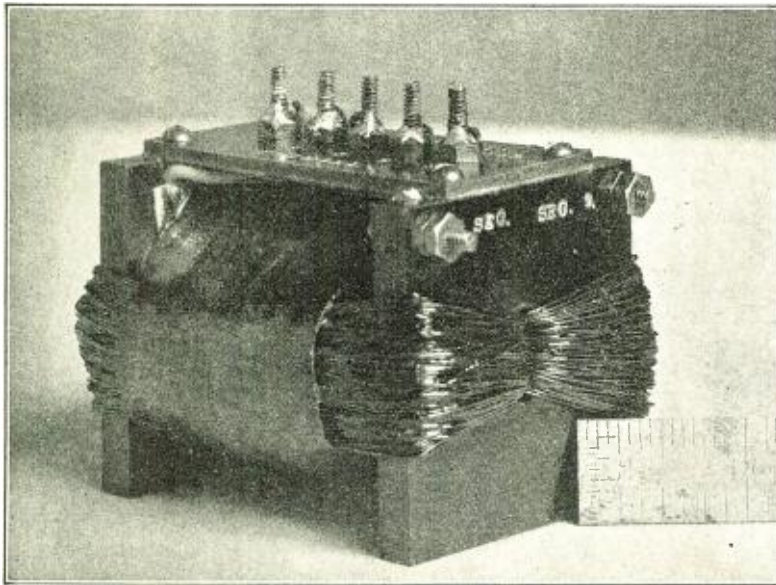

Appearance of the Finished Transformer. Note Its Size in Comparison to the Ruler. The Core Consists of a Bundle of Fine Iron Wire.

FOR interrupted C. W. transmission and telephony, a transformer is generally employed to impress tone signals upon the grids of the modulator tubes, so it is desirable that an output from this device should be accurately reproduced upon the grid of the modulator tube. As it is necessary to use some caution in the design and construction of the transformer, a few details and data for its design will be given for a type suitable for small low-power tube transmitters.

The average current moving in the microphone circuit of the average transmitter is very small, seldom exceeding 0.12 ampere with the microphone quiescent, so that an average of less than 0.1 ampere is present for the normal voice. Since the resistance of the carbon microphone varies around a minimum of 50 to 150 ohms, the power is about one watt. Where the transformer is employed directly upon the grid of the modulator tube, that grid is generally biased negatively so that the tube may function along the straight part of its curve. From its biased value the grid potential may be varied negatively or reduced positively and cause a uniform variation of plate potential; but if grid voltages were excessively large, such plate variation may not be strictly uniform after certain extremes of grid potentials were reached, resulting in improper reproduction of tone. The ratio within the transformer must not be made too high for this reason. For normal voice and tone frequencies the primary inductance may be made 0.045 H.

The secondary voltage should vary with the primary current. If a variable current moves in the few turns of coarse primary wire a magnetic flux established in the magnetic circuit varies also, and, as a secondary winding of many thousand turns is in this field of force, likewise a variable potential is induced in it. Now, if the secondary terminals were open, i.e., not connected to a load of moderate resistance, no current would move in the secondary system, hence its self-inductance and copper resistance are not effective and the voltage remains high. However, if the secondary terminals are connected to a load of moderate resistance, an appreciable current would then flow in the secondary system, causing its ohmic resistance and self-inductance to

become effective instantly, the latter reacting on the primary tending to still further reduce the secondary voltage which may fall to a very low value. Although the grid may be biased negatively its potential may be reduced through zero and become positive until appreciable current flows there, causing the decrease just mentioned. It may be help-

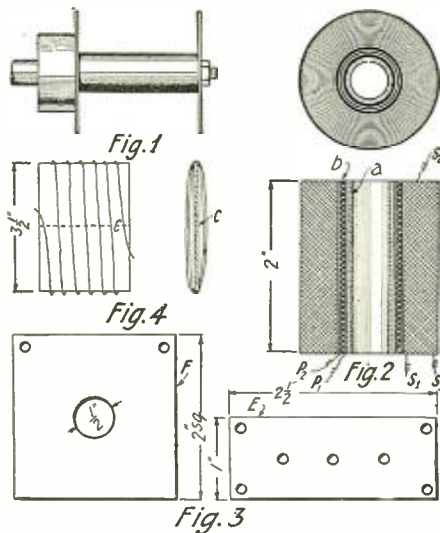

Mechanical Details Covering the Construction of the Transformer. Fig. 2 Shows End and Cross Section Views of Primary and Secondary Windings.

ful to try shunts of $\frac{1}{4}$ to 2 megohms across the secondary in order to find a value that maintains a more constant secondary load. This resistance would be used at R in Fig. 5.

A simple modulation transformer suitable for C. W. work is shown by the accompanying illustrations. A primary of 300 turns of coarse enameled wire is wound over a fibre tube 2" long. A secondary of 18,000 turns is then wound over the primary, as shown in Fig. 2. Two square bakelite blocks form the ends and supports, terminals being mounted for the secondary on a thin strip of bakelite connecting the blocks as at E and F in Fig. 3. The core of several hundred fine 26 iron core-wires is bundled and passed through the tube and end plates of the mount, then bent backward about the transformer as illustrated.

Construction: A fibre tube $\frac{1}{2}$ " inside diameter, $\frac{1}{16}$ " wall, is cut 2" long; this is carried upon a winding machine form shown in Fig. 1. A primary of 300 turns No. 26 enameled copper wire terminates in two stranded leads P1 and P2, in Fig. 2. Each layer of winding is separated by a strip of No. 100 empire paper 0.001" thick, cut 2" wide. Several layers of thicker paper are wound over the primary winding before starting the secondary of finer, No. 40, enameled wire. A stranded terminal several inches long, S1 in Fig. 2, is soldered to a foot length of No. 30 or No. 34 copper, after which the fine No. 40 is brushed clean with fine emery paper and soldered to the No. 30 terminal, rosin cored solder being used. This precaution of using an intermediate gauge No. 30 or 34 should be taken here, for changing abruptly from coarse to such fine gauges invariably results in breakage, unless one has attained some skill in handling such fine material. Corrosive soldering fluxes should never be used in making such junctions, as it may quickly destroy such fine copper. The winding of the secondary may progress after starting the first few turns very carefully, feeding the wires into layers extending to within $\frac{1}{8}$ " of each end of the unit where a drop of gum shellac should be deposited to secure these end turns firmly when the coil is removed from the form. Every layer is separated by a strip of empire paper until 14,000 turns are wound, at which point a section of No. 30 copper is carefully soldered in to provide a tap, S2 in Fig. 2. The winding is then carried on until 18,000 turns are wound where another fine length and stranded terminal finishes the coil. Two bakelite blocks are cut as shown in Fig. 3 at F. Several hundred core wires are packed closely into a bundle $\frac{1}{2}$ " in diameter and 7" long. These are best cut to length by winding a cardboard strip $3\frac{1}{2}$ " long, with many turns of 26 iron core-wire, and cutting them with metal shears along the dotted line C in

(Continued on page 1338)

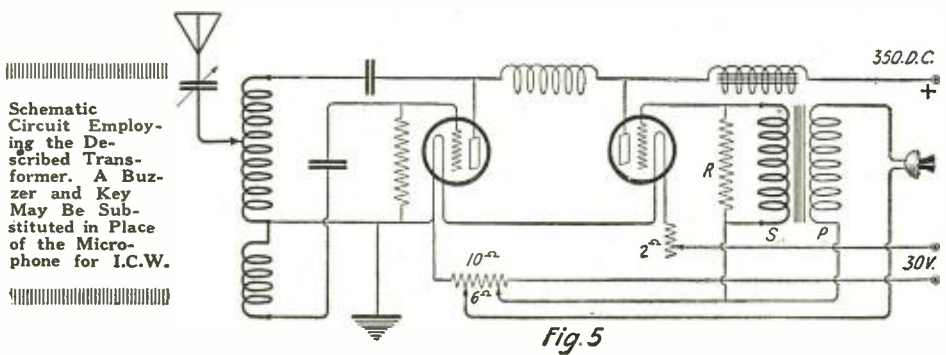

Schematic Circuit Employing the Described Transformer. A Buzzer and Key May Be Substituted in Place of the Microphone for I.C.W.

Practical Hints on Mast Construction

By JOHN F. BRONT

IN the erection of masts for the support of the aerial wires, difficulty is often experienced in obtaining poles of the desired height at a reasonable price, or in order to get a mast of the desired height shipment must be made from other districts and probably the freight bill for two railway cars required for the transportation of long poles is reflected in your lumber dealer's bill on the 10th of the month.

To raise your aerial above the veritable forest of trees and public service companies' wires very often means a great increase in both transmitting and receiving range. Such objects as trees, buildings, etc., generally act as imperfect conductors of high resistance, that is, they charge and discharge slowly and consume a considerable amount of your radiated energy.

The splicing of shorter masts to form a higher one is not a difficult feat and may be well done by the application of only a saw, a brace and bit and a hammer. It is desirable that the upper or top mast be of round wood of light weight, and that the lower be of larger diameter and of sufficient strength to avoid buckling when standing erect without guys. To use sawed lumber is to invite trouble, unless specially selected, clear, first-grade stock is used, and then the cost is much more than round unsawed stock, the latter being of greater strength and rigidity.

Probably the best wood to use is Oregon fir or cedar, but these woods are not available in all districts, and, therefore, some similar light wood of sufficiently close grain to be dependably strong would naturally be the next available choice.

The permanent splicing of the upper and the lower pieces or sections is not a tedious task and anyone should be able to make a good job of it with little or no trouble. The first thing to do is to cut the scarfs at the ends of both sections. The angle of the scarf will be decided by the diameter of the mast. If it is figured that the length of the angular cut will be approximately

four times the diameter of the mast, a satisfactory splice can be made. Take the one section, measure off the projected angle and saw into the side of the first section for a distance which should be approximately $\frac{1}{4}$ of the diameter, or a little less. Then starting at the end of the section saw up to the bottom of the first saw-cut, made before, and that section of the mast is ready, if the sawing has been true and straight. Attack the other section in the same manner and the two sections will be ready for the fitting together. Set the two sections together, fitting the scarfs, one to the other, and ascertain if the mast will be continuously straight if the scarfs are left as they are. It may be that some extra trimming will have to be done in order to align the two sections into one straight continuous mast.

After fitting and making certain that the scarfs are not rounded

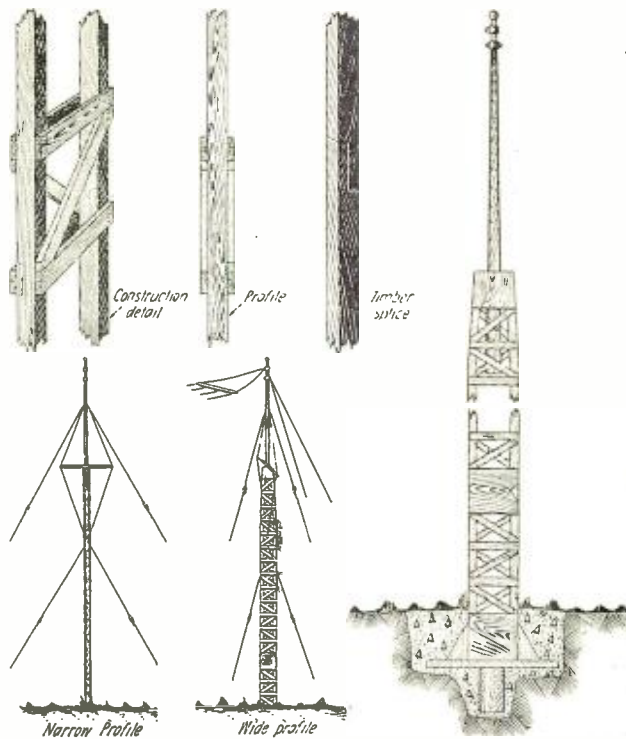

Detailed Construction of the Semi-Lattice Work Mast. This Type Is Guyed in Four Directions.

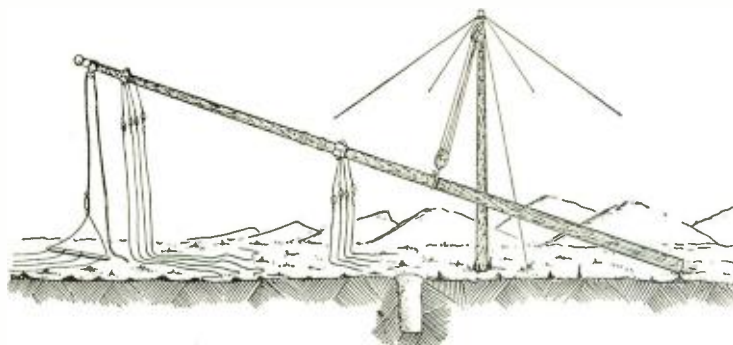

Method of Procedure for Erecting Mast. The Hoisting Mast Is Well Guyed.

portant that the turns be hammered down as they are being made, otherwise the coils of the wire will be loose and worse than useless. It is not necessary to tighten the wire after several turns have been wrapped on. Tapping the turns every two or three inches, as the wire is gradually wound on, will make it so tight that the wire will be under some tension, and will hold that portion of the splice in place very rigidly. Wrap the other end of the splice in a similar manner and the splice is completed and will

last as long as the wood itself; in fact the splice is much stronger than the original wood, under certain conditions.

The setting for the mast in the ground should be accomplished by digging a hole, the depth of which depends upon the height of the mast in question, but should be at least 3' deep. At the bottom work in some small stones before the pole is set in the hole and then jam large stones about the base after the butt has reached the bottom. Tamp solidly with earth to a height a little above the surface.

Difficulty is often experienced in raising the mast to its vertical position; the proper way is to use a "gin" pole, that is a shorter pole, which should be nearly half as high as the one to be set. The erection of the lower gin pole is easy and it should be set just beside the position to be occupied by the mast. Guys should be run out four ways by fastening lines to the top of the "gin" and securing them as far away from the base or butt as possible. A block and fall securely fastened at the top of the gin pole should be attached to a

on the sawed surfaces, bore two holes all the way through both sections so that the holes will be a little less than one third of the length of the diagonal length of the splice, away from the corresponding ends. Bolts $\frac{3}{8}$ " long, fitted with the largest washers obtainable affixed beneath head and nut, are drawn up tight.

Halfway between the bolt and the end of the splice, staple down the end of a small hand-coil of No. 12 iron wire and start wrapping slowly around that portion of the splice. As the turns are being gradually brought around the circumference, tap the wire into the wood in such a manner that it is drawn up tight and absolutely without kinks or irregularities. It is im-

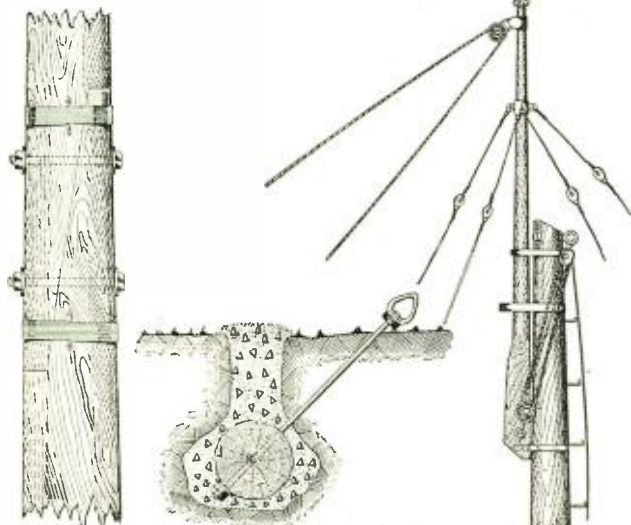

The Mast Guys are Attached to Deadman Anchors Embedded in Cement.

(Continued on page 1348)

A C. W. Oscillator for Measurement Purposes

By L. R. Felder

ANY radio set which the amateur experimenter builds, for example, a transmitter, receiver, wave-meter, etc., contains all the various radio elements such as inductance coils, condensers, resistances, etc. These elements are either built or bought outright by the experimenter. If they are bought he accepts the manufacturer's statement as to the constants of these elements; if built, he generally approximates their values by a calculation.

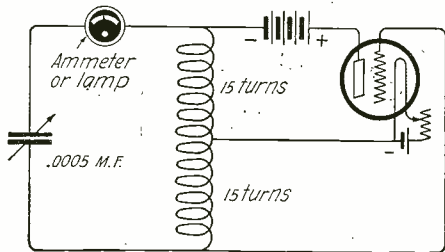

Fig. 1

This Is the Simplest Type of Oscillating Circuit. It Was Conceived by Hartley.

For really good work, the experimenter should know accurately the constants of his sets. If he has a tube transmitter he should know, for example, the R. F. resistance of his antenna coil, so that he will have no doubt as to the true efficiency of his set. In his receiver he should also know the resistance of his tuning coils, their inductances, the capacity of his condensers, and know the self and mutual inductances of his coupler, etc. The accurate knowledge of these constants is what distinguishes the advanced experimenter from his more slipshod brother. They furnish the data for future improved designs of sets.

These values can only be obtained by measurement. Measurement in itself is almost a separate field in radio to which the amateur should devote a little more of his time. Measurement usually requires a separate source of oscillations, which should preferably be undamped and steady. Until some time ago a buzzer excited radio frequency circuit was used as the generator of oscillations. While this gave fair results, it never was a very satisfactory source of oscillation due to erratic and freakish operation of the buzzer, changing of the note, sparking at the contact points, etc. Furthermore, inasmuch as the buzzer could only supply a very small amount of energy, very sensitive detecting devices had to be employed, such as thermocouples. Such apparatus is of course very expensive and, therefore, unavailable to most amateurs, whereas he is more likely to have R. F. ammeters and milliammeters.

The vacuum tube supplies a means of obtaining a very low-power oscillator

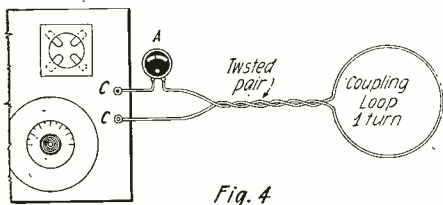

Fig. 4

A Coupling Loop May Be Used. The Method of Connecting Is Shown.

which is stable, supplies quite pure oscillations and is capable of furnishing sufficient energy to actuate the detecting devices usually available to most amateurs. It will be the object here to describe the design and construction of a low-power oscillator suitable for measuring purposes, and in future articles to describe the application of this oscillator to amateur measurements.

The oscillating circuit used in this measurement set is of the very simplest type and is designed to utilize a minimum of apparatus since apparatus around a station is generally at a premium. The very simplest type of oscillating circuit requiring a minimum of apparatus and easily constructed, which is suitable for measurement work, is the Hartley circuit in Fig. 1.

From this drawing it will be seen that the apparatus required is:

- 1 Variable condenser.
- 1 Inductance coil.
- 1 Tube socket.
- 1 Filament rheostat.
- 1 Tube.
- 1 Flashlamp indicator or ammeter.
- 1 Plate battery.
- 1 Storage battery.

The plate and storage batteries which are generally around the station, may be

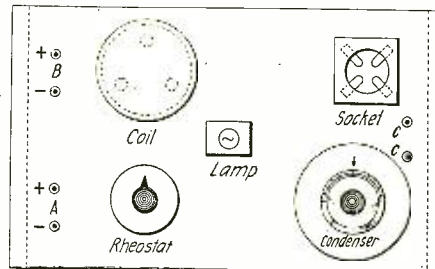

Fig. 3

Convenient Positions for Apparatus on Mounting Board.

used for this measurement set. When measurements are not being made the only apparatus tied up in the measuring outfit are the other five elements, since the tube need not be tied up unless the outfit is in use.

The oscillating tube may be an ordinary amplifier tube such as U. V.-201, but a low-power oscillator tube would be preferable, as more power could be obtained and the amount of current flowing in the circuit under test could be controlled over a wide range of values. On the U. V.-201 tube between 80 and 100 volts may be used on the plate and on the five-watt oscillator up to 300 volts may be used. Filaments should be operated at their rated values, or even slightly under. Since this is a measurement oscillator set, no particular advantage is to be gained by pushing the tubes too hard, and, therefore, it should be conserved as much as possible. The storage battery and filament rheostat in the case of the amplifier U. V.-201 tube should have a rating of six volts and one ampere current carrying capacity respectively, and in the five-watt tube these ratings should be 10 volts and 2.5 amperes current carrying capacity.

The oscillating circuit condenser is a variable condenser, maximum capacity 0.0005 mfd. This condenser in the ex-

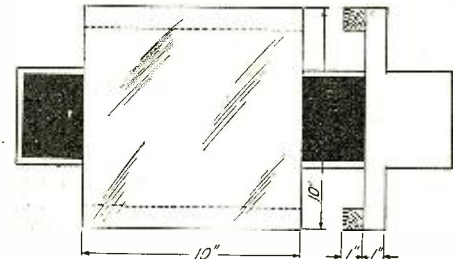

Fig. 2

The Size and Details of Construction of the Mounting Board are Here Shown.

reme case will have to withstand a voltage of about 1,000 volts. R. F. When using the U. V.-201 amplifier tube this voltage is much lower and the ordinary air spaced condenser will be satisfactory. In the case of the five-watt tube, if air insulation is used, the spacing between the condenser plates should be much greater than ordinarily. Good results have been obtained, however, by the use of oil in the condenser with normal spacing of plates, and its use is recommended for the higher power oscillating tube. This assures greater safety against arcing over between plates and in the case of an abnormal rise in voltage and an arc-over, the break down in insulation is self-healing. Only a good grade of insulating oil should be used, as the poorer grades contain dirt and grit which may actually bring on breakdowns.

The oscillator coil is made up of 30 turns of 3x16x38 Litzendraht wire with a tap taken off at the center turn for connection to the filament ground. If this Litz wire is not available, No. 20 D.C.C. will do. The coil is wound on a 4" O.D. tube of good insulating material, either formica or natural dielecto is best.

In series with the oscillating circuit is placed either a low reading radio frequency ammeter as an oscillation indicator, or if this is not available a small flashlight will do. The construction here described employs the flashlight as the fixed oscillation indicator, but provision is made for the insertion of an ammeter if necessary.

The actual construction of this extremely simple but useful oscillator will

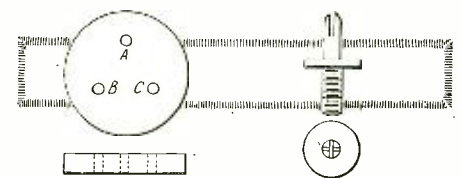

Fig. 5

Fig. 6

Left: Insulating Piece for End of Inductance Tube. Right: Split Lugs Used for the Coil Terminals.

probably be determined by the builder's own prejudices and ideas. There are so few elements in this set that no difficult obstacles will present themselves. However, the writer wishes to suggest the following construction which he has used and found simple and convenient.

All the apparatus, excepting the batteries, is mounted on a flat board made of seasoned wood, 1" thick and 10" square. (See Fig. 2.) Two strips of wood 1" square and 10" long are fastened to the ends of the baseboard un-

(Continued on page 1330)

A Handy Portable Set

By ARTHUR PAULSON and SIDNEY Y. WHITE

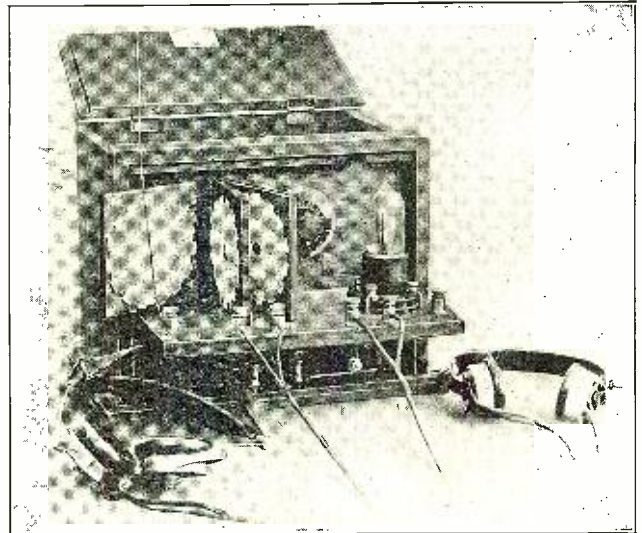
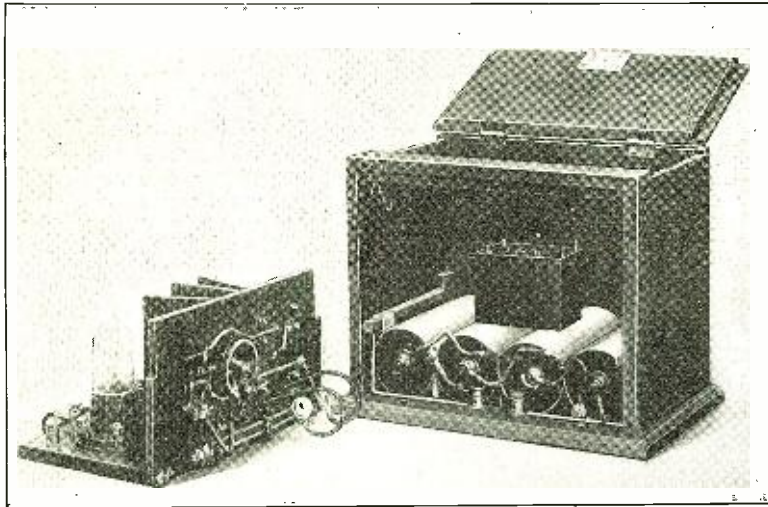

In this Photograph, the Instrument Panel Has Been Withdrawn to Show the Internal Construction of the set. The "B" Battery Fits Nicely Behind the Dry Cells.

By Drawing this Panel Out, the "A" Battery Circuit is Automatically Closed and the Set Is Ready for Operation.

WISHING a compact portable set to take with us on a voyage from New York to Galveston we constructed one of rather original design which should be of interest. It is a vacuum tube regenerative outfit, and proved to have a range of well over 500 miles. The over-all dimensions of the instrument are 7"x9"x11". An actual test aboard ship in Galveston, brought in concerts from Georgia, Tennessee, Kansas and Missouri regularly, while more distant points were also clearly heard in spite of the everlasting summer static of the Gulf. Amateurs were copied from every district except the sixth and seventh and also the St. Louis concerts on the whole trip from Galveston to New York. The power of eliminating unwanted stations was truly remarkable for such a simple set, as practically all single circuit tuners sacrifice some important quality to gain ease of adjustment. To place the set in opera-

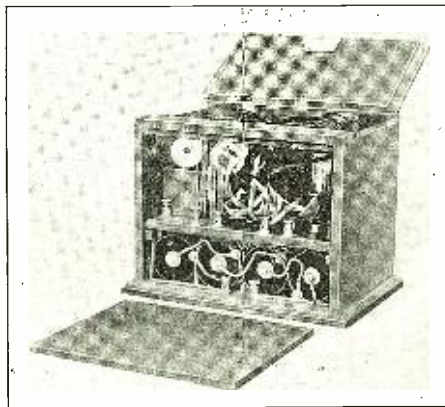

In this Illustration, the Cover is Raised and the Front Removed Showing the Phones, Batteries and Antenna in the Storage Position.

tion, the instrument panel is drawn forward. The top of this panel hits a cleat which arrests its progress, and the lower part drops and rests against shoulders on the side supports where the contacts for the "A" battery are mounted. Thus the panel is held firmly in place by its own weight at the same time lighting the filament. The "B" battery is snapped into the circuit in back of the board, and the antenna and either one or two pairs of phones are connected to the posts on the front of the panel. The chief departure from the conventional is the sliding panel with the unique method of locking in operating position and of completing the "A" battery circuit. The mounting of flat-wound coils on plywood panels to act as a variometer is a new idea, as well as leading the current for the tube filaments through the hinges. All the wiring is covered with

(Continued on page 1402)

A Study of Different Types of Coupling Used in Radio

By Louis Frank

CONSIDERABLE amount of the advice generally given the new amateur centers around the desirability of using loose coupled circuits in his receiver. Furthermore, he seems to get the impression that the only type of coupling is that produced by the proximity of two coils as in the average two circuit tuner, that is, inductive coupling. It seems, therefore, advisable to discuss this question of coupling, point out the different types and the particular uses of coupling in radio.

Whenever two circuits are connected

together so that there is a transfer of energy from one circuit to the other, these circuits are said to be coupled to each other. In general this is accomplished by one circuit inducing a voltage in the other circuit as a result of which a current flows and energy is available. The circuit in which the voltage is induced or the circuit to which the energy is transferred is called the *secondary circuit*. The circuit which does the inducing or transferring is called the *primary circuit*.

There are three main types of

coupling: 1. Resistance coupling; 2. Inductive coupling; 3. Electrostatic coupling.

Of these three, the first one, resistance coupling, is least important, as far as practical uses or applications are concerned. The circuit in Fig. 1 illustrates this type of coupling. In it the primary circuit consists of L, C, R, in series with G the source of voltage. The current flowing in circuit 1 produces a voltage drop across the resistance R, which is called the *coupling resistance*, and this voltage causes a current to flow in the secondary circuit 2, consisting of R, L₂, C₂, C₃. For any given circuits and a given amount of energy in the primary, the greater the voltage drop is across the coupling resistance R, the greater will be the coupling and the greater the

(Continued on page 1417)

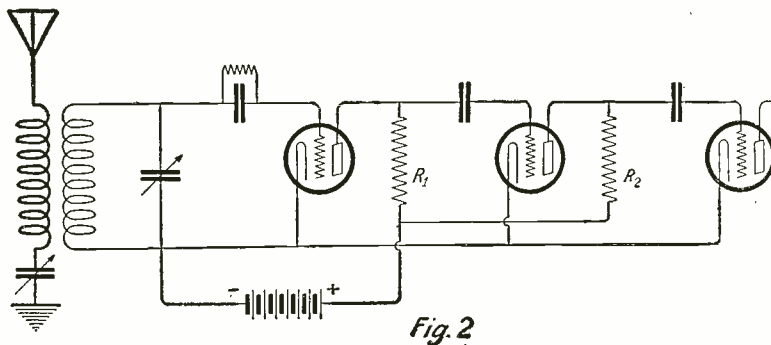

Fig. 2

Fig. 1 Illustrates a Resistance-Coupled Circuit, While in Fig. 2 the Same Type Is Shown Applied to a Cascade Amplifier

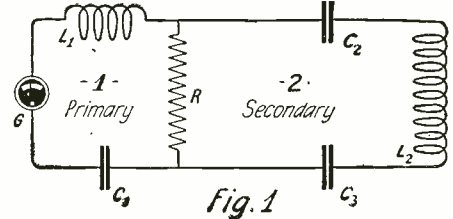

Fig. 1

A Mechanical Radio Relay

By JOHN F. BRONT

SOME interesting results have been obtained with a relay built in a similar way to the one described and sketched here. The mechanical working principle of the apparatus is not a new one, yet it is uniquely applied in the recording of received radio time signals by isolating them in a local circuit in which is included a recorder. Curiously enough the instrument is applicable to recording of continuous wave signals, more so than to those of decaying trains.

In detail we may examine what takes place when a straight steel wire has either or both of its ends thrust toward each other. A very slight movement of the ends toward each other is followed by the wire bowing outwardly in the center and forming an arc. The closer the wire is to its normal shape, the greater will be the movement of the center of the wire outwardly from its normal position, when pressure is applied at either or both ends in a direction along the original normal axis of the wire, for a given movement of the ends toward each other. The slight movement of the ends toward each other, in fact, is magnified in the resultant movement or bending out of the center. As the ends are moved nearer each other, the resultant outward movement of the center portion grows less. If a curve were drawn, it would show a steep portion at the beginning and gradually rounding off toward the point represented where the ends of the wire are supposed to be parallel with each other in the bending process. That is when the wire is bent double.

In the relay sketched here the steel wire is fastened to the diaphragm of a large sized receiving phone. At the center where the greatest movement takes place for a given thrust on either end, is placed a con-

tact which is included in a local circuit, as is a portion of the steel wire itself. The opposite end of the wire is securely held rigid. The contact below the center of the wire is adjusted by a micrometer arrangement which requires a large movement of the adjusting screw for a slight change in the height of the contact, which is made of spring brass and securely fastened at one end, while the lower end is drilled to pass

communicated to it, through the action of the rectified trains of continuous waves.

The whole apparatus is in fact an amplifier and relay at the same time, although it has been made up for relaying only. The diaphragm movement is amplified in the movement of the center of the wire, which movement is the agency in closing and opening a local circuit. Experiments were made which reversed the usual order of things and arranged for the breaking of a local circuit which would operate a recorder instead of the usual type which is made to close a local circuit.

Primary batteries were connected in series with the recorder and one end of the steel wire, the circuit leading through the relay contacts when the circuit is closed by the movement of the wire.

In the reception of decaying trains of waves there is a movement of the phone diaphragm for every rectified train and if this type of relay were employed in the isolation of such signals in a local circuit, the high frequency of the vibrations would be generally too rapid to agree with the mechanical possibilities of the moving element. However, in regard to continuous waves, where the diaphragm of the phone is attracted by the whole signal duration if the train is rectified by crystal detector or audion tube, the resultant movement of the diaphragm and therefore of the wire is not rapid, comparatively at least, depending on the speed of the transmitted characters from the distant station, the movement of the wire occurring only at the beginning and end of the attraction resulting to the diaphragm. In this type of relay, a fairly large sized phone and a wire about 18" in length are requisite for best results. Longer wires give greater movement in the center, but they are subject to very slight local vibrations which are undesirable.

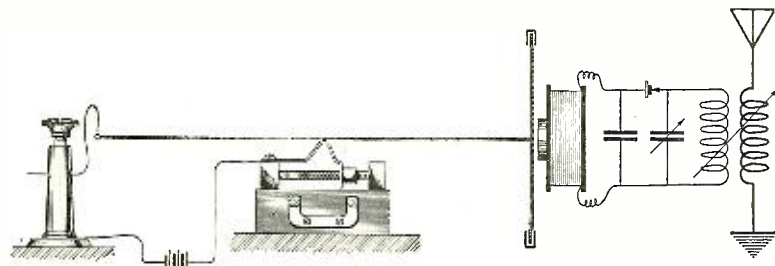

An interesting Type of Mechanical Relay Adaptable to the Recording of Received Signals. The Movement of the Diaphragm is Mechanically Magnified by a Steel Wire Which Completes a Local Circuit.

the screw of the adjusting arrangement, and fits against the adjusting nut.

In operation, the attraction of the diaphragm at each wave train makes a change in the position of the center of the wire and if the micrometer apparatus is adjusted correctly, a local circuit will be opened and closed at each movement of the diaphragm. Especially where continuous waves are being dealt with, this type of relay is most efficient, and it is necessary only to rectify the received trains, without going through the operation of heterodyning. Each arriving train will cause attraction and release the diaphragm, which movement is communicated to the steel wire.

The wire is not maintained at its exactly straight horizontal position, but slightly bowed down in the center to facilitate the action of a permanent magnet placed immediately below the wire so as to insure the movement of the center of the wire downward and not to one side or upward when the movement of the diaphragm is

Back Panel Honeycomb Coil Mounting

THE honeycomb and similar types of concentrated inductances are excellent pieces of apparatus, but the available means of handling them is crude at the best, due to their dimensions and shape. Especial difficulty is encountered when it is desired to mount them permanently back of a panel and manipulate the coupling and the inductance quantities from the front, by means of switches and knobs.

The writer has found special utility in a mounting such as that described here, where the coils are mounted upon a block as a unit, which unit, as a whole, may be inserted or taken out of the receiver cabinet

by loosening two screws in the base board of the receiver cabinet. Generally, however, in most cases the unit with sufficient size coils for a given range are left intact within the receiver.

Here the coils are mounted on the block, the center one permanently attached in a vertical position with regard to the holding block and securely held in place by a spring clip of brass, while the two outer coils are mounted on a strip of fibre attached to the block by small hinges to permit their swinging motion at such times as the inductive relation with the center coil is desired to be changed. A very light spring of coiled wire tends to pull the outer coils downward against the cam, which is quickly and easily cut from solid hard rubber or from a built up form from sheet dielectric material. The cam is firmly attached to the shaft of the knob which protrudes through the panel to the front.

When it is desired to change the unit of inductances it is not necessary to disturb the cams and it is only necessary to remove the screws which hold the block.

A scheme was adopted by the writer in constructing a receiver for a neighboring amateur who employed coils of fixed inductance for a three-coil receiver of the form illustrated in Fig. 2. The coils were wound in such sizes that

they fit closely within each other, at least two within the outer coil. The same system may be adopted for the making of radio frequency transformers by the novice who has no data on hand for the correct proportions of the constants.

Contributed by JOHN F. BRONT.

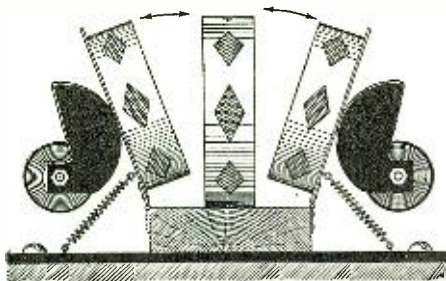

Fig. 1

A Novel Method for the Variation of Coil Coupling. The Eccentrics Force the Coils Toward the Center at an Even Rate.

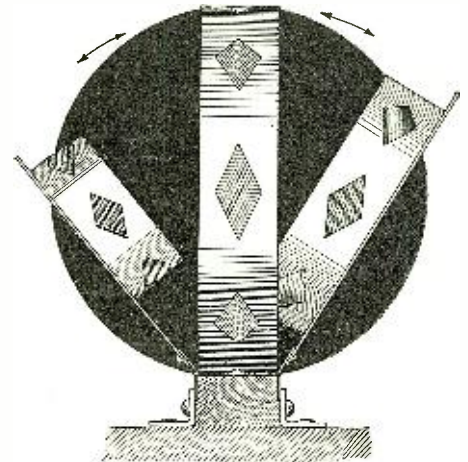

Fig. 2

The Usual Three Coil Honeycomb Arrangement Using Fixed Inductances.

An Efficient Short Wave Set

By H. S. POTTER

At the present time there is a tendency toward very simple receivers, and some very efficient ones have been developed of late by the various manufacturers. The short wave set described in this article gives results equal to any of the sets on the market today. It is exceedingly simple to operate.

Inductive or conductive coupling, if properly operated, will give about equally loud signals, so there is no objection from that point of view to the latter system. An objection which is frequently advanced to conductive coupling is that there is much broader tuning, but I have found that if the apparatus is properly constructed very fine tuning may be obtained. Alas, an inductively coupled set is very much more difficult to operate, due to its many controls.

There is no doubt that there is an increase in selectivity gained by using a variometer in the plate circuit, but this advantage is more than balanced by the increased difficulty in tuning in distant stations. As to signal strength, I have found very little difference to result from using or omitting the plate variometer.

The advantages of this set may be summed up as follows: the controls are very few and simple; the appearance is such as to recommend it to anyone; the operation is highly efficient and the cost is very low.

The following is a brief description of the construction of this set.

The panel is of 3/16" bakelite, 6x14". The polishing was done with a sheet of No. 1 emery, moistened with olive oil, followed by a clean, dry piece of flannel.

The holes were drilled as shown in Fig. 3. The drilling may be done with an ordinary hand drill. The holes for the mounting screws of the condenser must be drilled to fit the type of condenser used.

The antenna series condenser is mounted at the left end of the panel, and controlled by the knob and dial. Any .001 mf. condenser may be used. A balanced condenser would probably prove advantageous in fine tuning, but it is not at all necessary.

Probably the most difficult part of the construction of this set is the making and mounting of the inductances. The main, or stationary, inductance is wound

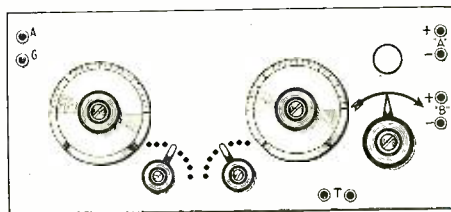

Fig. 1

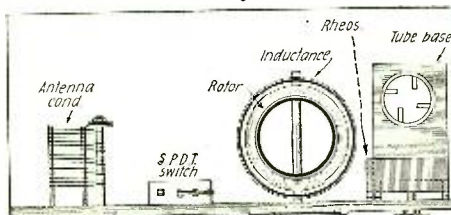

Fig. 2

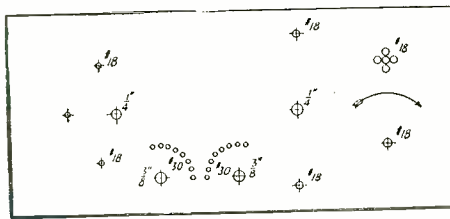

Fig. 3

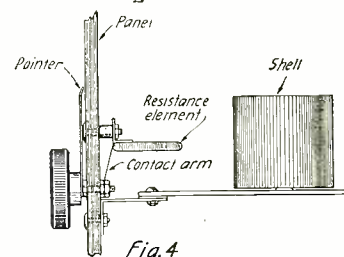

Fig. 4

Constructional Details and General Appearance of the Receiver Described. Although Having Only Two Main Controls It Is Very Efficient and Has a High Degree of Selectivity.

on a piece of bakelite tubing 3 1/2" in diameter, and 5 1/4" long. Using No. 24 D. C. C. wire, start 1/2" from the top, wind on 44 turns in 1 1/2", skip 1/2", and wind on 78 turns more. This winding should be tapped at the 7th, 18th, 31st, 44th, 64th, 84th, 104th turns, commencing from the top.

At the blank center space two 1/4" holes should be drilled, diametrically opposite to one another. These serve as bearings for the 1/4" rotor shaft. Two small holes are drilled in the form 3/4" from either end, and directly above and below one of the rotor bearings. The inductance is mounted on the panel by means of two 6/32" nickel plated, flat head machine screws 1/2" long. Great care must be exercised to get the two bearing holes in the rotor in line with the one on the panel.

For the moving part of the inductance system a hardwood ball rotor 3" in diameter is used. They are, in most cases, drilled for a 3/16" shaft, so it becomes necessary to drill out this hole for a 1/4" shaft.

A 32" hole is bored through the rotor and shaft, at right angles to the shaft, and a short piece of 3/32" brass rod driven into this hole, to lock the rotor to the shaft.

The rotor should be wound with 18 turns of No. 24 D. C. C. wire on each side, or 36 turns in all.

On the rear of the panel, near the center, is a single pole, double throw switch.

As may be seen by a glance at the hook-up this switch serves to connect the ground to either the first tap switch or the inductance side of the grid condenser. When in the latter position the receiver is more selective and is particularly useful for reception of radio-phon. With the changing over switch on the opposite side and the antenna connected the tuning is broader and better adapted for general reception.

The rheostat in this set was home-made. A strip of bakelite 1x2 1/4x3/16" was wound with resistance wire to a resistance of 6 ohms. This resistance element was mounted on the panel by means of two small brass brackets, and machine screws, as shown by the drawing. The edge of the resistance element is 1/4" from the panel. The brackets, which are home-made, measure 1/4"

lengths of brass tubing used as sleeves to slip over the machine screws. This means of mounting may be best understood by consulting the drawing of the tube controls (Fig. 4).

The shaft of the rheostat is a 1" length of 8-32 threaded brass rod. The contact arm is a piece of phosphor bronze 1/4x1/4", secured as shown in Fig. 4, by a pair of locknuts. On the front of the panel is a pointer, held between a nut and a knob threaded 8-32.

For the tube socket a home-made base was used, only the metal shell being purchased.

A piece of 1/8" bakelite 2 1/4x3 1/4" was used. A 1 3/8" hole was bored in this piece of bakelite, centered 1/8" from either side and from one end. Contact springs of phosphor bronze were attached in the proper positions to make good contact to the tube. (See Fig. 2). The base is supported to the panel by brass brackets 3/4" from angle to hole on one leg and 1/2" on the other.

The grid condenser has a capacity of about .0002 mf. Two strips of tinfoil 1x3/8" are separated by a piece of thin mica, and are so arranged as to have an active surface of 3/4"x3/8". The mica and foil are assembled between a piece of 1/8" bakelite, and a piece of fibre, each 1/2"x1 1/4", clamped together by small machine screws which pass through holes in the ends. These screws serve the double purpose of holding the condenser together and acting as terminals. A pencil mark on the fibre, between the screws serves as a grid leak. This may be varied until best results are obtained.

Almost any tube now on the market may be used. Although a soft tube requires a critical adjustment it gives better results than most hard, non-critical tubes. If a soft tube is used an adjustable "B" battery, made up of a dozen two cell flashlight cells soldered together in series, should be employed. This arrangement is more economical and satisfactory than a potentiometer.

Almost any kind of knobs, dials, switches and binding posts may be used. If all bright parts are nickel plated a very fine appearance will be obtained. A composition knob 1 1/4" in diameter was used on the rheostat, but if a readymade rheostat is used the knob supplied with it may be employed.

(Continued on page 1414)

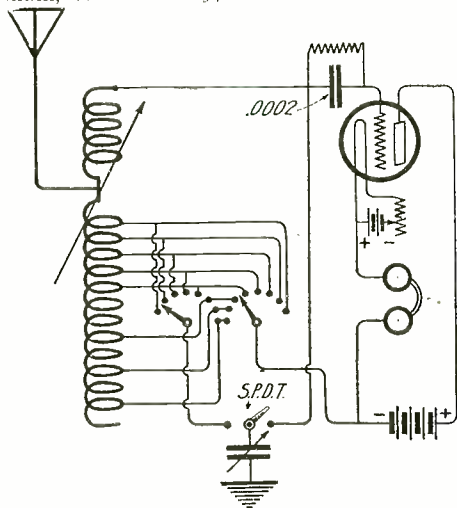

This Circuit Employs Conductive Coupling. The Feedback System Is Similar to the Ultra-audio Circuit. The Change-over Switch Allows for Sharp or Broad Tuning.

Awards of the \$50 Radio Wrinkle Contest

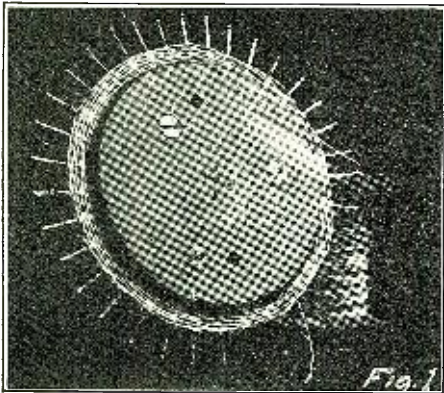

The Two Wooden Discs Grip the Nails Firmly While Winding.

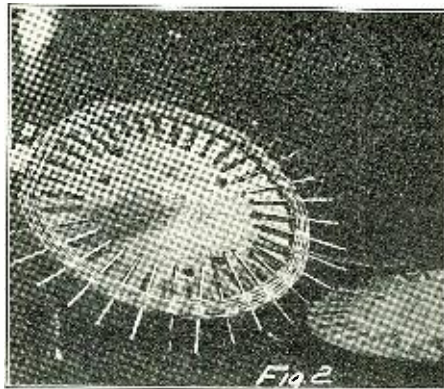

Outer Disc Removed, Showing Method of Formation.

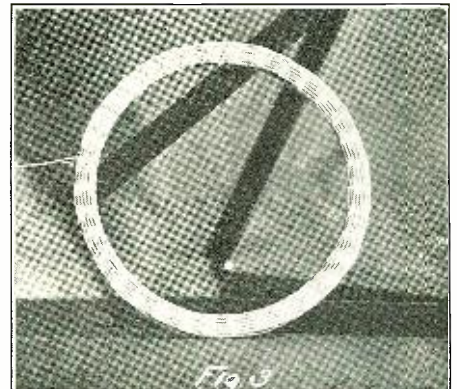

The Completed Coil After Removing the Nails.

First Prize

A NEW COIL WRINKLE

By J. W. H. Martin

In the various radio magazines there have appeared from time to time articles describing methods the amateur might use for winding inductances in receiving circuits. These have included the "duo-lateral," "honeycomb," "spider-web," and the "bank-winding," but none that I recall ever having described the method of winding, as herein.

When planning to build a tuner to give a range of from 150 to 3,000 meters, I struck upon an idea which may not be new in some respects, yet may help others in the construction of their coils.

The tuner that I desired to construct was to be wound on a 4 1/8" outside diameter fibre tube, and was to consist of about 425 turns of No. 24 D.C.C. magnet wire; this would require, in a single layer, a winding space of about 11". By the method herein described, I was able to get all the required turns into a 2 3/8"

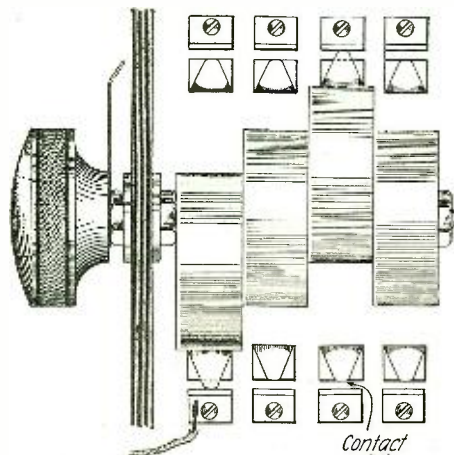
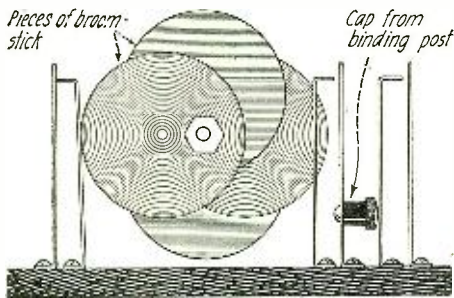

Here Is an Easily Constructed Panel Switch That Will Serve Many Purposes. It Is a Good Substitute for Jacks.

space, thus making the tuner very compact for its range and yet not using any of the methods above mentioned.

The winding is a series connection of "spider-web" coils assembled as pancakes or sections.

Two 1/4" boards were screwed together with three heavy flat head screws and turned down in a lathe to 4 9/64" diameter. (Fig. 1.) The circumference of (Continued on page 1410)

Winners Prize

FIRST PRIZE \$25

A New Coil Wrinkle
By Mr. J. W. H. Martin
12 Brown Apartments,
Coatesville, Pa.

SECOND PRIZE \$15

A Simple Panel Switch

THIRD PRIZE \$10

A Practical Inexpensive Loud Speaker
By Mr. H. E. Bailey
5546 Jackson Street,
Pittsburgh, Pa.

Second Prize

A SIMPLE PANEL SWITCH

The diagram shows a simple panel switch, which is constructed from parts easily secured. The switch can be used instead of jacks and the experimenter will find many other uses for it. A piece of broomstick is cut into pieces 3/8" thick and a hole is drilled through each piece 1/4" off center. The number of pieces used depends upon the circuit the switch is to control. The contact strips are made from some springy material. Half of the strips should be pointed to make a better contact. The strips can be put on one or both sides of the cams. A rod is threaded for about an inch on both ends and two nuts hold the cams from turning. One of the nuts can be loosened and the cams can be adjusted for different circuits; the rod is put through the panel and a washer is put on both sides of the panel and a pointer is fastened on between the knob and the nut on the outside of the panel. The contact strips are now fastened on a base so that when the knob is turned the cam presses a pointed strip against another strip making a contact between the two. If desired, a knob from a binding (Continued on page 1410)

Third Prize

A PRACTICAL INEXPENSIVE LOUD SPEAKER

By H. E. Bailey

Why spend five dollars for a 'tin' loud speaker when a simple and effective one can be constructed by anyone who has a little ingenuity and about 25c in cash?

The horn shown here was constructed by the writer, and, with only a Murdock 2,000-ohm receiver in the base and a detector and one-step music and ball-scores were heard clearly and easily all over a medium sized room and for a distance of about 40 feet from the horn. The tone was excellent and (Continued on page 1411)

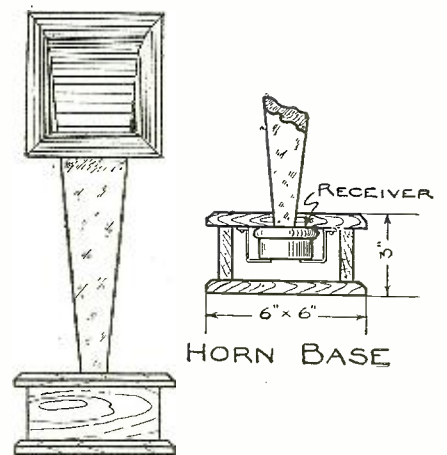

LOUD SPEAKER

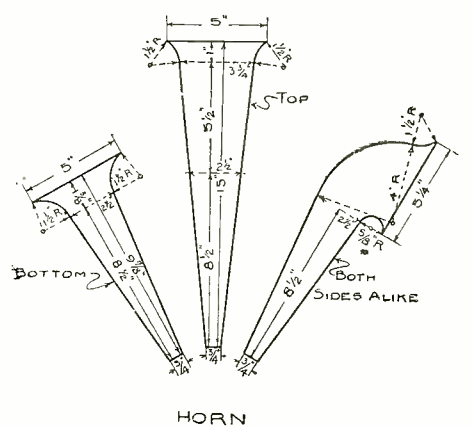

Accurate Mechanical Details are Here Given for the Construction of the Loud Speaker.

Useful Hints for Amateur Constructors

UTILIZING JACKS FOR SWITCHING PURPOSES

Extremely compact and neat multiple contact switches for panel mounting may be made from ordinary telephone jacks. They possess the desirable features of taking up a minimum of panel space, are easier of installation than switches of the more common types, requiring but one hole in the panel for mounting. Most telephone jacks on the present-day market are equipped with silver or platinum contacts, affording very low resistance at that point.

In order to adapt the jack for use as a switch, it is merely necessary to make a plunger of some insulating material, preferably of bakelite rod, of the approximate dimensions shown in Fig. 1. A hole drilled through the plunger as at "a" and having a small piece of stiff brass wire inserted in it, will prevent the removal or loss of the plunger when in the "out" position.

The uses to which such a multi-contact switch may be put are manifold. The accompanying diagram shows the correct method of connecting it for changing the antenna tuning condenser for series or parallel connection, although other uses will no doubt suggest themselves to the experimenter. A further advance in panel-neatness may be attained through stamping the head of the plunger with lettering corresponding to the use to which the switch is put, rather than engraving the panel surface.

Contributed by JOHN M. AVERY.

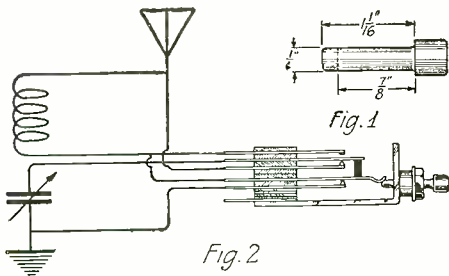

By Means of This Jack the Variable Condenser Can Be Placed in Series or in Parallel with the Antenna Circuit.

A SEMI-VARIABLE CONDENSER

Having had occasion to use different hook-ups, some calling for fixed condensers of several standard capacities, each one being different, I made 13 fixed condensers from waxed paper and lead foil in a flat shape, very compact, and all of the same length from end to end, providing for each one, a brass lug for each end for soldering purposes. These condensers I mounted in an unused corner of my cabinet, one snugly up against its neighbor, and assembled them one wire of each to a common lead wire to the center of the fan switch. The 13 ends thus left were brought to 13 contact points, completing the circuit for each condenser.

I laid off a small circle and divided it into 15 equal parts. A piece of heavy cardboard or a piece of thin wood is right for making a template. Then I selected 15 contacts, all of the same height and size, and spaced them in a complete circle on the panel, and drilled a hole in the center of this circle for the shaft. Any sort of knob can be used, the most satisfactory being one the threaded bushing for $\frac{1}{4}$ " rod, a set screw to hold the knob from coming loose being preferred. I then secured



A Semi-Variable Condenser of Novel Construction. By Connecting a Low Capacity Variable Condenser Across the Main Terminals, Variation May Be Obtained Between the Successive Fixed Capacities.

from a plumber a small remnant of nicked tubing, called flush pipe, cut it open from end to end with tin shears, flattened it out with a wooden mallet to prevent dents, then with the most dependable tool in my outfit (the ice pick) laid out a fan switch to go under the knob and revolve with the knob and pointer. The large end of the fan is just wide enough to cover three contacts at a time, and by so doing engages the capacities of the three corresponding condensers in parallel. There being but 13 condensers, while there are 15 contacts, is explained by the necessity of keeping the fan from "jumping the track" as well as to engage one very small (.0001 mfd) unit at the last point where the fan hits the stop. Two stops are needed for this arrangement to avoid a duplication of capacities which is not desirable, especially as they would fall out of the regular step up or down in their proper values. The pointer was constructed of a thin strip of nicked brass and as most of it is hidden by the fan it can be soldered directly under the fan or be made a part of the fan as desired.

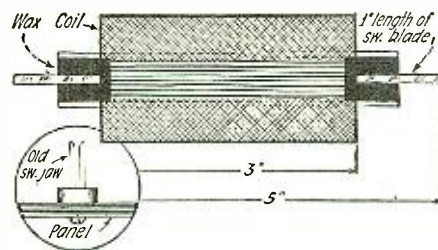

A Choke Coil Amplifier Made from Ford Coil Secondaries.

By using condensers in the order named and of capacities as follows: .004, .003, .003, .003, .002, .002, .001, .001, .0005, .0005, .0002, .0001, .0001. A range is given from .01 to .0001. The range may be increased or decreased by selecting different combinations for the three contact fan switch or by using a four fan or a two fan switch or by having two switches on the same shaft but movably separate, the latter, of course, being more elastic as any two condensers could be combined. Only one stop would be needed, and 15 condensers could be used instead of 13.

By adding a 2 or 3 plate air gap con-

denser across the terminals of the bank of fixed condensers any adjustment could be brought into reach.

Contributed by E. J. FRANKENFIELD

A SMOOTHING DEVICE FOR DIALS.

The radio enthusiast who has been annoyed by noise originating from his dial scraping on the panel, when he finds it necessary to turn same, will find this hint valuable. By simply glueing a piece of felt $\frac{1}{8}$ " thick, on the inside of the dial this nuisance will be abated. It is wise to make this washer about $\frac{1}{2}$ " smaller in diameter than the dial itself. This will prevent the felt from being seen from the front. By making use of such a washer it is also possible to prevent the condenser or anything else, from moving out of place.

When attempting this trick, first take the dial off the panel. Glue on the washer, put the dial back on the panel and after seeing that it fits tight against the panel, make it fast by screwing down the little set screw, incorporated in the dial for this purpose. It will be surprising how smooth and noiselessly the dial may be revolved. The revolving of the dial will not cause the felt to loosen and become annoying. It is a practical idea and the one who is interested enough to try it out, will wonder how he ever got along without it, and it will mean but a hardly noticeable expense.

Contributed by C. A. REBERGER.

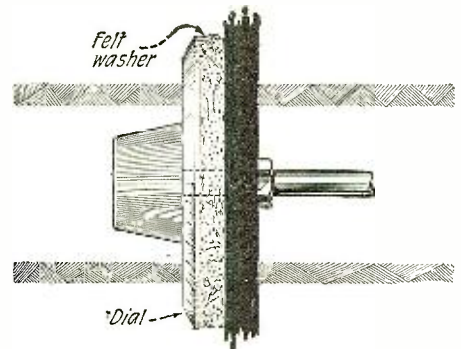

The Noise of Dials Scratching Against Panels Is Very Annoying. Here Is a Good Means of Preventing It.

FIFTY CENT CHOKE COILS FOR AMPLIFIERS

When the vibrator points stick and burn, and Henry starts bucking, the fond owner, after coaxing his pet to the nearest garage, is often told that a coil is burned out and is sold a new one on the spot. As a result I have been able to get coils with the secondaries in perfect condition for fifty cents each.

I have built several choke coil amplifiers, using Ford coils for the chokes, and have found them more efficient than transformers, and while the coils can be used as they are, they are rather bulky, and if the following directions are followed a neat appearing coil can be turned out that takes up very little room and can easily be mounted on the panel.

Remove the wood case from the coil and carefully chip off the wax insulation from the secondary, working very cautiously as the last of the wax is removed. It will be found that the secondary is wound in two pi, separated somewhat more than an inch, with cardboard tube insulation between primary

(Continued on page 1412)



Notice

MANY manufacturers are under the impression that the RADIO NEWS LABORATORIES are a mercantile institution. This is not the case. The RADIO NEWS LABORATORIES, although equipped and organized by RADIO NEWS, are run independently and are not connected with that magazine whatsoever. No charge is made for the testing of instruments and apparatus or for the issuance of Certificates.

We invite all manufacturers to submit their product to us for test, and they will be assured that all apparatus and instruments will be tested by Radio engineers of the highest order, who are, moreover, absolutely impartial in their findings. In awarding the percentages, a vote of four engineers is always taken on all points. For this reason, manufacturers may feel assured that the findings are never one-sided in any respect.

In connection with the testing of these instruments the LABORATORIES have made it a rule not to accept packages unless they are sent in prepaid. The LABORATORIES are operating at no profit whatsoever, so it cannot be expected that they should be put to additional expense.

All apparatus that has been tested will be returned either by freight or express collect.

H. GERNSBACK,
Chairman of the Board of Directors.

Apparatus Awarded Certificates

SUPREME BALANCED VARIABLE CONDENSER

A very rugged variable air condenser of the balanced type is made by the Supreme Electric Products Corp., 102 Main Street East, Rochester, N. Y. The supporting pillars for the fixed plates are $\frac{1}{2}$ " in diameter and are fastened to the end plates by eight heavy machine nuts. Both sets of plates are accurately spaced by machined washers. The movable plates run in brass bearings insulated with hard rubber. Shaft is $\frac{1}{4}$ " in diameter. Provision is made for panel mounting. Overall dimensions are $3\frac{5}{8}$ " in diameter by $2\frac{3}{4}$ ". The capacitance, as measured by a capacity bridge, was found to be: Maximum, 457.39 mmfs.; minimum, 30.18 mmfs. The phase angle difference is negligible. No instruction sheet accompanied the instrument. Arrived in good packing. Received a percentage rating of 84.

AWARDED THE RADIO NEWS LABORATORIES CERTIFICATE OF MERIT NO. 40.

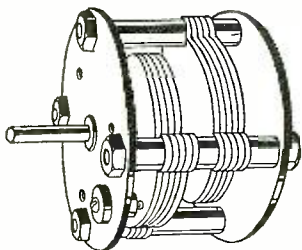

SORSINC TUNIT

For the more efficient reception of short waves for users of honeycomb inductances, this unit is offered by the Ship Owners Radio Service, Inc., 80 Washington Street, New York City. The Tunit is designed to plug into the standard honeycomb coil mounting. The primary is wound with green silk covered wire on a substantial bakelite tube, 3 inches in diameter. Over this a protective strip of fibre is placed. The secondary and tickler coils are wound on small wooden balls, which rotate inside of the primary tube. Stopping pins are provided to limit the rotation to 180° . A metal dial indicates the amount of coupling used. Pigtail connections complete the circuit to the rotors. Insulation is of bakelite throughout and the unit is sturdily constructed.

The wave-length range, with a 0.001 mfd. condenser in series with the antenna and a 0.0006 mfd. across the secondary, was from 150 to 650 meters. Oscillations could be easily produced over

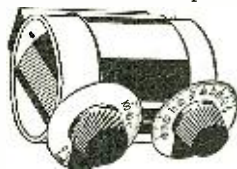

the entire range. The selectivity provided is good.

Arrived in good packing with instructions printed on the outside of the carton. Received a percentage rating of 77.

AWARDED THE RADIO NEWS LABORATORIES CERTIFICATE OF MERIT No. 44.

DE LUXE SOCKET

This moulded condensite vacuum tube socket is manufactured by Alden Napier Co., 5253 Willow Street, Springfield, Mass. The springs are made of leaves, and the ends are bent up so that contact to the side of the vacuum tube prongs is also made, thus decreasing the contact resistance. The finish is in dark maroon. Binding posts are furnished to make contact to the springs. Provision is made for screwing the socket down. The bayonet slot is cut on the inside of an added thickness in the side of the socket, so that no visible cut is seen on the outside. Overall dimensions are $2\frac{1}{2}$ " in diameter by $1\frac{1}{8}$ " in height. Arrived in good packing; no instruction sheets included. Received a percentage rating of 68.

AWARDED THE RADIO NEWS LABORATORIES CERTIFICATE OF MERIT NO. 39.

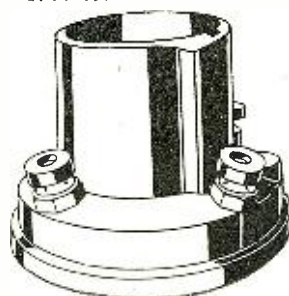

FISCHER DAF VARIOCOUPLER

The above illustrated variocoupler is manufactured by G. H. Fischer & Co., 317 Cypress Hills Road, Glendale, L. I. Both primary and secondary are wound with double cotton covered wire. The primary winding tube is 4" in diameter and is made of single X bakelite. There are single and multiple taps, the later at every 13 turns. Leads about 4" long are soldered to these taps. The secondary of 32 turns is wound on a composition rotor $3\frac{1}{2}$ " in diameter. Connections to this secondary are through the friction contact at the split bearings to Fahnestock clips at the bottom.

With a .0005 mfd. condenser across the secondary, a range of 150 to 445 meters was covered. The primary responds to wave lengths up to 700 meters.

Arrived in good packing with mounting spacers and screws.

Received a percentage rating of 70.

RECEIVED THE RADIO NEWS LABORATORIES CERTIFICATE OF MERIT NO. 45.

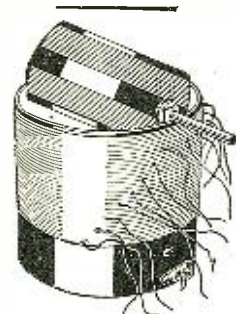

CHELSEA VARIABLE CONDENSERS NOS. 1 AND 2

Following suggestions offered by the Laboratories, the Chelsea Radio Co., 150 Fifth Street, Chelsea, Mass., have made considerable improvements on their condensers. The movable plates have been provided with a stopping arrangement which prevents continuous rotation. In addition pigtailed, consisting of thin brass ribbon have been added to replace the friction contact previously employed. The rest of the construction is essentially the same. End plates are of moulded bakelite, holding the stationary plates by means of machine screws through three cast pillars. The movable

plates are fastened to the steel shaft by a soft metal casting. A screw through the top regulates the pressure on the shaft. A nickel-plated pointer actuated by a knurled knob moves over a white scale stamped directly on the top plate, giving the relative capacity in the circuit. A transparent celluloid case surrounds

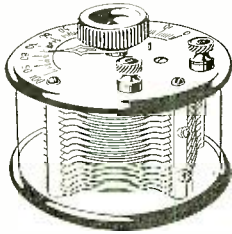

the entire condenser, excluding dust and allowing the inside to be seen. The condensers are made in two sizes. No. 1 is rated at .0011 mfd., while No. 2 is rated at .00068 mfd.

The actual capacitance, as measured on a capacity bridge, is as follows:

No. 1. Maximum 0.001179 microfarads, minimum of 35 micromicrofarads. The equivalent dielectric resistance was zero ohms and 24 ohms respectively, giving a phase angle difference which is negligible in the first case and approximately 16° in the second case.

No. 2 had a maximum capacitance of 515.27 micromicrofarads and a minimum of 12.22 micromicrofarads. The equivalent dielectric resistance was zero ohms and 60 ohms, respectively, which gives a negligible phase angle difference or maximum setting and approximately 1° 26' for minimum setting.

Arrived in good packing with paper templates in each individual carton. Received a percentage rating of 80.

AWARDED THE RADIO NEWS LABORATORIES CERTIFICATE OF MERIT NO. 47.

CHELSEA VARIABLE CONDENSERS NOS. 3 AND 4

These condensers are also manufactured by the Chelsea Radio Co., 150 Fifth Street, Chelsea, Mass. The same improvements as on the other two models have been incorporated, the inside construction being essentially the same. Since this condenser is intended for panel mounting, a cast counterweight is provided which is mounted on the end of the shaft to balance the weight of the moving element. Three brass machine screws are used to fasten the condenser to the panel, being screwed into brass inserts in the moulded bakelite end plate. A bakelite knob and dial, engraved with one hundred divisions reading from left to right, is furnished for the 5-16" shaft. A paper template for laying out the screw holes is also provided.

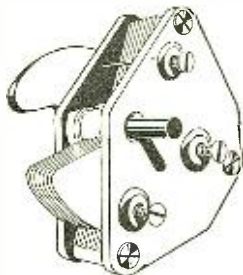

The condensers come in two sizes; No. 3 being rated at .0011 mfd. and No. 4 at .00055 mfd. The actual capacitance as measured on a capacity bridge as follows:

No. 3 Max. 1066.8 mmf. (0.0010668 mfd.). min. 22.02 micromicrofarads. The equivalent dielectric resistance was zero ohms and 29 ohms, respectively, giving a phase angle difference which is negligible in the

first case and approximately 20° in the second case.

No. 4 had a maximum capacitance of 524.42 mmf. (0.00052442 mfd.), and a minimum of 25.42 mmf. The equivalent dielectric resistance was zero ohms and 11 ohms, respectively. This gives a phase angle difference which is negligible for maximum setting, and approximately 12° for minimum setting.

Arrived in good packing in individual cartons.

Received a percentage of 80 in the final rating.

AWARDED THE RADIO NEWS LABORATORIES CERTIFICATE OF MERIT NO. 46.

HAMMARLUND VERNIER VARIABLE CONDENSERS

One of the best condensers we have yet seen, both as regards appearance and construction is the variable condenser made by the Hammarlund Mfg. Co., 144-146 W. 18th Street, New York City. The plates of both the .001 mfd. and the .0005 mfd. sizes, which are identical in construction, are shaped so that the effective area varies as the square of the angle of rotation. This makes the condenser especially desirable for wavemeters since it has a straight line wave length curve when plotted against degrees of rotation.

Hard brass plates 1-32" thick finished in white nickel, are pressed into the heavy milled standards which serve as supports. The shaft is 5-16" in diameter and runs in phosphor bronze bearings set in the bakelite end plates.

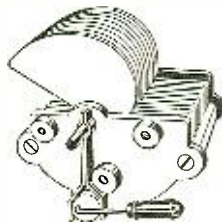

Stopping pins limit the motion of the movable plates to 180°. A heavy brass strip provides a wiping electrical contact at the end of the shaft. Adequate facilities are made for panel mounting. All metal parts are finished in white nickel.

A very novel arrangement is the vernier adjustment. As seen from the illustration, an eccentrically set cam moves the plates through a friction clutch. This clutch is set tightly enough to work properly when the vernier arm is moved but not tight enough to interfere with rotation produced by the turning of the dial. The adjustment may be regulated to 1.150 of a division on the dial by means of the adjusting handle.

As measured on a capacity bridge the capacitance values were as follows: 43 plate, maximum 1043.4 micromicrofarads, minimum 35.16 micromicrofarads. The equivalent dielectric resistance was zero ohms and 19 ohms, respectively, giving a phase angle difference which is negligible at maximum setting and approximately 11° at minimum setting. The 23 plate condenser gave the following readings: Capacitance, maximum 493.31 micromicrofarads, minimum 25.02 micromicrofarads.

Equivalent dielectric resistance, maximum setting zero ohms, minimum setting 8 ohms. Phase angle difference, negligible in the first case and approximately 6° in the second case.

Arrived in good packing with template for drilling mounting holes.

Received a percentage rating of 96.

AWARDED THE RADIO NEWS LABORATORIES CERTIFICATE OF MERIT NO. 49.

A. B. C. VARIABLE CONDENSERS

Condensite end plates are used in this well-made condenser, manufactured by A. B. Cole, 88 E. Kinney Street, Newark, N. J. The method of upsetting the stationary plates which makes the use of spacing washers unnecessary, is quite a novel idea.

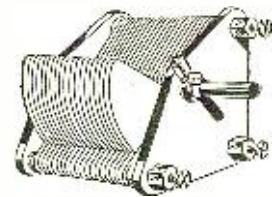

Five different sizes are made, 43 plate, 23 plate, 11 plate, 5 plate and 3 plate. The construction of each of these is identical. The 1/4" steel shaft runs in a lower bearing which is adjustable. The upper bearing is in the form of a split bushing which may be tightened to suit the individual taste. The contact to the movable plates is made through this split bushing.

In appearance the condenser is very neat. All metal parts are nicked. Black finished screws are provided for panel mounting, the holes for which are laid out on a paper template furnished with each instrument.

The following table gives the capacitance equivalent dielectric resistance and the phase angle difference of each condenser:

	43	21	11	5	3
Cap. Plate	43	21	11	5	3
Max. mmf.	872.6	427.5	214.8	93.2	91.09
Min. mmf.	20.7	13.5	10.55	10.15	9.05
Resist. Ohms					
Max.	11	6	5	15	11
Min.	18	12	9	8	7
Max. ... Negligible					
Min. ...	19'	19'	20'	18'	4'

Arrived in good packing in individual cartons.

Received a percentage of 88 for the final rating.

AWARDED THE RADIO NEWS LABORATORIES CERTIFICATE OF MERIT NO. 51.

FLETCHER VERNIER VARIOMETER

The vernier control in this variometer consists of a third winding rotating inside of the usual stator and rotor. The instrument is manufactured by the Fletcher Works, Glenwood avenue and Second street, N. Penn Junction, Philadelphia, Pa. Both rotors are self-sup-

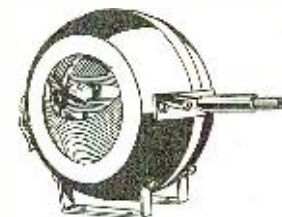

porting, thus reducing the amount of dielectric in the high frequency field. An auxiliary shaft inside of the main one, controls the vernier rotor of a few turns, rotating it 90° degrees on each side of the main rotor.

A well-finished wooden stator supports the stationary winding. Two brass brackets are used to fasten the instrument. All windings are of green silk covered

(Continued on page 1417)

Correspondence From Readers

THE BEST BROADCASTING STATION

Editor, RADIO NEWS:

On the cover of your October issue you show an operator drawing from his set what appears to be a cold Seidel of beer. Please inform me on what wave-length this is accomplished. Kindly publish the hook-up of this set and advise if it is powerful enough to reach Germany.

C. E. TOLLNER.

(Wavelength 2840 (Two ate for nought)!
Decrement 1/2 of 1 per cent.—Editor.)

WHERE ARE THEY?

Editor, RADIO NEWS:

As an old reader abroad I shall be obliged if you could spare a little of your valuable space and publish this letter. The real purpose is to get in touch with some of my old Radio pals with whom I was working during the war, particularly the crowd I was with at Hounslow, England before going overseas. I hope if any of them see this note they will write to the address given.

I must congratulate you on your publication. I wish it came out every week. It seems such a long time to wait for a whole month.

I am one of the few possessors of transmitters in this country and am only allowed to work on 10 watts, but, judging from the letters and comments in your journal I do sincerely hope that we are not allowed to misuse the ether to the listeners' inconvenience, as seems to be the case in your country.

CHARLES H. WOODS,
28 Durham Road,
Plumstead S. E. 18,
London, England.

MEDICAL CENTER CARES FOR SEAMEN

Editor, RADIO NEWS:

I am writing to inform you of the splendid work being performed by the MEDICAL CENTER, 231 W. 51st St., New York City, especially among seafaring men, suffering from special ailments.

This institution is for those who do not wish to go to the public clinic, but who cannot afford the high fees usually charged by specialists. As Radio operators' salaries are not over high, many of them will be glad to take advantage of the service the MEDICAL CENTER offers. Many of our members have been there and have reported that they have been greatly benefited by the treatment and that the fees charged them were extremely low. The institution charges only the actual cost of treatment, being self supporting.

All medical diagnosis is under the personal direction of Dr. Joseph Broadman, who recently delivered a series of lectures before the operators in the employ of the Radio Corporation of America and the students in the Radio Institute.

CLAUDE C. LEVIN,
President U. R. T. A.

THE CONDITION OF SEA-GOING OP'S

Editor, RADIO NEWS:

Noticing your nonpartiality toward printing knocks, boosts, etc., I wish to place before the readers of RADIO NEWS the conditions that really exist at sea in respect to wages.

On the back cover of your October issue the ad of the National Radio Institute erroneously states that operators on Shipping Board vessels receive "\$125 a

month right off" and passenger ship operators \$150. This is verified by a letter signed by Mr. J. B. Weed of the S. O. R. S. and NOT DATED.

This may have been so during the war and a short time after, but at the present time it sounds like QRN to me.

For the enlightenment of those who are not aware of the fallacy of these statements, allow me to state that we receive \$90 per month and less. The freighters get \$90 and so do the passenger ships. The second operator on these vessels gets \$70 and as for a man with a second-grade ticket, well, just let him try for a job. All second-operators have to be first grade ticket men. I hope this will find space in your column.

MILTON M. DAVIS,
S.S. City of Rome, KQZ.

(The advertisement in question was printed due to a mistake. A correction was printed in our December issue, page 1195.—Editor.)

ANNOUNCERS TAKE NOTICE

Editor, RADIO NEWS:

Having found that a word now and then through these channels apparently has

Some Interesting Articles Appearing in Practical Electrics for January

Electric Arc Soldering
Edisonia
Titanic Power Circuit
Electric Steam Generator
English Electric Heaters
Electric Hardening and Tempering process. By Maurice E. Pelgrims, Belgian Correspondent, Practical Electrics.
Oscillating Electric Fan.
Coal Scale Indicator
Small Hydroelectric Plant. By A. L. Cavanaugh.
Measuring Distances by Automobile.

a very favorable effect, I would like to discuss the latest discrepancy in broadcasting of any kind.

Although it has finally become evident to the various announcers that giving their call after every selection or section of a program is a necessity, we have yet to combat with the present evil, that of the clear annunciation of calls. Unless modulations and acoustics are perfect, and unless the selectivity of the receiver is also very good, voice will be accompanied by an indistinctness that will confuse many calls. Of course, the name of the city at which a station is located aids identification, but as the stations increase this advantage becomes nil.

A few of the stations frequently confused, especially at long distance, are WGY, which sometimes is read as WCI or WEY; WOC read as WOZ; WOH as WOA; WPE as WBE, WEE or WDE.

WMR has been read as WNR; often B is confused with D, P, and Z; for instance, WBT is WZT, WDE, etc., all through the list of phones.

How we are to remedy this condition remains for the announcers themselves, aided by outside suggestions, one of which would be to use special pronunciation for certain letters; for instance, the sound "ka" could be used for C, eliminating its confusion with Z, B, D, E, T and V; also the pronunciation of Z could be

"zed," the English way, and so on—the changes being standardized.

Suggestions are in order from all interested in the advancement of radio.

S. M. BODDINGTON, 8BMD.

WHAT THE PUBLIC THINKS OF SOME DEALERS

Editor, RADIO NEWS:

That was a fine and sensible article in the September RADIO NEWS, "Why Radio Sales Fall Off". Fellows of the type who wrote that article deserve credit for preventing radio from becoming a farce. Radio is a joke; people who have sets don't know the first thing about them; you are invited to their homes to hear concerts of statics and whistles, or perhaps a distorted loud-speaker. Of course, there are exceptions; there are about 50 fellows here who can make most any kind of a set work right. It is a peculiar thing, however, that none of them work for any radio store, excepting in one instance, and it is necessary for one to fool around for an hour or two before he finds what he wants. I should think it would be to the store's advantage to employ nobody but licensed amateurs to work for them.

About this catalog matter you are pretty nearly right. There is one big exception, and he deserves credit, namely, Hoyt, who not only publishes a big catalog with all kinds of apparatus in it, but doesn't charge anything for it; it is easily worth 25c.

When I send for articles listed in magazines, some ship them immediately and some wait a couple of months or so; some pack well, while others don't seem to care. It takes costly experimenting to sort them out.

It would be a good idea if, besides devoting two pages or so in describing articles of merit, you would lay a couple of pages aside where the amateurs could tell the manufacturers what is wrong with this thing and that. It is a good idea of yours, to award certificates, as the amateur by following your articles, can judge what to buy. For instance, I have been skeptical about buying strange rheostats. The wiring comes loose very easily on some, but all we have to do now is to look in your magazine and pick out one of those you have awarded a certificate of merit.

W. WILCOX,
New Bedford, Mass.

2BFF SPEAKS

Editor, RADIO NEWS:

It is with much interest that I read the letter of Mr. F. J. Petrequin in the November issue. The writer of this letter does not seem to think that the "brass pounder" gets as much thrill as the long-distance "phone hound." He thinks it more thrilling to reproduce a distant concert so that it can be heard blocks away and draw a crowd of friends who will be interested in radio by what they hear, and who will throw much business his way. In other words he uses radio as an ad which draws business and perhaps makes many shekels for him and then compares this with the thrill of the key-man which comes to him in the wee small hours, when he is chatting with his friends hundreds of miles away.

I think it would be safe to state that Mr. Petrequin does not know code, nor has he ever pounded a key. He states that he does not intend to install a phone set

(Continued on page 1390)

Radio Humor

HORRORS OF WIRELESS: THE

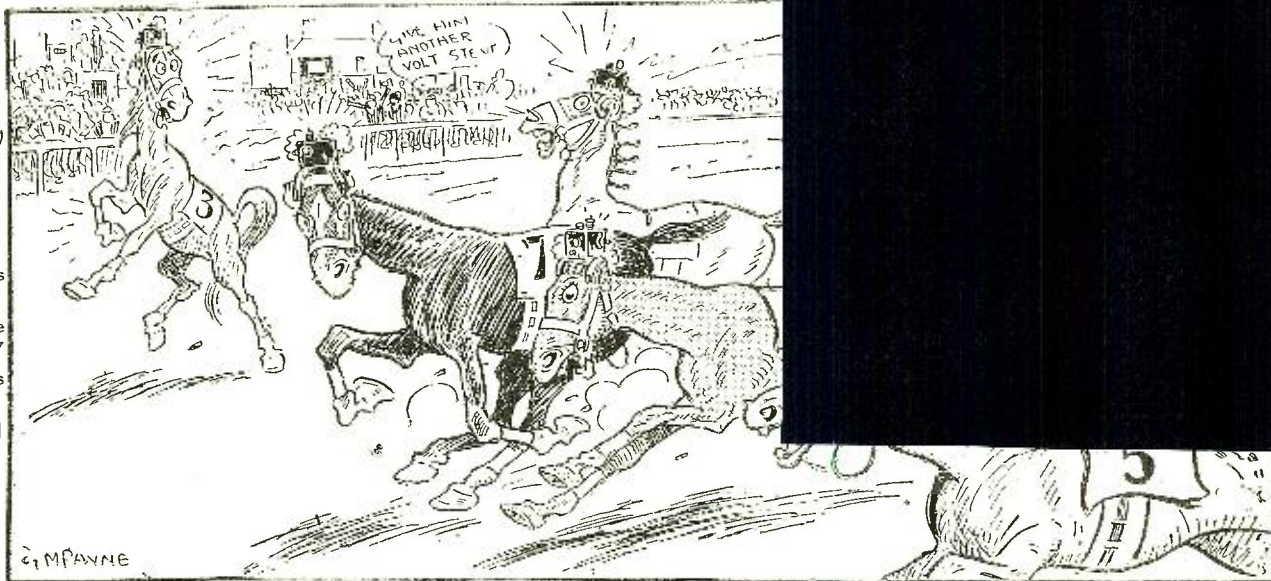

This Cartoon, Published Recently in Our English Contemporary, "Amateur Wireless" Shows What a Horse Race Would Look Like if the System Recently Described in the Paper Was Used.

Howling from the Second Step

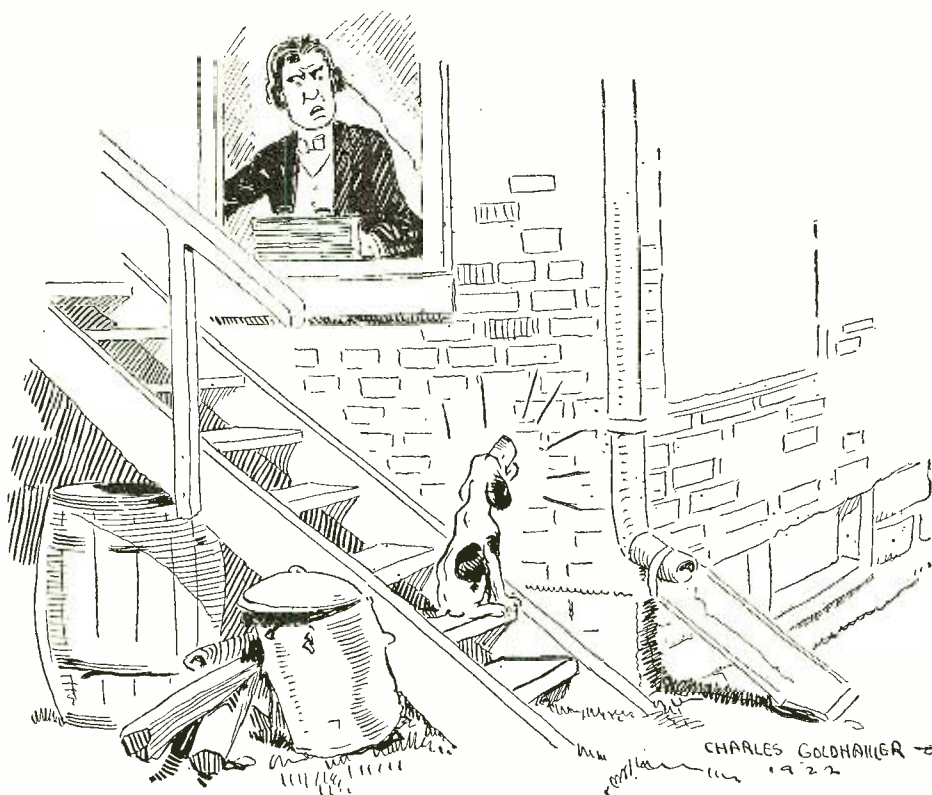

Formulae

BY JOHN D. FORREST

FOR the benefit of those who are interested in the deep, dark, dank investigation of the phenomena concurrent with radio practice (as it is practiced by myself), I will endeavor to detain you this evening, ladies and gentlemen, with some sound engineering data. The first will be some formulae:

The word formula comes from the Scandinavian word *Joqszxclkfj* which means, well, nothing more or less in my young life. Persons who associate themselves with formulae are called *Kjjjpm-buqsaxj* in the mother tongue, and as a general thing are no better than they are.

To find the specific gravity of a filament rheostat loading coil, divide the number of turns on the grid condenser by the value of the German mark expressed in microkilograms. Add three zeros to the answer and this will give you the equation of time, which is well known to astronomers. All you gotta do is hunt up an astronomer and he will translate this result into *Kanaka*, then you divide this by the number of kilowatts in the Hungarian Imperial gallon. There's the answer. Of course that isn't the Wright one, but why worry, anyway?

(Continued on page 1384)

Terms Used in Radio Practice

BY JOHN D. FORREST.

FOR the information of those embryo Marconis who are not quite familiar with abstract terms used in radio practice, I herewith set down the most important of the whole glossary. Needless to say, these have been glossed over as much as possible:

Automatic Broadcasting Station: The family heir who is "on the air" nightly from 6 P. M. to daylight.

Automatic Receiver: My wife on pay nights.

Ether: An anaesthetic which should be applied to all users of spark coils.

Aerial Ammeter: An instrument devised to tell more lies than a candidate for alderman. Much cursed and discussed by hams.

Antenna, harp: An aerial erected in Ireland.

Arc: The first non-radio-equipped vessel owned by Noah & Co., Ltd., for navigating the eddy currents in a highly damped period.

Arrester: A man with a red nose, big feet and who wears a blue suit.

Amplifier: An apparatus designed to howl like a Comanche Indian when a finger is pointed at it.

Amplification, co-efficient of: The difference in range of a receiver as told by the salesman and that found by the purchaser.

Battery: A park in New York which, in connection with the Brooklyn Bridge, is sold to up-state rustics for fabulously low prices.

Beat: A circuitous route assigned to policemen for sleeping on, and for their osculation of cooks at back doors.

Cage conductor: A political job held by Irishmen in public buildings.

Characteristic curve: See Paris styles for summer.

Choke coil: An instrument formed of manila rope, much used a few years ago by county sheriffs west of the Mississippi.

Critical position: See "My Eternal Triangular Memoirs of Hollywood" by Macks Inuit, 8vo. \$67 net; Clothes Press, Indiana Harbor, Kentucky.

(Continued on page 1384)

Club Gossip



a thorough understanding between broadcaster amateur and novice. It is our desire to teach the owner of radio receiving sets that telegraph signals are as interesting as concerts and that to the radio amateur is due some consideration. At present it is almost an impossibility to secure satisfaction in receiving, especially from distant stations, when the local amateur starts his I-K.W., which is usually the case. We have secured the assistance of many radio clubs and dealers, as well as broadcasting stations and we believe that every person interested in radio will help us in this movement, which will benefit all.

PHILADELPHIA AMATEUR RADIO ASSOCIATION.

The Philadelphia Amateur Radio Association held its first meeting of the Fall on Thursday, September 21, 1922, at 1521 Columbia Ave., which will be the association's permanent quarters in the future. The association was reorganized and new officers were elected; also, a new constitution was adopted. The Board of Governors were elected as follows: L. M. Knoll, chairman; B. Kantrow, C. G. Benzing, H. Blacker, J. Mooney, E. V. Eckert and J. Rau. The following officers were elected: L. M. Knoll, 6120 Carpenter St., president; J. S. Marsh, 7112 Sellers Avenue, Bywood, Pa., vice-president; W. B. Martin 1927 N. 20th St., secretary; H. C. Brooks, 1661 Brill St., treasurer; and J. W. Forsyth, 6543 N. Lambert St., correspondence secretary.

A very good plan for helping the amateurs to keep out of trouble with the broadcasting stations, regarding interference, was suggested, and all members agreed to help this plan along by making it a section of the constitution of the association. Plans were made for a very active amateur winter in Philadelphia. The Philadelphia amateurs are at last awake and have formed a strong and permanent union.

The Philadelphia Amateur Radio Association would like to advise all persons, before making a complaint to Government officials about interference from Philadelphia amateurs to send in the complaint, backed by proof to the Philadelphia Amateur Radio Association, which will take up the complaint with the accused amateur. By doing this, you will avoid many mistakes and save trouble for all.

This association has changed its meeting date to the first and third Thursdays of each month. In order to join, the applicant must hold an amateur's license and his name must be suggested by a member, and this will have to be seconded by another member. The applicant will then fill out an application blank, which will be subject to the approval of the Board of Governors. The dues are \$4 per year, payable the first quarter of the term. We would like to hear from other radio clubs throughout the country.

RADIO CLUB OF EAST HARLEM.

The Radio Club of East Harlem, which was recently organized, has elected as officers the following: Harold Itzel, president; John D. McEvily treasurer, and John N. Itzel, secretary. The main object is to promote the art of radio among the amateurs. We should like to hear from fans living in the vicinity of 125th St. to 26th St., east of Fifth Ave.

Such persons are requested to write to Radio Club of East Harlem, Harold Itzel, President, 176 E. 111th St. Anybody between the ages of 16 and 21 is welcome to join.

GREENPOINT RADIO ASSOCIATION.

The Greenpoint Radio Association has again been opened for this season, after the Summer closing. Plans are being made to obtain quarters in Greenpoint, and there install the DeForest receiving set of the club.

As part of the reorganization, the Club is instituting a drive for members. Membership is open to all desirable young men who have a knowledge of radio and also those who wish to have a broader knowledge of the subject. Anyone interested may call any Friday evening at 79 Eagle St., or write to the secretary, H. W. Gerlach, 113 Oak St., Brooklyn, N. Y. All communications will receive prompt attention.

RADIO CLUB OF AMERICA WITHDRAWS FROM EXECUTIVE COUNCIL

The Radio Club of America, leading amateur club of the country, formally withdrew from membership in the 2d District Radio Council recently. This action by the oldest radio club in the world comes as a climax to one of

the bitterest fights that has been waged since broadcasting gripped the general public. It marks the end, according to close observers, of the decisive influence which has hitherto been wielded by the council in local radio fields.

The battle commenced over the question of the council holding its annual radio show. Strong influences back of some of the commercial concerns interested in the various shows planned for this year were brought to bear in the fight, with the result that any serious competition from the council has been completely throttled.

The only successful radio shows held in this city have been under the auspices of the council, the others failing because of inadequate planning and lack of proper supervision.

During the struggle in the executive committee of the council the group at present in control succeeded in ousting Renville R. McMann from the presidency of the council through a technicality regarding his delegation to the council. Shortly after this an announcement was made that the annual show of the council would be held next March and would be limited to licensed amateurs and their friends.

The action of the Radio Club of America in withdrawing from membership in the council was taken as a protest against the manner in which Mr. McMann was driven out of the presidency. The latter is secretary of the Radio Club and one of its directors. The importance of the withdrawal is emphasized in the directorate of the Radio Club, which includes such famous men as Major Edwin H. Armstrong, Paul F. Godley, George Burghard, John Grinan, Louis G. Pacent, E. V. Amy, J. O. Smith, Minton Cronkhite and Walter Lemmon.

They were the men who took active part in managing the two previous shows held under the supervision of the council, and under their direction only manufacturers of standard and reliable apparatus were permitted to exhibit. In addition to this, being technical experts, they were able to plan a real organized display and arrange an instructive and entertaining series of features. Representing a non-commercial body, they were also able to exercise a powerful influence over the apparatus that could be admitted to the show.

At the present time there are two shows planned for this year in this city, both on an elaborate scale. Both are strictly business ventures. A careful survey of the manufacturing situation clearly indicates that both cannot be successful unless the booths are opened indiscriminately to every one engaged in the manufacture of radio equipment, irrespective of its merit.

Up to the time that he was forced from the presidency of the 2d District Radio Council, Mr. McMann had succeeded in securing assurances from twenty-eight of the country's oldest manufacturers that they would exhibit in a show held by the council for the general public. This assurance will undoubtedly be withdrawn, since the council is now limiting admission to licensed amateurs and their friends.

The Radio Club of America was first organized in 1908 and, so far as is known, was the first club of its kind in the world. Its membership has been carefully limited at all times, and numbers the most famous men in radio history. Whether it will branch out and assume the role which has been vacated by the 2d District Council has not yet been decided.

The formal letter of withdrawal was as follows:

"Executive Radio Council, New York:

"Gentlemen: This writer has been instructed by the board of directors of the Radio Club of America to inform you that, in view of the policy of the council, the club has resigned and has severed all connections with the Executive Radio Council of the 2d District.

Very truly yours,

"RENVILLE H. M'MANN,
"Corresponding Secretary."
(Abstract from N. Y. Tribune.)

TWO BROADCASTERS IN PORTO RICO

In reading the "I Want to Know" department of November Radio News, I noticed that you say that you know of only one broadcasting station in Porto Rico, that being WGAD.

I would like to inform you that there is also another broadcaster in Porto Rico, located in San Juan. This station uses four 250-watt tubes, two as oscillators, and two as modulators, with one 50-watt voice amplifier. It has been heard in Nova Scotia. The call letters are "WKAO."

FRANK W. WODRICH, Jr.
Porto Rico.

RADIO CLUB OF BROOKLYN, N. Y.

Opening its eighth successful year, the Radio Club of Brooklyn, N. Y., the largest radio club in the Borough, elected new officers for the coming term. For President, Mr. M. Greene (2KE); for Vice-President, Mr. W. Carter; for Secretary, Mr. C. Caggiano (2WK); for Treasurer, Mr. C. Knudsen, and for Sergeant-at-Arms, Mr. Rodde.

The first meeting was held for reorganization, necessary because of the condition brought about in the amateur world by the advent of broadcasting, and the creation of a new class of amateur, the radio fan.

New tentative plans have been worked out for the coming year. It is expected that some of the DX stations on the membership list will enter the Transatlantic tests in December. This Club counts among its members many of those connected with the well-known long-distance stations in the district.

To work hand in hand with the American Radio Relay League, of which this Club is a member, it is desirable that every amateur in the city get in touch with Mr. C. Caggiano, secretary, 245 Pacific St., Brooklyn, who will supply them with any information desired. He will gladly send a copy of the Club publication, the "Radio Log," to any amateur who makes the request.

The Radio Club of Brooklyn meets every second and fourth Thursday of the month at its headquarters, 854 Flatbush Avenue, and extends a cordial invitation to everyone to attend.

LIGA MEXICANA DE RADIO.

We wish to inform Radio News, and through it all American amateurs, that the first radio club in Mexico has been organized. This took effect on the night of July 12, when a body of 50 amateurs out of 250 that are known to exist in this city, gathered to set the basis on which the club is to work for the study and advancement of radio in this country. The name of the club is to be "Liga Mexicana De Radio," and embraces all amateurs throughout the Republic.

Officers were nominated and committees appointed thus: Technical Committee, to direct the activities of the club and give instructions and aid to beginners; Legal Committee, to study and form a constitution for the club, to make a set of rules and regulations to be presented to the Secretary of Communications, and to procure a more stimulating legislation for amateurs, as at present licenses are not granted for transmitters of more than 20 watts, using vacuum tube as generators; Special Committee, to work on traffic rules, arrange for demonstrations, organize intercommunication by relay, concerts, dances, etc.

We would like to get in touch with some American radio clubs and obtain copies of their constitutions and regulations and also to plan for the future international relay work.

Address all communications to Liga Mexicana de Radio, P. O. Box 867, Mexico, D. F.

RADIO INSTRUCTION IS OFFERED FREE.

The National Radio Engineering Company, of Atlanta, Ga., is offering, absolutely free of charge, a complete course in radio. This course of instruction is given by one of the oldest instructors in the country who trained operators many years for U. S. Shipping Board service and will qualify the student for a Government Commercial License within a few weeks. Code instruction will be transmitted daily from various stations throughout the country.

This offer is made after consideration of the radio situation of today. So many broadcasting stations as well as amateur stations are coming into use daily that it is necessary for



The "Q" Signals

R. N. Scribner, Chief Operator on the S. S. President Madison, makes some suggestions for improving the "Q" list

THE International list of abbreviations, commonly called the "Q" signals, fail in a great many ways to accomplish their object. With the great number of radio stations operating today, the increasing amount of traffic, and the multiplicity of wave lengths, there is an acute need for a "Q" list that covers a much greater field than the present one. It is admitted that most of the present abbreviations are entirely suitable for use and should not be changed. However, some of the signals should be enlarged upon, some should be deleted entirely from the list, and some new ones should be created. The "Q" list should be an instrument that covers every point of handling traffic operations, thoroughly and quickly. It should do away with the necessity of ever using a service message in ordinary operation. The International list stands today as it was first designed, with the exception of a few minor changes and additions. Operating conditions have changed considerably within the last few years. The increasing use of C.W. and the greater range of wave lengths used in ship to shore communication, are only instances where the present list fails miserably in its object. There is no reason why there should not be a really adequate list of abbreviations. Mr. Scribner suggests the following improvements:

QRB, as given in the list was evidently designed for use of coast stations solely. Why not change it to read, "What is your

distance from.....?" and make it useful to both ship and shore stations.

QRC is rarely if ever used and nobody would miss the expression if it was dropped.

QRG. Inasmuch as there is a very urgent need of an expression to mean, "What Company controls your radio apparatus?" QRG could very easily be changed in favor of the Radio Company where it would be of some use, instead of "What line do you belong to?", where it is never used.

QRH is another form that is not used. To make this really worth while it should be changed to mean, "What wave length are you sending on? Answer on...meters."

It is obvious that if one is already receiving a station he must certainly know his wave length (near enough for all practical purposes), but, when working with a station having a number of wave lengths, the transmitting station sometimes becomes "lost" and confusion resulting therefrom is apt to use up considerable time.

QRJ. With the addition of QTC to the list, QRJ was pushed further into the background, if such could be possible. Before the addition of QTC, QRJ was very seldom used, although it might well have been used for the same purpose as the present abbreviation QTC. However, it could be deleted from the list now, without compunction.

QRX. Nobody seems to have found a use for "I will call you when required." When

using the expression QRX, operators nearly always use it in conjunction with a number of minutes, except for a very short stand by of five minutes or less. If the expression read, "Stand by I will call you in..... minutes," it would nearly fill its true use.

QRY is very seldom used, but is a very commendable abbreviation. If coast stations, especially, would make common use of it during their busy hours, they would do away with a great number of interfering calls and QRM in general. After assigning a "turn number" to a ship there would be no excuse for the ship interfering with the coast station by calling again.

QSJ. While this abbreviation is a very useful one and is as frequently used as any one of the "Q" signals, it could be improved upon if there was some way of indicating just what charges were required by the inquiring station. If QSJ was used to signify the total charges, and QSJA, the coast station charges, QSJB the landline charges and QSJC the cable charges, the inquiring ship could signify by one signal exactly what was wanted. Ship tax would also be signified by QSJ. When working with foreign stations QSJ is used a great deal and nearly always the ship stations want charges itemized and unless the operator at the shore end understands your language pretty well, service messages are not very satisfactory.

(Continued on page 1310)

Vacuum Tubes On Board Ship

By Stanley Edgar

AT last the seagoing operator may legally use vacuum tubes for reception—at the paltry price of ten dollars a throw.

We have wondered whether the day would ever come when a ship radio receiver would be equipped with something slightly more modern than a Marconi coherer or a magnetic detector. An order has lately been issued that vacuum tubes, hitherto restricted for amateur use, may be used for commercial purposes and are sold for this purpose at \$10 each.

Well do we remember the time when, in a brief career on a British ship, we regularly wound up the old magnetic detector and tied a bit of red ribbon to one of the wheels so that we would know when it had run down. Signals were rare happenings in those days and a stationary red ribbon was our warning that the receiver was no longer in a state of maximum sensitivity.

But radio has progressed by leaps and bounds since then. The Fleming valve was developed and later the Audion. Vast improvements in methods of reception followed—the feed-back circuit, audio-frequency amplification, radio frequency am-

plification, loop reception, direction finding, external heterodynes for long wave reception, superheterodynes and, lastly, super-regeneration—all of which depended for their operation upon the three-electrode vacuum tube, the Audion.

Most amateurs probably have imagined that the radio room of an American ship contains the very latest developments in the radio art—a veritable radio Paradise, studded with vacuum tubes of all types for transmission and reception. And yet, only last week, we were on board a ship in New York harbor which was the proud possessor of a genuine antique coherer to assist the operator in his duty of protecting by radio the lives of the crew.

The operator of this ship was about as moth-eaten as his apparatus. He snapped out of a deep coma just long enough to express some strange views on the progress of radio. He "didn't think so much of these audions." Gave us to understand that he wouldn't have one of them around the shack. Pressed for an explanation, he solemnly outlined his argument in favor of coherers and against audions.

"These here audions," he declared, giv-

ing us the peculiar impression that he was speaking of some remote and unknown product, "these here audions are liable to demagnetize your phones."

We awarded him the bakelite grid leak as the greatest dumbell we had met in several weeks and left him fast asleep in his bunk.

Most ships have succeeded in advancing a few steps farther than this with the radio art. Some years ago those who were responsible for the radio equipment on board ships learned of crystal detectors, and crystal receivers were installed on practically all the vessels.

But there progress ended. The audion detector was invented and with it came the modern methods of transmission and reception which revolutionized radio. Directional reception, with its great usefulness as an assistance to navigation and the avoidance of collision between ships, was developed. One would expect that every ship on the ocean would immediately have been equipped with this simple and effective method of protection, but most ships still have their old-fashioned crystal detectors.

(Continued on page 1312)

Radio Digest

BRITISH WIRELESS TELEPHONE EXCHANGE

What is said to be the first wireless telephone exchange in the world has recently been established at Croydon, England, the point from which the aerial lines to the European Continent take their departure.

The chief use made of this exchange is to connect the aerial traffic controller, who has his headquarters in a control tower at Charing Cross, London, with the pilots of the air expresses flying between Croydon and the Continent of Europe.

This wireless exchange can also connect the airships, while in flight, with any office at the aerodrome at Croydon.

The pilot of each aerial service is now required to report his position to the traffic controller every fifteen minutes so that the progress and position of each machine is known throughout its journey. The controller is of particular use in directing the course of the airships in cases of fog, and in giving them special directions for landing.

The traffic controller also, from time to time, broadcasts from his wireless telephone weather reports to all machines in flight.

AN ELECTRON TUBE AMPLIFIER USING 60-CYCLE ALTERNATING CURRENT TO SUPPLY POWER FOR THE FILAMENTS AND PLATES.

Scientific Paper of the Bureau of Standards No. 450 obtainable from the Superintendent of Documents, Government Printing Office, Washington, D. C., describes an electron tube amplifier which uses 60-cycle alternating current to supply power for the filaments and plates.

Such an amplifier has the advantages of low first cost and cheapness of operation besides doing away with the inconveniences of the storage battery and the "B" battery.

This paper describes such an amplifier developed at the Bureau of Standards using a crystal detector and five stages of amplification, three stages of radio-frequency amplification and two stages of audio-frequency amplification.

The first arrangement tried consisted of one radio-frequency stage of amplification, tube detector, and one stage of audio-frequency amplification. The filaments of the three tubes were lighted by six volts supplied by a step-down transformer, the primary of which was connected to 110-volt, 60-cycle power mains.

It has been found that either "air-core" or iron core transformers may be used for coupling the output of one tube to the input of the next tube. The air-core transformer gives more amplification per stage, but is responsive to only a narrow band of frequencies owing to the low effective resistance of the windings; the iron-core type, while not giving as much per stage, allows amplification over a much broader band of frequencies.

A special type of air-core transformer, which will respond to signals on wavelengths from 600 to 1000 meters, is described. The coils of the transformer were wound in the form of a flat doughnut, the wire being wound in a manner similar to that of the open or basket type of coil winding. They are wound continuously from the inside to the outside. Two of the coils constitute an air-core transformer, one coil being connected in the plate circuit of one tube

and the other being connected to the grid circuit of the succeeding tube. It is found that when the primary and secondary transformers are placed about one-half an inch apart, the transformer gives best amplification at 600 meters; and when the coils are placed close together, the amplifier operates best at 1,000 meters. This is due to the increase of the capacity of radio-frequency, two stages of audio-frequency amplification, and a detector tube, may be constructed as described in this paper.

RADIO-FREQUENCY AMPLIFIERS.

Scientific Paper No. 449 of the Bureau of Standards, Department of Commerce, describes the construction of a radio-frequency amplifier which uses the transformer coupling method.

Radio-frequency amplification consists in the amplification of the received radio-frequency current before it is detected. By the use of radio-frequency amplification and a coil antenna, a signal which is very feeble can be made loud enough to be heard throughout a large room.

Radio Articles Appearing in December Science and Invention

Radio Race Horse.
Auto Has Concealed Radio Antenna.
Broadcasting Niagara's Roar.
Seventh Prize Radio Receiving Set—By George Goga.
"Radio Interference" Contest Announcement—\$100.00 in Prizes.
Make Your Own Radio Movies.
Radio Tuning Devices and Circuits—By A. P. Peck.
Radio Broadcast Station Photos.
Radio Broadcast—List of Latest Radiophone Broadcasting Stations and Call Letters.
Radio For the Beginner—Tenth Installment. By Armstrong Perry.
Radio Oracle.
Latest Patents.

Three methods are described by which the electron tubes may be coupled together so as to give radio-frequency amplification; resistance coupling, tuned-plate coupling, and transformer coupling, the last having been found most satisfactory.

In order to operate well, the radio frequency amplifier should have a transformer designed so that it will have small capacities in the windings as well as between the windings, and in connecting the transformer in the amplifier circuit care must be taken to have all connecting leads as short as possible.

The alternating current was rectified by means of a gas-filled two-element rectifier tube called a "Tungar" tube, but it was found that the residual hum was greater than when the alternating current was not rectified.

When an electron tube is used as a detector, there is impressed on both the plate and filament a 60-cycle alternating current voltage which, although small, becomes objectionable when amplified by one or two stages of audio-frequency amplification. When, however, a crystal

detector is used instead of an electron tube detector, it has been found that the 60-cycle hum is practically eliminated and that the crystal gives as good rectification as the tube detector.

After much experimental work, a circuit consisting of three stages of radio-frequency amplification, galena crystal detector, two stages of audio-frequency amplification, loud-speaking reproducer, and the necessary power transformer and rectification circuits was found which allowed the reception of music and telegraphic signals without too much interference from the humming noise just mentioned.

THE WIRELESS TELEPHONE IN DENMARK

The wireless telephone, which is rapidly being introduced over the entire world, has arrived in Denmark, and experiments and demonstrations have lately been held in this country with a view to bringing this new method of communication to the attention of the public. All of these experiments and demonstrations have proved quite successful in pointing out the advantages of this means of communication. The first of these experiments took place during the month of August when direct wireless telephone communication was established between Copenhagen and one of the Scandinavian-American Line ships off the coast of Norway, enroute to the United States. This experiment was conducted by the Danish Radio Aktieselskab (The Danish Radio Company, Inc.), which company has installed nearly all of the radio equipment found on Danish ships. Recently a demonstration was given by this same company when wireless telephone communication was established between one of the local telegraph news bureaus and Helsingør, a city lying about 30 miles north of Copenhagen on the sound. This demonstration was also a success, messages being received and understood with perfect ease.

The development of the wireless telephone has been and is undoubtedly being retarded to a considerable extent in this country on account of laws forbidding the use of all amateur radio telephone and telegraph outfits. In spite of these laws, however, there are at the present time about 1,000 radio amateurs. Many firms and institutions have endeavored to secure permission to operate sending and receiving stations, but none have secured such permission with the exception of certain schools, laboratories and educational institutions, and these for technical and educational purposes only. It seems that nothing will be done toward changing the present regulations until the proposed International Conference on regulations of wireless telephone and telegraph, which is to take place in Paris in January, 1923.

Much significance is attached to the experiments mentioned above, inasmuch as there seems to be a possibility of creating extensive wireless telephone communication in this country in the future, particularly if laws are passed permitting the use of amateur wireless telephone and telegraph outfits. Considerable has been done through the newspapers in this country to awaken interest in the development of the wireless telephone and references are made repeatedly to the increased use of this
(Continued on page 1404)



THIS Department is conducted for the benefit of our Radio Experimenter. We shall be glad to answer here questions for the benefit of all, but we can only publish such matter as is of sufficient interest to all.

1. This Department cannot answer more than three questions for each correspondent.
2. Only one side of the sheet should be written upon; all matter should be typewritten or else written in ink. No attention paid to penciled matter.
3. Sketches, diagrams, etc., must be on separate sheets. This Department does not answer questions by mail free of charge.
4. Our editors will be glad to answer any letter, at the rate of 25c for each question. If, however, questions entail considerable research work, intricate calculations, patent research, etc., a special charge will be made. Before we answer such questions, correspondents will be informed as to the price charge.

You will do the Editor a personal favor if you will make your letter as brief as possible.

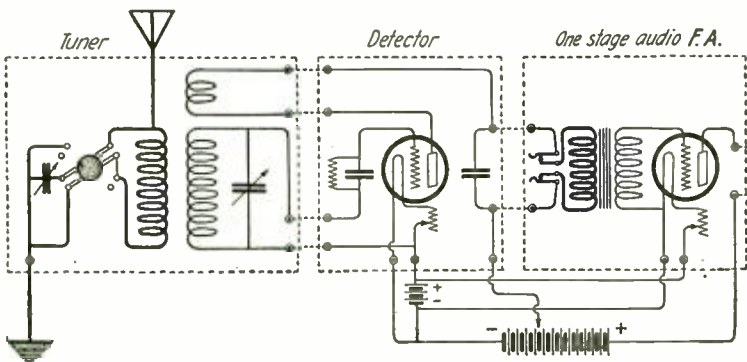

HONEYCOMBS AND AMPLIFIER.

(572) Mr. W. Kemp of Carlstadt, New Jersey, wants to know:

Q. 1. Please publish hook-up using following material: Triple honeycomb mounting, series and shunt switch, .002 M. F.; .001 M. F. and .0005 M. F. variable condensers, one .002 fixed condenser, tube socket, one rheostat, one grid leak and three stages of audio frequency amplification.

A. 1. The hook-up for the mentioned materials will be found on these pages. Use a six volt, 80-ampere storage battery for heating the tube filaments and 45 volts "B" battery for the amplifier plates with a tap off at 22½ volts for the detector tube.

RADIO AND AUDIO WITH TICKLER.

(573) Mr. J. E. Mullen of Raleigh, North Carolina, inquires:

Q. 1. Am I obtaining the maximum efficiency from the enclosed circuit, having received broadcasting stations up to 850 miles?

A. 1. You are obtaining good results with this circuit.

Q. 2. How can I add two stages of radio frequency amplification and one stage of audio frequency amplification to this arrangement and include a 43-plate condenser to advantage?

A. 2. This circuit is printed on these pages. Your grid condenser should be shunted by a grid leak of ½ to 1 megohm.

Q. 3. I have completed shielding my panel with tin foil and find I am not getting the distant points as well as before. All electrical connections are free from the tinfoil except the ground. Do you suppose the tinfoil absorbs the energy?

A. 3. Use one piece of tinfoil for shielding each instrument, connecting all to a common

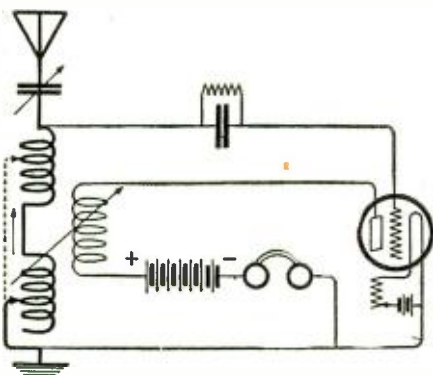

Q 540

Q. 580. Single circuit tuner with tickler feedback. The main inductance is split at the center, the tickler thereby being in equal inductive relation to the entire coil.

Q. 572. A honeycomb coil tuner with series multiple switch in conjunction with detector and amplifier. Binding posts are inserted in each unit to illustrate a convenient means of incorporating separate panels.

ground connection. One piece covering the whole panel surface creates considerable eddy currents resulting in loss of energy. If possible, reduce your aerial to one wire and increase the length.

ALL WAVE COUPLER AND CRYSTAL.

(574) Mr. Justin Chevalier of Fort Dodge, Iowa, requests the following information:

Q. 1. Please publish hook-up using "all wave coupler" with two switches, one for close tuning and the other for broad tuning, also variable condenser and crystal detector.

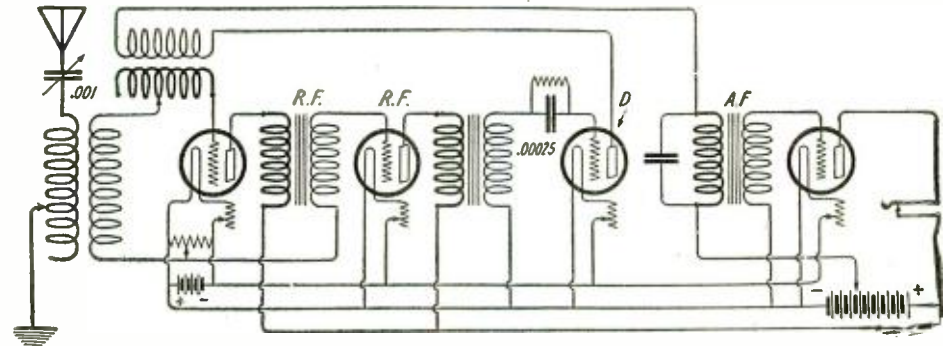

Q. 573. A tickler feed back circuit employing two stage radio frequency amplifier, detector and one stage audio frequency amplifier. A 43 plate variable condenser is shown in the antenna circuit.

A. 1. This circuit was published in the "I-Want-To-Know" column of the October issue of Radio News under No. 469.

Q. 2. How is the term "meter" used for receiving? Can a set with adjustments for 360 meters hear stations of that wave-length from any part of the world?

A. 2. "Meter" is the measurement unit used to determine the distance between the crests of successive waves transmitted from a station. A receiving set has in its circuit inductance and capacity which when varied can equal or become in resonance with the wave-length of various transmitting stations. The reception of signals from a distant station depends entirely upon the sensitivity of the receiver, power of the transmitter and existing atmospheric conditions.

WESTINGHOUSE WD-11.

(575) Mr. Paul J. Henry of Steubenville, Ohio, asks:

Q. 1. What is the correct capacity for grid condenser and leak for Westinghouse WD11 tubes?

A. 1. A grid condenser of .00025 M. F. and a grid leak of ½ megohm are suitable to use with this tube.

Q. 2. Can these tubes be used for amplifying?

A. 2. These tubes are efficient amplifiers.

Q. 3. Please publish hook-up using variocoupler, 43-plate condenser, two U. V. 201 Radiotrons one WD11 tube. I wish to use two stages of radio frequency amplification and detector using A.C. on the Radiotrons and a dry cell on the WD11.

A. 3. The circuits you desire were published in the "I-Want-To-Know" department of the October and November issues of Radio News under the numbers 471 and 504 respectively.

BEST TYPE TUNER.

(576) Mr. Whitney Hides, Menlo Park, California, inquires:

Q. 1. Which of the following is best for a tuner in a crystal set? Loose coupler, a variocoupler, honeycomb coils or a two-slide tuning coil?

A. 1. The variocoupler is very efficient for this use and is easy to handle.

Q. 2. How is a choke coil hooked up? Does a choke coil have one or two sliders?

A. 2. A choke coil consists of a single or multi-layer coil; its function being to retard the flow of radio frequency currents. It uses no sliders.

Q. 3. Kindly publish a hook-up for a two-slide tuning coil, one fixed condenser, crystal detector and phones.

A. 3. This circuit may be found in various back issues of Radio News.

EXPLANATION.

(577) Mr. Joseph G. Telmosse of Shawinigan Falls, Canada, wants to know:

Q. 1. Re your diagram in the November issue of Radio News, Page 877, answering to Question 506, I would like to have further explanations as to how you can get your circuit through the phones the way you have the diagram laid down. Also I do not think that you can get your results with a three-point switch to take the detector alone or with one step and two steps separately.

A. 1. In reference to the circuit you mention, assuming the switch to be on the lower point, we automatically place the detector and two stages of amplification into operation, the phones being in series with the plate of the last tube, the "B" battery current flow being through the phones to the plate, thence to the filament, completing the circuit to the common connection for the "A" and "B" batteries.

Placing the switch on the second point cuts out the first stage of amplification and places the plate of our detector tube in series with the primary of the second transformer. The phones are still in series with the plate of the last tube. Placing the switch on the top point places the plate of the detector tube in series with the phones and "B" battery.

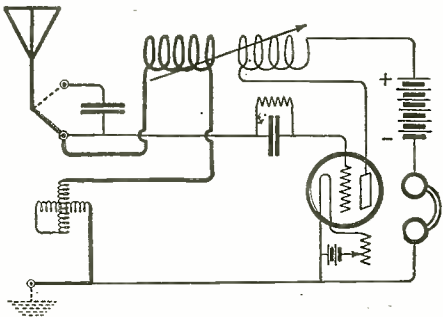

Q. 581. Circuit of the Aeriola Sr. Where a Large Aerial Is Used It Is Connected to the Upper Binding Post as Shown by Dotted Line.

WANTS EASIER TUNING.

(578) Mr. Wm. A. Pahl of Parkersburg, West Virginia, inquires:

A. 1. What can I add to my set to make tuning easier? I have a 100' single wire aerial 50' high, with the following apparatus: Crosley Book condensers, .0005 M. F.; 1 Bradleystat; 1 set 3-coil spiderwebs; 3000-ohm Murdock receivers; six volt, 100 ampere hour storage battery; 22½-volt "B" battery, Radiotron bulb, socket.

A. 1. Since you do not inclose the circuit you are using, we cannot state definitely what improvements might be made. We suggest the use of the circuit published in the October issue of Radio News in the "I-Want-To-Know" Department, under No. 482.

SKINDERVIKEN BUTTON CIRCUIT

(579) Mr. Eugene Enright of Brooklyn, New York, requests the following information:

Q. 1. How can I attach a Skinderviken button to a radio set?

A. 1. By attaching this button to the diaphragm of one of the phones, amplification may be obtained provided there is sufficient vibration of the receiver diaphragm to effect the movement of the carbon grains enclosed in the button. The Skinderviken button, in turn, should be connected in series with two or three dry cells, another pair of receivers or a loud-speaker.

GREBE REGENERATIVE CIRCUIT.

(580) Mr. G. F. H. Dehrinson of Charleston, South Carolina, writes:

Q. 1. Please publish a hook-up of the Grebe regenerative circuit using, I believe, in the circuit a split variometer.

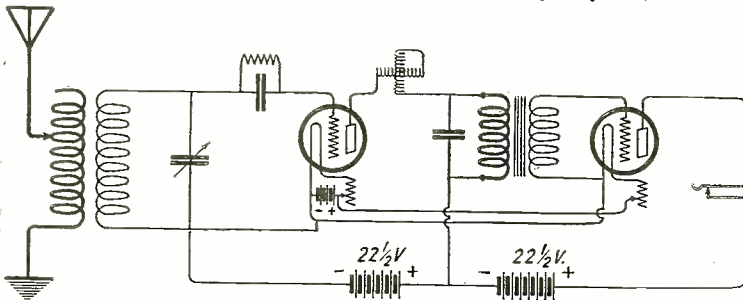

A. 1. The circuit you desire is printed on these pages.

Q. 2. Should not these instruments when connected in accord with a set similar to the Grebe be able to receive at least faintly, and when soldered be even better?

A. 2. The soldering of all connections will increase the efficiency of reception, however, no difficulty in reception should be experienced with unsoldered leads.

AERIOLA SR. HOOKUP.

(581) Mr. F. L. Gurnee of Howell, Michigan, inquires:

Q. 1. Please publish a hook-up for the Aeriola Sr. receiving set.

A. 1. The circuit you desire is printed on these pages.

Q. 2. Please give description of this set including the amount and size of wire to use in tuner.

A. 2. For the main inductance, wind 50 turns of No. 20 D.C.C. wire on a tube 3½" in diameter. 25 turns of the same size wire wound on a tube of slightly less diameter may compose the tickler, while 15 turns compose the coupler.

RADIO AND AUDIO FREQUENCY

(582) Mr. L. MacGillivray of Spokane, Washington, wants to know:

Q. 1. Referring to Question 497 in your October issue, is this set regenerative?

A. 1. The circuit you refer to is regenerative.

Q. 2. Does radio frequency amplification increase the sound?

A. 2. Radio frequency amplification increases the range of reception, audio frequency amplification is used to increase the volume of the received signals.

TWO STAGE AMPLIFIER AND JACKS.

(583) Mr. Joseph Bloeth of Brooklyn, New York, desires the following information:

Q. 1. I have constructed the outfit published in the August issue, page 256, Radio News. Please give hook-up adding two steps of amplification and jacks.

A. 1. The circuit you desire is printed on these pages.

Q. 2. Sometimes I have to place my hand on the grid variometer to receive music. How can this be avoided?

A. 2. The placing of the hand on the grid variometer is equal to adding a capacity to this circuit. Either you are not using enough inductance or a slight addition of inductance to this circuit will be necessary.

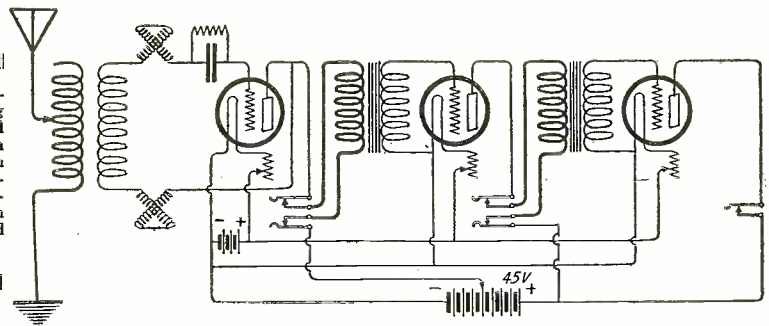

Q. 583. A three-circuit tuner using variocoupler and two variometers in connection with two stages of audio frequency amplification. Each stage is controlled by a jack.

STATIC ELIMINATOR?

(584) Mr. George Hildt of North Bergen, New Jersey, wants to know:

Q. 1. Is there such a thing as a "static eliminator"? If so, how can one be made or where may one be bought?

A. 1. Up to the present time, there is no apparatus which effectively eliminates static interference. However, the use of the resonance wave coil will reduce static interference considerably, but cascade amplification is necessary for its use.

Q. 2. What hook-up is best to use with a variocoupler, a variometer, a variable condenser, one detector tube (including potentiometer) and one step amplifier?

two 43-plate variable condensers, .001 M. F. fixed condenser, 22½-volt "B" battery, 6-volt, 60-ampere storage battery, phones. To cover the distance you mention, several stages of radio frequency amplification will be necessary. A circuit of this type appears on these pages.

Q. 3. What kind of aerial would you recommend?

A. 3. A one-wire aerial 150' in length will suit your purpose.

PLATE AND GRID VARIOMETERS.

(588) Mr. H. J. Postelwaite, Dayton, Pennsylvania, wants to know:

Q. 1. What are the advantages of a plate variometer and a grid variometer in a detector and two-stage amplifier outfit?

A. 1. The function of these variometers in a vacuum tube circuit is to tune the plate circuit with the grid circuit so that a retransfer of energy may take place between the plate and grid circuits, thereby producing the well-known regenerative effect.

Q. 2. Please show wiring diagram of these variometers in circuit.

A. 2. Such a circuit appeared in the "I-Want-To-Know" column of the November issue of Radio News under No. 505.

Q. 3. What size and kind of wire should be used in wiring a circuit?

A. 3. No. 14 gauge copper wire is the correct size for wiring.

RESONANCE WAVE COIL.

(589) Mr. Emil A. Hauck of Cincinnati, Ohio, requests the following information:

Q. 1. Please publish single circuit crystal hook-up for use with the resonance wave coil or static eliminator described in the September Radio News.

A. 1. The resonance wave coil is practical only with the use of cascade amplification.

Q. 2. Is capacitance or inductive coupling used?

A. 2. The resonance wave coil is capacity coupled.

PUSH AND PULL AMPLIFIER.

(585) Mr. Frank D. Elwell of Dayton, Ohio, asks:

Q. 1. Please publish a diagram showing the "push-and-pull" amplifier using two tubes in parallel as described in the Literary Digest of October 21.

A. 1. This circuit together with complete information appeared in the December issue of Radio News.

Q. 2. Please advise whether this arrangement is of any real advantage.

Q. 586. One stage of audio frequency amplification in conjunction with the regenerative circuit shown on page 1214 of the June issue of Radio News.

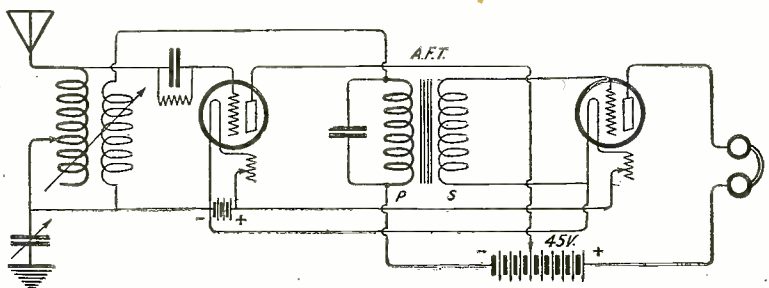

17 YEARS of KNOWING HOW



Almost since the inception of Radio experiments, MURDOCK RADIO apparatus has been a recognized leader among experts all over the country. The name "MURDOCK" stands as an absolute guarantee of quality apparatus—**priced as it should be.**

Sold by dealers everywhere

MURDOCK RADIO NO. 56 HEADSET

2000 ohms

\$5.00

3000 ohms

\$5.50

WM. J. MURDOCK COMPANY

344 Washington Avenue - - - - - Chelsea, Mass.

1270 Broadway
New York

Sales Offices:

509 Mission St.
San Francisco

MURDOCK RADIO

STANDARD APPARATUS SINCE 1904

American RADIO Exposition

The
Official Exposition for
American
Manufacturers

with the endorsement of the

NATIONAL RADIO
CHAMBER OF COMMERCE

*and sanction of the Radio
Apparatus Section of the*

ASSOCIATED
MANUFACTURERS OF
ELECTRICAL SUPPLIES

Grand Central Palace
New York

December 21st to 30th

(Sunday excepted but Christmas Day included)

This first really comprehensive Exposition is to be staged in a manner worthy of a great industry. The leading manufacturers have contracted for space. This opportunity to display Radio products to thousands of buyers during the holiday season is an unusual one. The exposition will be one of New York's big features in connection with National Radio Week

For further particulars write or wire

AMERICAN RADIO
EXPOSITION COMPANY

120 BROADWAY, NEW YORK
TELEPHONE JOHN 0009

Book Review

RADIO QUESTIONS AND ANSWERS. By Arthur R. Nilson. 5" x 7". 86 pages of text. Illustrations and diagrams. Published by McGraw-Hill Book Company, Inc., 370 Seventh Avenue, New York.

Written by one who has been an instructor in the East Side Y. M. C. A. Radio School, for the students and operators who are about to take the Government examination for a Radio Operator's License. Actual questions asked by the government examiners are answered in full and illustrated, where necessary, with clear and comprehensive diagrams.

Ten parts, covering radio theory, arc and spark transmitters, storage batteries and motor generators, receiving apparatus of all types, laws and traffic regulations, and additional questions without answers, are completed by two appendixes in which much useful information is given. A bibliography is provided for the student who wishes to go a little more deeply in radio theory.

A well written and useful book for the radio student and operator.

FOWLER'S PRACTICAL RADIO TEXT BOOK. By Alfred Fowler. 5½ x 8 inches. Cloth cover. 96 pages. Well illustrated with diagrams. Published by Schooley Stationery & Printing Company, 718 Delaware Street. Kansas City, Mo.

Presents in non-technical language the theory of operation of radio apparatus and explains many radio phenomena. Many practical hints are given for the erection, construction and use of various radio instruments. Practically every receiving circuit worth while has been shown, and notes on its operation have been included for the information of the reader.

A chapter takes up radio from the beginning, while another is devoted to suggestions for the beginner.

Many circuit diagrams show connections of a variety of receivers, including regenerative receivers and amplifiers. A few transmitting circuits are also included. An appendix explains the use of call letters and shows the assignment of call letters to all stations. Several useful lists are also given.

MODERN RADIO OPERATION. By J. O. Smith (2 ZL). Cloth covered book 6½ x 9 inches. 138 pages. With illustrations and diagrams. Published by the Wireless Press, Inc., 326 Broadway, New York.

Mr. J. O. Smith, of 2 ZL fame, is well qualified to write a good book on the radio telephone. As a prominent amateur, he has had many opportunities to study and experiment with all kinds of apparatus. It is the cream of this experience which he presents in "Modern Radio Operation."

In this book has been assembled valuable and instructive information for those interested in the present day transmitting and receiving equipment. All information is supplied in clear, understandable language, which can be readily assimilated even by the novice. Many details on the transmitting equipment used for radiophone broadcasting, as well as the receiving equipment used for reception, are well covered in several chapters of the book. As 2 ZL is essentially an amateur, and as such interested in C. W. and I. C. W. and radio telephony from the amateur standpoint, he has devoted many interesting chapters to cover these subjects.

As a closing feature, an appendix containing much

valuable data on the Armstrong super-regenerative receiver has been added. This is a book which should be on the shelf of every amateur and in the hand of every novice as well.

ELEMENTS OF RADIO TELEPHONY. By William C. Ballard, Jr., M. E. Imitation leather covered book, with 132 pages of text, illustrations and diagrams. Published by McGraw-Hill Book Company, 370 Seventh Avenue, New York.

To explain the fundamental principle of operation of the radiophone, Mr. Ballard, who is an assistant Professor of Electrical Engineering at Cornell University, starts from the very beginning and gives an interesting parallel between the wire and radio telephone systems.

This little volume presents in a simplified form a brief discussion of what happens when messages are sent and received by radio. A brief and simplified description of the apparatus necessary to accomplish this is also given. Finally, an unbiased section on information for the experimenter who desires certain results but who does not know how to go about it is presented in a very interesting and non-technical style.

Although the author takes up the theory of radio in a rather extended way, he has avoided the use of mathematics where possible, and where used, the treatment is qualitative rather than quantitative.

This is a book which recommends itself to the beginner who wishes to extend his knowledge of radio as well as to the more advanced amateur who wants to get the engineering and theoretical reasons for radio phenomena.

RADIO QUIZ BOOK. By James E. Smith. 6 x 9 inches, paper cover. 106 pages, with 92 diagrams and photographs. Published by the National Radio Institute, Washington, D. C.

Another book for the man who is preparing himself for the government radio examination for Radio Operator's License. It is a systematized review book, which answers in a clear and concise manner 260 actual questions asked at government examinations. Many diagrams and photographs illustrate the text. It also includes the Radio Laws and Regulations, together with useful tables and formulae, which are useful in the solution of radio problems.

CONSTRUCTION OF NEW TYPE TRANSATLANTIC RECEIVING SETS. By Milton B. Sleeper. 5" x 8" in paper cover. Published by The Norman W. Henley Publishing Co., 2 West 45th Street, New York.

This is the third of a series of very practical and interesting books written by Milton B. Sleeper. In this book, there is given complete information on the diagram of connections, and photographs on how to build and use new types of trans-oceanic receiving sets. Besides this, there is also much information given on the use and external connections of the loud speaker and its application in receiving high speed signals from distant transmitters.

To make this book still more valuable to the experimenter, a complete list of power trans-oceanic stations, and the recent recommendations and rules of the National Board of Fire Underwriters are also included.

This book is profusely illustrated with photographs of apparatus and diagrams of connection.

Rating Receiver Sensitivity in Ohms Is a Mistake

BY F. DIETRICH*

"YES this is a very good receiver. It has a resistance of four thousand ohms." This is a sale's talk that many clerks in the radio shops give to unwary purchasers of headset sets. In doing so, they not only show their ignorance concerning phone construction and design, but they help to create an impression that is entirely wrong. They are responsible for the notion that the sensitivity of a headset is indicated by the resistance of the receivers.

This policy of selling headsets on the strength of their resistance is wrong and should be discouraged by dealers. It not only hoodwinks a badly misinformed public, but it is a gross injustice to manufacturers who, for sound technical reasons, do not wish to carry the D. C. resistance of their headsets to such a high value. One might just as well measure the horsepower of an auto-

mobile by the size of its carburetor. The average 2,000-ohm headset is as sensitive and in many cases more so than the receiver with a resistance of 4,000 ohms. Radio receivers should be rated by their impedance. The Brandes headsets are designed to have the same impedance as the average circuit in which they are used, since it has been found that this gives maximum efficiency. This impedance varies, of course, with the frequency of the current. The Brandes company has taken as a standard 1,000 cycles and at this frequency their headsets have an impedance of 22,000 ohms. It has been found that this is the resistance of the average crystal or tube circuit. This in itself, however, does not guarantee the efficiency of a headset since there are many other requirements and features that determine the operating efficiency and sensitivity of a radio headset.

*President of C. Brandes, Inc.

Just pour in the Philco Electrolyte

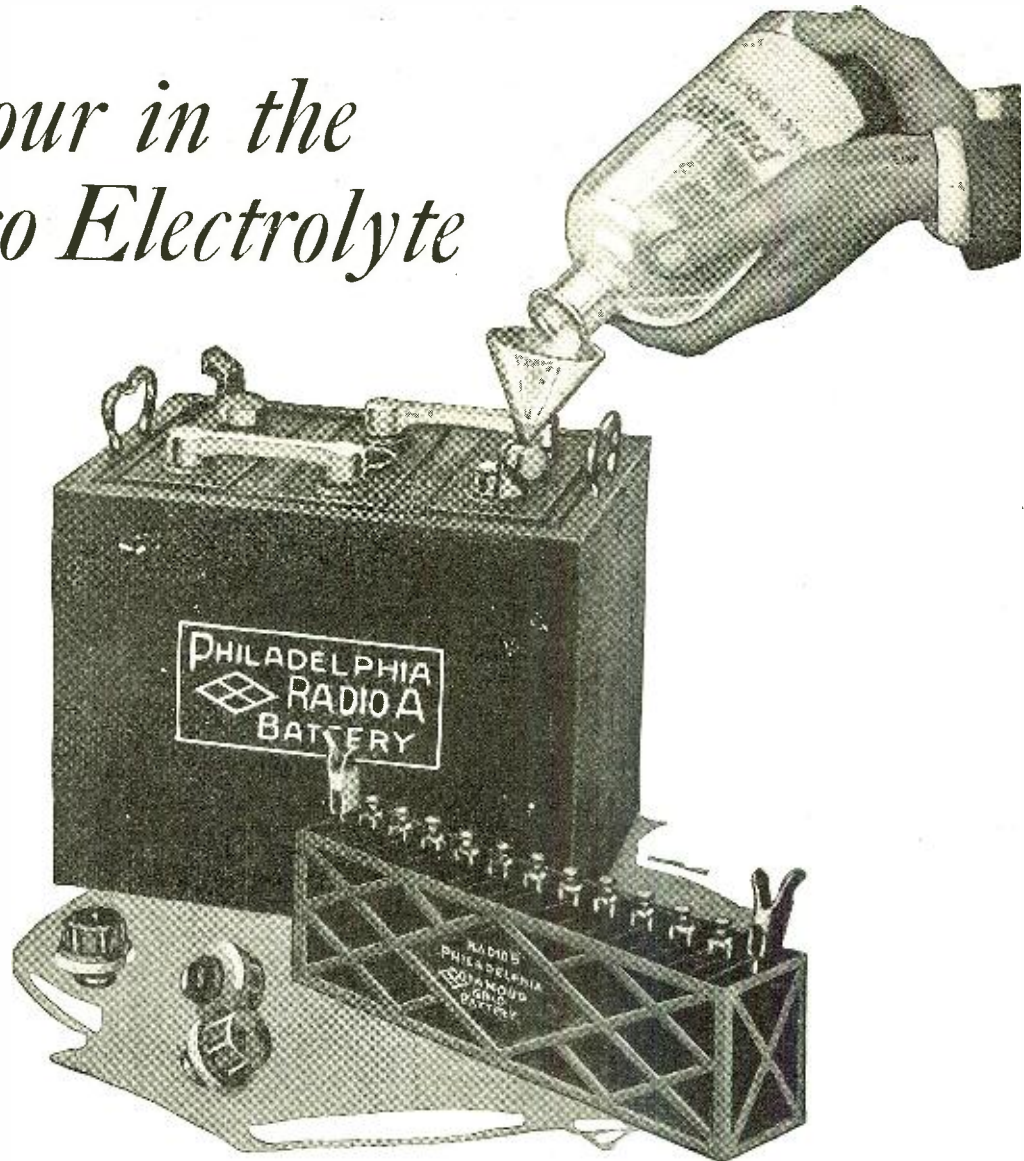

—and these remarkable new Philco Dynamic Radio "A" and "B" Batteries are ready for use. No waiting for any initial charging. No paying for battery life and current lost before you get them.

Philco Dynamic Radio Batteries are charged DRY at the factory—a revolutionary advance in battery engineering. That means their life doesn't start until the Philco electrolyte is added.

What's equally important—Philco Radio Batteries absolutely free radio reception from "frying," cracking noises in the head phones, and the need of constant "tuning in."

These wonderful new Philco Dynamic Radio Batteries give you the convenience of a dry-cell battery with all the advantages—the absolute dependability and long life—of a Philco Storage Battery, standard for automobiles, mine locomotives and other heavy-duty services.

Equip your radio with Philco Radio "A" and "B" Batteries NOW. You'll be astonished how much better results—at the increased pleasure and satisfaction—you get from your radio set.

Ask your dealer for them or go to the nearest Philadelphia Diamond-Grid Battery Service Station.

RADIO DEALERS—Philco Dynamic Batteries let you into the battery business on a package goods basis. No acid sloppage. No charging equipment. No batteries going bad in stock. Wire or write for details.

Philadelphia Storage Battery Company, Philadelphia.

Makers of the famous Philco Slotted-Retainer Batteries—standard for automobiles, electric passenger cars and trucks, mine locomotives and other high-power, heavy-duty battery services.

PHILCO

DRYDYNAMIC RADIO BATTERIES

Six—**MAIL THIS COUPON TODAY**

I want to know more about the new Philco Dynamic Radio Batteries.

Name

Street

City

State

Business

**COMBINATION VERNIER
and
VARIABLE CONDENSERS**

43 and 23 Plate



Built to give long service

Construction—

Metal end plates supported by best grade insulating material.
Rotor and Vernier supported by and turn in metal bearings.
Plates will always remain in true position.
All metal used is non-magnetic.
These models have been calibrated. The 43 plate has a ratio of 1 - 40 between minimum and maximum capacities. The vernier has a capacity effect equal to approximately three points on the dial.

List Prices

Vernier Panel type 43 plate Cap. .0012 M. F.	\$6.75
Vernier Panel type 23 plate Cap. .00056 M. F.	6.25
Vernier Table type 43 plate with 3-in bakelite dial	8.00
Vernier Table type 23 plate with 3-in bakelite dial	7.50
Regular type Variable Condensers:	
43 plate	\$4.50
23 "	4.00
11 "	3.50
3 " Vernier	3.00

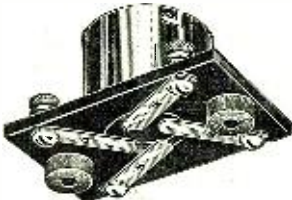

P. M. T. Co. Tube Socket

Heavy insulation base. Polished nickel brass socket. Phosphor bronze silver plated contact points, so spaced as to eliminate possible capacity effect.

Price 75 cents



P. M. T. Co. Tubular Mounting

Heavy fibre base and phosphor bronze contact springs. Price50c

P. M. T. Co. Audio Frequency Transformer

gives the highest amplification possible without in any way causing noisy circuits. Very efficient and has superior electrical characteristics. Positively guaranteed. Price \$4.50

Distributors and Dealers Wanted

Pittsfield Machine & Tool Company
Pittsfield, Mass.

very ill." If all the words in the text including the signature after "expect" were missed, it would be asked for by sending "expect ? ? end." This method is the simplest, and if it was standardized there would be no confusion in requesting parts of messages.

The above are some of the more necessary changes that should be made to the International list. No doubt, in the near future, it will become advisable to make still further additions for use with the radiophone. The primary objects of the "Q" signals are to facilitate handling of traffic and do away with conversation. Unless the "Q" list is broadened to meet existing conditions, there is sure to be time lost and confusion will result from an inadequate and concise means of expression "on the air."

Vacuum Tubes on Board Ship

(Continued from page 1303)

Of course, there was a reason—something about patents and competition between big radio companies; but it has always seemed to us that anything which prevents ships from being equipped with modern radio apparatus should be swept aside in the interests of humanity and for the protection of lives at sea.

We recall the day when we took out our first transatlantic liner. With the crew, there were over three thousand souls on board that ship, and we had to rely upon a little piece of crystal to receive messages from shore and passing ships. Each time we transmitted with our spark set the crystal was knocked out of adjustment and we had to play with it for a few minutes to find a sensitive spot. Later we purchased an audion which we connected up as a single stage amplifier. Still later we made our own regenerative set and for the first time were able to perform our duties and work traffic with any degree of comfort.

After each trip, as we arrived in New York, we had to carefully dismantle our innocent little contraption and hide it away in a closet, connect up the old crystal detector and leave it in full view. This was in case some mystical inspector might report the fact that we were committing the terrible crime of using modern radio apparatus on an American transatlantic liner.

We are glad, for the sake of the operators at sea, that vacuum tubes have at last been released for commercial purposes and hope that, in the future, the radio operator will be provided with efficient means of reception and that it will no longer be necessary for him to expend a large portion of his meager salary in the purchase and maintenance of vacuum tube receivers and amplifiers.

North Atlantic Radio Schedules

Now that shipping on the North Atlantic is once more becoming active—due largely to the coal strike in America—it has occurred to the writer that a few hints and some little information may be of service to those marine operators who, through enforced holidays ashore, may be a bit out of date in regard to wireless telegraph working on the North Atlantic route.

During the last few months I have noticed that a great number of vessels fail to QRX for such broadcasts as the ice and weather report issued twice daily by Cape Race—VCE. These reports are, of course, of utmost value to the navigator,

Just What You Want



WHETHER you require two binding posts, a simple crystal set, or one of the standard tube sets with amplifier and loud speaker, you may obtain it at the right price at any radio shop displaying the Sorsinc Sign. There is a skilled radio man on hand to advise you, too.

"It Pays to Buy at the Sorsinc Store"

Mr. Dealer—If you are a progressive merchant, you may display the Sorsinc sign. Let us tell you how.

Ship Owners Radio Service, Inc.

Wholesale Distributors

80 Washington St., New York

Boston, 46 Cornhill
Baltimore, 11 N. Eutaw St.
New Orleans, 740 Union St.
San Francisco, 591 Mission St.
Chicago, 538 So. Dearborn St.
Seattle, 67 Columbia St.

A Better Condenser for Less Money

Don't pay out a lot of good money for an old-style Variable Condenser when you can get the new, tested "Vermica" for half — get two Variable Con-



densers for the price of one. The "Vermica" is the latest development in Variable Condensers—sharper tuning—closer adjustment—impossible to short or get out of order—takes up less room on panel, also suitable for board mounting. Capacity .0005 MF. Made of extra-seasoned hard ply-wood, phosphor-bronze and copper. Endorsed by leading Radio authorities and sent on an absolute guarantee of complete satisfaction or money refunded. Order from us if your dealer can't supply.

Larger Production Makes Special Price
\$1.48
Postpaid

C. S. CHERPECK

3127 Davlin Court

CHICAGO

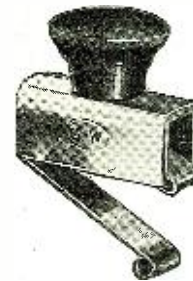

Famous G-W Sliders Now 15c.

Gehman & Weinert
42 Walnut St.
Newark, N. J.

EISEMANN

RADIO UNITS

Made to the highest electrical and mechanical standards.

EISEMANN MAGNETO CORP'N
Chicago BROOKLYN, N. Y. Detroit



RECEIVER AND DETECTOR

REGENERATIVE RECEIVING SETS

(LICENSED UNDER ARMSTRONG PATENTS)

WE PAY THE EXPRESS OR POSTAGE IN UNITED STATES, U. S. POSSESSIONS

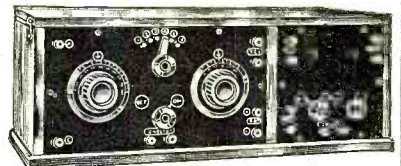

DETECTOR AND TWO-STEP

A beautiful solid mahogany regenerative set manufactured by C. D. Tuska Co. and licensed under Armstrong patents. Consists of Antenna inductance, secondary tuning condenser, plate variometer, coupling control, long and short wave switch, grid condenser, rheostat and tube socket. Engraved shielded bakelite panel and parts, metal parts nickel-plated. All parts are mounted on panel and cover is hinged to permit inspection and for replacing tubes. Wide range, 150-800 meters. The two stage amplifier shown to right matches this cabinet. Tubes, batteries, etc., are always sold separately; order from this page and save money.

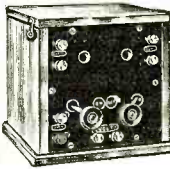

Made in two sizes. The RT225, is a complete receiving set with detecting unit and two stages of amplification as pictured above. The RT224, consists of complete tuning and detector unit in shorter cabinet (see division of panel). Easily operated. Same high grade construction and finish as other Tuska sets described to the left. Ideal sets for concert reception. Tubes, batteries, etc., are always sold separately. Order from us and save money.

- RT222—Tuska Receiver and Detector.....\$63.00
- RT225—Tuska Receiver, Detector and Two Stage Amplifier Set.....\$59.50
- RT224—Tuska Popular Receiver and Detector Set.....\$31.50
- RT226—Tuska Two Stage Amplifier.....36.00
- RT226—Tuska Two Stage Amplifier (shown in center).....36.00

GUARANTEED STANDARD PARTS AT LOW PRICES

Shipped in One Day—Order and Be Convinced
This Page Is Our Catalog—See Nov. and Dec. Also

OUR GUARANTEE

Your satisfaction guaranteed. If for any reason you do not feel satisfied with your purchase, you may return it and we will refund your money plus return charges. We give you the benefit of any reduction in price.



PHONES
Genuine Frost and Brandes head sets complete with cords.
Frost R162—Double head sets, 2000 ohm.....\$4.25
Frost R163—Double head sets, 3000 ohm.....5.25
Western Electric latest type double head set List price.....12.00. Our price.....10.50

Brandes Superior R166—Double head sets, 2000 ohm.....7.20

LOOSE COUPLER

This loose coupler is preferred by many because of its wide range 200 to 3500 meters. Mahogany finish. All metal parts are brass, nickel-plated and highly buffed. Secondary has 12 point switch mounted on Bakelite coil head. Windings are green silk-covered wire.
R800—Size, 5 1/2 x 18 inch.....\$6.50
R805—Two Slide Tuning Coil.....2.60

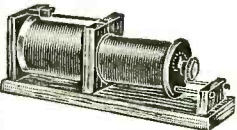

R800—Size, 5 1/2 x 18 inch.....\$6.50
R805—Two Slide Tuning Coil.....2.60

FROST JACKS AND PLUGS

Jacks are polished nickel, nickel-silver springs, pure silver contacts. Nickel washers for mounting on any panel 1-8 to 3-8 inch thick. Spread terminals make soldering easy.
R133—One spring (open circuit). Each.....\$0.46
R134—Two spring (closed circuit). Each......52
R131—Four spring (two closed circuits) Each......63
R135—Three spring (two open circuits, commonly called "single circuit filament control"). Each......70
R136—Five spring (two open and two closed circuits, commonly called "two circuit filament control"). Each......88
R132—Plug, telephone type with short knurled grip......35
R137—Plug (as shown), cord tips fit into plug.....1.05
R139—Plug with threaded barrel instead of set screw. Takes cord tips......55

CRYSTAL DETECTOR

A very high grade glass enclosed crystal detector including the crystal. All metal parts nickel plated. Adjustable to any point on the crystal.
R20—Enclosed crystal detector.....\$1.40
A lower priced but nicely constructed detector. Crystal included.
R30—Detector......88

Selected and tested galena or silicon. Each box contains enough for four to six ordinary crystals.
R12—Galena, per pkg. \$0.10
R13—Silicon, per pkg. .10

CABINETS

These are reasonably priced but sturdily built cabinets of weathered oak. The top is removable by loosening four screws. End posts are routed to take panel 3-16 inch thick. The panels are not included. See table for panel lengths.
R212—Can be used for detector and two step. Panel space, 5 1/2 x 12.....\$2.50
R214—Can be used for 2 variometers and 1 coupler. Panel space, 5 1/2 x 14.....2.75
R218—Can be used for 2 variometers and 2 detector. Panel space, 5 1/2 x 18.....3.00
R222—Can be used for 2 variometers, 1 coupler, detector and 2 step. Panel space, 5 1/2 x 22.....3.25

PANELS

Genuine Formica. Panels to fit our cabinets.
R262—Panel, 5 1/2 x 12 inches 3-16" thick \$1.38
R264—Panel, 5 1/2 x 14 inches 3-16" thick 1.64
R266—Panel, 5 1/2 x 18 inches 3-16" thick 2.08
R272—Panel, 5 1/2 x 22 inches 3-16" thick 2.53

VARIOMETERS

For efficiency, perfect inductive ratio, low capacity effect and neatness of design these variometers are unexcelled. All metal parts nickel-plated brass. Tight spring bronze contacts will wear indefinitely. Accurately turned rotors and stators, mahogany finish. Completely assembled and tested. Wound with two sizes of wire—No. 18 and No. 20.
R1300—Variometer, No. 18 wire. Price.....\$2.75
R1500—Variometer, No. 20 wire. Price.....2.75

AUDIO FREQUENCY AMPLIFYING TRANSFORMER

Correctly designed for minimum distributed capacity and low core losses. Maximum amplification without distortion. Use 10-1 for Cunningshams and Radiotron tubes; 3-1 for other makes. Fully mounted, cast aluminum feet, bakelite terminal panel.
R1510—Transformer, 10-1 ratio.....\$3.55
R1503—Transformer, 3-1 ratio.....3.50

RADIO FREQUENCY AMPLIFYING TRANSFORMER

Radio frequency transformer circuits help to eliminate static and interference, thus permitting easy, sharp tuning of long distance stations. Enclosed in metal case for shielding and can be mounted in tube socket if desired. Wiring diagrams furnished with each transformer.
R1500—Transformer. Each.....\$3.95

"B" BATTERIES

Standard brands, Franco, Eveready or Burgess. Never over five days old.
R230—2 1/2 volt Signal Corps type. Size 3 1/2 x 2 1/2 x 2 1/2 inch. Price.....\$1.26
R235—2 1/2 volt U. S. Navy variable—3 positive taps. Size, 5 x 3 x 2 1/2. Price.....\$1.98
R240—2 1/2 volt large variable—5 positive taps. Size, 6 1/2 x 4 x 3. Price.....2.25
R245—1 1/2 volt large leads only. Size, 1 3/4 x 3. Price.....3.80

INDUCTANCE COIL MOUNTING

For base or panel mounting. Connecting leads furnished, coil settings are adjustable by means of knobs. Made entirely of bakelite with nickel-plated brass metal parts. Coil position can be locked by knurled set screws.
R1603—Three coil mounting.....\$3.90
R1602—Two coil mounting.....3.00

BINDING POSTS

Complete with screw and washer. All brass, finished in polished nickel or with black composition top as listed. Order by number.
R110—Large size, all nickel-plated.....10c 95c
R122—Medium size, nickel-plated, with hole for phone tip or wire.....4c 36c
R112—Medium size, black composition top.....5c 48c
R120—Large size, composition top.....8c 85c

SWITCH POINTS AND STOPS

Brass, polished nickel finish. Screw size, 6-32 x 8 ins. long, two nuts with each contact point and one with the stops. Stops high enough for any type of lever and point.
R130—Switch Point, 3-16 inch diameter, 1/4 inch height. Each.....3c
R135—Switch Stops, 3c.....20c
R150—Switch Stops, 3c.....20c

180° VARIOCOUPLER

The primary and secondary windings of this coupler are properly proportioned and spaced. The center of the secondary is always in the center of the primary field. Unlike most couplers, it aids in tuning. Black fire base, brown formica tube, and nickel-plated metal parts. Panel or table mounting.
R1100—Coupler.....\$2.95

DIALS

Genuine Bakelite Dial as pictured. Sharply engraved divisions and figures filled with a brilliant white. Composition Three-inch diameter, with bushing for 3-16-inch or 1/4-inch shaft. Set screws included.
R500—Dial.....Each 55c Doz. \$6.00
Three-inch moulded composition dial as pictured. Has a luster that cannot be told from Bakelite. Set screws included.
R550—Dial, 3-16-inch Shaft.....30c Doz. \$3.00
R555—Dial, 1/4-inch Shaft.....30c Doz. \$3.00

VARIABLE CONDENSERS

Very best mechanical construction, heavy, hard aluminum plates. The vernier types are furnished with moulded dial and small knob for adjusting vernier. Plain types have 1/4 inch shaft.
R1443—43 plates .001 Mfd. without dial \$2.35
R1423—23 plates .0005 Mfd. without dial 1.85
R1411—11 plates .00025 Mfd. without dial 1.35
R1403—3 plates .00005 Mfd. without dial 1.15
R1441—41 plates vernier .001 Mfd. with dial 4.25
R1442—21 plates vernier .0005 Mfd. with dial 4.25

SWITCH LEVERS

A high grade, polished nickel-plated lever with solid moulded black composition knob. Complete with panel bushing, spring and two nuts. Each Doz.
R151—1" Radius 20c \$2.25
R153—1 1/2" Radius 20c 2.25
R155—1 1/2" Radius 20c 2.25

INDUCTION COILS

Rigidly wound, low distributed capacity. All coils are equipped with standard mountings. We can supply any of these coils without mounting plugs, for 50c less than the prices shown. The wave lengths shown are range limits, based on a variable condenser of .001 Mfd. capacity.
Number of Turns Wavelengths Price Mtd.
R1725 25 125-250 \$0.95
R1726 35 175-450 0.98
R1727 50 240-720 1.05
R1728 75 390-910 1.10
R1729 100 500-1450 1.14
R1730 150 600-2000 1.19
R1731 200 900-2500 1.28
R1732 250 1200-3500 1.36
R1733 300 1500-4500 1.38
R1734 400 2000-5000 1.59
R1735 500 2800-6100 1.65
R1736 600 4000-10000 1.80
R1737 750 5000-12000 1.95
R1738 1000 7900-15000 2.30
R1739 1250 9750-19500 2.55
R1740 1500 14500-26500 2.70

VACUUM TUBES

Genuine Cunningsham Tubes. Every tube guaranteed new and in original package. We do not sell "bootleg" tubes.
RC200—Detector.....\$4.45
RC201—Amplifier.....5.95



MAGNAVOX

The genuine R-3 Radio Magnavox with the 14 inch horn is the ideal loud speaker for use in homes, offices, amateur stations, etc. It operates from your 6 volt storage "A" battery and amplifier as it reproduces "B" battery voltage should be 90 to 200 for best results. "Radio brings it, Magnavox tells it."
R170—Radio Magnavox.....\$39.50

METAL AND BAKELITE SOCKETS

Bakelite brown finished socket for panel or base mounting. Double spring contacts held rigidly in place.
R1076—Bakelite socket.....\$0.65
R1075—Nickel metal socket......45

VACUUM TUBE RHEOSTATS

This is a reasonably priced, smooth acting rheostat that will mount directly on back of panel. Bakelite arrow knob.
R1050—Rheostat.....45c
Genuine Cutler-Hammer rheostats, we believe, are the best rheostats on the market today. Arranged for panel mounting. The picture shows the vernier type. All metal parts nickel-plated.
R1061—Vernier type, C. H. Rheostat.....\$1.40
R1062—C. H. Rheostat without vernier......95

GRID AND PHONE CONDENSERS

Mounting holes spaced to fit screws of above Grid Leak. Mica insulation, wrapped with varnished cambric tape. Capacity, .00025 Mfd.
R59—Phone Condenser.....15c
R55—Grid Condenser.....20c

VARIABLE GRID LEAK

Pencil mark type. Removable black enamel cap.
R50—Grid Leak.....20c

SPAGHETTI TUBING

For cabinet wiring. Yellow finish spaghetti.
R33—Per 4 ft. length.....27c
R32—Tinned Copper No. 16 Wire.....100 Ft. 75c

INSULATORS

These are very strong strain type insulators.
R360—Moulded insulator shown above to left. Each, 10c; Doz \$1.10
R365—Porcelain insulator shown above to the right. Each, 9c; Doz.....95c

ANTENNA WIRE

The following are 100 foot coils of 7 strand cable of No. 22 wire, which makes the best Aerial. Use phosphor bronze, where the span is 100 feet or more. It is stronger.
R350—Stranded Phosphor Bronze, 100 ft. \$1.47
R355—Stranded Copper, 100 ft......77
R356—Single No. 14 bare solid Copper Wire, 100 ft......42

LIGHTNING ARRESTER OR PROTECTOR

Mounts indoors. Porcelain base, nickel-plated cover. Listed by the Underwriters' Laboratories under April, 1922, regulations.
R300—Protector.....\$1.40

HOW TO ORDER

Order from this page. Please give number, description and price of the articles you order to help us avoid mistakes. Total the amount of your order and send Post Office money order, certified check or draft with your order. Be sure to give your name and street address on both letter and envelope. Do not include money for transportation. We pay it. For other items see ads of November and December.

Use A C H SHARP TUNER DIALS

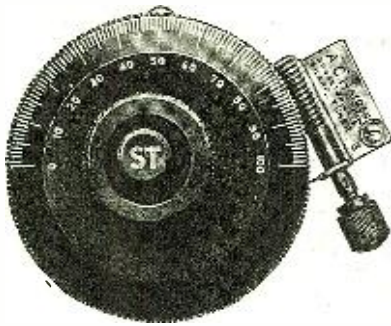

REASONS WHY

A movement of dial one-thousandth of an inch in either direction.

Perfect control of Sharp Tuning Instruments.

Avoiding interference of other stations.

Either hand control or a micrometer adjustment of the dial.

No matter what the capacity of your condenser no vernier condenser is needed.

ABOUT THE ACH SHARP TUNER

It is not an electrical device, but is a perfect mechanical control instrument. These Dials have been installed on the best known Receiving Sets, not because the electrical parts were not of the best, but because the owner wanted perfect control of the wonderful instruments inside. A good engine loses a part of its value unless it has a good control and so does a Radio Set. An unsteady hand on a plain Dial makes tuning hard, but on the ACH Sharp Tuner Knob it has no effect.

LET OTHERS ENJOY THE FUN

It is all right to be a wizard at sharp tuning by hand, be a sport and install on your set the ACH Sharp Tuners, so everyone from Grandpa and Grandma down to little brother and sister can have the fun of tuning in stations.

TO THOSE MAKING HOME MADE SETS

We make the ACH Variable Condenser fitted to the ACH Sharp Tuner Dial made in one size only, which we believe meets all requirements.

- Price of ACH Sharp Tuner Dial, 3" size \$2.50
- Price of ACH Variable Condenser 1.50
- Complete 4.00
- Price of ACH Variable Condenser without ACH Sharp Tuner Dial 2.50

Guarantee

The A. C. H. Shap Tuner Dial is a scientific instrument made to work accurately and guaranteed to do all we claim for it or money refunded.

FREE PLAN

In plain English so anyone over ten years old can build a long distance Detector set using tube. Free with mail order for ACH Dial, 50c without order.

A. C. Hayden Radio & Research Co.
 Brockton, Mass., U. S. A.
 Mail Orders Sent Prepaid in U. S. A.

but the reception of them is often mutilated by some vessel choosing the period of these broadcasts for calling up another station afloat or ashore. It is felt that these interruptions are due to ignorance rather than wilful indifference, and it is this that has largely suggested the writing of this.

The broadcast by VCE is scheduled to commence at 9.15 a. m. and p. m. 75th meridian time, although it may be delayed a few minutes owing to local circumstances. The message is sent but once at each broadcast period on the 600-meter wave, and consists of weather, ice and navigation information. The reports, at one time broadcast by St. Johns, BZM on 1600 meters at 8 a. m. and p. m. E. S. T. has now been discontinued, and the Cape Race report is the sole one available from Newfoundland.

On the English side the following stations broadcast items of interest to navigation at the under mentioned times—all on 600.

- Lands End—GLD, 2 a. m., 8 a. m., 2 p. m., 8 p. m., GMT.
- Malin Head—GMH, 2 a. m., 8 a. m., 2 p. m., 8 p. m., GMT.
- North Foreland—GNF, 2 a. m., 8 a. m., 2 p. m., 8 p. m., GMT.
- Wick Radio—GKR, 2 a. m., 8 a. m., 2 p. m., 8 p. m., GMT.
- Cullercoats—GCC, 3.30 a. m., 9 a. m., 3.30 p. m., 9 p. m., GMT.
- Fishguard—GRL, 3.30 a. m., 9 a. m., 3.30 p. m., 9 p. m., GMT.
- Valentia—GCK, 3.30 a. m., 9 a. m., 3.30 p. m., 9 p. m., GMT.

The last station is, at the moment of writing, out of commission due to the action of Irish Irregulars.

These warnings are always prefixed by the sign "TTT"—the international danger call—repeated at intervals.

On long wave, the weather and warnings broadcast by MPD (Poldhu) and latterly by MFT (Clifden) have been discontinued. The latter service will no doubt be resumed as soon as the political situation in Ireland becomes more stable.

"At present no report is available on long wave. The stations at Malin Head and Landsend broadcast a weather report at 9 (a. m. and p. m.) and 9:15 (a. m. and p. m.) respectively on a 600 meter wave.

A General Inference report for the British Isles is broadcast at 9.15 a. m., GMT and 8 p. m., GMT, by the British Air Ministry station in Kingsway, London, call letters GFA, who utilizes a wave of 4,100 meters, C.W.

One very important broadcast should not be overlooked. This broadcast is made by Leafeld at 1 a. m., GMT on 8,750 meters C.W., when messages for ships hitherto handled by Clifden are sent out.

The following particulars of European stations sending press in English will no doubt prove of interest. Operators, however, should only publish that press which is addressed to CQ and QST. Should any press which is specifically addressed to some particular party be copied and published aboard ship by those not having written authorization to do so, then the operator doing so is laying himself open to the very serious charge of "breach of secrecy." The times given are GMT.

- Leafeld—GBL, 8,750 CW., 1.50 a. m.
- Northolt—GKB, 6,900 CW., 2.00 a. m.
- Helsingfors—OJA, 6,200 CW., 9.30 a. m.
- Lyngby—OXE, 5,600 CW., 11.00 a. m.
- Leafeld—GBL, 8,750 CW., noon, 8 p. m., and midnight.
- Bordeaux—LY, 23,450 CW., 12.30 p. m.
- Nauen—POZ, 12,600 CW., 11.30 p. m.

There are, of course, many other programs, but these are more often than not in French or German.

With the increasing number of vessels fitted with tube transmitters for long wave

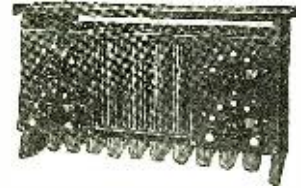

KICO Radio Storage "B" Batteries for EFFICIENT Receiving

THINK over the following FACTS before buying again.

1. KICO "B" batteries allow single cell variations by means of switches on mounted panels. (The first in the market with this feature.)
2. NOT an ACID battery.
3. Rechargeable from your 110-volt A. C. line in connection with the rectifier supplied.
4. One charge lasts from three to six months in the detector plate circuit.
5. Neat, efficient and compact.
6. Unlimited life.
7. Your money back if unsatisfied within a 90-day trial.

	(Plain)	(With Panels)
16 cell 22 volt.....	\$6.50
24 cell 32 volt.....	8.00	\$12.00
36 cell 48 volt.....	10.00	14.00
50 cell 68 volt.....	12.00	17.00
75 cell 100 volt.....	16.00	21.00
108 cell 145 volt.....	21.00	26.00

Literature gladly furnished.

KIMLEY ELECTRIC CO.
 1355 FILLMORE AVENUE BUFFALO, N. Y.

RADIO SUPPLIES AT CUT PRICES

- Western Electric Headsets \$12.50
 - Federal 2200 Ohm Headsets 7.00
 - Brandes Superior Headsets 7.00
 - Federal Amplifying Transformers 6.25
 - Thorlerson Amplifying Transformers 3.85
 - Jefferson Amplifying Transformers 3.75
 - Acme Semi-Mounted Transformers 4.25
 - Genuine Fireco Plugs 1.50
 - 3 1/2-inch Dials39
 - 4-inch Electrode Dials98
 - 43-Plate Variable Condenser 2.95
 - 23-Plate Variable Condenser 2.25
 - Fada Type Rheostats49
 - Moulded Sockets49
 - Eveready Variable B Battery, Large 2.25
 - Eveready B Battery, Small 2 1/2" V. 1.50
 - 45-Volt Cyclone Variable B Battery 2.75
 - 22 1/2-Volt Cyclone Variable B Battery 1.75
 - 22 1/2-Volt Cyclone Variable B Battery90
 - Emco Moulded Variometer 7.00
 - Emco Variocoupler 6.00
 - .005 Fixed Condenser50
 - .002 Fixed Condenser25
 - .0025 Fixed Condenser25
 - DeForest Type Crystal Detector 2.00
 - Electrode Insulators18
 - 7-Stranded Copper Aerial Wire, 100 ft.65
 - No. 14 Solid Copper Aerial Wire, 100 ft.45
 - Nickel Plated Binding Posts, per dozen..... .50
- Mail Orders promptly Filled if Accompanied with Money Order, also Postage to Cover

Kensington Radio Supply Co.
 4417 18th Ave. Brooklyn, N. Y.

RELIABLE RADIO APPARATUS

Our price list, mailed Free on request. Contains complete list of reliable Radio Sets and parts—Grebe, Paragon, Radio Corp., etc.

Mail orders given prompt attention.

Write today—Special Terms for Dealers.

The Klein Radio & Electrical Supply Co.
 48 Fulton St. and 34 Park Place - NEW YORK, N. Y.

RADIO DEALERS

In addition to carrying the usual Radio Corporation products, we are now distributors for New York State of the well-known Paragon Radio products, famous throughout the world.

Write for latest bulletin and price discounts.

20th Century Radio Corporation
 565 Fifth Avenue, New York City.

MARSHALL CONDENSERS
 FULLY ASSEMBLED or READY TO BUILD
 NEW HAVEN RADIO CO. Manufacturers, NEW HAVEN, Conn.

When the Chemist Harnessed the Thunder-bolt!



MAN and beast react with electric speed to a warning of danger, if the alarm is immediate and personal. Self-preservation is the first law of Nature. Yet subtle perils far more disastrous than any we expect to meet lurk in the shadow of our fancied security. They are the dreaded ogres of Famine and Disease.

A few years ago the world faced a famine more terrible than any in history. Nitrates, the most essential materials for enriching the soil, were being rapidly exhausted, and universal starvation seemed inevitable. Everyone knows that plants must feed, and if the ground is not replenished with the chemicals they have consumed, vegetation will eventually die out. Nature's way of making up the deficit is too slow for our concentrated population, and farmers have resorted to artificial fertilizers for ages. Europeans, always more receptive to the teachings of Chemistry than we, raise more than twice as much grain per acre as Americans, owing to their greater use of fertilizing chemicals.

The principal substance used for this purpose is sodium nitrate, better known as Chile saltpetre, because of the large deposits of it in that country. Millions of tons of this precious chemical were being mined annually, for vast quantities are consumed in making explosives and in other industries, besides that required for agriculture. Chile kept getting richer, but her nitrate beds got continually poorer until their inevitable exhaustion became a grisly prospect. *And there was no other source of supply!*

It was here that electro-chemists stepped in and devised a way of making nitrates from the air! They stole a trick from Nature, using an artificial bolt of lightning, the electric arc, to change the nitrogen and oxygen into nitric acid. This is indeed what happens during a thunder-storm, though to a very slight extent. Other methods followed, and thanks to Chemistry the air-made nitrates can now be sold for less than the saltpetre of Chile. Better still, the supply is unlimited.

Today we are confronted with similar crises. There are impending shortages of other important raw materials. Yet so great is the general confidence in chemistry to solve such problems, little anxiety is felt. A wealth of opportunity awaits the chemist of the present, particularly in the fascinating field of Electro-chemistry. In many industries there are hundreds of chemists employed by a single company. Thousands of concerns have chemists supervising the quality of their output and of the materials they buy. In countless capacities a knowledge of Chemistry is essential.

You Can Learn Chemistry at Home Dr. T.O'Conor Sloane Will Teach You

Dr. Sloane, Educational Director of the Chemical Institute of New York, is one of this country's foremost authorities on chemistry. He was formerly Treasurer of the American Chemical Society and is a practical chemist with many well-known achievements to his credit. Not only has Dr. Sloane taught chemistry for years, but he was for a long while engaged in commercial chemistry work.

The Chemical Institute of New York was originally founded to fill a long-felt need in the Educational field. Thousands of young men and young women, realizing the wonderful opportunities for the chemist produced by the recent war and the assumption by the United States of world leadership, were keenly anxious to enter this promising field. Many of these prospective students, however, were unable to give up their regular occupations to devote the necessary time to their training. Correspondence study at home was the only solution.

Dr. Sloane will teach you Chemistry in a practical and intensely interesting way. Our home study course written by Dr. Sloane himself is thorough, logical and remarkably fascinating. It is illustrated by so many experiments that are performed right from the start that anyone, no matter how little education he may have, can thoroughly understand every lesson. Dr. Sloane teaches you in your own home with the same individual and painstaking care with which he has already taught thousands in the class room.

The Personal Help of Dr. Sloane

Dr. Sloane will personally examine and correct all of your examination papers, pointing out your mistakes and correcting them for you. He will, in addition, give you any individual help you might need in your studies. This personal training will be of inestimable value to you in your future career.

Easy Monthly Payments

You can pay in small monthly amounts as you go along. The price of our course is very reasonable, and includes everything. There are no textbooks to buy extra, and the chemicals and apparatus used for experiments are supplied to the student *without additional charge*. Our plan places an education in chemistry within the reach of everyone.

Experimental Equipment

Given to Every Student Without Additional Charge

We prepay even the shipping charges on the outfit. It comprises 42 pieces of apparatus and 17 chemicals and reagents. The fitted, heavy wooden case serves not only as a carrying case, but also as a laboratory accessory for performing experiments.

Special 30-Day Offer

For a short period we are making a special offer that will be worth your while to take advantage of. Write for our free book, using the coupon below or simply a postal card. This will not obligate you in the least. Do not wait until tomorrow. Send the coupon now while you think of it, and let us tell you our story.

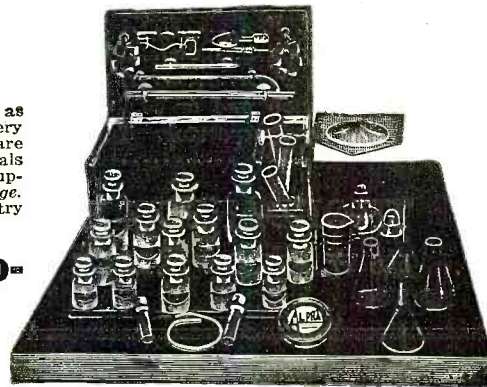

CHEMICAL INSTITUTE OF NEW YORK, Inc.
Home Extension Division 1,
140-R Liberty St., New York City.

Please send me at once without any obligation on my part, your free Book "Opportunities for Chemists," and full particulars about the Experimental Equipment furnished to every student. Also please tell me about your plan of payment and your special 30 day offer.

NAME

ADDRESS

CITY

STATE

R.N., 1-23.

Chemical Institute of New York, Inc.

Home Extension Division 1

140-R Liberty Street, New York City

BUY THE BEST

Thordarson Condensers and Amplifiers

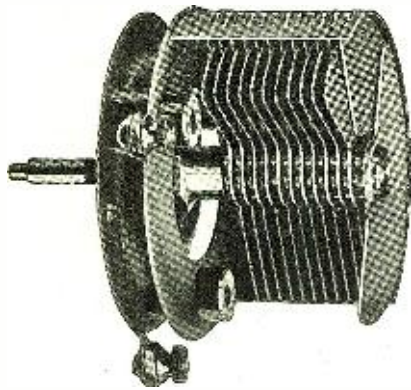

Our Latest Product

The best, most flexible and most complete variable condenser on the market today at any price.

Some of its features are: Movable and stationary plates completely shielded.

Stationary plates spaced accurately by special punched shell.

Movable plates secured by an ingeniously assembled comb separator brushing against the bearing.

Single bearing fastened directly to the shielding base plate without any dielectric.

Assembled by machine.

Lowest possible zero capacity and dielectric loss.

A vernier can be added by anyone at any time at a very small cost.

- 13 plate .00025 M. F. \$2.00
- With vernier, knob and dial... 3.50
- 23 plate .0005 M. F. 2.50
- With vernier, knob and dial... 4.00
- 43 plate .001 M. F. 3.00
- With vernier, knob and dial... 4.50
- Vernier, furnished separately if desired, with knob60

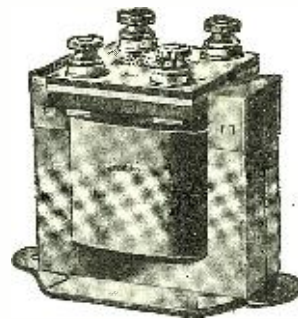

The new Thordarson 6 to 1 ratio audio frequency amplifying transformer. Designed for those desiring a higher transformer ratio than our standard. Unusually high and constant amplification without distortion over a broad band of audio frequencies. Core is twice the cross-section of that of the ordinary amplifying transformer and is made of special 36 gauge silicon steel. The coils have low distributed capacity. The high "Thordarson" standard has been maintained throughout.

- 6 to 1 ratio transformer.....\$5.00
- 3/4 to 1 ratio transformer..... 4.50

THORDARSON ELECTRIC MFG. CO.

500 W. HURON STREET

::

CHICAGO

long range work, a certain difficulty may arise in raising these stations, and the following information in regard to British ships will no doubt help. These vessels have instructions to listen in on a 2,400-meter wave (or 2,100) during each 35 to 45 minutes past each hour. In addition they generally maintain a listening watch on 2,100 meters during the first ten minutes of each hour unless otherwise engaged. From 15 to 18 minutes and 45 to 48 minutes past each hour a listening watch on 600 meters is to be maintained. To call one of these vessels during the above periods will generally gain attention provided, of course, that it is within range and not being QRM'd. If no reply is obtained after a couple of calls it will be useless to continue. Wait for the next period and try again.

It is hoped that the foregoing notes will prove of assistance to the many readers of RADIO NEWS afloat and should anyone desire further information of a similar character the writer may be reached by letter addressed care of the Editor of this magazine.

Contributed by E. FAIRHURST,
R. M. S. Baltic.

Radio Compass Aids Work of Ice Patrol

Perhaps the most spectacular as well as interesting demand upon the radio compass came to light recently when the report for the International Ice Patrol for the year 1921 was published, according to Arthur G. Shirt of Fall River, Mass., who relates to us this interesting sea incident.

It seems that the *Seneca*, one of the United States Coast Guard vessels assigned to the work, was standing by a large berg in lat. 42°42' N., long, 49°19' W., ascertaining its drift and direction of travel, when she received a radio from the steamship *Castle Point*, reporting herself in the ice fields, with but one day's supply of coal, no other vessel near and no aid obtainable from St. Johns. Although to leave the vicinity of the ice fields for any great length of time was clearly against the spirit of the Ice Patrol's orders, and against the purpose of its Commander, it was clearly the *Seneca's* duty to take the distressed vessel in tow. She started, therefore, for the *Castle Point*. At the same time the radio operator was searching the seas for a ship to which she might turn over the *Castle Point*. A response came from the steamship *West Gambo*, whose Captain expressed a willingness to tow the *Castle Point* into port. A rendezvous was arranged, and with the now helpless craft at the end of a hawser, the *Seneca* headed for it, as did also the *West Gambo*.

But a heavy fog set in, one of those notorious mists of the Newfoundland Banks that have to be hacked away and the chunks passed aft before a ship can make headway through them. To find a way to the appointed spot by the ordinary means of celestial observation was out of the question, and all deep-sea soundings on the Garnd Bank give practically the same depth and so tell nothing. It was almost impossible to see, and procedure was dangerous to say the least. The *Seneca* and its tow passed so close to a small berg that both vessels only passed clear by a prompt shift of the helm.

But she found the *West Gambo* by radio compass and found her without delay. Both ships dropped the idea of finding the rendezvous, took radio bearings of each other, and steamed directly down that bearing! The first bearings were exchanged when the vessels were fifty miles apart, and from that time until they were within sight of each other the goniometer was their only guide.



Phone Connectors

Connect Phones in One Second

Also used as Ground and Aerial Wire Connector No screws to tighten or get lost. Makes absolute contact and fine appearance. Sent prepaid anywhere in U. S. 35c per set. Attractive proposition to Dealers and Radio Manufacturers.

SCREW MACHINE SPECIALTY COMPANY
Screw Machine Products
314 29th Street Pittsburgh, Pa.

WATCH FOR THE VARIABLE **SUPERAMPLIFIER**

25 Radio Frequency Circuits POSTPAID 75c

Simultaneous R. F. & Audio Ampl., TUNERS, etc.

SUPERAMPLIFIER CO.

514 Fullerton Ave., Chicago

Remember Way Back When RADIO SUPPLIES WERE SO SCARCE?

Buy now while deliveries can be made

2 VARIOMETERS 12.50 WITH THREE 3 INCH VARIOCOUPLER MOULDED DIALS

Everything in Radio. Dealers Write

EHRLER-RADIO

30 N. Dearborn St. Div. A. Chicago

If you can't get it elsewhere, try New York's Radio Center.

We quote prices gladly.

Electric Service Engineering Co.

105 West 47th St. New York City

The Radio Guild

"BROADCAST RECEIVER"

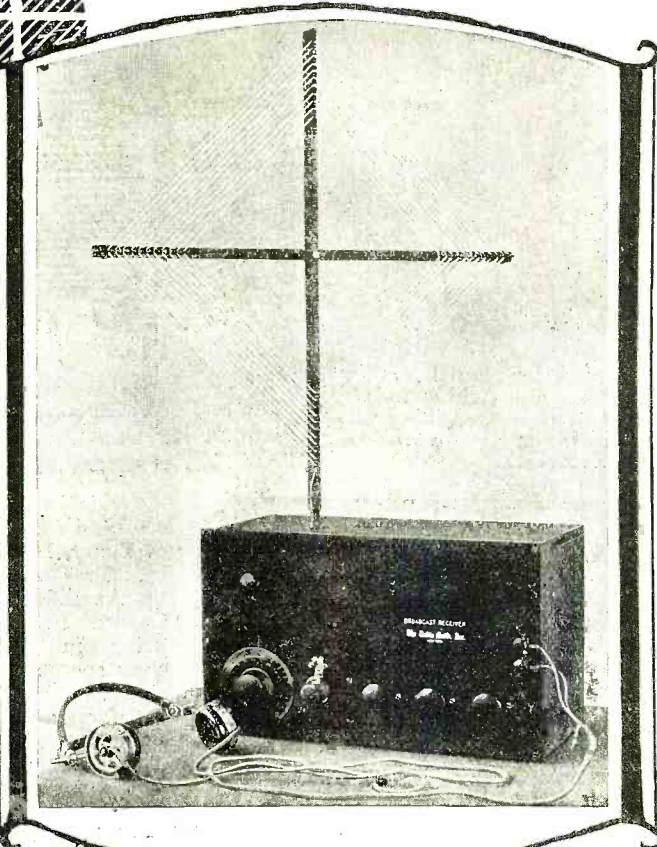
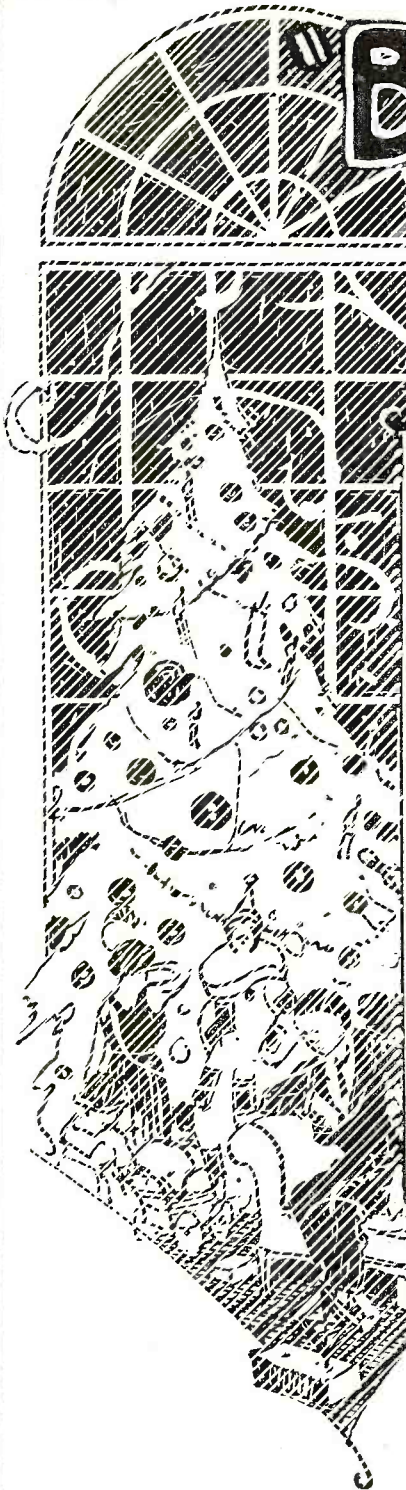

THE "BROADCAST RECEIVER" is a new departure in radio receiving sets. With the small loop aerial supplied with each instrument the receiving range is conservatively estimated at 75 to 100 miles. With an outside aerial and ground the range is over 1,000 miles. Designed by experts in radio frequency amplification it is highly sensitive and yet extremely simple to operate. Truly a better receiving set—an ideal Xmas gift. List price, including loop..... \$95.00
Dealers: Write for discounts.

The Radio Guild, Inc.

256 W. 34th Street

New York, N. Y.

Experts in radio frequency amplification.
Designers and manufacturers of the "Vox Humana,"
the R. G. 510 and the "Dashboard Special."

New York Coil Company Radio Products Are Built to Work—Not Just to Sell

THE leadership they enjoy is due to correct design, exceptional workmanship and eighteen years' experience in the manufacture of wireless and precision electrical devices. Two especially equipped factories and quantity production are responsible for our low prices.

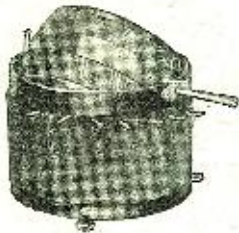

Price \$4.00

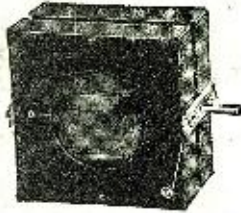

Price \$4.00

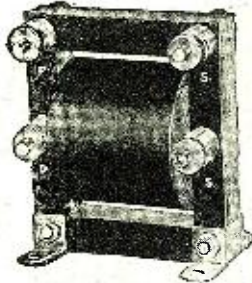

Price \$4.00



Mounted Varicoupler for Panel or table use, but three holes used in panel saves all laying out, drilling and soldering—nothing else like it. Price **\$8.00**

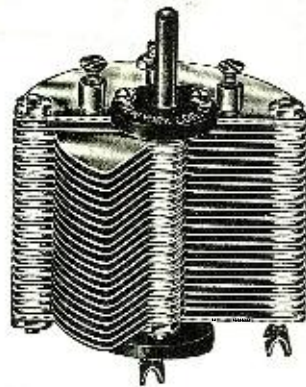

- 11 Plate **\$1.50**
- 23 Plate **2.00**
- 43 Plate **3.00**
- 3 Plate **1.25**

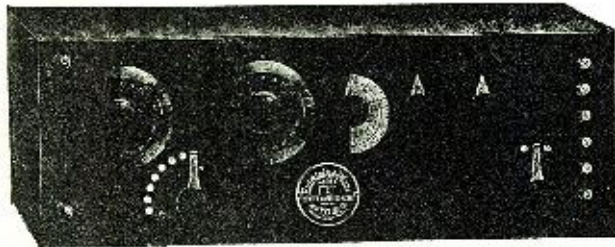

Receiving Set consisting of Tuner, Detector, Two stages of Amplification. Guaranteed to bring in more clear speech, music and entire satisfaction **\$50.00** Complete

NEW YORK COIL COMPANY
338 Pearl Street New York City

This is an unusual incident, but it is only one of the many ways in which the radio compass proves of value to the man at sea.

ARTHUR G. SHIRT,
87 Smith Street,
Fall River, Mass.

SOME TASK

Say, d'you know it's a deuce of a task
To answer the questions that passengers ask
For a land-lubber's questions out on the sea
Run through all the letters from A down to Z.

"Do you sail the ship at night time?" they ask with a smile.

"And when it rains, do you stop it for a while?"

"For you know, when it's raining (that is, I should think)

"It would run into the cellar and make the ship sink.

"And that man standing there at a thing like a wheel.

"He seems to be moving it round a good deal.

"And you say when he turns it he does it to steer.

"Well, now, ain't that funny; it really seems queer.

"And that bell there a-ringing; do you know, it struck eight?"

"My Lord, how the time flies, who'd think it so late?"

And then you explain, as you've done o'er and o'er,

About the ship's bell ringing and the time being four.

"Do you ever get seasick?" And you answer with glee,

"I never get seasick, but sick of the sea."

"How far do you think we are off from the shore?"

"Just a few miles, or is it some more?"

And you stand there and wonder how much they will stand.

Then risk it at five thousand miles off the land.

And should ever a lightship come into view

You've got to get busy and answer a few.

"Is that boat anchored there or tied to a rock?"

"And why is it there and not at the dock?"

"Are there men on it that stay there day after day?"

"My, how do they stand it, and what is their pay?"

"Supposing some night, just supposing, you know,

"That they ran out of oil and the light wouldn't show.

"Would they send out a boat in the night to the shore

"To get them some oil from a big grocery store?"

"Do the flying fish sing as they fly through the air?"

"And do they have feathers like the gulls flying there?"

"Do you ever get home-sick?" Now here's where they sigh

With sympathy showing in each anxious eye.

And you say in a voice that the sea has made rough

"Why no, for you see, I'm not home long enough."

Then they ask if you're married—you know how it is.

If the passenger's fair and you're on to your "biz,"

Just what would you tell her, and she all alone

And you three or four hundred miles from your home?

Say, d'you know it's a deuce of a task
To answer the questions that the passengers ask.

Contributed by S. E.

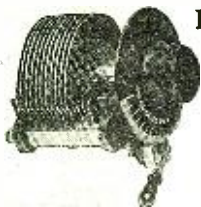

HAMMARLUND VERNIER VARIABLE CONDENSER

Super-accurate tuning
.001 Mfd. \$7.00
.0005 Mfd. 6.00
3 1/2" Bakelite Dial
\$1.00 additional

Pat. Appld. for

Rated 96% perfect by Radio News Laboratories—highest grading yet awarded any instrument. Full description in editorial section of this issue. Circular on request



DISTRIBUTORS WANTED

HAMMARLUND MFG. CO., Inc.
144-146 West Eighteenth Street
NEW YORK

WANTED

IN EVERY RADIO CLUB
EVERYWHERE

A Representative to solicit subscriptions to Science and Invention and Radio News.

These are acknowledged to be the most popular and most important magazines in the Radio field.

Every member of your club should have them both.

Our commissions are most liberal.

For details, write today to

C. J. Wolfe

EXPERIMENTER PUB. CO.

53 Park Place, New York

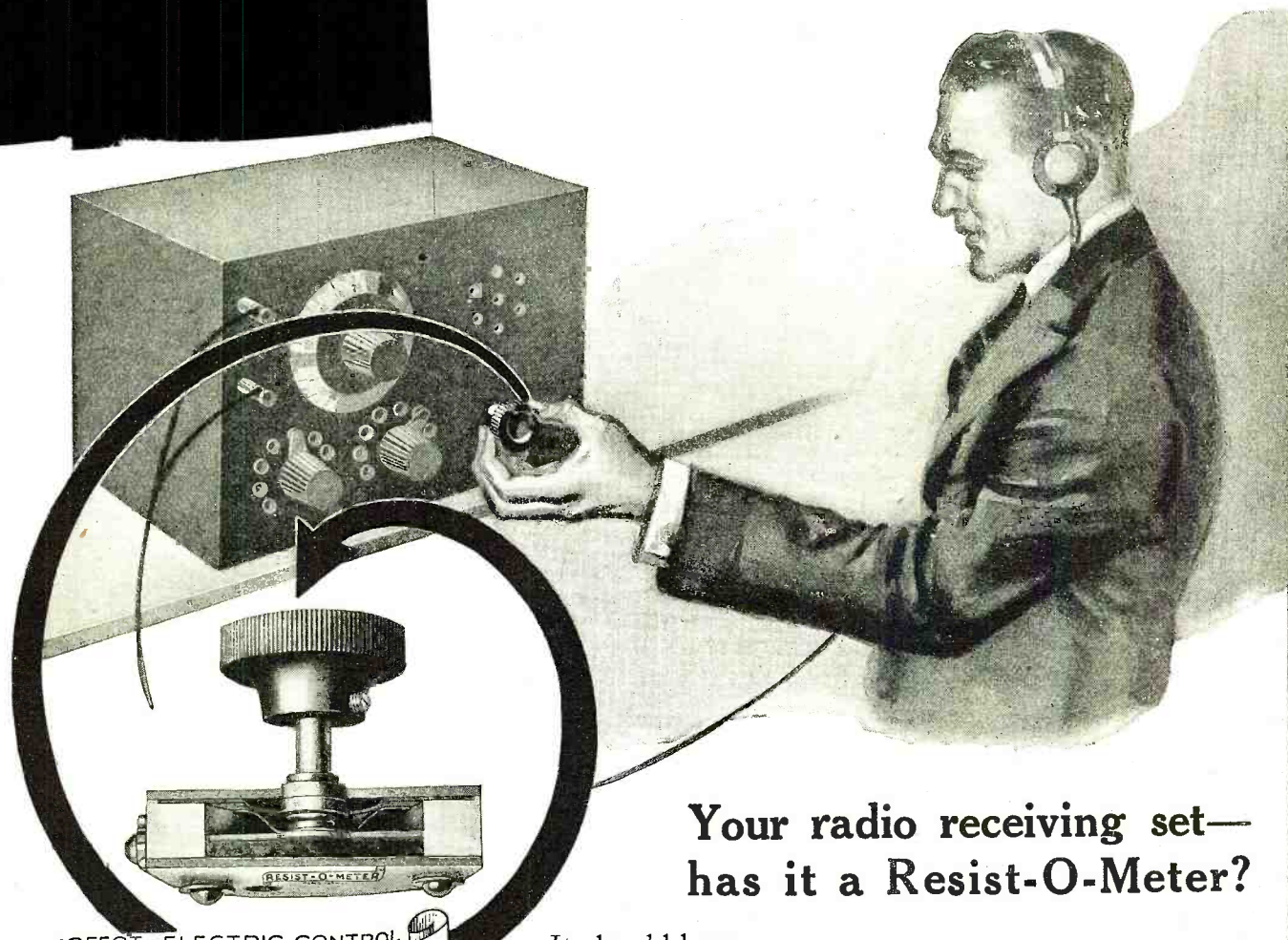

Your radio receiving set— has it a Resist-O-Meter?

It should have.

The Resist-O-Meter gives you a better outfit by far. You will notice the difference immediately. It is the **ideal** variable resistance.

You need these rugged instruments which provide for an extremely delicate **and continuous** variation in resistance to properly control the current flow from the "A" and "B" batteries of your radio set. Hook up a Resist-O-Meter. You will never go back to the old type.

The Scholes "Resist-O-Meter"—

—is micrometer controlled and **continuously** variable between the extreme ranges of its terminals.

—is non-microphonic.

Possesses the lowest resistance at full compression (practically zero).

—is made in models covering every requirement for radio use.

—is compact and convenient, and takes up very little space in standardized mounting.

The Scholes Radio & Manufacturing Corporation holds the sole license to manufacture this type of current control, under patents granted Mr. F. A. Rojas, Nos. 1315579 and 1366945, other patents pending. It is sold only under the trade mark name "Resist-O-Meter". Ask your dealer to supply you.

Write to Mr. H. L. Demuth

THE SCHOLLES RADIO & MFG. CORP.

33-36 West 18th St., New York City

PERFECT ELECTRIC CONTROL
RESIST-O-METER
TRADE MARK

The Resist-O-Meter illustrated is
Type A-Filament, Price \$1.80

WE MANUFACTURE THE PRODUCTS LISTED BELOW

Resist-O-Meters

Type A-Filament.
Type B-"B" Battery
Type C-Potentiometer
Type D-Variable Grid Leak

Test-Rite Condensers in following capacities:

Phone .001 mfd.
Grid .00025 mfd.
Grid .0005 mfd.
Grid Leak .0005 mfd. 1-meg.

V. T. Sockets

Engraved Binding Posts

Accessories

THIS "B" BATTERY WILL LAST 5 YEARS

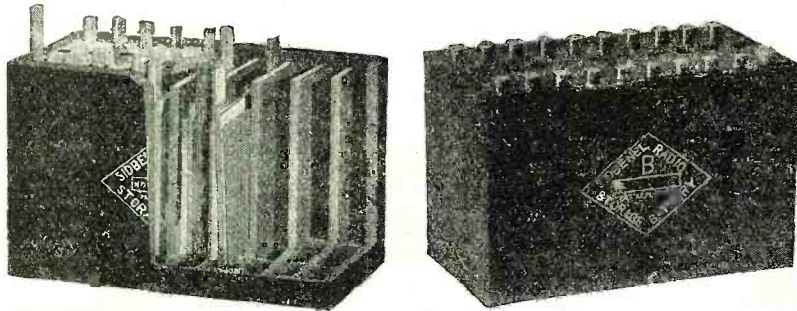

The Sidbenel is a storage "B" battery that will last five years of constant use without replacing parts. It will give continuous service for at least six months before it becomes necessary for recharging. It can then be recharged in a few hours to its original full capacity, all ready for another six months' use.

The Sidbenel storage "B" is something every radioist needs. Think of the money saved by not using dry "B" batteries which are of no use when they once become discharged. The Sidbenel pays for itself in six months.

It is so ruggedly constructed, that rough usage will not harm it. The container is one-piece genuine hard rubber. The battery boxes are made of hard rubber moulded into ten compartments. It comes in one, two, five, eleven and twenty-two units with voltage of 23, 44, 115, 250 and 500, respectively. Size 2 1/2 x 3 x 4 1/2 per unit.

Every inch of the Sidbenel storage "B" is constructed under our own patents. The plates are especially treated with a newly-discovered chemical that eliminates howling and screeching so commonly found in dry "B" batteries.

The Sidbenel storage "B" is shipped to you partly assembled. All you need do is to connect the plates together. This takes but ten minutes and is most simple, as instructions are furnished with each battery.

GUARANTEE

A two-year written guarantee is given with each Sidbenel Storage "B" battery. This is your complete protection.

For recharging, we furnish a rectifier for AC current which costs 25 cents extra. DC current requires none.

Order a Sidbenel Storage "B" today by mail and same will be shipped immediately. Money order or check. No stamps.

One unit, 23 volts.....	\$3.85	Five units, 115 volts.....	\$17.50
Two units, 44 volts.....	7.50	Eleven units, 250 volts.....	36.50
Twenty-two unites, 500 volts.....	\$65.00		

We are the manufacturers and distributors of a high class of radio apparatus bearing the name "Sidbenel." Complete sets ranging from \$3.35 to \$500. Also a number of knocked down sets which you can assemble yourself at a big saving in money to you.

FREE Send today for our complete catalog showing our apparatus—it's free. This catalog contains items at unheard-of low prices. It will be the means of saving you considerable money. Send for it at once.



SIDBENEL RADIO EQUIPMENT MANUFACTURING COMPANY
1663 Jerome Avenue New York City

The Largest Radio Mail Order House in the World

RADIO SALESMEN SAVE YOUR SPARE TIME!

Many Radio Salesmen are making the most of their spare time by securing subscriptions to **Practical Electrics, Science & Invention, and Radio News.**

These popular magazines are growing in importance daily and a few hours' "spare time" work will add very materially to your income. Many Radio Salesmen have made them a part of their regular line. We pay a very liberal commission.

For details, subscription blanks and sample magazines, write to **C. J. WOLFE.**

Experimenter Publishing Company, Inc. 53 PARK PLACE NEW YORK

VARIABLE CONDENSERS

3-Plate Verner	\$0.75
23-Plate .0005 Mfd.	1.75
43-Plate .001 Mfd.	2.25
24-Plate Balanced Cond.	3.75
44-Plate Balance Cond.	4.75

Aluminum Plates, accurate spacing. Get these condensers and improve your set. Shaft runs in bearings. Money back if you are not satisfied.

MONTROSE MFG. CO.

1200 Bedford Avenue

Brooklyn, N. Y.

VULCANIZED FIBRE Be sure and specify "WILMINGTON FIBRE"

Sheets, Rods, Tubes, Washers, Etc., Specialties

Wilmington Fibre Specialty Co. Wilmington, Del.
Branch Offices "Everywhere"

ENGLISH STILL A PUZZLE FOR MANY JAP OP'S.

Wireless telephony is the one field of American industry in which the Japanese seem unable to compete successfully, according to E. R. Dibble, manager for a big Pacific coast radio company. "So far," said Mr. Dibble, "the Orientals have copied and competed with the Yankees in almost every line of invention and industry, but in the wireless method of communication they seem to have made a 'fizzle' of their attempts. Either in war or commercially I do not believe they would be dangerous because of the misunderstanding they have regarding the American way of talking. All our English idioms are taken too literally; they do their best, but that is none too good. If a message is sent them it keeps the operators guessing so long that little satisfaction can be obtained.

"As an illustration, one of our operators on an Alaskan steamer heard a Japanese wireless operator working and asked for his position and who he was. The reply came back that he was Taki somebody and that he was working in the radio room.

"Another operator asked a Japanese boat for news concerning a noted athletic contest of interest to the Americans on a ship returning home from the far east, and the reply was 'Why should the honorable gentlemen combat?'

"When an American radio sender inquired regarding the report of a great typhoon in mid-ocean, the Japanese replied that it was an ill wind that blowed no one any great favor.

"Another questioner anxiously awaiting commercial news wished to inquire if the Chinese might again consider an embargo or boycott on certain American-made goods. The Japanese sent back the idiotic answer that so far there had been no boys captured by the Chinese for some time."

Contributed by F. W. FICKLE.

SPEED CHAMPION IS NOW J. C. SMYTH.

Joseph C. Smyth, of 269 86th Street, Bay Ridge, Brooklyn, N. Y., was awarded the championship at the recent Boston radio exposition. There were three separate contests: Jamming, cipher code and straight press, the stipulation being that the contestant showing to best advantage



Mr. J. C. Smyth of the Western Union, Who Now Retains the Code Championship.



These two pictures compare the size of the standard variable air condenser and the Dubilier Variadon.



The New Variadon— No thicker than an ordinary dial

THE following are the more remarkable features of the new Dubilier Variadon, the first practical mica variable condenser:

1. It is no thicker than an ordinary dial. Yet it serves the purpose of an air-condenser with several dozen plates.
2. It can be mounted on any convenient part of a receiver case (front or rear of panel).
3. Its adjustment cannot be destroyed by ordinary shocks, falls or vibrations. Hence short-

circuits are practically impossible.

4. It makes the vernier unnecessary.

5. It can be used as a grid-leak condenser, so that new tubes or different tubes can be adjusted to suit the receiving set.

Capacity .0004 or .0006 mfd. Retail price, \$2.50.

Capacity .001 mfd. Retail Price, \$3.50.

Supplied complete with dial and knob.

Other famous Dubilier Products

Dubilier Micadons

Micadons are little mica condensers which reduce tube noises. Made in a wide range of capacities. Price 35 cents to \$1.50 each, according to capacity.

The Ducon

Screw the Ducon in any lamp socket and thus do away with the antenna. The broadcasting station comes in loud and clear. Price \$1.50.

The Du-tec

A chemical rectifier of which every spot is sensitive. Eliminates tedious and frequent adjustment of "cat whisker." Does not oxidize with age. Price, mounted, 30 cents each.



DUBILIER Condenser & Radio Corp.
48-50 West 4th. St. N.Y.

DISTRIBUTORS AND BRANCH OFFICES

San Francisco, Cal.....709 Mission Street	Washington, D. C.....Munsey Building
St. Louis, Mo.....Syndicate Trust Bldg.	Chicago, Ill.....33 So. Clinton St.
Atlanta, Ga.....Forsyth Building

Distributed in Canada by General Electric Company, Ltd., Toronto.

Radio Catalogue FREE

One copy of this complete Catalogue of Radio Outfits, parts, Dictionary of Radio Terms, Instruction Book, and Guide to Successful Radio Work—one copy is yours Free.

Simply write us a post card and we will mail the complete book to you Free, by return mail.

It quotes the lowest prices, amazingly low prices on everything for the expert and the amateur. Every improved part, the most up-to-date outfits, everything that is needed of the most modern type—at the lowest possible prices.

It gives a list of broadcasting stations, and gives much information about radio construction and operation. Every one interested in Radio needs this complete catalogue and book of instruction.

Why Pay Higher Prices?

Montgomery Ward & Co. has for fifty years dealt on a Money-Back basis, absolutely guaranteeing everything they sell. With quality absolutely assured, why pay higher prices elsewhere? Write today for this Free Radio Book and see for yourself the Saving it will bring you.

One copy is yours Free. You need only write us a post card.

Write to the house nearest you. Address Dept. R-2
Chicago Kansas City St. Paul Fort Worth Portland, Ore.

Montgomery Ward & Co.
= The Oldest Mail Order House is Today the Most Progressive =

in all three contests would be awarded the silver cup and title. Smyth won all three.

In the jamming contest two transmitters were sending simultaneously into the phones, and the contestants were required to ignore the signals from one transmitter and copy the others, a rather difficult assignment. Smyth won this at a speed of 35 words per minute without error. The cipher code consisted of 10-letter code words secretly prepared, and transmitted by a Wheatstone transmitter. This contest was also won by Smyth who again made a perfect copy, and broke the world's record for speed in cipher code receiving, by copying the difficult words at a speed of 44 words per minute.

The straight press contest presented the closest race of all, as both Smyth and Theodore R. McElroy, the former champion, made perfect copies at a speed of 45 words per minute, and again at 50 words per minute. However, at 55 words per minute McElroy made six errors, while Smyth made five.

National Broadcasters' Bureau

(Continued from page 1274)

Walker made it clear that he did not wish to be mistaken for a pessimist. He is convinced that the radio industry is destined to become one of the greatest commercial enterprises in the world, but he insisted that the proper type of men should steer the radio ship, and the industry as a whole should be foremost in their minds and not permit the selfish interests of a few to guide an infant industry, with the risk of running the bark on commercial shoals that might spell its destruction when it has such a bright future.

The majority of the delegates to the meeting were optimistic of the future of radio and expressed themselves as confident that in January there would be a fresh spurt in all lines of the industry.

This feeling of optimism confirmed the decision of Milo E. Westbrooke, who attended the conference, made after the First National Radio Exposition last June, that January was the proper time to hold the second National Radio show, which will be in the First Regiment Armory, Chicago, January 13 to 20. By that time the school boys will have got well into their radio work in the school shops, the radio fans will be spending more time home at nights, the reception will be at its best and the dealers will have completed their inventories and know where they stand and what they want to buy.

A Radio Controlled Clock

(Continued from page 1260)

time signals are sent, thus closing the filament circuit of the vacuum tubes in the amplifier and the circuit in this relay which is so arranged as to operate the safety device.

As soon as the time signals are sent, the filament circuit is opened and everything set in readiness for the next signals. In fact, the signal operating this clock is a special signal sent before the standard ones and last from 9 hours, 26 minutes, 25 seconds to 9 hours, 26 minutes, 30 seconds exactly. The other signals have, therefore, no action on the electrical system which functions with a great regularity without any inspection for a long time.

THE VERNIER VARIOMETER

PATENT APPLIED FOR
NEW — RADICAL — DIFFERENT

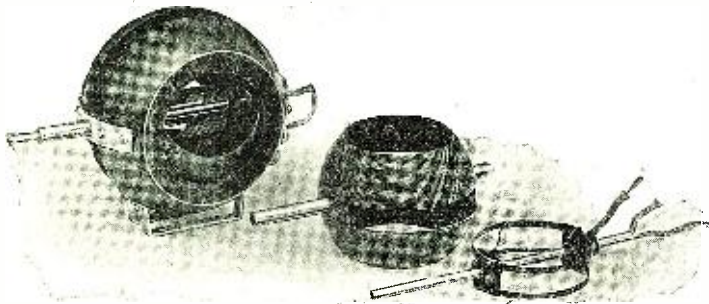

QUICK ADJUSTMENT—FINE TUNING—GREAT SELECTIVITY
ALL SOLDERED CONNECTIONS—NO SLIDING CONTACTS—INSULATED SHAFTS
GENUINE MAHOGANY WOOD—MINIMUM WEIGHT—HANDSOME FINISH

PRICE \$6.00

MANUFACTURED AND GUARANTEED BY

FLETCHER WORKS

GLENWOOD AVENUE AND SECOND STREET PHILADELPHIA

JOBBERS AND DEALERS WANTED



a New Willard "A" Battery for

A new Willard—at a new low price!

That's the Willard FW Radio "A" Storage Battery.

It has Willard-quality plates, selected wood separators, tested rubber jars, well-built acid-proofed container.

It has specially-designed terminals that do away with clips and insure tight, easily-made connections.

It has a special marking for the positive terminal, so that there's no chance of your hooking up the battery in reverse.

It has patented soft-rubber gaskets around the terminal posts to prevent leakage.

It has a stout roller handle that's easy on your hand.

And remember this—

All Willard Radio Batteries are Shipped Dry and Fully Charged

This means that you are always certain of a fresh battery—a battery in which there has been no deterioration—and *one you can put to work at once without charging*. All that is required is the adding of the electrolyte (a solution of pure sulphuric acid and water) which takes but a moment.

See the new Willard FW Battery at the nearest Willard Station or at your dealer's.

\$13.60

40
ampere-hour
capacity

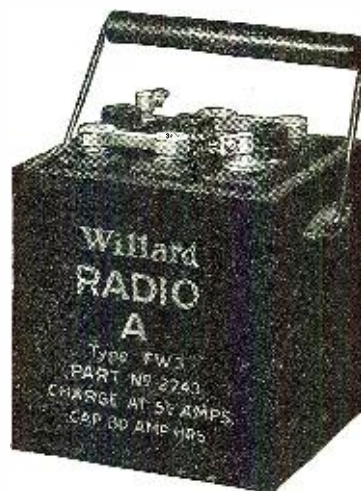

Made in Three Sizes

Capacity and prices of this new battery are as follows: 40 a. h., \$13.60; 80 a. h., \$17.50; 110 a. h. \$22.00. Prices slightly higher west of the Mississippi and in extreme South.

WILLARD STORAGE BATTERY CO.
Cleveland, Ohio

Made in Canada by the
Willard Storage Battery Co. of Canada, Limited, Toronto, Ont.

Willard STORAGE BATTERY

Don't Growl—

If you've used inferior equipment, and can't get results. It's not too late to throw it out and start over—with *Ace* material. If you have put up with poor service the past season—get started right this fall with *Ace* apparatus. Our socket illustrated herewith is a suggestion. Not a molded proposition to melt at the first touch of a soldering iron, but a base of $\frac{1}{4}$ " solid sheet Formica, with die cast shell and absolutely guaranteed. Grid leak incorporated in socket base—adjustable to suit tube—and the price as low as consistent with highest quality. We make complete receiving sets and numerous small parts—literature on request.



Type T-S VT Socket
\$1.50 with Grid Leak

ADDRESS DEPT. H-P

The Precision Equipment Company

2437-2439 GILBERT AVENUE, CINCINNATI, OHIO

RADIO CABINETS

Hardwood, mahogany finish. Hinged lid. Front rabbetted for panel.

By selling these Cabinets direct to the customer we are able to offer them at exceedingly low prices, post-paid.

Prices post-paid in United States, cash with order. Panels not included.

INSIDE DIMENSIONS				
Panel Size	High	Wide	Deep	Price
6x7 ins.	5½ ins.	6½ ins.	7 ins.	\$2.20
6x10½ ins.	5½ ins.	10 ins.	7 ins.	2.50
6x14 ins.	5½ ins.	13½ ins.	7 ins.	2.85
7x18 ins.	6½ ins.	17½ ins.	10 ins.	3.30
9x14 ins.	8½ ins.	13½ ins.	10 ins.	3.75
12x14 ins.	11½ ins.	13½ ins.	10 ins.	4.50

We also manufacture Radio Desks and Tables in mahogany and golden oak finish.

Send for prices and Dealers' proposition.

THE SOUTHERN TOY CO.
HICKORY, N. C.



RADIO SALESMEN SAVE YOUR SPARE TIME!

Many Radio Salesmen are making the most of their spare time by securing subscriptions to **Practical Electrics, Science & Invention, and Radio News.**

These popular magazines are growing in importance daily and a few hours "spare time" work will add very materially to your income. Many Radio Salesmen have made them a part of their regular line. **We pay a very liberal commission.**

For details, subscription blanks and sample magazines, write to **C. J. WOLFE.**

Experimenter Publishing Company, Inc.
53 PARK PLACE NEW YORK

Radio Head Sets

(Continued from page 1279)

ble. There is a limit, however, to the extent to which magnets may be magnetized, exactly as there is a limit to which a steel spring may be stretched. The value of the maximum strength to which a magnet may be magnetized depends upon the kind of steel used in the magnet. Certain steels permit only a low magnetization, while others permit of a high magnetization. The best kind of steel to employ in the case of telephone receivers is either chrome steel, or tungsten steel, and of the two tungsten steel is the better. In view of the fact that the sensitivity of the telephones depends upon the strength of the magnets, it is obvious that it is extremely important that the magnets should not weaken with age. There are some magnets that, originally strongly magnetized, gradually lose their magnetism and weaken with age. The writer knows some telephones now on the market which are in this class. Steels, such as chrome and tungsten, retain their magnetism, but even these will not, unless they are properly treated before being magnetized. They have to be passed through a hardening and ageing process in order that they retain their magnetism. One of the important qualifications of the good telephone is, therefore, that the proper steel must be used and that its magnetism must be retained over long periods of time.

2. Strength of magnetic field created by the current in the telephone coils CC. This is the second factor on which the sensitivity of the telephones depends. The strength of the magnetic field due to the current is dependent upon two factors; one, the value of the current, and two, the number of turns in the coils. That is, it is proportional to the so-called "ampere-turns," which is the product of current by turns. If we call the magnetic field due to the current, F; the current, c; the number of turns in the coil, n; then

$$F = k c n$$

where k is a factor of proportionality and is constant for each magnet. From this we see that the larger the current and number of turns are made the greater will be the magnetic field and hence also the sensitivity of the telephones. However, in practice the value of the telephone current is usually very small. This is due to the fact that the energy received by the receiving antenna is usually microscopic, if this term may be used, and furthermore the resistance of the detector, be it crystal or tube, is usually very great. Hence the telephone current is small. Therefore in order to make up for the small current it is necessary to use a very large number of turns on the coils in order to increase the sensitivity of the telephones. The amount of space available in which to wind the magnet coils is extremely small. Hence, in order to get a large number of turns in a coil it is necessary to use extremely fine wire. As a result a coil having a large number of turns, say between 3,000 and 5,000 and wound with the wire generally used, say No. 40 to No. 44 will naturally have a very high resistance.

From this it should be clear that the high resistance of telephones is due to the necessity of getting a very large number of turns of fine wire in limited space. Therefore, stating that telephones have a high resistance, say 2,000 or 3,000 ohms, in itself means very little. What counts is the number of turns in the coils. It should be emphasized that resistance figures mean little, for telephones may be wound with

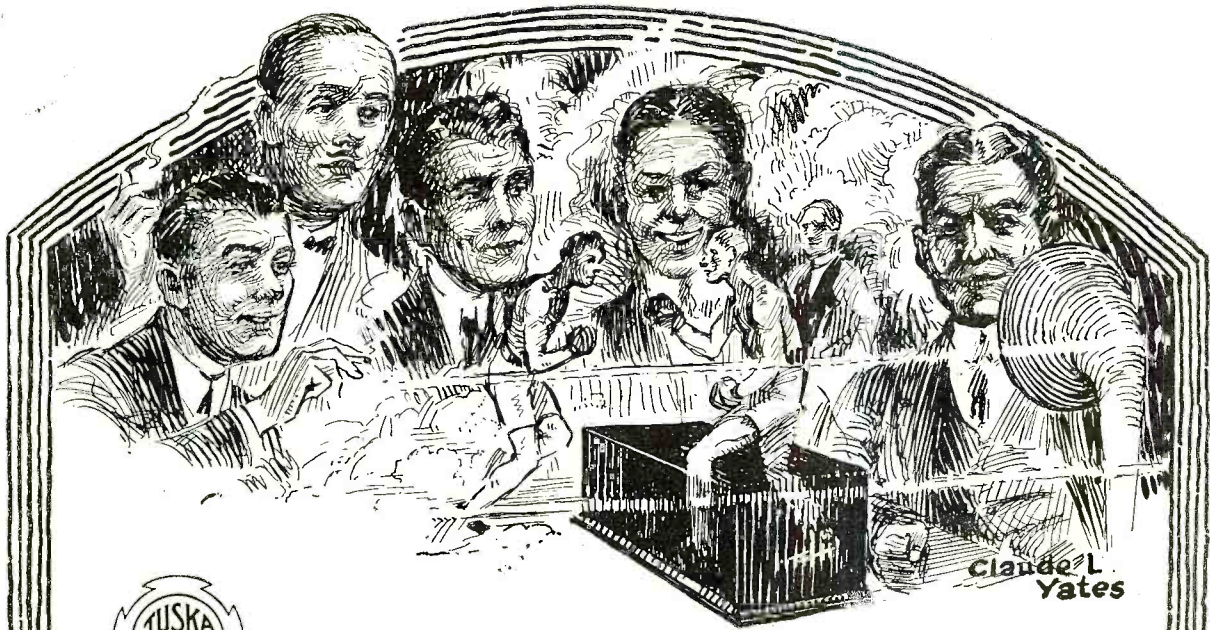

*Catalog Number Four
contains Marvelous
article on tuning
Receiving Sets.
Ten Cents
brings it
to you*

A KNOCKOUT!

Blow by blow 'till the finish! Tuska Quality Radio Apparatus gives you a ring-side seat in your favorite Morris chair.

Tuska Radio is supreme in quality, appearance and service.

Ask for Tuska Radio at your dealers today.

The C. D. Tuska Company
37 Bartholomew Ave.
Hartford, Connecticut

**TUSKA
RADIO**
Established 1911

Wimco Announces

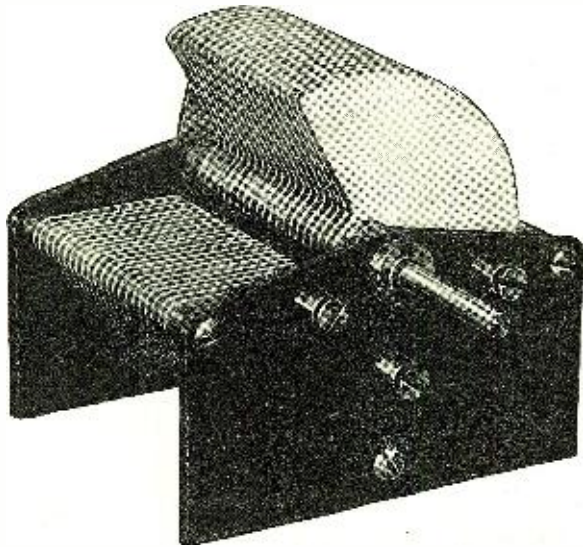

THE WIMCO VARIABLE CONDENSER

After months of experimentation to produce a really good Variable Condenser, we take pleasure in introducing to the trade The WIMCO Variable Condenser, which will be furnished in 43, 23, and 3 plate type. Tests Conducted by the Washington Radio Laboratories show that The WIMCO Variable Condenser of the 43 plate type has a resistance, at maximum capacity, of but .018 ohms, and the capacity at zero on the scale is but 15 micro-microfarads. These values, we believe, are lower than in any other condenser manufactured for general amateur use.

The WIMCO Variable Condenser is now in production and your orders will have our best attention.

We have a very attractive proposition for the Jobber, and solicit your inquiries. Write for complete price list and discount sheet.

THE WIRELESS MANUFACTURING CO., MANUFACTURERS
DISTRIBUTORS **Canton, Ohio**

MEMORIZE CODE IN ONE HOUR

TRADE MARK **BKUMA YRLSBUG** REG. AP. FOR

ATTENTIVE BEGINNERS WHO USE

DODGE ONE DOLLAR RADIO SHORT CUT

DO MASTER CODE

IN MINUTES INSTEAD OF WEEKS

DO QUALIFY FOR EXAM

IN HOURS INSTEAD OF MONTHS

DO SUCCEED

AFTER TOTAL FAILURE WITH OTHER METHODS

- 9 CCW Reports memorized Code in TWENTY MINUTES.
- 2 BXY Qualified by 3 hours' practice—15 minute periods.
- 9 CPK Reports failed with every other method.

USUALLY PAYS TO INVESTIGATE *B4 UBI*.

For One Dime will mail Honor Roll of Beginners in 12 Radio Districts who QUICKLY made themselves Licensed Operators.

For Every Dime of Cost Our Method Saves Dollars.

AFTER JANUARY 1, SHORT CUT WILL COST TWO DOLLARS

C. K. DODGE Box 200 **MAMARONECK, N. Y.**

resistance wire to give a very high resistance, but the number of turns would not be there, and inefficiency would result. Such phones, it appears, have been set loose on the market by unscrupulous makers. The phone should be wound with copper wire only.

Some telephones are today being sold for radio purposes which have very low resistances, say between 80 ohms and 350 ohms. Such phones, if used in the generally known circuits, will be found to be almost useless. Their sensitivity for radio purposes is too low, for the reason that these low resistance phones have not enough turns on their coils, and since the received current is small the ampere-turns are too small to produce any appreciable effect on the telephones. These phones would be suitable if the received current were very large, for then the small number of turns would be compensated for by the excess current. But, inasmuch as the current received is generally small, such phones are unsuitable for radio.

However, it is possible to adapt these low resistance telephones for radio purposes by means of suitable telephone transformers. This adaptation is made possible by the application of a certain principle in the theory of transformers. This principle is briefly this: A resistance in the low tension winding of the transformer is equivalent to the same resistance multiplied by the square of the transformer ratio when transferred to the high tension winding. Thus in Fig. 3, if r is a resistance in the low tension side, and T is the transformer ratio, then the equivalent resistance in the high tension winding would be given by R

$$R = T^2 r$$

The application of this principle to the use of low resistance telephones in radio is shown in Fig. 4. T is a telephone transformer whose high tension side is connected in the place where the telephones are ordinarily connected, right after the detector. P is a pair of low resistance telephones having a resistance of, say 100 ohms, and is connected in the low tension side of the transformer. Suppose the transformer has a ratio of 5 to 1, then the 100 ohms phones in the low tension side of the transformer are equivalent to

$$100 \times (5)^2 = 2,500 \text{ ohms}$$

when transferred into the high tension side. In other words, by means of the transformer we are able to transform the low resistance phones in the low tension side of a pair of high resistance phones in the high tension side. Thus with the transformer the low resistance phones should have the same effect as a high resistance telephone without transformer. Experiment shows this to be true.

In general, however, it is preferable to buy the high resistance phones, for the low resistance ones cost almost as much as the high, and besides, there is the added cost of the telephone transformer, and unless one has some skill and experience, best results are liable not to be obtained.

The properties of the pole pieces PP (Fig. 1 (b)) are different from those of the permanent magnet MM . The pole pieces should be made of very soft iron, so-called Swedish iron. This Swedish iron is so soft that it can be peeled with a knife, with ease. Unlike the permanent magnet steel which should retain its magnetism under all circumstances, this soft iron has the property of easily losing its magnetism, and of being easily magnetized. This is essential in order that the magnetic field set up in the pole pieces by the current should be able to follow without lag the variations in the telephone current.

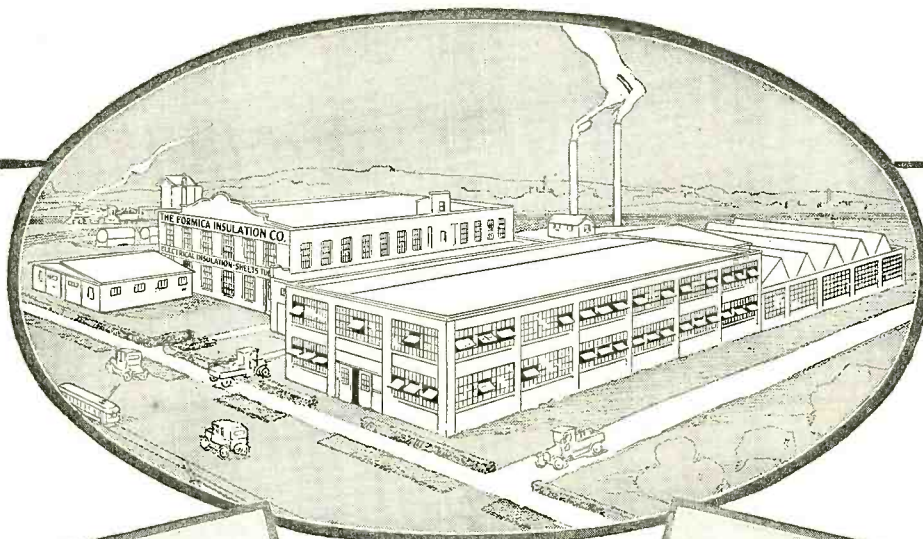

The Formica plant today

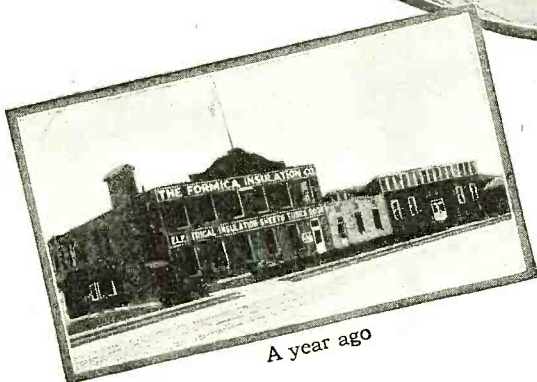

A year ago

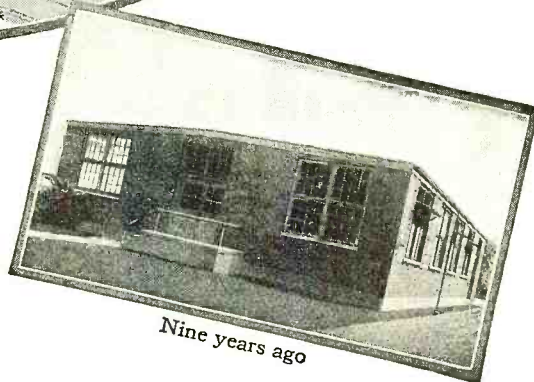

Nine years ago

Appreciation and Progress

NINE years ago the Formica Insulation Company began business in the small building shown at the right.

Two years ago the demand for the product from every branch of the electrical industry, forced a move to the building shown at the left where capacity was greatly increased.

Now, recently constructed additions to that plant have brought into existence the plant shown at the top—a plant with more than twice the capacity of the company—a year ago—and the largest in the industry.

Appreciation of a better insulating product—one that at very slightly increased costs removes thousands of troublesome and costly possibilities for insulation failure—has built the business.

If you do not know or use Formica write us now for literature and prices

THE FORMICA INSULATION COMPANY
4618 Spring Grove Ave., Cincinnati, Ohio

50 Church Street...New York, N. Y.	414 Finance Bldg....Cleveland, Ohio	422 First Avenue....Pittsburg, Pa.
9 South Clinton Street...Chicago, Ill.	1042 Granite Bldg..Rochester, N. Y.	1210 Arch Street..Philadelphia, Pa.
415 Ohio Building.....Toledo, Ohio	313 Title Building..Baltimore, Md.	Sheldon Bldg...San Francisco, Cal.

FORMICA

A Laminated Phenolic Condensation Product
SHEETS TUBES RODS

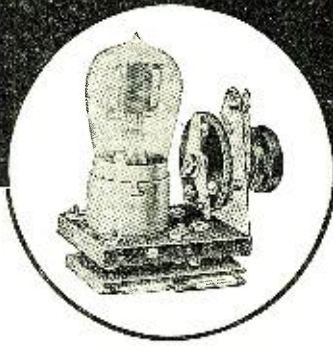

**USE RADIO EQUIPMENT
of HIGHEST STANDARDS**

THE WIRELESS SHOP—for more than ten years—has been manufacturing Radio Equipment of time-tried and proven merit. From the Atlantic to the Pacific, this company is serving people who know—and demand—the highest possible quality. Because you deal direct with the factory, we save you 20% on all supplies.

Note this Detector Unit for \$4.00

We are featuring at this time this complete No. 40 DETECTOR UNIT, designed for back of panel mounting. By using this new Unit it is a simple matter for any Amateur to build up a highly effective Receiving Set. All that is necessary is to drill 3 holes in your front panel, mount Unit, and wire to Tuner. Unit consists of socket for tube, rheostat, mica grid condenser and mica by-pass condenser as well as knob and indicator. SENT TO ANY ADDRESS FOR \$4.00.

If your name is not on our mailing list, send today for our interesting folder "RN 1" which fully describes a number of the latest and most approved Radio appliances.

THE WIRELESS SHOP
A. J. EDGECOMB
1262 W. SECOND ST. LOS ANGELES, CAL.

The diaphragm is generally made of iron or tin plate and is usually enameled and shellacked to avoid rusting. The uncoated diaphragm is about 0.007 inch thick, and the coated diaphragm is about 0.009 inch. This diaphragm is placed over the faces of the pole pieces, the clearance being about 0.002 inch between diaphragm and pole pieces. In constructing the phones, the pole pieces are not to the exact size to secure this clearance. The procedure in securing this clearance is to assemble the pole pieces and then grind down the faces of the pole pieces until this required clearance is obtained. It is very important that the clearance be obtained. Some phones are so poorly constructed that the clearance is so large the diaphragm is hardly affected by the current flowing through the phones. In purchasing phones, this point should be well looked into. It sometimes occurs that the diaphragm is not too far from but too close to the pole pieces and is not released at all, so that no response is given by the phones.

Other details of the design of the telephones, such as the design of the head band, ear caps, phone cords, etc., are small matters compared to the design of the magnets and coils as outlined above. The cords should, of course, be long enough to allow the wearer of the phones to move around comfortably, the head band should be light and should not become entangled with the hair; the mechanical design of the ear caps and head band should be such as to prevent outside noises from reaching the ear. These details are the so-called common-sense details, but in the purchase of the phones the electrical features must be stressed and looked into most carefully, for what ultimately counts in your radio set is not whether the head band is made of music wire or plain copper wire, but whether you can hear signals on your phones.

E l i m i n a t e
the
Storage Batteries
with
"SUNECO" ADAPTER

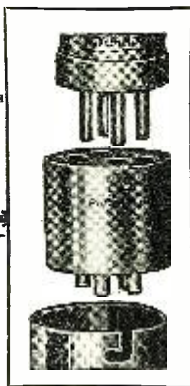

Directions:—
Insert tube in "Suneco" Adapter, then insert Adapter in any socket.

By use of the "Suneco" Adapter, you have minimum induction effects, and minimum dielectric loss. No solder contacts to corrode.

The "Suneco" Adapter enables you to use the famous Aeriotron WD-11 dry cell vacuum tube in any radio set, eliminating all necessity for storage batteries and the changing of wiring.
Saves Time **Saves Money**

Price \$1.50 each

If your dealer cannot supply you you send money order or cash to Dept. N.

Guaranteed by the N. Y. Tribune Institute.

SUN EQUIPMENT CO.

67 Exchange Place

New York

**A C. W. Oscillator for
Measurement Purposes**

(Continued from page 1292)

derneath and act as the legs or supports of the base. The disposition of the various parts on the base is shown in Fig. 3. Two pairs of binding posts marked "A" and "B" are used for the external storage and plate batteries, respectively. At the rear of the baseboard are mounted the coil and the valve socket, on neither of which adjustments have to be made. It is for this reason that they are put at the rear where they are out of the way. At the front are mounted the filament rheostat and variable condenser, on both of which adjustments have to be made. They have, therefore, been placed in the front where the control handles are easily accessible, without interfering with any of the other parts of the set. The small flashlamp and its socket are placed in the center of the board. It will be observed the two large elements, condenser and coil, are placed diagonally on the board, as are also the two small elements, the tube socket and rheostat, thus putting one small and one large element next to one another. This particular disposition of the apparatus makes for economy of space and reduces considerably the size of the entire outfit. The two binding posts at the right serve two purposes. They may be used to connect up a hot wire ammeter, in case this is desired, as an indicating device besides the flashlamp. They are also intended, and are so used by the writer,



Radio Frequency Amplification

MU-RAD Receiving Sets are the original product of independent experiments and experience of leading radio engineers. Five years intensive development of Radio Frequency Amplification have given Mu-Rad Sets exclusive points of difference—points that are well worth your consideration. First, unequalled *sensitivity*. Distances in excess of 1000 miles have been covered by Mu-Rad Sets using a 3-in. diameter, inside loop aerial. Second, the *selectivity* of Mu-Rad Sets which permits differentiation of stations 1% off tune and third, the *simplicity of operation*. All tuning can be done with one hand. The high selectivity is retained by the use of patent circuits and Mu-Rad R.F. Amplifier Transformers.



THE MA-12

Three stages of radio frequency amplification and detector. With 2 telephone plugs **\$12800**

THE MA-13

Three stages of radio frequency amplification, detector and two stages of audio frequency amplification. With 2 telephone plugs **\$16000**



Specifications

Cabinet: Solid mahogany, varnished, piano finish.
 Panel: Mirror polished black Radion.
 Dials: Non-warping metal—prevent body capacity effects.
 Condenser: 21 plate, permanent capacity.
 Modifier: A circuit unit, dial operated from panel, for controlling signal strength and stabilizing circuits.
 Rheostats: Special sector wound, smooth operation, positive contact.
 Filament Switch: Special positive toggle knife-blade construction.
 Binding Posts: Polished nickel, all in rear, plainly marked.
 Name Plates: Extra deep reversed etched, black with satin-silver high-lights.
 Wiring: Tinned copper bus-wire, all interior metal white nickel finish.

1000 Mile Range Guaranteed

Each MU-RAD set is sold with an attached guarantee of 1000 mile reception under average conditions using a small loop aerial.

Mu-Rad R F Amplifying Transformers

200-600 Meters-Air Core

THE same transformer that gives to MU-RAD Receivers their extreme R F Amplification. The skill of MU-RAD Radio engineers has been concentrated on this instrument until all the objections common to most transformers were entirely eliminated. The absence of the usual iron core increases efficiency through elimination of iron losses. No metal to produce undesirable capacity effects and eddy current loss. So very accurately are MU-RAD Transformers made that their performance varies less than a half of one per cent.

MU-RAD R. F. Amplifier Transformers as well as MU-RAD Sets can demonstrate their superiority before purchase. Ask your dealer to prove these points of difference.



THREE TYPES

Type T-11 for the first stage \$6.00
 Type T-11A for the second stage 6.50
 Type T-11B for the third stage 7.00

MU-RAD APPARATUS SOLD EVERYWHERE, WRITE FOR LITERATURE!

MU-RAD LABORATORIES, Inc.

801 Fifth Avenue, Asbury Park, N. J.



The New
 Star in
 the Radio
 World

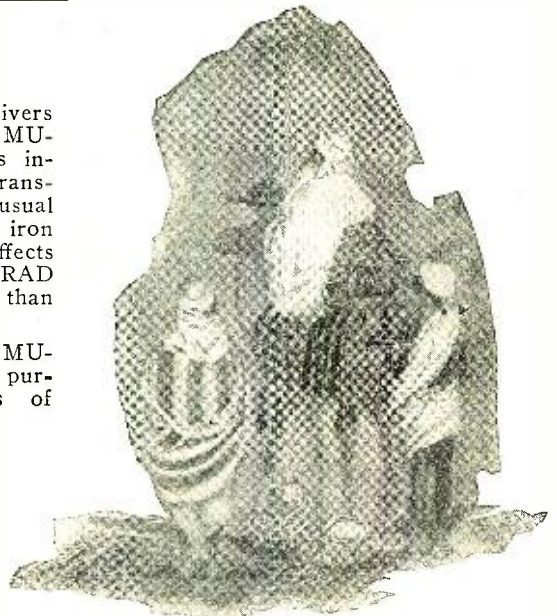

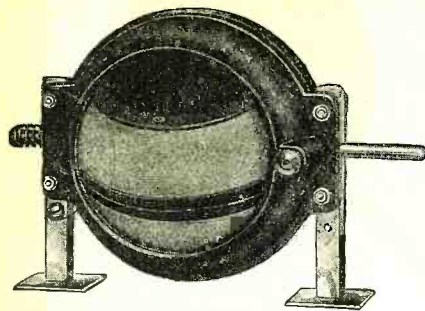

VARIOMETER
List Price - - - - \$6.50



The Finest
Radio
Apparatus
On the Market

The apparatus manufactured by the Radio Products Mfg. Co. is recognized as the very highest grade, designed to meet the most exacting requirements. Each unit is made complete in our own plant from the Redmanol moulding to the winding, assembling and final testing of the completed instrument.

Twenty years in the electrical manufacturing field gives us the wide experience, equipment and specialized organization necessary to produce the highest grade equipment to be had in this line.

Write us for full information.

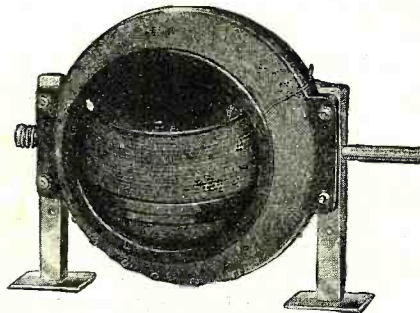
Radio Products
Manufacturing Co.
 667 W. Fourteenth St.
 CHICAGO, ILL.



VARIOCOUPLER
List Price - - - - \$6.50

ANNOUNCING
THE NEW GIBLIN RECEIVER, DETECTOR AND
2-STAGE AMPLIFIER

TUNER, \$15.50 DETECTOR, \$10.00 AMPLIFIER, \$24.50

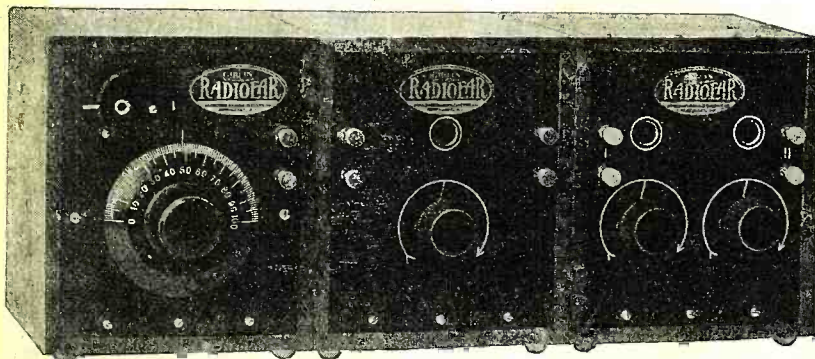

\$50 COMPLETE

A GENUINE PERFORMER
 INCORPORATING

SINGLE CONTROL TUNER—It is easily and quickly tuned with full efficiency on any wave-length.

DETECTOR—Receives either local or distant stations with perfect clearness.

AMPLIFIER—2 stages with separate filament control securing maximum volume without distortion.

LIBERAL DISCOUNT TO DEALERS
STANDARD RADIO & ELECTRIC CO.
 PAWTUCKET, R. I.

for connecting a one-turn loop for coupling purposes. In general it will be found that sufficient coupling can be secured between the main oscillation coil and the circuit under test. However, if occasion arises where closer coupling is desired without moving the set, a pair of twisted leads connected to a one-turn loop may be connected to the two right-hand binding posts for this purpose, as in Fig. 4. Of course both ammeter and coupling loop may be connected to the binding posts CC, since they are in series in the set.

Internal connections to studs

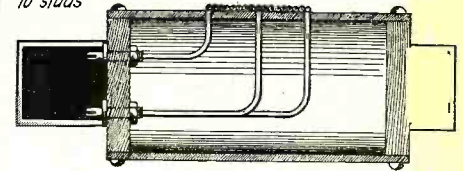

Fig. 7

Method of Connecting the Coil Taps to the Terminal Studs.

All the wiring is done underneath the baseboard and is covered with empire tubing. It may be seen that the set is simple, occupies very small space and in the form made may be easily stored away on a shelf where it will be out of the way when hot in use.

With the constants as given above, the set will have a range of approximately 200 to 500 meters. By constructing a number of large coils, each coil larger than the one preceding, greater oscillating ranges may be secured. Thus by the construction of a number of these coils a range from 200 to 3,000 meters may be obtained. If measurements are desired in the 200 to 500 meter range, coil No. 1 (the smallest) is used. If measurements are desired between 600 and 1,000 meters, the next larger coil, or No. 2 is used.

The following construction of the oscillating coil is used by the writer and is recommended for its advantages, which will be apparent. The three taps of the coil (two ends and center) are brought out on the inside of the coil. The ends of the coil are closed up with fibre or dielectric discs and one of them is drilled with three holes, as in Fig. 5. In these holes are fitted a combination of contact stud and split plug, details of which are shown in Fig. 6. These studs are inserted in the end discs and fastened to same by means of screws. The three leads from the coil are soldered to the threaded studs and then the discs are inserted in the ends of the coils and attached by hex nuts to the coil tube. Thus we have a closed coil tube with three split plugs making contact with the three-coil terminals. Three holes are drilled in the baseboard where the coil is mounted, the drilling being identical with that of the end disc on the coil, and the holes fitted with metal bushings in which the contact plugs on the coil disc fit tightly. The plugs, being split, a good tight fit ensuring positive contact between plug and metal bushing can be secured. Connections on the under side of the base are made from the metal bushing. It will be apparent, therefore, that a coil can easily be removed and replaced merely by pulling it out or by inserting, without making any connections, since connections are made automatically by means of the plug.

The drilling should be made in accordance with some such plan as that shown in Fig. 5. The center tap should be connected to the plug fitting in hole A, while the two end coil terminals are con-

(Continued on page 1337)



GRAND
CENTRAL
PALACE

AMERICAN
RADIO
EXPOSITION
DEC. 21ST
TO 30TH

R. M.
BELL

BUILD YOUR SET WITH BARAWIK STANDARD

PLATE CIRCUIT "B" BATTERIES

You can make real savings on these batteries. Don't pay more. We guarantee them to be equal any on the market regardless of price. Absolutely uniform. Extra long life.

R180 Signal Corps type, small size, 15 cells, 22½ volts. Each.....\$5c

R182 Large Navy size, 6½x4x3, 15 cells, 22½ volts. Each.....\$1.75

R184 Variable Large Navy size, 5 caps, volt range from 16½ to 22½ volts in 1½ volt steps. Each.....\$1.80

R186 Double Navy size 6½x4x3, 30 cells, 45 volts. Suitable for amplifier circuits and power tube use. Two or more of these units in series may be used in C. W. and radiophone circuits. Each.....\$3.40

R188 Combination Tapped 45 volts, 30 cell, 6½x4x3 battery. Tapped to give 45, 22½, 21, 19½, 18 and 16½ volts. Handles both detector and amplifier tubes. Each.....\$3.55

WILLARD "B" STORAGE BATTERY

Hotter results. No battery noises. Cheaper in the long run. Easily recharged by our Battery Charging Rectifier. Leak proof glass jars. Will last for years.

R205 Price.....\$9.00



BATTERY CHARGING RECTIFIER

Charge your battery at home over night for a few cents. Simply connect to any 110 volt 60 cycle light socket, turn on current and rectifier does the rest automatically. Will work for years without attention. Simple connections. Full charging charge which batteries should have. You can make it pay a profit charging your friends' auto batteries. Long connecting cords with pair of battery clips.

R201 For 6 volt battery.....\$13.95

R203 For 12 volt battery.....\$19.95

STORAGE "A" BATTERY

A very high grade battery made especially for radio service. Guaranteed for three years. Properly cared for will give many more years of service for filament lighting. Made of best new materials. Full capacity. The best battery buy on the market.

R194 6 volt, 40 ampere size. Each.....\$10.00

R196 6 volt, 80 ampere size. Each.....\$12.50

Prices are Transportation Paid

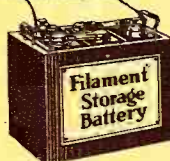

BATTERY CLIPS

R198 Two for.....25c

Clip onto storage battery terminals, lead connected. Make positive non-corrosive contact at all times.

WIRE CONNECTING CLIPS

R199 Per dozen.....30c

Small connecting clips for fastening leads onto binding posts, etc. Handy and useful. Every radiolist should have at least a dozen.

PORCELAIN BASE SWITCHES

R387 Single Pole Double Throw. Each.....20c

R384 Double Pole Double Throw. Each.....50c

Best grade. High heat resisting base. Diam. 2½ in. cap 1½ amp. Resist. 6 ohms. 1½ in. Knob with pointer.

R132 Each.....48c

POTENTIOMETER

Same style as above rheostat. Gives fine "B" battery adjustment. Resistance 200 ohms.

R133 Each.....\$1.05

VERNIER RHEOSTAT

Gives exceedingly fine control of "A" battery current. A necessity for best receiving results.

R135 Each.....\$1.19

QUICK ACTING VERNIER RHEOSTAT

Gives very fine control of current and can be switched on or off instantly at any desired point.

R124 Each.....\$1.38

PORCELAIN BASE RHEOSTAT FOR TABLE MOUNTING

R138 Each.....78c

RADIO TUBES

Standard Brands—Cunningham Radiotrons. Every one guaranteed new and perfect. We will ship brand in stock unless you specify otherwise.

R105 Detector. Each.....\$4.45

R110 Amplifier. Each.....\$5.95

R118 5 Watt Transmitter.....7.70

WE PAY TRANSPORTATION CHARGES EAST OF THE ROCKIE

THE PRICES QUOTED DELIVER THE GOODS TO YOUR DOOR FAST SERVICE—TRY US AND BE CONVINCED

THIS GUARANTEE PROTECTS YOU—Examine the goods we ship you. They must suit you in every respect. If you are not satisfied with your purchase return the goods at once and we will refund the price you paid.

SPECIAL OFFER ON TWO HIGH GRADE RECEIVING INSTRUMENTS

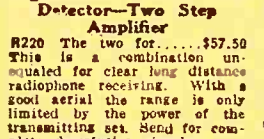

REGENERATIVE TUNER

R224—Price \$29.50

This is a standard make Armstrong licensed set. Range from 180 to 600 meters. Will tune sharply and bring in signals strong even under difficult conditions. Fine Mahogany finished large size cabinet. Satin finished Formica Panel. Two high grade variometers, with varcoupler for closest tuning. Engraved dials, knobs, switches, binding posts for all necessary connections, etc. A high grade outfit worth much more than we ask.

DETECTOR-TWO-STEP AMPLIFIER

R222—Price \$29.50

A very sensitive high grade instrument. Signals that cannot be heard with detector alone will be brought in strong. Has one detector and two amplifying circuits. Standard tube sockets, grid condenser in detector circuit, two amplifying transformers, 3 jacks and a plug. Satin finished Formica Panel. Fine Mahogany finish large size cabinet. Hinged top. Interior easily accessible. Binding posts for all necessary connections.

VACUUM TUBES

R115 High-Mu Audion. Has 5 times amplification of ordinary tubes. Oscillates anywhere from 2 to 300 volts on plate.

R116 Receptacle for above. Each.....\$5.00

R117 Adapter to adapt Myers tubes for use in any standard socket. Each.....\$1.05

VARIABLE GRID LEAK

Pencil mark type. Resistance may be varied exactly as needed. R180 Each.....24c

GRID CONDENSER

R162 Mounting holes spaced to fit size of above leak. Capacity .00025 MF. R163 Same as 162 but higher grade. Enclosed in metal case. R232 3 to 1 Ratio. Ea. \$3.69 R233 10 to 1 Ratio. Ea. 4.25

MYERS TUBES

Can be used in Myers receptacle or in any standard socket with adapter listed.

R119 For Audio Frequency Amplification.....\$3.50

R120 For Radio Frequency Amplification.....3.50

PHONE AND GRID CONDENSERS

R176 Grid Condenser .00025 with pencil mark leak. Each.....24c

MYERS CHOKE COIL

Designed to work with Myers tubes. Brings in loudest signals. Flexible over a broad band of wave lengths. Free from amplifier noise and distortion. Mounts in Myers special receptacle.

TUBULAR GRID LEAKS AND CONDENSERS—MOUNTED STYLE

R50.....1 Meg. R55.....2 Meg.

R51.....1.5 Meg. R57.....3 Meg.

R53.....1.5 Meg. R59.....5 Meg.

FOUR-IN-ONE SCREW DRIVER

R974 Each.....55c

Especially suitable for radio work. Will handle any size screw used. Smaller drivers nest inside larger one and are held in place with screw cap. Made of steel, nickel finished. Every radio builder can use several of these handy tools.

GRID AND PLATE CONDENSERS

R330 .00025 Mfd. Correct for Myers Tubes. R332 .0001 Mfd. For special circuits. R334 .00025 Mfd. For U. V. 201 and Gun. 301. R336 .0005 Mfd. For U. V. 200 and Gun. 300.

VACUUM TUBE SOCKETS

Our Special Socket. A wonderful value. Moulded entirely of bakelite. Four binding post connections. Right angled contact springs.

R148 Each.....39c

MOUNTINGS

R840 Single mounting. Each.....32c

R842 Double mounting. Each.....37c

R844 Triple mounting. Each.....76c

PORCELAIN BASE AND TUBE

R144 Cresley for either panel or table mounting.....42c

"HONEYCOMB" COILS

Carefully made—fine looking coils. Highest efficiency. Low distributed capacity effect, low resistance—high self inductance. Very firm enamel impregnation. Range given in meters when varied with .001 variable condenser. Mounted coils have standard plug mountings.

PARABOL COMBINATION TYPE FOR PANEL OR TABLE MOUNTING

One of the best designed and best made sockets on the market. Metal tube bakelite base.

R148 Each.....\$1.10

COIL MOUNTINGS

Turns	Range	Art. No.	Net Mntd.	Art. Price	Net. Price
25	120-250	R301	\$0.39	R320	\$0.97
35	175-450	R302	.42	R322	1.00
50	250-720	R303	.49	R323	1.07
75	390-912	R304	.54	R324	1.12
100	500-1450	R305	.58	R325	1.16
150	600-2000	R306	.63	R326	1.21
200	900-2500	R307	.72	R327	1.30
250	1200-3500	R308	.78	R328	1.36
300	1500-4500	R309	.82	R329	1.40
400	2000-5000	R310	.97	R330	1.55
500	2800-6100	R311	1.12	R331	1.70
600	4000-10000	R312	1.27	R332	1.85
750	5000-12000	R313	1.43	R333	2.00
1000	7900-15000	R314	1.70	R334	2.38
1250	9750-19500	R315	1.92	R335	2.60
1500	14500-26500	R316	2.18	R336	2.76

TWO AND THREE GANG SOCKETS

These sockets make it easy to build detector and amplifier units and make a neat, compact workmanlike job. Perfectly made of high grade materials. Quickly mounted on panel or base.

R147 Two gang socket.....\$1.20

R149 Three gang socket.....1.65

COIL PLUGS

Made of moulded bakelite. Fits any standard plug. Mounts any standard honeycomb coil.

R344 Each.....50c

FIXED CONDENSERS

Moulded cases, nicked binding posts.

R804 Each.....48c

PANEL MOUNTING COIL PLUGS

Take any standard mounted coils. Made of moulded bakelite, fits on brackets.

R345 Stationary. Each.....89c

R346 Movable with anti-capacity handle. Each.....\$1.10

CARBON PRESSURE DISC VERNIER RHEOSTAT

Current regulation is obtained by changing of pressure on carbon discs. This permits of infinitely fine variation of current. Very durable. Resistance—13 ohms. Capacity 2½ ampere.

R131 Each.....\$1.65

RADIO FREQUENCY AMPLIFYING TRANSFORMER

R995 Very special.....\$2.95

This transformer will get the long distance stations loud and clear. Permits of easy sharp tuning. Helps cut out static and interference. Makes your set sensitive enough to use a loop aerial. Enclosed in metal case affording perfect shielding. Suitable for panel or base mounting. Because of its special design can be mounted in U. V. T. socket. Works with any tuning. Wave ranges 150 to 350 meters. Wiring diagrams included.

OUR SPECIAL AUDIO FREQUENCY AMPLIFYING TRANSFORMERS

As high as three stages can be used without howling due to proper impedance ratio, minimum distributed capacity, low core losses and proper insulation. Mounted style has bakelite panel with binding post connections. Unmounted has core and coils assembled with two holes in core for fastening to apparatus.

R234 10 to 1 Mounted. Each.....\$3.69

R235 10 to 1 Unmounted. Each.....2.95

R236 3 to 1 Mounted. Each.....3.59

R237 3 to 1 Unmounted. Each.....2.85

THORADARSON AUDIO FREQUENCY AMPLIFYING TRANSFORMER

An especially high grade transformer with correct characteristics for Cunningham, Radiatron or A. P. Tubes. Wonderful results without distortion on one, two or three steps. Low distributed capacity. Fully mounted bakelite panel.

R232 3 to 1 Ratio. Ea. \$3.69

R233 10 to 1 Ratio. Ea. 4.25

RADIO CORPORATION TRANSFORMERS

Audio Frequency Amplifying Transformer. Especially designed for Radiotron tubes. 9 to 1 winding ratio.

R712 Each.....\$6.40

RADIO FREQUENCY AMPLIFYING TRANSFORMERS

Range 200 to 5000 meters. For long distance reception.

R714 Each.....\$5.95

OUR COMPETITOR AUDIO FREQUENCY AMPLIFYING TRANSFORMERS

While these are very low priced transformers, nevertheless they will give excellent results. They are carefully designed and carefully made. Quantity production and small profits make the low price possible. They will equal in results many transformers selling at much higher prices.

R238 Unmounted, with wire leads.....\$2.00

R239 Mounted, with binding post connections.....\$2.75

BARAWIK SPECIAL PANEL MOUNTING VARIABLE CONDENSERS

R812—43 plate .001 Mfd. \$2.35

R813—21 plate .0005 Mfd. 1.90

R814—11 plate .0005 Mfd. 1.40

R815—3 plate Vernier. .0005

These are especially high grade condensers and we guarantee them to be mechanically and electrically perfect. Fine polished end plates of heavy bakelite. Shaft ¼ inch diameter perfectly spaced to insure smooth, even reliable capacity. Our low prices save you money. These condensers are of the very best make and are not to be compared with many inferior cheap condensers offered. We guarantee them to please you or your money back.

COMBINATION VERNIER VARIABLE CONDENSERS

R824—23 plate .0005 Mfd. with dial and knobs. Price.....\$3.25

R826—43 plate .001 Mfd. with dial and knobs. Price.....\$3.95

The latest improvement in condensers consists of regular variable condenser controlled by large knob and dial mounted with a three plate vernier condenser, which is controlled by separate knob mounted above knob on dial. This arrangement permits of very fine tuning. Compact convenient mounting on panel. High grade design and construction. Finely finished.

ENCLOSED VARIABLE CONDENSERS

One of the best made condensers. Rigid, accurately spaced aluminum plates. Formica ends. Engraved scale. Knob and pointer. Clear transparent case.

R806—43 plate .001 Mfd. \$3.95

R808—21 plate .0005 Mfd. \$3.25

KNOCKED DOWN VARIABLE CONDENSERS

You can save money by assembling your own condensers. Formica top and base. Complete with all parts not assembled. Go together easily and perfectly. Panel moulding type.

R820—41 Plate .001 Mfd.....\$1.95

R821—21 Plate .0005 Mfd.....1.60

RADIO GOODS—DEPENDABLE QUALITY—LOWEST PRICES

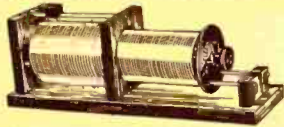

ARLINGTON RECEIVING TRANSFORMER

Will tune in all stations up to 3,500 meters. Very efficient on short waves and for radio-telephone reception. Used with our Detector Two Step Amplifier it produces very excellent results. Also does good work with crystal detector. Silk covered windings on ormica tubes. Very fine mahogany finish wood work. Base size 6 1/2 inches. Slider controls primary, 12 point switch on secondary. Can be tuned very close. A wonderful value at our price.

R720 Price \$6.48

TUNING COIL

Range up to 950 meters. Wound with bare copper wire, machine spaced. Ends of mahogany finished hard wood. Two easy sliding contacts on polished brass rods, four binding posts. Substantial, efficient, attractive. Length, 8 3/4 in.

R722 Price \$2.45

VARIOMETER

R410—Completely assembled, price \$2.89
R411 Not assembled but all parts complete, including winding form, \$1.90

Perfect in design and construction. Accurate wood forms of genuine solid mahogany. Correct inductive ratios. Solid bakelite windings. Positive contacts. Highest efficiency. A real bargain.

VARIO-COUPLER

With this loose coupler and two variometers, together with the necessary other parts, a highly efficient tuning set can be made. Easily mounted on panel. Primary winding on ormica tube. Inductively coupled for 180 to 600 meters. Multiple taps permit fine tuning.

R415 Price, completely assembled..... \$2.45
R416 Not assembled, but all parts complete..... \$1.35
R417 Rotor ball only. Each..... 29c
R408 Bakelite stator tube only. Each..... 35c

MOULDED VARIOMETER

Polished black moulded rotor and stator forms. Maximum inductance with greatest efficiency and minimum distributed capacity. A high grade durable instrument that will make up into a set you will be proud of and will get the best results. Wave length 180 to 650 meters. 4 1/4 in. square, 1 in. thick.

R412 Price \$4.25
R413 Brackets for panel mounting, pair..... 29c
R912 3 in. Dial and knob to fit..... 65c

MOULDED VARIO-COUPLER

This coupler is designed to work with the above variometer. The stator and rotor forms are of polished black moulded composition. Primary has seven taps to enable finest tuning. Wave length range 180 to 650 meters. Fitted with panel mounting bracket.

R410 Price \$3.95
R910 Moulded dial to fit..... 65c

1890 VARIO-COUPLER

R418 Price \$2.95

Our price shows you a big saving. An instrument of highest quality. The most efficient type of coupler, insures sharper tuning and louder signals. Primary and secondary wound on genuine bakelite tubes. Secondary connections through soldered flexible cables eliminates contact noises. Primary has 7 taps. Can be panel or table mounted. Range 180 to 650 meters.

BRASS ROD

Supplied only in 12 inch lengths.

R961 Threaded 6-32, per 12 inch length..... 8c
R963 Threaded 8-32, per 12 inch length..... 10c
R965 Solid 3-16 inch, per 12 inch length..... 10c
R967 Solid 1/2 inch, per 12 inch length..... 12c

TINNED COPPER WIRE

Size 14 tinned copper wire. For wiring sets. Best size for neat job and proper results.

R957 Ten feet for 12c

CHOKE COILS AND RESISTANCES

R355 100 Millihenrie Iron core choke coil. Each \$1.20
R354 10 Millihenrie Open core choke coil. Each \$2c
R357 2,000 ohm Non-inductive wire wound resistance. Each \$1.50
R356 12,000 ohm Moulded resistance. Ea. 5c
R358 5 Millihenrie Open core choke coil. Each \$2c
R359 1 Henrie Iron core, choke coil. Each \$1.20

PRESERVE THESE PAGES—ORDER FROM THEM AND SAVE MONEY FAST SERVICE—TRY US AND BE CONVINCED

THE PRICES QUOTED DELIVER THE GOODS TO YOUR DOOR

THIS GUARANTEE PROTECTS YOU—Examine the goods we ship you. They must suit you in every respect. If you are not satisfied with your purchase return the goods at once and we will refund the price you paid.

HOW TO ORDER—Write your Order plainly, state Article Number, Description and Price of Items wanted. Send Postoffice or Express Money Order, Certified Check or Bank Draft for Total of Order.

BARAWIK QUALITY HEADSETS

These headsets have proven on rigid tests to be one of the very best on the market. The tone quality is excellent with an unusual volume. Skilled workmen make them from only the best selected materials. The receiver cases are fine polished finish with polished black ear pieces. Fabric covered head band comfortably and quickly fitted to the head. Supplied with 5-foot cord. These sets were designed to sell for much higher prices than we ask, and at our price are a wonderful bargain. We guarantee that you will be pleased with them and agree that they are the best value by far yet offered. If they don't suit you we will cheerfully return your money.

R770—2000 ohm \$4.00

OTHER STANDARD BRAND HEADSETS

R751 Murdoch 56, 2000 ohm \$4.38
R752 Murdoch 56, 3000 ohm 4.95
R764 Frost, 2000 ohm 4.38
R766 Frost, 3000 ohm 4.95
R758 Western Electric, 2200 ohm 9.50

RADIO JACKS AND PLUGS

Finest grade jacks. Improved design. Best materials. Phosphor bronze springs. Silver contact points. Nickel finish. Mount on panels 1/2 to 3/4 in. thick.

R390 Open circuit. Each..... 45c
R391 Closed circuit. Each..... 52c
R392 Two circuit. Each..... 63c
Only
R393 Single circuit filament cont. 70c
R394 Two circuit filament cont. 88c
R395 Plug. Large space with set screws for attaching cord. Each 54c

TWO-WAY ROUND PLUG

R397 Each \$1.18

Takes two pairs of head set terminals. Quick easy connections. Polished round barrel. Fits any standard jack.

ENCLOSED DETECTOR

One of the finest crystal detectors on the market. Supersensitive galena crystal enclosed in heavy glass shield. Quick, positive adjustment. Brass parts polished nickel finish.

R730 Each \$1.35

GALENA DETECTOR

Easy fine adjustment. Crystals mounted in cup. Moulded base and knob. Brass parts polished nickel finish.

R732. Each 86c

DETECTOR CRYSTALS CAREFULLY TESTED

R736 Galena, Arlington tested, per piece..... 19c
R738 Sillicon, Arlington tested, per piece..... 18c
R735 Buzzer tested, Galena, per piece..... 12c
R737 Buzzer tested, Sillicon, per piece..... 12c

DETECTOR PARTS

R725 Price set..... 32c

All metal parts for crystal detector. No base included. Easily assembled. Polished nickel finish.

R727 Detector Crystal Cup. Each 10c
R728 Cat Whisker Wire, 5 feet for..... 5c

BAKELITE DIAL AND KNOB

Moulded of genuine bakelite, polished black finish. Fluted knob. Fine engraved scale with sharp clear graduations and figures in contrasting white enamel. This is the finest quality dial and knob in a very attractive pattern. Two inch cannot be supplied for 1/4 inch shaft.

R915 2 in. Diam for 3-16 in. shaft. Each..... 40c
R902 3 in. Diam. for 3-16 in. shaft. Ea. 49c
R903 3 in. Diam. for 1/4 in. shaft. Each..... 49c
R916 4 in. Diam. for 1/4 in. shaft. Each..... 74c

ONE-PIECE DIAL AND KNOB

Moulded in one piece of polished black composition with clean plain engraved scale and numerals in contrasting white enamel. Ribbed knob to fit the hand. A attractive neat pattern.

R900 2 1/2 in. Diam. for 3-16 in. shaft. Ea. 32c
R901 2 1/2 in. Diam. for 1/4 in. shaft. Ea. 32c
R904 3 in. Diam. for 3-16 in. shaft. Ea. 39c
R905 3 in. Diam. for 1/4 in. shaft. Ea. 39c
R906 4 in. Diam. for 3-16 in. shaft. Ea. 57c
R907 4 in. Diam. for 1/4 in. shaft. Ea. 57c

MAGNET WIRE

Insulated copper wire. Best quality even drawn wire, one piece to a spool. Prices quoted are for 8 oz. spools.

Double Cotton Covered	Enamelled Insulation	Sare Green Silk Covered
Number R990	Number R992	Number R991
Gauge Price	Gauge Price	Gauge Price
18..... 50c	20..... 45c	20..... \$0.78
20..... 60c	22..... 55c	22..... .82
22..... 75c	24..... 65c	24..... 1.02
24..... 85c	26..... 85c	26..... 1.18
26..... 95c	30..... 70c	30..... 1.70
28..... \$1.15	32..... 79c	32..... 2.05
30..... 1.65	36..... 98c	36..... 2.75

STRANDED ANTENNA WIRE

Cabled of fine copper strands. Very flexible. High tensile strength. Best for aerials.

R248—100 ft. coil 55c R249—500 ft. coil \$2.95

SPAGHETTI

For covering connecting wires in sets. For size 12 and 14 wires.

R955 Finest quality braided and saturated with best baked lustrous transparent insulating varnish, 3 feet for 29c
R956 Best quality braided and covered with black insulating compound. 3 feet for..... 15c

CABINETS

Fine looking cabinets solidly built. Made of genuine solid mahogany in elegant hand rubbed finish. You will be proud of your set mounted in one of these cabinets. Hinged tops. Front rabbeted to take panels. Panels not included. Prices are transportation paid.



Panel Size	Inside Dimensions			Art. No.	Price Each
	High	Wide	Deep		
6x7"	5 1/2"	6 1/2"	7"	R420	\$2.48
6x10 1/2"	5 1/2"	10"	7"	R422	27.85
6x14"	5 1/2"	13 1/2"	7"	R424	3.30
7x14"	6 1/2"	13 1/2"	7"	R423	3.60
7x18"	6 1/2"	17 1/2"	7"	R426	3.90
7x21"	6 1/2"	20 1/2"	7"	R425	3.90
9x14"	8 1/2"	13 1/2"	10"	R428	3.70
12x14"	11 1/2"	13 1/2"	10"	R430	4.40
12x21"	11 1/2"	20 1/2"	10"	R432	5.25

SOLID GENUINE CONDENSATE CELORON PANELS

Notice our very low prices on this fine quality grade 10 genuine solid sheet Condensate Celoron (a product with mechanical, chemical and electrical properties like formica and bakelite). Machines well without chipping. Won't warp. Waterproof. Highest mechanical and dielectric strength. Attractive natural polished black finish which can be sanded and oiled for extra fine work.

Panel Size Inches	1/4" thick	3-16" thick		1/4" thick		
		Art. No.	Price			
6x7"	R450	\$0.50	R460	\$0.75	R470	\$0.98
6x10 1/2"	R451	.75	R461	1.11	R471	1.47
6x14"	R452	1.05	R462	1.55	R472	2.05
7x14"	R458	1.20	R468	1.80	R478	2.40
7x18"	R453	1.55	R463	2.30	R473	3.10
7x21"	R457	1.78	R467	2.65	R477	3.60
9x14"	R454	1.60	R464	2.30	R474	3.10
12x14"	R455	2.10	R465	3.10	R475	4.15
12x21"	R456	3.15	R466	4.65	R476	6.20

ETCHED METAL NAME PLATES

Made of brass. Silver plated characters and border on black background. All plates are 1 inch long and 1/2 inch wide, except "INCREASE CURRENT" which are quarter circle 1 1/2 inch over all, and "ON" "OFF" which are 1/2 inch long. Attaching holes pierced.

R503 Per Dozen 35c

Not less than one dozen assorted sold. Specify marking wanted as follows:

Plate Variometer	Secondary	Aerial
Grid Variometer	Primary	Ground
Vacuum	Tickler	Phones
Primary Condenser	Lead's Call	Input
Secondary Condenser	Coupling	Output
Increase Current	Aerial	On
Off	Series	Off
Increase Current (to left)	Detector	1st Step
	A Battery	2nd Step
	B Battery	3rd Step

Blank—(Takes pencil or pen marks.)

ELECTRIC SOLDERING IRON

R957 Price \$5.75

Especially adapted to radio work. Will enable you to do neat clean work quickly. Simply attach to any light socket 110-120 volts. Complete with six foot cord and attaching plug. Renewable solder point. Will last a lifetime for ordinary home or light shop work. A wonderful value at the price.

ROBIN CORE SOLDER

R958 Per Coil 22c

Soft fluxing. Especially designed for soldering electrical connections. Fine for use with above electric iron. Will last a long time.

TINOL

R959 Per tube..... 19c

With this preparation you can solder your connections with the heat of a match. Works fast. Makes a perfect electrical and mechanical joint. Self fluxing.

LONG NOSE PLIERS

R970 Price 90c

The handiest pliers for radio work. Made of fine hardened steel. Length 5 inches.

DIAGONAL JAW NIPPERS

R972 Price \$1.10

For fine electrical work. Made of hardened steel. Length 5 inches.

ANTENNA INSULATORS

R260 Size 1x3 1/2
Two for 19c
R262 Size 2 1/2x3 1/2
Two for 50c
R264 Size 1 1/2x4
Two for 80c
R266 Size 1 1/2x10 1/2
Two for \$1.35

SOLID BARE COPPER WIRE

Solid Bare Copper Wire, size 14
R240—100 ft. coil 45c R242—500 ft. coil \$2.15

Solid Bare Copper Wire, size 12
R244—100 ft. coil 61c R245—500 ft. coil \$2.75

THE BARAWIK CO.

Chicago's Original Radio Supply House Beware of Imitators

102 South Canal Street

CHICAGO, ILL.



“Sparks” will tell you!

“B-D-X-X is THERE”

THAT'S the glowing tribute almost any ship radio operator (known as “Sparks”) will pay to Bakelite-Dilecto, if you ask him how good it is for radio panels.

This wonder material has been the choice of the United States Navy and Signal Corps for OVER EIGHT YEARS! THAT'S proof of its worth.

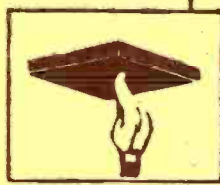

Resists Heat

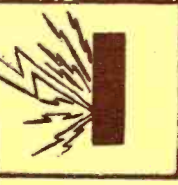

Highest Dielectric

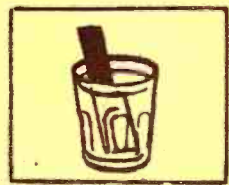

Water Proof



Resists Mild Acids and Solvents

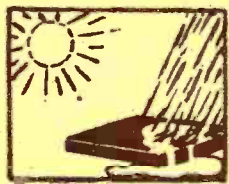

Cannot Warp or Swell

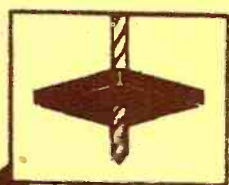

Tough; Yet Readily Machined

bakelite dilecto!

A Laminated Phenolic Condensation Product

See Bakelite-Dilecto's radio advantages at the left! The small sketches suggest B-D-X-X's amazing adequacy. No other material is so useful to radio.

Amateurs are advised to insist on Bakelite-Dilecto, X-X grade. Thus is assured successful performance of any radio outfit. Electrical supply men will get B-D-X-X cut to exact requirements. Write direct for more information and names of dealers near you.

The Continental Fibre Company
 Factory: Newark, Delaware

- Dealer service from—
- | | |
|--------------------------------------|----------------------------------|
| New York 233 Broadway | Pittsburgh . . . 301 Fifth Av. |
| Rochester . . 85 Plymouth Ave. South | San Francisco . . 75 Fremont St. |
| Chicago . . . 332 S. Michigan Ave. | Los Angeles . . 411 S. Main St. |
| Seattle 91 Connecticut St. | |

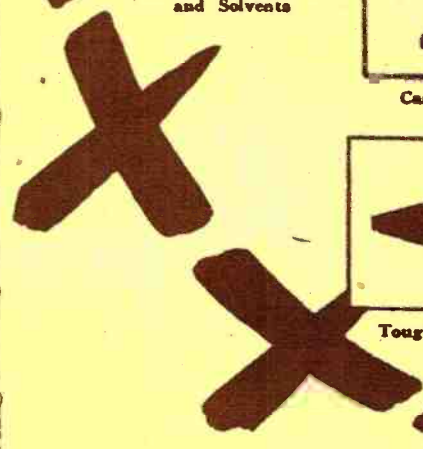

(Continued from page 1332)

ned to plugs B and C. By making such an arrangement correspondingly on the baseboard, the coil can be inserted **ONLY IN THE RIGHT WAY**, and thus correct connections are assured. Since there is only one way to insert the coil, this method of building same is fool-proof. It will be apparent that changing coils with this method of construction to secure any desired range of wave-lengths is merely a matter of taking out or putting in the desired coil without make any connections.

In order that this set may be ready for use as a measurement test oscillator it needs to be calibrated. The calibration will have to be made with a well-calibrated wavemeter as follows: In series with the wavemeter coil connect up either a radio frequency ammeter or a flashlamp as indicating device and couple the wavemeter to the measurement set oscillator, Fig. 8. Start the oscillator

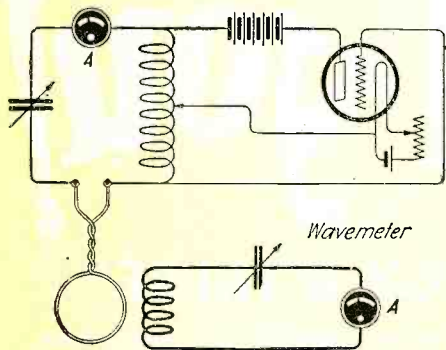

Fig. 8

By Use of a Wavemeter the Transmitting Oscillator Is Calibrated.

working at the lowest value of capacity on the variable condenser on which it is possible for the set to oscillate. Tune with the wavemeter until either maximum deflection is had on the indicating ammeter, or until the flashlamp lights up most brilliantly. Read the wave-length at that setting of the wavemeter. The transmitting oscillator is then oscillating at that wave-length. Do this throughout the range of the variable condenser on the measurement set and make a table, one column reading variable condenser degrees, the other reading corresponding wave-lengths. A curve can then be plotted of wave-length against degrees, which is the calibration of the oscillator. This procedure can be followed with each of the coils. Knowing the calibration of your measurement oscillator you will now be ready to use it in the measurement of your various constants, and in other calibration work.

It might be mentioned here that another simple oscillating circuit suitable for this type of equipment, employing the same apparatus with the addition of a plate battery condenser, as shown in Fig. 9, will also give very excellent results. Some people seem to prefer this

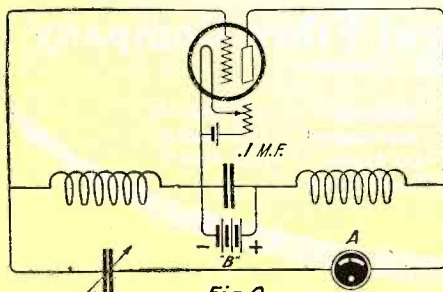
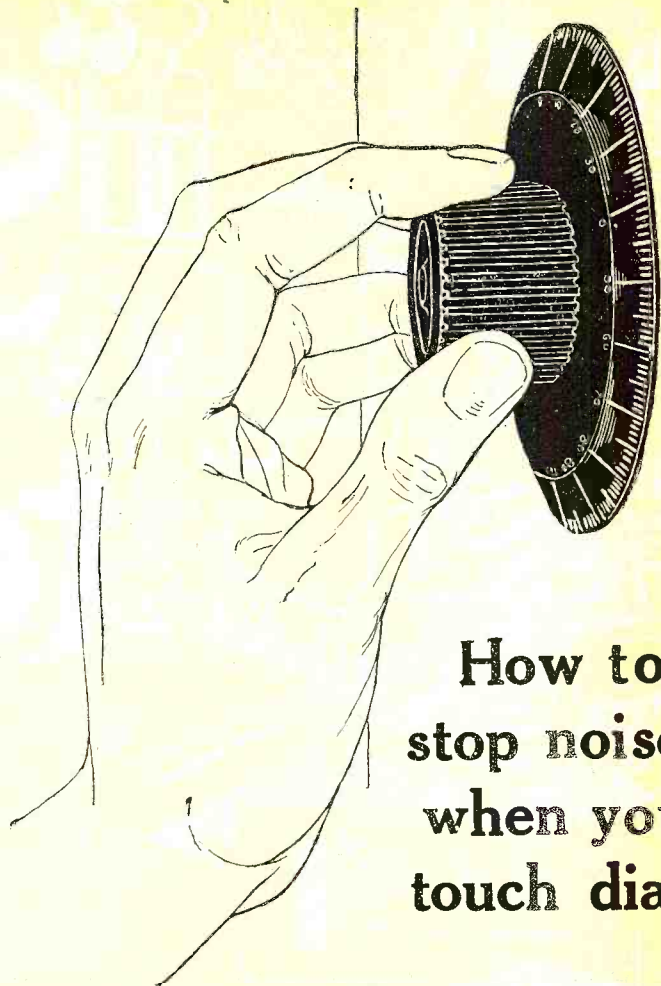

Fig. 9

This Circuit May Be Used Instead of That Shown in Fig. 1.



How to stop noises when you touch dials

Have you ever found, after tuning in a distant broadcasting station, that when you removed your hand from the dial, there is a growling noise which makes it impossible to hear anything else?

This is usually caused by two things—too much current through your detector tube filament and dials made from compounds which, being comparatively poor insulators, cause body capacity to make proper tuning an impossibility.

If you are positive that the proper amount of current is flowing through your filament and these distracting noises still persist they can be overcome only by removing the dials at present on your set and replacing them with dials made of RADION.

Tests have proved time and again that RADION is without question the supreme insulating material for wireless use.

Secure a dial from your dealer today. Take it home and place it on your set and you'll notice the difference immediately. Also have your dealer show you a RADION MAHOGANITE panel—the most beautiful panel made—easy to saw and drill. It is also warp and chipproof.

If your dealer can't supply you write us direct giving us his name and we'll see that your requirements are immediately taken care of.

Dealers are invited to write for lists

AMERICAN HARD RUBBER CO.

11 Mercer Street, New York

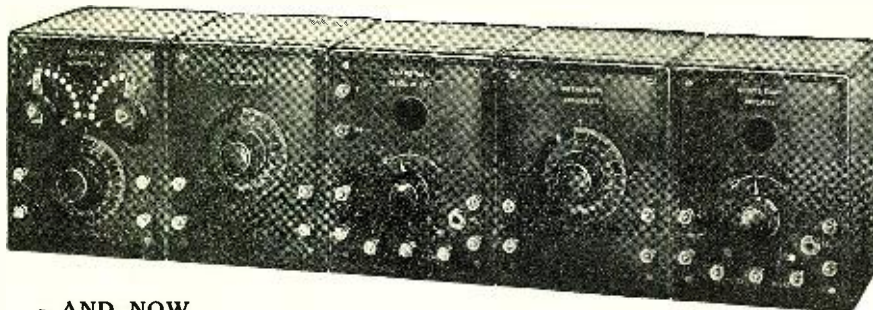

—AND NOW

THE QUEENS FIVE UNIT SYSTEM

Following in the popular wake of the Queens "Green Tag of Perfection" Variometers and Variocouplers, comes the Queens Five Unit System—a "Green Tag of Perfection" complete vacuum tube receiving outfit.

Popular demand is the reason for this. Radioists nation-wide requested it—so we perfected it for radioists, expressly to receive broadcasting.

The five units complete, embody a Queens Variocoupler in a single unit—two Queens Variometers in a unit each—a detector unit and a one step amplifier unit. Each unit is constructed of solid genuine mahogany with genuine bakelite panels. The binding posts are solid brass, triple nickel plated. New style knobs are uniformly used throughout, made of genuine bakelite with dials to match. Size of each unit is 5 1/2" wide x 7 1/8" x 5 7/8" deep. The five unit set sells for \$70.00, minus batteries and tubes. Additional steps of amplification may be added for a loudspeaker.

From end to end, every inch of these units are manufactured right in our own factory. This fact and huge production account for the popular low price. In line with Queens requirements, each unit is personally inspected and tested by our engineers before being shipped from our factory. After this, the "Green Tag of Perfection" is placed upon each. This is your protection and our guarantee—look for it. Every unit leaves our factory individually packed in cartons, neatly labeled. Every label carries a complete description of the contents.

Units also sold individually:

Variocoupler Unit.....\$15.00	Variometer Unit.....\$12.50
Detector Unit.....\$12.50	Amplifier Unit.....\$17.50

Write today for our valuable catalog showing our complete line of "Green Tag of Perfection" radio apparatus, together with attractive prices. It's free.

QUEENS RADIO COMPANY, INC.

12 Forest Street.

WINFIELD, L. I.

The Telmacophone in Every Home



The Telmacophone in your home provides entertainment and instruction for every member of the family. No one has to take turns or miss any part of the program. No need to change headphones from one person to the other. You are always assured a loud,

clear tone. Everybody can hear everything, clearly and distinctly.

The tone is produced by original Baldwin Type C. Unit and reflected into the outer horn. There is no metallic effect. Finished in black and gold to harmonize with any surroundings.

Correctly designed—fairly priced—unreservedly guaranteed. The ORIGINAL \$20.00 loud speaker and still the BEST. With original Baldwin Type C. Unit. Price complete \$20

If your dealer hasn't the Telmacophone in stock, send us his name and order direct from this ad enclosing \$20.00. Prompt shipment. Write for new free catalog.

RADIO DIVISION

TELEPHONE MAINTENANCE CO.

20 S. Wells St. Dept. B Chicago, Illinois

Quality Radio Exclusively

JOBBERS! DEALERS! The demand for the Telmacophone is great. Write for new catalog and discounts on our complete line. We are also distributors for the better standard lines.

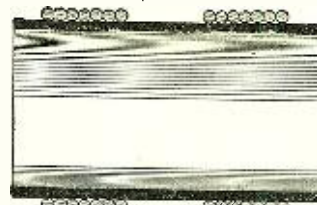

Fig. 10

This coil comprises two separate windings. It is employed in conjunction with the circuit of Fig. 9.

form of the circuit in preference to the one given above, but actual trial proves them to be about equal, and there is very little choice. Should this circuit be used, however, the condenser across the "B" battery should have a value of about 0.1 mfd. This acts as a bypassing condenser for radio frequency and should be of sufficient capacity to offer little impedance to the flow of R. F. currents. The coil should in this case be wound on the same tube, but in two parts, half the total number of turns in each part, and the two parts separated about 1/8", as in Fig. 10.

An Input Transformer for Telephone and Modulated C. W.

(Continued from page 1290)

Fig. 4. After passing the core through the unit, all wires are bent about the transformer and bound firmly with linen cord, then treated with shellac. Terminals may be very small machine screws with nuts, or binding posts.

The primary is approximately 0.045 henry; resistance 3 ohms. Ratio of winding in the transformer is 60 to 1. The secondary is of 14,000 and 18,000 turns, having a resistance of 9,000 ohms. The microphone current is obtained from a five-volt source, as shown in the schematic hook-up in Fig. 5. A buzzer and key may be substituted instead of the microphone for interrupted C. W. code work.

How Market Reports Are Made

(Continued from page 1264)

that short interval locked doors and disconnected telephones prevent anyone from obtaining advance information.

There are approximately 220,000 voluntary crop reporters located in all parts of the United States. A trained statistician or field agent is also placed in each state or group of similar states and supervises the work of gathering statistics in the territory under his charge. Each field agent tabulates the crop information received from his reporters, averages and summarizes the data, and reports the result to the Department of Agriculture at Washington.

Local reporters in every township, or other small civil unit in every county in the United States reports direct to the department every month crop conditions under their observation. Each county, also, is represented by a county reporter who reports his personal observations, the reports of neighbors and others, and information received by interviews and over the telephone. The monthly reports cover acreage, condition, yield, total production, stocks on farms, progress of farm work, wages, supply or deficiency of farm labor, fertilizers and seeds. These reports are

Now for Long Distance!

A way to get broadcasting from distant stations without interference

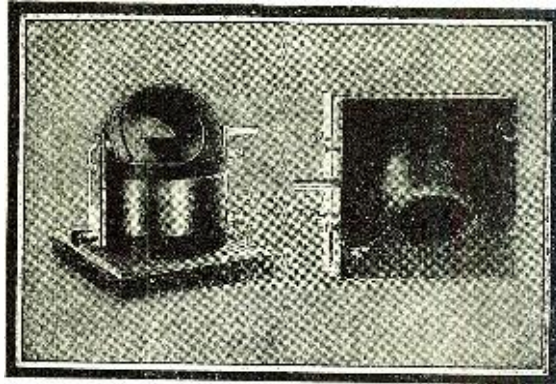

AN AMATEUR in Chicago desired to get the baseball championship results broadcasted from station WJZ in Newark, N. J. With an ordinary receiving set he found it impossible to do so because stations near at hand kept "butting in."

Shutting out nearby stations

He found an effective way to end this interference in the use of a Thoro-bred Variometer and a Thoro-bred Variocoupler.

These two instruments always provide the practically absolute precision and accuracy in tuning which is lacking with the ordinary types.

This sharp tuning enables you to more readily select the station you desire when two or more are broadcasting on approximately the same wave length. At the same time the use of these two Thoro-bred instruments tends to increase the strength of incoming signals and to eliminate interference from nearby stations.

The service of the Thoro-bred Variocoupler.

Ordinary variocouplers have a tap brought out for connection purposes at every six or seven turns of the primary. The Thoro-bred Variocoupler has **every one** of the

first seven turns tapped one turn at a time, and the balance every seven turns. Such exceedingly sharp tuning not only is a great aid in getting distant stations, but it also eliminates the usual "squeals" heard while tuning-in.

The service of the Thoro-bred Variometer

Continuous wave transmitters are so sharply tuned that even a fraction of a turn of inductance makes an appreciable difference in the returns secured. It is therefore impossible to tune your receiving set so as to throw out undesirable stations and concentrate on the desired one unless you use a variometer. The Thoro-bred Variometer is capable of exceptionally fine adjustment to any wave length between 200 and 600 meters. The combination of a Thoro-bred Variocoupler and Variometer therefore enables you to get distant stations without difficulty.

A quick way to get results

Go to your nearest radio or electrical dealer and ask for these two instruments **by name**. Do not accept substitutes because the ordinary types will not secure you the same results. In case your dealer cannot supply you just fill out the coupon below and they will be sent to you without delay.

COUPON

The Marshall-Gerken Co.
Toledo, Ohio, U. S. A.

My dealer cannot supply me with Thoro-bred Apparatus. Please send me C. O. D. the following:—

- Type VCO Variocoupler Price \$5.00
- Type MVG Variometer (For grid) 6.50
- Type MVP Variometer (For plate) 6.50

(Note: Choose one type of Variometer)

Name

Street

City State

Dealer's Name

Dealer's Address

Thoro-bred

RADIO PRODUCTS



HAVE YOU HEARD THE NEW RADIOLA GRAND?

No storage battery necessary; a complete and portable unit. Have your dealer order from us. We are also distributors of the famous Grebe products.



TRADE MARK
REGISTERED

Philadelphia Wireless Sales Corporation

Formerly Philadelphia School of Wireless Telegraphy

Wholesale Department: 1533 Pine Street PHILADELPHIA
Retail Store: 1326 Arch Street

made for about 60 crops which represent about 95 per cent of the total agricultural production in the United States. The messages are summarized at Washington and at a designated hour, on crop reporting day, the final estimate is released simultaneously to the press, telegraph agents, and for radio broadcasting purposes.

To secure a national view of the market situation, trained reporters are located in the principal consuming centers such as New York, Chicago, Boston, Philadelphia, Pittsburgh, Baltimore, Madison, Minneapolis, St. Louis, Kansas City and a number of other cities. These men report to branch offices in the respective cities and early each morning observe the supplies arriving at market and report the market transactions. A leased telegraph wire system covering 3,300 miles connects the various branch offices with each other and the market news is dispatched over the system as rapidly as it is compiled. Thus each office knows every morning the conditions prevailing in all the leading markets. The information is summarized in each office and immediately given out to the press and to radio stations.

A description of the activities of market reporters in a single market may give the reader some idea of the tremendous scope of this service. More than \$3,000,000 of business is transacted at the Chicago live stock yards every day. At 4:30 A. M. each morning a Chicago representative telephones the office of every railroad entering Chicago and receives a statement of the number of cars of each kind of live stock near enough to Chicago to arrive during the trading day. To this total is added the number of carloads that arrived during the night. With this information and his knowledge of the kinds of live stock shipped from different sections of the country at different seasons and of the number of animals usually loaded in a car, the reporter is able to estimate accurately the number of animals of each kind that will reach the market that day in time to be offered for sale.

At 6 A. M. this information is flashed everywhere throughout the United States. A second estimate is released at 7 A. M. At 8:30 the opening of the hog market is reported. At 9:10 a brief report on the condition of the hog market is flashed; at 10:30 A. M. a detailed report giving market and trade conditions in the cattle, hog and sheep markets, together with complete estimated receipts and detailed quotations on various classes and grades of each species, is dispatched. Shortly after the noon hour an estimate of the following day's receipts is released. A closing wire for the day is released between noon and 2 P. M. and contains information as to any changes which may have taken place after 10:30 A. M.

Similar methods are used in reporting the markets on other commodities. There are 14 permanent branch offices for fruits and vegetables in consuming centers, and 42 temporary offices located in producing sections. The division of dairy and poultry products has branch offices at New York, Chicago, Philadelphia, Boston, San Francisco, Minneapolis and Fond du Lac, Wis. Reports of receipts of butter, cheese and eggs and dressed poultry at the four eastern markets are released each morning. There is also a report of the quantities to be delivered for unloading that day, and of prices.

Other reports cover the receipts of butter, cheese, eggs and dressed poultry in cold storage, the quantities delivered, and the quantities remaining in storage. Weekly cotton bulletins are issued at Charlotte, Atlanta, New Orleans, Memphis and Dallas, giving daily prices of various grades of spot cotton,

"WE ARE NOW SIGNING OFF—GOOD NIGHT!"



Now Attach THE HOMCHARGER

To your AC lamp socket, snap the clips on your storage battery and "turn in."

While you sleep, the RADIO HOMCHARGER DE LUXE is silently charging your battery ---the charging rate being governed automatically. In the morning it is fully charged; ready for another evening's entertainment, and the cost has been less than a nickel for current consumed.

No muss, trouble, dirt—no moving of battery—loss of time. You can't connect it up wrong—it can't overcharge nor harm your battery in any way. Its beautiful mahogany and gold finish will harmonize with any living room.

Furnished complete with Ammeter, Attachment Cord and Plug, Charging Cable and Battery Clips, by all good dealers handling radio and electrical equipment, for \$18.50.

Ask your dealer for Bulletin No. 637, illustrating the new HOMCHARGER in actual colors, or write direct.

Caution. When buying a Rectifier insist upon the following:

- 1—SELF-POLARIZING feature, otherwise your battery may be ruined through reverse charging.
 - 2—AT LEAST FIVE AMPERE CHARGING RATE, otherwise it will require several days to fully charge your battery.
 - 3—UNDERWRITERS' APPROVAL, otherwise in case of fire your insurance may be void.
- The HOMCHARGER is the only Rectifier at any price which combines the above, three NECESSARY HOMCHARGING features.

The Automatic Electric Devices Company
118 West Third Street, Cincinnati, Ohio

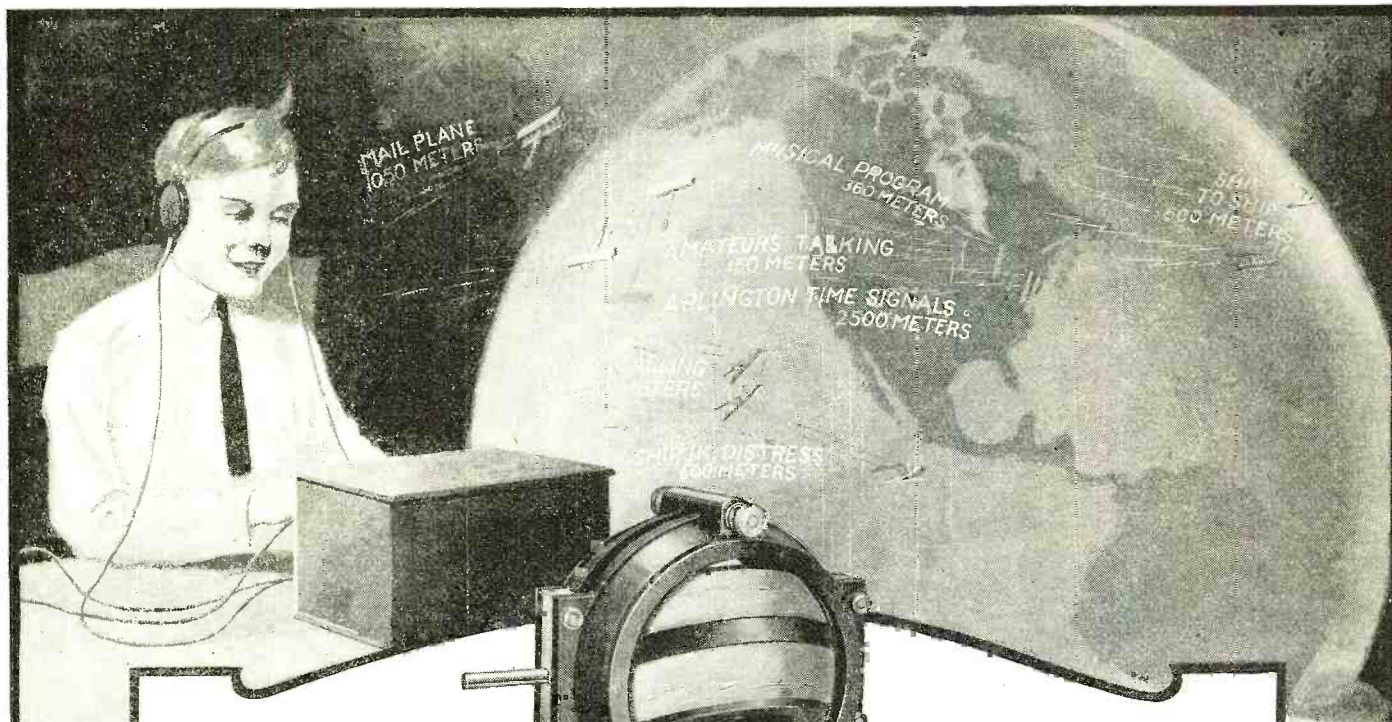

LISTEN IN
ON THE WHOLE RANGE

WITH A
DAYFAN VARIOMETER

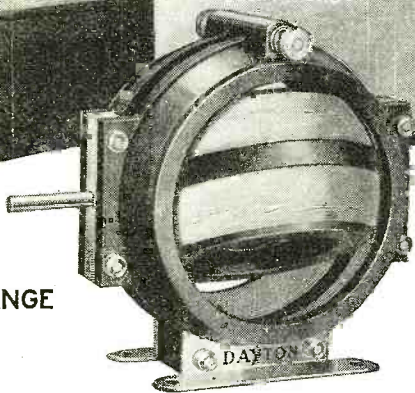

A Receiving Set Is No Better Than Its Parts

THE higher
Variometer
Station may be

Amazingly Clear!

The verdict of Amateur or Expert is always the same when speaking of the Elwood Phones. They invariably sound the praises of their tone clarity. This outstanding Elwood feature, however, is not a mere accident, but is the result of seventeen years' experience in building telephone and radio equipment.

Now you can purchase an Elwood Headset of 2000 ohms resistance for \$5.50; or one of 3000 ohms for \$6.50.

ELWOOD HEADSETS

Tone clarity, supreme sensitivity and head fitting comfort make Elwood Phones the choice of radio men who want full value for their money.

Sold by dealers everywhere. If yours is unable to supply you, we will be glad to send you a set as a matter of convenience on receipt of price. You are privileged to return them within a reasonable time if they do not measure up to your expectations.

ELWOOD ELECTRIC CO. INC.

2 Randall Avenue
Bridgeport, Conn.

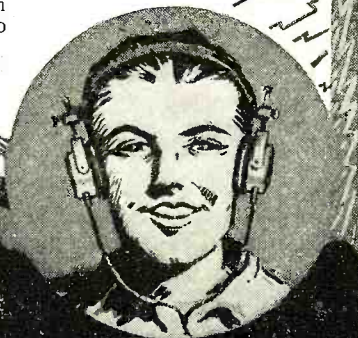

"When You Listen in with ELWOOD, You Get it ALL"

daily prices of future contracts at New Orleans and New York, prices of staple cotton and prices of cotton seed. The Chicago, Kansas City and Minneapolis grain markets are reported in a similar manner.

Before the use of radio there was considerable delay in dispatching these reports over the country, but by radio the messages of the market are now sent instantaneously to farmers in every nook and corner of the land.

Radio in Japan

(Continued from page 1264)

night, when I was just retiring, his father came post-haste to my hotel, and with great anxiety informed me that the boy was reposing in the Sannomiya police station, and that the authorities had placed a cordon of police round the residence forbidding even the servants to leave. It was only after several hours of argument, of frantic telegraphing and telephoning to Tokyo, and the pressure of my newspaper friends of influence, that they released the boy. Afterwards I learned that his receiving-set, with all the tools in his little workshop, even down to his pliers and screw-driver, were sent to the Foreign Investigation Department at Tokyo under the guard of two policemen. It was merely a crystal set of the very cheapest design.

Was it any wonder that I dismissed the idea of radio for Japan?

But my Japanese friends persisted. They were men who knew the trend of affairs in their native land, and they set the cables busy. A reply, very guarded, came back from the Communications Department at Tokyo, apparently after many days' deliberation, that broadcasting *might* be permitted in Japan under certain restrictions. Knowing Japanese officialdom, I was still very doubtful, but the upshot of more cables and many conferences was the forma-

It's Only a Step for You Now to a Fine Wireless Position

SURELY you have noticed how wireless is spreading over every part of the world. Every day you learn of some new field that is utilizing it—some new firm organized to push it forward. But do you realize that YOU can easily qualify for the wonderful opportunities that are opening? Do you know that you can quickly build up a complete knowledge of Wireless—and be ready any time you wish to for a fine Wireless position, either on land or on sea? Through our special method of home-study instruction a short period of your spare time can be turned into preparation for a worthwhile future in the fastest-growing field in America today—Wireless. No one is in a better position than you to cash in big on the wireless expansion that is sweeping over the world. You have the whole foundation, all ready to build upon. Our new easy method of instruction makes the rest pure fun—but fun that pays big.

Commercial wireless expansion is sweeping over the world like wildfire! Big opportunities are open—and every day get more numerous and attractive. You are in a fine position to cash in big on this growing field. Right at home in spare time you can easily build upon your present knowledge and quickly qualify. The coupon below will bring you an interesting free booklet—telling about the splendid opportunities open, and how you can share them. Mail coupon for booklet today!

New Method Makes It Easy to Qualify

Without obligation to yourself we would like to tell you more fully about the future wireless offers you. We would like to tell you about our Institute, which is officially recognized by the U. S. Dept. of Commerce. The National Radio Institute was the original and is today the oldest and largest school in America teaching wireless by mail. The government allows our graduates five to ten points credit when taking First Class Government License examinations. We have graduates in almost every part of the world who have quickly qualified through our special new method.

This method not only includes a comprehensive course of instruction written exclusively for us by some of America's greatest wireless experts (members of our own staff) but also includes, Free, a wonderful new in-

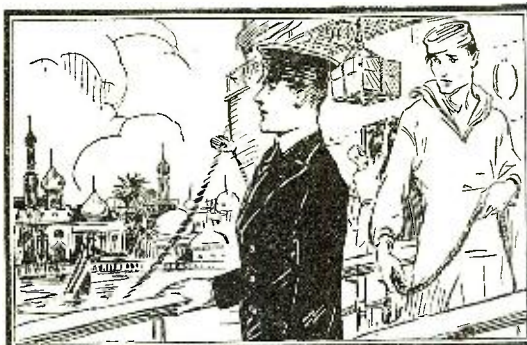

Both on sea and on land a fine future awaits the man who is qualified in wireless. No matter whether you wish to visit every nook and corner of the world or whether you prefer a land station, wireless awaits you.

vention patented and controlled only by us. This device, called the Natrometer, teaches you in half the usual time how to send and receive with speed and accuracy. This Natrometer (which can be purchased separately) is superior to any other device of its kind. Without aeriols or any outside device it sends you any one of 600 different messages at a speed which you can vary from 3 to 30 words

per minute. It is portable; also very attractive in appearance. It is noiseless; and it sends in a natural manner, not like a mechanical device. You get the messages thru its phones at whatever speed you wish. And this is **only one** of the features which our new method brings you. Others are listed below. Read them and you will realize why our students quickly qualify and why they step into the fine wireless positions that are waiting!

11 Points That Make This School the Best

1. New Easy Method of Instruction.
2. Wonderful Natrometer Given Free.
3. Government Credit and Recognition.
4. Our Location in Washington—Passing New Official Developments on to You.
5. Personal, Individual Attention of Great Experts.
6. Our Service in Obtaining You Employment.
7. Free Training in Wireless Telephony.
8. Unlimited Consultation and Advisory Service.
9. Free Post-Graduate Course in Our Washington Residence School If You Wish.
10. Membership in the Relay League.
11. Low Tuition Cost and Easy Terms of Payment.

Mail coupon today for our free illustrated booklet, "How to Learn Radio at Home." Without cost or obligation, we want to tell you more about this field, its big opportunities both on land and on sea, and just how our new method quickly qualifies you. No agent will call upon you. We just want to send you the facts. Mail coupon at once! National Radio Institute, Dept. 13-A, Washington, D. C.

MAIL COUPON FOR BOOKLET

NATIONAL RADIO INSTITUTE Dept 13A, Washington, D. C. Send me your free booklet, "How to Learn Radio at Home." Tell me about the opportunities open in wireless, about your institute, and about your special limited offer.	
Name	Age.....
Address	
City.....	State.....

Stop Spoiling TUBES!

You're not a voltmeter. And GUESSING voltage doesn't "go" with vacuum tubes. That's why nine out of ten of your tubes burn out prematurely. The Weston Filament Voltmeter shows you at any time the voltage your tubes require—(1) To assure 100% tube efficiency without danger of burnouts. (2) To duplicate results instantly. (3) To make exact tuning quick and easy.

Circular J describes this and other important Weston instruments for Radio use. Write for it.

WESTON ELECTRICAL INSTRUMENT CO.

173 WESTON AVE., NEWARK, N. J.

Makers of Electrical Instruments Since 1888

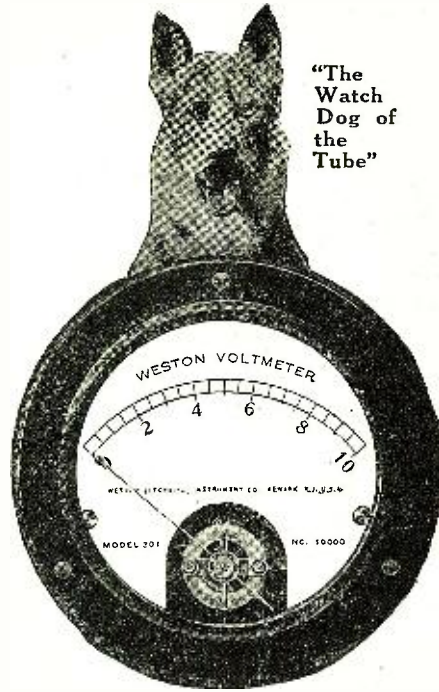

"The Watch Dog of the Tube"

Weston Filament Voltmeter

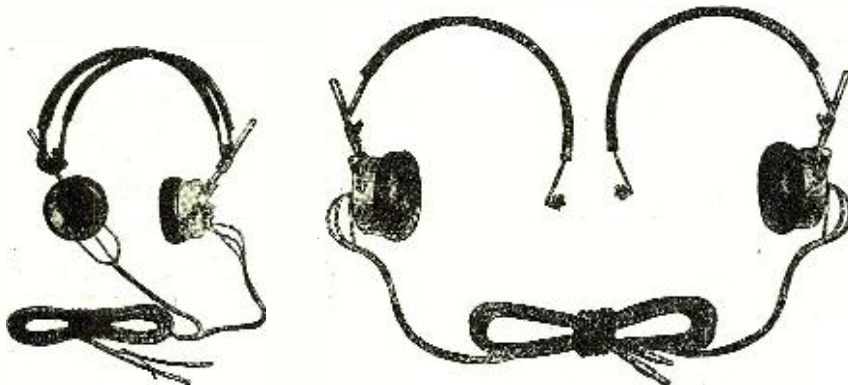

10-DAY

Premier Duplex

TRIAL

QUALITY PHONES

PAT. APLD. FOR

HEAD BANDS—Split into two single bands. With this feature two persons may use one set without having to hold the ear phone. The adjustment is simple and stays.

EAR PHONES—Are sensitive, clear, loud. Neatly finished and feel good on the ears. For sale by reliable dealers or by mail direct at

\$6.50 for 2000 Ohms

\$8.00 for 3000 Ohms

Premier Accessory and Specialty Corp.

25 CONGRESS STREET

NEWARK, N. J.

telephone connection for an office in Tokyo costs from \$750 to \$1,000 and one is lucky to get it within twelve months' time.

On the other hand, we found the younger, more liberal Japanese, many of whom had traveled abroad, who had the opposite idea. His superiors had also instilled into him the dread of Communistic ideas, but his more enlightened mind believed that the freer intercourse allowed the people, the more they learned of Western ways, and the more they had to think about, the less likely would they want to meet in dark corners and foster revolutionary ideas.

Needless to say we seized upon this more democratic argument and used it for all it was worth, but it was not until the end of August that we were allowed to give our first public demonstration of radio-telephony, and then only to a select group of officials and newspaper men. Since that day, Japan has caught the fever badly. The people, especially the universities and schools, have taken up radio with a zeal that threatens to eclipse the enthusiasm of even young America. Every newspaper in Tokyo (there are over 20 large dailies) is devoting space to it and clamoring to be allowed to install broadcasting stations. Aerials are springing up on high buildings where three months ago it meant penal servitude for the owners to have the suggestion of a copper wire showing. In short, the boom is on.

Radio work in Japan is not easy. The old regime in Government circles is seeing to that. The relaxation of the adamant restrictions is a very gradual process, and woe betide the radio man who tries to perform a stunt without written permission of the authorities. And, talking of authorities, these are just a few who had to say yes before we were granted our permit:

The Government Department of Communications, corresponding to the Federal authorities in America.

The prefectural Department of Communications, corresponding to the State authorities.

The Tokyo municipal council.

The Tokyo City Department of Communications.

Tokyo Police Headquarters.

Tokyo City Electric Department.

Every one of these bodies, having independent powers, had to be persuaded that we meant no harm, and when I mention that our printed permit, finally granted, bore the signatures and seals of no less than 15 officials, headed by that of Viscount Mayeda, Minister of Communications, it will be readily understood that it is not easy to enter the radio business in Japan.

However, it must be understood that we do not blame the Government for their extreme care, and ultimately their precautions will redound to the good of the business generally in this part of the world. There will be no muddle over broadcasting; hours will be clearly defined; stations will not be allowed to interfere with each other, and everyone interested in the business will be given a chance. So far the regulations are that no receiving sets are to be sold capable of receiving messages sent on a wave-length over 400 meters. The wave-length allotted us for our Tokyo broadcast is 230 meters, but we find this beneficial in preventing interference from the numerous commercial stations. Our permit restricts us to an area of 20 miles from the transmitting station. (Please page Dr. Steinmetz and ask him how we are to prevent our waves from going over the boundary!) This area, however, takes in the cities of

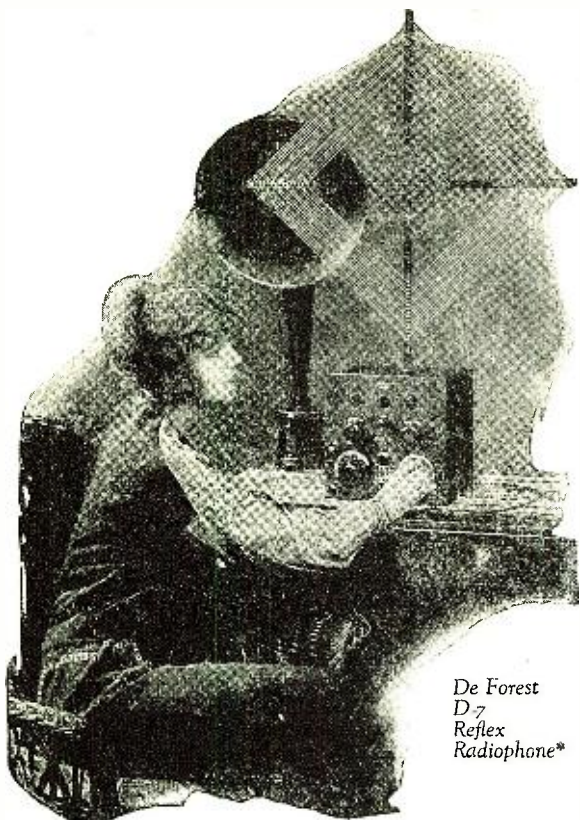

De Forest
D-7
Reflex
Radiophone*

Listen to Half the Continent for 1923

HERE'S the latest De Forest triumph, the D-7 Reflex Radiophone* Receiver. It's the newest and most sensitive set of them all, with a thousand mile range on a two-foot indoor aerial! That's what you've been waiting for. No outside aerial is needed. The whole set is as you see it here.

Easy to control with its single knob—small, compact, super-efficient—and an ornament to any library table!

Economical to operate, too, because you get five stages of amplification on three tubes, and correspondingly longer life for your storage batteries.

If you want to bring into your home the news, the music, the lectures of half the American Continent—with no trouble—clearly, without interfering noises—this is the set for you. And here's one set that is all you ever hoped a receiver could be. Ask your De Forest dealer about D-7 and the other De Forest sets—today.

De Forest Radio Tel. & Tel. Co.
Jersey City, N. J.



*Reg. U.S. Pat. Off.

What is the Finest Receiving Set Made?

To be worthy of this distinction, the set must have three characteristics—

World-wide receiving range—
Reception in all wave lengths—
Reception without distortion.

RadioCraft D-6 Regenerative Radiophone* (by permission of De Forest Radio Tel. & Tel. Co.) will receive even European stations, and of course all those on this continent.

It receives on all amateur, broadcasting, and transatlantic wave lengths.

In clearness and avoidance of distortion, it must be heard to be adequately described.

D-6 uses outside aerial only, and head sets or loud speaker.

It claims to be the finest receiving set now manufactured and any authorized De Forest dealer (who also carries the RadioCraft line) will be glad to prove this to you by actual demonstration.

RadioCraft Regenerative Radiophones* (by permission of De Forest Radio Tel. & Tel. Co.)

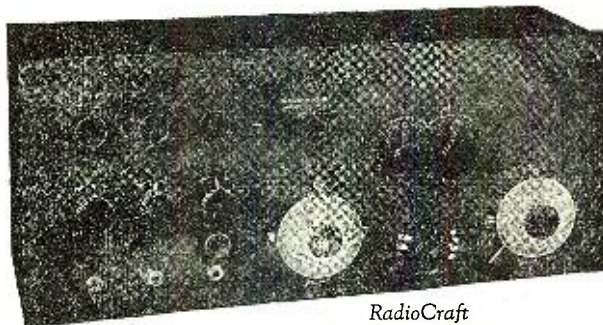

RadioCraft
Regenerative Receiver
Type D-6

range from the simplest to the most elaborate.

It is unnecessary to add that this entire line of De Luxe radio equipment is most exquisitely finished in every detail.

The RadioCraft Co., Inc.
139 Franklin St., Jersey City, N. J.



*Reg. U.S. Pat. Off.

TRADE **ESCO** MARK

QUALITY ALWAYS HAS BEEN AND ALWAYS WILL BE, THE WORLD'S SAFEST INVESTMENT



ESCO

HIGH VOLTAGE MOTOR-GENERATORS STAND PRE-EMINENT

Used by Leading Educational Institutions, U. S. Army and Navy Academies, Research Laboratories, Newspapers, Dept. Stores and Broadcasting Stations

BULLETIN 237 LISTS OVER 200 COMBINATIONS

SPECIAL APPARATUS DEVELOPED FOR SPECIAL REQUIREMENTS

MOTORS—DYNAMOTORS—GENERATORS—MOTOR-GENERATORS

ELECTRIC SPECIALTY CO.



211 SOUTH STREET
STAMFORD
Conn., U. S. A.

SOLD BY
PRINCIPAL DEALERS
EVERYWHERE



Tokyo, Yokohama, Omori and Tsurumi, a combined population of upwards of five million people.

American manufacturers of radio equipment will be interested to know that for a long time their products will hold sway over those of the Japanese radio companies, at least so far as receiving-sets for broadcasting are concerned. English and German sets are coming into this market, and the latter are particularly efficient and reasonable. Vacuum tubes made in Japan, although improving in quality as time goes on, are not yet up to the standard of American and English tubes, mainly because none of the factories have been equipped with machinery to properly evacuate the bulbs. However, one company is producing a 50-watt power tube which retails at \$15. This gives very fair results, but, as with all Japanese tubes produced so far, it is hard to get uniformity of characteristics.

American manufacturers having the Japanese market in mind—and it is a market with great possibilities—should remember that completed receiving-sets will find no sale, but in parts there is a tremendous field. Our experience has been that the Japanese like as much noise as the receiving set will produce, and therefore all apparatus for amplification, and particularly loud-speakers of the power type, have ready sale.

**Wireless Telephony
for Coast and Harbor
Services**

(Continued from page 1253)

scribed, a number of other cases arise where such means of communication can be used to great advantage.

For instance, the provision of such sets on tugs and pilot boats would enable them to keep in direct touch with the shore with a minimum of difficulty and thus to make arrangements at first hand for the berthing of vessels. Similarly for police craft on rivers, sets of this type would find highly useful employment, the power being adaptable to the service required.

In short, in all cases where simple and reliable short-range communication from a ship or a lighthouse to shore without the use of operators is a desideratum, the use of the Y series is strongly to be recommended.

**Radio in the National
Guard**

(Continued from page 1259)

fantry, many radio amateurs and those anxious to get into the new game, have donned the uniform of the soldier-civilian.

Colonel J. Hollis Wells, commanding officer of the regiment, recently claimed that "The practice of radio in the regiment has been our greatest recruiting agent." This is not hard to agree with, as the men who are only required to drill one night a week may be found gathered about the radio apparatus every night in the week.

The effect of the new innovation in the curriculum of National Guard training has been one of construction.



THE ACMESTAT

The New 100% Perfect Vacuum Tube
Filament Control

The Most Compact and Complete Rheostat
for Radio Work

The ACMESTAT:—Is of the compression type. Resistance element is indestructible and cannot get out of order. Capacity is 3 amperes and 10 watts. Control in one knob which opens circuit, gives vernier adjustments, and shorts out all resistance—allowing full battery pressure over filament when wanted.

Model A, Price \$1.75

Model B has an external switch for instant control of circuit with vernier adjustment set at desired valve.

Demand the AcmeStat of your dealer or write us, inclosing 10 cents extra for postage

THE ACME ELECTRICAL MFG. CO.

MILWAUKEE, WIS.

Pat. Apr. 16, 1912

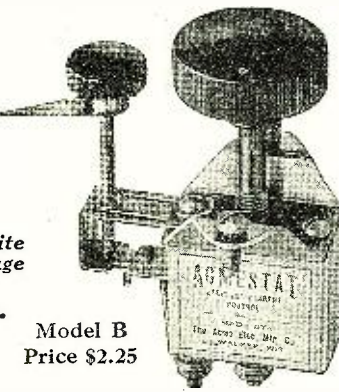

Model B
Price \$2.25

CARDBOARD TUBING

Seamless—Grey	Per Inch or Fraction	Per Ft.
2½, 3 and 3½ in. O. D.	3½c	30c
4, 4½ and 4¾ in. O. D.	4c	35c
5 in. Outside Diameter.	4½c	42c
5½ and 6 in. O. D.	5c	50c

Postage Extra—Shipping Weight, 1 lb. per ft.

Dealers Write for Discounts

MICHIGAN RADIO CO.
2173 Hillger Ave. Detroit, Mich.

BRASS Rods in round and square. Machine screws, any size.

Tubing and sheet. Nuts. Small drills and taps. Knobs and dials.

ANGIERS, U. S. A.
Streator, Ill. Bruce St. Plant

Radio Fans Praise WorkRite Products

READ THEIR LETTERS—

Why build your set with untested inferior parts when you can get WorkRite Radio Parts? Engineering skill, an up-to-date factory, and careful inspection backed by an old-established manufacturing company assures each WorkRite customer of highest quality products. The letters tell you what a few "WorkRite" fans think. There are hundreds of thousands of others like them.

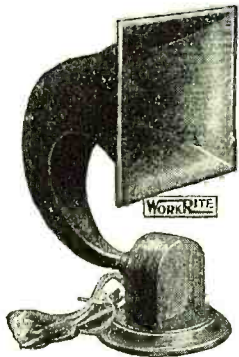

CONCERTOLA JR.

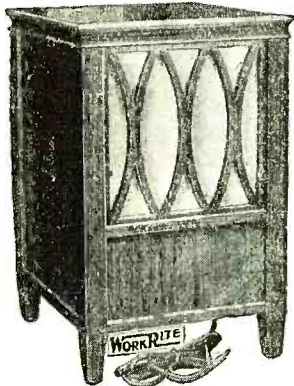

CONCERTOLA SR.

WORKRITE CONCERTOLAS Loud Speakers of "WorkRite Quality"

These two instruments are very popular with "WorkRite" fans, and when you read about them and compare them with other Loud Speakers on the market you will easily see why.

Except for the phone units. THERE IS NOT THE SLIGHTEST METAL, in either the WorkRite Concertola Sr. or Jr. The sound chambers are made from our specially developed material, which reproduces voice or music in a clear, loud tone without the slightest distortion. Just right for the home. Why listen to music through a "tin-panny" metal horn that loses all the beautiful tones of the artists, when you can get a WorkRite Concertola that will give you perfect reproduction of concerts?

The finish on these instruments is exceptional. The WorkRite Concertola Sr. is built from numerous plies of the finest mahogany, oil rubbed and finished exactly like your piano. It is 10" square by 15" high. Place it on your library table and run wires to your set in any other part of the house.

These Concertolas are designed for use with vacuum tube sets having two-stage amplification. WorkRite Concertola Sr., with Cord and Phone Unit. \$24
WorkRite Concertola Jr., with Cord and Phone Unit. \$12

WORKRITE CONCERT HEADPHONE

WorkRite Radio Fans who have had an opportunity to use this new headset have been unanimous in pronouncing it one of the best "WorkRite" Products. All we ask is: TRY THE WORKRITE CONCERT PHONES SIDE BY SIDE WITH ANY ON THE MARKET, even those costing twice as much, then you will know which is best.

Sanitary headband—aluminum phone cases—light but sturdy—Extremely sensitive and free from distortion—Try a set and see what a real phone is like. Price complete with cord, \$8.50.

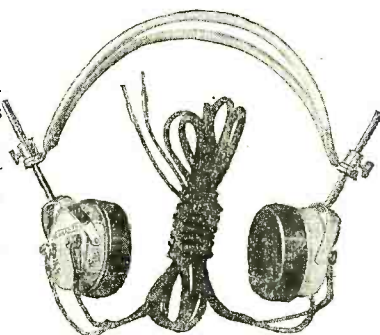

50,000 POSSIBLE ADJUSTMENTS WITH THE WORKRITE SUPER VERNIER RHEOSTAT

One radio fan says it is the marvel of the 20th century in the radio field. No set is complete without one. Indistinct and mushy music can be brought out clear and loud. Pushing the knob way in turns off bulb. Quick adjustment anywhere between 6½ ohms and zero, or by turning the knob you can get 50,000 different adjustments. POSITIVELY NEVER GETS HOT. All metal fittings made from brass and nicked. This WorkRite Super Rheostat will double the audibility of distant concerts. Price, \$1.50.

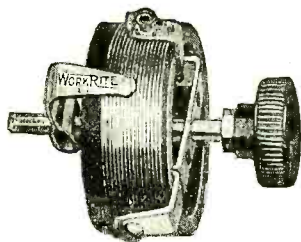

Patent applied for

SEND FOR COMPLETE CATALOG OF WORKRITE RADIO PARTS.

THE WORKRITE MANUFACTURING CO.
5541 Euclid Avenue Cleveland, Ohio

(BRANCH OFFICE: 2204 Michigan Avenue, Chicago)

Music and speech from Denver, Minneapolis, Kansas City and other cities could be heard and understood plainly 30 to 40 feet from the "Concertola." I certainly am well pleased with it.

JAMES JOHNSON,
Monticello, Mo.

I have been using one of your Concertolas on my 2-step and find it sends out a clear loud voice which can easily be heard throughout the house and is enjoyed by all.

C. S. YONELY,
1227 E. 124th St.,
Cleveland, Ohio.

The results with these WorkRite Rheostats are fine, and we are getting St. Louis, Denver, Houston, Kansas City and Omaha on a detector only, which was impossible with other rheostats.

E. H. STALEY,
Vernon, Tex. 8-24-22

I have been using your WorkRite apparatus and find same the most efficient on the market.

LESTER M. KAPP,
208 S. Main St.,
Oxford, Ohio. 8-26-22



LOUD SPEAKER WITH THE DOUBLE TONE-CHAMBER

**NO. 1. HOLDS
TWO PHONE
RECEIVERS**

\$4.50



**NO. 1R HOLDS
ONE PHONE
RECEIVER**

\$4.50

**PATENT
APPLIED
NO. 1
\$4.50**



Illustrating the double tone-chamber (Patent Applied For) which absorbs the mechanical noises, and produces the splendid results which have made the Qualitone popular.

Made of tough fibre and hard wood, finished throughout in mahogany. The double tone-chamber amplifies and throws the sound forward to the bell of the horn, producing a rich, mellow quality of tone and clear articulation.

Sold by leading jobbers everywhere. If you cannot secure one, order direct. Favor us with your local dealer's name.

THE DUAL TOOL CO.
SUPERIOR AVENUE & E. 124, CLEVELAND, O.

Practical Hints on Mast Construction

(Continued from page 1291)

point on the horizontal length of the mast, whereupon when raised from the ground by the block and fall, the butt end of the mast will just about over-balance the upper portion. In that case, when the mast is heaved off the ground by the block and fall, the lower end of the mast will remain on the ground while the upper end will gradually rise until the mast is in a vertical position when it is lowered into the hole prepared for it and steadied by the guys. It is held upright until firmly tamped in the ground and then the guys are permanently moored to stable anchors at as long distances as possible from the base of the mast.

An illustration shows the much used type of deadman anchor, being a slug of wood about 3' to 6' long, through which a long rod runs to the surface, having a large washer, a couple of lock nuts at the bottom and a swivel or turnbuckle at the top to which the mast guy is attached and screwed up to the proper tension. In the absence of wood slugs a sheet of scrap iron of fair surface may be substituted and will serve just as well.

One of the illustrations shows the construction of a mast with movable topmast, so arranged that it can be lowered until it is of the same height as the lower mast, by means of a block and fall, the fall line for which is normally fastened over a cleat at the bottom of the lower mast within easy reach of the ground. This type is particularly useful if it is desired to repair blocks, guys or insulators inserted in the guys. Bolts or pole steps permit access to the top from the ground by being distributed along the side away from that on which the top mast moves while in motion, guided by the semi-circular iron strap guides fastened at its lower extremity.

Another figure shows the construction of a semi-lattice type which may be fabricated from scrap lumber, mainly two by fours, and two or three by one braces, with a light pole inserted in the bracing at the top for additional height. This type should be well guyed in four directions, with the strain coming from a direction parallel with the flat side of the mast. With a topmast eight guys should be used.

KDY L at Salt Lake City

(Continued from page 1262)

ed 12' above the roof by the same two masts. It is an exact duplicate of the antenna with a cage lead in, also an exact duplicate of the one from the antenna proper. It is insulated from its support in the same fashion.

A ground connection to the steel frame of the building is also used to distribute more evenly the current flow immediately under the counterpoise in the steel frame of the building.

THE TRANSMITTER

The transmitter employs the vacuum tube system of generating high frequency alternating current in the radiating system. It is designed to deliver 50 or 100 watts of undamped

RADIO SERVICE PRODUCTS

The Acknowledged Standard of the Radio Amateur

The

AMPLITRON

(A Real Loud Speaker)

The Amplitron is a product of the Radio Service Laboratory and has been designed and constructed especially for radio work. This instrument fills the need for a moderate priced loud speaker. It reproduces radio phone speech and music without distortion—equally good for code. No exciting batteries or adjustments necessary. Uses a Baldwin Type "C" single phone.

Price as illustrated..... \$8.50

Price WITH BALDWIN PHONE AND CORD.. \$16.50



PRICE \$8.50
(Patent Applied For)



V. T. DETECTOR \$6.00



AMPLIFIER \$10.00



The original "Little Wonder" Complete Receiving Set including 2000 ohm headset and complete aerial equipment

\$15.00

Midset Type Detector and Two-Stage Amplifier, size 4½" x 4½" x 4½", Formica Panel, Oak Cabinet, interior construction equal to high-priced instruments.

RADIO SERVICE & MFG. CO.

EST. 1918
Sales Division: 507 5th Ave., N. Y. C. Factory: LYNBROOK, L. I.

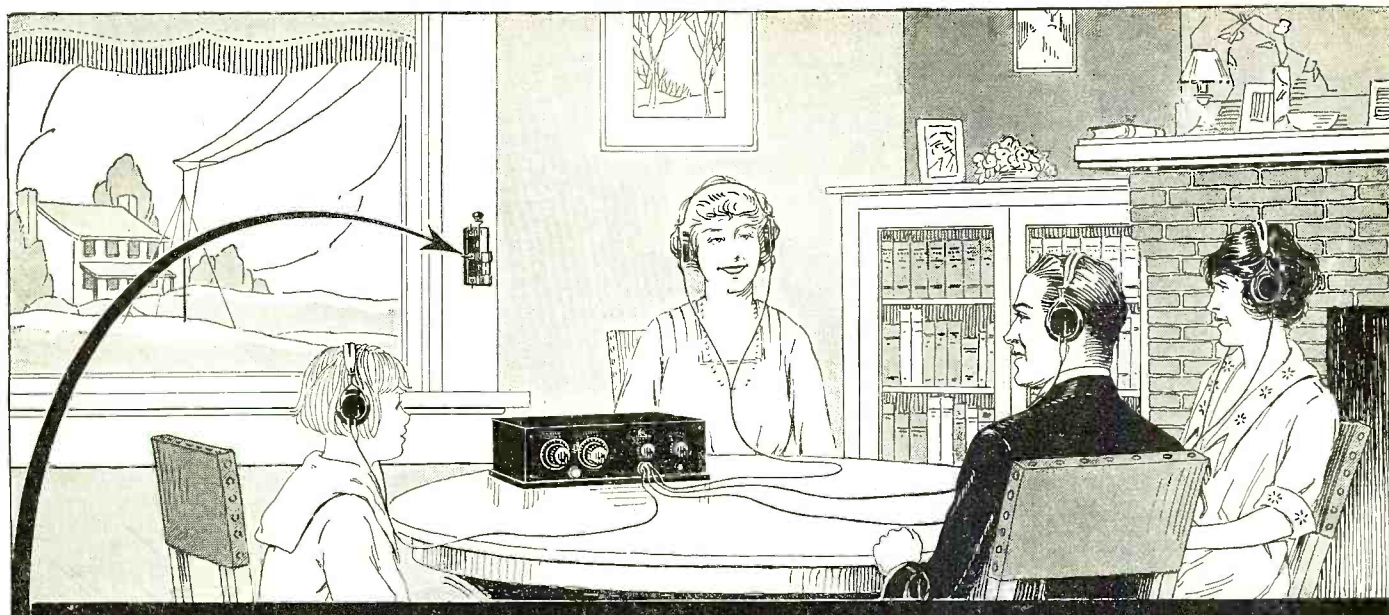

Radio Lightning Arrester Switch

This Lightning Protector Combines All the Merits of a Radio Ground Switch and a Vacuum Tube Lightning Arrester

(Patents Pending)

It gives continuous Vacuum Tube Arrester protection with a positive ground when desired.

By mounting both on one base we have produced a compact protective device combining the two best known means of lightning protection and at small additional cost over either one.

Approved and Listed by the Underwriters' Laboratories. The new Regulations of the National Board of Fire Underwriters permits its installation either outside or inside similar to a telephone fuse. This illustration shows its adaptability to indoor use.

Send for Bulletin No. 30, telling of the merits and disadvantages of both types, and how by combining the two on one base we have solved the lightning protection problem.

Cat. No. 602
Price \$3.50

To Radio Distributors and Dealers

Trade Discounts to Radio Distributors and Dealers who have established standing or can prove their status.

Local distribution is through Dealers where available.

Ask for our new Window Display Card designed to boost sales and featuring our Four-Phone Plug.

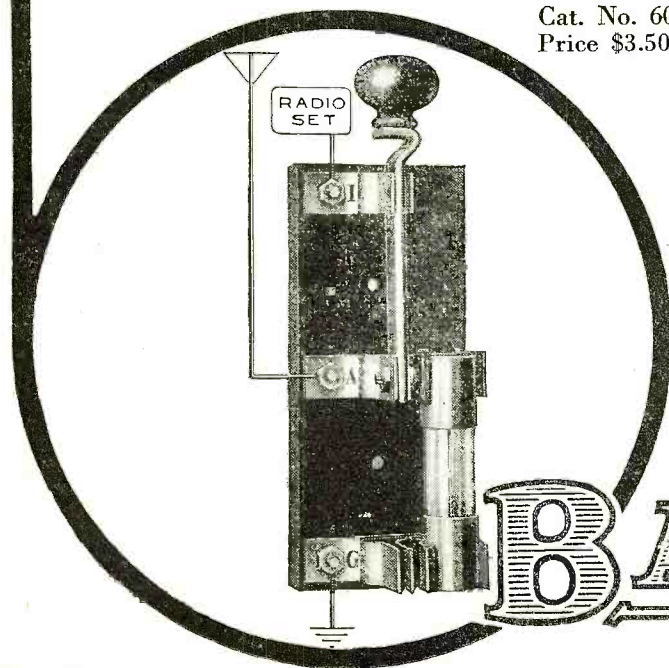

The Barkeley Electric Mfg. Co.

MIDDLETOWN, OHIO

15 So. Clinton St., Chicago

603 Century Bldg., Pittsburgh

75 Fremont St., San Francisco

1487 Broadway, New York

BARKELEW

ABOVE THE ORDINARY

RADIO dealers should distinguish between the ordinary distributor of Radio products, and the particular one best suited to supply them.

Cooperation, Service, Delivery and Satisfaction are the things we give you, besides the merchandise.

Our "Superadio" products signify superiority; also finest quality, perfect design and absolute guarantee. The same terms apply to the standard equipment we distribute, that of the Radio Corporation of America, Murdock, Acme, Baldwin, DeForest, Stromberg-Carlson and others.

Write for our dealers' price lists and discounts.

The Superior Radio & Telephone Equipment Co.

81 E. Long Street



Columbus, Ohio

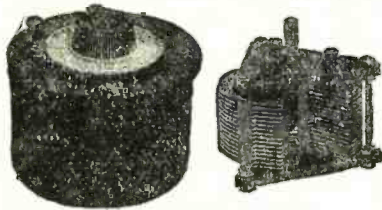

TYPE 247 CONDENSER

DESIGNED NOT MADE

Would you buy diamonds at a corner grocery store? Of course not; you do not expect the grocer to be a diamond expert! Then why buy condensers that are simply made instead of being designed?

For many years the GENERAL RADIO COMPANY has been supplying the research and educational institution laboratories throughout the country with radio apparatus of the highest quality. The Bureau of Standards and other government laboratories are extensive users of our equipment. The experience obtained in this line has enabled us to design instruments for the citizen radio field that represent the latest developments in engineering and mechanical skill.

For seven years we have been supplying radio condensers that have been a standard for low losses and excellency in construction. Our latest addition to this line of condensers is the type 247. Send for Free Radio Bulletin 911-N and learn why these condensers are so popular.

MODERATELY PRICED AS FOLLOWS:

- Type 247A—.001 M. F. Mounted, ShieldedPrice, 06.00
- Type 247B—.001 M. F. Unmounted, with Counterweight..Price, 3.75
- Type 247E—.0005 M. F. Mounted, ShieldedPrice, 5.56
- Type 247F—.0005 M. F. Unmounted, with Counterweight..Price, 3.25

This condenser is but an example. We manufacture a complete line of the finest radio instruments and parts.

GENERAL RADIO COMPANY

Massachusetts Avenue and Windsor Street, CAMBRIDGE, 39, MASSACHUSETTS

Standardize on General Radio Company Equipment Throughout

Do not confuse the products of the GENERAL RADIO CO. with those of the other concerns using the words "General Radio." The General Radio Co. has been manufacturing radio and scientific instruments for many years. It has no affiliations with any other company.

modulated energy to the radiating system at normal rating. The circuit used is the Stanley, or, as it is better known in this country, the reversed feed back. This circuit is probably the best known today for use on comparatively short wave-lengths. The inductances are mounted on the front of the main panel thus assuring rapid and convenient change of wave-length. All meters are mounted on this panel and every vital circuit is metered. The Heising system of continuous current modulation is employed. A cam switch is used to determine whether undamped continuous waves, interrupted continuous waves or voice be transmitted. It this way code may be used when desired. During the first test this transmitter put five thermo couple amperes into the radiating system at a slight overload. Normal antenna current will be in the neighborhood of four amperes. A wave length of 360 meters will be used for music, news and like matter, 485 meters will be used for weather reports.

Power Supply

Power for the installation which involves the filaments of the power tubes, motor-generator, charging of batteries and lighting of the station is furnished by a special three-wire system directly to the generator room. The motor-generator is a two-unit machine with a one horse-power motor directly coupled to a 600-watt 1,500-volt compound wound generator, double commutator type. This machine supplies the high voltage used on the plates of the power tubes. The filaments of these tubes are lighted by a special step-down transformer mounted in the transmitter. Power for lighting the filaments of the receiving set is furnished by storage batteries which are kept charged by a mechanical rectifier from the alternating current line. Generator, rectifier and batteries are kept in a separate room away from the operating room and the studio thus eliminating all disagreeable noises.

The Operating Room

The operating room adjoins the studio and opens to the roof. The room has concrete walls and is made non-reverberatory by hanging heavy cloth on all sides at a distance of 8" from the actual wall.

LISTENING TO THE WORLD'S GRAND OPERA

With TRESKO TUNERS—"If you don't buy a 'Regenerative Tuner' licensed—you will not have a Tuner"



DE LUXE TYPE

AMPLIFIER TO SUIT \$35.00

TRESKO SUPER-UNIVERSAL REGENERATIVE TUNER

Cabinet 12 x 17½ inches. Formica or Hard Rubber Panel. Weight, 15 lbs.; shipping 25 lbs. Wave length range, 150-25,000 M. Tuners inside—three, AS, BS, RS. Recommended by users of the Bureau of Market Reports and guaranteed to get all the wireless signals, either CW, spark, or telephone within the range of the sending station. This is the only tuner in the world that has this range of wave lengths and gets the signals on the smallest possible single wire aerial. Arlington time, Annapolis, San Diego signals clearly read through even a violent thunder storm. Nearly all stations in the United States of the Bureau of Markets come in on this tuner in the center of the United States, and no point in the country would prevent the reception of these signals. It is recommended for the Farmer, Bureau of Markets, Schools, Colleges, etc. There is nothing about it to get out of order or need replacing except the high voltage batteries, a replacement of which costs only a few dollars. We ship only by express. We do not ship without testing and calibrating with bulb, and each one is absolutely guaranteed to do just as we claim or we will refund your money. You do not need to know anything about wireless to operate this tuner or to get the signals and telephone reports. Cabinet is highly polished and all parts nickel finish. If you wish extra loud signals you may use one or two step amplifier, as posts are provided on the tuner for this purpose. It is complete with all that is needed except a pair of phones and a few dry cells to light the filament of the Audion. Ready to use when it arrives with full directions so that a child can operate it. Priced at \$125.00, F. O. B. factory. Detector, \$5.00 extra.

Licensed under Armstrong U. S. Patent No. 1113149

CIRCULAR FREE

TRESKO — DAVENPORT — IOWA

Box 148



~ Simplicity ~ The Keynote of Crosley Radio Apparatus

Simplicity always means efficiency. Simplicity permits quantity production at moderate cost. Crosley Radio Apparatus, through its simplicity, has set a new standard of value, combining the utmost efficiency with remarkably low prices.

Crosley Radio Apparatus should not be judged by price but by performance. It is performance that has made possible the wonderful success of the Crosley Manufacturing Company in the Radio Field.

Crosley Tuned Radio Frequency Amplification, made possible through simplicity and efficiency of construction, is the outstanding feature of the year. This feature in our instruments is one of the items that has caused so much favorable comment on Crosley Apparatus.

It is now well known that other apparatus is judged by the standard of performance set by the Crosley Manufacturing Company. Complete sets from \$25 up and all kinds of Radio Parts.

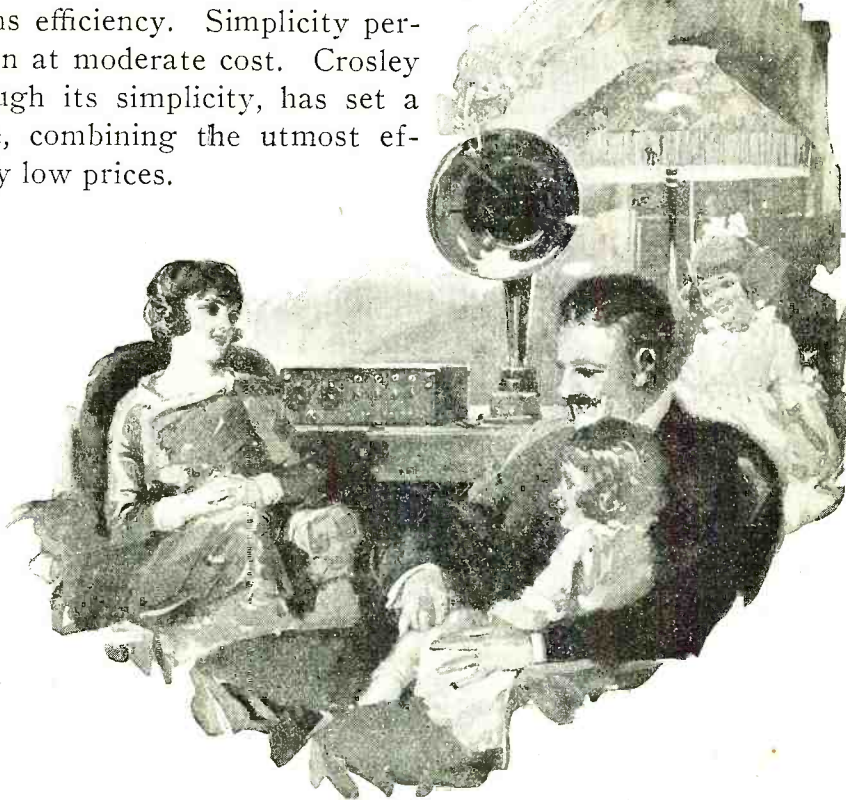

Write for Catalog.

CROSLEY
BETTER-COST LESS
RADIO

CROSLEY MANUFACTURING CO.

Dept. RN4

Cincinnati·Ohio

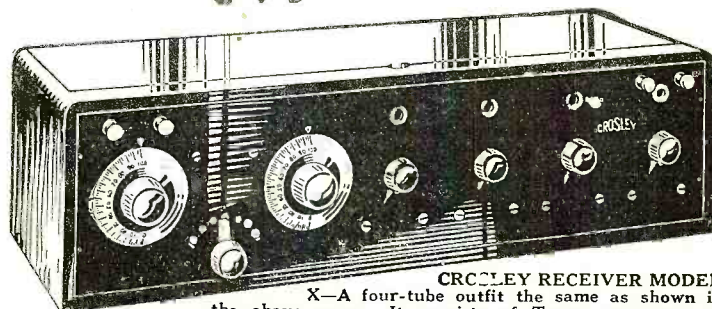

CROSLEY RECEIVER MODEL X—A four-tube outfit the same as shown in the above scene. It consists of Tuner one stage of Tuned Radio Frequency Amplification (the feature that has made this instrument so popular) Detector and Two Stages of Audio Frequency Amplification in a beautiful mahogany finished cabinet. It will bring in distant stations loud and clear. Price without phones, batteries or tubes.....\$55.00

Eventually you will buy better apparatus

The AMERTRAN

Super-audio frequency amplifying transformer



Ask your Electrical Dealer, or, sent carriage charges collect. (Wt. 1 lb.)

WHEN a man interests himself in any hobby, such as photography, automobiling, or what not, he usually starts in by buying cheap, crude equipment.

Immediately he begins to realize that he wants better equipment, more skilfully designed apparatus.

It is the same with radio. Profit by your own experience in other matters, and decide now that you will not be so handicapped.

The Amertran has the greatest amplification (38.6 in one stage with Radiotrons*) and is without distortion over the whole range of audio frequencies.

* Send for leaflet No. 975.

American Transformer Company, Newark, N. J.

Designers and Builders of Radio Transformers for Over Twenty Years.

The transmitter and the receiver are installed in this room. All controls are mounted on a switchboard behind the operating table and convenient to the operator.

THE STUDIO

The studio adjoins the operating room and also has concrete walls hung with heavy cloth. Absolutely no echo is noticeable in this room even with the aid of sensitive microphones which would detect an echo which the human ear could not hear unaided.

The Chicago Radio Show

(Continued from page 1262)

hand from New York City, brought about harmonious co-operation in every department of the radio industry represented at the show.

One of the features of the show was a broadcasting station. Thousands viewed the "workout" of professional musicians within the small, glass-enclosed station, while an amplifier gave them a close-up program with the unique distinction afforded the listeners of hearing and seeing the musicians at the same time.

On a raised platform in the center of the show demonstrations were given by Francil, Radio expert, showing how a miniature automobile could be driven and directed and how water was pumped in heavy or light volume and how a ball could be dislodged from the top of a brass pole, all with a sending set. Mind-reading by radio was demonstrated by "The Great Mahendra" illustrating the transmission of "occult" power by radio. These innovations enlivened the show considerably for those who had come "to see something new." Then there was dancing, an address by Ralph C. Watrous, president of Armstrong's Licensees' Association and an illustrated lecture on broadcasting by G. H. Clark, Radio Corporation of America.

Nearly 100 exhibitors had acquired booths and one of the most notable was that of the "Atlanta Journal," coming as it did from the Georgia metropolis to boost its own broadcasting station "WSB," whose radius is 1,000 miles.

According to H. P. Davis, vice-president of the Westinghouse Electric and Mfg. Co., broadcasting is here to stay. Mr. Davis expressed his opinion that any attempts to close broadcasting stations would meet with popular protest and improvement in the operation of stations during the last six months shows they will soon be so perfect nobody will want them silenced.

Exhibits were shown from Japan, France, England, Germany and Holland, creating much interest.

Selectivity

(Continued from page 1278)

can do no more than arrange the system so that absorption by surrounding structures is a minimum.

Inductance coils which are to be used directly in the antenna system should

Big Improvements for Your Set at Small Cost

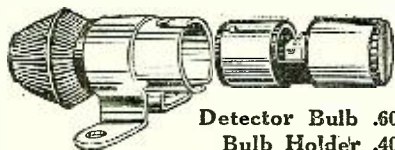

Detector Bulb .60
Bulb Holder .40

A New Kind of Detector RADIUM JEWEL DETECTOR

IMPROVED crystal detector, yet it requires no battery and no adjusting. Extremely sensitive. Occasional tuning is the only care required.

Steps up the efficiency of your detector set several times. Saves fuss and inconvenience. Worth a great deal more to you but you can buy it from most any dealer complete with holder for \$1.00.

AEROPLUG—The Socket Aerial Eliminates Lightning Danger and Reduces Static

MAKES a powerful aerial of your electric lighting circuit, simply by screwing it into the ordinary lamp socket. Uses no current. NO danger. Can't get out of order. A good aerial in any kind of weather.

Used for Crystal Sets Only When Close to Stations \$150

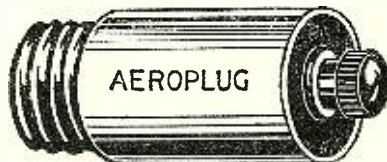

If your dealer can't supply, we will mail direct

STAR MANUFACTURING CO. 868 BERGEN STREET NEWARK, N. J.

The "All Wave" Coupler

TRADE MARK
WAVE LENGTH—150 to 3000 Meters
FLAT AND BACK WOUND

Eliminates the use of all Variometers, Varicouplers and Loading Coils, inasmuch as it performs in one compact unit the functions of all of these devices combined.

For the Novice—The "All Wave" Coupler enables the greenest novice to attain the same results attained by the expert in building the simplest, most compact and most efficient radio receiving set possible.

Be Prepared for increases in the wave lengths of the broadcasting stations which are necessitated by their increasing number.

Unusual Results Attained—Individual users of the "All Wave" Coupler have written us that in New Jersey they have listened in as far west as the University of Wisconsin and Chicago, whereas in Montreal, Canada, it is nothing unusual to bring in Schenectady, Detroit, Chicago, Pittsburgh, Newark and the Arlington time signals direct.

Beware of Imitations—Of the "All Wave" Coupler. Look for the trademark, "All Wave" on the rotor.

\$9.00 Six efficient Hook-ups sent upon receipt of 10c stamps or Free with each "All Wave" Coupler



Patents Pending

Guaranteed with an Absolute Money-Back Guarantee to Operate as Advertised

CAPITOL PHONOLIER CORPORATION

54-60 Lafayette Street, New York City

**MAGNAVOX—
pioneers in the
RADIO field**

IT was in 1913 that the Magnavox electro-dynamic receiver made its first public demonstration, when telephone communication was held between Denver and New York—a revolutionary advance.

The rise of Radio Broadcasting found Magnavox apparatus already fully developed to make possible the reproduction of wireless music and speech in ample volume and marvelous clearness.

**R-2 Magnavox Radio
with 18-inch horn**

This instrument is intended for those who wish the utmost in amplifying power: for clubs, hotels, dance halls, large audiences, etc. It requires only .6 of an ampere for the field.

Price **\$85.00**

**R-3 Magnavox Radio
with 14-inch horn
(as illustrated)**

The ideal instrument for use in homes, offices, amateur stations, etc. Same in principle and construction as Type R-2.

Price **\$45.00**



3-stage

**Model C Magnavox
Power Amplifier**

For use with the Magnavox Radio and insures getting the largest possible power input.

2-stage, \$ 80.00
3-stage 110.00

The facilities and experience back of each piece of equipment bearing the Magnavox trade mark are unrivaled anywhere in the world.



PALS AGAIN
Never a dull evening in the home

The relaxation, the gayety and the stimulus which all the world is seeking, Magnavox Radio will bring to your own hearth and home.

With the Magnavox Radio, every incoming signal registered by the receiving set is reproduced to the utmost degree of sensitivity and power. This incomparable superiority, based on scientific reasons known to every expert, has by general popular opinion given Magnavox the distinctive title of the **Reproducer Supreme**.

Magnavox Radio and Power Amplifier are readily attached to any good receiving set—no other equipment gives you the uniform enjoyment of radio at its best.

Magnavox Products can be had from good dealers everywhere. Our interesting new booklet (illustrated in three colors) will be sent on request.

The Magnavox Co., Oakland, California
New York: 370 Seventh Avenue

MAGNAVOX
Radio
The Reproducer Supreme

**Best Charger for
Radio "A" or
Automobile
Batteries**

\$35.00

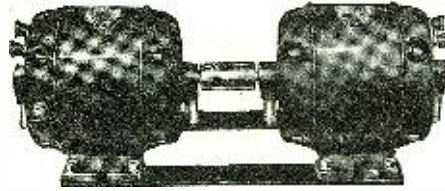

Northwestern Motor-Generator Set

Makes battery-charging easy. Just plug in to your light or power line and connect leads to poles of your battery. Recharges the regulation 6-volt, 80 ampere storage battery in 4-8 hours, depending upon its degree of exhaustion.

Set consists of 1/4-h. p., 110 volt, 60 cycle, split-phase fan-cooled, alternating current motor linked to a 1/4-h. p. direct current generator of special design. It converts AC to DC and steps down the line voltage from 110 or 220 or other high voltage, to 8 volts—for battery charging.

Motor can be used separately for a multitude of household and workshop power purposes.

These are net factory-to-user prices. Cash must accompany order as our margin permits of no expense for accounting or collection. Our money-back guarantee protects you fully.

The complete set, as illustrated, is offered for the price usually charged for 1 motor alone\$35.00

Northwestern Synchronous Generator for operating Spark Gap in broadcasting 1/8 hp., 110 volt, 60 cycle, split phase A. C. 20.00

Northwestern General Purpose Motor, 1/4 hp., 60 cycle A. C., fan cooled, operating at 1740 r.p.m. the right speed for household washing machines, cream separators or for small drills, lathes, grinders, etc. Others charge just about double our factory-to-user price. 13.50

NORTHWESTERN ELECTRIC CO.
412 South Hoyne Avenue Chicago, Ill.

LEARN THE CODE AT HOME

"Just Listen—The Omnigraph will do the teaching"

with the

OMNIGRAPH

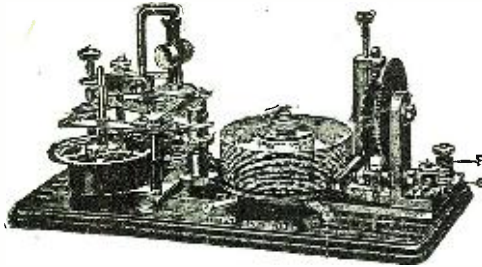

THE **OMNIGRAPH** Automatic Transmitter will teach you both the Wireless and Morse Codes—right in your own home—quickly, easily and inexpensively. Connected with Buzzer, Buzzer and Phone or to Sounder, it will send you unlimited messages, at any speed, from 5 to 50 words a minute.

THE **OMNIGRAPH** is not an experiment. For more than 15 years, it has been sold all over the world with a money back guarantee. The **OMNIGRAPH** is used by several Depts. of the U.S. Govt.

—in fact, the Dept. of Commerce uses the **OMNIGRAPH** to test all applicants applying for a Radio license. The **OMNIGRAPH** has been successfully adopted by the leading Universities, Colleges and Radio Schools.

Send for FREE Catalog describing three models, \$14 to \$30. DO IT TODAY.

The Omnigraph Mfg. Co., 20 Hudson St., New York City

If you own a Radio Phone set and don't know the code—you are missing most of the fun

Ozburn-Abston Radio Co., Inc.

600-612 Monroe Ave., Memphis, Tenn.

RADIO PRODUCTS OF MERIT

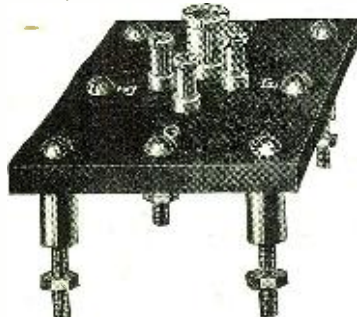

Positive Contact socket for the one and one-half volt Aeriotron WD-11 tube. No loose or oxidized spring contacts, consequently no tube noises. Cat. No. B-2.

Price \$1.25



MINIATURE JACKS
for all uses

For standard tube prongs or for use with Miniature Plug. Cat. No. C-100. Price..11c
For Phone Tips. Cat. No. C-101. Price..11c
For large prongs of WD-11 tube or 50 watt tube. Cat No. C-102. Price16c

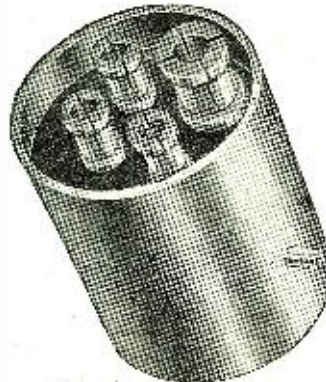

An Adapter for the Aeriotron WD-11 tube. Fits any standard socket. No wiring changes necessary, merely insert Adapter and substitute dry cell for 6 volt storage battery. Cat. No. 0-1. Price.....\$1.40



Miniature Plug made of polished bakelite and nickel metal parts. Used to replace binding posts where quick, positive action is desired. Cat. No. C-1. Price..25c

have a low effective resistance at the frequency for which they are to be used.

The remaining opposition found by the antenna current is that which really is in the form of a back-pressure. We have two back-pressures:

The first, due to inductance and called inductive reactance; and the second, due to capacitance and called capacitive reactance. These two items always oppose each other, and if properly adjusted, they may be made to cancel each other. It is not possible, however, to do away with the antenna resistance. The problem of reception then, is one in which the total opposition to the current is reduced to a minimum (equal to the resistance) by neutralization of the capacitive and inductive reactances. For a given receiver already installed, the resistance is more or less fixed, and selectivity can only be obtained by arranging the net reactance so that it is equal to zero for the desired signal. The reactances (inductive and capacitive) appear as obstructions to the current flow and, therefore, are measured like resistances in terms of ohms.

It can be shown that the inductive reactance is equal to the expression $2\pi fL$, where f =frequency in cycles per sec. L =inductance in henries.

It can also be shown that the capacitive reactance is given by the expression

$$\frac{1}{2\pi fC}$$

where f =frequency in cycles per sec. C =capacitance in farads.

It is important to note that these expressions depend not only upon the constants of the circuit, (L and C) but are dependent upon the frequency of the incoming signal. We must also remember that these terms always oppose each other, and that in order to obtain maximum signal strength they should exactly balance.

Fig. 2 shows how the reactances of a simple circuit vary with frequency. It is, of course, understood that the frequency of the incoming signal is obtained by dividing the velocity of propagation by the wave-length. The horizontal scale can, if desired, be marked in wave-lengths.

The simple circuit shown in Fig. 1 is approximately represented by the circuit shown in Fig. 3, in which C represents the total circuit capacitance for Fig. 1; L represents the total inductance, and R represents the total effective resistance.

The curves shown in Fig. 2 show how the reactances vary, and are constructed for an adjustment for 360-meter reception. Curves 1 and 2 are plotted for the case of low inductance and high capacitance, and curves 3 and 4 are plotted for the case of high inductance and low capacitance. These curves are applicable to such a circuit as shown in Fig. 3, and will approximately indicate the relations for the circuit of Fig. 1. These curves are worthy of considerable attention because they disclose the behavior of such a circuit when working at more than one frequency.

Note that curves 1 and 2 cross at a frequency corresponding to a wave-length of 360 meters. This means that the net reactance for this frequency (834,000 cycles per second) is zero. A maximum signal will then result for the 360 meter wave, being limited only by the resistance of the circuit. A signal having a wave-length of 400-meters (750,000 cycles per second) will, however, encounter a reactance (net reactance) of 66 ohms. The 400-meter signal will evidently be to some degree excluded.

Now consider the curves 3 and 4.

Bradleystat Tests Amaze Radio Engineers

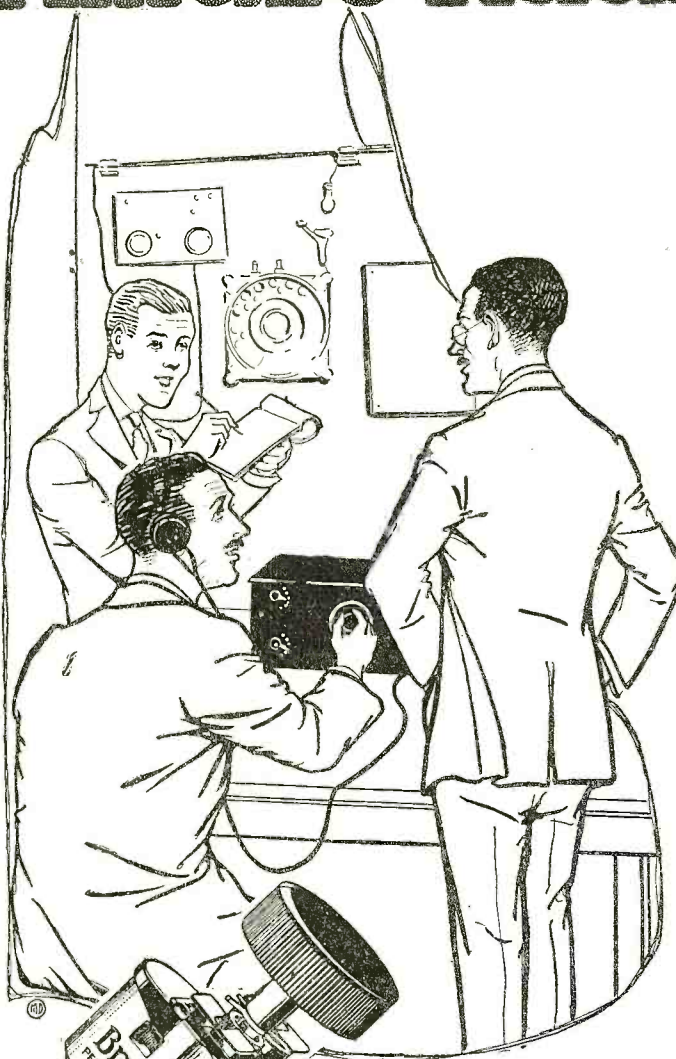

Startling Effects Revealed by Laboratory Tests

Following are extracts from the unbiased report of the Amorc Laboratories, New York and San Francisco—

"Tested Bradleystat after 32 hours of continuous burning of tube. Battery voltage dropped from 6.88 to 6.01, but current varied only 2 points, which was unimportant.

"We discovered a very important point thereby. As voltage dropped, your device automatically adjusted itself through temperature of discs and thereby maintained better adjustment than any other rheostat.

"You have rendered radio a great service with your device." (Signed) H. Spencer Lewis.

Are you getting the benefit of our twenty years of experience with graphite rheostats? Order your Bradleystat, today, for better radio.

Allen-Bradley Co.

Electric Controlling Apparatus
287 Greenfield Ave., Milwaukee, Wis.

Member of the National Radio Chamber of Commerce

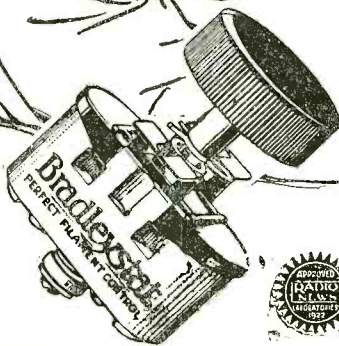

Retail Price

\$1.85

P. P. 10c Extra

Ask for the Checkered Box at leading radio dealers. If your dealer cannot supply you, please send us his name and we will arrange with him to demonstrate the Bradleystat.

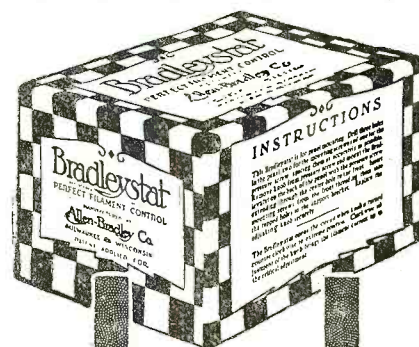

Bradleystat

REGISTERED

U. S. PAT. OFF.

PERFECT FILAMENT CONTROL

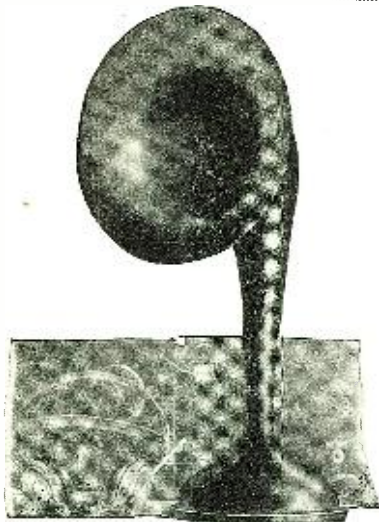

Quality First

THE Roller-Smith loud speaker comprises two special receivers built permanently into a heavy cast aluminum horn. By matching the receivers as a pair and the pair to the horn we attain the quality of reproduction which characterizes a fine phone, combined with volume sufficient for any average room.

You will be surprised to hear the difference between it and the raucous shouter type or it and the fish horn squawker.

No batteries required.
Handsome black crystalline enamel finish.

Price, but eighteen dollars.
Send for Bulletin No. V-20.

ROLLER-SMITH COMPANY
Electrical Instruments, Meters and Circuit Breakers



MAIN OFFICE:
15 Barclay Street, New York

WORKS:
Bethlehem, Pennsylvania

Offices in Principal Cities of U. S. and Canada

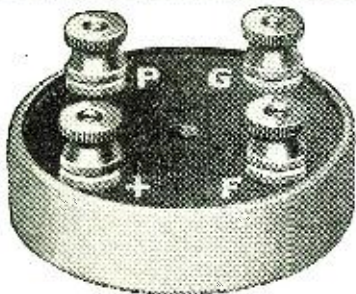

(Patent Pending)

Samples Mailed Free to Rated Jobbers

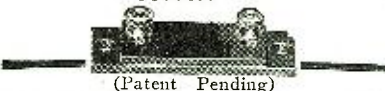

(Patent Pending)

Up" feature enables the operator to increase to any capacity up to .005 simply by adding extra plates of Mica and Copper Foil. 35c for capacity .0005. An envelope containing 20 Mica and 20 Copper Plates, 25c. Order direct if your dealer hasn't Schindler's in stock.



Type G-2
Tested GRID Condenser
00025 Mfd.

Grid-Phone and Grid-Leak Condensers of definite capacity and resistance. Prices on application.

Radio Frequency Transformers

\$2

No radio set is complete without radio frequency amplification, and radio frequency amplification isn't perfect without Schindler's new improved transformers. Schindler's Transformers insure the highest type of amplification. They insure clearness, eliminate noise and static disturbance and bring the distant stations within your reach. Signals heretofore too weak for detection on outdoor antenna are made audible on small indoor loop aerials wherever Schindler's Transformers are applied. Price \$2. Order direct if your dealer can't supply you.

"Build-Up" Mica Condensers 35c

CHARLES SCHINDLER 1401 W. Delaware
Manufacturer of Radio Parts and Specialties. Toledo, Ohio

Here again we have the reactances balanced for the 360-meter signal. If we assume the circuit resistance to be unchanged, we may say that the signal will come in just as well as before. The 400-meter wave, however, encounters a reactance which is much greater than in the previous case.

(Note: The actual number of ohms present at any frequency is found by the relation: Impedance² = Resistance² + Net Reactance² where Impedance = total ohms in the circuit.)

Curves 1 and 2 are plotted for .0607 millihenry and .0006 microfarad respectively. Curves 3 and 4 are plotted for .1214 millihenry and .0003 microfarad respectively. These combinations represent the situation for reception for 360-meter signals when using a rather large and a rather small antenna.

Fig. 2 shows clearly the great advantage of using high inductance and low capacitance.

It is evident that selectivity can at least be improved by the use of the small antenna. If the antenna cannot be easily reduced, a condenser may be inserted in series. The effect of a series condenser is a reduction of the total circuit capacitance. In selecting a condenser, one should be certain that it is efficient. The addition of a poor condenser may defeat its purpose because of the added losses which accompany it. This advice also applies to the selection of inductance coils.

There is another advantage in operating the receiver with high inductance which is not always appreciated. The voltage operating the detector (the voltage across the inductance) is given by the expression $2\pi LI$. It is evident that more voltage will exist if L is great, providing of course that I (current) does not fall.

In concluding, the writer particularly wishes to emphasize the fact that receivers using the simple circuit shown in Fig. 1, and employing the vacuum tube detector, should not be operated in the oscillating conditions. Considerable interference is being experienced in congested sections due to the fact that such receivers are operating in conjunction with oscillating vacuum tubes. The circuit forms a good transmitter, and is capable of influencing receivers for a considerable distance. It is interesting to note that in Great Britain steps are being taken to avoid such a situation as we are experiencing in certain localities.

Capacitive Coupling for Long Wave Regeneration

(Continued from page 1278)

for the latter is that the same immediate variable constants of the receiver, when used for long waves, require more actual manipulation for a given change in the wave-length of the receiver. Whereas for shorter waves a moderate change in the circuit constants may pass over and completely miss the signals from short wave stations due to the fact that a very small change in the constant of one part of the set, say a variable condenser of .001 mfd., will in comparison make a greater change for a given manipulation than when tuned near to the frequency of a longer wave. The short wave too is generally very much sharper than the longer wave, which is hampered by harmonics of its own, those of other stations, and probably emissions from receivers nearby to the receiver in question. I might

RADIO ANTENNA TOWERS

Simple. Sturdy. Easy to erect. Built of galvanized steel. Will last for years. 100 ft. high or less. Fitted to take pipe mast at top. Immediate shipment. Write TODAY for prices.

Radio Department
STOVER MFG. & ENGINE CO.
FREEPORT, ILLINOIS

CUT PRICES

Buy DIRECT from Manufacturer
Here is a sample list for your selection. Look them over and **SAVE**

	List Price	Our Price
UV 200 Detector Tube	\$5.00	\$4.00
UV 201 Amplifier Tube	6.50	5.25
Federal Phones, 2200 Ohms	8.00	5.50
Dictagraph Phones, 3000 Ohms	12.00	6.50
Thordarson Audio Frequency Transformer	4.50	3.25
Porcelain Rheostat De Forest Type	1.20	.45
Klosner Vernier Rheostat	1.50	.75
Perfection Potentiometer, 240 Ohms resistance	1.65	1.05
"A" Battery Exide 6 V. 40 Ampere hrs., Type 3-LXL-3	17.50	13.50
"A" Battery Exide 6 V. 80 Ampere hrs., Type 3-LXL-6	23.00	17.95
Bright Star, 22 1/2 volts "B" Batteries	1.75	1.20
3-inch Unbreakable Dial and Knob		
1/4-inch hole	1.00	.30

Send Money Order. Our Catalogue "L" Free with each Order. WE PAY POSTAGE
Perfection Radio Corporation of America
149 West 23d Street New York, N. Y.
"Make PERFECTION your SELECTION"

INSTANT—POSITIVE—NOISELESS

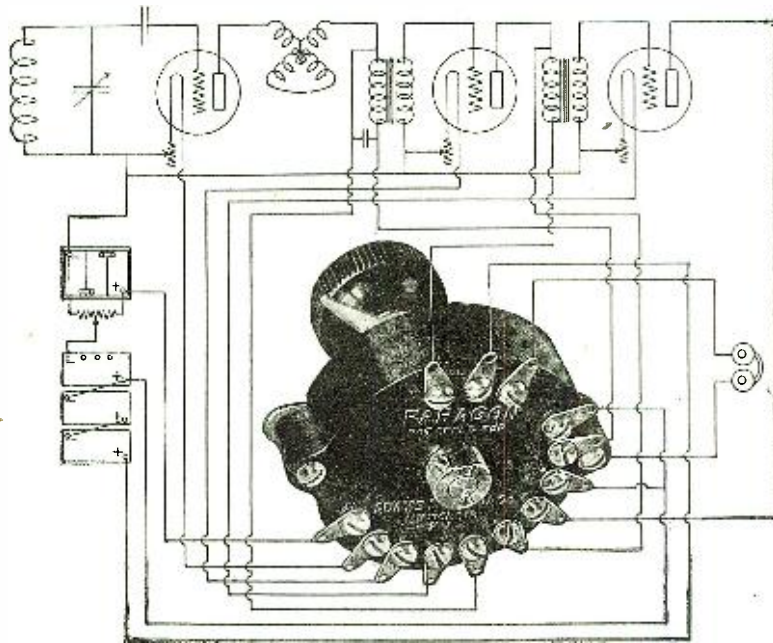

Paragon Stage Control Switch

Plugs and jacks are now obsolete. The PARAGON Stage Control Switch combines the functions of three multi-circuit jacks and the telephone plug. It controls, automatically and progressively, all the filament circuits, plate battery circuits and input and output circuits of the detector - two - stage amplifier.

Switching from stage to stage is instantaneous, positive, noiseless. All battery circuits are protected. The wiring of amplifier is simplified.

The switch base is made of molded Condensite. One piece serves as a commutator

support and housing. No moving switch parts are open to view when switch is in position on panel. A ratchet gives proper feel and locates switch position. The wiring diagram, illustrated above, shows the method of connection when this

new PARAGON switch is employed for control of detector and two-stage amplifier. The switch may also be used for an unlimited combination of vacuum tube circuits. $2\frac{3}{8}$ " in diameter, $\frac{3}{4}$ " in thickness. Price \$3.00.

We have just issued a new illustrated catalogue of Paragon radio parts. A copy is yours for the asking.

- Also Manufacturers
of
PARAGON
Radio Telephone
Transmitters
V. T. Control Units
Rheostats
Potentiometers
V. T. Sockets
Amplifier
Transformers
Detectors
Control Dials
Amplifiers
Receivers
Switches
Variometers

ADAMS-MORGAN CO., 6 Alvin Ave., Upper Montclair, N. J.

PARAGON

Reg. U. S. Pat. Off.

RADIO PRODUCTS

"SIGNAL TRIUMPH"

COUPLER-METER

THIS instrument marks a new stride toward the ultimate in Radio perfection.

It is a combination of vario-coupler and variometer; it is simplicity itself; it is efficient to a surprising degree; there are no taps, no solder and no complications.

DEALERS—Stock it now—there is no end to the demand. Retail at \$6.50, including 3-in. dial.

Sample will be sent on memorandum to any rated concern, upon request.

We also manufacture complete V. T. Receiving Sets, with or without amplification, fixed and variable condensers, dials, V. T. sockets, binding posts, etc. Write for discounts and full details.

DO IT NOW!

If your Dealer cannot supply your order direct.

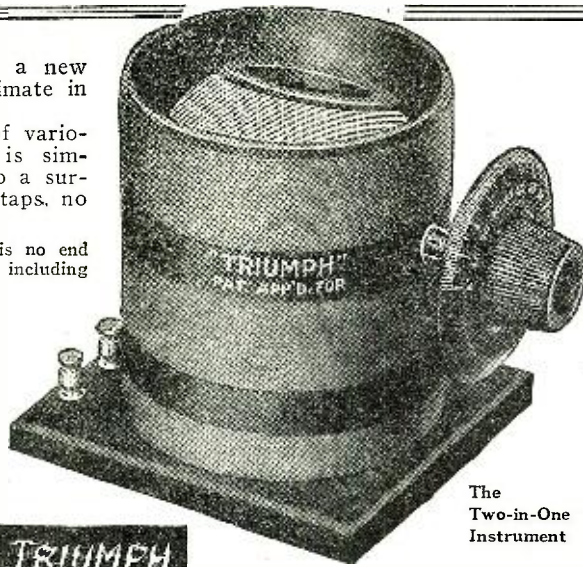

TRIUMPH

The Two-in-One Instrument

SIGNAL RADIO & ELECTRIC CORP. 64 UNIVERSITY PLACE NEW YORK CITY

Are YOU From Missouri?

Mounted
\$4.50

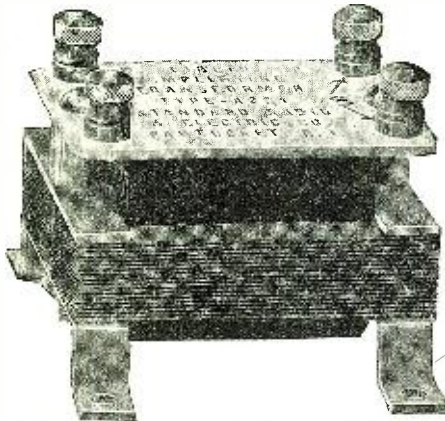

Unmounted
\$3.50

In one month this Transformer has received approval from Maine to California

THEN TRY THIS

GIBLIN Audio-Frequency AMPLIFYING TRANSFORMER

Designed for use with standard amplifying tubes. Maximum amplification without noise or distortion. May be placed in any position without pre-magnetic coupling and squealing.

STANDARD RADIO & ELECTRIC CO.

PAWTUCKET, RHODE ISLAND

LIBERAL DISCOUNTS

3000 OHM SETS, \$3.98

PLUS 20 CENTS POSTAGE AND PACKING
Satisfaction Guaranteed or Money Back.



We mail phones the day your order arrives. Every pair tested, matched, and guaranteed as sensitive as \$8 to \$10 Sets. Circular Free.

Tower Mfg. Company

105 STATION STREET, BROOKLINE, MASS.

KEEP A DAY AHEAD

of the headlines of tomorrow's newspapers!

Don't be satisfied with the regular broadcasted programs! Get the most out of radiol! Hundreds of radio enthusiasts are doing it!

Equip your vacuum tube set with a

FINCH RADIO RELAY

and you will automatically receive and at the same time have a permanent record of all the important and interesting news events of the world, whether or not you know the code.

Send Today for Booklet R1

FINCH RADIO MFG. CO.
303 FIFTH AVE., N.Y. CITY.

mention here a case of trouble from harmonics which although having little or no bearing on the subject in mind, nevertheless may be of interest. At a certain station in the south of France the third harmonic from "FL" (Eiffel Tower) came in so strong as to render receiving of the signals of another station possible only under difficulties.

However, in regard to the capacitive coupling, there is no doubt that the capacitive coupling scheme for the lower frequencies (longer wave-lengths) is a great improvement over that of the inductive scheme. In considering them both we may keep in mind that if the inductive scheme is used, there must be a certain amount of mutual induction between the two circuits. Where there is mutual induction, there is induction and a transfer of energy. If there is none, or extremely small mutual induction, there is no induction and, therefore, no transfer of energy. Where there is a transfer of energy from one winding to the other, there is a loss of energy and at the same time the surrounding conductors, perhaps from other parts of the receiver which should not be in the formed field at all, are absorbing energy which may or may not improve the audibility of the received signal. In many cases it not only does not improve the signal but many squawks and howls may be traced directly to that cause.

Considering the fundamentals of some simple characteristics of a high frequency circuit, we are reminded that any oscillating circuit is more or less of an antenna. If its form be of the correct practical kind it will radiate when it is desired that the circuit do so. When no radiation is desired, another form of circuit will fill the expectations. Taking the instance of radiation, we find that for the detection of this radiation there are three principal means of detecting or absorbing the energy from radiating circuits. "Radiating Circuits" we may class as those which radiate largely or a large amount of their entailed energy as *Radiating Circuits*, while those radiating feebly we may class as "Non-Radiating Circuits." This classification is made because all oscillating circuits radiate a certain amount of their energy, be it small or large. However, the first of the three best known methods of picking up energy and isolating it in a local circuit is that of placing conductors at right angles to the static field; second, placing conductors at right angles to the magnetic field; and third by placing non-conductors in the field. The last method is not used in ordinary practice, although it has some manifest possibilities of great utility in specific applications.

In the ordinary antenna of the usual form, the first and second methods are incorporated often unconsciously by the antenna builder, especially by the novice or the amateur experimenter. The dimensions and form of the ordinary antenna combine the two methods in one application. It is manifest that the combination of the two methods would appear to be really the best and the most efficient. One might point out that the building up of current in the receiver windings is at least certainly not disparaged by a point of view gained from first thought of the actual action taking place during the reception of signals.

The logical conclusion is that a combination of the two coupling methods would bring about the reception of signals with better audibility than either

FOR BETTER RESULTS USE

EVEREADY

"A" and "B" BATTERIES
WITH YOUR RADIO SET

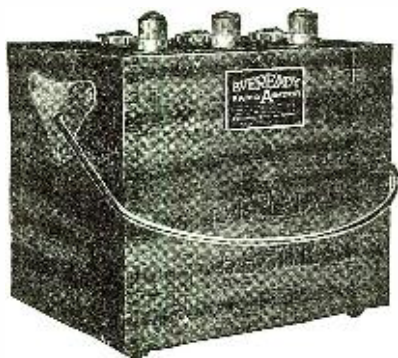

EVEREADY "A" BATTERIES

- No. 6810 - 50 Amp. Hrs. - \$15.00
- No. 6860 - 90 Amp. Hrs. - 18.00
- No. 6880 - 110 Amp. Hrs. - 20.00

Hardwood Box, Mahogany Finish—Convenient Handle, Nickel Plated—Rubber Feet, Protect the Table

Cannot Be Accidentally Short-Circuited

Unique arrangement of taps permits current to be drawn at 2, 4 or 6 volts.

EVEREADY "B" BATTERIES

Guaranteed to Be Absolutely Noiseless

No. 766 is the most popular size, and its use is recommended by most radio engineers and by experienced operators. The larger size of its 15 cells result in a much longer life, which far outbalances its increased cost over our No. 763. We strongly recommend the use of this No. 766 where ultimate economy is the important consideration. It is equipped with Fahnestock Spring Clip Binding Posts, giving variable voltages from 16½ to 22½ in 1½ volt steps. Dimensions: length 6⁵/₈" ; width 4" ; height 3" ; weight 3 lbs. 7 oz.

Price, \$3.00

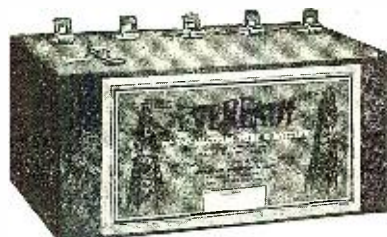

No. 763

Contains 15 cells of small size and enclosed in waterproof cardboard box. It is equipped with five brass strip positive taps ranging from 16½ to 22½ volts in 1½ volt steps, which covers the requirements of all present day soft detector tubes. Because of its limited capacity, due to its small cells, this battery is recommended for use only where light weight and small space are essential. Dimensions: length 3³/₄" ; width 2" ; height 2¹/₂" ; weight 13 oz.

Price \$1.75

No. 767

Contains 30 cells of the same size as in No. 766. This battery was designed especially for use in connection with vacuum tube receiving sets employing a detector and one or more stages of amplification. In reality it is two No. 766's in one box. It therefore has the same desirable characteristics of economy and long life as the No. 766, and is recommended for use wherever 45 volts is required. It is provided with five positive taps ranging from 16½ to 22½ volts for detector tube control, and a 45 volt tap for the amplifier tubes. All terminals are of the Fahnestock Spring Clip Binding Post type. Dimensions: length 8" ; width 6³/₄" ; height 3" ; weight 9 lbs.

Price \$5.50

No. 746

Contains 72 cells of the same size as in No. 766, and gives a maximum voltage of 108. It is equipped with Fahnestock Spring Clip Binding Posts giving following voltages: 16½, 18, 19½, 21, 22½, 45, 108. This type of battery is frequently used in connection with loud speaking devices requiring high amplification. With the above arrangements of taps, it is possible to use the same battery to operate not only the loud speaker, but the radio receiving set as well. These taps also make this an ideal battery for those who wish to experiment with a Super-Regenerative Circuit. The battery is assembled in a wooden box of neat appearance and sturdy construction. Dimensions: length 17" ; width 9" ; height 3¹/₂" ; weight 20 lbs.

Price \$15.00

Columbia Ignitor Six-Inch Dry Cells equipped with Fahnestock Connectors

Columbia Dry Cells are suitable for the filament or "A" circuit of Westinghouse WD-11 Vacuum Tubes, which require one six-inch dry cell per tube

NATIONAL CARBON COMPANY, Inc.

Long Island City, N. Y.

Atlanta

Chicago

Cleveland

Kansas City



Stahl Insulated Short-Proof Variable Condenser

*Impossible for Plates
to Short Circuit*

Insulation Complete—All plates are made of high grade dielectric material. One surface of each plate is electro-copperplated. Copper surfaces cannot touch. Climate and weather conditions cannot affect it.

Uses half the usual space—Closeness of plates allows smaller size. Can be placed farther apart in set, reducing inductive effect.

Manufacturers of Radio Sets are invited to arrange with us for the adoption of the Stahl Insulated Condenser as standard equipment.

WRITE FOR BULLETIN

Stahl Rectifier Co. 1457 W. Congress St. Chicago :: Illinois

Actual Size 23 Plate

Standard Capacity	
11 plate, 00015.....	\$3.00
23 plate, 0005.....	\$3.30
43 plate, 001.....	\$3.75

Prices without dial or knob

of them alone, when utilized with the opposite of the method usually used for the respective short and long waves. And certainly indications point out that a combination of the two methods will more nearly fill the requirements in the long short wave receiver, which is generally the aim of the average experimental builder of radio receivers.

If we suppose, say, an increase in signal strength using the combined methods is 1/64 of unity audibility, the difference is not apparent to the ordinary ear yet when we employ a three-stage amplifier the difference is quite apparent.

The coupling capacitive scheme, if desired, can be quite easily incorporated in the receiver with little trouble or expense. A simple three-plate variable condenser will generally serve the purpose very well. The accompanying diagram shows the negative of the plate battery connected through the phones to the filament. The positive of the plate battery is split into two legs, the first leads to the tickler coil and the other either directly or indirectly to the ("RE") or lower leg of the secondary receiver, thence leading through the coupling condenser to the filament. The upper plate of the coupling condenser leads to the grid lead of the secondary circuit.

The action of the coupling condenser is very simple. The total capacity between the three plates remains the same, whether the middle plate is moved one way or the other. This maintains the tuning of the secondary of the receiver stationary, as far as it is concerned by the manipulation of the coupling condenser. The capacity of the upper plate to the center one is decreased as the middle plate is moved outward because of the reduction of the actual working surface of the opposing plates. Nevertheless the capacity of the upper to the lower plate is proportionately increased. The effect of the movement of the center plate is the same as if two variable condensers were connected in series with a lead from between them leading to the filament, and the changes in their capacity effected differentially. That is, as one is reduced the other is increased, maintaining their total series capacity the same for all adjustments.

The scheme combining the two methods is really most practical, and careful application to the projected receiver will show some excellent results after its completion. The flexibility and the ease of adjustment is highly desirable. Other capacitive coupling schemes may be interpolated, but the net result, and in most cases the actual hook-up, is really the same.

SPECIAL OFFER

1 COUPLER \$15²⁵
2 VARIOMETERS



Moulded Variometer \$5.50

Moulded Coupler \$5.00

VARIOMETER. The stators and rotor are moulded of hard rubber and are highly polished. Green double silk-covered wire used. All parts nickel plated. Clearance between rotor and stator is .0005 with a + or - of .0002 either way. Large dimensions permit the use of low resistance wire. No paraffin or shellac used in wiring. Shaft 3-16" or 1/4". Wave length, 150 to 650 meters.

COUPLER. 180°. Rotor moulded of hard rubber, all windings of green double silk-covered wire. Primary tube made of high di-electrical composition 1/8" thick, mounted at 45° angle, adapted for base and panel mounting. Shaft 3-16" or 1/4" nickel plated fittings. Primary wound with 50 turns of wire tapped every fifth turn. Effective tuning range, 150 to 650 meters.

We pay transportation charges. If you are not satisfied in every way with our equipment return it at once and we will refund the purchase price.

Radio Instrument & Panel Co. 26 N. Desplaines St. CHICAGO, ILL.

The Marconi Radio Bell

(Continued from page 1263)

its travel, thus cutting the circuit, at the end of the allotted period. The magnet then ceases to be energized and the handle reverts to its original position.

The "call receiver," as will be seen from the photograph, is also a self-contained unit. It consists of two receiving valves with auxiliary circuits and condensers, for amplification and tuning of the incoming call signal; a reaction transformer increases the sensitivity and the signal passes through a galvanometer and two relays to a bell. In practice, the incoming signal is first received in the usual way by the main receiver, the telephone terminals of which are connected to the primary of a variably coupled transformer, the



The Tube-O-Phone Fits any receiver. Works with any set.

Single Tube-O-Phone (for 2 people) - \$2.50
 Pair of Tube-O-Phones (4 people) - \$4.50
 Extra branch for one person - \$1.25

Postpaid Guaranteed
 Attractive discounts to dealers

SCIENTIFIC DEVICES CO.

BOX 129 :: :: WILKINSBURG, PA.

BATTERIES

DIRECT FROM FACTORY
AT WHOLESALE PRICES

Finest materials and workmanship. Long life—easy charging. Guaranteed 24 mos.

11 Pl. (6V.)—Ford, Chev., Mitchell, Hupp, Grant, Vellie, \$12 Saxon.....

13 Pl. (6V.)—Buick, Cleve., Reo, Paige, Dort, Nash, \$14 Hudson, Stude.,

7 Pl. (12V.)—Dodge, Franklin, Royal, Briscoe, \$17.50 Crow Elkhart.



Radio Batteries

80 amperes.....\$11 100 amperes.....\$13
 Shipped express C. O. D. day order is received.

WESIDE BATTERY CO., Dept. 26

4445-47-49 W. Madison St. Chicago, Ill.

PACENT ESSENTIALS

STANDARD WITH LEADING MANUFACTURERS

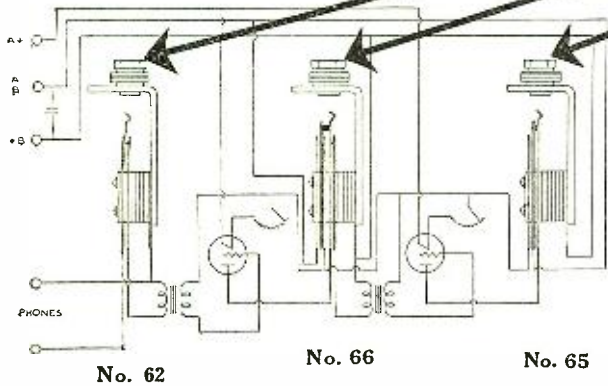
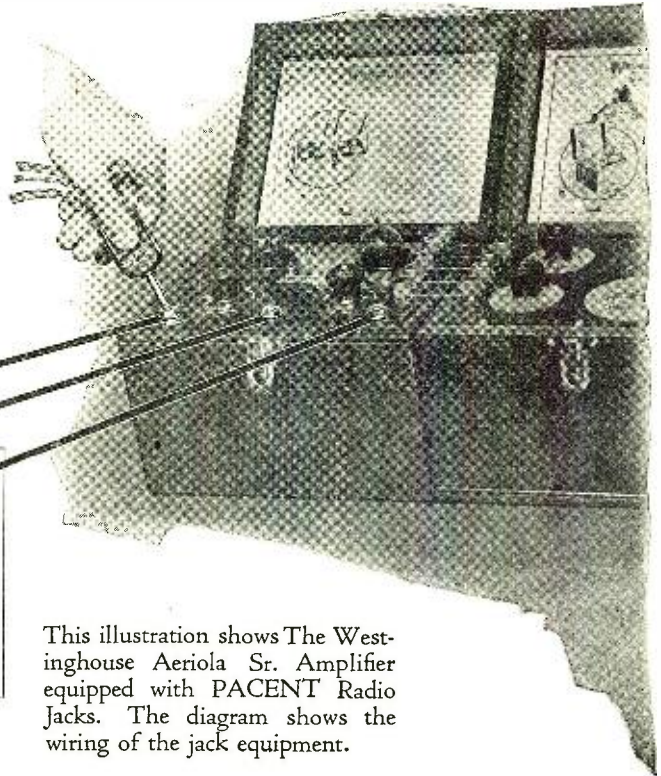

This illustration shows The Westinghouse Aeriola Sr. Amplifier equipped with PACENT Radio Jacks. The diagram shows the wiring of the jack equipment.

Better Results with Pacent Jacks

When a radio set manufacturer puts his name on a set he acknowledges responsibility for satisfactory performance of *every part*. The parts that he doesn't make, he necessarily chooses with the greatest care. Experienced Radio Engineers choose PACENT Radio Jacks as standard equipment. This is the set manufacturer's acknowl-

edgment that PACENT Jacks meet his requirements and can be depended upon to function properly. Good sets are made BETTER with PACENT Jacks — the FIRST Radio Jacks made. Every PACENT product embodies the highest radio engineering skill and over fifteen years practical radio experience.

Don't Improvise—“PACENTIZE”

Look for the PACENT Trade Mark. It is your guarantee of QUALITY, ACCURACY and DEPENDABILITY in Radio Essentials.

Write for descriptive Bulletins (R. J. 106)

PACENT ELECTRIC COMPANY

INCORPORATED

Manufacturers and Distributors of Radio and Electrical Essentials

Executive Offices: 22 Park Place, New York, N. Y.

BRANCH OFFICES

Philadelphia, Bourse Building
Chicago, 33 So. Clinton Street.



Washington, D. C., Munsey Bldg.
San Francisco, Sheldon Bldg.

Members, Radio Section, Associated Mfrs. of Electrical Supplies

*Canadian and British Licensees:
Colonial Radio, Ltd., Hamilton, Canada*

Save \$4
on the worlds
supreme Head Set



**DICTOGRAPH
Radio HEAD SET**
Was \$12 - Now \$8

Now you get the world-famous Dictograph Radio Head Set at a clear reduction of \$4.00! The tremendous demand has made necessary increased production on a gigantic scale. The new price is only \$8.00—for the same supreme Dictograph Head Set that has always sold at \$12.00. Made by the makers of

world-standard Dictograph products, including the marvelous "Acousticon" for the Deaf, the Detective Dictograph, the Dictograph System of Loud Speaking Telephones.

3000 Ohms, for all types receiving sets. Regularly furnished as standard equipment on leading radio receiving sets.

The Standard of the World

**DICTOGRAPH
Radio LOUD SPEAKER**



The perfect Loud Speaker for the home. A handsome instrument of superb quality—and only \$20, complete with 5 ft. flexible cord. Reproduces every sound in clear, natural tones, free from noise.

\$20

DICTOGRAPH PRODUCTS CORPORATION
220 W. 42nd STREET (Branches in all principal cities) NEW YORK CITY

"IMPROVED" ANTI-CAPACITY JACKS
The First and Only Jack Designed Exclusively for Radio



"Improved" Double Circuit Jack. Price\$1.00
Closed Circuit Jack85c
Open Circuit Jack70c

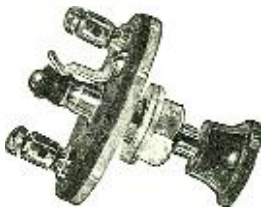

"Improved" Battery Switch
Price\$1.00

AFTER putting up with adaptations of the old telephone jack for years, the radio industry has enthusiastically received the much-needed "Improved" Jacks.

The practical elimination of capacity by doing away with long parallel leads and the binding post terminals—no soldering necessary—are features that especially appeal to the radio expert.

Many radio manufacturers, appreciating the value of the "Improved" Jacks, are now using them, adding to the appearance of their sets and saving money.

The "Improved" Battery Switch instantly connects or disconnects the "A" battery and protects your expensive set from tampering.

To the Trade

Our definite sales policy affords you protection. Wire, write or call for open territories.

RADIO IMPROVEMENT CO.
25 West 43rd Street New York, N. Y.

ELECTRICAL EMPLOYEES!
PRACTICAL ELECTRICS

We desire a Special Representative in every Electrical Manufacturing Plant—everywhere—to solicit subscriptions to

The most unique and interesting magazine in the electrical field. It is an electrical magazine for the man who is not an electrician—for the novice and the beginner—as well as for the experimenter, the proficient electrician and the electrical engineer. It is written in plain "everyday" language that all can understand. Many of the world's foremost electrical writers, experimenters and students contribute to its pages. Many novel features and prize contests each month. We pay splendid commissions. For details, sample copies and subscription blanks write to
C. J. Wolfe, PRACTICAL ELECTRICS CO., Inc., 53 Park Place, N. Y.

secondary forming the grid circuit of the first valve of the "call" receiver. This circuit is very accurately tuned by means of a variable condenser to the particular note frequency allocated. The plate circuit of this first valve is inductively coupled to the grid circuit of the second one and also contains a grid condenser and leak, together with the secondary of the reaction transformer. Note frequency tuning is accomplished at this stage by another variable condenser. The anode circuit includes a small galvanometer and the windings of a telegraph relay, connected to another dashpot. Owing to the presence of the grid leak the second valve normally allows the passage of sufficient current to hold over the tongue of the relay against the "dead" stop. The reception of a signal, however, renders the grid so negative as to reduce the current through the valve. This reduced current is no longer sufficient to hold over the tongue of the relay, which consequently passes to the other stop, thus immediately completing the circuit through the dashpot relay. This dashpot is timed in the same manner as the one which controls the duration of the signal at the transmitting end, and once set in motion by the telegraph relay, it completes its travel and operates the bell. It will be seen that only those signals sent by the "call" transmitter can operate the "call" receiver and ring the bell.

The "call" transmitter and "call" receivers are connected up to the main set through the respective terminal boards, each connection being clearly marked. The telephones are hung on the rest provided on the extreme right of the "call" receiver, this automatically putting the latter in a stand-by position, ready for registering a call. To effect the call, the send-receive switch of the main set at the transmitting end is placed in the send position (i.e., to the left) whereupon the valve set starts oscillating. The handle of the "call" transmitter is then pulled down to its full extent and released. From this point onwards the operation is automatic, as the handle is restored after the required period has expired, this being determined as explained above, by the transmitter dashpot. At the receiving end, the call bell is set in motion and continues to ring until the telephones are removed from the rest, whereupon the "call" receiver will automatically be put out of action and its valve extinguished. The high and low tension circuits for the valves of both call transmitter and receiver are fed from the already existing source used for the main sets.

The far-reaching importance of this new development needs little further emphasis, especially in its application to a network of stations. Suffice it to say that by effecting a saving in stand-by charges and materially adding to the convenience of operation, it leads as a natural sequence to a far more practical and extensive use of wireless telephone services. And so, owing to the devotion and constant application to their task, research engineers in all parts of the world are daily overcoming hitherto impossible obstacles, and without a doubt the time is not far distant when one shall be able to call up any radio telephone station with as much ease as one calls a telephone number by means of the automatic system, without requiring the need of a central, and permitting the conversation to be conducted in all secrecy, just as on a private wire, actually.



AMRAD RADIO

for the

HOME

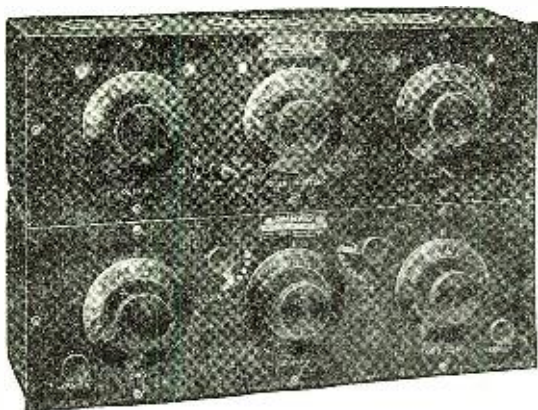

Amrad Short Wave Receiver, Price \$107.50
Amrad Crystal Receiver, Price 21.50

Note: If you can't see these actual instruments at your dealer's, write us for free Bulletins B and 345.

Amrad Radio in YOUR Home provides a common interest to every member of the household—almost every hour of the day. Something instructive and entertaining to keep the family together, especially in the evening.

Amrad Radio Receiving Sets—large or small—incorporate the latest, TESTED refinements only possible after many years of actual radio engineering manufacturing experience.

Superior performance, reasonable cost, lasting satisfaction—if your Radio is Amrad.

Order Amrad from your dealer. If he doesn't stock at present, place your order with him. Complete Catalog, describing entire Amrad Line, 10 cents in stamps.

AMERICAN RADIO AND RESEARCH CORPORATION

General Office, Factory and Laboratory

203 College Ave., Medford Hillside, Mass.

New York
 15 Park Row

Chicago
 220 So. State St.



CHELSEA REGENERATIVE RECEIVER

A Real Broadcast Receiver

Range 150 to 800 meters

- ¶ Perfection in design
- ¶ Pleasing appearance
- ¶ Simple and accurate tuning

\$40.00

A Chelsea product, embodying Chelsea equipment throughout. Licensed under Armstrong U. S. Pat. No. 1113149. For amateur use only

Write for our new No. 7 catalogue

CHELSEA RADIO COMPANY

179 Spruce Street Chelsea, Mass.

Broadcasting to the Neighbors

(Continued from page 1263)

noon hour the men constructing the building are entertained by music from KLS, Warner Brothers' Radio Station, which transmits between twelve and one o'clock. All report the signals loud and, except when street cars pass, every word may be distinguished. This is a remarkable feat and has not been paralleled as yet.

Upon another occasion an amateur operator residing five blocks distant from Larzelere was annoyed by the music from the San Francisco Examiner one afternoon. Not hearing the station "sign off" he concluded that someone nearby was playing a phonograph in his backyard. Hearing the music again the following day the inquisitive amateur decided to investigate. After prowling around the vicinity to the west of his home he finally located the "phonograph" at 1458 24th Avenue. The skeptical amateur could hardly believe that he had heard radio telephone music from such a distance with such clarity.

For the benefit of the investigator Mr. Larzelere disconnected the Magnavox and substituted a pair of receivers and let the amateur verify the fact that he was hearing actual radio telephone music.

Mr. Larzelere states that practically none of the neighbors possess radio receiving instruments, and he hit upon this unique idea of re-broadcasting music entirely for the pleasure of the nearby residents, some of whom even in this era of radio had never heard radio music through the air.

Baseball enthusiasts were entertained from October 4 to 8, when the results of the baseball games between the New York Giants and the New York Yankees were broadcasted by KPO in this city. Mr. Larzelere had his apparatus working so that the score, play by play, was known to the residents of Sunset District in San Francisco at practically the same time the plays occurred at the Polo Grounds in New York City.

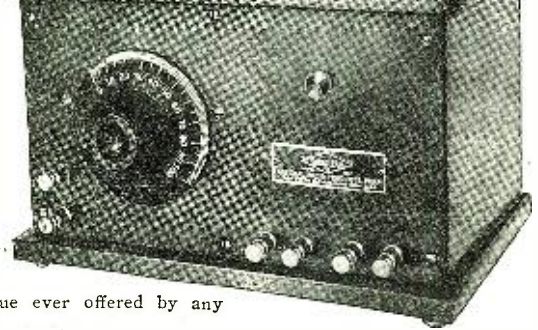

Here's the Radiolean Jr.

Everybody wants this popular price Radio Set.

Looks like a Detector Tube Set and can be changed into one at small cost. The Biggest Value ever offered by any Radio manufacturer.

This wonderful crystal receiving set is being sold for \$12.50 retail price which includes all equipment except phones. Head phones from \$3.00 upward. Get our prices on any radio goods you need and compare same with other dealers.

SPECIAL XMAS OFFER

WESTERN ELECTRIC HEAD-SETS (Army type) **\$7.50**

U. S. NAVY TUBES (Amplifying, Detector and Transmitting)... **\$4.25**

PORCELAIN RHEOSTATS Each **35c**

The "Radiolean Jr."

PRICE **\$12.50**

without Headset **\$15.00**

with Headset

Order the Radiolean Jr. at any Radio Dealer, Department Store, etc., or Direct from

NATIONAL RADIO PRODUCTS CORP.

509 Fifth Avenue
New York

Some Real DX Work

(Continued from page 1289)

I resumed the hunt and immediately picked up 9AMB, Denver, Colo. A few seconds later came forth 4BX, Wilmington, N. C., calling "CQ." I hesitated and wondered why Godley used all those mysterious looking radio frequency circuits, separate heterodyne, 'n everything. A slight variation of the tickler element and there was 5KC, Plaquemine, Ala., who was communicating with 8DX, Detroit, Mich. A few seconds later I was listening to 5PX, Fort Worth, Texas, calling "CO" 9BED, St. Louis, Mo., was heard. Then 9APS, Covington, Ky., 4BX, Wilmington, N. C., was logged again calling 9AAP, Milwaukee, Wis. Again I heard 5PX, Fort Worth, Texas. I was rambling at the speed of light from one place in the North to the South, thence to the East, and over to the West. The results were great. Here is 8AB, Port Huron, Mich., 9BED, St. Louis, Mo., 9BBF, New Ulm, Minn., and again 4BX, Wilmington, N. C., working with 9II, Fort Wayne, Ind. 4EB, Palmetto, Ga., calls forth to 9ARZ, Clear Lake, Iowa. 8BAR, Lancaster, N.Y., is

Radio Fans

Save time and money in getting and keeping your Radio Set in working order. Our new book, "The Home Radiophone," explains in simplest terms the construction, installation and operation of all types of radio sets. It also contains alphabetical list of 400 broadcasting stations, conventional signals, and a fund of other useful information about Radio.

Every radio owner should have it. Mail letter with 25 cents today.

NATIONAL RADIO INSTITUTE

Dept. 13 A-2 Washington, D. C.



BOYS! A REAL RADIO SET ABSOLUTELY FREE

RUSH your name and address and we will tell you HOW you can get this RADIO SET ABSOLUTELY FREE. RADIO SET comes to you complete, with single slide tuning coil, crystal detector and phone condenser, AND DOUBLE HEAD PHONES. No batteries required; no experience. Write Today for Free Radio Plan.

HOME SUPPLY CO.
131 Duane St.
Dept. 218
New York City

The BENWOOD Co. INC.

RADIO

"WORLD-WIDE MAIL ORDER SERVICE"

1500 Miles With CW! 1100 Miles Voice!

Music Heard 40 Feet From Phones By Stations In 300 to 400 Mile Radius

THESE are actual results obtained by our testing station WEB, using the Benwood CW Transmitter shown herewith. You can get just as good results with it. This high class set is just the thing for your broadcasting and DX work—using CW, ICW, Modulated Buzzer or Voice Transmission. An ideal set for the local radio club or the more progressive amateur. Think of the range this set will give you! If centrally located, you will be heard in almost every state in the Union. It is manufactured exclusively by and for the Benwood Co. and combines the best in material, workmanship and design.

RADIATES 1½ TO 3 AMPS. ON AVERAGE ANTENNA

We guarantee that this outfit will radiate 1½ amperes on the average amateur antenna. It will radiate 2 to 3 amperes when used with an antenna whose fundamental wave length is 225 to 275 meters. That is why you can get such wonderful results.

The set comes to you completely assembled with all parts mounted on panel, as shown, and completely wired. You can start sending as soon as you insert tubes and attach to antenna and ground. The outfit is complete with motor generator minus tubes, and consists of the following: Panel 12x18x3/16, angle supports, hardwood base, 3 tube sockets, 1 power rheostat, one 80-watt filament trans., 1 modulation trans., 1 CW inductance, 1 hand transmitter, one 0.3 Radiation meter, one 0.500 milliammeter, one 21-plate condenser, one 43-plate condenser, 1 tapped condenser, one L300 choke coil, one 2000-volt filter condenser, one 10,000 ohm grid-leak, plug and jack connection for microphone buzzer and CW, one 600 volt 220 watt motor generator. Boxed for shipment, \$350.00 f. o. b., St. Louis, Mo.

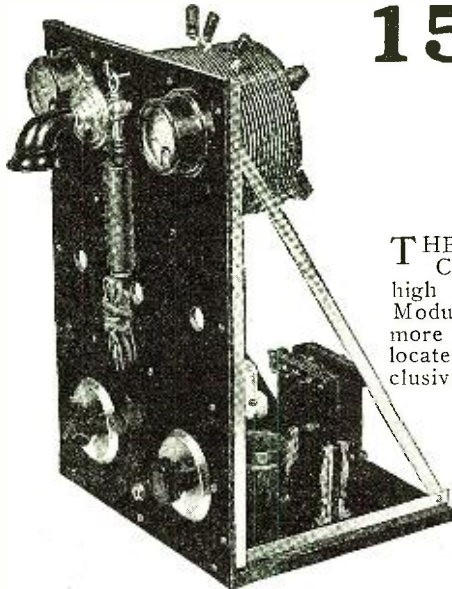

The Benwood C W Transmitter

Licensed under Armstrong U. S. Patent No. 1,113,149 and pending letters of patent No. 807,388
Simple, compact, up-to-the-minute construction—incorporating all the improvements made possible by our years of experimenting—and it gets results!

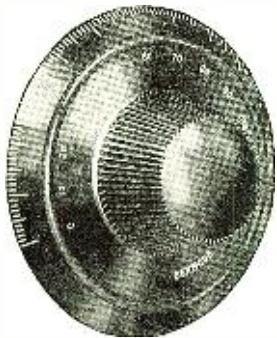

Benwood Bakelite Dial

SOLID Bakelite throughout—highly polished. Has extra large, tapered knob, which fits the fingers perfectly. The knurling is particularly fine and sharp, affording an excellent grip. Graduated 0 deg. to 100 deg., all markings clearly defined in white and stamped into the solid Bakelite—won't wear off. Ribs on reverse side prevent turning too far. Dial lies perfectly flat against your panel and will not warp or buckle.
BC-7, Dial, 4" diam., \$2.00
BC-8, Dial, 3½" diam., 1.75 each.



Benwood V. T. Socket

SOLID, highly polished, molded Bakelite, specially designed for either base or panel mounting—the only one of its kind. Firmly holds any standard four-prong detector or amplifier tube. Minimizes ground hum and noises in operation of amplifiers. Terminal posts plainly marked. Base is 2¾ in. square, height 1½ inches. \$1.00 BC-10, each.....

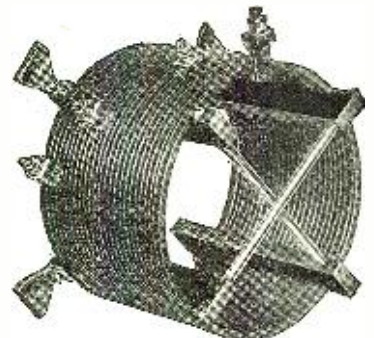

Benwood C. W. Inductance

THIS is the only CW Inductance made for panel mounting. The copper ribbon is wound on FORMICA supports, giving highest possible insulating qualities. Each Inductance furnished with four of the new type BENWOOD PATENTED HELIX CLIPS, which will fit either a round or flat surface. Each clip furnished with moulded insulated handle which enables tuning of the set with current on. Standard size, as shown in cut, consists of 25 turns of edgewise wound soft drawn copper strip 3/16 inch in width and 1/16 inch in thickness. Turns are full 6 inches in diameter. Type BC-15, for wave-lengths under 250 meters, each \$8.50
Type BC-16, for wave-lengths over 250 meters, each 12.50

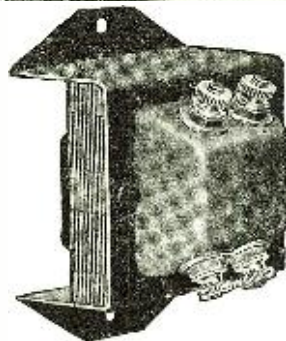

Benwood Audio Transformer

COMPLETELY sheathed in metal, avoids all inductive effects and gives full 4 to 1 amplification without howling or squealing. Base is 2¾"x3¾", height only 2 inches—ideal for either base or panel mounting. Core is best laminated steel, giving highest transference of energy. Use it with any amplifier tube and get strong, clear signals, BC-6, each \$5.00



Benwood Variable Condenser

NOTE the improved stationary plate design—this condenser has the greatest capacity for over-all size of any variable condenser made. Single bearing, wiping contact assures positive connections. Heavy aluminum plates will not bend or buckle. Bakelite ends. 43 plate, .0015 mfd., each.....\$5.00
21 plate, .0008 mfd., each...4.00
11 plate, .00025 mfd., each...3.75



Benwood Binding Post

HAS tapered knurled, solid Bakelite grip to match Benwood dials. Exposed metal parts highly nickel-plated. BC-16, as shown..... 20c

CATALOG: Send 10c in stamps for price list, also complete catalog and price list of DeForest radio equipment.

DEALERS: We manufacture a complete line of radio apparatus. We have stock on hand and ready to ship. Write or wire for our attractive proposition. New price list just issued.

THE BENWOOD CO., INC. 1111 OLIVE STREET ST. LOUIS, MO.

USE THIS COUPON

The Benwood Company, Inc.
1111 Olive St.
St. Louis, Mo.

Enclosed is 10c in stamps—please send me your up-to-date catalog and latest prices.

Name

Address

City State

Beautiful "Pioneer"
VARIO Meters and Couplers
 (Circassian Walnut Finish)

Much superior to wood, in durability, beauty and operating efficiency.
 Both rotor and stator are wound with the finest green silk-covered wire—very attractive.
 Hardware is solid brass, nicked and buffed—richly beautiful.

Something New in Variocouplers

Wound on the **INSIDE** of the sphere—just like a variometer!

This exclusive construction gives truly remarkable results. Patent applied for.

"Pioneer" Variometers and Variocouplers are accurately balanced—each instrument being tested before it leaves our plant. Contacts are positive, enabling operator to give a delicate shading to all signals—a source of infinite satisfaction to the set owner blessed with a true ear for harmony. A surprise for you in selectivity and amplification.

Wave-lengths—150-750 meters.
 Table or Panel Mounting.
 Order thru your dealer. Say "Pioneer or Nothing" and stick to it. Circular on request.

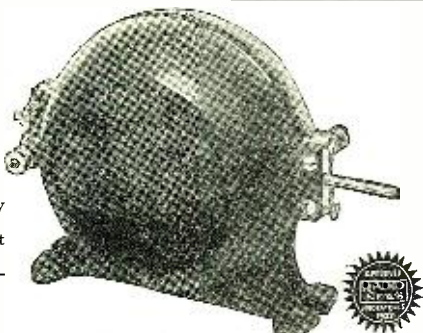

Pioneer Variometer—\$6.50

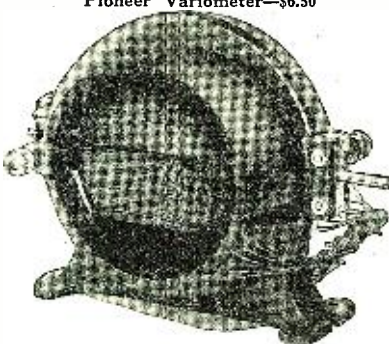

Pioneer Variocoupler—\$7.00

PIONEER RADIOPHONE CORPORATION - Galesburg, Illinois

confabing with 8CJY, Gienshaw, Pa. Where is that wishing well you gaze into and see your future lovers and enemies? Where is that magic lamp which you rub and bring forth things unthought of? All these weird things could never bring me more joy than this simple contraption of rubber, lamps, wire and batteries. What old man "Million Bucks," in his palace of arts, books and music, could boast a sport more regal than that which I enjoy in my humble little shack in the dead of the night? Here is 9BEC, Muncie, Ind., in the hub of some 1,500 miles of gossip by land and water chattering away. Here is 8BAR, Lancaster, N. Y., calling 8BCJ, Ashtabula, O. Another Godley record smashed! I tried for bigger game and found static, arcs and harmonics whining through the ether in a mad medley of flat whistling notes. But arcs are too common to the average operator. I tried again for another Godley record breaker. Here is 5JY, New Orleans, La., calling "CQ" and WUBA, Camp Alfred Vail, New Jersey, some 5,500 miles away, calling 9AT, Chicago. WUBA was logged again at a later time. I could go no further East unless I could cop off an English chap playing with a 200-watt spark. A thought soon convinced me that the British are not there with the punch. I could accomplish no better results. Through the night I kept filling the log with new amateur calls. At 2:55 a. m. I listened to 6ASJ, Oakland, Cal., carry on an idle gossip with 6UP, San Diego, Cal.

It was broad daylight on the Pacific Coast. My work was finished. I yawned, stretched, lighted a far smoked on nervously until I felt as though the covers had been carefully tucked around me, whereupon I passed way into oblivion.

Do you, kind reader, believe that amateurs on the Atlantic Coast can communicate directly with amateurs in other parts of the world? Do you want to believe this, but find no evidence worth taking seriously? Let's sum up what was actually accomplished from sundown to 2:55 a. m. on the nights of Sept. 15, 16, 23 and 24 in order to settle this great wave of popular interest among scientists and amateurs on these questions. About the easiest way out is to publish the correct data from my radio log, which is reproduced herewith:

Data from radio log of Thos. A. Marshall and H. R. Slocum on an amateur hunt on September 15-16 and 23-24. Time kept was 10½ plus zone, or Honolulu local time, which is a difference of 5½ hours between Washington and Hawaiian local time. Symbols used are as follows:

- *Intercepted messages; **Intercepted conversation; ***Intercepted conversation and messages; ****Intercepted calls and conventional signals; without symbol indicates only call letters were intercepted.
- 6:10 P. M. 5PX, Fort Worth, Texas, and 9DPL, Kansas City, Mo.***
- 6:12 P. M. 5NU, and 9UU (Frost, Texas, and Chicago, Ill).**** **
- 6:15 P. M. 5PX, (Fort Worth, Texas, and Kansas City, Mo.)*
- 6:17 P. M. 5ZTU de 9UU (Chicago, Ill).
- 6:21 P. M. 5PX de 9DPL (Kansas City, Mo.)**
- 6:25 P. M. 5PX de 9DPL (Kansas City).*
- 6:25 P. M. 9DPL de 5PX (Fort Worth, Texas).** ****
- 6:26 P. M. 9DPL de 5PX (Fort Worth, Texas).****
- 6:27 P. M. 5PX de 9DPL (Kansas City).** ****
- 6:28 P. M. 9DPL de 5PX (Fort Worth, Texas).** ****

It's in the air, but does your equipment catch it?

Get it clearly, comfortably, dependably with these:



With horn \$24.50
 With phonograph attachment, \$12.50

Atlas Amplitone Loud Speaking Unit with horn or with phonograph attachment

—The hit of the recent Chicago Show; an instrument that we think cannot be improved upon at any price. Clear, sweet tone, absolutely without the shrill mechanical shrieking heard in so many instruments.



Price \$8.00

Atlas Head Phones

—A worthy companion of our Loud Speaker; light and comfortable; perfectly matched pairs; giving every sound clearly and definitely, and holding its sensitiveness indefinitely.

Sent on request through your dealer—give his name; or sent direct, carriage charges prepaid, on receipt of price, or C. O. D., subject to examination.

Multiple Electric Products Co., Inc. 450 Fourth Avenue NEW YORK

School of Radio Telegraphy

Complete course in Radio covering arc, spark and vacuum tubes. Enrollments now being accepted for both day and evening classes. Positions assured all graduates. Your first month's salary as a radio operator is more than your entire tuition. Instruction in Morse on the sounder if desired.

Call, phone or write for information.
Y. M. C. A. RADIO SCHOOL
 158 East 86th St. New York City
 Telephone Lenox 6051
 "The Best Radio School in the East"



Made for all Phones Ask Your Dealer

THEY ARE GOOD PUT THEM ON YOUR PHONES

Slip out the metal disc and slip in the MICA PHONE. Result—Clearer, better tone, all noises eliminated. Write for circular. Discounts to dealers and jobbers. MICA PHONES sell fast.
 Radio Mica Products Co., 156 E. 43d St., New York

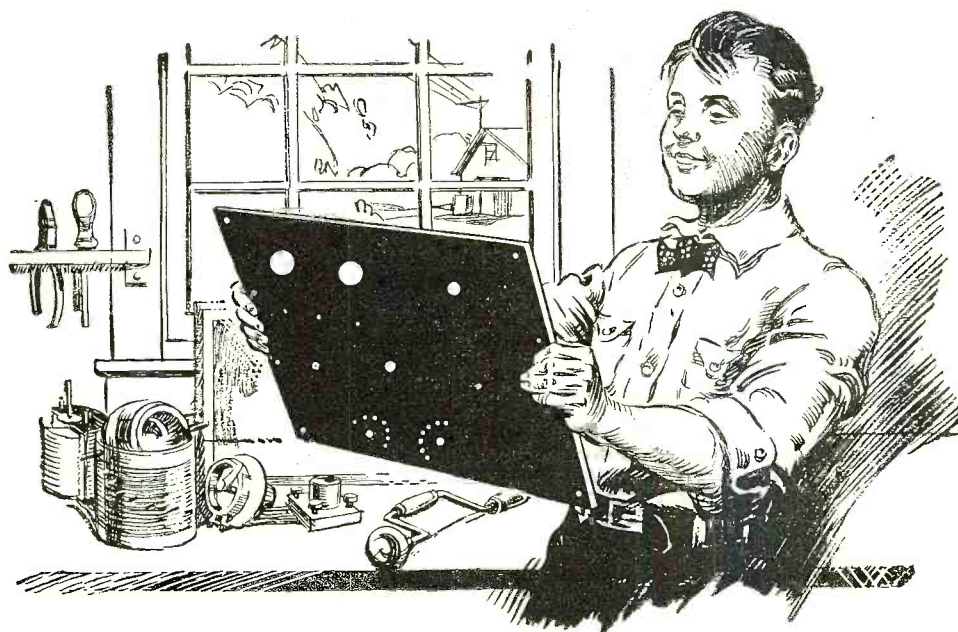

This Panel Will Improve Your Set

CONDENSITE CELORON

The best panel made is none too good for your set. Dependable insulation is vital because it has a direct bearing upon the clearness and sensitivity of both transmission and reception.

Every thinking radio enthusiast certainly wants the highest type panel he can obtain and the surest way to get it is to insist upon Condensite Celoron.

This strong, handsome, jet-black material is not merely an insulating material—it is a radio insulation made to meet high voltages at radio frequencies. That is why it will give you greater resistivity and a higher dielectric strength than you will ever need.

Make your next panel of Condensite Celoron. It machines readily, engraves with clean-cut characters and takes a beautiful polish or a rich dull-mat surface.

An Opportunity for Radio Dealers

Condensite Celoron Radio Panels and Parts offer a clean-cut opportunity to the dealer who is keen on building business on a quality basis. Write us today. Let us send you the facts. You'll be interested.

DIAMOND STATE FIBRE COMPANY

BRIDGEPORT (near Philadelphia), PA.

Branch Factory and Warehouse, Chicago

Offices in principal cities

In Canada: Diamond State Fibre Co. of Canada, Ltd., Toronto

CONQUEROR



THE
"Rolls Royce"
 of
RADIO
 RECEIVING SETS

Custom built. One Knob Control, capable of an unprecedented degree of super-sharp tuning.

The most beautiful, easiest to tune, clearest tone—tuner, detector and 2 step amplifier made anywhere at any price—bar none.

LEWIS & DeROY RADIO CORP.

560 Seventh Avenue

::

New York City

Moulded-RADIO-Accessories

Manufactured of Approved Material

Specifications Solicited

**Knobs
 Couplers**

**Dials
 Panels**

**Rotors
 Stators**

International Insulating Corporation

Radio Dept.
 25 West 45th St.
 New York City

Factory
 Springfield,
 Mass.



AMSTERDAM

SERVICE EXCHANGE

AMSTERDAM .. OHIO
 "The Radio City"

卐 RADIO 卐

Complete Stock—Both Sets and
 Parts—All Makes.

**ROSE
 RADIO SUPPLY**

129 CAMP STREET
 New Orleans, La.

Send 10c for latest catalog.

- 6:29 P. M. 9APH (Chicago, Ill.).**

- 6:30 P. M. CQ de 5PX (Fort Worth, Texas).
- 6:32 P. M. 5 ZF de 6BJY (San Diego, Cal.).****
- 6:34 P. M. 4BQ (Rome, Ga.).
- 6:38 P. M. de 4BQ (Rome, Ga.).*
- 6:42 P. M. 8BWA de 4BQ (Rome, Ga.).*
- 6:46 P. M. 9AUA de 9DSM (Omaha, Neb.).** ****
- 6:47 P. M. 7ZU de 6BJY (San Diego, Cal.).
- 6:48 P. M. 9AUA de 9DSM (Omaha, Neb.).****
- 6:49 P. M. de 5ZH (Amarillo, Texas).*
- 6:50 P. M. 7LU de 6AOI (Riverbank, Cal.).*
- 6:51 P. M. 6ZM de 9AMB (Denver, Colo.).****
- 6:52 P. M. CQ de 4BX (Wilmington, N. C.).****
- 6:54 P. M. 8DX de 5KC (Plaquemine, Ala.).** ****
- 6:55 P. M. 9DTE de 6EC (Orange, Cal.).
- 6:56 P. M. 6ZM de 9AMB (Denver, Colo.).****
- 6:57 P. M. CQ de 9BED (St. Louis, Mo.).
- 6:58 P. M. CQ de 5KC (Plaquemine, Ala.).
- 6:59 P. M. CQ de 9APS (Covington, Ky.).
- 7:00 P. M. CQ de 9DQ (Peoria, Ill.).
- 7:02 P. M. 9AAP de 4BX (Wilmington, N. C.).
- 7:03 P. M. de 9UU (Chicago, Ill.).****
- 7:04 P. M. 5EK de 4BX (Wilmington, N. C.).
- 7:06 P. M. CQ de 9AMB (Denver, Colo.).
- 7:07 P. M. CQ de 8AB (Port Huron, Mich.).****
- 7:08 P. M. 8AB de 8BPL (Unlisted).

- 7:11 P. M. de 9DPY (Unlisted).****
- 7:12 P. M. 9BBF (New Ulm, Minn.)

- 7:13 P. M. 9II de 4BX (Wilmington, N. C.).
- 7:14 P. M. 9BEK de 4BQ (Rome, Ga.).
- 7:17 P. M. 9ARZ de 4EB (Palmetto, Ga.).
- 7:19 P. M. de 6BJY (San Diego, Cal.).**
- 7:20 P. M. 8CJY de 8BAR (Lancaster, N. Y.).**** **
- 7:20 P. M. CQ de 9BEC (Muncie, Ind.).
- 7:21 P. M. CQ de 9AO (Chicago, Ill.).
- 7:32 P. M. 8ALT de 8AB (Port Huron Mich.).
- 7:35 P. M. CQ de 9DHB (Elk City, Kan.).
- 7:37 P. M. 3BQ (Hoquiam, Wash. and Vancouver Barracks, Wash.).**
- 7:38 P. M. 9DSM de 9AMB (Denver, Colo.).
- 7:39 P. M. 7KJ de BQ3 (Vancouver Barracks, Wash., Spark Station).**
- 7:48 P. M. 9AMB de 9ALT (Appleton, Wis.).** ****
- 7:50 P. M. CQ de 5JW (New Orleans, La.).
- 7:52 P. M. 9AT de WUBU (Camp Alfred Vail, N. J.).****
- 7:53 P. M. CQ de 9UU (Chicago, Ill.).
- 7:55 P. M. 9BF de 4EB (Palmetto, Ga.).****
- 7:57 P. M. SALT (Dawson, Pa.).
 ** ****
- 8:02 P. M. de 9AGS (Aurora Ill.).
- 8:04 P. M. 5ES de 8OW (Pittsburg, Pa.)****

Insure your copy reaching you each month. Subscribe to Radio News—\$2.50 a year. Experimenter Publishing Co., 53 Park Place, N. Y. C.

**VERNIER RHEOSTAT
Model 200**

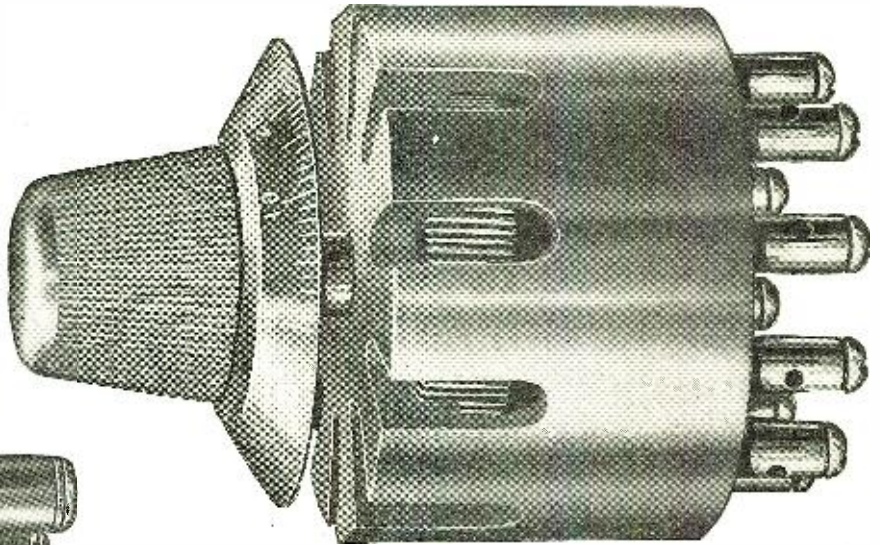
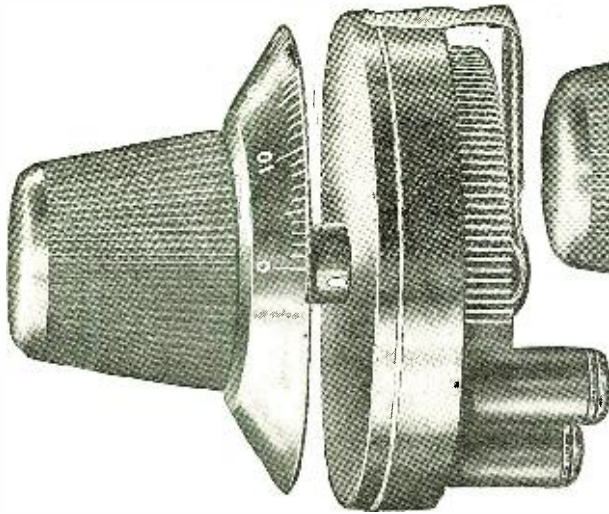

THE AMPLITROL

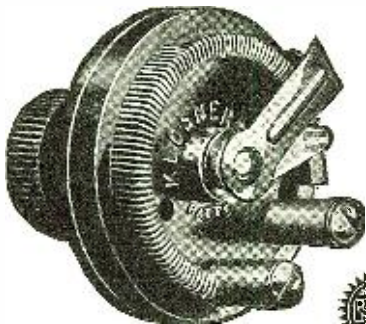

MODEL 100

The Original Vernier Rheostat
\$1.50



*No panel can be up-to-date
without these two*

**Only a Rheostat With a
Vernier Can Make Your
Set More Sensitive.**

**Does Away With Plugs and
Jacks—Makes Tubes Last
Many Times Longer.**

It is impossible to tune out interference without perfect adjustment of your detector tube. No ordinary rheostat can give you the fine adjustment necessary.

The Klosner **VERNIER** Rheostat has a micrometer adjustment that permits getting **EXACTLY** on the very spot for perfect reception

The Klosner operates both coarse and fine adjustments with **ONE** knob—a feature protected by broad patent claims. Wire-wound like all true electrical instruments.

And it has a graduated **DIAL** to show just where it is set. No guessing.

Condensite, phosphor bronze contacts, white graduations on black dial

\$1.80

Now, for the first time you can have complete control and adjustment of each amplifier tube merely by turning a simple knob. Do away with all jacks, plugs, rheostats and switches. The Amplitrol knob switches on the plate circuit and adjusts the filament circuit at the same time. You turn on any stage of amplification at will.

Lengthens the life of the tube from one-third to one-half, as it absolutely prevents suddenly throwing a heavy current onto the delicate filament. With the Amplitrol, the current is turned on **GRADUALLY**.

Genuine condensite, white graduations on a black dial, phosphor bronze contacts. Highest grade. Complete with wiring instructions,

\$4.00

If your dealer cannot supply you, don't make the mistake of accepting something "just as good." We will take care of your order direct.

KLOSNER IMPROVED APPARATUS CO.

Originators and Sole Manufacturers
2024 Boston Road, New York City

K L O S N E R

The Living Room Is No Place For a Storage Battery

Locate it in a permanent place away from fine furniture and rugs, then use a

LEICH NON-TUNE RADIO RECTIFIER

to keep it in condition. No attention—just throw the switches. Safe—Convenient—Dependable.

Your tubes will work more consistently with the steady voltage delivered by a fully charged battery, and your evening entertainments will not be subjected to the annoyance of continual adjustment of tube filaments.

Your battery will have a longer life under these conditions.

The Non-Tune Radio Rectifier needs no attention while charging. During power interruptions storage circuit is automatically opened. The Non-Tune Rectifier is a **time-tested** instrument that is used extensively for railway signal and other work which requires an efficient and dependable machine.

ASK YOUR DEALER—OR WRITE FOR BULLETIN No. 100.

LEICH ELECTRIC CO.

Manufacturers
Telephones—Switchboards—Accessories
GENOA, ILLINOIS.



Listen On Your Radio

WITH



BRIGHT STAR "B" BATTERIES

NOISELESS LONG SERVICE STRONG RECUPERATION

Bright Star Battery Co.

NEW YORK
CHICAGO
PORTLAND, ORE.



Nickel Plated
HOLE FOR ANY SIZE PIN TIP.
At all dealers
35c PER PAIR

The Plug-a-Post Binding Post takes phone pin tips, spade tips, or plain wire with a death-like grip.

Dealers Write for Proposition

Radio Technical Laboratories
9-15 Clinton St. Newark, N. J.

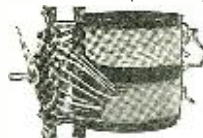

A COMPLETELY

connected coupler. Simply mount and connect in circuit. No taps to solder, no parts to buy, no dial to one side, no electrical connections to dial or pointer arm shafts. Compact and rotor always in center of field. 90 turns No. 22 green silk wire on primary. Postpaid, complete with indicator arm\$6.50
Same coupler with rotor toward one end, without special connections\$3.50
Knock down coupler with printed winding directions\$1.50

The W. J. Radio and Mfg. Co.
3020 4th Ave. S. Minneapolis, Minn.

- 8:07 P. M. 5EK de 8ALT (Dawson, Pa.).
- 8:08 P. M. CQ de 9AOG (Lawrence, Kans.)****
- 8:08 P. M. 5EK de 8ALT (Dawson, Pa.)****
- 8:10 P. M. 9AMB (Denver, Colo.).** ****
- 8:12 P. M. CQ de WUBA (Camp Alfred Vail, N. J.)***
- 8:25 P. M. 9AOG de 8BFM (Akron, O.).
- 8:26 P. M. CQ de 9APS (Covington, Ky.).
- 8:42 P. M. 9AMB de 6AHF (Spark Station at San Diego, Cal.)**
- 8:44 9AMB de 6AHF (Spark Station at San Diego, Cal.)****
- 8:57 P. M. 5KC de 8ALT (Dawson, Pa.).
- 8:58 P. M. 9OX de 5KC (Plaquemine, Ala.)** ****
- 9:01 P. M. de 8OH (Hubbard, O.).
- 9:04 P. M. CQ de 9APS (Covington, Ky.).
- 9:05 P. M. CQ de 5KC (Plaquemine, Ala.).
- 9:06 P. M. 9DTE de 6EC (Orange, Cal.).
- 9:09 P. M. de 6AHF (San Diego, Cal., Spark Station)*
- 9:11 P. M. 5 KT de 9APS (Covington, Ky.).
- 10:06 P. M. CQ de 9BJV (Connellsville, Pa.).
- 10:07 P. M. 5KC de 9 ALT (Appleton, Wis.).
- 10:10 P. M. 9AA de 9APS (Covington, Ky.).
- 10:16 P. M. CQ de 9APS (Covington, Ky.).
- 10:21 P. M. 9XD de 9JU (Chicago, Ill.).
- 10:30 P. M. de 7ZO (Casper, Wyo.).
- 10:31 P. M. 8BCY de 7ZO (Casper, Wyo.)****
- 10:35 P. M. CQ de 5 KC (Plaquemine, Ala.).
- 10:38 P. M. CQ de 9CPB)**** (Unlisted.)****
- 10:39 P. M. 9AMB de 9CPB (Unlisted.)****
- 10:41 P. M. de 7ZO (Casper, Wyo.)**
- 10:42 P. M. 9AJA de 6BJU (San Diego, Cal.).
- 10:57 P. M. 4BV de 9CPB (Unlisted).
- 11:03 P. M. 9UH de 5KC (Plaquemine, Ala.).
- 11:05 P. M. CQ de 9PS (Wichita, Kans.).
- 11:11 P. M. 5KC de 8AB (Port Huron, Mich.).
- 11:12 P. M. 8AB de 5KC Plaque-mine, Ala.)****
- 11:13 P. M. 5KC de 8AB (Detroit, Mich.)**
- 11:14 P. M. 9CNV? 9CNV? de 5KC Plaquemine, Ala.).
- 11:18 P. M. 9AER de 9UU (Chicago, Ill.).
- 12:14 A. M. de 7XC (Seattle, Wash.)*
- 12:18 A. M. 7XC de 6ABX (Wood-land, Cal.)** ****
- 12:22 A. M. de 9BBL (Kokomo, Ind.)****
- 12:27 A. M. 9DNC de 9CPB (Un-listed).
- 12:27 A. M. 8AB de 8AB (Port Huron, Mich.)****
- 12:37 A. M. CQ de 9AOG (Lawrence, Kan.).
- 12:47 A. M. 9ZAR de 9UU (Chicago, Ill.).
- 12:56 A. M. 9II de 9CPB (Unlisted)**
- 1:00 A. M. 9II de 9CPB (Unlisted)**
- 1:18 A. M. 9AOG de 6ASJ (Oakland, Cal.)**
- 1:24 A. M. 9BTT de 9BCP (Un-listed)**
- 1:30 A. M. 9AWM de 6KA (Los Angeles, Cal.)**

WANTED—Back numbers of RADIO NEWS, Sept., Oct., Nov. and Dec., 1921; Jan. and Feb., 1922. Experimenter Pub. Co., Inc., 53 Park Place, New York City.

Increase the Range of your AERIOLA SR. with the new AC AMPLIFIER



AERIOLA AMPLIFIER

Model AC
Complete with 2WD-11A vacuum tubes
(without batteries)

\$68.00



VOCAROLA LOUD- SPEAKER

Model LV
\$30.00

THE new AC Amplifier, to a considerable extent, increases the reception possibilities of the Aeriola Sr. With head telephones and the AC Amplifier reception ranges of one hundred to three hundred miles become possible for the owner of an Aeriola Sr., depending on local conditions. Used with the Vocarola loud-speaker, the Aeriola Sr. and AC Amplifier fill a whole room with music and speech received over distances of ten to thirty miles.

Anybody can make the simple connections required, including mother and the girls.

See this New Amplifier at Your Dealer

Radio Corporation of America

Sales Dept. Suite 2065
233 Broadway
New York City

District Office
10 South La Salle St.
Chicago, Ill.



This symbol of quality
is your protection

Before buying radio apparatus, always consult the book "Radio Enters the Home." Price 35 cents by mail or at your dealer.

BRACH VACUUM RADIO PROTECTOR

Does More Than Arrest Lightning
—It Lessens Static Interference

Your enjoyment of Radio will be greatly enhanced by the addition of this Arrester to your equipment. It is the instrument skilled Radio Engineers always specify.

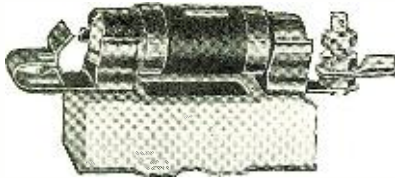

Indoor Type \$2.50

Irresponsible competitors have intimated that Brach Arresters lose their vacuum. Many years use by largest electrical companies have convinced engineers that such statements are not founded on facts.



Outdoor Type \$3

L. S. BRACH MFG. CO., Newark, N. J.

16 Years Specialists in Lightning Protective Apparatus
Also Makers of Solderall—Best for Soldering Radio Connections
COAST REPRESENTATIVES—Pacific States Elec. Co., San Francisco,
Los Angeles, Oakland, Seattle, Portland, Spokane

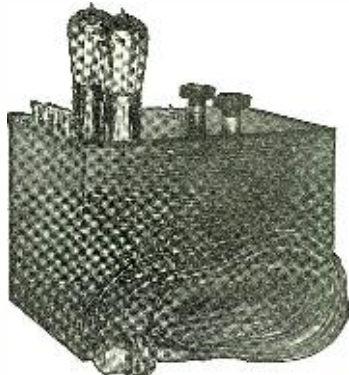

Throw away your battery for the loud speaker. Use this Rectifier on your power Amplifier! This new invention supplies both the plate and filament current on the Western Electric Power Amplifier.

Write—at once—for Bulletin "N-1" which fully describes this wonderful new invention.

UNIVERSAL

& RESEARCH CO.

199 So.
Fair Oaks Ave.

Pasadena
California

DEALERS:—Write for Attractive Sales Proposition.

BAKELITE RADIO PARTS

Moulded To Your Design

Northern Industrial Chemical Co.

11 Elkins St. Boston, Mass.

Moulders of Electrical Insulation



WHY
PAY
MORE
?



When You Can Get the

"GRAND"

Variometer and Variocoupler

Guaranteed to stand the highest test, or money refunded, for

\$2.75 Each

Send money order to **AUSTIN PRODUCTS CO.**
319 S. Desplaines St. CHICAGO, ILL.

- 1:33 A. M. 9AWM de 6CU (Los Angeles, Cal.).
- 2:24 A. M. 6CU de 6ASJ (Oakland, Cal.).**
- 2:50 A. M. 6ASJ de 6UP (Spark Station at Los Angeles Cal.).**
- 2:51 A. M. 6UP de 6ASJ (Oakland, Cal.).**
- 2:55 A. M. 6ASJ de 6UP (Los Angeles, Cal.).**
- Radio Log of September 16-17, 1922.
- 6AW (Palo Alto, Cal.).
- CQ de 8BG (Cleveland Heights, Ohio).
- De 8IB (Columbus, Ohio).**
- De 7MF (Eugene, Ore.).
- 5AV de 6AK (Walnut Grove, Cal.).**
- 9BJV de 9CDV (Lena, Ill.).
- 6AAT (Santa Rosa, Cal.).***
- 6AJH (San Ysidro, Cal. spark sta.)**
- 6AAT (Santa Rosa, Cal.).**
- 6ATQ de 6ZQ (Berkeley, Cal.).**
- 6BB de 6GX (Sacramento, Cal.).**
- De 6 APW (Glendale, Cal.).
- 6ATM de 6BQL (San Francisco, Cal.).**
- AEH (San Diego, Cal.) testing out set.
- 7AF de 6APW (Glendale, Cal.).*
- 6XC de 6AAT (Santa Rosa, Cal.).*
- 6APW de 6BQL (San Francisco Cal.).**
- 6BQL de 6APW (Glendale, Cal.).**
- 5QI de 7LU (Greybull, Wyo.).****
- 7LU de 5XC (Seattle, Wash.)
- 6AEH (San Diego, Cal.) testing radio set.

- 6BPZ de 7XC (Seattle, Wash.).**
- 1GV de 8BKE (Huntington, W. Va.).
- 6BPZ (Unlisted)**
- 5ZA de 6BZC (Unlisted).
- 9AC de 6 CP (Alameda, Cal.).
- 9BZI de 5DI (Houston, Texas).**
- 9AC de 6BQC (Los Angeles, Cal.).
- 6CP de 6ABU (Oakland, Cal.).
- 9ZAA de 5 DI (Houston, Tex.).**
- 6GX de 6 EA (Los Angeles, Cal.).
- 9DTM de 6ZS (Bakersfield).
- CQ de 9BZI (Ackley, Iowa).****
- 6GX de 6EA.
- 9ZAF de 6 APW (Glendale).****
- 7XC de 7LU (Greybull, Wyo.).****
- 6ZAC de 6ZE (San Francisco, Cal.).**
- 6CPF (Unlisted).*
- 6KV de 6BSA.*
- 9YAW de 6 CP (Alameda, Cal.).
- 4BV de 6CP (Alameda, Cal.).
- 9BZY de 9BZI (Ackley, Iowa).****
- 9CNS de 6ARB (San Francisco, Cal.).**
- 6AWT and 6CP.
- CQ EAST? de 6 AWT (San Francisco, Cal.).****

Guglielmo Marconi never dreamed that 50 watts of electrical energy would vibrate that great elastic medium, called ether, sufficiently to be detected some 6,000 miles away. Fifty watts is a mere trifle of energy in regards to electrical consumption, but it is enough to penetrate the ether round the world. Let us find out just how much energy 50 watts is equivalent to. According to the formula, a watt equals .7375 foot-pounds of work in one second of time, therefore, 50x.7375 equals 36.87 foot-pounds of work, or it will do approximately 1-15 of the amount of work that a London dray horse did in one second of time. It is equally possible that the vacuum tube will come in for all commercial and government use in the near future. The tube permits communication by continuous-wave telegraphy, by discontinuous or interrupted wave telegraphy which corresponds to the spark method. It is the only reliable method for radio telephone.

Spark and arc systems are interference makers, and, in my estimation, a nuisance. The arc pollutes the good ether with harmonics, mush, and hisses galore. This

WANTED—Back numbers of Radio News, Sept., Oct., Nov. and Dec., 1921, Jan. and Feb., 1922. Experimenter Publishing Co., 53 Park Place, New York City

A Chemistry Laboratory for \$7.00

Think of it, fellows! Here is a real chemistry outfit with regular chemical apparatus that performs those fascinating, actual chemical experiments.

This outfit is not a toy, put up merely to amuse, but a practical laboratory set, with all the chemicals, apparatus and reagents necessary to perform real work and to teach the beginner all the secrets of inorganic chemistry. With this outfit we give free a book containing a Treatise in Elementary Chemistry, useful data and recipes, and 100 instructive amusing experiments.

DESCRIPTION OF THE OUTFIT

The outfit consists of forty-four (44) chemicals all C. P. (chemical pure) put up in appropriate wooden boxes, glass bottles and hermetically closed jars. The acids are put up in glass bottles, with ground-in glass stoppers, and there is a sufficient quantity of chemicals supplied (mostly one to two ounces) enough to make dozens of experiments with each.

The apparatus furnished are all of the best obtainable make and of standard laboratory size and shape. 17 pieces of apparatus furnished with this outfit.

The instruction book is a real Chemistry Course for the Beginner. Some of the Contents

are: Division of Matter: This is a Treatise on Elementary Chemistry, and deals with the theory of the Elements, Molecules and Atoms, etc.

100 EXPERIMENTS

How to make chemical tricks; how to make invisible and magic inks; how to test flour; how to test soil; how to make chlorine gas and smoke (German War Gas); how to bleach cloth and flowers; how to produce oxygen and hydrogen; how to make chemical colors; how to test acids and alkalies, and hundreds of interesting hints and formulas.

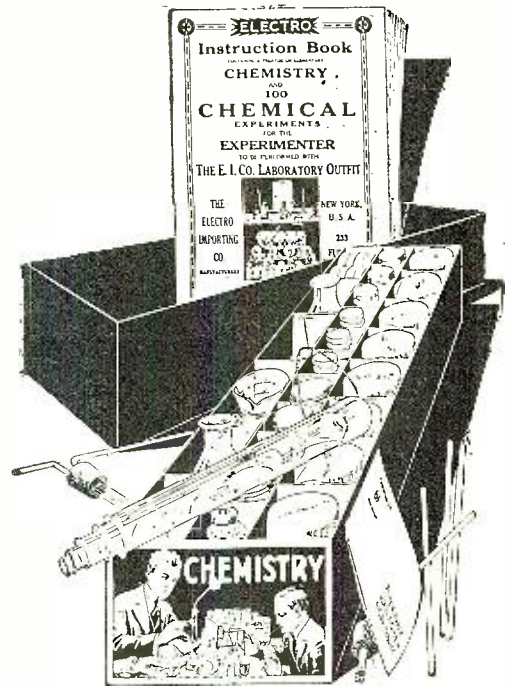

\$7.00

ELECTRO

Instruction Book

CONTAINING
A TREATISE ON ELEMENTARY
ELECTRICITY
AND
100 Electrical Experiments
TO BE PERFORMED WITH
"The Boy's Electric Toys"

ELECTRO IMPORTING CO.
NEW YORK, U.S.A.

Every Fellow Wants
the
**BOY'S
ELECTRIC
TOYS**

The Boy's Electric Toy contains: Enough material to make and complete over twenty-five different electrical apparatus without any other tools except a screwdriver furnished with the outfit. Student's chromic plunge battery, compass-galvanometer, solenoid, telephone receiver, electric lamp. Enough various parts, wire, etc., are furnished to make the following apparatus:

Electromagnet, electric cannon, magnetic pictures, dancing spiral, electric hammer, galvanometer, voltmeter, hook for telephone receiver, condenser, sensitive microphone, short distance wireless telephone, test storage battery, shocking coil, complete telegraph set, electric riveting machine, electric buzzer, dancing fishes, singing telephones, mysterious dancing man, electric jumping jack, magnetic geometric figures, rheostat erratic pendulum, electric butterfly, thermo electric motor, visual telegraph, etc., etc.

This does not by any means exhaust the list, but a great many more apparatus can be built actually and effectually.

With the instruction book we furnish one hundred experiments that can be made with this outfit, nearly all of these being illustrated with superb illustrations. No other materials, goods or supplies are necessary to perform any of the one hundred experiments or to make any of the 25 apparatus. Everything can be constructed and accomplished by the means of this outfit, two hands and a screwdriver.

The outfit contains 114 separate pieces of material and 24 pieces of finished articles ready to use at once.

We guarantee satisfaction.
The size over all the outfit is 14 x 9 x 2 3/4. Shipping weight, 8 pounds. "The Boy's Electric Toys" outfit as described, \$7.00. Immediate shipment.

SEND FOR YOUR SET TODAY

REMEMBER

JUST CLIP THE COUPON—DON'T SEND MONEY

ELECTRO IMPORTING CO., 233 Fulton St., New York City

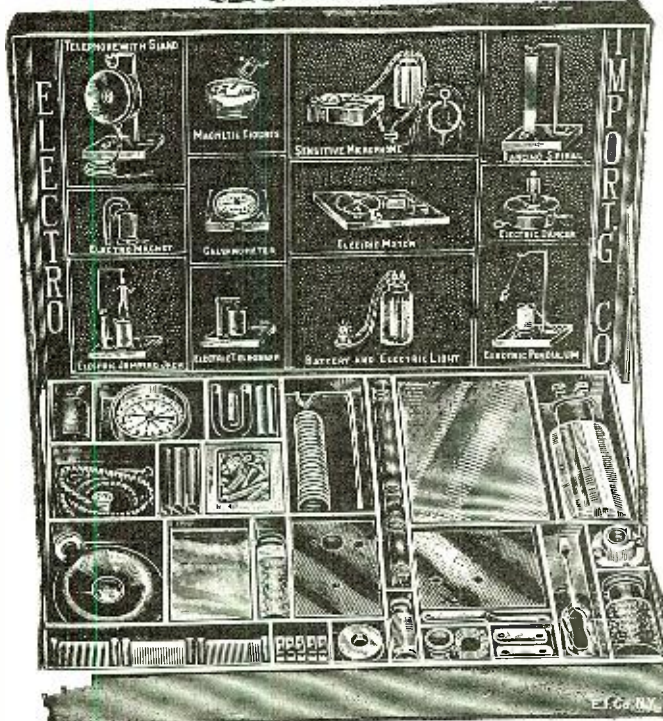

ELECTRO IMPORTING CO.,
233 Fulton St., New York.
Please send me by express THE
CHEMICAL LABORATORY. If I don't
like it I need not accept it. If I want
it I only pay \$7.00 plus the few cents
express charge.

.....
.....
.....

RN-1-23

ELECTRO IMPORTING CO.,
233 Fulton St., New York.
Please send me by express THE BOY'S
ELECTRIC TOYS. If I don't like it I
need not accept it. If I want it I only
pay \$7.00 plus the few cents express
charge.

.....
.....
.....

RN-1-23

At Last A different and better LOUD SPEAKER THE TIMMONS TALKER

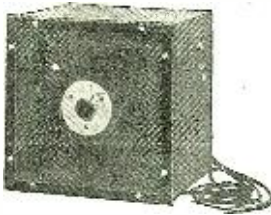
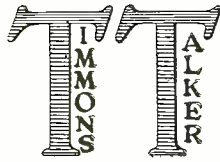

Price
\$35.00

If your dealer cannot supply you,
write us for information and booklet.

NOT merely a head phone attached to a horn, but a scientifically constructed instrument, with a simple, fool-proof amplification which allows you to get the utmost from your set.

Its construction gives an unusual volume of beautifully mellow, rich tone which will make your set the talk of the neighborhood.

Built in a solid mahogany cabinet and needs no extra batteries.

J. S. TIMMONS
Germantown, Philadelphia, Pa.

BELL MOULDED BAKELITE RADIO PARTS

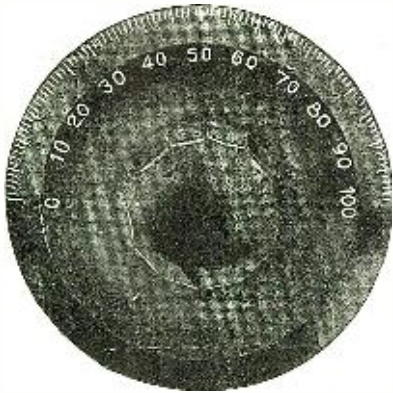

Price, \$1.00

Genuine Bakelite highly polished. Fine clear cut graduations and numerals. Knob fits fingers perfectly and allows fine adjustment. No corners to catch dust. Moulded stops—Runs true. 3 1/2" Dial.

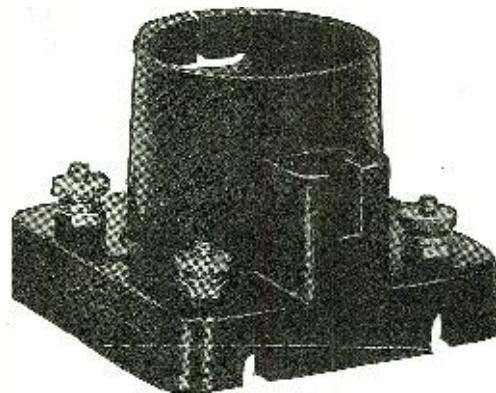

Price, \$1.00

Genuine Bakelite. Heavily nickeled phosphor bronze springs designed to make double electrical contact. Adapted for panel or base mounting. Reinforced T slot allowing use of sending or receiving tubes without adjustment.

Attractive Discounts to the Trade

Manufacturers of Moulded Insulation since 1911

BELL MANUFACTURING CO., 14 Elkins St., BOSTON, MASS.

ARE YOU WISE?

To our low prices on all standard radio supplies:

Clapp-Eastham HR Sets	\$33.00
HZ	33.00
Westinghouse RC Sets	112.50
Senior Sets	50.00
Junior	29.00
Baldwin phones	14.00
Variometers and variocouplers	3.00
Thordarson amplifying trans.	3.95
Erach lightning arresters	1.90
UV-200 Radiotrons	4.50
UV-201	6.00
Homchargers	16.00
Master Baldwin Clarophones	20.00
R-3 Magnavox	40.00

Terms: Cash with order—add postage.

Let us know your needs and we will save you money
Mutual Radio Sales Company.
WILMINGTON Box 252 DELAWARE

GIVE YOUR EARS A TREAT!—USE

RED-HEADS
3000 Ohms
Now \$6.50
At your dealers or direct on receipt of price.

A Triumph in Radio, Receiver Design
The Newman-Stern Co. Newman-Stern Building, Cleveland, O.

system is an efficient interference maker. Think of it, 500,000 watts are required to carry on continuous communication from Honolulu to San Francisco. There is more energy consumed in one day by this system than by all the amateurs in the United States in six months. It is quite true that arc and spark systems hamper the good work that bulb transmitters can do. How many of you amateurs have listened to a continuous-wave chap a couple of thousand miles away, then comes a deafening bombardment from an old rotary spark, or worse yet, a Ford spark coil in a nearby rural district? There is nothing to do but shut down and wait until the "ham" gets tired of "fussing" up the air while he communicates with an amateur 25 or possibly 50 miles away.

I hope to see the time when it will be a misdemeanor, or an act of committing a nuisance to send signals with a spark or an arc transmitter. Let us hope this time will come in the near future. It means success to the vacuum tube, which must come forth.

Many radio men of unquestionable integrity and the highest standing as scientists have investigated various types of circuits employed in radio. The list includes names that command respect in England, Germany, France, Italy and the United States. Most amateurs and professionals have only a vague idea of how hard these men have worked, and what they have found. They may be experts of proven ability and experience, but they do not tell you exactly what is required for an efficient type of receiver suitable for the amateur. Frequently I have observed, in wireless magazines, circuits for reception of continuous-wave stations. A great many of these circuits are of little importance to a professional amateur, because they do not produce signals from any distant point.

Several commercial concerns recommend radio frequency transformers for the amateur, claiming that the signals as well as the range of reception will be greatly increased. If the amateur is a short-wave man being particularly interested in the reception of signals from 400 meters down, he encounters difficulties in obtaining radio frequency transformers that will give any appreciable energy amplification. So far, I have not been able to obtain very satisfactory results with radio frequency amplifiers for 200 meters.

In the following I will endeavor to help you decide more intelligently the real essentials of a perfect continuous-wave receiver, audion, amplifier, antenna, etc. I am going to do this because there are a great many radio fans who lack good sound knowledge of the right type of circuit, or have not the facilities to experiment. After experimenting considerably for over a year with various types of inductances, variometers, inductive and conductive circuits for short-wave reception, I have finally settled on a simple, regenerative single circuit. The circuit is well known to radio men, but the question naturally arises whether or not the amateur employs the right parts for his receiver. This type of receiver enables the operator to tune with ease, and above all, get all three circuits in resonance which is required for continuous wave signals from a distant station. I found that variometers are not necessary, and that secondary condensers are trouble makers. In presenting the method of construction, reference should be made to Fig. 1. The receiver is designed for extremely effective reception over a range of wave lengths in which the average amateur is interested. The ensemble is harmonious, both as to appearance and performance. It has, of course, established for itself an

HAVE YOU SOMETHING TO SELL OR EXCHANGE?
A classified ad in Radio News will reach over 225,000 at a cost of only 15 cents a word.

Clearer than A Bell

THE "RICO" LOUD-SPEAKER PHONE

a remarkable phone

a remarkable price **\$4⁵⁰**

Here is the **loud-speaker phone** for which you have been waiting! For the first time you are now able to buy a single 2,000-ohm **loud-speaker phone** that has been planned by radio and acoustic engineers for one purpose, and one purpose only—namely, to reproduce sounds clear and loud through a horn.

Used in any standard horn, it will amplify the weakest of sounds so that the whole family can hear your radio all over the house. Furnished complete with a five-foot (5 ft.) cord.

The RICO LOUD-SPEAKER PHONE will prove a revelation to you, if you have used regu-

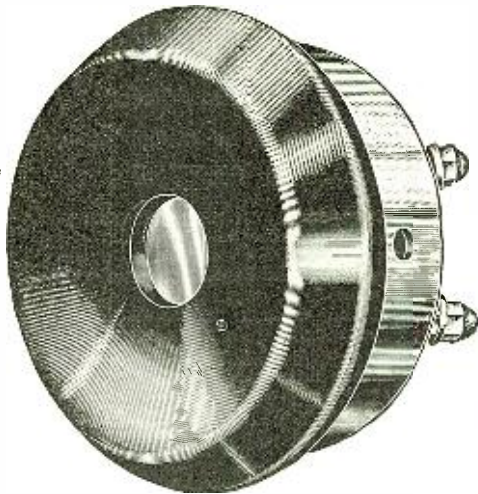

Loud-Speaker Phone With Cord

lation head receivers for loud-talkers.

We are so convinced that you will be enthusiastic about this phone that we make this

SPECIAL OFFER:

Try this LOUD-SPEAKER PHONE for five days, and simply consider the money you are sending in to us as a deposit. If, at the end of five days, you are not convinced that it is the best loud-talker phone you have ever seen or heard, return it to us and your

money will be promptly re-funded.

SEND NO MONEY!

Just write us and tell us that you wish one or more of these phones, and we shall rush the order to you at once. Pay your postman the price of the phone and then test it out at our expense.

Note the new construction. The pull in the center of the diaphragm is where it should be, **in the mathematical center**. The result: Clear and loud tones, **NO DISTORTION**.



Rubber Head Band

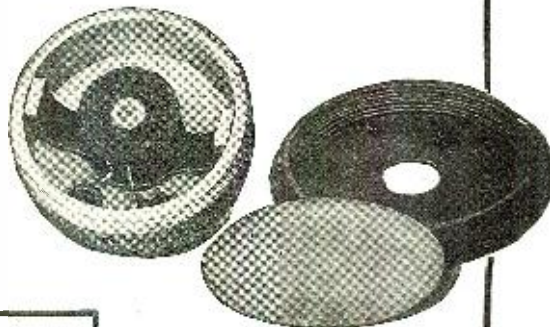

RICO Tri-pole Head Sets are the fastest selling phones in America

Rico No. 20, 2000 ohm Double Head Set with pure rubber covering. Now **\$5.00**

Rico No. 30, 3000 ohm Double Head Set with pure rubber covering. Now **\$5.50**

Mail your order at once, if the dealer can not supply you. Insist upon RICO Tri-pole. There is a very good reason why you should use RICO phones, and that is they are different—not merely Phones, but

Phones built for Radio or Telephone Work

PRICE LIST

Parcel Post—Paid Anywhere in North America

No. 25 Special Loud-Speaker Phone with cord	\$4.50	No. 15 1500 ohms Single Head Set	\$3.25
No. 20 2000 ohms Double Head Set	5.00	No. 75 75 ohms Double Head Set	5.00
No. 30 3000 ohms Double Head Set	5.50	No. 5 5 ohms Double Head Set	5.00
No. 40 4000 ohms Double Head Set	9.50	No. 2 1500 ohms Receiver only	2.00
No. 50 5000 ohms Double Head Set	12.50	No. 3 1500 ohms Receiver only	2.25
No. 60 6000 ohms Double Head Set	15.00	No. 05 5 ohms Receiver only	2.00
No. 10 1000 ohms Single Head Set	3.50	No. 075 75 ohms Receiver only Telephone Work	1.00

Guaranteed in Every Particular

Dealers and Jobbers

Write for our wonderful proposition. Cash in on the fastest growing phone business in the United States.

MANUFACTURED BY

RADIO
INDUSTRIES
CORPORATION
131 Duane Street, New York City
Cable Address: Ricotrade, N. Y.



CLEAR-TONE

MULTI-POLAR
RADIO PHONES

‘The Phone With a
Mellow Tone’

Not just as good as other Radio
phones, but BETTER.

CLEAR-TONES are exactly what the name implies, clear distinct modulation, supersensitive to weak signals, yet they have the amplitude of a loud speaker. Attractive sanitary headbands made from nickle-plated silver that will not tarnish, made especially for comfort to fit any head without catching the hair or causing the slightest discomfort, or Standard wire headbands of the Navy type.

Four coils, four points of contact, therefore, Double Clearness, Double Amplitude, Unlimited Range—truly a remarkable achievement in Radio Phones. Approved by many Radio experts after severe tests. CLEAR-TONES give far better service than phones costing a great deal more. Built for endurance, from the highest quality materials obtainable, and by electrical engineers who know how.

Distributors and dealers should get in touch with us now for open territory. Order from your dealer; if he cannot supply you, order from us.

Manufactured and Guaranteed by

Leslie H. Moulton Manufacturing Company
WESTPORT STATION
KANSAS CITY, MISSOURI

\$8.00
2400-Ohms

Juniors
\$5.00

Foreign substances which might mar the finished part, lower di-electric resistance, or cause di-electric losses are never found in

VUL-COT Fibre

We sort, dust and cut our own rags and make all the paper used in Vul-Cot Fibre.

Prompt deliveries in sheets, rods and tubes or of parts machined to your specifications.

AMERICAN VULCANIZED FIBRE CO.
503 Equitable Building, Wilmington, Del.

SALES OFFICES

BOSTON	PHILADELPHIA	CLEVELAND	CHICAGO
NEW YORK	PITTSBURGH	DETROIT	ST. LOUIS

Complete Stock for Immediate Shipment at Chicago

Western Agents	Canadian Agents
Western Electric Company	Northern Electric Company

LIMITED

SAN FRANCISCO	SEATTLE	MONTREAL	TORONTO	WINNIPEG
PORTLAND	OAKLAND	OTTAWA	HALIFAX	CALGARY
		REGINA	VANCOUVER	



FIBRE and Fibre Parts for Radio

Panels, Discs, Washers, Coilheads, End-plates for Variable Condensers, Strips and Special Shapes.

J. SPAULDING & SONS CO., Inc.

New York	484 Broome Street
Boston	14 Elkins Street
Philadelphia	141 North 4th Street
Chicago	659 West Lake Street
Tonawanda	New York

RUSONITE

CRYSTAL RECTIFIER

MULTIPOINT (Patent Pending)

A synthetic CRYSTAL DETECTOR
sensitive over its entire surface.

Eliminates all detector troubles. 50% increase in clearness and volume. Endorsed by Radio experts and press. Awarded certificates of excellency. Sets a new standard of efficiency. Price post-paid, mounted, **50¢**

Sensitiveness guaranteed.

Dealers and Distributors quoted attractive discounts.

Rusonite Products Corporation
15 Park Row—Dept. N—New York City

enviable reputation as the most efficient type of hook-up for continuous-wave signals.

The tuner employed is a Remler variocoupler, having 50 turns on a 4" form, and a rotatable element inside, having 60 turns; 11 taps are taken off the inductance. The first tap is at six turns, the rest are tapped off at four turns each, that is, 10th, 14th, etc. The last tap has eight turns. The wire used for winding the tuner is No. 20 B. & S. D. S. C. copper wire, and for the tickler element No. 24 B. & S. D. C. C. copper wire. Secure a panel 28x6 1/4", preferably some type of insulating materials that does not absorb moisture or its insulating quality is not affected by weather. Remember that the panel is the very foundation of your set. Make doubly certain that the material is of high volume and surface resistance, because these are essential factors. Bakelite is recommended. Get a piece having a handsome, high, glossy finish that will not deteriorate. It will look good for years and is good! Formica is also recommended because it is easy to machine, and helps you do a workman like job on your panel. Keep in mind that every amateur takes pride in the appearance of his set, and in fact, a great deal depends upon the neat, efficient, construction for best results.

Right here I might as well describe one of the most essential instruments that a radio man needs. A Pearland condenser permits you to tune with your hand on the knob without the body affecting the tuning. The vernier attachment allows an adjustment about 25 times as fine as the plain condenser. The shafts for the vernier and also for the main plates extend out far enough to eliminate the hand effect. Another type that is equally as efficient as the Pearland is the De Forest, having an extra plate and an arrangement for securing a handle to the extra rotor plate. I have used this type of condenser and strongly recommend it. Note the long handle extending from the condenser in Fig. 1. A hole should be drilled in the left-hand side of the panel 3" from the end of the shaft of the type of condenser as described in the foregoing. This condenser should have a capacity of approximately .0005 mfd. Drill a hole 6" to the right of the condenser for the shaft of the tickler coil. Midway between the condenser shaft and the tickler element, install a rotary switch and 11 contact points. Mount three 7-ohm rheostats equally spaced along the bottom of the panel as low as possible. A wooden base, 28x6", and shellacked, is secured to the panel. A rubber panel is placed on the wooden base for mounting the sockets and transformers upon. Mount the three sockets behind the rheostats. Mount the transformers as shown in Fig. 23. General Radio transformers are recommended because the average radio fan, not being familiar with the types of efficient transformers, has little to guide him in his choice. Most any transformer can amplify, but it will also amplify the stray fields, thereby causing howling, hissing and distortion. Two steps only are required. Be sure to connect the short side of the secondary of each transformer to the negative side of the "A" battery. There is a reason for making the above mentioned connections; it is done to get the right grid bias, or correct negative grid potential on the grid of each tube. Some circuits connect the lower side of each secondary below an ohm resistance. This is not necessary, as the method shown in the wiring diagram in Fig. 2 will give you all the necessary amplification for long distance signals. If static is bad, use two steps of amplification to find a continuous

wave station, then shift to one step, which will enable you to read signals fairly well. Secure a .00025 mfd. grid condenser and a 1-megohm grid leak and holder to the rubber bottom panel. Mount these two elements as near the detector tube as possible. A bridging condenser will cause the circuit to oscillate when the audion battery is low; therefore I recommend that you install a standard variable bridging condenser. A switch for disconnecting it should be placed in front of the panel. General Radio sockets are recommended. Do not substitute cheap material, as you will lower the efficiency of the circuit. Use cambric sleeving, and No. 14 B. & S. plain copper wire for all leads. A word of caution here will, as they say, not be amiss. Do a neat wiring job. Make all connections as short as possible. Keep the various wires from running parallel to each other for any great distance. Remember, a neat workmanlike job will find its reward in the satisfactory results which you will obtain. See Fig. 3 for arrangement of circuits, wiring, panels, etc.

This circuit is not quite as selective in tuning as an inductive coupler, but it simply reaches out and brings in long distant stations. Practice tuning through interference with the tickler element, and I am quite sure you will have little difficulty in weeding out interference.

Next comes the tube proposition. It must be borne in mind that results depend entirely upon the type of tubes you employ. Secure several UV-200 Radiotrons and test them for best results. Hard tubes are the most efficient. I recommend that you get several of these tubes from your local dealer and pick out the two best tubes, returning the others to the dealer, if possible. The tube will not in some cases oscillate until full brilliancy is obtained. Use a fully charged 6-volt battery.

You should have a battery especially designed and trouble-free. Poor batteries will not give the necessary signal audibility, and are, therefore, not desirable for DX work. Make all connections exactly as shown in Fig. 2. Caution: Never connect more than 22 volts to the radiotron "B" battery binding posts; too high voltage seems to bring about some internal action which causes the tube to become less sensitive. Part of the first battery is connected in common to both audion and amplifier. A potentiometer is not absolutely necessary, but it gives a closeness of control of the plate circuit voltage, which gives better signal strength ratio. By all means use some method for varying the "B" battery potential.

If the circuit does not oscillate, reverse the tickler connections. Be sure the audion battery is fully charged to six volts. Use VT-1 in the first step of the amplifier, and a VT-2 in the second step. This arrangement gives less stray amplifications, and also gives greatest signal amplification. Use Baldwin head telephones.

A variometer in the grid and plate circuits will work in conjunction with this circuit, but it is questionable whether or not the addition of these will result in an improvement great enough to warrant the introduction in either circuit. However, I do not recommend the use of a variometer, as it only makes tuning for continuous-wave stations rather difficult. A very small variometer in the secondary circuit would probably help in eliminating interference in a congested location. A switch should be placed in front of the panel and connected to the terminals of the variometer in such a manner as to enable the operator to short-circuit the variometer out of the circuit.

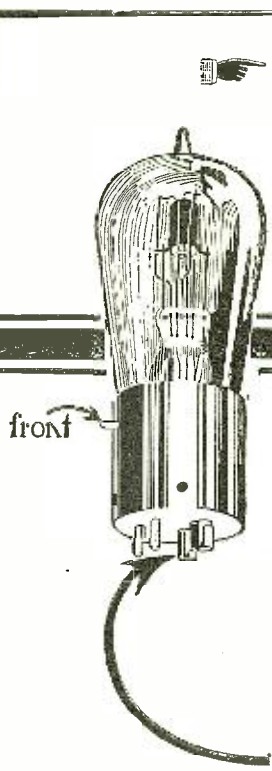

Different tubes require different capacity fuses.

When ordering, therefore, state exactly what tube fuses are for.



Easier for the Camel!

To borrow a proverb, "It is easier for a camel to go through the eye of a needle," than it is for excess current to "burn out" a tube protected by the

RADECO SAFETY FUSE

(Pat. Pending)

CAUTION:

Do not force fuse on filament terminals. If contact solder is rough, file or sand-paper down so that fuse slips on easily. Filament terminals are the two farthest from the locking projection on base of tube.

Different from anything else made for vacuum tube protection, the Radeco Safety Fuse fits directly upon the filament terminals of any standard bulb, is usable with any standard socket and is positively reliable in its action because it is scientifically accurate.

4 IN A PACKAGE \$ 1

NEW

STYLE

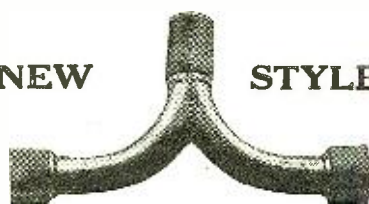

PHONE ADAPTERS

Connect your phones directly with loud sounder of your Victrola or Grafonola without trouble and without springing phone headpiece

\$ 2

Add Postage on 2 lbs.



Crystal Detector Set

Biggest value made. Has Buzzer Test, Tapped Primary Vario Coupler, Var. Condenser, Cord Tipped Jacks, Bakelite Panel.

\$ 20

We carry a complete stock of standard goods. Order from any standard Catalog.

WD11 ADAPTERS—make WD11 tubes fit standard sockets... \$1.50

RADIO EQUIPMENT CO.

630 Washington Street

Boston, Mass.

New England's Oldest Exclusive Radio House

antennae, one 656' or one wave-length, and the other 1250' or twice the wave-length, may be connected to two receivers located alongside one another. Simultaneous tuning on 200 meters can actually be accomplished without interaction between the two circuits. The two antennae should not be placed parallel, but should be separated at least 300' at the receiving end and the longest antenna extending beyond the receiving station. A return lead should be made low and entering the room from the opposite direction of the other antenna. This system permits two operators to search for amateurs which is a decided improvement over the old flat top system. Fig. 4 illustrates the method of installation of two Beverage antennae, as used on the nights of September 15 and 23.

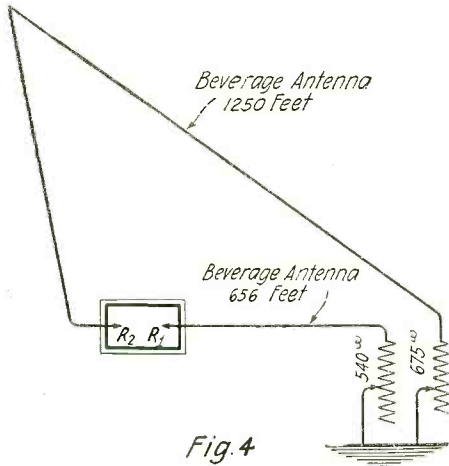

Fig. 4

Here Two Beverage Antennae are Used, Allowing Two Receivers to Simultaneously Tune to the Same Wave.

A Modified Multiple Tuner.

(Continued from page 1289)

primary and secondary that is in circuit at all times. This will insure the maximum transfer of energy at all waves. The primary should have about 50 turns on a 3½" tube, and the secondary about 30 turns on a tube of the same diameter. The secondary may be mounted within the primary and at right angles to it, or if desired a standard variocoupler may be used with the secondary locked in position at zero coupling and the link coils wound about the two inductances.

To sum up the advantages of this set it is well known that a single circuit tuner brings in slightly louder signals than a three-circuit regenerator, due to the close coupling inherent in the former. The three-circuit set, on the other hand, is much more selective. By the use of the intermediate link, all the advantages of tight coupling are obtained without its disadvantages, its broad tuning.

The writer, who has had a set of this kind for eight years, can bring in signals distinctly from all parts of the country through interference from WBAH and WLAG three miles away. A crystal detector set using the same principle brings in NAA (1,100 miles distant) practically any night.

WHAT THE WIFE THINKS

While it is true that a radio set does keep men home at night, it also keeps the weeds in the garden and the lawn-mower in the shed.—By A. J. DE LONG.

BUILD YOUR OWN RADIO

and
Get a Sixty Dollar
Outfit for **\$20⁰⁰**

We furnish all parts complete; give you easily-followed instructions for assembling. No shopping 'round for parts or wasting time and money on parts that don't fit.

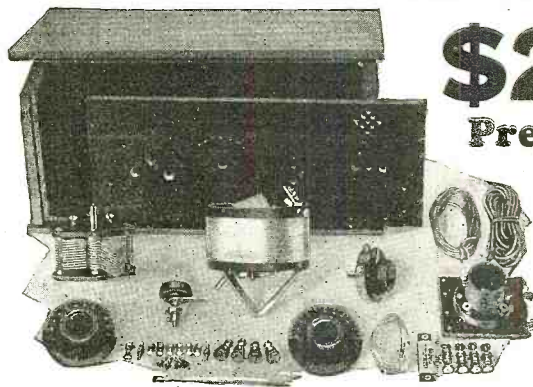

\$20
Prepaid

Screw Driver and Pliers are only tools needed

Our Lot No. 1—\$20 Outfit

Includes the Following

1 Cabinet (panel size 6 x 14 in. \$3.30	4 Hard Rubber Binding Posts. \$.25
1 3/16 in. Formica Panel, drilled, marked and lettered 4.68	1 Switch Lever50
1 23 Plate Condenser..... 2.65	6 Switch Points..... .18
1 180 Degree Coupler..... 5.00	2 Stops..... .06
2 Dials..... 1.00	15 Ft. No. 14 Copper Wire..... .15
1 Rheostat..... 1.10	5 Ft. No. 22 D. C. C. Wire..... .05
1 Socket..... .55	12 Ft. Varnished Tubing..... 1.20
1 Base..... .35	Screws and nuts..... .50
1 Grid Leak and Condenser..... .75	Cost If Bought Separately..... \$22.50
4 Nickel Plated Binding Posts .20	

All for \$20 prepaid—making a set that would cost you at least \$60 if bought assembled.

Our Lot No. 2—Accessories

If you have not the following accessories, which are necessary to make this a complete phone receiving unit, ready to tune in, you can purchase them from your local dealer or from us at the following prices:

1 Eveready "A" Battery (90 Amp. hours)..... \$18.00	200 Ft. Antenna wire..... \$1.80
1 Eveready "B" Battery..... 1.70	50 Ft. Ground Wire..... .60
1 Pair Frost Phones..... 5.00	1 Lightning Arrester..... 1.50
1 Vacuum Tube..... 5.00	1 Ground Clamp..... .20
6 Insulators..... 1.20	Cost If Bought Separately..... \$35.00

Our price if bought in one lot \$30 prepaid

Combine lot No. 1. (\$20.00 set) with lot No. 2 and, at a cost of only \$50.00 you have the "makings" of a long-distance radio outfit—the equal of any \$100.00 complete set on the market.

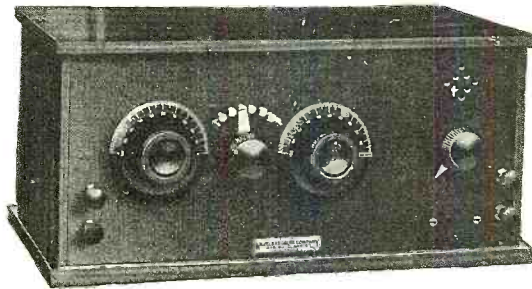

"Lefax" Radio Handbook Free

What's more, for a limited time we will give you FREE a copy of the \$3.50 Lefax Radio Handbook with your first order for Waveland products amounting to \$20 or more. Your name stamped in gold on the front cover if desired.

"Waveland Pays the Postage"

ORDER NOW Sending us cash, money order, draft or check and we will immediately ship you the parts prepaid with our guarantee that if you are not completely satisfied you may return them at our expense and we will instantly return your money.

Don't Waver — Write Waveland

WAVELAND RADIO COMPANY

Incorporated
1349 North Clark Street :: :: Chicago, Illinois

Any Publication using our name "AMATEUR RADIO CALL BOOK" is an infringement on our Copyright.

THIRD EDITION JUST OFF THE PRESS



ALL UNDER ONE COVER

An Official List of all Amateurs, Special Amateurs and Broadcasting Stations of **United States and Canada.**

—ALSO—

A large map, size 24 in. x 36 in., printed in two colors, showing location of every Broadcasting Station in **United States and Canada** and each district.

—AND—

How to Construct and Operate A Honeycomb Coil Set and Two Step Amplifier.

PRICE \$1.00 COMPLETE (DO NOT SEND STAMPS)

Order from your dealer—If your dealer hasn't them, send direct

DEALERS WRITE FOR PROPOSITION

RADIO DIRECTORY & PUBLISHING COMPANY

45-C VESEY STREET

NEW YORK, N. Y.

ARKAY UNIVERSAL

CAM SWITCH

Requires no Jacks or Plugs — Gives Absolute Control of Amplifier Circuits with One Knob.

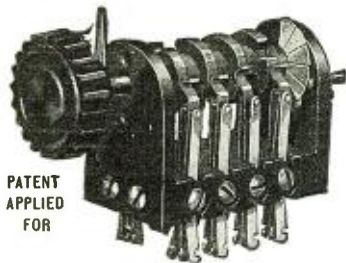

PATENT APPLIED FOR

Can Be Used as an 8-pole, Double-Throw Switch with Slight Adjustment. Filament Control if Desired.

PRICE \$5

Other ARKAY Products

- Arkay Loud-Speaker Radio Horn, \$5.00
- Arkay Crystal Detectors, 75c
- Arkay Vernier Adjusters, \$1.00
- Arkay Phonograph Attachments, \$1.50
- Arkay Variable Condensers—

15 Plate—.0005 Mfd. Capacity, \$3.75; 29 Plate—.001 Mfd. Capacity, \$4.75 Unmounted, no dial or knob.

Manufacturers, Jobbers and Dealers Will Be Given Liberal Discounts

RILEY-KLOTZ MANUFACTURING CO. 17 MULBERRY STREET NEWARK, N. J.



Wireless Supplies and Equipment at Wholesale

MORSCAN RADIO CO.
196 Market Street, Newark, N. J.



The Only Quality 3000-Ohm Guaranteed Head Set for \$5.00

TRUE-TONE RADIO MFG. CO.
188 No. La Salle Ave., Chicago, Ill.

A Novel Radio Desk

(Continued from page 1282)

are using and a right-hand throw gives the added amperes the loud speaker is using. This provides a very simple method of keeping account of the discharge of the "A" battery. An anti-capacity switch is also here provided, allowing the operator at will to connect with the earphones or the loud speaker.

Anti-capacity switches are employed to give the voltage meter readings. Throw to the left and the operator has the detector tube voltage reading; throw to the right and he gets the amplifier tube voltage. This gives a superior control of plate voltage, down to a fine point.

The voltage dial for the detector tube runs from 16½ to 22½ volts; that for the amplifier to 70 volts. The switches are controlled by points, with the first point dead and every other one a contact for a different voltage. Connection can be so rigged that the loud speaker can be used, while the operator is using the earphones. A red pilot light on the panel at the right warns of any connection being up, so that the operator cannot close the desk and leave the "A" battery to run down over night.

The "A" battery is concealed inside the panel, but is accessible if it is necessary to remove it, and is set into a lead pan. The front of the receiving panel is removable in order to put in new tubes as desired.

Such an outfit may be built by anyone who wants to keep up the appearance of a room by having only a certain style of furniture.

Some Practical Points in Amplifier Operation

(Continued from page 1277)

changing from one to another wave-length no change is made in the tickler coupling. As a result, if the tickler coupling should be lower for the new wave-length and is not, change noises are likely to make their appearance. It is, therefore, best always to alter the feed-back coupling when any other change is made in the tuning of the set.

Howling noises in amplifiers are also a source of considerable trouble, and is a case of audio frequency oscillations in the amplifier system caused by regeneration. Naturally the greater the amplifying possibilities of an amplifier the more liable will it be to howling. Many amateurs realizing this, resort to the poor remedy of working their amplifiers at low amplification, as for example reducing the filament currents, in order to eliminate howling. Obviously this is no remedy at all, since an amplifier is designed to amplify and should be worked for all the amplification that it is capable of. In fact an amplifier which shows no tendency to howl may be a very poor one. Elimination of howling should not be obtained by a sacrifice of amplification. By understanding the causes of howling we may be able to arrive at other more desirable remedies.

Oscillations in an amplifier are the result of regeneration due to feedback coupling between plate and grid circuits of the amplifier, exactly as in a regenera-

tive receiver, the difference being that in the receiver the regenerative action is intentional and in the amplifier it is accidental and undesired. This regeneration in the amplifier may be due to either inductive or electrostatic coupling between grid and plate of the amplifiers. Thus the electrostatic coupling may be provided by the inherent capacity in the tube itself; or by the capacity between grid and plate leads in the wiring of the amplifier. Inductive coupling may also be due to the coupling between grid and plate leads of the wiring; or to coupling between transformer windings in plate and grid circuits due to interlinking of flux paths and so on. The case of transformer coupled amplifiers may be considered from the point of view of tuned grid and plate circuits. The distributed capacity of the transformer coils in grid and plate acts as the tuning condenser, thus tuning grid and plate circuits and providing the necessary regenerative action. Any of these means provides sufficient coupling between plate and grid to initiate oscillations if there is present a circuit which is able to oscillate, and experience shows that there always is. It is not essential that the plate of one tube be directly coupled to the grid of the same tube. If the plate of any tube is coupled to the grid of any other tube oscillations are bound to occur. The entire amplifier system oscillates at a frequency which is determined by the most favorable constants of the system and at a frequency which gives the least losses.

Not only may the amplifier oscillate at audio frequency, but it may also oscillate at radio frequency and still produce noises in the phones. The noises in the phones when the amplifier oscillates at radio frequency are due to blocking action on the grid exactly as in the case of the receiver above described. Due to very high amplification the grid of a tube may be given a very high negative potential which immediately stops the oscillations. The charge on the grid gradually leaks off until a potential is reached which permits the oscillations to start again. This starting and stopping of oscillations takes place at an audio frequency rate which depends upon the values of leak and condenser.

The problem of preventing howling then is the problem of eliminating the feed-back coupling between the grid and plate of tubes. To put it in other words if we can prevent the electrostatic or electromagnetic fields of the plate circuit from reaching the grid circuit and causing variations in the grid circuit we will be able to avoid howling.

The following methods will be found to be of great assistance in accomplishing this purpose:

1. Proper wiring of amplifiers. This is where a great deal of the trouble experienced generally arises. Wiring should be arranged so that all leads are as short as possible thus giving minimum coupling. Care should be taken that grid and plate leads should be as far apart as possible thus preventing any transfer of energy between the two circuits. Most important of all grid and plate wires should not be run parallel to one another as the coupling is thereby considerably increased.

2. Transformers should be mounted so that their cores and coils are at right angles to each other, thus securing minimum coupling between different stages. In order to prevent spreading of the magnetic field the transformers should be encased in an iron shell thus concentrating the lines of force around the transformer. In order to prevent elec-

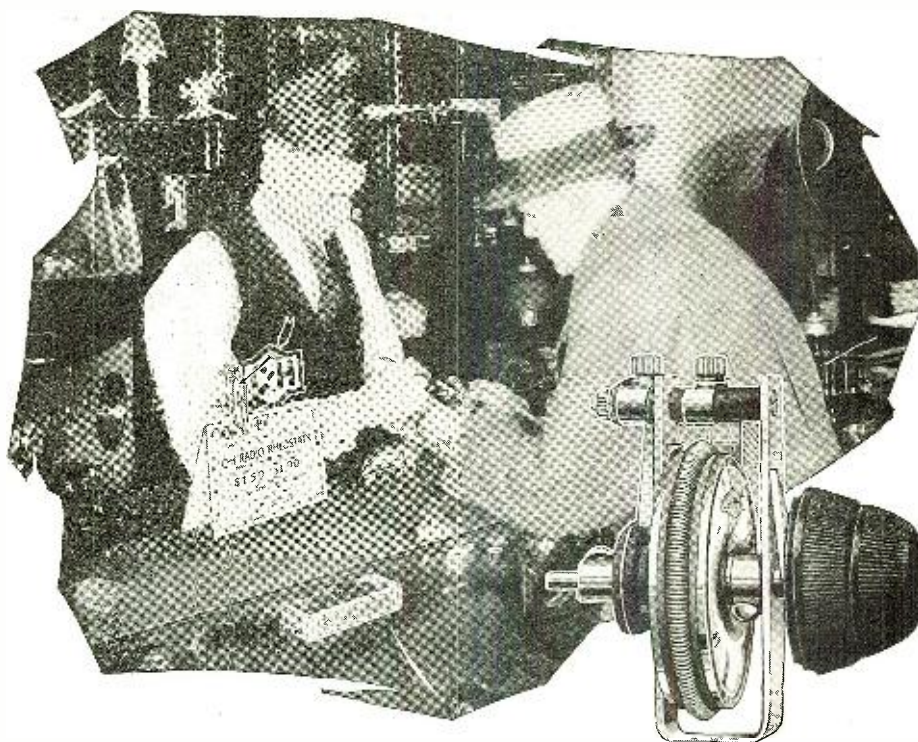

Dealers Point with Pride to the C-H Trade-mark

The C-H trade-mark that guarantees your satisfaction is engraved in the satin-nickel finish of every radio rheostat.

One of the first things any dealer will point out in showing you a genuine Cutler-Hammer Radio Rheostat is the famous C-H trade-mark engraved in the satin-nickel body.

As a practical electrical man, the dealer knows the protection this trade-mark gives the buyer—he knows that “radio rheostats built by rheostat builders” means perfection as the result of years of experience, not hasty design to meet a sudden demand.

For more than a quarter of a century the engineers of Cutler-Hammer have been the aggressive pioneers in the development of rheostatic control, and their signature of approval—the C-H trade-mark—is known and respected in every industry the world over.

The dealer is proud to show, as representative of his stock, these rheostats of recognized and guaranteed quality, and he recommends them with full confidence, knowing that they were designed by specialists to give you un-failing satisfaction.

THE CUTLER-HAMMER MFG. CO.
MILWAUKEE - WISCONSIN

Over a Quarter Million in Use

C-H RADIO RHEOSTATS
“BUILT BY RHEOSTAT BUILDERS”



C-H Radio Rheostat Type 11601-H1 has the vernier adjustment for full current regulation. This is particularly necessary for the accurate control of the detector tube, which has very critical characteristics. Type 11601-H2 is furnished without vernier for amplifier tube control.

Both types are finished in beautiful satin nickel, and are provided with large, comfortable knobs of genuine Thermoplas. A highly nickeled adjustable pointer at all times indicates the resistance cut in or out of the circuit, and positive travel stops terminate the rotation at “full on” and “full off” positions. At the latter position, the circuit is completely open, protecting the battery, and obviating the use of additional switches.

C-H Rheostats are easily adjustable for panels from $\frac{1}{8}$ to $\frac{1}{2}$ inch in thickness and are packed with full instructions and template complete ready for mounting.

Type 11601-H1 . . . \$1.50
With Vernier

Type 11601-H2 . . . \$1.00
Without Vernier



"The Party"

Licensed Under Armstrong U.S. Pat. 1113149



PRESCO
RADIO
J. Halstead Bell Sales Dept.
Davenport, Iowa, U.S.A.



End your battery troubles with "Chi-Rad" Storage "B" Battery

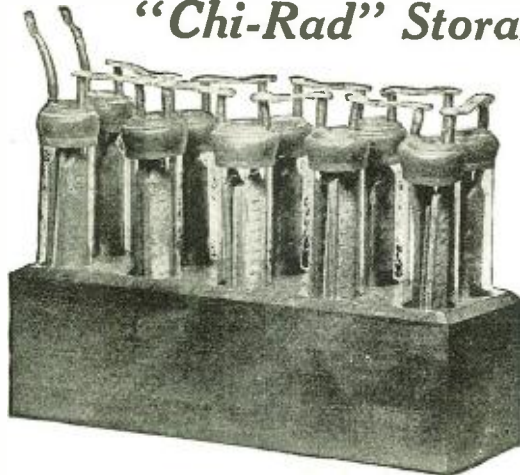

It's built to give good service. Absolutely unequalled in quality and price—half the cost of the cheapest well-made storage "B" battery. Better and cheaper than dry cell "B" batteries because rechargeable.

Will operate a tube approximately 1,000 hours on a single charge. Recharged over night with "Chi-Rad" Storage "B" Battery Charger at a cost of about 5c.

No noises or leakage losses with "Chi-Rad" Storage "B" Batteries. Guaranteed for service, or to be returned at our expense. Order your battery NOW.

Write for your free copy of our catalog.

- No. 101—"Chi-Rad" Storage "B" Battery, 22½ volt section (mounted)\$6.00
- 2½ volt section (single cell)50
- No. 101A—"Chi-Rad" Storage "B" Battery Charger 1.90

Dealers: Write for territory on "Chi-Rad" radio parts and sets.

CHICAGO RADIO APPARATUS CO., Inc.
415 South Dearborn Street Chicago

Thornton Audio Frequency
Amplifying **Transformer**
"The Transformer Supreme"
We still have territories open for Jobbers Write for particulars
Thornton Transformer Co., Inc.
30 Church St., New York

WE'VE MOVED TO LARGER QUARTERS
Where we can carry larger, better-assorted stocks of Radio Sets and parts—and give our customers even better service than before.
Apex Cuts costly corners. You get full benefit of our saving.
Send 2c stamp for Apex Price Bulletin.
Apex Radio Company, Inc.
New Address: 6914 So. Halsted St., Chicago

tric lines of force from spreading the metal case and core of the transformers should be grounded, thus putting these shields at earth potential, and preventing transfer of energy.

3. If possible each tube and its associated apparatus should be mounted in a separate chamber which is lined with copper gauze or foil and grounded. Any energy which may be transferred from other circuits to the shielded circuits is absorbed in the shield and run to ground.

4. A common source of coupling between different circuits is due to the use of a common "B" and common "A" battery. It is of course too expensive to use different batteries for each stage although this is the best way of eliminating this source of coupling. However by shunting the "B" battery with a high capacity the coupling may be considerably reduced.

5. Finally there is that disturbing source of coupling due to the operator wearing headphones whenever he moves his hand in the vicinity of the set or makes adjustment. Two remedies for this may be suggested. The first is that the panel of the receiver and amplifier should be lined with a copper shield and grounded. Thus any variations due to the operator's body will be effectively absorbed by the eddy currents in the shield and run to earth. The second is that the leads of the telephones should also be sheathed in copper gauze tubing and grounded to the case of the telephones, if metallic, and then grounded to earth.

The above precautions apply specifically to prevention of audio frequency oscillations. They also apply to the prevention of radio frequency oscillations which may cause howling and which always reduces the efficiency of the amplifier system. A further precaution in the case of radio frequency oscillations is in the use of very small choke coils of a few turns in the grid leads of the amplifiers, or a small resistance in the grid leads. These act to prevent the circuits from oscillating.

Stray fields which spread out and cause coupling and transfer of energy between different parts of circuits depend upon the size and shape of coils used in the set. Naturally large coils will spread the electric and magnetic fields considerably farther than small coils. Hence small coils should be used wherever possible. This will explain why radio frequency transformers are gradually being more and more reduced in size. The coils on them are becoming smaller and smaller so that the electric and magnetic fields are concentrated in the space around the coils themselves. The shape of the coil often influences coupling. Certain types of coils have very little leakage and the lines of force are concentrated in the coil itself. Of these types the toroidal coil is the best example. In this type of coil the external field is reduced to a minimum and hence coupling and transfer of energy is in a minimum. Wherever this type of coil can be effectively used it will be found to help considerably in reducing howling.

There are other types of noises, not due to regeneration and coupling, which often cause considerable annoyance. These are due to causes which result in small variations in plate current which are considerably magnified by the amplifier before they reach the telephones. Some of these causes are:

1. Bad "B" batteries and run down storage batteries. Any variations in battery voltage naturally make themselves felt either as lower filament current or lower plate voltage, hence the

final result is a varying plate current which produces noises. A rundown storage battery is apt to do this and an old "B" battery. If but one cell of the "B" battery is bad it will make itself felt in harsh and grinding noises in the phones. Hence the solution is to watch your batteries and see that they are always in good condition.

2. Noises due to microphonic contacts. Anything which causes a variation in plate current will cause a noise in the phones. Poor contacts which vary and thereby alter the resistance in the circuit ultimately cause a variation in plate current and hence noises. All contacts should be firmly and securely soldered to avoid any such occurrence.

3. Noises due to gas and ionization. The presence of gases always results in somewhat erratic operation. Any variation in voltage may produce abnormal changes in currents due to presence of gas and ionization of the gas. These cannot of course be guarded against. However by careful operation of the tube a good operator can secure excellent results by operating with proper potential.

4. Mechanical vibration of the tube. Whenever the tube is jarred or vibrates, noises are heard. This is due to the fact that the elements in the tube are also jarred and hence the relative distance between the elements varies and the plate current varies in accordance. The best way to avoid noises due to mechanical vibration is to mount the tube either on springs which take up the vibration or on heavy rubber bases.

These are the principal causes of howling and tube noises and for best results should be eliminated as far as possible. The methods here outlined will yield satisfactory results if carefully observed.

My Trip in the Electron Bottle

(Continued from page 1282)

comparison with that of the plate, and only a few electrons are stopped in their flight to the plate; the greatest number of electrons reach the plate and a strong current flows into the plate circuit.

"When the grid is charged negatively, instead of attracting the electrons, it repulses them because they are negatively charged and it is well known that two similar polarities repulse each other. The repulsive effect is such that not only no electrons reach the grid, but few reach the plate, reducing considerably the current in the plate circuit as it is proportional to the electrons' flow from the filaments to the plate. During all the time, the grid remains negative and the electrons are crowded in the space between the filament and the grid, but as soon as the grid polarity changes, they rush again to the plates as the obstacle is then removed. It may be understood, therefore, that the system works as a valve which, having no mechanical part, may be operated at any speed, opening and closing the plate circuit when the polarity of the grid is changed."

With a clear understanding, I woke up. It was all a dream and I found myself with the book in my hand, staring toward the ceiling looking for the electrons. It had been a trip into an electron bottle and all, of course, in my imagination.



"Can those shrieks"

HOW often have you sat helpless while some amateur Farrar has tried to hit "High C." But when your radio set starts in to show off its shrieking talent you need not go through another ordeal. Just drop in at your nearest radio store and order an Acme *Audio* Frequency Amplifying Transformer. Hook it up to your detector set and sit back easy. You'll be surprised how clearly and distinctly incoming sounds may be heard. Then, too, the tones are natural. Something usually so lacking in the ordinary set.

You will also want the Acme *Radio* Frequency Amplifying Transformer because this will greatly increase the range of your set whether it be vacuum tube or crystal detector. Both Acme *Audio* and Acme *Radio* Frequency Amplifying Transformers

sell for only five dollars. Your set is not complete without them.

The Acme Apparatus Company (pioneer transformer and radio engineers and manufacturers) are also manufacturers of one and two-stage amplifying units, detector units, detector and two-stage amplifying units, the Acme Clear Speaker, the Acme phone. Acme C.W. and spark transmitting apparatus offer the amateur an opportunity to not only receive but send his own messages. For sale at radio and electrical stores or write direct to the Acme Apparatus Company, Cambridge, Massachusetts, U. S. A., or New

York Sales Office, 1270 Broadway. Ask also for instructive free booklet on the operation of amplifying transformers, both audio and radio frequency types. You need it.

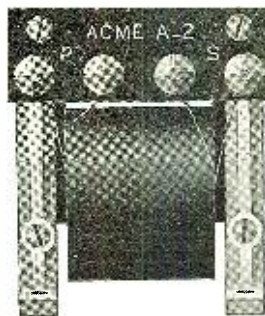

Type A-2 Acme Amplifying Transformer
Price \$5.00 (East of Rocky Mts.)

ACME

for amplification

Trade  Mark

The Set that Grows



Front View Panel No. 2



Rear View With Cover Removed Panel No. 9

Here is the nucleus of your future set.
A 150-300 meter audio detector equipped with potentiometer.
You can add other panels for loud speaking, greater distance and more selective tuning.
Our bulletin No. 302 describes these novel sets with their outstanding features.
Write for it!

THE E-D MANUFACTURING CO.
PHILADELPHIA, PA.

"LISTEN IN WITH ED."

Copper is Essential in Every Outfit

Even in the least expensive radio outfits, where a penny counts in figuring up costs, *Copper* is specified for aerials.

Copper being the best conductor of electricity, it is the metal that can be depended upon to carry the signals with the greatest strength and clearness.

Wherever electricity is to be conducted, USE COPPER.

COPPER & BRASS RESEARCH ASSOCIATION

25 Broadway - New York

Hit it anywhere!

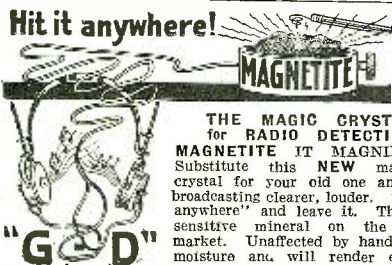

THE MAGIC CRYSTAL for RADIO DETECTION
MAGNETITE IT MAGNIFIES—Substitute this NEW marvelous crystal for your old one and hear broadcasting clearer, louder. "Hit it anywhere" and leave it. The most sensitive mineral on the world market. Unaffected by handling or moisture and will render efficient service indefinitely. **PRICE PER**

CRYSTAL, 50 cents. Post-paid. DEALERS write for our proposition.
"G-D" RADIO HEADSETS, 2900 OHMS, Price \$4.25, POST-PAID. Satisfaction Guaranteed on ALL our Products. Write for catalogue of our complete line on radio equipment.
GIBBONS-DUSTIN RADIO MFG. CO.
2859 W. 9th St. Dept. G Los Angeles, Cal.

VACUUM TUBE REPAIRING

SAVE ON **150** DETECTORS SAVE ON **300** AMPLIFIERS

We are repairing all detectors and amplifiers using a tungsten filament such as the following tubes: Marconi, Moorehead, De Forest, A. P. Electron relays U. V. 200, U. V. 201, C-300, C-301 and many other such tubes using a tungsten filament.

Repairing detectors and amplifiers for \$3.50. The repaired tubes we warrant will give you the same absolute satisfaction that you would expect to receive from new tubes.

We are now in a position to guarantee prompt deliveries and assure satisfactory results.
Dealers, agents, and customers wanted
GEORGE H. PORELL CO., Inc.
West Somerville Mass.

VACUUM TUBE REPAIRING

Terms Used in Radio Practice

(Continued from page 1301)

Code: Language spoken by a resident of Arkansas.

Communication, radio: A species of madness very prevalent during the colder months and which effects young and old alike. See "List of Ills Peculiar to Temperate Zone," and the speech of William Shakesfeller on "The Canning Season Is Here, Have You Bought Your Broadcasting Station?" Also a means of sending the SOS signal used by anti-prohibition sea captains who try to run across Bedloe's Island without castors on their vessels.

(To be concluded in next issue)

Formulae

(Continued from page 1301)

The power factor of the aerial switch is much simpler. To find it, all you gotta do is stand on a good sized radiator and grasp the lead in well above the loading coils while the key is depressed. If this procedure is unfruitful of results you had better phone for an ambulance because you are dead, and, of course, if dead you need not then worry your head about the formula at all. After your demise all you do is fly around at night with your newly attached and rehabilitated wings, and tie knots in ham lead ins and hang tin cans on their aerials, which aids in transmission and increases their capacities through your loving hands from the other side of the veil; if it rains, this increases their capacity wonderfully.

The phase difference between the primary transformer and the grid leak is easy to ascertain by direct methods. Take a small size Kolster decimeter, with a range from 7/8 to 87,654,321 meters, insert a variable condenser in the center of the "B" battery, and drop by drop, fill the remainder of the cabinet with dumbbells until the phase displacement registers X tons on the red dial. Then sit down and figure out on a sheet of cold rolled aluminum just how long it will be before the sanatorium ambulance comes along and takes you away.

(To be concluded in next issue)

Mr. Murchison's Radio Party

(Continued from page 1269)

"Don't mind him, Mrs. Murchison," said Mrs. Bimberry, giving Mr. Murchison a cruel glance. "He's nothing but a man—a mere man—"

"Oh! I am, am I?" cried Mr. Murchison, flaring up. "Well, I'll thank any woman that comes into my house—"

"Who are you calling a woman, Murchison?" demanded Mr. Bimberry fiercely. "If you mean my wife I'll tell you we did not come here to be insulted! You enticed us here to hear what you call radio, but if you did it to insult my wife and me I'll mighty soon show you—"

Mr. Bimberry was actually doubling his fists and something horrible might have happened immediately if Mr. Brownlee had not drawn the attention of one and all by clapping his hands together.

"Please! One moment, folks!" he cried. "Please listen to me one moment!

WANTED—Back numbers of Radio News, Sept., Oct., Nov. and Dec., 1921, Jan. and Feb., 1922. Experimenter Publishing Co., 53 Park Place, New York City

I know you are all disappointed because Mr. Murchison's radio does not work, but you forget that Brownlee is here! I know something about radio. I have studied it. It is my life's joy. It was well that Mrs. Murchison invited me here tonight, because—"

"Because what?" asked the indignant Mrs. Bimberry grimly.

"Because," said Mr. Brownlee, "instead of the evening being a failure on account of Mr. Murchison's lost antenna, it may turn out to be an evening we will all remember all our lives. And why? Because, with your permission, we will make a most interesting experiment."

He paused to allow his words to have full effect, and then proceeded:

"Recently," he said, "things no one dreamed possible have been done with radio. One man, instead of using outside antenna wires, has received with perfect results the radio concerts through his bed springs. Another man received them by using a common window screen. But, most marvelous of all, another man—doing away with all antenna—has received the concerts through his own body! Yes, it is indeed wonderful, Mrs. Bimberry, as your face shows me you think. And, with the kind permission of one and all, we will try that very thing. We will use Mrs. Murchison as the antenna and, if we have success, we will still hear the radio program tonight!"

Instantly everyone was excitedly interested and Mr. Brownlee flew from spot to spot, disconnecting a wire here and attaching it there, winding a wire around Mrs. Murchison's waist and running another from her ankle to the radiator for a ground connection. When all was ready Mr. Brownlee tuned in and, to the wonder of all present, a voice—very faint and very indistinct—muttered from the horn of the loud-speaker. Mr. Bimberry threw the first monkey-wrench into the amazed admiration of the listeners.

"But you can't hear it," he said. "I can't make out a blame word. I don't call that such-a-much. If that's the best you can do, Brownlee, I call the whole business a fiz—"

Mr. Brownlee was working at the dials nervously, now turning one, now hastening to see that the ground wire was well connected with Mrs. Murchison's ankle. He was excited and flustered. He stopped and wiped his face, for it was hot work.

"One minute!" he cried. "We've got something; we've almost got it! All we need is—just let me think this out a moment! Ground wire—feed wire—induction—voltage—battery—antenna. I have it! I know what's the matter!"

"What?" asked Mr. Bimberry. "What's wrong?"

"Mrs. Murchison," said Brownlee. "Mrs. Murchison is wrong. She's not—not enough. There isn't enough of her. What we need is more of her. She doesn't gather enough wave. We need somebody big—huge."

He looked at Mr. Bimberry, who was large, but his eye passed him and alighted with an eager glare on Mrs. Bimberry, who was far larger. In an instant he had connected her with the radio box. In another instant he had detached the ground wire from Mrs. Murchison's ankle and had attached it to Mrs. Bimberry's.

"You!" he exclaimed joyfully. "Just what we need!"

"Sir!" exclaimed Mrs. Bimberry haughtily. She turned to her husband. "Joseph," she said, "we will go. I have been sufficiently insulted in this house! And as for you, Mary Murchison, if you think you can let your guests be outraged in this manner the less we

ATWATER KENT

RADIO RECEIVING SET

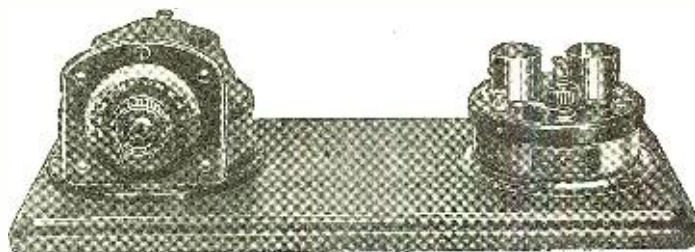

THE two instruments shown above comprise an excellent and complete receiving set. The Coupled Circuit Tuner and Detector Amplifier on the mahogany mounting board present a beautiful appearance. Complete outfit as above, unwired, \$32.00

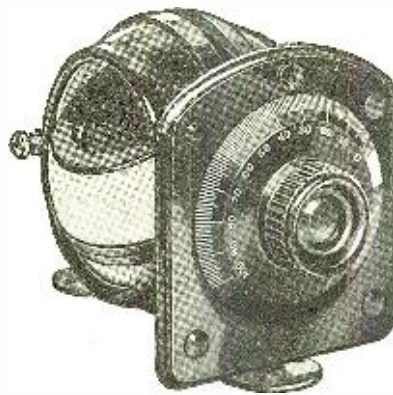

The Mounted Variometer carries through the standard quality of Atwater Kent products. For an open set it supplies a finished instrument unsurpassed in both appearance and performance.

Mounted Variometer, \$10.00

ATWATER KENT MANUFACTURING COMPANY
4943 STENTON AVE. Radio Dept. PHILADELPHIA, PA.

AERIAL-A

THE RADIO SET FOR YOUR HOME!

Aerial-A surpasses in selectiveness and strength of tone, machines of many times its price.

Designed especially for the layman, the Aerial-A set is the easiest to operate, and the simplest to tune, on the market.

Rich in appearance, compact, durable—this handsome set will add to the attractiveness of any home.

Aerial-A is easy to operate under all conditions—dampness and weather changes do not affect it.

Price of Receiver Set..... **\$25⁰⁰**

Manufactured by

W.E. Supply & Service Corp.

18 MURRAY STREET, NEW YORK

“ILLINOIS” THE RELIABLE CONDENSER THAT IS MADE RIGHT AND STAYS RIGHT

	Panel	Cased		Panel	Cased
67 Plates.....	\$7.00	\$8.50	23 Plates.....	\$2.75	\$4.00
43 Plates.....	3.50	4.75	13 Plates.....	2.25	3.50

Vernier with single movable plate applied to 13, 23 or 43 sizes, \$2.00 extra.

Above list is for our Regular Style with Knob, Pointer and Scale. We also furnish the Condenser with smooth 3-16 inch staff suitable for Dial at 15c off list.

A 3-inch Bakelite Dial with Condenser, add 50c to list.

Fully Assembled and Tested. IMMEDIATE SHIPMENT.

Money back if not satisfied. Just return within 10 days by insured Parcel Post.

Sent Prepaid on Receipt of Price, Except: Pacific States, Alaska,

Hawaii, Philippines and Canal Zone, add 10c. Canada, add 25c.

No Discounts except 5 per cent on orders of 6 or more. Send for Bulletin.

G. F. JOHNSON, 625 Black Ave., Springfield, Ill.

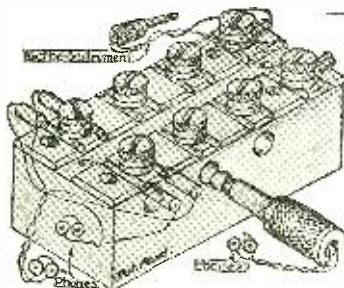

Price \$1.50
at your Dealer's, or by Mail direct on receipt of price plus 4c for postage in U. S. A.

“McCALL UNIVERSAL” PHONE CONNECTOR

Accommodates 1-8 pairs, cord tips (in opposite slots under screwhead—see sketch) or 1 to 3 plugs in side holes; also takes spade tips or wire.

Dealers and Jobbers—Write for proposition and folder illustrating other Radio parts we make, including our special binding post connectors.

Manufactured by **ILLINOIS RADIO CO.**

800 S. 4th St.

Springfield Ill.



—IT REPLACES
rheostats
meters
expert operator



AMPERITE

Automatic Filament
Current Adjuster
RELIEVES YOU OF ALL
TUBE TROUBLES



\$1.10 with mounting

Manufacturers
**RADIALL
COMPANY**

99 WARREN STREET
NEW YORK

see of each other the better! Good night!”

At that moment Mr. Brownlee must have touched a dial or a wire, for the mumbling whisper from the horn suddenly came forth loud and clear in the introductory words of the “Reduce to Music” selection. Clear and strong, as if aimed directly at Mrs. Bimberry came these words:

“No one, except for reasons of laziness or gluttony has any excuse to be fat!”

For a moment Mrs. Bimberry's face went purple; her vast bosom heaved with anger. She cast a murdering glance at poor Mrs. Murchison and started toward the door.

But only started toward the door. At the first stride the ground wire became taut. For a moment the queen of Westcote society stood on one leg, her arms stretched out before her and one leg extended backward toward the top of the radiator to which she was wired, like a high art nature dancer, hopping on one leg.

“Ready! Begin!” cried the voice from the radio horn: “Hop! Hop! Hop! Down!”

Mrs. Bimberry hop—hop—hopped and at the word of command “Down!” she sat down on the floor so suddenly that all her hairpins fell out and a tall glass vase of chrysanthemums fell off the table, but she did not have to follow the next command. It was “Raise your right foot!” and Mrs. Bimberry did not have to raise her right foot; it was already high in the air, pointing to the top of the radiator. It was her ground connection but it had no connection with the ground.

And still, relentlessly, through Mrs. Bimberry and out of the horn, came to her ears valuable advice on how to reduce. Radio is indeed wonderful! But that was not what Mrs. Bimberry was saying just then.

A Selective Long-Wave Receiver

(Continued from page 1275)

inductance so as to prevent self oscillation. The heterodyne is now started as usual on a W.L. nearing that of the transmitting station. If the signals to be received are very distant and not yet heard, increase slightly the regenerative coupling, modifying, at the same time, the tuning of the receiver. As soon as the signals are heard, tune the heterodyne so as to give the beats a convenient pitch, then slowly increase the regenerative coupling again; the amplification increases considerably when tightening this latter coupling and at the same time the selectivity becomes greater and greater and the tuning requires adjustment more and more closely, as it becomes exceedingly critical.

In order to get still better results, when it is desired to listen to farther and weaker stations, the power radiated by the local heterodyne must be adjusted to an optimum value; this amount can be controlled by varying the filament current of the oscillator tube or its plate voltage. The same result may also be obtained by varying the coupling between the coils of the receiver and those of the heterodyne. Again, that last adjustment is very critical also, and needs some experiments before obtaining the maximum results.

On a small aerial (110 ft. long and 24 ft. high) erected at La Ferte St. Cyr in about the middle of France, at the writer's home station, using this method of reception, quite a lot of American long-wave stations may be heard, the selectivity being so great that there is practically no jamming. Some powerful

trans-Atlantic stations such as NSS, WQK, WGG, WIL, WSO, etc., are always very strong, on aerial as well as on frame and are easily readable at all times of the day. These distant stations are received in this manner much more strongly than by adding, to a single-tube regenerative set, one and even two stages of audio frequency amplification, which method, as is well known, is not very efficient and does not allow any selection, since it amplifies more atmospheric and loud signals than weaker ones. On the other hand, it is also more efficient than a two-stage radio frequency amplifier and, above all, much more selective. It is, however, fair to say that this particular set is more difficult to manage than an all-round amplifier and is useful for long waves only (waves above approximately 4,000 to 5,000 meters). But I will say, in the hands of a skillful amateur it is capable of giving really astounding results and so deserves to be tried by the experimenter.

The Static Question

(Continued from page 1275)

It is reasonable to believe that these components will not be exactly proportioned in both the waves even though they are generated by the electric-discharge method.

THE STATIC WAVES and the WIRELESS WAVES differ. To what extent, no one is able to say, but for the sake of demonstration, I have given the percentage of each component present in each wave in Fig. 2.

Note that in the wireless wave I assume a 60 per cent electro-magnetic component with a 4 per cent electro-static component. This is due to the inductance present in our generating apparatus. In the case of the STATIC WAVE I assume just the reverse condition existing and we have a 60 per cent electro-static component and a 40 per cent electro-magnetic component.

My theory is borne out by all the latest devices which have been perfected for the elimination of static electricity, or static waves.

One of the strongest supporters of this theory is the Rogers underground system, where the shielding effect of the earth blots out a great portion of the static-component of the wireless and static waves and naturally leaves the electro-magnetic component of the wireless wave (which affects the buried wire electro-magnetically) stronger than the electro-magnetic component of the static wave.

The wiping out of the electro-static component of the wireless wave decreases the strength of the signals received considerably, but several stages of amplification bring the signal intensity back to normal and of sufficient intensity to be easily read when it is absolutely necessary for OVERHEAD ANTENNA stations to discontinue operating.

The LOOP antenna, while not being buried, simply responds better to the electro-magnetic component of the waves and is hardly affected by the electro-static component of waves. It is a purely electro-magnetic effect. Here too the signal must be brought up by the introduction of several stages of amplification.

Static eliminators which actually eliminate all static present in our wireless receivers are becoming an everyday news feature and since 1908 the writer has been reading about devices of that nature. Unfortunately, signals are as yet coming through static waves to me and I will certainly be grateful to any one who has in his possession the secrets of operation of these day-dreaming affairs—one who will be kind enough to send description and diagram of connections of the outfit to this or any other magazine for the sake of suffering humanity, in the forms of operators.

What have you to say regarding your observations of static, as it is generally misnamed?

Burgess, the Radio Battery

—designed by wireless specialists

It doesn't take long for a radio engineer to tell the difference between a Burgess and an ordinary battery. The Burgess begins to perform at once like a *radio* battery should—and a Burgess *continues* for a longer time.

The reason is that Burgess Radio Batteries are designed, made and sold by *radio* engineers. Burgess didn't rush into the field with merely a collection of flashlight cells. Burgess experimented and perfected the most efficient "B" battery *a long time* before the present popularity of radio began. Don't take our word for it—ask any radio engineer.

Leading manufacturers of radio equipment specify "Burgess." Burgess "B" Batteries are handled by all progressive jobbers and dealers. "Look for the Black and White Stripes." And if your dealer doesn't handle Burgess Radio Batteries, just address:

BURGESS BATTERY COMPANY
Engineers—Dry Batteries—Manufacturers
FLASHLIGHT—RADIO—IGNITION—TELEPHONE

General Sales Office: Harris Trust Bldg., Chicago
Laboratories and Works: Madison, Wisconsin

Branches:
New York Boston Washington St. Paul Kansas City New Orleans

In Canada: BURGESS BATTERIES, Ltd.
Winnipeg, Toronto, Montreal

BURGESS

RADIO BATTERIES

"ASK ANY RADIO ENGINEER"

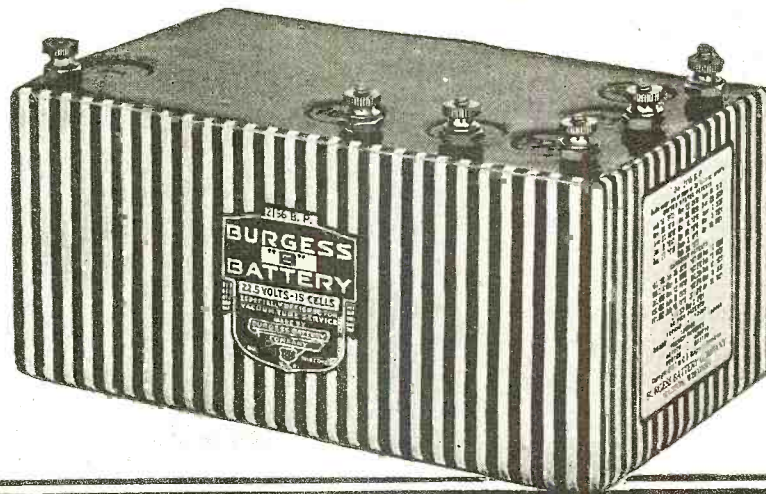

RADIO HEADQUARTERS

PLAY SAFE
Buy Standard Equipment

Order from This List

Westinghouse Aeriola, Sr. Receiver.....	\$65.00
Westinghouse AC Amplifier for Aeriola Sr.	68.00
Clapp-Eastham RZ Receiver-Amplifier.....	100.00
Clapp-Eastham HR Regenerative Receiver.....	40.00
Clapp-Eastham HZ 2-Stage Amplifier.....	40.00
Grebe RORN Rad. Freq. Amplifier.....	60.00
Grebe CR-9 Receiver Amplifier.....	130.00
Grebe CR-5 Receiver.....	80.00
Grebe CR-3 Receiver.....	80.00
Grebe CR-3 Receiver.....	65.00
Grebe RORD Detector-Amplifier.....	75.00
Grebe RORE 2-Stage Amplifier.....	55.00
Kennedy 281 Short Wave Receiver.....	80.00
Kennedy 521 2-Stage Amplifier.....	55.00

Tubes, Batteries and Phones are extra.

Remler No. 330 Detector Panel.....	8.50
Remler No. 331 Amplifier Panel.....	6.00
Remler No. 333 same with Cam Switch.....	9.00
Remler No. 505 Panel-mounted Variocoupler.....	12.00
Remler No. 502 Panel-mounted Variometer.....	10.50
Remler No. 500 Moulded Variometer.....	7.50
Remler No. 503 Variocoupler.....	5.40
Workrite Variometer.....	5.25
Workrite Variocoupler.....	5.00
Clapp-Eastham F-735 43-Plate Var. Condenser.....	4.75
Chelsea No. 1 43-Plate Var. Condenser mounted.....	5.00
Chelsea No. 2 23-Plate Var. Condenser mounted.....	4.50
Chelsea No. 3 43-Plate Var. Condenser with dial.....	4.75
Chelsea No. 5a .00025 mfd. Var. Condenser.....	3.35
Murdock No. 367 43-Plate Var. Condenser, in case.....	4.50
Murdock No. 368 23-Plate Var. Condenser, in case.....	4.00
Murdock No. 3660 43-Plate Var. Condenser, no case.....	4.00
Murdock No. 3680 23-Plate Var. Condenser, no case.....	3.25
ABC No. 650-11 11-Plate Var. Condenser.....	3.00
ABC No. 650-3 3-Plate Var. Condenser.....	2.25
Radion 3-inch Dial.....	.75
Radion 4-inch Dial.....	1.00
Moulded Bakelite 3-inch Dial.....	.75
Cunningham C-300 or Radiatron U. V. 200 Detector tube.....	5.00
Cunningham C-301, Raditron U. V. 201 Amplif. Tube.....	6.50
Westinghouse WD-11 Tube.....	6.50
Jefferson No. 49 Tube Socket.....	1.00
R. C. UR-342 Porcelain Tube Socket.....	1.00
Signal R-75 Tube Socket.....	1.00
Clapp-Eastham HT Bakelite Panel Socket.....	1.00
Remler No. 810 Jr. Filament Rheostat.....	1.00
Howard Vernier Rheostat.....	1.50
Paragon No. 25 Panel Rheostat.....	1.50
Bradley Stat. Filament Controller.....	1.85
R. C. PR-535 Rheostat.....	3.00
Cutler-Hammer H-1 Vernier Rheostat.....	1.50
Cutler-Hammer H-2 Plain Rheostat.....	1.00
R. C. PR-536 "A" Battery Potentiometer.....	2.00
Batteries—See our catalogue.	
Frost Fones No. 162, 2000 ohms.....	5.00
Frost Fones No. 163, 3000 ohms.....	6.00
Murdock No. 56 Phones, 2000 ohms.....	5.00
Murdock No. 56 Phones, 3000 ohms.....	5.50
Murdock No. 57 Phones, 3000 ohms.....	7.50
Baldwin Type C Phones.....	16.00
Baldwin Type C Unit.....	8.00
Brandes Superior Phones.....	14.00
Brandes Navy Phones.....	14.00
Westn Electric Phones.....	12.00
Westinghouse Vocarola.....	30.00
Magnavox R-3, 14-inch Horn.....	45.00
Acme A-2 Amplifying Transformer, semi-mounted.....	5.00
Jefferson No. 41 Amplifying Transformer.....	4.25
Jefferson No. 45 Amplifying Transformer.....	7.00
R. C. UV-712 Amplifying Transformer.....	7.00
Murdock No. 358 .0007 Mfd. Fixed Cond. Federal No. 15 Universal Plug.....	1.25
Frost No. 132 Plug.....	1.00
Frost No. 137 Plug.....	1.25
Frost No. 131 Jack.....	.90
Frost No. 133 Jack.....	.65
Frost No. 134 Jack.....	.75
Frost No. 135 Jack.....	1.00
Frost No. 136 Jack.....	1.25
Rotary Lever switches—See our Catalogue.	
Cabinets and Panels—See our Catalogue	
Brach No. 223 Outdoor Vacuum Gap Protector.....	3.00
Brach No. 200 Indoor Vacuum Gap Protector.....	2.50
Keystone Radio Lightning Arrester.....	2.00
Antenna Insulators, Magnet Wire, Card-board Tubing, Bakelite Tubing, Fibre Tubing, Spaghetti, Radio Boxes, Crystal Detector Supplies, Battery Charger, Loading Coils, Radio Tools, etc. See our Catalogue.	

FREE CATALOG, illustrated, sent on request.

DEALERS—Buy reliable equipment from a house of established reputation. Send for catalogue of tested and approved apparatus and our discount sheet.

IN BUSINESS SINCE 1860

JULIUS ANDRAE & SONS CO.
117 MICHIGAN ST. MILWAUKEE, WIS.

The New Schmidt High Frequency Alternator —A Rival of Vacuum Tube

(Continued from page 1266)

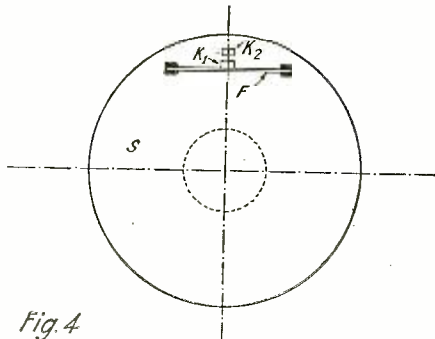

Fig. 4

Diagram of the Automatic Speed Regulator Mounted on the Flywheel of the Alternator.

To this end the winding is made of copper ribbon, Fig. 2; the coils are insulated from each other by layers of mica and the iron is in the form of an iron cylinder of thin iron wire surrounding the windings. By this method there are very small losses of lines of force and at the same time rapid cooling of the iron. It is obvious that in these machines, especially when working on short wavelengths, care must be taken that the rotation of the generator be kept as constant as possible. In a still simpler way, Schmidt has obtained this result by a centrifugal regulator invented by him, in which the centrifugal force and the weight work one against the other. On a disc, Fig. 4, near the circumference, there is a double bent spring F, which carries the contact K-1. Opposite to it is found on S another contact K-2, at a distance equal to the bend of the spring. If the centrifugal force is great enough, K-1 and K-2 come in contact.

If, therefore, the speed of rotation is too great, a slight weight in excess of the spring is sufficient to bring the contacts K-1 and K-2 together, before K-2 has reached its lowest point, whereby the length of the contact depends upon the speed of rotation. The regulator works on a relay, which as in the Tirrell Regulator short circuits the resistance in the existing circuit of the driving motor of the alternating current machine. Measurements show that between full load and running idle, a change in speed of 1/100 per cent can be taken care of.

A proof of the great advantages of this arrangement was shown during experiments which were carried out with a little 2-kilowatt 6,000-cycle machine in communication between Berlin and Amsterdam (600 kilometers).

The antenna current was eight amperes, the wave length 900 meters. In spite of this short wave, there was a very good and constant tone without interfering sounds in the reception. The audibility

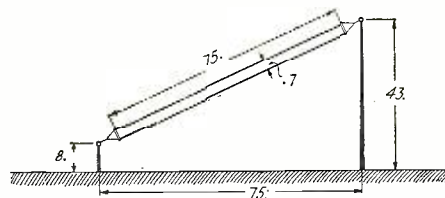

Fig. 5

Using a 2 K.W. Machine It Was Possible to Put 8 Amperes into this Aerial at the Low Wave of 900 Meters.

Beldenamel
TRADE MARK

Antenna Wire

A Recognized Improvement

Made of High Conductivity Enameled Copper Wire in either the Ordinary Stranded or our Special Loss-Reducing Braided Type.

On Reels or in Cartons of Convenient Size

Buy it from your Jobber

Belden Manufacturing Company
2300 South Western Avenue
CHICAGO

Eastern Office and Warehouse, Metuchen, N. J.

GET AN
F.R.S.
Long Distance
Single Bulb
RECEIVER

\$17.50



RESPONDS to wave lengths up to 600 meters. All molded Panels, Dials and Sockets. Has Variocoupler and "Read 'Em" Binding Posts, Rheostat and Rotary Switch, complete. Fine Mahogany Cabinet with Phone Compartment. May be hooked up in any standard circuit. Pin a Money Order to this ad, mail it today and you will be all set to enjoy the wonderful programs broadcasted every day.

FOR \$40

we will send you the F. R. S. Complete Two-Stage Long Range Receiver, including Cabinet—ready to hook up. A \$125 value!

Batteries, Tubes and Phones extra
F. R. S. RADIO CORPORATION
409 E. E. Fort St., Detroit, Mich.

AGENTS

Our established quality rewards your effort with liberal commissions even on large orders. "Triple-test" multimount crystals and "Triple-tone" special gold alloy cat-whiskers are today the best sellers to jobbers and retailers. High priced but unequalled in quality and sales helps. Repeat orders assured. State territory you want.

FOOTE MINERAL CO., Inc., 107 N. 19th Street, Philadelphia, Pa. Established 47 years

RADISCO PRODUCTS

RADIO DISTRIBUTING CO.,
NEWARK, N. J.

"BECOME A LIGHTNING TRICK CARTONIST"
Send \$1.00 for Snappy Program of Trick Cartoon Stunts and Complete Instructions. Circulars Free! BALDA ART SERVICE, Dept. 14, Oshkosh, Wis.

TELEGRAPHY

(Morse and Wireless) and RAILWAY ACCOUNTING taught thoroughly. Big salaries; great opportunities. Oldest, largest school. Endorsed by Telegraph, Railway, Radio, and Government officials. Expenses low—opportunities to earn large portion. Catalog free. GODGE'S INSTITUTE, 9 Street, Valparaiso, Ind.

BEST BY TEST DX RADIO FREQUENCY AMPLIFYING TRANSFORMERS



Patents Pending

DX TRANSFORMERS are used by U. S. BUREAU OF STANDARDS, U. S. NAVY ENGINEERS, LARGE RADIO MANUFACTURERS AND SOME OF THE FOREMOST CONSULTING ENGINEERS OF AMERICA.

(One of the latter, after most thorough comparative tests, states that DX TRANSFORMERS have the HIGHEST AMPLIFICATION of any Radio Frequency Transformer on the market.)

DX RADIO FREQUENCY TRANSFORMERS are used throughout the United States; they have proven **BEST BY TEST**; their superior qualities have earned for them a National Reputation.

AN ATTRACTIVE PROPOSITION TO JOBBERS AND DISTRIBUTORS.

IT PAYS TO HAVE THE BEST

**RADIO
INSTRUMENT COMPANY, INC.**
WASHINGTON, D. C.

SEND FOR LITERATURE

	Wave length Range	Price
DX-1	170—450....	\$8.00
DX-S	400—1200....	8.00
DX-2	900—3000....	8.00
Standard Plug Mounting	1.00

(If your dealer does not have DX RADIO FREQUENCY TRANSFORMERS write us.)



*It's wonderful
what a "Socostat"
(Socket-Rheostat)
will do*

One Radio "Bug" said: "My set is 60 to 70 per cent. more efficient since I hooked up the 'Socostat.' To take out the 'clicks and buzzes' it's wonderful what a 'Socostat' will do."

WHETHER you own a Radio Frequency set or have a Super-Regenerative Receiver, you need a "Socostat" to assure a clear, sensitive filament adjustment. It guarantees a smooth, positive contact and will increase the efficiency of any V. T. Radio set. The "Socostat," which combines the rheostat and socket in one unit, reduces a great deal of extra wiring and permits a more compact set.

Manufactured by

FEDDERS MFG. CO., INC.

55 Tonawanda Street, Buffalo, N. Y.



Single-Unit Socket and Rheostat for Table or Panel Mounting.
Price\$2.50



For Young and Old

Every member of the family can enjoy wireless entertainment—music—lectures—sport news, etc. The sending stations are putting out better programs than ever now.

**Stromberg-Carlson
RADIO
Head Set**

For amateur or professional use.

Extremely sensitive, reproduces accurately faint long distance signals, and is unsurpassed for comfort and adjustability. Forked cord permits two persons to "listen in" simultaneously.

Made by a firm with 28 years' experience in designing and manufacturing high grade telephone and radio apparatus.

Stromberg-Carlson apparatus—Head-sets, Radio Jacks and Radio Plugs—may be obtained from your electrical merchandise dealer, or write for free bulletin 1029-R.



**Stromberg-Carlson
Telephone Mfg. Co.
Rochester, N. Y.**

without amplification reached 218 for a telephone of 3,600 ohms resistance. The receiving aerial in Amsterdam was at a height of 500 meters, and the sending antenna of the shape and measurements indicated in Fig. 5. For wireless telephony the same arrangement can be used with good results. The results obtained make it reasonable to expect that the arrangement of Schmidt will come into sharp rivalry with the vacuum tube transmitter. The C. Lorenz Company today has installations of this system running from 1 to 1,000 K. W., with wave lengths running down to 1,000 meters. The Figs. 6 and 7 show the machines for a 500-K.W. installation now under construction. For each 400 K.W. two such high-frequency machines are used, between which the driving motor is coupled. The high tension in no part of the machine exceeds 1,000 volts. The alternating current machine has a strong air cooling system; the cooling air is sucked in from below and is blown out into the open room. The frequency transformer is built into an oil tank, whose oil is kept cool by coils through which cooling water passes. The installation works on wave-lengths of 20,000, 12,000 and 8,600 meters. The combined efficiency of the transformer for all waves is about 88 per cent.

**Correspondence From
Readers**

(Continued from page 1300)

or a C. W. set. But until he does, he will not know what the word thrill means, unless he measures the thrill by the amount of money he makes selling his services in installing radio sets. To the real key-man the money consideration is only one of getting together a good transmitter and receiver.

If it be considered a wonderful thing to hear music thousands of miles away and to amplify it to the *n*th degree, how much more wonderful is it to hear a fellow brass pounder, just as far away, calling and to answer him and chat with him a while or relay a message to him, if such is the order of the time? I have listened to concerts both near and far until I was so tired of them I nearly became disgusted with radio and turned on the key for a diversion, which is never tiresome, but seems ever to have new wonders and new fascinations.

I have never been to a convention of phone "hams" and don't know how they would act, but to go to a convention of key hams is where we find the real spirit of radio. We meet personally friends with whom we have often spoken, but have never seen. The atmosphere is charged with a feeling of good fellowship and we leave determined to do greater distance and make more friends for the betterment of the radio art. Most certainly has code many rewards for the man who takes the time and has the patience to master it.

I read also in the November issue your reply to Leonard S. Cohn, and I think you have very aptly put it. It is impossible to please anyone who will not tell you what he wants. But I take sides with many who say that you are slighting the radio amateur, for there is little in your recent issues that appeals to him. Since your magazine has assumed such large proportions why not set aside a certain space each month for the amateurs and give them the articles they want? Do I hear you say, "There's the rub, what do they want?" Why not find out? Announce



**High
Efficiency**

HEAD SETS

- Army and Navy Type:
 - 2500 ohms, per pair \$10.00
 - 3200 ohms, per pair 12.00
- Swedish-American Type:
 - 2200 ohms, per pair 8.00
- Victor Type:
 - Single coil, double magnet 6.00

Jacks, Plugs, Microphones and other Radio Parts

Ask for our Liberal Trade Prices

American Electric
COMPANY

CHICAGO - U. S. A.

HAS THE UNDERWRITERS' O. K.

Strong—Durable—Inconspicuous

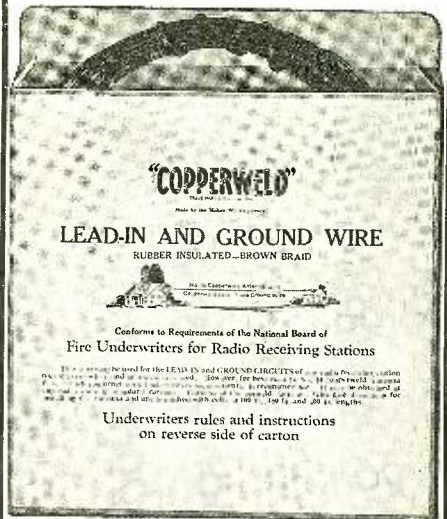

**BUY IT IN CARTONS
COPPER CLAD STEEL COMPANY
NEW YORK CHICAGO
BRADDOCK, P. O., RANKIN, PA.**

Hear Those Distant Stations!

With the JM-6 Radio Frequency Amplifier. Absolutely dependable for clear, long distance reception.

Write now for data and prices.

MASSEY RADIO COMPANY
Winchester Virginia

**T'S A
LONG
LONG
WAY**

**TO SOME OF THE
BROADCASTING STATIONS
YOU CAN PICK UP WITH A**

DX TYPE NO. 58 R. F. RECEIVER

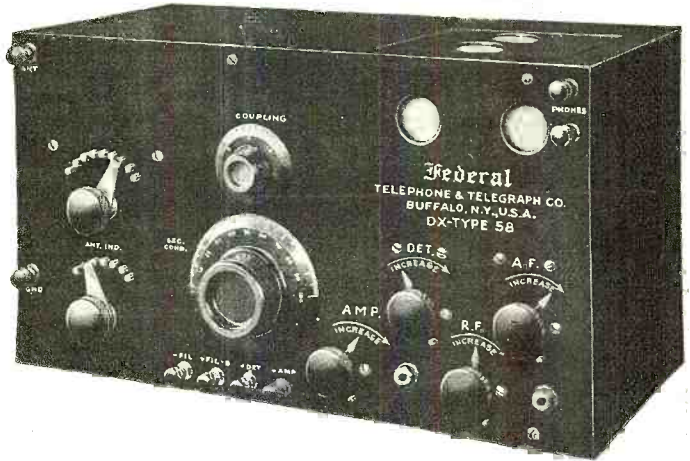

Federal

DX TYPE NO. 58 R. F. RECEIVER

An Instrument of Great Selectivity and Exceptionally Long Range.

If you don't like the program you are listening to—you can find another more suited to your taste.

BULLETIN NO. 119-W FULLY DESCRIBES RADIO FREQUENCY APPARATUS

WRITE FOR YOUR COPY

Federal Telephone and Telegraph Company

BUFFALO, N. Y.

An Historical Epoch In Radio—Pioneer Slashes Prices

**Duck Instruments—The Leading Line Since 1909 at Prices to You
Less than Most Dealers Cost**

It was always the Duck policy to sell its products direct—from factory to consumer. After much consideration we have decided to continue this policy rather than to distribute our products among dealers. With the thousands of radio concerns in all parts of the country, we of necessity must deliver our goods to the consumer at an exceptional saving. Being the only long-established manufacturer with a mail order patronage of vast proportions, we are in a position to sell our nationally known line at even less than most dealers' cost price. Our new established prices average 30% below our previous and regular prices. We manufacture the most complete line of radio instruments in America—82 instruments. We are one of the oldest radio houses, dating back to 1909. Our products have stood the test of time and have a world wide reputation among experienced and discriminating users of radio apparatus. We claim without fear of successful contradiction to have the finest line of radio instruments in America, bar none, from the standpoint of completeness, skillful workmanship and advanced radio thought.

DUCK'S NEW PANEL TYPE VARIABLE CONDENSER acclaimed by all that have seen it to be the peer of any on the market. Pigtail connections, i. e., no sliding contacts. Base and top moulded bakelite. Aluminum separators, i. e., even spacing and simple means of adjusting plates. Mounting screws furnished. Concealed by dial. Brass bearings; 1/4" shaft.



FREE PAMPHLET Mailed on Request, Illustrating and Briefly Describing Many of Our Instruments with New Prices on Our Complete Line.

Just a Few of the Many Duck Products at Revolutionary Prices:

- | | | |
|--|---|---|
| Duck Bakelite Dial 3/16" or 1/4"\$0.55 | Duck "CQ" Receiving Set in mahogany cabinet, with detector and two stage amplifier59.50 | Duck No. A213 One Step Amplifier Panel10.50 |
| Duck Positive Contact Socket70 | Duck "CQA" Three Stage Radio Frequency Amplifier, in hinged mahogany cabinet49.00 | Duck No. A214 Two Step Amplifier Panel27.00 |
| Duck Filament Rheostat\$0.70 | Duck "RFQ" Two Stage Radio Frequency Amplifier, in hinged mahogany cabinet39.00 | Duck, The Original Arlington Receiving Transformer 9.75 |
| Duck Radio Frequency Potentiometer 1.15 | Duck No. A204 Parts for Short Wave Receiving Set, in mahogany cabinet39.50 | Duck Navy Type Receiving Transformer16.10 |
| Duck Moulded Plate or Grid Variometer, less dial 4.65 | Duck No. A211 Parts for Short Wave Receiving Set\$24.95 | Duck No. A220 One Step Radio Frequency Amplifier Panel13.60 |
| Duck Super-selective Mahogany Form Plate or Grid Variometer 3.60 | Duck No. A212 Detector Panel 5.25 | Duck No. A221 Two Step Radio Frequency Amplifier Panel28.00 |
| Duck Variocoupler 3.60 | | Duck No. A223 Three Step Radio Frequency Amplifier Panel38.50 |
| Duck Switch Parts for Variocoupler 1.25 | | |
| Duck Panel Type 23-plate condenser 2.50 | | |
| Duck Panel Type 43-plate condenser 3.15 | | |
| Duck Panel Type Vernier Condenser 1.65 | | |

Note:—Positively the very best variable condenser on the market. Pigtail connections; aluminum separators.

Postage or express extra on all goods. Estimate postage, and if too much we will refund. We do not hold up order for insufficient postage.

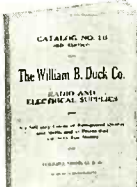

Get Your Catalog Out and See Startling Reductions

**Duck's Combined
Radio Catalog
and Text Book
No. 16, 256 pages**

Continuously since 1909 Duck's Radio catalogs have never been equalled for completeness and great wealth of radio data.

Send 25c in coin, carefully wrapped for your copy of this wonderful catalog—the most unusual and complete book ever put between two covers. Over 50 pages radio hookups and invaluable and up-to-date information on radio. Everything worth while in radio listed in this catalog.

The WILLIAM B. DUCK CO., 231-233 Superior St., Toledo, Ohio

Quality Design
 + **Workmanship**
 + **Materials**
 = **RELIABILITY**

Radio-A Recharger



This unit is the product of a firm of pioneers in the battery charging field. Our commercial apparatus is used in thousands of the best equipped battery service stations in the country.

Materials and workmanship are the finest available.

RADIO-A is *built* not assembled. Simple to use—just plug in at any 110-v. A. C. lamp socket, attach clips to battery, turn on current and you have your own charging plant.

Only one moving part, which will last for several thousand hours.

The only Recharger with a *one piece* Removable Vibrator can be replaced by a child.

Think of the convenience of not having to carry your battery to the Service Station this winter.

The Battery will always be full of pep.

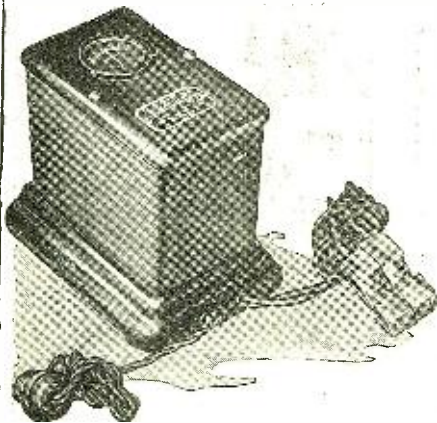

A compact portable Recharging unit that will fully charge a 100 AH battery overnight for 5c to 10c.

A useful and lasting Xmas Gift. Lasts a lifetime.

**KING ELECTRIC
MANUFACTURING CO.
INC.**

1681 Fillmore Avenue
Buffalo - N. Y.

the beginning of such a department and ask for articles. I think you will find a generous response from the rank and file of amateurs. Your publication should have a column or more of "Calls Heard". You have mentioned this in past issues, but did not seem to favor it. But really to find out, ask the amateurs what they want.

JOHN B. DOWDEN, 2BFF,
Glen Cove, N. Y.

(Here we are: "Ask for articles!" We asked for a bunch of them, but very few came in, and the reason is, most probably, because all those amateurs who can write something are too busy making money or doing something else. We wish that some of the gang would write something interesting that we could publish for the benefit of all.

Regarding "calls heard," we shall comply with the desire of the "hams" and publish every month some calls heard. All you have to do if you wish to have them published is to send them in, according to the directions given in the department "With the Amateurs" in this issue.—Editor).

RE QRM

Editor, RADIO NEWS:

May I be permitted, through your paper, to suggest a means of extending the *real* Radio Amateur's official life?

The method I suggest is for some of the district radio inspectors to get busy and earn their salaries by either correcting adjustment of, or, in flagrant cases, confiscating radio transmitting apparatus owned by certain unsportsmanlike hams, who make no attempt of their own volition to adjust their sets to the wavelength allotted. My receiving set can reach over 800 meters, and some of these birds are going strong beyond that. Unfortunately, I cannot read code very fast, so am unable to make a report giving call letters. I have been away from radio for many years, but am still heart and soul for the true amateur. I've heard many complaints here in Toledo about these amateurs who hash up good long-distance concerts and much unjust criticism of all amateurs. I don't think it fair to the majority that they are blamed for the work of a few irresponsibles, but unless something is done pretty soon to abate this nuisance, there is liable to be some unpleasant restrictions laid down for all amateurs. I hope your magazine can find some means of having this sort of thing stopped.

WALTER S. H. ATKINSON,
Toledo, Ohio.

A CANADIAN OPINION

Editor, RADIO NEWS:

I have been following with much amusement the feud between the amateur and the novice. What is it all about, anyway? In my own little town there are about 50 BCL's and two actively operating amateurs, 3YH and myself (more coming later) both using C. W., 5 and 20 watts respectively. Now, 3YH, while operating on 200 meters, with 1.5 amps., cannot be heard on 360 meters at a BCL station about four or five hundred feet away. No complaints of interference have been received by either of us from any persons using real tuners. The solution to the QRM problem then seems to be the use of medium power C. W. transmission by the amateurs, during concert hours at least, and the use of proper three-circuit tuners or honeycomb coil sets by the BCL's.

What's all this talk about RADIO NEWS having gone to the bad and canning the

USE OUR FACTORY

Manufacturers and dealers who require wireless apparatus or parts can obtain quantity output and guaranteed delivery. We have over half a million dollars invested in special and automatic machinery. Wire and metal products our specialty. Send sample your product and receive our quotation on making.

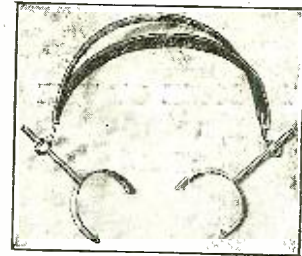

HEADBANDS

You know this headband. We can make prompt shipment on your order. Get our prices.

THE AUTOYRE COMPANY

Oakville, Conn.

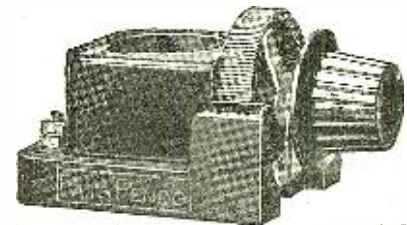

KING RHEO-SOCKET

Price \$3.00, f. o. b., N. Y. C.

This rheostat embodies compact, increased efficiency, having shorter connections and less wiring. It will bring in stations you have never heard before.

Make this King Rheo-Socket a part of your up-to-date set. A high-grade article in red bakelite with phosphor-bronze contacts and alloy resistance wire.

For base or panel mounting

KING AM-PLI-TONE

82 Church St., New York City

Mrs. of the famous King Am-Pli-tone

Jobbers:

Wire or write for interesting proposition

Our moulded variometer and other moulded products will mean satisfied customers and more sales to you, Mr. Jobber and Dealer, why not write to us for full particulars?

The RIDgewood RADio Shop

1603 Myrtle Ave., Ridgewood, L. I.

Amateurs, we rewind and repair fones; send them to us.



3500 Ohm Headset, \$8.00

2200 Ohm Headset, \$6.00

MANUFACTURED BY

The Carlisle & Finch Co.

229-231 E. Clifton Avenue

CINCINNATI, OHIO

Eastern Representative:
W. K. Thomas, 41 Park Row, N. Y.

ARE YOU SELF-CONSCIOUS?

Embarrassed in company, lacking self-control? Let me tell you how you can overcome these troubles.

M. VERITAS, 1400 Broadway, New York City

Free till February 1st

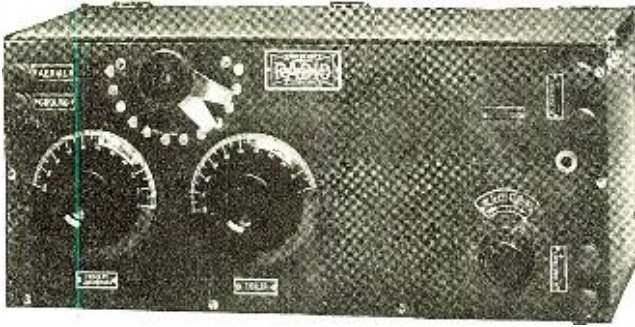

Outside View of the Fremont A.W. No. 1—\$35.00 Set

The Most Complete and Authoritative

Book on RADIO

Size 4 1/2 x 7 1/4 Inches

Furnishes official and reliable radio data from the U. S. Bureau of Standards. Contains 252 pages filled with Radio meat. 268 diagrams and illustrations.

Includes Elementary Electricity for Radio Beginners, Dynamo-Electric Machinery, Radio Circuits, Electro Magnetic waves, Transmitting and Receiving Apparatus, Crystal Detectors.

Bound in Full Cloth. Only \$1.00 postpaid. Order your copy today to insure prompt delivery.

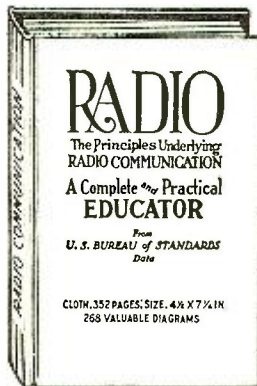

A 2000 Ohm Double Head Phone

WITH every purchase of our unassembled Fremont A. W. No. 1 Receiving Set. A wonder Radio Value. Here is your opportunity to get a worthwhile set—all parts, except detector tube, furnished. Panels are drilled ready to be put together. Six hook-up diagrams included with each set. Radio panel 6x14x3-16 inches. Guaranteed ranges 150 to 3000 meters. Price, **\$35.00.**

Here is another Knock Down Set for \$15.00

NO PHONES INCLUDED WITH THIS SET

This set is designed according to the "Radio Constructor Plan" No. 1 of the Consolidated Radio Call Book Co. Plans and instructions 50 cents extra. All parts furnished—all holes drilled—ready to be put together. Receives telephone broadcasting and wireless signals from 150 to 600 meters.

Material includes 43 plate variable condenser, dials, necessary wire, switch, knobs, switch points, binding posts, material for cabinet. "Radion" panel drilled ready for assembly. Illustration shows complete variometer for which tubes and all necessary parts are included.

All parts of the above R. C. No. 1 come well packed. Price \$15.00.

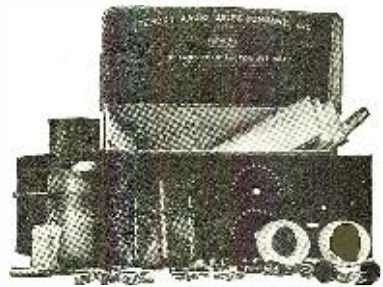

Order direct from this advertisement. Those wishing additional Radio accessories please send for catalog. P. O. M. O. and Express M. O. acceptable.

FREMONT RADIO SALES CO. 50 CHURCH STREET NEW YORK CITY

"SUPER-HETERODYNE, THE ROLLS ROYCE METHOD OF RECEPTION"—E. H. Armstrong

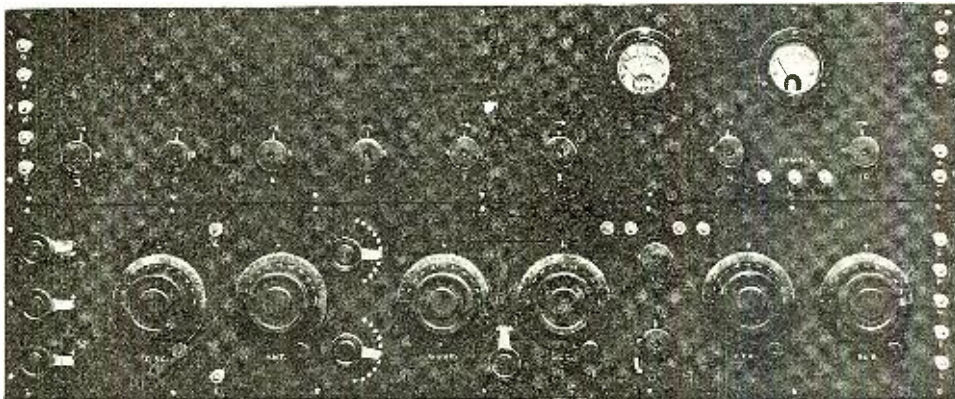

Armstrong Super-Heterodyne Receiver, 160 to 850 meters; 850 to 25,000 meters. Average range, 3000 miles.

This Method of Reception Used By

Paul F. Godley at Ardrossan, Scotland, and received 27 American Amateurs 3000 miles. Commercial Ship to Shore Traffic 3000 miles and over.

Advanced Amateurs for Extremely Long Distance Reception.

Obtainable Exclusively thru

EXPERIMENTERS INFORMATION SERVICE

Designers of the Highest Class Radio Apparatus in the World

23d Floor, 220 West 42nd Street, New York City

REQUEST CATALOG H COVERING FULL LINE.

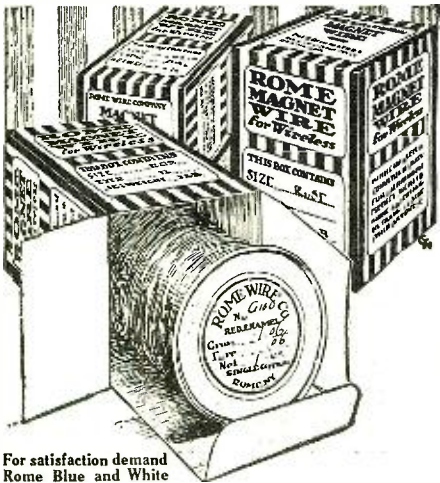

For satisfaction demand Rome Blue and White Package or Label.

ROME RADIO WIRE

Magnet Wire

Best Quality Plain Enamel Covered; Enamel and Single or Double Cotton Covered; Single or Double Cotton Covered.

All sizes: 1/4-lb. to 40-lb. packages.

Antenna Wire

Best Quality Solid or Stranded Copper Antenna Wire, plain or tinned; put up in lengths of 100-ft. and 150 ft., or on 24" reels of 200 lbs.

At Your Dealer's

ROME WIRE COMPANY
 ROME, N.Y. BUFFALO, N.Y.
 DISTRICT SALES OFFICES
 NEW YORK . . . 50 Church Street
 CHICAGO . . . 14 E. Jackson Blvd.
 DETROIT . . . 25 Parsons Street
 LOS ANGELES . . . J. G. Pomeroy, 316 Azusa Street

Makes Your Radio Set Work Better

Perfect reception can be had only when wire connections are soldered. SOLDERALL and a match make perfect joints—guaranteed equal to wire or bar solder.

At Leading Jobbers and Dealers or Sent Postpaid for 25c a tube. Solderall Co., Dept. B, Newark, N. J.

SOLDERALL
A Metal in Paste Form

amateurs? I can't see why anyone should kick in a serious way just because you have increased the size of the magazine by putting in articles interesting to the novice, and not cutting out any amateur stuff. We amateurs should realize that the publishers of RADIO NEWS are in the business for their living, not as a philanthropic institution and as such are entitled to make the contents of the magazine of interest to the greatest number of people. All the new magazines are, and, I fear, some of the old ones have become, 100 per cent broadcast magazines and I think that credit is due to RADIO NEWS for not going that way; nowadays, it is truly living up to its name, as it covers the whole radio field, and does it well.

If you can get them, I would like to see a few more articles on small C. W. and phone transmitters, not for my own benefit particularly, but for that of the many novices who are getting interested in those peepings below 200 meters, regardless of Mr. Petrequin's point of view. In passing, I should like to ask Mr. Petrequin if he ever listened in on an Eastern amateur station and tried to pick up a few "Sixes." If he has done this successfully, I will bet it has been an eye-opener to him after what he said about it being "easy" to tune C. W. in. He likes the pleasure of pulling in the DX phones, but why doesn't he try to get exactly twice the pleasure by building a C. W. transmitter and try to pound signals out as far as he can, too? People often knock things they haven't tried. I used to knock C. W. until my partner, Carl Rumpel, forced me to use it at this station, and now I never use the spark unless it is absolutely necessary.

When are you going to publish a list of the Canadian broadcasting stations? You can get one all written for you from the Canadian Department of Marine and Fisheries' "Official list of Radio Stations of Canada," which can be obtained from the department for the sum of one dollar, which includes all future supplements. (loose leaf with hard covers). The list of broadcasting stations in this book gives time schedules, etc., as well as locations of stations.

H. S. GOWAN,
 CANADIAN 3DS,
 120 West King Street,
 Kitchener, Ontario.

(A list of the Canadian broadcasting stations was published in the last issue of RADIO NEWS. As for you Canadian hams, why don't you write to us telling of what is going on across the border, for the benefit of all? Tell them we will be glad to hear from them—Editor.)

THE BAD LANDS OF RADIO IN CANADA

Mention has been made many times of ether pockets in various parts of the United States, but never before has there appeared a report of a similiar condition in Canada. But this article is to announce the discovery of one of these mysteries in no less a location than at the largest and most exclusive summer resort hotel in all the dominion, namely, The Bigwin Inn, on lake of Bays, Muskoka.

For demonstration purposes a complete set was sent up to the hotel early this summer, consisting of a honeycomb coil system with detector and two stages of amplification; all were of the author's construction. Before shipping, numerous tests were made, ascertaining the working range of the outfit, and satisfactory distances with the outfit resulted. However, upon locating the aerial between the two highest points obtainable, the dancing pavilion and dock buildings, it was found by the operator upon try-

World's Largest Distributors of RADIO HEAD PHONES

Following phones for immediate delivery—

All phones made by reliable telephone makers with many years of experience.



MAKE	CHARGE	LIST
Murdock phones	2000 ohm	\$ 5.00
Murdock phones	3000 ohm	5.50
Frost-Fone	2000 ohm	5.00
Frost-Fone	3000 ohm	6.00
Schwarze Electric	2000 ohm	5.00
Schwarze Electric	3000 ohm	5.50
Elwood Electric	2000 ohm	5.50
Manhattan phone	2000 ohm	6.00
Manhattan phone	3000 ohm	7.00
Connecticut	3000 ohm	7.00
Stromberg-Carlson	2200 ohm	7.50
Leich Electric	2000 ohm	7.50
Holtzer-Cabot	2200 ohm	8.00
Coryphone	2000 ohm	8.00
Brandes Superior	2200 ohm	8.00
Western Electric	2200 ohm	10.00
Dictograph	3000 ohm	8.00
Kellogg	2400 ohm	10.00
Baldwine Type "C"	Double	16.00
Baldwine Type "C"	Single	8.00
Brown phones (English Make		
—adjustable	4000 ohm	20.00
Brown phones (English Make		
—adjustable	8000 ohm	22.00
Schwarze Electric (Single)	1000 ohm	2.50
Planet Loud Speakers, with Western Electric Receivers		\$40.00

Liberal discounts to agents, mailing prepaid. Send money order or cash in registered letter. Agents wanted everywhere. Write for discounts.
B. E. POLCZYNSKI & CO.
 Capitol Building Detroit, Mich.

PUR-A-FORMER
\$350

Here's an audio amplifying transformer without any frills or fancy finishes—just solid honest value. The PUR-A-FORMER is compact and strongly built—amplifies without howl or distortion. Takes minimum space in your set and will produce results equal to many selling at double the price. Winding ratio 4 1/2 to 1. Buy them at all good dealers.

DEALERS ONLY—

Write for Harry Alter's RADIO "POCKETBOOK."
 A net price catalog of radio supplies published each month. Our wholesale prices hit bottom.
 The RADIO "POCKETBOOK" sent free to dealers only. Use your letterhead.
HARRY ALTER & CO.
 We Sell Wholesale Only
 126 N. May Street Chicago

Radio Supplies

All Standard Goods—Immediate Deliveries
 Distributors for
BALDWIN, BRANDES and FROST PHONES, MONROE RECEIVING SETS.
 Atwater-Kent, Chelton, Chelsea, Thordarson, Burgess, Cunningham, Magnavox and many others.. A Complete Line. Largest Stock in the Middle West. Write for Catalogue.
DEALERS—ATTRACTIVE DISCOUNTS
AMERICAN RADIO MFG. CO. Dept. A.
 107 E. 13th ST., KANSAS CITY, MO.



The Future of RADIO

The fun and entertainment that you and your friends get from Radio should never be marred by failure of your apparatus to properly do its part—and it won't fail if it is properly made.

The Radio "fans" of today will be the Radio experts of the future—**provided** the equipment used **now** gives service and satisfaction. If you are interested—much or little—in Radio, don't let inefficient equipment discourage you. Insist on SIGNAL parts and SIGNAL sets.

Every SIGNAL item is made in a factory that has grown up with "wireless". One of the earliest manufacturers of such equipment, SIGNAL offers you, now, Radio parts and Radio Sets that are **right**, and are **dependable**. To insure getting all there is—to be confident that nothing goes by you without your consent—say SIGNAL, and stick to it, when you buy equipment of any kind.

SIGNAL Electric Mfg. Co.

Factory and General Office 1923 Broadway, Menominee, Mich.

Atlanta, Boston, Cleveland, Chicago, Minneapolis, Montreal, New York, Pittsburgh, St. Louis, San Francisco, Toronto.

You'll find our local address in your Telephone Directory.



Signal Junior Detector Units

For the amateur, and also the rapidly growing commercial field, we have developed an entirely new line of apparatus, in which is incorporated the very latest advancement of the science of Radio.

Each individual unit is primarily a separate and distinct device, complete in itself, yet by adding one to another any combination may be obtained, from the simplest crystal detector through all the stages of radio frequency and audio frequency amplification.

Seasoned knowledge and experienced handcraft are built into these units—the product of a plant and an organization whose history in Radio dates back to the earliest days of "wireless."

Coupon for Guide to Radio Satisfaction.

Please send, without obligation, your interesting book about SIGNAL parts and sets, to the name and address written on the margin of this page. (1922)

RADIO MERCHANDISE

F. D. PITTS COMPANY

(Incorporated.)

219 COLUMBUS AVE., BOSTON, MASS., U. S. A.

Wholesale Only

Distributors for

- A. H. Grebe and Co.
- Acme Apparatus Co.
- Adams Morgan Co.
- American Eveready Works.
- American Radio and Research Corp.
- Atwater Kent Mfg. Co.
- Baldwin, Nathaniel Co.
- Burgess Battery Co.
- Chelsea Radio Co.
- Clapp-Eastham Co.
- De Forest Tel. and Tel. Co.
- Dubilier Condenser Co.
- Electrose Mfg. Co.
- Fada.
- Fahnestock Elec. Co.
- Federal Tel. and Tel. Co.
- France Mfg. Co.
- Frost, Herbert H. and Co.
- General Radio Co.
- Jewell Elec. Inst. Co.
- Magnavox Co.
- Mitchell, R. and Co.
- Murad Laboratories.
- Murdock, Wm. J. Co.
- Pacent Elec. Co.
- Radio Corp. of America.
- Remler Radio Mfg. Co.
- Signal Elec. Mfg. Co.
- Western Elec. Co.
- Weston Elec. Inst. Co.
- Wireless Press.



"GREBE RADIO"

- Grebe CR-3 Receiver, 150-1000 meters\$65.00
- Grebe CR-5 Receiver and Vacuum-tube Unit, 150-3000 meters...\$80.00
- Grebe CR-8 Receiver and Vacuum-tube Unit, 150-1000 meters...\$80.00
- Grebe CR-9 Receiver, Detector and Two-stage Amplifier. 150-3000 meters\$130.00
- Grebe CR-10 Radiotone Concert Receiver, Detector and Three-stage Amplifier, Victrola type.....\$315.00
- Grebe RORK Two-stage Amplifier\$55.00
- Grebe RORD Detector and Two-stage Amplifier\$75.00
- Grebe RORN Tuned Radio Frequency Amplifier.

, "Without going out of doors," said Lao-Tzu, "one may know the whole world." "Let a GREBE RECEIVER bring the whole world to your evening fireside."

DEALERS—Attractive discounts and immediate deliveries from stock! Send for Our Latest Price List, No. 3.

"F. D. PITTS CO. NEW ENGLAND DISTRIBUTORS OF GREBE RADIO"

Compare These Prices

Why Pay More When You Can
Get Rock Bottom Prices From Us

Save Save Save

Just glance over our list and send us your money order. Twenty-four hours after receiving your order, it is on its way to you.

List Price	Our Price
\$5.00 Radiotrons UV-200	\$4.25
6.50 Radiotrons UV-201	5.75
16.00 Baldwin Phones Type C	13.98
7.75 Baldwin Unit Loud Speakers	6.75
45.00 Magnavox	38.00
25.00 Western Electric Phones	11.00
Same as used in Signal Corps	
8.00 Federal 2,200 ohm Phones	6.00
8.00 Brandes Superior Phones	7.00
1.00 Double Jacks	.60
.70 Single Jacks	.50
2.50 Bull-Dog Plugs	1.25
1.50 100 ft. stranded Aerial Wire	.50
.50 Aerial Insulators	.20
1.00 100 ft. stranded Aerial Wire	.40
75.00 P-agon RA-10	68.00
25.00 90 Ampere guaranteed storage Battery	16.00
8.00 Westinghouse W. D. 11 Tubes 1/2 Volt operated on 1 Dry Cell. Can be used as Detector or Amplifier	6.50
1.50 Sockets for W. D. 11 Tubes	1.00
1.00 Rheostats	.75
1.00 Fada Rheostats	.65
1.00 Vacuum Tube Socket	.50
18.50 Homchargers, new style	16.50
3.50 B Batteries Volt Meters 0-50-V.	2.75
4.50 Murdock Enclosed 43 plate Variable Condensers	4.00
4.00 Murdock Enclosed 23 plate Variable Condensers	3.75
3.25 Murdock Panel Mounting 23 plate Variable Condensers	3.00
4.00 Murdock Panel Mounting 43 plate Variable Condensers	3.60
3.75 23 plate Variable Condensers	2.25
4.75 45 plate Panel Mounting Variable Condensers	2.50
12.00 Western Electric VT-1	7.50
13.00 Western Electric VT-2	8.50
8.00 Atwater-Kent Variometers	7.25
8.00 Atwater-Kent Variocouplers	7.25
4.50 Thordarson Audio Transformers	3.75
1.00 Fixed Condenser	.50
1.50 Crystal Detectors	.75
8.00 3,000 Meter Loose Couplers	4.75
4.00 Tuning Coils	2.00
Contact Points (per doz.)	.15
Switch Levers 1/2 in. Radius	.25
Honeycomb Coils All Sizes 20% Discount	

Space being limited we are obliged to omit many items.

Write for our quotations.

Cut Rate Radio Co.

P. O. Box 472 Newark, N. J.

A QUALITY BATTERY Guaranteed Two Years

MARKO STORAGE BATTERY COMPANY
1404 Atlantic Ave. Brooklyn, N. Y.



NICK'S RADIO BARGAINS

VARIOMETERS (150 to 600 Meters)	\$2.74
COUPLERS (150 to 600 Meters)	2.43
43 PLATE VARIABLE CONDENSERS	2.56
23 PLATE, \$1.91	11 PLATE 1.70

The return of these instruments gladly accepted if not satisfactory. Note—The Radio News would not insert this ad if we handled UNSATISFACTORY MERCHANDISE.

NICK'S RADIO SHOP

26 N. Desplaines Street Chicago, Ill.

ing out the set, that the most desired station, *The Toronto Daily Star* with a 1-K.W. radiophone, 150 miles away, could not be heard. When a station with a thousand mile range was entirely inaudible at that distance, it at once appeared that there was something wrong somewhere.

This surmise led to the staging of three special concerts by *The Star* at midnight the most probable time to get through. On each occasion not a peep was heard. Although a station 10 miles from the hotel on similar power (two-stage receiver) got them clearly. Immediately, *The Star* reported to the manufacturer of its broadcasting set, a large and reputable firm, which immediately sent up to the Inn one of its radio engineers, who took along a representative line of receiving equipment of its own manufacture. On arrival, this man disconnected the author's set and installed his own, and his tests resulted in this report.

Bigwin is located in a perfect ether pocket, where not even a telegraph station can be heard.

Things drifted on and the author in turn traveled up to the northern wilds to try his luck having previously sent up another two-stage set that worked perfectly in Toronto and that was calibrated for *The Star*. Having arrived at the Inn, a three-night test was made, as follows:

On each of the nights good radio weather prevailed, but during the hours scheduled with *The Star*, nothing was heard, but the American stations came in well and the following were heard loud enough to use a horn: Louisville, Ky., St. Louis *Despatch*, Indianapolis, Kansas City, Anacostia, and all the large stations of the east.

A new theory at once formed in the author's mind as a result of these latter tests, namely that in that ten-mile band, somewhere between Toronto, and the Inn was an obstruction of some description which was not a mineral deposit, because the receiving station's aspect was a high island looking south over a stretch of lake, three miles wide.

There's a mysterious something somewhere, but what is it?

BROADCASTING IN ENGLAND

Editor, RADIO NEWS:

With reference to your article in the October issue of RADIO NEWS concerning the broadcasting situation in England, I would like the American amateurs really to know how badly off we are for radio concerts in England. During the early part of this year it was arranged for various companies to combine, with a view to supplying the British public with a good radio concert service. Hundreds of people have actually bought receiving sets and are now wondering if they are really going to hear anything this coming winter. Now, here is another hitch; the broadcasting companies cannot come to any agreement as to who is going to operate the stations. When that is settled, there will possibly come forward some more postoffice restrictions. Even now we hear that the radio music cannot be received in any public place of entertainment. Regenerative receivers are not allowed. The receiver must be capable of tuning to the broadcasting station only. At present, the issue of receiving licenses is held up because the broadcasting has not commenced. The *Daily Mail* concerts are still being sent out from Holland, and they are far from sufficient to satisfy the demand. The music has been received in Liverpool and as far north as Edinburgh, but at times it has been difficult to hear any of it in Lon-

Why Cole Condensers Are Better!

Spacers Integral with Stator Plates

The spacer and the stator plate are all one in Cole Variable Condensers. Stator and rotor plates are equidistant at every point on the dial to the half-thousandth of an inch. No chance for buckling or loosening. Just one of many exclusive features of marked superiority. Made by well-known radio manufacturers of 17 years' experience. Laboratory tested. Write today for interesting circular.

A. B. COLE, Inc.

88 E. Kinney St. Newark, N. J.

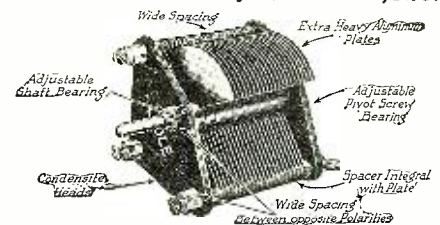

Panel Service

We offer to the amateur and dealer **Real Panel Service**. Our panels are cut to your order. Only genuine Bakelite or Formica used.

1/8" per square inch	.02
3/16" " " "	.02 1/2
1/4" " " "	.03

We also carry a full line of radio essentials. Dealers will find it profitable to have our latest price list and discount sheet.

PITTSBURGH RADIO AND APPLIANCE CO., INC.

"Pittsburgh's Radio Shop"
DESK A

112 Diamond St., Pittsburgh, Pa.

NATIONAL RADIO CO.

50 Union Square, N. Y. C.

Manufacturers of

"LISEN-IN"

3000 Ohm Phones \$7.50, Variable Condensers, Dials, Etc.
Write for proposition

Radio Salesmen Save Your Spare Time!

Many Radio Salesmen are making the most of their spare time by securing subscriptions to *Practical Electrics*, *Science & Invention*, and *Radio News*.

These popular magazines are growing in importance daily and a few hours' "spare time" work will add very materially to your income. Many Radio Salesmen have made them a part of their regular line. We pay a very liberal commission. For details, subscription blanks and sample magazines, write to C. J. WOLFE,

EXPERIMENTER PUBLISHING COMPANY, Inc.

53 Park Place New York

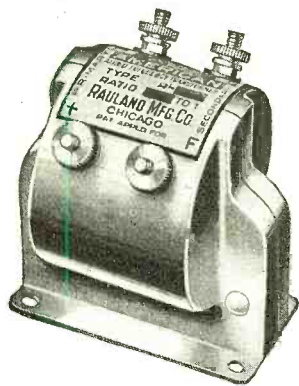

To Strengthen Weak Signals To Bring-in Distant Stations To Get the Full Joy of Radio

Scientific *Amplification* is the one secret of successful and satisfactory reception of Radio messages.

You will never know the full joy of Radio until you have hooked up to your set, a set of



"All American" Amplifying Transformers

(Radio and Audio Frequency)

Our *Radio-Frequency Transformer* (type R-10) brings in signals of 150 to 550 meter wave-length, and amplifies them many-fold, clear and sharp, largely eliminating static and other disturbances.

Our *Audio Frequency Transformers* amplify the detected signals, so that messages that would otherwise be audible only thru head-phones come in strong enough to be enjoyed by a roomful of people thru a loud-speaker horn.

LIST PRICES

R-10—Radio Frequency (150-550 meters) \$4.50
R-12—Audio Frequency (Ratio 3 to 1) 4.50

R-13—Audio Frequency (Ratio 10 to 1) \$4.75
R-21—Audio Frequency (Ratio 5 to 1) 4.75

Send for **Bulletin No. 22.** It explains the technical and mechanical reasons for the splendid performance of "All-American" Amplifying Transformers. When you send for it, please give the

name and address of the Radio Dealer thru whom you prefer to buy. Don't let *anybody* sell you a Radio outfit at any price, with any other than "All American" Transformers.



RAULAND MFG. CO.

35 So. Dearborn St., Chicago, Ill.

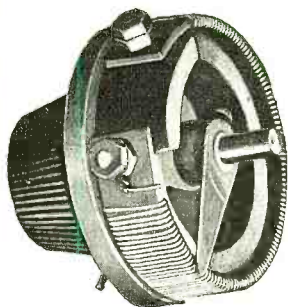

SEE THAT SWITCH

No. 200—The New Improved Hipco Wireless B Battery
The Rotary Switch Lever makes it easy to instantly get any desired

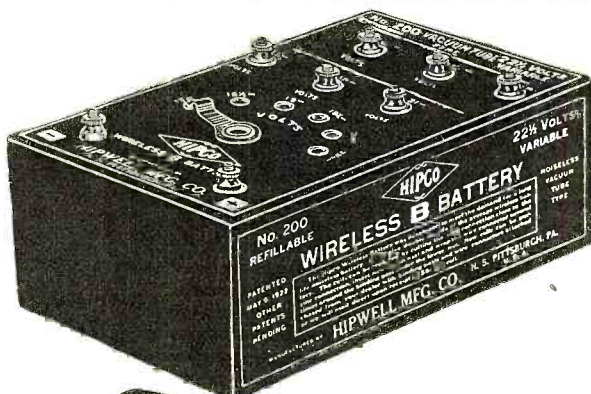

The Hipco Rheostat is especially designed for filament control of vacuum tubes. It operates on 4 to 6 volts. The resistance is made of a non-corrosive alloy and can be very readily renewed.

Made with several styles of knobs to match various dials.

List Price, \$1.00 each



Phone Condensers .001 MFD. at.....	35c
Phone Condensers .002 MFD. at.....	35c
Grid Condensers .0005 MFD. at.....	35c
Grid Condensers .00025 MFD. at.....	35c
Grid Leak Condensers .0005 MFD. at.....	.50c
Grid Leak Condensers .00025 MFD. at.....	.50c

For Sale at all Radio Supply Dealers

If your dealer does not have Hipco Products, write us direct. We will be glad to send our illustrated literature.

HIPWELL MFG. CO., N.S. Pittsburgh, Pa.



BUY A HIPCO MULTIPHONE

Price \$4.00 Complete With
Four Sets of Head Phones

Let your friends and family listen in—reproduction 100% perfect. No trouble—nothing to get out of order.

ROTARY SWITCH LEVERS

WITH SAME KNOB
AS ILLUSTRATED

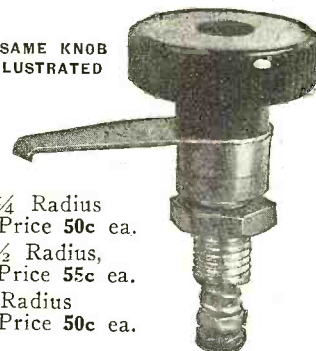

- No. 1-1/4 Radius
List Price 50c ea.
- No. 2-1/2 Radius,
List Price 55c ea.
- No. 3-1 Radius
List Price 50c ea.

We also manufacture same with knob to match Rheostat illustrated.

PLAY SAFE! Insist on Getting UNITED PRODUCTS

Follow the example of the Radio-wise experts who buy each part with an exact knowledge of its true value.



United Transformers

amplify weak sounds; bring in distant stations; with clear, pleasing distinctness.

A beautiful piece of workmanship with sturdy steel shell, furnished in black enamel with buffed nickel strip, \$4.50.

"United" Variable Condenser

with Vernier Attachment Dial and Knob
46 plate.....\$6.50
26 plate.....\$5.50
Only Vernier with Stop



United Variable Condensers Without dial or knob

Correct in design, high grade in workmanship. Plates are held positively so that short-circuiting is practically impossible.

LIST PRICES:

43 plate	\$4.50	5 plate	\$2.75
23 plate	\$4.00	3 plate	\$2.25
11 plate	\$3.50		

United Transformers and Condensers have been adopted as standard equipment by leading makers of radio receiving sets. Their judgment is a safe guide for you.

Tell your dealer you want "United" or nothing.

Circular free.

United Mfg. & Distributing Co.
536 LAKE SHORE DRIVE
CHICAGO

KEYSTONE DIAMOND MOUNTS
HIGHLY SENSITIVE—LOUD TONES ONLY.
MOUNTED IN LOW TEMPERATURE
NON-OXIDIZING ALLOY.

CRYSTALS

25¢ POSTPAID MONEY REFUNDED IF NOT SATISFIED.
PATRONAGE OF DEALERS INVITED.
THE KEYSTONE PRODUCTS CO. 168 GARDENIA AVE.
ROYAL OAK—MICH.

JOY-KELSEY CORPORATION
Manufacturers
RADIO EQUIPMENT
4021 West Kinzie St. Chicago Ill.

don. The newspapers gave the proposed broadcasting wide publicity, but the delay in producing the goods has caused the British public to lose a considerable amount of interest.

A. WILKINS,
Seaforth, Liverpool, England.

A FEW WORDS FROM THE GREAT LAKES

Editor, RADIO NEWS:

I would like to say a few words in regard to the friction between amateurs and radiophone broadcasting stations.

The attitude of the former toward the latter is, in a sense, to be expected, but should not be cultivated. Neither will be eliminated on account of the other's existence.

The idea of discouraging the amateur is entirely out of the question. The amateur of to-day is the commercial operator of to-morrow, and upon him rests a large part of the development of radio. They are the ones who have really taken a keen, constructive interest in radio-telegraphy—anyone even suggesting an elimination of the amateur is taking a very narrow-minded view of the matter.

Likewise, radio telephonic broadcasting is a permanent indispensability. It is a great asset to the people and its possibilities seem unlimited.

The point to discuss is not which will be doomed—but what adjustments must be made to minimize interference and permit both parties to operate with a large degree of freedom, without interfering with commercial traffic?

I have noticed that nearly 75 per cent of the amateurs, and some broadcasting stations, have a tendency to transmit a wave the decrement of which is much higher than that allowed by law, making it practically impossible to tune out. If all short-wave stations would reduce their decrement even below .2 and at a power sacrifice, I am sure one step toward harmony would be accomplished.

At the rate radio has and is developing would it be surprising if waves could be radiated from transmitters having large amplitude and comparatively small base so that a receiver of a degree of selectivity could completely tune out one of two stations, while being in close proximity to both?

GEORGE N. MUSIL, KDUZ,
Commercial operator, Great Lakes,
Buffalo, N. Y.

WHAT A NEW ZEALANDER THINKS OF IT

Editor, RADIO NEWS:

You are to be congratulated for the marvelous growth of your "three year old baby." For a magazine to increase its circulation more than two hundredfold in such a short space of time is probably without precedent. I am a commercial operator, and have subscribed since No. 3 was issued. While your magazine contains some articles that are of no more than passing interest, there are sufficient technical articles appearing in each issue to keep me as a subscriber.

You are to be congratulated for starting the laboratories for testing the advertisers' apparatus. I only wonder that you did not do it before. The "Model Engineer" of London inaugurated a similar scheme some 12 years ago.

Keep up the good work and I will continue to be a subscriber and a booster, having already caused several in Australia to become regular readers.

L. S. LANE,
Randrick, New South Wales.

The Latest and Most Essential Part of an Efficient Tube Set

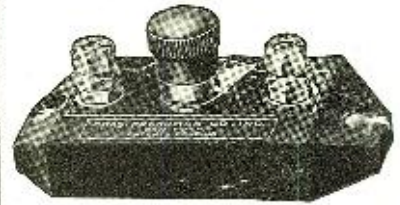

Variable Grid Leak and Micon Condenser (Combined)

Obtainable in an unbroken range from zero to 5 megohms—all intermediate points. Fixed capacity—.00025 M. F. Improves your set by Clarifying Signals

Lowering Filament Current
Increasing Battery Life
Eliminating Hissing

Price only \$1

At your Dealers—Otherwise send purchase price and you will be supplied without further charge.

Manufactured by

CHAS. FRESHMAN CO., Inc.
97 BEEKMAN ST., NEW YORK

What Kind of A Man Are YOU!



Are you 100% alive? Are you a strong, healthy, vigorous, clean-blooded, clear-brained specimen—overflowing with pep and vitality? Or are you a weak complaining misfit—an apology for a real man—afflicted with Catarrh, Constipation, Indigestion—crippled with Rheumatism, Rupture, Flat Chest, Weak Spine—wretched with Nervousness, Impotency, Prostate Trouble and the numerous other results of Bad Habits and Excesses?

No matter what your condition is, or what caused it, you can banish your ailments and revive your Flagging Powers and Manhood with **STRONGFORTISM**—The Modern Science of Health Promotion. I guarantee it.

Mention the subjects on which you want special confidential information and send with 10c (one dime) to help pay postage, etc., on my book, "Promotion and Conservation of Health, Strength and Mental Energy." It's a man-builder and a life-saver. Send for my free book, Right Now TODAY.

STRONGFORT
The Perfect Man

LIONEL STRONGFORT
Physical and Health Specialist
Dent. 57 Founded 1895. Newark, N. J.

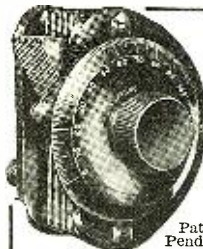

RADIO STORES VARIABLE CONDENSER

Counter weight under dial. Brass studs through aluminum plates. Die cast. Shaft held true center through brass bushings. Binding posts mounted on metal straps. No insulation tapped—inserts throughout. Precision workmanship—best engineering design.

Pat. Pend.
23 Plate, .0005 mfd. Capacity ratio, 12 to 1 \$4.25
43 Plate, .001 mfd. Capacity ratio, 22 to 1 \$4.75

IMMEDIATE SHIPMENTS
RADIO STORES CORPORATION
National Distributors and Manufacturers
218-222 WEST 34th STREET
Dept. N. NEW YORK CITY

Westwyre Variable Condensers
WESTWYRE RADIO CO.
WESTFIELD, MASS.

LIGHTNER PLAYS WITH LIGHTNING

Editor, RADIO NEWS:

The following may be of interest to Radio fans:

Out in this part of the United States we have what are commonly called dry sand storms. One night recently, while we were listening in on Denver, Colo., Indianapolis, Ind., St. Louis, Mo., and other stations, at about 9 p. m., one of these storms struck us. The very instant it hit, everything was cut off. At the same time I could hear a steady knocking in the head phones. I disconnected the box and reached out to grab the antenna to put it away, when I was almost knocked down by a discharge of static electricity. There was a steady glow from the end of the antenna. When the ground wire was placed within about one inch of the antenna an arc of electricity would jump across, and when left within about a half-inch of the antenna, a steady stream of electricity would snap off. At the very instant the jam occurred on the lower end of the antenna, a large light appeared on the end farthest away. The snap from the extreme end could be heard over 100' away and above the noise of the storm. This condition kept up for over three hours. When the wires were about 3" apart, a noise like meat frying was produced.

G. A. LIGHTNER,
Olustee, Okla.

BROADCASTING Q R M

Editor, RADIO NEWS:

Can't you start some kind of a campaign among your thousands of Radio fans and readers to get Washington to do something about this wave-length question? Since all the good stations have gone to 400 meters it is worse than ever, as they are square on 400 meters and all come in together.

COLUMBIA RADIO PARTS

Columbia Moulded Variometer

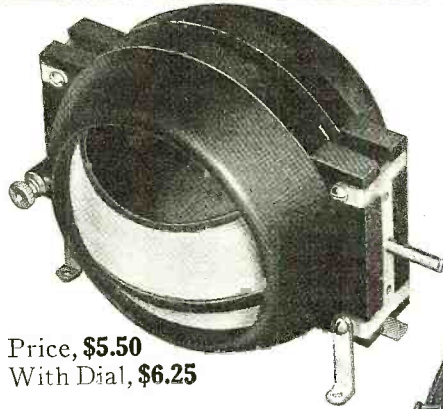

Price, \$5.50
With Dial, \$6.25

A SUPERIOR instrument with the Stator and Rotor of moulded hard rubber. Accurate electrical and mechanical construction throughout; designed for best values of maximum and minimum inductance and minimum distributed capacity. Has 3-16" shaft, with spring tension to secure electrical contact. Adapted for both base and panel mounting. All metal parts highly nickelled. An essential radio instrument of beauty and efficiency.

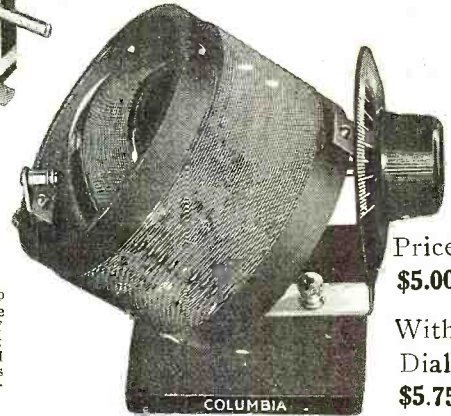

Columbia 180° Moulded Variocoupler

A MOST efficient 180° coupler designed for sharp tuning from 150 to 650 meters. Stator made of a highly dielectrical composition. Rotor of moulded hard rubber; both wound with green silk covered wire. All metal parts nickel plated and mechanically correct. Ten taps are provided. Has 3-16" shaft with spring tension to insure electrical contact; base and panel mounting.

Price \$5.00
With Dial \$5.75

Columbia Apparatus will add beauty and efficiency to your outfit. Bakelite Dial and Knob, \$.75
If your dealer does not stock our items, send your order direct. Territories still open for Manufacturers' Representatives

COLUMBIA RADIO CORPORATION

2760 Diversey Avenue
Chicago - Illinois

The RADIOGEM

(Patents Pending)

\$1 Receiving Set—The Simplest Radio Outfit **\$1**
Made—Yet as Practical as the Most Expensive!

You need know absolutely nothing about wireless to operate and enjoy the RADIOGEM. It is so sturdy, so simply constructed that it is small wonder radio engineers who have tested it have pronounced the RADIOGEM a brilliant achievement. The RADIOGEM is a crystal radio receiving set for everyone at a price anyone can afford.

Why The RADIOGEM Can Be Sold For Only \$1
Here's the secret: The RADIOGEM Construction eliminates all unnecessary trimmings, cabinets and the like, which do not play any part in the operation of a set. You receive the RADIOGEM unassembled, together with a clearly written instruction book, which shows you how to quickly and easily construct the set, using only your hands and a scissor. The outfit comprises all the necessary wire, contact points, detector mineral, tube on which to wind the coil, etc., etc. The instruction book explains simply and completely the principles of radio and its graphic illustrations make the assembling of the RADIOGEM real fun. Remember the RADIOGEM is a proven, practical radio receiving set and will do anything the most expensive crystal set will do.

The RADIOGEM is the Prize Winner of the Age
Out of hundreds of radio models submitted recently in a great nation-wide contest, radio engineers, the judges, unanimously chose the RADIOGEM as the winner—the simplest radio-receiving set made! And the RADIOGEM costs you nothing to operate; no form of local electricity is required.

DEALERS The RADIOGEM is the wonder item of the radio age. It is storming the country, for the RADIOGEM'S price is so low everyone is able to buy one. Write immediately for full particulars before that shop across the street beats you to it.

Hear the programs of the Broadcasting Stations on the RADIOGEM

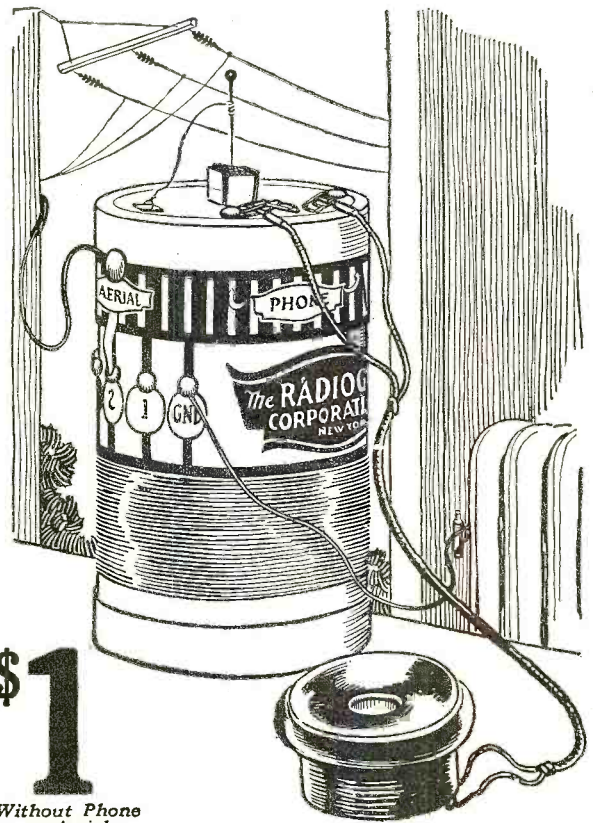

\$1
Without Phone or Aerial

Receives up to 20 Miles



The Ideal Xmas Gift

The Remarkable New Plan-o-phone Radio Loud Speaker



"Listen In" with a Plan-o-phone during 1923! The Remarkable PLAN-O-PHONE Radio Loud Speaker.

Sent prepaid if your dealer cannot supply you.

Price
\$3.50

Cord and receiver not included. Weight 2½ lbs., height 11 in., Bell diameter 6 in.

Here is the sensation of the Radio World in both the remarkable results and amazing price. For \$3.50 you can now equip any 2-stage amplified receiving set to entertain a roomful of people with the broadcasting program. Insert any good phone receiver in the Plan-o-phone and you have a good loud-speaker. Nothing half so satisfactory at anywhere near half the price.

Fully Guaranteed

Cord and Phone not included.

The PLANET POWER AMPLIFIER



An essential unit with a receiving set that does not produce sufficient volume. Constructed so that either a 5 watt power tube or an amplifying tube can be used, depending on the volume desired. Equipped with potentiometer.

Price \$27.50 without tube

DISTRIBUTORS

Beaudette & Graham Co. Boston
General Misc. Co. Newark, N. J.
Jones Elec. & Radio Mfg. Co. Baltimore, Md.
The McGraw Co. St. Louis, Mo.
B. E. Polczynski & Co. Detroit, Mich.
Harold M. Schwab, Inc. New York City
Wolverine Elec. Corp. Grand Rapids, Mich.
Diamond Elec. Supply Co. Peoria, Ill.
Western Radio Co. Kansas City, Mo.

Planet Radio Corporation

1227 So. Wabash Ave. Dept. A2 Chicago

Dealers: Write for details.

CUT PRICES

Sterling 43 Plate Variable Condensers. \$4.00
Queens Variometers. 4.75
Electrose 4-inch Dials. 1.00
Klosner Rheostats. 1.25
Federal Single Circuit Jacks. .60
Federal Single Circuit Filament Control Jacks. .85
Copperclad Antenna Wire. .45
Paragon and Westinghouse Receiving Sets in stock. Big reductions on all radio apparatus too numerous to list. It will pay you to write us for your radio wants.

SOLAR RADIO CORPORATION
(532 Nostrand Ave.) Brooklyn, N. Y.
2 Stores (879 Flatbush Ave.)

Genuine GANAERITE Crystals

Individually Tone Tested.
Most Sensitive Mineral Rectifier Developed.
Mounted Crystals, Postpaid, 50c.
Trade Discounts to Dealers and Clubs
Now Delivering Promptly on Large Orders.

THE HARRIS LABORATORY
26 Cortlandt Street New York City

It is impossible to hold any one of them for five minutes at any time and with any kind of a set. Radio is going to be too good a thing for the country at large to get the setback it is now getting on account of all the good stations coming in at once. I believe if some one would work out a plan and get the several million Radio fans to push it, those wonderful figureheads we have in Washington would stop talking and do something.

The bill, on account of the educational advantages of Radio in sight, is just as important as the tariff or any other bill, and should be given some attention. The first attempt some one made is a failure for all good stations went to 400 meters and are square on 400, while before they were scattered a little below and over 360 meters. Also, the spark station interference seems to be even worse at 400 meters.

I believe you are the ones who can solve this problem, and help Radio to take a leap forward that will astonish the country, making it more of a necessity in a short time than telephones, lights, etc., especially in small towns and rural districts.

WALTER L. EDWARDS,
Murfreesboro, Tenn.

BROADCASTING NEEDS IMPROVEMENT

Editor, RADIO NEWS:

We note with interest that the National Radio Chamber of Commerce contemplates some measures tending toward the correction of the "chaos" now existing in radio broadcasting. The tendency is toward a jam. The broadcasting stations seem endowed with the very human tendency to enjoy the sound of their own voices. They all want to talk at once, and keep it up, and their number is increasing almost daily it would seem.

The policy of the larger and better stations in the choice of its program matter is excellent. Radio is a potential power in the uplift and betterment of the people, as well as a mere means of entertainment. It has wonderful educational possibilities. It is equally capable of abuse in the hands of the selfish or unthinking. So much has been written in connection with this that it seems superfluous to reiterate it.

However, some of the minor stations, and we have one in Chicago in mind, seem to have adopted a policy of simply catering to the whim of a fickle-minded portion of the public. To those in charge of this station, as they frankly admit, their object is to please that portion of the public which takes the trouble to express an opinion and these people seem to prefer the foxtrot-jazz quality of music. This then is what is served, and the management has picked out Sunday evening to serve it. We believe that it will take but a few broadcasting stations working on this policy to cheapen, degrade and rob broadcasting of its possibilities for the general good. Those who care for the din of the underworld dance hall may enjoy it without forcing others into it. Not so with radio. It is thrust upon you. It is not a matter of selection or individual choice to one with radio ears, and living within short range of the sending station Without being in the least puritanical the writer believes that it would be appropriate for stations broadcasting on Sunday to provide music of high grade and worth listening to, and for this one day in the week at least, to cut out the jazz trash.

The very nature of radio suggests long distance reception. Much of the pleasure of using the radio is in hearing what is going on in some distant place. The sale of the higher grade receiving instruments is based largely upon their long range pos-

\$ 7.65 NOW

Don't judge a headset by its name alone, but insist upon proving its quality at the manufacturer's risk. TRIMM Professional phones are guaranteed equal to other headsets selling for \$10.00 to \$15.00. Positively guaranteed for one year against any defect.

Accurately matched. Perfect reproduction and articulation at any range. Designed and built by highly skilled experts of long experience.



One-piece magnet, formed (not punched), guarantees uniform tempering and magnetizing. Cases and caps made entirely of high grade Phenol compound, free from sulphur and corrosive gases; odorless and warp-proof. New type head band insures perfect comfort.

Free Trial Professional superior to any \$10.00 If you do not find the TRIMM headset return it and your money will be refunded.

DEALERS: Our wholesale and retail distributors are fully protected. Write for quantity discounts and full particulars. We ship your first order on approval.

TRIMM RADIO MFG. CO.

Dept. 33 24-30 S. Clinton St., Chicago

CUT PRICES TO CONSUMERS

	List Price	Our Price
UV 200 Tubes	\$5.00	\$4.30
UV 201 Tubes	6.50	5.60
1½ volt WD11 tubes	6.50	5.60
Murdock Phones, 2000 ohm	4.00	
Murdock Phones, 3000 ohm	5.00	
3 Plate variable vernier condensers	.75	
23 Plate variable condensers	1.35	
43 Plate variable condensers	1.65	
1½ in. rheostat dials, moulded	.25	
3 in. moulded dials	.29	
22½ volt B Batteries	.85	
Moulded sockets	.38	
Rheostats	.46	
Switches	.18	
Potentiometers	.90	
Plugs	.59	

All Kinds of Radio Material at Cut Prices

All Material Guaranteed

Mail Orders only. No store trade. Mail check or money order (no stamps or currency).

RADIO CUT PRICE CO.

320 Broadway Room No. 412 New York City

RADIO PANELS

Solid Silicon Fibre

All Panels 3-16" thick.

Size	Price	Size	Price
6x7	\$0.60	7x18	\$1.70
6x10½	.90	9x14	1.80
6x14	1.14	12x14	2.00

Radio Fibre Products Co.

250 Bergenline Ave., W. Hoboken, N.J.

sibilities. Unless broadcasting stations recognize these points, they may defeat their purpose. Means should be provided whereby some periods each evening are left open, free from all local broadcasting and amateur telegraphing.

It would appear that the two important points to be made clear are: First, the advisability of providing something really worth while listening to; secondly, opportunity to hear it. Fortunately, most of the broadcasting stations seem to be operated by persons who recognize the importance of the first named condition although not all of them.

It may do no harm to bring these points to notice, even at the risk of repetition.

N. A. MATTISON,
Chicago, Ill.

A PLEA FOR A NIGHT OFF

Editor, RADIO NEWS:

I confidently believe station operators, radio artists and radio enthusiasts, both old and young, with small sets and long range equipment will join me in this suggestion that the management of broadcasting stations, by localities, arrange with each other and agree upon a one-night layoff each week for the following reasons:

First, it will give operators and artists the equivalent of a Sunday rest. Second, and most important, it will permit a tryout of receiving stations in any locality to determine their range and the variety of adjustments necessary to pick up out-of-town sending stations.

I live in Chicago, almost in the shadow of several large antennae. I have with great care built up during the Summer an elaborate 5-tube set in anticipation of some opportunity to try it out during the Winter evenings, but with two high powered broadcasting stations and a half-dozen smaller sets waiting like hawks for their turn at the air or even sometimes doubling their dissimilar wave bands, how can a chap expect to get out of his own backyard, so to speak? I like to go visiting occasionally; that is, I should like to hear someone else besides homefolks, but with every moment of my off duty time crowded full of home-made legitimate and "canned" music frequently designated as "So and So testing" how am I to get away? The country fellow has the advantage over the city chap in this matter.

On one occasion, in a 30-minute period of relief from local disturbances during the early evening broadcasting hour, I was able clearly to tune in just six stations, viz., Detroit, Louisville, Kansas City, Waco, Oklahoma City and Denver and later on during the evening I heard Schenectady and, of course, I heard that popular Southern Station "The Atlanta Journal." All of these stations furnished a wide variety of program readily available for selection, but all too quickly spoiled by a local carrier wave. I experienced more real thrill in that 30 minutes than for the whole of the rest of the week. So I am pleading for a night off, and, as a basis for an agreement, I suggest that the New England states and New York City close up absolutely tight on Monday night of each week between the hours of 7 p. m. and 10 p. m. local time; that the Pittsburgh and the Buffalo longitude close Tuesday nights; that Detroit, Chicago, Indianapolis, etc. close Wednesday nights; that St. Louis, Kansas City, Omaha, etc. close Thursday nights; that Denver and that longitude close Friday nights, and the Pacific Coast observe Saturday nights, each area to observe the same hours 7 to 10 p. m. in its own local time.

This will give every one a chance. Let's



MIGNON MIGNON MIGNON
RADIO APPARATUS
BEST BY TEST

Straight Line
Variable Air Condensers

- Type "A" .0005 M. F. \$4.50
- Type "A" Vernier .0005 M. F. \$6.00
- Type "B" .0008 M. F. \$5.00
- Type "B" Vernier .0008 M. F. \$6.50
- Type "C" .0017 M. F. \$6.00
- Type "C" Vernier .0017 M. F. \$7.50

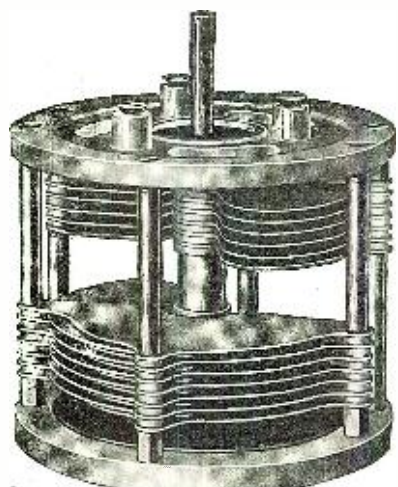

SOLD BY ALL LEADING ELECTRIC FIRMS and RADIO DEALERS

Type "B" .0008 M. F. \$5.00

Authorized Factory Representatives

Niagara Sales Corporation, 3-5 Waverly Place, New York, N. Y.
Western Radio Distributing Co., 1114 L. C. Smith Bldg., Seattle, Wash.

For New York Metropolitan Territory
Radio Stores Corporation, 218 West 34th Street, New York, N.Y.

Our Products are on exhibit at the Permanent Radio Fair, Hotel Imperial, New York, N. Y.



Write for Literature
Mignon Electric Mfg. Corp.
25-35 South Water St.
Rochester, N. Y.



GET A Micro-Coupler!

and tune with a smile. No hairbreadth adjusting. Note features. COMBINED COARSE & VERNIER ADJUSTMENTS. Use same as Standard Vario-coupler. Instantaneous coupling indicator. Coils far enough from hand to practically eliminate body capacity. NO METAL PARTS OR COMPOUNDS. Movable coil tapped. Closest Hex. Coupling possible. Permits shortest possible grid lead. Excellent for DX CW and PHONES. Tested with small antenna, one tube, on WSB, WGY, etc. Results guaranteed. Tubes 110-450 Meters. Panel Mounting, eight and four lugs (mounter in no time D, \$3.60; Unit Panel, 5x5, complete, \$7.75; with Universal crystal detector (makes an ideal, compact and complete receiver, very efficient), \$9.25.

(This instrument fully protected in all countries by Patents Applied For.)
THE AMATEUR RADIO EQUIPMENT SUPPLY
1504A Federal Street Philadelphia, Penna.



Galena Crystal, Mounted35c
Galena Crystal, Unmounted25c
IMMEDIATE DELIVERY
Manufacturers, Jobbers, Dealers,
Write for quantity prices
GALENA CRYSTAL MFG. CO.
2894 Fulton Street Brooklyn, N. Y.

Dealer talks

Fake Radio Dealers Invade Southwest

IT seems that radio must undergo many tribulations. Not the least of these is the cheat and swindler. A member of the species has just bobbed up in the Southwest. A man calling himself Chester Valrez, posing and using the business stationery of a radio dealer ordered from this company C. O. D. an MR 6 DeForest Set. The company decided to ship the set and it was paid for on arrival. Then things began to happen. We received another order for a shipment of 5 of a cheaper grade instrument to another town C. O. D. Valrez requested that his dealer discount be mailed him direct. We to bill customer. This looked a little fishy. However, the machines were shipped C. O. D. but his discount was held pending information. This soon came in abundance. The shipment was not accepted as it had been ordered by the unsuspecting buyer with the understanding that the sets were MR 6 S and not the cheaper grade. Reports show that Valrez had also tried this scheme before with greater success. The gentleman is still at large. Let this serve as a warning to the Southwest to deal only with legitimate radio dealers and to beware special price advantages offered by sharpers. The results are always disastrous to the unwary. We shall be glad to mail to legitimate dealers a copy of our new catalog with full descriptions of standard advertised products of the following companies:—Western Electric, DeForest, Acme, Sleeper, Atwater-Kent, Musio, Murdock, Stromberg Carlson, Dublier, Marshall-Gerken and others. Use the coupon for convenience.

NORTH AMER. RADIO & SUPPLY CORP.
5 Columbus Circle - New York, N. Y.

Kindly send us your New Radio Catalog.

Firm Name

Street

City

NOVO "B" BATTERIES FOR RADIO

22½-45 & 105 VOLTS

NOISELESS
DEPENDABLE
GUARANTEED
ASK YOUR DEALER

NOVO MANUFACTURING CO.

424-438 W. 33rd ST.
NEW YORK

531 SO. DEARBORN ST., CHICAGO.

see who will be the first and others to follow in this movement.

W. M. BEAR,
Chicago, Ill.

AN OLD TIMER REPLIES

Editor, RADIO NEWS:

You published a letter of mine in the August issue and I noticed a couple of replies in the October number, one from G. Havelly Humes, and the other from S. Kruse, both of whom took my letter too seriously; it was written in fun and to try and make some of the fellows think a bit.

Both of the answers to my letter sounded as though I had accused them personally of causing the interference; whether I have heard either of them, I cannot say, but now I have my suspicions.

I am sorry that Mr. Humes looks on radio as a game. I had always viewed it as a science.

Radio has sure changed since I first took it up, back in 1908. We were not very particular about wave lengths, or sharp tuning of transmitters, in fact, we did not know very much about that. With a good spark coil and a key it could be heard for a few miles.

For Mr. Kruse's benefit, Monrovia is 150 miles from San Diego; it is 20 miles from Los Angeles and 10 miles from Pasadena; if he will look on a map, he will see that I am located near quite a few broadcasting stations. There are about 30 licenses for broadcasting stations within a radius of 40 miles, 20 of which are operating. The Long Beach-Avalon radiophone is also in that radius, besides a large collection of the "sixes."

The broadcasting stations don't mix, although there are a number on at one time, as they tune sharply and do not interfere with anything else.

However, with the amateur it is different. Many fellows say, when they put in their transmitters, that they are going to get across anyhow; they get as broad a wave as possible and interfere with other amateurs as well as broadcasters. They have a noisy spark and they play with the key a great deal. From September 15 to October 15 some amateur held down his key almost every evening from 7 o'clock to 10 and it was impossible for anybody in this section to tune him out; he also had it going during the day. We were not able to locate the source, as he quit when we tried a loop.

In the last paragraph of my August letter I said that if the fellows would think about it they would see why the Government is taking matters in hand and trying to get more laws to regulate amateur transmission.

These new laws would give the amateur a wider band of wave-length and it would enforce them. At present things seem to be rather "wild" because of the new amateur stations springing up, but this will settle down in time.

To the fellows who have no use for the broadcastings, is it not a selfish idea that you want the ether for yourselves? They do not interfere with you, so where can you find any arguments against them?

HARRY MORRIS,
Monrovia, Cal.

A Handy Portable Set

(Continued from page 1293)

varnished cambric tubing and connected by lugs. A grid condenser and leak are employed in the circuit shown, but the set described uses the method of biasing the grid by tapping the filament rheostat. This is practiced in Navy tuners and amplifiers.

R. P. C. Midget Radio Pocket Receiver



Size 1-11-32x3½x6¾

Price \$3.00

THE R. P. C. MIDGET POCKET RECEIVING SET is designed to meet the wants of the novice (an opportunity to get acquainted with the mysteries of the RADIO ART) and who, having learned the A B C of Radio, may readily become a more serious student of this most important field of investigation.

This receiver is made of the finest material. It is mounted in a polished wooden case, fully equipped with a FIXED CONDENSER for tuning. It has a range of approximately 25 miles of clear distinctive receiving.

THE R. P. C. MIDGET is truly the wonder of the age in size, price and quality. Not a mere toy but a scientifically built Crystal receiving set comparing favorably with many higher priced sets on the market.

* Without head phones, \$3.00 post-paid everywhere.

Discount to Jobbers and Dealers
Radio Products Corporation
of America

55 Broadway, New York, U. S. A.

Radio & Auto Storage Batteries

CHARGED FROM A LAMP SOCKET, at a Cost of a Few Cents, With an **\$15 F-F BOOSTER**



F-F BATTERY BOOSTERS Charge Automatically Operating Unattended. Leave Your Battery just where it is, without even disconnecting it. Screw Plug in Lamp Socket; Snap Clips on Battery Terminals; Turn Switch and Battery is Charged in Morning. Is it not gratifying to feel that Your Radio Batteries will never fail and You will be always Ready to Receive All Radiophone Broadcast Music, Sermons & News, never having to be careful, or tell Friends

Charges Auto & Radio Batteries. Your Batteries are dead? Both Waves of Current are Rectified thru Adjustable & Easily Renewable infusible Carbon Electrodes, which Maintain a Constant Efficiency & Last thousands of hours. Also Charges Batteries right in Auto. No skill Required. AMMETER Shows Current Flowing. Eliminating Guess Work. COMPLETE. COMPACT. SELF-CONTAINED. PORTABLE. AUTOMATIC CHARGING UNITS. F-F Battery Boosters are Full Wave Magnetic Rectifiers for 125-125 Volt 60 Cycle A. C. POPULAR PRICES: Type A Charges Radio "A" 6 Volt Batteries at 6 Amperes \$15 Type B Charges Radio "B" Batteries Up to 12 Volts \$16 Type A-B Charges Both Your "A&B" Radio Batteries \$20 Type 12 Charges 12 Volt Batteries at 5 Amperes \$15 Type 166 Charges 6 Volt Batteries at 12 Amperes \$20 Type 1612 Charges 12 Volt Batteries at 7 Amperes \$20 Type 1626 is a Combination of Types 166 & 1612 \$28 The Larger Types are for heavy Batteries, or where time is limited. Shipping Weights 11 to 15 Pounds. Purchase from your Dealer, or Send Check for Prompt Express Shipment. If via PARCEL POST have remittance include Postage & Insurance Charges. Or have us ship Type desired C. O. D. Other F-F Battery Boosters Charge Batteries from Farm Lighting Plants & D. C. Circuits. For GROUP CHARGING use our 100 Volt Automatic ROTARY Rectifier, 12 Battery, 8 Ampere Capacity \$135. ORDER Now, or WRITE Immediately for FREE RADIO-AUTO & ROTARY Bulletins 32 & 32A. OFFICES & WORKS THE FRANCE MFG. CO., Cleveland, Ohio, U.S.A. Can. Rep.: Battery Service & Sales Co., Hamilton, Ont., Can.

TO RADIO DEALERS

State Territories NOW Open. Aggressive Dealers can make good profits selling Guaranteed Radio parts.

Write for Complete Information
RAY-DI-CO. ORGANIZATION, Inc.
1215 LeLand Avenue, Chicago

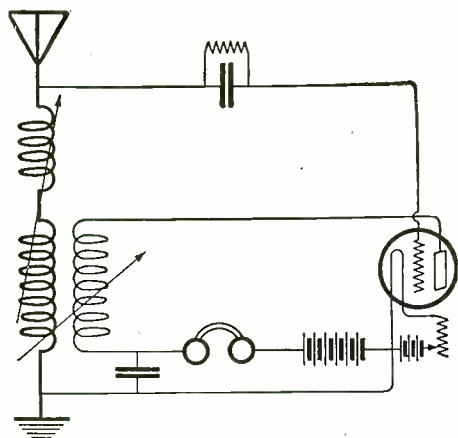

The Three-Coil Regenerative Circuit Used in the Portable Receiver.

We think this type of receiver well suited to the average non-technical user while the simple control fits it especially well for the amateur who desires C. W. reception.

The Voluntary Lid

(Continued from page 1288)

job. When this plan is adopted it must be respected, religiously, and this means that unlicensed and improperly adjusted stations must be hunted down and turned in. In bygone days such a station bothered no one but its neighborhood amateurs, and if they could put up with it there was no harm done; but to-day such a station will bring discredit upon all of amateur radio and must not be permitted to exist. We would suggest that clubs establish committees to help local amateurs and render assistance when needed to get a station properly adjusted, but if the operator persists in operating illegally after being warned, he should be turned in to the inspector without mercy—we have too much at stake.

What about local work, which used to occur in the early hours of the evening? Honestly, we don't know, and it will be up to the amateurs of each club to decide for themselves how they will divide their hours. The time after 10:30 is going to be very precious and, solely because it is not as important as DX work, we are afraid local work will have to be got over by the time 7 o'clock rolls around. Low-powered battery-operated C. W. sets of course can be used for local work all evening long and not cause a particle of QRM for the broadcasting fan next door, but most of the lads who do local work have a far different kind of equipment—hi!

Our transmitters must improve. There will be too many of us with traffic to move at 10:30 and too many listeners with dumb-bell tuners for us to continue much longer with the cycle-consuming spark of pre-war days. For the very efficiency of our traffic moving the selfish spark will have to yield to the valve set. We hasten to say, though, that there are selfish C. W. sets too, and we are just as much agin a bum C. W. without rectifiers and filters as we are against the ordinary spark, and for exactly the same reason—it takes up too big a place in the air, its wave is too broad. We cannot be pushed into an adoption of C. W. versus spark against our will, but left to our own devices we believe it is evident to any thinking amateur that the quiet efficiency of the little bottles is just the thing we need—filtered D. C. C.W. transmitters.

Now lets get busy on our self-imposed 10:30 lid. Remember that the League does not feel that it can back a mem-

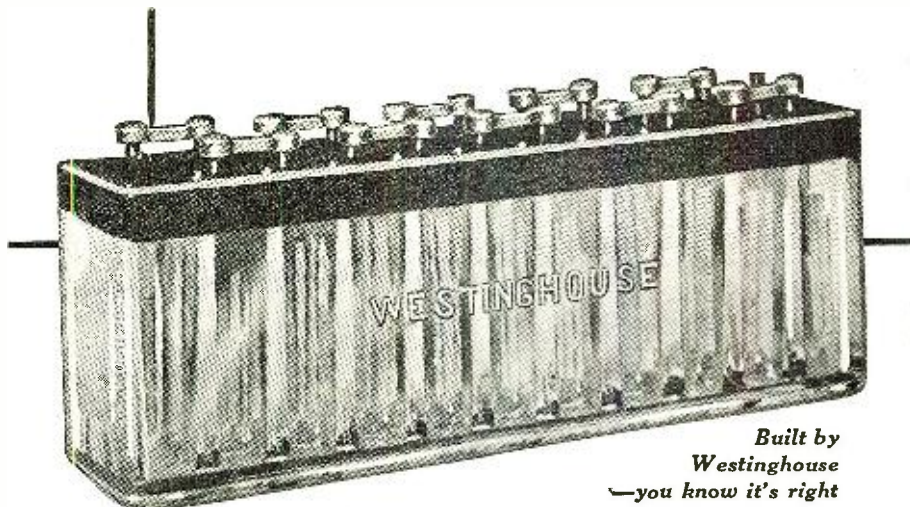

Built by
Westinghouse
—you know it's right

THIS newest Westinghouse Radio "B" Battery is a 22-volt, glass-case baby storage battery that is a marvel for steady, noiseless, full-powered service. Lasts indefinitely because it can be recharged repeatedly—making it not only the most satisfactory, but ultimately the most economical type of "B" battery. Sold by radio dealers, and also by more than 2000 Westinghouse Battery Service Stations.

WESTINGHOUSE "A" BATTERIES. Ten sizes—27 to 162 ampere-hours' capacity; 4, 6 and 8 volts. Slow-discharge, long-life batteries built especially for radio work.

WESTINGHOUSE UNION BATTERY CO., Swissvale, Pa.

WESTINGHOUSE

RADIO "A" and "B"

BATTERIES



M P M

MILLION POINT MINERAL

The World's Greatest Radio Crystal

M. P. M. is supersensitive, reproduces from every point on its surface and has record of receiving concerts over six hundred miles.

Ask your dealer for M. P. M. or send 50c for two M. P. M. Crystals, concert-tested and guaranteed.

M. P. M. SALES COMPANY

Dept. N. 247 So. Central Los Angeles, Cal.

PREMIER RADIO PRODUCTS

For People Who Care
PREMIER
"Universal" Radio Jacks
Fits All Standard Plugs

Slide type spring mounted
adjustable to register all sizes



SAVE YOU \$1.00

HERE'S HOW

Fits Any Plug—You don't have to buy a so-called "Radio" plug—an old telephone plug will do just as well; these can be had for little or nothing. A Premier jack is adjusted to fit it in a "jiffy."

Adjustable Thimble or Bushing—Permits mounting on any thickness panel from 3/8 to 7/16 inches—no spacer washers or shims required, thus more finished—"He-knows-what-he's-about" appearance when mounted on panel.

PRICES—All Spring Combinations

- No. 131—2 Circuit\$0.90
- No. 133—Open Circuit65
- No. 134—2 Circuit75
- No. 135—3 Spring—Auto Fil. Con..... 1.00
- No. 136—5 Spring—Auto Fil. Con..... 1.25

DON'T GUESS—Use a

PREMIER "7-IN-1" Variable Grid Leak

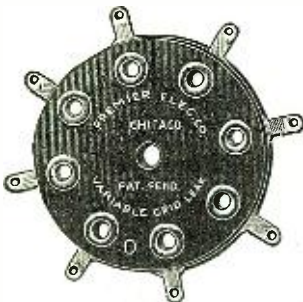

Price 50 Cents Each

Has seven carefully calibrated values of leak resistance of 1/2 Megohm each between terminals. Bakelite discs protect "leaks," assuring permanency of resistance. Don't guess—a grid leak is a mighty important unit in securing the best results from all tube sets. A Premier Variable makes this sure and easy.

PREMIER UNIVERSAL RADIO PRODUCTS—Are all their name implies and will survive. We make a full line of Apparatus and Complete Sets. Why not begin STANDARDIZING NOW?

WRITE FOR BULLETINS 102 AND 203

PREMIER ELECTRIC COMPANY

Manufacturers—Est. 1905

3804-3810J RAVENSWOOD AVE., CHICAGO

PAY NO EXPRESS

JANUARY RADIO SLAUGHTER

Sent postpaid, insured, anywhere upon receipt of money order, cash or check. Storage Batteries shipped express collect.

- \$5.00 Detector Tubes, (Guaranteed)... \$3.00
- 6.50 Amplifier Tubes, (Guaranteed)... 3.50
- 6.50 W. D. 11-1 1/2 Volt Tubes 5.75
- 4.75 43 Plate Variable Condensers.. 2.65
- 3.75 23 Plate Variable Condensers.. 1.95
- 3.50 Double Slide Tuning Coils..... 1.95
- 5.00 Vario Couplers 2.50
- 5.00 Variometers 2.75
- 1.50 Klosner Vernier Rheostats..... 1.19
- 1.00 Fada Type Rheostats60
- 8.00 Federal or Dreyfuss Head Sets 6.15
- 1.75 Variable B. Batteries, 22 1/2 Volt 1.00
- 8.50 Everett Head Sets 6.15
- 2.00 Telegraph (Learners' Outfits).. 1.00
- 1.50 Detectors60
- 4.50 Thordarson Transformers 3.65
- .35 Grid Condensers15
- .50 Grid Leak Condensers25
- .35 Galena or Pyrites, Mounted..... .15
- 25.00 Federal Broadcast Outfits..... 17.50
- 25.00 Crystal Outfits, Complete..... 12.50
- 3.00 Racony Aerial Plugs..... 1.50
- 1.00 3-inch Hard Rubber Dials..... .45
- 1.00 Moulded Sockets60
- .60 Porcelain Sockets25
- 6 Volt Guaranteed U. S. Storage Batteries\$7.50 up

PRICE LIST FREE

Broadway Electrical Novelty House

134 Third Ave., New York, N. Y.

ber who runs loco in a congested locality and smears a whole county with QRM from the minute his supper is down, but that it will safeguard the interests of its law-abiding members in communities where the Rochester Plan is adopted and respected.

One thing more. Noise this about a bit. Let it be known that we amateurs have decided among ourselves to preserve some quiet hours, out of consideration for the broadcast listeners. Spread a little honest propaganda in your local newspapers.

K.B.W.

Radio Digest

(Continued from page 1304)

telephone not only in the United States, but also in Germany, England and France. It is hoped that the wireless telephone, now that its advantages have been clearly demonstrated and proven, will soon leave the experimental stage and enter into actual practical use.

NO INTERFERENCE BETWEEN 360 AND 440 METERS

For some time the Department of Commerce Radio Section has insisted that there was no actual interference between the broadcasting stations using a 360-meter and a 400-meter wave, if good sets were used and properly tuned, and this contention has been proved recently. The Radio Inspector at San Francisco has submitted a report to the Radio Section of the Department of Commerce which it is believed will be of interest to the radio public. Because of numerous complaints in California that serious interference was experienced by listeners-in while two neighboring stations were transmitting simultaneously, one on 360 meters and one on 400 meters, the Radio Inspector conducted a personal test which he describes as follows:

"I arranged a test with a single coil tuner and also two inductive tuners located at a point midway between the two transmitting stations. These two stations, which were about a mile apart, were then requested to transmit at exactly the same time. It was found that with the single-coil tuner it was impracticable to separate the two waves. However, by using an inductive tuner, a change of six degrees either way, would tune out either one of the stations. This corresponded to a change of about six meters on either side of the transmitting wave.

"As the receiving station was located on almost a direct line between the two stations mentioned, it seemed to demonstrate beyond any possible doubt that with a selective tuner, it would be entirely feasible to receive from either station at will, without interference from the other.

"There will no doubt be much complaint from single-coil receivers and from other stations having very large aerials; but it is thought the interference will result in the ultimate improvement of receiving apparatus throughout the district. A campaign of education is being instituted by the Broadcasters Association, and it is intended that an inexpensive form of resonance trap is to be placed upon the market, for installation in conjunction with single-coil receiving stations, which will enable the operators thereof to reject unwanted signals, within the range of 300 to 600 meters."

INTRODUCING DEL Felco RADIO B BATTERIES

THEY ARE

- Dependable
- Extra Heavy
- Longer Life
- Fully Guaranteed
- Easily Connected
- Larger Cells
- Connections Positive
- Once Tried Always Used

DISTRIBUTORS WANTED

DEALERS and JOBBERS

WRITE FOR OUR PROPOSITION

Delfelco Battery Corporation

Pawtucket, R. I., U. S. A.

General Office
12 Meeting Street

Factory
28 Bayley Street

Standard Radio Horn

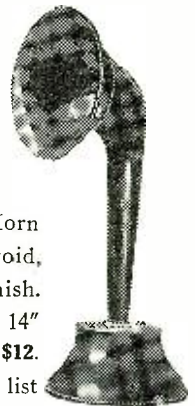

Standard Radio Horn made in rubberoid, black enamel finish. Made in 3 Sizes. 14" Bell 24" high, list \$12. 7" Bell. 19" high, list \$7.50. 5" Bell, 14" high, list \$5. Gem 11" Bell, 14x16" list \$7.50.

Write for particulars.

Manufacturers! Let us quote you prices on special horns to meet your requirements.

Standard Metal Mfg. Co.

231 Chestnut St.
Newark, N. J.

PHANTOM-CIRCUIT "BUILD YOUR OWN"

This Marvel of Mystery, without aerial, ground or loop, brings in Music instead of Static Showers. We consistently hear concerts on Magnavox from stations 100 miles distant, loud enough to be heard 150 feet from horn. The simplicity of this circuit will surprise you. Complete instructions, including price list of parts, constants and photo of circuit sent prepaid for 60c.

VESCO RADIO SHOP,

Vacaville, Calif.

FREE

Complete price list of radio parts.
Write Aitken Radio Co.,
412 Superior St., Toledo, Ohio.

CLASS B STATION LICENSES ISSUED TO OPERATE ON 400 METERS

CALL	STATION
WDAF	Kansas City Star, Kansas City, Mo.
WOC	Palmer School of Chiropractic, Davenport, Iowa.
WHB	Sweeney School Co., Kansas City, Mo.
KDKA	Westinghouse Elect. & Mfg Co., West Pittsburgh, Pa.
WSB	Atlanta Journal Co., Atlanta, Ga.
WFI	Strawbridge & Clothier, Phila., Pa.
WBAP	Wortham-Carter Pub. Co., The Star Telegram, Fort Worth, Texas.

ELEVEN NEW BROADCASTERS

Additional broadcasters licensed during the week as limited commercial broadcasting stations, on 360 meters, are as follows:

KFED	Billings Polytechnic Institute, Polytechnic, Montana.
WNAQ	Charleston Radio Elect. Co., Charleston, S. C.
KFCK	Colorado Springs Radio Co., Colorado Springs, Colo.
WNAX	Dakota Radio Apparatus Co., Yankton, S. D.
WOAJ	Ervin's Electrical Co., Parsons, Kansas.
WNAW	Henry Kunzmann, Fortress Monroe, Va.
WBAQ	Lyradion Mfg. Co., Mishawaka, Indiana.
WNAV	People's Tel. & Tel. Co., Knoxville, Tenn.
WRAY	Radio Sales Corporation, Scranton, Pa.
WPAL	Superior Radio & Tel. Equipt. Co., Columbus, Ohio.
WOAF	Tyler Commercial College, Tyler, Texas.

Alternating Current for Filament Lighting

(Continued from page 1287)

tory results cannot be obtained without the use of a complicated filter circuit. My own experiments have convinced me that this is not the case. With the circuit described hereafter I have listened in every night for a year to KDKA, about 35 miles distant from my home, and this without the slightest trace of A.C. hum. In addition to KDKA, I have also heard, almost nightly, WWJ of the *Detroit News*, WOR the station of the Bamberger Store at Newark, WJZ the Westinghouse station at Newark and very plainly WGY at Schenectady. And now that the summer static season is past I am adding new stations to my list right along.

My circuit consists of a Murdock loose coupler for tuner, crystal detector, 21 plate variable condenser, and Remler detector panel with UV-201 bulb. The transformer is a Tri-volt, with three taps giving 6, 9 and 20 volts at different taps. The "B" battery consists of two blocks of 22½ volts each. I have found that a plate voltage of about 40 is correct, a lower voltage not giving the desired loudness of signals and a higher voltage resulting in a slight A.C. hum which is difficult to control.

The hook-up here shows plainly how the apparatus is connected. The Remler panel is modified by removing the "B" battery potentiometer and replacing it with the tapped side next to the panel, the graphite side out. The wire connecting the one intake



INSTRUCTIONS FOR BUILDING AND OPERATING LOOP AERIAL SET

About one-quarter Actual Size.
We do not sell complete sets.

Cotoco

TRADE MARK REG. U. S. PAT. OFF.

Makes Radio Frequency Easy Free Instructions for Simple Successful Loop Aerial Set

Diagrams and instructions arranged to disprove the popular fallacy that Radio Frequency is complicated. Everyone admits the success of Cotoco methods in Radio Frequency reception with tapped transformers. Range—hundreds of miles with small loop. And rare tone clarity. Now it is made simple. Follow directions and you must succeed. Every connection clearly shown. Every requirement accurately listed.

Your dealer should have your Free copy. If not write us.

The Mark COTOCO is assurance of Quality. Insist upon COTO-COILS. Original and Best Radio Inductances.

COTO-COIL CO.

87 Willard Avenue
PROVIDENCE, R. I.

**Dealers!
For a red hot
Selling Window**

Have your radio man assemble one of these sets. Show it in your window with duplicates of all its parts about it. Show the price of all the parts. Sales will surprise you.

LOUD SPEAKER FOR ANY CRYSTAL SET BY USING THE Steinmetz Amplifier \$8.50



NO STORAGE BATTERY REQUIRED
Amplifying unit uses a Westinghouse tube which requires only a single dry cell in place of the storage battery. Tube and batteries for this unit \$7.95. For a two-stage amplifier use two of these units. Amplifying unit sold knocked down for \$5.95. Hear the concerts all over the house.

SUPERIOR CRYSTAL SET \$4.75
STEINMETZ PHONES are of exceptional merit, 2000 ohms, \$5.00; 3000 ohms, \$6.50; single phone, \$1.75. Equal to any ten or twelve dollar phones made.
Catalog 5c at your dealers or
STEINMETZ WIRELESS MFG. CO.
Manufacturers and Engineers
5706 Penn Avenue Pittsburgh, Pa.

HYGRADE SPECIALS

7 Stranded Copper Aerial Wire, 200 ft.	\$1.00
Electro Insulators, per dozen	2.00
No. 763 Eveready Variable B. Battery	1.25
No. 766 Eveready Variable B. Battery	2.25
No. 767 Eveready Variable B. Battery	4.25
45 Volt Cyclone Variable B. Battery	2.50
Arkay Loud Speaker	3.89
Thordarson Amplifying Transformers	3.49
Federal Amplifying Transformers	5.95
Skindervikin Transmitter Buttons	.75
Firco Bull Dog Grip Phone Plug	.98
2000 Ohm Murdock No. 56 Head Set	4.40
3000 Ohm Murdock No. 56 Head Set	4.40
Federal 2200 Ohm Head Set	6.50
Dictograph 3000 Ohm Head Set	7.50
Western Electric Head Set	10.50
6 volt 30 amp. MARKO STORAGE BATTERIES	9.25
6 volt 60 amp. BATTERIES	12.95
6 volt 80 amp. are GUARANTEED 2 YEARS	16.95
6 volt 100 amp. BATTERIES	21.00

Above prices are F. O. B. New York
HYGRADE ELECTRICAL NOVELTY CO.
41 West 125th Street New York, N. Y.

WANTED—Back numbers of Radio News, Sept., Oct., Nov. and Dec., 1921, Jan. and Feb., 1922. Experimenter Publishing Co., 53 Park Place, New York City.

Here's A Real "Built-to-Stay" Aerial Mast



Do away with aerial troubles and insure good steady receiving by erecting your antenna on Durecon Steel Masts. Our ten-foot mast on the roof and a taller mast in the back yard or two ten-foot roof masts make an ideal equipment.

Made in Sections

Durecon Steel Masts are built in sections of special analysis seamless tubular steel, lighter in weight, offering less wind resistance, and much stronger than ordinary metal construction. Sectional feature simplifies erection. Two people can quickly erect a fifty foot mast with ease.

Shipped Complete

Durecon Steel Masts in the following heights: 10 ft., 20 ft., 25 ft., 30 ft., 35 ft., 40 ft., 45 ft., and 50 ft. can be supplied from stock complete with all fittings—guy clamps, cable clamps, guy anchors, and guy cable to support mast under any wind strain. A Durecon delivered to you is ready to put up—no additional parts to be shipped around for.

An Attractive Addition to Your Radio Outfit

Durecon Steel Masts are better in the long run than any sort of makeshift mast you can put up—stronger and more permanent. They are professional equipment priced for the amateur's pocketbook. They add 100% to the "get-up" of your radio outfit. Write us now for illustrated circular and prices.

Dealers!

Durecon Steel Masts are overcoming a big bugbear in the building of a satisfactory receiving station. There is a big potential demand for Durecons right in your locality. Write us now on your business stationery for dealer discounts. Some good territory is still open.

Waukesha Steel Products Co.
Dept. 51, Waukesha, Wis.

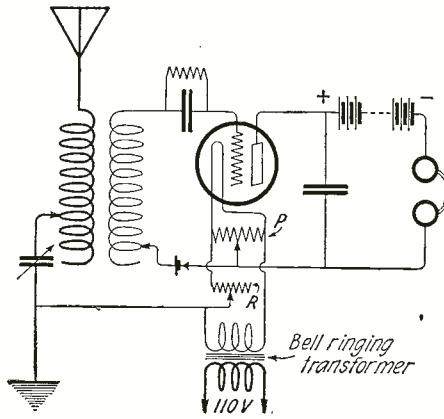

A Circuit Using A. C. for Filament Lighting. The Incoming Signals are Rectified by a Crystal Detector and Amplified by the Tube.

binding post with the filament socket is removed entirely from the panel and another wire substituted, running from the intake binding post to the sliding switch on the potentiometer. The small flexible leads for the "B" battery are also removed from the panel, as they are not needed. When the circuit is connected as indicated, excellent results will be obtained. I have found, however, that by tapping from the 6-volt posts of the transformer I do not get sufficient voltage for my filament and it is necessary to use the 9-volt taps, being careful in the operation of the rheostat in order not to burn out the filament. This can easily be done, as I have used one bulb for a year, from three to four hours each night.

With apparatus connected as above, incoming signals are detected by the crystal and amplified by the tube, but there will be a resultant hum from the A.C. current which cannot be entirely eliminated by the potentiometer. However, by the use of one more wire, this hum can be entirely done away with so far as receiving purposes are concerned. This wire is connected from one of the binding posts of the transformer to the ground wire. The degree of quietness achieved in this way is surprising, and if the potentiometer is carefully adjusted there will be no trace of A.C. hum in the phones. I have used steadily two sets of Murdock 3,000-ohm phones on my outfit, and with both pairs connected, signals come in much louder than on any single bulb set with storage battery

Save Your "A" Battery

By a Quick Weekly Check-up with the "Chaslyn" Sink-or-Swim Ball Tester Set.

Conditions of acid instantly disclosed by the way the 3 balls of different colors and weights sink or swim.

Depth of acid tested by Depth Gauge.

Distilled water added neatly with air-controlled rubber-stopper.

Set of 3 as illustrated, \$1.00. Order from your Dealer. If he tries to sell you something else, send us his name and address and your dollar. Set will be mailed prepaid.



CHASLYN COMPANY

4315 Kenmore Ave., Dept. 1, Chicago



World Radio Batteries

Save You 50%

WRITTEN TWO-YEAR GUARANTEE

Direct factory to user sales methods save you 50%. Highest quality material insures you 100% service. Every battery backed by our written two-year guarantee. You take no risk. Batteries shipped Express C. O. D. for your inspection. Mail your order today.

COMPARE THESE PRICES

RADIO PRICES	
6 Volt, 40 Amps.	\$8.50
6 " 60 "	10.00
6 " 80 "	12.50
6 " 100 "	14.50

No other manufacturer offers such a high quality battery at such a low price. Save 50% on your next battery and get better and longer service—buy a World Storage Radio Battery.

WORLD BATTERY CO.

1219 S. Wabash Ave. Dept. R Chicago, Ill.

The READ-EASY

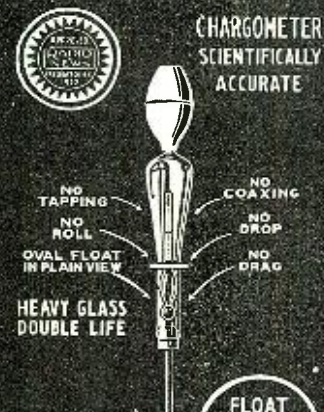

Sold on a strict Guarantee Adopted by Leading Battery Manufacturers

GET ACCURATE BATTERY READINGS

DON'T RUIN YOUR BATTERY

BY USING INACCURATE

BATTERY TESTERS

THE READ-EASY INSURES ACCURACY

Frequent inspection is your only insurance against heavy repair bills, loss of time and untold inconvenience. But a test tells you nothing unless your readings are absolutely accurate. Know the truth about your battery. Read-Easy will tell. Order yours today.

No Spilling or Splashing of Acid
A Protection for Your Clothing and Rugs

DEALERS AND JOBBERS—Our proposition means quick turn-over and volume sales. Our attractive counter display moves our goods off the dealers' shelves. We can give immediate delivery now in quantity lots.

Read-Easy is a quality, precision product. Handle the best hydrometer and you'll sell the most.

ALA MANUFACTURING CO.

Radio Dept. No. 12

401 to 419 S. Sangamon St. Chicago, Ill.

RADIO OWNERS—If your dealer can't supply you, send \$1.25 direct to us and we will send at once parcel post prepaid insured.

EVERY RADIO SET

should have this protective device in the house lead if an outside antenna is used. The

S&C Radio Lighting Protector

eliminates all danger from lightning or crosses with high voltage power circuits. Installed out-doors and never fails to intercept and keep out-doors high potential currents of any nature. No ground switch required. Used by people who "know". Write for free illustrated circular.

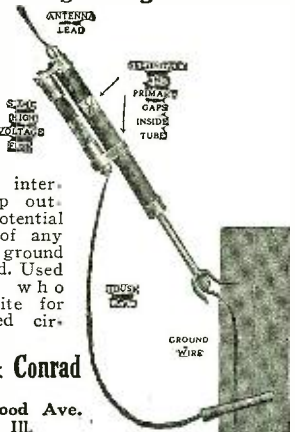

Schweitzer & Conrad INC.
4437 Ravenswood Ave. Chicago, Ill.

to which I have ever listened. My aerial is about 40 feet high, one strand about 75 feet long.

It is best to use an amplifying tube, as it will be found much quieter than a detector tube. It is not necessary to use the Remler panel, as I have secured just as good results from a home made panel, using an ordinary high-resistance graphite potentiometer.

Contributed by

Lee B. Wentz, Pittsburgh, Pa.

Those Other Worlds

(Continued from page 1271)

this question we must first understand the general principle of radio communication.

The unaided human voice will not carry far. This is due to the fact that sound waves travel through the air and the air is so disturbed by the elements, by mechanical obstruction and by the myriads of living things about us that these sound waves are soon broken up and die out.

The first step in long distance transmission of the human voice was the translation of the sound waves produced by the human voice into electromagnetic waves which were not affected by air conditions or mechanical obstructions. These electric waves were sent over wires and changed back to sound waves at the receiving station. The telephone was the result. But telephones required wires and switch boards and their use was limited by the expense and mechanical connections. The next step in voice transmission was wireless or radio communication. In this system the sound waves produced by the voice were changed into inaudible waves in space and thus sent broadcast to be picked up and changed back into sound waves by anyone possessing the necessary receiving apparatus and the key note of the inaudible ether waves.

The significance of radio development, then, lies in the fact that we have found that the ether is constantly in motion and that we can convert the sound waves of the human voice into ether waves not audible to us. Also we can construct mechanical ears by which we can detect these inaudible waves and translate or transpose them to suit the range of our human sensibilities. But what about other inaudible sounds which we do not ourselves produce? We walk along the street and hear nothing but the usual street noises. Yet we know that the air is full of music from the various broadcasting stations and that we could "tune in" at will if we had our radio receiver with us. But what else is there in the air that we do not think of? Our general broadcasting is done at from 360 to 480 meters wave length and commercial work utilizes waves up to 30,000 meters in length. But what is there beyond that. Marconi believes he has detected wave lengths of 140,000 meters and if he is right, they were not consciously sent by human agencies. Were they from Mars or Venus, or were they from some spirit world of which we have often speculated? Humans speak in vibrations up to 30,000 per second. The mechanical voice of the radio apparatus speaks in vibrations up to several million per second. Perhaps the people of Mars have voices and ears attuned to fifty million and those of Venus to one hundred million. And what is the wave length used by those humans who have left this known world of ours and in whose continued existence most of

Sensitive
Tuning Range
200-600 Meters

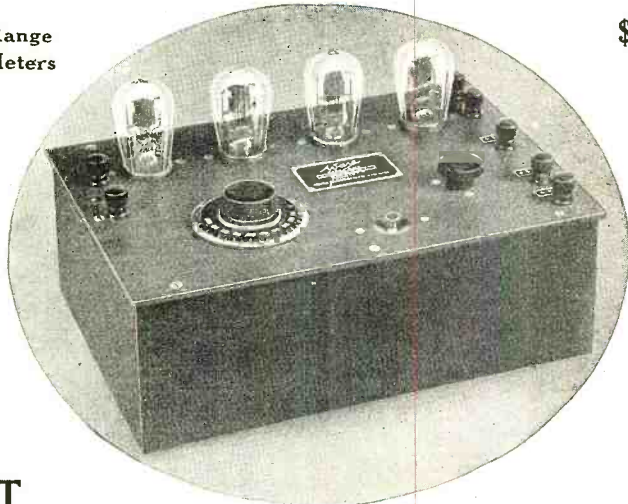

Price
\$110.00
without
tubes

THE MOST SENSITIVE RECEIVING SET ON THE MARKET

This 3-Step Radio-Frequency Amplifier Detector Set:

1. Will operate in any location—not excepting steel buildings.
2. Will nightly bring in the broadcasted programs 1,500 miles on indoor coil aerial.
3. Will cover enormous distances on outdoor aerial.
4. Will eliminate interference—static, induction, interfering radio stations—to an extent that will prove a revelation.
5. Will reproduce the broadcasted programs with absolutely perfect tone quality.
6. Requires no other knowledge to operate than is contained in the printed instructions.

Ware
TYPE AD2

R-F AMPLIFIER-DETECTOR
RECEIVER

Dealers' Correspondence Invited—Descriptive Booklet on Request

WARE RADIO CORP'N

160-162 Duane Street

New York City

Better Results from RADIO

by using the

AMPLITONE RADIO Antenna

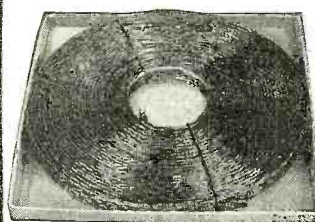

Gives much greater efficiency than ordinary copper wire or similar makeshifts, because it is specially designed for radio use. Braided flat of 10 pure copper wires, affording greater capacity, essential in bringing in signals clearly.

Gives Louder, Clearer Signals, Reduces Rapping and Increases Range. Makes the Little Set Work Well and the Big Set Work Better. With Amplitone you no longer need aerial spreaders and a lot of special apparatus to erect an aerial. A single 75-ft. length of Amplitone will give better results than a number of single wires or other makeshifts.

Amplitone Antenna, 75-foot length, with 2 antenna clamps, shipped prepaid for **\$4.50**

W. C. SHINN MFG. COMPANY, 1301 Lytton Bldg., Chicago, Ill.

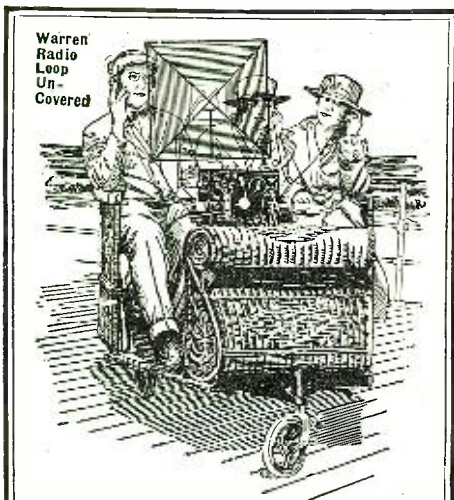

Warren Radio Loop Un-Covered

**SELECT YOUR PROGRAMS
Eliminate Interference with
A WARREN 18-INCH
DIRECTIONAL LOOP**

Pivoted and equipped with a honeycomb coil so that it can be directed to pick up just the station you want to hear. No matter how many stations there are near you, the Warren Directional Loop cuts out all but one.

Protected from dust, weather and any possible harm by tight cover.

- Type A-737 (300-700 meters) 6 inches square—non-directional \$10.00
- Type A-7236 (175-1000 meters) 6 inches square—non-directional 12.00
- Type B-2537 (300-700 meters) 18 inches square—directional 20.00
- Type BL-2520 (200-18,000 meters) with honeycomb coil, 18 in. sq.—directional... 25.00

Send for Bulletin T, 102

V-DE-CO RADIO MFG. CO.
ASBURY PARK, N. J.

Dept. N

**Haynes
Ideal Circuit**

Due to the remarkable results which are being obtained everywhere with this new circuit and the flood of inquiries which we are receiving as to recommended parts for it, we are listing them below with our special price on the complete set.

- Booklet on Construction and Operation of "Ideal" Receiver \$0.50
- 7" x 15" x 3-16" Radion Panel 1.60
- 180° Coupler 4.50
- Haynes Precision Var. Cond. .00025 Mfds. 3.90
- Mica Grid Condenser, .00025 Mfds.30
- 2 Fada Switches at .40c80
- 24 Soldering Lugs at 1/2c12
- 2 3" Dials, at \$1.00 2.00
- 6 Switch Parts at 3c18
- 4 Switch Stops at 3c12
- 1 Fada Socket 1.00
- 1 Fada Rheostat75
- 8 Binding Posts at 10c80

Total \$16.57

Our Special Price on Complete Set \$15.00
Include Postage

Haynes Radio Co., Inc.
629 Lexington Ave., N. Y. C.

Parts and Accessories for makers of radio apparatus



Details and Prices on request
GENERAL RADIO CORPORATION
Mfrs. & Distributors of
First Quality Radio Equipment
including **MUSIC MASTER RADIO AMPLIFIER**
624-628 Market St. Philadelphia

us believe? We will come to that later.

Now look at another possibility suggested by the development of radio. It is known that light and heat waves are of exactly the same character and form as those used in radio transmission. The receiving set for light is our eyes and it receives directly from the ether without any translation of the ether waves to air waves. The white light we see is a mixture of many kinds of colored lights and we have learned to break it up into its component parts at will. But here again we find that the human organ for light perception, like the ear for sound perception, is very limited in range and the same kind of ether waves of different characteristics are not registered at all. We have overcome this restriction for the ear by radio, will we soon do the same thing for the eye? There is inaudible sound all about us to which we can "tune in" at any time we desire. Why not other objects all about us to which we shall be able to "see in" at will in the future? The air about us is full of sounds we cannot hear. Why not also full of "things" we cannot see? We know the "wave length" for some of the music. How soon shall we learn the "wave length" for the "things" we cannot now see so that consciousness of them will be as readily attainable as that of the music is now?

What is Birth and Death? This is not a frivolous question nor is it irrelevant. Nothing is more generally feared by good and bad alike than Death. There is nothing of which we are more totally ignorant than Death. We have beliefs about it—many and different beliefs but what do we know about it? We have many religious creeds but which one can offer a theory of Birth and Death which can be divorced from belief?

The other day I was listening to music on my radio set. It was clear and distinct. Then suddenly it grew faint and died out completely. I had made no change in the instrument yet the music was gone. I changed the tuning and there it was as distinct as before. It had been there all the time but it had passed out of my consciousness. Perhaps death is like that? The human body is made of matter. But the scientists tell us that matter is really force or energy. The human organism responds to and gives off vibrations of a certain character—wave length we may say. The senses of those about it are "tuned" to the same character of vibrations and they see it. Then something changes the "wave length" of these vibrations in one of us—interference it is called in radio. Our vibrations are no longer perceptible to the fixed tuning of the senses of others about us and we are called "dead." Are we really dead any more than the music was dead, or have we simply changed? With the radio receiver I could readily change to the new wave length because it was close by and easily found. Perhaps some day we shall find the "wave length" to which we change at death and then there need be but a short break between this life and the next.

And the same theory applies to "seeing" those in the "other worlds." We see the body here but most of us believe we cannot see the spiritual body after death. But light and radio waves are the same sort of phenomena and the same reasoning applies as above. What are the characteristics of the "light" waves that are reflected from the spiritual body? Our human eyes are not tuned to them any more than our ears are tuned to the radio waves. We have sent photographs by radio waves and they were invisible during their



IN making itself undisputed leader in New England, our school has become prominent nationally.

If you contemplate training for a Commercial License, it is an important first step to write at once for our latest catalog.

Students may enter at any time.

MASSACHUSETTS RADIO and TELEGRAPH SCHOOL, Inc.

18 Boylston St. Boston, Mass
Formerly Boston School of Telegraphy. Established 1903
G. R. Entwistle, Radio Director R. F. Trop, Telegraph Director

HEADSET CORDS
Construction—Best quality tinsel conductor. Inner braid of soft cotton, outer braid either silk or mercerized cotton of any color. Both braids closely but loosely braided to insure maximum flexibility. Terminal tips of any type attached by our special process, which is insurance against loose tips or braid pulling back from tip and baring conductor. Prices—Send us your specifications to-day. We will submit sample cords and quote prices which will interest you.
Mfrs. of all kinds of braiding and cords.
AMERICAN FABRIC CO. INC.
289 THURBERS AVE.
PROVIDENCE R. I.

"SECO" HEAD SETS TRANSFORMERS
are standard quality products. Dealers write for our proposition.
We also do commercial winding for Telephones and Transformers.
SCIENTIFIC EQUIPMENT CO.
Ridgewood New Jersey

Make your own Radio Set
Parts consist of: Inclosed Detector, Mounted Galena, Formica Panel (holes bored), Tuning Coil, Switch, Switch Points, Binding Posts, Solderal, Wire, Tubing and Screws.
Sent postpaid for only \$3.45
Cabinet 90c extra
Try to match at three times the cost
ERNEST ELECTRIC CO., Radiophone Manufacturers
4849 Easton Avenue St. Louis, Mo.

EXCELLO-TONE DIAPHRAGMS for your Radio Phones, by actual test give 25 to 100 per cent. louder and clearer tone than diaphragms ordinarily furnished with head sets. Non-corrosive. When ordering please give diameter of diaphragm required and make of phone. Price 50c per set, postpaid. Please Remit by money order. Grimes & Mitchell, 2171 Bedford Ave., Brooklyn, N. Y.

flight through space. They were caught again by mechanical means and translated to the key range of our eyes, How far will this development proceed? When will another Marconi come forward with a "sight receiver" with which we can translate the light waves from "those other worlds" to the wave length adjustment of our eyes?

And then—what? We sit in our earthly living room. The furnishings are familiar. The family is about us and we discuss the events of our day. We desire a change. We put on our super-radio ear phones and our "optio"—frequency spectacles. We tune our radio to one million meters and our "optio" to one-ten-thousandth centimeter light and we are in paradise or purgatory. We no longer hear the human voice nor comments on the coal strike or the corn crop. The voices are different and they talk of different things. The furniture—where is it? The room is different or perhaps we are out of doors. There are other things about us and, as all furniture is but a group of electrons or force units, there is nothing strange about two things being in the same place.

In short we are in one of "those other worlds." What it is like we do not know but it may be similar to this one. I say "one" of them because there is no way of knowing how many there are and no limit to their number from a scientific standpoint. And the possibility does not end there. The business and life in those other worlds may be just as real as it is in this world. Here, some men have two offices, sometimes in different cities. Will the man of the future do the same with other worlds. Will his office door bear the sign "Here Mondays and Fridays—World No. 10 balance of week?" And will he translate his secretary with him? Why not?

A New Radio Loud Speaker

(Continued from page 1271)

phragm arrangements that it is considered a decided step in advance.

The device which Mr. Marriott has evolved consists of a thin leaf-shaped spruce panel supported on pegs and with a little iron armature fastened to the board near the point where a stem would join the leaf. The ear cap and diaphragm on an ordinary radio receiver are removed and the phone is laid on the iron armature so that it sticks to it. A clamp in the frame grips the phone case and a knob is turned to pull the phone magnets from the armature. Then any currents passing through the phone change the magnetic pull on the armature and vibrate the spruce panel.

The piece of spruce used is about 10" long and wide with irregular leaf-like edges. The spruce is carefully selected Washington wood, cut, braced, dried and waterproofed to produce the desired sound and prevent warping.

When the leaf is mounted in mahogany supports and placed on the library table or mantel, it looks as though it had been designed for an ornament rather than as a speaker, and since the sound is given off by both sides of the board, the tendency is to fill the room with music so that the stranger is usually at a loss to know where the sound comes from. Operating the device just loud enough for an ordinary parlor gives the most pleasing effect; its tone is mellow and free from the harsh

The Hit of

New England



Radio

Products

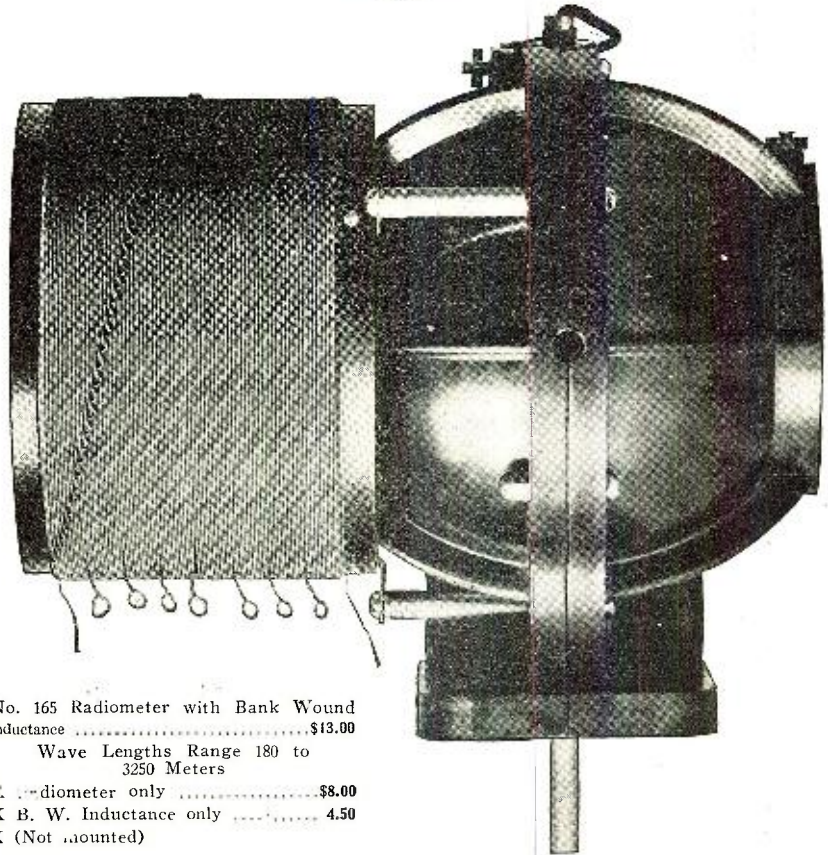

- No. 165 Radiometer with Bank Wound Inductance\$13.00
- Wave Lengths Range 180 to 3250 Meters
- Radiometer only\$8.00
- X B. W. Inductance only 4.50
- X (Not mounted)

Jobbers and Dealers write for Discounts on the above. We also manufacture knob and dial, bakelite socket, vario coupler, bank wound inductance, variable condenser, insulated binding posts, contacts, C. W. Inductances, choppers and phonocaps.

R. MITCHELL & CO.

255 Atlantic Ave.

Boston, Mass.

For 47 yrs. Mfrs. of Scientific and other equipment.
Look for trade mark on every piece.



Carter "TU-WAY" Plugs and "HOLD-TITE" Jacks

The Carter "TU-WAY" Plug permits TWO phone sets to be connected. Takes ALL types of tip cord terminals or wires. Non-breakable one-piece handle not affected by body capacity; no screws used to hold handle. Price, \$1.50 each.

The Carter "HOLD-TITE" Jack eliminates usual insulation stack-up between frame and springs. Wide spaced terminals; heavy tapered phosphor bronze springs; heavy pure silver self-cleaning contacts. No spacer washers, 1 to 5 springs. Prices, 70c to \$1.10.

Write for Bulletin describing new Vernier Control Rheostat and new Automatic Plate Circuit Control Rheostat which eliminates filament control jack and change-over switches.

CARTER RADIO CO.

209 S. State Street

CHICAGO

MONEY for You Add to your Salary—Make extra Pin Money. Start a lucrative business of your own. Spend an hour each day taking subscriptions for the "Radio News." We'll pay well and you'll enjoy the work. Write for full particulars. Circulation Dept., RADIO NEWS, 53 Park Place, N.Y.C.

RIGGS RECTIFIER

\$12.50



Prepaid anywhere in the U. S.

CHEAPEST, BEST AND MOST EFFICIENT ON THE MARKET, ONLY ONE ADJUSTMENT.

We guarantee the type B-3 to please you. Not only to do all we claim for it, but to please you. If you don't like it, we will take it back and return your money.

THE RIGGS MFG. CO.
 Urbana, Ohio Everett, Washington

Dreyfuss Phones for Long Range Receiving

The extreme sensitivity of Dreyfuss Phones makes them widely popular for long range receiving and listening in on low power stations. **Can be used as loud speakers.**

Excellent workmanship. Designed by engineers with over 18 years' experience in the radio field. Aluminum backs, rubber caps, finest materials.

2000 Ohm Concert Type
\$800 List

3000 Ohms, per pair - - - - - \$1200

1000 Ohms, single head band set, per pair - - - - - \$475

One Plug FREE with each pair of Phones

Immediate Deliveries!

P. M. DREYFUSS CO., Inc.
 150-152 Chambers Street, New York City
 179 Greenwich St., 29 Cedar St.,
 New York City Newark, N. J.



RADIO CLUB PINS

An emblem made to order for your Club will work wonders—write today for free 52-page catalog, showing Radio emblems, class rings and pins. Samples loaned to officers.

No. 987

METAL ARTS CO., INC., 7755 South Ave., Rochester, N. Y.

scratchings and vibrations usually present. Any of the ordinary iron diaphragm telephone receivers, which can be heard loudly in the room when used with the ordinary loud-speaking devices, will operate this invention. Mr. Marriott has applied for a patent on the new loud-talker.

A New Coil Wrinkle

(Continued from page 1296)

these discs was marked off into 35 equal spaces on the crack between them. Then holes were drilled diametrically $\frac{3}{4}$ " deep on these marks so as to just receive a 4d finish nail. Thirty-five nails are then stuck in the holes; the winding can then be started at any nail and proceed by weaving in and out every other nail as the disc is turned by hand or with a slow lathe. To make a neat job, be very careful not to miss weaving between every other nail. As there are an odd number of nails, after the third turn is in place a wire will appear to cross between each nail. The winding may proceed in this manner until the desired number of turns are in place for each pancake. (Fig. 1.)

After one coil is completed it may be removed by unscrewing the three screws. The two discs are then separated and the winding is intact with the nails. (Fig. 2.) To make the coil secure, as the nails are withdrawn the coil should be run through and through where the nails come out with about No. 36 cotton thread; using a bodkin or needle. Remove only six or eight nails at a time. Fig. 3 shows a finished coil.

Each pancake for my tuner was wound with 25 turns of No. 24 D.C.C. The finished coil was $\frac{49}{64}$ " inside diameter, $\frac{47}{8}$ " outside diameter and $\frac{9}{64}$ " thick. Seventeen coils, of course, were needed and then assembled on the tube, as shown in Fig. 4. Care should be taken to put the coils on with the windings all in the same direction, then connect the inside of one coil to the outside turn of the next adjoining coil.

The advantages of winding a tuner in this fashion are:

- (a) As efficient as a honeycomb or other type of anti-capacity winding.
- (b) Additional coils can be added without disturbing other windings already in place.
- (c) Taps can be taken off at will at any point and especially at the splices between the coils.
- (d) It is not necessary to mount the coils on a tube, as they can easily be bound together rigidly with thread.
- (e) Are very handy in making up different sizes of inductances for experimental work by adding or taking off coils at will and so prevent any "dead end" effect, etc.

The tuner built by the author using this method is all that is to be desired in a tuner of long range and dead end switches are found to be unnecessary.

A Simple Panel Switch

(Continued from page 1296)

post may be fastened to the outside strip, which in turn will move another set of contact springs.

Will the Author kindly forward his name and address to the Editor?

MICON TESTED MICA CONDENSERS



All Capacities
Price 25c to \$6.00

Antenella



No Antenella or Aerial Needed
Price \$2.00

At your dealers—otherwise send purchase price and you will be supplied without further charge.

CHAS. FRESHMAN CO., Inc.
 97 Beekman Street New York City

Spirala HIGH GRADE CABINET LOUD SPEAKERS

Do not be deceived by our low prices. SPIROLAS are not cheap instruments made to sell at a low price. They are rather a remarkable development made possible by the invention of the SPIRAL tone chamber (patent pending) which not only allows us to market a cabinet instrument of the highest grade in every respect at an almost sensational price, but gives many exclusive advantages over the common cabinet type speaker, which is nothing but an ordinary horn enclosed in a cabinet—great compactness for a full sized tone chamber and a really complete elimination of metallic, "horn" noises. SPIROLAS are especially recommended to music lovers who can appreciate an absolutely pure, natural tone.

We make a complete line of equally high class construction throughout, with fine hand rubbed finishes. ALL SPIROLAS ARE SOLD UNDER ABSOLUTE MONEY-BACK GUARANTEE—ten days to see and try them for yourself.

SPIROLA CONCERT—Complete with special, powerful built-in unit and cord ready to hook up in place of phones, beautiful mahogany or oak finish, bronzed throat **\$12.50**

SPIROLA DE LUXE—New, improved duplex type for use with your headset, two complete speakers in one, eliminating the usual interference between phones, same finish as above **\$4.85**

Satin black finish, nickeled fittings, otherwise same as DE LUXE..... **\$3.85**

We also make the DE LUXE and black finish types for use with a single loud speaker unit. In ordering state whether for use with headset or unit. At dealers or postpaid.
 (C. O. D. if preferred.)
L. H. DONNELL MFG. CO.
 Dept. A, Box 70 Ann Arbor, Mich.



Radio Salesmen Save Your Spare Time!

Many Radio Salesmen are making the most of their spare time by securing subscriptions to **Practical Electronics, Science & Invention, and Radio News.**

These popular magazines are growing in importance daily and a few hours' "spare time" work will add very materially to your income. Many Radio Salesmen have made them a part of their regular line. We pay a very liberal commission.

For details, subscription blanks and sample magazines, write to **C. J. WOLFE,**

EXPERIMENTER PUBLISHING COMPANY, Inc.
 53 Park Place New York

A Practical Inexpensive Loud Speaker

(Continued from page 1296)

showed little or no tendency to over-vibrate on the high notes.

The horn itself is made from stiff red cardboard similar to that used as covers for note books, and this material may be purchased for about ten cents at any stationery store. Lay out the design with a ruler and compass to the dimensions shown. Cut out the parts and bend them to the required shape, taking care to make no sharp bends in the cardboard. A little trimming may be necessary to make the edges around the curves fit nicely.

The secret of assembling the horn is in the use of surgeon's adhesive tape, which seems to have a peculiar affinity for the cardboard and makes an excellent cementing tape for the corners. This tape may be purchased at the drug store; it should be 1/2" wide and cost about 15 cents.

In assembling the horn, cut the tape into strips about 10 inches long and fasten the inside seams, first pressing the tape firmly in place and rubbing slightly with a small block of wood. For a short time after the outside seams are covered, the horn may be held in true shape by elastic bands. The base may be any small wooden box at hand or specially constructed to any desired dimensions. The cover, which is to support the horn and receiver below, should preferably be at least 1/2" thick. To receive the horn a square tapered hole should be cut through the cover. Push the horn firmly in the hole and glue it in place or attach it on the under side of the cover by four strips of adhesive tape reaching up inside the horn. The cover may be hinged to the box to facilitate a quick change of receivers



The finished loud-speaker

from the head-band to the box.

To hold the receiver tight against the bottom of the horn, two clips of brass or iron should be fastened to the underside of the cover and bent in such shape as to hold one of your particular type of receivers firmly in place. A slot should be cut in the side of the box to receive the phone cord.

To operate the horn, first tune your set to maximum loudness using the headphones. When optimum adjustment has been secured, slip one of the receivers out of its socket and under the clips in the horn base. On account of the change in capacity of the phone cord it may be necessary to readjust the tuner. A 30' section of lamp cord inserted in the phone circuit will permit the horn to be placed in any desired room without moving the receiving set.

The horn gives considerable amplification and is free from the objectionable "tinny" sounds experienced with sheet iron horns. On the whole, the excellent results to be obtained from a horn of this type are well worth the time and trouble expended in its construction.

That Satisfying Pride in Your Radio Set

You know how it is when you own anything that is really fine. You're proud of it and jealous for it and want others to appreciate it as you do. Your customer can feel in full measure that satisfying thrill of pride in his radio set if you have sold him Kennedy equipment. Even such friends as are not radio "fans" will also admire the handsome appearance and perfect finish of a Kennedy installation. And those who are radio experts will be even more enthusiastic over its splendid performance.

KENNEDY EQUIPMENT

The Beautifully Finished and Wonderfully Efficient

KENNEDY

Short-wave Regenerative Receiver, Type 281

(All Kennedy Regenerative Receivers are licensed under Armstrong United States Patent No. 1,113,149)

An ideal set for general use. Highly sensitive, selective and efficient—easy to operate—finely made in every detail. Meets the requirements of keen radio students who recognize and demand the best. Yet it is so simple to use that perfect results can readily be obtained by novices. Ask your dealer to show you the Kennedy Type 281, Regenerative Receiver, and write our nearest office for latest Kennedy Bulletin C-3.

THE COLIN B. KENNEDY COMPANY

INCORPORATED

SAN FRANCISCO

U. S. A.

ST. LOUIS

KENNEDY
EQUIPMENT



REFILLABLE TYPE
Refills with Standard Flashlight unit cells

ENCO "B" BATTERIES

for Wireless

Noiseless and Dependable.

Various Sizes.



STANDARD TYPE

ENCO ELECTRIC NOVELTY CO.
603-607 West 130th Street : : New York City

Get a Handy Binder for your RADIO NEWS. Holds and preserves six issues, each of which can be inserted or removed at will. Price 65c. Experimenter Pub. Co., Inc., Book Dept., 53 Park Place, New York.



Recharge Your Battery at Home

Charges Both A and B Radio Batteries

Don't be without the use of your Radio Receiving Set while your battery is being charged. Get a Valley Charger and charge your battery right at home. Attach the Charger to your home lamp socket—attach the clips to the battery terminals and you will get a quick, tapering charge which just exactly charges your battery, but cannot overcharge or harm it in any way.

Will charge the A 6 volt battery at a 5 ampere rate, and the B 22½ volt battery at the required ½ ampere rate. 45 volt B batteries may be connected in parallel so that they can also be charged.

SATISFACTION GUARANTEED. If your local distributor cannot supply you, write direct to

VALLEY ELECTRIC COMPANY,
Department R, ST. LOUIS, MO.

----- Mail the Coupon -----
Valley Electric Co., Dept. R, St. Louis, Mo.
Gentlemen: I am enclosing money order (or check) for \$18.00, for which send me a Valley Battery Charger with five-panel glass display case and indicator. If not satisfactory, I will return it and get my money.

Name _____
Address _____

\$18.00
F.O.B. St. Louis



Send for Our Catalog!

Among the many lines which we offer you at attractive prices during January are—

HIGH GRADE VARIOMETERS

\$2.00

Dealers and Radio Fans who want Quality Goods should send in the coupon at once.

David Killoch Company
57 Murray St.
New York City

Wholesale _____ Retail _____

DAVID KILLOCH COMPANY, R-N-J
57 Murray Street, New York City.

Please send me catalog and prices.

Name _____
Street _____
City _____ State _____

TIMES APPLIANCE CO., INC.
145 WEST 45th STREET, NEW YORK
WHOLESALE ONLY

Radio Parts, Sets and Equipment of All Kinds

Send for Our Price Schedule. Will Ship to Any Part of the U. S. and Canada

Use of High-Power Vacuum Tubes

(Continued from page 1273)

ciency it will be possible not only to cut the energy necessary for filament excitation down to a small fraction of what it now is, but at the same time the life of a cathode can be increased enormously, so that the practical application of electron tubes of large power will certainly not be limited by an unduly short life.

These developments will come gradually, for the practical construction of powerful tubes giving thoroughly satisfactory operation requires a great deal of development work. It would be rash, however, to predict the limitations of the ultimate use of vacuum tubes in the power field.

—Abstract from the *Electrical World*.

Fifty Cent Choke Coils for Amplifiers

(Continued from page 1297)

and secondary. After being sure the connection between the two coils of the secondary is in good condition, the two sections should be slid snugly together on the cardboard tube.

The primary and iron core should now be pulled out of the tube, and the ends of the tube cut off, leaving about one-half inch projecting from each end of the secondary.

The primary winding is now removed from the iron core, and the core itself is cut off so that it is a trifle shorter than the secondary windings. It should now be wound with tape to take the place of the wire removed and inserted in the cardboard tube. A little of the wax is now melted and poured in each end until a layer about one-eighth inch thick is formed.

Two pieces one inch long are sawed from an old switch blade. The two free ends of the secondary winding are now threaded through holes punched in each end of the cardboard tube and soldered to the pieces of switch blade. The two pieces are then inserted in the tube as far as they will go, taking care to have them in line, and hot wax poured around them until the cardboard tube is full. Several turns of Empire paper are glued around the secondary and the coil is finished.

For panel mounting two switch jaws of the correct height are mounted at the proper distance on the panel, and the coil is snapped into place.

In my opinion a well designed choke coil amplifier will give more volume of sound than one constructed with transformers, and much less distortion.

Contributed by E. I. HENNINGER.

The A. C. Line as a Source of Current for the Vacuum Tubes

(Continued from page 1270)

market and will probably be the fore-runner of the series, the second unit of which consists of an audio frequency amplifier, also supplied with A. C.

Fig. 5 shows the circuit of a one-stage



Patent Applied For **\$450** Postage 10c.

RHAMSTINE*

Radio Frequency Transformer

A handsome, efficient unit, of the high Rhamstine* standard.

The bayonet mounting allows changes of transformer instantly for the other wave lengths without disturbing base or wiring.

The type 1 R. F. Transformer, with its range of 200 to 500 meters, gives best results with the present broadcasting lengths.

We will gladly send descriptive folder.

Manufactured by
J. THOS. RHAMSTINE*
2152 E. LARNED ST., DETROIT, MICH.
*Maker of Radio Products

"SUPERLATIVE" AMPLIFICATION

You Can Increase Your Range Eliminate Howling and Distortion Bring Out the Full Clear Tone in Volume



No. 41 WITH

JEFFERSON

Amplifying Transformers

Furnished in two types either mounted or unmounted. Coils specially wound with No. 40 and No. 44 wire on a core of the finest rolled Silicon steel.

SEND FOR RADIO BULLETIN
Prompt Deliveries

JEFFERSON ELECTRIC MFG. COMPANY
424 S. Green St., CHICAGO

Vesta "A" and "B" batteries for radio sets are noted for their long life.

VESTA

COSTS LESS PER MONTH OF SERVICE

Memorize the code in 3 hours by the CORYDON SNYDER METHOD. I don't ask you to take my word or any one else's. If YOU fail, return the course within one week for dollar back. You run no risk even if you have failed with other methods. There are no words or phrases that must first be memorized. Send \$1.00 to Corydon Snyder, 1161 S. Ridgeland Avenue, Oak Park, Ill.

ELIMINATE the STORAGE BATTERY by using BRU No. No. 4 SOCKET, the only socket that takes the dry cell tube. Unconditional guarantee. \$1 postpaid.

BRUNO RADIO CORP., 152 West 14th St., New York City

audio frequency amplifier with the filament of the tubes lit with A. C. The two tubes are mounted in parallel in a pull-push fashion with two amplifying transformers fitted with taps in the middle of the windings. The connections are such that an oscillation makes the grid, G, positive and G1, negative. This results in increasing the plate current of one tube and decreasing the plate current in the other. If these two plate currents pass through the primaries of P1 and P2 of the second transformer so that the oscillation in the secondary is the result of both plate currents added, the system still functions as an ordinary audio frequency amplifier. To accomplish this, it is necessary to oppose the two flux produced by the D. C. current in the plate circuits. If the same type of tube is used for 1 and 2 of the same size of primaries, the resulting flux is zero. Therefore, if the plate currents are altered, in the same way, by the A. C., for instance, the resulting flux remains zero. Under these conditions no electrical force is induced in the secondary, S2, but only oscillations which are to be amplified. In fact, the oscillations caused by the signals add to each other in the secondary, S2 while the extra oscillations produced by the A. C. current from the main, subtract from each other.

It is possible to use a second stage of amplification by using two more tubes connected in the same way. However, it should be remarked that four tubes are necessary to produce the same results as a three-tube audio frequency amplifier of the standard type.

Before concluding, we wish to mention a system also developed by Mr. Valette, which cuts out entirely the roar caused by the machine whether damped or undamped waves are received in the regenerative circuit. Some amplifiers, with three and five tubes which were tried with this system, gave a perfect amplification whether receiving C. W. or spark. The process consists of producing in the receiver very strong oscillation of high frequency, but quite different from that of the signals.

To sum up, it seems that the real solution of the use of A. C. line for supplying vacuum tube receivers and amplifiers is near. It is hoped that within a few months we shall see the ideal receiver equipped with a plug which will be inserted in the lamp-socket in the same way as any other electrical appliance, rendering the radio receiver really practical for everybody.

Boost National Radio Week

Static is Greatest Obstacle in Radio

(Continued from page 1265)

power of 80,000 meter-amperes, but this station will soon be largely increased in its power output. The antenna system at Bordeaux has a more effective height than the one at Sainte-Assise. He computes the radiating capacity of "Radio Central," the new radio-telegraph station of the Radio Corporation of America at Long Island, New York, in terms of 56,000 meter-amperes at present. The powerful station of the United States Navy Department at Annapolis or Greenbury Point, Maryland, is rated as being

C-H THERMOPLAX
COLD MOULDED



For Speed and Economy In Building Quality Radio Parts

C-H Thermoplax the only Thermoplax made, embodies every qualification the radio engineer and manufacturer desires. It is electrically and mechanically a perfect radio material, and effects great economies in production. In some cases assembly costs are practically eliminated. Parts may be moulded in any shape with ratings, trademarks, directions or inserts incorporated during the moulding process. Large production per die is possible with a correspondingly low cost.

Standard Thermoplax Knobs

Cutler-Hammer manufactures a standard line of Thermoplax knobs of various sizes and kinds. Prices may be had on application.

In the designing of radio parts, C-H sales engineers in all principal cities are ready to assist. Three sources of supply, New York, Milwaukee and Toronto, insure rapid production free from delays.

The Cutler-Hammer Mfg. Co.

Works: Milwaukee Offices and Agents and New York in Principal Cities

Associated Canadian Plant: ELECTROPLAX CO., Toronto

C-H THERMO
COLD MOULDED

If it isn't Cutler-Hammer it isn't Thermoplax



Send for this Booklet

Descriptions and illustrations of various parts including a standard line of knobs.

Try REYNOLDS RADIO Service

9 Z A F from DENVER K L Z

Clapp-Eastham H R Receiver	\$40.00	Grebe CR5 Receiver	\$80.00
Kennedy Type 281	80.00	Grebe CR8	80.00
Kennedy Type 220	125.00	Grebe CR9	130.00
Kennedy Type 110	250.00	Accessories, Supplies - Everything in Radio	

Send 15c for our new Catalogue—Refunded on first order amounting to \$5

REYNOLDS RADIO CO., Inc. 1534 Glenarm St. Denver, Colo.

LARGEST DISTRIBUTORS OF RADIO APPARATUS IN THE WEST

Insure your copy reaching you each month. Subscribe to Radio News—\$2.50 a year. Experimenter Publishing Co., 53 Park Place, N. Y. C.

ekko
Makes a loud speaker of your phonograph



**listen to radio through
your phonograph**

Ekko connects your head phones with the tone arm of your phonograph and transmits Concerts and Programs through the tone chamber.

The best Loud Speaker you can use—utilizes the scientific design of the phonograph tone chamber, produces a mellow pure tone. Not adapted to crystal sets without amplification. If your dealer does not yet carry Ekko, use the coupon—send \$3 and we will mail one immediately, postpaid. Money back if not satisfied. Mention the make of your phonograph and name of your local dealer.

THE EKKO COMPANY
911 Harris Trust Bldg., Chicago.

Enclosed \$3.00. Please send me one Ekko Radio phonograph adapter. My money back if not satisfactory. My phonograph is a

Name

Address

Dealer's name

DEALERS!

If the Holiday Sales have depleted your stock—reorder now for mid-winter sales. Prompt deliveries are absolutely guaranteed—and our discounts are most liberal.

We Are Jobbers For Grebe Receiving Sets Federal, Fada and Radio Shop Products Murdock Products Baldwin Phones

Write for Our Special Proposition "Z"

THE RADIO SHOP

—OF NEWARK—

76 SPRINGFIELD AVE.
NEWARK, N. J.

KRL

Myers High-Mu Audion A tube which brings in the stations five times louder than other tubes. Try one of these efficient little vacuum bulbs, \$5. Receipts, \$1. KRL Circuits. Postage and insurance free.

**THE KEHLER RADIO LABORATORIES, Dept. R
ABILENE, KANSAS**

capable of operating at 30,000 meter-amperes at present. Its capacity will be increased to 50,000 meter-amperes in the near future. Thus according to the head of the radio research laboratory of the Navy Department, the most powerful radio-telegraph stations in the world, in the order named, are Bordeaux, Sainte-Assise, both in France, and "Radio Central" of Long Island, U. S. A. An arc-transmitter is in operation at Bordeaux, while machines are employed at the other two stations.

At this juncture, the opinion of Doctor Austin was consulted as to the future use of tubes for radiating electric energy. Both at home and abroad, he indicated the expanding service of the tube to the extent of making the blanket statement, "If the tube is developed as expected the arcs and machines will be discarded." The Post Office Department of Great Britain recently decided to use the tube in its national chain of radio-telegraph stations. The Marconi station at Carnarvon, in Wales, is already employing tubes for radiating electric energy. At home, the "Radio Central" at Long Island, with Alexanderson alternators installed is also experimenting with tube-transmitters. The research laboratories of the Bell Telephone System have recently developed a 100-kilowatt tube transmitter which is a giant compared to the so-called peanut tube used in the vacuum-tube radio-telephone receivers.

The Head of the U. S. Naval Radio Laboratory is dubious about the contemplated development of the loop as a form of antenna for radiating electric energy. He cites the formula that the power of the loop to radiate electricity decreases in proportion to the square of the wave length. He is of the opinion that the loop antenna, other than its expanding services in "picking-up" electric energy, for transmission purposes will be, if used at all, restricted to very short wave lengths for some time to come.

While abroad, Doctor Austin visited Brussels, London, Berlin, Paris, and made short excursions to outlying points. He was chosen one of the vice-presidents of the organization of the International Union of Scientific Telegraphy. Other officers elected were, General Ferrie of France, president; Doctors Eccles of England, Vanni of Italy, and Bjerknes of Norway, vice-presidents. Doctor Goldschmidt of Belgium was elected secretary-general of the association, which was formed in 1919 under the auspices of the International Research Council of the different allied governments. This organization is not concerned with the problems incident to the use of radio apparatus but confines its deliberations to such major subjects as the laws of wireless transmission, apparent changes in direction of radio signals, fading, atmospheric disturbances, and other fundamental problems governing the accurate measurements of electromagnetic waves. In fact, one section of this organization is devoted to the study of methods of measurements and developments of measuring instruments for the more precise determinations of the fundamental quantities involved in radio telegraphy.

An Efficient Short Wave Set

(Continued from page 1295)

The cabinet has inside dimensions of 14x6x5", and is made of 1/4 inch quartered oak. The cover is hinged so that it may be raised to insert or remove the

Radio Patents for Sale

Several inventions of well-known Radio Authority are for sale. The patents in question have to do with radio receiving instruments, such as Condensers, Telephone Headband, Crystal Receiving Outfits (the latter is a combination of detector and tuning coil all in one), Rheostat, etc. Address Box No. 55, care of RADIO NEWS.

RADIO MAILING LISTS

We can furnish:

10975 Radio Dealers by states.....	per M.	\$7.50
1320 Radio Mfrs.	per list	12.50
1369 Radio Supply Jobbers	per list	12.50
260 Radio Stations	per list	4.00
257 Mfrs. who make complete sets.....	per list	4.00
14000 Radio Amateurs and managers of Radio Stations	per M.	7.50
20 Radio Mfrs. in Canada	per list	1.50
87 Radio Supply Jobbers, Canada.....	per list	2.50
131 Retail Radio Dealers, Canada.....	per list	3.00
125 Mfrs. and Jobbers in England.....	per list	4.00

Send remittance with order.

TRADE CIRCULAR ADDRESSING CO.
166 W. Adams Street Chicago, Ill.



This official 14 K. gold plated lapel button is now being given free to all new members of the Radio Experimenters' League. See special notice under Wireless heading in Classified Section this issue. Old members who have not yet received their lapel buttons, send at once for one free. Tell your friends to join Radio Experimenters' League, Run by Amateurs for Amateurs, 9-15 Clinton Street, Newark, N. J.

WHY not spend Spring, Summer and Fall gathering butterflies, insects? I buy hundreds of kinds for collection. Some worth \$1 to \$7 each. Simple outdoor work with my instructions, pictures, price list. Get posted now. Send 10 cents (NOT STAMPS) for my Illustrated Prospectus. Mr. Sinclair, Dealer in Insects, Dept. 37, Ocean Park, Calif.



Radio Salesmen Save Your Spare Time!

Many Radio Salesmen are making the most of their spare time by securing subscriptions to Practical Electrics, Science & Invention, and Radio News. These popular magazines are growing in importance daily and a few hours' "spare time" work will add very materially to your income. Many Radio Salesmen have made them a part of their regular line. We pay a very liberal commission. For details, subscription blanks and sample magazines, write to C. J. WOLFE,

**EXPERIMENTER PUBLISHING
COMPANY, Inc.**

53 Park Place New York

tube, throw the change over switch, and to inspect the inside.

Strips of 1/2" oak are fastened on the inside. 3/16" from the front edge and the panel secured to it by screws, so that the panel surface sets flush with the edges of the cabinet.

The cabinet may be finished up in any desired manner, but the simplest is to merely stain it with oil stain and then varnish or wax it.

Although the set will work after a fashion when wired in almost any manner, good results cannot be obtained with poor wiring. Number 14 bare copper wire should be used. All leads, particularly in grid circuit, should be short as possible. Close, parallel grid and plate wires should be carefully avoided.

If it is desired to obtain loud signals it is a simple matter to connect an amplifier to this set. The "A" battery posts on the amplifier should be connected in parallel to those on the set, and the phone posts of the set connected to the input posts of the amplifier.

Just a word as to some of the results which I have achieved with this set. Using a two step amplifier, also home-made, I can bring in the nightly phone concerts from WJZ so loudly that they may be heard all over the top floor of my home. This station, and many others, may be heard with the phones several feet away without the use of an amplifier. All the long distance relay spark stations come in loudly.

If any amateurs who experience difficulty in the construction of any part of this set will write me a letter explaining their difficulties, I will try to clear up the point for them.

I would like to hear from those who complete sets along lines herein mentioned. Address letters to H. S. Potter, 148 Union Ave., Mt. Vernon, N. Y.

The Electro-Static Loud Speaker

(Continued from page 1276)

but a current, although weak, passes through it. These matters are considered in the electrical industry as poor insulating materials, such as slate, agate, some forms of paper, gelatine and lithographic stone.

When such materials are used as dielectrics in a condenser constituted as shown in Fig. 1, they act as a dielectric with a high resistance in series in the circuit. The attracting forces in such a device may easily be shown by the following experiment. A condenser is built as shown in Fig. 7; an armature E is carefully applied upon the surface of a flat plate of one of

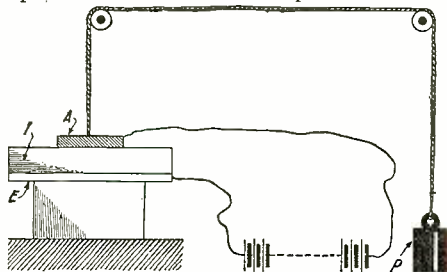

By This Means the Attractive Force May Be Measured in Pounds.

the dielectrics mentioned above. A disc, A, connected to a source of current, is applied on the other side, the battery being connected to the other armature, E. Under these conditions the only dielectric is the very thin layer of air which is present between the armature A, and the semi-dielectric plate, I. When the current is applied to this condenser, the surface of the semi-dielectric in contact with the thin

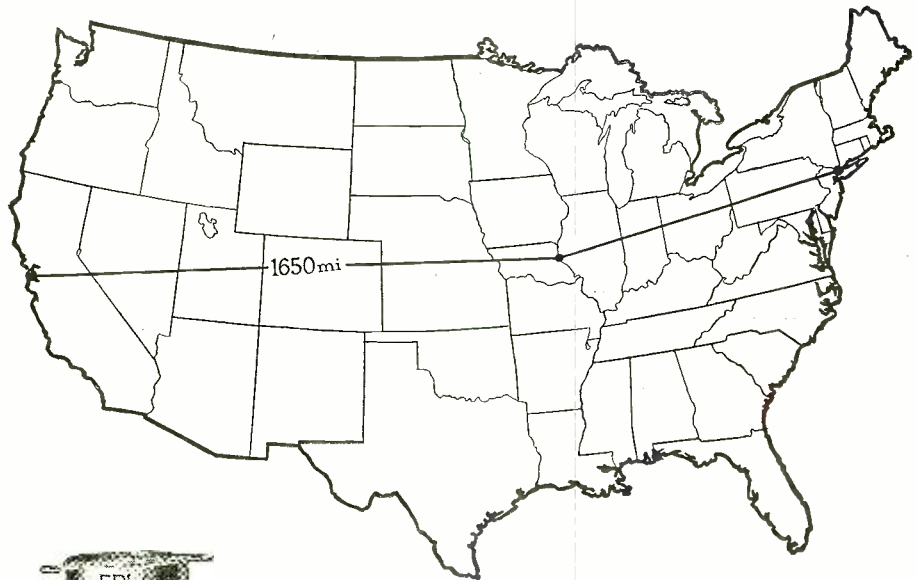

Both in results and intrinsic value, Erla radio frequency transformers have no equal. List price, \$4.00.



Erla bezels add 100% to the appearance of any receiving set. Fit 1 1/2" hole in any 1/8" to 1/4" panel. Price, 20c.

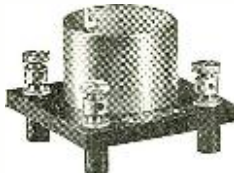

The strongest and most beautifully finished socket on the market. Nicheled shell. Radiobase. Price, \$1.00.

JOBBERS—Erla products sell on sight, and stay sold, creating business in steadily increasing volume. Write for our liberal terms and discounts.

Quincy, Ill., Listens in on New York and San Francisco

N. G. Dowdell, 116 N. 5th St., Quincy, Ill., writes:

"With Erla radio frequency transformers in my FRL super receiver, I listen to concerts a thousand miles away every evening. The other night, I heard KUO at San Francisco as clearly as Chicago."

This is but one of the many instances where Erla radio frequency transformers are demonstrating their superiority in long distance reception.

Because of their unique ability to overcome the high capacitance effects of domestic vacuum tubes, as well as their own reduced capacitance, they produce unequalled magnification without distortion.

To make sure of a receiving set that is the last word in up-to-dateness and efficiency, write for our Bulletin No. 12, showing guaranteed hook-ups using Erla radio frequency, with full directions for installing.

ELECTRICAL RESEARCH LABORATORIES
Dept. C 2515 Michigan Ave., Chicago

ERLA

Trade-Mark Reg.

RADIO SALESMEN SAVE YOUR SPARE TIME!

Many Radio Salesmen are making the most of their spare time by securing subscriptions to **Practical Electrics, Science & Invention,** and **Radio News.**

These popular magazines are growing in importance daily and a few hours' "spare time" work will add very materially to your income. Many Radio Salesmen have made them a part of their regular line. **We pay a very liberal commission.**

For details, subscription blanks and sample magazines, write to **C. J. WOLFE.**

Experimenter Publishing Company, Inc. 53 PARK PLACE
NEW YORK



Sharp and Clear as a Bell, MASTER RADIO RECEIVERS

Bring in both music and speech

However distant the source of entertainment, MASTER RECEIVING SETS respond with a clarity so sharply defined you wonder if the entertainers are not in the same room, but invisible.

Exceptional engineering skill was employed to develop MASTER RADIO RECEIVERS. Only the very choicest of materials have been used in their construction. Consequently it is not to be wondered that their performance is truly remarkable.

MASTER RECEIVERS tune clear and sharp with a high degree of selectivity on all wave lengths within range; they practically overcome radio's greatest drawback—static and undesired signals. They are made to perform where other receivers balk.

MASTER RECEIVERS are an exquisite product. Write for booklet which fully illustrates them.

Master Receivers are Master built throughout. Parts made and assembled in our own plant.

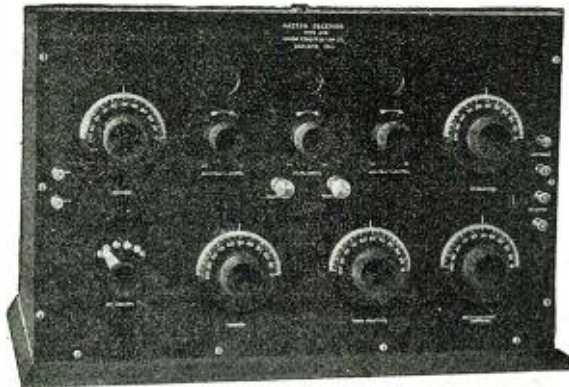

UNION CONSTRUCTION COMPANY
Manufacturers of Master Radio Products
OAKLAND, CALIFORNIA

NOTICE Radio and Electrical Employees

We wish to have a special representative in every Electrical Manufacturing Plant to show *Practical Electrics*—and to secure yearly subscriptions for it.

Practical Electrics is more interesting than fiction—and the most novel and unique electrical magazine published.

Just think!—an electrical magazine, covering each month in "snappy articles", fully illustrated, the complete electrical developments of the month in plain everyday English that all can understand.

This is the only electrical magazine the student—or beginner—can appreciate.

It is for the electrical professional man—the electrical experimenter—and the electrical engineer, each will enjoy *Practical Electrics* every issue.

Every electrical employee will want *Practical Electrics*.

We pay you large commissions—and require only a few hours spare time work. For details, sample magazines and order forms write

Mr. C. J. Wolfe, PRACTICAL ELECTRICS PUB. CO., 53 Park Place, N. Y. City

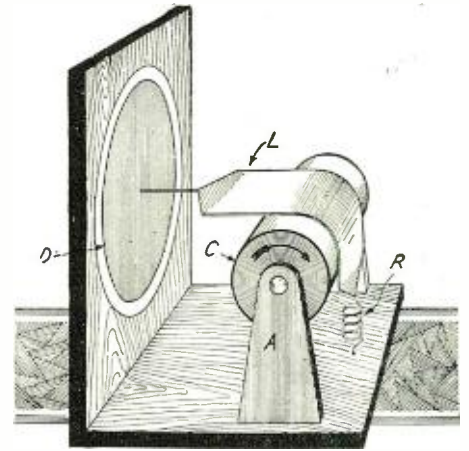

This Illustration Shows a Type of Electro-Static Telephone with an Imperfect Dielectric.

layer of air is charged, acting also as a high resistance in the circuit.

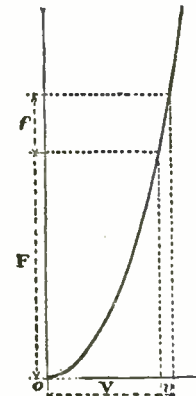

Variation "F" of the Attractive Force "F" for a Value "V" of the Variable Tension.

It is important that a good contact between the dielectric I, and the armature, E, be obtained so that the resistance of the contact be negligible in comparison with the resistance of the semi-dielectric material itself. It is necessary, also, that a thin layer of air be present between the armature, A, and the surface of the dielectric and in order to obtain this, the surfaces must be carefully polished and perfectly flat and dry.

In such an apparatus, which may easily be built for demonstration, the phenomenon of the attraction is more marked than in the previous system because the armatures are much closer together. It is easy to measure the attracting forces by means of a weight, P, pulling upon the armature, A. With a disc of 10 square centimeters submitted to a tension of 300 volts, the attracting forces may be found to be up to several pounds. When the other armature, E, which may be tinfoil, is not carefully applied, on the dielectric, I, the surface of contact constitutes another condenser which is in series with the first dividing, the tension applied in two and therefore reducing the attracting forces in the same proportion. The circuit, Fig. 9, shows the development of a loud-speaker arrangement based upon the mechanical construction of Fig. 8. The same system could be constructed by using an ordinary phonograph, the dielectric being in this case a dielectric of the same shape as the standard phonograph record

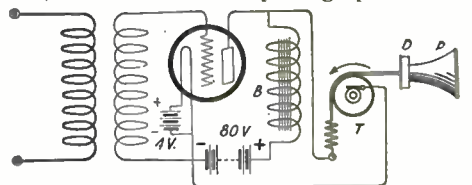

Hook-up of Electro-Static Telephone Used as a Loud Speaker in Conjunction with an Amplifier.

and the other armature being a spring in contact with it. Since this loud-speaker system, which may also be used as a recorder, is operated by tension, it is necessary to use some step-up transformers. The polarizing tension may be obtained from the "B" battery, which is used with the amplifier, but an iron core choke coil should be connected in parallel with the device so as to

permit the direct current to reach the plate of the vacuum tube. When the signals are sufficiently amplified, the electrostatic system provides the means for a good loudspeaking arrangement. Very little experimenting has been done with this system and here is opened for the amateurs, a most interesting field for research and experiments.

Radio News Laboratories

(Continued from page 1299)

wire coated with an adhesive as well as protective solution. Pigtail connections are used to complete the circuit to the rotors, which are furnished with shopping pins. The binding posts for external connections are in the form of two wood screws with washers for clamping the wire.

The wave length range with a 32-turn secondary in series was from 180 to 425 meters. The inductance of the variometer alone is 148.2 microhenries minimum and 961 microhenries maximum. Vernier control changes the inductance by 16 microhenries.

Arrived in good packing with no instruction sheet enclosed.

Received a percentage rating of 82.

AWARDED THE RADIO NEWS LABORATORIES CERTIFICATE OF MERIT NO. 52.

5 FT Reports Some DX

(Continued from page 1286)

through the efforts of the Mexican Government to keep out all radio sets. At the mine where we will be, we will have 110 volts D. C. Maybe we will rig up an amplifier tube as a transmitter and astound the world by "getting across" as IBCG did, only we will be endeavoring to get across the border, to the United States.

I will be glad to give any fellow ham a report of his signals if he will call us between 7:30 and 9:00 P. M., Mountain Time. The mail here is too expensive to send them each a card as it costs 10c for either a card or a letter. I can't answer them, but will report to them through the columns of RADIO NEWS.

For their information we submit herewith a list of all stations heard and logged between Oct. 4 and Oct. 20, 1922.

2FP, 4GL, 5ZA, 5ZH, 5ZO, 5ZAC, 5ZAG, 5ZAM, 5ZAW, 5XD 5XV, 5SF, 5SM, 5NN, 5NK, 5TC, 5TM, 5IX, 5PX, 5QI, 6AJH, 6BEL, 6BJQ 6TBC, 6XAD(?), 6ZA, 7OX, 7ZX, 8ZZ, 9AMB, 9ANQ, 9BEN, 9BEK, 9PS 9ZA 9ZAF. LEIGH C. PARKER, JR., and LINTON HUDSON, of Shreveport, La.

A Study of Different Types of Coupling

(Continued from page 1293)

amount of energy transferred to the secondary. It will be evident, however, that this particular method of coupling two circuits together is wasteful and inefficient, since a very large portion of the total energy is wasted in the coupling resistance R in the form of heat. It, therefore, has a very limited field of application.

Its main application is in the field of resistance coupled amplifiers, as illustrated in Fig. 2. Here the coupling resistances are the plate resistances R in the plate circuits of the amplifier tubes.



Perfect Reception

BRANDES *Matched Tone* headsets are the standard equipment of the receivers made by the leading radio manufacturers. The listener judges a radio receiver by what he hears. It follows that Brandes *Matched Tone* headsets must have the qualities that the radio manufacturer demands.

If your receiver is not equipped with Brandes *Matched Tone* headsets, you are not hearing the music perfectly.

Send ten cents in stamps for the "Beginner's Book of Radio." It explains radio in terms that anyone can understand.

DISTRIBUTORS AND DISTRICT OFFICES:

Munsey Bldg., Washington, D. C.	709 Mission St., San Francisco, Cal.
33 S. Clinton St., Chicago, Ill.	76 Pearl St., Boston, Mass.
704 Granite Bldg., Pittsburgh, Pa.	802 Forsyth Bldg., Atlanta, Ga.
1220 Nicollet Ave., Minneapolis, Minn.	
International Electric Company, Wellington, N. Z.	

C. Brandes, INC.

Matched Tone Headsets

237 Lafayette St., New York
Dept. RN

Made in Canada by Canadian Brandes, Ltd., Toronto, and distributed by Perkins Electric, Ltd., Montreal.

MAKE THIS A RADIO CHRISTMAS

McTIGHE ALKALINE STORAGE "B" BATTERY

for RADIO OUTFITS

The McTighe Alkaline Storage "B" Battery is the most satisfactory for radio use. It gives 22 volts, is inexpensive—noiseless—cannot be damaged by short circuit, overcharging, standing idle or uncharged. Can be fully charged from any light socket for less than one cent. Is furnished in an oblong glass container which nests neatly.

The McTighe Rectifier is cheap, simple, durable, and effective, and should be used when charging the McTighe "B" Battery.

Battery, \$5.00. Rectifier, \$1.50. Rubber Filler, 25c.
F. O. B. Irwin, Pa. Prompt shipments.

Discount to Dealers.

ECONOMIC APPLIANCE CO.
IRWIN, PENNA.

Dr. T. O'Connor Sloane Will Teach You CHEMISTRY Right In Your Own Home



DR. T. O'CONNOR SLOANE, A. B., A. M., LL. D., Ph. D., Educational Director, Chemical Institute of New York, formerly Treasurer, American Chemical Society and a Practical Commercial Chemist as well as a noted instructor.

Good chemists command high salaries. Industrial firms of all kinds pay tempting salaries to get the right men. Salaries of \$10,000 a year are not unusual for chemists of exceptional abilities. The work of the chemist is extremely interesting. If you are fond of experimenting, take up chemistry. If you want to earn more money, the way is open through our Course in Chemistry.

You Can Learn at Home
Dr. Sloane will teach you Chemistry at home in a practical, intensely interesting way. Our Course is remarkably simple. No special education required—if you can read and write plain English you can thoroughly understand and master every lesson.

Easy Monthly Payments

The price of our course is very low and the tuition includes everything, even the chemistry outfit—there are no extras to buy with our course. You can pay in small monthly amounts as you go along. Our plan places a chemical education within the reach of everyone.

Experimental Equipment Given to Every Student

One special feature of our course is that we give to every student, without additional charge, the chemical equipment he will need for his studies, including forty-two pieces of laboratory apparatus and eighteen different chemicals and reagents. The fitted, heavy wooden box serves as a carrying case for the equipment and as a laboratory accessory for performing experiments.

SPECIAL 30-DAY OFFER

In addition we are making a special offer for a short time only. You owe it to yourself to find out about it. Mail the Coupon to-day for free book, "Opportunities for Chemists," and full details of our special offer. Act immediately before this offer is withdrawn.

CUT HERE

Chemical Institute of New York, Inc.
(Home Ext. Division IA), 140-R, Liberty St., N. Y. City
Without obligation or cost, send me your free book, "Opportunities for Chemists," and full particulars about the Experimental Equipment given to every student, your plan of payment and special 30-day offer.

Name.....
Address.....
City..... State.....

Screw Machine Products

We solicit your inquiries on accurate screw machine products in either steel or brass. A permanent and separate division is maintained. We are serving some of the largest consumers in this line with perfect satisfaction and our enlarged capacity will enable us to serve you.

Address:
Screw Machine Division
The Oliver Typewriter Co.
Works: Woodstock, Illinois

AMERICAN TIME CLOCK REPAIR & SUPPLY CO.

SECOND HAND TIME CLOCKS
Bought, Sold, Repaired and Exchanged
ALL WORK GUARANTEED

We Carry a Full Line of Supplies

489 Broadway, near Grand St., Phone, Canal 7951

The voltage generated across the first plate resistance R_1 in the detector circuit is applied to the secondary grid circuit of the succeeding amplifier tube by resistance coupling. After amplification it appears as a larger voltage across the resistance R_2 which is coupled to the next stage and still further amplified. The particular advantage of the resistance coupling here is that this type of amplifier is more stable than transformer or inductance coupled amplifiers, and does not result in howling. Furthermore, it is possible to use a larger number of stages of amplification with resistance coupling than it is with other types of coupling. The energy wasted in the plate coupling resistances is not considerable because of the fact that the plate currents are so exceedingly low. Apart from this use, resistance coupling is hardly ever utilized purposely, and so we will leave it and pass to the other two more important types of coupling.

Inductive coupling may be accomplished by the two following methods: 1. Electromagnetic induction; and 2. Direct inductive coupling. These two

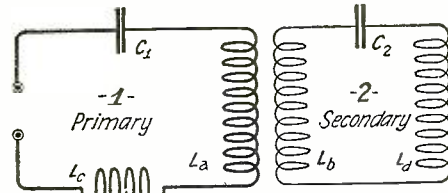

Fig. 3

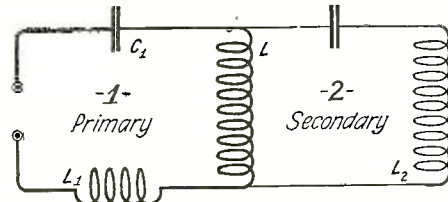

Fig. 4

Inductive Coupling May Be Accomplished by Electromagnetic Induction as in Fig. 3 or Direct Inductive Coupling as in Fig. 4.

methods are illustrated in Figs. 3 and 4 inductance in both primary and secondary respectively. In Fig. 3 it will be observed that the coupling takes place, due to mutual inductance between primary and secondary circuit, while in

LEARN ELECTRICITY IN 3 MONTHS



Make this the most profitable and enjoyable summer of your life. Come to Chicago, the electrical center and the country's greatest summer resort city. Learn Electricity in America's oldest, largest and best equipped school. Earn your way, free employment dept.

FREE R. R. FARE If you come now we will pay your railroad fare and give you free a course in auto truck and tractor electricity, a course in radio, and a life scholarship in the great Coyne School. This is the greatest offer ever made by a school. Write at once for particulars as we cannot keep this offer open long.

Write Today Coyne

Trade and Engineering Schools
1300-1310 W. Harrison St., Chicago, Ill.
Dept. 5941

Don't Wear a Truss

BE COMFORTABLE—



Wear the Brooks Appliance, the modern scientific invention which gives rupture sufferers immediate relief. It has no obnoxious springs or pads. Automatic Air Cushions bind and draw together the broken parts. No salves or plasters. Durable, Cheap. Sent on trial to prove its worth. Never on sale in stores as every Appliance is made to order, the proper size and shape of Air Cushion depending on the nature of each case. Beware of imitations. Look for trade-mark bearing portrait and signature of C. E. Brooks which appears on every Appliance. None other genuine. Full information and booklet sent free in plain, sealed envelope.

BROOKS APPLIANCE CO., 218B State St., Marshall, Mich.



BURROWES

Home Billiard & Pool Tables

Magnificently made in all sizes, at all prices. Game exactly same as standard table. Become expert at home. Use in any room, on any house table or on its own folding stand. Quickly leveled. Put up or down in a minute. Full playing equipment free. Small amount down, small payments for a few months. Ask your dealer or WRITE us TODAY for Catalog.

E. T. BURROWES CO., 102 Free St., Portland, Maine

Write for free catalog illustrating and describing our complete line of 1500 Good Tools.

GOODELL-PRATT COMPANY
Toolsmiths
Greenfield, Mass., U. S. A.

W. L. DOUGLAS

\$5 \$6 \$7 & \$8 SHOES FOR MEN and WOMEN

W. L. Douglas shoes are actually demanded year after year by more people than any other shoe in the world.

W. L. DOUGLAS shoes for style, material and workmanship are unequalled for the price. It is worth while for you to know that when you buy W. L. Douglas shoes you are getting the benefit of his forty years experience in making the best shoes possible for the price.

W. L. DOUGLAS shoes are always worth the price paid for them. Wear them and save money. Protection against unreasonable profits is guaranteed by the price stamped on every pair.

W. L. DOUGLAS shoes are sold in 110 of our own stores in the large cities and by shoe dealers everywhere. Ask your shoe dealer to show you W. L. Douglas shoes. Only by examining them can you appreciate their value. Refuse substitutes. Insist upon having W. L. Douglas shoes with the retail price and the name stamped on the sole. The retail prices are the same everywhere.

If not for sale in your vicinity, write for catalog.

TO MERCHANTS: If no dealer in your town handles W. L. Douglas shoes, write today for exclusive rights to handle this quick selling, quick turn-over line.

President
W. L. Douglas Shoe Co.
172 Spark St. Brockton, Mass.



Boys Shoes \$4.00 & \$4.50

W. L. Douglas name and portrait is the best known shoe Trade Mark in the world. It stands for the highest standard of quality at the lowest possible cost. The name and price is plainly stamped on the sole.

Fig. 4, coupling is effected by a common inductance in both primary and secondary circuits.

In direct inductive coupling, as in Fig. 4, consideration will show that this is a case of a combination of inductive and conductive (resistance) coupling. Not only is there a voltage induced in the secondary circuit, due to the inductance L , but since the inductance L also has some resistance the voltage drop due to the resistance will also be active in the secondary circuit. Thus, a case of direct inductive coupling includes resistance coupling. However, at radio frequencies the reactance of the inductance, namely $2\pi fL$, is generally much greater than the resistance, hence the effect of the resistance coupling is negligible and usually not considered.

The degree of coupling is generally expressed qualitatively by the expressions "loose" and "close" coupling. Consider the circuits of Figs. 3 and 4. By saying that the secondary circuit (circuit 2 in each case) is coupled to the primary (circuit 1 in each case) we mean that the primary circuit transfers energy into the secondary circuit. This is due to the effect of current flowing in the primary circuit. Now if current flowing in the primary circuit has such an effect on the secondary circuit, then it is reasonable to expect that current flowing in the secondary will have a like effect on the primary. Now when the circuits are so arranged that the primary circuit induces voltage in the secondary, but that the secondary has very little or no reaction on the primary, then we say that the circuits are *loosely coupled*. If, however, the secondary has a considerable effect or reaction on the primary and induces back into the primary another voltage, then the coupling is said to be *close*.

This qualitative idea of coupling may be expressed accurately by a factor called the "Coefficient of Coupling." In either of the above cases of inductive coupling there is an inductive which is *common* to both primary and secondary circuits. In the case of the direct coupled circuit of Fig. 4, inductance L is common to both circuits. In the case of the electro-magnetic coupled circuit of Fig. 3 it is the mutual inductance which is common to both circuits, which may be designated as M . The coupling coefficient is then defined as the ratio of the common inductance to the square root of the product of the total inductance of the primary circuit by the total inductance of the secondary circuit, as in the equations following, which hold in order for the direct coupled circuit and electro-magnetic coupled circuit respectively:

$$\text{Coefficient of Coupling } k = \frac{L}{\sqrt{L_a L_b}}$$

$$\text{Coefficient of Coupling } k = \frac{M}{\sqrt{L_a L_b}}$$

where L_a and L_b are the total inductances of primary and secondary circuits.

It will be seen from the above that the coupling in a direct coupled circuit can be increased by making the common inductance L larger. In the case of the magnetically coupled circuit the coupling can be increased by making the mutual inductance larger, and this is accomplished by bringing the two coils L_a and L_b closer together. By bringing these two coils L_a and L_b closer and closer, until they are practically superimposed on each other, it will be evident that the magnetically coupled circuit may be reduced to an equivalent direct coupled



Portable type CONNECTICUT
Variable Condenser, J-107,
\$6.50.
Panel type, J-108, \$5.50.

You'll Improve Your Set by Using a CONNECTICUT Condenser

A man in Philadelphia did it, and got such good results that he wrote us as follows:

"Are you recommending the use of your Variable Condenser in connection with the radio receiving sets? If not, you are certainly justified in doing so, for its use in connection with my receiving set has enabled me to intercept (and with good volume) the musical programs broadcasted from New Orleans, St. Louis, Atlanta, Anacostia, Davenport, Cleveland, Rochester, Schenectady, Troy, Boston, Springfield, and many others, which was not possible before, or, in fact, with any other condensers, many of which I have tried.

"Your condenser is connected between the lead-in and the instrument, and makes it possible to enjoy the program from Schenectady and Pittsburgh with the detector tube alone; in fact, your condenser has made my set so sensitive that the thought of buying a more expensive set is no longer considered.

"Another advantage of the condenser, and which was not possible before, is to be able to tune out at will many local broadcasting stations."

Are not these the results you are looking for, too?

*We shall be glad to send a booklet
telling about this condenser, on request.*

CONNECTICUT TELEPHONE & ELECTRIC COMPANY
Meriden Connecticut

"NENCO" "B" Batteries



THE MOST EFFICIENT MADE
Last Longer—Serve Better—Cost Less

Made In
All Standard Sizes and Voltages

National Electric Novelty Co.
53 Walker St. New York, N.Y.

Get a Handy Binder for your RADIO NEWS. Holds and preserves six issues, each of which can be inserted or removed at will. Price 65c. Experimenter Pub. Co., Inc., Book Dept., 53 Park Place, New York.

EARN BIG MONEY

LEARN THE AUTOMOBILE BUSINESS

the world's greatest industry. Millions of cars, tires, batteries, etc., need constant service. Thousands of trained men wanted. Wonderful opportunities open to men who "know how." Come to Michigan State Auto School and get this training now. Our course fits you to fill any automotive job. Our graduates always in demand. More than 18,000 graduates throughout world holding good jobs or in business for themselves.



Make \$2000 to \$10,000 Yearly

Our graduates are able to step into good jobs as soon as course is completed. Many go into business for themselves. Edwards (Mich.) was offered \$40.00 per week a few days after completing our course; Nelson (N. Y.) took our course when 17, now has five men working for him; Tirb (Mich.) gets \$50.00 per week; Wolf (Iowa) making about \$75.00 weekly in business of his own; Anderson (Minn.) made \$300 per month in garage of his own. Hundreds more like these in our files.

Complete Course Includes

Auto Mechanics, Auto Electrics and Radio.

The Big Auto Factories here in Detroit, the auto center, endorse our courses which cover every branch of the auto business—construction, operation, upkeep and repair of autos, trucks, tractors, farm lighting plants and gas engines. We teach by actual experience on each machine. Auto electrics and Radio fully covered. Students visit auto factories, meet executives and service men and learn methods right. M. S. A. S. training is complete and practical.



Special Courses in Battery Repairing, Tire Repairing, Brazing, Welding, and Machine Shop Practice. All teaching done by actual practice.

Good Positions Await Our Graduates

Factories, garages and service stations continually ask for our graduates. Positions offer good pay with excellent opportunities for advancement, or go in business for yourself. Write Today. Gives complete information about courses and opportunities in automobile business. Be a go-getter! Train for Success—let us help you. Write today.

Michigan State Automobile School
5341 Auto Bldg., Detroit, Mich.

circuit in which the common coupling inductance is equivalent to the two superimposed inductances, as shown in Fig. 5.

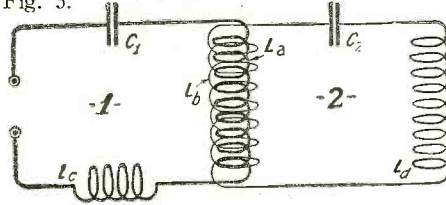

Fig. 5

In This Circuit the Common Coupling Inductance Is Equivalent to the Two Superimposed Inductances.

The practical importance of coupling in reception is in the aid which it lends in the elimination of interference and the selection of the frequency, which it is desired to receive. This may be readily shown by the use of reactance

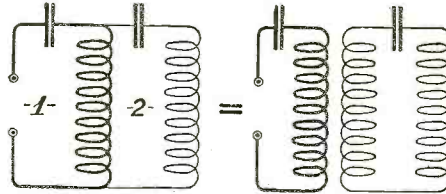

Fig. 6

Fig. 6a

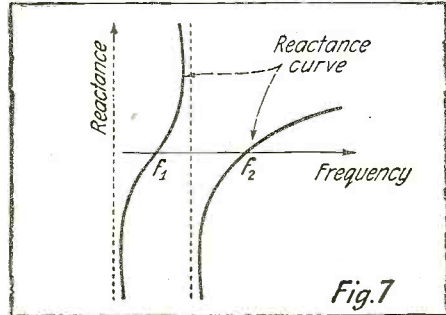

Fig. 7

The Circuit of Fig. 6 Is Equivalent to that of Fig. 6a. The Reactance Curve of Fig. 6 Is Shown Just Below. Note That the Circuit Reactance Reduces to Zero at Two Different Frequencies.

curves. Consider the circuit of Fig. 6, which is equivalent to that in Figure 6 (a), as explained in the previous paragraph. The reactance of the circuit, Fig. 6, is given in the graph of Fig. 7. It will be observed in this graph that the reactance curve crosses the zero axis

U.S. PATENTS



Don't Lose Your Rights

Before disclosing your invention to anyone send for blank form "Evidence of Conception" to be signed and witnessed. A sample form together with printed instructions will show you just how to work up your evidence and establish your rights before filing application for patent. As registered patent attorneys we represent hundreds of inventors all over the U. S. and Canada in the advancement of inventions. Our schedule of fees will be found reasonable. The form "Evidence of Conception" sample, instructions relating to obtaining of patent and schedule of fees sent upon request. Ask for them, a postcard will do.



270 OURAY BLDG., WASHINGTON, D. C.

"Originators of form Evidence of Conception"

PATENTS

C. L. PARKER
Formerly Member
Examining Corps,
U. S. Patent Office.
PATENT - LAWYER
McGill Bldg., Wash., D. C.

Patents, Trade Marks, Copyrights, Patent Litigation
Handbook for Inventors. "Protecting, Exploiting and Selling Inventions," sent upon request.

PATENTS Secured

Prompt service. Avoid dangerous delays. Send for our "Record of Invention" form and Free Book telling How to Obtain a Patent. Send sketch or model for examination. Preliminary advice without charge. Highest References. Write TODAY. J. L. Jackson & Co., 361 Ouray Bldg., Washington, D. C.

OLD MONEY WANTED

\$2 to \$500 EACH paid for hundreds of old or odd Coins. Keep ALL old money, it may be VERY VALUABLE. Send 10 cts. for New 11's COIN VALUE BOOK, size 4x6. Get Posted. We pay Cash. CLARKE COIN CO., Ave. 79, Le Roy, N. Y.

PATENTS

To the Man with an Idea

I offer a comprehensive, experienced, efficient service for his prompt, legal protection and the development of his proposition. Send sketch, or model and description, for advice as to cost, search through prior United States patents, etc. Preliminary advice gladly furnished without charge.

My experience and familiarity with various arts frequently enable me to accurately advise clients as to probable patentability before they go to any expense.

Booklets of valuable information and form for properly disclosing your idea free on request. Write today.

RICHARD B. OWEN
PATENT LAWYER
2 Owen Building, Washington, D. C.
2276-A Woolworth Bldg., New York City

ELECTRICAL FREE Training Book

Send me your name and address and I will send you my big new Electrical Training Book Free. It will show you how to qualify for high paying jobs in Electricity. Thousands now open. Prepare at home—quickly—during spare time under an Electrical Engineer. Take advantage of this unusual offer—only temporary. A. W. Wicks, President WICKS ELECTRICAL INSTITUTE Dept. 1077 3601 Michigan Ave. CHICAGO

You can be quickly cured, if you

STAMMER

Send 10 cents for 288-page book on Stammering and Stuttering, "Its Cause and Cure." It tells how I cured myself after stammering 20 yrs. B. N. Bogue, 492 Bogue Bldg., 1147 N. Ill. St., Indianapolis.

PATENTS

UNITED STATES & FOREIGN

RADIO & ELECTRICAL CASES A SPECIALTY

Avoid Delays. Profit from Your Invention. Write today for free book "How to Obtain a Patent." Send Sketch or Model of your idea for preliminary examination and my report. Your rights will be carefully safeguarded and held in strict confidence. Highest references. Prompt Personal Attention to each case.

CLARENCE A O'BRIEN
Registered Patent Lawyer
501 SOUTHERN BUILDING, WASHINGTON, D. C.

FREE
WRITE
TODAY

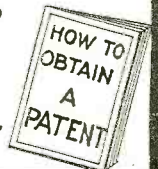

at two points, namely f_1 and f_2 . In other words there are two frequencies at which the circuit reactance reduces to zero and at which maximum current therefore flows, but between these two values the reactance rises to extremely high values and approaches infinity. Hence by the use of such a circuit as Fig. 6, it is possible to suppress and eliminate any undesirable frequency and receive another frequency either larger or smaller than the one suppressed.

It is a property of all coupled circuits that there are two frequencies at which the reactance is zero and current, therefore, a maximum. The interference created by these two frequencies depends upon how far apart the two zero-reactance frequencies are, and the distance apart is determined largely by the degree of coupling. For very close couplings the two frequencies are very far apart. This explains why many people who have tuned their sets to 360 meters often receive equally well on 600 meters and therefore experience considerable code interference. Their coupling is so close that the two zero reactance frequencies may turn out to be 360 and 600 and consequently they receive very loud signals on 600 as well as 360. On the other hand, for very loose coupling the two zero reactance frequencies come very close together, say 360 and 380 meters, and thus the possibility of interference with stations transmitting at higher wave-lengths is considerably reduced. This is the real explanation for the high selectivity of the loosely coupled receiver, and why amateurs recommend it.

Not only are these principles of coupling important for reception, as explained above, but they are equally important for transmission. Thus a closely coupled transmitter also has two frequencies of zero reactance or maximum current considerably separated from one another and hence will be more apt to create considerable interference since it transmits at two frequencies. If it were loosely coupled, its two zero reactance frequencies would be very close to one another or would coincide, and hence would create little or no interference. (This, of course, does not apply to certain special types of transmitters which are especially designed to operate with close couplings such as quenched gap transmitters.) It will be evident that a transmitter which has its two peaks at 200 and 205 meters will create much less interference than one which has its two peaks at 200 and 300 meters.

Another interesting and important application of the above principles of coupling is in the suppression of undesirable harmonics in certain transmitters. It is well known that an arc transmitter generates a fundamental frequency and harmonic frequencies. Sometimes one or more of these harmonics are quite intense and are, therefore, undesirable since considerable interference is created. In laboratories, when measurements are made, these harmonics are naturally very troublesome and must be eliminated. This can be accomplished by the so-called "fly-wheel" circuit which is nothing more than an application of the direct coupled circuit of Fig. 8, which is equivalent to that of Figure 8 (a) in an actual antenna circuit, where the antenna capacity C_a is substituted for the lumped capacity C . The reactance curve for this combination is given in Fig. 9, where it will be seen that there is a zero reactance frequency f_1 at which the current will be a maximum and an infinite reactance frequency f_2 at which the current will be zero. Thus the fly-wheel circuit is adjusted until it is in resonance with the undesired har-



Do You Enjoy
Good
Music?

You will gain the utmost satisfaction and enjoyment from radio concerts, lectures, fashion talks, and sport news if you will "listen in" with

Bestone Wireless Apparatus

Because Bestone products are scientifically correct—because they embody the best quality materials and careful workmanship—the final result is radio apparatus that reproduces music, speech and signals with exceptional clarity, volume and absolutely without distortion.

Wide Range of Bestone Radio Sets

The Bestone line is comprehensive—it includes many types of Crystal and Vacuum Tube Receiving Sets. Prices range from \$22.50 to \$125.

Bestone Sets are simple to install and operate—no technical knowledge of electricity or radio is required to obtain maximum results. Every Bestone Set is fully tested and guaranteed.

Amateurs, Radio Supply Jobbers and Dealers—
Write for illustrated Catalog "N"

HENRY HYMAN & CO., Inc.

MANUFACTURERS

Executive Offices
476 BROADWAY, NEW YORK.

Branch
212 W. AUSTIN AVE., CHICAGO, ILL.

BESTONE No. 703 V. T. TUNER AND TUBE SET

This highly efficient receiving set combines neatness of design, simplicity of construction, pronounced audibility and low price. Receiving results compare favorably with higher priced instruments.

Cabinet is mahogany finished, French polished. All apparatus mounted on Bakelite bevelled and machine engraved panel.

List price (including 2,200 Ohm Bestone Headset) \$25.00.



Red Devil Pliers

The Handiest of All-Around Tools

THEY are sturdy—designed for hard work and long wear. "Red Devil" Pliers make hard jobs easy.

"Red Devil" Slip Joint Plier No. 924—6½ inch, shown at bottom, a combination tool for all-around handiness, 50c. At dealers or us.

MECHANICS' TOOL BOOKLET FREE

"Red Devil" Tools—American Made

SMITH & HEMENWAY CO., Inc.

273 BROADWAY Mfrs. of "Red Devil" Tools NEW YORK, N. Y.

WANTED:

Back numbers of Radio News, Sept., Oct., Nov. and Dec., 1921; Jan. and Feb., 1922.
EXPERIMENTER PUBLISHING CO., Inc., 53 Park Place, New York City

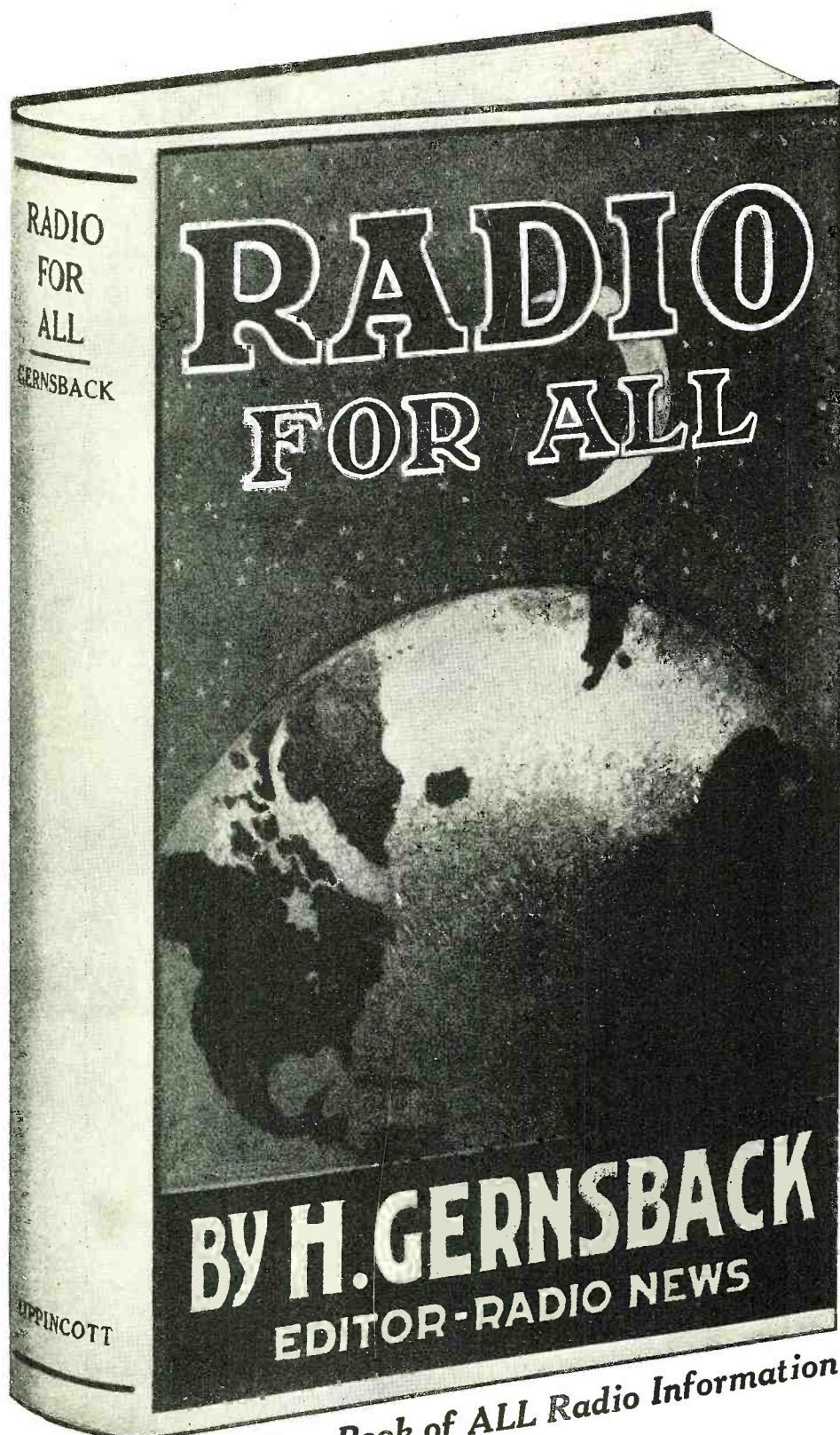

The Complete Book of ALL Radio Information

PRICE \$2.00

Add postage for 2 lbs.

Make all remittances payable to and mail to
EXPERIMENTER PUBLISHING CO., Inc.
 53 Park Place -:- New York, N. Y.

RADIO FOR ALL

By H. GERNSBACK

Editor "Radio News," "Science and
Invention" and "Practical
Electrics"

With over 130 illustrations and
diagrams, and 12 photographs,
300 pages, size 8¼ x 5½".

What the novice in radio needs is a book in which he can get all the information necessary for him to understand radio telephony and telegraphy, to make or buy a receiving set suitable to his means, to know how to operate his set, and, after he has an understanding of the radio art, information that will enable him to advance and get the most out of his outfit. All this must ordinarily be dug out of text-books, pamphlets and government publications, but the aim of this book is to have all the data and information that the beginner will need from the time that he takes up radio. It is a permanent, comprehensive reference book for the dyed-in-the-wool dabbler in Radio.

WHAT THE BOOK IS.

A combination of a radio course for the novice in radio telegraphy and telephony with a reference book for the more experienced amateur. Half a dozen books in one.

FOR THE BEGINNER.

The theory of radio carefully explained with drawings.

Description of and instruction for operating instruments of receiving and sending sets, with all picture diagrams of the wiring of the apparatus.

How to make your own receiving set, costing from \$3.00 to \$50.00.

How to read diagrams; for every picture diagram there is a corresponding technical diagram using the symbols instead of drawings.

How to tune sharply and eliminate interference from other stations.

How to protect your set from lightning, and the laws regarding installation.

Explanation of time and weather signals.

FOR THE MORE EXPERIENCED AMATEUR.

How to make a practical vacuum tube detector, two stage amplifier set costing less than \$50.00, that will work.

How the radio compass works.

All about underground aerials, loop aerials and directional aerials.

Formulae for finding wave length; miscellaneous formulae for finding capacity of condenser and other instruments. Tables of wire resistances, wave lengths and their corresponding frequencies, approximate wave lengths for different aerials, tuning coil data, and much more invaluable information.

SPECIAL FEATURES.

Lists of all the broadcasting stations in the United States and Canada for concerts, time signals, weather reports, press, stock market reports, etc., with their call, wave length and time of sending.

Detailed description of Washington weather signals and their translation. Description of a modern broadcasting station and its operation.

Large map showing location of all U. S. radio telephone broadcasting stations suitable for hanging up in radio room.

Collection of miscellaneous radio information for the amateur.

IN OTHER WORDS.

The information that you ordinarily have to dig out of government publications, text-books, pamphlets, etc., is handily combined in this one book.

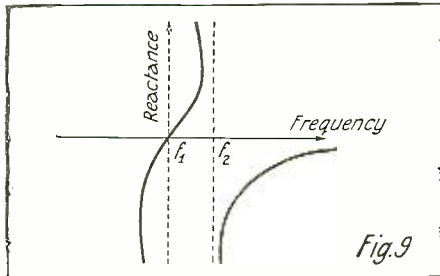
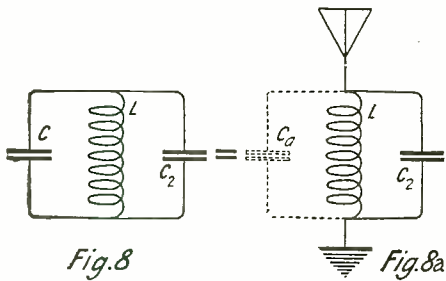
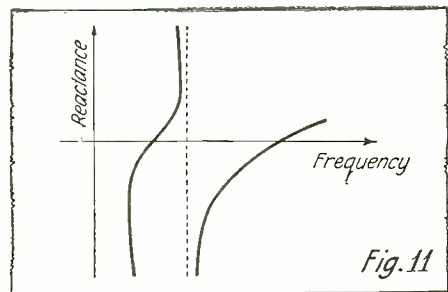
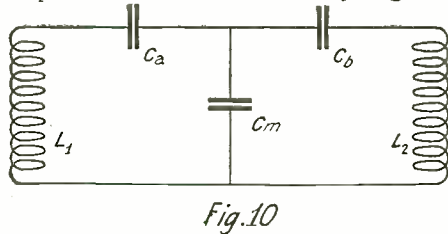

Fig. 8 is an Application of the Direct Coupled Circuit and Has Its Equivalent in Fig. 8a. It Will Be Seen from the Curve that it is a Zero and Infinite Reactance Frequency.

monic when it becomes the infinite reactance frequency and then the antenna circuit is tuned to the desired frequency or zero reactance frequency. In this way the objectionable harmonic is eliminated. Should there be more than one objectionable harmonic, it becomes necessary to introduce a fly-wheel circuit for each harmonic to be suppressed.

We finally come to capacity or electrostatic coupling, in which the transfer of energy from primary and secondary circuits are effected by means of a condenser. A simple electrostatically coupled circuit is illustrated by Fig. 10.



An Application of the Capacity Coupled Circuit is Shown in Fig. 10. Like the Inductively Coupled Type this Circuit Has Two Zero Reactance Points, But They Are Very Close Together.

In the case of capacity coupling we again have different degrees of coupling, loose and close. The coefficient of coupling is here defined as the ratio of the common capacity reactance to the square root of the product of the primary capacity reactance and the secondary capacity reactance. In the case illustrated in Fig. 10, this turns out to be given by the expression:

$$k = \frac{\sqrt{C_a C_b}}{C_m}$$

From this expression of reactance it appears that the smaller the common capacity, the greater is the degree of coupling. This is consistent with the above definition, since the capacity reactance varies inversely with the capacity. Thus we see that in capacity coupled circuits in order to increase

Make it a RADIO Xmas!

With a Michigan "Senior" Regenerative Receiving Set

M.R.C.-7, \$125.00

This set is manufactured and licensed under the Armstrong U.S. Patent 1,113,149, and is the last word in Radio Receiving Sets. A detector and two stages of amplification bring in the signals and amplify them so that they can be heard through a loud speaker, thus providing pleasure for the many rather than the few. The simplicity of construction, the new type sockets which insure permanent and positive contact and perfect alignment of the tubes, the Michigan "Split Hair" Vernier dial adjuster, the Vernier detector tube Rheostat, all make possible your receiving long distant stations with unusual regularity. The cabinet is in keeping with the world famed Grand Rapids quality reputation, it is exclusively attractive and has few equals. All in all the Michigan "Senior" Regenerative Receiving Set is stamped with the hall mark of quality, not only in its Radio engineering perfection, but in its attention drawing attractiveness. You cannot afford to buy a receiving set until you have seen and examined this set. If your dealer cannot supply, write us. We manufacture the Michigan "Junior" (non-regenerative) tuner and detector, MRC-3, with Dictograph Head Set and Plug, \$57.50.

Our Catalog of Michigan QUALITY Radio Parts is yours for the asking

MICHIGAN RADIO CORPORATION

GRAND RAPIDS, MICHIGAN

SPEED UP YOUR PRODUCTION

by sawing bakelite, formica, brass, copper, carbon or wood on a

JUNIOR BENCH SAW

A precision machine especially adapted to rapid and accurate work. All metal construction. Top 10"x13" elevates for grooving. Special guide accommodates panels as long as 24". Saws 1 1/2" stock. Easily driven by 1/4 or 1/3 h. p. motor. Attachments for grinding and sanding. Special saws for bakelite, brass, etc., furnished from stock.

Junior Bench Saw with guides and 6" wood saw..... \$28.75
 Motor driven unit as shown, mounted on iron base with 1/4 h. p. ball-bearing motor, belt tightener, belt, cord, plug and switch. \$60

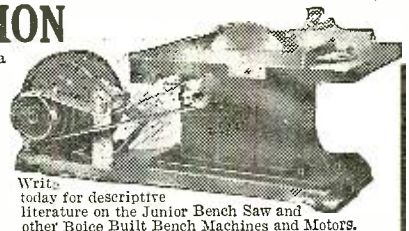

Write today for descriptive literature on the Junior Bench Saw and other Boice Built Bench Machines and Motors.

W. B. & J. E. BOICE, Dept. 701, 114 Twenty-third St., Toledo, Ohio.

RADIO APPARATUS

★ SEND 10 CENTS FOR CATALOG ★
 Money Credited to First Dollar Purchase
EMPIRE RADIO CORPORATION

271 WEST 125 ST.

NEW YORK CITY

Know Who Is Sending

Get twice the pleasure and usefulness out of your receiving set. Look up the name and location of any ship or land station whose messages you pick up—learn the name and address of that amateur whose sending set you just heard.

4th EDITION OF THE CONSOLIDATED RADIO CALL BOOK

In a new large size—280 pages—88 more valuable pages than the 3rd Edition and featuring

7 Two-Color Radio Maps

Five of them are Continental Maps showing all stations throughout the world handling commercial traffic, with their calls; one showing the amateur radio districts of the United States and the principal radiophone broadcasting stations with their calls; and a map of the United States Weather Forecast Zones. Seven wonderful, two-color radio maps with a wealth of information that will give you a great deal of pleasure and knowledge.

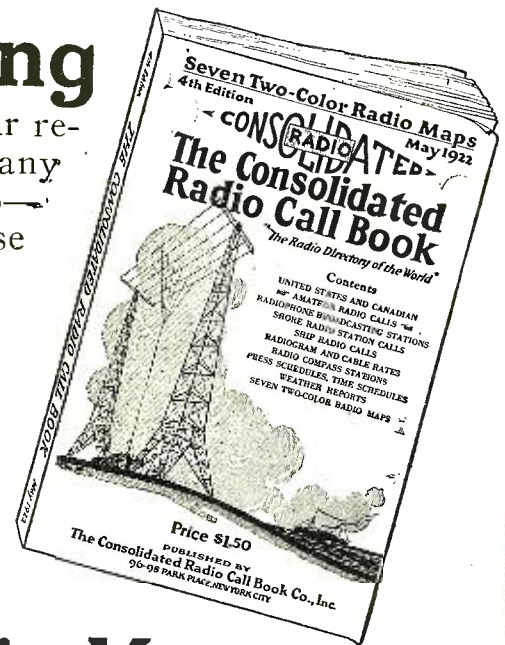

Every Amateur Call in the U. S. and Canada is Listed Besides Other Valuable Information Contained in This New Book

All Amateur Radio Calls of the United States and Canada; Every Vessel, Coast Station, and Radio-Compass Station in the World; Radiophone Broadcasting Stations of the United States; Every High-Power Station in the World, Special Land Stations of the United States; Time Signals. Hydrographic and Weather Reports of the United States and Principal Foreign Countries, International Abbreviations; Assignment of International Calls; Press Schedules; Radiogram Rates; Cable Rates; International Morse Code and Continental Signals; and Complete General Information covering Distress Calls, International Safety Signal, Use of 800-Meter Wave Length, Amendments and Changes in Various Government Regulations, How to Determine Charges on Radiograms, Free Medical Advice by Radio to Vessels, and much other useful information.

\$1.50
Prepaid

And every vessel and land station in the world is represented and listed alphabetically, according both as to name of vessel or land station, and to call letters. The Consolidated Radio Call Book is the only book in print officially listing all the Radio calls as issued by the Bureau of Commerce. And the New Radiophone Broadcast Section is particularly complete and gives all available information concerning calls, wave lengths, PROGRAMS, etc.

The third edition of 10,000 copies was exhausted in two weeks. The fourth edition is selling just as quickly. Don't wait until it is all gone. Order at once, either direct from us or from your favorite dealer.

Published by

Consolidated Radio Call Book Co., Inc.
96-98 Park Place, New York City

Great 40-page Supplement FREE to all who have the 4th Edition Call Book

As a special service to the readers of the Fourth Edition of the Radio Call Book, we have printed, at great expense, a 40-page supplement containing the latest amateur radio calls of both the United States and Canada, and other calls issued very recently. It is absolutely free to all those who write for it, provided you have bought a copy of the fourth edition of the Consolidated Radio Call Book. This wonderful supplement brings the call book up to the very last moment and on account of the many changes that have taken place and which are fully covered by this supplement, every radio amateur or professional is urged to send for his free copy of this supplement today.

Send to us direct or get it from the dealer from whom you bought the 4th Edition Call Book

the coupling we decrease the common or mutual capacity and vice versa, whereas in inductively coupled circuits, to increase the coupling we increase the common or mutual inductance. This is the first difference between inductive and capacitative coupling.

The reactance curve of a capacity coupled circuit, such as Fig. 10, is given in Fig. 11. It will be observed that, as in the inductively coupled circuits, there are two zero reactance frequencies. However, mathematical analysis shows that even for very closely coupled circuits these two zero reactance frequencies are very close together. In other words, in the electrostatic coupled systems it may be considered that there is only one zero reactance frequency. This is another point of difference between the inductively coupled circuits and the capacity coupled circuits. As a result of this difference it is found that the electrostatic coupled circuits are superior to the inductively coupled systems from the point of view of sharpness of tuning.

In general, the inductively coupled circuits find a larger sphere of application than the capacity coupled system, and they are used in almost all variety of transmitting and receiving circuits in commercial application. The capacity coupled circuits are used to a small extent in receiving systems, but very little in transmitting systems. One particularly important application of the capacity coupled circuit in transmitters is the case of the Colpitts circuit as used in tube transmitters, Fig. 12. This circuit is an excellent one and is very much favored by amateurs, as it is well adapted to their low capacity antennae.

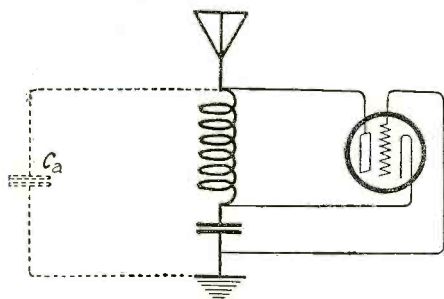

Fig. 12

The Colpitts Capacity Coupled Circuit as Used in Tube Transmitter.

It is hoped that the explanation of the various types of coupling and illustrations of the applications and uses of coupling will clear up any vague and hazy notions which may have existed.

Clayton R. Gerst's Station at Cleveland, Ohio

(Continued from page 1287)

has an Amrad vernier variometer connected to it, antenna series condenser and switches for cutting instruments in or out.

The top cabinet contains the long-wave outfit and detector and two-step amplifier. A four pole double throw DeForest switch in the center of this cabinet changes over from short to long wave instantaneously. Beneath it is a multi-jack in which three plugs can be inserted. I am using three pairs of phones and a large speaker. Brandes Superior, Roller-Smith Universals and Red Head phones are used. The long wave set uses honeycomb with condensers.

Although the receiver is large and

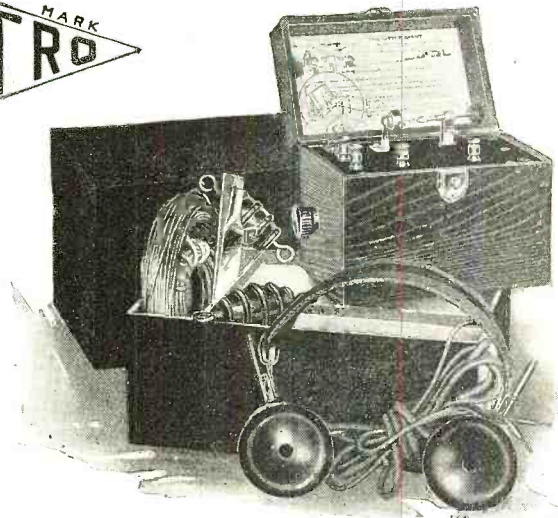

THE Little Giant Receiving Outfit Radio for Everybody

Simplified—More Efficient—Lower Priced

IN less than a half hour after you bring home this magic box the family can listen to the radio programs of music, entertainment and instruction. You don't need to know how it works or anything about radio. All you do (once the detector has been adjusted) is pull out the easy sliding rod on the side of the Little Giant Set until the sounds come in strong and clear.

Costs nothing to maintain. Nothing to get out of order. Encased in a neat American Walnut Cabinet with a polished black composition panel board and all metal parts heavily nickel plated—the Little Giant Set is a very attractive article.

Complete in every detail. Nothing more needed. Metro headphones, expressly made to co-ordinate with the Little Giant, are extremely sensitive. The Little Giant Set, Metro Headphones and Aerial complete, neatly packed in black leatherette box.

Complete
Outfit
with
Metro Head-
phones, Aerial,
Insulators,
Ground Wire,
and Ground
Clamp.
Packed in
Black
Leatherette
Box.

\$15

DEALERS—Sell Something Everybody Is Buying

Metropolitan Radio Corporation
67-71 Goble St. . . . Newark, N. J.

The Newest Book on the Newest Subject INCREASING RADIO EFFICIENCY Through SUPER-REGENERATION

A direct, simple explanation of the newest radio invention; its methods, circuits and operation. Complete and thoroughly practical. First article of this kind published.

\$1.00

At Bookstores, Radio Stores or by Mail
RADIO CONSULTATION BUREAU
Plymouth, Mass.

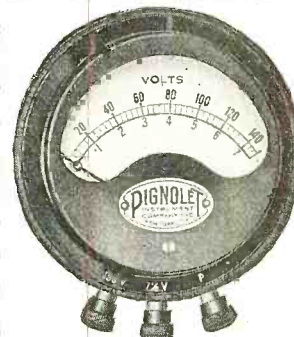

Pignolet RADIO VOLT- METER

One In-
strument
Makes All
Tests

Write for
booklet with
suggestions for testing and adjusting Radio
Sets.

Pignolet Instrument Co., Inc.
116 Liberty Street, New York, N. Y.

very complicated it is giving wonderful results. No expense was spared when building it, and I used the best of everything.

My aerial consists of a single wire about 50' long and about 25' high. With this set I can get the broadcasts from Atlanta, Fort Worth, Texas on the South, Denver, Kansas City, Davenport, Iowa in the West and about all of the Eastern Coast stations, on the loud speaker. Using radio frequency amplification I can get Detroit, Mich., WWJ, on a loud speaker without aerial or ground, occasionally. Using about 5' of wire for an aerial running from the binding post of the receiver to the ceiling I can get them on the loud speaker in most any kind of weather.

The transmitter is exceedingly compact and nicely arranged. I intend to put up a cage and give this transmitter a good try out. From results obtained on a single wire I expect to do some real long distance work with it, using a cage.

I have been in the game since 1907 and am more interested now than ever.

CLAYTON R. GERST.
2974 West 25th Street,
Cleveland, Ohio.

Dr. Lee de Forest Speaks

(Continued from page 1267)

Dr. de Forest said he did not believe that the Heavyside or ionized atmospheric layer had much or anything to do with long distance radio transmission, but that it might indeed have quite a little to do with freak fading and other effects in radio transmission and reception. He said that there was no doubt in his mind that one may from a transmitting station send out a radio impulse, as for example, across the ocean, and that the ether wave together with the complementary ground wave proceed out in all directions from the antenna. Also that these traveled on following the curvature of the earth in the same way as the waves do in the Squier wired-wireless system. In this case, the waves follow along the metal conductors, and it seemed, he said, that the same phenomenon occurs in transmissions over the earth, the waves simply gliding along, guided by the earth's surface which acts as a more or less perfect conductor.

We asked Dr. de Forest regarding his latest venture into the field of applied science, that in which he applies his vacuum tube amplifier to the motion picture and produced a new talking movie. Full details concerning this latest invention of the Doctor, are given in *Science and Invention* for January. He stated among other things that he had heard the Vogt talking motion pictures in Germany, and did not consider them perfect by any means. He also stated that by very careful research he had succeeded in building a practically perfect multiple stage audion amplifier, which will operate for months without giving any noises or other trouble of an electrical nature. A very interesting phase of his recent experiments in the laboratory employing the recording and reproducing vacuum tube apparatus used with his talking movies, was the fact that by placing copper shields or boxes around the amplifier and oscillator sets, and grounding these shields, all inductive effects between the different amplifiers and the oscillators were entirely eliminated, a point to keep in mind wherever multiple stage amplifiers and oscillators are used in radio telegraphy and telephony, especially when placed close together.

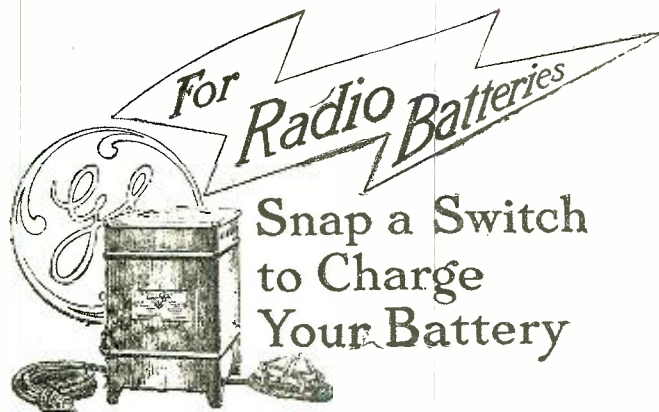

If you have a radio receiving set using a storage battery, haven't you often wished for a simple efficient means for recharging this battery without lugging it away to a service station?



charges storage batteries from any alternating current lighting circuit with a minimum of expense and trouble. You can do your charging right in your own home and without lifting the battery from its present position.

The Tungar is not new—thousands have been used for charging automobile starting and lighting batteries for years. Tungar has no moving parts to wear out or require oil. It requires no attention while charging but may safely be left on the battery all night.

If your dealer in radio or other electrical supplies does not carry Tungar, write us and we will send you literature and tell you where you can get one.

Address Merchandise Dept., General Electric Company,
Bridgeport, Connecticut

General Electric Company
General Office Schenectady, N.Y. Sales Offices in all large cities. 35A-80C

SMASHING PRICES!

- Famous Pink-a-tone Crystal Radio Receiving outfits, regularly priced at \$25, including double headsets...\$12.00
- Famous No. 2-a Stromberg-Carlson Double Headphones, 2,000 ohms... 5.00
- Guaranteed Auth Double Headphones, 2,200 ohms... 4.00
- Guaranteed Connecticut Double Headphones, 2,000 ohms... 4.00
- Handsome mahogany Finished Cabinets, size 7"x7"x7", with hinged cover and brass clasp and compartment for phones... 2.00
- Coils for crystal sets... .50
- Bakelite Binding Posts engraved "TEL," "ANT" and "GND" in white lettering, each... .10

We Pay the Postage.

NATIONAL SERVICE CO.
1834 Broadway New York City

THE GOODMAN



PATENT PENDING

The Niftiest Short Wave Tuner on the Market. Only \$6 & PP on 1 lb. Send for pamphlet

L. W. GOODMAN
DREXEL HILL, PA.

Major _____, Halifax, N. S., writes: "Delighted. Received Schenectady clearly on one tube first time I tried the GOODMAN. Would have saved trouble and money by buying months ago."

OPPORTUNITY AD-LETS

Follow these advertisements every month. Reliable advertisers from all over the country offer their most attractive specials in these columns.

Classified advertising rate fifteen cents a word for each insertion. Ten per cent discount for 6 issues, 20 per cent discount for 12 issues. Name and address must be included at the above rate. Cash should accompany all classified advertisements unless placed by an accredited advertising agency. No advertisement for less than 10 words accepted.

Objectionable or misleading advertisements not accepted. Advertisements for the March issue must reach us not later than January 1st.

THE CIRCULATION OF RADIO NEWS IS OVER 225,000

EXPERIMENTER PUBLISHING CO., INC., 53 Park Place, New York, N. Y.

Aeronautics

Build and Fly Your Own Plane. Small cost. I start you making big money. C. E. Lay, 3727 Saybrook, Cincinnati, Ohio.

Agents Wanted

\$75.00 to \$150.00 Weekly. Free samples. Lowest priced gold window letters for stores, offices and autos. Anybody can do it. Large demand. Exclusive territory. Acme Letter Co., 361 M West Superior, Chicago.

Ambitious men, write today for attractive proposition, selling subscriptions to America's most popular automobile and sportsman's magazines. Quick sales. Big profits. Pleasant work. Digest Pub. Co., 9528 Butler Bldg., Cincinnati.

Amateur Agents Wanted in every city and town to sell radio apparatus. A few stocking agencies still open. Delfelco, 12 Meeting Street, Pawtucket, R. I.

Rummage Sales Make \$50.00 Daily. We start you. Representatives wanted everywhere. "Wholesale Distributors," Dept. 73, 609 Division Street, Chicago.

Agents Wanted in every city and town to sell standard radio apparatus. Attractive discounts given. If interested, write us at once stating age and radio experience. Wilmington Electrical Specialty Co., Inc., 912 Orange St., Wilmington, Delaware.

We Wish Representatives in every community to secure subscriptions for Radio News, Science and Invention, and Practical Electrics. This is a wonderful opportunity for Amateur Radio Enthusiasts to make big money quickly. Write Experimenter Publishing Co., Inc., 53 Park Place, New York City.

American-Made Toys

Manufacturers on Large Scale, also homeworkers, wanted to manufacture Metal Toys and Novelties. Millions needed of Barking Dogs, Wag Tail Pups, Wild Animals, Automobiles, Indians, Cowboys, Baseball Players, Cannons, Toy Soldiers, Crowning Roosters, Statues of Liberty, Miniature castings of Capitol, Bathing Girl Souvenirs and others. Unlimited possibilities. Guaranteed Casting forms furnished manufacturers at cost price from \$5.00 up, with complete outfit. No experience or tools necessary. Thousands made complete per hour. We buy goods all year and pay high prices for finished goods. Cash on delivery. Contract orders placed with manufacturers. Catalog and information free. Correspondence invited only if you mean business. Metal Cast Products Co., 1696 Boston Road, New York.

Automobiles

Automobile Owners, garagemen, mechanics, send today for free copy of this month's issue. It contains helpful, instructive information on overhauling, ignition troubles, wiring, carburetors, storage batteries, etc. Over 120 pages, illustrated. Send for free copy today. Automobile Digest, 528 Butler Bldg., Cincinnati.

Books

We Buy and Sell back issues of Radio Amateur News and Electrical Experimenter. Boston Magazine Exchange, 109 Mountfort St., Boston, Mass.

Books. Any kind. Lists. Higens's, S2441 Post Street, San Francisco.

Vibrations, Sounds, Lights and Colors. Illustrated. Stevens Publishing Company, San Francisco, California.

Sexology Books only for professional and advanced student readers. Forel, Kraft-Ebing, Kisch, Robie, Ellis, Freud, Key and other authorities. The Modern Book Association, 4150 Santa Monica Blvd., Los Angeles, Calif.

Business Opportunities

Become a Landscape Architect. Dignified, Exclusive Profession. Little competition. \$5,000.00 to \$10,000.00 income for experts. Easy by our method. Begin earning 3 weeks after you enroll. Write today. American Landscape School, 11R, Newark, N. Y.

Chemistry

Learn Chemistry at Home—Dr. T. O'Connor Sloane, noted educator and scientific authority, will teach you. Our home study correspondence course fits you to take a position as chemist. See our full page ad on page 1315 of this issue. Chemical Institute of New York, 140 Liberty Street, New York City.

Correspondence Courses

Used Correspondence Courses only one-quarter original price. Free bargain price list, 1000 courses. Courses bought. Students' Exchange, 45 West 42d St., New York.

Dollars Saved—Used correspondence courses of all kinds sold, rented and exchanged. List free. (Courses bought.) Lee Mountain, Pisgah, Alabama.

Correspondence Courses at less than half original prices. Any school, any subject for men or women. Bulletin 1074 free. Courses bought. Instruction Correspondence Exchange, 1966 Broadway, New York.

Educational

Used Correspondence Courses only one-quarter original price. Free bargain price list 1000 courses. Courses bought. Students' Exchange, 45 West 42d St., New York.

Electric Supplies and Appliances

Electric Tattooing Outfits. Illustrated Catalogue, 10c. Waters Mfg., 1050 Randolph, Detroit.

Exchange

Amateur Agents wanted in every city and town to sell radio apparatus. A few stocking agencies still open. Delfelco, 12 Meeting Street, Pawtucket, R. I.

For Sale—9 BLW's 1/2 kilowatt transmitter, \$25. Jack Jones, Bellevue Farm, Liberty, Missouri.

200-20,000 Meter Receiver, including Radiotron \$35.00. Two-step amplifier, \$25.00. Box 205, Williamsport, Pa.

Two-Filament Audiotrons, \$6.00, individually tested and guaranteed. Canlum-Hood Co., Ames, Iowa, or Leeds, Iowa.

For Sale—Two thirty-foot steel radio towers, special construction. Flat top antenna, 5-wire also if desired. Full particulars from R. F. Fowler, Frankfort, Indiana. 9BK.

For Sale—Twenty-watt phone set in excellent condition, a wonderful bargain. Fred Lesler, Redfield, So. Dakota.

For Sale—New Western Electric Loud Speaker complete. Will sell at dealer's cost. R. F. Fowler, Frankfort, Indiana. 9BK.

500-Mile Broadcast Receiver, complete with bulb and batteries, \$45. P. O. Box 1504, Providence, R. I.

Regenerative Receiver and Two-Step, oak cabinet, Remler variometers, filament jacks, \$60.00; Regenerative receiver and detector, \$30. Portable crystal receiver, \$15.00. Send for particulars. Herman Seikel, 48 15th Ave., Columbus, Ohio.

For Advertisers

Advertise, country town newspapers. Lists free. Pannel Company, Covington, Kentucky.

Ford Owners

Sport Cars, fast, saucy, hug the turns and stick to the road—make you glad you're a Ford owner. Can easily be built by aid of life-size "Red-i-Kut" patterns and picture instructions. The "Pal" system delivered complete with pressed metal streamline tail for \$6.40. Garage men make big money building them. Send 5-cent coin for prospectus on making sport cars—Jiffy Tops and Gosum Windshields. Kuempel Co., 313 Kuempel Bld., Guttenberg, Iowa.

Health

Diseases and Their Innate Healer. Book 50c. Arthur J. Stevens, Wauson, O.

Tobacco or Snuff Habit Cured or no pay; \$1 if cured. Remedy sent on trial. Superba Co., S.B., Baltimore, Md.

Help Wanted

Used Correspondence Courses only one-quarter original price. Free bargain price list, 1000 courses. Courses bought. Students' Exchange, 45 West 42d St., New York.

Be a Mirror Expert, \$3-\$10 a day; spare time home at first; no capital; we train, start you making and silvering mirrors. French method. Free prospectus. W. R. Derr, Pres., 26 McKinley St., Baldwin, N. Y.

Be a Detective. Excellent opportunity, good pay, travel. Write C. T. Ludwig, 964 Westover Bldg., Kansas City, Mo.

Earn \$25 Weekly, spare time, writing for newspapers, magazines. Experience unnecessary; details free. Press Syndicate, 566, St. Louis, Mo.

All men, women, boys, girls, 17 to 60, willing to accept Government Positions. \$117-\$190, traveling or stationary, write, Mr. Ozment, 251, St. Louis, immediately.

Instruction

Learn Chemistry at Home—Dr. T. O'Connor Sloane, noted educator and scientific authority, will teach you. Our home study correspondence course fits you to take a position as chemist. See our full page ad on page 1315 of this issue. Chemical Institute of New York, 140 Liberty Street, New York City.

Mouth-Organ Instructor, 25c; play in one hour. Boxing Instructor, 25c. Minstrel Show Guide, 10c. Elsea Co., Bowling Green, Ohio.

Mathematics Taught by Mail. Arithmetic, Algebra, Geometry, Mensuration, Trigonometry, Logarithms and Mechanics' courses. Harding School, 76 Brighton, Highland Park, Michigan.

Vibrations, Lights, Colors, Sound (illustrated). Electronic Radio Active Principles. Write for table contents. 242 Powell, San Francisco, Calif.

Languages

World-Romic System. Master key to All Languages. Primers, 15 languages, \$1.94 each language; Arabic, Chinese, Danish, Dutch, English, French, German, Italian, Japanese, Panjabi, Polish, Portuguese, Russian, Spanish, Swedish. Pronunciation-Tables, 92 languages, 30c each language. Languages Publishing Company, 8 W. 40th Street, New York.

Mail Order Business

\$50 week evenings. I made it. Mail Order Business. Booklet for stamp tells how. Sample and plan, 25c free. 12 articles worth \$3. Alraid Scott, Cohoes, N. Y.

Miscellaneous

Send us your Metal Work. We are equipped to do metal stamping power press work, soldering and plating, etc. Estimates furnished. T. E. Bennett Co., 7 Beverly Street, Providence, R. I.

Christ's Message to Earth through Vibration, Force of Mind, 30c. Prof. James, 10c. Barbara Rigler, 3122 5th Ave., Chicago.

Motorcycles--Bicycles

Used parts for all motorcycles cheap. State wants. Schuck Cycle Company, 1922 Westlake, Seattle, Wash.

Don't buy a Bicycle Motor Attachment until you get our catalog and prices. Shaw Mfg. Co., Dept. 6, Galesburg, Kansas.

Musical Instruments

Cornetists, Trombonists, Saxophonists, Clarinetists, send for "Free Pointers," mention instrument. Virtuoso School, Buffalo, N. Y.

News Correspondents

Earn \$25 Weekly, spare time, writing for newspapers, magazines. Experience unnecessary; details free. Press Syndicate, 566, St. Louis, Mo.

Office Devices

Save half on office machines, equipment, addressers. Multigraphs, Duplicators, Dictaphones. Pruitt Company, 172 North Wells, Chicago, Ill.

Patents

Unpatented Ideas can be sold. I tell you how to protect them, and help you make the sale. Particulars free. Write W. B. Greene, 106 The Atlantic, Washington, D. C.

Personal

Vibration and Color; What do they mean to you? Interesting literature free. Robert Knox, Box 728, San Francisco, Calif.

Exchange cheery letters with new friends! Send stamp. Betty Lee, Inc., 4254 Broadway, New York City.

Horoscope—Life revelation. Send birthdate. 10c. St. Germain Society, Sharpsburg, Pa.

Your Horoscope, business, changes, social, matrimonial prospects. Send birthdate and 10 cents (stamps) for remarkable test reading. Zanya, 202-F West 105th St., New York.

Patent Attorneys

Millions spent annually for ideas! Hundreds now wanted! Patent yours and profit! Write today for free books—tell how to protect yourself, how to invent, ideas wanted, how we help you sell, etc., 301 Patent Dept., American Industries, Inc., Washington, D. C.

Patents. Send drawing or model for examination and report as to patentability. Advice and booklet free. Highest references. Best results. Promptness assured. Watson E. Coleman, Patent Lawyer, 624 F Street, Washington, D. C.

Patent. Electrical cases a specialty. Pre-war charges. R. P. Fishburne, 310 McGill Bldg., Washington, D. C.

Patents—Trademarks. Thirty-five years experience. Send model or sketch for opinion as to patentability. Free "Inventors Guide". Highest references and personal attention assure best results. Franklin H. Hough, 927 Washington Loan & Trust Bldg., Washington, D. C.

Patents Secured, Prompt Service. Avoid dangerous delays. Send for our "Record of Invention" form and Free Book telling how to Obtain a Patent. Send sketch or model for examination. Preliminary advice without charge. Highest references. Write Today. J. L. Jackson & Co., 356 Ouray Bldg., Washington, D. C.

Herbert Jenner, Patent Attorney and Mechanical Expert, 624 F Street, Washington, D. C. I report if patent obtainable and exact cost. Send for circular.

Inventors Benefited. Ideas developed and patented. Experimental machinery built. Only individual attention. Richardson & Rogers, 31 Abbee Building, Washington.

Patent application, filed on partial payment plan. Trademarks, copyrights, etc. Milo B. Stevens and Company, 604 F Street, Washington, D. C. Established 1864.

Patents—Trademarks. 30 years of confidential service; expert advice, prompt action, reasonable fees. Send for free book No. 64. Edgar Tate & Co., 245 Broadway, New York; 635 F Street, Washington, D. C.

Inventors: Protect your invention through A. M. Wilson, Inc., Washington, D. C. Over 20 years of efficient, expert, confidential service. Skilled in Radio-Electrical, Chemical and Mechanical fields. Our 1922 illustrated booklet, giving much necessary and very useful information which every inventor should know, will be sent free upon request. Prompt and careful attention. Highest references. Moderate fees. Send sketch or model for our careful opinion and preliminary advice. Write today to A. M. Wilson, Inc., (Radio 3 ARH), 325 Victor Bldg., Washington, D. C. (Successor to business established in 1891 by A. M. Wilson.)

Patents—Send for form "Evidence of Conception" to be signed and witnessed. Form, fee schedule, information free. Lancaster and Allwine, 269 Ouray Bldg., Washington, D. C.

Phonographic Supplies

Build Your Own Phonograph. Big saving. Pleasant, instructive work. Complete instructions, blue-prints, etc., absolutely free. Write today. Associated Phonograph Co., Dept. AP-13, Cincinnati, Ohio.

Printing

Everything Printed.—Long run specialists. Samples. Quality Printery, Marietta, Ohio.

Radio Outfits and Supplies

Well financed manufacturer will manufacture non-regenerative radio receiving units in lots of 1000 or more in exclusive models with your name, or to your specifications. Box 26, Radio News.

Salesman Wanted

Salesman Wanted to travel Central states with complete line of Radio parts. Western Radio Dist. Co., 408 S. Dearborn St., Chicago, Ill.

Scenery To Rent

Settings for Opera. Plays, Minstrels. Plush Drops. Address Amelia Grain, Philadelphia.

Song Writers

Song Writers!—Learn of the public's demand for songs suitable for dancing and the opportunities greatly changed conditions offer new writers, obtainable only in our "Song Writers' Manual and Guide" sent free. Submit your ideas for songs at once for free criticism and advice. We revise poems, compose music, secure copyright and facilitate free publication or outright sale of songs. Knickerbocker Studios, 319 Gaiety Bldg., New York.

Stamps and Coins

Stamps—50 Varieties, Africa, Brazil, Peru, Cuba, Mexico, etc., 10c. 50 different U. S. 25c; 1,000 mixed, 40c; 1,000 hinges, 10c. List free. C. Stegman, 5956 Cote Brillante, St. Louis, Mo.

Telegraphy

Wanted—Young men and women to learn Morse and Wireless Telegraphy. Railroads and Wireless Companies in great need of operators. We teach you quickly, and procure positions at big salaries. Great opportunities for advancement. All expenses low; can earn part. Write today for free catalog. School established 1874. Dodge's Telegraph Institute, "M" Street, Valparaiso, Indiana.

Ventriloquism

Ventriloquism taught almost anyone at home. Small cost. Send 2c stamp today for particulars and proof. Geo. W. Smith, Room 544, 125 N. Jefferson, Peoria, Ill.

Wanted To Buy

Cash for Old Gold, Platinum, Silver, Diamonds, Liberty Bonds, War, Thrift, Unused Postage Stamps, False Teeth, Magneto Points, Jobs, any valuables. Mail in today. Cash sent, return mail. Goods returned in ten days if you're not satisfied. Ohio Smelting Co., 304 Hippodrome Bldg., Cleveland, Ohio.

Full value paid for old gold jewelry, watches, diamonds, crowns, bridges, dental gold, silver, platinum, gold or silver ore, magneto points, war savings stamps, old false teeth. Packages held 4 to 12 days and returned if our offer is not satisfactory. United States Smelting Works (The Old Reliable), 120 So. State St., Dept. 16, Chicago, Ill.

Wireless

\$10.00 Variometers—\$3.00 while they last, manufacturers' samples. Horton, Christie Street, Ridgefield Park, N. J.

DeForest—O T 3 Radiophone, including motor generator, tubes, microphone, etc., all in A1 condition, and ready to install at \$140. Selling because of installation of high power set. Address W. H. A. R., Gazette Review, Atlantic City, N. J.

Variometers, large size, with 3 inch dial, \$2.85. Variocouplers, 14 taps, with dial, \$2.50. .002 mfd. International variable condensers, \$4.25. 23 plate condensers, \$2.35; 43 plate, \$2.85. Detector units, complete, without tube, \$2.95. Triple coil mountings, \$2.75. \$6 head sets, \$3.85 pair. Bargains in receiving sets. Send for bulletins. H. Butterworth, 331 Quincy St., Brooklyn, N. Y.

3-inch composition dial and knob, 45c. Switch points, 2 1/2c. All standard apparatus. Postpaid. Quick Service. Amateurs Supply Store, Carrollton, Mo.

New Western Electric VT 2s at \$6.40. Breunig, 2252 Roscoe, Chicago.

Increase your Crystal Receiving Range by using a "PT" Ultra-Sensitive coil in your crystal detector. It adjusts in a second; secures more sensitive results than ordinary springs or catwhiskers; and is almost impossible to jar out. Price twenty-five cents silver. "PT" Crystal Contact Company, Box 1641, Boston, Massachusetts.

Stromberg-Carlson Phones. The professional headset at the amateur's price. Super-sensitive, comfortable, durable. Impedance correct for phone work with modern vacuum tubes. Equipped with five-foot polarity indicating, moisture-proof, silk cords. A real radio headset for \$7.50. Carrollton Radio Shop, Carrollton, Missouri.

Radiotron Tubes, while they last: UV200, \$4.40; UV201, \$5.75. Genuine unused tubes. Cut Rate Radio Sales, Box 1462, Miami, Florida.

Government Radio—1/2 KW Panel Transmitter complete \$115.00; 1/2 KW Synchronous 775; 1/4 KW 500 cycle Motor-generator \$47.50. Send for list. Eaton, 1915 South Twelfth, Philadelphia.

For Thirty Days. Radiotron tubes, detector, \$5.00, Premium Composition Socket, Amplifier \$6.50, premium Socket, Erado Variocoupler \$5.00, premium Sterling Rheostat. Erado Variocoupler \$4.50, premium Sterling Rheostat. Many others. Write for our list of premiums. Enid Radio Distributing Co., Enid, Oklahoma. Radio WNAF.

Sockets for WD-11 dry cell tubes 50c. Franklin Radio Mfg. Co., 711 Penn Ave., Wilkinsburg, Pa.

Vacuum Tube Sockets 50c each. Money back guarantee. I. Fonger, 145 Pine St., Muskegon, Michigan.

Variable Condensers—23 plate, \$1.60; 43, \$2.60. Aluminum plates .03. Machined Spacers .08 and 15 per doz. Condensite Ends 25c pair. Gravenstede, 84 Hancock Ave., Jersey City, N. J.

Act Quick Sale. Oak Cabinets 6x6 1/2 x 18 with genuine 3-16 Celeron panel, \$3.75. Haupt Radio Supply Co., 2442 Ogden Ave., Chicago, Ill.

Telefunken 500 cycle ship set complete, \$250. Crocker-Wheeler motor generators, 500 cycle, \$75. Complete Western Electric broadcasting and receiving outfit, \$375. Three KW "Coffin", \$20. Kienzle, 501 East 84th Street, New York.

Radiotron, Westinghouse, Myers & W.E. V.T.S. We specialize in the distribution of vacuum tubes which are opened and tested before shipping, thus assuring you satisfactory operation. Radiotron U.V.200 detector \$5. Radiotron U.V.201 amplifier \$8.50. Radiotron U.V.202 power tube transmitter and amplifier \$8. All Radiotron and Cunningham tubes supplied with Radeco safety fuse at premium. Westinghouse WD11 Aeriotron Detector tubes operating on one dry cell, eliminating storage battery, \$8. Western Electric 216A Amplifiers for W. E. Loud Speakers, \$12. Myers Hi-Mu, audions and detector, \$5. A complete stock of well known vacuum tube accessories and radio supplies awaits your order. Postage, insurance and KRL credits free. Immediate delivery or remittance returned. Try us. The Kehler Radio Laboratories, Dept. R, Abilene, Kansas.

Triplex loudness of signals! All sets. Cost few cents. Directions 25c. Dealers wanted. Magnoco, Boston 30, Massachusetts.

Black Fibre Panels, nicely finished, 7"x18"x3/16", \$1.25. Cut to order any size, .01 sq. in. Immediate delivery. Geo. H. Mollahan, Lowell, Mass.

Ten Duo-Lateral Coils, 25 to 400, mounted. One 500 unmounted, waxico mounting, \$20. Harold Mauze, Joliet, Ills.

Wireless (Continued)

Build your own electrolytic storage battery charger. Plates and complete instructions, \$1.00. Descriptive Circular Free. Peerless Electrical Parts Co., 105 Harris Street, Rochester, N. Y.

Ten percent discount on all standard radio goods. Prompt service. Superior two step amplifier \$25.00. QST Radio Service, Williamsport, Pa.

Amateurs, "Phantom Circuit". Make your own phantom receiver. Has range of 400 miles without aerial or ground. Nothing short of marvelous. For 50c we will send you this circuit, together with a copy of our catalog and a year's membership to the Radio Exchange, which entitles you to purchase all of your radio goods at prices you cannot equal elsewhere. This circuit alone is worth 3 times the price we ask for it. A few of our specials: Moulded variometers, \$4.95; moulded variocouplers, \$4.45; Spirala loud speakers with receiver and cord complete, \$4.85; 6 volt 60 ampere hour storage batteries, Stewart, \$10.00; 6 volt 100 ampere hour batteries, \$15.95. Get your orders in immediately. The Radio Exchange, 511 Seventh St., Sioux City, Ia.

Special R. C. S. Radio Crystals. Most sensitive crystals obtainable. Combination of three, Pyrite, Super-Galena and Silicon, mounted in fusible metal, 25 cents each. Zincite, mounted, 25 cents each. Pyrite, Extra Grade A, 20 cents each. Satisfaction guaranteed. Dealers write for prices. Radio Crystal Supply Co., 2130 Eighth Avenue, West, Seattle, Wash.

For Immediate Delivery—Tubes, Magnavox, Westinghouse Receiving Sets, Phones, Condensers, Rheostats, Variometers, Couplers, Panels, Transformers, V. T. Sockets, Dials, Switch Points, and full line of parts. R. B. Electric Co., Galva, Ill.

All R. E. L. Members Wear a Radio Experimenters' Lapel Button. (See cut on page 14 of this issue.) Be identified as an alert and progressive radio enthusiast. Join the Radio Experimenters' League conducted by amateurs for amateurs. Every member receives one of these 14K gold plated lapel buttons, also a membership card and private identification code number. All members of the League are entitled to a 10% discount on any approved standard receiving or transmitting radio apparatus. You may also have your choice of any of the following: (1) The Theory of the Armstrong Super-Regenerative Receiver, written by Major Armstrong himself, with 10 diagrams. (2) Diagram of Armstrong Super Receiver with accurate panel layout, list of parts and where to get them, also three photos. This set actually works. (3) Wiring diagram showing how to convert a receiving set into a combination local transmitting and receiving outfit using only a few inexpensive additional parts. (4) We have a limited number of tested Peanut Tubes on hand at the special price of \$2 each. (5) Diagram how to make a simple and inexpensive wavetrap to separate 200 and 400 meter waves and prevent interference. (6) Wiring diagram of the best transmitting set we have seen for C. W., voice or buzzer. We always have the facts on the latest developments. If you have any hard nuts to crack or questions to ask, shoot them in; we will send a "dopesheet". We old timers are sincerely glad to lend a hand wherever possible. This is one of the most valuable features of membership. Any owner of a radio set is eligible for membership. Join the League today, enrollment and registration fee 50c, includes button, membership card, 10% discount privilege, and choice of any one of the above "Dopesheets". Other "dopesheets" in the above list or special "dopesheets" answering questions, 50c each. Radio Experimenters' League, 9-15 Clinton Street, Newark, N. J. More Radio clubs invited to affiliate.

Wireless Telephone, we hear Kansas City, Mo., 1250 miles, fine on a single bulb. Do you? There is radio music in the air each evening, and the living voices of the artists can be reproduced in your own home and enjoyed by you and your friends. Are you satisfied with your receiving set or would you like to build one that will receive over 6000 miles on a single bulb and quit experimenting? One that will be equal to any regardless of claims and price—with which you can read Honolulu, California, German, South American, French and English stations, and practically all of the high-powered foreign and domestic stations, as well as amateur stations as far west as New Mexico. Anyone can assemble this outfit and wire it up and the remarkable ranges that may be obtained will surprise you. Why not make a set up to date and efficient? Don't experiment with unknown circuits. We will promptly mail you our simple diagram of a complete short and long-wave receiver, 175 to 20,000 meters, together with complete instructions for wiring and assembling, price of each part and where they can be bought, leaving nothing to guess about, on receipt of 50c in coin or stamps. Here is a diagram no amateur can be without. Build your own Wireless Telephone receiver. Virginia Novelty Company, Martinsburg, W. Va.

Edison B. Battery Units—One positive and one negative plate for 10c. 18 sets will make a 24-volt battery. Wilkinsburg Wireless Shop, 711 Penn Ave., Wilkinsburg, Pa.

This Is Real Service—Panels cut to order, smooth sawed edges. We cut them exactly to size and ship the same day your order is received. 1/4" thick, \$0.01 1/2 per square inch; 5-16" thick, .02; 3/4" thick, .03; 7-16" thick, .03 1/4; 1/2" thick, .04. Why pay more? These radio panels are made of the highest grade black fibre. This material possesses high dielectric strength, is inexpensive, unbreakable and easy to work. Our special offer, radio panels 6x6 1/4", 50c; 6x12 1/4", \$1. We also carry a complete stock of fibre rod and tubes, the real thing for electrical insulation. Special prices quoted on application. We pay postage. Radio Instrument & Panel Co., Box 75, Cicero, Illinois.

We Repair Tubes. S. Strobel, 4001 N. 6 St., Phila, Pa.

Attention!—50 Vacuum tube hook-ups. The greatest collection of vacuum tube circuits ever brought under two covers at such insignificant cost. These diagrams will be found in the great "Rasco" catalog, which contains raw materials and parts in a greater profusion than any other catalog. 15c in stamps, or coin, will bring the catalog to you. Radio Specialty Co., 96-98 Park Place, N. Y.

Boys! Don't Overlook This. The "Rasco" Baby Detector. Greatest detector ever brought out with molded base. Fully adjustable. See former advertisements in this publication, or our catalog. Detector with Galena Crystal, complete 50c, the same detector with Radiotone Crystal, 75c prepaid. Send for yours today. Radio Specialty Company, 96-98 Park Place, New York City.

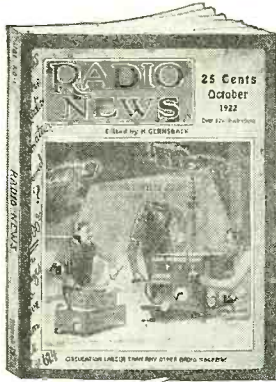

For Special Clubs
Class No. 45



For Special Clubs
Class No. 50



For Special Clubs
Class No. 30



For Special Clubs
Class No. 60



With Hearst's International
Both to One Address
Class No. 105



For Special Clubs
Class No. 37



For Special Clubs
Class No. 50

Christmas Gifts for All

Give a subscription to your favorite magazines for Christmas. They make a most welcome, pleasing and appropriate gift and remain a gracious and constant reminder of the giver throughout the whole year. No other gift at such small expense can compare favorably with a yearly subscription to a few of your favorite magazines.

You can make your selection from the Radio specials or the attractive combinations listed on these two pages—or you can make up your own clubs from the magazines named and by adding the class numbers shown and multiplying the total by five, you will have the correct cost of your special club (see following example).

Example.—Suppose that you wish to subscribe to Radio News, Science & Invention and Boys' Life. Radio News is Class 45, Science & Invention is Class 45, and Boys' Life is Class 35, total 125. Multiplying by 5 equals 625. You remit \$6.25, a saving of \$0.75 over the regular subscription prices.

Should you wish to renew your own subscriptions, no matter when they expire, we will see that they are extended for the proper time.

Please do not wait for the last minute rush—send us your list now to insure arrival of the magazines by Christmas. We will enclose Christmas cards in your name if desired.

RADIO SPECIALS

Can be clubbed with any publication by using their class numbers as explained above.

Class Nos.	Magazine	Regular Price	Extra for Canada	Class Nos.	Magazine	Regular Price	Extra for Canada
45	RADIO NEWS	\$2.50	\$0.50	40	Q. S. T.	\$2.00	\$0.00
45	SCIENCE & INVENTION	2.50	.50	75	Scientific American	4.00	.50
45	Wireless Age	2.50	.50	50	Popular Science Monthly	2.50	.00

A FEW SPECIAL CLUBS

RADIO NEWS..... \$2.50	Both	SCIENCE & INVENTION. \$2.50	Both
SCIENCE & INVENTION. 2.50	} \$4.50	PRACTICAL ELECTRICS.. 2.00	} \$4.00
You Save \$0.50		You Save \$0.50	
(Canada \$1.00 extra)		(Canada \$1.00 extra)	
SCIENCE & INVENTION \$2.50	Both	PRACTICAL ELECTRICS. \$2.00	Both
American Magazine..... 2.50	} \$4.75	People's Home Journal 1.25	} \$2.75
You Save \$0.25		You Save \$0.50	
(Canada \$0.50 extra)		(Canada \$0.50 extra)	
RADIO NEWS..... \$2.50	Both	SCIENCE & INVENTION. \$2.50	Both
Boys' Life..... 2.00	} \$4.00	Review of Reviews..... 4.00	} \$5.25
You Save \$0.50		You Save \$1.25	
(Canada \$0.75 extra)		(Canada \$0.50 extra)	
RADIO NEWS..... \$2.50	Both	SCIENCE & INVENTION. \$2.50	Both
Woman's Home Companion. 1.50	} \$3.75	Review of Reviews..... 4.00	} \$5.25
You Save \$0.25		You Save \$1.25	
(Canada \$0.50 extra)		(Canada \$0.50 extra)	

(Continued next page)

Make all remittances payable to and mail to
EXPERIMENTER PUBLISHING CO., Inc.
 53 Park Place -:- New York, N. Y.



For Special Clubs
Class No. 30



For Special Clubs
Class No. 20



For Special Clubs
Class No. 40



For Special Clubs
Class No. 45

RADIO NEWS.....\$2.50 } Both
American Magazine..... 2.50 } **\$4.75**
You Save **\$0.25**
(Canada \$0.50 extra)

SCIENCE & INVENTION \$2.50 } Both
Collier's Weekly..... 2.50 } **\$4.25**
You Save **\$0.75**
(Canada \$3.00 extra)

RADIO NEWS.....\$2.50 } Both
Review of Reviews..... 4.00 } **\$5.25**
You Save **\$1.25**
(Canada \$0.50 extra)

RADIO NEWS.....\$2.50 } Both
McCall's..... 1.00 } **\$3.25**
You Save **\$0.25**
(Canada \$0.50 extra)

RADIO NEWS.....\$2.50 } All for
PRACTICAL ELECTRICS.. 2.00 } **\$6.25**
SCIENCE & INVENTION. 2.50 }
You Save **\$0.75**
(Canada \$1.50 extra)

PRACTICAL ELECTRICS..\$2.00 } All for
Boys' Life..... 2.00 } **\$6.00**
American Magazine..... 2.50 }
You Save **\$0.50**
(Canada \$0.75 extra)

SCIENCE & INVENTION \$2.50 } All for
*Hearst's International..... 3.00 } **\$7.50**
*Cosmopolitan..... 3.00 }
You Save **\$1.00**
(Canada \$1.50 extra)

RADIO NEWS.....\$2.50 } All for
American Magazine..... 2.50 } **\$5.75**
People's Home Journal..... 1.25 }
You Save **\$0.50**
(Canada \$0.50 extra)

SCIENCE & INVENTION \$2.50 } All for
Boys' Life..... 2.00 } **\$5.00**
McCall's..... 1.00 }
You Save **\$0.50**
(Canada \$0.75 extra)

RADIO NEWS.....\$2.50 } All for
Review of Reviews..... 4.00 } **\$7.00**
PRACTICAL ELECTRICS.. 2.00 }
You Save **\$1.50**
(Canada \$1.00 extra)

SCIENCE & INVENTION \$2.50 } Both
Boys' Life..... 2.00 } **\$4.00**
You Save **\$0.50**
(Canada \$0.75 extra)

RADIO NEWS.....\$2.50 } Both
Christian Herald..... 2.00 } **\$3.75**
You Save **\$0.75**
(Canada \$0.50 extra)

RADIO NEWS.....\$2.50 } Both
Modern Priscilla..... 2.00 } **\$4.10**
You Save **\$0.40**
(Canada \$0.75 extra)

RADIO NEWS.....\$2.50 } Both
Pictorial Review..... 1.50 } **\$3.75**
You Save **\$0.25**
(Canada \$0.50 extra)

PRACTICAL ELECTRICS..\$2.00 } All for
Review of Reviews..... 4.00 } **\$6.75**
Collier's Weekly..... 2.50 }
You Save **\$1.75**
(Canada \$3.00 extra)

RADIO NEWS.....\$2.50 } All for
*Hearst's International..... 3.00 } **\$7.50**
*Cosmopolitan..... 3.00 }
You Save **\$1.00**
(Canada \$1.50 extra)

PRACTICAL ELECTRICS..\$2.00 } All for
McCall's..... 1.00 } **\$4.25**
Pictorial Review..... 1.50 }
You Save **\$0.25**
(Canada \$0.50 extra)

SCIENCE & INVENTION \$2.50 } All for
Review of Reviews..... 4.00 } **\$6.75**
Pictorial Review..... 1.50 }
You Save **\$1.25**
(Canada \$0.50 extra)

RADIO NEWS.....\$2.50 } All for
*Cosmopolitan..... 3.00 } **\$7.00**
*Good Housekeeping..... 2.50 }
You Save **\$1.00**
(Canada \$2.00 extra)

SCIENCE & INVENTION \$2.50 } All for
Youth's Companion..... 2.50 } **\$5.50**
McCall's..... 1.00 }
You Save **\$0.50**
(Canada \$1.00 extra)

RADIO NEWS.....\$2.50 } Both
Youth's Companion..... 2.50 } **\$4.50**
You Save **\$0.50**
(Canada \$1.00 extra)

SCIENCE & INVENTION \$2.50 } Both
Modern Priscilla..... 2.00 } **\$4.10**
You Save **\$0.40**
(Canada \$0.75 extra)

RADIO NEWS.....\$2.50 } Both
People's Home Journal..... 1.25 } **\$3.25**
You Save **\$0.50**
(Canada \$0.50 extra)

SCIENCE & INVENTION \$2.50 } Both
People's Home Journal..... 1.25 } **\$3.25**
You Save **\$0.50**
(Canada \$0.50 extra)

RADIO NEWS.....\$2.50 } All for
*Hearst's International..... 3.00 } **\$7.00**
*Good Housekeeping..... 2.50 }
You Save **\$1.00**
(Canada \$2.00 extra)

SCIENCE & INVENTION \$2.50 } All for
*Cosmopolitan..... 3.00 } **\$7.00**
*Good Housekeeping..... 2.50 }
You Save **\$1.00**
(Canada \$2.00 extra)

SCIENCE & INVENTION \$2.50 } All for
McCall's..... 1.00 } **\$6.25**
Review of Reviews..... 4.00 }
You Save **\$1.25**
(Canada \$0.50 extra)

PRACTICAL ELECTRICS..\$2.00 } All for
Youth's Companion..... 2.50 } **\$7.25**
Review of Reviews..... 4.00 }
You Save **\$1.25**
(Canada \$1.00 extra)

SCIENCE & INVENTION \$2.50 } All for
*Hearst's International..... 3.00 } **\$7.00**
*Good Housekeeping..... 2.50 }
You Save **\$1.00**
(Canada \$2.00 extra)

RADIO NEWS.....\$2.50 } All for
Woman's Home Companion.. 1.50 } **\$5.60**
Modern Priscilla..... 2.00 }
You Save **\$0.40**
(Canada \$0.75 extra)



With Cosmopolitan
Both to One Address
Class No. 95

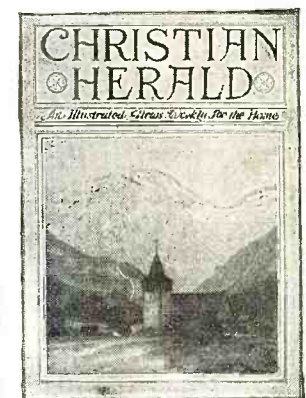

For Special Clubs
Class No. 30

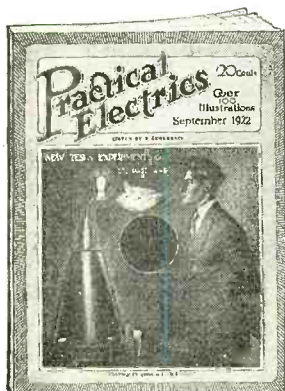

For Special Clubs
Class No. 35



For Special Clubs
Class No. 20



For Special Clubs
Class No. 35

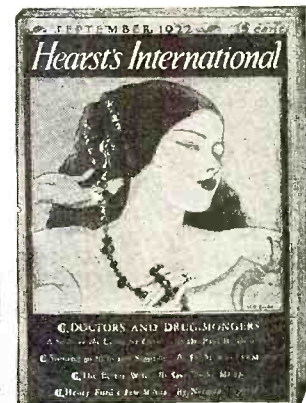

With Good Housekeeping
Both to One Address
Class No. 95

"Rasco Has It"

Partial List of Goods Listed In
"Rasco" Catalog
No. 8

- Detectors
- Navy Knobs
- Switch Handles
- Pointers
- Lock Nuts
- Cord Tips
- Copper Ribbon
- Switches
- Crystal Cups
- Sliders
- Litz Wire
- Rotors
- Panel Scales
- Switch Levers
- Condenser Plates
- Carbon Balls
- Audio-Frequency Transformers
- Bakelon Panels
- Name Plates
- Crystals
- Bornite
- Silicon
- Radiocite
- Condensers
- Ground Clamps
- Plugs
- Contact Arms
- Aerial Connectors
- Bus Bar Wire
- Enameled Wire
- Transformer Coils
- Copper Strip
- Flexible Cord
- Knobs
- Panel Knobs
- Key Knobs
- Binding Posts
- Lock Posts
- Machine Screws
- Switch Stops
- Telegraph Key Knobs
- Hard Rubber
- Binding Posts
- Nickel-plated Switch Points
- Zinc Spark Gap Ends
- Panel Switches
- Mounted Crystals
- Tin Foil
- Rheostat Windings
- Spring Clips
- Antenna Connectors
- Lock Fork
- Spacing Washers
- Carbon Grains
- Blow Torches
- Minerals
- Copper Pyrites
- Iron Pyrites
- Soft Metal (Hugonium)
- Threaded Brass Rod
- Cord Tip Jacks
- Vacuum Tube Sockets
- Mica Diaphragms
- Radio Cement
- Choke Coils
- Magnet Wire
- Brass Rod
- Grid Leak Condensers
- Phone Cords
- Metal Dials
- Universal Panel Bearing Handles
- Switch Knobs
- Potentionmeter Windings
- Binding Post Name Plates
- Spaghetti-Insulating Tubing
- Radio Frequency Transformers
- Instrument Posts
- Hexagon Nuts
- Spring Binding Posts
- Switch Studs
- Cap Nuts
- Brass Lugs
- Copper Lugs
- Dials
- Lubricated Switches
- Panel Switch Levers
- Mica
- Vario-Coupler Rotor
- Battery Switches
- Switch Blades
- Selenium
- Diaphragms
- Carbon Buttons
- Transformer Stampings
- Solderall

- Galena
- Zincite
- Mineral Sets
- Brass Washers
- Copper Braid
- Jacks
- Rheostat Windings
- Vacuum Tube Fuses
- Lock Washers
- Dial Verniers
- Resistances
- Silk Wire
- Honeycomb Coils
- Phone Condensers
- Separable Cord Tips
- Composition Dials
- Plugs
- Aerial Insulators
- Phones

"Build Your Own!"

THE Radio Specialty Company, "RASCO" for short, is probably the most unique radio parts supply house in the United States, if not in the world today. This Company makes a specialty of **SMALL ORDERS**. No order can be so small to get immediate and prompt attention, for the simple reason that most of our orders are small.

The reputation of this Company was built solely on service. Ask any of your acquaintances what they think of "RASCO" goods, "RASCO" service, "RASCO" promptness! Thousands of unsolicited testimonials on file prove that we serve the public best!

Many houses claim that their orders are shipped within twenty-four hours. A year's record in our Order Department actually shows that over 99% of our orders leave within twelve hours after receipt. We invite you to try "RASCO" service on a 50c order. **MAKE US PROVE WHAT WE SAY.**

Sixty-eight per cent of all of our customers come back for more goods after they have tried our service once. The reason is very simple, as we specialize in very small orders. We could not stay in business if we had to look for new customers continually.

"RASCO" SERVICE IS WHAT COUNTS!

"Rasco" Catalog No. 8

The new "RASCO" catalog, No. 8, will prove a revelation to the man who "builds his own." In this catalog are listed more parts and more items than you have previously thought possible to obtain.

The new "RASCO" catalog contains over 500 different radio items, and has been greatly enlarged over the preceding one. **IT NOW CONTAINS 64 PAGES, INSTEAD OF 40.**

Price Reductions

Many items have been reduced to give our customers the benefit of the lower prices that enlarged production makes possible.

Factories in Brooklyn, N. Y., and Elkridge, Md.

These two factories, where our screw machine work, our stamping and our composition work is turned out, make it possible for us to offer the very lowest prices in the country.

75 Vacuum Tube Hook-Ups!

These hook-ups of ALL important vacuum tube connections are given in clear diagrams with complete explanations. This is the one and only catalog containing such a wealth of information on all Vacuum Tube sets, giving all the correct values of all the elements, so that any amateur can readily hook up a set with the instructions furnished.

All Armstrong Circuits: These important circuits are explained clearly, all values having been given, leaving out nothing that could puzzle you.

Just to name a few of the Vacuum Tube circuits: The V.T. as a detector and one-step amplifier; regenerative circuit; DeForest ultraudion; V.T. to receive undamped and spark signals; Armstrong circuits; one-step radio frequency amplifier and detector; three stage audio-frequency amplifier; short wave regenerative circuits; V.T. radio telephone; 4-stage radio frequency amplifiers; radio and audio frequency amplifier, inductively coupled amplifier; Armstrong superautodyne; radio frequency amplifier and crystal detector; combination V.T. detector one stage amplifier; two stage radio frequency amplifier and detector with feedback coupling (regenerative); regenerative receiver, using single spider web coil; Armstrong super-regenerative circuit; two stage radio frequency amplifier coupled to a two-circuit tuner, using two-slide tuner regenerative receiver; two stage audio-frequency amplifier, using crystal or V.T.; one stage radio frequency detector, two stages audio-frequency with feed-back coupling to first tube; power amplifier with loud speaker; regenerative receiver and one stage amplifier for DX work; one stage radio frequency detector with feed-back coupling; very sensitive circuit with two stages of radio frequency and regenerative detector; one to ten mile radiophone transmitter; three stages radio frequency, two stages audio-frequency, loop reception; crystal detector with rectification; one tube super-regenerative receiver; short wave regenerative receiver with two variocouplers, capacity-coupled tuner; trap circuit to eliminate interference; selective circuit to eliminate interference.

If you were to buy a book containing all of these 75 Hook-ups you would have to spend from \$3 to \$7.00 to secure the same information.



ILLUSTRATION FULL SIZE

300 Illustrations

This catalog contains over three hundred illustrations. On account of its very great cost, it can not be distributed free of charge.

Mailed only on receipt of 15c. in stamps or coin

DEALERS

Get Our Special Proposition

This business was originated with the sole purpose to cater to the amateur who has small orders. **ALL OF OUR ORDERS ARE SMALL** and that is why your small order will never be side-tracked by us. A trial order will make you a life customer. "We can only stick you once." Try us with a 50c order.

ALL GOODS PREPAID



98 PARK PLACE, NEW YORK CITY

Factories
Brooklyn, N. Y., — Elkridge, Md.

Get This Wonderful New Book About

LOUD-TALKERS

HOW TO BUILD THEM

by H. WINFIELD SECOR

Associate Editor of Science and Invention

25 cents, postpaid

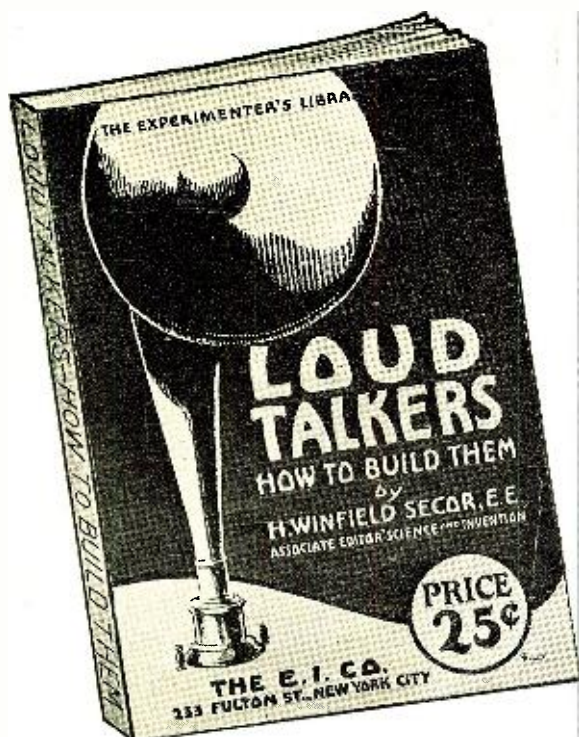

This book describes how to build two distinct and different types of radio loud-talkers, which can be built with either electro-magnetic field to be excited from storage battery, as well as permanent magnet field requiring no separate battery excitation. The third chapter deals with improvised loud-talkers and gives clear and complete instructions on how to build suitable horns for use with radio receivers of the Baldwin and other types. Several elaborate hook-ups are given of the author's own radio receiving set, comprising one stage of radio-frequency, detector and three stages of audio-frequency amplification, together with all the connections for the loud-talker.

Complete data is given for all the parts of the loud-talkers, including the field magnet windings, as well as the diaphragm or moving coil windings, and also the step-down transformer to be connected between the vacuum tube amplifier and the loud-talker proper.

In preparing these designs the point has been constantly kept in mind to use the simplest parts possible, so that practically anyone can build a successful loud-talker equivalent to the commercial types costing \$40.00 or more.

Even where the experimenter does not possess the skill or the time to make all the parts himself, which are really few in number, he may save a great deal of money, or at least half the price of a commercial loud-talker, by having the difficult parts made in a local machine shop, and then assembling them and winding the coils himself. Circuit connections and data for the size of wire, etc., are given for placing the loud-talker on a separate floor or in another part of the house not occupied by the radio receiving set. A very valuable book, giving data which cannot be obtained anywhere else and which has not been published before.

64 pages, 25 illustrations, bound in beautiful two-color cover, size 5½ x 7½ inches; Price prepaid, 25 cents.

Have You a Copy of These Two Books?

HOW TO MAKE A RADIO-PHONE RECEIVING SET

By ROBERT E. LACAULT
Associate Editor RADIO NEWS

25^c

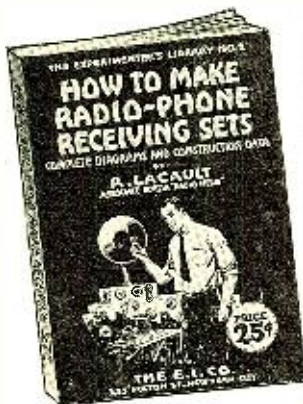

A non-technical book for the beginner. Gives complete constructional data on the building of a complete Crystal Detector Set, Tuning Coil, Loose Coupler and a Single Audion Tube Set with Amplifying Units. It furnishes all dimensions and working drawings of every part that must be constructed by the amateur. Written in plain, simple language that anyone can understand. The opening chapter gives a complete description of the theory of radio and tells what it's all about, teaching the principles of wireless so that the constructor knows what he is doing.

48 pages, 25 illustrations.

Bound in Beautiful
Two-Color Cover

Size 5½x7½ inches. Prepaid 25c.

RADIO FREQUENCY AMPLIFIERS AND HOW TO MAKE THEM

By JOHN M. AVERY

25^c

This book is for the more advanced amateur, showing the construction of the Radio Frequency Amplifying Transformer and giving complete constructional data. It shows the application of Radio Frequency to amplifying units that the amateur may already possess and gives 15 hook-ups showing practically every use Radio Frequency Amplifying Transformers can be put to.

32 pages, 15 illustrations

Bound in Beautiful
Two-Color Cover

Size 5½x7½ inches. Prepaid 25c.

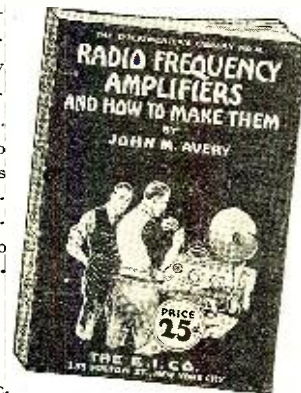

Order from your dealer—or direct from us
233 FULTON STREET
THE E. I. COMPANY NEW YORK CITY, N. Y.

NATIONAL AIRPHONE PRODUCTS

Pronounced by Experts to Be the Greatest Radiophone Crystal Outfit Ever Produced. Awarded the Certificate of Merit by the "Radio News Laboratories," N. Y. Tribune Institute, N. Y. Eve. Mail Institute

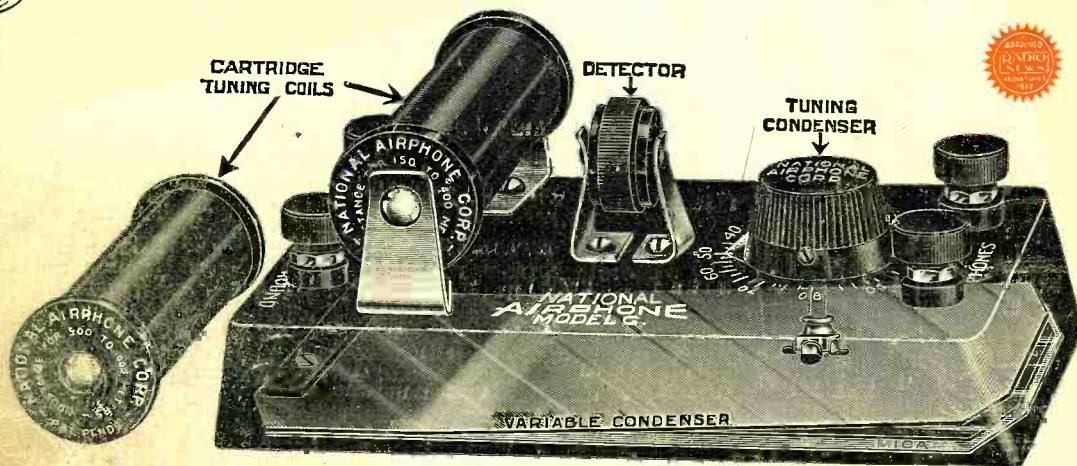

\$12.50

Without
Phones
Patents Pending

NATIONAL AIRPHONE

(MODEL G)

Endorsed by Engineers as the Greatest Radiophone Ever Seen or Heard

To operate simply connect aerial, ground and head-phones. Will receive radio broadcast entertainments and commercial reports within a radius of 25 miles; Code signals 1000 miles and over depending upon coils used.

OUTSTANDING POINTS OF SUPERIORITY:

1. Most Compact Radiophone Receiving Set Made.
2. Rugged construction throughout, nothing to get out of order.
3. Entire casing constructed of hard rubber composition. No wood, no warping, no losses through leakage.
4. Ultra-sensitive Foolproof Detector; entirely enclosed in composition case. Air and dustproof, no fussy minerals, no Cat-whiskers, no balls nor springs.
5. Use of interchangeable cartridge tuning coils gives wide range over which radiophone broadcast or radio telegraph signals can be heard. 25 miles or over for radiophone concerts; up to 1000 miles for telegraph signals depending upon coils used.
6. Two Cartridge tuners, supplied with each outfit; one takes in general broadcasting stations 150 to 400 meters, the other ranges from 500 to 1000 meters.
7. Variable Mica Condenser used is acme of simplicity—high capacity, impossible to short-circuit.

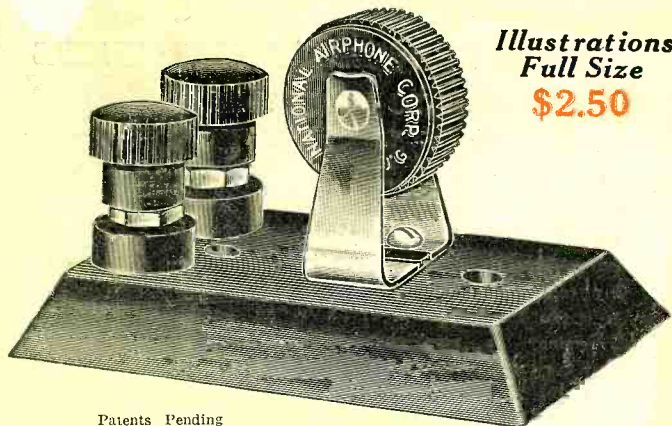

Illustrations
Full Size
\$2.50

GOLD GRAIN DETECTOR

FOR PANEL MOUNTING

\$2.00

After you have fussed with catwhiskers, springs, balls and adjustment handles, and after you have almost become a nervous wreck, hunting for "the elusive sensitive spot"—you will welcome with open arms our 100% GOLD GRAIN DETECTOR.

This Detector has no catwhiskers, no springs, no balls, no adjusting handles; no fussing; 100% foolproof. The Detector is entirely enclosed in hard rubber composition cartridge, but it is NOT a fixed detector.

A special crystal is used, while contact is made with hundreds of loose grains of pure gold. There is always a multiplicity of contacts. The Detector is sealed hermetically. The contact with the crystal is always perfect.

Due to these revolutionary improvements, this Detector has been pronounced by experts to bring in signals and sounds louder than any other detector on the market. You will be surprised at the great volume of sound you are able to obtain with the GOLD GRAIN DETECTOR.

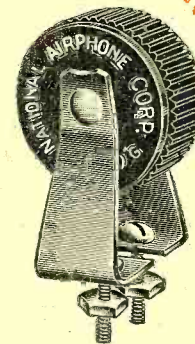

Actual Size

Patents Pending

You are protected by this Guarantee:

Should any National Airphone Gold Grain Detector not be in first-class condition when purchased and within five days you return it to us unbroken, or unopened, we will refund your money or give you another one as you may prefer. Or if at any time within a year one should become defective or unsatisfactory to you we will take it back if unbroken or unopened and give you another in its place.

SEND NO MONEY

COUPON

National Airphone Corporation,
18 Hudson Street, New York, City, N. Y.
Gentlemen:

Please send me prepaid
for which I will pay the postman the amount advertised on this page.

If within five days I do not find the apparatus all you claim for it, or if for any reason I am not satisfied, I may return same to you in good condition and you will refund the full purchase price.

NAME
STREET AND NO.
CITY STATE

Distributors--Write for Exclusive Territory
Jobbers and Dealers--Send for Price List

NATIONAL
AIRPHONE
CORPORATION
18 HUDSON STREET NEW YORK