

DECEMBER 1948

40 CENTS

**EVERYTHING IN TELEVISION · RADIO · ELECTRONICS
FOR THE RADIO SERVICE - TECHNICIAN**

RADIO

MAINTENANCE

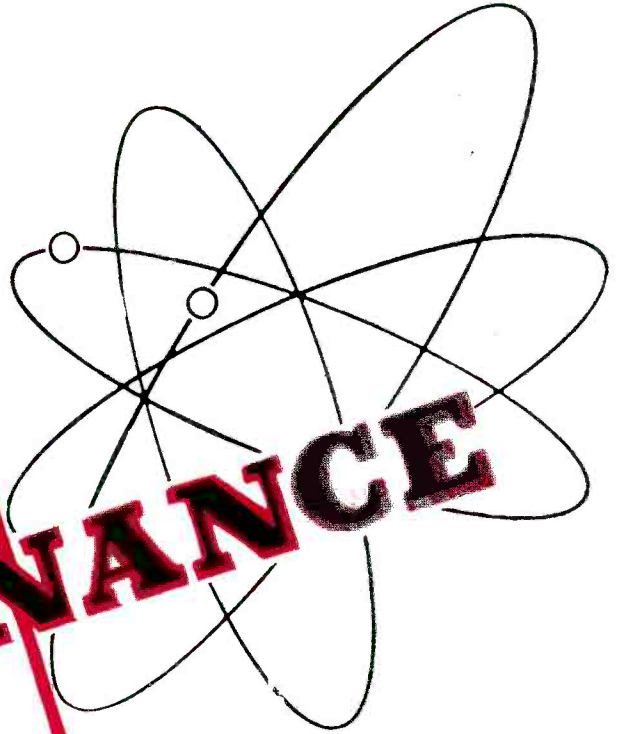

**FM DETECTORS PART II
TV INTERFERENCE
WIRE RECORDERS
CHECKING TV
RECEIVER
LINEARITY**

YEARLY SUBSCRIPTION \$3.00

BOLAND & BOYCE INC., PUBLISHERS MONTCLAIR, N. J.

"KEN-RAD TUBES HAVE DONE A JOB FOR ME!"



"You can get a testimonial from me on Ken-Rad tubes any time!

"I use them. I've been using them for years. Believe me, no other tube can touch them.

"They're quality tubes. When I pass them on to a customer I know he won't come back mad.

"My customers come back, all right. But satisfied. They want me to do another job for them!"



R. W. RIEDY, Modern Radio Service, 518 West Broad Street, Bethlehem, Pa. Typical of thousands of radio servicemen, coast to coast, Mr. Riedy uses Ken-Rad tubes because he knows he can depend on them to satisfy customers.

EMMETT MERCER, Foreman, is responsible for the weighing of cathode sleeves to check coating weight (shown below). Another example of the great care that is taken in making Ken-Rad tubes.

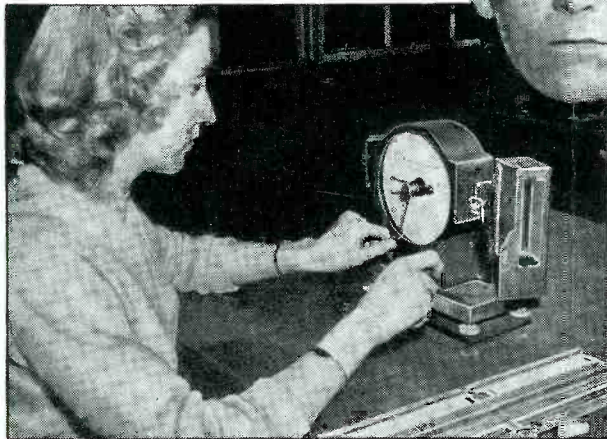
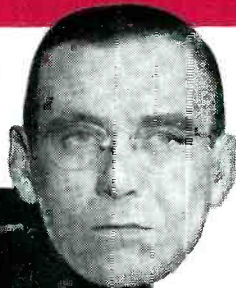

178-GA13-8850

"KEN-RAD TUBES ARE MADE TO DO A JOB!"

"We make Ken-Rad tubes to perform better, last longer, satisfy customers and increase business for you

"I've been helping to make them for years. And I can tell you we check and recheck, test and retest, over and over again, the smallest parts that go into our tubes

"We test the tubes themselves for noise, microphonics, static, life, shorts, appearance, gas, air and hum.

"You can count on them to bring customers back satisfied."

KEN-RAD Radio Tubes

PRODUCT OF GENERAL ELECTRIC COMPANY

Schenectady 5, New York

The Serviceman's Tube



**"TV.....
and ALL
SEVENTEEN"**
Says R. K. Mosier

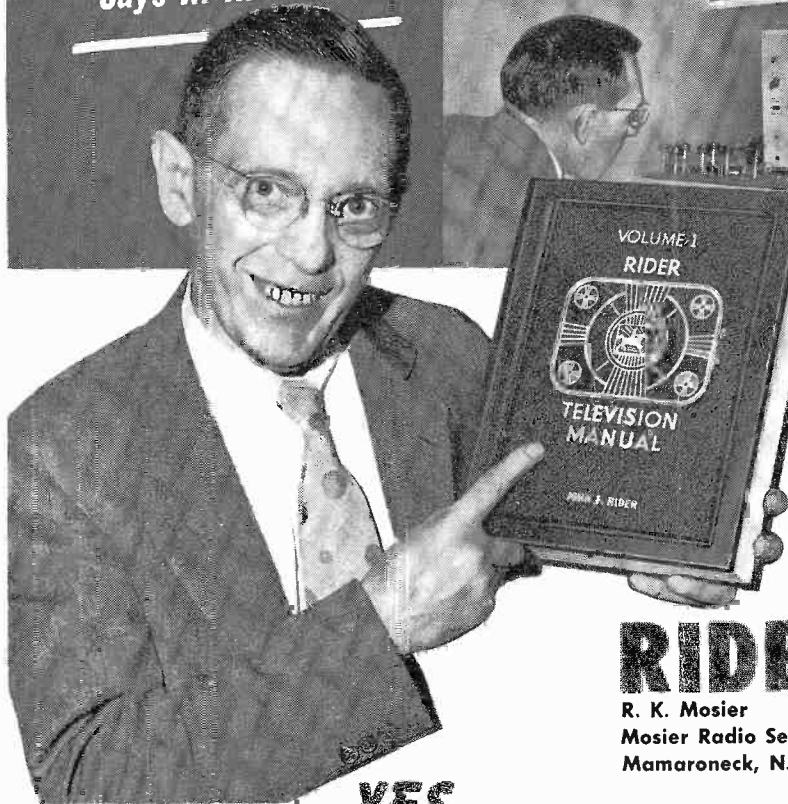

"We are fully aware of the importance of Television. It appears as the brightest spot for the future of all radio servicing. But TV, even with its surprisingly rapid growth, does not offer enough servicing volume to support our organization. We realize, as we prepare ourselves for the TV future, that we must continue to service AM radio as today's basic income of our business. That's why we now have a standing order with our wholesaler to keep us up to date with all the latest

RIDER MANUALS"

R. K. Mosier
Mosier Radio Service
Mamaroneck, N. Y.

YES... he has found, like thousands of other successful servicemen, that a complete set of *Rider Manuals* saves time, saves money, builds business. Each *Manual*, kept handy to the bench, is a source of ready reference for all sets from 1930 to 1948. Service data on 80% of the receivers now in American homes can be found only in the first fourteen volumes of *Rider Manuals*.

"Volume 1 **RIDER TELEVISION MANUAL** is up to the usual high standards of all the other *Rider Manuals*" —R. K. Mosier
Over 1400 Pages (equivalent of 2000 pages because of the 440 sq. inch GIANT SIZE schematics). PLUS 2 Separate Books... "HOW IT WORKS" and INDEX.....\$18.00
Includes everything needed on 1946-47 Television Receivers (complete and kit) of 34 leading manufacturers.

"We are equally pleased with the **RIDER PA MANUAL**"
—R. K. Mosier
The first industry-wide service manual covering products of all leading manufacturers of PA amplifying systems, manufactured since 1938 to date. 2024 pages.....\$18.00

... and you, too, should have all *Rider Manuals*

Volume XVII\$16.50
Volume XVI\$ 8.40
Volume XV\$19.80
Volume XIV to VII
(each volume)\$16.50
Volume VI\$12.50
Abridged Manuals I to V
(one volume)\$19.80
Record Changers and
Recorders\$ 9.00
Master Index, covering
Manuals, Vols. I to XV. \$ 1.50

JOHN F. RIDER, PUBLISHER, Inc., 480 Canal Street, New York 13, N. Y.
Export Agent: Rocke International Corp., 13 E. 40th St., N.Y.C., Cable, ARLAB.

On the Way...

VOLUME

18

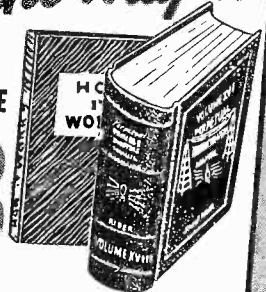

At Your Jobber's Soon
2000 Pages PLUS Separate
"HOW IT WORKS" BOOK

Rider Manual data is RELIABLE, the OFFICIAL AUTHORIZED data right from the Service Departments of the set manufacturers themselves. They know the correct procedures for their sets, and have cooperated fully in getting this authoritative data to you through *Rider Manuals*. Successful servicemen know that they can turn to a *Rider Manual* for all the information they need on any set brought into the shop. They know that the *Rider-Exclusive "Clarified Schematics"* provide time-saving breakdowns of multi-band jobs; that with Volume XVIII even wire recorders are covered, along with FM and AM sets and record changers. ONLY RIDER GIVES YOU SUCH COVERAGE!

Both books, complete.....\$1980

RIDER MANUALS mean *mean* **SUCCESSFUL SERVICING**

NOTE: The Mallory Radio Service Encyclopedia, 6th edition, makes reference to only one source of radio receiver schematics—Rider Manuals.
ANOTHER NOTE: The C-D Capacitor Manual for Radio Servicing, 1948 edition No. 4, makes reference to only one source of receiver schematics—Rider Manuals.



As another year draws to its close, we pause in retrospect of what has gone behind . . . and think wishfully of what is yet to come. To all our friends we are anxious to extend the very warmest greetings of the seasons. It is our sincere wish that this holiday season hold every gladness for you and yours. And may the New Year ahead be one rich in happiness. Our thanks to you for past business favors, and your help in even further establishing the name RADIART VIBRATORS as the leader in the field. It is our pledge to continue to deliver the best in vibrators — to keep faith with you — and your customers.

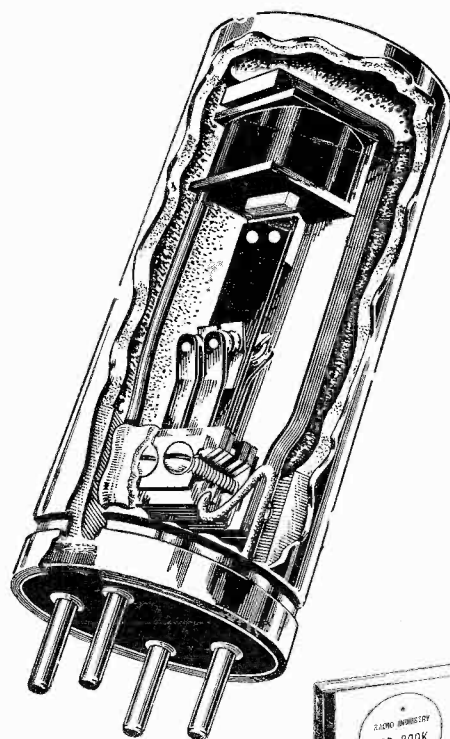

THE ONLY VIBRATOR LINE LISTED IN SAMS' RED BOOK

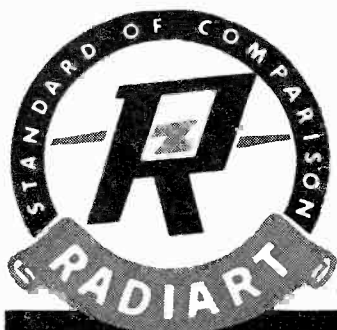

The Radiart Corp.

CLEVELAND 2, OHIO

EXPORT-SCHEEL INTERNATIONAL, 4237 N. LINCOLN AVE., CHICAGO 18, ILL.

RADIO

MAINTENANCE

INCLUDING
ELECTRONIC
MAINTENANCE

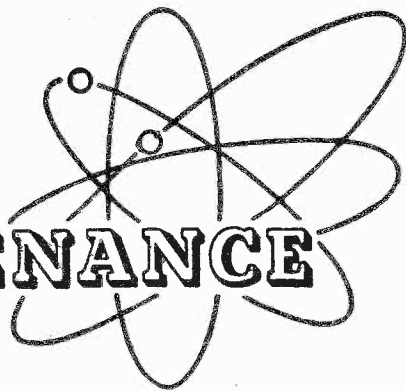

Volume 4

DECEMBER 1948

Number 12

CONTENTS

Electronically Speaking	4
Customer Confidence is Important	6
Business practices for the radio man	A. K. O'Brien
FM Detectors, Part II	8
The second article in the FM detector series	J. Richard Johnson
How to Clear Up the Picture	11
Hints on overcoming TV receiver interference	Max Alth
Maintenance of Wire Recorders	14
Experiences with the Peirce 55B	Willard Moody
Checking TV Receiver Linearity	16
Using the Philco Crosshatch Generator	Allan Lytel
Time Savers	18
H. Leeper	
The Notebook	30
The Industry Presents	32
Over The Bench	34
John T. Frye	
Review of Trade Literature	37

WILLIAM F. BOYCE
Publisher

JOSEPH J. ROCHE
Editor

VICTOR M. TURNER
Art Director

MORTON SCHERAGA
Contributing Editor

THOMAS A. BYRNES
Director of Field Services

AL JOHNSTON
Circulation Manager

ADVERTISING REPRESENTATIVES

Eastern
Herbert J. Olsow
480 Lexington Ave.
New York 17, N. Y.
Plaza 9-0861

Midwestern
Stuart J. Osten
333 No. Michigan Ave.
Chicago 1, Ill.
Dearborn 2-3507

Copyright 1948, Boland & Boyce, Inc.

Radio Maintenance is published monthly by Boland & Boyce, Inc., at 34 No. Crystal St., East Stroudsburg, Pa., U.S.A.; Executive and Editorial Office, 460 Bloomfield Ave., Montclair, N. J. Subscription Rates: In U. S., Mexico, South and Central America, and U. S. possessions, \$3.00 for 1 year, \$5.00 for two years, single copies 40 cents; in Canada, \$3.50 for 1 year, \$6.00 for 2 years, single copies 45 cents; in British Empire, \$4.00 for 1 year, \$7.00 for 2 years, single copies 60 cents; all other foreign countries, \$5.00 for 1 year.

Entered as second class matter July 13, 1946, at Post Office, East Stroudsburg, Pa., under the Act of March 3, 1879.

Change of address: Four weeks' notice required for change of address. When ordering a change, please furnish an address stencil impression from a recent issue if you can. Address changes cannot be made without the old stencil as well as the new one.

First again

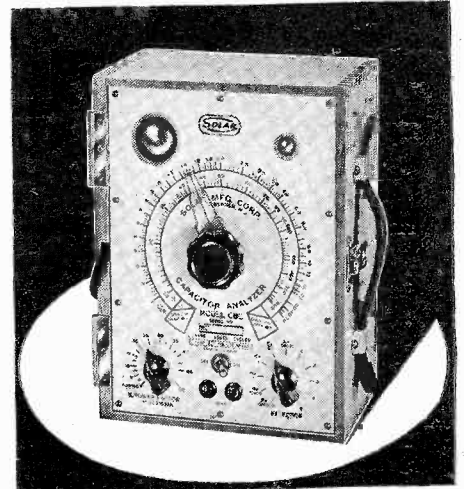

with radio men!

Again this year, radio service men are showing an overwhelming preference for Solar capacitor analyzers—specifically for Model CBC, worthy successor to Solar's famous Model CB, which out-sold all other capacitor analyzers combined.

Model CBC is small in size, light in weight, big in performance and dependability... the ideal low-cost instrument for the service industry:

- Capacitance range... 10 mmf to 800 mf
- Power factor range... 0 to 50 per cent
- Resistance range... 100 to 7,000,000 ohms
- "Quick as a wink" Magic Eye Wien bridge balancing
- Built-in adjustable voltage power supply
- Simplified leakage and Insulation Resistance tests
- Easy to read clear scales

Write today for Bulletin IN-3, which also includes description of Model CF, the Analyzer with the remarkable patented "Quick-check."

SOLAR CAPACITOR SALES CORP.
NORTH BERGEN, NEW JERSEY



SOLAR CAPACITORS

"Quality Above All"

TRANSVISION



NEW Television Kits, and Equipment Important Advances in TV Reception and Servicing!

NEW 10" TV KIT

at amazingly LOW PRICE!

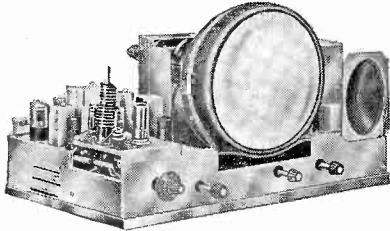

MODEL 10A TV KIT

The new Transvision Model 10A electromagnetic TV Kit gives a bright, stable 52 sq. in. picture. Has 10" picture tube, and **CONTINUOUS TUNING** on all 12 channels. Its high sensitivity makes for improved long distance reception; especially good on high channels. Complete with all-channel double-folded dipole antenna and 60 ft. of lead-in wire.
MODEL 10A TV KIT, less cabinet.....Net \$199.00
MODEL 12A TV KIT, same as above, but has a 12" picture tube.....Net \$263.00

NEW STREAMLINED CABINETS

for Transvision Model 10A or 12A TV Kit. Made of select grain walnut with beautiful rubbed finish. Fully drilled, ready for installation of assembled receiver.
Walnut Cabinet for 10A or 12A (Specify).....Net \$44.95
 Mahogany and Blonde slightly higher.

TRANSVISION ALL-CHANNEL TELEVISION BOOSTER

To assure television reception in weak signal areas, or areas which are out of range of certain broadcast stations, Transvision engineers have designed this new booster. It increases signal strength on all television channels. **Tunes all television channels continuously.** Can be used with any type of television receiver. Unusually high gain in upper television channels.
Model B-1.....LIST \$44.95

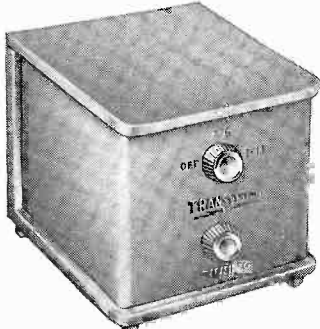

ALL-CHANNEL BOOSTER

TRANSVISION REMOTE CONTROL UNIT KIT

Will operate any TV receiver from a distance. Turns set on, tunes in stations, controls contrast and brightness, turns set off. Ideal for installations where the television receiver is inaccessible. Tuner unit is a high gain, all-channel unit with about 50 micro-volt sensitivity. Easy to assemble in about an hour.
Model TRCU, with 25 feet of cable.....Net \$69.00
 Without cabinet.....Net \$65.00

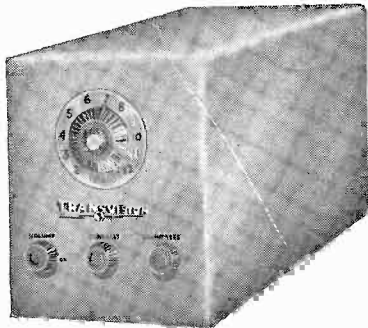

REMOTE CONTROL UNIT KIT

NEW . . . TRANSVISION SWEEP SIGNAL GENERATOR FOR TELEVISION AND F.M.

Complete frequency coverage from 0-227 MC with no band switching. . . . Sweep width from 0-12 MC completely variable. . . . Accurately calibrated built-in marker generator.

OUTSTANDING FEATURES: (1) Frequency range from: 0-227 MC. . . . (2) Dial calibrated in frequency. . . . (3) Sweep width from 0-12 MC completely variable. . . . (4) Self-contained markers readable directly on the dial to 5% or better. (No external generator required to provide the marker signals). . . . (5) Crystal controlled output makes possible any crystal controlled frequency from 5-230 MC. . . . (6) Plenty of voltage output—permits stage-by-stage alignment. . . . (7) Output impedance 5-125 ohms. . . . (8) Directly calibrated markers 20-30 MC for trap, sound and video IF alignment. . . . (9) RF for alignment of traps for IF channels when a DC volt meter is used as the indicating medium. . . . (10) Unmodulated RF signal to provide marker pips simultaneously with the main variable oscillator. . . . (11) Markers can be controlled as to output strength in the pip oscillator. . . . (12) Power supply completely shielded and filtered to prevent leakage. . . . (13) All active tubes are the new modern miniature type. . . . (14) Phasing control incorporated in the generator.
MODEL NO. SG.....Net \$99.50

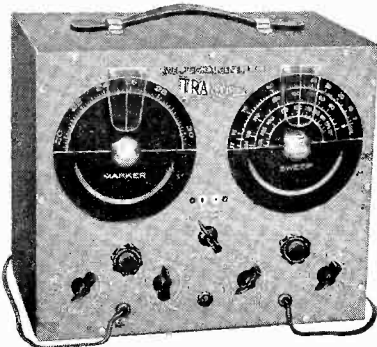

SWEEP SIGNAL GENERATOR

NEW 8-PAGE CATALOG showing complete Transvision line now available at your distributor, or write to:

TRANSVISION, Inc. Dept. RM **New Rochelle, N. Y.**

In Calif.: Transvision of California, 8572 Santa Monica Blvd., Hollywood 46

All prices 5% higher west of Mississippi; all prices fair traded. All prices subject to change without notice.

Radiomen . . . You Can Get Into the
TELEVISION BUSINESS
 In a BIG WAY with the
TRANSVISION DEALER PLAN

WRITE FOR FOLDER D-1

ELECTRONICALLY SPEAKING

On Sunday, October 10, 1948, empowered delegates from nine Radio Technicians Guild units in New York State and the New England States, met in Rochester, N. Y., to discuss the details of the formation of a national association of Radio Technicians Guilds. Delegates to the Rochester meeting voted unanimously to effect a national organization immediately. They approved the constitution of an organization which is to be known as the American Radio Technicians Guild, incorporated under the laws of the State of New York. The first annual meeting of the new organization will be held in June 1949.

A major stride toward the introduction of giant-screen television in motion picture theaters was made at the Hotel Jefferson in St. Louis, when RCA unveiled the new experimental television projector for the first Midwest showing of 20 by 15 foot television pictures, using improved projection equipment. Engineering of the new projector stemmed from the development of a 7-inch kinescope or picture tube, for operation at 80 kilovolts. Use of the 7-inch tube has made possible shrinkage of dimensions of the entire optical system. In operation, pictures appearing on the face of the picture tube are caught by a saucer shaped mirror and reflected through a correcting lens directly to a viewing screen. A



Sidney C. Patrette (on left), radio serviceman of San Jose, California, receives the July prize in the Hytron Servicemen's Contest from Russ Hines, Hytron Representative (on right). Frank Quement of Frank Quement, Inc. looks on.

20 x 15 foot screen image, suitable for the average motion picture theater, is obtained with the projector located 40 feet from the screen.

Passengers between Washington and Chicago aboard a non-stop DC-4 flight of Capital Airlines are now enjoying the latest in entertainment as they watch a Philco television set. First run for this new "Television Express" was on October 9, on the flight leaving Washington at 12:30 P.M., and the passengers were able to watch the entire fourth game of the World Series, and then part of the Notre Dame-Michigan football game. Good reception was obtained from stations up to 180 miles away, as the plane flew at an altitude of approximately 10,000 feet. Plans are now under way to extend this television service to other flights.

The FCC has decided that it can not grant approval to any of the over 300 applications for new television stations now pending, until it has made a thorough study of TV frequency allocation. The Commission also announced that no action would be taken on any new applications until this study is completed. The reason for the suspension of station approval was the increased crowding of the bands and the growing number of complaints about station interference. This decision of the FCC will not affect the stations now operating. The chairman of the Commission also pointed out that the usefulness of receivers now on the market or installed will in no way be affected. The plan now is to have an engineering conference study the problem and recommend a new allocation table. At a later stage, the conclusions of the engineering conference will be discussed at industry conferences; and subsequently a new national television allocation plan will be established.

A sealed-in device which automatically turns off an automobile's television set when the car is in motion is the answer to safety officials' concern over the advent of auto video. Now being perfected by the Hallicrafter Co. is a small auto television set with a tamper-proof device which does just that. A companion unit is a back seat set which is not affected by the shut-off device, and

→ to page 38

THE NEW DU MONT TYPE 274-A OSCILLOGRAPH IS EVEN BETTER FOR

**RADIO and
TELEVISION
Servicing**

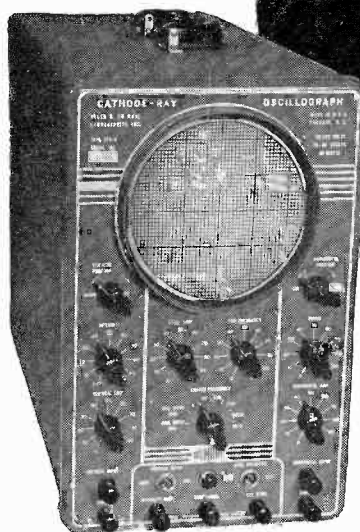

**TWICE THE BAND WIDTH!
THREE TIMES THE
SENSITIVITY!**

★ With several notable improvements over its predecessor, the Du Mont Type 274, this new Du Mont Type 274-A is an even finer instrument for the job of radio and television servicing.

An improved vertical deflection amplifier offers a sensitivity of better than 0.2 rms volt/in., and a range (within 30%) of 20 cps to 100 kc in frequency response.

As a result, in your servicing of both radio and television receivers, you can now look at *more parts* of *more*

circuits with still greater accuracy and therefore *better results*.

For example, you can see *lower level* signals and you can handle *more parts* of the detector and i-f circuits. You can now minimize "hum" troubles more easily, and you can do a better job on sync circuits as well as on other circuits of television receivers.

In fact, with the new Type 274-A, you can't miss doing an all-around, bang-up, more satisfactory and therefore more profitable job. And remember, the new Type 274-A still has the big, 5-inch tube!

Cat. No. 1420-A with 5BP1-A..... \$136.50

Cat. No. 1422-A with 5BP11-A..... \$139.25

DU MONT

**ALLEN B. DU MONT
LABORATORIES, Inc.**

Passaic • New Jersey

Cable Address: Albeedu, Passaic, N. J., U. S. A.

CUSTOMER CONFIDENCE IS IMPORTANT

by A. K. O'Brien
United Radio



The author of this article writes: “. . . Obviously, I am not a writer, but I am prompted to submit this article because of the appalling situation existing locally, which situation I have reason to believe is not unique to this locality. There are numerous shops here operated by men lacking in business experience who in their desperation are following practices which will result in their own financial ruin and harm to the radio service industry as a whole. I sincerely hope that application of some of the ideas presented may help in preventing a complete debacle. I have made a new start since the war ended, and have successfully applied the principles recommended.” We would like to hear from our readers concerning their reaction to this serviceman’s idea.

A RECENT survey in a large city regarding cheating by a group of radio servicemen again spotlights one of the most vital questions of the day relating to the radio service industry and particularly to the independent serviceman-dealer.

I, as a practical serviceman, am especially concerned with those ex-soldiers without previous business experience who have risked their hard earned savings in a little shop. They may easily become victims of the pitfalls that lead to bankruptcy and disillusionment, which will tend to embitter them against the free enterprise system.

At the outset let me state my firm belief that any man with the intelligence required to become a qualified radio technician will do business strictly on the level from the start. He will surely do so after he finds out that honest business is the only consistently profitable business.

The fabricated charges or cheating problem is not a new one. In reality, it is not a deep seated problem, but a symptom of underlying disorders and difficulties which beset those

engaged in a very difficult and complicated business. These troubles pester the old established serviceman in the same manner as they do the new man entering the field, but in order to state problems and search for solutions, let us examine the usual procedure followed in opening a radio service business.

Our young technician finds a store in what appears to be a thriving community center. If the rental charges mean anything, the neighborhood must be very good indeed. He did not overlook the one or more shops already operating in the immediate vicinity.

He invests a major portion of his capital in the usual fixtures, working stock, test equipment, and car or truck for making house calls. If he has any money left after setting aside the essential cash reserve he decides to stock a leading brand of radios in order to pick up some easy money on sales. This is when he gets his first shock: No franchise is available in his territory regardless of his qualifications. This means that he will be forced to stock off-brands

bought from ordinary suppliers with none of the juicy discounts. This situation can be met to some degree through offers made in radio trade magazines. Getting on the mailing list of some of these firms will result in some very profitable transactions and will also enable the serviceman to compare prices with those charged locally.

The new shop owner has one advantage in that he has accumulated no war time ill-will which he now has to overcome. But he does not as yet have any good will. If his competitors are established and competent, all he can expect from their clientele is the disgruntled customer whose dissatisfaction may or may not be the fault of the competitor. He soon finds out that some customers are “like that.”

He then places an ad in the classified columns of the local newspapers, signing a six months contract to lower daily cost of insertion. He soon begins to wonder if anybody ever reads this section. Twenty-five ads have been counted in one local column during flush times, dropping to

half a dozen when business begins to tighten up. This type of advertising has its place, but does not produce immediate results in our field. He will be likely to supplement the newspaper advertising with hand bills which he pays boys to deliver.

One day a man comes in carrying a small ac-dc radio. (I select the ac-dc set because the series filament makes it an easy mark for the cheater). The customer reports that the radio just took a sudden notion to quit playing. (The estimate charge question is being disregarded as it is a regional matter. I have never been able to apply it successfully in my scene of operations and I am attempting to report my own personal experience and observation.)

This is our new shop owner's first opportunity to sell himself, although it has never occurred to him that he is a salesman as well as a technician. (Every shop owner should take advantage of a night course in salesmanship.) He should bear in mind that he must merit the customer's confidence in his integrity and truthfulness and that technical and business ability will not suffice where customer confidence is missing. Experience has shown that the customer will buy off-brand products if recommended by the serviceman-dealer in whom he has that all important confidence.

Returning to the ac-dc set, let us assume several possible conditions:

Condition 1

As he plugs in the radio, our mechanic discovers that a.c. is not reaching the set through the plug. He should put on a new plug immediately. If the radio lights up, let it get warm and then check it aurally for troubles. Point these troubles out to the customer, but if he says he will play the radio as it is, charge him only the retail price of the plug plus not more than a few additional cents.

Condition 2

He finds the notorious broken wire, loose tube, shorted antenna, etc. I firmly believe that, like it or not and even in violation of sound business principles, small jobs of this type will have to be donated under present conditions and charged to good will. Since our friend has already spent several dollars getting this man into the shop, isn't it common sense to invest a little more and

thus take no chance of losing the good will of a neighbor and a possible future customer?

Condition 3

The radio does not light up when a.c. is applied, necessitating checking of the tubes. One tube with open filament is found. After taking the usual precautions, a new tube is placed in the radio. It then plays. If a check indicates the need, place one or more tubes in the set and call the customer's attention to the improvement in performance. Also point out other trouble apparent by this time, such as hum, distortion, etc. If at any point he stops you, charge him only the retail price of the tubes he wants put in the set but warn him of future troubles. If it is probable that the rectifier may be damaged soon, advise him that you cannot give regular guarantee on this tube and give him the reasons.

Do not make a service charge, or he may try to hold you responsible for the future operation of the entire radio. (We are assuming that an accurate indexed file is kept of all job tickets so that information may be at hand in case of complaint.) More on the guarantee problem later.

Condition 4

In this case the radio needs bench testing, and expensive repairs are indicated. I believe that where a regular service job is done, it is best to do a complete repair job, rather than a patch job, as it is very likely that the customer will expect you to guarantee the performance of the entire radio for the guarantee period or longer. The estimate must be made with detached objectivity. Do not be swayed by the customer's statement that he won't spend much on it. And do not be influenced by the fact that he may take the job to a competitor if your price appears too high. Never permit the customer or your competitor to make your prices.

(Much has been written on the subject of charges based on the actual cost of doing business. There are many of these costs, both apparent and hidden. Don't overlook bad checks, lost accounts, vehicle expense and depreciation, instrument depreciation and obsolescence, free services and amortization of starting costs, etc. I give no credit on repair work, but as a corollary handle complaints promptly and fairly.)

Under condition 4 it is a common experience nowadays to find that the cost of repairing a small set often exceeds the price paid for it. Any radio can be made to operate properly, but in cases of this kind, do not give an estimate as the customer may be shocked and sincerely believe that you are attempting to overcharge. It is better to tell him frankly that while you can repair the radio, the cost would be prohibitive in relation to the value of the radio. True, he may take the set to another shop where a patch job will be done, but don't let that worry you. The shop that does the job will inherit the headache and the customer will come to place confidence in you rather than the competitor, when your predictions come true.

If you decide to give an estimate on the set, be sure to allow for troubles which develop after the set gets hot, such as noisy tubes, drifting coils, noisy speakers, etc. If you suspect these conditions request that the customer leave the set long enough to permit a thorough examination, unless questioning the customer has given enough information for a fair estimate.

Never start a job before the customer knows how much it will cost.

Label all parts installed and never charge for a part not used.

Now we come to the root of our trouble: The guarantee. Undoubtedly the fear of a complaint is the chief underlying cause of a good many cases of so-called dishonesty.

Experience shows that whether the customer pays 50 cents or fifty dollars for a job, he expects the radio to perform like new for an indefinite period. Knowing this the serviceman has an urge to add some arbitrary amount to protect himself. This results in the overcharging of some customers, while others actually get jobs done for less than cost.

Cures

Satisfaction has been gained through a system whereby a customer is given an opportunity to buy insurance at a stated fee, based on the size and complexity of the set, covering those parts not replaced. As a part of this plan, two colored invoices are used, one stating that the set is only partially guaranteed, and the other setting forth the rules

→ to page 39

FM DETECTORS — PART II

by J. Richard Johnson

TWO IMPORTANT NEW FM DETECTOR CIRCUITS ARE DISCUSSED HERE: THE SINGLE STAGE LOCK-IN OSCILLATOR AND THE SUPERREGENERATIVE TYPES

IN the servicing of FM receivers, the detector circuit is of vital importance. The quality of the output signal is largely determined in this section and directly affected by detector adjustments. It is so completely interrelated with other portions of the receiver that misadjustment of the front end of the i-f section can impair detector operation.

These important relations were emphasized in our previous article, in which we considered the operation of discriminators and ratio detectors. In this article we shall discuss two important new FM detector circuits. These are the single stage lock-in oscillator, and the superregenerative (Fremodyne) types.

Oscillator Locking Action

Two basic principles are involved in the operation of the lock-in oscillator detector, used in Philco FM receivers. The first principle involves the synchronizing, or locking action resulting in an oscillator circuit when a strong external signal of nearly the same frequency is injected into the oscillator circuit.

Suppose, for instance, that the circuit of Fig. 1 is oscillating at a frequency of 1000 kc. If a strong 1001 kc. signal is now injected at points *a* and *b*, the oscillator frequency tends to change from 1000 toward 1001 kc. If conditions are right, the oscillator frequency may change completely to 1001 kc. and coincide exactly in both frequency and phase with the injected signal. Changes in frequency of the injected signal, if not too great, are then followed exactly by the oscillator frequency.

The conditions for locking are the inherent instability of the oscillator and the strength of the injected sig-

nal. The less stable an oscillator is and the lower the effective *Q* of the tuned circuit, the easier it is to make it lock with the external signal. The stronger the injected signal, the greater influence it has on the phase and frequency of the oscillator.

An example of the synchronizing action described above is the sync circuit of a television receiver. There the sync pulses from the video signal are fed to the circuit of a blocking oscillator or a multivibrator. The oscillator frequency locks to the sync pulses in both phase and frequency

Lock-in Detector Operation

The basic circuit diagram of the lock-in oscillator detector is illustrated in Fig. 2. It consists of three fundamental parts:

1. Tuned input circuit such as

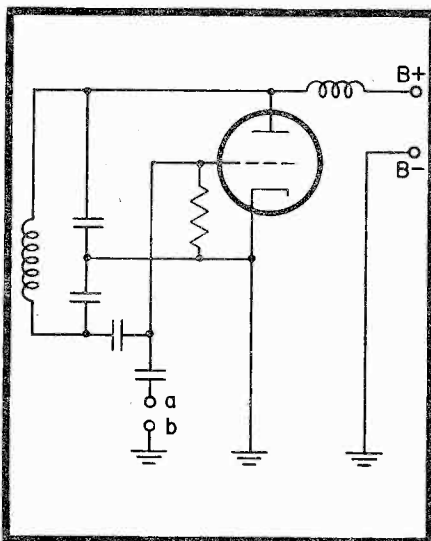

Fig. 1. A relatively strong signal injected into the grid circuit of the simple oscillator (Colpitts) causes the oscillator frequency to "pull" toward the frequency of the injected signal. If the frequencies are near enough to each other, the oscillator frequency can "lock" to the injected signal and follow all its frequency changes.

found in nearly every detector (T1).

2. Local oscillator circuit, whose tuned circuit is L3-C3.

3. Plate feedback circuit provided by L4, etc.

L3-C3, R1, C5, the cathode, and first and second grids of the tube form a Colpitts oscillator circuit, tuned to oscillate at the intermediate frequency. R1 and C5 provide oscillator bias, and r-f choke RFC provides a d-c return for the cathode without shorting the r-f voltage on that element.

The components are so designed that the input signal and the oscillator signal appear in the plate circuit as a series of pulses. These pulses are fed back in T2, 90 degrees out of phase, so as to give the effect of reactance and keep the oscillator frequency locked to the incoming signal. R2 loads the circuit so that the effect of the frequency variation of the oscillator from the center value on the plate current is linear. As the oscillator is "pulled" away from its free frequency, the plate current variations resulting develop a varying voltage across R3, which is the audio output of the detector. R2 is a sufficient load to make the plate variations closely proportional to frequency variation of the oscillator, in the frequency range of operation.

This fact is very important to the serviceman. For instance, if R2 should age and take on a somewhat higher value, circuits of T2 have a sharper frequency response. This causes non-linearity in the output curve and introduces distortion.

A special tube is employed with the lock-in single stage detector. This tube is the FM-1000. It resembles a converter but is especially designed for this special application.

A very important advantage of this

type of detector is its adjacent channel selectivity. Only a signal to which the local oscillator of the detector is locked will produce any a-f output signal. Thus an interfering signal which would be audible in ordinary detectors cannot be heard in this detector as long as its frequency (center) is slightly removed and/or its signal strength is somewhat less. An interference signal must be almost as strong as the desired signal to break the lock between the desired signal and the local oscillator. In fact, the stronger of two signals operating on the same channel can be separated by this detector in many cases in which other detectors would be ineffectual.

Fremodyne Detector

Another type of FM detector applied to home receivers is the Fremodyne, developed by Hazeltine Laboratories and used by several receiver companies. The Fremodyne is a combination superheterodyne mixer, local oscillator, i-f stage and second detector. It therefore cannot be considered as a replacement or substitute for the detectors previously discussed. When used, it constitutes the complete receiver in itself, except for an additional a-f amplifier. As a complete receiver it is only slightly less sensitive than many of more conventional design, and the quality of output is satisfactory. At the same time it allows a complete receiver to be built using only two tubes and very compact in overall dimensions.

The basic circuit of the Fremodyne is shown in Fig. 3. Ordinarily a dual triode is used (in this case a 12AT7). V2 is the oscillator, serving the same purpose as the heterodyne oscillator in any superheterodyne receiver. Voltage from this oscillator is applied to the grid of V1 through small mica condenser C14.

V1 has three important functions, as follows:

Mixer function. The signal from the local oscillator mixes with the incoming i-f signal in V1, which thus acts as a triode mixer. An intermediate frequency signal is thus produced.

I-F amplifier function. The i-f signal formed by the mixing action at the grid of V1 is amplified and appears in amplified form in the plate circuit of V1.

Superregenerative detector function. L3, C3, C4, and the tube form

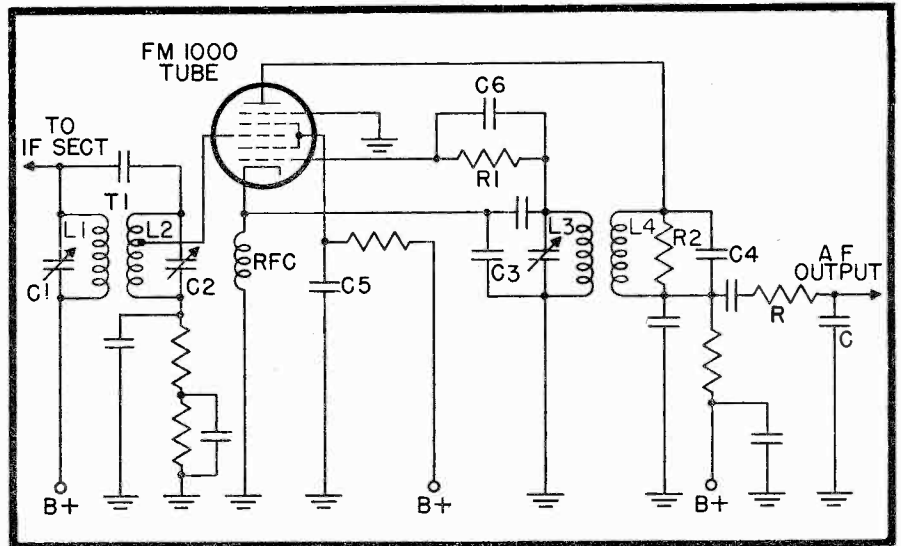

Fig. 2. Basic circuit of the lock-in oscillator single stage detector, such as used in Philco receivers.

a Colpitts superregenerator. Since the action of a superregeneration is not used in any other way in home receivers, a digression on the theory is in order here.

The regenerative oscillator detector, shown in Fig. 4, was once popular for broadcast reception. Although unstable and not consistent in operation (to say nothing of radiation about the neighborhood!) this detector is very sensitive because its operation is near the point of oscillation where there is considerable regener-

ation.

In the superregenerative detector, the oscillatory circuit is made to go in and out of oscillation at a supersonic rate. The detector is thus kept much nearer to steady oscillation than is possible in the regenerative type. It is, therefore, more sensitive. This is the principle applied in the detection portion of the Fremodyne circuit.

The superregenerative detector was first applied to the reception of AM signals. In this case, however,

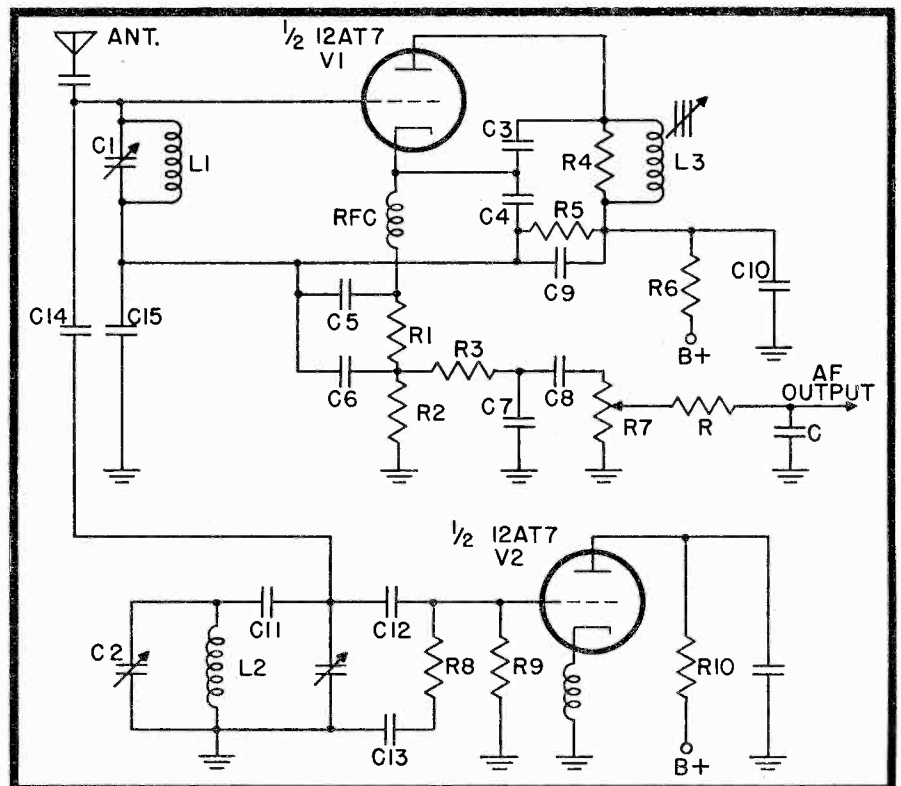

Fig. 3. Circuit of the Fremodyne special superregenerative type FM converter and detector.

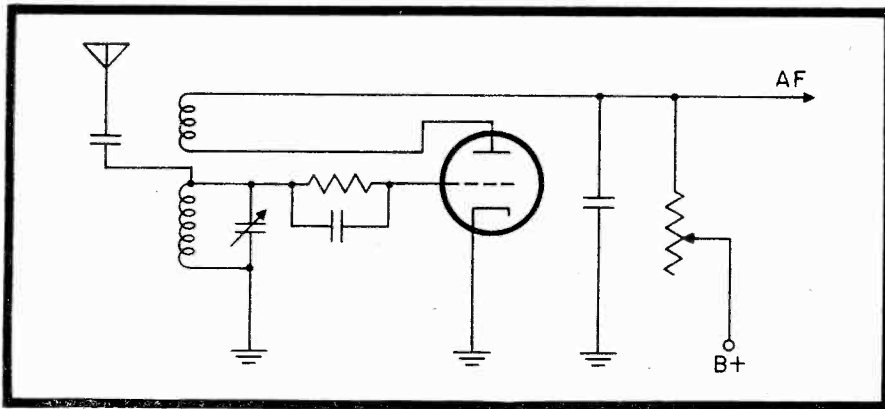

Fig. 4. The regenerative detector illustrated in this diagram was once very popular for broadcast reception, and is famous for its sensitivity. The superregenerative detector carries the basic principle one step further and is even more sensitive.

FM demodulation is possible by a slight detuning from the received signal's center frequency so as to operate on the side of the resonance curve. This method is often referred to as "slope" detection and was used in many prewar television receivers to adapt them to the FM sound channel.

The high sensitivity of the superregenerative detector has made it very popular in small, portable high frequency communications equipment. In the Fremodyne circuit, it accounts for the relatively strong a-f signal output available for input FM signals of reasonable signal strength. The use of a dual triode tube, and the need for only one additional stage for a-f amplification, make for an ultra-compact two tube complete FM receiver.

Another feature of the Fremodyne circuit is that very little alignment is necessary. Tracking a two gang condenser for oscillator and mixer tuning is about all that is required. The intermediate frequency is not critical and need be kept only sufficiently accurate to prevent discrepancies in the dial reading.

De-emphasis Circuits

A necessary part of the detector output circuit is the de-emphasis circuit (R and C in the detector diagrams). This circuit is required because of the pre-emphasis applied to the signal at the FM broadcast station.

The object of using pre-emphasis and de-emphasis is the reduction of noise developed in the transmission and reception of the signal. Although the FM method, and the auxiliary circuits used with it, are designed to discriminate against noise, these mea-

asures are not perfect, and there is always a threshold of minimum signal strength and modulation degree at which noise starts to become audible. Additional reduction of noise allows more signals to be received without interference, even though it may not appreciably affect the performance on strong stations. Also, even on the strongest stations, there is a tube noise level in the receiver output signal which can be greatly reduced by de-emphasis.

The operation of emphasis — de-emphasis is as follows:

1. At the FM broadcast station, the audio frequency components of the modulation signal are amplified in an amplifier with a special frequency characteristic. This characteristic, illustrated in the graph of Fig. 5, causes the audio components of highest frequencies to be amplified the most.

2. The FM signal, with the a-f signal treated for high frequency emphasis, is transmitted to the receiver and demodulated in the receiver's FM detector. Because of pre-emphasis, the demodulated a-f signal has the high frequency emphasis given it at the transmitter.

3. Meanwhile, the usual amount of noise components has been added to the signal during transmission and reception. The addition of this noise bears no relation to the emphasis on the a-f signal, but a large proportion of the noise components have frequencies in the emphasized range.

4. At the receiver detector output circuit, the de-emphasis circuit applies a compensating effect to the a-f signal. This compensating effect is designed to bring the a-f characteristic back to the condition in which the high frequencies are in proper proportion to the other lower frequency components. This of course means that the higher frequency components are suppressed to where they are relatively no stronger than the low frequency ones.

5. The noise components of the signal, being more numerous in the high frequency range, are at the same time suppressed in the same proportions. Since these noise components were not previously emphasized they are now reduced to a very low level while the high frequency a-f components are being returned to normal.

The emphasis applied at the transmitting station is adjusted to a

→ to page 36

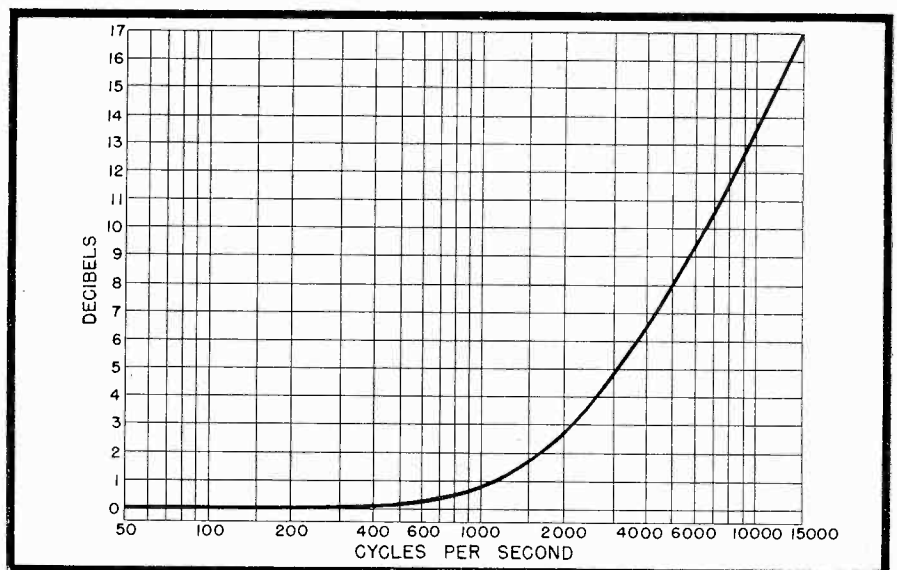

Fig. 5. FCC graph showing pre-emphasis characteristic curve.

HOW TO CLEAR UP THE PICTURE

Techniques and tricks you can use to eliminate interference from TV receivers.

by Max Alth

A FREQUENT and often difficult problem facing the serviceman installing television receivers is interference. The eye is so much more quickly tired and annoyed than the ear, and the TV band is so wide, that interference-free locations are far and few between.

The solution of this problem is often difficult, and occasionally downright impossible. It can be summed up in these words: *Increasing the signal to noise ratio*. Raising the level of the picture signal fed the receiver, or lowering its noise content, or both, will improve the quality of reception.

To simply throw more antenna on the mast, or to install a preamplifier without first considering the nature of the interference is a waste of time.

The problem should be carefully and logically attacked so that the interference may be recognized, its point of origin located, and its means of entering the set learned.

AM broadcast interference looks like a wire mesh across the screen. Its frequency being fixed, the pattern will always be cross hatched. It is usually confined to the immediate vicinity of a transmitting antenna, and since some of the newer AM stations can make grand maw's hearing aid burst into song within a five mile radius, the immediate vicinity is plenty of area.

Moving and redirecting the TV antenna does not help, since the signal blankets the area. Filtering the TV antenna input at the set helps. Reducing the lead-in pick-up helps. Where the interference is weak, and objectionable only because it is strong in comparison with the TV signal, increasing the TV signal by using more antenna, directing, raising antenna, preamp's, etc., all help.

FM interference is always on the

diagonal, its frequency changing almost constantly. A sort of herring bone pattern. The same methods used for combatting AM interference helps, the fight being a lot more difficult since FM is much closer to the wanted TV frequency.

Diathermy interference makes the picture seem as though it has gone under water, a wavy sort of effect. Filtering the antenna circuit is generally useless as the interference is very broad in frequency. Moving the antenna, reducing the lead-in pick-up, sharpening its pick-up pattern, all help. The best, and only certain cure is the elimination of the trouble at its source, when and if it can be found.

The diathermy oscillator should be completely shielded, and its power supply completely filtered. A metal or metal screen box should be placed all around the works, the parts of this box bonded into one electrical unit, and grounded. Standard or home made line filtering components may be used.

It is a waste of time to attempt to filter diathermy and other interference out at the set's a-c input. For one thing, the set already has as

much line filtering as will work, and r-f running up and down the a-c line can easily jump to the antenna lead, and the set components directly.

Auto ignition tears the picture apart. It comes and goes as the car passes.

Since most cars travel on the road, the solution is the raising or shielding of the antenna. This may be done with a false ground. It may be a metal screen placed beneath the antenna, or a series of rods, $\frac{1}{4}$ wave in length, fastened umbrella fashion to the mast a distance below the antenna. The antenna may be moved to the back yard side of the house. Its lead-in pick-up reduced, its pick-up pattern sharpened. A reflector and a director narrow the vertical pattern of the pattern, as well as the horizontal.

Ham interference is probably the worst to contend with. A ham signal can throw the picture out of sync., cross hatch the screen, draw black bands across it, produce fire flies when the transmitter is keyed, and sometimes the ham himself comes in on the audio channel. In some cases the ham interference can be so bad, it appears that the TV station is having trouble, and is going off the air.

The headache lies in that almost everything in the ham transmitter can cause trouble. Everything from the basic oscillator, up through the doublers to the final stage can generate harmonics which fall directly in the middle of the TV channel, the i-f frequency of the set, the sync pulses, etc. And it doesn't all have to come out the antenna.

The buffer stage of one transmitter, feeding a disconnected final feeding a disconnected antenna, interfered with TV reception eight miles away.

However, high powered ham transmitters can and have been operated

Some of the harmonic relations between amateur bands and TV channels.

(Figures in parentheses are ham bands)

TV CHANNEL	HAM BAND	HARMONIC
CHANNEL 1 44-50 Mc.		
CHANNEL 2 54-60 Mc.	(28 Mc.) (27 Mc.) (14 Mc.)	x 2 x 2 x 4
CHANNEL 3 60-66 Mc.	(21 Mc.)	x 3
CHANNEL 4 66-72 Mc.	(14 Mc.)	x 5
CHANNEL 5 76-82 Mc.	(27 Mc.)	x 3
CHANNEL 6 82-88 Mc.	(28 Mc.) (21 Mc.) (14 Mc.)	x 3 x 4 x 6

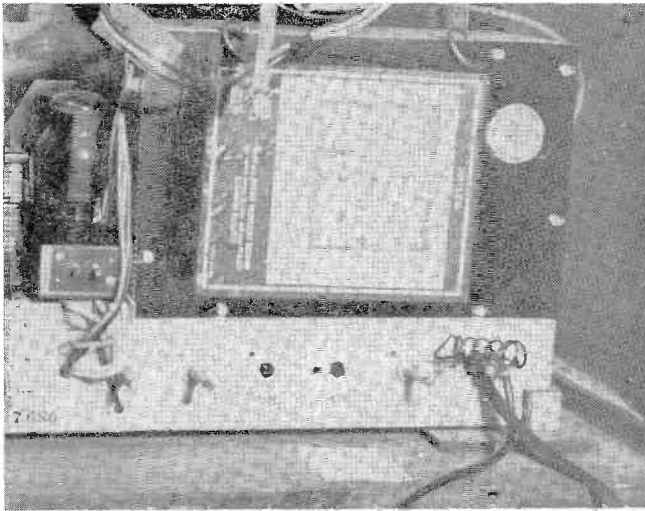

A home made transformer couples a 90 ohm line to a 300 ohm input. Six turns of heavy wire, wound on a half inch form, goes across the 300 ohm input. The coax taps, auto-transformer fashion on the coil.

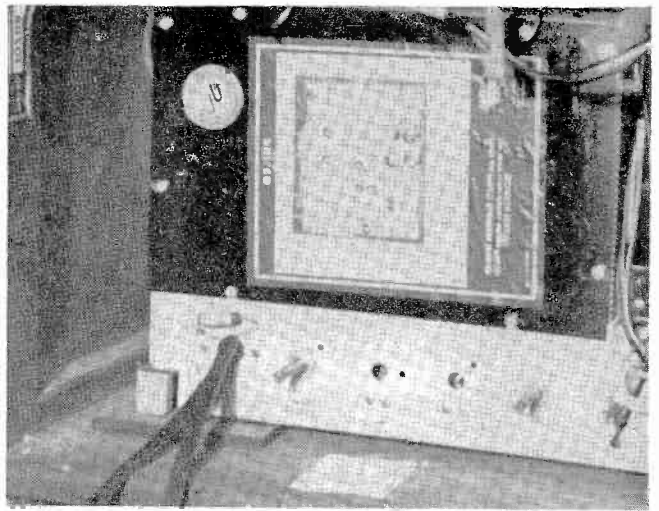

A layer of #23, D.C.C. wire wound over a 1/4 watt, 1000 ohm resistor, and connected across the antenna input will reduce AM and ham interference. (The interfering fundamental frequencies are shorted out).

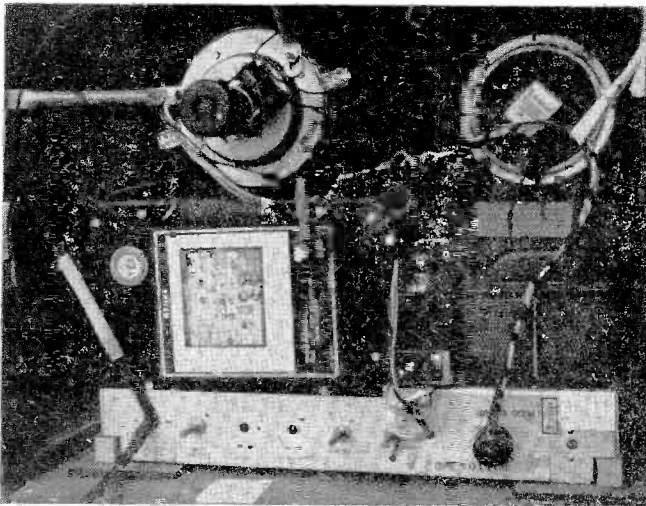

A length of 300 ohm line is connected across the antenna input. Four inches of aluminum, wrapped around the line, is moved up and down until the interference is minimized.



Trolley car, and auto interference was eliminated in this installation when the antenna was raised to 35 feet. At 15' and 25' the picture was unsatisfactory.



Twisting the antenna lead reduced interference pick up from nearby cars to a minimum.

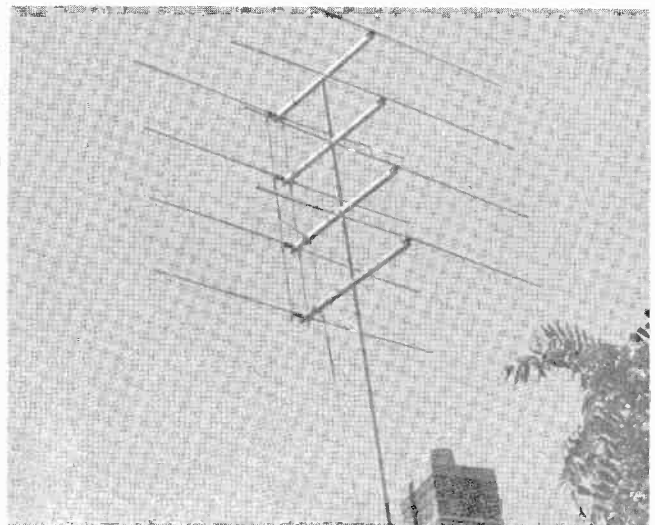

This multi-element array, necessary in weak signal areas, will pick up 7 to 9 db more than a single dipole.

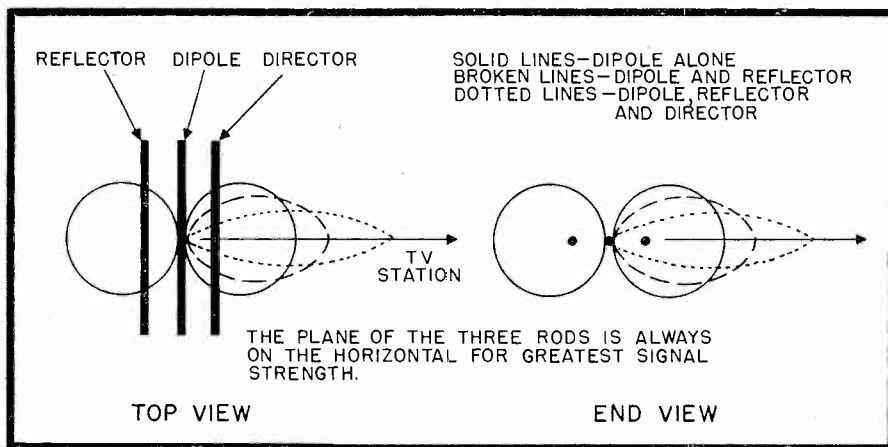

TV antenna pick up patterns.

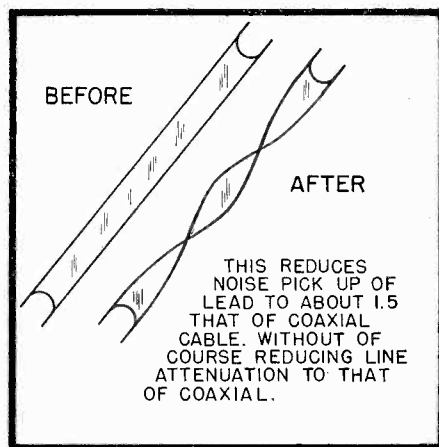

Transposing a 300 ohm line to reduce its pick up.

satisfactorily within a few hundred feet of TV antennas. The transmitters were properly shielded and the harmonics eliminated. And, the fundamental was filtered at the TV set.

The transmitter must be properly shielded. It must be fully metal, or metal screen enclosed on all sides, top and bottom. The metal parts forming the cabinet must be well bonded to one another. It helps to ground the cabinet. All the leads going in and out of this cabinet must be filtered; the a-c power line, the antenna for spurious signals, mike leads, remote relay leads, etc. Regular filters will do for the a-c line, and home made filters will also work well.

Harmonics of whatever frequency are being generated must be suppressed or at least confined to the transmitter cabinet. Traps and filters in the various oscillator circuits, and antenna coupling circuits will help. Exactly where and what will of course depend upon the individual transmitter.

It is a good idea to hold a telephone conversation with the TV set

owner while you fool with the transmitter.

The ham transmitter's fundamental frequency, which brings his cheery voice and black band across the screen into your TV set, cannot be suppressed without, of course, suppressing the ham. This frequency, and multiples of this frequency, or what have you, that interfere with the i-f of the TV set, etc., can be successfully trapped out at the TV antenna.

Interfering frequencies can be trapped out at the TV antenna provided they are comparatively fixed, narrow in frequency width, and far enough away from the desired signal. There are commercial filters for this purpose, or if you prefer, a simple, home made filter as described in the accompanying sketches.

Neighboring TV sets without r-f and preselector stages to isolate their oscillator from their antenna, can be quite a problem. They will cross hatch the screen, cause the audio channel to whistle, the picture to lose contrast, and to go out of sync en-

tirely.

The only real solution is the use of a preamplifier ahead of the offending TV set. There are advertised isolating traps, etc. But the offending frequency is too close to the desired frequency to permit very effective filtering. The offending oscillator is only the width of the i-f band away from the desired signal.

Moving the antenna, redirecting it, readjusting its pick-up pattern may help. It all depends upon the individual case.

These are the more common sources of interference. To mention a few others: Power leaks in transformers mounted nice and high on poles so that they can look your TV antenna right in the eye; defective neon signs; defective motors.

Ghosts, a different sort of trouble, but trouble nonetheless, are not always caused by reflections. A mistuned video trap circuit, and a mismatch in the antenna system can cause ghosts. This is checked by tuning to several channels. If the ghost

→ to page 41

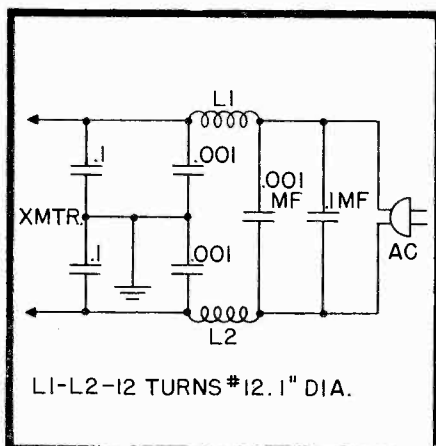

Line filter for ham transmitter power supply.

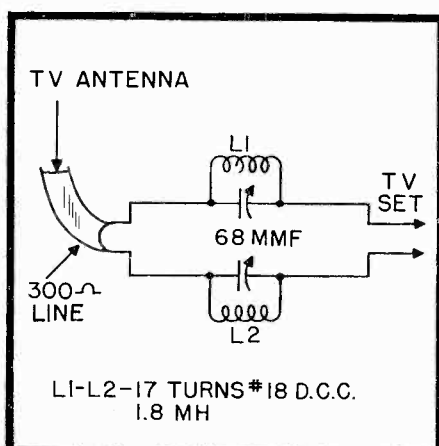

Trap for removing 14 Mc. ham signal from TV set antenna.

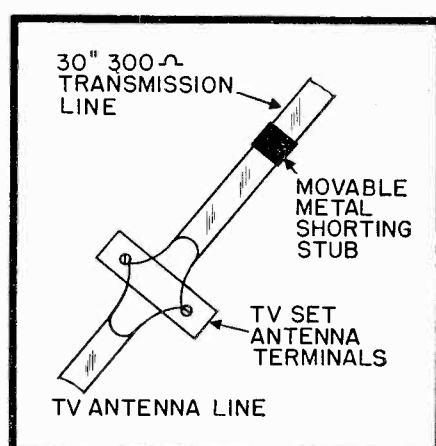

Home made wave trap used for interfering signals that are close in frequency to the desired signal.

MAINTENANCE OF WIRE RECORDERS

by Willard Moody

Here are the experiences of a serviceman with the maintenance of one type of wire recorder

THE magnetic wire recorder is a practical instrument which is finding application in business as an office dictating machine. It is also used in the home for recording radio programs, special events, and parties. As the fidelity is somewhat limited, it seems best suited at present to the voice range and is ideal for use as a dictating machine.

The wire recorder has no cylinders to be replaced or shaved. The wire can be used many thousands of times. When a new recording is to be made, the old one is "erased". However, it is not the purpose of this article to give the basic theory of wire recording, but to present the results of practical servicing experience with one specific type, the Peirce 55B, shown in Fig. 1, which is a representative and high quality instrument. The troubles that develop in other equipment, and their remedies, will be similar to a certain extent—just as in the case of radio set servicing, where similar circuits are encountered in the products of different manufacturers.

For the most part, the troubles seem to be more mechanical than electrical in nature. As far as the Peirce 55B is concerned, the operating voltages are moderate and the tubes have reasonably long life. A 5Y3 which does not show the same reading approximately for each plate in an emission tube tester, may cause

faulty relay operation or excessive hum. A 6V6 in the audio oscillator stage, if weak, may result in a lack of "erase" action and poor recording. These troubles have been noted. The output and other tubes don't break down very often. The grid condensers seem to stand up. The filters occasionally require replacement. A multiple filter in a drawn aluminum can is used.

By far the most common trouble is a dirty head. The steel wire, in passing through the magnetic head, causes a certain amount of grime to be deposited in the head. It may be cleaned with a suitable brush dipped in carbon tetrachloride. In addition to causing distortion, the dirty head may result in wire breakage. It is a good idea to advise the owner of the equipment to clean the head whenever a slight distortion is observed.

The next most common trouble is wire breakage, or jumping off the spool due to improper tension. On "Rewind" the tension will be greater, about twice as much as on "Listen." The tension can be checked by putting a thumbnail under the wire (with the machine running) and lifting it up. It should be possible to feel a slight pull, but not a great tension. There should be no slack in the wire or it will jump the head when switching from "Listen" to "Rewind" or "Stop". These functions are obtained by manipulating a four position rotary switch knob on the front panel. The fourth position is "Record".

The brake adjustments at the rear of the instrument govern the ten-

sion. The adjustments are made by loosening locknuts and adjusting the pressure of bolts on metal strips. These strips have soft fiber pads which bear against the metal drive wheels of stainless steel. Screwing a bolt in increases the pressure, and screwing it out has the opposite effect. The bolt is locked by tightening a nut after adjustment. The spring tension can be checked by pressing the spring away from the drive wheel and feeling the pressure with finger tips, then noting the effect on wire tension. A reasonable pressure should be felt. Too much may cause wire breakage or slow up the drive rotation; too little may cause the wire to unravel and jump the groove in the magnetic head.

The view in Fig. 2 shows the rear with the instrument cover removed and the main drive wheel and rubber belts taken off. Incidentally, after being in service for several months, these belts may stretch and not allow the motor to drive the mechanism properly. As the belts are not expensive, their replacement is no problem.

In operation, a two contact relay above the 6SQ7 may close and, by a mechanical lever action, disengage wheel 1 from wheel 5. At the same time a four contact relay above the 6V6 is open and wheel 2 is in contact with wheel 1. Thus 1 turns while 5 does not. The rotations are shown in the lower part of the drawing. Alternatively, when the four contact relay closes, it pushes down away from 1 and the two contact relay is open, so that 4 is driving 5.

If the brake adjustment on 5 is

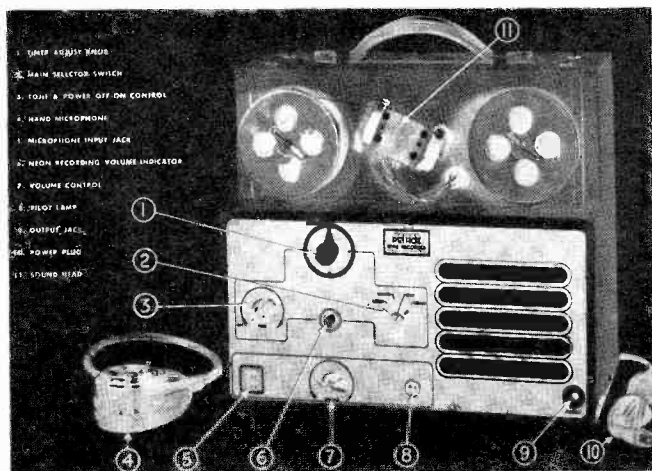

Fig. 1. Magnetic wire recorder reproducer, front view.

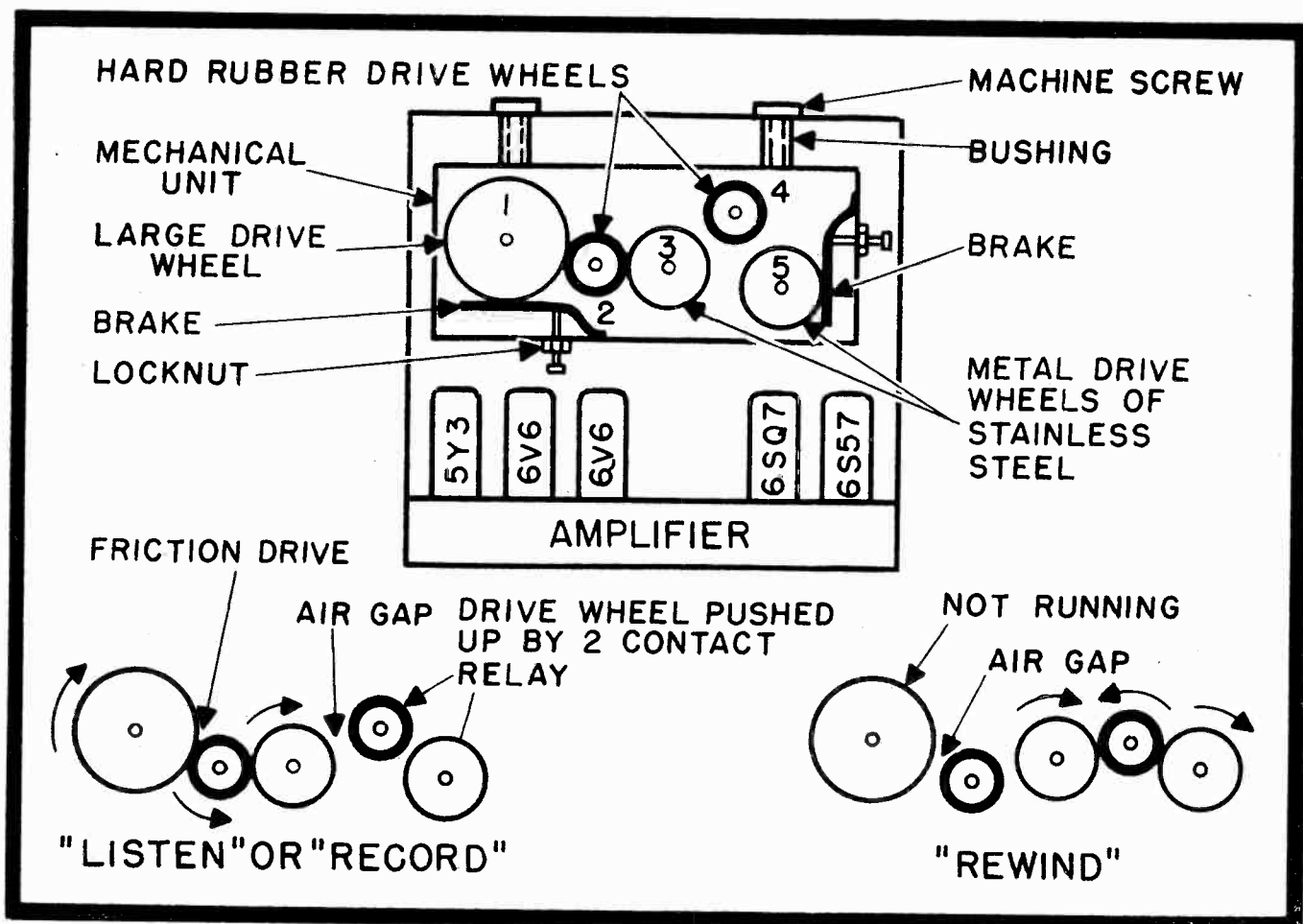

Fig. 2 Magnetic Wire Recorder and Reproducer, Rear View, Instrument Cover removed.

too tight, stalling and stoppage of 4 and 5 may occur. Faulty operation of the relays may be due to dirty contacts which can be cleaned with a piece of fine emery paper, $\frac{1}{4}$ " wide and 2" long. Slip the paper between the contacts and pull back and forth carefully. An open or shorted relay coil can be found readily with an ohmmeter. Normally the coil resistance for each relay is about 2200 ohm.

The drive wheels of hard rubber—2 and 4—seem to cause relatively little trouble, but with time a glazed surface may develop which can be corrected by wiping the wheel surfaces with a rag that has been saturated with carbon tetrachloride. This will restore the normal friction effect. Cotton may be used.

Wheel 2 is kept in contact with 1 by two springs attached to a sliding metal member which also holds 2 in position. A similar arrangement is used for wheel 4 to allow it to bear against 5 when desired. These metal sliders may stick and bind, causing the relays to chatter or even

to burn out. The surfaces may be filed down if necessary, or an oil application may correct the trouble. The springs may lose their springiness after several months, making the installation of new ones a requirement for proper operation.

To replace the springs, it is first necessary to remove the mechanical assembly from the cabinet. This is done in the following manner: To take off the magnetic head, unplug it. Remove the screw on the right. The one on the left, front view, need not be taken out. Gently pull the head out straight from the cabinet. A slight twisting motion may be helpful. Now remove the rear cover of the cabinet. Disengage the flexible shaft from the timer mechanism by reaching into the interior with the left hand, and pulling on it carefully, while holding the timer knob firmly with the right hand. Incidentally, always check, on reassembling, to see that you have the shaft in position and that the timer pointer position is correct, before you screw the back cover in place. The

timer knob is loosened with an Allen hex wrench and the pointer adjusted to zero for full counter-clockwise rotation.

The flexible shaft ends in a split open part which is inserted in the timer. If the timer seems loose or doesn't work, spread the end of the shaft open with a screwdriver before replacing it, reinsert, and check operation. The timer may also fail to function if the gears are gummed up. They can be cleaned with carbon tetrachloride. Vaseline or machine grease of light grade may then be applied.

After the timer is disengaged, the four screws at the top of the case can be removed and the mechanical system is then pulled straight back and out. If necessary, to secure greater freedom of action in taking it apart and working on it, the Jones plug which connects the mechanical assembly to the chassis may be unplugged. This will free the unit from the main chassis.

Faulty operation of the neon level

→ to page 45

CHECKING TV RECEIVER LINEARITY

by Allan Lytel

Crosshatch generators make possible rapid adjustment of television receiver sync circuits.

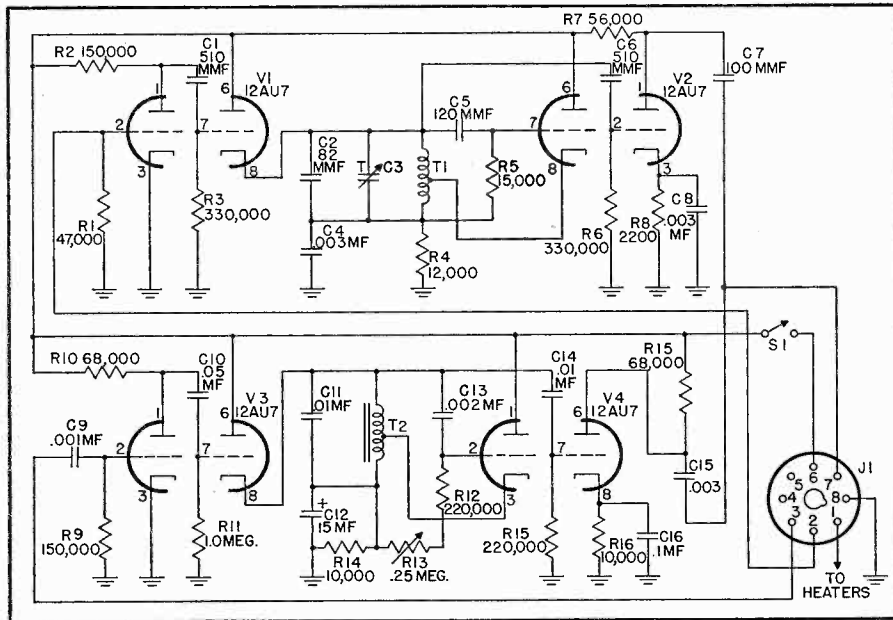

Fig. 1 Schematic diagram of Philco crosshatch generator.

ADJUSTMENT of the controls of many television receivers is made difficult unless there is a test pattern available. An example of this is the linearity controls. Their adjustment is best accomplished through the use of an instrument such as the Philco crosshatch generator. In the average case of control adjustment and receiver alignment, linearity controls do not require the use of a special device such as this generator, but where there is doubt as to the exact adjustment or difficulty in making the adjustment, this unit will prove invaluable.

The schematic diagram of this

crosshatch generator, Model 5072, is illustrated in Fig. 1. Pin 2 is the horizontal syn input, pin 3 is the vertical sync input. Pin 1 and 8 are the heater voltage, and pin 6 is the plate voltage. The output is taken from pin 7. This unit consists of two sync amplifiers and two driven oscillators together with output tubes. Each oscillator produces a square wave when triggered by its input sync and these resultant waves are fed together through the output. Normally, there are twelve horizontal lines and sixteen vertical lines. A drawing of the correct adjustment is shown in Fig. 2, while Fig. 3 is an

illustration of incorrect vertical linearity, and Fig. 4 shows improper horizontal linearity. Since this unit does not contain its own power supply, there must be a connection to the power supply of the television receiver through a tube socket.

An adapter harness is used to supply these voltages and take off the required sync as well as to supply the output signal to the video tube. Harness No. 1 is designed for use with the Philco television receiver Model 48-1000, or Model 48-2500. This harness has four adapter units which must be plugged into the television receiver. The Red adapter is plugged into the vertical output tube socket and the vertical tube is replaced because this adapter is designed to take off vertical sync.

The Black adapter is plugged into the chassis receptacle for the deflection yoke plug, and this plug is placed in the adapter socket. This is the point where the horizontal sync is taken off for the generator. The Green adapter is plugged into the video output tube socket and the tube replaced in the adapter socket. This acts to feed the output of the generator into the grid circuit of the video output tube.

Heat and plate power is taken off through the Yellow adapter, which is plugged into the audio output tube socket, and this tube need not be replaced unless sound is desired.

Philco's recommendation for the

→ to page 44

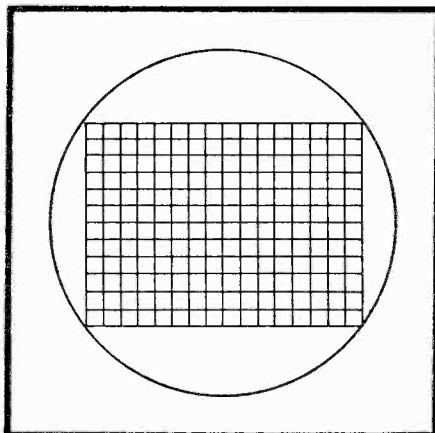

Fig. 2 Correct adjustment.

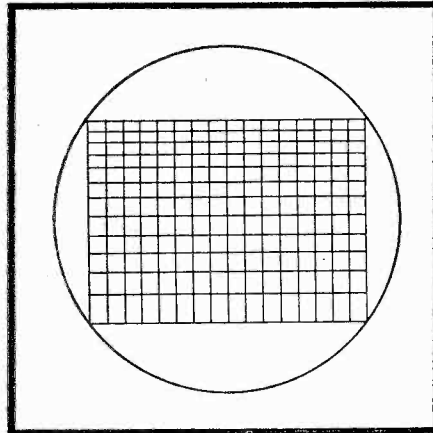

Fig. 3 Improper vertical adjustment.

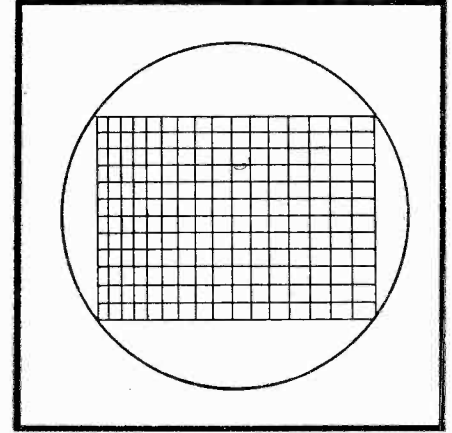
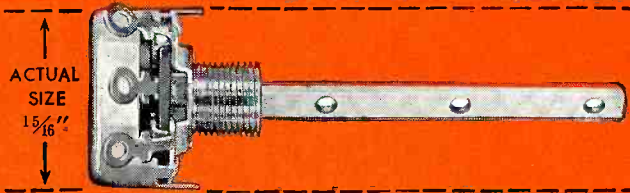

Fig. 4 Improper horizontal adjustment.



Get Acquainted with the Little Fellow with the **BIG** Advantages

The All New Mallory Midgetrol



Offers These **BIG** Advantages...

BIGGER MARKET

The small size of the Mallory Midgetrol lets you service portables, auto radios and small AC-DC receivers which require $1\frac{5}{16}$ " controls.

SIMPLER INSTALLATION

The unique shaft design of the Mallory Midgetrol saves installation time with *all* types of knobs.

SIMPLER STOCKING

Electrical characteristics let you use the Mallory Midgetrol to replace $1\frac{1}{8}$ " as well as $1\frac{5}{16}$ " controls. Stocks are further reduced because no special shafts are needed.

Both mechanically and electrically, the Mallory Midgetrol is amazingly quiet. Tests prove it *stays* quiet! And the Mallory Midgetrol offers nine *all new* features.

It's the NEW Standard in Carbon Controls. See your Mallory distributor.

- NEW SIZE
- NEW DESIGN
- NEW SHAFT
- NEW EXTENSION
- NEW SWITCH
- NEW ELEMENT
- NEW CONTACT
- NEW TERMINAL
- NEW TWO-POINT SUSPENSION

P. R. MALLORY & CO. Inc.
MALLORY

CAPACITORS... CONTROLS... VIBRATORS...
SWITCHES... RESISTORS... RECTIFIERS...
VIBRAPACK* POWER SUPPLIES... FILTERS
*Reg. U. S. Pat. Off.

APPROVED PRECISION PRODUCTS

P. R. MALLORY & CO. Inc., INDIANAPOLIS 6, INDIANA

TIME SAVERS

by H. Leeper

AUTO RADIO TUBE SOCKET

Auto radios of the type illustrated operate with the tubes in a suspended position—opposite from the usual upright position. The weight of the tubes often loosens the terminals due to continual jarring over a period of time.

The resulting poor contacts cause noise or no operation at all. It is wise to go over such terminals when working on sets of this type—to avoid future complaints.



CLEANING CONTACT POINTS

Many contact points or terminals are difficult to reach with liquid cleaner employing the methods of application which are ordinarily used.

A piece of bare wire may be used as shown to guide the cleaner to the desired location.

The cleaner is placed on the wire with an eyedropper or any hollow glass tube open at both ends, so that the quantity of the liquid used is easily regulated. The cleaning liquid will run down to the contact point or terminal to be reached.

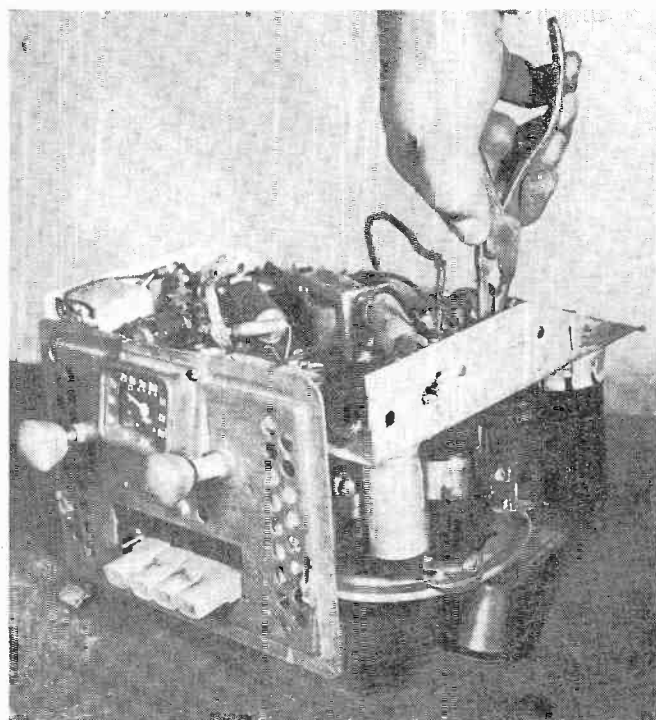
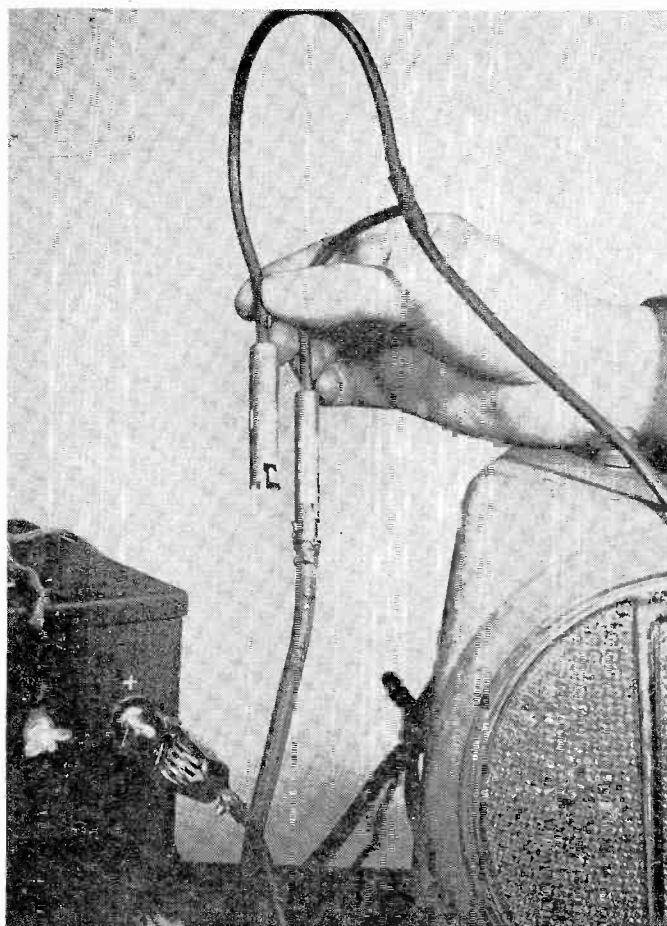

TESTING OF CAR RADIOS

Two or more metal connectors of the type which retain fuses, may be attached to one wire leading to the shop battery or battery eliminator. In use, the proper size is always available to fit the radio under test.

Since the battery circuit or the eliminator is usually fused—the original fuse may be blanked out, or left in the connector and held in place when not being used by the second part of the connector (not shown) which comes as part of the fuse retainer.

Set by Set, Volume by Volume - PHOTOFACT Boosts Your Profits!

Build the Service Data library that helps you earn more. Have at your finger-tips the most accurate, uniform and practical service data ever produced—everything you need for easier, more profitable work. From the moment you get them, PHOTOFACT Folder Sets and Volumes pile up increasing profits for you, month after month, year after year. For success in servicing, for bigger earning power, you owe it to yourself to keep your PHOTOFACT library up-to-date!

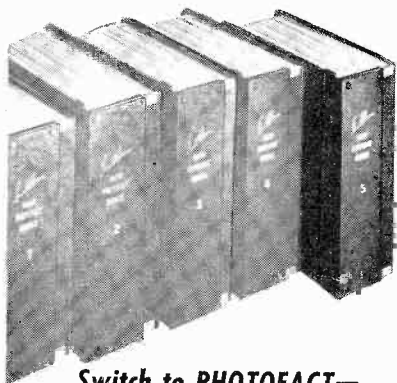

Switch to PHOTOFACT—
the Best Service Data Buy
You'll Ever Make!

Your Price
Each Volume, **\$18.39**
In DeLuxe Binder

NOW! PHOTOFACT VOLUME 5 ON SALE AT YOUR JOBBER'S TODAY!

Latest addition to the famous PHOTOFACT Volume series—brings your file of postwar receiver service data right up to December 1948! Most accurate and complete radio data ever compiled—preferred and used daily by thousands of Radio Service Technicians. Everything you need for faster, more profitable servicing: Exclusive Standard Notation Schematics; photo views keyed to parts lists and alignment data; complete parts listings and proper replacements; alignment, stage gain, circuit voltage and resistance analysis; coil resistances; record changer service data, etc. Order Volume 5 today—keep ahead with Photofact—the *only* Radio Service data that meets your *actual* needs!

- Vol. 5. Covers models from July 1, 1948 to Dec. 1, 1948
- Vol. 4. Covers models from Jan. 1, 1948 to July 1, 1948
- Vol. 3. Covers models from July 1, 1947 to Jan. 1, 1948
- Vol. 2. Covers models from Jan. 1, 1947 to July 1, 1947
- Vol. 1. Covers all postwar models up to Jan. 1, 1947

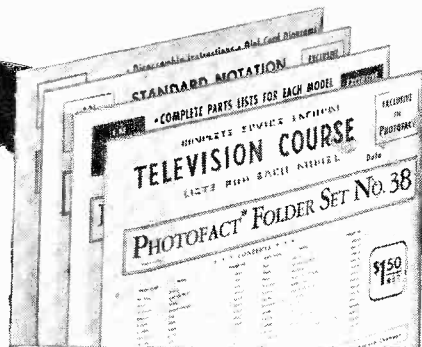

Stay Ahead of the Game with PHOTOFACT Folder Sets . . .

You can't afford to miss a single PHOTOFACT Folder Set! You get not only the most complete and accurate Radio Service Data ever compiled—but you keep up with fast-moving developments. Have all the advantages that make PHOTOFACT indispensable to thousands of Service Technicians—PLUS—exclusive new TV Folders on popular Television receivers—the invaluable TV Course (don't miss the sections on wave pattern trouble-shooting, and antennas)—full data on the latest Record Changers—all this in addition to full coverage of current radio models. Subscribe regularly to PHOTOFACT Folder Sets—to make your work easier, quicker, more profitable. Issued two Sets per month. Subscribe at your Jobber today. **\$150 PER SET ONLY**.....

You'll Use These Practical Books Every Single Working Day!

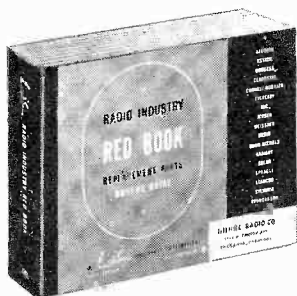

The Radio Industry RED BOOK

NOW—stop wasteful hunting through dozens of incomplete parts manuals. The RED BOOK tells you *in one volume* what you need to know about replacement parts for approximately 17,000 sets made from 1938 to 1948. Includes complete, accurate listings of all 9 major replacement components—not just one. Lists correct replacement parts made by 17 leading manufacturers—not just one. Covers original parts numbers, proper replacement numbers and valuable installation notes on: Capacitors, Transformers, Controls, IFS, Speakers, Vibrators, Phono-Cartridges. *Plus*—Tube and Dial Light data, and Battery replacement data. 448 pages, 8½ x 11; sewed durable binding. **ONLY \$3.95**

1947 Changer Manual

Complete, accurate service data on over 40 postwar Record Changer models. Shows exploded views, photos from all angles. Includes change cycle data, adjustment notes, service hints, complete parts lists. **PLUS**—complete data on leading Wire, Ribbon, Tape and Disc Recorders. 400 pages; hard cover; opens flat. Order now! **ONLY \$4.95**



Tube Placement Guide

Shows you exactly where to replace each tube in 5500 radio models, covering 1938 to 1947 receivers. Each tube layout is illustrated by a clear, accurate diagram. Saves time—eliminates risky hit-and-miss methods. 192 pages; handy index. **ONLY .. \$1.25**



Dial Cord Stringing Guide

The book that shows you the *one right way* to string a dial cord. Here, in one handy pocket-sized book, are all available dial cord diagrams covering over 2300 receivers, 1938 through 1946. Makes dial cord restringing jobs quick and simple. **ONLY \$1.00**



FREE Photofact Cumulative Index

Send for the FREE Cumulative Index to PHOTOFACT Folders covering *all* postwar receivers up to the present. You'll want this valuable reference guide to the Radio Service Data preferred and used by thousands. Helps you find the Folders you want in a jiffy. Get this FREE Index at your Jobber or write for it now.



BOOST YOUR EARNING POWER!

Mail This Order Form to Your Parts Jobber Today
or send to HOWARD W. SAMS & CO., INC.
2924 E. Washington St., Indianapolis 7, Ind.

- My (check) (money order) for \$.....enclosed.
Send following Photofact Volumes: Vol. 5.
 Vol. 4. Vol. 3. Vol. 2. Vol. 1. (\$18.39 each).
 Send the RED BOOK. \$3.95 per copy.
 Automatic Record Changer Manual, \$4.95.
 Tube Placement Guide, \$1.25
 Dial Cord Stringing Guide, \$1.00
 Send FREE Photofact Cumulative Index.

Name.....

Address.....

City..... State.....

HOWARD W. SAMS & CO., INC.
INDIANAPOLIS 7, INDIANA



POWER

25 Watts Power Handling Capacity

SENSITIVITY

14½ ounces of ALNICO 5

FIDELITY

Broad Frequency Characteristics
50-13,000 cycles

PERFORMANCE ENGINEERED!

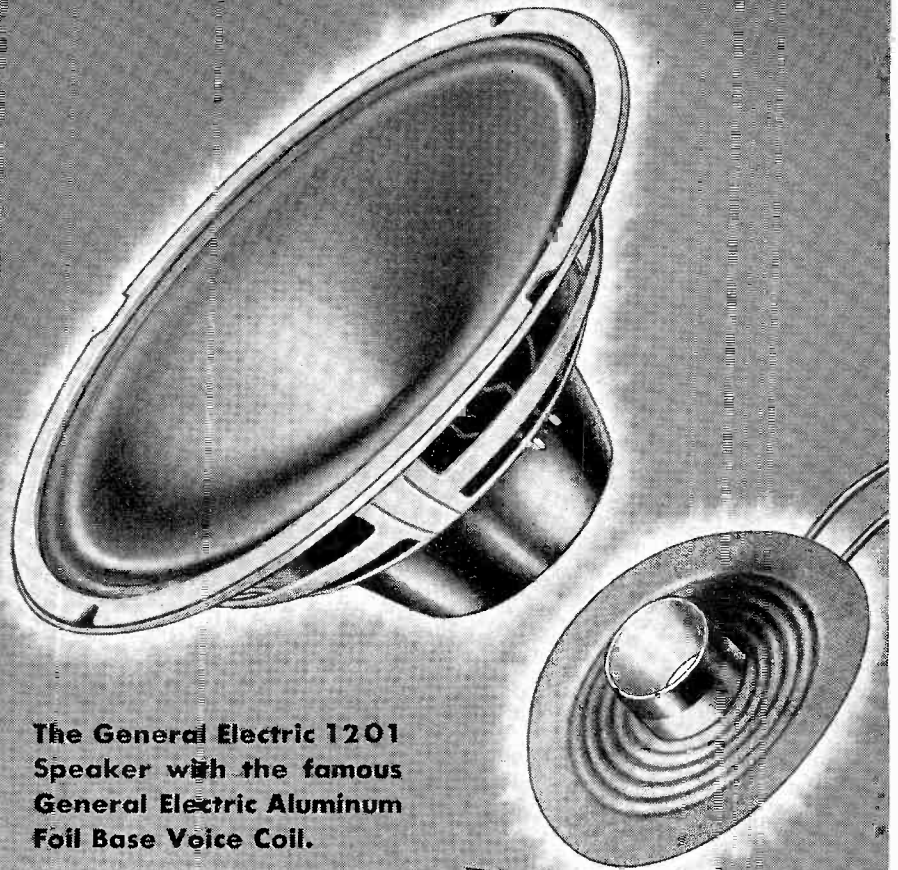

The General Electric 1201 Speaker with the famous General Electric Aluminum Foil Base Voice Coil.

FROM THE SMALLEST TO THE LARGEST:

- Every G-E speaker is *Performance-Engineered* at Electronics Park
- Every G-E speaker is equipped with the *Aluminum Foil Base Voice Coil*
- Every G-E speaker is an *Alnico 5* speaker
- Every G-E speaker cone is designed to last
- Every G-E speaker has a *Big Market*

For complete information on General Electric Speakers write: *General Electric Company, Electronics Park, Syracuse, New York.*

Demonstration PROVED to Distributors in these and many other cities that the 1201 is OUTSTANDING IN QUALITY.

ATLANTA	LOS ANGELES
BALTIMORE	NEW YORK
BOSTON	PITTSBURGH
CHICAGO	SALT LAKE CITY
CLEVELAND	SEATTLE
DALLAS	SAN FRANCISCO
DETROIT	WASHINGTON

You can put your confidence in—

GENERAL ELECTRIC

169-G9

The **ALL-AMERICAN FIVE**

and **HYTRON** go together



Build a better mouse trap and the word gets around—but fast. Same with Hytron a-c/d-c tubes. Many years of experience. Many millions of tubes. Constant engineering cooperation with dozens of prominent radio set manufacturers. All help make Hytron a-c/d-c tubes better. Make it natural to think of Hytron when you think of the All-American Five.

The lowly a-c/d-c tubes must pack a heck of a lot of performance—at a price. Hytron tubes do. They offer the special advantage of being built to the strictest requirements of leaders in the small set field. GT or miniature—you, too, will find Hytron a-c/d-c tubes your best choice.

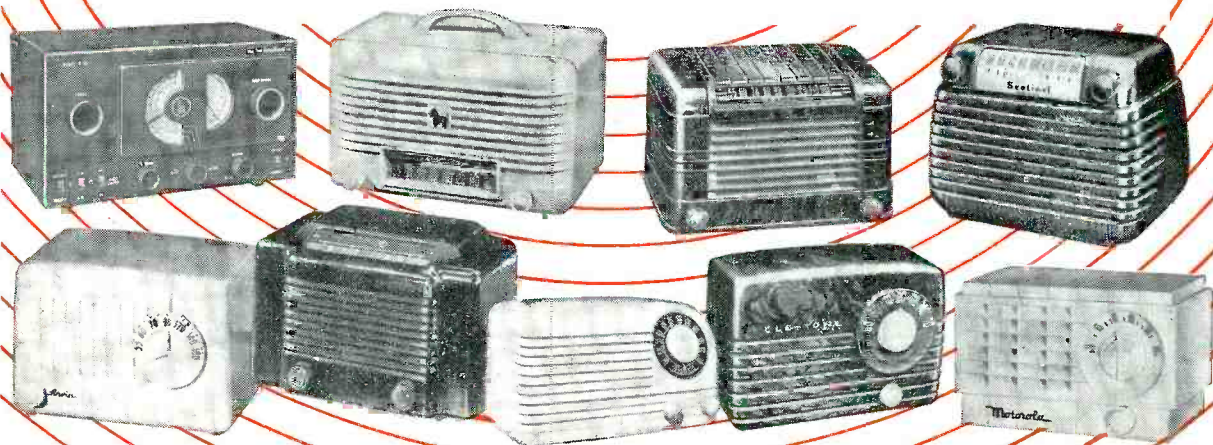

SPECIALISTS IN RADIO RECEIVING TUBES SINCE 1921.

HYTRON
RADIO AND ELECTRONICS CORP.

MAIN OFFICE: SALEM, MASSACHUSETTS



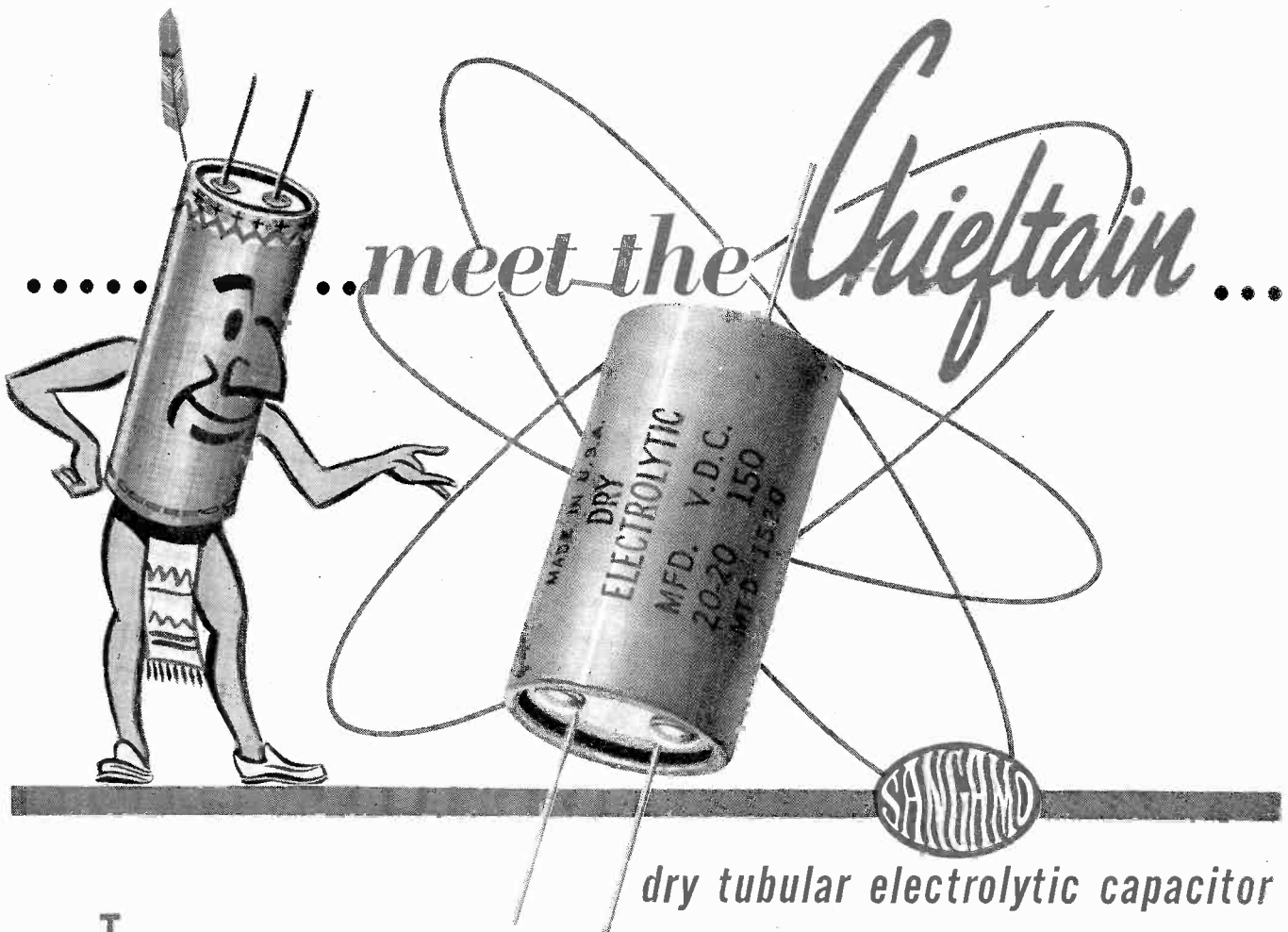

dry tubular electrolytic capacitor

Type MT and MTD electrolytic capacitors, "Chieftains" of the Sangamo line, are built to provide longer life, greater dependability, and better electrical characteristics. Ideal for replacements, they fit anywhere! Their small physical size makes them a "natural" for application in tight spots beneath a chassis, and the bare tinned-copper wire leads make them easy to mount.

Sangamo "Chieftains" are contained in hermetically-sealed round aluminum cans and are tightly encased in heavy cardboard sleeves on which polarity is clearly indicated. Double, pure paper spacers assure adequate

breakdown characteristics and all sections are tightly held in place within the container. Multiple staking connects the terminal tabs to the electrodes, providing permanent low resistance contact throughout the life of the capacitor. The low voltage units are supplied with etched cathodes to maintain uniform capacity when the capacitor is subjected to heat and high ripple currents.

"Chieftains" are manufactured under controlled conditions of almost surgical cleanliness, utilizing the very finest materials and production procedures available in the industry, for your assurance of quality in every respect.

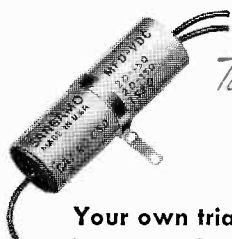

Tomahawk



Warrior

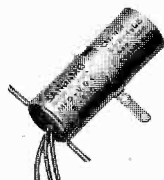

Apache



Mohican

Your own trial-use will convince you that new standards of dependability and longevity have been built into Sangamo Electrolytics. Order from the new Sangamo Electrolytic Capacitor Catalog No. 825B, which is yours for the asking, and without obligation.

SC 4810



SANGAMO ELECTRIC COMPANY

SPRINGFIELD • ILLINOIS

Buy WHERE YOU SEE **THIS BANNER**
 . . . because **IT'S BETTER FOR YOU!**

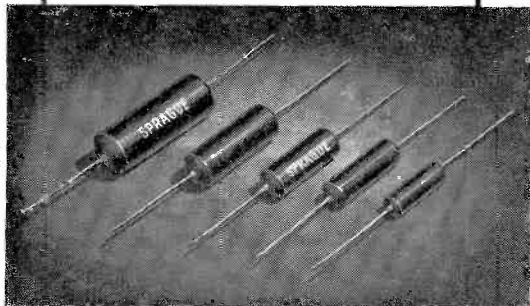

SPRAGUE TM TUBULARS

The first truly practical MOLDED Paper Tubulars! Now in stock—ready for your use—See your SPRAGUE Distributor.

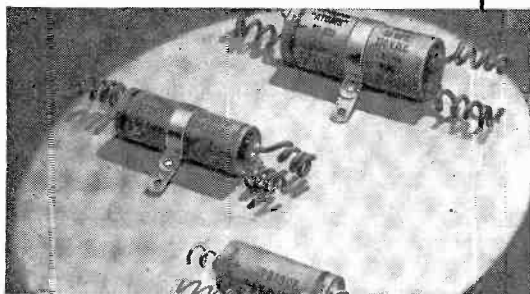

SPRAGUE ATOMS—DRY ELECTROLYTICS

You can make up virtually any required capacity-voltage combination with a small stock. Keep a representative supply in your shop. **SAVE TIME—SAVE MONEY—SAVE SPACE!**

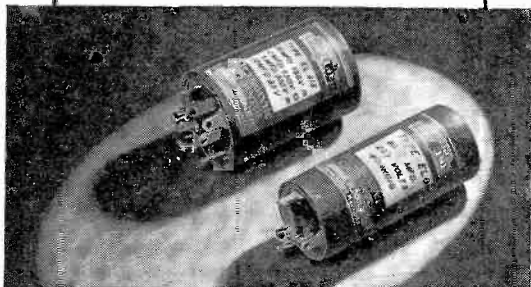

SPRAGUE EL SELF-MOUNTING MIDGET CAN CAPACITORS

No other Dry Electrolytic gives so much dependability in so small a space! Tinned, Twist-Prong Tabs for easy soldering; quick, universal self-mounting. **SAVES TIME—SPEEDS RELIABLE SERVICE!**



Yes, its better for you *and your business* to buy where this banner is displayed because the SPRAGUE BANNER identifies a Distributor who agrees that *"It's foolish to play penny-ante when your business is at stake!"*

Your Sprague Distributor is a successful business man. He knows the parts business intimately—and he knows that to really build a bigger, more successful service business, you should use only the best replacement parts. That's why he features Sprague Capacitors and *Koolohm Resistors. His business depends on your success and he wants you to remember that **YOUR REPUTATION AND YOUR CUSTOMERS ARE TOO VALUABLE TO RISK FOR THE FEW PENNIES "SAVED" BY BUYING INFERIOR OR UNKNOWN "BARGAINS"!**



Yes! We're Listed in the **RED BOOK**

Looking for the correct Sprague replacement capacitors for any receiver manufactured from 1938 to 1948? It's easy—just refer to The Radio Industry **RED BOOK** . . .

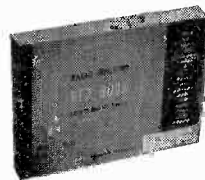

CAPACITORS

SPRAGUE

*KOOLOHM RESISTORS

*T.M. Reg. U.S. Pat. Off.

SPRAGUE PRODUCTS CO., North Adams, Mass. • (JOBING AND DISTRIBUTING ORGANIZATION FOR THE PRODUCTS OF THE SPRAGUE ELECTRIC COMPANY)

GREATEST ADVANCE IN V.O.M. HISTORY

Beautiful Streamlined Instrument.

Large 5 1/2 Inch Meter in special molded case under panel.

Resistance Scale Markings From .2 Ohm To 100 Megohms... Zero Ohms Control Flush With Panel.

Only one switch... Has Extra Large Knob 2 1/2" Long... Easy To Turn... Flush With Panel Surface.

New Molded Selector Switch... Contacts Are Fully Enclosed... will retain lubrication without dust contamination.

Batteries Easily Replaced... New Double Suspended Contacts.

All Resistors Are Precision Film Or Wire Wound Types... Sealed For Permanent Accuracy.

Unit Construction... Resistors, Shunts, Rectifier, Batteries All Are Housed In A Molded Base Built Right Over The Switch... Provides Direct Connections Without Cabling... No Chance For Shorts.

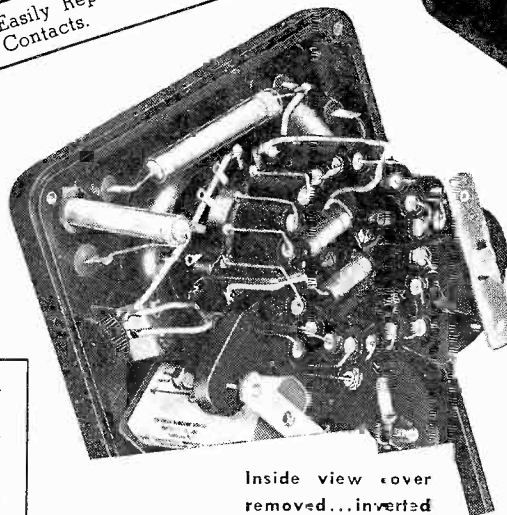

Inside view cover removed...inverted

TECH DATA

D.C. VOLTS: 0-3-12-60-300-1200-6000, at 20,000 Ohms/Volt
 A.C. VOLTS: 0-3-12-60-300-1200-6000, at 5,000 Ohms/Volts
 D.C. MICROAMPERES: 0-60, at 250 Millivolts
 D.C. MILLIAMPERES: 0-1.2-12-120, at 250 Millivolts
 D.C. AMPERES: 0-12, at 250 Millivolts
 OHMS: 0-1000-10,000; 4.4 Ohms at center scale on 1000 scale;
 44 Ohms center scale on 10,000 range.
 MEGOHMS: 0-1-100
 DECIBELS: -30 to +4, +16, +30, +44, +56, +70
 OUTPUT: Condenser in series with A.C. Volt ranges

TRIPLETT ELECTRICAL INSTRUMENT CO. • BLUFFTON, OHIO

In Canada: Triplett Instruments of Canada, Georgetown, Ontario

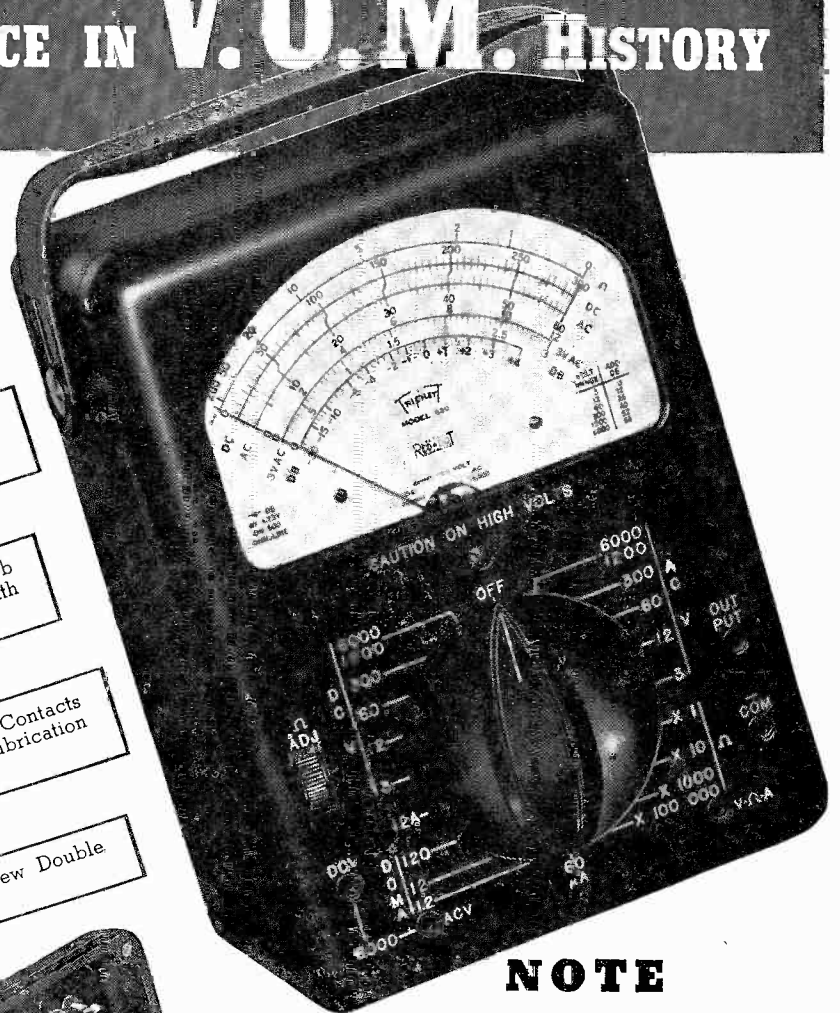

NOTE the Sensational Improvements Model 630

\$37⁵⁰ U.S.A.
Dealer Net

Leather Carrying Case \$5.75
ADAPTER PROBE FOR TV
HIGH VOLTAGE TESTS EXTRA

A completely new Volt-Ohm-Mil-Ammeter that does more... has proved components... and will give a lifetime of satisfaction.

Precision first... to Last

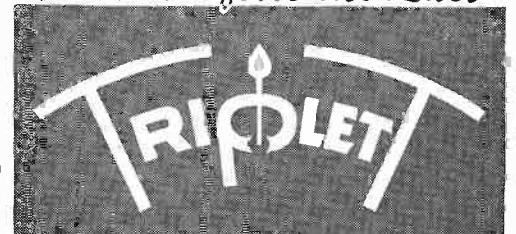

Look for the distributor
who displays this sign!

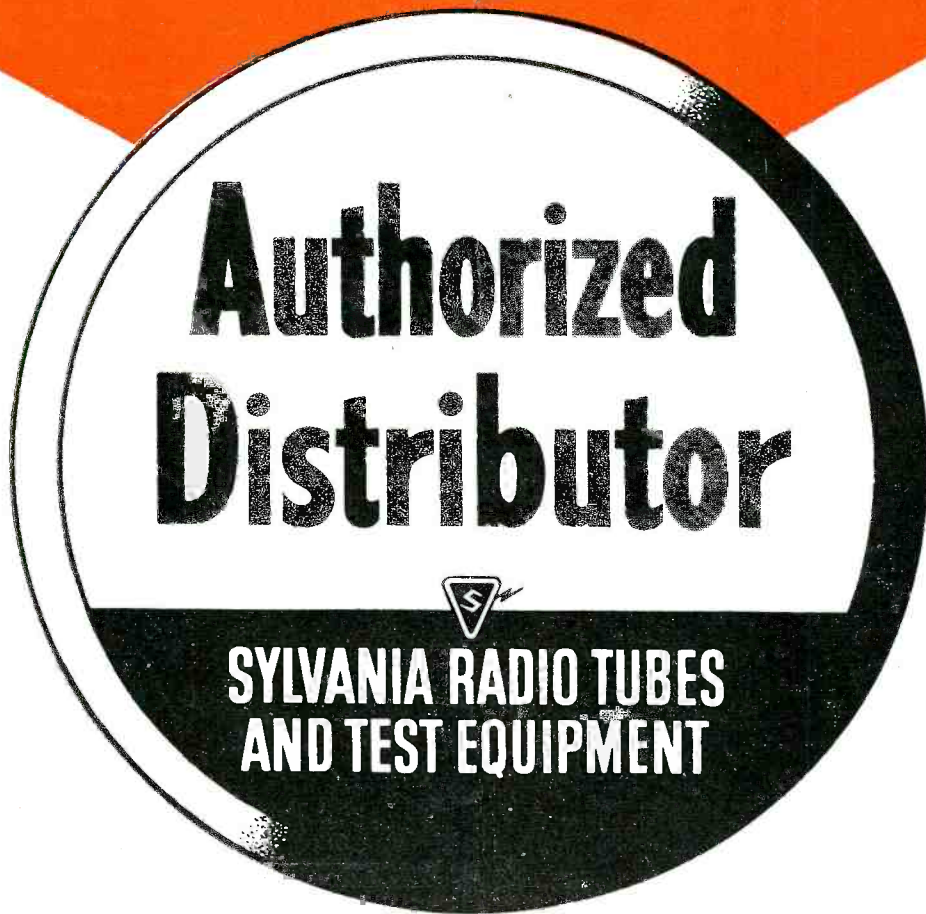

AS a part of its 1948 program, Sylvania Electric will supply each of its authorized distributors with this new decal, printed in red, yellow, black and three shades of green. It's worth your while to look for this sign on

his windows, doors and trucks — it is your assurance that this distributor will supply you with genuine Sylvania radio tubes and top-quality test equipment — and that you can count on prompt, courteous service as well!

Sylvania Electric Products Inc., Radio Tube Division, Emporium, Pa.

SYLVANIA  **ELECTRIC**

MAKERS OF RADIO TUBES; CATHODE RAY TUBES; ELECTRONIC DEVICES; FLUORESCENT LAMPS, FIXTURES, WIRING DEVICES; ELECTRIC LIGHT BULBS

**START THE NEW YEAR RIGHT
BUILDING YOUR PARTS PROFITS**

PHILCO
PARTS, TUBES, BATTERIES
AND OTHER ACCESSORIES

For the coming year don't guess or gamble—concentrate on the brand you *know* is first choice with radio owners—*Philco*, the leader of the industry 18 straight years. Here's your biggest replacement market . . . Philco owners . . . and the surest way to sell it is by featuring Philco parts and accessories. Take advantage of Philco year 'round promotions to get more profitable parts business from Philco owners and from *all* radio owners, every month of 1949.

Ask Your Philco Distributor

BATTERIES

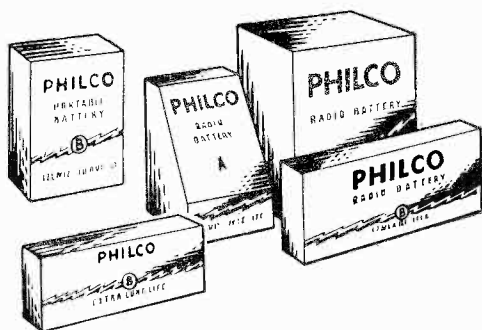

TUBES

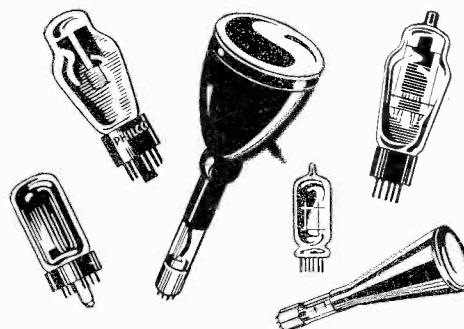

ACCESSORIES

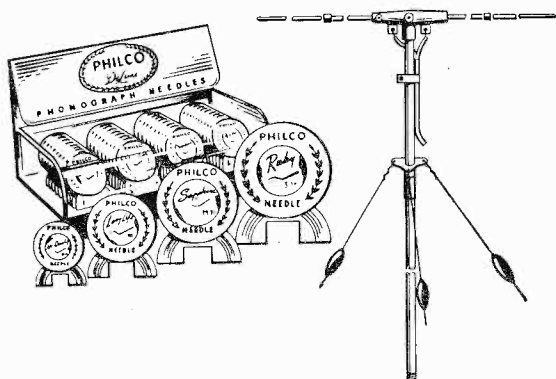

PARTS

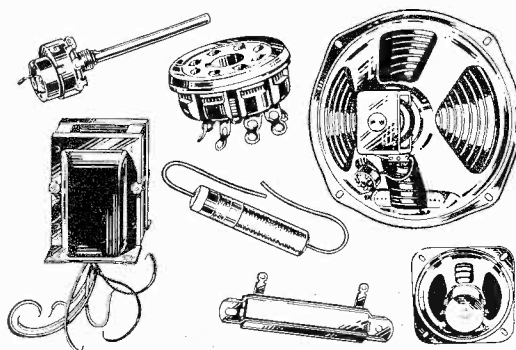

Build YOUR OWN TEST EQUIPMENT

Heathkit ELECTRONIC SWITCH KIT DOUBLES THE UTILITY OF ANY SCOPE

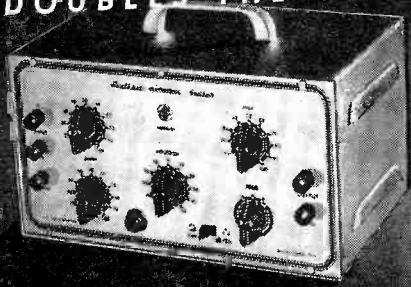

\$34.50

Gives two separately controllable traces with individual inputs on any scope. See both the input and output traces, locate distortion, phase shift, etc., immediately. Individual gain controls and positioning control. Coarse and fine sweeping rate controls. Complete Heathkit matches others, with 5 tubes. All metal parts are punched, formed and cadmium plated. Complete with tubes, all parts, detailed blueprints and instructions. Shipping Wt. 13 lbs.

Nothing ELSE TO BUY

HEATHKIT CONDENSER CHECKER KIT

\$19.50

Nothing ELSE TO BUY

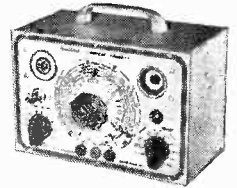

A condenser checker anyone can afford to own. Measures capacity and leakage from .00001 to 1000 MFD on calibrated scales with test voltage up to 500 volts. No need for tables or multipliers. Reads resistance 500 ohms to 2 megohms. 110V 60 cycle transformer operated complete with rectifier and magic eye indicator tubes. Easy quick assembly with clear detailed blueprints and instructions. Small convenient size 9" x 6" x 4 3/4". Wt. 4 lbs.

HEATHKIT SIGNAL GENERATOR KIT

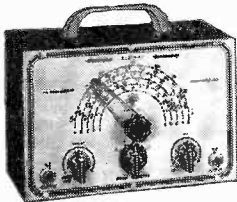

\$19.50

NOTHING ELSE TO BUY

Every shop needs a good signal generator. The Heathkit fulfills every servicing need, fundamentals from 150 Kc. to 30 megacycles with strong harmonics over 100 megacycles covering the new television and FM bands. 110V 60 cycle transformer operated power supply.

400 cycle audio available for 30% modulation or audio testing. Uses 6SN7 as RF oscillator and audio amplifier. Complete kit has every part necessary and detailed blueprints and instructions enable the builder to assemble it in a few hours. Large easy to read calibration. Convenient size 9" x 6" x 4 3/4". Wt. 4 1/2 lbs.

HEATHKIT SIGNAL TRACER KIT

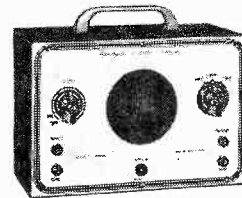

\$19.50

Nothing ELSE TO BUY

Reduces service time and greatly increases profits of any service shop. Uses crystal diode to follow signal from antenna to speaker. Locates faults immediately. Internal amplifier available for speaker testing and internal speaker available for amplifier testing. Connection for VTVM on panel allows visual tracing and gain measurements. Also tests phonograph pickups, microphones, PA systems, etc. Frequency range to 200 Mc. Complete ready to assemble. 110V 60 cycle transformer operated. Supplied with 3 tubes, diode probe, 2 color panel, all other parts. Easy to assemble, detailed blueprints and instructions.

Small portable 9" x 6" x 4 3/4". Wt. 6 pounds. Ideal for taking on service calls. Complete your service shop with this instrument.

HEATHKIT SINE AND SQUARE WAVE AUDIO GENERATOR KIT

The ideal instrument for checking audio amplifiers, television response, distortion, etc. Supplies excellent sine wave 20 cycles to 20,000 cycles and in addition supplies square wave over same range. Extremely low distortion, less than 1%, large calibrated dial, beautiful 2 color panel, 1% precision calibrating resistors, 110 V 60 cycle power transformer, 5 tubes, detailed blueprints and instructions. R.C. type circuit with excellent stability. Shipping weight 15 pounds.

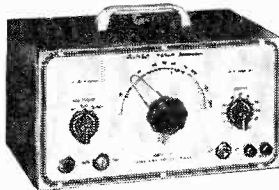

\$34.50

Nothing ELSE TO BUY

THE NEW HEATHKIT VACUUM TUBE VOLTMETER KIT

The most essential tool a radio man can have, now within the reach of his pocketbook. The Heathkit VTVM is equal in quality to instruments selling for \$75.00 or more. Features 500 microamp meter, transformer power supply, 1% glass enclosed divider resistors, ceramic selector switches, 11 megohms input resistance, linear AC and DC scale, electronic AC reading RMS. Circuit uses 6SN7 in balanced bridge circuit, a 6H6 as AC rectifier and 6 x 5 as transformer power supply rectifier. Included is means of calibrating without standards. Average assembly time less than four pleasant hours and you have the most useful test instrument you will ever own. Ranges 0-3, 30, 100, 300, 1000 volts AC and DC. Ohmmeter has ranges of scale times 1, 100, 1000, 10M and 1 megohm, giving range .1 ohm to 1000 megohms. Complete with detailed instructions. Add postage for 8 lbs.

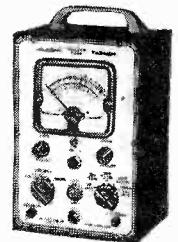

\$24.50

Nothing ELSE TO BUY

HEATHKIT FM AND TELEVISION SWEEP GENERATOR KIT

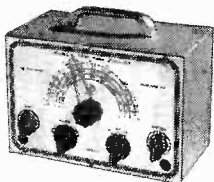

\$24.50

NOTHING ELSE TO BUY

THE BASIC FM AND TELEVISION SERVICE INSTRUMENT

At the lowest cost possible, anyone can now service FM and television receivers. The Heathkit sweep generator kit operates with oscilloscope and covers all necessary frequencies. A few pleasant hours assembling this kit puts any organization in position to share the profits of the FM and TV boom.

Every part supplied — grey crackle cabinet, two color calibrated panel, all metal parts punched, formed and plated. 5 tubes, complete detailed instructions for assembly and use. Shipping weight 6 lbs.

The NEW 1948 HEATHKIT 5 INCH OSCILLOSCOPE KIT

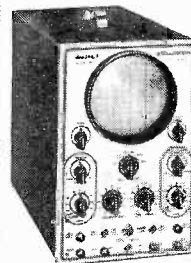

\$39.50

NOTHING ELSE TO BUY

New improved model of the famous Heathkit Oscilloscope. Building an oscilloscope is the finest training for television and newer servicing technique and you save two-thirds the cost. All the features and quality of instruments selling for \$100.00 or more. Supplied complete with cabinet, two color panel, 5BP1 tube, 2 5Y3 tubes, 2 6SJ7 tubes and 884 sweep generator tube. Power transformer supplies 1000V negative and 350 volt positive. Sweep generator 15 cycles to 30 M. cycles. Has vertical and horizontal amplifiers. Oil filled filter condensers for long life. Complete blueprints and instructions included.

The HEATH COMPANY
... BENTON HARBOR 10, MICHIGAN

WANTED
**Economical, Positive,
 Tube and Battery Tester**
 combined with
**complete 20,000 ohms per volt
 circuit testing facilities.**

Must handle all modern tubes with full anti-obsolescence features. Must test all up-to-date A.M.-F.M. and TV. circuits.

Now Available!

THE NEW PRECISION SERIES 654

COMBINATION

Cathode Conductance Tube Tester
 Dynamic (Under-Load) Battery Tester
 High Sensitivity A.C. and D.C. Circuit Tester
 (20,000 ohms per volt D.C.)

Ranges to 6000 Volts*, 120 Microamperes,
 12 amperes, 60 Megohms, + 70 DB
 *(30,000 Volts with Series TV-2 Super
 High Voltage Television Test Probe.)

Series 654 is a rugged, complete, compact, high sensitivity Service Laboratory designed to meet the specific needs of the modern electronics service-maintenance technician, with utmost practical economy — conforming fully to the "Precision" high standards of quality, workmanship and performance!

TUBE AND BATTERY TESTING FEATURES

- Tests all modern tube types including Noval 9 pin, dual capped H.F. tubes, and TV amplifiers, via time-proven RMA-recommended, emission test parameters.
- Filament voltages — ¼ to 117 V.
- Absolute Free-Point 10 element lever selection for both short and merit tests.
- Dual short-check sensitivity.
- Individual Tests of Multi-Section Tubes.
- Ballast Unit Tests.
- Micro-Line adjustment.
- Pilot and signal light tests.
- Noise and Condenser test jacks.
- Dynamic "under-load" test for all popular radio A, B, and C dry batteries.
- Built-in, brass geared roll chart.
- Anodized, etched, easy reading, heavy gauge aluminum panel.
- Fuse Extractor Post.
- Telephone type cabled wiring using plastic-insulated, moisture resistant hook-up wire.

CIRCUIT TESTING FEATURES

- 5 D.C. Voltage Ranges: — 20,000 ohms per volt.
- 5 A.C. and Output Voltage Ranges: — 1000 ohms per volt
 0-12-60-300-1200-6000 volts . . .
 also 0-30,000 volts via optional TV-2 Television Test Probe.
- 6 D.C. Current Ranges: — 0-120 microamperes.
 0-1.2-12-120 MA
 0-1.2-12 Amperes
- 3 Wide Resistance Ranges: — 0-6000-600,000 ohms. 0-60 megohms.
 (No A.C. power required)
- 5 Decibel Ranges from —12 to +70 DB.

- ★ Fully Rotary Selective Ranges and Functions.
- ★ Only 2 pin jacks for all standard ranges.
- ★ 50 microampere, 45/8" Wide-Angle meter.
- ★ 1% Wirewound and film-type resistors.
- ★ All circuits isolated from power line.

SEE this new "Precision" Test Instrument on display at leading radio parts and equipment distributors. Write directly for the latest Precision catalog describing the full Precision line of quality Electronic Test Instruments for all phases of A.M., F.M. and TV.

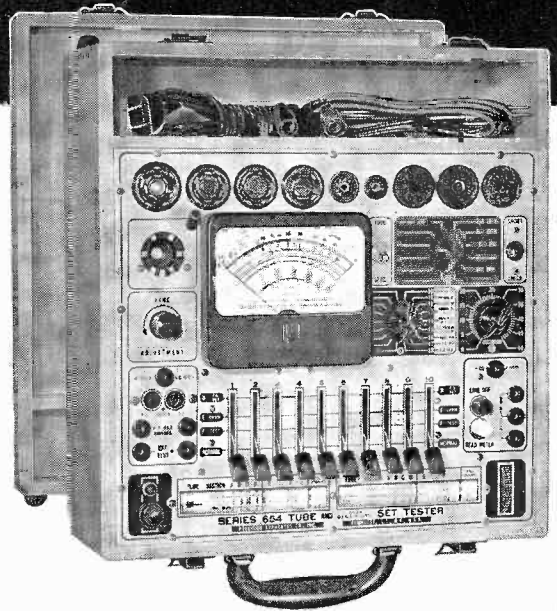

Series 654 is available in 4 distinctive models to suit individual application requirements.

- ★ 654-P . . . PORTABLE . . . In hardwood portable case, with tool compartment and hinged removable cover. Size 12 x 13 x 6".
 Complete: — \$106.40
- ★ 654-MCP . . . LAB. PORTABLE . . . Open style Metal Case Portable. Fine dull black ripple finish on heavy gauge steel. Size 10 1/2 x 12 x 6".
 Complete: — \$103.55
- ★ 654-PM . . . PANEL MOUNT . . . In standard size panel mount, size 12 1/4 x 19", with dust cover. For rack, cabinet or wall mount.
 Complete: — \$106.40
- ★ 654-C . . . COUNTER . . . In modern, chrome-trimmed counter cabinet. Fine black ripple finish on heavy gauge steel. Size 16 x 13 1/2 x 7" slopes to 3" at front. Complete: — \$108.90

Coming Soon—Watch for
 Official Announcement
 —Worth Waiting For:
 The New Series E-400
 WIDE RANGE SWEEP GENERATOR
 The New Series ES-500
 MULTI-PURPOSE 5" OSCILLOSCOPE



PRECISION APPARATUS CO., INC.

92-27 HORACE HARDING BOULEVARD • ELMHURST 5, NEW YORK

Export Division: 458 BROADWAY, NEW YORK CITY, U. S. A. • Cables: MORHANEX

Why Your RAYTHEON Tube Distributor* Recommends

The New RAYTHEON BANTAL TUBE



It's Easier to STOCK

At the same price as ordinary tubes one Raytheon *Bantal* takes the place of *two*—cuts your stock problem in half! The Bantal 12SK7GT, for example, replaces, without shielding, either the GT or metal equivalent. Fast turnover, less money tied up in stock, more profit on your investment.

*Your Raytheon Distributor sponsors the famous Bonded Dealer-Service Program. Ask him for full details on this business building plan.

It's Easier to SELL

All these advantages at
NO EXTRA COST

Rugged Eight-Pillar Construction — Short pillars direct to elements; low grid-plate capacitance—greater stability.

Completely Shielded Internally — No external shielding hardware or installation labor. Increases your service profit.

Glass Button Stem — Low Loss.

Glass-To-Glass Seal — Permanent Vacuum.

Wide Lead Spacing — No Electrical Leakage.

Strong Non-Flexible Leads — No Base Shorts.

Glass-To-Dumet Vacuum Seal — No Air Leaks.

EIGHT POPULAR TYPES — 6SA7GT — 6SJ7GT — 6SK7GT — 6SQ7GT — 12SA7GT — 12SJ7GT — 12SK7GT — 12SQ7GT.

SUPERIOR FOR HEAVY DUTY SERVICE — Recommend Raytheon Bantals particularly for replacements in sets or equipments requiring tubes of long life and greater dependability. Their superior performance assures customer satisfaction and repeat business.



RAYTHEON MANUFACTURING COMPANY

RADIO RECEIVING TUBE DIVISION

NEWTON, MASSACHUSETTS • CHICAGO, ILLINOIS • LOS ANGELES, CALIFORNIA

RADIO RECEIVING TUBES • SUBMINIATURE TUBES • SPECIAL PURPOSE TUBES • MICROWAVE TUBES

Laboratory Standards

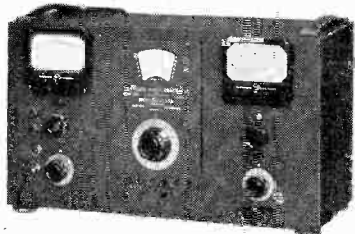

STANDARD SIGNAL GENERATOR

Frequency range: 75 kc. to 30 mc. Output 0.1 microvolt to 2.2 volts. MODEL 65B

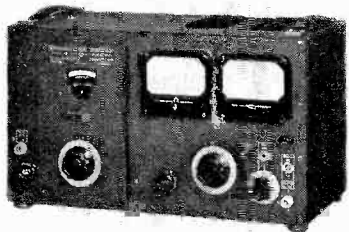

STANDARD SIGNAL GENERATOR

Frequency range: 2 mc. to 400 mc. Output 0.1 microvolt to 0.1 volt. MODEL 80

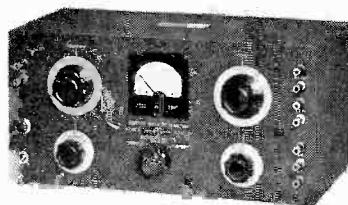

SQUARE WAVE GENERATOR

5 to 100,000 cycles. Recommended for AM, FM and television testing. MODEL 71

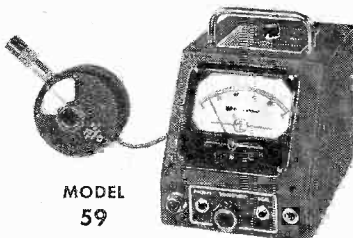

MODEL 59

MEGACYCLE METER

A versatile grid-dip oscillator covering the frequency range of 2.2 mc. to 400 mc.

CIRCULARS ON REQUEST.

MANUFACTURERS OF
Standard Signal Generators
Pulse Generators
FM Signal Generators
Square Wave Generators
Vacuum Tube Voltmeters
UHF Radio Noise & Field Strength Meters
Capacity Bridges
Megohm Meters
Phase Sequence Indicators
Television and FM Test Equipment

MEASUREMENTS CORPORATION
BOONTON NEW JERSEY

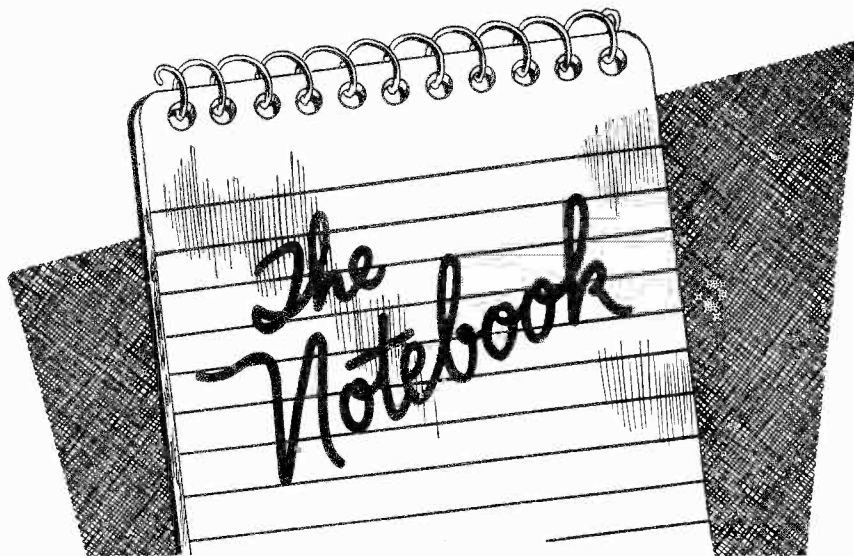

The Notebook combines with *Case Histories* to form one department. This department will consist of readers' ideas and suggestions for kinks and gadgets which have proved helpful to them, plus case histories of some of the tough ones we have all come across. Tell us about the problems you have encountered with certain sets and how you have solved them. With the case histories give us a clear and brief explanation as possible stating the symptoms, the cause, and remedy; give the make, model number, and if possible, the year. Of particular interest are those receivers manufactured from 1937 to the present. Keep your suggestions for useful gadgets and twists both simple and practical. *Radio Maintenance* will pay \$2.00 for each item published in this department.

CLEANING CONDENSERS

In cleaning midget variable condensers I find that a chicken wing or tail feather does a fine job. The plates on these small condensers are too close together to use a pipe cleaner or similar article.

O. J. McDaniel,
Sumatra, Fla.

TEST LEADS HOLDER

Test leads being pulled out of a meter can be very annoying. A very handy way of keeping them put is by using a cable clamp, screwed un-

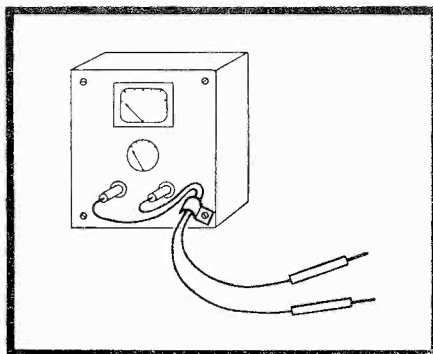

der one of the panel mounting screws, as illustrated.

Hy Davidowitz,
Brooklyn, N. Y.

AUTO SET CONDENSER

The buffer condenser is a source of much trouble in auto sets, and should be checked or replaced when auto radios are serviced. This condenser is used for protection of the vibrator points, as well as the elimination of noises in the rectifier circuit. It is good practice to open up the vibrator case and inspect the points for condition. They should be free from pits and bumps. Do not try to file or dress the points. Replace the vibrator with correct type.

Arthur W. Greengard,
Los Angeles, Calif.

TUBE IDENTIFICATION

Identification symbols on glass tubes which have faded beyond legibility may be restored by rubbing the glass envelope of the tube through the short hair in back of your ear, in a back-and-forth motion, for about 5 to 10 seconds. Usually one treatment of this type brings out the tube type symbol to a degree at which it can be read. However, there are extreme cases where this treatment may have to be repeated several times before the type symbol becomes legible.

Robert Shute,
Poquonnock Bridge, Conn.

LOCATING BAD TUBES

To locate quickly an open filament in a "dead" ac-dc set without removing the tubes from their sockets, place the chassis upside down

on the bench and bridge across the filament pins of each tube with an ordinary neon tattle-lite. The light will glow when placed across the open tube filament. The line cord and a-c switch can also be checked with this light.

Clyde Dearing,
Greenfield, Ind.

STANDOFF INSULATOR

Plastic brackets made for holding 1/2" diameter dowels for towel racks make a good standoff insulator for bringing that Amphenol twin lead down from the I'M or TV dipole on the roof. Besides making good insulators, they hold the twin lead

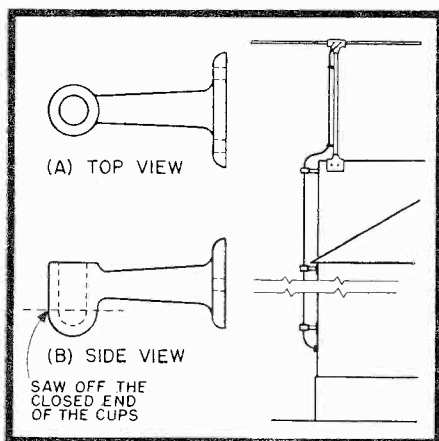

away from the house, preventing swaying and slapping against the side of the building in windy weather. The plastic brackets are made of tough plastic and are provided with convenient mounting holes. Simply saw off the closed end of the cups.

Arthur Trauffer,
Council Bluffs, Iowa.

REMOVING DIAL KNOBS

In removing dial knobs from radio receivers, I find that some are very difficult to get off. In that case I make a loop of wire and loop it between the knob and panel, and simply pull slowly. If there is sufficient clearance, I use insulated hookup wire, thus preventing marring of the knob in troublesome cases. In cases where removal of the knob is extremely hard, I place two loops 45 degrees apart under the knob, with good results and without marring the panel. There is little chance of either marring the finish or of breaking the knob.

John A. Flor,
Milwaukee 9, Wisc.

Build Business 3 ways

FROM NEW AND OLD CUSTOMERS

with Exclusive
NEW
SERIES 12

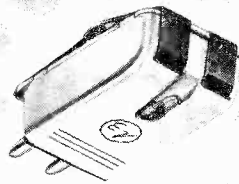

LIGHTEST
MOST EFFICIENT
CRYSTAL CARTRIDGE
EVER PRODUCED



NEW IDEA WINS CUSTOMERS CREATES MORE BUSINESS

1. With only 3 basic types you can make normal replacements of over 150 standard models
2. You offer all record fans a new aid in obtaining finer reproduction and preserving records.
3. You help record lovers get more plays out of old worn records.

Everyone likes the way the new TORQUE DRIVE improves performance . . . hushes surface noise and needle talk . . . reduces record wear, increases record life, gives more needle plays. Comes in low, medium and high voltage, with replaceable Osmium-tip or Sapphire-tip long-life whisker needle. Available individually or in kits.

Series 12 with Osmium-tip needle . . . List price \$7.50
Series 12 with Sapphire-tip needle . . . List price \$8.50
At your E-V Distributor or write for Bulletins 141 and 142.

ELECTRO-VOICE, INC., BUCHANAN, MICH.
Export: 13 East 40th St., New York 16, U.S.A.
Cables: Arlab

HANDY KIT MAKES SALES AND SERVICE EASY

Enables you to make most replacements immediately. Saves time! Cuts overhead! Increases profit! Available in Kit "A" (Osmium) or Kit "B" (Sapphire). Each kit contains 6 cartridges, 4 extra needles, mounting plates, literature, replacement chart.

New Model L-14 for MICROGROOVE

New Microgroove Crystal Cartridge also available now—at same price. E-V Model L-14 has smooth, peak-free response to 12,000 c.p.s. No filter necessary.

New Model 20 MAGNETIC CARTRIDGE

Now available for REGULAR or MICROGROOVE records. Uses Model 503 Matching Transfilter.

E-V Pat. Pend. Licensed under Brush Patents.

IT PAYS TO REPLACE WITH

Electro-Voice

**INDISPENSABLE!
AN ESSENTIAL TOOL
FOR YOUR REPAIR KIT!**

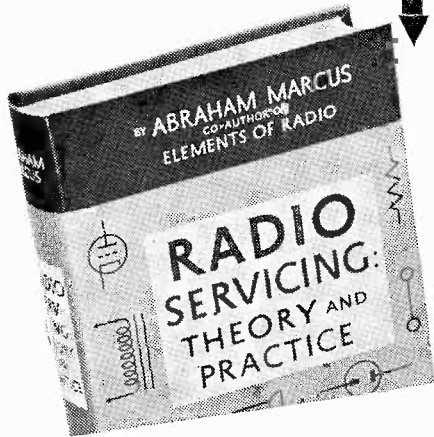

RADIO SERVICING: THEORY AND PRACTICE

By Abraham Marcus

author of *Elements of Radio*

This book, the sequel to *Elements of Radio*, is essential equipment for all practical radio men—whether you are a service man, maintenance engineer or a manufacturing superintendent. Specific practices of radio repair and the more advanced problems of radio servicing are explained in clear language and over 575 drawings. It may be used by amateur craftsmen or students.

All Standard Servicing Instruments



ABRAHAM MARCUS' first book **ELEMENTS OF RADIO** sold over half a million copies!

For the first time in any book, an extensive section covers all standard servicing instruments — meters, electron-ray-tube indicators, tube checkers, etc. — their parts and their operation, graphically illustrated by 70 drawings in one chapter alone. It discusses electrical and radio theory, components and parts; the many uses of electron tubes, control circuits, power supplies, repair, replacement and readjustment. The sections on the latest developments in Frequency Modulation — FM — bring this practical book right up to the minute.

CHAPTERS include: Electrical and Radio Theory • Components and Parts • The Electron Tube, as a Rectifier, as a Detector, as an Amplifier, as an Oscillator • Special Tubes • Circuits • Receivers • Instruments Used for Servicing, Procedures, Techniques • Repairs, Readjustments, etc.

832 pages plus 16 pages of photographs, 575 drawings. Completely indexed and tabulated. No other reference materials are needed. Its clarity and completeness make it invaluable for the ham or professional.

Send for your copy now!
Mail check or money order for \$5.95 to

PRENTICE-HALL, Inc., Dept. 309-B
70 Fifth Avenue New York 11, N. Y.

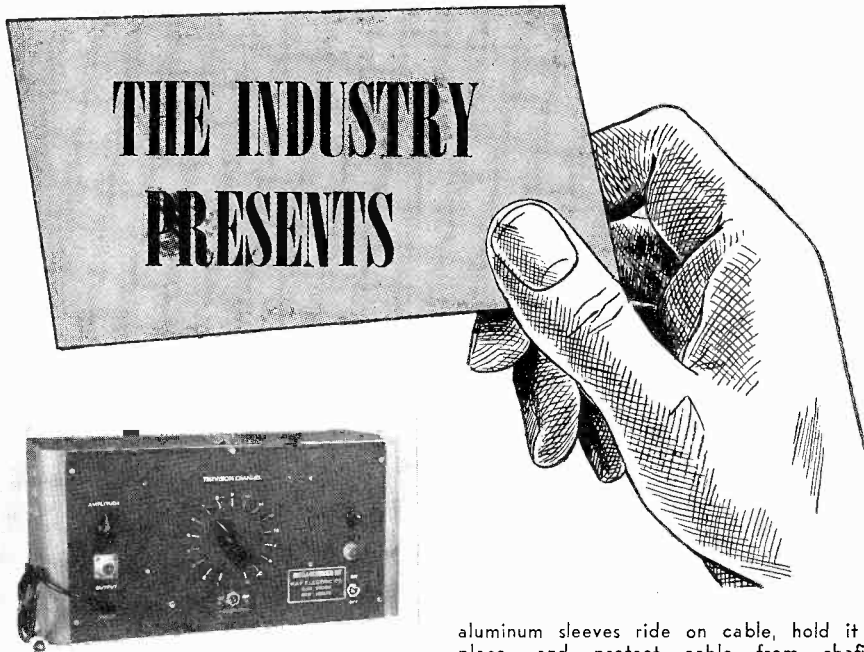

MEGA-MARKER

The Mega-Marker, Sr. is a twelve channel single dial switched crystal controlled marker oscillator, providing accurate sound carriers for all twelve TV channels. As an improvement, the Kay Electric Co., Maple Ave., Pine Brooks, N. J., has added tone modulation to the instrument. This addition permits aural identification of its output in the receiver loudspeaker. The modulation may be switched on or off. By its use, the local oscillator may be aligned by using only the instrument and the television channel and loud speaker.

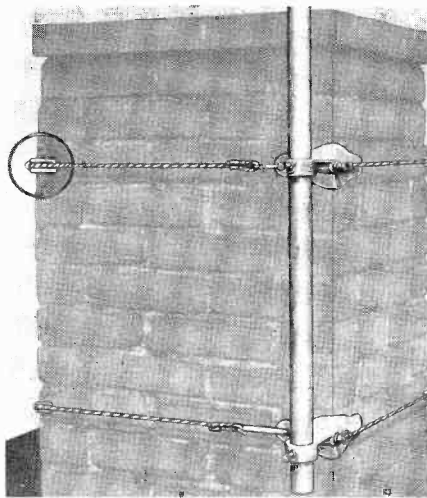

ANTENNA MOUNT

The Mastercraft Antenna Mount is designed to eliminate the common hazards and troubles of roof installations. The antenna can be strongly secured by one man with no special tools in five minutes. The Mastercraft Antenna Mount is protected by Product Liability Insurance. Specifications and contents of each set are as follows: 2 strong aluminum castings (fit any chimney corner) with set bolts and lock nuts. The mount accommodates all size masts up to 1 3/8" outside diameter. Mounts may be spaced to assure maximum rigidity, using only one set for each installation. 6 stamped and shaped

aluminum sleeves ride on cable, hold it in place, and protect cable from chafing against chimney corners.

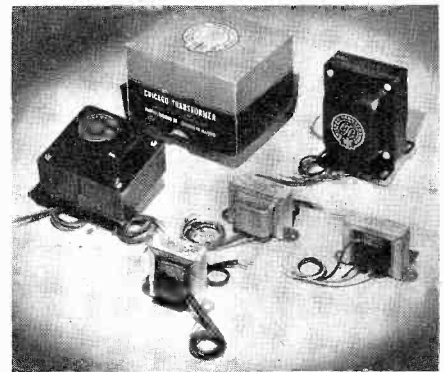

TRANSFORMER REPLACEMENTS

The Chicago Transformer Division, Essex Wire Corp., 3501 Addison Street, Chicago, Ill., has now made its entry into the replacement parts field. Included in the line are power transformers and chokes, driver, speaker matching, interstage, and output transformers in a range of practical ratings. Quality construction throughout, RMA color-coded leads, pinned lead ends, and standard dimensions mountings are features.

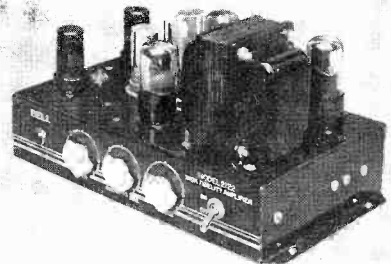

RADIO PHONO AMPLIFIER

The new Model 2122 High Fidelity Radio-Phone Amplifier has these features. Four inputs: radio, one for crystal and two magnetic pickups; built-in pre-amplifier for each magnetic input; each input is individually equalized; bass and treble boost with attenuation. The amplifier, in addition to having

inputs for a radio tuner and any crystal pickup, contains two special inputs for the new type magnetic pickups and is therefore very useful for microgroove applications. Built-in pre-amplifiers and individual equalization of each of the magnetic pickups assures proper match and response from the various types of new magnetic pickups. This amplifier is manufactured by the Bell Sound System, Columbus 7, Ohio.

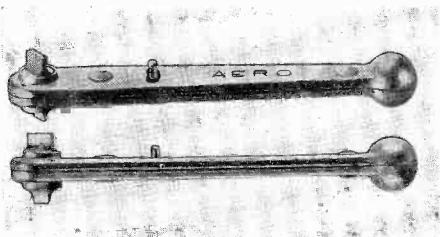

RATCHET SCREWDRIVER

The Aero #5200 is a new screwdriver designed to permit the application of leverage to drive screws, and to reach into areas inaccessible to common screwdrivers. The ratchet permits use of the tool in confined spaces and the reversing lever makes the tool suitable to drive or remove screws. The screwdriver has blades for large and small screws and a ball end grip. Overall length is 3 7/8". The standard tool is made for slotted screws only, but it is available with special drivers for Reed & Prince, Phillips and other screws for assembly operation. The tool is manufactured by the Aero Tool Co., 6930 Avalon Blvd., Los Angeles 3, Calif.

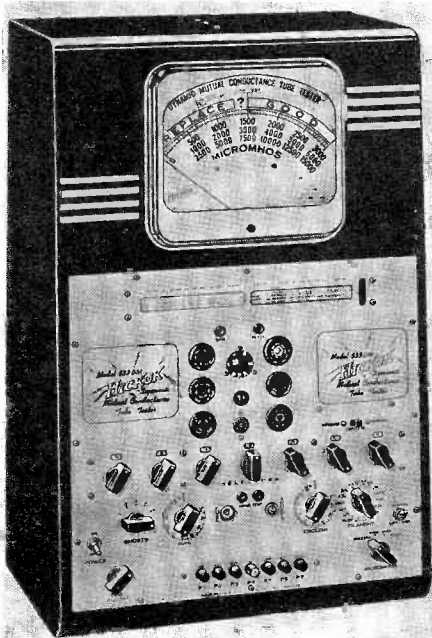

DISPLAY TUBE TESTER

The Model 533 DM is a new Hickok Display Tube Tester to let customers see for themselves the condition of their tubes on a big 9-inch illuminated scale. This tester tests all present-day tubes and has provision for new tube designs, so it is not likely to become obsolete. The instrument uses rectified current to energize plates and grids using two rectifiers. Meter shows microhm ranges of 0-3000, 0-6000, 0-15,000. Roll chart in panel makes tube data easily and quickly available. Gas test provision eliminates gas-y tubes (which ruin a.v.c. and i-f stages).

→ to page 43



Each Resistor is CLEARLY MARKED to show Resistance, Wattage and OHMITE Trade Mark

Guesswork's gone . . . when you use genuine Ohmite Little Devil insulated composition resistors. Each unit, in all three sizes—1/2, 1, and 2 watts—is color-coded and individually marked for quick, sure identification.

Millions of these superior quality resistors are being used today by manufacturers, servicemen, and amateurs. They meet joint Army-Navy Specification JAN-R-11, including salt-water immersion cycling and high humidity tests. They can be used at their full wattage ratings at 70 C (158 F) ambient temperature. Little Devil resistors dissipate heat rapidly . . . have low noise level and low voltage coefficient.

Ratings for maximum continuous RMS voltage drop are high: 350 volts for the 1/2-watt unit, 500 volts for the 1-watt unit, 1000 volts for the 2-watt unit. All units have high insulation breakdown voltage.

Little Devils are completely sealed and insulated by their molded plastic construction. Leads are soft copper wire, hardened immediately adjacent to resistor body, strongly anchored, and hot solder coated. They're light, compact, easy to install.

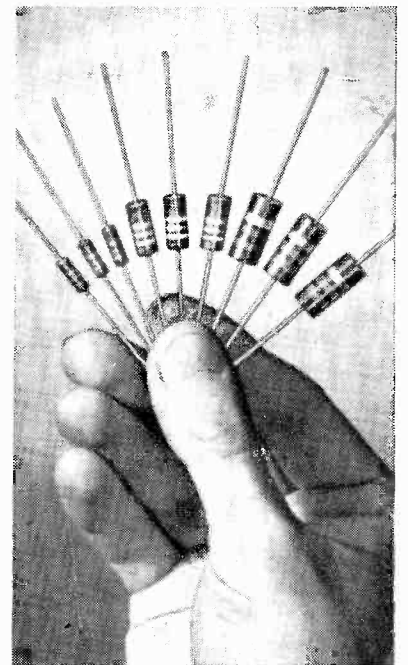

Little Devils are available in Standard RMA values . . . 10 ohms to 22 megohms. Tol. $\pm 10\%$ and $\pm 5\%$. Values to 2.7 ohms available in 1-watt size, $\pm 10\%$ tolerance.

OTHER OHMITE PRODUCTS

BROWN DEVIL RESISTORS—Rugged, dependable, wire-wound, vitreous-enameled. Easily mounted by tinned-wire leads. Tol. $\pm 10\%$. 5-, 10-, 20-Watt sizes. **DIVIDOHM ADJUSTABLE RESISTORS**—Used as multi-tap resistors or voltage dividers. Provide odd resistance values quickly. Vitreous-enameled. See your distributor for these and other Ohmite products.

OHMITE MANUFACTURING CO.
4913 Flournoy Street • Chicago 44, Ill.

Be Right with
OHMITE

RHEOSTATS • RESISTORS • TAP SWITCHES



American Beauty

ELECTRIC SOLDERING IRONS

are sturdily built for the hard usage of industrial service. Have plug type tips and are constructed on the unit system with each vital part, such as heating element, easily removable and replaceable. In 5 sizes, from 50 watts to 550 watts.

TEMPERATURE REGULATING STAND

This is a thermostatically controlled device for the regulation of the temperature of an electric soldering iron. When placed on and connected to this stand, iron may be maintained at working temperature or through adjustment on bottom of stand at low or warm temperatures.

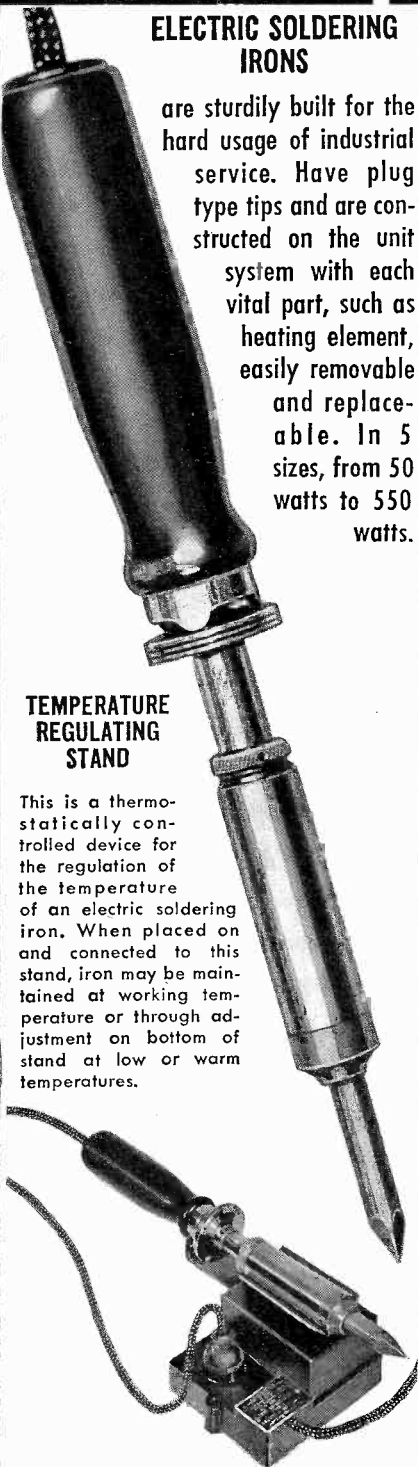

For descriptive literature write

110-1

**AMERICAN ELECTRICAL
HEATER COMPANY
DETROIT 2, MICH., U. S. A.**



by John T. Frye

DO you pride yourself on being an independent sort of serviceman? Do you want your customers to realize that they are doing you no favor when they bring their radios to you for repair, but that, on the contrary, it is you who are doing them a favor in working on their sets?

I know several servicemen who feel just that way. This is especially true of fellows who entered the game after the beginning of the war. To them, radio servicing is a business in which the number of sets to be repaired is apparently limitless; and trying to keep up with the amount of business that pours in through the front door is nerve-racking. Just to catch up with the sets sitting around on the floor is their main goal, and the sight of a customer lugging in another broken-down radio arouses a feeling within him that is very close to resentment.

It is rather difficult for a good mechanic to retain his sense of values. He knows so much about a subject concerning which those with whom he comes in contact know so little, that it is hard not to get an inflated idea of his own intelligence, and not to take a rather dim view of the intelligence of others. After all, when you are constantly being asked to do something for others that they don't know to do for themselves, you are quite likely to develop a mild superiority complex and to have a secret conviction that what you do not know is hardly worth knowing. What is worse, this feeling is likely to be apparent to others, especially to customers.

That attitude is all wrong, and the sooner it is put aside the better. There is no such thing as a really independent serviceman, for he is dependent on his customers for the

purchase of his tools, for the payment of his rent, for the fuel to heat his house and shop—yes, and for the very bread that he eats. We who were in the service game during the depression years have not forgotten how things were then. We remember that a customer was as welcome as the flowers in May, and there was no doubt in our mind as to who was doing whom a favor when he brought his radio to our shop.

I would be one of the last to belittle the knowledge and intelligence that is necessary in radio servicing, but I have never deluded myself into thinking that radio servicemen, or any other expert mechanics, have a corner on the brains department. True, they have a great deal of highly specialized information, but that knowledge represents only a small corner of the single field of science. When you think of how many other fields of knowledge there are, you will see things in their proper proportions.

The housewife who talks vaguely about her radio needing "a new balancer, or something like that," may appear almost moronic to you; but just how active a part could you take in one of those sewing circle sessions in which the talk is all about "bias" (and this is neither the grid-leak nor cathode-resistor variety), "basting," and "inverted pleats"? Or, if you are not a "shutter bug," how much sense do you get out of all that chatter about "F/1.9 lens, K2 filter, focal plane shutter, depth-of-focus" that you hear when a group of camera fans gets together?

The businessman—and the radio serviceman must never forget that he is one—must have respect both for himself and for his customer. Oddly

enough, the more of the former he has, the more of the latter will be apparent in his dealings with others. The fellow who really has confidence in his own ability does not have to be constantly proving to himself and to the world that he is good; instead, he has plenty of time to consider the feelings of other people. He is not brusque because he does not like to be treated brusquely; he goes out of his way to do little favors because he is aware of how much he appreciates having little favors done for him.

Anyone who deals with the public is going to encounter some unreasonable requests, and the radio serviceman is no exception. We all know the fellow who tries to chisel on service charges, the woman who thinks you should fix her radio at once, ahead of all others, because "you have always done all of our radio work," and the man who insists that if you knew your business, you could take the night-fading out of his receiver.

The point to keep clearly and constantly in mind while correcting the wrong ideas that these people have, is that you must do so without injuring their self-esteem. Do not just say that you cannot grant their request because it is unreasonable. Try to explain that you would like very much to do what they ask, but then go ahead to show that you simply cannot do it without doing an injustice to others. If you can get this point across without making them think less of themselves for having made the request in the first place, they will not think less of you for saying "no." That is what the famous sales executive meant when he said that the businessman should make an art of saying "no."

When you can do so without too much trouble, try to grant these requests for a little "extra" service. The old customer who brings his guest to you with a little personal radio "that has never been quite right," has probably told his friend what a good serviceman you are and wishes to impress that friend with his ability to get things done. If you can take care of the little radio, you will have made a friend for life out of your customer. The same thing is true when you get a frantic call from a lady whose radio has gone dead right on the eve of her big party.

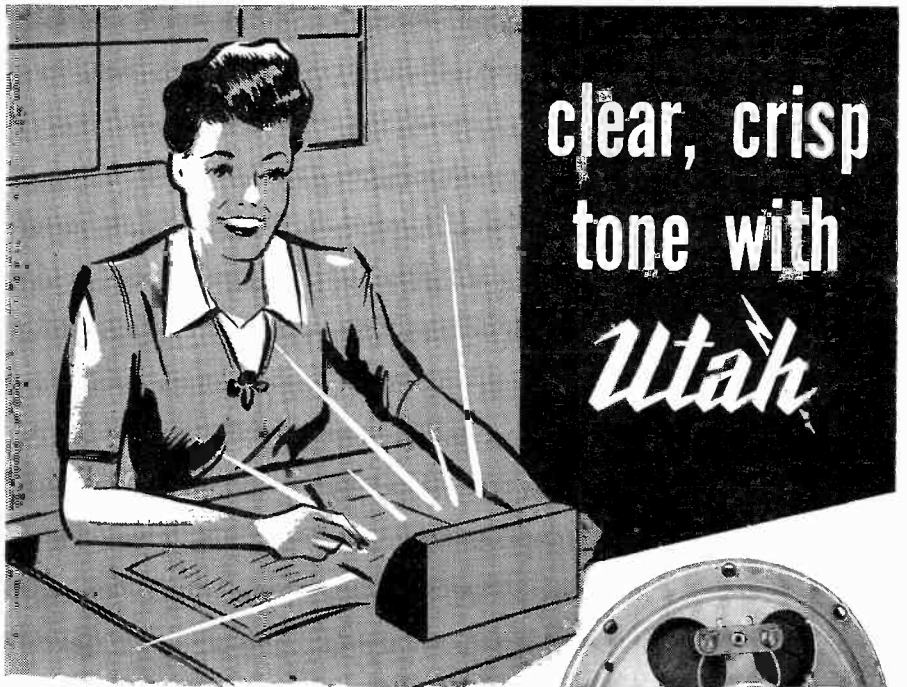

Inter-Comm REPLACEMENT SPEAKERS

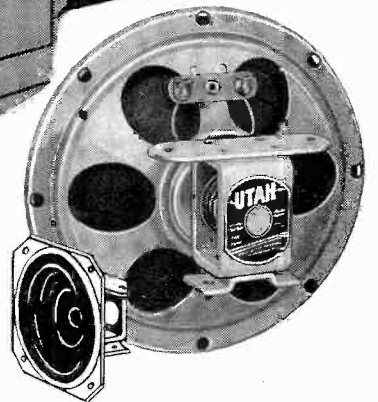

INTER-COMMS speak right up when the new Utah Inter-Comm Replacement Speakers are used. Your customers are pleased because voices are true and easily understood. Two new Utah Speakers are now available for inter-comm and similar sound applications. The SP4AI and SP5AI are built with 44 ohm voice coils and .68 oz. Alnico V Magnets. Dust covers are standard. Order from your jobber now.



UTAH RADIO PRODUCTS
HUNTINGTON, INDIANA
DIVISION OF INTERNATIONAL DETROLA CORPORATION
EXPORT DIVISION: MORHAN EXPORTING CORP., N.Y.C.

UTAH SPEAKERS SPEAK FOR THEMSELVES



HIGH OUTPUT CRYSTAL CONTROLLED FM-AM SIGNAL GENERATOR

World Famous
HICKOK

**MODEL
288X**

The most popular FM-AM generator.
• High FM output. • Fundamental frequencies to 110 MC. • FM frequencies to 160 MC. • Two sweep frequencies—30 KC and 50 MC. • Self contained decibel meter. • Audio frequencies 0 to 15,000 cycles. • Plus many other features.

See Your Jobber Today or Write for Literature.

THE HICKOK ELECTRICAL INSTRUMENT CO.
10634 Dupont Avenue • Cleveland 8, Ohio

→ A Sensational Announcement to the Top "1/3" in Servicing . . .

After 2 years of Preparation CREI Introduces its New Home Study Course in

TELEVISION AND FM SERVICING

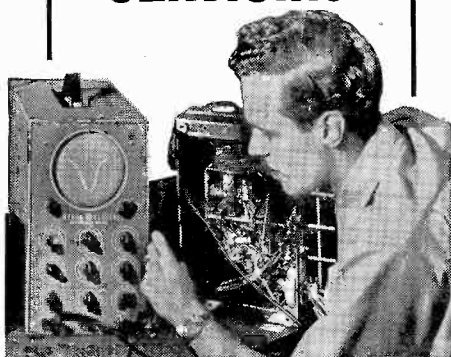

G. E. PHOTO

100% PRACTICAL "ON-THE-JOB" COURSE

1948 is the big changeover year—from radio to television. It is the year for you and all servicemen to make the big decision. Either you are going to catch up with the new developments in the industry, or you are going to be passed by. There are new techniques—entirely new methods of technical "know how" to be learned and mastered, if you are going to be in a position to handle good-paying Television and FM business.

This new course was prepared by CREI at the request of several large manufacturers, distributors and dealers who said, "We must have more servicemen trained to handle the approximately 800,000 television sets and 4,000,000 FM sets to be produced this year alone! CREI knows exactly what you need and every effort has been made to keep this course practical and to the point. If you are now in service work you will be able to thoroughly understand and apply each lesson. It has been reviewed and checked by qualified service experts who know what you must know to get ahead in this booming field."

Start your training now and you start applying your new-found knowledge immediately. Every lesson in this course can be helpful in your daily work. As you progress in your training you will find yourself equipped to handle complicated Television and FM work that only a few months ago looked "impossible". The time to start is now.

It costs you nothing but a few minutes time to read the interesting facts and the complete lesson-by-lesson outline. So practical, so simple to understand.

↓ GET ALL THE FREE FACTS NOW — FILL OUT AND MAIL COUPON

Capitol Radio Engineering Institute
16th & Park Rd., N.W., Dept. RT-12
Washington 10, D. C.

Please send me complete details of your new home study course in Television and FM servicing. I am attaching a brief resume of my experience, education and present position.

Name
Street
City Zone State

I am entitled to training under G. I. Bill

If you can save the situation, anyone will have a hard time trying to tell her that you are not the best and most considerate radio serviceman in town.

Without wishing to be a pessimist I have great doubts that the present boom in radio servicing will become the normal state of affairs. In fact, there are already some signs pointing toward a return to the times when it was necessary to go out after business instead of letting business come to you.

When the time does come when we again have a buyers' market, the people will take their cherished business to those shops in which they have received the best service and the most courteous treatment. The serviceman who prides himself on his "independence" should then be completely happy, for he will find the people with radios to fix will not bother with him at all. ✓✓✓

FM Detectors

→ from page 10

standard value so it can be compensated easily at the receiver. The standard value is referred to as "75 microseconds." This means that a resistor and condenser connected as R and C in Fig. 2 and 3 should have a time constant of 75 microseconds to restore the a-f components to their proper proportions. The time constant is calculated by multiplying the resistance value in megohms by the capacitance value in micromicrofarads. For instance, some receivers use a series resistor of 15,000 ohms and a condenser of 5,000 mmf. This combination gives the exact 75 microsecond de-emphasis. The value is not critical and many receivers use a 100 microsecond characteristic, a 100K ohm resistor and a 1,000 mmf condenser being a popular combination.

Of course, removal of de-emphasis components may, under some conditions, appear to have no effect. For this reason, some servicemen may tend to play down their importance. But overall performance, both as to quality and noise level reduction, will soon prove its value. The wise serviceman, understanding the reasons for the de-emphasis circuit, will see to it that it is properly maintained. ✓✓✓



All-Channel TV Antenna

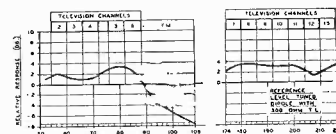

MEGACYCLES

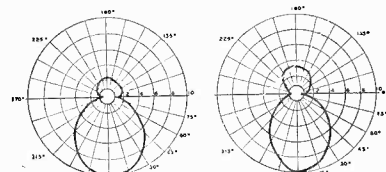

Horizontal Directivity 60 mc.

Horizontal Directivity 190 mc.

It's simpler, lower in cost, easier to erect, has oversize elements and the famous adjustable V dipole design which permits adjustment in both horizontal and vertical planes. Covers all 12 channels. List \$20. Send for test chart, full details and discount.

PREMAX PRODUCTS
DIVISION CHISHOLM RYDER CO., INC.

4907 Highland Ave., Niagara Falls, N. Y.

An easily remembered FOLDED DIPOLE LENGTH FORMULA

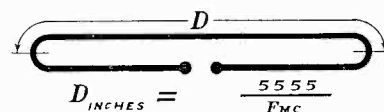

(assuming rod or tubing elements of conventional air-spaced construction)

This easily remembered formula is just a sample of the wealth of useful, directly applicable information radio servicemen will find in the ANTENNA MANUAL.

Also, the basic theory on antennas, transmission lines and propagation will help you cope with problems involving FM, television, VHF two-way installations and the other new applications in the rapidly expanding radio service field. Keep ahead of the game with the

antenna manual

\$350

AT YOUR DEALER. On mail orders from us, \$3.60 postpaid; foreign, \$3.75.

Editors and Engineers LIMITED

1315 KENWOOD ROAD, SANTA BARBARA, CALIFORNIA

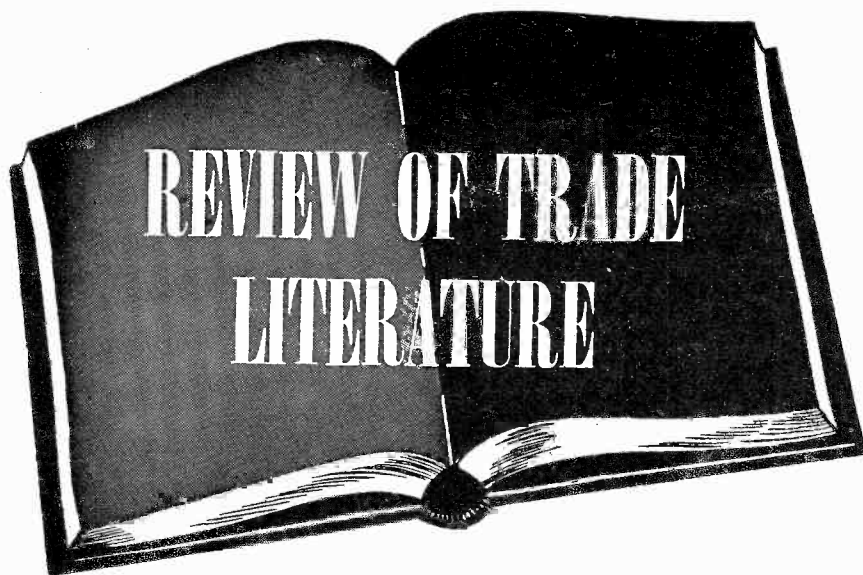

To avoid delay when writing to the manufacturer give issue and page number.

Radio Industry Red Book—Howard W. Sams has just published the Radio Industry Red Book, a replacement parts buyers' guide, produced with the cooperation of 17 leading parts manufacturers. It lists parts for approximately 17,000 radio models produced between 1938 and 1948, and covers all nine major components: Tubes and dial lights, capacitors, transformers, controls, i-f coils, speakers, vibrators, batteries, and phono cartridges. Its 22" x 8½" double spread makes for easy reading, and the full index makes for quick reference. This book, which lists all replacement parts data needed by the radio serviceman, should prove an invaluable guide in his day-to-day work. The information contained in the Red Book is authoritative and has been collected into one source for the first time in radio history. 440 pages, price \$3.95

1949 Tube Reference Book—The 19th edition of RCA Tube Department's Tube Reference and Calendar Notebook is now on the presses and will be distributed shortly. This edition of the vest-pocket guide to essential tube data has been completely revised and expanded to include television data and new, up-to-date information on tubes and batteries. As always, the book includes a world atlas complete with an 8-page section of United States maps, day-to-day diary, date and memo section, and a 1949 calendar. This

book is the customary gift to radio servicemen from RCA tube distributors, and will be available exclusively from RCA Victor and Cunningham Tube distributors.

Audio Amplifier Manual—The Audio Amplifier and Associated Equipment Manual has been brought out by Howard W. Sams & Co., 2924 East Washington St., Indianapolis, Ind. This is a specialized manual of Photofact Folders covering amplifiers, FM tuners and recorders treated by Photofact since the end of the war. Postwar models of 31 manufacturers are included. The Manual also contains complete material on the Brush Sound Mirror and the Webster 79 and 80 wire recorders. Bound in strong paper cover, the manual is fully illustrated. 352 pages, price \$3.95

New Reference Manual—A new reference handbook for the serviceman, the radio amateur and the communications operator, the Postwar Communications Receiver Manual CRI, has been announced by Howard W. Sams & Co., Indianapolis, Ind. The manual covers more than 50 postwar communications receivers, including a number of units designed for aircraft and marine application. It is amply illustrated, and its schematic diagrams are very good examples of clear circuit presentation.

264 pages, price \$3.00

RADIO NOISES

can be

JIFFY CHECKED

with the

AEROVOX

INTERFERENCE FILTER SELECTOR

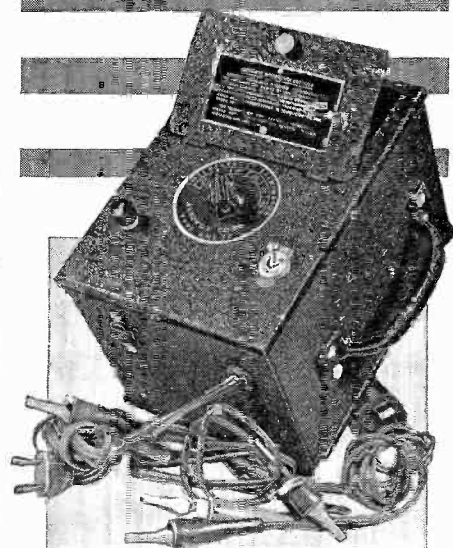

● Convert radio noises into extra sales dollars! Aerovox Type ANL-37 Selector does the trick. Connect it with noise-producing source. Various plugs and clips permit variety of connections and ground. Turn knob when interference is minimized, dial indicates correct Aerovox Type filter to install. It's simple, positive, profitable

● ● ● ●

● Ask our jobber about this money-making equipment. Order your Selector today. Described in current Aerovox catalog. Ask your jobber for your copy—or write us.



**FOR RADIO-ELECTRONIC AND
INDUSTRIAL APPLICATIONS**

AEROVOX CORP., NEW BEDFORD, MASS., U.S.A.
Export: 13 E. 40th St., New York 16, N.Y. • Cable: 'ARLAB'
In Canada: AEROVOX CANADA LTD., Hamilton, Ont

CHECK!

TOUGHER POWER RESISTORS .. GREENOHMS

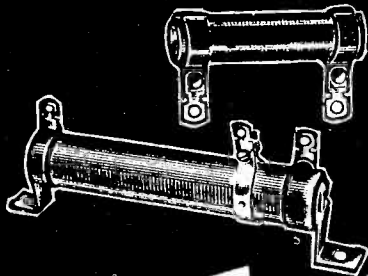

CEMENT COATED

Special cold-setting inorganic cement. Wire winding unimpaired because no intense heat is used in processing. Also no corrosion because no water glass is used. A DIFFERENT cement coating.

OVERLOAD INSURANCE

A Greenohm takes a 500% overload when necessary. Hot enough to light a cigarette! Yet cement coating does not soften, bubble, crack, peel, flake!

FIXED AND ADJUSTABLE

Available in fixed (5 to 200 watt) and adjustable (10 to 200 watt) types. Widest selection of resistance values. And they save you money. Just compare prices!

CLAROSTAT



Ask your
Clarostat
jobber for
latest cat-
alog. Or
write us.

Controls and Resistors

CLAROSTAT MFG. CO., INC. • DOVER, N. H.

In Canada: CANADIAN MARCONI CO., Ltd
Montreal, P.Q., and branches

Electronically Speaking

→ from page 5

permits viewing of the TV screen when the car is in motion. R. W. Durst, executive vice president of the company, also revealed that the idea is past the theoretical stage and that rapid strides are being made toward production of the auto video unit.

The JFD Manufacturing Co. held the 5th session of its continuing series of TV antenna installation forums in Rochester, N. Y., on Tuesday evening, November 23, 1948, at the Sheraton Hotel. Fundamental installation and reception problems were discussed and analyzed by leading engineers in the field, and the lectures followed by question and answer periods, during which specific problems brought up by the audience were examined to obtain the most workable solutions. These meetings are conducted by Mr. Albert J. Friedman, Chief Antenna Development Engineer, who has conducted the previous meetings. Mr. Friedman's discussion was on the study of every major type of television and FM antenna and its particular place in today's increasingly complex television field.

Radio receiving tube sales increased sharply in August of this year, registering an increase of more than seven million over July sales, and more than two million above August of 1947, the Radio Manufacturers Association reports.

Production of television receivers in the United States will reach the 100,000 a month mark during the last quarter of this year, it was predicted by James H. Carmine, vice president of distribution, Philco Corporation. According to him, in New York City alone, television receivers are being installed in private homes at the rate of 1,000 per day, and this number promises to increase substantially in the weeks just ahead. At the same time television is coming to additional cities across the country. ✓ ✓ ✓

STATEMENT OF THE OWNERSHIP, MANAGEMENT, CIRCULATION, ETC., REQUIRED BY THE ACT OF CONGRESS OF AUGUST 24, 1912, AS AMENDED BY THE ACTS OF MARCH 3, 1933, AND JULY 2, 1946, OF RADIO MAINTENANCE, published monthly at East Stroudsburg, Pa.

State of New Jersey } ss.
County of Essex }

Before me, a notary public in and for the State and county aforesaid, personally appeared Joseph J. Roche, who, having been duly sworn according to law, deposes and says that he is the editor of RADIO MAINTENANCE, and that the following is to the best of his knowledge and belief, a true statement of the ownership, management (and if a daily, weekly, semiweekly or triweekly newspaper, the circulation), etc., of the aforesaid publication for the date shown in the above caption, required by the Act of August 24, 1912, as amended by the Acts of March 3, 1933, and July 2, 1946 (section 537, Postal Laws and Regulations), printed on the reverse of this form, to wit:

1. That the names and addresses of the publisher, editor, managing editor, and business manager are: Publisher, William F. Boyce, 45 Hillcrest Rd., West Caldwell, N. J.; Editor, Joseph J. Roche, 598 Valley Rd., Upper Montclair, N. J.

2. That the owner is: (If owned by a corporation, its name and address must be stated and also immediately thereunder the names and addresses of stockholders owning or holding one per cent or more of total amount of stock. If not owned by a corporation, the names and addresses of the individual owners must be given. If owned by a firm, company or other unincorporated concern, its name and address, as well as those of each individual member, must be given.) Boland & Boyce, Inc., 460 Bloomfield Ave., Montclair, N. J.; William F. Boyce, 45 Hillcrest Rd., West Caldwell, N. J.; Joseph J. Roche, 598 Valley Rd., Upper Montclair, N. J.; Mary Ann Boyce, Wayne, N. J.

3. That the known bondholders, mortgagees, and other security holders owning or holding 1 per cent or more of the total amount of bonds, mortgages, or other securities are: None.

4. That the two paragraphs next above, giving the names of the owners, stockholders, and security holders, if any, contain not only the list of stockholders and security holders as they appear upon the books of the company but also, in cases where the stockholder or security holder appears upon the books of the company as trustee or in any other fiduciary relation, the name of the person or corporation for whom such trustee is acting, is given; also that the said two paragraphs contain statements embracing affiant's full knowledge and belief as to the circumstances and conditions under which stockholders and security holders who do not appear upon the books of the company as trustees, hold stock and securities in a capacity other than that of a bona fide owner; and this affiant has no reason to believe that any other person, association, or corporation has any interest direct or indirect in the said stock, bonds, or other securities than as so stated by him.

JOSEPH J. ROCHE,
Editor.

Sworn to and subscribed before me this first day of October, 1948.

(Seal) S. R. MASSA,
(Advt.) Notary Public of N. J.

New Book makes AUTO RADIO REPAIR twice as easy!

Covers all auto
Radio types from
mid-1930's to
present, includ-
ing mobile FM.



Just Out!

SERVICING THE MODERN CAR RADIO, by A. L. Hurlbut

Second edition, 702 pages, 8½ x 11, 222
illus., over 500 circuit diagrams... \$7.50

Here—written by a practical auto radio expert of 20 years' standing—is everything to help the beginner or experienced serviceman gain profitable skill in the fast-growing field of car radio servicing. A complete guide to the work. Book not only describes installation, testing, and repair methods fully, but also gives needed special facts of car radio circuits, differences between car and home radio servicing problems, shop set-up and business-getting ideas, etc. And invaluable for all jobs is the big gallery of circuit diagrams on hundreds of models, old and new.

Practical facts and methods on:

- getting into the car radio business
- differences between mobile and home radios
- antennas and input circuits
- power supplies
- circuit features
- auto electrical systems
- setting up shop
- car set installations
- antenna installation
- loudspeaker installation
- remedying interference
- servicing procedure
- vibrator maintenance
- loudspeaker servicing
- car-radio alignment
- push-button tuning, etc.

OPPORTUNITY OF A LIFETIME

for alert servicemen, says A. A. Ghirardi
author of famous radio servicing books
and articles

"SERVICING THE MODERN CAR RADIO represents an opportunity no wide awake serviceman can afford to miss. There are over 9,000,000 car radios—approximately 16 out of every 100 radio receivers in use—a wonderful field for increasing business; stepping ahead of competition! Good auto radio men are scarce, and this book gives you a gold mine of information you need to cash in on this profitable, fast-growing business."



ALFRED A. GHIRARDI

10 DAYS' FREE EXAMINATION

Murray Hill Books, Inc.
(Division of Rinehart & Co.)
Dept. RM-128, 232 Madison Ave.,
New York 16, N. Y.

Send me Hurlbut's Servicing the Modern Car Radio for 10 days' examination on approval. In 10 days I will send \$7.50, plus few cents postage, or return book postpaid. Postage paid on cash orders; same return privilege. (Books sent on approval in U. S. only. Price outside U. S., \$8.00, postpaid.)

Name
Address
City (Zone) & State
Occupation

Customer Confidence

→ from page 7

relating to an unconditional guarantee. A block diagram marked with location of parts installed is also helpful and can be made a part of all bills and invoice forms.

No plan of this kind will satisfy all cases. We may well envy the automobile mechanic whose customer does not expect a 10 year old automobile to run like new and who knows the difference between the rear end and the fan belt. Your best assurance of handling the guarantee problem is to have gained that customer confidence we have deemed so important

Licensing has been offered as a cure for dishonesty. I am not in favor of licensing for the following reasons:

1—The necessary increase in prices would gradually stifle the repair business.

2—It would lead to many restrictions against, and eventually the demise of, small business.

3—The licensing scheme would have to include business stability as a qualification because the lack of ability to make money is the basic cause of dishonesty in the radio service business. How could a political licensing bureau pass on that phase?

4—I believe it to be against the free enterprise system.

However, there is a definite need for voluntary associations to carry on public educational programs, apprentice training, and democratically imposed self-policing of the industry.

After sweating over these hypothetical radio jobs, the day comes when our friend discovers that he is not getting enough business from the advertising done thus far. There are a number of ways to get new business.

1—Open up a checking account in the neighborhood bank, and while doing this, solicit all the employees of the bank for their radio work. These connections will be invaluable later on when the need to finance appliance sales arises, especially in view of the fact that it is extremely difficult for small service-dealers to secure financing from sources available to large stores.

2—Call on all of the business houses in the vicinity. You will find that they will welcome you to the

neighborhood, and it is better than an even bet that you will return with several repair jobs.

3—Systematically canvass every house in your territory, taking time to establish a friendly feeling with the occupants. This will get more business. Even during the "threadbare thirties" I never failed to keep work in the shop with this plan.

4—If you have a typist-stenographer, make a list of selected streets, and through means of a criss-cross directory have her call the subscribers and offer free inspection of their radios in the home.

These plans actually create business as they are instrumental in inducing people to modernize radios, add record players, and even repair radios that would otherwise be left as they were.

Eventually our young business man will be offered contract work by dealers who do not maintain a service department for installation of auto radios and large radios in homes. The contract usually requires that the serviceman perform the labor of installing parts that prove defective during the guarantee period. For these services he is paid a flat fee. There is nothing inherently wrong with this type of work, but occasionally an unscrupulous store manager will take advantage of the less experienced serviceman. Make certain that the agreement provides that any extra trips due to the failure of the store to send proper parts, are paid for at regular service call rates. Otherwise, you may find yourself running around to suit the whim of some store manager who is trying to impress his customers at your expense. I learned this the hard way many years ago.

As a radio serviceman you are rendering a vital service. You can make an honest living and survive under any conditions while building your business on a solid foundation that will lead to both pride of accomplishment and financial security.

You can laugh off the complaints of your competitors that there are too many shops; that there is no service work because too many new radios have been sold; that department stores are offering radios for sale at retail for less than you have to pay wholesale.

Earn the confidence of the people in your neighborhood and you cannot lose. ✓✓✓

TWO GREAT BOOKS...COVERING EVERYTHING IN RADIO & TELEVISION

EVERYTHING IN RADIO AND ELECTRONICS IN ONE BOOK!

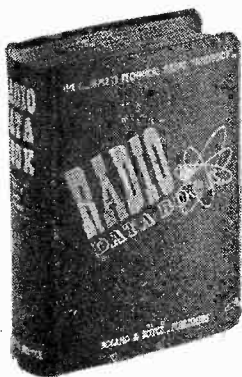

THE RADIO DATA BOOK

the only radio handbook of its kind . . . 1148 pages . . . 12 sections, each covering a radio subject more completely than any other book!

Used by Engineers, Servicemen, Designers, Laboratory Technicians, Draftsmen, Operators, Inspectors, Amateurs, Experimenters, Research Development, Consultants, Broadcast Technicians, Planners, Installation Men, Military, Marine, Police, Fire, Forestry and Railroad Communications.

Anyone and everyone in radio and electronics can use this book!

SECTION 1. 150 BASIC CIRCUITS

Each circuit properly classified and clearly labeled for instant reference! Every basic operating unit in the entire field of electronics for the convenience of everyone in radio—150 circuits—completely illustrated—ALL in this one section!

SECTION 2. TEST EQUIPMENT

All types of volt, current and ohmmeters, tube checkers, condenser meters, inductance meters, bridge measuring devices, RF signal generators, AF signal generators, signal tracers, distortion analyzers, test speakers, oscilloscopes, square-wave generators, frequency meters, field strength and tuning meters are explained and illustrated.

SECTION 3. TESTING AND MEASURING

How to use test equipment and make every kind of measurement in radio. This section alone is worth the price of the entire book.

SECTION 4. ANTENNAS

This section presents complete information on all antennas, transmitting and receiving. Completely illustrated, showing various types of antennas, their construction and wave patterns.

SECTION 5. SOUND SYSTEMS

The planning, selection of equipment and the assembling and combining of various components in complete PA installations. Every type of unit used is described and analyzed in detail.

SECTION 6. RECORDING

This section is the only complete description of disc recording found in any radio manual on the market. Here all phases of recording are covered—both home and commercial.

SECTION 7. TUBE MANUAL

The only uncommercial tube manual giving complete listing of all transmitting and receiving tubes with each tube base illustrated alongside the description.

SECTION 8 & 9. CHARTS, FORMULAS, CODES, GRAPHS, SYMBOLS

Here in these two sections are found all data and information useful to anyone in radio and electronics.

SECTION 10. TESTED CIRCUITS

98% of all equipment built in radio & electronics is covered here in a section presenting the typical circuit with parts lists and descriptions of each type. This is by far the most useful collection of circuits ever presented.

SECTION 11. DICTIONARY OF ELECTRONIC TERMS

This dictionary will explain every radio term—any word used in radio.

SECTION 12. BIBLIOGRAPHY

Here is a unique and valuable list of books for anyone desiring further details on any subject in Radio.

12 complete books in one only
Less than 42c per book!

\$5.00!

THE MOST COMPLETE TELEVISION MANUAL

THE VIDEO HANDBOOK

768 pages . . . 14 sections, covering every phase in television . . . over 800 illustrations . . . handsomely bound in Du Pont Fabrikoid with red and silver letters.

How Television Works, Basic . . . through advanced.
How to Design and Engineer Television.
How to Troubleshoot and Repair Television, Safety procedures.
How to Select and Install a Television Antenna.
How to Create a Television Show.
How to Build an Operating Television Receiver Complete instructions.
How to Select a Television Receiver.

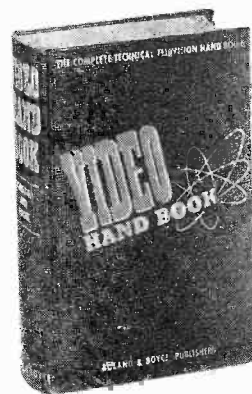

SECTION 1. TELEVISION, PAST, PRESENT AND FUTURE

Here you will find an account of the inventions, discoveries and developments that led to the present system of television.

SECTION 2. FUNDAMENTALS OF ELECTRONIC TELEVISION

In this chapter, a simplified explanation of the complete electronic television system is given.

SECTION 3. THE TELEVISION STATION—PICK-UP—CONTROL—TRANSMISSION

Each operation and piece of equipment is taken in a step-by-step presentation, illustrated with photographs, schematics, white on black scope patterns and graphs, and simplified line drawings.

SECTION 4. THE TELEVISION RECEIVER

Programming and Production

Each stage is individually studied and its function completely described as a unit and in relation to all the other stages.

SECTION 5. TELEVISION ANTENNA SYSTEMS

Circuit Variations—Design—Mechanical Features

The proper antenna for the various receivers and locales are explained.

SECTION 6. CREATING A TELEVISION SHOW

In television programming is tightly interwoven with technical operation—the man who knows this and studies both will profit greatly.

SECTION 7. DESCRIPTIONS OF MODERN TELEVISION RECEIVERS

Troubleshooting—Interpreting Test Patterns—Alignment—Repair

This section includes a circuit diagram of every type of receiver on the market today.

SECTION 8. INSTALLING TELEVISION RECEIVERS

Every step is covered . . . pre-installation surveys, equipment required, locating and erecting the antenna, laying transmission lines, locating the receiver in the building.

SECTION 9. SERVICING TELEVISION RECEIVERS

This is another section devoted to detailed, how-to-do-it procedure, this time on servicing the receiver.

SECTION 10. TELEVISION TEST EQUIPMENT. HOW TO USE IT—HOW TO BUY IT

Section 10 of the VIDEO HANDBOOK was expressly designed to give you this information—it can save you as much as \$1000.00 in purchasing test equipment.

SECTION 11. BUILDING A TELEVISION RECEIVER

Included here are complete plans, diagrams, photographs of components needed and step-by-step assembly instructions.

SECTION 12. DATA SECTION

Here are compiled all the graphs, charts, curves, nomographs, symbols, formulas and rules used in television.

SECTION 13. TELEVISION TERMS

A complete dictionary of words, terms, phrases and titles used in television.

SECTION 14. BIBLIOGRAPHY

This is the most complete list of literature on television issued to date.

**ADVANCE SALE
ORDER NOW!**

\$5.00

These books are best sellers in the radio and television field. Make sure you get your copies . . . order now! Use this coupon to order either one or both books—get them both, you'll profit by the valuable information they contain!

Mail This Coupon to Your Jobber Today — or Direct to: RM-12
BOLAND & BOYCE, 460 Bloomfield Ave., Montclair, N. J.

Send me 1 RADIO DATA BOOK

- I enclose \$5.00 (\$5.50 Foreign)
 I enclose \$1.00 and will pay postman \$4.00 on delivery (in U. S. only)

NAME

ADDRESS

CITY

ZONE

STATE

Send me 1 VIDEO HANDBOOK

- I enclose \$5.00 (\$5.50 Foreign)
 I enclose \$1.00 and will pay postman \$4.00 on delivery (in U. S. only)

BOLAND & BOYCE INC., PUBLISHERS

Clear the Picture

→ from page 13

ting is identified on each channel the cause is local.

Reflections are not cured, but avoided, by moving the antenna, re-directing it, changing its pattern, and shielding it. This can be done with a metal screen placed between the unwanted reflection and the antenna, at least ten feet away from the antenna.

In many cases, the service man can check and learn whether or not the trouble is coming into the TV set by way of the a-c line, by disconnecting the antenna from the set.

When the power line is cleared, the antenna lead-in is checked by dis-

connecting it from the antenna, and connecting it to the set. Continued interference indicates lead-in pick-up. This can be reduced by using a lower impedance lead-in, and correcting the matching at both ends, of course, or a coaxial cable, or by transposing the 300 ohm line.

The lead can be rerouted, taking care to avoid large metal objects or sharp bends.

With the lead-in pick-up reduced or eliminated, the antenna should be rotated so that the source of noise can be located, and its physical width estimated. In this way you can learn whether or not the interference blankets the area, or whether it emanates from one narrow area, and can be avoided.

If the interference is directional but unfortunately in the same direction as the TV station, you will at least know where the offender is.

A straight dipole with reflectors and directors makes a sufficiently directive antenna for locating interference. The antenna can be moved to several points on the roof, and a rough cross obtained. A 50-200 Mc. portable receiver comes in handy for following up the direction finder. ✓

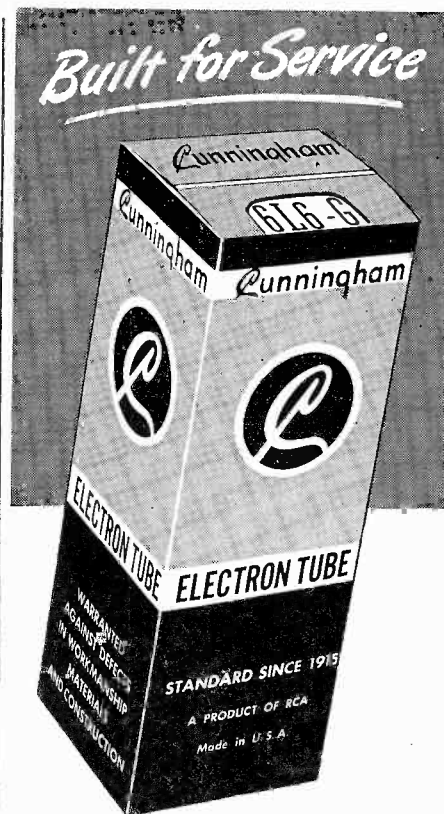

The winning tube!
in ...



• Experienced servicemen in Nebraska have elected Cunningham tubes ... because Cunninghams have demonstrated their long life and top performance since 1915. You can count on more satisfied customers if you replace with top-quality Cunninghams ... "the tube that's built for service."

See your
CUNNINGHAM DISTRIBUTOR

HICKS RADIO COMPANY
Lincoln

Cunningham Tubes

A product of
RADIO CORPORATION OF AMERICA
Harrison, N. J.



**FOR TELEVISION TESTING
AND SERVICING**

**TEE VEE
SCOPE**
Model TV90

Net Price
\$127.50

Combines the two essential instruments needed in television testing—alignment—service. A complete oscilloscope and a complete sweep generator that can be used independently. Tee Vee 90 combines two units for compactness and portability—meticulously engineered in advanced design and construction. Oscilloscope also has its own variable linear sweep. Sinusoidal sweep with phasing control for use with internal R.F. sweep generator when testing band pass characteristics. Synchronization provision for either internal positive, external or line frequency.

Z axis terminal permits intensity modulation of electron beam. Input jack provided for marker signal. Independent sweep has range of 4.5 to 30 m.c. in 3 bands giving choice of any I.F. frequency desired. Band width can be varied continuously from 50 K.C. to 50 M.C. Attenuation of R.F. output is continuously variable and is applied through low loss coaxial cable. Traveling detector probe included for observing signal at any point of R.F. circuit under test.

105-130 volts 50-60 cycles. Weight 25 lbs. Size 14 x 8 x 12½ inches. Finished in attractive hammertone grey. Supplied complete with tubes, probe, coaxial output cable and operating instructions ready to operate.

WRITE FOR CATALOGUE 1 M

RADIO CITY PRODUCTS CO., INC.

152 West 25th St.  New York 1, N. Y.



WHEN a radio repair man knows how effectively his telephone can be used in building business, there's little he can leave undone in publicizing his telephone number and the fact that his telephone is a good medium through which his customers can reach him.

There are a lot of methods of attaining this end. Here is one of the most unusual and striking signs ever used in putting over a telephone number, telephone service, and selling the idea. It's used by a St. Paul, Minnesota firm, with the words **AS CLOSE AS YOUR TELEPHONE** and the telephone number in neon-outlined letters. E. W. Fair.

ACCURATE MEASUREMENT WITH A VOLTMETER

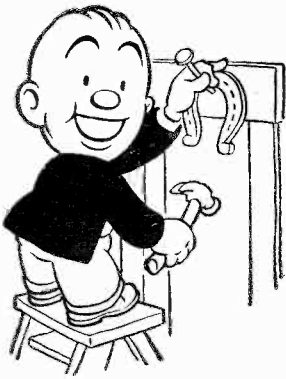

It's More Than Luck

It's more than luck—that, for 23 years, Quam Speakers have been manufactured by the same management in a field that is noted for rapid, and sometimes sudden, changes.

It speaks well for the sound business policies of the company, its progressive engineering developments and the consistently high quality that has distinguished Quam Speakers.

It also explains the confidence in the stability of the company, and in its product, Quam Speakers, by service men and manufacturerers alike.

Always specify Quam for Speaker replacements, you can depend on their quality, their performance and their guarantee!

Write for Catalog of Quam Adjust-A-Cone Speakers.

QUAM NICHOLS COMPANY

530 East 33rd Place, Chicago 16, Illinois

Quam Speakers are listed in the Radio Industry Red Book.

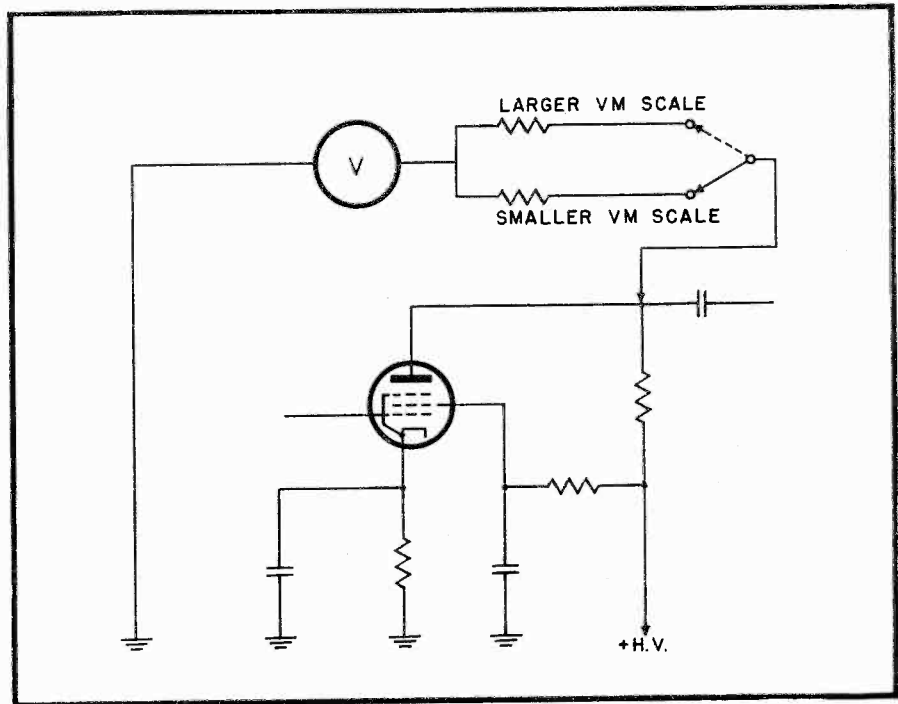

WITH a little extra work and the application of simple arithmetic, an ordinary voltmeter can be used in a great many cases to get the same answers as a tube voltmeter on d-c circuits.

Here's how it's done. As an example, suppose it is desired to measure the true plate voltage of a simple resistance coupled amplifier stage as shown in Fig. 1. First measure the plate voltage on the lowest voltmeter range that can be used. Call this voltage indication E_s . Then measure the plate voltage with the next highest voltmeter range. Call this second voltage indication E_l . The two indications will be different.

Now comes the mathematics.

Divide the full scale value of the larger voltmeter scale by the full scale

value of the smaller voltmeter scale. Call this ratio a factor, F . Put all these figures in the following formula:

$$E_t = \frac{E_l \times (F - 1)}{E_s}$$

where E_t = True voltage at the plate of the tube.

E_l = Voltage indicated on larger voltmeter scale.

E_s = Voltage indicated on smaller voltmeter scale.

F = Ratio of larger scale to smaller scale (full scale value of one divided by full scale value of the other). D. N. Parker

Notice to Service Organizations!

RADIO MAINTENANCE Magazine Special Group Plan

Radio Servicemen enrolled in service trade organizations may subscribe to RADIO MAINTENANCE at a special Group Plan price. WRITE US FOR PRICES. Here's how it's done:

1. Offer open to members of Radio Servicemen's Associations, societies or organizations.
2. Applies to all orders from these organizations containing five or more names.
3. Orders must be on the organization letterhead and must give the name and address of each subscriber. State subscriber's service status (is he a shop owner, employee of service department, service manager, etc?) Magazines will be delivered to subscriber's address.
4. Payment must accompany each order.
5. If a serviceman already has a subscription he may renew it through this group plan, but be sure to mark plainly "RENEWAL" in these cases.
6. Address all orders to:

RADIO MAINTENANCE Magazine, 460 Bloomfield Ave., Montclair, N. J.

FREE

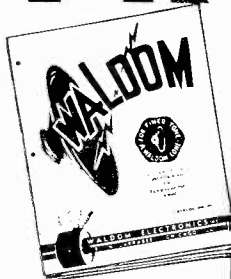

**SERVICE MEN
REPAIRMEN!**

**WALDOM
REPLACEMENT
CONE
MANUAL**

Just mail your name and address today for **FREE** copy of the big 20 - Page **WALDOM Replacement Cone Manual**, listing replacement data for 69 different brands of speakers—from Admiral to Zenith! Manual also gives complete instructions, together with clear illustrations for installing cones properly. Invaluable reference guide for servicemen and repairmen. Get your copy **FREE!** Just send name and address.

FOR FINER TONE A WALDOM CONE
Waldom Replacement Cone Assemblies will satisfy the high standards of precision workmanship and performance set by you and by your customers because . . .



- **WALDOM CONE ASSEMBLIES** feature **HAWLEY** diaphragms with the patented thin, tapering edge that assures maximum speaker efficiency and true low frequency response.
- **WALDOM CONE ASSEMBLIES** are guaranteed unconditionally as to construction and performance. Only the very finest voice coils and spiders, precision made to exact specifications, are used.
- **WALDOM CONE ASSEMBLIES** carry Full R. M. A. Warranty.

Write for Your FREE REPLACEMENT CONE MANUAL! The big 20 - Page **WALDOM Manual** puts every bit of replacement cone information at your fingertips, in seconds! It will speed your speaker repair work, and help you handle those jobs more profitably. Send your name, address for **Free** copy.

WALDOM ELECTRONICS, INC., Dept. RM
911 N. LARABEE STREET CHICAGO, ILLINOIS

Industry Presents

→ from page 33

The instrument tests diodes separately with low voltage to prevent paralysis of the elements. Power supply is 100-130 volt, 50-60 cycles. The tester is manufactured by the Hickok Electrical Instrument Co., 10634 Dupont Ave., Cleveland 8, O.

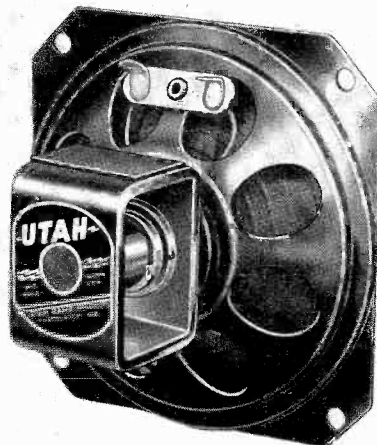

INTER-COMM SPEAKERS

Utah Radio Products, 1123 E. Franklin St., Huntington, Ind., has announced the availability of two new inter-communication speakers, the four-inch SP4A1 and the five-inch SP5A1. Both are built with 44 ohm voice coils and a .68 oz Alnico V magnet. They come complete with dust cover.

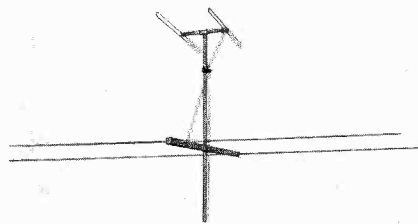

"HIGH FREQUENCY" TV ANTENNA

RCA Tube Department has announced a new, supplementary "high-frequency" TV antenna (Type 203A1). It is designed for mounting on the same mast as the RCA 225A1, or similar antennas, and is especially intended for use in areas where television stations are operating on both high (7 to 13) and low (2 to 6) channels. The antenna, a folded dipole and folded dipole reflector, increases signal reception from stations operating in channels 7 to 13. Both the high-frequency and the low-frequency antenna may be oriented independently, and a "harness" is used to couple the two antennas into a single transmission line. The harness acts like an automatic switch, so that when the receiver is tuned to stations in high channels, only the high-frequency antenna appears to be connected to the transmission line, and similarly with low channel stations. This "automatic switching" feature is accomplished by actually making tuned circuits of the sections of transmission line used in the harness. ✓✓✓

→ to page 44

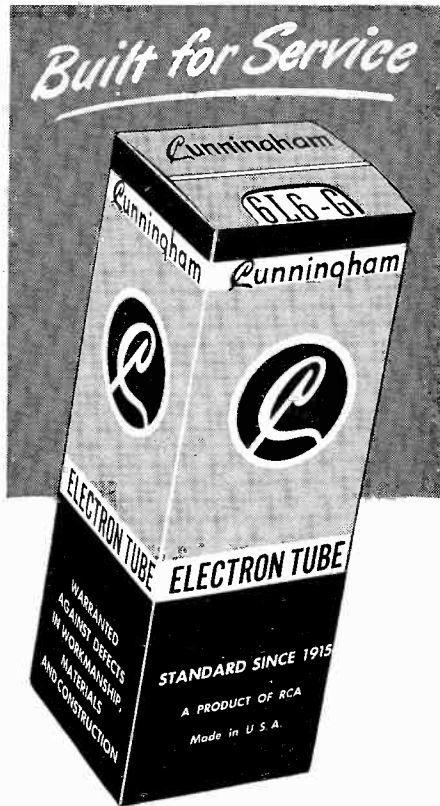

**The winning tube!
in...**



• West Virginia votes for Cunningham . . . the tube that gives long terms of service. That's because Cunningham tubes have been satisfying particular customers for over 32 years.

See your
CUNNINGHAM DISTRIBUTOR

HICKS RADIO SUPPLY
Charleston



free

1949

NEWARK

CATALOG



For EVERYONE interested in
**TELEVISION • RADIO • ELECTRONICS
SOUND SYSTEMS • INDUSTRIAL EQUIPMENT**
EVERYTHING in standard brand equipment!

Professionals! Radio Hams! Television Enthusiasts! Beginners! Oldtimers! Amateurs! Hobbyists! Here's one book that's a **MUST** for you! Our **FREE** 148 page catalog jammed with over 20,000 different items. The smallest part to the most complete industrial system from one dependable source!

24-HR. MAIL ORDER SERVICE • ONE YEAR TO PAY

3 GREAT STORES: Uptown at 115 West 45th St. and Downtown at 212 Fulton St. in **NEW YORK** 323 W. Madison St. in the heart of **CHICAGO**

MAIL ORDER DIVISIONS: 242 W. 55th St., N. Y. 19 and 323 West Madison St., Chicago 6, Illinois



MAIL COUPON NOW
Newark Electric Co.
Dept. L-13, 242 W.
55th St., N. Y. 19 N. Y.

Please send me **FREE** the Newark 1949 Catalog
NAME _____
ADDRESS _____ CITY _____ STATE _____

TV Receiver Linearity

→ from page 16

use of this crosshatch generator consists of five steps:

1. Remove the rear panel from the receiver.

2. Plug in the proper adapters in the proper sockets and attach the harness to the generators. Be sure to dress the cable as far as possible from the high-voltage source.

3. Apply power to the receiver and generator. Do not attempt an ad-

justment until there has been a five minute warm-up period.

4. Check the spacing of the vertical and horizontal lines on the picture tube.

5. Adjust the horizontal and vertical linearity as required to produce a series of equally spaced lines.

Experienced servicemen will recognize this as a help for difficult cases of this adjustment, and beginners will find that this is a method which will assist in the familiarization with these linearity controls. ✓ ✓ ✓

Industry Presents

→ from page 43

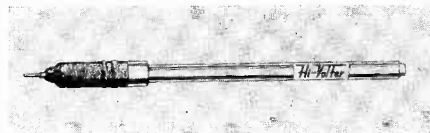

HIGH VOLTAGE TESTER

The "Hi-Volter" is designed for television technicians. It operates with all vacuum tube voltmeters having input impedances of 10 megohm, and is a multiplier that extends the range of existing instruments by 10. It

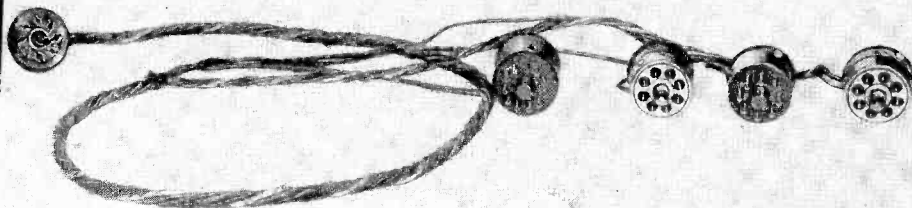
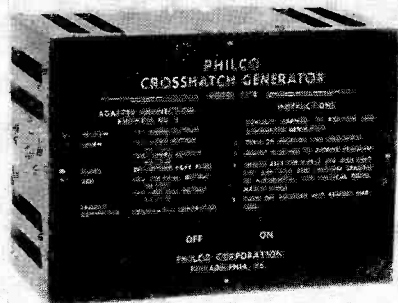
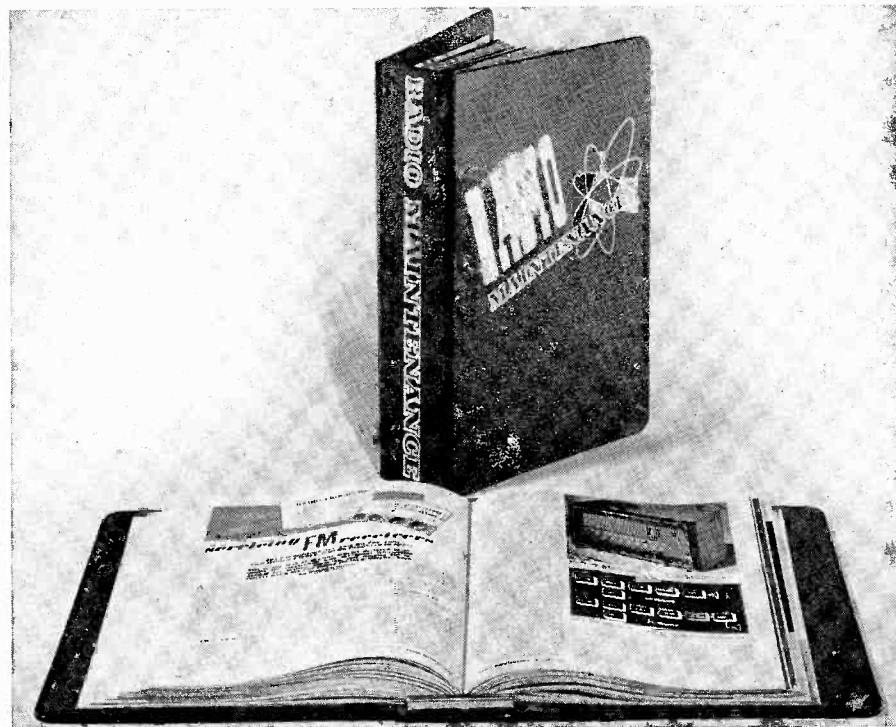

Fig. 5 The crosshatch generator, shown above, is simple, compact, and well worth its cost.



Keep your back numbers of **RADIO MAINTENANCE** in these handsome green and gold binders. Each binder will hold up to 18 copies of the magazines without puncturing holes or mutilating them in any way. They are held securely but are easily removed if desired. With the index printed at the end of each year, your magazines will be a constant reference for . . . a valuable service library. Send for your binders now!

RADIO MAINTENANCE
160 Bloomfield Avenue
Montclair, N. J.
Please send me . . . binders at \$2.00 each.

Total amount enclosed
Name
Address
City Zone
State

BINDERS

TO PRESERVE YOUR
RADIO MAINTENANCE
MAGAZINES

Industry Presents

→ from page 44

is guaranteed to be better than 2% accurate. Where VTVM is not available, the "Hi-Volter" may be used with a microammeter by calibrating the meter scale directly in kilovolts. The instrument is constructed with a cadmium plated test prod and safety grip. The safety factor is 25,000 volts. Complete information may be obtained from the Richard Mattison Co., 114 East 16th St., New York 3, N. Y.



MULTIPLE TESTER

The Bradshaw Instrument Co., 348 Livingston St., Brooklyn 17, N. Y., has announced the new Multi-Tester Model 30. This instrument has a 3% accuracy for d.c. and 5% accuracy for a.c. on all ranges. Its sensitivity is 1000 ohm/volt, and is powered by a self-

contained 4.5 volt battery. The Model 30 covers 21 ranges: A-C voltages: 0-12.5/25/125/250/1250; d-c voltage: 0-5/10/50/100/500/1000 volts; d-c mills: 0-1/100 ma; resistance: 0-10,000/100,000/1 megohm; decibels: From minus 10 to plus 57 db in five ranges. The instrument comes in bench, portable, and kit form models, and weighs 5 pounds. Further information may be obtained by writing directly to the manufacturer.

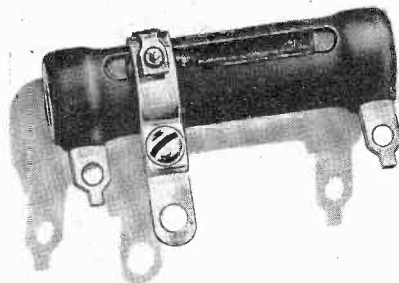

WIRE WOUND RESISTORS

International Resistance Co., 401 N. Broad St., Philadelphia 8, Pa., has added 91 new ranges to its current line of Power Wire Wound Resistors. These resistors are made with "climate-proof" cement coating and will operate continuously at full rating. A supplemental catalog sheet listing all ranges in fixed and adjustable types, available terminals, tolerances and list prices may be obtained free of charge by writing to the company. ✓ ✓ ✓

DID YOU KNOW

BIRDIES and oscillations in AC-DC sets can often be traced to filter condensers, even though these condensers measure up to their rated capacities. These condensers generally develop a high RF resistance that can only be cured by a new unit of the right capacity.

If an auto radio has loctal tubes, and is noisy and refuses to play, first check the construction of the tube sockets. These are often molded loctal type, of flimsy construction, and the contacts break and do not make connection with the tube pins. Make sure to use high quality sockets for replacement.

When you are replacing the rectifier tube in an AC-DC battery portable with a selenium rectifier, make sure to check the circuit to see if the filament voltage for the battery type tube is obtained from the B supply. If it is, a suitable dropping resistor should be placed in series with the

filaments, because of the fact that the selenium rectifier delivers a much higher output than the usual rectifier tubes. The output potential is about 6½ volts or so higher than the voltage obtained from a 35Z5.

By connecting an RF coil across a set of headphones and using same as an exploring coil, it is a simple matter to locate ignition noises, etc. in car installation. By holding the coil close to the various wires under the dash, the one causing the trouble can soon be located and the noise eliminated by the use of a filter. ✓ ✓ ✓

Wire Recorders

→ from page 15

indicator may be due to a defective 500,000 ohm potentiometer which can be checked easily with an ohmmeter.

The circuit is not extremely complex and it is doubtful that the average expert serviceman would have much trouble with it. The relay adjustments are sometimes critical and a neat balance must be struck between spring tension on the drive wheels and the relay throw in each case. ✓ ✓ ✓

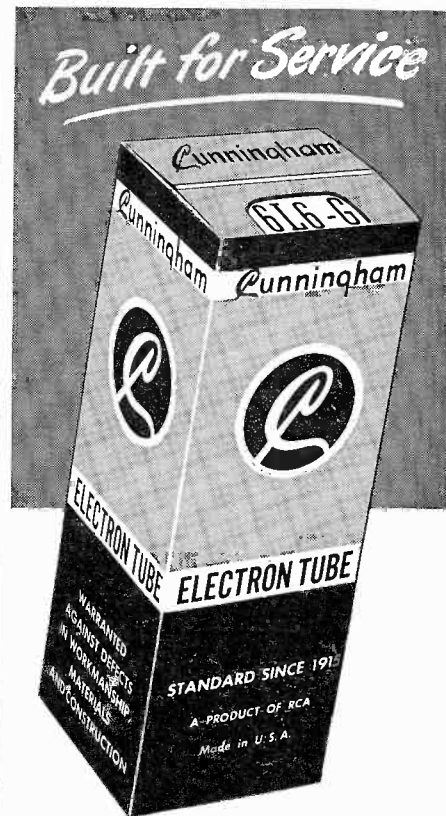

The winning tube!
in . . .



• Cunningham carries Wisconsin on a platform of quality and performance. That's why your customers are candidates for Cunningham tubes . . . why Cunninghams should be *your* choice.

See your
CUNNINGHAM DISTRIBUTOR
ELECTRO-PLIANCE DISTRIBUTORS
Milwaukee
STANDARD RADIO PARTS CO.
Racine

Cunningham Tubes
A product of
RADIO CORPORATION OF AMERICA
Harrison, N. J.

BACK NUMBERS . . . get them while they last

JANUARY 1946

THE PROBLEMS OF ORGANIZATION
TELEVISION RECEIVER INSTALLATION
RADIO MAINTENANCE IN AVIATION
USING THE OSCILLOGRAPH FOR
DISTORTION MEASUREMENTS

APRIL 1946

A MIDGET AUDIO FREQUENCY
OSCILLATOR
IF I WERE A SERVICEMAN
AN EQUALIZED AMPLIFIER FOR
MAGNETIC PICKUPS

MAY 1946

PA SYSTEMS
TEST PANEL FOR THE MODERN BENCH
RINGING THE BELL

JUNE-JULY 1946

FUNDAMENTALS OF TELEVISION
VOLUME CONTROL TAPERS
THE ELECTRONIC OHMMETER
VECTOR ANALYSIS

AUGUST 1946

AVC CIRCUITS
FM TROUBLESHOOTING
TELEVISION RECEIVER FUNDAMENTALS
RECORD CHANGERS

DECEMBER 1946

TELEVISION RECEIVERS . . .
THE RF SECTION
TUNING THE INDICATORS
PART II—THE OSCILLOGRAPH . . .
HOW TO USE IT
REPLACING AUTO CABLES

JANUARY 1947

SERVICING BY EAR
TELEVISION RECEIVERS . . . VIDEO
CHANNEL
PART III—THE OSCILLOGRAPH . . .
HOW TO USE IT
MINIATURE TUBE CHART

FEBRUARY 1947

THE OSCILLOGRAPH . . . HOW TO USE
IT PART IV
TELEVISION RECEIVERS . . . THE SOUND
CHANNEL
THE AUDIO OSCILLATOR
SELENIUM RECTIFIERS

MARCH 1947

ANTENNAS . . . FM AND TELEVISION
PART I
SERVICING AUTOMATIC RECORD
CHANGERS
OSCILLATORS AND CONVERTERS
TELEVISION RECEIVERS . . . THE VERTICAL
SWEEP

APRIL 1947

ANTENNAS . . . FM AND TELEVISION,
PART II
PHASE INVERTER CIRCUITS
A UNIVERSAL SPEAKER
TELEVISION RECEIVERS . . . THE
HORIZONTAL SWEEP

MAY 1947

THE OPEN AND CLOSE CASES
VOLTAGE DOUBLERS
SIGNAL TRACER
TELEVISION RECEIVERS . . . THE
CATHODE RAY TUBE

JUNE 1947

WHEN THE CUSTOMER ISN'T RIGHT
TEST EQUIPMENT MAINTENANCE
CRYSTAL CONTROLLED SIGNAL
GENERATOR
TELEVISION RECEIVERS . . . THE
POWER SUPPLY

JULY 1947

SERVICING FM RECEIVERS
TEST EQUIPMENT MAINTENANCE, PART II
TELEVISION RECEIVERS . . .
FLYWHEEL SYNC

AUGUST 1947

SPEAKER MATCHING
TEST EQUIPMENT MAINTENANCE, PART III
SERVICING FM RECEIVERS
TELEVISION . . . HF POWER SUPPLIES

SEPTEMBER 1947

SERVICING IS BIG BUSINESS
ANTENNA SYMPOSIUM
TELEVISION PICTURE TUBE
SERVICING FM RECEIVERS PART III

NOVEMBER 1947

TEST EQUIPMENT SYMPOSIUM
HOW'S YOUR SERVICING FUTURE?
TELEVISION TEST EQUIPMENT

DECEMBER 1947

ABOUT WIRE RECORDERS
RURAL RADIO SERVICE
AUTO RADIO NOISE
ALIGNMENT METHODS

JANUARY 1948

HOW TO IMPROVE YOUR SIGNAL
TRACING TECHNIQUES
SPECIAL F.M. CIRCUITS
WHAT'S NEW IN VIDEO SECTIONS?

FEBRUARY 1948

LET'S WORK TOGETHER
HOW TO USE SWEEP GENERATORS
VOLTAGE REGULATORS

MARCH 1948

HOW TO ELIMINATE HUM
TELEVISION INTERCARRIER SYSTEM
SWEEP GENERATORS FOR FM ALIGNMENT
PART II

APRIL 1948

NEW FM SIGNAL GENERATOR
DB CALCULATORS MADE EASY
GET THE MOST FROM YOUR VTVM
AFC IN FM

MAY 1948

TROUBLESHOOTING RECEIVER DISTORTION
INTERFERENCE
A POCKET FM SIGNAL GENERATOR
A SWEEP GENERATOR FOR F.M. & T.V.

JUNE 1948

INTERFERENCE PART II
HEATER-CATHODE HUM
SUPER SERVICE
F. M. AND YOU

JULY 1948

OHM'S LAW IN RADIO SERVICING
INTERFERENCE PART III
HOME SERVICE CALLS . . .
DO THEY PAY?
SERVICING RC FILTERS

AUGUST 1948

ADVERTISING WILL BUILD YOUR BUSINESS
INSTALLATION OF F.M. ANTENNAS
CUSTOM BUILDING
YGS-3 SIGNAL GENERATOR

SEPTEMBER 1948

SERVICING WITH VTVM
TRANSMISSION LINE PROBLEMS
RADIO PHOTOGRAPHS
RECEPTION UNLIMITED

NOVEMBER 1948

RECORD CHANGER REPAIRS
SIGNAL TRACING TV
NEW TV INSTRUMENTS
F.M. DETECTORS

RADIO MAINTENANCE MAGAZINE

460 BLOOMFIELD AVE., MONTCLAIR, N. J.

Please send me the back
numbers checked here . . .
I am enclosing 35c for each
copy, or \$2 for any 8 copies.

January 1946
 April 1946
 May 1946
 June-July 1946
 August 1946
 December 1946

January 1947
 February 1947
 March 1947
 April 1947
 May 1947
 June 1947

July 1947
 August 1947
 September 1947
 November 1947
 December 1947

January 1948
 February 1948
 March 1948
 April 1948
 May 1948

June 1948
 July 1948
 August 1948
 September 1948
 November 1948

Have selected 8 copies . . .
enclosing \$2.00

NAME

ADDRESS

CITY

ZONE

STATE

OPERATE RADIO RECEIVERS FROM SINGLE BATTERY?

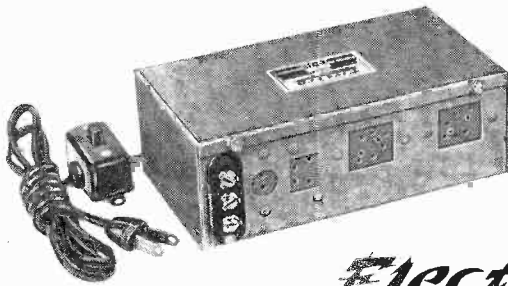

It's Easy with this SYNCRON POWER UNIT

ELECTRO
ELECTRICAL AND RADIO EQUIPMENT

The Model "Q" Syncro power provides A & B voltages from a 6-volt battery with only 1/8 the drain that an auto radio exerts on battery. Gives over three weeks reception for a 4-tube radio from a single storage battery charge. Costs but a few cents a day to operate.

There is a big country market for the Model "Q", and the Model "R", for dealers in the farm country, and for city dealers whose customers have summer homes. Model "R" for 2-volt 4, 5, 6 and 7-tube radios. Model "Q" for 1.4 volt, 4, 5 and 6-tube radios.

There is an Electro Battery Eliminator for every requirement operating from either 110V, 220V, 50 to 60 cycles, or from 6V storage battery; also 6V, 15 amp. Model "A" operating from 110V, to 50 to 60 cycles. All are completely filtered and hum free. Compact units of sturdy construction with Hammerloid finish. Operate in any position.

ELECTRO PRODUCTS LABORATORIES

PIONEER MANUFACTURERS OF BATTERY ELIMINATORS
549 W. Randolph Street, Chicago 6, Illinois

ANNOUNCING

A COMPLETE LINE OF ASTATIC Long-Playing PICKUPS and CARTRIDGES

that includes JUST WHAT
YOU'RE LOOKING FOR!



FLT-33 CRYSTAL
TRANSCRIPTION
PICKUP



FL-33 CRYSTAL
PICKUP



510-QT-33
CRYSTAL PICKUP

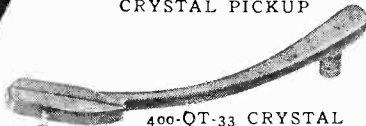

400-QT-33 CRYSTAL
TRANSCRIPTION
PICKUP

WANT a two-in-one pickup that plays both LP and 78 RPM Records with the simple switching of cartridges . . . so simple that a child can make the change in a few seconds? Or, perhaps you are looking for comparable reproduction quality, with more emphasis on economy? Regardless of whether your requirements point to cartridges employing ceramic elements or magnetic-type units . . . whether you prefer permanent or replaceable needles, metal, sapphire or diamond . . . whether cost is first or secondary . . . whatever the conditions to be met—there now is a unit of Astatic precision engineering and construction, that will exactly fill the bill. Space permits mention here of only a few. Why not write for new brochure, giving complete information, illustrations, on the Astatic Long-Playing Equipment Line?

Astatic Crystal Devices
Manufactured Under Brush
Development Co. Patents

Listed in the Radio Industry Red-Book



Built for Service

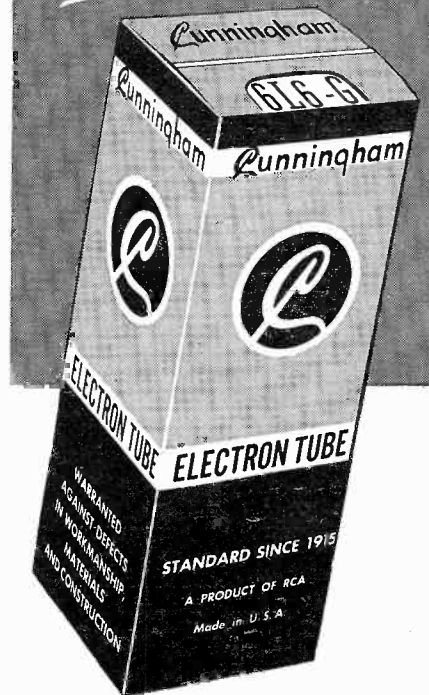

The winning tube!

in . . .



© Cunningham tubes have carried Wyoming because of their long-standing record of reliability. The quality of Cunningham tubes accounts for their long life and top performance. That's why—when you use Cunninghams—you're bound to have satisfied customers.

See your
CUNNINGHAM DISTRIBUTOR

CASPER SUPPLY CO.
Casper

Cunningham Tubes

A product of
RADIO CORPORATION OF AMERICA
Harrison, N. J.

ADVERTISERS

Aerovox Corporation 37	Hytron Radio & Electronics Corp. 21	Radio City Products
Agency: Austin C. Lescaboura	Agency: Henry A. Loudon	Agency: Jaman Adv.
A-G Radio Parts Co. 48	Jensen Industries, Inc. 3rd Cover	Radio Corporation of
Agency: Arthur Liebscher	Agency: Burton Browne	America 41, 43, 45, 47
American Electric Heater Co. 34	P. R. Mallory Co., Inc. 17	Agency: J. Walter Thompson
Agency: Dudgeon, Taylor & Bruske	Agency: Aitken-Kynett	Raytheon Mfg. Co. 29
Astatic Corporation 47	Measurements Corporation 30	Agency: Walter B. Snow
Agency: Wearstler Adv., Inc.	Murray-Hill Books 39	John F. Rider, Publisher 1
Capitol Radio Engineering Inst. 36	Agency: Harry P. Bridge Co.	Agency: Shappe-Wilkes
Agency: Henry J. Kaufman	Newark Electric Co. 43	Howard W. Sams Co., Inc. 19
Clarostat Mfg. Co., Inc. 38	Agency: Chernow Co., Inc.	Agency: Geo. Brodsky
Agency: Austin Lescaboura	Ohmite Mfg. Co. 33	Sangamo Electrical Co. 22
Allen B. Du Mont Labs., Inc. 5	Agency: The Fensholt Co.	Agency: Arthur R. Mogge
Agency: Austin Lescaboura	Permoflux Corporation 48	Solar Mfg. Corp. 3
Editors & Engineers 36	Agency: Turner Adv. Agency	Agency: O. S. Tyson & Co.
Agency: David E. Helen, Adv.	Philco Corporation 26	Sprague Products Co. 23
Electro-Products Laboratories 47	Agency: Hutchins	Agency: Harry P. Bridge
Agency: Merrill Symonds	Precision Apparatus Co. 28	Sylvania Electrical Products, Inc. 25
Electro-Voice, Inc. 31	Agency: Shappe-Wilkes	Agency: Newell-Emmett
Agency: Henry H. Teplitz	Prentice-Hall 32	Transvision Inc. 4
Erie Resistor Corp. 48	Agency: Franklin Spier Inc.	Agency: H. J. Gold Co.
Agency: W. S. Hill Co.	Premax Products 36	Triplett Electrical Instrument Co. 24
General Electric Co. 20, 2nd Cover	Agency: Norton Adv. Service	Agency: Western Adv. Agency
Agency: Maxon, Inc.	Quam-Nichols Co. 42	Utah Radio Products Corp. 35
Heath Co. 27	Agency: Triangle Adv. Agency	Agency: Bonsib Adv. Agency
Agency: G. Dean Arend	Radiart Corporation 2	Waldom Electronics, Inc. 43
Hickok Electrical Instrument Co. 35	Agency: Ohio Advertising Agency	Agency: E. H. Brown Adv. Agency
Agency: White Advertising Co.		

SPEAKER SPECIALIST

Build yourself a reputation for improved tone of every speaker job you handle. A.G. will back you with the finest reconing service.

- Cones and fields in stock for any speaker
- Full range frequency test
- Audio test at full power rating
- Professional workmanship

Send a trial speaker, parcel post, for quick reconing and return in perfect condition . . . 5"—\$1.50 . . . 12"—\$3.00 . . . others low too!

A. G. RADIO PARTS CO.

3515 N. 17th St.

Philadelphia 40, Pa.

ERIE "CERAMICONS"®



- require less space
- are more efficient at high frequencies
- have greater dependability than any other type condenser

When repairs call for replacement—replace with ERIE "CERAMICONS." If your distributor cannot supply you, write us for information.

New catalog on request.

Electronics Division
ERIE RESISTOR CORP., ERIE, PA.
LONDON, ENGLAND TORONTO, CANADA.

Permoflux

SPEAKERS

YOUR JOBBER CAN SUPPLY YOU!

Permoflux quality and dependability—the same as supplied to the major set manufacturers—is your assurance of complete customer satisfaction. You'll find Permoflux Speakers easy to install and readily available in both PM and Electrodynamic types. You'll find too, that it pays to give your customers "tops in tone" with a Permoflux Replacement Speaker.

TWO COMPLETE
FACTORIES TO SERVE YOU

PERMOFLUX

WRITE FOR
FREE BULLETIN

PIONEER MANUFACTURERS OF PERMANENT MAGNET DYNAMIC TRANSDUCERS

PERMOFLUX CORPORATION

4900 WEST GRAND AVE., CHICAGO 39, ILLINOIS

236 SOUTH VERDUGO ROAD, GLENDALE 5, CALIFORNIA

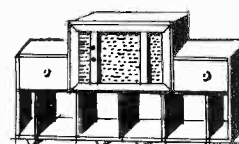
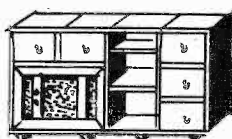
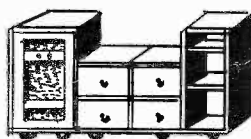
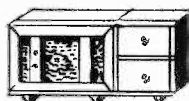
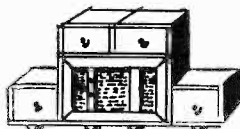
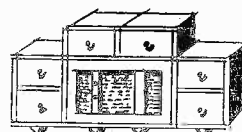
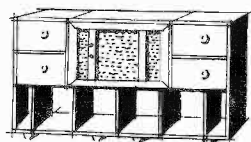
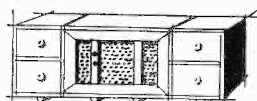
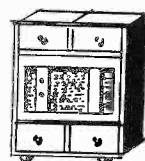
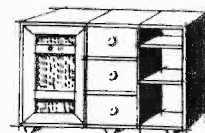
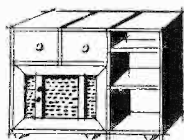

Jensen Customode

It's your move! You are assembling a Home Entertainment Center or a Ham Shack and need fine loud speaker performance and cabinets for the ever expanding requirements of audio-video equipment. Designed by leading furniture stylists and electronics engineers, Customode's "building block" versatility enables you to create thousands of cabinet variations as you wish—when you wish. *It's your move!* Write today for literature and scale cut-up illustrations. Jensen Manufacturing Co., 6637 S. Laramie, Chicago 38, Ill.

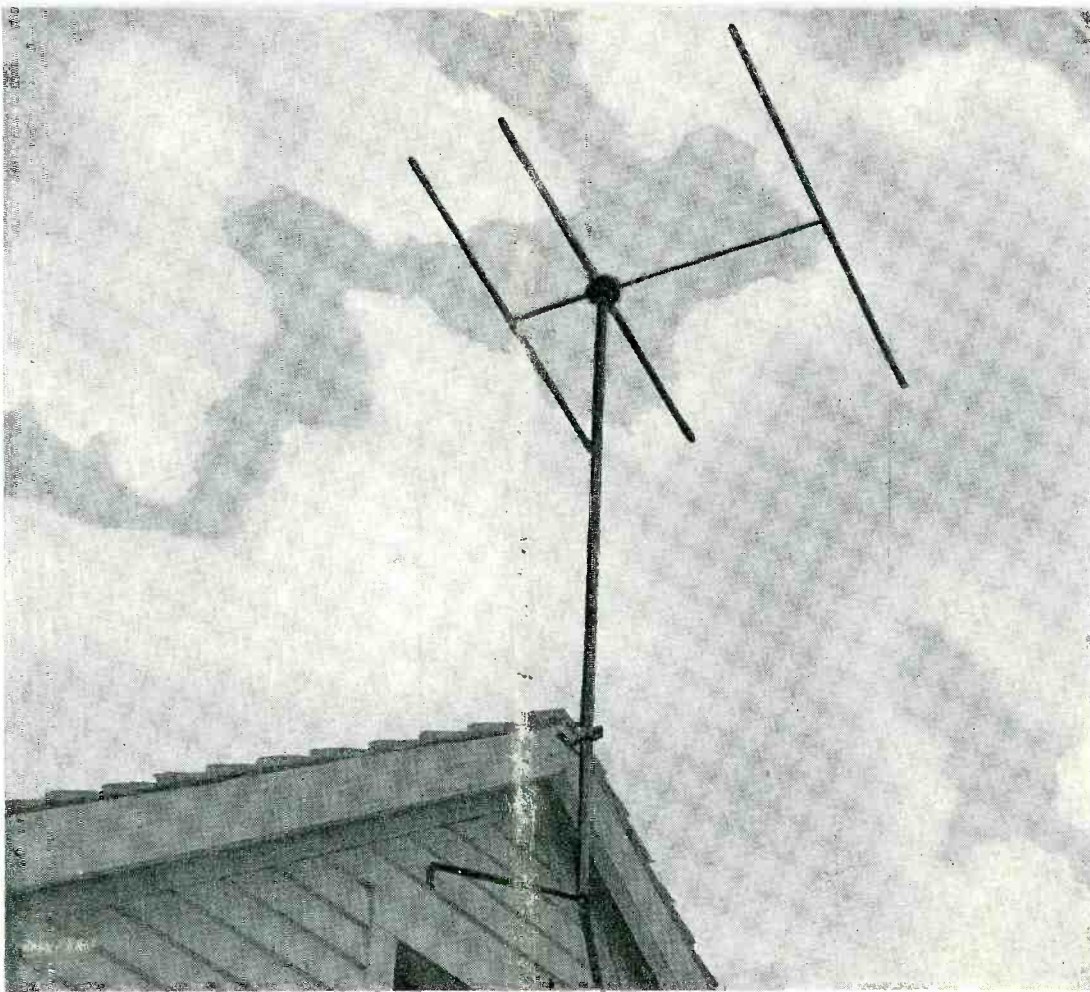

**How to make
more money
in the servicing
business!**

Your local jobber believes in helping you—his best customer—to make more money, because then you will become a bigger customer and everyone will be happy!

In line with this policy, he pledges his high standard of service and better buys for radio servicemen . . . AND he will present ideas to help you expand your business. In the months to come he will feature a different subject each month on this back cover of RADIO MAINTENANCE. This may be in the nature of new moneymaking ideas, or announcements of special sales in his store, or suggestions on the proper equipment for your work. In all cases, the idea will be to help you—the radio serviceman—make more profit.

Of course his staff of experienced clerks are ready to serve you every day. Drop in his store today—browse around. He has all kinds of good buys you may want to look over. Just mention RADIO MAINTENANCE—and watch this back cover for extra profit for you!

RADIO MAINTENANCE

460 Bloomfield Ave.

Montclair, N. J.