

RADIOS • APPLIANCES • FM and TELEVISION • RECORDS • COMPONENT PARTS

RAJ RADIO & APPLIANCE JOURNAL TELEVISION



WISC
OMROLD
HAROLD R KOLTE

TELEVISION casts
a powerful new
light on Radio's
28th BIRTHDAY

NOVEMBER 1948

From: RADIO & APPLIANCE JOURNAL
A KOLBE PUBLICATION
RKO BUILDING, RADIO CITY, 1270 SIXTH AVE.
NEW YORK 20, N. Y.
RETURN POSTAGE GUARANTEED
Postmaster: If undeliverable FOR ANY REASON, notify sender, stating reason, on FORM 3547, postage for which is guaranteed.

Sec. 562, P. L. & R.
U. S. POSTAGE
PAID
NEW YORK, N. Y.
Permit No. 10521

SMART NEW STYLING
that every woman wants!



Mr. Chippendale would have said:

"One of my masterpieces!"

Mrs. Customer will say:

"Wonderful for my living room!"

And you'll say: *"Best seller!"*

The new Stromberg-Carlson Chippendale is exquisitely designed, proportioned and executed in hand-rubbed matched mahogany veneers.

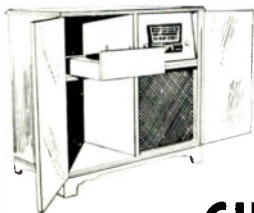

The
CHIPPENDALE

#1407-PFM
FM-AM Radio-Phonograph

The Chippendale #1407-PFM is one of many superb new Stromberg-Carlson instruments that are destined to write salesbook history for franchised Stromberg-Carlson dealers. Available for early delivery, for Christmas profits.

GREAT NEW FEATURES
that every man will go for!

- 1** **New Chromatic Tone Selectors**—visual color guides to fine blending, with separate treble and bass controls
- 2** **New Rocket Tuning for FM and AM**—a flick of the finger to select any station
- 3** **New Velvet-Action Record Changer**—with automatic stop and Hushed-Point "LT" pick-up
- 4** **New Signal Maximizer**—adjustable antenna circuit increases signal strength, reduces noise and interference
- 5** **New Finger-Touch Service Selectors**—instant choice of services: FM, AM, record player
- 6** **Exclusive "Full-Floating" 12" Alnico V Speaker**—for superlative tone quality

STOP!—LOOK! and LISTEN!
There is nothing finer than a
STROMBERG-CARLSON

Stromberg-Carlson Company, Rochester 3, N. Y.
— In Canada, Stromberg-Carlson Company, Ltd., Toronto



ONLY PHILCO HAS IT!

THE
Balanced Fidelity
REPRODUCER



Specially developed by Philco in collaboration with the engineers who created the amazing

Long Playing Record

The Philco Balanced Fidelity Reproducer is the remarkable result of long research in the Philco laboratories and close collaboration with the engineers who developed

the revolutionary new 45 minute record. It is specially constructed and precisely balanced to stay in the record's unique microscopic grooves. It avoids distortion and wear. And, through proper balance and proportion, it permits *fullest enjoyment* of the wide range of tone and "concert hall" realism which distinguish this new type of recording. *There's nothing else like it on the market!*

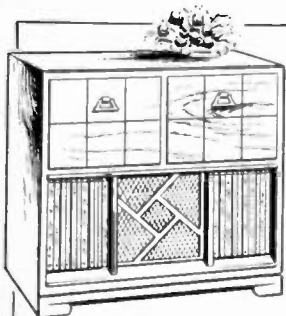

PHILCO 1609. Stunning Double Tone Arm Console. FM-AM . . . \$259.50

PHILCO 1405. Smart table combination for LP and Standard records \$129.95

The exclusive Philco Balanced Fidelity Reproducer is yours to sell in a wide range of new Philco Double Tone Arm Radio-Phonographs covering every price bracket.

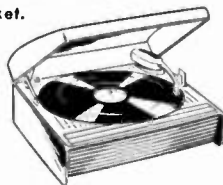
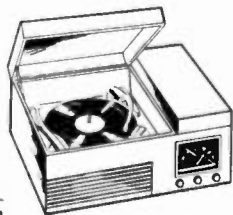

PHILCO M-15. Album-Length Record Player. Equips any radio or phono, old or new, to play LP records. \$29.95

PHILCO

Famous for Quality the World Over

RADIO & APPLIANCE JOURNAL

NOVEMBER • 1948

VOL. 65

No. 11

ALEX H. KOLBE
Publisher

NAT BOOLHACK
Editor

JOHN A. RICHARDS
Associate Editor

Business Department
AARON LAFER

VINCENT T. COSTELLO
Art Director

MARY LOUISE KAUFFMAN
Circulation Manager

IN THIS ISSUE

The Month in Radio and Television—RAJ News Roundup	6, 8
Television Takes to Air and Rails	8
Washington News Highlights	10
Make Every Week National Radio Week	12, 13
Illustrated Industry News	14, 15
"I Shopped the Loop for Television"	16, 17
Forty a Day—the Winston Story	18, 19
How to Conduct Yourself in the Customer's Home	20, 21
How New Orleans Planned Its Radio in Every Room Campaign	34

This Month's Cover

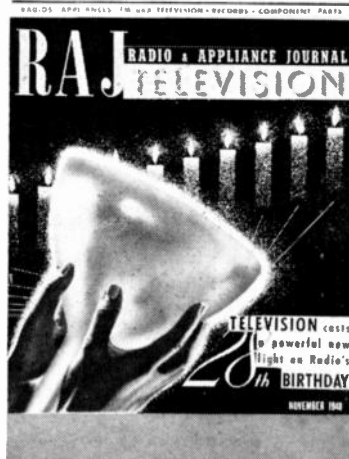

Television has edged in beside radio as National Radio Week gives new impetus to the snow-balling Radio in Every Room—Radio for Everyone campaign. How every week can be a promotion week is told on pages 12 and 13 in this issue.

Note: The television tube and diagram which made our October cover so effective are schematics of the Howard W. Sams & Co., Inc., Indianapolis, publishers of radio and television service manuals.

Subscribers changing their address should notify the Subscription Department one month before the change is to take effect. Both old and new address must be given. RADIO & APPLIANCE JOURNAL, 1270 Sixth Ave., New York 20, N. Y.

DEPARTMENTS

Journal Pictorial	14, 15
New Products (Radios, Television, Consoles, Phonographs, TV Accessories)	24, 32
News and Notes of Manufacturers and Distributors	36, 37
New Appointments	38, 41
Editorial	42
Advertisers' Index	42

Member of



OVER 30,000

Controlled Circulation Audit, Inc.

RADIO & APPLIANCE JOURNAL with which is combined RADIO & TELEVISION JOURNAL and ELECTRIC APPLIANCE JOURNAL is the complete business magazine for retail dealers who buy and sell Radios, Television Receivers, Appliances, Phonographs, Records, Master Servicing Component Parts; and is published monthly for Radio & Appliance Dealers, Jobbers, and Service Men by Kolbe Publications, Inc., Radio City, 1270 Sixth Avenue, New York 20, N. Y. Phone: Circle 7-5842. Alex H. Kolbe, President and Treasurer. Subscription \$3.00 per year in U. S. A., its possessions, South America, Canada and all other countries \$4.00 per year payable in American currency in advance. Price 25 cents per copy. Entire contents copyright 1948. No material in RADIO & APPLIANCE JOURNAL may be reprinted without consent of publisher.

Printed in U.S.A.

Radio & Appliance JOURNAL • November, 1948



NOW AN OLYMPIC FIRST TELEVISION WITH "MOTION PICTURE" QUALITY

Here's news to gladden your heart! In Olympic Star*brite television you get a SHORT line of magnificently styled instruments—from a 54 sq. inch picture table-top—to an amazingly compact 5-way console—and including the sensational, exclusive Olympic DUPLICATOR—to top the entire volume market at unmatched prices.

Distributors: Some Territories still open. Write or wire.
Dealers: Write for full details today.



MODEL TV-922

Big 54 sq. inch Star*brite picture screen, clear and brilliant even in a fully lighted room. 22 tubes, in Olympic "FRAME LOCK" circuit. FM audio system. Compact mahogany cabinet 20 1/4" wide x 13 1/4" high x 19 1/4" deep. Also model TV-922B in blond oak. (Illustrated)

Olympic
*Star*brite*
television



EXCLUSIVE DUPLICATOR! MODEL RTU-3

Multiplies your television profits. Just connect to ANY standard TV receiver—no antenna needed—simple as an extension telephone. Same principle as famous "HOTELVISION" installations in the New Yorker, Roosevelt, Stevens and other top-rank hotels. Ideal for cafes and other commercial installations.



5-WAY 18th CENTURY CONSOLE MODEL TV-928

New "Magic-Microscope" folding screen, 54 sq. inch picture of flicker-free, glare-free brilliance.

"FRAME LOCK" image control — FM/AM radio, automatic record changer — 32 tubes — all housed in graceful 18th century mahogany cabinet only 35 1/4" wide x 34 3/4" high x 17 1/4" deep. Also model TV-928 LP, plays both standard and new long-playing records.



OLYMPIC RADIO & TELEVISION, INC.
34-01 38th Avenue, Long Island City 1, New York

TV Tax Protest

The Pennsylvania courts have ruled that television is in the same category as motion pictures so far as tax regulations go, and a levy of \$25 is called for on all business establishments in which public viewing of television occurs.

In an effort to halt a tax which may set a precedent and spread, the RMA has taken steps through its executive vice-president, Bond Geddes, and John W. Van Allen, general counsel, to contact the NAB and television broadcasters for the purpose of jointly protesting the tax. By taking this stand, RMA made known its intention to sue if necessary in its attempt to reverse the hampering State court ruling. The main contention of RMA is that television is under the jurisdiction of the Interstate Commerce Commission, and is therefore not within the province of State courts.

RCA Relents

Last month the RCA Victor Division announced that purchasers of RCA Victor television receivers would be offered its Television Owner Contract on an optional basis. This meant that installation and service on RCA sets was at length thrown open to independent servicemen and service organizations of dealers handling RCA sets.

In announcing the modification of its service and installation policy, RCA was adhering to a policy line established some two years ago, which was to the effect that the sale of a service contract with a television receiver would "continue only so long as shall be necessary to assure customers proper installation and quality service, and to insure the dealer and manufacturer of customer good will."

Still feeling that installation and servicing of television receivers by competent personnel is of paramount importance to the future of the industry, the RCA Service Co., Inc., will continue to fulfill the company's contract which set owners take out on an optional basis. The new policy permits other competent service organizations to perform installation and service for those set owners who elect dealer or independent service contracts.

Television on the Common

There was baseball on historic Boston Common during the three World Series games played in the Hub city last month, and an estimated 100,000

Television Preview in Wilkes-Barre



While the television camera grinds nearby, a visitor to the Parade of Progress, Wilkes-Barre, watches the image of two 1898-styled girls appear on the screen before her. Some 40,000 saw mobile units televise a variety of programs.

Bostonians, unable to buy tickets for the games, flocked to the natural amphitheatre to watch the classic.

By permission of Mayor James Curley, 100 television receivers were installed in a large semi-circle and ellipse under the trees along the concrete Mayor's Walk. Each receiver was mounted on a stand 7½ feet high, permitting as many as 100 people to watch the diamond play on each set at one time.

Training for Servicemen

Twelve lectures on every phase of television have been scheduled for Fall, Winter and Spring, 1948-49, by the Associated Radio Servicemen of New York, Inc. Max Leibowitz, president, and Sam Marshall, program director, announced that the lectures will be a combination of theory and practical work. Cooperating companies include Howard W. Sams, Transvision, Bendix Radio, Delehanty Institute, and U.S. Television, and subjects range from antennae, through cathode-ray tubes and circuits, to servicing and test equipment.

March of Television

Detroit had a new and modern television station in WJBK-TV by late October and the premiere of the sta-

tion was woven around The Ford Theatre. Tests on channel 2 had been running during morning and afternoon hours long before the station opening. In this way dealers and servicemen were aided in the sale and installation of additional sets in the Detroit area.

In Rochester, New York, meanwhile, ground was broken by Dr. Ray H. Manson, president of Stromberg-Carlson, for the new transmitter building atop Pinnacle Hill, which will house that city's first television station, WHTM.

Crosley Credit

After completing an arrangement with Commercial Credit Company covering installment sales of refrigerators, freezer units, radios and television receivers, the Crosley Division of AVCO Manufacturing Corporation offered customers a national credit plan through Crosley dealers.

Commercial Credit Corporation, the financing subsidiary of the credit firm, with headquarters in Baltimore and local offices in 300 points throughout the country, will provide the financing facilities. Crosley becomes one of the estimated 275 manufacturers sponsoring the financing service.

More for your customers'

Christmas Money



Model 376

Your customers will want THIS!

FM-AM automatic radio-phonograph. *Natural color tone.* Amazing G-F Electronic Reproducer. 12" speaker. Mahogany veneered console. Model 376. **NEW LOW PRICE \$249.50***

Available with G-E electronic LP (long playing) record player—at slight extra cost.



Here are gifts *your* customers will want for Christmas giving—gifts that offer them *more* for their Christmas money—gifts that are *performance-engineered* at Electronics Park for *value*, for *tone*, for *power*—for all around *acceptance!* Call your G-E radio distributor for complete details and prices, or write *General Electric Company, Receiver Division, Electronics Park, Syracuse, New York.*



Model 62

Your customers will want THIS!

G-E "Wake-up-to-music" Clock-Radio. It's a fine-toned radio, an accurate G-E electric clock and an electronic reminder—all in an ivory plastic cabinet. Model 62. **\$41.95***



Model 201

Your customers will want THIS!

De luxe AC-DC superheterodyne table radio. G-E *natural color tone.* 5 1/4 inch G-E Alnico 5 speaker. Big performance—extra big value. Full-size ivory plastic cabinet. Model 201. **\$37.95***

For greater Christmas Sales
... push and sell General Electric's complete line:

- FM-AM Radios
- Radio-Phonographs
- Table Models
- G-E Daylight Television
- Portables
- Clock-Radios
- Farm Sets



Model 150

Your customers will want THIS!

G-E 3-way portable. AC, DC, or batteries. Exceptional power, tone and performance. Maroon, ivory or light gray plastic cabinet. Simulated leather handle. Model 150. **\$39.95***
(less batteries)



Model 145

Your customers will want THIS!

It's new! It's *different!* It's exquisite! Very thin personal portable—a slender 2 3/4 inches. Weighs only 7 1/2 lbs. AC-DC-batteries. Stunning maroon plastic case. Model 145. **\$44.95***
(less batteries)

**Western prices slightly higher. Prices subject to change without notice*

GENERAL ELECTRIC

178-G10

Dealer Unity

Dealer groups in the boroughs of New York City are becoming increasingly active in fields closely related to their business interests. The Cooperating Appliance Dealers Association of Brooklyn, for instance, recently held a testimonial dinner at the Hotel St. George, at which over 1,000 persons—manufacturers, distributors, and dealers—attended. Purpose of the gathering was to promote unity within the radio, television, and appliance industry, and to help these groups iron out common difficulties.

In Queens, the filing of a summons and complaint by Marino Jeantet as a private dealer against the Monarch-Saphin Co. for selling below fair-traded prices, represented an instance where a single dealer was acting on behalf of the entire Queens Electrical Appliance Merchants Association. The same firm had a suit filed against it by General Electric on the same count earlier this year. The Queens dealer's action emerged as an expression of a concerted dealer stand for the welfare of the industry.

High Frequency Antenna

Installation of television receivers has required the use of a high frequency antenna in so many cases in the metropolitan New York area that Tele-Tone has tacked \$10 to the price when selling its receiver TV-149. The additional charge will include a high frequency antenna as part of the initial installation. The inclusion of such an antenna will provide the best possibility of reception on all channels.

"Dry" Club TV Appeal

The Salvation Army, 120 West Fourteenth Street, New York City, has been appealing for funds to provide a television set for its liquorless Bowery Red Shield Club, so that men who are determined not to drink will not be lured into barrooms by television. The sum of \$244 has been raised to date.

Electrification Conference

Twenty-three associations and groups are sponsoring the National Farm Electrification Conference to be held at the Congress Hotel, Chicago, November 17-19. Clif Simpson, NERA's managing director, has been appointed by George Rietz, of General Electric's Farm Industry Division, who is chairman of the Conference, to head a panel discussion on the topic, "How dealers should meet the electrical needs of farm families." Power suppliers, home economic groups, manufacturers and distributors, the farm press and radio, together with retail dealers will hear how the electrical needs of farm families can be met.



Baseball was bowing out and football in when this Philco TV set was installed for passengers' enjoyment on Wash.-Chi. flight of Capital Airlines.

TV Takes to Air and Rails

BENDIX was in on a television first last month. Engineers from the firm's radio division had installed a television receiver in the lounge of the Marylander, the Baltimore & Ohio railroad's Washington to Jersey City express. A non-directional antenna and special circuits—all designed to compensate for directional change of the train, interferences in the form of buildings, poles, and man-made and geographical obstructions—performed well en route and made possible reception of most of the second game of the World Series.

Except for two blind spots, one between Aberdeen, Maryland, and Wilmington, Delaware, the other around Trenton, midway between New York and Philadelphia transmissions, there was continuous reception. Following this demonstration of successful television reception aboard a train speeding along at 80 miles an hour, B & O officials are considering making permanent receiver installations on its crack trains.

Several days after television took to the rails for the first time in history the medium took to the skyways. This time the Philco Corporation had a hand in the event. The non-stop DC-4 Capital Airlines flight from Washington to Chicago, leaving the capital at 12:30, October 9, had a Philco 12-inch screen set aboard. The 44 passengers were able to view the entire fourth game of the World Series.



Miss Frieda Hennock, member of FCC, tunes in second World Series game for the newspaper and magazine press. TV show was first on moving train.



**NEW 3-WAY
PORTABLE**

Model 568. Plays on AC-DC and self-contained Single Battery Pack... Alnico 5 PM Speaker... Handsome maroon plastic cabinet with weave-type grille, sliderule dial and integrated control knobs. 11½ in. wide. *Less batteries.*

\$29⁹⁵

"4 New Tops" IN YOUR TOP PROMOTION LINE

In every category—from Compacts to Consoles—Emerson gives you product and price LEADERS to SELL AT A PROFIT—with "step ups" all along the line... On every count, Emerson Radio and Television is the industry's No. 1 Promotion Line!



FM SENSATIONAL EMERSON "CONQUEROR"

Model 602. Genuine (NOT "Superegen") Frequency Modulation. The great new performance, promotion and price leader. **\$29⁹⁵** Only



Emerson Radio and Television

"IMAGE PERFECTION" TELEVISION

Model 606 with BIG 52-sq.-in. screen—Miracle Picture Lock—FM Staticclear Circuit. All advanced features. One of a GREAT line at popular prices. **\$349⁵⁰**

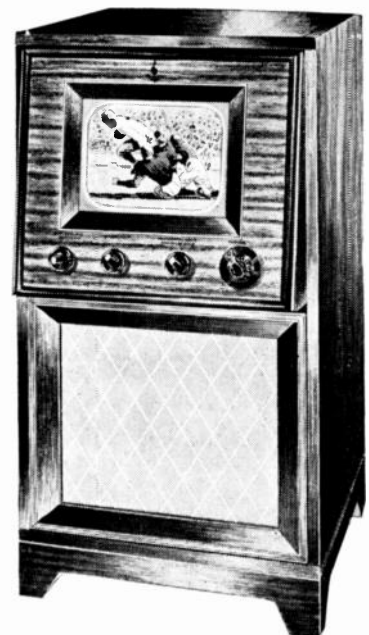

PHONORADIO MODEL 579

*Biggest Selling
"Combination"*

AC—Automatic—a COMPLETELY SATISFYING Phonoradio with superb performance features and superb TONE. A great SELLER—a great LEADER for your combination business. **\$49⁹⁵** Only

EMERSON RADIO AND PHONOGRAPH CORPORATION • NEW YORK 11, N. Y.

Radio & Appliance JOURNAL • November, 1948

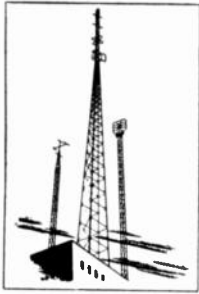

Washington News Highlights



Higher Frequency Bands

Representing the Radio Corporation of America and the National Broadcasting Company, Elmer W. Engstrom, vice-president in charge of research of RCA Laboratories, discussed the challenge of what he termed television's phenomenal rise before the Federal Communications Commission at a meeting of that agency last month. He cited the factors bringing on that rise as 1) the FCC's decisions on standards and allocations, which provided the stable basis for planning, 2) conversion to peacetime manufacturing with maximum utilization of wartime developments by the radio industry, and 3) the vision and courage of broadcasters in pioneering, in the face of monetary losses, because of their faith in the future of the industry.

Commenting on steps for furthering the development of the industry, Mr. Engstrom pointed out several avenues of approach to the Commission. One was the authorization of use by television stations of high power. Another was the suggested use of additional channels for television below 300 megacycles. Further exploration of the characteristics of the band 475 to 890 megacycles was also cited as a possibility by the RCA vice-president. Work in these upper reaches of the radio spectrum was being conducted by RCA in Washington, so as to contribute to the FCC hearings. Mr. Engstrom pointed out.

Record Figures

Television receiver production soared to a new monthly peak in September. RMA reports, with the 88,195 manufactured sets bringing the total output for three quarters of the year to 488,133, and the total industry output now probably exceeding 725,000.

FM-AM radio set production also reached a new high of 171,753 in September. This brought the year's production to more than a million, close to the total output of this type of receiver for all of 1947.

Promotion Minded

In recognition of the growing importance of television in the radio in-

Hawaiian Greeting



• Eustace Vynne, center, manager of the San Francisco Region for **Farnsworth Television & Radio Corporation**, shown arriving in Honolulu, where he signed Service Motor Co., Ltd., as his firm's distributor in the Territory of Hawaii. He was greeted by Peter F. Fukunaga, president and general manager of Service Motor, and G. G. Geoffroy, manager of the firm's wholesale department.

dustry, the Advertising Committee of RMA has been expanded to increase the direction given radio and television set merchandising and promotion during the balance of 1948 and in 1949. Chairman George M. Gardner of the RMA Set Division appointed the new members to the committee, over which Stanley H. Manson, manager of advertising and public relations of Stromberg-Carlson was reappointed chairman. Named vice-chairman to assist Mr. Manson was Lee Pettit, manager of advertising division, electronics department of General Electric. The revised committee held its first meeting on Wednesday, October 6, at the Roosevelt Hotel, New York, and drew up plans for the coming year, perfecting at that time plans for the "Radio-in-Every-Room" campaign and National Radio Week promotion.

Focus on Foreign TV Markets

Though domestic demands far exceed current television production, RMA's Export Committee, Transmitter Division and Engineering Department are shaping plans to insure future overseas markets for American television apparatus.

Receiving top consideration are plans to insure the adoption of RMA television standards in foreign countries. To secure initial use of these standards, foreign distributors will be urged to press for their use in all promotion of set sales by RMA television receiver manufacturers and the Export Committee of RMA.

The Transmitter Division contemplates sales in foreign lands long before receivers will be promoted. Technical problems already uncovered are two, the general overseas use of 50-cycle power, and variations in Europe and Latin America from the standard of 525 lines in television pictures.

Radio Week Response

Retail and wholesale trade organizations, together with groups associated with the broadcasting industry, have already responded to the RMA-NAB National Radio Week Committee's invitation to participate in the observance of National Radio Week, November 14-20, Chairman W. B. McGill, Westinghouse Radio Stations, Inc. reports. More than a dozen trade groups have pledged their aid in making the 28th anniversary of radio broadcasting, stressing the theme "Radio-in-Every-Room . . . Radio-for-Everyone," the industry's greatest joint celebration.

Mobilization

An "RMA Plan for Utilization of Industrial Resources for Military Purposes as Applied to the Radio Division of the Electronics Industry" has been presented to the Munitions Board by RMA's Industry Mobilization Policy Committee. Aim of the plan was outlined to be "to create as many prime contractors as possible and get the industry as a whole back into government business."

400,000 Admiral

RADIO-PHONOGRAPHS NEED THIS



Comes smartly packaged in transparent plastic container



\$1,500,000 REPLACEMENT BUSINESS FOR ADMIRAL DEALERS



No matter how sturdy a precision instrument may be, constant abuse is bound to impair its efficiency. The snap-in cartridge housed within ADMIRAL'S Miracle Tone Arm is a sensitive mechanism, and repeated dropping of the tone arm will cause damage.

Today 400,000 ADMIRAL radio-phonographs with Miracle Tone Arm are a year old or older. Each one of these should have a NEW snap-in cartridge if the ultimate in tone fidelity is to be maintained.

Here is a potential market for over 400,000 replacement cartridges. At \$3.95 each, this means a total of \$1,500,000 in sales reserved exclusively for ADMIRAL dealers.

GET YOUR SHARE OF THIS PROFITABLE REPLACEMENT BUSINESS

How many of *your* customers own ADMIRAL radio-phonographs with Miracle Tone Arm that are a year old or older? Every one is a sure-fire prospect for the snap-in cartridge. Here is YOUR OPPORTUNITY for quick, profitable sales.

Attractive display carton (left) placed in your service department or with fast-moving traffic items will mean FAST SALES and SATISFIED CUSTOMERS. Your ADMIRAL distributor has available a supply of hard-selling, compelling penny post cards which you may send to customers. Take advantage of this fast, inexpensive and easy way of letting your customers know the replacement snap-in cartridge is now available. PHONE OR WRITE YOUR ADMIRAL DISTRIBUTOR TODAY.

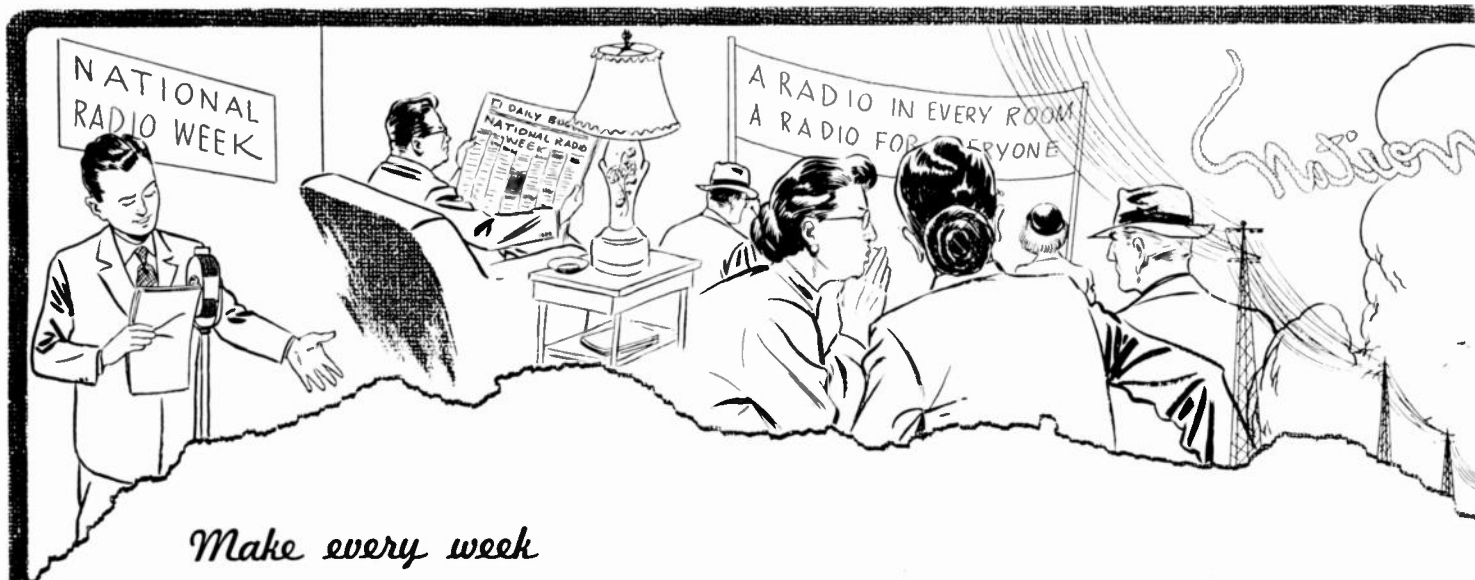

Make every week

NATIONAL RADIO WEEK

The industry's 28th birthday focuses attention on ever-present sales opportunities in radio . . . and television

RADIO'S celebration of its 28th birthday—National Radio Week, from November 14th to the 20th—has focused the attention of the nation on the theme a Radio in Every Room—a Radio for Everyone, and has catapulted the “Voice of Democracy” contest before the eyes of a national audience. By this twin appeal it has, in addition, enabled dealers in the radio, television and appliance industry not only to share the limelight during radio's anniversary, but also to cash in on the revitalized selling which accompanied the celebrating.

But it did something else, too. It did something, that is, for those dealers with foresight enough to latch onto an idea and put it to work for themselves. For those dealers who are slower to grasp the real significance of so great an event as National Radio Week, a little meditation will bring to light one salient point. There can be other, less grandiose, but effective radio weeks in every community where dealers will take the initiative to plan and execute a promotion campaign for the benefit of their businesses.

Elaborate Preparation

A glance at the ingredients that went into the National Radio Week promotion will give a clear indication of what such smaller campaigns would entail. The impact of radio's 28th anniversary, for instance, was felt

by dealers on the local level weeks before the event came off. Newspapers and radio stations gave widespread dissemination to the cooperative, community advertising which focused the public's attention on radio's coming event. The same copy stressed the technical advancements in today's radio receivers and the variety and excellence of current radio programs. Copy plugged the theme a Radio in Every Room—a Radio for Everyone. Posters were forwarded to dealers so that they could display them in their windows and in their showrooms.

Manufacturers cooperated by mailing additional information on National Radio Week to dealers handling their products in showrooms. In regular mailings, literature outlined methods whereby additional display, merchandising, and advertising efforts on the part of every dealer could aid the entire campaign.

Voice of Democracy

Jointly sponsored by the Radio Manufacturers Association, the National Association of Broadcasters, United States Junior Chamber of Commerce chapters in hundreds of cities, and the U. S. Office of Education, the “Voice of Democracy” contest was given equal billing with radio's 28th birthday party. The contest was a repeat on last year's successful, nationwide contest for tenth, eleventh,

and twelfth grade high school students. It centered on broadcast scripts related to the democracy theme, a subject on which 20,000 high school contestants from 500 towns and cities throughout the United States wrote competitive scripts on its inaugural occasion.

As with last year's contest, four national winners were slated for selection from state winners on the basis of one from each of six major geographical areas. RMA and NAB committed themselves jointly to grant college or university scholarships, each worth \$500, to national winners. Radios and other prizes, in turn, were donated by cooperating dealers and distributors for local winners and their particular schools. For those dealers who contributed generously with such prizes, the sales volume and the publicity, both springing from the impetus of the well-organized, national program of radio and television selling, will more than compensate for any donation, no matter how generous.

Range of Participation

The NAB distributed a series of model broadcasts, of five minutes each, to local radio stations for use throughout National Radio Week. Making the talks were: James Stewart, motion picture star, on “Platform for Democracy”; Dr. John D. Studebaker, editor of School Life, on “Education for Democracy”; Justin Miller, NAB president, on “Freedom of Expression”; Maj. Gen. Luther Miller, U. S. Army Chief of Chaplains, on “Freedom of Worship”; and U. S. Junior Chamber of Commerce President Paul Bagwell, on “Democracy at Work.”

Transcriptions like these were not



only used by local radio stations, but were used for the guidance of local participants through the distribution of mimeographed sample scripts. Groups like the Lions, Kiwanis, Rotary, and radio stations licensed to universities and other educational institutions were provided with publicity releases so that they could lend a hand in making the week's campaign a success. Finally, rounding out the variety of participants in the mammoth celebration were such stars as Eddie Cantor, Kate Smith, and Arthur Godfrey, all of whom devoted one-minute spot announcements to National Radio Week during the celebration period.

Industry Horizons

Such was the preparation, planning, and execution of one promotional campaign, National Radio Week. It has given widespread publicity to the entire radio industry, publicity which inevitably spilled over into television, the startling youngster which is sprouting on the vitamins of an electronic age. It has given a strong impetus to dealer sales, which should run high for a good many weeks to come.

But every dealer knows that there are periods when sales volume tapers off. And it is during those periods when exemplary promotion campaigns bear fruitful ideas. The scope of the national program of radio and television promotion just concluded should not discourage local dealers from joining hands and planning campaigns of their own. Dealers have the spade-work of two local promotional schemes to fall back on. For two widely-separated cities, Hartford, Connecticut,

and New Orleans, Louisiana, have already taken the initiative and have proven that aggressive promotional campaigns are profitable. (See Bombshell in Radio Selling stories—March and October issues, Radio & Appliance Journal).

Step by step operations of such previous campaigns can form the preliminary outlines of any projected promotion on the part of those local dealers who see more than a successful celebration of radio's 28th birthday in National Radio Week. The question of television and its role in any such promotion need not hamstring attempts at making a go of it. Some areas are ripe for strong television promotions, others must wait a while. It is merely a question of timing, and every locality must determine for itself the nature of the main emphasis. New Orleans dealers solved that problem without much trouble. They merely excluded television from the main drive, so as not to confuse the public. Then they published a small pamphlet called "Facts About Televi-

(Continued on page 34)



These posters, supplied to dealers by RMA, are being used effectively by dealers to tie-in with National Radio Week.



Journal Pictorial: Photographic Review of Events of Interest in the Radio and Appliance Industry

Motorola has taken a miniature table model radio and adapted it for special use with this convertible chair bed. By merely pushing a button, the radio listener who enjoys solid comfort can relax and tune in favorite programs while taking life easy.



Below are some of the promotional pieces Noblitt-Sparks Industries, Inc. are furnishing dealers who sell Arvin electric heaters. Pieces include six-color displays, sales guides and folders. Newspaper ad mats are thrown in for good measure.



The June Taylor Girls, right, display a bit of themselves as well as a number of Emerson radio models during an interlude in the Ed Sullivan television program over the Columbia Broadcasting System.



New Orleans' energetic radio dealers followed Hartford's aggressive merchants in planning a Radio in Every Room campaign. (See "Another Bombshell in Radio Selling", October issue of RAJ). Below, several hundred dealers and their sales staffs while meeting in the Roosevelt Hotel, New Orleans, to perfect plans for the campaign.



Thousands of visitors to the National Television and Electrical Living show jammed the Walker-Jimieson exhibition booths in Chicago's Coliseum, below, where Webster-Chicago wire recorders and record changers were on display.



Above, members of the Industry Relations committee of the Representatives of Radio Parts Manufacturers, Inc., who met recently in Chicago. Left to right, seated, S. K. Macdonald, Phila., P. R. Sturgeon, Boston, L. W. Beier, Cleveland; back row, J. Y. Schoonmaker, Dallas, left, chairman, Jane Drucker, Public Relations, and F. B. Hill, Minneapolis. Announced program of organization stresses information and service to manufacturers, distributors, dealers, and servicemen.

C. S. Bettinger, western sales manager of the Philco Corp., with Mrs. Bettinger, below, before leaving San Francisco for a meeting of Philco dealers in Honolulu.



This boxcar full of Bendix radios is slated for Tulsa, Oklahoma, where Evans Home Furnishings is exclusive dealer for Bendix. R. C. Collier, order department, and G. Peters, traffic, are about to seal the car.



Olympic executives below, left to right, G. M. Solomon, service mgr., A. A. Juviler, pres., Jay Gardner, sales repr., P. L. Shoanen, exec. v-pres., looked pleased after a preview in the Panel Room, Hotel New Yorker.



A Tele-Tone television set, below, is Mrs. America's after winning over some 30 finalists in the perfect housewife contest at Asbury Park, N. J. Mayor Smock makes the presentation to the beauty, Maria Strohmeier, of Philadelphia.



A new, satinized, plastic Rembrandt television receiver is the center of attention at the Better Homes Exposition at White Plains, N. Y. The plastic finish of the set gives decorators and homemakers a TV unit which blends with a variety of furniture.



Some strange and not so funny methods being used to sell television in Chicago's famous Loop area

"GOOD morning," said the clerk. "May I help you?"

I nodded. "I'm interested in seeing a television set."

"All right. Was there any particular set you had in mind?"

"No. I just moved from Columbus, Ohio. I've had a glimpse of television sets operating in taverns here in Chicago, and since we're settling in town I've decided we'd better have a set."

"I see," replied the salesman. "If you'll just step this way, I have a set which . . ."



Do you greet shoppers promptly?
Author waited 27 minutes once.

This might have been the opening of the fifth or fortieth sales interview which I went through for two weeks, during which time I "shopped" for television in the Chicago area.

I was doing it at the suggestion of Ed Gourfain, head man of our agency, who knows that national advertising must be tied in with good point-of-sale techniques to be effective. Ed felt my best introduction to the radio and television field would be to take a glimpse at the merchandising and sales techniques employed in Chicago's outlets. So I covered the Loop stores thoroughly, plus a good sampling of neighborhood ones.

If the shortage of television sets which some salesmen talked about is real, it is not immediately evident to a shopper in Chicago. I was, for example, quickly exposed to 15 different television receiver makes and three times that many different models. It would be reasonable to expect that competition would have led to the development of some excellent selling techniques. I found this to be a false assumption.

With a few outstanding exceptions, the television salesman I encountered in Chicago either doesn't know the basic principles of retail selling, or has forgotten them. He certainly doesn't put them to use. He is either uninformed or badly informed. He is not aggressive. He is often discourte-

ous. He falters when he should take the initiative and close a sale. He knocks his competitor's product without basing his criticism on thorough knowledge, and often doesn't trust his own product or his own knowledge to risk a demonstration. I am convinced that most of the people who buy television in Chicago are "sold" by the television medium itself, by neighbors, or by friends, most of whom are satisfied set owners. They are seldom sold by a salesman.

Blondes Preferred

Take for example the experience I had in a large specialty shop in Chicago's Loop, which had an entire floor devoted to television and radio displays, including demonstration rooms. There were more clerks than shoppers in sight in the central lounge, but I walked clear through it, even into the individual display rooms, without being approached by a single salesman. I took a seat beside a table piled with literature, determined to wait until I was either approached by a salesman or was driven out by hunger. A fair proposition. I thought. Well, it took exactly 27 minutes by my watch before I was accosted by a young salesman, who asked rather apathetically if there was something I wanted.

"Yes," I said. "I'm interested in a television-radio-phonograph."

He escorted me to a small demonstration room where a combination set was hooked up, with a television program already tuned in. I was impressed until I discovered its cost, over \$1200. I told the salesman I was looking for something under \$700. He immediately turned aggressive, snapped the doors closed over the still-lighted screen, and remarked in a voice that would have shriveled even a tough customer: "Well, if that's the way it is we might as well go in here." He led the way to another demonstration room.



Do you size up customers and demonstrate to fit their purse? Some salesmen never think of it.



I SHOPPED FOR TEL

By Ver Lynn Sprague

A set costing \$595, plus installation and service policy charges, was on display, and I asked him to demonstrate it.

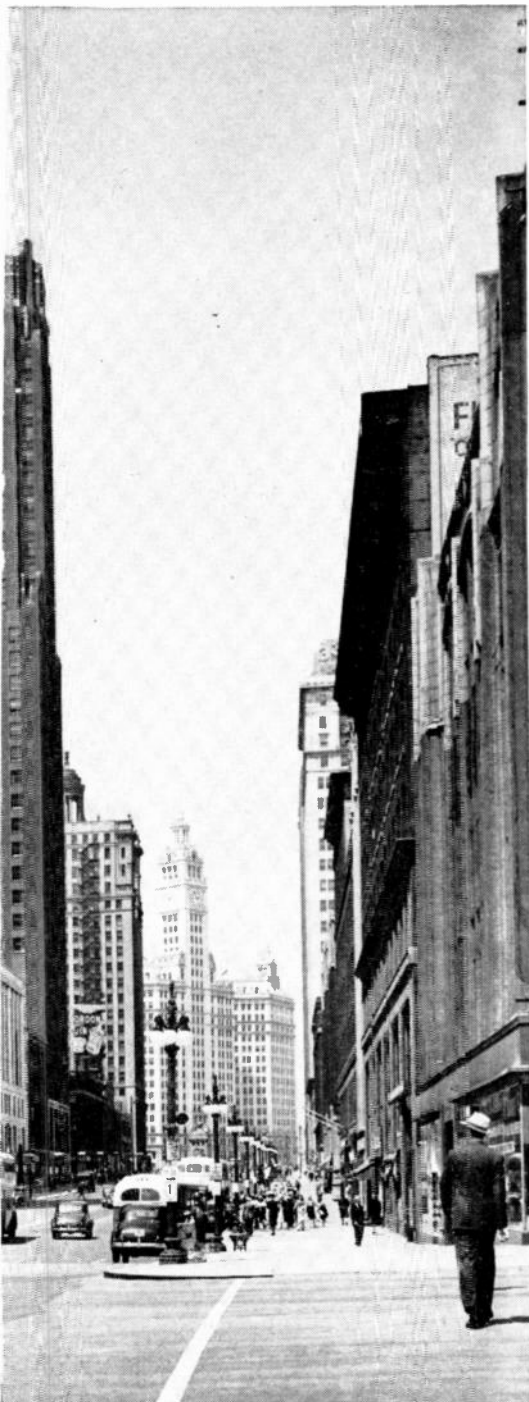

Photo by Ewing Galloway

THE LOOP TELEVISION

Field Merchandiser

Gourfain Cobb Advertising Agency

"It's not hooked up for television," he told me. "Anyway, the television is like the one I showed you. Here, let me demonstrate the record player."

He placed a record on the turntable, started it, then suddenly left me, exclaiming: "Listen to that for a while. Excuse me." I lowered the volume, took a seat, and watched through the glass partition as my salesman stopped to speak to an attractive young blonde seated in the center of the lounge.

The record finally played out, the



Do you make customers feel welcome to return for further demonstrations? If not, you should.

changer went to work but, to my dismay, I heard the same record being played over again. My sales friend was still busy with the young lady, demonstrating, as far as I could see, nothing but charm. When the phonograph began playing "Bongo, Bongo, Bongo" a third time I fled in horror, not wishing to be the only inhabitant of Chicago who knew the complete lyrics to the Congo tune. When I stepped into the elevator I cast a final glance in the direction of the salesman, but he was still engrossed in conversation with the blonde.

This was by far the outstanding example of discourtesy and bad salesmanship which I encountered in my sample survey. Admittedly the attractive young woman was tough to compete with, but I insist this is typical of the general apathy and clumsiness demonstrated in Chicago television showrooms with greater aptitude than that shown in actually demonstrating television sets.

One fellow I ran into was operating five different table models simultaneously, alternately cutting them in by means of a connecting switch to two available aerials. I nudged him and pointed to several 3-way combinations, each of which represented choicer sales for him and higher profits for his employer. "It might be a good idea if a fellow bought one of these bigger sets," I said. "Then his radio and record player would also be in the same cabinet."

"Yeah," he admitted reluctantly.

"Some people do that." He went back to twisting dials and I withdrew.

Real Comfort

Another salesman sat in the only available chair in the showroom while he demonstrated a set. Maybe he was tired. If he was, it wasn't from spending late hours pouring over literature published by the company making the set. He was the same one who claimed the firm was not making a set illustrated in their folder. He was wrong, for I had seen the same set demonstrated in several other stores.

In general, salesmen knew more about the technical aspects of television than they did about sales psychology. Although I requested descriptive literature everywhere, less than half the stores I visited had any to give me. Only three . . . I said three . . . of the salesmen I came across asked me questions like: What is the size of your family? What are your program interests? Nor did they attempt in any way to determine my personal needs or interests in order to direct their sales approach to my individuality. Not one of them offered to let me tune a set.

A hundred or more experiences similar to those described here convinced me that a tremendous inertia exists at the points of sale in television retail outlets in Chicago. Salesmen and retailers apparently are still under the impression that a clamoring seller's market exists today. And they have forgotten how to sell, or refuse to exert themselves in applying sound selling techniques.



Is your display a selling asset? Author found no dearth of TV sets, only apathy about sound selling.

To a newcomer to the lush television field, shopping for television in Chicago has convinced me that the time has come for an old-fashioned revival of old-fashioned salesmanship. The penitent and converted sales sinner who hits the sawdust trail first and hardest will not have to wait long to reap his reward.



Irving Winston, inset, forceful president of Winston Radio & Television Corporation, and, above, the store that is known throughout the New York metropolitan area as one of the busiest television centers in the city.

F O R T Y A D A Y !

That's the phenomenal TV selling pace maintained by this aggressive Brooklyn merchant

EIGHT blocks from the end of the Flatbush Avenue line of New York's Interborough subway is a radio and television dealer who is working wonders. He is Irving Winston, president of Winston Radio and Television Corporation. From an 1866 Flatbush Avenue location stems the chief activity of the concern, with a whiteware adjunct several doors down the street at 1858, a warehouse six blocks removed, and an elaborate service department up the street and around the corner on Avenue N.

In the main store, which is sprinkled with merchandise typical of radio, television and appliance dealers, eight salesmen are busy with a steady flow

of all sorts of traffic. Local residents from the neighboring business and residential districts come and go, rubbing elbows with customers from distant parts of Brooklyn, as well as other New York boroughs.

Most of the customers wind up in the extensive television salon on the premises, which is arranged to bear the brunt of the trade gravitating to Winston's. Fifteen salesmen carry the Winston line to distant points of metropolitan New York, to parts of Long Island, and follow live leads in New Jersey and lower Connecticut. Forty-five service men are geared to offer service to the buyers of the more than 10,000 sets already sold, and to the

owners of the average 40 sets a day Winston is now selling in its field of operation.

A Television Center

Though Winston Radio and Television Corporation came into being on the first of September, 1945, the idea of setting up a firm concentrating on television took form some ten years before this date. At that time, Irving Winston, after seeing a DuMont set in operation, became convinced of the future of the television industry. A tall, direct man who treats every customer with infinite patience. Winston, just turned thirty-five, subsequently fell back on years of merchandising experience in establishing

his successful television venture.

He was quick to see industrial television in bars and grills as more than the initial television market. He visualized it as the advertising medium for the eventual arrival of television in the home, and pushed sales in this initial market with as much enthusiasm as any dealer in New York. In line with this, he early advertised in the trade papers of the bar and grill proprietors, and proved to be the first such television advertiser in this medium. He became the first dealer in the metropolitan area to sponsor a television program, the Jamaica Arena amateur boxing bouts, from 9 to 11 p.m. every Monday night. Starting on June 1, 1947, over DuMont's WABD, Winston continued this sponsorship for a year and a half.

In no time at all distributors recognized the Winston store as a first rate market place. Manufacturers began sending merchandisers to consult with the president of Winston about television market information. The installation and service policies of the Winston firm became renowned throughout the New York area, and satisfied customers began telling their friends.

The store that had started as a television outlet became a television center.

Smart Merchandising

Relying on the sound merchandising philosophy of pleasing customers and spreading its name far and wide through publicity and advertising, Winston Radio and Television had little trouble winning a topnotch position in the budding television industry.

From the outset Winston's president determined that business would never lag because of lack of efficient service. Hence, in addition to adding the best known products to its line, the best available technicians were added to the service organization. To keep this service the finest, skilled men were sometimes added to an already large staff. This policy of keeping a large and efficient serviceman's pool paid off as the volume of television business increased during the three years since the birth of the organization.

Mindful of the fact that too often sets sold over the counter become dead issues with dealers once consummated, the elaborate service in television was designed to do two things, so far as Winston was concerned. It would in-

sure repeat orders and guarantee the making of more customers. And it would create a healthy foundation for the growing television industry.

Publicity, in the trade papers, in such newspapers as the New York Times, through the television medium itself, did the rest. The reputation of the firm automatically spread with the growing list of customers.

Such things as tube bottlenecks did not make too serious a dent in this business which concentrated so on television. Winston merely adopted a flexible merchandising policy, selling what was available at any particular time. In the coming months there will be no variation of this policy, since guaranteed products and guaranteed service are a Winston trademark.

Throughout its three-year history, Winston did a small volume of credit business, but the bulk of it was on a cash basis. The firm never delved into the petty-payment installment business, following a policy of 25 per cent down and 12 to 18 months for the balance. Hence, the new credit curbs had little impact on its business. In fact, the curbs acted as a spur to Winston

(Continued on page 30)

The comfortable salon is becoming one of the attributes of a good television dealer's premises. Sets in this Winston showroom are arranged so that customers may view products which interest them in solid comfort. Since the days of late 1945, the firm has concentrated on service and satisfaction. Now its customers are providing as many as 15 leads for field salesmen to track down. As a result, Winston is catering to a wide metropolitan market through one store.

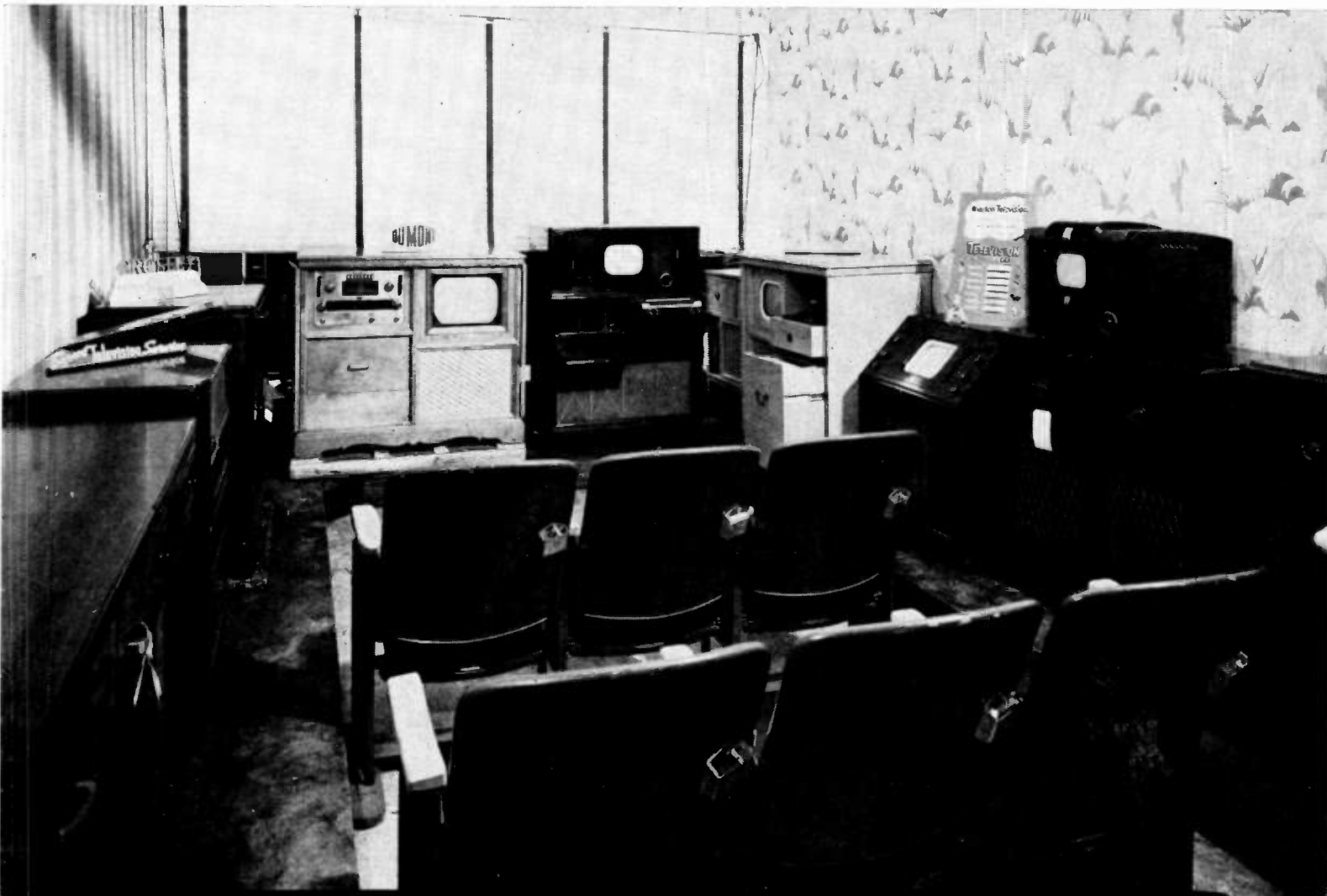

WHERE QUALITY
AND RESULTING PRESTIGE ARE
PARAMOUNT, LEADING MUSIC
MERCHANTS PROFITABLY
FEATURE THE INCOMPARABLE
CAPEHART

THE *Capehart*

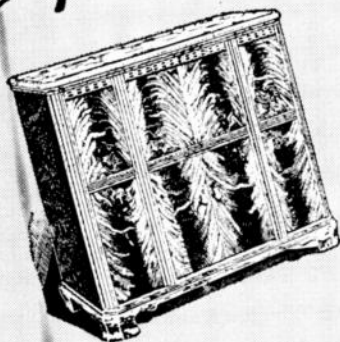

One of the great luxuries of life

Those who are in a position to gratify their desire for the very best in everything, including the world's great music—superbly reproduced—naturally choose the DeLuxe Capehart for their homes. It costs more, yes—but it is one of the world's finest instruments for musical reproduction.

You can explore the world with its powerful radio receiver—offering standard broadcast and EM reception—or provide supreme reproduction of the music in your record library.

Hear it at

KNABE'S

584 FIFTH AVENUE
AT 47TH STREET BRYANT 9-0700

Reproduced from a recent issue
of "The New York World-Telegram"

Farnsworth TELEVISION & RADIO CORPORATION,
FORT WAYNE 1, INDIANA

How to Conduct Yourself in the Customer's Home

By

Errol Jones

Amie Associates

This article is digested from a recent address given before the Town Meeting of Radio Technicians in N. Y.

SEVERAL years ago when very little was known about television reception at points distant from metropolitan New York, an Amie crew was sent to a point 70 miles out of New York City to a city completely surrounded by hills. The men were to install a set at a point in the bottom of the valley. It was a ticklish time, for the installation of this particular set would be the means of establishing a reputation in the area.

The crew discovered that, in order to get any height, a 60-foot mast would have to be erected. But to erect a mast without first knowing whether any signal could be received was absurd. So the crew went to the mayor, explained that it was engaged in an attempt to bring in television, and asked his advice about procuring a 60-foot ladder, at the same time hinting that the fire department could probably be helpful.

Without further ado, the mayor solicited the aid of the fire chief, and



Even after his installation crew has observed good conduct rules while servicing, a dealer may find it wise to make a personal visit to his customer's home to verify absolute satisfaction.

in no time at all the fire department had run up a ladder to the desired height. But the department, the installation crew, and the curious crowd which had gathered were all disappointed. It was impossible to obtain any reception.

This is a story of resourcefulness and of courtesy. As outsiders, the members of this service crew handled themselves as such, courteously seeking aid from those who could be of help. And they wound up getting it.

Entrances and Exits

The approach by this crew to a town 70 miles out of New York is not much different than that which every crew going into a customer's home should be. Friendliness with the superintendent can lead to aid from him later, perhaps in sharpening a drill, or lending a ladder.

Use of the service entrance, either in an apartment, private home or cottage, should be ritual. The foot mat should be used for exactly the purpose it is to serve. Wearing a hat while inside is discourteous and tools and outer clothing can be left in the kitchen. The master of the house is, of course, the person to contact, and making suggestions to him is always better than asserting definite opinions.

"May I suggest this set be placed here, it will not be in the direct rays of the sun," or, "I believe you will be more satisfied with the reception if the antenna were placed away from the road," are examples of appropriate suggestions.

When beginning work, it is well to remember to keep everything neat and clean. The antenna and cable can be assembled on the roof or in the driveway. With care, there need be no holes left in the lawn nor marring marks on the side of the house. If no throw cloth is available to place over the set while working with it, the customer can readily supply old newspapers which will serve the purpose. A final courteous touch is to clean up when finishing, using broom and dust-cloth. Throughout, of course, loyalty to the particular set being serviced is essential. Even to the extent of stating, should the customer ask an opinion about the set, that "I so like this particular set that I have one at my own home."

Service Backbone

So that a service department follows some of the fundamental rules of conduct essential in every visit to a customer's home, the entire organization must reflect these qualities considered

most essential in persons serving the public. Courtesy, friendliness, forcefulness are things a customer remembers. Willingness, cooperation, industriousness, imagination, alertness, and intelligence are other qualities which a customer likes to see in a serviceman working on his pride and joy—his television set.

Every dealer building a service organization must select his men with a view to obtaining a final department which reflects all these qualities. Young men, eager for an opportunity in this new industry, can be molded into part of such an organization. Older men, men over 40 years of age, can be steady, consistent workers who lend a professional air to a service department. Regardless of the age of those persons selected for a service department, one essential point must be kept in mind. It will cost a minimum of \$150 to train a serviceman. This investment can be lost easily if a trainee cannot produce quickly, or if he gives up at the end of the training period.

Above all, the success of a television business depends on its service force, on the men selected to carry your business into the customer's home.

Never before



Just plug it in, push a button, and get a great picture right away. That's the matchless demonstration you can make with this closed-front beauty with built-in antenna and push-button tuning. And it retails for about \$75 less than comparable models!



Side-by-side comparison with models costing \$50 more proves this the easiest selling AM-FM radio-phonograph for price and quality-conscious buyers. Its low price includes a plug-in attachment for long-playing records—or, at low-cost, the changer below.

Big Christmas Advertising Program sends all prospects to your door

Advertising-wise, Bendix Radio is "pouring it on" during the Christmas buying season. And here's what that means to you. As the only Bendix Radio dealer in your community you will get *all* the benefit of our national advertising. Every prospect interested in these matchless 1949 models is directed straight to you.



Wouldn't it be wonderful to offer gift buyers a small, long-range 3-way portable in jewel-like plastic at the price of an ordinary table model? Here it is—for plug-in or battery or AC-DC current—a self-selling "natural" for the Christmas trade.



All consoles will have it. Single-arm changer plays long-playing or standard records Inter-mixed, shuts off current after last record.

**SEND THIS COUPON TODAY, REMEMBER—THIS FRANCHISE IS
AVAILABLE TO ONLY ONE SELECT DEALER IN EACH COMMUNITY**

Christmas Merchandise

with such **"Buy-Now" Appeal**

BIG NAME—TOP QUALITY

Radio and Television

PRICED TO MEET ANY COMPETITION

It's a neat trick—but Bendix Radio dealers can do it! They offer nationally advertised radio and television—backed by a famous self-selling name and reputation and built to Aviation Quality standards—at figures competitive with price-built private brands. *And they can do it at a fine profit that's protected in every*

way. These are only the highlight advantages of our new, power-packed direct-to-dealer merchandising plan. There's still time to get in on it and capitalize on the big Christmas search for better values. But hurry—this protected-profit franchise is available to only one select dealer in each community.

HOW CAN YOU MISS WITH A PROGRAM LIKE THIS!

- The appointment of only one dealer in each community
- Direct factory-to-dealer shipments
- Freight prepaid to destination
- Low consumer prices competitive with national chains and mail order houses
- Liberal dealer discounts
- Nationally advertised retail prices protected by your exclusive franchise
- Radio and television built to Bendix Aviation Quality standards
- A complete line of radios and radio-phonographs including famous Bendix Long-Range FM
- The most advanced television created by the acknowledged leaders in radar and radio engineering
- Consistent national advertising that builds store traffic for you
- Compelling point-of-sale promotion helps
- Special promotion models to meet competitors' "off-season" distress sales
- Plus many new profit-building features soon to be announced.

Bendix Radio

AND TELEVISION

DIVISION OF
BALTIMORE 4, MARYLAND
DEPT. H



*Please send me all the facts about your new direct-to-dealer,
radio-television merchandising plan.*

MY NAME _____ MY FIRM _____

MY ADDRESS _____



A RAJ SECTION

Starrett's Ambassador

Manufactured by Starrett Television Corporation, 521 Fifth Avenue, New York City

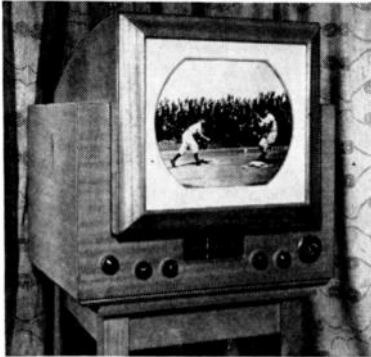

This table model television set is The Ambassador, made by the Starrett Television Corporation. The set has 31 tubes and one rectifier. A feature is the new 16-inch metal tube. Additional features are AM and FM. Cabinet finishes include mahogany, walnut, and bleach. Model stands 25½ inches high. Lists at \$695. Say you saw it in *Radio & Appliance Journal*, November, 1948.

*New Merchandise
for Fall
and Holiday
Buying*

**NEW RADIOS
TELEVISION
CONSOLES
RECORDERS
PHONOGRAPHS
TV ACCESSORIES**

Deluxe Tele-Console

Manufactured by Olympic Radio & Television, Inc., Long Island City, New York

Olympic's 18th century period television console features the Magic Mirro-Scope, a method of casting images on the television screen which is flicker-free, produces no glare or eye strain. Console also contains 10 tube FM-AM radio of 10 watts output, and Webster dual-speed record changer. Changer plays both standard and 33 RPM long playing records. Ample storage space for records and albums. In mahogany finish only. Lists at \$595. Say you saw it in *Radio & Appliance Journal*, November, 1948.



**ONE
stands out...**



OAK RIDGE ANTENNAS!

There's good reason why Oak Ridge STANDS OUT as a leader in the field of antennas and antenna accessories. For when sound, practical engineering, the best materials and sturdy construction go into a product the result is outstanding performance. Such is the quality and craftsmanship of every Oak Ridge product.

Oak Ridge is constantly developing new products to make TV and FM antenna installations easier, quicker and better! Whatever your antenna requirements are — see Oak Ridge products first...they're the finest! Send today for your Oak Ridge Catalog.

Write Dept. 106



OAK RIDGE ANTENNAS

239 E. 127th St., New York 35, N. Y.
Manufacturing Division of Video Television, Inc.

**Are you in TELEVISION
for FUN or for PROFITS?**

It's no FUN if there are not enough PROFITS, that's certain. MAJOR offers you a line of top-notch performers, priced mighty competitively, PLUS territory protection (AND price-protection) with as much as 33-1/3 MORE PROFIT for YOU! Interested? Write, wire or phone (MURRAY HILL 7-2394) for full details.

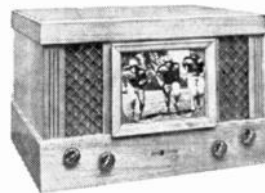

MAJOR "First Nighter" in handsome cabinet in choice of woods. Big 10-INCH TUBE. From . . .

\$375⁰⁰ retail



MAJOR "Life-View" receiver with 7-INCH TUBE. Clear, brilliant picture. At only . . .

\$189⁹⁵ retail

Complete line, up to \$2195.00

Distributors! Dealers! Get our prices, details!

MAJOR TELEVISION

General Offices: 19 W. 44th St., New York 18, N. Y.

Crosley Radio-Phonograph

Manufactured by Crosley Division, Avco Manufacturing Company, Cincinnati, Ohio



A single-post, automatic record changer is a feature of this new Crosley AM-FM radio-phonograph. Phono plays twelve 10-inch or ten 12-inch records and is housed in convenient slide-out drawer. Tone system has light tone arm plus permanent sapphire stylus designed to eliminate record scratch and wear by resting on sides of sound grooves. Radio section offers complete FM and AM broadcast coverage. Radio controls are mounted on a convenient tilt-view tuning panel. Other features include continuous tone control, beam power output, and a powerful 10-inch concert-type permanent magnet speaker. Two spacious album compartments are included in the 18th century styled mahogany cabinet.

Say you saw it in *Radio & Television Journal*, November, 1948.

Jewel Wakemaster

Manufactured by Jewel Radio Corporation, 583 Avenue of Americas, New York City

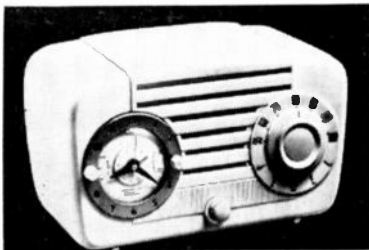

By setting the time and pre-selecting your station, this Jewel radio, called the Wakemaster, awakens the user with a chosen radio program. Five tubes. superheterodyne. including rectifier. Equipped with Telechron automatic clock and alarm. Plastic cabinet in either walnut or ivory can harmonize with modern or traditional settings. Retail for \$29.95 in walnut, for \$32.95 in ivory.

Say you saw it in *Radio & Appliance Journal*, November, 1948.

The Washington

Manufactured by Stewart-Warner Corporation, 1826 Diversey Parkway, Chicago, Illinois

A direct-view table model television set, Stewart-Warner's "The Washington" has optional custom-built, style matched base. Set features new "Wonder Window," providing 10 per cent larger picture area than former models utilizing 10-inch tubes. Channel selector tuning eliminates need for vernier tuning.

Say you saw it in *Radio & Appliance Journal*, November, 1948.

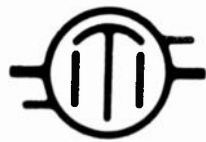

The VISION in Television

Industrial leader

pioneer

announces

remote control,

home television

Television, Inc.,

in the postwar field of commercial television for hotels, schools, taverns and hospitals,

in the development of remote control and multiple screen television equipment for public viewing,

its forthcoming production of high quality television receivers for the home.

a proven feature of Industrial's commercial equipment, will be incorporated in the Industrial home receiver line.

by Industrial has been designed to the same high standards of picture quality and rugged dependability which have earned an enviable reputation in the commercial field among both users and service men.

Write for Details.



357 LEXINGTON AVE., CLIFTON, N. J. • GREGORY 3-0900

Zenith Adapter

Manufactured by Zenith Radio Corporation,
6001 W. Dickens Ave., Chicago, Illinois



This Zenith adapter attaches to most FM-AM combinations made by the same firm by simple plug-in arrangement. Unit includes lightweight Cobra Tone Arm, turntable, motor, and special guard to protect arm when not in use. Housed in black stag case. Arm exerts only five grams pressure on records; retractable type filament modified for smaller grooving of long playing discs. Not affected by extremes in temperature and humidity. Special motor drives turntable.

GE Charging Radio

Manufactured by General Electric Company,
Electronics Park, Syracuse, New York



Model 160, a new addition to the GE line of portable radios, weighs 17 pounds, has a streamlined maroon plastic cabinet with a brass speaker grille. Features a 2-volt rechargeable storage battery and a built-in charger. After from 12 to 15 hours of constant playing, battery can be recharged by plugging set into ordinary AC house power. Built-in indicator shows when charging is needed. Other features include built-in Beam-A-Scope antenna and 5¼-inch Alnico 5 dynapower speaker. Set has five tubes. Retail in east for \$79.95.

Say you saw it in *Radio & Appliance Journal*, November, 1948.

FM Teletuner

Manufactured by Vision Research Laboratories,
87-50 Lefferts Blvd., Richmond Hill,
New York

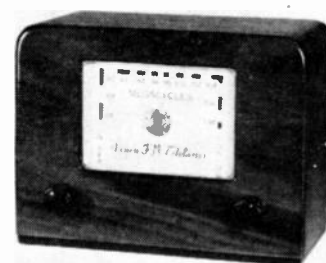

This FM tuner can be connected between the television receiver and antenna to tune in all FM stations. A Vision Research product, the tuner amplifies and converts FM signals for reception through the television sound channel. Works on either channel 2 or 3. Switch-thru arrangement permits television reception when tuner is off. Teletuner comes in rich grain cabinet, has lighted airplane type dial, plus self contained power supply.

Say you saw it in *Radio & Appliance Journal*, November, 1948.

Multiply Television Profits!

Taybern **T-V** Duplicators

"TELEVISION EVERYWHERE"



FOR

- ★ HOTELS
- ★ BARS & TAVERNS
- ★ HOSPITALS
- ★ SCHOOLS
- ★ HOMES
- ★ CLUBS
- ★ INSTITUTIONS
- ★ RESTAURANTS
- ★ AUTO COURTS
- ★ THEATRES
- ★ RESORTS

1 or 100 may be attached to any standard television set . . . Economical installation . . . Simple to operate . . . Superb performance.

Exclusive territories still available—
Write for Literature Today!

TAYBERN EQUIPMENT CO., INC.
120 GREENWICH STREET • NEW YORK 6, N. Y.

NEW LEAD-IN SUPPORTS THAT GIVE BETTER TELEVISION and FM RECEPTION!

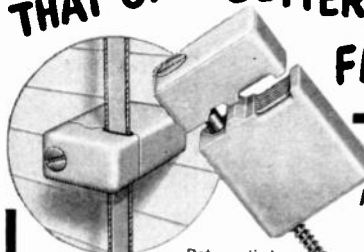

Pat. applied for No. 9418

Two major causes of TV Black-out, FM Fadeout are eliminated with Porcelain Products' exclusively designed lead-in supports. They give rigid support preventing lead-in wire from twisting in wind or going slack; short circuits are stopped by giving quick moisture drainage at support yet wire is held firmly without injury to insulation. Made of highest quality porcelain, resistant to weather extremes, factory assembled, screws rust-proofed, no maintenance, low initial cost. For all popular types of lead-in cables.

WRITE FOR FOLDER

OTHER ANTENNA AND LEAD-IN ACCESSORIES



No. 1925

Insulated Screw Eye. Overall length 7-1/4", 5/16" insulator hole.



No. 1961

Split Bridge Ring Insulated Screw Eye. Overall length 3-5/8", 5/8" insulator hole, 1/4" diagonal slot.



No. 500

Antenna Strain Insulator, Brown glaze porcelain, size 2-1/8" x 1-9/16", 3/8" hole.

Porcelain Products, Inc.
FINDLAY, OHIO

Emerson Conqueror

Manufactured by Emerson Radio & Phonograph Corporation, 111 Eighth Avenue, New York City

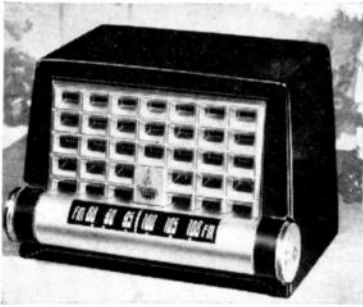

Model 602 is named the "Conqueror". The manufacturer claims it is the lowest priced FM set on the market. It has just been released to the public. Retail at \$29.95. The "Conqueror" is a genuine FM, not a makeshift or "supperregen" FM receiver.

Say you saw it in *Radio & Appliance Journal*, November, 1948.

Television Duplicator

Manufactured by Taybern Equipment Company, 120 Greenwich Street, New York City



This duplicator reproduces on its 63 square inch screen the same program as that on the master television receiver. Contains its own on-off volume control and contrast control. Has no effect on picture quality or sound. Comes in blond, mahogany, and walnut. Stabilized synchronization and complete audio circuits; 10 tubes, two rectifiers; operates on line voltage of 115 volts, 60 cycles. Requires only plug-in adapter and use of audio and shielded television cable for installation. No additional antenna necessary.

Say you saw it in *Radio & Appliance Journal*, November, 1948.

"How to Train Your Salesmen for Competitive Selling" gives you the essential facts you need to know to plan for the highly competitive year that lies ahead. It will appear exclusively in the December issue of RAJ.

Tele-Scope

Manufactured by Wavell Corporation, 1346 Chestnut Street, Philadelphia, Penna. This Tele-Scope magnifier is the first flat, plastic, non-liquid lens developed for television use. Increases size of image of 10-inch set up to 172 square inches, or from 3 to 4 times original size, without distortion, and with complete clarity and improved visual depth. Weighs 3 lbs. Fingertip adjustment for individual vision, and mounting bracket placement. Framed in either walnut or mahogany. Retail for \$29.95.

Say you saw it in *Radio & Appliance Journal*, November, 1948.

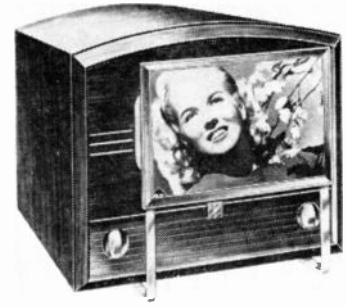

where roof installations are difficult

use the **UNIVERSAL**
windo-tenna

for window or indoor use

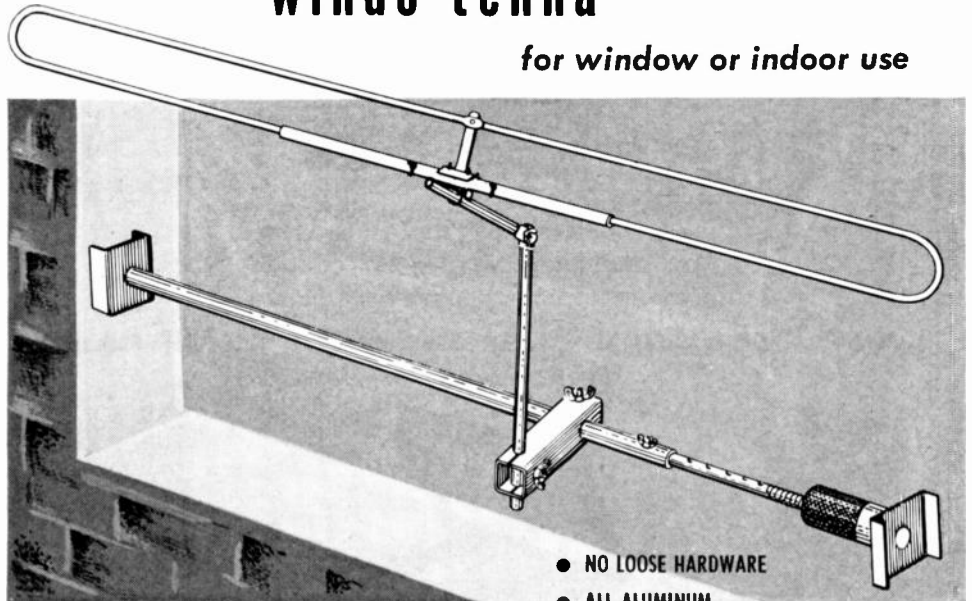

This simple, economical TV window antenna is effective, rigid and adjustable to any average-size window. No chisels, hammers, drills, screw drivers or special tools are needed—
JUST POSITION AND ATTACH!

The UNIVERSAL WINDO-TENNA is necessary where roof installations are dangerous, difficult or not permissible. You can install it either on a window, door or any indoor location.

- NO LOOSE HARDWARE
- ALL-ALUMINUM
- All-directional orientation, vertically, diagonally, horizontally
- Completely packaged with dipole element

look at this

LOW PRICE!

\$13.50 list price

DISTRIBUTORS INVITED Write for prices and descriptive literature.

VERI-BEST TELEVISION PRODUCTS, INC. • 8-10 FORREST STREET, BROOKLYN, N. Y.

Dual Groove Changer

Manufactured by Webster-Chicago Corporation, 5610 Bloomingdale Avenue, Chicago, Illinois



This Webster-Chicago record changer features two needles, one regular tip for standard discs and a micro-ground tip for microgroove records. Manual or automatic play on speeds of 78 and 33 1/3 RPM. Tilt-O-Matic tone arm adds to record life by permitting automatic play with absence of lateral pressure and with minimum vertical pressure. Say you saw it in *Radio & Appliance Journal*, November, 1948.

Flextron TV Lens

Manufactured by Electro-Steel Products, Inc., 11-14 No. Seventh Street, Philadelphia, Pa.

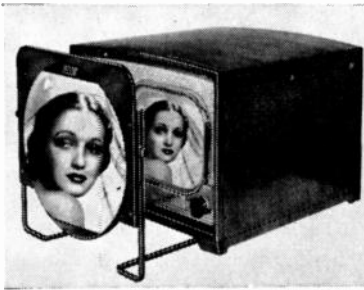

This Flextron manifold lens for 7- or 10-inch television screens is adjustable up or down, forward or backward. Comes in clear or blue, the latter showing increased popularity. Round lens permits unusual refinement in convexity and assures clear, sharp image. Suited to in-between size table models particularly. Masked on all four sides, ground from clear plastic to eliminate glare and distortion.

DuMont's Sutton

Manufactured by Allen B. Dumont Laboratories, 515 Madison Avenue, New York City



Model RA-103 in the DuMont television line is a small-space receiver. Has DuMont's exclusively patented Inputuner and tuning eye for quick, accurate tuning. Speaker is 10-inch permanent magnet dynamic. Twenty-five tubes plus three rectifiers. Styled in functional modern design and finished in blond hardwood. Produces a 72 square inch direct-view picture with FM and television on all channels. Say you saw it in *Radio & Appliance Journal*, November, 1948.

Hy-Lite Antenna

Manufactured by Hy-Lite Antenna Inc., 528 Tiffany Street, Bronx, New York

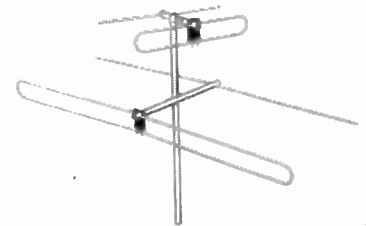

This television antenna, Model LC-30-S, is one of a new, low-priced line of all wave antennae. Antenna has folded dipoles for both high and low frequency, both with reflectors. Lists at \$15.75. Say you saw it in *Radio & Appliance Journal*, November, 1948.

STEELMAN

Lp Record Players

... and Lp Microgroove Records

— a combination that means to recorded music what color does to painting and perspective to drawing!

COLUMBIA DISTRIBUTORS PREFER STEELMAN LP RECORD PLAYERS
"The Tone Quality is Better"



MODEL 352—List Price \$49.95
Two pick-up arms (plays LP and Standard Records). Two speed motor, power transformer; 3 tubes, 5 watt output, 6 1/2" Alnico Speaker, dual channel tone control, inverse feedback for maximum volume with minimum distortion. Size 14 1/4" x 15 1/2" x 7 1/4".
MODEL 307—Same, for LP Records only\$42.50
MODEL 308—For standard records only\$39.95



MODEL 342—List Price \$39.95
Two pick-up arms (plays LP and standard records). Two-speed motor, 3 tubes, 2-watt output, 5" Alnico Speaker. Case constructed like a jewel box, felt lined with stitched top.

MODEL 340—For LP records only\$29.95



MODEL 362—List Price \$59.95
"Featheride" Tone Arm for LP records, special "retractable" tone arm for standard records, two-speed motor power transformer, 3 tubes, 5 watt output, 6 1/2" speaker, dual channel tone control, inverse feedback, deluxe case designed for style and durability.

STEELMAN RADIO CORP.

742 EAST TREMONT AVENUE

BRONX 57, N. Y.

The year 1949 will be a competitive one for dealers in the radio, television, and appliance industry. Every dealer must survey his credit structure and keep his business operation sound, if he wants to meet his competition on equal grounds at all times. Read "How to Get Credit and How to Keep It", an article which analyzes some of the basic problems of dealer credit, appearing exclusively in the December issue of Radio & Appliance Journal.

ASK YOUR DISTRIBUTOR FOR A DEMONSTRATION

He Now Has
The V-M DUO-
SPEED CHANGERS
In Stock



801
DUO

You Owe It To Yourself and Your Customer,
to display and sell these amazing record
changers.

A demonstration by your distributor will con-
vince you.

- SINGLE TONE ARM
- TWO-SPEED MOTOR
- TWO-NEEDLE CARTRIDGE
- PLAY "STD" & "SLOW" RECORDS.

V-M CORPORATION
BENTON HARBOR, MICH.

"I read it from cover to cover with deep interest

**I want to congratulate you on your
September issue. Your feature article
on *Dynamic* certainly is an interesting
subject, giving valuable assistance to
the great number of dealers who sub-
scribe to your publication"**

Says

**S. I. Godley
President of Sternfield-Godley, Inc.
Prominent New York advertising agency.**

*Editorial alertness plus knowledge of dealers' prob-
lems is making the "Journal" the most valued media
for advertisers who want to reach the radio-tele-
vision and appliance merchant.*

**(over 30,000 Circulation--CCA)
Radio & Appliance Journal**



World's finest radio-phonograph
—that's what experts and owners
alike say of the Scott 800-B (shown
here in one of the many cabinet de-
signs available—the Chippendale).
Elegantly engineered, beautifully
housed, here is an instrument to be
sold—and owned—with pride.

Not just television . . . but Scott
Television. Here are Scott precision
engineering, sensitivity, selectivity
translated into exciting television.
Big 16 x 12 screen (192 square
inches of screen surface) folds into
top of cabinet when not in use. A
receiver for those who want the
finest in video entertainment.



Good Company

Retailers who hold the Scott franchise
are the leaders in the whole field of
radio and television.

They offer—and with considerable
pride—the world-famous Scott
radio-phonographs and the new
Scott Projection Television Receiver.

Naturally, the number of Scott dealerships
is restricted, but a few may now be granted
to retailers who meet Scott's high standards.

You will find yourself in "good company"
with the Scott franchise. For details, write
Scott Radio Laboratories, Inc.,
4541 Ravenswood Ave.,
Chicago 40, Illinois.



FORTY TELEVISION SETS A DAY!

(Continued from page 19)

sales, since it made it possible for this concern to compete for that business which no longer automatically goes to installation establishments.

As a direct impetus to wide metropolitan sales, Winston has its fifteen field salesmen following live leads that are funneled to the firm's main office, are passed along by satisfied customers, or are dug up by the enterprising salesmen themselves. It has been estimated that one good customer can stir up, by favorable reports, from 10 to 15 solid leads for the Winston firm.

Service Department

Service remains Winston's pillar of strength. In 1945, the days of View-tone, the days of trial and error for television technicians, Winston started out as did others in the infant industry, with one installation crew and a tremendous yen to try its luck in the novel field. As RCA, DuMont, Philco, Farnsworth, Emerson, Stromberg-Carlson and a host of other models were

gradually added to the firm's line, the crews began to multiply. Green men were broken in, after screening oral and written tests, by experienced technicians. Even today new servicemen go through the same processing, winding up on benchwork for six to eight weeks. After that, if retained, they are about ready for work in the field, servicing or installing sets.

Guiding spirit of the service organization is Sy Cantor, the service manager, a quiet, efficient fellow who can keep several men going at once, and can jump into any spot in his organization in time of emergency. He has radar experience with the Marines to back up his service work, and a strong right arm in the person of Bob Montez, shop foreman, a design engineer with ten long years in radio repair and three in television. Between them they direct the activities of five men in the shop, nine men on service calls, and about 12 installation crews.

The organization clears from 50 to 55 service calls a day, calls which require anything from moving a wire to taking out a flicker. Installation is geared to completing from 32 to 36 in a single day. The range of work is as wide as is possible in the television industry today, varying from small home sets to extensive industrial sets, a high percentage of which Winston garnered in its earliest days.

This is the organization which, though doing a tremendous volume of business, made a special effort to clear the service shop of all sets prior to the Louis-Walcott boxing match—and did it. It has been maintaining 48-hour service for some time now, and has \$4000 worth of test equipment, the most extensive possible, to help do the job. In addition, Winston's service department has pioneered in installation work in the New York area, venturing as far east of New York as South Hampton and into upper reaches of New York State to experiment on installations. These ventures turned into costly ones, and the coverage area has now shrunk to within a 50-mile radius of New York City.

As a natural consequence, some manufacturers have forwarded some of their sets for pre-testing by Winston technicians, relying heavily on the firm's practical knowledge of the field for recommendations.

It's a Hit!

Boost Your Television Sales
With The New

MODEL TV4
13 CHANNEL

TELEBOOSTER

PILOT LIGHT INDICATES WHEN
BOOSTER IS ON

- Clears - Brightens
- Better Image Definition
- Easy to Install - Simple to Operate



\$22.95
List

Prices slightly higher West of the Rockies.

• FEATURES •

- Increase gain for brighter, sharper pictures.
- Improves TV reception in fringe areas.
- Synchronization holds better.
- Variable tuning for maximum gain.
- Reduces inter-channel interference.
- Permits use of indoor antennas in many locations.
- Helps reduce ghost images.
- Uses two 6AK5 tubes plus selenium rectifier.

Dealer inquiries invited. Write for catalog. Choice territories still available for Mfg. Reps. Write for complete details.

SONIC INDUSTRIES INC.

2999 THIRD AVENUE

NEW YORK 55, N. Y.

No Tricks

The service policy built with such patience has brought results. One television customer, who bought from a competitor, joined the Winston fold recently. He refuses to go back to the firm of his original purchase, preferring Winston and its reputable service. Similar sentiments are tacitly admitted by the host of customers who purchase RCA sets from Winston, even though they are aware of the fact that RCA does its own servicing. The Winston name has a magic of its own in the television field.

Added cognizance of this was shown by the Radio Parts Industry Coordinating Committee at its recent Town Meeting, held in New York's Hotel Astor. Listed among the speakers on the agenda was Irving Winston, assigned to cover the topic "How to conduct yourself in the customer's home," for the symposium on TV installation in the home. During the three-day meeting Winston's president had occasion to address some 2500 to 3000 servicemen.

That is what a service policy coupled with alert publicity has done for one metropolitan dealer. It has built a reputation hard to equal, and has created a business volume—40 sets a day average—hard to beat.

INSTANT HIT SCORED

AS ~~CROSLEY~~ SCOOPS

lowest-price field

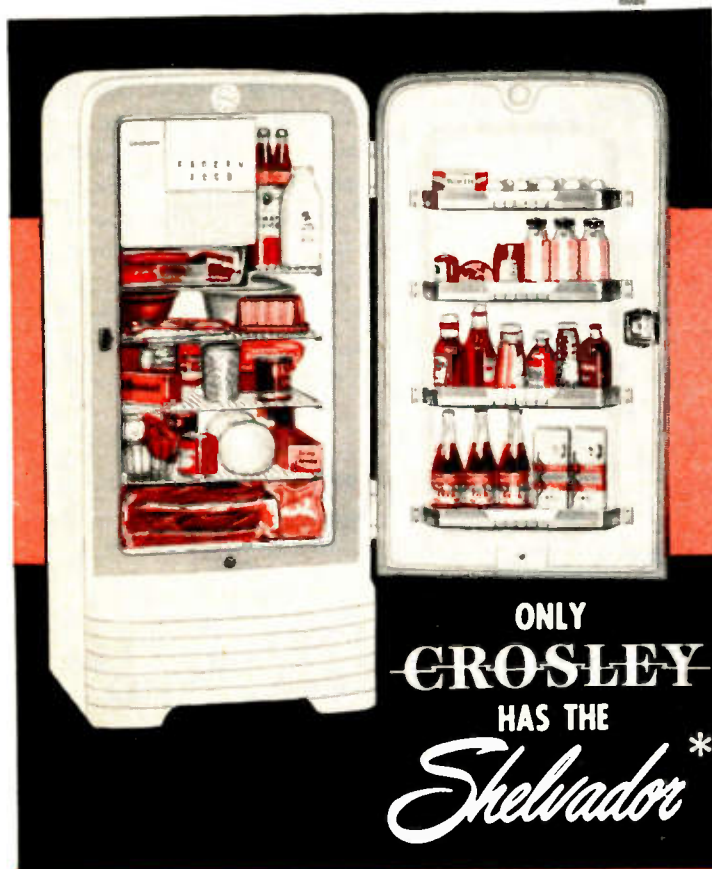

trade and public alike respond to newest model offering full 7 cu. ft. storage in floor space of a "4"

NEW... ALL-NEW
~~CROSLEY~~
*Shelvador**
 REFRIGERATOR

ONLY
~~CROSLEY~~
 HAS THE
*Shelvador**

● Imagine a full 7 cu. ft. refrigerator that saves money and saves kitchen space—and includes the popular Shelvador* at no extra cost! It's the refrigerator all America is acclaiming as the "small budget" answer to the "small kitchen" problem—your chance to cash in on the biggest refrigeration scoop of your time.

provides
BIG STORAGE
 for small kitchens

it's a **BIG 7**
 in the price range
 of a "6"

NOW

a Shelvador*
 refrigerator
 for
Every Price
Every Need
6 MODELS

put yourself "on velvet" with a Crosley franchise

~~CROSLEY~~

Division—*AVCO* Manufacturing Corporation
 Cincinnati 25, Ohio

*®

Shelvador* Refrigerators ● Frostmaster Home Freezers ● Ranges ● Radios
 Radio-Phonographs ● FM ● Television ● Shortwave

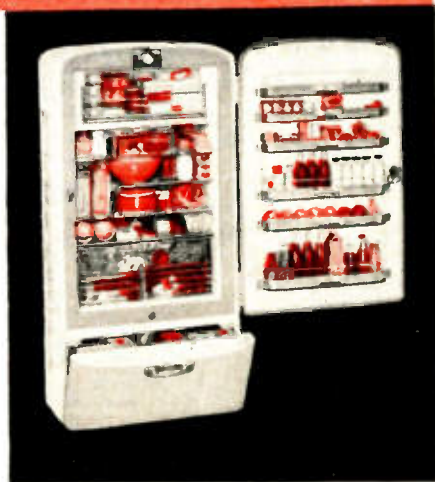

Microgroove Player

Manufactured by Califone Corporation,
1041 N. Sycamore Ave., Hollywood, Calif.

Two specially-designed needles permit playing, by this Califone model 2P, of both the long-playing microgroove records and regular records and transcriptions. Needle pressure is eight grams. Player has Califone patented two-speed turntable with "microgrip" pad.

Say you saw it in *Radio & Appliance Journal*, November, 1948.

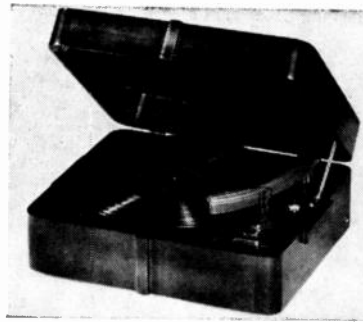

Meck TV Receiver

Manufactured by John Meck Industries, Inc.,
Plymouth, Indiana

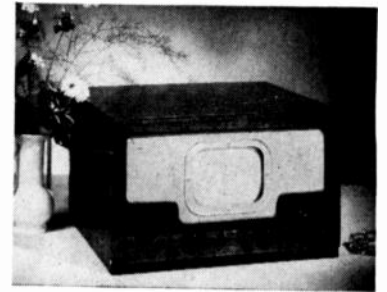

This multi-channel television receiver has a 7-inch picture tube. Selection by rotary switch, plus vernier tuning control which provides sensitivity on weak stations and permits tuning out of inter-station interference. Brilliance and definition adjustment by double deck control. FM reception on audio channel. Has 18 tubes, plus four rectifiers. Cabinet in hand rubbed mahogany. Retail for \$179, less installation.

Say you saw it in *Radio & Appliance Journal*, November, 1948.



HUNTON PLASTICS COMPANY

presents

HUNTON MAGNIFYING LENSES

... MAGNIFY YOUR SALES PROFITS
WITH A TRIED AND PROVEN LENS.

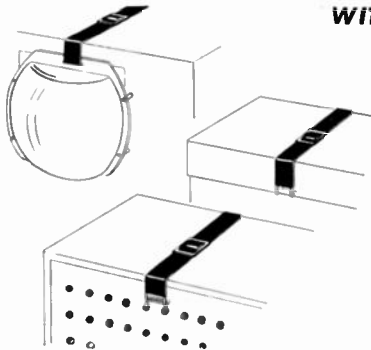

- Optically engineered liquid lens. • Enlarges 7-inch tube to 10-inch picture. • Enlarges 10-inch tube to 15-inch picture. • Wide viewing angle without any distortion.



For your protection these lenses are insured under Products Insurance Coverage by the manufacturer, who firmly stands behind any claims.

OUR SIMPLIFIED MOUNTING is not only good looking but easy to assemble on all table model receivers and most consoles. Attachment is made in two minutes without need for tools, brackets, special mountings for different models, or extra-large supporting tables.

10" LENS LIST PRICE

Broadview #10 \$21.95
Regular #10 — 22.95
Azure #10 — 23.95

7" LENS LIST PRICE

Broadview #7 \$18.00
Azure #7 — 18.95

Made in U.S.A.

THE MAGNIFYING LENS IS PRICED FOR QUICK SALE AND TURNOVER!

Aside from lower price, its neat design and mounting go well with fine cabinetry. Its bigger, brighter, clearer picture is easier on the eyes. Here is an enlarging screen with both price and quality appeal. Each Magnifying Lens is individually packed and comes equipped with a universal strap mounting for all table model receivers and most consoles.

And HUNTON AZURE FILTERS

These filters are produced from non-inflammable Plastic polished to a high optical finish. They sharpen contrast, reduce glare and reduce eye-strain. They are very easily applied:

1. Peel off the paper backing of adhesive as shown in the diagram.
2. Apply the filter over your television set as illustrated.
3. Caution: Clean with soap and water, and avoid the use of kitchen scouring powder and similar abrasives. Noxon silver polish can be used.

Distributor and dealer inquiries invited

PRODUCED IN THE FOLLOWING SIZES:

Size	List Price
#7—5 1/8" x 6 3/4"	\$1.50
#10—7" x 9"	1.95
#12—12" x 9 1/4"	3.45
#15—14 1/4" x 10 1/2"	5.75
#20—14" x 17 1/2"	8.75

Made in U.S.A.

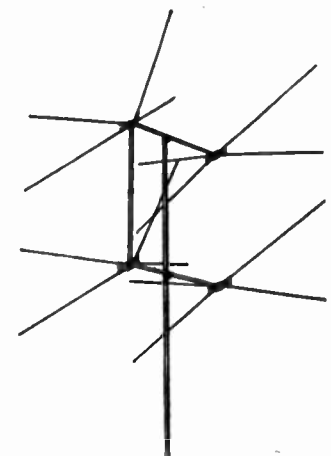
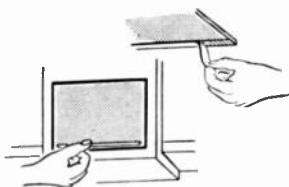

This high-gain stacked "V" beam antenna is capable of bringing in every channel from 5 to 13 and increases gain from channel 2 to 13. It also has unidirectional pattern—all channels; non-varying center impedance—all frequencies with a front to back ratio of 15 DB all frequencies.

Say you saw it in *Radio & Appliance Journal*, November, 1948.

HUNTON PLASTICS COMPANY • 11 SO. VAN BRUNT STREET • ENGLEWOOD, N. J.

RMA-NAB Liaison

To promote continued joint industry cooperation and action, RMA President Balcom recently appointed two liaison committees to work with representatives of the National Association of Broadcasters and the FM Association. Early meetings of both groups are planned, aimed at sparking broadcasting services and receiving set sales for AM and FM radio, and television. Past RMA President Paul V. Galvin of Motorola Inc. heads the committee cooperating with a similar NAB group. Also included in the group are George M. Gardner of Wells-Gardner Co.; H. C. Bonfig of Zenith Radio Corp.; Dr. Allen B. DuMont of Allen B. DuMont Laboratories; Frank M. Folsom, RCA Victor Division; and L. F. Hardy of Philco Corporation. For liaison with the FM Association, RMA Director H. C. Bonfig of Zenith was named chairman of the RMA group, while Ray H. Manson of Stromberg-Carlson Company was appointed vice chairman.

Avco Predicts

Writing in the first issue of a quarterly newsletter to stockholders, Victor Emanuel, president of Avco Manufacturing Corporation, declared that Avco's Crosley Division would produce more than 175,000 television receivers in 1949. During the same year Mr. Emanuel felt that the industry as a whole would pass the million mark, production being limited only by the availability of tubes.

For Free

As an outgrowth of TV-FM antenna installation forums conducted in television centers throughout the nation, the JFD Manufacturing Company has instituted a free advice center to which all servicemen can turn for the analysis and solution of their TV-FM antenna installation and reception problems. Called the JFD TV-FM Antenna Installation Service Department, servicemen may avail themselves of the service by addressing the company, 4110 Fort Hamilton Parkway, Brooklyn 19, New York.

G.E. Plans Radio Drive

• *The General Electric Company* announced to its distributors a nationwide fall program on radio and television receivers. The program is designed to meet the competitive radio market predicted for the balance of 1948, and involves price reductions on one clock-radio, AM-FM table models, and radio-phonographs in two important price brackets.

FLEXTRON MAGNIFYING LENS

adds that plus to your tv sales



AMAZING FLEXTRON LENS FITS ALL SETS — GETS BIG CUSTOMER RESPONSE

Sell to all your TV customers! Gives them more real 'seeing pleasure' — clearer, sharper, extra-large image. No glare or distortion. With Blue FLEXTRON, customers view pictures in normal room-light. A handsome FLEXTRON style for every TV set—each perfectly adjustable, beautifully engineered.

Flextron Senior. 10" or 12" screens. List — Clear, \$34.95 — Blue, \$39.95.

Flextron Junior. 5" or 7" screens. List — Clear, \$19.95 — Blue, \$21.95.

Flextron #3 (Round). 7" or 10" screens. List — Clear, \$27.50 — Blue, \$29.95.

Flextron De Luxe. Console style. List — Clear, \$39.95 — Blue, \$44.95.

Five other models available in low-price range.



Make extra profits on every TV sale! Send today for descriptive circular containing complete information and distributors' prices. A few distributorships still available — write at once for information.

MANUFACTURERS OF

FLEXTRON

ELECTRO-STEEL PRODUCTS, INC.

112-14 N. SEVENTH ST. PHILA. 6, PA.



TRANSVISION

NEW Television Kits, and Equipment Important Advances in TV Reception and Servicing!

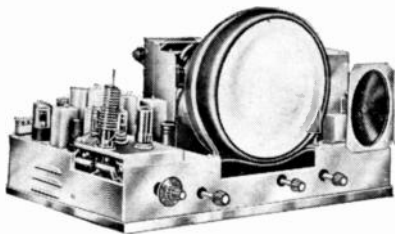

MODEL 10A TV KIT

NEW 10" TV KIT at amazingly LOW PRICE!

The new Transvision Model 10A electromagnet TV Kit gives a bright, stable 52 sq. in. picture. Has 10" picture tube, and CONTINUOUS TUNING on all 12 channels. Its high sensitivity makes for improved long distance reception; especially good on high channels. Complete with all-channel double-folded dipole antenna and 60 ft. of lead-in wire.
MODEL 10A TV KIT, less cabinet Net \$199.00
MODEL 12A TV KIT, same as above, but has a 12" picture tube Net \$263.00



ALL-CHANNEL BOOSTER

NEW STREAMLINED CABINETS

for Transvision Model 10A or 12A TV Kit. Made of select grain walnut with beautiful rubbed finish. Fully drilled, ready for installation of assembled receiver.
Walnut Cabinet for 10A or 12A (Specify) ... Net \$44.95
Mahogany and Blonde slightly higher.

TRANSVISION ALL-CHANNEL TELEVISION BOOSTER

To assure television reception in weak signal areas, or areas which are out of range of certain broadcast stations, Transvision engineers have designed this new booster. It increases signal strength on all television channels. Tunes all television channels continuously. Can be used with any type of television receiver. Unusually high gain in upper television channels.
Model B-1 LIST \$39.95

TRANSVISION REMOTE CONTROL UNIT KIT

Will operate any TV receiver from a distance. Turns set on, tunes in stations, controls contrast and brightness, turns set off. Ideal for installations where the television receiver is inaccessible. Tuner unit is a high gain, all-channel unit with about 50 micro-volt sensitivity. Easy to assemble in about an hour.
Model TRCU, with 25 feet of cable Net \$44.50
Without cabinet Net \$42.50



REMOTE CONTROL UNIT KIT

NEW . . . TRANSVISION SWEEP SIGNAL GENERATOR FOR TELEVISION AND F.M.

Complete frequency coverage from 0-227 MC with no band switching. . . . Sweep width from 0-12 MC completely variable. . . . Accurately calibrated built-in marker generator.
OUTSTANDING FEATURES: (1) Frequency range from: 0-227 MC. . . . (2) Dial calibrated in frequency. . . . (3) Sweep width from 0-12 MC completely variable. . . . (4) Self-contained markers readable directly on the dial to .5% or better. (No external generator required to provide the marker signals) . . . (5) Crystal controlled output makes possible any crystal controlled frequency from 5-230 MC. . . . (6) Plenty of voltage output—permits stage-by-stage alignment. . . . (7) Output impedance 5-125 ohms. . . . (8) Directly calibrated markers 20-30 MC for trap, sound and video IF alignment. . . . (9) RF for alignment of traps for IF channels when a 10C volt meter is used as the indicating medium. . . . (10) Unmodulated RF signal to provide marker pips simultaneously with the main variable oscillator. . . . (11) Markers can be controlled as to output strength in the pip oscillator. . . . (12) Power supply completely shielded and filtered to prevent leakage. . . . (13) All active tubes are the new modern miniature type. . . . (14) Phasing control incorporated in the generator.
MODEL NO. SG Net \$99.50

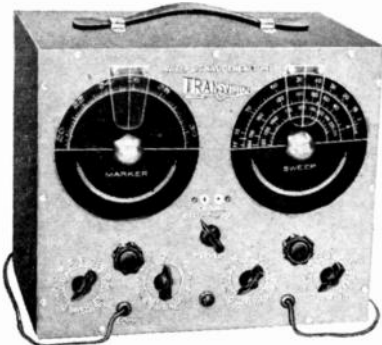

SWEEP SIGNAL GENERATOR

RADIOMEN . . . You Can GET INTO The
TELEVISION BUSINESS
In a BIG WAY with the
TRANSVISION DEALER PLAN
WRITE FOR FOLDER D-1

NEW 8-PAGE CATALOG showing complete Transvision line now available at your distributor, or write to:

TRANSVISION, Inc. Dept. RAJ **New Rochelle, N.Y.**

In Calif: Transvision of California, 8572 Santa Monica Blvd., Hollywood 48

All prices 5% higher west of Mississippi; all prices fair traded. All prices subject to change without notice.

How New Orleans Planned 'Radio in Every Room' Campaign

Distributors meeting: Held on Thursday, August 19 at the New Orleans Public Service Conference room. About twenty members of twelve distributor organizations attended. The purpose of this meeting was to outline and formulate plans and assure full backing and cooperation of all segments of the industry.

Distributor Salesmen meeting: Held on Wednesday, August 25 at the St. Charles hotel. Breakfast served. Attended by thirty-four executives and salesmen from fourteen distributors. Purpose was to explain to distributor salespeople their important part for insuring success of campaign.

Retail Committee luncheon: Held on Thursday, August 26 at Arnaud's restaurant. Attended by twelve "key" retail radio dealers representing department, furniture, music and appliance stores. The purpose was to advance information of campaign plans and to select a chairman. (George Marcuse of the Radio Center, an outstanding neighborhood radio and appliance store, was chosen).

Radio and Press Luncheon meeting: Held on Wednesday, September 1 at International House. Attended by ten newspaper and broadcasting executives. Purpose was to advise this influential group of the results of the Hartford Campaign and also to point out that there was to be a large increase in paid advertising by the New Orleans dealers and their distributors.

Dealer Meeting: Held on Monday, September 20, Grand Ball Room, Roosevelt Hotel. Attended by more than 400 radio retailers and their salespeople. Purpose was to secure their enthusiastic support and follow-through by all retail merchants in the Greater New Orleans area.

National Radio Week (Continued from page 13)

sion" and distributed it to all dealers, to keep all key persons informed on the subject.

The momentum of first the Hartford, then the New Orleans, and finally the National Radio Week drives may yet be the cause of a rash of promotion campaigns all over the country. If so, dealers should not take a dim view of such prospects. For if every week were radio week somewhere the industry would scarcely be harmed. Dealers, must, however, take the initiative in planning and executing such local promotion campaigns of their own.

**SENSATIONAL
NEW
AMAZING**

**VERSATILE
NEW**

**TOM THUMB
PORTABLE
BIKE RADIO**



SALES WINNING FEATURES

- ★ TELESCOPIC ANTENNA
- ★ EASY MOUNTING
(Quickly Detaches for Portability)
- ★ POWERFUL RECEPTION
- ★ BEAUTIFULLY FINISHED METAL CASE

LIST PRICE

\$24.95
LESS BATTERIES

FEATURES ANTI-THEFT
LOCKING DEVICE

**JUST IN TIME
FOR THE HOLIDAYS**

Multi-purpose powerful battery operated bike-portable radio — can be mounted on bicycle or carried as a personal portable radio — supplied complete with all bicycle mounting hardware and telescopic antenna — simple mounting — quickly detachable. Whip antenna plugs into radio — slide rule dial — vernier tuning — full size alnico #5 speaker operates on inexpensive flashlight cells and standard 67½ volt "B" battery. Attached handle for ease in carrying when used as a regular portable — lightweight — case beautifully hammer-tone finished.

Size 7¼ x 4¼ x 3½

Weight 3 Lbs. 3 Oz.

**FOR YOUR RIDING & PORTABLE PLEASURE
IT'S THE NEW TOM THUMB "BIKE" RADIO**

Write, Wire or Phone for Special Discounts and Franchised Territories!

AUTOMATIC RADIO MFG. CO., INC.

122 Brookline Ave., BOSTON 15, Massachusetts



NEWS AND NOTES OF MANUFACTURERS AND DISTRIBUTORS

- **Industrial Television, Inc.**, Clifton, N. J., which has specialized in commercial television, has announced its intention to place on the market receivers for home use to be known as the ITI Century line. Showings for distributors and sales representatives are planned for the near future.
- **The JFD Manufacturing Co., Inc.**, Brooklyn, N. Y., has announced the 5th in a series of TV antenna in-

stallation forums to be held at the Sheraton Hotel, Rochester, N. Y. on November 23. Installation and reception problems will be discussed by leading engineers.

- **Motorola, Inc.**, Chicago, Ill., has announced that sales for the nine months ended August 28, 1948, were \$38,801,926, a 21 per cent increase over sales for a like period in 1947. Net profits, after taxes and reserves,

were \$2,207,765, or \$2.76 per share on common stock.

- **Major Television Corporation**, mid-western television manufacturer, has opened general offices at 19 West 44th Street, New York City, and plans to introduce to distributors and dealers throughout the country its line of television receivers, units and projectors.
- **Air King Products Co., Inc.**, Brooklyn, N. Y., last month inaugurated a price increase on its line of radios and wire recorders amounting to from five to 15 per cent. Labor and material costs were cited as the reason for the increases. The firm's line of Spotlite-Brite television receivers was not affected by the price changes.

- **Telecoin Corporation**, originator of the launderette, chain of self-service automatic laundries, has expanded its distribution activities to commercial television. A television manufacturing affiliate, Tele-Video Corporation has been established at Upper Darby, Pennsylvania, with Paul Weathers, electronics expert with RCA Victor for 16 years, as president.

- Arthur C. Ansley, founder and formerly president of Ansley Radio Corporation, has announced the formation of a new company, the **Arthur Ansley Manufacturing Company** of Doylestown, Pennsylvania. Among the new company's first products will be three portable phonographs, but the four models of record playing equipment also to appear represent a concentration on high-fidelity, sound reproducing equipment.

- Simultaneous with the announcement by Tel-O-Tube Corporation of America of full production on 16-inch metal television receiving tubes, **Starrett Television Corporation** announced it is equipping sets for immediate delivery with the new tube. Twelve Starrett sets are now being equipped with the Tel-O-Tube. The firm now has a showroom at 521 Fifth Avenue, New York City, where dealers may apply for franchise applications.

- **Webster-Chicago Corporation**, manufacturer of wire recorders, automatic record changers, phonographs and nylon needles, conducted a five-day managers school during the first week in October. The school provided special sales training for men heading up Webster-Chicago Products divisions among key distributors.

- **Motorola Inc.** has purchased the inventory and certain assets of the Car Radio Division of the International Detrola Corporation, Detroit, producers of car radios for automobile manufacturers. Motorola will continue manufacturing car radios and will now supply them direct to automobile manufacturers.

GI Leads Again

MODEL DR—Deluxe model 4 pole shaded pole motor for use in all high-grade instruments in which the ultimate in performance is desired.

with **TWO** rim drive
DUAL SPEED PHONOGRAPHS
for **BOTH 33 1/3 and 78 R.P.M. Records**

MODEL DM—Compact low cost 2 pole, shaded pole motor designed for portables, table models and other instruments in which space is an important factor.

The new long-playing microgroove records are here. Their enthusiastic reception proves that your 1949 customers will want, *and demand*, dual speed phonographs—operating at 33 1/3 R.P.M. for the new records, and at 78 R.P.M. for their existing record collections.

Only General Industries gives you a choice of TWO great new rim drive dual speed phonomotors to meet this profitable market. Built with the same precision that distinguishes all GI Products, these dependable rim drive dual speed motors have been thoroughly tested under all operating conditions.

NOW is the time to get complete information about prices and delivery of GI phonomotors, engineered and designed expressly for this newest development in the record industry. Write *today* to:



The GENERAL INDUSTRIES Co.

DEPARTMENT F • ELYRIA, OHIO

• Stromberg-Carlson has appointed **Marshall and Deyerle, Inc.**, of Roanoke, Virginia, wholesaler for 28 counties in that state. The Rochester firm also announced the appointment of **Lighting Fixture & Electric Supply Co., Inc.**, of New Orleans as distributor of the firm's radio and television products to service authorized dealers in 56 parishes of Louisiana, 41 counties in Mississippi and two in Alabama.

• **H. Kenneth Hardie** has been appointed treasurer and acting controller of Universal Moulded Products Corp., Bristol, Va., radio and television cabinet manufacturing firm, to succeed **Allyn R. Bell**, who resigned to accept a post with Deep Rock Oil Co., Tulsa, Oklahoma. Mr. Hardie is a graduate of the Wharton School of the University of Pennsylvania, was for 13 years with Sun Oil Co., Philadelphia, whence he was loaned for a time to the Ohio Emergency Pipelines, Inc., Cleveland, and joined the Houdry Process Corporation in late 1946. With Houdry, Mr. Hardie was assistant treasurer, controller and secretary. In his new post with Universal, Mr. Hardie will be responsible for cost accounting, time-keeping, general accounting, and general office departments.

• **Hunton Plastics Company** of Englewood, New Jersey, has announced the appointment of the following distributors: Edwards Sales Company, 2123 East 9th Street, Cleveland, Ohio; Lund Hansey, 549 West Washington Blvd., Chicago, Illinois; and Massey Associates, 1153 Vermont Avenue, Washington, D. C.

• **Noblitt-Sparks Industries, Inc.** has appointed the following distributors in Detroit, Michigan, and Dallas, Texas: Daybert Distributing Company, 2287 Jefferson Avenue, Detroit, to distribute Arvin radios and electrical appliances in metropolitan Detroit and in 35 eastern Michigan counties; and Raco Appliance Company, 1111 Wood Street, Dallas, to distribute the same products in Dallas and 35 east Texas counties.

• **Tele-Tone Radio Corporation** has announced the appointment of Electrical Specialties Company as distributor for its products in the Michigan area. In business since 1911, the new distributor has handled products of nationally-known radio manufacturers since 1922.

• **Over 1,500 RCA Victor** dealers from communities in western Pennsylvania, eastern Ohio, and West Virginia gathered at Pittsburgh's William Penn Hotel last month to celebrate the formal entry of RCA Victor television into that section of the country. Hamburg Brothers, local distributors, presided at the gathering.

LIFE - SIZE TELEVISION

IS HERE!

It's new! It's amazing! It's taking the country by storm! Every installation creates more comment — more demand for Cortley's LIFE-SIZE, LIFE-LIKE Television.



48 SQUARE FEET
OF SHARP, BRILLIANT PICTURE

Yes, the Cortley Projection Television Set astonishes everyone — throwing a picture varying in size from several inches up to 6 x 8 feet onto a screen — just like a home movie projector!

UNLIMITED SALES OPPORTUNITIES

Bars, Restaurants, Halls, Homes, Clubs, Churches — these are but a few prospects. They have been clamoring for LIFE-SIZE Television and now you can supply them.

WRITE - WIRE - PHONE TODAY for additional information and price! Get in on this new, easy-to-sell market now.

A limited number of Cortley Distributorships are now available. Write for particulars today!

CORTLEY TELEVISION CORP.

Dept. D, 15 WEST 27TH STREET

NEW YORK 1, N. Y.

Tel. MU 3-3624



VISION... proudly presents

the first **SUPER DE LUXE BOOSTER**

Three stages of high-gain, broad band amplifiers, adjustable gain and smooth continuous tuning... that is what makes the **VISION TELEBOOSTER MODEL TVZ** the finest in its field.

Check These Features

- Continuous tuning over all tv channels, no bandswitching.
- Helps overcome noise and interference conditions.
- Vernier tuning makes the hairline adjustment easy and accurate.
- Gain control permits just the right amount of gain for each station.
- Eliminates need for outdoor antenna in many locations.
- Use three (3) type 6AK5 tubes in stable, high-gain circuit.
- Self contained power supply using long life selenium rectifier.
- Easy to install, just plug into AC outlet and connect to set and antenna.



MODEL TVZ

\$54.50
LIST

Prices slightly higher on the West Coast.

NEW! TELEVISION FRONT END TUNER MODEL TF

Vision Television Front End Tuner Model TF contains an RF Stage, Mixer and Oscillator incorporating an ingenious continuous tuning mechanism to provide stable and sensitive performance over all 13 channels.

Technical Information Supplied on Request

NEW! THE FM TUNER FOR TELEVISION

A new money maker in the television accessory field is the **VISION FM-TELE-TUNER**. Just connect the same way as a Booster, turn TV set channel selector to an unused channel and tune in FM during the hours when TV is not being broadcast.

\$29.95 List



VISION RESEARCH LABORATORIES INC.

87-50 Lefferts Blvd., Richmond Hill, N. Y.

... for

**INCREASED
SALES
and
PROFITS...**



DeWald 8-504 "Personal" Portable

in
RADIO
and
TELEVISION

for
SOMETHING
BETTER,
it's

DEWALD



DeWald BT-100 High-Definition TELEVISION

For more than a quarter-century DeWald's proven quality and outstanding performance have been creating satisfied customers and building good-will.

Write today for full information

JOBBERS — REPRESENTATIVES

Some choice territories still available.

DEWALD RADIO MFG. Corp.
35-15 37th Ave., Long Island City 1, N. Y.

New Appointments



JOHN T. THOMPSON

• John T. Thompson has been appointed replacement tubes sales manager for the **General Electric Tube Divisions**, Schenectady, N. Y. Mr. Thompson was formerly in sales, market research, and purchasing posts with the firm.



LESLIE J. WOODS

• Leslie J. Woods has been elected vice-president of the Industrial Division, **Philco Corporation**. Mr. Woods has been with the organization since 1925 and has assumed increasing responsibility in engineering and sales.

• Harry Ripps has been named the **Admiral Corporation New York Distributing Division's** sales representative for sections of the Bronx territory.

• The **Tele King Corporation** announces that Mr. Sol Sherman has joined its staff in an executive capacity.

5 MINUTE INSTALLATIONS GYRO-TENNA*

**NO
TOOLS
NAILS
BOLTS
SCREWS
GLUE OR
CEMENT**

- The Television-FM Antenna of a 1,000 Positions**
- A removable window antenna
 - Covers all frequency ranges 44-216 mc, channels 1 to 13 and FM
 - Non-directional Provides reception from all points of the compass
 - Expandable to full folded dipole or straight dipole and reflector
 - Secured firmly by expansion bolt principle.
 - Designed for maximum broad band performance.
 - Strong, lightweight aluminum with genuine lucite insulation.
 - Sells right across the counter TV-FM buyers can install easily.

Manufactured by
PUBLIC OPERATING CORP.
100 West 42nd St., N. Y. 18, N. Y.

National Sales Representatives
APEX ELECTRONICS SALES CORP.
192 Lexington Ave., N. Y. 16, N. Y.

* Trade Mark - Patent Applied for

**1675
LIST**

Switch to PHOTOFACT— the Best Service Data Buy You'll Ever Make!



Thousands of Radio Service Technicians are *right!* They've found the way to quicker, easier, more profitable servicing. Join these thousands of successful money-making Servicemen who have switched to PHOTOFACT Service Data. Learn for yourself how this accurate, easy-to-use, practical data saves you time, makes your work easier, helps you earn more. PHOTOFACT gives you 100% useful service data—every photograph, every diagram, every bit of information helps you do a *complete job*. You owe it to yourself to switch to PHOTOFACT. There'll be a big difference in the time you save and the bigger profits you'll earn every single working day.

Subscribe Regularly to PHOTOFACT Folder Sets

Here's the most accurate and complete Radio Data ever compiled—issued regularly two sets per month. Keeps you right up-to-the-minute on all current receiver production. Your best buy in Service data—practical, useful information that makes money for you every day by saving you time on service jobs. Shows you everything you need to know about the sets you service—in clear, accurate, uniform style. Packed with extra help—full PHOTOFACT data on Automatic Record Changers—communications receivers—amplifiers—*plus* new PHOTOFACT Television Folders—exclusive, uniform coverage of popular Television Models, data proved best by actual service clinic experience. Subscribe at your Jobber today, for regular monthly issues. **\$150 PER SET ONLY.....**

PHOTOFACT VOLUMES The Preferred Service Data



Your Price
Each Volume,
In DeLuxe Binder **\$18.39**

Bring your file of post-war receiver Service Data right up to July, 1948! Here's the most accurate and complete radio data ever compiled—preferred and used daily by thousands of Radio Service Technicians. Includes: Exclusive Standard Notation Schematics; photo views keyed to parts lists and alignment data; complete parts listings and proper replacements; alignment, stage gain, circuit voltage and resistance analysis; coil resistances; record changer service data, etc. Order Volume 4 today—keep your Photofact library up-to-date—it's the *only* Radio Service Data that meets your *actual* needs!

- Vol. 4. Covers models from Jan. 1, 1948 to July 1, 1948
- Vol. 3. Covers models from July 1, 1947 to Jan. 1, 1948
- Vol. 2. Covers models from Jan. 1, 1947 to July 1, 1947
- Vol. 1. Covers all post-war models up to Jan. 1, 1947

FREE Photofact Cumulative Index

Send for the FREE Cumulative Index to PHOTOFACT Folders covering *all* postwar receivers up to the present. You'll want this valuable reference guide to the Radio Service Data preferred and used by thousands. Helps you find the Folders you want quickly. Get this Index at your Jobber or write for it today.



1947 Record Changer Manual

Nothing like it! Complete, accurate data on over 40 post-war models. Exclusive exploded views, photos from all angles. Gives full change cycle data, information on adjustments, service hints and kinks, complete parts lists. PLUS—for the first time—complete data on leading Wire, Ribbon, Tape and Paper Disc Recorders! 400 pages; hard cover; opens flat. Order now! **\$4.95 ONLY.....**



Receiver Tube Placement Guide

Shows you exactly where to replace each tube in 5500 radio models, covering 1938 to 1947 receivers. Each tube layout is illustrated by a clear, accurate diagram. Saves time—eliminates risky hit-and-miss methods. 192 pages, completely indexed. **\$1.25 ONLY.....**



Dial Cord Stringing Guide

The book that shows you the *one right* way to string a dial cord. Here, in one handy pocket-sized book, are all available dial cord diagrams covering over 2300 receivers, 1938 through 1946. Makes dial cord restringing **\$1.00** jobs quick and simple. **ONLY.. \$1.00**



Radio Industry RED BOOK

The RED BOOK tells you *in one volume* all you need to know about replacement parts for approximately 17,000 sets made from 1938 to 1948. Includes complete, accurate listings of all 9 major replacement components—not just one. Lists correct replacement parts made by 17 leading manufacturers—not just one. Covers original parts numbers, proper replacement numbers and valuable installation notes on: Capacitors, Transformers, Controls, IF's, Speakers, Vibrators, Phono-Cartridges. Plus—Tube and Dial Light data, and Battery replacement data. 440 pages, 8½ x 11; **\$3.95** sewed binding. **ONLY.. \$3.95**

BOOST YOUR EARNING POWER!

Mail This Order Form
to HOWARD W. SAMS & CO., INC.
2924 E. Washington St., Indianapolis 7, Indiana

My (check) (money order) for \$.....enclosed.

- Send the RED BOOK. \$3.95 per copy.
- Send PHOTOFACT Volumes in DeLuxe Binder:
- Vol. 4. Vol. 3. Vol. 2. Vol. 1 (\$18.39 each).
- Automatic Record Changer Manual, \$4.95.
- Tube Placement Guide, \$1.25.
- Dial Cord Stringing Guide, \$1.00.
- Send FREE Photofact Cumulative Index.

Name.....

Address.....

City.....State.....

HOWARD W. SAMS & CO., INC.
INDIANAPOLIS 7, INDIANA

Beautiful
**AEROLUX
FLOWERLITES**

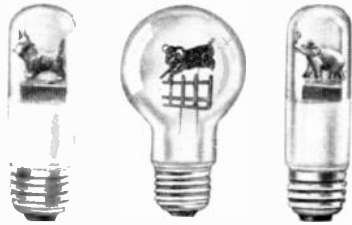

CHEER LITES
To Merry the House



NEW — ORIGINAL
Completely Charming

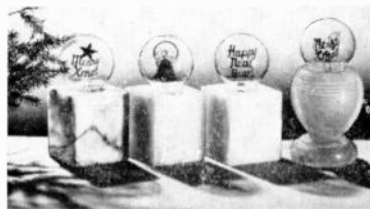

YOU'LL LOVE THEM



**America's Smartest
Gift Line
Easy To Sell Too!**

Write for catalog

AEROLUX
LIGHT CORPORATION
653 Eleventh Ave., New York 19

New Andrea Television Models

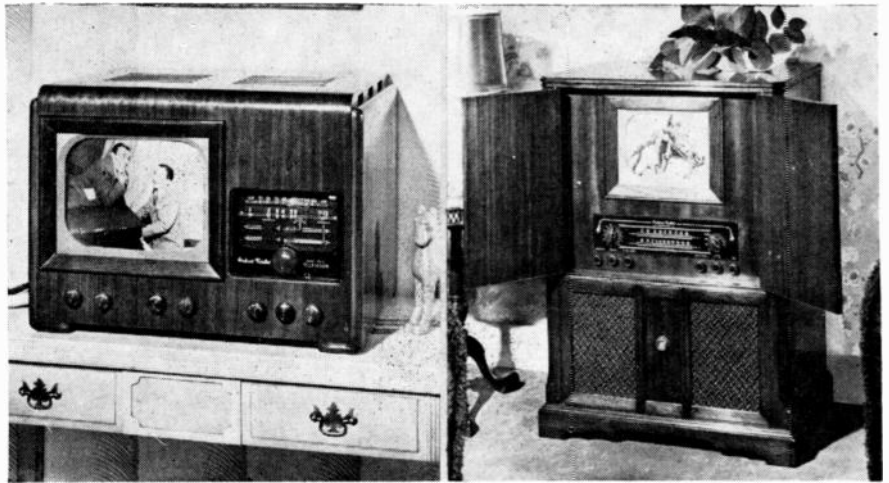

Shown above are two of the new television models just introduced by Andrea Radio Corp., pioneer television manufacturer whose plant is located at 27-01 Bridge Plaza North, Long Island City, New York. In a full page advertisement which appeared in the September issue of *Radio and Appliance Journal*, the identifying captions underneath these two models were inadvertently misplaced. In the photo above, the set at the left is the table model T-VK12 . . . for those who want BIG picture performance in a compact, efficiently-engineered set . . . OVERSIZE 12-inch picture tube 217 per cent larger picture than the conventional 7-inch tube table model . . . complete 26-tube plus 3-rectifier-tube chassis plus standard AM and new FM broadcast bands . . . in piano-finish mahogany . . . also available in highly polished blonde mahogany . . . BT-VK12. Photo on right is the console-model CO-VJ12-2 . . . OVERSIZE 12-inch picture tube . . . complete 28-tube plus 3-rectifier-tube chassis . . . standard AM and new FM broadcast bands . . . Automatic Phonograph . . . piano-finish mahogany cabinet . . . companion model BCO-VJ12-2 in highly polished blonde mahogany has all the features of the CO-VJ12-2.

• **Majestic Radio & Television Corporation** announced the appointment of the following seven distributor organizations: Twin States Distributing Co., Charlotte, North Carolina; Neidhofer & Co., Chicago, Illinois; G. W. Onthank Co., Des Moines, Iowa; Neidhofer & Co., Milwaukee, Wisconsin; G. W. Onthank Co., Omaha, Nebraska; Foreman Distributing Co., Portland, Oregon; and Seattle Radio Supply, Seattle, Washington.
• The Division of Polan Industries of the Zenith Optical Company has appointed the **John J. Kopple Associates**, 60 East 42nd Street, New York, representatives of its radio and television products, which include mirrors, corrector plates and mounts.



FINEST PROFESSIONAL NITRATE COATING

MELODISC WHITE LABEL

- 6 1/2" HEAVY ALUMINUM .30 LIST
- 8 HEAVY ALUMINUM .40 LIST
- 10 HEAVY ALUMINUM .60 LIST
- 12 HEAVY ALUMINUM .80 LIST

MELODISC RED LABEL

- 6 1/2" LIGHT ALUMINUM .20 LIST
- 8 LIGHT ALUMINUM .30 LIST
- 10 LIGHT ALUMINUM .45 LIST

JOBBER: SEND FOR SAMPLES AND DISCOUNTS

Melodisc
ALUMINUM BASE
HOME RECORDING PRODUCTS
Corporation
FREEPORT LONG ISLAND

FOR SALE BY ALL LEADING JOBBERS

New Appointments



JACK CHERRY

• Jack Cherry has been appointed sales manager of the Service and Parts Division of the **Philco Corporation**, Philadelphia. Mr. Cherry has been with the firm for 14 years, serving in engineering and sales positions.

• The Anthony Dillon Company has been appointed representative for Starrett Television Corporation in the Chicago area. A former regional sales manager for RCA Victor, Mr. Dillon is establishing a showroom at 317 West Huron Street where the Starrett line will be displayed to dealers.



MODEL T-10
27" high—20"x26" top

Presenting . . . The SWIVEL TOP TELEVISION TABLE

Sateen Full Swivel action puts an end to juggling of table and set or shifting furniture for best view of screen. Wherever placed, Sateen Swivel Top faces viewers. Beautifully designed Queen Anne table in Walnut or Mahogany matches appointments of any room. Ideal unit for set manufacturers to offer TV trade.

Distributors and Dealers — write for booklet on this and other model tables.

SATEEN PRODUCTS CO., INC.

264-6 47th Street, Brooklyn 20, N. Y.
Tel. GEdney 9-8402



J. A. O'CONNOR

• J. A. O'Connor has been appointed Boston representative for **Starrett Television Corporation** with offices at 130 Lincoln Street, Allston.



WILBUR C. PATTERSON

• Wilbur C. Patterson has been named supervisor of refrigeration advertising for the **Westinghouse Electric Appliance Division**, Mansfield, Ohio. Mr. Patterson has been a newspaper man for 21 years and will have a hand in preparing all advertising for the firm's line of household refrigerators.

Classroom Radios

"Classroom Radio Receivers." published by the Radio Manufacturers Association, and prepared jointly by the Office of Education and the RMA Joint Committee on Specifications for School Audio Equipment, has been made available as a guide for teachers and administrators. Designed to improve the use of radio in public and private schools throughout the United States, the booklet deals with the purchase and utilization of radios for classrooms.

Four aspects of buying and using radio receivers in the classroom are covered by the booklet: utilization, teaching with radio, considerations for purchase, and technical considerations.

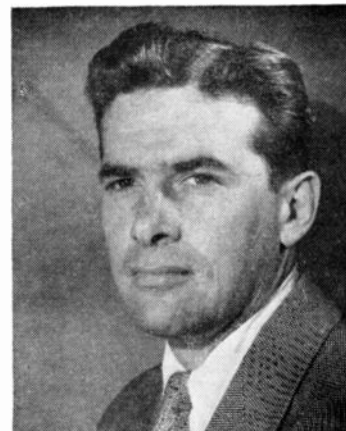

EDWARD FISHBEIN

• Edward Fishbein has been appointed manager of the **Emerson Television Service Corporation**, New York City. He was formerly cooperative advertising manager and assistant sales promotion manager of the firm.

• **Tele-tone Radio Corporation** has appointed the Williams and Shelton Company, Charlotte, N. C., as distributors for the North and South Carolina sales territories. Organized in 1898, the newly-appointed distributors are among the oldest in the wholesale distribution field in the area.

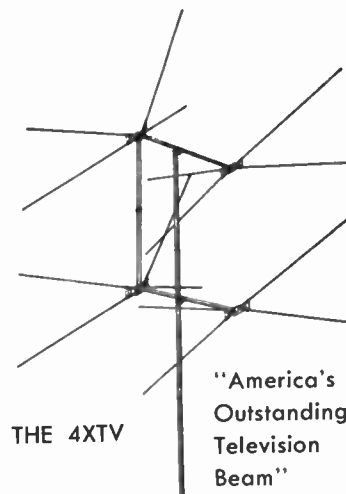

Conical "V" beam. Unidirectional pattern 2-to-13 — 14 DB F to B ratio all channels — Total weight 6 3/4 lbs.

AT YOUR JOBBER OR WRITE US

November • 1948



NOVEMBER • 1948 • VOL. 65 No. 11

Who's Killing Cock Robin?

SEVERAL weeks ago, J. Herbert Stickle, advertising manager of the Westinghouse Electric Corporation's Home Radio Division addressed the Fall Business Meeting of the Associated Chain Drug Stores in New York. Ordinarily, a talk by a radio executive to another business group that is outside the immediate scope of this industry would not be news. But Mr. Stickle, who is earning a reputation for clear-sighted thinking and pungent manner of expressing himself, took another crack at radio merchants, and deservedly so.

You may recall that early this year, Mr. Stickle hit out at those sceptics who were then ready to write off the entire radio receiver business because of the advent of television. Now, he still feels that radio dealers are killing radio before the public actually wants it killed. "So long as the radio merchants feel that television is supplanting radio, the industry will need new outlets such as 'chain drug stores,' blasted Mr. Stickle, adding, "I pick the druggist for several reasons: he has proved himself a versatile merchandiser; he depends more than any other merchant on radio advertising to help build traffic and volume."

How many other radio manufacturers will decide to select other types of retail outlets for their products is a moot question, but this much is certain, many of them are thinking in that direction and the competitive trend doesn't bode any good for the established radio dealer.

Of course, the rapid advent of television at the beginning of this year and its continued accelerated boom is responsible for the situation, but no one can blame television for the muddled kind of thinking now rife among so many radio merchants. There is no reason why the introduction of a wonderful new product such as television should have frightened dealers into abandoning radio entirely. We say this despite the fact that many retailers have told us that the public is not interested in radio any more, particularly in television areas.

But is it true that the public has dropped radio like a hot potato? We doubt it. Just look at the income statistics for the entire country and see how many people earn less than \$2500 a year. These folks (and there are a lot of them) are still prospects for radio, and will be for a long time to come. We maintain that it's the dealer's fault if he insists on spoiling a radio sale by stressing television. Television is powerful enough to sell itself, and is finding its own market. But radio still has its place, and it's not the graveyard, as too many people are prone to think.

ADMIRAL CORPORATION	11
<i>Agency: Cruttenden & Eger</i>	
AEROLUX LIGHT CORPORATION	40
<i>Agency: Direct</i>	
AUTOMATIC RADIO MFG. CO.	35
<i>Agency: Allied Advertising</i>	
BENDIX CORPORATION	22, 23
<i>Agency: MacManus, John & Adams</i>	
CORTLEY TELEVISION CORP.	37
<i>Agency: Chelsea Adv.</i>	
CROSLY DIV. AVCO MFG. CORP.	31
<i>Agency: Roy S. Durstine, Inc.</i>	
DE WALD RADIO MFG. CORP.	38
<i>Agency: Morton M. Magidson</i>	
ELECTRO-STEEL PRODUCTS, INC.	33
<i>Agency: David Cooperson</i>	
EMERSON RADIO & PHONOGRAPH CORP.	9
<i>Agency: Grady & Wagner Co.</i>	
FARNSWORTH TELEV. & RADIO CORP.	20
<i>Agency: Warwick & Legler, Inc.</i>	
GENERAL ELECTRIC COMPANY	7
<i>Agency: Maxon, Inc.</i>	
GENERAL INDUSTRIES COMPANY	36
<i>Agency: Meldrum & Fewsmith, Inc.</i>	
HOME RECORDING PROD. CORP.	40
<i>Agency: Direct</i>	
HUNTON PLASTICS CO.	32
<i>Agency: Direct</i>	
INDUSTRIAL TELEVISION, INC.	25
<i>Agency: Chester Parish Assoc.</i>	
LYTE PARTS COMPANY	Third Cover
<i>Agency: Conti Advertising</i>	
MAJOR TELEVISION CORP.	24
<i>Agency: H. W. Hauptman Co.</i>	
OAK RIDGE ANTENNAS	24
<i>Agency: Knapp-Shepard, Inc.</i>	
OLYMPIC RADIO & TELEVISION, INC.	5
<i>Agency: Butler Advertising</i>	
PHILCO CORPORATION	3
<i>Agency: Hutchins Advertising Co.</i>	
PORCELAIN PRODUCTS, INC.	26
<i>Agency: Beeson-Faller-Reichert, Inc.</i>	
PUBLIC OPERATING CORP.	36
<i>Agency: Sternfield-Godley, Inc.</i>	
HOWARD W. SAMS COMPANY, INC.	39
<i>Agency: George Brodsky</i>	
SATEEN PRODUCTS COMPANY	41
<i>Agency: Consuelo Evans</i>	
SCOTT RADIO LABORATORIES	29
<i>Agency: Leo Burnett Company, Inc.</i>	
SONIC INDUSTRIES	30
<i>Agency: Direct</i>	
STEELMAN RADIO CORPORATION	26
<i>Agency: Ray-Hirsch Co., Inc.</i>	
STROMBERG-CARLSON CO.	Second Cover
<i>Agency: Federal Advertising</i>	
TAYBERN EQUIPMENT CO.	26
<i>Agency: Robert Holley & Co., Inc.</i>	
TELREX, INC.	41
<i>Agency: Direct</i>	
TRANSVISION, INC.	34
<i>Agency: H. J. Gold Co.</i>	
VERI-BEST TELEVISION CO.	27
<i>Agency: Metropolitan Adv. Co.</i>	
VISION RESEARCH LABS.	37
<i>Agency: Jaman Adv., Inc.</i>	
V-M CORPORATION	29
<i>Agency: Art Fernwalt Adv.</i>	
WESTINGHOUSE ELEC. CORP.	Fourth Cover
<i>Agency: Fuller, Smith & Ross, Inc.</i>	

Tops Them All!

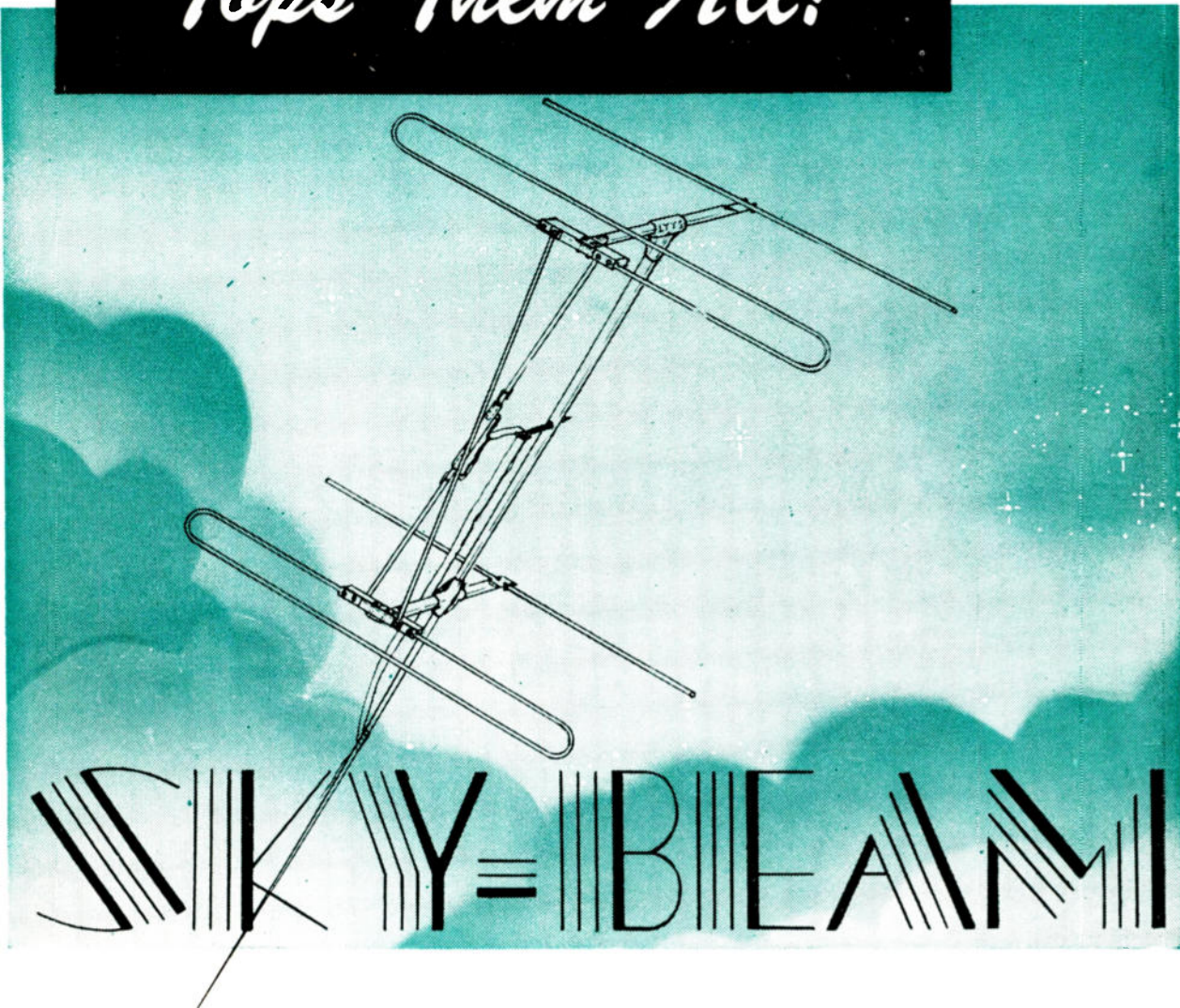

THE ONLY HIGH FREQUENCY ANTENNA

Announcing SKYBEAM, the only successful high frequency antenna in the field. This amazing antenna includes all the proven fine features of Lyte products, precision, rigidity, proven scientific construction

SKYBEAM is guaranteed to produce the ultimate in television reception, the only high fidelity, high frequency antenna covering channels 7 to 13.

Aluminum tubing used throughout. Insulated with plastic, partly assembled, complete, extremely light weight (3 1/2 lbs.). Factory adjusted for maximum efficiency. Packed in individual cartons.

FOR PERFECT TELEVISION RECEPTION on all high frequency channels the Lyte SKYBEAM IS an absolute necessity.

DEALERS—Even the finest Television Set is only as good as its Antenna. Install the new LYTE for 100% Brighter, 100% Sharper, clearer images with minimum interference. Satisfied customers mean more PROFITS for YOU! Specify LYTE—the best by every test.

CHECK THESE FEATURES:

- Easily attached to existing installations.
- Only perfected high frequency antenna.
- Scientifically manufactured and tested.
- Guaranteed to produce outstanding results.
- Easy to install

LYTE PARTS CO.

15 WASHINGTON AVE., PLAINFIELD, N. J.

199 MAIN ST., DUBUQUE, IOWA

PLAINFIELD 5-2100

DUBUQUE 8884

Buyers agree ON THE 203

The new Westinghouse 203 is a triple-threat set with the finest of all three sales-winning features:

1. Improved AM reception gives super-sensitive, noise-free reproduction of the full tonal range.
2. Genuine Westinghouse Rainbow Tone FM . . . the quietest, most sensitive FM ever developed.
3. Superb automatic record changer plays 10 twelve-inch, or 12 ten-inch records with smooth, silent operation and quick 4-second changing speed.

. . . all this performance packed into an excitingly styled cabinet of rare beauty . . . and priced to convert shoppers into buyers.

NOTE TO DEALERS:

This is one of the many new feature-packed Westinghouse radios that build sales and profits for Westinghouse dealers. If you don't handle Westinghouse radios, get on the bandwagon now!

HOME RADIO DIVISION
WESTINGHOUSE ELECTRIC CORP.
SUNBURY, PA

MODEL 203

AM, FM radio-phonograph
in a striking modern cabinet
of blonde frosted oak or
dark mahogany.



You can be sure . . . if it's

Westinghouse

RADIO TELEVISION