

Combining  
**ELECTRIC  
APPLIANCE  
JOURNAL**

# **RADIO** & *Television* **JOURNAL.**

**AUGUST, 1946**

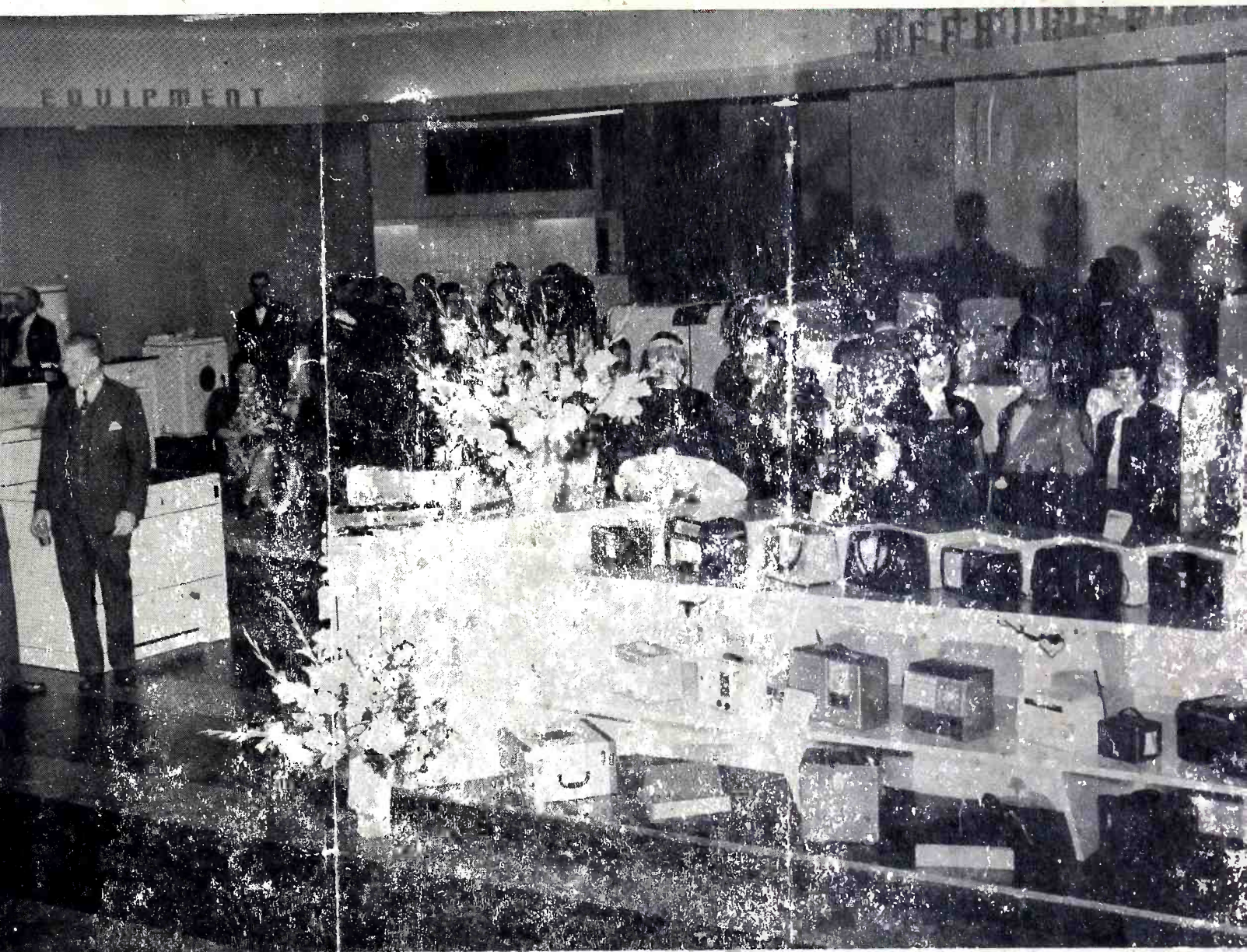

Wilf Bros. Store, Germantown, Pa.

## **IN THIS ISSUE**

• PREFABRICATED HOMES—THREAT OR PROMISE?  
• IS FAIR TRADE THE ANSWER?  
• PROFIT MAKING SALES METHODS

• PRACTICAL TIPS ON SERVICING  
• LATEST RADIOS AND APPLIANCES  
• NEWS OF THE INDUSTRY

**The Industry's Most Important Announcement Since Pre-war**

See Page 19



# Here's How Radio Industry Says "OK"

## TO FEDERAL'S NEW MINIATURE SELENIUM RECTIFIER

TYPE-403D2625

**HALF MILLION ALREADY ON ORDER!**

**Now** being used in radio receivers, voltage multipliers, speech amplifiers, PA systems, electronic organs, business machines — wherever a low-voltage low-current d-c source is required — replacing type 117Z6-117Z3 and other rectifier tubes.

The "landslide" of orders which followed the announcement of this new rectifier means just one thing — another outstanding contribution which fills a great need in the electronic industry. Now, in hundreds of applications, this 5-plate rectifier stack is proving its value — in money saved, reduced assembly time, new space savings, longer life, instant starting. It measures only  $1\frac{1}{4} \times 1\frac{1}{2} \times \frac{3}{8}$  inches, and will go into restricted spaces where a tube and socket won't fit.

Though miniature in size, this rectifier embodies "full-scale" quality throughout, with **Center-Contact** construction and all of the other features which have made Federal Selenium Rectifiers the standard of quality in the industry. They're available now — in quantity. Write to department 6000 for prices and data.

**CHARACTERISTICS:**  
Type 403D2625 Rectifier

Maximum RMS Voltage.....	130 volts
Maximum Inverse Voltage.....	380 volts
Maximum Peak Current.....	1200 ma.
Maximum RMS Current.....	325 ma.
Maximum DC Output.....	100 ma.
Approximate Rectifier Drop.....	5 volts

# Federal Telephone and Radio Corporation

In Canada:—Federal Electric Manufacturing Company, Ltd., Montreal  
Export Distributors:—International Standard Electric Corporation



Newark 1,  
New Jersey

# ANOTHER DUAL-TEMP\* EXCLUSIVE

\* Trade Mark registered

Dual-Temp is really two refrigerators housed in one beautiful cabinet . . . each completely insulated from the other . . . each with its own cooling system . . . each with its individual cold control. Temperature in either compartment can be varied independently. For example, freezing locker can be set at 15° below zero, while temperature throughout the moist cold compartment remains at an average of 38°. No other refrigerator can do that!

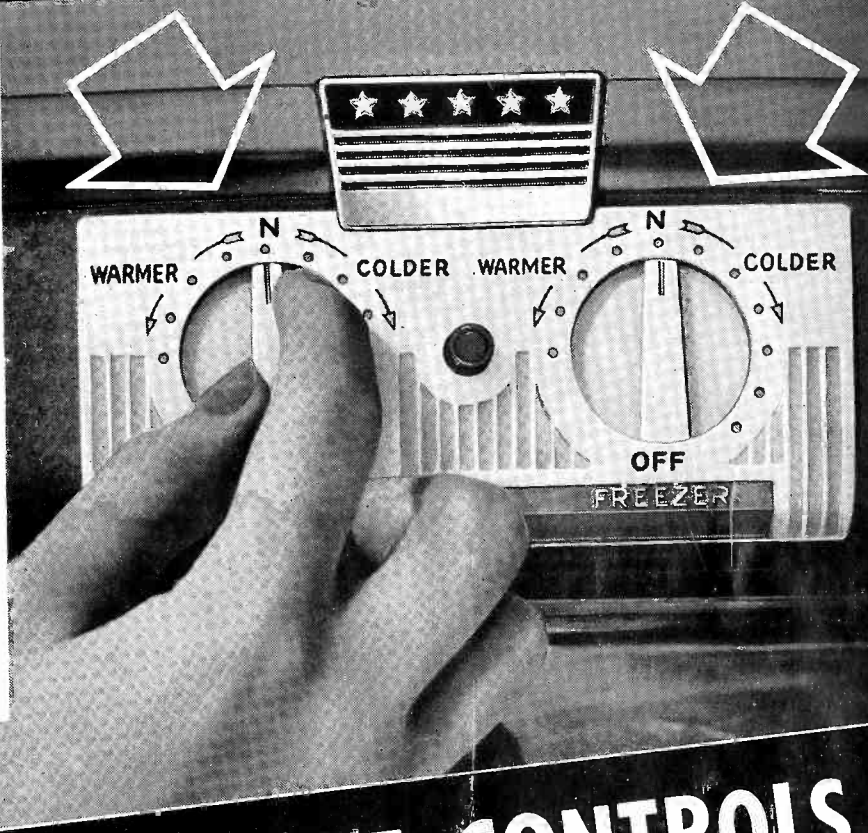

## TWO TEMPERATURE CONTROLS

### MORE DUAL-TEMP EXCLUSIVES

**1. Two Refrigerators in One—**Above, a built-in freezing locker; below, a huge purified moist-cold compartment . . . as independent in their operation as though they were two separate refrigerators.

**2. Built-In Freezing Locker—**Quick-freezes foods at temperatures as low as 15° below zero . . . the sub-zero temperature required for efficient fast freezing.

**3. No Defrosting—**Dual-Temp's huge, purified moist-cold compartment *never* has to be defrosted.

Completely insulated from the freezing locker, temperature never goes below freezing. No freezing means nothing to defrost.

**4. No Covered Dishes—**With 85% relative humidity throughout, foods can be placed *anywhere* in the moist-cold compartment and kept fresh for weeks without covering.

**5. Sterilamp Protection—**acts like sunshine to retard mold growth, reduce spoilage due to bacteria, and combat offensive odors. Only Dual-Temp has this important feature.

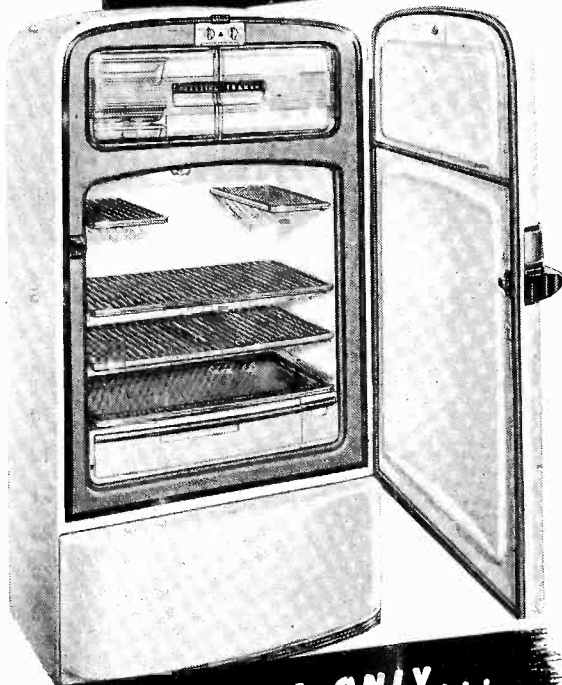

REMEMBER! ONLY . . .

# Admiral

CAN BUILD A DUAL-TEMP REFRIGERATOR



# RADIO TELEVISION JOURNAL

AUGUST

## Contents

### MAL PARKS

Editor

NATHANIEL J. KERN.....Associate Editor  
**LZ ZAM**.....Technical Editor  
**B. F. HOLLEY**.....Washington Editor  
**JIMMY KENT**.....Merchandising Editor  
**FRED MERISH**.....Management Editor  
**CORDON CHAMBERS**.....West Coast Editor  
**E. H. COOKE**.....Canadian Editor  
**BETTY BOBIN**.....Circulation Manager

### ALEX H. KOLBE

Publisher

IRVING N. COOPER  
 Eastern Advertising Manager  
 1270 SIXTH AVENUE  
 New York 20, N. Y.  
 Circle 7-5842

BRANCH OFFICES:  
 412 WEST 6th STREET  
 Los Angeles 14, Calif.  
 Vandyke 8815  
 FREDERICK STERN, Manager

30 N. LA SALLE STREET  
 Chicago, Ill.  
 GORDON B. EWING, Manager

EUROPEAN OFFICE:  
 6 RUE DE PASCAL  
 Brussels, Belgium  
 JULIAN BLOCK, Manager

### FEATURES

- PREFABRICATED HOUSES—THREAT OR PROMISE?** ..... 14  
 Builders of prefabricated homes are planning to merchandise their products as package units already equipped with many electrical appliances. Read what producers of these houses are doing and how their plans may affect radio-appliance dealers.
- SERVICE INSURES SALES** ..... 21  
 The Campbell Radio Co., Shreveport, La., is using its maintenance department to push sales of radios. Firm is concentrating on merchandising high priced receivers in its attractively remodeled store.
- IS FAIR TRADE THE ANSWER?** ..... 24  
 Pre-war merchandising evils are once again apparent in selling radios and electrical appliances. A well known authority in this field tells why Fair Trade protects manufacturer, distributor, and retailer from unethical fringe operators.
- AIMS AT HIGH PROFITS** ..... 28  
 Santen's Home Appliance Shop has its selling organization geared for steady sales at a profit. One of the firm's sales features is the holding of appliance demonstrations for women's clubs, homemaker groups, etc.
- WINDOWS SPOTLIGHT SALES** ..... 34  
 Location in high-traffic area pays off for dealer. Stresses interior and exterior displays to build sales volume. "Make displays simple, colorful, and light them well," states this retailer.
- SELLS MORE APPLIANCES** ..... 43  
 Separate departments for each line boosts profits. Smart planning helps avoid pre-war merchandising drawbacks. Crews of inside and outside salesmen will be employed to sell more goods. Cooking schools will draw prospects to the store.

### MASTER SERVICING SECTION

- ALIGNMENT AND DIAGRAM OF BELMONT MODEL 5D128** ..... 38  
 Electrical specifications, alignment procedure, and schematic drawing of this receiver are included on this page.
- THE MASTER SERVICEMEN'S QUESTION BOX** ..... 40  
 Here are questions and answers to some of the every-day problems which confront the radio technician. Practical tips are given on servicing receivers, phonographs, auto radios.

### DEPARTMENTS

- 25 YEARS AGO IN THE JOURNAL ..... 5
- EDITORIALLY SPEAKING ..... 6
- DEALER DOINGS ..... 8
- OUR READERS WRITE ..... 10
- TRENDS ..... 12
- NEW MERCHANDISE FOR MORE SALES ..... 31
- NEWS OF THE INDUSTRY ..... 45
- ADVERTISERS' INDEX ..... 49
- JOURNAL'S END ..... 50

Volume

61

RADIO Television JOURNAL combines Master Servicing; and is published monthly for Radio-Television Dealers, Servicemen and Jobbers by Kolpar Publications, Inc., Radio City, 1270 Sixth Ave., New York (20), N. Y. Phone Circle 7-5842, Alex Kolbe, Pres. and Treas.; Mal Parks, Vice-Pres. and Gen. Mgr. Price 25c per copy. Printed in USA.

Number

2



**25 YEARS AGO**  
IN THE  
**JOURNAL**

It was pointed out in the first feature article 25 years ago that phonograph dealers could look forward to a profitable Fall season. The

reasons advanced for this hold true even today. The article explained that the phonograph and record give much entertainment value at small cost. Even in hard times, it continues, people manage to afford some entertainment and relaxation. The writer believes that one reason why business had been slow was due to a lack of appreciation of the necessity for real selling effort on the part of the dealer. Other reasons advanced for a lack of sales volume at this time were political indecision in Washington, unsettled international relations, and the shortage of homes. Who says history doesn't repeat itself?

\* \* \*

A new record merchandising idea was a Victrola record designed as a clock's face. Produced by the Reincke-Ellis Co., for Victory dealers, the face and dial of this clock were made as an exact reproduction of a Red Seal record. This "record that tells time" was hung in store windows, in the interior, or both, as a reminder to passers-by of the products handled by the merchant. The thought behind this advertising idea was that everybody looks at a clock.

\* \* \*

What constitutes clean business practice? Dr. Frank Crane answered this question by saying, among other things, that "A clean profit is one that has also made a profit for the other fellow." He stated, too, that "Any business whose prosperity depends upon damage to any other business is a menace to the general welfare." Sounds like good common sense.

\* \* \*

A star salesman in a Chicago store was enterprising enough to have his own business cards printed in an unusual way that encouraged customers to see or phone him when needing merchandise. The cards were similar to ordinary business cards as far as the salesman's name, address, and business connections were concerned. But instead of being a single piece, each card was "double," resembling in make-up a return postcard. On the "return" part of the card was written "For your convenience, save this card, jot down list of goods needed, and phone or drop in for prompt attention to your order."

**THE WORLD'S SMALLEST PORTABLE PHONOGRAPH**



MADE BY  
**THORENS**  
OF SWITZERLAND

THORENS #55  
Retail Price \$22  
Fed'l Excise Tax Incl.

Made by Thorens of Switzerland, makers of the finest musical instruments and sound-recording equipment used throughout the world. Plays all your favorite 10 in. and 12 in. records with a fine, melodious tone quality. You carry it like a camera—weighs about 4 lbs. Size 11"x4 3/4"x2". This phonograph is so new that we have been unable to provide enough to supply the demand—it is extremely popular—"the life of the party" wherever it goes. Retail Price \$22. incl. Fed'l Excise Tax. Assorted colors.



295-5th AVE., NEW YORK 16, N. Y.



*They Stay in adjustment*  
... because of  
**TWO TIER BONDED CONSTRUCTION**

**WEBSTER**

*Automatic Record Changers*

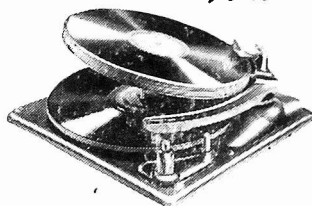

MODEL  
56

*Other important features*

Two-Tier Bonded Construction, exclusive with Webster Record Changers, places the entire changer mechanism between two formed steel plates, where it is held rigidly in place by five bonded steel posts. This construction keeps the moving parts of the mechanism in proper relationship at all times, eliminating service troubles which stem from warpage. Webster's Two-Tier design assures dependable operation and flawless enjoyment of records.

- Velocity trip — changes more kinds of standard records than the usual "fixed radius" or "oscillating groove" type of trip action
- Fool-proof operation — pickup arm can be moved without damage while machine is in change cycle
- Protects finest records, yet will change many old, badly worn records.

THE CHOICE OF MUSIC LOVERS EVERYWHERE

**WEBSTER**  **CHICAGO**

5610 Bloomingdale Avenue, CHICAGO 39, ILLINOIS  
32 years of Continuous Successful Manufacturing



## *Editorially Speaking*

**I**T SEEMS to me that our industry is suffering from a common characteristic of the American people as a whole. This is the tendency to swing from extremes of optimism to deepest despair in a very short period of time.

I am referring, of course, to the current wave of defeatism which seems to be sweeping the industry, because, in a few instances, it has become necessary to *sell* radios and appliances to the consumer.

Now, you and I have discussed the imminent buyers' market for many months and we have always known that this buyers' market would eventually appear. Time after time, we have said that the customers will not break down the dealers' doors to secure radios and appliances for very long. But, just because the buyers' market seems to be here at last is no cause for despair or defeatism.

Nor can I go along with some industry spokesmen who say that dealers must "fight for business" as though this were some newly-discovered and exceptional competitive condition which radio and appliance dealers have never before encountered. All of us, in facing the competitive era which is here now, should not lose sight of the fact that this industry lived through the greatest depression the world has ever known. It has managed to survive and make money during an unparalleled wartime period when the flow of goods was shut off by government edict. Any industry that has the background of merchandising ability, ingenuity, imagination and inventiveness such as has been displayed by radio and appliance dealers over the past fifteen years, need have no fear for the future.

Speaking for myself personally, I think that radio and appliance dealers should welcome the advent of the buyers' market which many people believe we are entering now. It means that competition will clarify itself. It means that we will have to get out and hustle to sell merchandise. This means, in turn, that our merchandising ingenuity will be sharpened and we will have the personal satisfaction of doing the job which we are fitted to do. In talks with hundreds of radio and appliance dealers from coast to coast during the past four years, I have found that a common complaint was the fact that they, as trained and aggressive merchandisers, had nothing to sell. And when you have a salesman with nothing to sell and no competitive challenge to meet, then you have a very unhappy man, indeed!

So, it isn't necessary to look on this buyers' market as something which must be battled bitterly. All we have to do is face the fact that we are now in the kind of a business we have always been in. We know that the old fundamentals of selling and merchandising which we have used in the past will work again. We know that there is a tremendous amount of buying power among the general people, and whether or not each radio and appliance dealer gets his share of this buying power will depend on the job of selling and merchandising which he does.

So, let's make up our minds that we are in this business to stay. Let's realize that there is nothing new or mysterious about competition. Let's decide now that we can sell all the radios and appliances that manufacturers can produce during the next few years. And let's decide, right now, that we are really only entering our element when we get in the thick of a good, hard, competitive situation.

There is money to be made in the radio and appliance fields today. And, I am confident that the radio and appliance dealers who have been in this business during the past fifteen troubled years will have no difficulty in profiting from this buyers' market which too many people are making too much ado about.

*Mal Parks*



# Listen for something that isn't there

● Ask prospects to *listen*—for needle noise, hiss, scratch or rattle—for annoying sounds they hear in ordinary radiophonographs . . . sounds that are conspicuously absent in a Zenith. Then, turn the volume all the way *down*. Even *then* there is no mechanical chatter. That's because Zenith's "Sensational New Way To Play Records," with the COBRA Tone Arm, is an *entirely new method* of record reproduction. The Cobra's delicate filament floats gently on the record with less than  $\frac{1}{8}$  ounce pressure, picking up every modulation and beaming it into the amplifier on a Radionic Wave. Yes, listen to a Zenith, and make this "listening test" part of every demonstration, for only with a Zenith can you *listen for something that isn't there*.

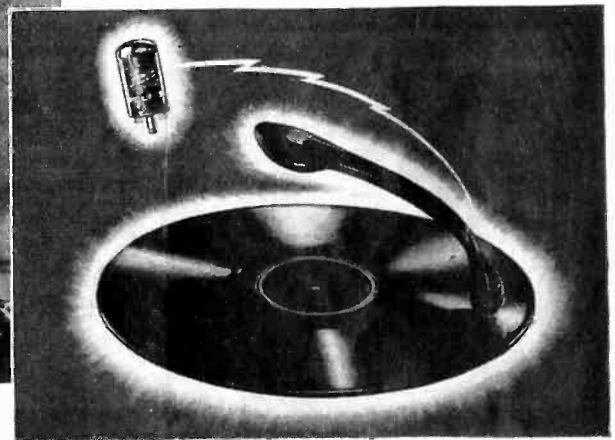
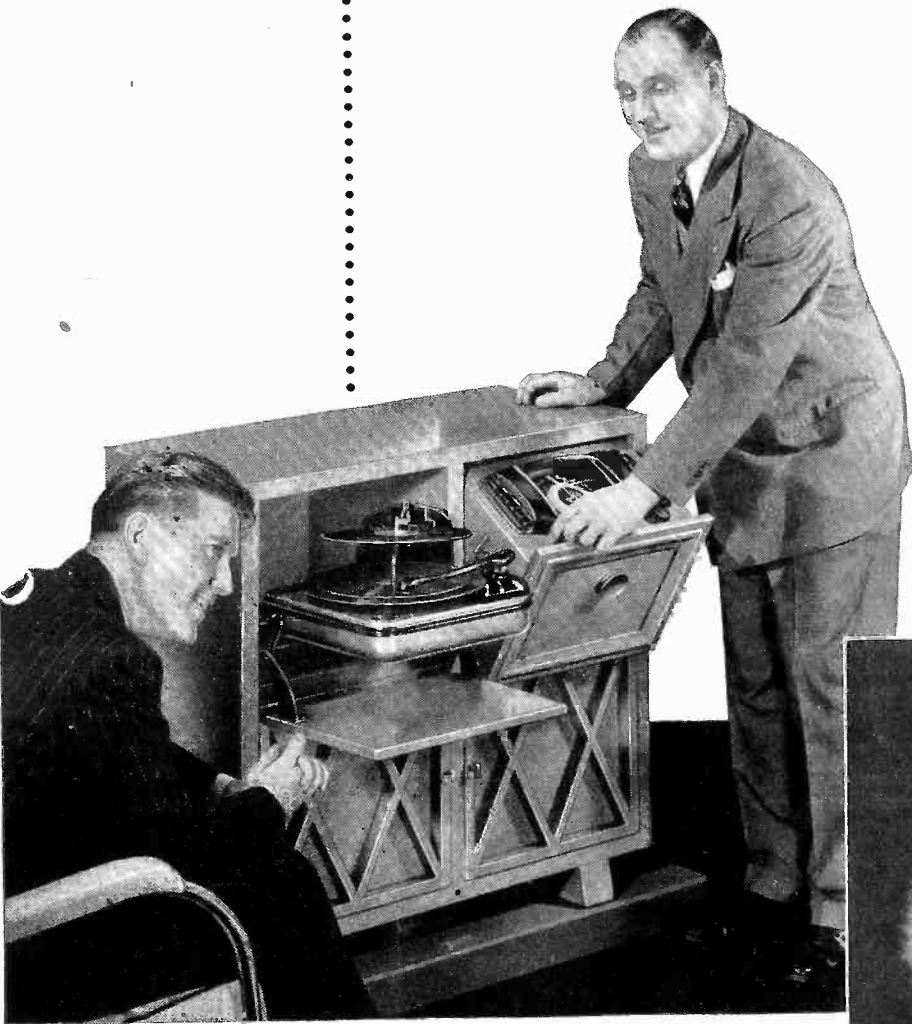

ONLY **ZENITH** HAS THE **COBRA** TONE ARM

The Cobra brings out every note of every instrument . . . the sparkling highs . . . the mellow bass notes . . . the rich overtones—just as the artist himself would like to hear them. And, complementing this new method of reproducing records radionically, Zenith's Silent-Speed Record Changer operates so quickly, so quietly, that there is virtually an unbroken flow of music. Once your prospects *listen* and hear the difference, only Zenith will satisfy them.

**The Sensational  
NEW WAY  
to Play Records!**

**ZENITH**

**BACKED BY 30 YEARS OF RADIONICS EXCLUSIVELY**



# DEALER



● It's good to have these metal-can electrolytics available once again. In fact, the Aerovox postwar line contains the greatest choice of electrolytics yet offered. There are many different types of metal-can electrolytics now available. Because of generous sections and metal cans, these electrolytics really "can take it"—hour after hour, day in and day out, month after month—in equipment that must stand the gaff.

## ● Ask Our Jobber . . .

Ask for the latest Aerovox catalog containing that outstanding choice of electrolytics, as well as other types of capacitors. Or write us direct.



**FOR RADIO-ELECTRONIC AND INDUSTRIAL APPLICATIONS**

**AEROVOX CORP., NEW BEDFORD, MASS., U.S.A.**  
 Export: 13 E. 40th St., New York 16, N.Y. • Cable: 'ARLAB'  
 In Canada: AEROVOX CANADA LTD., Hamilton, Ont.

**Hagerstown, Md.**—Here's a new slant on outside selling of radios and appliances. Norman Holzapfel and Joseph Firey, who own the store bearing their names on East Washington St., are planning mobile trailer units from which they will sell sets and appliances. Each unit will be manned by one or two salesmen who will display goods from the trailer in neighboring communities. Demonstrations and sales will be made directly from the trailer. Advance newspaper advertising will pave the way for each mobile unit in communities visited.

\* \* \*

**Hutchinson, Kans.**—James Robinson, proprietor of the Robinson Electric Co., is doing a steady business selling farmers in this area. One way he does this is by "using" his customers. Every satisfied customer who furnishes a "hot" prospect for an appliance receives a small gift if the lead develops into a sale. This method, in addition to dealing on an informal basis with customers, is paying off for this merchant.

\* \* \*

**Spartanburg, N. C.**—A new radio and electrical appliance store has been opened at 116 N. Converse St. The establishment, Graham-Turner Appliance Co., is promoting table model sets and traffic appliances. The firm is located in a new building.

\* \* \*

**Worcester, Mass.**—Color is being used to highlight new goods in the recently remodeled store of the William J. Davidson Corp. Citron yellow is the featured color, and this shade is stressed from the front to the rear of the establishment. Pastel blue and grey are used with the citron yellow for greater effect. Another feature is the illumination of interior displays when the lights in the windows are switched off.

**Washington, D. C.**—"We will use our service department to back up our sales," states Joseph C. Kennedy, proprietor of the Kennedy Radio Service, 2407 14th St., N. W. This retailer has found it



Joseph C. Kennedy, owner, is shown at his modern service bench. This dealer plans to continue operating his maintenance department at a profit by giving expert and speedy service. Sales and repair sections are segregated.

profitable to separate his sales and maintenance sections in his establishment. The first floor of the store is devoted to radio and appliance merchandising, while the second floor has been set aside for repair work.

\* \* \*

**Chicago, Ill.**—Since the adoption of his postal card notice system, M. Roselli, proprietor of the Austin Radio & Sales Shop, 6020 North Ave., has increased his profits from servicing by 33 per cent. Patrons who leave radios for maintenance are told they will receive a card within a week informing them of the completion of the repair work. Thus less time is lost from "front office" business between customers and technicians, and more time is devoted to actual work.

\* \* \*

**San Francisco, Calif.**—In building a high sales volume, William F. Riley, owner of "Riley's," 1465 Haight St., capitalizes on actual demonstrations under the best of conditions. This dealer promotes the idea that his store

# DOINGS

is very eager to give prospective purchasers an opportunity of seeing how each radio or appliance operates, whether or not they are prepared to buy. In such an atmosphere, he believes, patrons feel free to discuss their needs. Attractive displays and eye-appealing surroundings are good aids to sales, Riley finds.

\* \* \*

**Salt Lake City, Utah—Lewis A. Dahl** has opened a new store in Midvale on the corner of Main St. Lines handled by this retailer include radios and electrical appliances, heating equipment and kitchen merchandise.

\* \* \*

**Arlington Heights, Ill.—To** get a greater share of profits from sales of receivers and electrical goods, the interior of the Electronic Service Shop, 22 E. Northwest Highway, has been remodeled. Donald Hager, owner, has renovated the store, using knotty white pine wall paneling. Hager feels that the remodeling should help to sell more radios and appliances.

**Springfield, Mo.—Guy M. Hinchsliff and L. M. Shockley** have opened a new store at 520 West Walnut St. The co-owners have planned a complete home appliance department featuring a full line of receivers, traffic and major electrical appliances.

\* \* \*

**San Bernardino, Calif.—The Cullen Radio Shop** is currently carrying on a newspaper advertising campaign that is bringing numerous new customers to the store. Using as its starting point the slogan, "The quality of a man's work is no better than the tools he uses," the firm is building a profitable service business. Each newspaper ad is illustrated with a picture of an instrument used in radio maintenance, and the purpose of the service is explained in the advertising copy.

\* \* \*

**Dallas, Texas.—Clarence M. Cockrell, Jr., John C. Winniford, and Mary Winniford,** have incorporated the Cockrell Electric Co. to do business here as a radio and appliance dealership.

## RCA RETAILERS AND JOBBERS MEET



Plans for merchandising RCA Victor records were consolidated at a recent meeting of RCA dealers and distributors held in New York. Shown here, with a newly-designed dealer display piece are, left to right, M. F. Blakeslee, regional manager; H. J. Allen, field sales manager; J. W. Murray, vice president of RCA's record activities, and Jack Williams, advertising manager.

SMOOTH YOUR  
SELLING ROAD WITH

*Smooth Power*

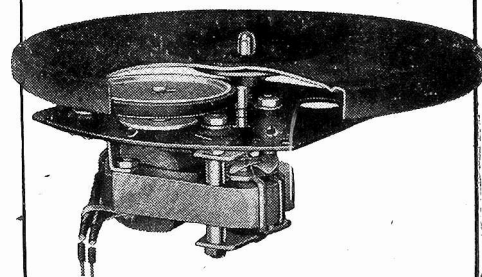

When you equip your new phonographs and record-changers with Smooth Power motors, you're adding a definite asset to your line. That's because every motor in the wide GI line has built into it that quick pick-up, quietness and smooth-as-velvet performance that users demand.

Then too, their modern design and accurate manufacture gives them long, trouble-free life . . . to add reliability to your products.

You can smooth your selling road if you *standardize on Smooth Power motors.*

**THE GENERAL INDUSTRIES co.**

DEPT. MT • ELYRIA • OHIO





Mal Parks:

I've been reading, today, about your fishing trip. I got quite a kick out of it—especially your statements about the length of the working week being wrong. If you can do something about it, I'm with you. Fish five days, and work two! How about entering a bill with Congress? It passed so many crazy bills in its last session, perhaps they won't feel bad in stopping to do some good for mankind just this once.

Very truly yours,

Hy Leve

**Service Hardware & Radio Co.  
479 Cambridge St.  
Allston, Mass.**

\* \* \* Good friend Hy Leve, who is also vice-president of the Massachusetts Radio Technicians' Guild is evidently a devotee of Izaak Walton which is all right, but your Editors sometimes figure Mal Parks' devotion to fishing is just downright laziness because he seems to do most of it lying under a shady tree with his hat pulled down over his eyes. However, your diligent staff took his words at face value and have duly petitioned Congress to act in the matter. Which reminds us, have you used your influence, as a voter, with your local Congressman lately? Do you know who he is? Do you know how you, as a radio and appliance dealer, can help manufacturers and other industry leaders and organizations get relief from oppressive Washington legislation? If not, you'll get the real low-down in the next issue when one of the industry's best-known figures, a man prominent in W.P.B. circles during the war and a 25-year veteran of radio writes his Washington comments, exclusively for your Radio Journal. Be sure to watch for this new feature in the next issue.

Gentlemen:

One of our advertisers, Paul J. Costulas & Co., a radio store, is interested in placing an advertisement with our company and is eager to use the copy contained on page 36 of the

May Radio Parts Trade Show issue. The copy he has in mind is the one with the various pictures of stores with the heading, "Where to Buy it, a Satire by Stanley Clymer."

If we can get your written permission to use this copy for our ad we shall appreciate it very much.

Very truly yours,

**Walter Stone, Display Department  
Myers Newspapers & Affiliated Neighborhood  
Publications  
7519 N. Ashland Ave.  
Chicago 26, Ill.**

\* \* \* We felt you'd like to see the above letter because it emphasizes how so many fellow dealers, just like yourself, put Radio Journal's practical Editorial material to worthwhile, profitable use. Now that the emphasis will once again be placed on selling and merchandising, you can look to Radio Journal to continue the kind of down-to-earth helps through which it has aided so many thousands of readers over the thirty-year period of its existence. We've just been privileged to employ a recognized and outstanding authority on dealer merchandising plans and you'll find an increasing amount of the kind of Editorial material, which Mr. Costulas plans to use in his own advertising, in forthcoming issues. Meanwhile, if you have any merchandising problems covering selling, advertising, display, etc., please let us try to help you. We have assembled a staff of really good experts whose knowledge has been gained right on the firing line of business and their only job is to work with and for you. Send along your problems and we'll do our very best to help you solve them. Remember, we're as close to you as your nearest mailbox.

Editor, Radio & Television Journal:

We liked your editorial by Mal Parks, "It's Stupid to Give Away Profits," which appeared in the June issue. It is timely and right to the point, and we would like to get two hundred copies, with your permission, to use extracts of it to send to our dealers.

Very truly yours,

**Willis W. Silkworth  
Silkworth Distributing Co.  
1659 N. Saginaw St.  
Flint 4, Mich.**

\* \* \* Mr. Silkworth's nice letter typifies the many which we received on the subject of Editor Mal Parks' June Editorial. In fact, the requests for reprints of this Editorial far exceeded anything we have ever experienced. We are certainly mighty happy that progressive and forward-looking distributors such as Mr. Silkworth are as interested in their dealers' business policies as they are in their own. It is only by close cooperation among all groups in the radio and appliance fields that we can hope to solve the problems which will become increasingly acute as time goes on.

# EMERSON RADIO SPEEDS THE MARCH OF TELEVISION

*First Postwar Models Acclaimed by the Press, Trade and Public*

**EMERSON PREVIEW IN TELEVISION GIVEN**

Table Model at \$150, Console at \$250 Shown — 8,000 to 10,000 Sets by Year-End Seen

The first two post-war television receivers to be produced by the Emerson Radio and Phonograph Corporation were shown yesterday at a press preview at the company's offices here. One, a table model with seven-inch screen, will retail at approximately \$150; the other, a "chair-side" console and radio, will sell for approximately \$250.

Benjamin Abrams, president of the company, said production of the two models will get under way next week and will reach fairly substantial proportions by September. He estimated total production between now and the end of this year would range between 8,000 and 10,000 sets. He added at first distribution of receivers will be limited to the New York City area.

Pointing out that the new television receivers incorporate much that was learned during the war, Mr. Abrams remarked that the set priced at around \$250 is a better set than the pre-war model sold for a little less than \$500. He described the chair-side model as affording greater visibility for those sitting or standing, and as representing a distinct improvement over the direct and indirect receivers produced up to this time. The chair-side model, on which will center, is housed in a walnut console, and has thirty-two tubes, including the ten-inch cathode ray television frequencies. A specially designed selector switch lights a small green indicator as each station is tuned. The speaker is of twelve-inch size.

Mr. Abrams said it was a fortunate circumstance that engineering and manufacturing facilities of the radio industry can be used for production of television receivers, for which there "will be an incalculable market for many years to come." He said that with an industry production capacity of 20,000,000 radio receivers per year, and with a normal demand of from 12,000,000 to 15,000,000 sets full utilization of the industry's facilities on regular radios could not help but result in overproduction within a few years. He added evolution of television should be given every opportunity to stem from the use of black and white projection, instead of waiting for the development of color television which may require several years of further research.

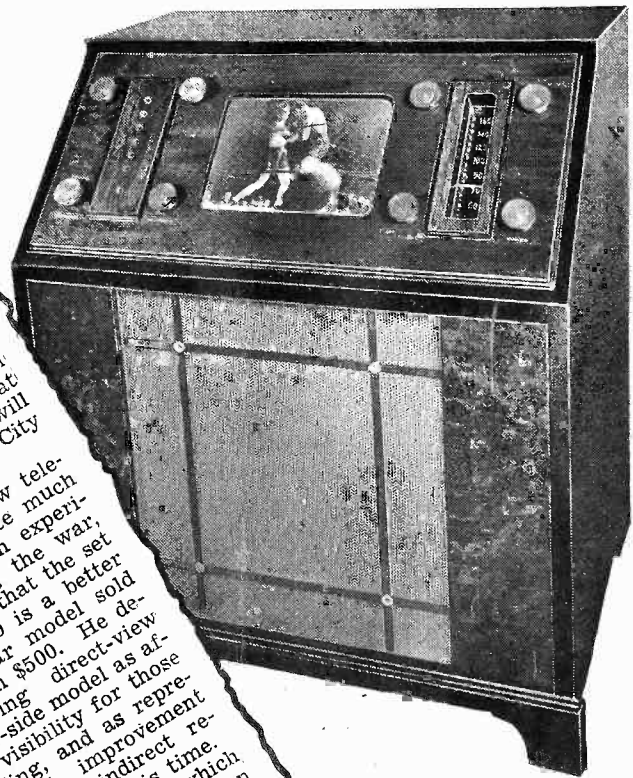

**Now—  
Full Vision!**

*All can see from  
anywhere in the room*



The news item (at right) tells part of the story. The genius of Emerson engineers—the popular prices made possible by modern production methods—and Emerson's progressive efforts to speed the day when television will span all of America, are part of another and greater story that will unfold as time goes on. Keep your eyes on—

# Emerson Radio and Television

EMERSON RADIO & PHONOGRAPH CORP., NEW YORK 11  
*World's Largest Maker of Small Radio*



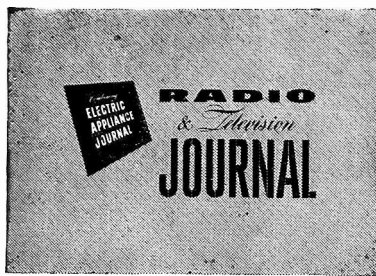

# TRENDS

SIGNIFICANT FACTS OF INTEREST TO THE INDUSTRY

The Federal Communications Commission has licensed on an experimental basis a new "radio-paging" service. The Telephone Answering Service, New York, has received permission from the FCC to erect a high-frequency transmitter in order to establish a radio message service. This would permit the sending of messages to persons sitting in a ball park, theatre, etc. Each subscriber to the service would receive a small portable receiver upon entering a theatre, for example, and listen for his code number by bringing the set to his ear. The receiver, which is about one and a half times the size of a package of cigarettes, would be audible to him only.

\* \* \*

**Rising prices and the growing volume of credit dealings has moved the Federal Reserve Board to tighten its controls on credit. The repayment time on many types of transactions has been shortened, and credit control on goods in the \$1,500 to \$2,000 range has been reimposed. Deadlines for repayment have been cut to one year for all durable merchandise excluding autos, which remain at 15 months.**

\* \* \*

*The supply of wood for radio cabinets continues to be tight. Although production of lumber has been steadily on the increase, shortages of labor, particularly of key men, continue to hamper the industry. More radio set manufacturers are insuring a supply of receiver cabinets by buying up furniture manufacturing companies. The latest firm to do so is the Sonora Radio & Television Corp., Chicago, which has absorbed the Sterling Wood Manufacturing Co., according to Joseph Gerl, president.*

\* \* \*

Here's a brand new selling angle which uses a photoelectric system. Invisible beams of light are flashed across areas where a specialized sales job is to be done. When a customer breaks this light beam, the electric eyes are brought into action and a sales message is automatically delivered. Sounds like a good idea, but it is unlikely that this device will entirely replace the salesman.

\* \* \*

**Several new developments in the radio and appliance fields are reported which may hit the market in the near future. These include**

**a midget radio which weighs ten ounces and can be carried in the pocket or purse; a clothes and dishwasher combination; a toaster-cooker with a variety of uses; a combination heater and fan in which the heater is converted to a fan in less than a half-minute; a refrigerator which uses hot water as the refrigerant; and an electrical coffee percolator which makes coffee strong or weak according to taste.**

\* \* \*

*Production of table model radios has already passed pre-war peaks. Obviously this high rate of manufacture cannot continue unless a market exists for these goods. Methods of production have improved over pre-war techniques, but marketing methods have lagged somewhat behind. To continue high year 'round production, selling methods have to be streamlined and modernized to keep pace with high-speed production.*

\* \* \*

Figures released by the Government indicate that employment has reached that long talked-about figure of 60,000,000. Employment at this level means a continued demand for home necessities such as radios, refrigerators, records, etc. Radio and appliance dealers can look forward to high volume sales for some time to come.

\* \* \*

**Some manufacturers are increasing the prices of sales promotion helps which they supply to radio dealers because of higher costs. However, these producers are continuing to absorb part of the costs of these merchandising aids in order to help the retailer sell more goods.**

A high ranking Army officer has admitted the deliberate smashing of quantities of surplus radio equipment. It is revealed that this costly apparatus was then sold by the Army to a junk dealer. The officer responsible for this waste has stated that "it was an error in judgment." One amateur radio operator has testified that he bought as junk aircraft radio transmitter-receiver sets valued at \$4,000 each for \$6 apiece, and then resold these goods at a tremendous profit. A southern steel company has admitted that it purchased 124 tons of damaged radio equipment for about \$1,300.

BETTER

# FM Reception



## AMPHENOL DIPOLE ANTENNAS

Amphenol Dipole Antennas and Dipole Antennas with Reflectors are engineered to provide excellent reception of FM even in zones of low signal strength.

The directional array virtually eliminates reflected signals, while the swivel feature on the mounting bracket and the mast head of the reflector types allows for tilting of the antenna plane to the optimum angle. An exclusive feature of all Amphenol FM Antennas is the Amphenol Twin-Lead low-loss transmission line from antenna to receiver.

## TWIN-LEAD TRANSMISSION LINE

A recent Amphenol innovation—a perfect parallel-line lead-in wire extruded with polyethylene dielectric. This low-loss transmission line is highly efficient, inexpensive and completely moisture-proof, and remains flexible at temperatures well below zero. Twin-Lead is manufactured in three impedances that cover requirements for all Broadcast, FM and Television reception.

-  300 OHM provides best impedance match for FM and Television.
-  150 OHM is for experimental work and other special applications.
-  75 OHM is best suited to match a 1/2 wave element and should be used where receiver input impedance is 75 ohms.

**AMPHENOL**

**AMERICAN PHENOLIC CORPORATION**  
CHICAGO 50, ILLINOIS  
In Canada • Amphenol Limited • Toronto

COMMUNICATIONS CABLES • AMERICAN TELETYPE • INDUSTRIAL TELETYPE • TELEVISION AND RADIO ANTENNAS • RADIO COMPONENTS • ELASTICS FOR ELECTRONICS



# Pre-

## THREAT OR PROMISE

# ?

By Nathaniel J. Kern  
Associate Editor

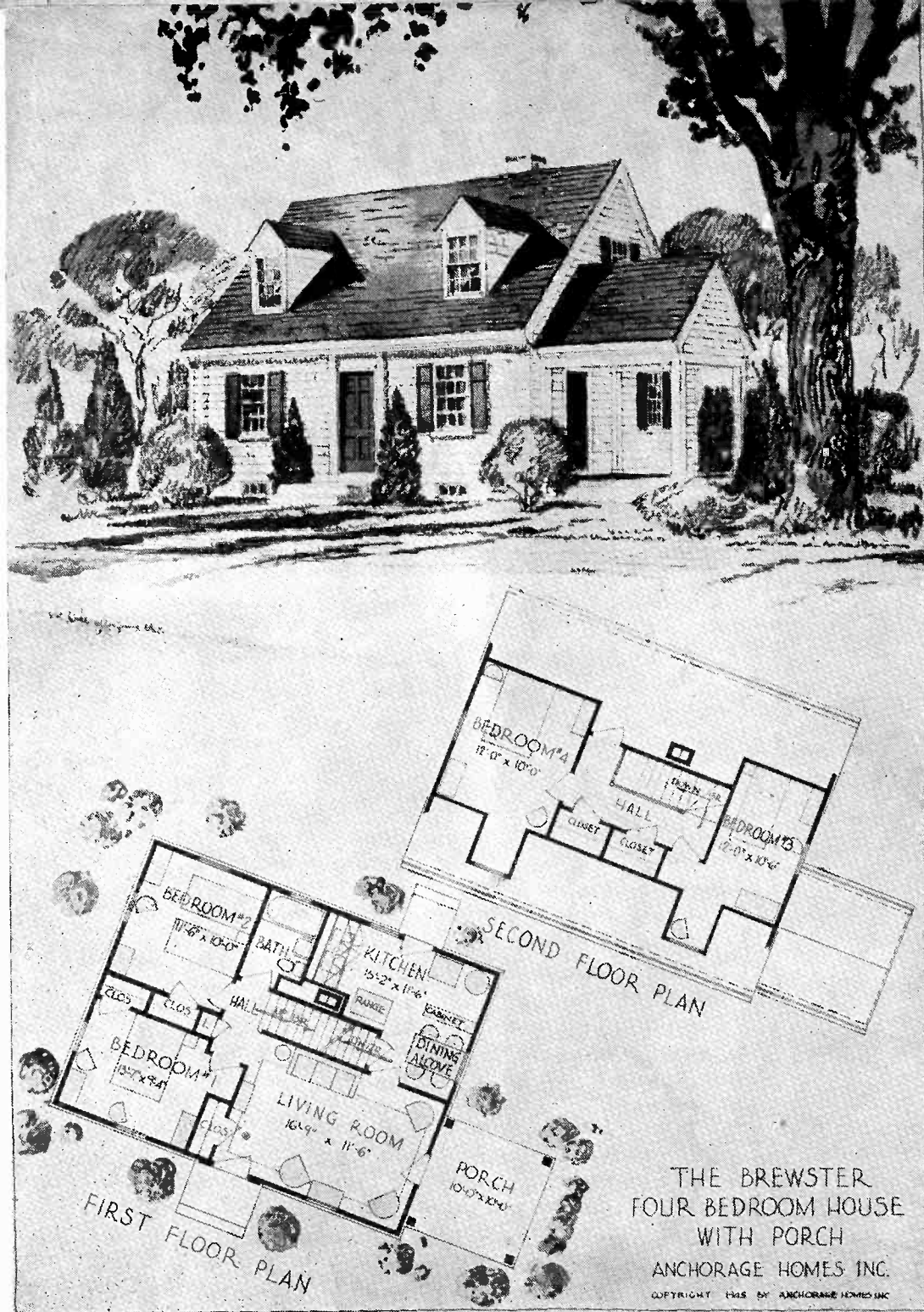

The tremendous mushroom growth of the prefabricated housing industry can mean one of two things for the radio and appliance dealer:

1. High sustained profits for many years to come.
2. A terrific drop in sales volume.

This boom or bust outlook is no idle prediction. It is based on *facts* supplied by leaders in the prefabricated housing business. Builders of prefabricated houses have announced that they will merchandise mass-production homes as a *package unit* complete with refrigerators, washing machines, ironers, kitchen cabinets, ranges, heating units, and, in many cases, radios.

This means that manufacturers or dealers of "houses-in-parts" will buy appliances directly from

producers, thus by-passing the independent radio and appliance retailer.

Early this year, Wilson Wyatt, Federal Housing Expediter, announced that the Government planned to build 850,000 prefabricated homes and 1,600,000 conventional dwellings by the end of 1947. In other words, one out of every three homes built during this period will be a prefabricated home—many sold as complete packages!

However, relatively few mass production homes have been constructed so far because of a critical shortage of building materials. The original goal of 250,000 prefabricated homes sought by the Government for this year has been revised to 100,000 dwellings. At the present time, there are 328

# Prefabricated Houses

manufacturers of prefabricated homes. Most of these producers are feverishly busy franchising dealers who will erect these houses and equip them with appliances.

The prefabricated housing industry cannot be shrugged off as a fad which was borne and nurtured by the war-time shortage of materials and the tremendous pent-up demand for homes. Manufacturers of prefabricated units have spent millions of dollars and years of experimenting since mass production homes first caught the public's interest in 1932.

Pioneers in the prefabricated housing business predict that the homes they are championing will eventually replace the traditional type of home completely. This statement certainly provides much food for thought for the radio and appliance dealer.

Once building materials are available in quantity, parts for prefabricated homes will roll off assembly lines in much the same manner that autos are streaming from production lines today. A complete assembly for a mass-production home can be manufactured in a few minutes, after the industry swings into high-speed operation.

Prefabricated homes will be made from a variety of materials including plywood, steel, aluminum, concrete, and plastics. Prices for these dwellings will range in price from \$3,500 to \$10,000, depending on type and equipment used. Some of these homes are superior to conventional dwellings in many respects.

In making the prefabricated home, the frames of the house shell, wall panels, ceilings and roofs, are placed on jigs which have been laid out according to pattern. The frames are then fastened together and moved by conveyor belt to receive insulation, interior and exterior coverings, etc. Parts are trimmed and finished by machine, packed and shipped to the dealer. Prefabricated house dealers move the assembly to the building site, attach it to the foundation, and it is ready for its occupant. A house can be constructed and furnished within a week, and all the purchaser need do—according to those in the industry—is to move in his furniture and hang up his hat and coat!

One of the chief selling points for suppliers of prefabricated homes is the "package" deal. By furnishing mass-production homes already equipped with major electrical appliances, these manufacturers hope to swell their sales volume. As an added incentive towards buying a "packaged"

home, prefabricators are prepared to offer their customers liberal credit inducements.

The shortage of major electrical appliances has up to now prohibited builders from entering into "package" deals. But after appliances and building materials become plentiful, many prefabricators will concentrate on merchandising "packaged" homes. The seriousness of this situation for the radio-appliance dealer is quite apparent.

The Editors of RADIO & TELEVISION JOURNAL have contacted representatives of the prefabricated home industry to learn how their plans will affect the status of the radio and appliance industry. The following excerpts from letters written to this magazine by a representative cross-section of prefabricated house manufacturers are reproduced here.

H. G. Kramer, Sales Manager, Anchorage Homes, Inc., Westfield, Mass.—"We will include in our 'package' a complete electric system, including wiring, outlets and fixtures. We will also furnish a kitchen range, and a water heater. The buyer will have his choice whether these appliances will be gas or electrically operated. We will hazard the guess that because of the controls possible with mass-produced homes, that radios will, to a certain extent, will move from the field of appliances to that of installed systems which will not only permit radio reception in each room but also intercommunication between rooms."

J. K. Eichelberger, Vice President, Capital Prefabricators, Inc., Austin, Tex.—"The products of this company will be sold throughout the South-

## WHAT PREFABRICATION MEANS to the RADIO and APPLIANCE DEALER

Builders of prefabricated homes are planning to merchandise their products as package units already equipped with many electrical appliances. This move can divert much business from the radio and appliance retailer, to whom these sales should go. Read what producers of these houses are doing which may affect the status of the radio-appliance industry, and what you, the dealer, can do about it.



west by its dealers-erectors, under franchise agreement. It is our hope that we will be able to not only give our customers a complete home, but various electrical appliances. However, up to the present writing, we have found the appliance people wary of prefabrication. We have therefore had to organize a subsidiary company to handle this merchandise."

J. William Schuchardt, Vice President and Director of Sales, General Houses, Inc., Chicago, Ill.—"Inasmuch as our houses are planned to be distributed through outstanding building and material dealers throughout the country, we have set as our aim the marketing of a complete product. By this I mean that ultimately we expect to sell houses with complete furnishings right down to draperies, radios and electrical appliances. The outstanding building and material dealers are today handling many household appliance lines, and this will undoubtedly increase in the future. This is a growing trend since financing is designed to cover not only the house itself but all pertinent appliances."

John T. King, President, New Century Homes, Inc., Clinton, Ind.—"We believe that the ultimate growth of the prefabricated house industry will eventually result in many traffic and heavy appliances being installed in, or furnished with, the prefabricators 'package.' We also believe that this industry will not become a really major force in upsetting normal distribution and trade channels for at least 20 years, as it is still very definitely an 'infant' industry. Our interest in this matter, and our plans, are not fixed. We do envision great savings to home buyers through the prefabricator furnishing as much as possible in the way of equipment. It is possible for the large prefabricator to supply household equipment to the house buyer at a lower cost than presently charged by the household appliance retailer."

Foster Gunnison, President, Gunnison Homes, New Albany, Ind.—"Our homes come complete with heating equipment, and a 52 gallon hot water heater. We also supply as optional features an electric range and refrigerator. All other appliances must be furnished by the owner."

W. B. Larkin, Manager, Butler Mfg. Co., Kansas City, Mo.—"The aluminum panel house which we expect to market will not include any electrical appliances. We expect that our erector-dealer will secure these items along with other items such as plumbing and heating equipment which we expect him to secure locally. Actually, we would much rather furnish all of these parts complete, so that our home as we ship it out from our plant will be complete in every respect."

S. J. Goodland, Vetter Mfg. Co., Stevens Point,

Wisc.—"We believe that in the future our homes will be sold complete with all appliances such as refrigerators, ranges, dishwashers, cold storage cabinets, etc. It is our opinion that these appliances will be designed in a unit particularly adapted for mass production of prefabricated houses."

A. J. Breckenridge, Sales Manager, Green's Ready-Built Homes, Inc., Rockford, Ill.—"We will include with our home, range, refrigerator, garbage disposal unit, automatic washing machine, clothes drying unit, and hot water heater, in addition to regular home utility equipment. Our reason for this is that it makes possible the financing of a home including the above equipment as a single 'package' unit."

This sample of letters clearly indicates the trend taken by the prefabricating industry. It is up to the radio and appliance dealers themselves to see that sales of sets and appliances to owners of prefabricated houses should be made by them. This business belongs to the independent radio-appliance merchant. He is most qualified to merchandise, install, and service this equipment.

Included in this issue is a list of prefabricated home builders. In order to safeguard future business, radio-appliance retailers should write to each of these prefabricators. They should advise the builder that:

1. The radio and appliance business rightfully belongs to them.
2. They are best equipped to sell these goods.
3. It is unfair competition to sell homes as a complete "package."
4. They can cooperate with home builders for their mutual advantage.

The prefabricated house industry can be a threat or a promise to the radio and appliance dealer. It is up to him to decide which it shall be.

## Prefabricated Home Builders

Ask these manufacturers what plans they have regarding the sale of appliances in your area.

Admiral Homes, Inc.,  
149 Water Street,  
West Newton, Penna.

American Box and Lumber Co.,  
103 Park Avenue,  
New York 17, N. Y.

Allegheny Engineering Corp.,  
32 Broad Street,  
Salamanca, N. Y.

American Elevator & Mach. Co.,  
500 E. Main Street,  
Louisville, Ky.

Allen & Baird, Inc.,  
154 W. 1st Street,  
Reno, Nevada

American Engineered Homes,  
275 Fell Street,  
San Francisco, Calif.

Allied Housing Associates,  
Langhorne, Penna.

(Continued on page 18)

# YOU CAN PROFIT

*from War Surplus*

## **ELECTRONIC EQUIPMENT and COMPONENT PARTS**

Maybe you've wondered how YOU could get into the war surplus disposal business...on a profitable basis. Maybe you've been discouraged by red tape, by distant, inaccessible depots, or by the difficulty of choosing and quickly obtaining the kind of goods YOU can sell, in the quantities you can handle.

### Here's YOUR Opportunity

Whether you're a retailer, wholesaler or manufacturer, this Raytheon catalog answers your questions—makes it *easy and convenient* to select, order and get delivery on the merchandise you want. It's just like ordering regular commercial merchandise from a wholesaler or manufacturer.

And make no mistake about this: all the material offered by Raytheon is *salable merchandise*—carefully segregated from scrap-and-salvage items of war surplus. It's all electronic gear made for the Army and Navy by America's finest electronic manufacturers. And it's all in the catalog—described—indexed—priced—easy to find and easy to order.

It's the most complete, most usable, most informative catalog of war surplus electronic equipment yet offered! Send for it at once—that's the first step. Then get in touch with Raytheon for technical advice and merchandising plans for speedy action.

### **RAYTHEON MANUFACTURING COMPANY**

Acting as Agent of the  
War Assets Administrator under Contract No. 51A-3-46  
60 East 42nd St., New York 17, N. Y.

West Coast Office:  
2802 N. Figueroa St., Los Angeles, Cal.



*Excellence in Electronics*



**SEND FOR CATALOG TODAY**

#### **RAYTHEON MANUFACTURING COMPANY** Surplus Property Division

60 East 42nd Street, New York 17, N. Y.

GENTLEMEN: Send your new Catalog of salable and immediately-available war surplus electronic equipment to

Name.....

Company.....

Street Address.....

City..... Zone..... State.....

## Prefabricators

(Continued from page 16)

- American Houses, Inc.,  
570 Lexington Ave.,  
New York, N. Y.
- American Trade Exchange,  
Cross Lake, Minn.
- Anchorage Homes, Inc.,  
Elm Street,  
Westfield, Mass.
- Anderson, C. V.,  
811 Woodrow Street,  
Oildale, Calif.
- Anderson Homes,  
215-221 12th Street, South,  
Virginia, Minn.
- Anderson Trefall & Co.,  
207 W. Washington Ave.,  
Madison, Wisc.
- Arbee Products,  
Latonia & E. Pacific Streets,  
Seattle, Wash.
- Arizona Pre Fab Sales,  
220 E. Van Buren,  
Phoenix, Arizona.
- Arrow Construction Co.,  
2401 Valley Street,  
Dayton 3, Ohio
- Atkinson, W. P. ("Bill" Lumber & Mfg. Co.,  
APCO Tower,  
Oklahoma City 2, Okla.
- Atlanta Lumber Co.,  
3100 4th Avenue,  
Tampa, Florida
- The Attica Lumber Co.,  
East Tiffin Street,  
Attica, Ohio
- The Barden & Robeson Corp.,  
Penn Yan, N. Y.
- Barrett & Hilp,  
918 Harrison St.,  
San Francisco, Calif.
- Bartlett, O. L.,  
46 Brook Road,  
Fairfield, Ohio
- Beam, J. M. & Bro.,  
Route No. 2,  
Vale, N. C.
- Becker, Robert,  
7040 15th Street, N. W.  
Seattle, Wash.
- Bennett Lumber Corp.,  
190 Oliver St.,  
No. Tonawanda, N. Y.
- Bent Steel Co., Inc.,  
43-24 37th Street,  
Long Island City 1, N. Y.
- Black Lumber Co.,  
Martinsville, Ind.
- Boone Industries,  
P. O. Box 5,  
Boone, Iowa
- Brady Construction Co.,  
707 Spokane Street,  
Seattle 4, Wash.
- Bralei Homes, Inc.,  
P. O. Box 109  
5th and Vine Streets,  
No. Little Rock, Ark.
- Brandon's Plumbing Service Co.,  
347 W. 4th St.,  
Reno, Nevada.
- Brown, Kieth, Bldg. Supplies,  
P. O. Box 430,  
Salem, Oregon.
- Brown-Bush,  
1711 Washington Blvd.,  
Venice, Calif.
- The Brownlee Co.,  
River Rouge 18, Mich.  
(3 Hawks Ave.)
- Burke Millwork Co.,  
Box 1844,  
Seattle 11, Wash.
- Bush Prefab. Structures, Inc.,  
370 Lexington Ave.,  
New York, N. Y.
- Butler Lumber Co.,  
Chase City, Va.
- Butler Mfg. Co.,  
Kansas City, Mo.
- California Pre Fab Corp.,  
5301 Valley Blvd.,  
Los Angeles 32, Calif.
- Campbell, J. W., Inc.,  
Corner 10th & Laurel Sts.,  
Palatka, Florida.
- Capital Prefabricators, Inc.,  
P. O. Box 821,  
Austin, Texas.
- Capp Mfg. Co., M.  
601 Washington Street,  
Minneapolis, Minn.
- Carlson Furniture Mfg. Co.,  
12231 Aurora Ave.,  
Seattle, Wash.
- Cavetown Planing Mill Co.,  
Cavetown, Md.
- Central Contracting Co.,  
407 Tower Petroleum Bldg.,  
Dallas, Texas.
- Central Millwork & Lumber Co., Inc.,  
125 Queen Anne Ave.,  
Seattle 9, Wash.
- Century Prefab. Corp.,  
Kinas Highway,  
Haddon Hgts., N. J.
- Certified Homes, Inc.,  
19 Market Street,  
Brighton 35, Mass.
- Challenge Co.,  
North River Street,  
Batavia, Ill.
- Charlotte Lumber & Mfg. Co.,  
2828 So. Boulevard,  
P. O. Box 3094,  
Charlotte 3, N. C.
- Chisholm Lumber & Supply Co.,  
647 W. 3rd Street,  
Reno, Nevada.
- Chornooky, Peter,  
85 E. 7th Street,  
New York 3, N. Y.
- Churubusco Lumber Co.,  
Churubusco, Indiana.
- City Lumber Co.,  
75 Third Street,  
Bridgeport, Conn.
- Clairton Commercial Co.,  
St. Clair Ave. at State St.,  
Clairton, Penna.
- Clements Corp.,  
Southport, Conn.
- Colack Engineering Co.,  
802 2nd Street, S. E.,  
Canton 2, Ohio.
- Collins, Vernil S.,  
1204 Evans Avenue,  
Bremerton, Wash.
- Connors Builders Supply Co.,  
Crandon, Wisc.
- Convertible Homes, Inc.,  
503 Railway Exchange Bldg.,  
Denver, Colo.
- Conway Homes, Inc.,  
Conway, S. C.
- Cooke Construction Co.,  
901 Maple Ave.,  
Plainfield, N. J.
- Cozy Cottages, Inc.,  
1895 So. High Street,  
Columbus 7, Ohio.
- Cranwood Corp.,  
9991 Central Ave.,  
Detroit 4, Mich.
- Crawford Co.,  
2019 No. 3rd St.,  
Baton Rouge, La.
- Critchfield Co.,  
San Francisco, Calif.
- Cromar Mfg. Corp.,  
Williamsport, Pa.
- Cumberland Homes,  
P. O. Box 500,  
Middlesboro, Ky.
- Currier Lumber Co.,  
17507 Van Dyke Ave.,  
Detroit 5, Mich.
- Custom Bilt Homes,  
601 E. Broadway,  
Long Beach, Calif.
- Dade Bros., Inc.,  
Old Country Road,  
Mineola, N. Y.
- Davet Enterprises, Inc.,  
Room 834, 25 Broad St.,  
New York, N. Y.
- Davies Co., H. J.,  
3934 Geary Blvd.,  
San Francisco 18, Calif.
- Defoe Shipbuilding Co.,  
Housing Division,  
Bay City, Mich.
- Dickerson & Co., R. C.,  
714 Lincoln Ave.,  
San Jose 10, Calif.
- Drycemble Corp.,  
5335 Southern Ave.,  
Southgate, Calif.
- Drycemble Corp.,  
Houston, Texas.
- Economy Housing Co.,  
6th and Chestnut Street,  
Wahoo, Nebr.
- Economy Portable Housing Co.,  
Factory & Hazel Streets,  
West Chicago, Ill.
- Econ-O-Homes, Inc.,  
P. O. Box K, Patterson Sta.,  
Baltimore 31, Md.
- Eddy Shipbuilding Corp.,  
Corner Harrison & Cass.,  
Bay City, Mich.
- G. S. Eidelbach, Jr.,  
457 So. Main Street,  
San Antonio, Texas.
- Elston Lumber Co.,  
401 Lancaster Street,  
Marietta, Ohio.
- Equity Lumber Co.,  
505 Liberty St.,  
Painsville, Ohio.
- Fabricated Homes, Inc.,  
445 Porter Avenue,  
Brooklyn, N. Y.
- Farwest Sales & Engr. Co., Inc.,  
625 Provident Bldg.,  
Tacoma 2, Wash.
- Fenestra Bldg. Panels,  
Div. of Detroit Steel Products Co.,  
Hugg Rd. & E. Grand Blvd.,  
Detroit, Mich.
- Flury & Crouch, Inc.,  
4600 Georgia Avenue,  
West Palm Beach, Florida.
- Folk, Ora,  
Monroe, Washington.
- Ivon R. Ford Lumber Co.,  
McDonough, N. Y.
- Ford Mfg. & Supply Co.,  
2430 Greensboro Ave.,  
Tuscaloosa, Ala.
- The Forest City Material Co.,  
17903 St. Clair Ave.,  
Cleveland 10, Ohio.

(Continued on page 20)



# **IMPORTANT ANNOUNCEMENT**

## **TO THE**

### **27,586 READERS OF**

# **RADIO & TELEVISION JOURNAL**

Effective with the September Issue your Radio and Television Journal will revert back to its former name of **RADIO & APPLIANCE JOURNAL** by which it was known from 1930 to 1939. Over 90 per cent of our readers surveyed suggested this move and your Editors feel it will better illustrate the *complete* coverage which your Journal has always given its readers. And . . . concurrent with this change in name you will find a newly-modernized, more practical, entirely different Radio & Appliance Journal. Ahead of the parade as it has been for 30 years, your Radio & Appliance Journal will bring you a publication embodying Editorial ideas and format utterly unlike anything this industry has ever seen. Over a full year's work and thousands of dollars have gone into this revitalized Radio & Appliance Journal in order to make it more helpful to you. The buyer's market is here . . . the emphasis is on merchandising and selling and, the industry's *oldest* dealer merchandising publication has reconverted to help you do the best merchandising and selling job in the country so that radio and appliance dealers can get *more* than their share of the consumers' dollars in the competitive era which lies just ahead.

### **REMEMBER**

claims are easy to make, harder to prove. But, the evidence proves that Radio & Appliance Journal (founded 1916 as Talking Machine Journal) has served its readers with more Editorial and advertising firsts than any other publication in the field. The September Issue continues this proud record so . . . be sure to . . .

**WATCH FOR THIS MODERNIZED, PRACTICAL,  
SPARKLING AND DIFFERENT SEPTEMBER  
ISSUE OF**

# **RADIO & APPLIANCE JOURNAL**

1270 Sixth Avenue

New York 20, N. Y.

The Industry's **COMPLETE** Dealer Magazine

## Prefabricators

(Continued from page 18)

**Fox Bros. Mfg. Co.,**  
St. Louis 4, Mo.

**Fox & Co.,**  
1620 Blake Street,  
Denver, Colo.

**Foy, M. C. & Son,**  
5800 So. Boyle Ave.,  
Los Angeles 11, Calif.

**Freelen, Frank,**  
11862 44th St. So.,  
Seattle, Wash.

**Fuller Houses, Inc.,**  
Beech Aircraft Co.,  
Wichita, Kans.

**GBH-Way Homes, Inc.,**  
Walnut, Ill.

**Gem Trailer Co.,**  
P. O. Box 204,  
Twin Falls, Idaho.

**General Erectors, Inc.,**  
1605 Court Sq. Bldg.,  
Baltimore 2, Md.

**General Houses, Inc.,**  
400 W. Madison St.,  
Chicago, Ill.

**General Industries, Inc.,**  
3033 Wayne Trace,  
Ft. Wayne 5, Indiana.

**General Mobile Home Coach Co.,**  
417 7th Street,  
Hoquiam, Wash.

**General Plywood Corp.,**  
3131 West Market St.,  
Louisville 12, Ky.

**General Timber Services, Inc.,**  
Panel House Division,  
1324 Pierce St.  
Omaha 8, Nebr.

**Georgia Consolidated Contrac. Co.,**  
Ellaville, Ga.

**Georgia Housing Co., Inc.,**  
Waterville Road,  
Macon, Georgia.

**The Getzel Corp.,**  
2712 So. 28th St.,  
Milwaukee 7, Wisc.

**Gibbs Cabinet Shop,**  
15101 Ambaum Road,  
Seattle 66, Wash.

**G. F. Mfg. Co.,**  
Exira, Iowa.

**Goodyear Yellow Pine Co.,**  
Picayune, Miss.

**Grand Rapids Lumber Co.,**  
47 Scribner Ave., N. W.,  
Grand Rapids 4, Mich.

**Grayco Corp.,**  
861 Grinnet Drive,  
P. O. Box 626,  
Shreveport 86, La.

**Green Lumber Co.,**  
Laurel, Miss.

**Green's Ready-Built Homes,**  
1221 18th Ave.,  
Rockford, Ill.

**Gregg & Son,**  
25 Crown St.,  
Washua, N. H.

**Gunnison Homes, Inc.,**  
New Albany, Ind.

**Hardin, Ira H. Company,**  
P. O. Box 29, Sta. "C"  
Atlanta, Georgia.

**Hamill & Jones,**  
3029 Exposition Place,  
Los Angeles 16, Calif.

**Harbaugh, Chas. Lumber Co.,**  
Twin Lakes, Wisc.

**Harnischfeger Corp. Houses Div.,**  
100 Lake St.,  
Port Washington, Wisc.

**Maurice R. Harrison,**  
285 No. 9th St.,  
Hialeah, Florida.

**Hayes-Lucas Lumber Co.,**  
8th and Maple Sts.,  
Brainerd, Minn.

**Hilz, Robert G.,**  
Hilz Homes Co.,  
801 Railroad St.,  
Toronto, Ohio.

**Hochwalt Lumber Co.,**  
E. 3rd St. and Broadway,  
Meridian, Idaho.

**Hodgson, E. F. Co.,**  
1108 Commonwealth Ave.,  
Boston, Mass.

**Home Builders Co.,**  
P. O. Box 477,  
Billings, Montana.

**Home Corporation of America,**  
121 Dodge Ave.,  
De Kalb, Ill.

**The Homeola Corp.,**  
(Buffelen Division)  
9 So. Clinton St.,  
Chicago 6, Ill.

**The Housing Corp.,**  
316 Southern Bldg.,  
15th and H Sts., N. W.,  
Washington, D. C.

**Houston Ready-Cut House Co.,**  
3601 Polk Ave.,  
Houston, Texas.

**Howell Woodworking Shop,**  
1004 Howell St.,  
Seattle 1, Wash.

**Hoyt & Givan Lumber Co., Inc.,**  
(Manufacturers for Pre-Fabricated  
Home Builders,  
Brown Sales Corp.),  
Los Angeles, Calif.

**H. M. K. Builders Co.,**  
1205 American Bank Bldg.,  
Portland 5, Oregon.

**Hudson Supply & Equipment Co.,**  
1727 Pennsylvania Ave. N. W.,  
Washington 6, D. C.

**John L. Hudson Co.,**  
8401 S. E. 70th St.,  
Portland 12, Oreg.

**Hull Housing Co.,**  
7701 Erath St.,  
Houston 12, Texas.

**Huron Homes,**  
Box 272,  
Lexington, Michigan.

**Illinois Lumber Mfg. Co.,**  
Cairo, Ill.

**Intermountain Houses,**  
Logan, Utah.

**Jackson & Wood Lumber Co.,**  
Laneville, Texas.

**Jaeger, E. E.,**  
Clarksville, Mo.

**J. K. Lumber Corp.**  
Seneca Turnpike,  
New Hartford, N. Y.

**Johnson Co.,**  
23 So. Dock St.,  
Sharon, Pa.

**Johnson, Harold E. Bldg. Co.,**  
6th and Walnut Sts.,  
Columbus, Missouri.

**John A. Johnson Co.**  
270 41st Street,  
Brooklyn, N. Y.

**Kaiser Community Homes,**  
417 So. Hill St.,  
Los Angeles 13, Calif.

**Kashner-Bender, Inc.,**  
704 So. Spring St.,  
Los Angeles 14, Calif.

**Keim Mfg. Co.,**  
1101 E. 95th St.,  
Chicago 19, Ill.

**Kennedy, M. L.,**  
7120 N. E. Killingsworth,  
Portland 13, Oregon.

**Kenview Homes, Inc.,**  
168 Somershire Drive,  
Rochester, N. Y.

**King, T. C., Company,**  
Anniston, Alabama.

**Knilhaug, Ted,**  
11061 16th Ave. S. W.,  
Seattle, Wash.

**Koch, Raymond,**  
General Bldg. Contractors,  
1763 West Century Blvd.,  
Los Angeles, Calif.

**Krieger Steel Sections, Inc.,**  
11-11 34th Ave.,  
Long Island City, N. Y.

**Kurtz Lumber Co.,**  
1860 E. Market St.,  
Akron 5, Ohio.

**Lair, E. C. Lumber Co.,**  
712 No. Chapel St.,  
Louisville, Ohio.

**Lakeside Cabinet Shop,**  
Bellevue, Wash.

**Lakeside Lumber Co.,**  
Oswego, Oregon.

**Larson, Frank J.,**  
3532 South 9th St.,  
Salt Lake City 5, Utah.

**Larsen, Franklin,**  
294 So. California St.,  
Ventura, Calif.

**Latisteeel Corp.,**  
3272 E. Foothill Blvd.,  
Pasadena 8, Calif.

**Lawson Casket Co.,**  
720 New York Ave.,  
New Castle, Indiana.

**Louis E. Legg Lumber Co.,**  
Marshall, Mich.

**Lehman, C. H. and Geo.,**  
Route No. 9, Box 203,  
Fresno, Calif.

**Lester Lumber Co.,**  
242 Franklin St.,  
Martinsville, Va.

**Lifetime Builders, Inc.,**  
1243 So. Evantson,  
Tulsa, Okla.

**Lincoln Lumber Co.,**  
2201 E. 14th St.,  
Oakland, Calif.

**Lincoln Lumber Co.,**  
Plentywood, Mont.

**Lindsay, Claude T., Inc.,**  
824 Taraval St.,  
San Francisco, Calif.

**Livernois & Stone Co., Inc.**  
438 Dublin St.,  
Columbus, Ohio.

**Lovewood, Andrew, Products,**  
8900 Fremont Ave.,  
Seattle, Wash.

**Lozell & Kozell,**  
Helen and Catherine Sts.,  
McKees Rocks, Pa.

**Lumber Fabricators, Inc.,**  
Elkton, Mich.

**Lumber & Millwork Co.**  
Maryland Ave.,  
Halethorpe, Md.

**Mabry and Woodward, Inc.,**  
3620 First Ave.,  
Seattle, Wash.

**MacArthur & Sweet, Inc.,**  
3650 W. Pico Blvd.,  
Los Angeles 6, Calif.

**Malnor, Matthew,**  
P. O. Box 383,  
Sheboygan, Wisc.

**Marsal Co.,**  
Room 710 816 W. 5th St.,  
Los Angeles 13, Calif.

**Martin, McCoy and McDonald,**  
800 W. North Ave.,  
Chicago 22, Ill.

(Continued on page 23)



The remodeled front shows the slanting windows which are designed to eliminate glare at night.

# SERVICE INSURES SALES

Dealer uses repair department to push sales of high price radios

*By George R. Johnson*

The Campbell Radio Co., Shreveport, La., is using merchandising methods which are increasing sales and cutting costs of operation.

Not only is the firm selling more new radios—many of them in the higher price brackets—but it is also increasing its volume of radio maintenance work.

The sale of expensive receivers is being built up to a large volume by the installation of a modern living room studio. The privacy of this sales closing room insures against interruptions while the customer is being sold. High quality sets are merchandised here in surroundings of fine furniture, attractive draperies, and other furnishings which are part of a well furnished-home.

This studio in the establishment is furnished as the home of one who owns an expensive radio-phonograph combination might furnish his. Sound-proofing eliminates outside disturbances which might distract the customer.

Installation of the studio is part of the remodel-

ing recently completed by the firm. The interior and exterior of the establishment have been completely modernized, making it one of the most attractive stores in the area.

An unusual feature has been incorporated in the company's new showroom windows. They are built at an angle, with the bottom of the glass extending back approximately 12 inches behind the top. The lighting fixtures are also angled, thus eliminating glare at night and giving the illusion of having no windows.

The service department is closely tied in with the sale of new radios by a policy of "service after the sale." This means that every receiver sold is serviced during the entire guarantee period. This policy helps the sale of new sets to a great extent because of war-time experience, when some customers found efficient service difficult to obtain.

A telephone call is made to the customer one week after the sale to determine whether or not the set is functioning properly. Two weeks later, a





**Mrs. Helen Finch, who deals with radio maintenance customers for the Campbell Radio Co., is shown handling an order. No servicemen are in sight to be cornered into unnecessary conversation. The service department is located a half block from the radio showrooms. A truck is used to shuttle repair jobs from store to service shop. On major maintenance work, the firm queries patrons after completion of repair work to learn whether set is giving good performance.**

personal first-hand inspection is made of the radio by a technician. Each month during the guarantee period, customers are called regarding the performance of their sets.

The Campbell Radio Co. is finding that customers are willing to wait until receivers can be delivered under its service policy rather than to purchase from a dealer who can make immediate delivery, but who hasn't a complete policy of "service after the sale."

Campbell's is emphasizing the sale of records, with the knowledge that a large percentage of sales will be on radio-phonograph combinations. They are sold only in albums because of the larger unit sale and the ease of carrying inventory.

"We have found it profitable to suggest to customers that they might need some phonograph records," says J. Evan Campbell, manager-buyer. "They are also easy to sell over the telephone."

The record album display is approximately five feet long, double faced, with space for 20 albums. It is placed adjacent to the display of radio-phonograph combinations and regular phonographs.

graph combinations and regular phonographs.

By employing a woman in the radio maintenance department to conduct business with the customer bringing a set in for repair, difficult problems can be handled without becoming involved in lengthy technical conversation. She is trained to make practical written explanations of a customer's complaint from which the service department can diagnose the trouble.

Mrs. Helen Finch, radio service employee, has sufficient technical knowledge to make a complete report on the company's repair certificate. From it the radio technician obtains data with which to locate and repair the trouble.

This certificate is stamped on the rear of the repair ticket. In addition to the customer's complaint, it contains space for tabulating cost of immediate trouble repair and complete overhauling. If the patron requests an estimate before having the radio repaired, it is recorded and given to the customer.

The service department is located a half block from the company's showrooms. A truck regularly transports sets from the receiving office to the repair department. By having customers bring their sets into the showrooms, they are exposed to the radio displays, thus boosting the sale of new sets.

On all major servicing jobs, the customer is contacted within one week in regard to performance of the set. If there is trouble, it is handled at once above other jobs that are in the store.

"This system gives us a higher average price in repair work, gives the customer better performance for the instrument and creates customer good-will," declares Mr. Campbell.

Two technicians are employed especially to handle car radios. The firm has four other technicians, who turn out many radios each week. The company is government-approved for veteran training on the job, and under this plan employs two ex-servicemen.

After 20 years in the radio sales and service business, Mr. Campbell has adopted a three-point formula necessary to operate profitably. First, good technical know-how and proper equipment. Second, maintenance of good management, along with proper records available at all times. Third, all guarantees, promises of delivery and estimates on prices must be religiously adhered to to the entire satisfaction of the customer.

The company was established in 1925 as a service organization with a small sales department. Today, its showrooms alone cover 2,400 square feet of space. This expansion has been made by the use of progressive ideas to save time and increase efficiency plus close coordination between service and sales departments.

## Prefabricators

(Continued from page 20)

- Maryland Modern Housing Corp.,  
Penn R. R. & Francis Ave.,  
Halethorpe, Baltimore 27, Md.
- Mastroinni, Jos. N.,  
826 W. 6th St.,  
Reno, Nevada.
- Meyer Bros.,  
737 Bainbridge St.,  
Philadelphia 47, Pa.
- Midland Bldg. Industries, Inc.,  
907 E. Michigan St.,  
Indianapolis 6, Ind.
- Midwest Fabricating Co.,  
P. O. Box 334,  
Mansfield, Ohio.
- Midwest Housing Corp.,  
625 E. Eastern Ave.,  
Janesville, Wisc.
- Midwest Prefab. Co.,  
3745 Minnehaha Ave. So.,  
Minneapolis, Minn.
- Midwest Prefab. Bldgs.,  
307 So. 54th St.,  
Springfield, Ill.
- Mifflinburg Body Works, Inc.,  
200 Madison Ave.,  
New York 16, N. Y.
- Minter Homes Corp.,  
Huntington, W. Va.
- Modelow Co., Inc.,  
3415 Carr Place,  
Seattle 3, Wash.
- Modern Bldgs. Mfrs.,  
2310 No. 6th Ave.,  
Pine Bluff, Ark.
- Monarch Co.,  
117 W. Kingsmill St.,  
Pampa, Texas.
- Monroe Corp.,  
Room 402, Kresge Bldg.,  
Indianapolis, Ind.
- Mott Bros., Inc.,  
131-33 Avery Ave.,  
Flushing, L. I., N. Y.
- Moyer Company,  
Central & Wabash Ave.,  
Linwood, N. J.
- M. B. M. Co.,  
2821 Rucker Ave.,  
Everett, Wash.
- M. & M. Construction Co.,  
2430 Greensboro Ave.,  
Tuscaloosa, Ala.
- McCrary-Rodgers Co.,  
304 Ross St.,  
Pittsburgh 19, Penna.
- McFab Co.,  
Fresno, Calif.
- McGary, Walter J.,  
2301 So. Dixie Ave.,  
Dayton, Ohio.
- N. & A. Cabinet Works,  
2017 Simpson Ave.,  
Hoquiam, Wash.
- National Homes Corp.,  
U. S. 52 By-Pass,  
Lafayette, Ind.
- Nettleton and Baldwin, Inc.,  
1109 No. 36th St.,  
Seattle 3, Wash.
- New Century Homes, Inc.,  
7238 Wisconsin Ave.,  
Washington, D. C.
- New Century Homes, Inc.,  
Clinton, Indiana.
- Nichols and Cox Lumber Co.,  
1035 Godfrey Ave. S. W.,  
Grand Rapids 7, Mich.
- Nicoll & Co.,  
1212 19th St.,  
Oakland 7, Calif.
- North End Shop  
8525 1/2 Greenwood Ave.,  
Seattle 3, Wash.
- Northern Prefab. Corp.,  
12-14 Ridge St.,  
Glen Falls, N. Y.
- Northside Bldg. Supply Co.,  
P. O. Box 66,  
Doraville, Georgia.
- Ocean Pines Realty Co.,  
1 South Main St.,  
Toms River, N. J.
- Oliver-Loughland Co.,  
230 E. Verdugo Ave.,  
Burbank, Calif.
- Olympic Cabinet Shop,  
8704 Ranier,  
Seattle 8, Wash.
- Orter, Ralph H.,  
3031 W. Van Buern St.,  
Phoenix, Arizona.
- Page & Hill Co.,  
Shakopee, Minn.
- Palace Corp.,  
Flint, Michigan.
- Panhandle American Houses,  
821 W. 6th Street,  
P. O. Box 2163,  
Amarillo, Texas.
- Parts Mfg. Co.,  
Traverse City, Mich.
- Pease Woodwork Co., Inc.,  
Blue Rock & Turrill Sts.,  
Cincinnati 23, Ohio.
- Peerless Housing Co.,  
300 4th Avenue,  
New York 10, N. Y.
- Pemberton Corp.,  
270 41st Street,  
Brooklyn, N. Y.
- Peoples Supply Co.,  
149 South Dock Street,  
Sharon, Penna.
- Place & Co.,  
111 So. Webster Street,  
South Bend 21, Indiana.
- Plainfield Lumber & Supply Co.,  
403 Berckman Street,  
Plainfield, N. J.
- Pomona Factory-Built Homes,  
426 W. 2nd Street,  
Pomona, Calif.
- Port-A-BL-Homes Co.,  
Orange, Texas.
- Porter, Frank G.,  
1020 Seaboard Bldg.,  
Seattle 1, Washington.
- Portland Door Co.,  
604 Mead Bldg.,  
Portland 2, Oregon.
- The Prebilt Co.,  
114 Carter Street,  
Chelsea 50, Mass.
- Precision Bldg. and Supply Co.,  
1233 10th Avenue,  
Columbus, Georgia.
- Precision Built Homes Corp.,  
Trenton 3, N. J.
- Precision Cut Homes Corp.,  
2337 Tulane Ave.,  
New Orleans, La.
- Precision Homes Co.,  
1011 E. Channel Street,  
Stockton, Calif.
- Preco Corp.,  
Bellingham, Wash.
- Prefabricators, Inc.,  
256-64 Colvin St.,  
Baltimore, Md.
- Pre-Fab Bldg. Co.,  
1290 Cedar Street,  
Berkeley 2, Calif.
- Prefab. Construction Co.,  
P. O. Box 247,  
Dayville, Conn.
- Prefab. Cottage Co., Inc.,  
1671 McDonald Ave.,  
Brooklyn 30, N. Y.
- Prefabrication Engineering Co.,  
1417 American Bank Bldg.,  
Portland 5, Oregon.
- Prefab. Homes, Inc.,  
P. O. Box 1112,  
Phoenix, Arizona.
- Prefab. Corp.,  
1395 Northern Blvd.,  
Roslyn, N. Y.
- Pre-Fab Industries,  
1535 So. Main Street,  
South Bend, Indiana.
- Pre-Fab Industries Corp.,  
5th St. and Valley Rd.,  
Richmond, Va.
- Prefab. Mfg. Co.,  
4080 E. Sheila Street,  
Los Angeles 22, Calif.
- Prefabricated Products Co.,  
4000 Iowa Street,  
Seattle 6, Washington.
- Production Line Structures,  
941 No. La Cienega Blvd.,  
Los Angeles 46, Calif.
- Purdue University,  
Lafayette, Indiana.
- Raleigh Prefab. Homes, Inc.,  
1325 So. Blount St.,  
Raleigh, N. C.
- Randolph Lumber Co.,  
1121 E. 33rd Street,  
Indianapolis, Ind.
- Rasnick Mfg. Co.,  
8000 Washington Ave.,  
Houston 7, Texas.
- Revis, R. W.,  
Newman, Ill. (Box 9)
- Richards Lumber Co., H. W.,  
Cedar Street,  
Carrollton, Ga.
- Rieger, H. R. Co.,  
4634 Parrish St.,  
Philadelphia 39, Pa.
- Rickard Lumber Co.,  
336 E. Michigan Ave.,  
Lansing, Mich.
- Rilco Laminated Products Co.,  
221 Conyngham Ave.,  
Wilkes-Barre, Penna.
- Rilco Laminated Products Co., Inc.,  
W-1581 First Nat'l Bank Bldg.,  
St. Paul 1, Minn.
- Riverside Box Co.,  
208 No. Broadway,  
St. Louis 2, Mo.
- Robertson, Edward,  
Robertson Lumber Co.,  
Marianna, Arkansas.
- Roelofa, Henry J.,  
Box 151,  
Hull, Iowa.
- Roof Structures, Inc.,  
122 W. Lockwood Ave.,  
Webster Groves 19, Missouri.
- Rowe & Thompson,  
9004 So. 19th St.,  
Tacoma 6, Wash.
- Rush Construction Co.,  
4539 Greenwood Ave.,  
Chicago 5, Ill.
- Saco Mfg. Co.,  
270 First St.,  
Milan, Mich.
- Scott Co., W. W.,  
P. O. Box 967,  
Huntsville, Ala.
- Scott Lumber Co.,  
1112 Chapline Street,  
Wheeling, W. Va.
- Sectional Garage Works,  
2344 Bailey Ave.,  
Buffalo 11, N. Y.
- Se-Kure Corp.,  
209 Anderson St.,  
Pittsburgh 12, Pa.

(Continued on page 30)



# Is Fair

*\*By Jack Geartner*

**M**OST men owned, in their youth, an Ingersoll watch. At one time the Ingersoll Co. sold 18,000 watches a day to 80,000 retail outlets at \$1 each. The watch carried a fair markup. There was a profit in it for the manufacturer, the distributor, and the retailer, and the customer was satisfied that when he paid a dollar for an Ingersoll watch, he got his money's worth.

In Philadelphia, a dealer decided he would attract new customers through a "loss leader." He offered the Ingersoll dollar watch at 79c. He sold lots of watches, but the Philadelphia market was ruined. No other dealer could get a dollar for the watch. The public simply waited for the next 79c sale.

The classic Ingersoll story illustrates a merchandising truth. Goods come to have an accepted value to the public. Whenever a merchant deliberately devalues merchandise, he tends not only to hurt the sales of other merchants and destroy the good-will of the trade-mark, but also destroys the total market for the goods.

Progressive retailers and manufacturers noting many such sad merchandising incidents and the destruction they caused, sought to have Congress and the various states adopt fair trade legislation to legalize resale price maintenance. Their efforts were first rewarded by the passage of the California Fair Trade Law in 1931. Such laws have now been adopted in 48 states. The Congress of the United States also adopted the Miller-Tydings Act, which legalized in interstate commerce resale price maintenance agreements for commodities sold in a state where such agreements are valid under state laws.

*\*Mr. Geartner is sales manager for the Electronic Corp. of America, Brooklyn, New York.*

Today a manufacturer of branded merchandise can determine by contract the price at which his merchandise will be resold to the public. The manufacturer need only enter into a contract with one or more retail outlets. This contract requires the retailer to sell at a stipulated price. Should any outlet then sell at less than the agreed price, the manufacturer can get a court order to restrain price cutting on the product in question. If the retailer persists in this practice, he can be cited by the court for contempt. Fair trade laws have been upheld by the Supreme Court and by various state courts. They are legal and enforceable.

But they are more than a weapon designed for the protection of the manufacturer. They are, in fact, insurance for the security of the ethical retailer.

Both radio manufacturers and dealers have a large stake in living up to fair trade laws and fair trade principles. Every radio dealer can recall incidents when a competitor offered, in large newspaper space, a de luxe radio at half the usual price while having for sale only three or four sets, and those nailed to the floor. By the time the Better Business Bureau got around to investigating, the damage was done. Today, more than ever the radio dealer needs the protection of fair trade. More than double the pre-war number of radio manufacturers are now in the field. Many of these firms may not be able to support their products with a vigorous sales, promotional and advertising effort. They may be left to compete on only one feature, price. By not fair trading their merchandise or failing to enforce fair trade contracts, they invite certain stores to cut the price of their merchandise.

Their volume may be maintained, but the majority of radio dealers suffer.



# Trade the Answer?

**Pre-war merchandising evils are once again apparent in selling radios and appliances. In this article, Mr. Geartner tells why Fair Trade protects manufacturer, distributor, and dealer from unethical fringe operators**

Students of merchandising have pointed out that cutting does not increase volume. A lull always takes place after price cutting, for the consumer has stocked himself up at the expense of the retailer. The retailer who lowers the price does not increase the market for radios by anything like the extent necessary to balance the loss of profit to all dealers. Instead of sales being made on the basis of sound general merchandising, they are contingent on how long the dealer can keep his price the lowest—or whether he can afford to degenerate the character of his store.

An experience from the book publishing and selling business is worth noting. Probably no items have been more used as loss leaders than books. One New York City department store, for many years sold books at a tremendous loss to increase traffic in the store and volume in other wares. Through this practice this particular store came to control an estimated 5 per cent of the book sales of the entire nation. Meanwhile, the smaller stores who sold books as their principal product could not operate on a loss leader basis. The number of book outlets diminished. Coverage of the book reading public dropped, the number of books sold did not increase. Sales were simply channelized through one large outlet.

It was this experience as much as anything else that induced the book publishing industry, supported by the vast majority of the retail book outlets, to carry the violation of the Feld-Crawford Act to the highest court in New York State where the act was upheld. As a matter of fact, there is particular danger of such a situation developing in the radio industry in the future.

If one large store or a chain of stores could sell standard brands of radios supported by national advertising at a substantially smaller markup than

the average store, before long there would be not greater sales or bigger markets but a freezing out of the smaller business man. The big outlet would have a disproportionate share of the purchasing and bargaining power. Manufacturers would scramble to offer these large customers special inducements, and the larger outlet would have even greater leverage over its smaller competitor. Furthermore—and this is important to all manufacturers—the big outlets could then say, “We will not sell each and every brand—we will sell only one or two.” Or equally likely, they would move into private brands in order to exert even more leverage on their remaining nationally advertised sources.

The principal argument against fair trade is that it tends to keep prices up and does not pass on to the consumer the savings of efficient production. This is particularly untrue of the radio industry. Competition among manufacturers of whom there are many, will guarantee that even at the fair trade price, each manufacturer will be required to give the consumer a better and better buy. The manufacturer will have to make as good a radio as he can at as low a price as he can in order to get a fair share of the market. Under fair trade, he will simply be certain that the retailer will get enough of a markup for a reasonable profit. Fair competition among manufacturers continues. Unfair competition among retailers is eliminated.

It seems likely that the more reputable radio manufacturers will fair trade their merchandise. The problem will then become one of enforcement. How determined will the manufacturer be to police his retail outlets? How determined will the distributor be to police outlets if it means the immediate loss of a good sized order? Obviously fair trade cannot be a matter of convenience, to be used

*(Continued on page 30)*

# THERE ARE 2 SIDES

## THE MANUFACTURER'S

Our side starts with the making of finer radio tubes — by constantly keeping ahead in radio research.

Over the past twenty years, Sylvania research has brought you many important advances in radio tubes. "Another Sylvania first" has become a familiar term in the radio industry.

Among these Sylvania "firsts" are the famous Lock-In tube and the mighty little T-3 tube of proximity fuze fame.

Sylvania tubes are famous for quality as well as performance. Parts for these tubes are made by Sylvania. Raw materials, parts and final assembly are all tested and proved by the highest electrical and mechanical standards.

For you, these tubes are sure to mean *customer-satisfaction*.



# SYLVANIA

MAKERS OF RADIO TUBES; CATHODE RAY TUBES; ELECTRONIC DEVICES;



# TO EVERY TUBE PROBLEM



## THE RADIO RETAILER'S

Your side concerns selling tubes that will build goodwill, open new profit opportunities.

Sylvania makes the tubes you want . . . and helps you in your business, too.

Extensive *national advertising*, reaching millions of Americans, *presells* Sylvania tubes for you. The customer-pulling power of these tubes builds goodwill for future set sales.

Sylvania *business aids* help streamline your business. Valuable *technical aids* speed your radio servicing. Coast-to-coast *market research surveys* tell you what the public wants in radio.

By carrying the *complete line* of Sylvania tubes, you will always have what the customer wants. For full information on tubes, and helps for the retailer, see your Sylvania distributor *today!*

**SYLVANIA ELECTRIC PRODUCTS INC.**  
*Emporium, Pa.*

# ELECTRIC



INCANDESCENT LAMPS, FIXTURES, WIRING DEVICES; ELECTRIC LIGHT BULBS



We Are Pleased to Announce the Opening of  
**Paris' Newest Appliance Shop and Sporting Goods Store**  
 TUESDAY, JULY 7 AT 10:00 A. M. (No Merchandise Will Be Sold On Opening Day)

Featuring  
**"Brand Name" Merchandise Famous For Its Quality**

**We Invite You to See These Fine New Appliances**

Some are available now... others will be available soon... we hope... in either case we want you to see this grand assortment of modern appliances and new sporting equipment!



**ON THEIR WAY TO YOU**

For Your Convenience and Pleasure  
**AMERICA'S FINEST APPLIANCES**

- HOT POINT ELECTRIC**
  - Refrigerators
  - Ranges
  - Dishwashers
  - Water Heaters
  - Disposal Traps
  - Washing Machines
  - Garbage Disposals
  - Steel Cabinets
- MAGIC CHEF**
  - Gas Ranges
- EUREKA**
  - Cleaners and Scepters
- BRONHITE**
  - Ironers
- AMERICAN STOVES**
  - Coal Oil Ranges
- SERVEL ELECTROLUX**
  - Gas Refrigerators
- SCHAFER PAK-A-WAY**
  - Freezer Cabinets
- PITTSBURGH**
  - Water Heaters
- EMERSON**
  - Radios
- STROMBERG CARLSON**
  - Radio Record Players
- HUMPHREY**
  - Gas Heating Stoves
- ANOMATIC**
  - Washing Machines
- E.C.A.**
  - Victrol Records
- RADOLAS**
  - Microphones

**Plus... These Small Appliances**

• Irons • Coffee Makers • Electric Fans • Roasters • Food Mixers • Presto Cookers • Toasters • Hot Plates • Cooking Utensils

**Sporting Goods**

• Fishing Tackle • Baseball • Golf Equipment • Outdoor Motors • Sport Clothing • Football • Basketball • Ammunition

**SANTEN'S HOME APPLIANCE SHOP 'INC.'**  
 and  
**SPORTING GOODS STORE**  
 Paris, Kentucky

415 Main St.  
 Phone 44

This newspaper ad brought many customers on opening day.

# AIMS AT HIGH PROFITS

Santen's Home Appliance Shop knows what it wants: steady sales at a profit; and it also knows how it's going to get this business.

Henry J. Santen, Jr., co-proprietor with his brother B. J. Santen, of this firm, located at 415 Main St., Paris, Ky., states that they have formulated a merchandising program aimed at a high sales volume.

The first step towards this goal was taken recently when the co-owners completely remodeled their store. As a result, these dealers now have one of the most modern and complete radio and appliance establishments in this area.

"We're handling many fine brands of receivers and electrical goods, and we are convinced that we can sell more of these by displaying and selling in attractive surroundings," the retailers have declared.

When the revamped store opened for business last month, a steady stream of prospective customers passed through the store on opening day. Present at this grand opening were many representatives of manufacturers and distributors of the goods which the store is featuring. The establishment has already made a solid "hit" with the residents in this community.

The new building measures 23½ feet by 100. Many of the latest ideas in store design and display were used in constructing this establishment. The store-front features a large plate glass front which gives passers-by an unobstructed view of the interior.

At the rear of the store is a modern, glass-enclosed office. Here is a stairway which leads to the second floor display section. An elevator has been installed between these floors to facilitate the moving of goods. This second floor will plan a vital part in the firm's selling plans.

### *Make Store Headquarters*

One "angle" which the store will stress is that it is the headquarters for all kinds of radios and appliances. Everything for the home under one roof, will be the theme used by the co-proprietors in getting *more* business. In view of this, the store carries numerous lines of sets, table and major appliances, records, and other goods.

By carrying these diversified lines the organization plans to maintain a steady year 'round business. A full line of sporting goods is also sold by the store. Goods such as fishing tackle, baseball and football equipment, etc., help prevent seasonal slumps in business.

### *Four-Point Sales Plan*

A four-point selling plan has been conceived which the store believes will swell its sales volume.

First, the firm will continue to use newspaper advertising as a way to bring 'em in. A full page ad was run in a local newspaper preceding the opening of the modernized store. This ad was successful in bringing many visitors to the establishment.

Second, direct mail advertising will be employed to build good-will and to keep constantly in touch with customers. The co-owners are completely sold on the benefits of smart direct mail advertising and will use this medium to keep their sales volume at a high level.

Third, window and in-store demonstrations are planned to sell merchandise. "An old proverb says that a photograph is worth a thousand words," says Henry J. Santen, Jr. "Carrying this idea further, a practical demonstration of a radio-phono-

graph combination or washing machine is more valuable at times than thousands of words by a salesman. We intend to cash in on demonstrations by showing customers how an appliance actually saves them time and effort."

Fourth, the second floor to the establishment will be used to demonstrate the value of the new appliance to home maker clubs and other such organizations in this area. The second floor department is fully equipped to accommodate members of women's clubs, and also to exhibit new appliances in operation.

### *To Use Model Kitchens*

The display area on the upper floor has been designed to permit arrangements of model kitchens. It is also arranged to facilitate the holding of cooking classes for women's organizations.

"As far as possible, we're going to encourage home maker clubs to visit our store," asserted Henry J. Santen, Jr. "We believe that we can boost our sales volume and help our customers by holding appliance demonstrations for groups at a time."

Full service on all goods sold here is promised to customers. The store has pledged itself to back up its sales with speedy and efficient service.

Lines handled by the firm include such well-known names as Emerson, Stromberg Carlson, Hot Point, Eureka, and many other nationally-famous brands.

**A large selection of radios and appliances is carried by the store. The establishment measures 23½ by 100 feet and emphasizes the fact that it carries a complete stock of merchandise for the home. One of the firm's selling features is the holding of appliance demonstrations for women's clubs, home-maker groups, etc.**



## Prefabricators

(Continued from page 23)

Shappert Engineering Co.,  
Blaine and E. Menominee St.,  
Belvidere, Ill.

Shawhean, J. F. Distributing Co.,  
400 E. Lenda St.,  
Ft. Worth, Texas.

Shelter Industries, Inc.,  
630 5th Ave.,  
New York, N. Y.

Shurtleff Co.,  
Mfg. Division,  
Elgin, Illinois.

Sisley, Al.,  
847 So. 149th St.,  
Seattle 88, Wash.

Smith, Ivy H. Co.,  
P. O. Box 5098,  
Jacksonville, Fla.

Smith and Hill,  
716 Lee Street,  
Des Plaines, Ill.

Snead & Co.,  
Orange, Va.

Solar Homes Co.,  
59 Main St.,  
Brattleboro, Vt.

South Bend Fabricating Co.,  
South Bend, Wash.

Southern Mill & Mfg Co.,  
525 So. Troost Ave.,  
P. O. Box 1087,  
Tulsa 1, Okla.

Southwest American Houses,  
2005 Canal St.,  
Houston 1, Texas.

Standard Engineering Co.,  
28 Francisco Blvd.,  
San Rafael, Calif.

Stannard, James H.,  
No. 5 La Vista Way,  
San Rafael, Calif.

Star Cabinet Mfg. Co.,  
10618 Cedar Ave.,  
Cleveland 6, Ohio.

Steel-Bound Construction Co., Inc.,  
P. O. Box 87,  
Southgate, Calif.

Steelcraft Mfg. Co.,  
16 E. 72nd St.,  
Cincinnati, Ohio.

Sterling Prefab. Homes,  
32 Atlantic St., Inc.,  
Garfield, N. J.

Storagewall, Inc.,  
40 Great Jones St.,  
New York 12, N. Y.

(Continued on page 47)

## Fair Trade

(Continued from page 25)

when it serves the manufacturer's purpose and to be abused in the interest of an occasional "shot in the arm."

The answer must be that the sound administration of the fair trade contract requires an alert group of retailers who are prepared to stand fast on their contracts and insist that the manufacturer do the same. The policing of violations, once called to the attention of the manufacturer by competitive retailers, is the responsibility of the manufacturer. The manufacturer's integrity and desirability as a source should be measured by the degree of support given to his fair trade contracts.

Margins permitted to the retailer are based on the experience of more than 20 years of radio merchandising. They are believed to provide a fair profit but not an excessive one to the retailer.

In the final analysis, the retailer's success or failure is based not on the number of transactions, but on the profit resulting therefrom. Finagling with prices and markups is almost always done without a due regard for the cost of doing business. A reduction of 10 or 15 per cent in the selling price of merchandise may represent the elimination of profit on the particular item sold. If such price cutting is general, the historical markups will eventually be changed and dealers will have to do all of their business on smaller markups.

**DEALERS EVERYWHERE FLOCK TO ELECTROMATIC FOR THE MOST EXCITING SET ON THE MARKET...**

**MODEL 607A "COLURATONE" COMBINATION RADIO & AUTOMATIC PHONOGRAPH**

Now that the buying public has seen and heard this remarkable Coluratone combination, dealers are clamoring for reorders and more reorders. Hundreds of leading stores have already promoted Coluratone in large newspaper space. No wonder it's so popular! It's the first postwar set with *real* postwar features, and at no premium in price. Send in your order now.

### FUTURAMIC DESIGN

Beautifully designed cabinet with improved acoustics.

### AUTOMATIC RECORD CHANGER

Plays twelve 10" or ten 12" records. Smooth and quick change action, feather-light crystal pickup, automatic rejector button.

### THE ELECTROMATIC PIANO TEST

The famous "Piano Test" is your sure-fire sales clincher. We furnish you with a special recording that wraps up the sale in jig time.

### PERMANENT BOND VENEERS

No peeling, no warping. Hard core wood and precious-grained veneers bonded forever by high frequency induction heating.

### ULTRA-MODERN RECEIVER

Contains built-in Teleceptor antenna, Densi-Flux speaker with Alnico 5 magnet, Ferro-Perm transformers, Ampli-bass circuit, Travelite indicator, Vernier dial action.

**WRITE FOR DETAILS TODAY!**



# ELECTROMATIC

MANUFACTURING CORPORATION, 88 University Place, New York City

IMMEDIATE DELIVERY

RADIO & TELEVISION JOURNAL, AUGUST, 1946



# NEW RADIO MERCHANDISE

## Crosley Portable Radio

Set manufactured by Crosley Corp., Cincinnati 25, Ohio, has shock-proof cabinet molded of lustrous gunmetal plastic. Operates on ac, dc, or batteries. Has



5 tubes, including one rectifier. Set features automatic sensitivity control, enclosed loop antenna. Plastic control knobs. Measures 8 inches high, 12 inches wide, 5¼ inches deep. Slide rule dial provides for easy tuning.

## Musaphonic Radio-Phonograph

This radio-phonograph combination, made by General Electric Co., Bridgeport, Conn., has cabinet

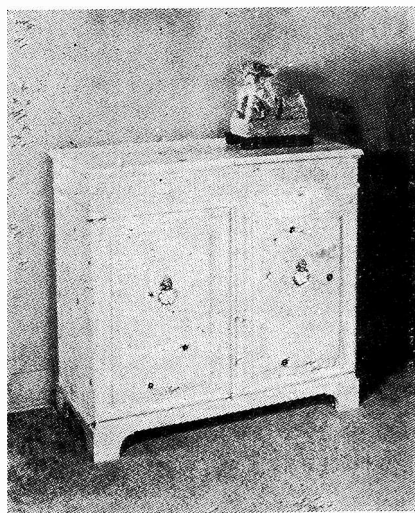

of contemporary styling and is suitable for modern and traditional

interiors. Knotty pine is used in cabinet. The left section of the top is solid. Radio controls are under lift lid on right hand of the top. Behind left hand door is "roll out" phonograph drawer. Beneath drawer is storage space for about 120 discs. Overall dimensions are 36 9-16 inches high, 36½ inches wide, 18½ inches deep. Set has 16 tubes including rectifier and tuning indicator. Receives on 7 bands. Also features push-button tuning, GE electronic reproducer, dual spread tone controls.

## Lear Desk Model Radio-Phonograph

Desk radio-phonograph combination is manufactured by Lear, Inc., 230 East Ohio St., Chicago, Ill. One side is a complete desk with smooth sliding drawers; the

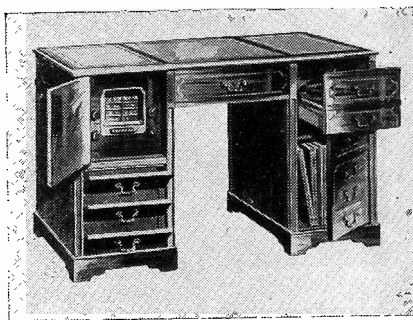

other side contains a Lear radio, an automatic record changer, and ample record storage. The desk is in 18th Century styling, finely built of hand-rubbed Honduras mahogany veneers, with a top grain genuine leather top. Opening one drawer-louvre below the built-in radio automatically opens all three louvres for radio or record playing.

## Andrea Portable Radio

Three-band short wave portable, including marine channels, is made by Andrea Radio Corp., 27-01

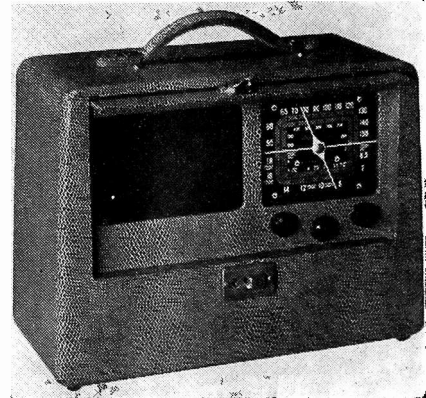

Bridge Plaza North, Long Island City 1, New York. Receiver has 5 tubes and rectifier. Operates on ac, dc, or long-life batteries. Designed with vanishing front cover, harmonizing with the better type of modern luggage. Equipped with automatic snap lock and key to prevent unauthorized use. All parts in set are "climate sealed" for added protection. Self-contained high-grain oversized loop for standard broadcast band, with self-contained 25 foot wire hank for short wave use. Provision for attaching outside antenna for all bands. Measures 14 inches wide at base, 10½ inches high, 6¼ inches deep.

## "American" Wall-Type Radio

Produced by American Communications Corp., 306 Broadway, New York, N. Y., this Model 6K

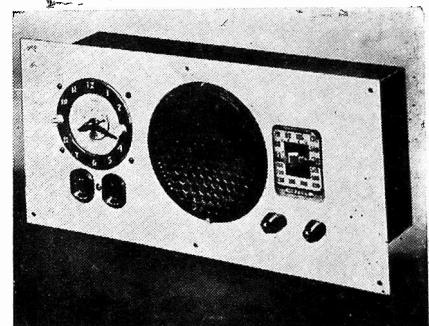

built-in wall type radio is available in harmonizing colors to

(Continued on next page)

# PRESENTING THE LATEST

(Continued from preceding page)

match interior walls or kitchen tile. Has duplex receptacle conveniently located for plugging in other appliances. Features Telechron alarm clock with automatic switch which turns radio on or off. Designed to mount between the studs with ample clearance from the front to back partition. Louvers provides for dissipation of interior heat. Set is 6-tube superhet. Mounting dimensions of interior box: 4 inches deep, 6 inches wide, 14 inches long. Front panel measures 7½ inches by 16 inches. Priced at \$57.85, including Federal excise tax.

## Electromatic Radio-Phonograph

Maker is Electromatic Mfg. Corp., 68 University Place, New York. Table-top automatic radio-phonograph combination is equip-



ped with separate stave legs which converts this set into a modernistic chairside model. Legs stand the set 16¼ inches above floor level. Legs are made of hand-rubbed walnut to match cabinet, and can be attached or detached with ease.

## Viewtone Portable Radio-Phonograph

Manufactured by Viewtone Television & Radio Corp., 81 Wiloughby St., Brooklyn 1, N. Y. This set can be carried around like luggage, or it can be used in the home as a table model. Automatic record changer handles ten 12-inch or twelve 10-inch records:

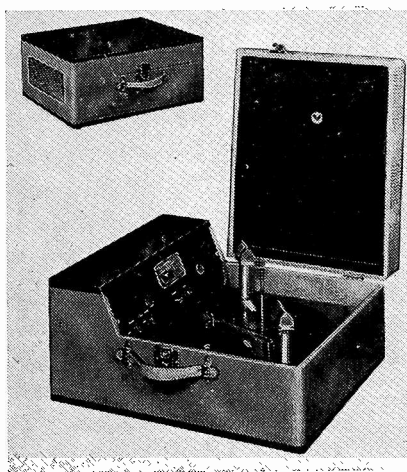

has crystal pick-up. Record player is turned off automatically after last disc is played. Protective self-locking arm is provided for carrying. Radio is 5-tube superhet with automatic volume control. Combination comes in sturdy two-tone simulated-leather case with lock and key, and strong handle. Attractive mats for use by dealers in local advertising are supplied without charge.

## Electronic Laboratories Inter-Com System

Made by Electronic Laboratories, Inc., Indianapolis, Ind. This "De Luxe Utiliphone" provides a two-way intercommunications system for offices. Consists of two speaker units, both of which are controlled by a push-button so that either speaker may be turned on or off at will. This is accomplished by a three-way wire connection

which permits instant use of either speaker. System is simple to install or operate. Can also be used

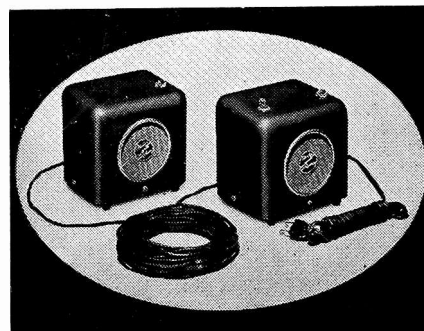

in restaurants, theatres, garages, etc., to connect different departments. It is effective over a range of more than 500 feet, and has a tonal fidelity equal to that of high-quality radio. Priced at \$29.95.

## Jefferson-Travis Radio-Phonograph

Produced by Jefferson-Travis Radio Mfg. Corp., 245 East 23rd St., New York, this combination radio-phonograph is equipped with

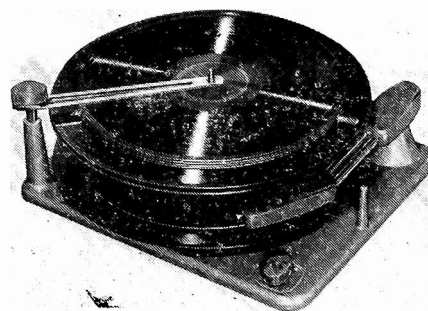

long-playing tape recorder. The recorder makes it possible to take programs off the air with no personal supervision. Clock on the console panel automatically turns recorder on, and then switches it off when program time has elapsed.

# GOODS FOR MORE SALES

## Zenith Record Demonstrator

New demonstrator for discs, made for record dealers exclusively, is being produced by Zenith



Radio Corp., 6001 West Dickens Ave., Chicago, Ill. Features "Cobra Tone Arm." "Secret" interior volume control regulates maximum output.

## Arvin Electric Iron

Maker is Noblitt-Sparks Industries, Inc., Columbus, Indiana.



Automatic electric iron has segment on dial devoted exclusively to synthetic fabrics. The firm states that while a low heat for ironing synthetic fabrics is available in most irons today, the inclusion of a synthetic fabric segment on the dial, along with linen, wool, rayon, and silk, is a distinct Arvin feature.

## "Quality" Electric Range

Introducing its first postwar, full-sized 40 inch electric range, Roberts & Mander Corp. has placed in production Model LE-5G at its Hatsboro, Pa., plant. Features include triple time control of oven, appliance outlet, and "Econo-Cooker," "Warmolator" for warming food and dishes, and a large storage compartment with handy lid rack. The oven is automatically illuminated whenever the door is opened. Entire cooking surface is also lighted. Flush-to-wall design and standard, built-in cabinet

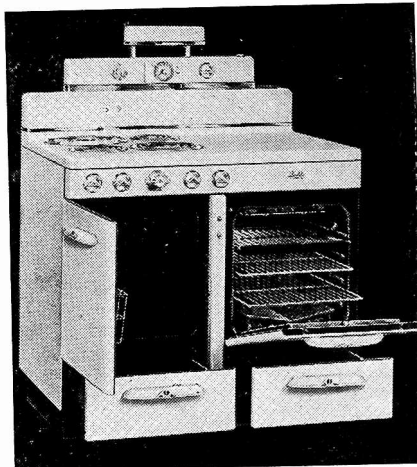

type base makes for modern kitchen layout. Finish is of full porcelain enamel.

## Mastercraft Fluorescent Kitchen Fixture

Mastercraft Electric Co., 181 Bruce St., Newark 3, N. J., announces the production of the "Modern", a new two or three-light kitchen fixture in two types of mounting. Mountings available are the easy plug-in type for rapid installation in existing sockets, and where underwriters' approval is desired, the "Modern" is available for installation on 5-inch and 6-inch collar and cross-bar. Fixture is finished in long-

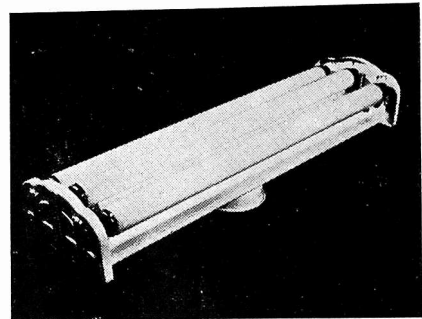

life enamel. This coating cannot chip or crack even if the surface is dented, and will not discolor or turn yellow. Finish also features high reflection for maximum light output.

## Vap-O-Lec Heating Unit

The electric vapor (central) heating unit is produced by the Cronholm Mfg. Co., 2500 S. E. Hawthorne Ave., Portland 15, Ore. Uses steam vapor heat generated

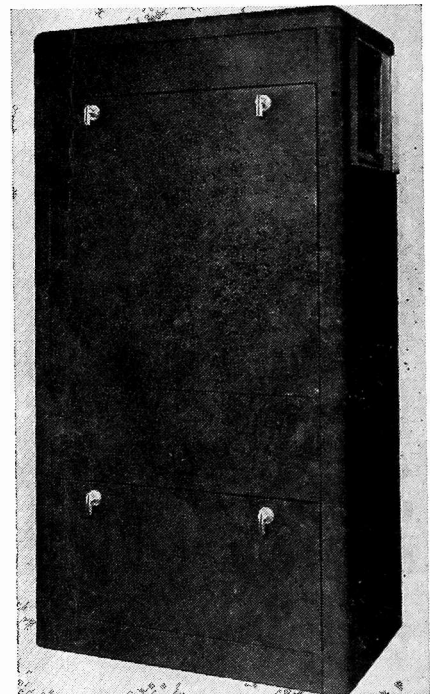

electrically. Heats without loss of natural humidity. Unit is fully automatic and is finished in attractive colors.



# Windows . . .



Location in high-traffic area pays off for dealer. Stresses interior and exterior displays to build sales volume. Retailer says, "Make displays simple, colorful and light them well." Store remodeled with eye towards selling more radios and electrical appliances to passers-by.

This is one of five display windows used by Miami, Fla., merchant to "pull" in customers. Note paper streamers.

*By Harrie H. Bierman*

The combination of profit-pulling displays and a location on a high-traffic street is bringing business to the Moore Appliance Corp., Miami, Fla.

"Our traffic-building display methods," Paul Moore, president, points out, "is helping us sell more radios and electrical appliances. Since we moved into this store, we've concentrated on promoting in-store traffic. Our sales volume indicates that we are succeeding."

In blueprinting their merchandising plans, Moore and his associates—his wife, Mrs. Paul Moore, and Howard M. Wygant—first selected a location in a bustling community shopping center in Miami's Northwest section. Their next step was to completely streamline and modernize the store chosen.

With a view towards displaying the new receivers and appliances in attractive settings, the establishment was revamped both inside and out. These extensive changes included the tearing out of partitions, rebuilding the structure's front, removal of the old wooden floor and the out-moded electrical system.

The showroom of the modernized establishment has a concrete floor surfaced with asphalt tile in alternating red and white squares. The exterior of

the building has been replaced with an eye-arresting store front, constructed mostly of glass. Fluorescent lighting was installed, and the interior was re-decorated in an attractive pale green and cream color scheme.

One result of the structural face-lifting was a battery of five fine display window displays. Customer-approval of these displays has already been voiced in terms of a rising sales volume.

The location was picked, and the window construction decided upon, after a careful study of traffic movement—both auto and pedestrian—in that area. Not only does auto traffic move along the main thoroughfare on which the store is situated, but much of it starts at this corner.

To draw the attention of passers-by, the store uses its five windows to the best advantage. The firm's display ideas can be summed up as follows: "Make displays simple make them colorful, and light them well."

In a recent window display used by the firm to highlight the new models of radios and phonographs, the window decorating material was crepe paper in an effective combination of canary yellow and emerald green. These colors harmonize with

# Spotlight Sales

the decorative scheme of the store's interior.

A scalloped valance of green paper was carried along the upper edge of the window, while the corners were filled in from top to bottom with fluted, triangular pieces in yellow. Manufacturers' advertising cutouts were effectively worked into the display, too.

"We use to the utmost advantage the dealer helps made available to us by distributors and manufacturers," Moore declared. "Furthermore, the materials used by us in the window cost relatively little, and we are able to dress up our displays and attract customers at small cost."

Each item in the above-mentioned display was given prominence by placing it on a pedestal and covering with crepe paper in one of the two colors used. To stress the "individuality" of each item shown, pedestals of different shapes and sizes were used.

In order to spotlight the attention of passers-by on a particular radio or appliance on display, a crepe paper ornament is attached to the pedestal on which it stands. Another method of achieving this effect is to draw a paper streamer down to the item from the window top above the valance. Devices of this kind enables the store to build a window display around a particular article.

Each of the establishment's single windows, and each section of the double window is lighted by three 40-watt fluorescent lamps installed in a triple fixture. The store interior itself is lighted by 16 fluorescent fixtures mounting four 40-watt lamps each.

"Our window displays," Moore reports, "have a very healthy effect on building sales volume. While we don't have sufficient goods of all types to deliver at present, we do have a very satisfactory back-log of future orders, most of them accompanied by deposits. Moreover, our displays constantly remind passers-by, on foot or in cars, of what we have for sale."

At night, the well-lighted double window can be seen from a considerable distance by potential customers. An illuminated sign suspended over the store is visible from both directions along the main street on which the establishment fronts. The lights are controlled by a time clock and remain on until 11 p. m.

Very frequently, according to Moore, people who see the displays during the evening come in during the day to make inquiries. On Saturday evenings, when the store is open late, there have been as many as 50 families in the store at one time. To maintain a lively interest in the windows, displays are changed on a regular monthly schedule.

Interior displays have been given the same careful consideration as those in the windows. During the remodeling process, wooden roof support posts were replaced with tubular steel columns. Built around each of these is a two-step fixture for the display of small radio models and other small appliances. The steps are covered with linoleum, painted green to match the walls, and have a bright metal binding.

Capped by a rounded molding, a partition, two feet high, separates the display window space from the showroom. This partition is made up of removable panels. The window flooring is raised 17 inches above the showroom floor. The removal of one of the panels gives access to the space between the showroom window area. By this arrangement, room for the storage of small merchandise is provided.

**Howard M. Wygant, vice president and general manager of Moore Appliance Corp., arranges a radio display on a two-step fixture. Built around a roof-supporting pillar, this display shows effectively sets and table appliances.**



## New Device Takes Telephone Messages

An ordinary telephone receiver, a wire recorder, a push-button control box, an elaborate system of acoustic relays,—this is the new "Ipsophone," which can do everything on the phone, and talk too! It automatically answers phone calls, takes and gives messages, records long conversations, faithfully plays back everything it has heard whenever its master commands, and rebuffs unwanted callers with a busy signal. When the owner is busy or out the instrument waits out the caller's four rings, then speaks: "This is the Ipsophone, Blank Co., Mr. Blank's office, attention, please speak—now." The gadget then waits politely twelve seconds for the caller to retrieve his composure, and then repeats the invitation.

### How It Operates

It will record every word for a thirty-minute duration without interruption. To get a complete report any time, the Ipsophone's master can call from outside and, after the machine has announced itself, say firmly, "Hello, hello." The Ipsophone then switches to another track and slowly announces a series of pre-set numbers. After each number in the code the master repeats "hello, hello." At the end of the combination, the Ipsophone plays back the messages. At the end of the message, the Ipsophone emits a sign-off buzz, the signal for the master to command "Erase, Erase," and the record is automatically wiped clean.

### Marketing Plans

The Ipsophone is a German invention, developed during the war by Ernst Keller, a young ballistics expert. About 80 Ipsophones are now being used by Swiss firms, the rental being \$35 per month. The manufacturer is planning to market the machine throughout the world.

Astatic Nylon 1-J

PICKUP CARTRIDGE

X-RAY VIEW

A. 2-64 Ejection Screw  
 B. Crystal  
 C. Needle Guard  
 D. Taper Nylon Chuck  
 E. Taper Nylon Needle Knee  
 F. Sapphire Playing Tip  
 G. Needle Locating Fin

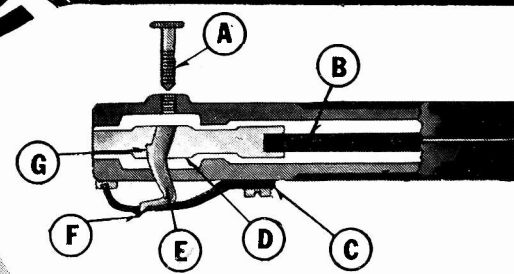



**GIVES AND MAINTAINS IMPROVED PERFORMANCE**

**T**HIS important, new-type Crystal Pickup Cartridge, employing a Nylon Chuck and matched, replaceable, sapphire-tipped Nylon Needle, contributes immeasurably to improved phonograph reproduction. Among its many advantages are: suppression of mechanical resonances of crystal element, improved tracking at low needle pressure, reduced record wear, and permanent needle reproduction with needle replacement advantages. The use of Astatic's Nylon 1-J Cartridge assures phonograph manufacturers and ultimate users or owners alike that the quality of reproduction will remain constant regardless of needle replacements because the Nylon needle is matched to the cartridge and **NO OTHER** type of needle may be used.

The Nylon 1-J Cartridge is furnished with Astatic Studio Master 400 Transcription Pickups and new Model 508 Pickups for 10" and 12" records.

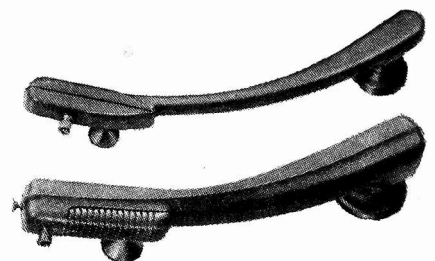

THE **Astatic**

**ASTATIC**

**CORPORATION**

CONNEAUT, OHIO

Astatic Crystal Devices  
 manufactured under Brush  
 Development Co. patents.

IN CANADA: CANADIAN ASTATIC LTD., TORONTO, ONTARIO



# Master Servicing

A SECTION OF RADIO & TELEVISION JOURNAL

*In This Issue*

Diagram of  
Belmont Model  
5D128

Question Box

AUGUST  
1946



**NOW!**  
**MRC-5 PORTABLE  
RECORD  
CHANGER  
PHONOGRAPH**

**Built to MASCO'S  
High Standards of Per-  
formance and Appearance**

#### FEATURES

- Plays 10 twelve-inch records or 12 ten-inch records.
- 2-Post Record Changer...unfailing action...freedom from record spoilage.
- 2-tone luggage-type carrying case.
- Low needle pressure pick-up.
- 3-Tube Amplifier.
- 2.5 Watts Power Output.
- Five-inch Alnico 5 P. M. Speaker.
- Separate tone and volume controls.
- 115-Volt 60-cycle operation.

We're proud to present this handsome, sturdy, luggage-type model. Compact and acoustically built, it is destined for big sales on its eye appeal and splendid performance.

Note the many outstanding listed features.

In line with MASCO policy this unit will be priced competitively.

#### EARLY DELIVERY

Price Pending OPA Approval  
Write Dept. C

**MASCO**

MARK SIMPSON MANUFACTURING CO., Inc.  
32-28 49th Street, Long Island City 3, N.Y.



**SOUND SYSTEMS and Accessories**

RAvenswood 8-5810-1-2-3-4

# BELMONT MODEL 5D128

## ELECTRICAL SPECIFICATIONS

**Power Supply** ..... 105-125 volts, DC or 50-60 cycle AC, 27 watts. 25-cycle model also made.

**Frequency Range** ..... 530-1650 kc.

**Intermediate Freq.** ..... 455 kc.

**Antenna** ..... Built-in loop; provisions also for external antenna connection.

**Tuning** ..... Two-gang capacitor.

**Speaker** ..... 5-inch, P.M., voice coil impedance 3.2 ohms.

**Power Output** ..... 0.94 watt undistorted. 1.4 watts maximum.

**Sensitivity** ..... 30 microvolts average for 50-milliwatt output.

**Selectivity** ..... 52 kc. broad at 1000 times signal at 1000 kc.

### ALIGNMENT PROCEDURE

- Output meter across 3.2-ohm output load.
- Volume control at maximum.
- Chassis must be removed from cabinet for proper alignment. Slight adjustments of the oscillator and antenna trimmers can be made, without removing the chassis, through holes provided on the bottom of the cabinet.
- Connect ground post of signal generator to B- of radio.
- Align for maximum output. Reduce input as needed to keep output near 0.4 volts.

SIGNAL GENERATOR			TUNER SETTING	ADJUST TRIMMERS TO MAXIMUM OUTPUT (in order shown)
Frequency	Coupling Capacitor	Connection to Radio		
455 kc	1 mf	12SA7 grid	Rotor full open (plates out of mesh)	Input and output trimmers on IF cans
1650 kc	.1 mf	12SA7 grid	Rotor full open (plates out of mesh)	Oscillator trimmer C4
1400 kc†	None	See note below	1400 kc	Antenna trimmer C2

† For this adjustment chassis should be removed in cabinet and loop connected. Lay generator lead near loop and turn up output. Loop will pick up energy. Antenna trimmer can be reached through a hole in the bottom of the cabinet.

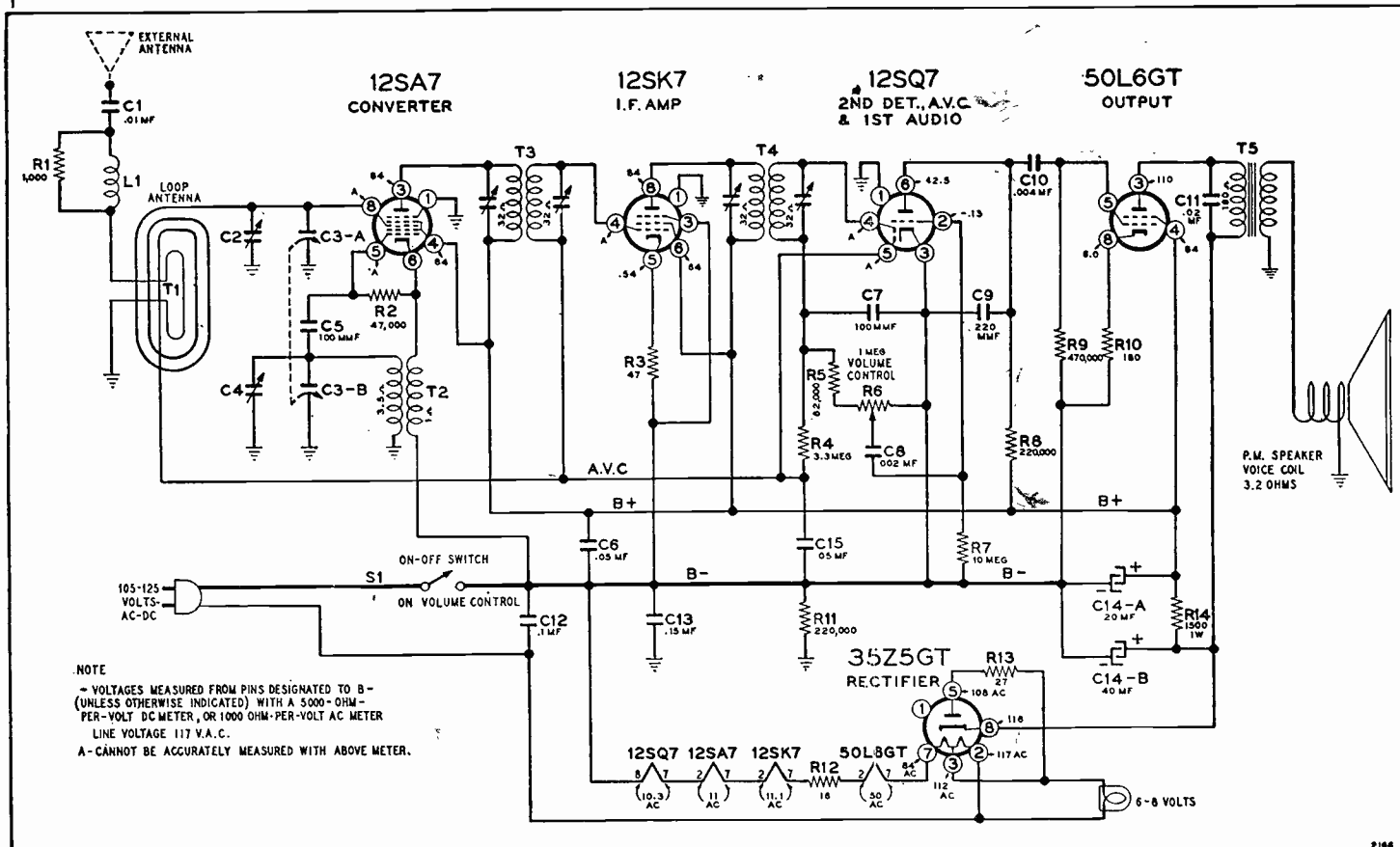

NOTE  
 - VOLTAGES MEASURED FROM PINS DESIGNATED TO B- (UNLESS OTHERWISE INDICATED) WITH A 5000-OHM-PER-VOLT DC METER, OR 1000 OHM-PER-VOLT AC METER. LINE VOLTAGE 117 V.A.C.  
 A-CANNOT BE ACCURATELY MEASURED WITH ABOVE METER.



# Highlights in THE 1946

## Jensen LINE

★ *Hypex*  
PROJECTORS

★ **COAXIAL**  
SPEAKERS

★ *Speech Master*  
REPRODUCERS

★ *Bass Reflex*  
REPRODUCERS

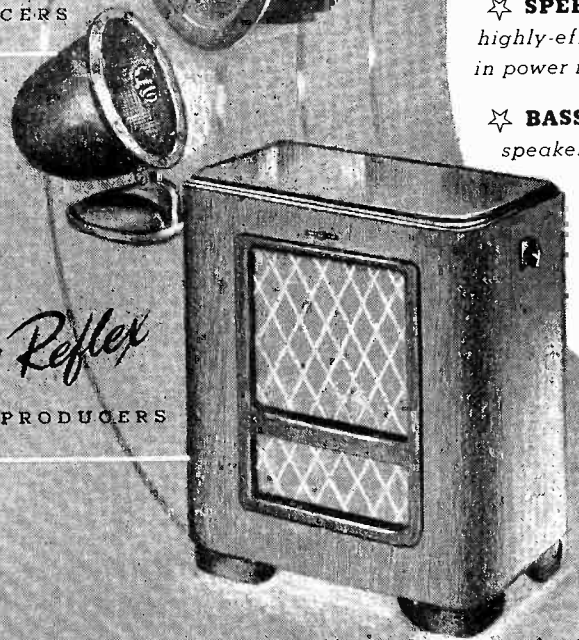
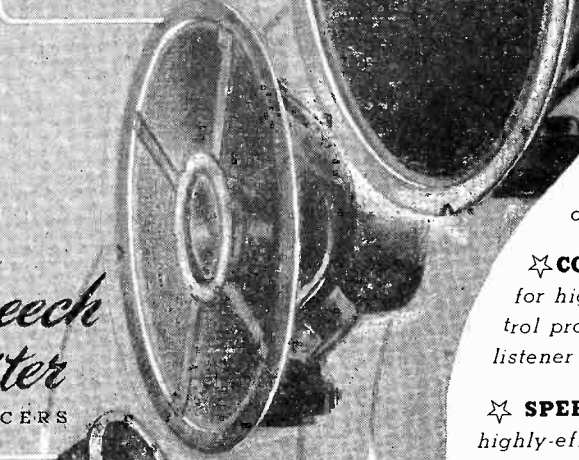

★ **HYPEX Projectors** better than ever—more efficient. They have the famous Hypex "flare formula"—not exponential—developed by Jensen acoustical research. Driver units employ the Jensen "Annular" diaphragm, clamped at periphery and center—another exclusive feature!

★ **COAXIAL Speakers.** Now four improved 15" and 12" designs for high-fidelity, extended-range reproduction. High-frequency Control provides instant fidelity adjustment to suit program quality and listener preference. Available in complete Reproducers.

★ **SPEECH MASTER Reproducers.** Designed especially for crisp highly-effective speech reproduction. Desk-, panel-, wall-mounting types in power ratings for low-level and high-level applications.

★ **BASS REFLEX\* Reproducers.** A complete line of reproducers with speaker installed, or enclosures only, in fine furniture or utility styles—all with the smoothly extended low-frequency range for which Jensen Bass Reflex is justly famous.

\*Trade Mark Registered

*These are only a few of the many distinguished products in the complete Jensen line. Write for catalogs and data sheets for further information.*

JENSEN MANUFACTURING COMPANY  
6623 S. LARAMIE AVE., CHICAGO 38, ILLINOIS  
In Canada—Copper Wire Products, Ltd. 11 King Street West, Toronto

**Jensen**  
SPEAKERS  
WITH **ALNICO 5**

*Specialists in Design and Manufacture of Acoustic Equipment*



# The Master

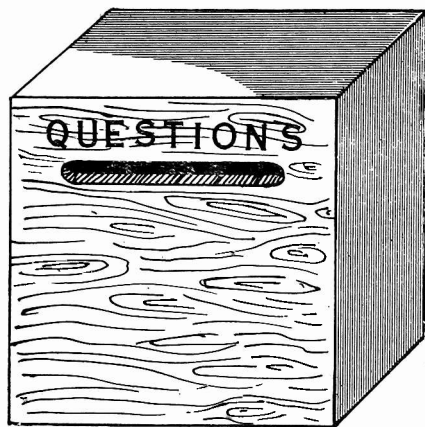

# Servicemen's

## QUESTION BOX

**Question:** I have an automatic record player which produces music with a rhythmic growling, a sort of wow-wow effect. It seems that the record increases in speed and slows down alternately during each revolution. The tone-quality of the phonograph is completely spoiled by this misbehavior. What part of the machine should I suspect?

**Answer:** *This kind of trouble is found in many makes of automatic record players, but it is usually no fault of the machine. It is caused by the operator leaving the records on the selector blade supports for several days. In some players the record rests only on a small support at each side of the record, while in others it rests on a support at one side and one at the center. The records remain on these small supports and become warped. It is the bent records that cause the annoying growling by producing varying pressure on the needle. Some times the records are so badly warped that the selector blades cannot slide between them to take a record from the stack, causing the whole machine to jam. Your customers might be tactfully told that the records should not be left on the selector blade supports for any appreciable length of time. Warped records may be straightened by stacking them in a pile*

*with one thickness of newspaper between each record, putting a flat board on top, large enough to cover a record, and weighing down the stack. The pile of records should remain under pressure for at least two weeks.*

**Question:** An auto radio had performed perfectly for several months, but suddenly developed interference which was present only when the motor was running. I replaced suspected tubes and checked all loose connections. The battery voltages seem O.K.

**Answer:** *Try checking for trouble in the ignition and generator systems. With the set installed in the car, the motor should be run until the generator is charging at full capacity. Then quickly turn off the ignition switch. The generator is then still charging but the ignition is dead; and, if the interference is still heard this of course is proof that the ignition is not the source of the trouble. Next loosen the generator, throw off the belt, and start the motor. No interference now definitely establishes that the generator is causing the trouble. If a new condenser installed on the generator does not eliminate all the noise, the commutator should be cleaned by holding a strip of 000 sandpaper on it while the motor is running. The brushes should be resealed by lifting each slight-*

*ly, slipping the sandpaper between the brush and the commutator, sand side up, and rocking the commutator and sandpaper both at the same time. Hold the paper down against the commutator with the fingers on both sides of the brush. Reseating the brushes should completely eliminate the interference.*

**Question:** The motor of a record player brought into my shop fails to run until the turntable is started by hand; then it drags and squeaks. Lubricating the bearings has not helped very much. Can you suggest something that I haven't looked for?

**Answer:** *It has been our experience that phonograph motors frequently become stuck either because of improper lubrication, or the lack of lubrication. Try freeing the motor by squirting a few drops of gasoline into the bearings with an oil can or eye dropper. Move the shaft by hand until the gasoline works in. When the shaft feels free turn on the motor and let it run to free it further. Then oil the motor bearings with SAE #10 oil or its equivalent. In stubborn cases, where the motor will not loosen, it must be taken apart. The shaft and bearings should be washed in gasoline and lubricated as above mentioned, and reassembled. It should then run like new.*

**Question:** I have come across several Philco models 608P and 610P which operate satisfactorily on radio position but when switched to phonograph position have a disturbing hum very similar to that produced by an open grid circuit. However, detailed checking of the sets shows no such trouble and all filter circuits check O.K.

**Answer:** We have found that these radio-phonograph combinations, as well as a good majority of the beam-of-light combinations are very susceptible to this type of trouble. This hum is caused by magnetic pick-up of the power transformer's field. This can be checked by removing the black shielded lead from the coupling transformer to the set; this should stop the noise. Reinsert this lead and remove the brown lead from the pick-up to the coupling transformer; the noise should continue. A good remedy is to remove the coupling transformer from the top of the cabinet, mounting it on the left-hand side of the cabinet approximately eight inches from the top. This should effect a disappearance of all the hum.

**Question:** One of my customers brought in a Firestone Model #S7406-7 with the complaint that it lacked volume. A thorough bench check of this set revealed one weak tube but no circuit defects. After the tube was replaced and the set returned to the customer he came back with the same complaint. Is there something I haven't looked for?

**Answer:** Probably your customer is living in a neighborhood where receiving conditions are very poor. We recommend that an external antenna, as high above all obstacles as possible, be installed. The antenna lead-in wire should be connected to the "A" terminal on the chassis rear, and a good ground connected to the screw marked "G." This should appreciably increase the volume for the reception of all stations.



**RAYTHEON**  
MANUFACTURING COMPANY

*Excellence in Electronics*  
RADIO RECEIVING TUBE DIVISION  
NEWTON, MASSACHUSETTS CHICAGO

... and put Raytheon tubes in my set please." That's the customer specifying "Raytheon" — a name he knows to be synonymous with quality and dependability. Stock Raytheon tubes to keep your customers happy; to keep your business growing.



**ANOTHER NEW MODEL**  
*by Newcomb*  
**The KXP-30**  
**Phonograph or Monitoring Amplifier**

Again leading the field in the production of quality sound equipment...

Newcomb announces a NEW MODEL 30-Watt phonograph amplifier, the KXP-30... Its truly remarkable performance, its unusual flexibility of application make the KXP-30 the perfect answer to the amplifier needs of the most critical... For wired music reproduction; as a monitoring or playback amplifier for broadcast or recording studio, the KXP-30 is unequalled... In the home, as a deluxe phonograph amplifier, its full quality treble and bass tones at even lowest volume levels make this outstanding contribution by Newcomb the newest answer to the postwar demand for quality in the sound reproduction field... Freedom from hum; dual-acting, distortion free individual tone controls; extended flat frequency response from 20 to 20,000 cycles... these and many other features combine to make the KXP-30, as all Newcomb products, the logical choice of the quality-minded buyer... *Not Merely as Good as the Others, but Better than All Others!*

Send for details of our complete line of sound equipment.

**THE SOUND OF QUALITY**

*Newcomb*  
**AUDIO PRODUCTS CO.**  
MANUFACTURERS  
DEPT. H 2815 S. HILL STREET, LOS ANGELES 7, CALIFORNIA

# RECORD RELEASES

## ARA

- 157 What Is This Thing Called Love—Ginny Simms with Lou Bring Orchestra  
I Get a Kick Out of You  
158 It's a Wonderful World—Jan Savitt  
Swingin' Back to Bach  
159 Idaho—Town Criers  
Where the River Shannon Flows

## COLUMBIA

- 37050 Somewhere in the Night—Frank Sinatra  
One Love  
37055 Night and Day—Claude Thornhill & Orchestra  
Smiles  
37056 Bothered by the Blues—Wiley Walker and Gene Sullivan  
After I'm Gone  
37053 Blue Skies—Benny Goodman & Orchestra. Vocals by Art Lund  
I Don't Know Enough About You

## DECCA

- A-458 Andrews Sisters Album—Five records of songs which this trio helped popularize, including Beer Barrel Polka, Beat Me Daddy, Eight to the Bar, and others  
A-469 Al Jolson Album—Old-time favorites such as California, Here I Come, April Showers and Sonny Boy are among those in this album  
40009 Passé—Jean Sablon  
These Foolish Things  
23615 To Each His Own—Ink Spots  
23622 In a Shanty in Old Shanty Town—Johnny Long & Orchestra  
Blue Skies  
23616 Coconut Grove—Harry Owens & His Royal Hawaiian Hotel Orchestra  
My Isle of Golden Dreams  
45002 Bass Polka — "Whoopie"—John Wilfahrt & Band  
Jenny Polka  
DA-420 The Happy Prince—Bing Crosby and Orson Welles with supporting cast, music and sound effects from an Oscar Wilde fairy tale.  
23611 Something Old, Something New—Dick Haymes and Helen Forrest  
Why Does It Get So Late So Early  
B-1023 Songs of Trinidad Brunswick Album of Calypso classics composed and sung by Wilmoth Houdini and Gerald Clark's Night Owls  
50001 Amigo (Bolero)—René Cabel  
Tu Nombre (Bolero)  
18876 And Then It's Heaven—Russ Morgan & Orchestra  
Under the Willow Tree  
18777 Guitar Polka—Lawrence Welk & Orchestra  
Rogue River Valley

## DIAMOND

- 2035 Which Way Did My Heart Go—Nat Brandywynne Orchestra  
All of Me

- 2036 I Got the Sun in the Morning—Nat Brandywynne Orchestra  
Sweetheart of Sigma Chi  
2037 Boa Hog Blues—Ken Billings Trio with Irene Wiley  
Irene's Boogie Blues  
2038 Big Fat Joe—Ken Billings Trio with Irene Wiley  
My Milkman

## DISC

- 604 School Days—From Songs to Grow on Series, sung by Charity Bailey  
5054 Rosie (Make It Rosie For Me)—Pee Wee Russell Jazz Ensemble  
Take Me to the Land of Jazz  
5055 I'd Climb the Highest Mountain—Pee Wee Russell Jazz Ensemble  
Red Hot Mama

## RCA

- M-1053 Brahms' Hungarian Dances—Erica Morni, violinist, with Arthur Balsam at the piano  
11-9189 Village Swallows Waltzes—Boston Pops Orchestra with Arthur Fieldler, conductor



## Our Hats off to The "Birch" Line of Portable Phonographs

The unanimous verdict of the thousands of dealers who attended the recent convention in Chicago . . . "The Birch line of portable phonographs stole the show." Here are the very good reasons why:

They are built by seasoned phonograph manufacturers who developed the "Know-How" through 25 years of styling and improving the phonograph.

Thorough planning and engineering of design have made these graceful, stream-lined models different in every way.

And what a tone each Birch model has . . . tone that outreaches in volume and quality anything of equal size. A truly wonderful combination of design, coverings, special features and tone.

### YOUR NEAREST DISTRIBUTORS WILL GLADLY ACQUAINT YOU WITH THE VALUE OF "BIRCH" FRANCHISE

- |   |  |
|---|--|
| ALABAMA, Birmingham—Forbes Dist. Co., 1912 Fourth Ave.                  | NEW JERSEY, Newark—Dale-New Jersey, Inc., 79 Lock St.                      |
| ARKANSAS, Little Rock—Frank Lyon Co., 1020 Main St.                     | NEW YORK, Albany—B. H. Spinney Co., 97 Broadway.                           |
| CALIFORNIA, Los Angeles—Pacific Music Supply Co., 1024 South Santee St. | NEW YORK, Buffalo—Radio Equipment Corp., 147-151 Genesee St.               |
| CALIFORNIA, San Francisco—J. M. Sahlein Music Co., 718 Mission St.      | NEW YORK, New York—Dale Dist. Co., 40 East 32nd St.                        |
| COLORADO, Denver—Finch-Ernest Corp., Speer Blvd. at 9th Ave.            | NEW YORK, Rochester—Erskine-Healey, Inc., 420 St. Paul St.                 |
| CONNECTICUT, New Haven—Dale-Connecticut, Inc., 240 Whalley Ave.         | NEW YORK, Syracuse—B. H. Spinney Co., 1133 West Genesee St.                |
| D. C., WASHINGTON—Washington Wholesalers, 1733 Fourteenth St., N. W.    | NORTH CAROLINA, Charlotte—Southern Radio Corp., 1201 W. Morehead St.       |
| FLORIDA, Miami—Florida Radio & Appl. Corp., N. W. Fifth St. at 1st Ave. | OHIO, Cincinnati—The New York Supply Co., 2624 Colerain Ave.               |
| GEORGIA, Atlanta—Hopkins Equipment Co., 418 W. Peachtree St., N. W.     | OHIO, Cleveland—Arnold Wholesale Corp., 5209-5215 Detroit Ave.             |
| ILLINOIS, Chicago—Pilgrim Dist. Co., 600 W. Jackson Blvd.               | OHIO, Columbus—Appliance Dist. Corp., 174 No. Front St.                    |
| IOWA, Davenport—Midwest-Timmermann Co., 114-116 Western Ave.            | OHIO, Dayton—The New York Supply Co., 531 E. Third St.                     |
| LOUISIANA, New Orleans—United Dist., Inc., 510 Poydras St.              | PENNSYLVANIA, Allentown—Bell-Clark & Co., 14th & Gordon Sts.               |
| MAINE, Portland—Hub Cycle & Radio Co., Inc.                             | PENNSYLVANIA, Philadelphia—Pierce Phelps Dist., Fifth & Noble Sts.         |
| MARYLAND, Baltimore—Nelson & Co., Inc., 1000 S. Linwood Ave.            | PENNSYLVANIA, Pittsburgh—Hamburg Bros., 305 Penn Ave.                      |
| MASS., Boston—Hub Cycle & Radio Co., Inc., 596 Commonwealth Ave.        | RHODE ISLAND, Providence—Milhender Distributing Co., 387 Charles St.       |
| MASS., Boston—Milhender Dist., Inc., 619 Atlantic Ave.                  | TENN., Knoxville—C. M. McClung & Co., Inc.                                 |
| MASS., Springfield—B. H. Spinney Co., 62 Hampden St.                    | TENN., Memphis—P. F. Crenshaw, Jr., Co., 32 West Iowa Ave.                 |
| MASS., Worcester—Walker Electrical Supply Co., 15 Union St.             | TEXAS, Dallas—Adleta Co., 1900 Cedar Springs.                              |
| MICHIGAN, Detroit—Brennan Appliance Dist., 5245 Grand River Ave.        | TEXAS, El Paso—Midland Specialty Co., 427 W. San Antonio St.               |
| MICHIGAN, Menominee—Wm. Van Domelen Co.                                 | TEXAS, Houston—Reader's Wholesale Dist., 414 Washington.                   |
| MINN., Minneapolis—W. R. Beamish Co., 1612 Harmon Place.                | UTAH, Salt Lake City—Mountain States Dist., Inc., 32 Exchange Place (103). |
| MISSOURI, Kansas City—Jenkins Music Co., 1217 Walnut St.                | VIRGINIA, Richmond—Wyatt-Cornick, Inc., Grace at 14th St.                  |

**Ted McElroy**  
World's Largest Manufacturer of  
Wireless Telegraphic Apparatus  
COMPLETE CENTRAL OFFICE EQUIPMENT  
**McElroy Manufacturing Corp.**  
82 Brookline Avenue • Boston, Massachusetts

**BOETSCH BROS.** 221 EAST 144th ST.  
NEW YORK 51, N. Y.



# ***Sells MORE Appliances***

**Separate departments for each line boosts volume; planning helps avoid pre-war merchandising drawbacks.**

Outside selling on an unusual prospect plan is an outstanding feature of the new major appliance department which Bullock's, Los Angeles, recently completed.

The new department, managed by A. P. Moffatt, has 7,000 square feet of floor space which makes it one of the largest on the West Coast. It includes separate sales departments for each major appliance line, two model kitchens for demonstrations and cooking schools, unusual display ideas, and sales helps in the form of private sales-closing offices, telephone offices and an independent sales promotion office.

The department was planned specifically to eliminate all pre-war drawbacks to effective appliance merchandising. First, all lines are separated by brands. Five brands of refrigerators will thus be five distinct departments, showing from ten to fifteen models contrasted against kidney-shaped plywood pictures. Customers who come in to see a particular make of refrigerator will not be distracted by the sight of others. The same is true of

seven lines of washing machines, seven of ranges, etc. All displays are "broken up" to capitalize on brand loyalty. Only when a customer demands to see something else will she be escorted from the display at hand. Bullock's salesmen voted 100 per cent for this plan, designed to save time in closing sales.

In the rear will be a laundry section with all automatic washers, ironers and supplementary equipment. A proposed home freezer department will also be added. In the extreme rear is the separately-managed radio department with record listening booths, and a kidney-shaped display panel for vacuum sweepers.

A striking feature is six large inset bays, three on each side of a sloping ramp which leads up into the half-story appliance department from the main floor. Measuring 8 x 8 feet by 4 feet deep, these are plaster-finished "picture frames" in which Mr. Moffatt will show one appliance from each line, where the largest number of passers-by can see them.

*(Continued on page 44)*



**This section of the store is devoted to merchandising gas ranges. Seven lines of ranges are carried by the firm.**

(Continued from page 43)

Brilliantly lighted, these bays tell the whole appliance story at a glance, and salesmen expect to "fish prospects from the ramp" frequently. The last two bays will be two small kitchenettes, with small range, refrigerator and sink for selling apartment dwellers.

Bullock's expects a heavy volume of package kitchen sales, difficult for the store in the past because of insufficient space. Therefore, the new department contains two complete model kitchens, one all-gas, one all-electric, large enough for cooking demonstrations, and designed to fit Los Angeles homes.

A cooperating appliance distributor will arrange contracting for installation, or the customer can pay for this separately, if desired. More model kitchens may be added later, when Mr. Moffatt has tested the market thoroughly.

Cooking schools will average twice a week, but instead of jamming the department they will be conducted in the upstairs store auditorium which seats 1,600. With appliances and equipment mounted on wheels, the appliance department will furnish everything used and circulate prospect cards directly.

By far the most outstanding step is intelligent sales management, which Mr. Moffatt hopes will eliminate many errors in appliance merchandising. The store will use an inside crew of 16, including several women on kitchens, vacuums, and other lines. When stock becomes plentiful, Bullock's will likewise operate an outside selling crew, who will remain *strictly outside the store*.

"Every outside man will have a good, thoroughly profitable job," Mr. Moffatt explained. "Each

floor man inside will be given a specific length of time to close the sale with any prospect—from seven to ten days. If at the end of this time he has not made the sale, the prospect goes to the outside man who is stationed in the territory where the prospect lives. The city will be zoned for each man, varying in size to give each the same earning opportunities. Outside men will receive double commissions as an incentive to keep them working. This will get rid of the situation where a salesman has a good week, then shirks for the next several days and doesn't make calls. Under our plan outside salesmen will get car expenses, and be induced to make plenty of calls, at night, during the day, or whenever possible."

This passing along of prospects will be fair to floor men—any of whom are entitled to jump in their cars any evening and make outside calls. If they do not, the prospects are no longer theirs; even if the inside man made the first contact. Bullock's reasons that this means two men have worked on every prospect before he is lost altogether. Outside men, in addition, will get all calls coming in from their zones, plus regular customers who ask for a man to call. "We want our outside men to be reliable, ambitious, and equally well paid with the inside staff," Mr. Moffatt summed up.

The ill-will and loss usually resulting from poor service or warranty maintenance on appliances has been gotten rid of by building a complete new service shop. Elaborately set up, it will be geared to overhaul completely any appliance from a sweeper to a refrigerator. The shop is located in a downtown warehouse, and will give very rapid service on any Bullock-sold appliance.

The sales approach in the department is pointed toward complete package kitchens which the store hopes to make its chief postwar appliance field.

**View of Bullock's appliance department. The firm aims at selling many "packaged" kitchens. Separate inside and outside sales crews will be employed to sell more goods. Cooking schools will be used to draw prospects to the establishment. Two complete model kitchens, one all gas and the other all electric, are on display at the store.**



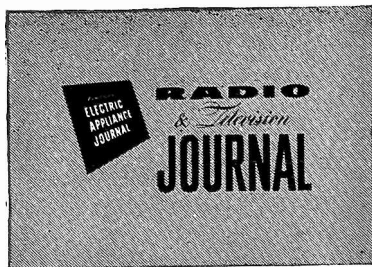

# TRADE NEWS

Accurate reports about People and Events in the Industry.

## National Electronics Conference Oct. 3rd to 5th

The National Electronics Conference will be held in Chicago at the Edgewater Beach Hotel on October 3rd through the 5th. Included in the program will be exhibits of electronic developments, technical sessions presided over by leaders in the industry, and luncheons and banquets. For conference and hotel reservations, write to the hotel at Chicago 40, Ill.

## To Distribute Howard Radios in West

Negotiations have been completed and contracts signed between the Howard Radio Co., Chicago, and Associated Radio Distributors, San Francisco, for the latter firm to distribute Howard radios and combinations to dealers in northern California and ten counties in Nevada.

The distributing firm recently opened new headquarters in a two-story building at 1251-53 Folsom St., in San Francisco. The quarters are modernly designed and contain a large display floor area with streamlined show cases. Attractively-built floor displays are being used to show new merchandise in an effective manner.

## Presto Names Aldrich General Sales Manager

Presto Recording Corp. announces the appointment of Thomas B. Aldrich as general sales and advertising manager to succeed R. C. Powell. Mr. Aldrich has been with the company for the past ten years in the capacity of factory sales engineer in the New York metropolitan area.

## National Union Adds Radios to Line

J. J. Clune, sales manager, distributor division, National Union Radio Corp., Newark, N. J., announces the addition of radio receiving sets to the company's expanding line of electronic equipment and parts for national distribution.

Mr. Clune points out that

NU's merchandising policy continues to emphasize the promotion of products directed particularly to the needs of its radio parts distributors and independent radio service dealers. Part of the company's



## N.U. PRESENTATION MODEL

policy is the elimination of quota commitments on the part of the distributor and dealer, thus insuring a balanced inventory and a profitable turnover.

The "Presentation Model," G-619, 6-tube AC-DC receiver is the first of a series of 5 diversified models soon to be announced. This first table model is housed in a rich-toned mahogany all-wood cabinet. It employs a 6-tube r.f. super-heterodyne circuit with broadcast band tuning and full vision slide rule dial scale. Set has built-in loop antenna and measures 13 inches wide, 8¾ inches high and 6½ inches deep.

## GE Announces Plans for New Radio-Tele Models

An all-purpose home entertainment instrument, combining television, frequency modulation, standard broadcast and a record-player, will be produced next year by the Receiver Division of the General Electric Co.

Announcement of plans to market this complete unit, which will sell for approximately \$475, has been made by Paul L. Chamberlain, manager of sales for the division, at a special sales meeting of district managers of the Electronics Department.

This model will be equipped with a ten-inch picture tube affording a picture of approxi-

mately eight inches wide by six inches high and will be able to tune in all 13 television channels without the need of service work, Mr. Chamberlain said.

In addition to AM reception, this model will receive FM on the new frequency band and will also have an automatic record player in the phonograph.

Mr. Chamberlain said that the company plans to market four television receivers by next year. They will range from a small direct view table model to a de luxe large-screen projection receiver which will sell for almost \$1,200.

District managers who attended the meeting, which covered sales, manufacturing and advertising, were: W. M. Boland, San Francisco; R. J. Meigs, Kansas City; W. M. Skillman, Dallas; G. S. Peterson, Chicago; R. P. Van Zile, Cleveland; T. B. Willard, Atlanta; T. B. Jacobs, Phila.; H. J. Mandernach, New York, and R. L. Hanks, Boston.

## Electromatic Display Card



Electromatic Mfg. Corp., 88 University Pl., New York, is making available to its retailers counter and window display cards of its table radio-phonograph combinations.

## Majestic Appoints Lindholm Division Manager

Announcing a key appointment in the field organization of its West Coast division, Majestic Radio & Television Corp., and Majestic Records, Inc., have named A. J. Lind-

holm as acting division manager.

"Al" Lindholm has been with McCormack & Co., San Francisco wholesale distributors of Majestic radios and records and other household appliances, in the capacity of manager of the Majestic radio and record division. Mr. Lindholm's headquarters are located in San Francisco.

## OPA Grants Increase to Fixed Capacitor Makers

Office of Price Administration has announced that manufacturers of fixed capacitors have been given an additional interim increase of 10.2 per cent over their base date prices for fixed capacitors.

This action, effective August 12, provides the price increase by changing the increase factor granted producers of these radio parts on October 11, 1945, from 16.4 per cent to 26.6 per cent.

## Roberts & Mander Issue New Catalog and Manual

A few full-color catalog featuring "Quality" steel cabinets and cabinet sinks has been published by Roberts & Mander Corp., Hatboro, Pa., makers of "Quality" Ranges.

The entire "Quality" steel kitchen cabinet line is illustrated and described in this book, which is of value in planning the modern kitchen. The outstanding feature of this catalog is a full-color center spread, which shows a modern kitchen completely equipped with steel cabinets, sink, and range.

In addition to the catalog, a complete and easy-to-follow installation manual is also available. This manual gives simple instructions for the proper installation of "Quality" cabinets, and helpful hints in planning and laying out the modern kitchen. The book will be useful to dealers in renovation work.

## Walsco Contest Open to Radio Technicians

Walter L. Schott Co., Beverly Hills, Calif., producers of the Walsco line, is inaugurating a price contest open to all radio technicians, servicemen, hams, etc. \$1,000 worth of prizes such as a typewriter, wrist watch, automobile tires,



set of Rider's Manuals, and many other valuable prizes will be awarded for suggestions for new items to be added to the Walsco line. All that is required is a short description or sketch of items needed by servicemen or technicians and not already available in practical form.

This contest closes September 30. All entries must be submitted on blanks which are available at all radio parts jobbers.

#### Distributor Appoints Six to Sales Staff

The appointment of J. J. McCormack as sales manager has been announced by Slap & Lasky of Philadelphia, distributors of radio and electrical appliances in eastern Pennsylvania, South Jersey and Delaware.

Additional appointments made to the sales staff of this firm were Roy Siegel as manager of ARA record division; Paul Lasky, Frank F. Curson, Marvin Glouser and Theodore Kaplan all of whom have been recently discharged from the U. S. Army.

#### Decca Records Elects Three New Officials

New York officers for Decca Records, Inc., were elected at a meeting of the company's board of directors held recent-



MILTON R. RACKMIL

ly, Jack Kapp, president of the company, announces.

Milton R. Rackmil, previously vice president and treasurer of Decca, was named executive vice president. Harry C. Kruse, former vice president of Decca Distributing Corp., and Leonard W. Schneider, former director of advertising and sales promotion for the company, were elected vice presidents. Samuel Yamin was named secretary; Louis A. Buchner, treasurer; Isabelle Marks, assistant secretary, and Irving Wiener,

assistant treasurer. David Kapp continues as vice president in charge of recording.

"All of our newly elected officers have served Decca Records, Inc., faithfully for a number of years and have played a leading part in bringing recorded entertainment to a new level of excellence," Mr. Kapp stated when he announced the appointment of the new officers.

#### Electrical Industries Point-of-Sale Aid

Electrical Industries, Inc., 42 Summer Ave., Newark 4, N. J., is offering a new compact easel display that merchandises its product at point of sale. This help for dealers measures 10 inches wide by 4 inches deep, and provides separate display of the firm's bottle warmer, its gift package and the new design, uni-vent vaporizer receptacle.

The display is easily set up, and to prevent tearing it is broken in at the folding points. It is printed in two colors on heavy display board with all outside surfaces varnished.

#### D. W. May Takes Dealers on Cruise

The D. W. May Corp., New York distributors, announced a short time ago the first cruise for the radio and appliance industry since Victory. The party will leave New York on September 28 on a special train arriving in Montreal late that afternoon, and all guests will be transferred to the "S. S. Tadoussac" for a cruise up the St. Lawrence and Saguenay Rivers.

At the time, the May organization announced this, there was no merchandise available to make this trip possible, and so arranged that those retailers could purchase this trip at a very nominal fee, and the May organization would take care of any other expenses incurred.

It is announced by D. W. May, president of the firm, that arrangements have been made to furnish a package of merchandise, so that their retailers could enjoy this trip without outlaying any money for same, but by purchasing merchandise at OPA list price, and at full discount. They are offering a free trip on a purchase of 28 Burkaw safety electric heaters at \$27.80, less the full regular trade discount.

#### Nezerka Promoted by Turner Co.

Renald P. Evans, president of The Turner Co., Cedar Rapids, Iowa, recently announced that William J. Ne-



WM. NEZERKA

zerka has been named vice president and sales manager of the Turner firm and elected to the board of directors. Mr. Nezerka has been sales manager of the firm which produces microphones and electronic devices.

Mr. Nezerka has been largely responsible for the development of Turner's sales organization which now covers the entire United States and export markets.

#### Bickford Bros. Distributes Duo-Therm Products

The appointment of Bickford Brothers Co., western New York distributors of electrical and home appliances, radio and records, as representatives for Duo-Therm oil furnaces and space heaters in the vicinity of Rochester and suburbs is announced by the Duo-Therm division of the Motor Wheel Corp.

In conjunction with their program to introduce the Duo-Therm line to their dealers, Bickford Brothers Co. has made extensive plans for a special meeting to be held this month at Hotel Rochester. Charles Corcoran, sales manager of the company, is in charge of arrangements and will lead the discussion of Bickford's pending merchandising and promotional plans for the Duo-Therm products with retailers attending the meeting.

The Rochester distributing company plans to make available their advertising, store display, sales personnel training and other promotional resources in helping retailers.

#### Dealer Group Outing

The Electrical Appliance Merchants' Assn. of Queens County, Inc., New York City, held its annual outing on the 20th of this month at the Timber Point Club, Long Island, N. Y. The principal event of the day featured a soft ball game between retailers and distributors. A gala time was held by all those attending the function.

#### E-L Announces New Phonograph Attachment

A new vibrator inverter, designed to permit operation of alternating current phonographs with direct current, is now in production by Electronic Laboratories, Inc., of Indianapolis, according to Walter E. Peek, vice president.

Compactly designed for convenient installation under the turntable or in a corner of the phonograph cabinet, the unit measures 4½ x 4 x 2¼ inches and weighs only 14 ounces. With an input of 115 volts direct current, the inverter's output is 110 volts, 60 cycle alternating current, providing a maximum load capacity of 25 watts.

Though primarily intended for use with a phonograph, the vibrator inverter may also be utilized with timing devices, ac electric razors and similar equipment incorporating the use of small synchronous motors with low wattage requirements.

Electronic Laboratories also manufacture inter-communication systems, vibrator power supplies, aircraft equipment, electronic toys and other specialized electrical equipment.

#### DX Radio Products Moves

According to Tom Centracchio, vice president and general manager of DX Radio Products Co., Inc., general offices as well as all production will be moved to 2310 W. Armitage Ave., Chicago, by September 1. The DX radio speaker and crystal divisions, formerly at 1552 Milwaukee Ave., are already set up and in production at the new address. Coil, loop antenna, machine tool and transformer manufacturing will be moved without work interruption, in order to keep pace with the necessary shipments of these vital radio components.

The firm also reports a new jobber line, details of which will be forthcoming soon.

## Prefabricators

(Continued from page 30)

- Stout Houses, Inc.,  
212 Stephenson Blvd.,  
Detroit 2, Mich.
- Stratmoor Co.,  
14000 Grand River,  
Detroit 27, Mich.
- Sturtevant Millwork & Lumber Corp.,  
Metz Homes Div.,  
Hicksville, L. I., New York.
- Tacoma Lumber Prefab Co.,  
3001 No. Starr St.,  
Tacoma, Wash.
- Takapart Products Co.,  
Babylon Turnpike,  
Freeport, N. Y.
- Tec-Bilt Homes of Miami, Inc.,  
Ludlum Drive and Rosedale Drive,  
P. O. Box 95,  
Miami Springs, Florida.
- Texas Prefabricated Housing Co.,  
9003 Denton Drive,  
Dallas, Texas.
- Thomas Cabinet Shop,  
Box 157, Route 4,  
Kent, Wash.
- Timber Structures,  
3400 N. W. Yeon Avenue,  
Portland, Oregon 8.
- Timber Structures, Inc.,  
316 New York Ave.,  
Trenton, N. J.
- Tovell Construction Co.,  
403 W. Monument St.,  
Baltimore, Md.
- Unicon, Inc.,  
912 Baltimore Ave.,  
Kansas City, Mo.
- Universal Fabricating & Mfg. Co.,  
213 E. Randolph,  
Enid, Okla.
- United Housing Products Co., Inc.,  
310 Richardson St.,  
Brooklyn, N. Y.
- U. S. Homes, Inc.,  
B-6 Bldg.,  
Bell Aircraft B-29,  
Assembly Plant,  
Marietta, Ga.
- U. S. Lumber & Construc. Co.,  
500 No. Stanford Rd.,  
Columbus 9, Ohio.
- U. S. Portable Housing Co.,  
1629 K Street, N. W.,  
Washington, D. C.
- U. S. Plywood Corp.,  
55 West 44th St.,  
New York, N. Y.
- Vacuum Concrete, Inc.,  
Phila., Pa.
- Van Gordon & Son, C. S.,  
Eau Claire, Wisc.
- Vasquez and Webber,  
2552 E. Charleston,  
Las Vegas, Nevada.
- Vetter Mfg. Co.,  
313 Wood St.,  
Stevens Point, Wisc.
- Victory Housing Corp.,  
5105 No. Washington St.,  
P. O. Box 2467,  
Denver, Colo.
- Ware Laboratories,  
1851 Delaware Parkway,  
Miami, Florida.
- Well Built Mfg. Co.,  
Bound Brook, N. J.
- Western Engineering Co.,  
4417 W. Charleston St.,  
Seattle, Wash.
- Western Home Builders,  
615 Alaska St.,  
Seattle, Wash.
- West Way Mfg. Co.,  
14013 Aurora Ave.,  
Seattle 33, Wash.
- Weyerhaeuser Timber Co.,  
Eastern Distributing Yards,  
P. O. Box 629,  
Newark 1, N. J.
- Wickes, Inc.,  
1575 S. 6th St.,  
Camden, N. J.
- Wilcox Sales Co.,  
West Bridge St.,  
Blackfoot, Idaho.
- Williams Construc. and Engr. Co.,  
House Prefab. Dept.,  
Route No. 2, Box 344,  
1002 E. Maryland Ave.,  
Phoenix, Arizona.
- Williamson, Inc.,  
Pechtigo, Wisc.
- Wingfoot Homes, Inc.,  
1144 E. Market St.,  
Akron 16, Ohio.
- Wingrath Lumber Co.,  
536 E. Main St.,  
Patchogue, L. I., N. Y.
- Winner Mfg. Co., Inc.,  
Box 399,  
Trenton, N. J.
- Wolsey Co., K. V.,  
137 Green St.,  
Malden 48, Mass.
- Wood Prefab Co.,  
RFD No. 7, Box 1488,  
Portland 16, Oregon.
- Woodcrafts,  
606 Taylor Ave.,  
Seattle 9, Wash.
- Woods, Charles J.,  
33 Knight St.,  
Milford, N. H.
- Wright Prefab. Houses,  
180 Nassau Street,  
Princeton, N. J.
- Young's Prefab. Engr. Co.,  
P. O. Box 188,  
Union Gap, Washington.

# FOR SALE

A complete list of every manufacturer of radio and electronic parts. This list is cross-indexed according to manufacturers with their products listed after each company's name and it is also broken up into product listings with the names of manufacturers of each product.

In addition, this list also contains the alphabetical and geographical listing of every factory representative of the manufacturers listed. An invaluable working tool for every parts jobber, serviceman and company sales-manager this list is offered for a short time only.

Bound in an easy-to-handle pocket-size book of over 300 pages this list is carefully tabulated, cross-indexed and has been designed for ease of reference.

Ordinarily, such a list from ordinary sources would cost you hundreds of dollars. However, it is now being offered for sale at the ridiculous sum of only \$2.00 for this authoritative Yearbook and Directory of radio and electronic manufacturers. The supply is limited. Checks must accompany all orders which will be shipped to you postage prepaid.

*Tear Off and Mail Today*

-----  
**THE PARTS JOBBER YEAR BOOK**  
1270 Sixth Avenue  
New York 20, N. Y.

Here is my \$2.00. Send me the Yearbook and Directory of Radio-Electronic Manufacturers.

NAME .....

COMPANY .....

ADDRESS .....

CITY ..... ZONE ..... STATE .....

### Tung-Sol Dealer Help

Tung-Sol Lamp Works, Inc., Newark, N. J., has made available to dealers through its jobbers a new yearly calendar. The firm believes that this type of advertising is the surest and most economical way for a retailer to get his name into a customer's home for an entire year.

Tung-Sol has commissioned a well-known artist to paint the calendar picture for 1947.

### Federal Telephone & Radio Producing Hook-up Wire

A thermoplastic insulated radio hook-up wire, tested to underwriters standards, is now in volume manufacture by Federal Telephone and Radio Corp., Newark, N. J., associate of International Telephone and Telegraph Corp. It is claimed that the extreme flexibility of Federal's intelin hook-up wire, its small outside diameter, and permanent colors facilitate quick, accurate assembly and easy servicing.

The firm states that oxidation and changes in tempera-

ture do not effect this wire. It will not crack or become brittle, and will remain operative under all conditions of humidity.

The free stripping feature is an aid to quick servicing, the conductor is left clean and bright for instant tightly soldered connections. The wire is available in solid or stranded types ranging in size from 24 to 14 for high or low voltage needs in radio, electronics, appliances, and communications and comes in 14 brilliant colors.

### Galvin Denies Rumored Sale of Motorola

Recently at the Chicago Furniture Mart and the Music Show at the Palmer House rumors were rife to the effect that Paul V. Galvin was giving up active management of the Galvin Mfg. Corp., makers of Motorola home and car radio. In the following statement to RADIO & TELEVISION JOURNAL Mr. Galvin makes denial of this rumor. Says Mr. Galvin:

"My attention has been called to a trade rumor that I, personally, am selling out my interest in the Galvin Mfg. Corp. and giving up my active management of the concern. There is absolutely no foundation for this rumor. I have no intention of selling my interest and I am not even discussing the matter of sale with anyone. Nor do I have any idea of giving up my active management of the affairs of the company."

### IRC Volume Control Kit

The International Resistance Co., Philadelphia, Pa., announces its IRC volume control kit, 18 type D, all-purpose controls, six switches and five special shafts—a wide utility stock suited to 87 per cent of all replacements. The kit is delivered factory-packed in an all-steel cabinet. The cabinet is free with the kit of 18 controls ordered at standard control prices.

### GE Offers Free Booklet on Tubes

Characteristics, ratings, prices and warranties of General Electric transmitting and industrial electron tubes are listed in a new 8-page booklet, ETX-10, prepared by the Tube Division of the company's Electronics Department.

According to R. W. Metzner, replacement sales manager of transmitting and industrial tubes for the division, this publication, called the "quick-selection" chart, marks the first time that a complete under-one-cover listing of these tube types has been made available.

Copies of ETX-10 are available at GE tube distributors or on request to the Tube Division, Electronics Department, General Electric Co., Schenectady, N. Y.

### Emerson Radio Names Tullo Vice President

Harvey Tullo, who recently rejoined Emerson Radio and Phonograph Corp. as director of purchases was elected vice president in charge of purchasing, at a recent board of directors meeting, according to an announcement made by Benjamin Abrams, president. Mr. Tullo recently left the Zenith Radio Corp. of Chicago where he was vice president in charge of purchasing.

### Named Sales Chief of Burkaw Electric Co.

Appointment of Emanuel Heller as director of sales and

advertising has been announced by Raymond Weyl, president, Burkaw Electric Co. of New York. Mr. Heller will have full charge of the merchandising of Burkaw's new lines of phonographs now in production and other products to be introduced later in the year.

Mr. Heller reports immediate shipment of Burkaw recording blanks for use with home recorders, including the firm's own Model PR-40 recorder-playback. The discs are in 6-inch, 8-inch and 10-inch sizes, packed in separate manila folders and retail for 30 cents, 40 cents and 60 cents, respectively.

Engaged in the industrial banking field for several years prior to his war service, Mr. Heller was recently discharged after having served over four years in the Army, his last assignment was Sgt. Major of an Eighth Air Force fighter station in England.

### Ward Leonard Offers New Free Bulletin

The Ward Leonard Electric Co., 31 South St., Mt. Vernon, N. Y., is offering without charge its Bulletin 104 on mid-range metal base relays. The company states that the relays displayed in this booklet are designed for use in small radio transmitters, aircraft control circuits and applications where space is limited. This fully illustrated bulletin includes coil and contact data, contact arrangement diagrams, dimension sketches of front and rear mounted units, and enclosing cover data for both standard and heavy duty relays.

### Radio Reception Bulletin

Radio Receptor Co., Inc., 251 West 19th St., New York 11, N. Y., has made available a new 8-page illustrated bulletin listing and describing various types of selenium rectifiers for d-c applications and requirements. Sizes, ratings and other information are included.

### Timings to Represent Chicago Manufacturers

George H. Timmings has resigned as sales manager of the DX Radio Products Co., 2310 Armitage, Chicago, after an association of eight years. He will devote all of his time to serving the radio industry in and around Chicago as a manufacturers' agent.

**Only Electronic**

BRINGS YOU THE  
SMOOTH MODERN CASE  
of **ENDURING STEEL**  
1947 PERFORMANCE  
By SHIELDING  
Against  
ELECTRICAL INTERFERENCE

■ SUPER-GAIN CIRCUIT  
■ PLANETARY DRIVE

Mellow-toned  
VOICE CHAMBER

**NE** NORTHEASTERN ENGINEERING, Inc.  
MANCHESTER NEW HAMPSHIRE

ENGINEERS AND MANUFACTURERS OF THE BEST IN ELECTRICAL AND ELECTRONIC EQUIPMENT



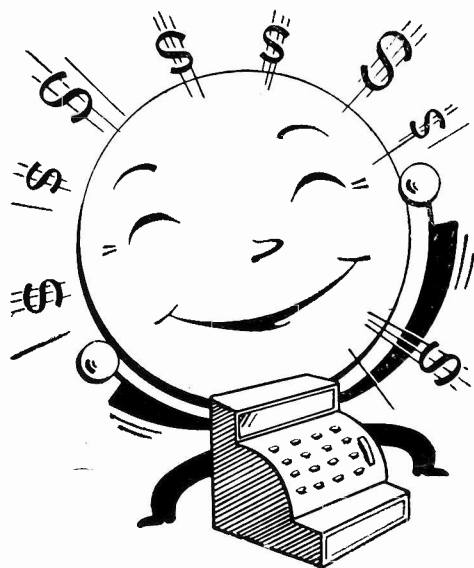

# THE BELL RINGS

more consistently  
for merchants  
who stock

## RECORDISC

HOME  
RECORDING BLANKS

Made by . . . backed by . . .  
the world's largest manufacturer  
of home recording blanks. And known,  
admired and desired by thousands of  
amateur and professional recording  
enthusiasts.

Bond base, aluminum base  
and steel base . . . of superior  
quality . . . at lowest  
prices. Your Recordisc distributor  
will gladly show you how a Recordisc  
Department can be built into  
a major division of your  
store.

### THE RECORDISC CORP.

395 BROADWAY, NEW YORK 13, N. Y.  
Cable Address: Recordisc, New York, N. Y.  
Export Dept: Royal National Company, Inc.  
89 Broad Street, New York

# ADVERTISERS' INDEX

AUGUST, 1946

ADMIRAL CORP. ....	3
Agency: Cruttenden & Eger Adv.	
AEROVOX CORP. ....	8
Agency: Austin S. Lescarbourea & Staff	
AMERICAN PHENOLIC CORP. ....	13
Agency: Burton Browne Adv.	
ASTATIC CORP. ....	36
Agency: Wearstler Adv. Inc.	
BOETSCH BROS. ....	42
Agency: Drummond McKay	
ELECTROMATIC MFG. CORP. ....	30
Agency: Reiss Adv.	
EMERSON RADIO & PHONOGRAPH CORP. ....	11
Agency: Grady & Wagner Co.	
FADA RADIO & ELECTRIC CO. ....	52
Agency: Sternfield-Godley, Inc.	
FEDERAL TELEPHONE & RADIO CO. ....	2
Agency: Rickard & Co.	
GENERAL INDUSTRIES CO. ....	9
Agency: Fuller & Smith & Ross, Inc.	
JENSEN INDUSTRIES, INC. ....	39
Agency: Allan D. Parsons	
McELROY MFG. CO. ....	42
Agency: Shappes-Wilkes, Inc.	
NATIONAL UNION RADIO CORP. ....	51
Agency: Hutchins Adv. Co.	
NEWCOMB AUDIO PRODUCTS CO. ....	41
Agency: Stevens Hall Adv.	
NORTHEASTERN ENGINEERING, INC. ....	48
Agency: Direct	
RAYTHEON MFG. CO. ....	17
Agency: J. M. Mathes	
RAYTHEON MFG. CO. ....	41
Agency: Burton Browne Adv.	
RECORDISC CORP. ....	49
Agency: Shappes-Wilkes, Inc.	
REXON, INC. ....	5
Agency: Direct	
MARK SIMPSON MFG. CO. ....	37
Agency: Edward Hamburger Adv. Co.	
SYLVANIA ELECTRIC PRODUCTS, INC. ....	25-27
Agency: Newell-Emmett Co.	
WEBSTER-CHICAGO CORP. ....	5
Agency: William Hoffman Associates	
ZENITH RADIO CORP. ....	7
Agency: Critchfield & Co.	

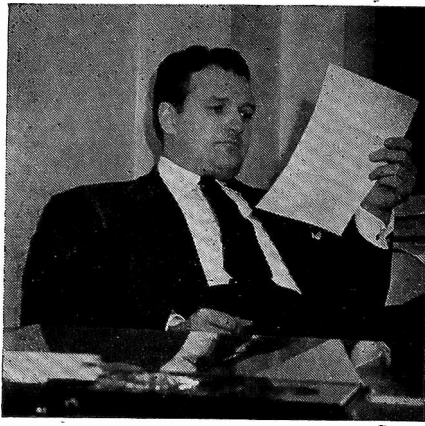

Hello there, had another fairly interesting month which I wish you folks could have shared with me . . . over to Toots Shor's with Bendix's **Earl Hadley** and N. Y. Branch Manager **W. H. Autenrith** together with Universal's ubiquitous **Bill Cashman** and Federal Telephone and Radio Agencyman **Jimmy Johnson** who served with our own former Lt.-Commander **Bill Kline** whom I'd like you all to meet one of these days soon . . . down to Trenton and had wonderful lunch with **Arthur Ansley** and capable assistant **Harriet Weston** . . . Alex and I were properly thrilled at Ansley's spacious 57,000 square feet of factory space and the way they build those cabinets warmed the cockles of an old-time antique furniture refinisher like myself . . . former Baltimore Association president **Jimmy Wong** up to the office to chat with us and we've arranged to get some of his ideas on how to handle today's record business problems since Jimmy has done a real job of selling records over the past few years . . . down to Philadelphia and talked before the Appliance Dealer's Association at their annual outing and, as usual, got stage-fright when I saw the array of really distinguished guests assembled there . . . the fact that nine lovely beauties competing for the Miss Philadelphia title were present had nothing to do with it . . . oh, yes, this was the month, too, when I was invited to talk before the De-

# Journal's End

By Mal Parks

troit Radio Servicemen on September 23rd and a few days later I'm to have the pleasure of meeting and talking to a new group being formed in Milwaukee . . . apart from that, got in a little surf fishing, tried out a couple of new recipes and just loafed around the rest of the time . . .

. . . Speaking of recipes, got a grand one from Sylvania's **Paul Ellison** for potted chicken which I made and can report it to be a gastronomical masterpiece . . . Paul was honored by having a profile of himself appear in a national advertising magazine this month and I wonder how many of you knew that he is a recognized gourmet, one of the country's most famous collectors of original Jazz records, a tireless worker on many important Committees but, most important of all, the kind of fellow you're proud to call friend . . .

. . . Apropos of that, wasn't it Benjamin Franklin who once said . . . "Don't value a man for the quality he is of, but for the qualities he possesses" . . .

. . . Grand letter from **Francisco E. Borrelli** of the Glorium Radio Co., from way down there in Montevideo, Uruguay, complimenting us on your Radio Journal and telling us how helpful it is to him . . . thank you, Senor Borrelli, now just wait until you see the September issue . . . we hope you'll enjoy reading it as much as we've enjoyed planning it for you . . .

. . . Nice letter from Commerce Secretary **Henry A. Wallace** whose political enemies obscure the sound work done by the Department . . . as one corn farmer to another I can't help but feel that Hen-

ry's sound thinking is becoming more gradually realized for its value among a growing number of people . . . at any rate, he's invited me down for a chat and we're going to see just what he and the Department can work out to aid in the distribution problems encountered by our industry.

. . . Response to our new S. F. F. D. W. E. T. G. F. (Society For Five Day Weekends To Go Fishing) has been tremendous and we look to see Chapters spring up throughout the country . . . membership is simple, just work two days and spend the other five in a long weekend trying to catch your favorite fish . . . interested persons can secure their charter membership by writing me.

. . . Seriously, sometimes it's good to get away from business for a little while so that when we come back we bring a fresh viewpoint to our problems . . . we've done just that in the office here, and, come next issue, we've a wonderful, newly-designed Radio Journal planned for you . . . we're reverting back to the name we carried from 1930 to 1939 so, when your postman brings you that familiar wrapper next month be sure to open it immediately because it'll contain the first issue with the old name which 90 per cent of our readers suggested we use . . . Radio & APPLIANCE Journal . . . there'll be a wealth of new features, more practical helps, the most modern format . . . in fact, we're real proud of it.

Well, . . . it was swell to be here again this month and I'll be looking forward to visiting with you again in September.

# NEW 7-PIECE STORE DISPLAY FOR N.U. DEALERS

A store-wide promotion  
in a new, flexible,  
easy-to-fit-in form



## Order yours today from your N. U. Distributor

Be one of the first to show this brand new display idea—that sells your service skill and tells customers how and why you can insure their radio enjoyment. Full of life, action and interest—printed in 10 colors on heavy cardboard—each unit is a complete display with easel and ribbon streamer. Display them as a group or as individual window, counter or shelf cards. Order from your N.U. Distributor now for immediate shipment.  
NATIONAL UNION RADIO CORPORATION, NEWARK 2, NEW JERSEY

# NATIONAL UNION RADIO TUBES AND PARTS





# FADA

## LEADERSHIP

### ...based on Facts

SUPERIOR PERFORMANCE • DEPENDABILITY  
OUTSTANDING BEAUTY • CONSUMER ACCEPTANCE

The new line of FADA radio receivers, each brilliantly designed for beauty of appearance and precision made for beauty of tone, fully justifies our slogan, "The Radio of Tomorrow . . . Today!"

But FADA leadership is based on far more than superior appearance and tone qualities. Yes—the name FADA is more than just a name. It is a symbol, too. It symbolizes more than thirty years of acceptance by the people of America from the tiniest hamlets to the largest cities.

This penetrating acceptance is the result of consistent, continuous, relentless sales promotion and advertising . . . through newspapers, magazines, billboards, radio announcements, spectacular signs, etc. This penetrating acceptance is the result of year in and year out service by Fada radios in hundreds of thousands of American homes.

That's why you can place your faith in FADA for rapid continuous sales for many years to come!

YOU CAN ALWAYS DEPEND ON

# FADA Radio

*Famous Since Broadcasting Began!*

THE RADIO OF TO-MORROW...  
TO-DAY!



6 TUBES  
652 SERIES



6 TUBES  
1000 SERIES



5 TUBES  
609 SERIES



637 SERIES

Superheterodyne AC de Luxe Portable Radio Phonograph with Automatic Record Changer.



FADA 6 tube models are equipped with the new FADA "Sensitive-Tone" . . . assuring greater sensitivity and clearer reception.

FADA RADIO AND ELECTRIC COMPANY, INC., LONG ISLAND CITY, N. Y.