

**Radio** - BUILD A ROBOTIC LAWN MOWER

AUGUST 1990

# Electronics®

TECHNOLOGY - VIDEO - STEREO - COMPUTERS - SERVICE

## BUILD R-E's VIDEO FRAME GRABBER

Capture any video image with your computer!

## BUILD A DIGITAL PRESSURE GAUGE

Semiconductor sensor makes it practical

## MICROWAVE TECHNOLOGY

The world above 300 MHz

## AC POWER MEASUREMENT

A back-to-basics primer

## BUILD A SOLID-STATE DISK DRIVE

Easy plug-in board speeds up your computer and reduces wear and tear on your hard disk



\$2.50 U.S.  
\$2.95 CAN

A  
**GERNSBACK**  
PUBLICATION

XXXXXXXXXXXXXXXX 5-DIGIT 60506  
390736DHMD997G093 08 43  
JAN 91  
RE  
MR ROBERT DAHM  
997 GRAND AV  
AURORA, IL 60506

**FLUKE**



**PHILIPS**

**High Resolution Digital Meter:**  
4000 count digital readout. 20,000 count mode (Fluke 87) for 4 1/2 digit resolution

**Backlit display:** Makes it easy to read the DMM in dark, cramped quarters. Automatically shuts off after 68 seconds to save the battery.

**Recorder:** records minimums and maximums, plus true arithmetic average, audible Min Max Alert, selectable response times—1 second and 100 ms (all models) plus 1 ms Peak Min Max (Fluke 87)

**Holster with Flex Stand™:** Protects meter and provides test lead storage. Flexible leg allows meter to be hung from peg, bent around a pipe, or used almost anywhere.

**Analog Meter:** High-speed analog display updates 40 times/second—as fast as the eye can follow. X10 Zoom bargraph mode (Fluke 83 and 85) makes high resolution offset measurements a snap.

**Frequency counter:** Accurate down to 0.5 Hz; also measures duty cycle

**Capacitance meter:** Autoranging, with manual ranging at the touch of a button

FLUKE 83	FLUKE 85	FLUKE 87
Volts, ohms, amps, diode test, audible continuity, frequency and duty cycle, capacitance, Touch Hold,* relative, protective holster with Flex-Stand™	Volts, ohms, amps, diode test, audible continuity, frequency and duty cycle, capacitance, Touch Hold,* relative, protective holster with Flex-Stand™	Volts, ohms, amps, diode test, audible continuity, frequency and duty cycle, capacitance, Touch Hold,* relative, protective holster with Flex-Stand™
\$199*	\$229*	\$289*
0.3% basic dc accuracy	0.1% basic dc accuracy	0.1% basic dc accuracy
5 kHz acV	20 kHz acV	20 kHz acV
Analog bargraph and zoom	Analog bargraph and zoom	High resolution analog pointer
Three year warranty	Three year warranty	True-rms ac
		1 ms PEAK MIN MAX
		4 1/2 digit mode
		Backlit display
		Three year warranty

\*Suggested U.S. list price

# Multi-Meter

Meet the meter that brings an entire test bench to your job. The versatile Fluke 80 Series do-just-about-everything "Multi" Meter.

It offers everything you'd expect from an advanced handheld DMM, plus a lot you'd find only in dedicated instruments. Plus Fluke-exclusive features you can't buy anywhere else. All built with the most advanced surface mount design and single-chip ASIC technology for a thinner, tougher, more reliable package.

There's a fully annunciating display for clear operation. Duty cycle function. High-speed analog indicator. A protective holster with innovative Flex-Stand™ for easy, adaptable operation. Audible Input Alert™ to reduce the risk of damage to the meter, the user, and the unit being tested. Plus the strongest warranty in the business.

All good reasons to move up to the truly-multi Fluke 80 Series today. You'll find 80 Series DMMs at your Fluke distributor. For immediate, off-the-shelf delivery. Call

1-800-44-FLUKE, ext. 33 for the name of your nearest distributor.

John Fluke Mfg. Co., Inc. PO Box 9090 M/S 250C, Everett, WA 98206 U.S. (206) 347-5400 CANADA 416-890-7600 OTHER COUNTRIES (206) 356-5500

© Copyright 1992, John Fluke Mfg. Co., Inc. All rights reserved. Prices and specifications subject to change without notice. Ad no. 01C2-F80

FROM THE WORLD LEADER IN DIGITAL MULTIMETERS.

**FLUKE**

CIRCLE 121 ON FREE INFORMATION CARD



## BUILD THIS

- 31 VIDEO FRAME GRABBER**  
Add a vision system to your PC!  
**Gene Toner**
- 41 DIGITAL PRESSURE GAUGE**  
Build a solid-state portable electronic pressure gauge.  
**Anthony J. Caristi**
- 45 THE LAWN RANGER: PART 3**  
Build the motherboard and the motor-control board.  
**Raymond Rafaels**

## TECHNOLOGY

- 51 AC POWER MEASUREMENT**  
A refresher course on the principles of measuring power.  
**Harry L. Trietley**
- 60 INTRODUCTION TO MICROWAVE TECHNOLOGY**  
The terminology and technology of microwave electronics.  
**Joseph J. Carr**

## COMPUTERS

- 73 BUILD A SOLID-STATE DISK DRIVE**  
Construction details on the battery-backed RAM disk  
**Mark Hatten**

## DEPARTMENTS

- 6 VIDEO NEWS**  
What's new in this fast-changing field.  
**David Lachenbruch**
- 16 EQUIPMENT REPORTS**  
Beckman Industrial RMS225 DMM.
- 18 DRAWING BOARD**  
Video-scrambling techniques.  
**Robert Grossblatt**
- 67 HARDWARE HACKER**  
Data compression.  
**Don Lancaster**
- 79 AUDIO UPDATE**  
The High End Hi-Fi Show.  
**Larry Klein**
- 73 EDITOR'S WORKBENCH**  
A low-cost logic analyzer  
**Jeff Holtzman**



**PAGE 60**

## COMPUTER DIGEST



**PAGE 73**

## AND MORE

- 96 Advertising and Sales Offices**
- 96 Advertising Index**
- 12 Ask R-E**
- 97 Free Information Card**
- 14 Letters**
- 84 Market Center**
- 25 New Lit**
- 20 New Products**
- 82 PC Service**
- 4 What's News**

## ON THE COVER



If the idea of capturing video images on a computer grabs you, take a look at our Video Frame Grabber. The inexpensive, half-length card plugs into any PC expansion slot, and accepts standard NTSC black-and-white or color input. Once you've captured the shot from your video camera, you can manipulate the image—to create line drawings or negative images, for example—and store or print it. Put actual photographic images in your desktop-published newsletters or brochures, or use the frame grabber for electronic photography, security systems, computer "slide" presentations, or automatic inspection. For all the details, turn to page 31.

## COMING NEXT MONTH

### THE SEPTEMBER ISSUE GOES ON SALE AUGUST 2.

#### R-E's VOCAL ZAPPER

Filter out the vocal tracks from recordings—then dub in your own voice!

#### BUILD THE LAWN RANGER

Our concluding installment.

#### THE AGONY OF AM

What does the future hold for the AM band?

#### BUILD A 100-MHz FREQUENCY COUNTER

Based on the Intersil 7216, it's accurate and easy to build.

#### BUILD R-E's DIGITAL DASHBOARD

Part 2 will return with complete construction details.

As a service to readers, RADIO-ELECTRONICS publishes available plans or information relating to newsworthy products, techniques and scientific and technological developments. Because of possible variances in the quality and condition of materials and workmanship used by readers, RADIO-ELECTRONICS disclaims any responsibility for the safe and proper functioning of reader-built projects based upon or from plans or information published in this magazine.

Since some of the equipment and circuitry described in RADIO-ELECTRONICS may relate to or be covered by U.S. patents, RADIO-ELECTRONICS disclaims any liability for the infringement of such patents by the making, using, or selling of any such equipment or circuitry, and suggests that anyone interested in such projects consult a patent attorney.

RADIO-ELECTRONICS, (ISSN 0033-7862) August 1990. Published monthly by Gernsback Publications, Inc., 500-B Bi-County Boulevard, Farmingdale, NY 11735 Second-Class Postage paid at Farmingdale, NY and additional mailing offices. Second-Class mail registration No. 9242 authorized at Toronto, Canada. One-year subscription rate U.S.A. and possessions \$17.97, Canada \$23.97, all other countries \$26.97. All subscription orders payable in U.S.A. funds only, via international postal money order or check drawn on a U.S.A. bank. Single copies \$2.50. © 1990 by Gernsback Publications, Inc. All rights reserved. Printed in U.S.A.

**POSTMASTER:** Please send address changes to RADIO-ELECTRONICS, Subscription Dept., Box 55115, Boulder, CO 80321-5115.

A stamped self-addressed envelope must accompany all submitted manuscripts and/or artwork or photographs if their return is desired should they be rejected. We disclaim any responsibility for the loss or damage of manuscripts and/or artwork or photographs while in our possession or otherwise.

## Radio-Electronics®

Hugo Gernsback (1884-1967) founder

M. Harvey Gernsback,  
editor-in-chief, emeritus

Larry Steckler, EHF, CET,  
editor-in-chief and publisher

#### EDITORIAL DEPARTMENT

Brian C. Fenton, editor

Marc Spiwak, associate editor

Daniel Goodman, technical editor

Kim Dunleavy,  
assistant technical editor

Teri Scaduto, assistant editor

Jeffrey K. Holtzman  
computer editor

Robert Grossblatt, circuits editor

Larry Klein, audio editor

David Lachenbruch  
contributing editor

Don Lancaster  
contributing editor

Richard D. Fitch  
contributing editor

Kathy Campbell, editorial assistant

#### ART DEPARTMENT

Andre Duzant, art director

Injae Lee, illustrator

Russell C. Truelson, illustrator

#### PRODUCTION DEPARTMENT

Ruby M. Yee, production director

Janice Box,  
editorial production

Karen S. Tucker  
advertising production

Marcella Amoroso  
production assistant

#### CIRCULATION DEPARTMENT

Jacqueline P. Cheeseboro  
circulation director

Wendy Alanko  
circulation analyst

Theresa Lombardo  
circulation assistant

Michele Torriolo, reprint bookstore

Typography by Mates Graphics

Cover photo by Diversified Photo  
Services

Radio-Electronics is indexed in  
*Applied Science & Technology Index*  
and *Readers Guide to Periodical Literature*.

Microfilm & Microfiche editions are  
available. Contact circulation department  
for details.

**Advertising Sales Offices listed  
on page 96.**

Radio-Electronics Executive and  
Administrative Offices:

1-516-293-3000.

Subscriber Customer Service:

1-800-288-0652.

Order Entry for New Subscribers:

1-800-999-7139.

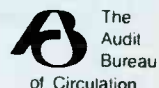



### DELUXE TEST LEAD KIT

Users call TPI test leads **The Absolute Best**. The TLS2000 features the highest quality cable in the industry — with spring-loaded safety-sleeved plugs. U.L. listed (file E79581). Kit: \$29. Leads & probes only: \$19. Satisfaction guaranteed. **TEST PROBES INC.** Call toll-free for catalog: 1-800-368-5719.

CIRCLE 226 ON FREE INFORMATION CARD

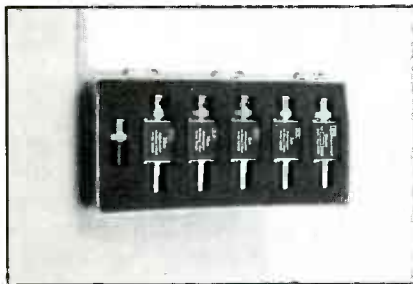

### BNC ATTENUATOR KIT

Contains 4 attenuators — 3dB, 6dB, 10dB, 20dB; 1 feedthrough and 1 termination. Thick-film circuitry for low reactances. Rugged design resists shock and lasts longer. Rectangular shape stays put on the bench. **Impedance:** 50Ω **Frequency:** 1GHz. **Maximum Power:** 1kW peak, 1W avg. **VSWR:** 1.2:1. Attenuator Accuracy: ±0.2dB. Terminations Resistance Tolerance: ±1%. \$150.

**TEST PROBES INC.** Call toll-free for catalog: 1-800-368-5719.

CIRCLE 227 ON FREE INFORMATION CARD

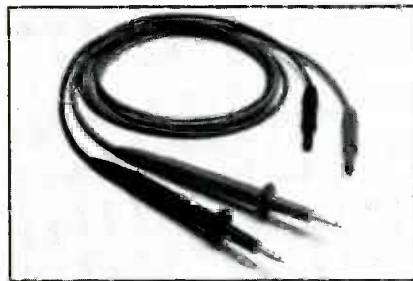

### ECONOMICAL SILICON RUBBER TEST LEADS

Best value in moderately priced leads. High quality, soft, silicon rubber cable. Banana plug on measuring tip accepts push-on accessories. Plugs have spring-loaded safety sleeves. Model TL1000 \$14. Satisfaction guaranteed. **TEST PROBES INC.** Call toll-free for catalog: 1-800-368-5719.

CIRCLE 228 ON FREE INFORMATION CARD



### COAX ADAPTER KIT

- Create any adapter in seconds
- Make all combinations of BNC, TNC, SMA, N, UHF, Mini-UHF, F and RCA

The TPI 3000A kit contains male and female connectors of all 8 types, and 6 universal interfaces. Simply screw any combination of 24 connectors to one of the interfaces to create the desired adapter. \$150.

**TEST PROBES INC.** 9178 Brown Deer, San Diego, California 92121. Call toll-free for catalog: 1-800-368-5719.

CIRCLE 225 ON FREE INFORMATION CARD



## No Better Probe Ever at This Price!



Shown here  
Model SP150 \$49  
Switchable 1x-10x ....

CIRCLE 180 ON FREE INFORMATION CARD

## Risetime less than 1.5 nsec.

- **Universal** - works with all oscilloscopes
- **Removable Ground Lead**
- **Excludes External Interference** - even on scope's most sensitive range
- **Rugged** - withstands harsh environments including high temperature and humidity
- **Advanced Strain Relief** - cables last longer
- **Available in 10x, 1x and switchable 1x-10x**
- **10 day return policy** - performance and satisfaction guaranteed

**TEST PROBES, INC. TPI**

9178 Brown Deer Road  
San Diego, CA 92121  
Toll Free 1-800-368-5719

Call for free catalog and Distributor in your area

CIRCLE 123 ON FREE INFORMATION CARD



# WHAT'S NEWS

## Individual atoms as building blocks

Scientists at IBM's Almaden Research Center (San Jose, CA) have managed to position individual atoms on a surface, and have used that technique to build structures one atom at a time. Besides helping scientists to better understand the fundamental behavior of atoms on surfaces—knowledge that is crucial to many industrial processes—the achievement opens the door for a broad range of future applications. Some of the possibilities are building custom molecules, making ultra-small electrical circuits, storing data on an atomic scale at densities more than a million times greater than is now possible, and perhaps even duplicating structures atom-for-atom. The technique might one day be adapted to reduce the size of semiconductor chips by a factor of more than 500.

The process, which demonstrates that atoms can be moved across a surface and accurately positioned where desired, was first used to create the letters "IBM" in xenon atoms. Next, a chain of seven xenon atoms bound together—the first atomic cluster built one atom at a time—was created. Both demonstrations required the atoms to be cooled to  $-269^{\circ}\text{C}$  ( $-453^{\circ}\text{F}$ ), which is only slightly higher than absolute zero.

Physicists Donald M. Eigler and Erhard K. Schweizer (a visiting scientist at Almaden, on leave from the Fritz-Haber-Institut in Berlin) used a special scanning tunneling microscope (STM) to move the atoms into place and to view their progress. STM's can image individual atoms

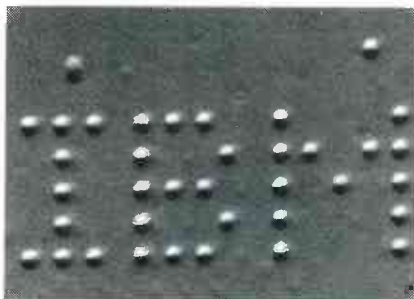

"IBM" IS SPELLED OUT IN INDIVIDUAL atoms. IBM scientists used a scanning tunneling microscope to move single xenon atoms across a surface and precisely position them one at a time to form the letters. The distance between the atoms in the pattern is about 50 billionths of an inch; the image has been magnified approximately 2.9 million times.

on a metal or semiconductor surface by scanning the tip of a needle over the surface at a height of only a few atomic diameters. To study how atoms and molecules interact with surfaces, Eigler built an STM that could operate with extraordinary sensitivity and precision. He placed the STM in a high vacuum, cooled it with liquid helium, and isolated it from vibrations.

In a process similar to using the motion of a nearby magnet to move another magnet, a xenon atom can be "dragged" across a surface by placing the STM's needle tip close to the atom and moving the tip parallel to the surface. At the desired position, the tip is lifted, leaving the atom fixed in its new location. The exacting process—atoms are moved at a rate of 16 billionths of an inch per second—requires the STM operator to maintain a delicate balance of several attractive forces between the atoms. It took 22 hours to move the xenon atoms to form the letters "IBM."

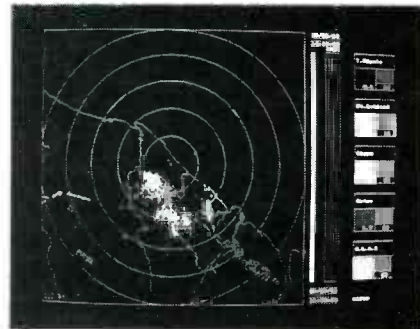

THE SAFIR SYSTEM MAPS STORMS IN REAL TIME AND FORECASTS LIGHTNING danger zones up to a half hour before it strikes.

real time and issues lightning warnings through the use of radioelectric interferometry. Potential applications for the lightning-detection system are at rocket-launching sites, flight-testing centers, air bases, civilian airports, and air-navigation centers.

As soon as it begins developing, a thunderstorm produces changes in the atmospheric electric field. The SAFIR system monitors those changes at their inception. One type of sensor detects and traces high-frequency radiating sources from the heart of a cloud to lightning discharges that strike the ground, and a second sensor measures the electrostatic field on the ground. Together, the two sensors detect the phenomena that precede a strike.

A typical SAFIR installation consists of three detection stations, located 12–62 miles apart, that feed data to a central station where it is processed and displayed in real time. That setup covers 186 square miles, with a locating accuracy ranging from a few hundred yards to three miles. The system can monitor storms as they develop, producing maps that indicate "lightning discharge danger zones" on the ground and in the air. Danger zones are detected and located up to 30 minutes before the first lightning bolts strike the ground lessening the chances of a strike.

R-E

## Lightning forecaster

A system that predicts lightning before it strikes was developed by Dimensions, a French firm, in the course of research conducted at the French Matinal Institute of Aerospace Research. It is hoped that the

new lightning-detection system will help to eliminate lightning-caused damage and related fatalities. The SAFIR system—which has been successfully tested at several sites, including the Kennedy Space Center—monitors storm activities in

# It's no fluke.



Made in the U.S.A.

Feature	Fluke Model 77	Beckman Industrial RMS225
Digits	3-1/2 Digits	4 Digits
Resolution	3,200 Counts	10,000 Counts
Accuracy	0.3%	0.25%
Automatic Reading Hold	Touch Hold®	Probe Hold™
Analog Bar Graph	31 Segments	41 Segments
Battery Life	2,000 Hrs	1,000 Hrs
10A Range	✓ (Fused)	✓ (Unfused)
Protective Holster	✓	✓
3 Year Warranty	✓	✓
True RMS		✓
Auto Min Max™		✓
Relative Mode		✓
Self-Resetting Fuse		✓ (40mA Input)
Price	\$159*	\$149

® Touch Hold is a registered trademark of the John Fluke Mfg. Co., Inc. \* 1990 Fluke and Philips Catalog

Your best auto-ranging multimeter for the money. It doesn't happen by accident.

It takes expertise, painstaking R&D, and a solid commitment to provide you with the features you've asked for at a price you can afford.

When you add it all up, the new Beckman Industrial RMS225 simply outperforms any meter in its class. And like all the

other multimeters we've built over the years, it's designed for long lasting and

trouble-free use. So, go visit your local distributor today and check out the new RMS225 digital

multimeter. Once you compare it to the others, the choice will be obvious.



**Beckman Industrial™**

An Affiliate of Emerson Electric Co.

Instrumentation Products Division  
 3883 Ruffin Road, San Diego, CA 92123-1898  
 (619) 495-3200 • FAX (619) 268-0172 • TLX 249031  
 Outside California 1-800-854-2708 Within California 1-800-227-9781

© 1990 Beckman Industrial Corporation. Specifications subject to change without notice. Fluke is a registered trademark of John Fluke Mfg. Co., Inc.

CIRCLE 98 ON FREE INFORMATION CARD

JN189-01-0890

---

---

# VIDEO NEWS



**DAVID LACHENBRUCH,**  
CONTRIBUTING EDITOR

● **Video goes “wireless.”** In a little-noted change in its “part 15” rules on RF interference, the FCC last year voted to allow wireless electronic products with increased frequencies and no restrictions on usage, bandwidth, or type of modulation, as long as the uses are non-interfering. That will permit such limited-area uses as wireless loudspeakers. One of the most interesting new products permitted under the new regulations is the “home TV station.” The first such station actually to be tested and approved by the FCC is the *Videocaster* by accessory manufacturer Gemini Industries.

The *Videocaster* consists of a small transmitter and receiver, and its principal purpose will be to connect such devices as VCR's to TV's without using cables. Thus one VCR can feed all the TV's in a home, as long as each TV is equipped with a receiver. Another suggested use is monitoring a baby-sitting camera while visiting next-door neighbors. Transmissions are in the 900-MHz frequencies. The *Videocaster* will sell for about \$100, including one transmitter and one receiver. Approvals of competing systems are expected soon.

● **Cardboard cassette.** Video junk mail has arrived—in the form of the throw-away cassette. The VHS-compatible (though not approved) cassette is made of cardboard, and in large quantities can sell for about \$1.00, including tape, duplicating, and four-color label. Developed by Philmax, a Baltimore company, it's designed for premium, catalog, and give-away uses where durability isn't required. The tape is designed to be played five to ten times, although tested copies have lasted for as many as 150 plays. The developers say that the throw-away tapes won't damage VCR's. The tape stops playing when it no longer tracks correctly.

● **NEC “shakes out.”** Plagued with chronic overproductions and cutthroat competition that are bringing prices below the profit level in many instances, the consumer-electronics industry saw the first victim of a widely anticipated “shakeout of the '90's” in NEC, the American subsidiary of

Japan's Nippon Electric Company. NEC, which has been offering televisions, VCR's, and audio systems on the American market for nine years, has decided to abandon those traditional consumer-electronics lines. Instead, it will concentrate on such things as its sophisticated TurboGrafx video-game system, personal computers, and custom “home theaters,” including the *Improved-Definition-TV (IDTV)* two-piece projection system it has developed. Its color-television factory in McDonough, GA, is being converted to the production of laptop computers and monitors.

In a move also related to the worldwide competitive situation in consumer electronics, the European giant Philips (which produces Philips, Magnavox, Sylvania, and Philco products in the United States) is buying a 25% interest in the audio-video operations of Denmark's Bang & Olufsen, noted for its high-styled (and high-priced) audio and video components. Both companies that are involved said the move would help them compete in the high-priced high-end market.

● **8mm winning camcorder war.** Sony, whose Beta system lost the competition for home VCR's to JVC's VHS, is winning a victory in the struggle for format supremacy in mini camcorders, as more brands begin to move to Sony's 8mm format over JVC's VHS-C (for “compact”) system. The first major consumer-electronics brand name in the VHS camp to move to 8mm will be Zenith, which will add an 8mm camcorder to their line this fall. The fact that Zenith is defecting is particularly significant. Zenith was the first traditional American brand to enter the VCR market, in 1977, when it chose the Beta format (its recorders were made by Sony). As Beta lost the race, Zenith switched to VHS machines (supplied by JVC). Zenith's new 8mm camcorder will be made by Sanyo.

Full-size VHS is still the leading camcorder format in the United States. In the first quarter of 1990, 57.5% of camcorders sold here used standard VHS cassettes. For all of 1989, the figure for VHS was 63%. **R-E**



**FULL FEATURES FOR JUST  
\$129.95**

- 20MHz Frequency Counter
- Capacitance Meter
- Logic Probe
- Transistor Tester
- Continuity Tester
- LED Tester
- Diode Check
- 10A Ammeter
- Voltmeter
- Ohmmeter

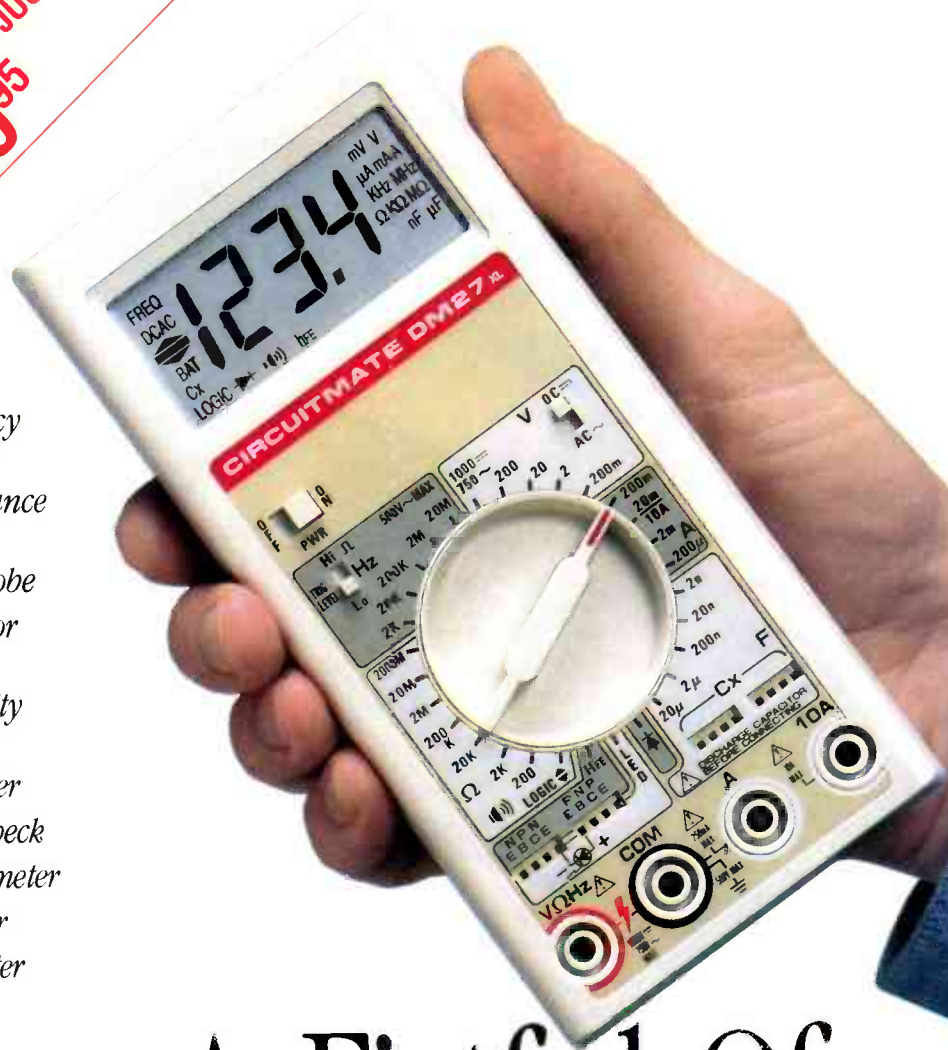

# A Fistful Of Functions.

With more uses and features than most other hand-held multimeters, the DM27XL and DM25XL really pack a punch; especially when you've got to troubleshoot or analyze a variety of components and circuits.

Standard functions include capacitance measurement to 20 $\mu$ f, logic probe to 20MHz, transistor tester and resistance ranges to 2000M $\Omega$ . The DM27XL further adds 20MHz frequency counting capability with selectable

trigger sensitivity, plus an LED tester. Both meters feature an enhanced display, including a large, easy-to-read LCD, a full set of function annunciators and a battery-saving Auto Power Off.

Grab a DM25XL for just \$109.95, or a DM27XL for just \$129.95 (suggested retail price) at your local Beckman Industrial distributor. After using one, you won't be able to function without it.

## ***Beckman Industrial™***

*An Affiliate of Emerson Electric Co.*

Instrumentation Products Division  
 3883 Ruffin Road, San Diego, CA 92123-1898  
 (619) 495-3200 • FAX (619) 268-0172 • TLX 249031  
 Outside California 1-800-854-2708 Within California 1-800-227-9781

© 1990 Beckman Industrial Corporation All specifications subject to change without notice.

**CIRCLE 195 ON FREE INFORMATION CARD**

JN193-01-0890



## REASONS FOR SELECTING CIE

- Approved for educational benefits under the G.I. Bill for Veterans and other eligible persons.
- CIE provides printed job resumes, letters of recommendation, and lifetime Employment Service for all graduates at no extra charge.
- State-of-the-Art laboratory equipment is yours to keep and it comes assembled, ready for hands-on-experiments.
- Only CIE offers an Associate Degree program based on actual study time used. The faster you complete your degree, the less your overall tuition.
- Upon graduation, CIE offers you free preparation to pass the Certified Electronics Technician Exam.

# CIE

**CLEVELAND INSTITUTE OF ELECTRONICS** 1776 East 17th Street • Cleveland Ohio 44114  
PHONE TOLL FREE 1-800-321-2155 / In Ohio 1-800-523-9109



# LEARNING...

# THE KEY TO SUCCESS

## A CAREER IN ELECTRONICS STARTS WITH CIE.

**F**or the last few years, the electronics field and related industries have been growing at an incredible pace. And today, a career in electronics offers more opportunities and greater rewards than ever before.

Just ask any of the many graduates of the Cleveland Institute of Electronics who have landed high-paying positions with aerospace, computer, medical and communications firms. They'll tell you success didn't come easy... but that CIE made it all worthwhile.

**SPECIALIZED TRAINING** CIE isn't just another be-everything-to-everybody correspondence school. We're accredited by the National Home Study Council. And with more than 1100 graduates each year, we're the largest independent home study school specializing exclusively in electronics. CIE has been training career-minded students like yourself for over 50 years and we know the business inside and out.

**PRACTICAL TRAINING** CIE students learn by doing, using sophisticated electronic learning tools that we've designed and developed. One such tool, our 4K RAM Microprocessor Training Laboratory, teaches programming, interfacing and lets you work with a broad range of computers in a way that working with a single, stock computer simply can't.

We combine that valuable hands-on training with our unique Auto Programmed® lessons, designed to teach you step-by-step and principle-by-principle. The result is practical training... the kind of experience you can put to work in the marketplace.

**PERSONALIZED TRAINING** While some of our students have a working knowledge of electronics others are just getting started. That's why we have 10 career course levels from Basic to Advanced. They let you start where you want. Learn at your own pace. And learn as much as you like. You can even earn an Associate in Applied Science Degree in Electronics. And when you need help, our trained professionals are on hand to assist you by phone or mail.

Learning electronics isn't easy, but getting started is. For a CIE catalog and enrollment information, just mail the coupon below. Or call toll-free 1-800-321-2155. In Ohio, call 1-800-523-9109.

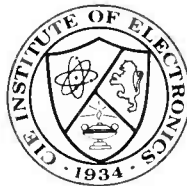

Accredited by the Accrediting Commission of the National Home Study Council, Washington, D.C.



Some courses feature the CIE Microprocessor Training Laboratory, an integral part of computers. You'll gain all the practical experience needed to work with state-of-the-art equipment of today and tomorrow.



**YES! I want to get started. Send me my CIE school catalog including details about the Associate Degree program.**

Print Name \_\_\_\_\_

Address \_\_\_\_\_ Apt. \_\_\_\_\_

City \_\_\_\_\_ State \_\_\_\_\_ Zip \_\_\_\_\_

Age \_\_\_\_\_ Area Code / Phone No. \_\_\_\_\_ / \_\_\_\_\_

Check box for G.I. Bulletin on Educational Benefits

Veteran  Active Duty

**MAIL TODAY!**

**CIE** CLEVELAND INSTITUTE OF ELECTRONICS  
1776 East 17th Street, Cleveland, Ohio 44114

ARE-172

# ASK R-E

WRITE TO:

ASK R-E  
Radio-Electronics  
500-B Bi-County Blvd.  
Farmingdale, NY 11735

## DTMF CONTROLLER

I'm trying to build a circuit that uses the telephone DTMF (Dual Tone Multi Frequency) tones as the basis to control several different devices. My problem is that I'm having a hard time finding out exactly what frequencies are used for all the rows and columns. The books I've looked through list only the twelve telephone keys, but I thought there were more that. Could you tell me how many there are?—F. Geof, Hunter, NY

You're right that there are more than twelve standard DTMF tone combinations available, and I'm surprised how few people are aware of that. Most of the books that talk about telephones only refer to the tones produced by the standard keypad, but that's because they're only dealing with telephones, not DTMF in general.

Even though the standard telephone uses only twelve tone combinations, there are really sixteen available. There are actually eight official DTMF tones, organized as shown in Table 1. Seven of them are in everyday use with telephones, but the eighth one, the last member of the high group, isn't used in any of the common consumer telephone devices although I've heard that it has some applications in military and industrial equipment.

It used to be a real pain in the neck to build a DTMF receiver because it had to be done with lots of filters, decoders, and so on. These days, the decoding methods have become almost completely digital (as has just about everything else), and semiconductor manufacturers have produced a wide variety of chips to both generate and decode the tones with an accuracy that's way beyond the earlier circuits made with acres of discreet components.

The official list of tone combina-

DTMF STANDARDS	
GROUP	FREQUENCY
LOW	697 Hz
LOW	770 Hz
LOW	852 Hz
LOW	941 Hz
HIGH	1209 Hz
HIGH	1336 Hz
HIGH	1477 Hz
HIGH	1633 Hz

tions is shown in Table 2, and you can see that the last four digits all use the 1633-Hz tone as one of their components. Most of the available IC's that produce and read DTMF tones will let you handle all sixteen tones but, if you want to do that, you won't be able to use a regular telephone keypad in the design. That shouldn't be much of a problem since just about all the IC's that generate DTMF will accept either a row-and-column or binary input. That means you can use any one of the commercially available matrix keyboards—or even make your own.

If your circuit can deal with straight binary, the design is even easier because chips like National

Semiconductor's 5088 converts binary directly to DTMF and has an output level that will directly drive the telephone line. How things have changed!

## DIY VOR GENERATOR

We would like to build a VOR generator in order for us to test IN-38 course indicators, part of the navigation system in Cessna aircraft. According to the service manual, a standard VOR input is defined as an audio signal consisting of 30 Hz and 9960 Hz at 0.5-VRMS  $\pm$  0.05 VRMS. Can you offer any help?—P. Jamison, Sutter Creek, CA

Your letter isn't really clear about the form of the output signal but it seems to me that you're looking for a pair of simple oscillators. If that's the case, there's a wide variety of circuits you can use to get the job done.

Probably the easiest way to generate the frequencies you need at the required level and degree of accuracy is to build the circuit with a pair of 555 timers. The design is shown in Fig. 1. There's not much to explain about the circuit since it's one of the simplest 555 layouts you can build. Because you're looking for a pair of particular frequencies, the trimmers will let you tweak the output to get to the exact values you need.

The 555 is extremely stable and

TELEPHONE DTMF ASSIGNMENT				
Hz	1209	1336	1471	1633
697	1	2	3	A
770	4	5	6	B
852	7	8	9	C
941	*	0	#	D



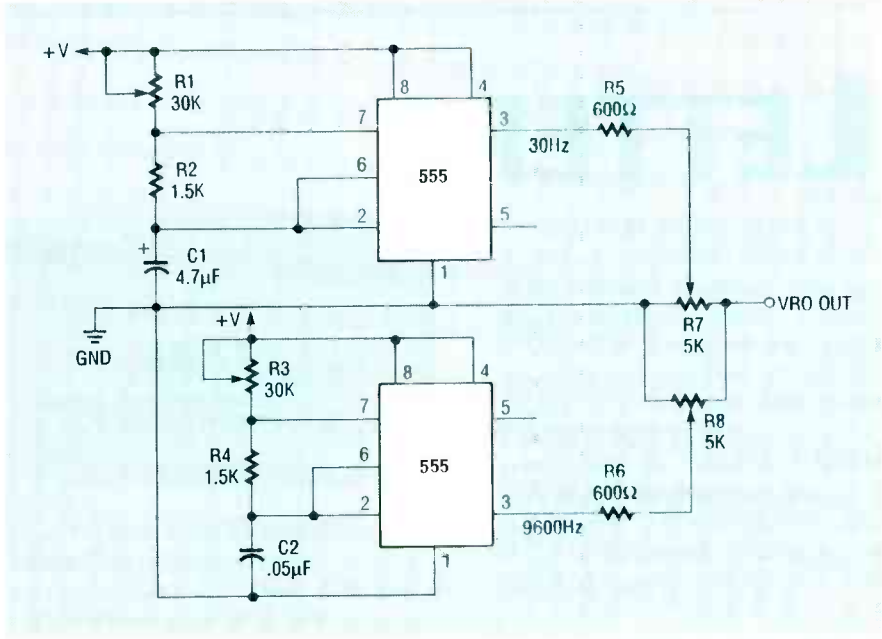

FIG. 1

the output frequency is relatively immune to changes in voltage. Unfortunately, the output voltage is going to depend on the supply voltage so it's a good idea to use a regulated supply. You can either buy one ready made or, since you're going to be laying out the circuit anyway, it's not much more work to add a three-terminal voltage regulator and pair of capacitors to the board. That will give you a stable supply voltage and peace of mind as well.

Sounds like a good deal to me. I don't know if the two frequencies have to be mixed together and, if so, whether they have to be of equal amplitude. In any case, you can use the simple resistor summing circuit shown in the schematic to combine the two frequencies or add a mixing amplifier. If you do decide to use an amp, be careful about the one you use since adding more electronics to a circuit always introduces the possibility of more distortion.

As for the circuit itself, you don't have to make a PC board to do the job. A breadboard can be used as a temporary solution, or you can build it on a piece of perforated construction board and wirewrap the connections between components.

There's nothing critical about the parts layout and, since there are trimmers to adjust both the output frequencies and the amplitude, you can get the exact signal you want with standard-tolerance parts. It's

still a good idea, however, to stay away from ceramic disc capacitors; use something like mica or tantalum. The actual value of a ceramic disc can be as much as 100% off, and even though the circuit is tolerant, there are limits to everything. R-E

**MAIL THIS COUPON FOR FREE FACTS!**  
**TRAIN AT HOME FOR A BETTER CAREER**  
 42 ways ICS can help you improve your life

Rush free facts and color brochure on how I can train at home for the career I have chosen. I understand I am under no obligation and no salesman will visit me.

**CHECK ONE BOX ONLY!**

**ASSOCIATE IN SPECIALIZED DEGREE PROGRAMS**

<input type="checkbox"/> Business Management	<input type="checkbox"/> Civil Engineering Tech.
<input type="checkbox"/> Accounting	<input type="checkbox"/> Mechanical Engineering
<input type="checkbox"/> Business Management with option in Finance	<input type="checkbox"/> Electrical Engineering
<input type="checkbox"/> Business Management with option in Marketing	<input type="checkbox"/> Electronics Technology

**CAREER DIPLOMA PROGRAMS**

<input type="checkbox"/> Computer Programming	<input type="checkbox"/> Legal Assistant	<input type="checkbox"/> Wildlife/Forestry Conservation
<input type="checkbox"/> Personal Computer Specialist	<input type="checkbox"/> TV/VCR Repair	<input type="checkbox"/> Veterinary Assistant
<input type="checkbox"/> High School Bookkeeping	<input type="checkbox"/> Mapping	<input type="checkbox"/> Diesel Mechanics
<input type="checkbox"/> Secretarial	<input type="checkbox"/> Catering Gourmet Cooking	<input type="checkbox"/> Electrician
<input type="checkbox"/> Medical/Dental Office Assistant	<input type="checkbox"/> Fitness & Nutrition	<input type="checkbox"/> Interior Decorating
<input type="checkbox"/> Legal Secretary	<input type="checkbox"/> Small Business Management	<input type="checkbox"/> Drafting
<input type="checkbox"/> Fashion Merchandising	<input type="checkbox"/> Air Conditioning & Refrigeration	<input type="checkbox"/> Motorcycle Repair
<input type="checkbox"/> Auto Mechanics	<input type="checkbox"/> Microcomputer Repair	<input type="checkbox"/> Gun Repair
<input type="checkbox"/> Hotel Restaurant Management	<input type="checkbox"/> Electronics Management	<input type="checkbox"/> Photography
<input type="checkbox"/> Child Day Care Management	<input type="checkbox"/> Travel Agent	<input type="checkbox"/> Journalism/Short Story Writing
<input type="checkbox"/> Police Sciences	<input type="checkbox"/> Art	<input type="checkbox"/> Dressmaking & Design

Name \_\_\_\_\_ Age \_\_\_\_\_  
 Address \_\_\_\_\_ Apt. # \_\_\_\_\_  
 City/State \_\_\_\_\_ Zip \_\_\_\_\_  
 Phone ( ) \_\_\_\_\_

**ICS** International Correspondence Schools  
 Dept. DE570, 925 Oak St., Scranton, PA 18515  
SINCE 1900  
 A Subsidiary of National Education Corporation

**CIRCLE 191 ON FREE INFORMATION CARD**

# Cable TV

## Descrambler Article Parts

We stock the exact parts, PC Board and AC Adaptor for two articles published in Radio-Electronics magazine on building your own CABLE TV DESCRAMBLER

<b>February 1984 issue</b> #701 Parts..... 19.00 Includes all original parts. #702 PC Board..... 7.95 Original 3x4 etched, drilled and silk-screened pc board. #704 AC Adaptor..... 7.95 Original 18 Volt DC @ 200ma. <b>#701, 702 &amp; 704..... 29.00</b>	<b>February 1987 issue</b> #301 Parts..... 29.00 Includes all original parts. #302 PC Board..... 7.95 Original 5x8 etched, drilled and silk-screened pc board. #304 AC Adaptor..... 7.95 Original 18 Volt DC @ 200ma. <b>#301, 302 &amp; 304..... 39.00</b>
----------------------------------------------------------------------------------------------------------------------------------------------------------------------------------------------------------------------------------------------------------------------------------	----------------------------------------------------------------------------------------------------------------------------------------------------------------------------------------------------------------------------------------------------------------------------------

Free article reprint with purchase.

<b>Snooper Stopper..... 39.00</b> Cable TV descramblers can be detected, protect your privacy with the Snooper Stopper. Free article on Cable Snooping.	<b>Macrovision Kit..... 29.00</b> Macrovision...now you see it, now you don't with our macroscrubber kit. Article was published in Radio Electronics 1987 issue.
------------------------------------------------------------------------------------------------------------------------------------------------------------	---------------------------------------------------------------------------------------------------------------------------------------------------------------------

**CALL TOLL FREE 1-800-332-3557**  
 Cut side USA 1-508-699-6935  
 Visa, Master Card and C.O.D.  
 Add \$3.50 S & H. \$6.00 outside USA.

Visa

MC

D & D Electronics, Inc., PO Box 3310, N Attleboro, Ma 02761

CIRCLE 186 ON FREE INFORMATION CARD

7-122C

AUGUST 1990

**cordata**

**386SX COMPUTER WITH VGA MONITOR**



- 100% IBM compatible.
- 80386SX-16/8 MHz speed, upgradable to 20 MHz.
- One 3-1/2" 1.44 MB floppy disk drive.
- One 5-1/4" 1.2 MB floppy disk drive.
- 40 MB hard drive/28 millisecond access time. • 1 MB RAM on motherboard, expandable to 8 MB.
- Expansion slots: three IBM AT compatible accessory slots, one IBM PC/XT compatible accessory slot.
- Three 1/2" peripheral bay.
- Built-in VGA video support.
- Battery backed real time clock/calendar.
- One serial port. • One parallel port.
- 80387SX-16 math co-processor socket.
- 101 key detachable IBM style keyboard.
- Zero wait state. • Phoenix BIOS.
- Included MS-DOS 4.4.
- Dim.: 16"Wx18"Dx5"H.
- Model # CPC8248.

• **One Year Warranty through Cordata.**  
• **Factory New! Factory Perfect!**

**VGA monitor:**

- 14" non-glare color monitor.
- 100% IBM compatible.
- 42 mm dot pitch. Mfr. Sugg.:
- 256 colors.
- Resolution: 640x480.
- Dim.: 14.72"W x 12.40"H x 15.64"D.

**\$2,968.00**

**DAMARK PRICE:**

**\$1499<sup>99</sup>**

Item No. B-2150-143578  
Insured Ship/Hand.: \$49.00

**FOR FASTEST SERVICE  
CALL TOLL FREE  
1-800-729-9000**



DAMARK INTERNATIONAL, INC.  
6707 Shingle Creek Parkway, Minneapolis, MN 55430  
Customer Service • 612-566-4940

Please rush me: \_\_\_\_\_ Cordata Computer(s)  
@ \$1499.99 each, plus \$49.00 s/h each.  
Item No. B-2150-143578  
MN res. add 6% sales tax.

Name \_\_\_\_\_  
Address \_\_\_\_\_  
City/State/Zip \_\_\_\_\_  
 Check/MO  VISA  Master Card  Discover  
Card No \_\_\_\_\_  
Exp. Date \_\_\_\_\_ Ph # ( ) \_\_\_\_\_  
Signature \_\_\_\_\_

**DELIVERY TO 48 U.S. STATES ONLY**

# LETTERS

## POWER SUPPLY BOARDS

For those interested in building our "Generic Linear Power Supply," (*Radio-Electronics*, June 1990): Etched and drilled PC boards are available from the author. Two boards cost \$12.50 postpaid. Orders from Canada should include an additional \$.25, and orders from South Carolina should include 5% sales tax. Write to John Wanamaker, Rt. 4, Box 550, Orangeburg, SC 29115.

## TAKING IT TO THE LIMIT

I'm writing to thank you for an excellent magazine. *Radio-Electronics* always presents the latest in technology, such as your coverage in *What's News* (May 1990) of the world's first true digital optical processor.

In particular, I enjoyed Don Lancaster's *Hardware Hacker*. His article on op-amp noise is the first I have seen in any magazine that explains what those parameters (current noise and voltage noise) are, and how to optimize a circuit for them. I have been an electronics engineer for nine years, and they don't teach those details in school. I recently went through several days of optimizing a circuit for drift in which I learned a lot about a similar set of parameters involving offset current drift and offset voltage drift. It isn't often that you have to push a part to the edge of its specifications, but when you do, there aren't many good places to turn to for the necessary information. I would really enjoy a tutorial series by Don Lancaster on op amps that examined those parameters used when pushing the edge of technology.

On another note, I was equally unimpressed with the article in the same issue concerning how to choose the right transistor for your next design. In that article, Josef Bernard explained that as long as your design does not "push the limits," and "sticks to middle ground," it's hard to go wrong! Of course it is! I read the article in the first place to



learn what types were best for high-power, high-frequency (RF) amplifier, and other specialized applications. We know how to use a general-purpose switching transistor—now show us how to use a transistor to build a UHF amplifier.  
JOHN BURGAN  
NORTH PALM BEACH, FL

## DON'T ARGUE WITH NYQUIST!

The excellent article "Inside Digital Oscilloscopes," which appeared in the May 1990 issue of *Radio-Electronics*, presented some interesting and useful information about oscilloscope technology. While I enjoyed the article, I must quibble on one point. The article states: "... sampling rate must be at least double the bandwidth ..." of the sampled signal. The term "bandwidth" is a bit vague. As I recall, the correct application of the double-frequency law for sampled signals requires sampling at double the highest frequency component in the signal. That distinction is important. For example, a pure sine wave, say 1 MHz, has a very narrow bandwidth, although the sampling rate must be twice the frequency (not bandwidth), or 2 MHz, to reconstruct the 1-MHz signal.

That requirement is easily understood in consideration of, first, the need to detect both positive and negative signal excursions and, second, the assumption that the signal is a perfect sine wave.

Given the sine-wave definition, and given (as Fourier proved) that any complex wave is composed of sine waves, then the sampling rate of twice the highest component fre-



## CORRECTION

In our "Solid State Wiper Control" construction article (**Radio-Electronics**, April 1990), we regret that there were several editorial errors that need correcting:

- In Fig. 1 on page 47, Zener diode D1 is backward. Also, RY1 should be connected as shown in the partial reprint of Fig. 1 shown here. The center terminal of the switch in RY1 goes jointly to the Low side of the motor (MOT) and the Low terminal on S2. The left terminal of the switch on RY1 goes jointly to the pole terminal on S2 and the hot input accessory + 12VDC from the battery.

- In Fig. 2 on page 47, RY1 should be connected as shown in the reprint of Fig. 2 shown here. Also, the last sentence of the original caption is incorrect. Switch 1 of RY1 goes in parallel across S2-b; the center terminal of switch 1 goes to the PULSE terminal on S2-b, while the top terminal of switch 1 goes to the pole terminal on S2-b.

- The parts-placement diagram of Fig. 3 on page 48 was improperly registered, and was reprinted on page 35 of the May 1990 issue. However, the power and ground leads need to be revised.

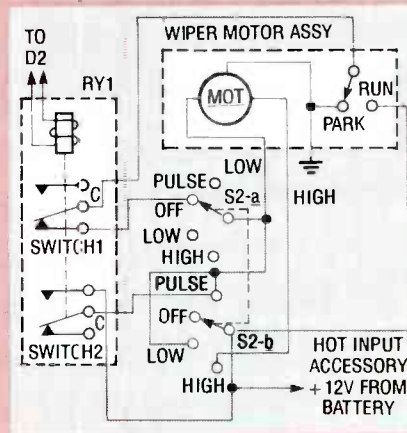
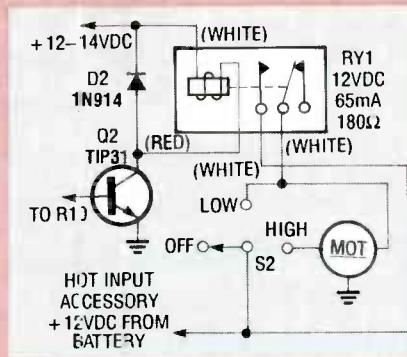

quency provides information sufficient to reconstitute the signal.

DAVE SWEENEY  
SOMERS POINT, NJ

*You are, of course, quite right. The article should have said either "absolute bandwidth" or "maximum bandwidth," instead of simply "bandwidth." Thanks for the clarification.—Editor*

### KEEP 'EM COMING!

I'm writing to show my support for Robert Grossblatt's *Drawing Board* series dealing with the generation of video signals. I am a student at the University of Miami, studying electrical engineering. After being inspired by the first article in the series, I went to the library to get more information on the subject. Although those sources covered the video signal, timing, etc., none of them discussed the hardware needed to create those signals. I would like to compliment **Radio-Electronics** on doing just that—enabling me to get first-hand expe-

rience in a subject not covered elsewhere. Keep 'em coming!

DAVID G. BURD  
MIAMI, FL

### DRAMA ON THE AIRWAVES

**Radio-Electronics** readers might want to tune into a high-tech, futuristic techno-drama, *RUBY 3*, that is being produced for radio by the ZBS Foundation. The story, set in the 21st century, follows the adventures of two women: Ruby is a tough, witty detective who is hired to find the source that is causing a buying frenzy in the City of Malls on the planet Summa Nulla and Inana is on a spiritual mission in which she faces a series of life-threatening tests. The two characters create a drama that is at once comic, action-packed, mythical, and spiritual. The series of 20 self-contained half-hour shows will be broadcast on various public-radio stations beginning on October 1, 1990.

KATHY GRONAU  
ZBS FOUNDATION  
FORT EDWARD, NY

## Put Professional Knowledge and a COLLEGE DEGREE in your Technical Career through HOME STUDY

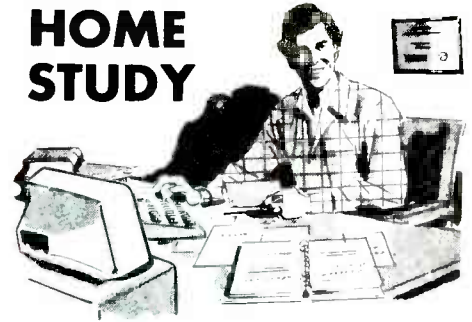

Add prestige and earning power to your technical career by earning your Associate or Bachelor degree through directed home study.

Grantham College of Engineering awards accredited degrees in  
**electronics and computers.**

An important part of being prepared to *move up* is holding the right college degree, and the absolutely necessary part is knowing your field. Grantham can help you both ways—to learn more and to earn your degree in the process.

Grantham offers two degree programs—one with major emphasis in **electronics**, the other with major emphasis in **computers**. Associate and bachelor degrees are awarded in each program, and both programs are available completely by correspondence.

No commuting to class. Study at your own pace, while continuing on your present job. Learn from easy-to-understand lessons, with help from your Grantham instructors when you need it.

Write for our free catalog (see address below), or phone us at toll-free 1-800-955-2527 (for catalog requests only) and ask for our "degree catalog."

Accredited by  
the Accrediting Commission of the  
National Home Study Council

**GRANTHAM**  
*College of Engineering*  
250 Frontage Road  
Slidell, LA 70460

# EQUIPMENT REPORTS



## Beckman Industrial RMS225 Professional Digital Multimeter

*A feature-packed true-RMS  
meter that's easy to use.*

CIRCLE 35 ON FREE INFORMATION CARD

AS MUCH AS WE APPRECIATE THE STRIDES that manufacturers have made in packing more and more features into handheld multimeters, we realize that it's not always appreciated by the professional user. If your job calls for making accurate voltage measurements, then a meter's ability to measure capacitance, for example, is just excess baggage.

That seems to be the philosophy behind the RMS225, the newest addition to the professional line of Beckman Industrial Corporation (Instrumentation Products Division, 3883 Ruffin Road, San Diego, CA 92123-1898)

The RMS225 measures resistance, and DC and AC voltage and current. It can also test continuity and diode junctions. A host of special features add versatility to the meter without making it more difficult to use.

The RMS225 offers five DC voltage ranges (1.0–1000 volts full scale) with a rated accuracy of 0.25%. Three AC voltage ranges (10, 100, and 750 volts) offer a rated accuracy of 1.0% for sinewaves from 45 Hz to 2 kHz. The accuracy for the true RMS measurements decreases slightly for other waveforms. Six resistance ranges (1K–40 megohms) and three AC and DC current ranges (10 mA, 40 mA, and 10 amps) are also offered.

The meter is housed in a gray,

high-impact thermoplastic case that measures about  $6\frac{3}{4} \times 2\frac{3}{4} \times 1\frac{1}{4}$  inches and weighs less than 12 ounces. The front panel sports a 4-digit LCD readout with analog bargraph, three pushbuttons, a rotary function selector, and four input jacks. The meter fits easily in one hand, and all controls can be operated by the thumb of that one hand—something that can't be said for many other "handhelds."

### Menu-selected features

Three pushbuttons below the LCD readout are used to access the meter's special functions. Hitting the MENU button calls up the menu, and allows you to scroll through the selections.

Range lock is the first feature that is menu selectable. Although the meter is in an auto-ranging mode when it is first powered up, it is possible to lock the meter scale to a given range. Like all other menu selected features, range lock can be de-selected with the CLEAR button.

Probe Hold is a convenience feature that allows the user to take a reading without looking at the meter's display—a stable reading is held in the display for later viewing. The meter beeps to indicate that it has captured a stable reading.

A relative mode is also accessed from the menu. That mode allows

the user to set a reference value, and all other readings display with respect to that reference.

Auto Min Max is a mode in which the meter measures and stores the minimum and maximum values, while displaying real-time readings. It's ideal for unattended monitoring.

### Using the meter

The RMS225 is very easy to use. Although we were initially skeptical about the presence of a menu on a DMM, we were happy to find that Beckman's implementation was intuitively easy to use—even without reading the manual. Of course, we do encourage users to read operating manuals; this meter's manual was well written.

Unlike many other 4-digit multimeters, the RMS225 offers a 10,000-count resolution—in other words, its maximum reading is 9999, which results in a higher measurement resolution. For example, you can resolve 0.1-volt changes even when measuring a 500-volt signal. A 3½-digit meter would be able to resolve changes of 1 volt on the same signal.

We didn't have the opportunity to overload the meter, but we know that accidents can happen. That's why we like the self-resetting fuse that protects the low-current (40 mA) input jack. We also liked the continuous tone that warns when measurements exceed the meter's input ratings, and the lightning-bolt annunciator that warns the user of a potential hazard when measured signals exceed 25 volts.

We also did not have the opportunity to try the protective holster with Flex Strap that is normally supplied with the meter. (Ours was an early production model.) Besides offering protection, the holster, with its probe holders and strap, can make many measurements more convenient.

The RMS225 carries a suggested retail price of \$149. That competitive pricing should get the meter into a lot of hands rather quickly. **R-E**



# PLUG IN. TURN ON. GET DATA. FAST. FREE SOFTWARE. NO PROGRAMMING.

**NEW!**

**Turnkey ProtoKey™ 8-channel data acquisition system...the accurate, low cost solution to real time data collection from your IBM compatible PC...with user-friendly software included.**

Sophisticated, without being frightening. Truly functional. Amazing accuracy. More than mere hardware. Requires no programming skills. And, truly affordable at only \$395.

All describe the hot, new Global Specialties American-made ProtoKey™ 8-channel data acquisition system, which includes ■ 8 A/D input channels with 12 Bit resolution ■ selectable conversion times of 7 Hz or 30 Hz ■ 3 input ranges from 5 Volts to 50mV ■ 100 uv resolution ■ thermocouple linearization ■ interfaces to a variety of transducers ■ plus, operating software and a complete users manual.

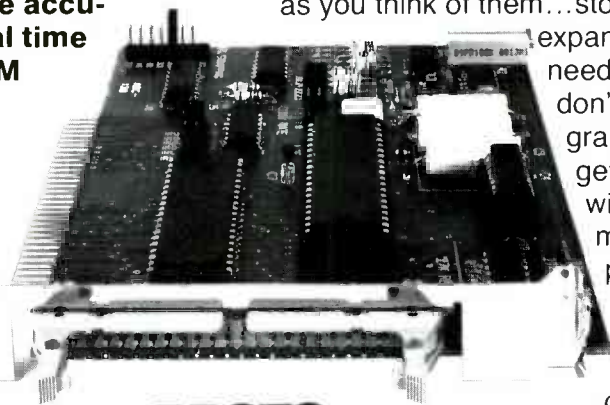

Now you can create daring experiments as fast as you think of them...store them indefinitely...expand or modify them as needed. Best of all, you don't have to be a programmer, because you get an unlimited data window with Global's menu-driven software package...the power of a programmable package, without the hassle...simplified operation with everything you ever need to know right there on the screen in pop-up menu formats. Plus, on-line help, with interfaces to popular spreadsheet or analysis programs...with just a single keystroke.

Get the facts today. Just say, "Data...fast!" We'll understand. That's ProtoKey!

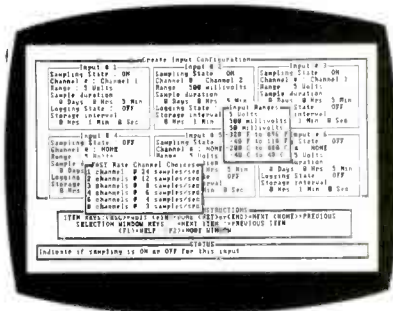

*Easy does it!*



Call toll-free for details  
**1-800-572-1028**

**GLOBAL SPECIALTIES**

CIRCLE 188 ON FREE INFORMATION CARD

Global Specialties. An Interplex Electronics Company  
70 Fulton Terrace. New Haven, CT 06512.  
Telephone: (203) 624-3103 © Interplex Electronics 1989.  
All Global Specialties breadboarding products made in USA.

A0012

# DRAWING BOARD

## Video-scrambling techniques



ROBERT GROSSBLATT,  
CIRCUITS EDITOR

TRUST ME, PEOPLE, THIS IS THE LAST thing I'm going to have to say about video—at least for a while. You know enough now to make a pilgrimage to your local library and get a lot more information than I can squeeze into this column. And, in any event, my bench has been covered with video junk for a few months now and I'm getting the itch to start messing around with something else.

Video-signal scrambling is the only basic subject we haven't really looked at.

Scrambling methods go from the simple to the ridiculous, and the ones you're likely to encounter locally depend entirely on who you happen to be getting the signal from. Small cable companies use relatively simple methods, but the people running the satellite systems go much further because they have less control over who can get the signal. Last I heard, there's no law against owning a satellite dish, but hook into the cable without authorization and you're in really deep... trouble.

Most of the current scrambling methods fall into one or more of the following four categories:

1. Screwing around with the sync signals.
2. Screwing around with the picture.
3. Screwing around with everything.
4. Screwing around with something else.

While I'm the first to admit that it's not the most informative list in the world, it's really what's going on. It's also impossible to describe every method there is because new ones are being devised as fast as old ones get beaten. But let's look at a few of them.

### Screwing up the sync

The most common method of scrambling, and one of the oldest, is to mess up the horizontal sync. If your TV can't find it, there's no way for it to lock its horizontal oscillator to the beginning of each line of video. The result will be a weirdly colored, wavy bar somewhere in the middle of the screen and a totally unwatchable picture. As you probably realize, the vertical bar is the sync portion of each line that really belongs off to the right and left of the screen. A line of video using this method looks something like Fig. 1.

It takes only a simple twist of a knob for the broadcaster to remove the horizontal signal but, since he wants to put it back in later, there has to be some way to put it back—at the right time and the right level. The information used to be buried in the IF but that's been largely replaced with encoding the information and sticking it in the vertical interval. Since the FCC eased their control of what can and can't be done during vertical retrace, people have found all sorts of uses for it. One of the newer wrinkles in the wonderful world of sync suppression is to change the transmitted sync level in each field of video. The amount of gain needed to put things back is encoded in the vertical interval. The descrambler hardware knows how to get that information and, consequently, how much gain to use to restore horizontal sync.

### Screwing up the picture

One method that my cable company is starting to use now messes up both sync and picture. The basic scrambling technique is simple and

makes the picture even worse than just suppressing sync. What's also interesting is that, even though it's newer, it's theoretically much easier to beat than suppressed sync.

All that's done is to invert the entire video line using 0 IRE as the center point. As you can see in Fig. 2, horizontal sync gets stuck in the picture area (positive IRE numbers) and picture information winds up in the control-signal area (negative IRE numbers). The TV can't find the horizontal sync and, since picture luminance and chroma are upside down, the colors are backward.

You might think that all that has to be done to clean everything up is to put the whole signal through a wideband, inverting amp—and you would be right—except for one thing. If you look carefully at Fig. 2, you'll see a positive-going pulse immediately following the sync area. If you invert the line, that spike will be negative-going, and look something like a delayed version of horizontal sync. The bottom line is that it's going to confuse the horizontal circuitry in the TV and the picture will still be messed up.

The way to beat the system is to invert the picture and then run it through a circuit that does two things: First it watches for horizontal sync, and then, during the period that the spike is being transmitted, it adds a version of the spike that's 180 degrees out of phase. That will null out the spike and leave a restored picture.

The circuitry needed to beat this is simple. As a matter of fact, you already know enough to design it. You'll need an amp that can handle video frequencies (top around 6 MHz), a sync separator, a counter,



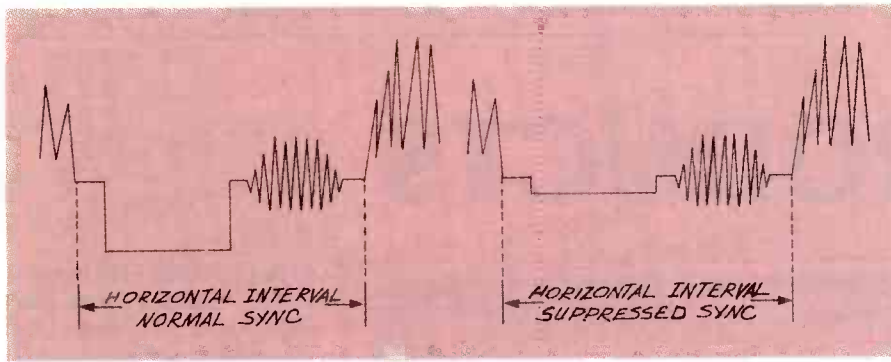

FIG. 1

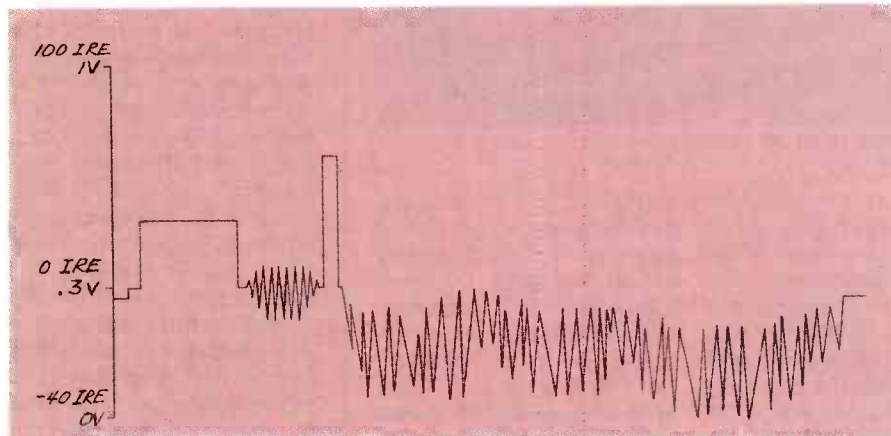

FIG. 2

and finally, a mixing amp.

### Screwing up everything else

All the methods we've looked at so far are the kinds of things you find done by cable companies. They're all fairly easy to implement, and the circuitry to do the job (on both ends) can be produced at manageable economic levels.

Satellite systems don't have the luxury of an exclusive client list. Anyone who has a dish can get their signal so they need some sort of scrambling that's going to be more difficult to beat. Most of these guys use scrambling methods that really tear the video apart. A system like this is much more difficult to break. It's not impossible, just much more difficult.

If you look at some of them on a scope, you'll see things that don't even look like video. Sync (both horizontal and vertical) seems to be nonexistent and the video is strange as well. That's understandable since a lot of satellite scramblers change the order of lines and sometimes even superimpose miscellaneous waveforms on top of the whole mess.

The initial stage of designing any

circuitry to decode scrambled signals is to look at the waveform. Because there are so many ways that the signal can be screwed up, the only piece of advice I can give you is to use a dual-trace scope. Put a line of plain video on one channel and the scrambled signal on the other. By triggering off real video, you may be able to see a pattern.

Breaking scrambled video is not something you can toss off between breakfast and lunch. It takes a lot of analysis and design. And, of course, depending on what you do with your new knowledge, you may be risking a paid vacation in the slammer. That isn't to say that digging into a scrambling technique is not fun to do—I'm a firm believer in having a good time at the bench. If you do have an urge to try it, remember that there's always some pattern to the scrambled signal. Keep an eye out for a horizontal and vertical interval. A good rule of thumb is that no matter what's done to the signal, it has to be put back together, and the numbers we worked out a few months ago regarding field- and frame-repetition rates should give you a starting point.

R-E

## evaluating an ANTENNA (MATCH)

FIG. 9

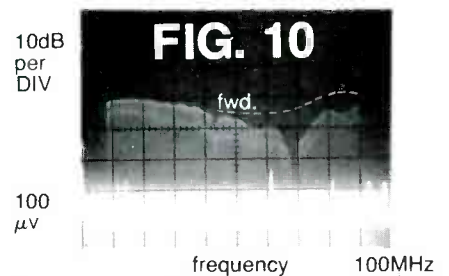
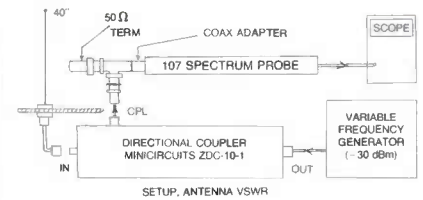

The degree of match between a 50  $\Omega$  source and an antenna is obtained with the set-up illustrated in fig. 9. The tuning, Q, and reflection loss are available. The CPL output with either an open or direct short on IN is plotted as the fwd line in fig. 10. Then the cable to the antenna is attached, and the scope photo of fig. 10 results. The difference between these lines is desired. The scope indication of "37 dB" forward, "12 dB" reverse, indicates the reflected loss is down 25 dB at 68 MHz; (1.1 VSWR)  $1/320=0.3\%$  of the applied power is reflected or about 99.7% of the available power is radiated (or at least absorbed) by the antenna. Conversely, 99.7% of the received power is applied to a 50  $\Omega$  receiver. Since the probe can "see" a low level, only a low radiated signal is required. The discrete lines are signals received by the antenna. The logarithmic response allows evaluation of good matches.

**107 SPECTRUM PROBE®**

converts your scope into a  
100MHz spectrum analyzer

**\$199** direct

**Smith Design** 1324 Harris  
Dresher, PA 19025 (215) 643-6340

CIRCLE 193 ON FREE INFORMATION CARD

# NEW PRODUCTS

**DEVELOPMENT SYSTEM.** Designers who are developing systems based on *Motorola's* popular family of 68HC05 Customer Specified Integrated Circuit (CSIC) microcontrollers can debug hardware and software faster and easier than ever before, using the *CDS8/05* development system. The first entry in *Motorola's* "Jewelbox Family," the affordable *CDS8/05* provides a complete professional development environment in a portable 11 x 12 x 2-inch package.

The system provides real-time, non-invasive emulation of the microcontroller. Time-saving features include a window-oriented user interface, menu-driven commands, single-step execution, symbolic debugging, software breakpoints, continuous run mode, and memory mapping. As the system is the first commercial product based on *Motorola's* 68332, which replaces the equivalent of nine



CIRCLE 10 ON FREE INFORMATION CARD

peripheral chips, the *CDS8/05* takes advantage of the 32-bit microcontroller's advanced integration.

To make it completely portable, the *CDS8/05* was designed with alternate power sources: either a universal 85-265-volts AC, 50-60-Hz power supply or a 9-18-volts DC converter. The system also features a bus analyzer that contains an 8K-by-80 real-time trace buffer. The bus analyzer can connect to on-board non-volatile RAM that stores macros loaded in the lab for use in the field.

The included software-development package runs on

an IBM PC, XT, AT, or compatible computer, which also serves as the host computer for the *CDS8/05*. PC interconnect software and a macro assembler/linker are included with the software. The interface features symbolic debugging of assembly-language programs, macro definition and state collection, help screens and escape to DOS.

The *CDS8/05* development system costs \$2950.00.—**Motorola Inc.**, Microprocessor Products Group, 6501 William Cannon Drive West, Austin, TX 78735-8598; Tel. 512-891-3184.

**THREE-CHANNEL OSCILLOSCOPE.** For easy analysis of low-level and high-speed signals, *Leader Instrument's* model 1100 100-MHz, three-channel, dual-time-base oscilloscope features six-trace capability with 500- $\mu$ V maximum sensitivity and 5-ns maximum sweep speed. Other features include alternate triggering, alternate time base, and variable holdoff. The 1100's high-intensity CRT and extensive triggering controls provide a

bright, stable display, even of complex signals. TV-V1, TV-V2, and TV-H sync-separator circuits allow optimum triggering of video signals, and alternate timebase allows simultaneous observation of vertical and horizontal TV signals.

The model 1100 oscilloscope costs \$1545.00.—**Leader Instruments Corporation**, 380 Oser Avenue, Hauppauge, NY 11788; Tel. 800-645-5104 (in NY, 516-231-6900).

**SURGE-PROTECTED TRIPLE OUTLET.** Designed for situations where electrostatic discharge (ESD) is a concern, *Plastic Systems'* model *SP-0301* has three surge-protected outlets configured in one unit, and also provides assurance that the electrical

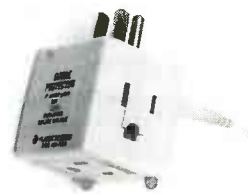

CIRCLE 12 ON FREE INFORMATION CARD

ground is accurate. Two highly visible LED's allow quick verification of surge protection and ground suitability. The monitor also provides a plug-in ground point for a standard 0.175-inch banana plug that is grounded for safety through a one-megohm resistor.

The model *SP-0301* spike-and-ground-alert outlet costs \$29.50.—**Plastic Systems, Inc.**, 261 Cedar Hill Street, Marlboro, MA 01752; Tel. 508-485-7390.

**FILTER-SUBSTITUTION BOXES.** With the *Krohn-Hite 3000 Series Flexi-Filters*, the response can be changed to fit many applications—without purchasing additional filter cards. As many as four filter channels have independently variable parameters to allow tailoring of their response. With the push of a button, the user selects Butterworth, Bessel, Chebyshev, or RC responses with attenuation slopes from 6-48 dB/octave in 6-dB/octave steps. Each channel can be independently set to be low-pass, high-pass, band-pass, band-reject, amplifier only, or any combination (such as low-pass with band-reject). Cutoff frequencies are tunable



CIRCLE 13 ON FREE INFORMATION CARD

from 0.001 Hz to 200 kHz. The filter boxes, which have differential or single-ended inputs, separately adjustable input-output gains of up to 10,000, and output gain adjustable in 0.1-dB steps, can be fine-tuned to suit the user's application. Additional features include up to two oscillator outputs, battery power, and IEEE-488 control of all parameters.

The 3000 Series filter-substitution boxes range in price from \$1995.00 to \$3600.00.—**Krohn-Hite Corporation**, Avon Industrial Park, Bodwell Street, Avon, MA 02322; Tel. 508-580-1660, ext. 31.

**THREADED BANANA JACKS.** To solve the problem of "not enough hands" while handling test equipment and making multiple test contact points on terminal blocks



CIRCLE 11 ON FREE INFORMATION CARD





**CIRCLE 14 ON FREE INFORMATION CARD**

and strips, *ITT Pomona Electronics* has introduced a threaded banana jack. Available in three standard thread sizes, each unit is an integrally machined banana-jack receptacle and screw, with an insulated hex-head housing. The terminal strip jacks thread directly into industry-standard barrier and terminal strips.

The integral threaded studs, which are nickel-plated for corrosion resistance and low contact resistance, meet or exceed the torque specifications for the screws that they replace in the terminal strips. The insulated heads are  $\frac{5}{16}$  hex, to match the most common hex drivers.

Models 5699, 5700, and 5701 are 6-32, 8-32, and 10-32 thread, respectively. Each is available in seven colors for easy recognition. The list price is \$2.75 each, with quantity discounts available.—*ITT Pomona Electronics*, 1500 East Ninth Street, P.O. Box 2767, Pomona, CA 91769; Tel. 714-623-3463.

**TELEPHONE-NETWORK SIMULATORS.** Two additions have been made to *Telecom Analysis Systems'* popular *TAS 100* family of telephone-network simulators. Designed for testing modems, fax machines, voice/data terminals, transmission test sets, and telephone sets, models *TAS 121* and *TAS 122* are compact tools for de-



**CIRCLE 15 ON FREE INFORMATION CARD**

velopment, reliability testing, manufacturing, field support, and maintenance.

The *TAS 122* provides simultaneous bi-directional simulations of trunk impairments, and the *TAS 121* provides uni-directional impairments. On both units, impairment features include attenuation and noise; gain and group-delay distortion; phase jitter and frequency offset; nonlinear distortion; gain hits, phase hits, and impulses; and satellite delay and echo. Simulation of central office (exchange) variables is also provided, including loop current, ring voltage, ring frequency, and signaling frequencies and cadences. Both models simulate 4- and 2-wire private lines. Automatic calibration and diagnostics assure test integrity. Standard GPIB and RS-232C remote-control interfaces are provided.

Prices for the *TAS 121* and *TAS 122* telephone-network simulators start at

\$11,950.00.—*Telecom Analysis Systems, Inc.*, 34 Industrial Way East, Eatontown, NJ 07724; Tel. 201-544-8700.

**ELECTROMAGNETIC-RADIATION MONITOR.** Designed to meet the rising concern about the potential hazards of low-level electromagnetic radiation, *Walker Scientific's ELF-50D* field monitor is a hand-held instrument that provides accurate readings instantly on a digital display.



**CIRCLE 16 ON FREE INFORMATION CARD**

The *ELF-50D* measures the extra-low-frequency (ELF) electromagnetic radiation that is generated from power lines, TV's, video displays, home appliances, and other

## OEI OPTOELECTRONICS

The only name in **HANDI-COUNTERS**

Check These Incredible Features On The All New UTC3000

- **10Hz to 2.4GHz Range.**  
Simply amazing!
- **10 Digit LCD Display.**  
1Hz resolution to over 150 MHz direct. Readable in bright sunlight.
- **RF Signal Strength Bargraph.**  
16 Segment, Zero, & Full Scale adjustment. SEE the input signal!
- **Super Sensitivity.** <1mV 10-200MHz. <5mV to 2GHz for efficient antenna pickup.
- **6 Functions.** Frequency, Period, Ratio Time Interval, Average, & Prescale.
- **Hold Button.**  
"Locks in" your exact Measurement FAST!
- **Extruded Aluminum Enclosure.**  
Designed to fit every hand.
- **Priced Right! Only \$375.**  
Includes Needs, AC Charger/Adapter. Or Select Our Most Popular **HANDI-COUNTER**, the model 2210A that set the standard in handheld frequency counter technology! **Value Priced at only \$239.**

Professionals and Hobbysts all over the world have chosen **OEI** for 16 years! **Shouldn't YOU?**

**HANDI-COUNTERS! ...Only from OEI!**  
Choose the model that fits your needs... and your budget! **CALL NOW!**



Model	UTC3000	2600H	2210A	1300H/A
Function	Freq. Period Ratio, Interval, Avg. Prescale	Frequency	Frequency	Frequency
Range	10Hz-2.4GHz	10MHz-2.4GHz	10Hz-2.4GHz	1MHz-1.3GHz
Display	10 Digit LCD w/Function Annunciators	10 Digit LCD	8 Digit LED	8 Digit LCD
RF Signal Strength Indicator	16 Segment Adjustable Bargraph	16 Segment Adjustable Bargraph		
Price	\$375.	\$325.	\$239.	\$179.

Sensitivity: <1 to <10mV typical. Time Base:  $\pm 1$ ppm,  $\pm .5$ ppm add \$75. LED Models:  $\pm .2$ ppm add \$80. LCD Models: Needs & AC charger adapter included. Carry Case, Antennas and Probes extra. One year parts & labor warranty on all products.



**Toll Free Order Line: 1-800-327-5912** FL (305) 771-2050 • FAX (305) 771-2052

5821 NE 14th Avenue • Ft. Lauderdale, FL 33334  
Visa, MC, COD, Cash, M.O. accepted. Personal Check allow 3 weeks. 5% Shipping, Handling, (Maximum \$10) U.S. & Canada 15% outside continental U.S.A.  
In FL add 6% sales tax. Full-line Product and Accessory Catalog available on request.



**CIRCLE 187 ON FREE INFORMATION CARD**

equipment. By simply switching the unit on and holding it where radiation is suspected, a reading is instantly provided on the 3½-digit display.

The *ELF-50D* is calibrated to measure with ±1% accuracy the electromagnetic radiation generated from any 50- or 60-Hz device. It has two switch-selectable measurement ranges: a low range from 1 milligauss to 2 Gauss, and a high range up to 20 Gauss.

The *ELF-50D* electromagnetic-radiation monitor has a suggested list price of \$225.00.—**Walker Scientific, Inc.**, Rockdale Street, Worcester, MA 01606; Tel. 800-962-4638.

**CAPACITANCE METER.** *Boonton Electronics'* model *7200* capacitance meter accurately measures 1-MHz capacitance in the presence of loss—and measures the parallel conductance loss as well. The unit will compute and display on command the parallel resistance, dissipa-



**CIRCLE 17 ON FREE INFORMATION CARD**

tion, quality factor (Q), the equivalent series capacitance and resistance, ΔC, and Δ%. It features a 0–2000-pF capacitance range and a conductance range of 0 to 2000 μS. Test levels are programmable from 15 to 100 mV.

The *7200* accepts, measures, and displays external bias voltages to ± 200 V. An optional internal supply provides programmable bias voltages to ±100 V. That, together with fast analog C, G, and V outputs, make the instrument useful for C-V and G-V plots of semiconductor devices. When operated on the GPIB bus, the C, G, and V information is available simultaneously for rapid data

transfer.

The model *7200* capacitance meter costs \$4,495.00.—**Boonton Electronics Corp.**, 791 Route 10, Randolph, NJ 07869; Tel. 201-584-1077.

**PORTABLE FUNCTION GENERATOR.** A versatile general-purpose signal source, *Beckman Industrial's* model *FG2A* function generator performs over seven frequency ranges (0.2 Hz through 2 MHz) and a very large array of signal outputs, including both TTL pulse outputs and adjustable low-distortion sine-, square- or triangle-wave signals. The instrument offers the convenience of push-button



**CIRCLE 18 ON FREE INFORMATION CARD**

selection of power, frequency range, and wave form. It is housed in a durable case that has a cushioned handle/tilt stand and recessed areas in the top cover for easy stacking of multiple units. Applications for the portable field-test instrument include such things as testing vibration, servo systems, audio systems, and ultrasonic devices, as well as in R&D and in teaching electronics.

Various controls provide flexibility. The duty-cycle control allows users to change the nominal 50% duty cycle of the signal to any desired value, and the DC offset control adds a variable DC-offset voltage to the signal. The VCF input, which permits the frequency to be controlled with an external DC control voltage, is useful for generating 1000.1 or 1.1000 sweep signals.

The model *FG2A* function generator has a suggested list price of \$215.00.—**Beckman Industrial Corporation**, Industrial Products Division, 3883 Ruffin Road, San Diego,

# CABLE - TV

## SIGNAL REMOVERS

- FOR ELIMINATION OF SEVERE INTERFERENCE
- FOR "CENSORING" OF ADULT BROADCASTS



**FOR FULL DESCRIPTION OF USES ask for our free brochure**

- ATTENUATION - 45 dB TYPICAL
- BANDWIDTH - 4 MHz AT 5 dB POINTS
- INSERTION LOSS - 2 dB

MODEL	TUNING RANGE	FOR CHANNELS	PASSBAND	PRICE	SHIPPING
23H	50-66 MHz	2,3 (or 6 meter ham)	50-300 MHz	\$30	NO SHIPPING or C.O.D. CHARGES
46FM	66-108 MHz	4,5,6 (or any FM)	50-300 MHz	\$30	
1417	120-144 MHz	14(A) 15(B) 16(C) 17(D)	50-400 MHz	\$30	
1822	144-174 MHz	18(E) 19(F) 20(G) 21(H) 22(I)	50-400 MHz	\$30	
713	174-216 MHz	7,8,9,10,11,12,13	50-400 MHz	\$30	

**3 for \$75 - 10 for \$200 - mix or match**

CALL TOLL FREE FOR C.O.D. OR SEND CHECK TO ORDER  
FAST DELIVERY  
30 DAY MONEY BACK GUARANTEE (3 FILTER LIMIT)

**Star Circuits**  
P. O. Box 94917  
Las Vegas, NV 89193-4917  
**1-800-433-6319**

# KENWOOD OSCILLOSCOPES

ANALOG OSCILLOSCOPES W/O READOUT

**MODEL CS-5135**  
40 MHz, Dual Channel.  
Delayed Sweep.  
REG. \$895.00 SALE \$719.95

**MODEL CS-5155**  
50 MHz, 3 Channel.  
6-Trace, Delayed Sweep.  
REG. \$995.00 SALE \$819.95

**MODEL CS-5165**  
60 MHz, 3 Channel.  
6-Trace, Delayed Sweep.  
REG. \$1095.00 SALE \$899.95

**MODEL CS-2150**  
150 MHz, 4 Channel.  
8-Trace, Delayed Sweep.  
REG. \$2395.00 SALE \$1495.95

ANALOG OSCILLOSCOPES W/READOUT/CURSORS

**MODEL CS-5130**  
40 MHz, Dual Channel.  
4-Trace, Delayed Sweep.  
REG. \$1095.00 SALE \$899.95

**MODEL CS-5170**  
100 MHz, Dual Channel.  
4-Trace, Delayed Sweep.  
REG. \$1695.00 SALE \$1399.95

**MODEL CS-6010**  
100 MHz, 4 Channel.  
10-Trace, Delayed Sweep.  
REG. \$1995.00 SALE \$1699.95

**MODEL CS-6020**  
150 MHz, 4 Channel.  
10-Trace, Delayed Sweep.  
REG. \$2395.00 SALE \$1999.95



**MODEL CS-4025**  
20 MHz, Dual Channel  
Oscilloscope.  
REG. \$495.00

**SALE \$349.95**

**PRINT™**

Products International  
8931 Brookville Rd.  
Silver Spring, MD 20910  
(800)638-2020 (301)587-7824  
FAX# 301-585-5402  
EASY ORDER FAX LINE (800)545-0058

**800-638-2020**



**CIRCLE 192 ON FREE INFORMATION CARD**



CA 92123-1898; Tel. 619-495-3240.

**NTSC-PAL-SECAM TV/MONITOR/VCR.** Incompatible TV-broadcasting systems—NTSC, PAL, SECAM—have created problems in international communications for years. The *Multicombo* and *Super Multicombo* TV/monitor/VHS VCR's allow PAL tapes to be enjoyed with no loss of quality. *Ten-Lab* describes the units as the first "built-in, up-dated American (NTSC) video centers that have foreign systems capabilities."



CIRCLE 19 ON FREE INFORMATION CARD

Both cable-ready sets are available in either 20- or 27-inch sizes, and feature 155 channels, wireless remote controls, double multi-function on-screen color display, hi-fi stereo sound, MTS broadcast stereo decoder, and two built-in full-range speakers. The *Multicombo*s provide play-back of NTSC and PAL videotapes in color, and SECAM playback in black-and-white. The *Super Multicombo*s also allow PAL and SECAM recording (in full color), as well as PAL and SECAM monitoring (PAL in color, SECAM in B&W). For the proper color, video quality, sound linearity, and synchronism, the sets provide 525 lines, 60 Hz for NTSC and 625 lines, 50 Hz for PAL.

The 20- and 27-inch *Multicombo*s cost \$1345.00 and \$2495.00 and the 20- and 27-inch *Super Multicombo*s cost \$2100.00 and \$3200.00, respectively.—**Ten-Lab Multi-system Video Products**, 11064 Mississippi Avenue, Los Angeles, CA 90025; Tel. 213-473-66551.



CIRCLE 20 ON FREE INFORMATION CARD

**SYNTHESIZER/CLOCK GENERATOR.** Designed for engineers who require an affordable, basic frequency source, *Novatech's 2901A* synthesizer/clock generator offers 10-ppm accuracy, stability, good spectral purity, and low harmonic distortion. The instrument's output frequency is adjustable from 200 kHz to over 32 MHz with 5-digit resolution. Sine-wave and TTL-compatible outputs are available on the front panel. The sine-wave output amplitude is adjustable from 100 mV to 1.1 volts peak-to-peak. The *2901A* also has an auxiliary sine-wave-tracking output on the rear panel that is equal to the front-panel sine-wave output plus 128 MHz. The unit is housed in a convenient

bench-top case with tilt-up bail.

The *Novatech 2901A* frequency synthesizer/clock generator costs \$750.00.—**Novatech Instruments, Inc.**, 1530 Eastlake Avenue East, Suite 303, Seattle, WA 98102; Tel. 206-328-6902.

**THREE-WIRE CIRCUIT ANALYZER.** *A.W. Sperry's* easy-to-use, hand-held circuit analyzer, model *CA-300A*, warns against faulty wiring in 3-wire receptacles. As soon as the



CIRCLE 21 ON FREE INFORMATION CARD



**With The Market Proven VA62A Universal Video Analyzer™**

Are you finding it tough to service today's hi-tech VCR and TV circuits? Successful video servicers have told us that, to them, the new technology meant lost profit and troubleshooting grief until they tried the VA62A's time tested, functional analyzing methods. "The VA62A cuts servicing time and increases profits . . ."

\*Based on a nationwide survey of users who reported an average time savings of 54% compared to their previous test equipment.

**Cut Your Video Servicing Time by 54%\***



**\$3,495 Patented**

You can prove it to yourself, in your shop, absolutely risk free—and share in the profits successful video servicing can bring. Call **1-800-SENCORE (736-2673)** and ask about our exclusive VA62A instrument evaluation program. Tech-Tape Video Preview and FREE full line color catalog are also available.

**SENCORE®**  
3200 Sencore Drive, Sioux Falls, SD 57107  
100% American Made

CIRCLE 185 ON FREE INFORMATION CARD



**BK PRECISION**  
MAXTEC INTERNATIONAL CORP.

**SUMMER**  
*Sale-ibration*

**MODEL 560**  
Programmable In/Out  
of Circuit IC Tester.  
REG. \$3500.00 SALE \$2940.95  
FREE AK-560 SOFTWARE!!!  
FREE 1541A or 2520 Scope!!!!

**MODEL 2120**  
Oscilloscope, 20 MHz,  
Dual Trace.  
REG. \$549.00 SALE \$374.95

**MODEL 1541A**  
Oscilloscope, 40 MHz,  
Dual Trace.  
REG. \$845.00 SALE \$597.95

**MODEL 2160**  
Oscilloscope, 60 MHz, Dual-  
Trace w/Delayed Sweep.  
REG. \$1099.00 SALE \$874.95

**MODEL 388-HD**  
"Test Bench," 41 Range, 3½  
Digit, Multifunction DMM.  
REG. \$129.00 SALE \$99.95!

COMPLETE B&K LINE AVAILABLE  
"CALL FOR YOUR PRICE QUOTES"



**MODEL 2522**  
Oscilloscope, 20 MHz,  
10 MS/s, Dual Trace, DSO.  
OLD LIST \$1495. NEW LIST \$995.

ONLY **\$835<sup>95</sup>**

**PRINT™**

Products International  
8931 Brookville Rd.  
Silver Spring, MD 20910  
(800)638-2020 (301)587-7824  
FAX (301)585-5402  
E Z Order Fax Line 1-800-545-0058



**800-638-2020**

CIRCLE 200 ON FREE INFORMATION CARD

unit is plugged in, a succession of yellow and red indicators signal exactly which wire in the receptacle is the defective one.

The CA-300A will not normally trip a GFCI (Ground-Fault Circuit Interrupter). It is intended for use on 110- to 125-VAC circuits.

The CA-300A 3-wire circuit analyzer costs \$4.50.—A.W. Sperry Instruments, Inc., 245 Marcus Blvd., Hauppauge, NY 11788; Tel. 516-231-7050.

**REMOTE/WALL SWITCH ON/OFF CONTROL.** For security purposes, or just for the sake of convenience, the versatile model 72-320 from Midland

can be used manually or remotely to control on/off functions as well as to dim lights.

A keychain-size transmitter controls both functions from a distance of up to 50 feet away.

The transmitter, which uses UHF radio technology on coded channels, can handle up to 400-watt incandescent bulbs in indoor or outdoor settings. (For example, a porch or garage light can be controlled from within a car.)

All kinds of household devices can also be manually turned on and off, and lights dimmed, using the permanently installed wall switch.

The model 72-320 remote control/wall switch with the included light-dimmer function fits in a standard-sized electrical box. It has a suggested retail price of \$39.95.—Midland International Corporation, Consumer Communications Division, 1690 North Topping, Kansas City, MO 64120; Tel. 816-241-8500.



CIRCLE 22 ON FREE INFORMATION CARD

# NEW LIT

**EQUIPMENT, TOOLS & SUPPLIES FOR ELECTRONIC MAINTENANCE AND SERVICE 1990 (Volume 01).** PRInt Products International Inc., 8931 Brookville Road, Silver Spring, MD 20910; Tel. 800-638-2020; \$2.00

PRInt Products' 1990 catalog contains a wide selection of products for electronic troubleshooting, maintenance, and repair. Several major manufacturers are represented. Some of the items featured in the 64-page brochure are Pace desoldering and PC-board repair products; Leader, Hitachi, B&K, Kenwood, Simpson, Beckman, and Hameg test instruments; tools and supplies from Cooper, Crescent, Weller, and Xcelite; and PRInt's own line of tool cases.

1990

PRInt Products International  
EQUIPMENT, TOOLS & SUPPLIES FOR ELECTRONIC MAINTENANCE & SERVICE

Call Our Toll Free Number  
800-638-2020

LOCAL FAX (301) 587-7824 (301) 585-5402

Easy Order Fax Line 800-545-0058

**MBT-250**  
The Next Generation

Circle 24 on Free Information Card

**COOL-AMP/CODUCTO-LUBE BROCHURES.** The Cool-Amp Conducto-Lube Co., 8603 S.W. 17th Avenue, Portland, OR 97219; Tel. 503-244-2230.

These two booklets high-



CIRCLE 25 ON FREE INFORMATION CARD

light the uses of *Conducto-Lube*, an electrically conductive lubricant, and *Cool-Amp*, a product developed for silver-plating high-ampere connections on the job. Originally developed for high-speed air-blast breakers, Conducto-Lube is highly conductive because it contains pure silver. Power

losses and overheating can be reduced using *Cool-Amp*, which deposits a coat of silver that provides lasting protection against oxidation. It is widely used in radio and TV stations.

**HIGH DEFINITION SURROUND SOUND;** by Herbert I. Gefvert. Audio Video Technologies, Inc., 60 East Ida, Antioch, IL 60002; 312-395-6321; \$6.00, postpaid; \$10.00 with room templates.

This fact-filled guide, written to help those who plan to install a surround-sound system to select the best format for their listening rooms, covers all aspects of sound theory. All of the various surround-sound formats are discussed, including Dolby,





High Definition Surround Sound

by Herbert J. Gebert

CIRCLE 26 ON FREE INFORMATION CARD

Sony SRS, Lucas THX, and Audio Video Technologies' own Omnisound. Dispelling the idea that surround sound requires spending a lot of money and sophisticated electronic components, the booklet explains how effective surround sound can be accomplished without using decoders and black-box amplifiers. To help the reader customize a system to his environment, room templates are available.

**THE ABC'S OF DMMs.** John Fluke Mfg. Co., Inc., P.O. Box 9090, Everett, WA 98206; 1-800-44-FLUKE; free.

Offering a short course on the operation, capabilities, and selection of a digital multimeter, this 16-page brochure can also be used as a quick-reference guide. It features sections on the common uses of the instrument—AC- and DC-voltage



CIRCLE 27 ON FREE INFORMATION CARD

measurements; resistance, continuity, and diode tests; and DC- and AC-current measurements. In addition, multimeter safety is discussed, and accessories are described. Each section of the booklet is clearly illustrated and includes a glossary of electronic and multimeter-related terms.

**THERMAL MANAGEMENT SOLUTIONS: HIGH POWER FABRICATED EXTRUSIONS.** Aavid Engineering, Inc., One Kool Path, P.O. Box 400, Laconia, NH 03247; 603-528-3400; free.

This solution-oriented illustrated catalog describes Aavid's full line of fabricated extrusions for cooling high-power semiconductors. Standard and customized extrusions are offered for virtually all medium- and high-power devices, including power modules and stud-mount devices, transistors, rectifiers, GTO's, and SCR's. Extrusions for cooling DC-to-DC converters and press-pack (hockey puck) devices

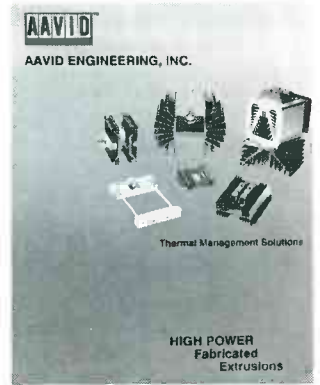

CIRCLE 28 ON FREE INFORMATION CARD

are also covered. The catalog includes detailed dimension drawings, performance curves, and mounting specifications. The extrusions are available in a variety of anodized and chromate finishes.

**1990 DATA ACQUISITION AND CONTROL CATALOG.** Analog Devices, Literature Center, 70 Shawmut Road, Canton, MA 02021; 1-800-4-ANALOG; free.

In its 258 pages, this cata-

# THE HOUSE SITTER THAT DOESN'T NEED A KEY

Use the keyboard to set emergency phone numbers, high and low temperatures, listen-in time and more

ALERT/CANCEL key cancels automatic dial-out, allows you to answer phone

WHAT IS key lets you listen to function settings and dial-out numbers

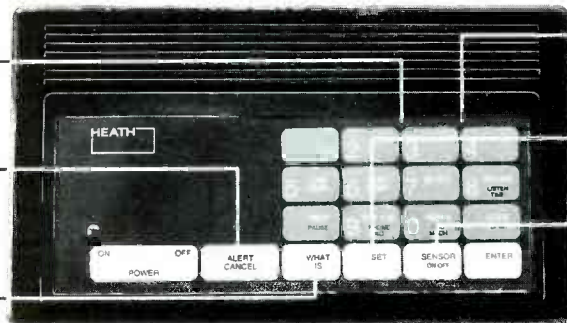

Use the keyboard to ask for information

SET key allows you to change previous settings

SENSOR ON/OFF key chooses the functions to report

**ONLY \$129.95**

"This is 555-3210. Alert condition is OK. Temperature is 65°. Electricity is on. Sound level is OK." Monitoring your home from work or a vacation spot is made easy with the Heath/Zenith House Sitter Security Monitor/Dialer.

## Monitors Your Home

When you call, the House Sitter will report on the AC electric power, the room temperature – comparing it with high and low limits you've already set, loud noises such as burglar alarms and fire alarms, the unit's own battery backup condition, and an additional alert condition. You can even listen to the sounds in the room using the built in microphone.

©1990, Heath Company  
Subsidiary of Bull Data Systems, Inc.

## Dials Out In Alert Conditions

Set the unit to call out to your office, neighbors' and relatives' to announce any alert conditions that are outside preset limits. Up to four numbers can be programmed.

## Order Toll Free 1-800-253-0570

The SD-6230 House Sitter is yours for only \$129.95\*. To order, call toll-free 1-800-253-0570. VISA, MasterCard, American Express or your Heath Revolving Charge card accepted. Use order code 601-015.

See our full line of electronic products for your home in the **Heathkit** catalog – call 1-800-44-HEATH for your **FREE** copy.

**Heath®**  
Benton Harbor, MI

\*Price does not include shipping and handling, or applicable sales tax.

CIRCLE 86 ON FREE INFORMATION CARD

# Radio-Electronics mini-ADS

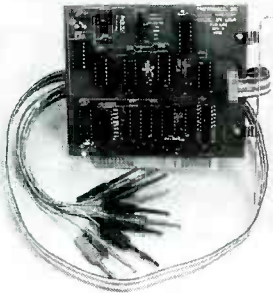

**LOW COST PC LOGIC ANALYZER.** Designed for students and hobbyists working with 5V TTL/CMOS signals in the Khz range. 36" data cable—eight channels, external clock, ground. Selectable trigger & clock edge, internal clock (1Hz-100Khz). Full-featured software, state table graphics, file/print utilities, etc. Over 100,000 samples/sec on 12 Mhz AT. LA1—\$99.95. **PHOTRONICS, INC.** 109 Camille St., Amite, LA 70422 (504) 222-4146.

CIRCLE 201 ON FREE INFORMATION CARD

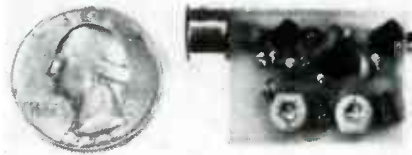

**SIMPLY SNAP THE WAT-50 MINIATURE FM TRANSMITTER** on top of a 9v battery and hear every sound in an entire house up to 1 mile away! Adjustable from 70-130 MHZ. Use with any FM radio. Complete kit \$29.95 + \$1.50 S + H. Free shipping on 2 or more! COD add \$4. Call or send VISA, MC, MO. **DECO INDUSTRIES, Box 607, Bedford Hills, NY 10507. (914) 232-3878.**

CIRCLE 127 ON FREE INFORMATION CARD



**A VIDEOPHONE CHIP, DRAM, A/D etc.** (6 chips & discretes), capture any NTSC video picture and sends it over the phone in 12 seconds. It displays on any composite monitor or TV (VIA VCR). It is offered, presently in KIT form. The CONTROL chip ONLY, and schematic are available for \$59.95. from: **PMC ELECTRONICS, Box 11148, Marina Del Rey, Calif. 90292.**

CIRCLE 184 ON FREE INFORMATION CARD

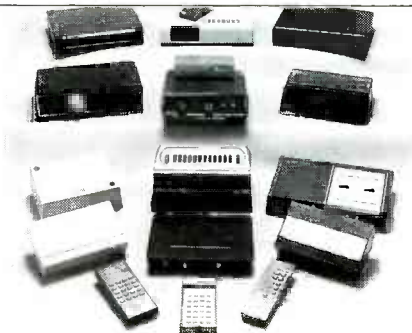

**CABLE TV CONVERTERS AND DE-SCRAMBLERS** SB-3 \$79.00 TRI-BI \$95.00 MLD-\$79.00 M35B \$69.00 DRZ-DIC \$149.00. Special combos available. We ship COD. Quantity discounts. Call for pricing on other products. Dealers wanted. FREE CATALOG. We stand behind our products where others fail. One year warranty. **ACE PRODUCTS. P.O. Box 582, Saco, ME 04072 1 (800) 234-0726.**

CIRCLE 75 ON FREE INFORMATION CARD



**THE MODEL WTT-20 IS ONLY THE SIZE OF A DIME,** yet transmits both sides of a telephone conversation to any FM radio with crystal clarity. Telephone line powered - never needs a battery! Up to 1/4 mile range. Adjustable from 70-130 MHZ. Complete kit \$29.95 + \$1.50 S + H. Free Shipping on 2 or more! COD add \$4. Call or send VISA, MC, MO. **DECO INDUSTRIES, Box 607, Bedford Hills, NY 10507. (914) 232-3878.**

CIRCLE 127 ON FREE INFORMATION CARD

## CALL NOW AND RESERVE YOUR SPACE

- 6 x rate \$940.00 per each insertion.
- Fast reader service cycle.
- Short lead time for the placement of ads.
- We typeset and layout the ad at no additional charge.

Call 516-293-3000 to reserve space. Ask for Arline Fishman. Limited number of pages available. Mail materials to: mini-ADS, RADIO-ELECTRONICS, 500-B Bi-County Blvd., Farmingdale, NY 11735.

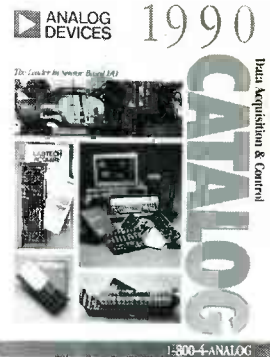

CIRCLE 29 ON FREE INFORMATION CARD

log provides complete product descriptions, configuration charts, block diagrams, specifications, and pricing for sensor-to-host subsystems. Featured are products such as modular signal controllers, PC-compatible data-acquisition adapter boards, distributed data-acquisition and -control hardware, and a variety of applications software. A helpful tutorial and reference section guides users through the selection and configuration process.

**DATA CONVERSION PRODUCTS SHORT FORM CATALOG 1990.** Micro Networks/Unitrode, 324 Clark Street, Worcester, MA 01606; 508-852-5400; free.

This 12-page booklet provides an overview of data-conversion products for high-end-industrial and military/aerospace applications. It contains more than 75 product groups, organized



CIRCLE 30 ON FREE INFORMATION CARD

into easy-to-read specifications tables. It includes digital-to-analog converters, analog-to-digital—including sampling and multi-channel—converters, and data-acquisition systems. A broad selection of track/hold amplifiers is highlighted. **R-E**



# Get hands-on training for a high-paying career in today's booming electronic information industry as you build your own complete data communications system

**Includes XT-compatible computer you keep!**

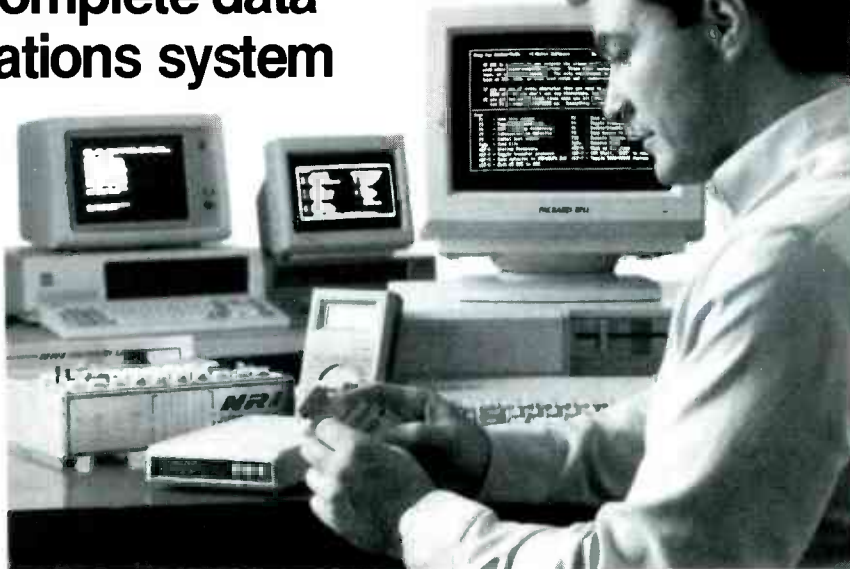

**NRI's new Data Communications training gives you the high-tech, hands-on skills in demand in today's explosive new electronic information industry. Now with NRI, you actually build and go on-line with your own powerful data communications system, complete with IBM PC/XT-compatible computer, 2400 baud modem, communications software, breakout panel, test instruments, and more!**

your modem, and you're ready to put your system on-line with a world of electronic information.

**Go on-line with the exclusive NRI network**

Your NRI training continues by giving you exciting real-world experience in data communications.

It's a fact: The hot jobs in electronics today are in the electronic information industry. An explosion in new technologies is turning desktop computers into high-powered, high-speed data communications systems—making it possible for computers to talk to computers the world over.

Already, electronics technicians trained to install and service the new data communications equipment demand and get \$25,000, \$30,000, \$35,000 a year and more.

Now with NRI, you get hands-on data communications know-how, so you too can cash in on today's multibillion-dollar electronic information industry. NRI's ready to help you succeed now with new at-home training featuring a powerful data communications system you build, program, operate, and keep!

## **NRI trains you from the basics on up—giving you everything you need to get a fast start in data communications**

Your NRI training starts with the electronics fundamentals you need to understand and service all data communications equipment. As you assemble your NRI Discovery Lab®, a complete breadboarding system included in your course, you perform experiments and demonstrations that show you electronics principles at work firsthand.

Quickly moving on, you use NRI's professional digital multimeter to take voltage, current, and resistance measurements, testing a variety of circuits you build on your

Discovery Lab—circuits just like those in today's data communications equipment.

And that's just the beginning. With a solid foundation in electronics behind you, you're ready to build your own powerful data communications system.

## **Breakthrough training includes 512K computer, 2400 baud modem, communications software, breakout panel, much more**

At this point in your training, you're sent the new IBM PC/XT compatible Packard Bell VX88 computer. Following NRI's clearcut instructions, you easily master your computer's powerful operating functions, then move on to build your own complete data communications system.

You begin by programming the RS-232C communications interface built into your computer, giving the Packard Bell the power to transmit data over serial lines. Next you construct a high-quality breakout panel, an indispensable diagnostic tool you use to examine and test the internal workings of your interface.

Then, completing your state-of-the-art system, you power up the 2400 baud modem included in your course and take it through a series of comprehensive tests and demonstrations. In no time, you have a firm understanding of the data conversion system built into

Having completed your data communications system, you actually take it on-line to "talk" to your instructor and other NRI students, complete a final project by computer link, and leave messages on the NRI Bulletin Board.

Step by step, NRI gives you a complete hands-on understanding of the technology that's powering today's booming electronic information industry. Step by step, you get what it takes to start a high-paying career as today's in-demand data communications technician!

## **FREE 100-page catalog tells more**

Send today for NRI's big, 100-page, full-color catalog describing every aspect of NRI's hands-on training in data communications, as well as at-home training in other fast-growing, high-tech career fields.

If the coupon is missing, write to NRI School of Electronics, McGraw-Hill Continuing Education Center, 4401 Connecticut Avenue, NW, Washington, DC 20008.

## **NRI School of Electronics**

McGraw-Hill Continuing Education Center  
4401 Connecticut Avenue, NW  
Washington, DC 20008

For career courses approved under GI bill  
 check for details

### Check one catalog only

- Data Communications
- Computers and Microprocessors
- Robotics
- TV/Video/Audio Servicing

- Computer Programming
- Electronic Music Technology
- Cellular Telephone Servicing
- Security Electronics
- Digital Electronics Servicing
- Basic Electronics

Name \_\_\_\_\_ (please print) Age \_\_\_\_\_

Address \_\_\_\_\_

City/State/Zip \_\_\_\_\_ Accredited Member National Home Study Council 3-090

# Radio Shack Parts Place <sup>SM</sup>

**YOUR NEARBY SOURCE FOR HOBBY AND REPAIR ELECTRONICS**  
Over 7000 Locations in the USA—NOBODY COMPARES!

## Try Our Special-Order "Hotline"



ICs, Crystals, Tubes, Lots More

Your Radio Shack store manager can special-order a wide variety of parts and accessories from our warehouse—vacuum tubes, ICs, microprocessors, phono cartridges and styli, crystals, even SAMS Photofacts® manuals. There are no handling charges or minimum order requirements—just fast delivery to our store near you.

## Battery Special-Order Service

Hundreds of Types Available Now

In addition to our large in-store stock, Radio Shack can now supply almost any currently manufactured battery—even special communications batteries for walkie-talkies and pagers. Batteries are sent from our main warehouse to the Radio Shack near you. Never a postage charge!



### Plug-In Board

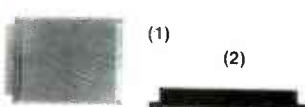

- (1) 72-Position Board. Great for a variety of projects. Popular 100" contact centers. 4 1/2 x 5 1/16". #276-192 ..... 4.99  
(2) Socket for Above. #276-1452 ..... 4.59

### Resistor Buys

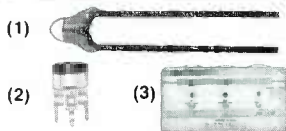

- (1) Thermistor. #271-110 ..... 1.99  
(2) 0.1W Trimmers. 1k, #271-280; 4.7k, #271-281; 10k, #271-282; 47k, #271-283; 100k, #271-284 ..... Each 49¢  
(3) Color-Code Decoder. #271-1210, 69¢

### Hookup Tools

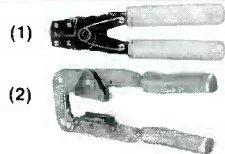

- (1) D-Sub Pin Crimper. Crimps #20, #24 and #28 pins. #276-1595 ..... 9.95  
(2) IDC Tool. Attaches IDC-type plugs to flat cables. #276-1596 ..... 12.95

### Cooling Fan

18<sup>95</sup>

Quiet and Efficient



Protect your equipment! This 4" fan operates on 120VAC and provides about 65 cubic feet per minute airflow. It's easy to mount and rated 11 watts. #273-241

### Car Connectors



- (1) Solderless Motorola-Type Plug. Fits car radios and many scanners. #274-709 ..... 1.39  
(2) Solderless Jack. #274-710 ..... 1.39  
(3) Lighter Outlet DC Plug. #274-335 ..... 1.99

### Tran and Choke



- (1) Power Transformer. 120VAC primary. Secondary is 18VAC. 2.0 amps, center-tapped. 2 3/4 x 2 1/4 x 2". #273-1515 ..... 8.99  
(2) 0.1 mH RF Choke. #273-102 ..... 99¢

### Project Box

Only 3<sup>99</sup>



Transmitter Case. Ideal for an RF or infrared control, beeper or portable device. Durable molded case has a removable end panel and compartment for 9V battery. 3 3/4 x 2 5/16 x 1". #270-293

### Security Switches

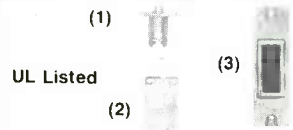

- (1) Normally Closed. #49-513 ..... 1.29  
(2) Tamper Switch. For alarm panel or siren. Normally open. #49-528 ..... 1.59  
(3) Panic Switch. N.O. #49-517 ..... 1.49

### Prewired Temperature Module



19<sup>95</sup> Just Add Battery

You can use it "as-is" for a thermometer. Or, add switches to select F or C display and simple circuits to control a buzzer, LED, fan or heater at preset temperatures. Automatic attic exhaust fan controller is just one possible application. 1/2" digits. Range: -40 to +120° F. 2 1/16 x 1 3/8 x 1 1/8". Requires "AA" battery. Low current drain. With complete data. #277-123

### Connectors for Test Equipment



- (1) Solderless Male BNC. For RG-58 cable. #278-185 ..... 3.59  
(2) 90° BNC Adapter. #278-116 ..... 3.99  
(3) Stackable Banana Plugs. Built-in jack for "chain" hookups. Solder type. One red, one black. #274-734 ..... Set of 2/1.59  
(4) Flex Banana Plugs. #274-730, Set of 2/1.69  
(5) Gator Adapters. #270-354 ..... Pair/1.89  
(6) Mini-Hook Adapters. Fit test probe tips. #270-334 ..... Pair/2.59  
(7) Micro Flat Test Clips. 1 red, 1 black. #270-336 ..... Set of 2/1.19

### Crimp D-Sub Connectors



Gold-Plated Contacts

Pos.	Type	Cat. No.	Each	Pos.	Type	Cat. No.	Each
9	Male	276-1427	.99	25	Male	276-1429	2.49
9	Female	276-1428	1.19	25	Female	276-1430	2.99

### Autoranging Probe DVM

39<sup>95</sup>



Great for Tight Spaces

Data-hold button freezes display and lets you remove tester for easy reading. Has continuity sounder, low-battery indicator and overload protection. Measures to 400 volts AC/DC and resistance. Includes batteries, manual, case. #22-165

### 4-in-1 Soldering Tool



Provides up to 60 minutes of operation and refills with butane lighter fuel. #64-2161 ..... 29.95  
2.4 mm Replacement Tip. #64-2162 ..... 9.95  
1.0 mm Replacement Tip. #64-2163 ..... 9.95  
Blow Torch Tip. #64-2168, Heat Blower Tip. #64-2169, and Hot Knife Tip. #64-2170 are available on special CMC order ..... Each 9.95

Over 1000 items in stock! Binding Posts, Books, Breadboards, Buzzers, Capacitors, Chokes, Clips, Coax, Connectors, Fuses, Hardware, ICs, Jacks, Knobs, Lamps, Multitesters, PC Boards, Plugs, Rectifiers, Resistors, Switches, Tools, Transformers, Transistors, Wire, Zeners, More!

Prices apply at participating Radio Shack stores and dealers. Radio Shack is a division of Tandy Corporation.

**Radio Shack**  
**AMERICA'S**  
**TECHNOLOGY**  
**STORE** <sup>SM</sup>

CIRCLE 78 ON FREE INFORMATION CARD



# BUILD R-E's VIDEO FRAME GRABBER

*Give your PC  
the gift of sight—with  
RE's inexpensive  
frame-grabber.*

**V**ision—probably the ultimate computer enhancement. What's the big deal? Once an image is digitized, applications are limited only by the imagination. Such as? How about electronic photography, automatic inspection, security systems, pattern recognition, image processing/enhancement, desktop publishing—to name just a few.

Yesterday, adding vision to a PC was expensive; today it's not. These days you can add a capable vision system to any standard PC for well under \$150, depending on the state of your junk box.

Our frame grabber is a half-length card that plugs into any 8- or 16-bit expansion slot. The card accepts standard NTSC black-and-white or color video input, and digitizes it at a resolution of 256 by 256 pixels, with 14 shades of gray. Images are captured in real time at a rate of 60 per second; depending on your PC's video system, the frame grabber can display images at a rate of about two per second.

The card works best with a VGA system, because its analog inputs are amenable to displaying gray-scaled data, but all other standards (Hercules CGA, EGA) are supported, but at lower resolution. When displayed on a VGA system, the image approaches a black-and-white broadcast picture in quality. The "real-time" video capture allows images to be digitized on the fly from any source, so the source need not stand still or be freeze-framed.

Images that you capture are stored in the TIFF (Tagged Image File) format; most desktop publishing and pixel-based paint programs read TIFF files directly. Our software also includes basic editing functions and a print function that lets you get hard copy on common dot-matrix and laser printers.

## How it works

Our image capture board accepts any RS-170 specification video signal, be it from a video camera, camcorder, or VCR, color or black-and-white. In case you're new to the field, a standard video signal is composed of two fields, one in which the even



GENE TONER

scan lines are displayed, the other in which the odd scan lines are displayed. Our board captures the even field.

Figure 1 shows a block diagram. The video signal is applied to a differential video amplifier (IC1) that serves two purposes: signal gain and noise rejection. The video amplifier must have sufficient bandwidth for the application. We chose an LF353 dual-FET input op-amp: it has a 4-MHz bandwidth, which is enough for our application. The output of the video amp drives the sync separator (IC2) and the video DC restoration block (IC3 and IC4).

A National LM1881 is the hub of the sync separator. (see Fig. 2). That IC is a video engineer's delight, as it provides composite sync, vertical sync, odd/even frame detection, and burst-gate/black-level timing information. The odd/even frame signal is used to detect and capture the even frame, since this frame has a full line of video on line one. The black-level timing signal is used by an LM398 sample-and-hold amplifier (IC3) to sample the video for its black-level reference. This level is later subtracted from the amplified video to fix the reference level at ground for subsequent digitization.

The subtraction process leaves us with a ground-referenced video signal with an amplitude of about 3.3 volts at the white level, just right for digitization by A/D converter IC13.

To digitize the incoming video at the frame rate, a flash A/D converter must be used. Other types of A/D converters (such as the common successive-approximation type) are too slow to digitize six bits of information in the 200 ns required by this application. A flash A/D converter has  $2^{n-1}$  comparators so that a conversion can be done in one clock cycle. The low phase of the clock initiates conversion, and the high phase transfers the data to the capture memory. In our case,  $n = 6$ .

The digitization hardware is controlled by software: the two communicate via a two-bit command latch that together with

the six data bits occupy several addresses in the PC's I/O space. The two command-latch bits are connected to data-bus lines D0 and D1. To avoid conflict with other boards, the I/O address is configurable via a pair of address-selection jumpers (JU6 and JU7) that allow you to select one of four base addresses (02E0, 02F0, 03E0, and 03F0). The circuit occupies four addresses in the I/O space, but only two are actually used.

The software checks for the presence of the image-capture board in a PC as follows: First it writes to the command latch (sets D0 and D1 high) and then reads back the data port (IC16) and checks the two high bits (D6 and D7). That bit displacement ensures that the software finds our card and not any others.

The decoding scheme is implemented by IC17, an eight-bit magnitude comparator (74HC688), and IC18, a triple three-input OR gate (74HC4075). The latter provides three outputs:  $\overline{WR0}$ , which is used to clock the command latch;  $\overline{WRT}$ , which is used to reset the pixel counters; and  $\overline{RD0}$ , which is used to read captured data into the host PC.

The command latch consists of both halves of IC19, a dual-D flip-flop (74LS74). The two bits of this latch control the two operating modes of the card: capture and read. We'll discuss each in turn.

### Capture mode

To initiate a capture, the software first resets the pixel counters and the line counters (IC9-12) by writing to the base address plus one. After reset, the board is ready to take a picture. To do so, a capture request and the start of an even frame must be synchronized.

Synchronization is accomplished by writing ones to the command latch. Doing so drives the  $\overline{Q}$  output of IC19-a high, which in turn clocks a capture request into IC8-a, a dual-D flip-flop. Its output enables the output of the gated oscillator and divide-by-four circuit (XTAL1, IC6, and IC7), which clocks the A/D converter (IC13). The enabled

### Resistors

All resistors are 1/4-watt, 5% unless otherwise noted.

R1	75 ohms
R2, R3	511 ohms, 1%
R4, R5	2300 ohms, 1%
R6	390 ohms
R7	150 ohms
R8	680,000 ohms
R9, R14	1000 ohms
R10-R13	10,000 ohms, 1%
R15, R16	330 ohms
R17	2200 ohms
R18	220 ohms, 1/2 watt
R19, R20	5100 ohms

### Capacitors

C1, C2	150 pF
C3, C8	0.22 $\mu$ F, metal film
C4, C5	0.1 $\mu$ F, metal film
C7	68 pF, disk
C10	0.1 $\mu$ F, disk
C6, C9, C11	1 $\mu$ F
C12-C22	0.01 $\mu$ F, disk
C23	22 pF

### Semiconductors

IC1, IC4	LF353N dual bi-FET op-amp
IC2	LM1881N video sync separator
IC3	LF398N FET sample/hold amplifier
IC5	74LS04 hex inverter
IC6	74LS00 quad two-input NAND gate
IC7, IC19	74LS74 dual-D flip-flop (National Semiconductor)
IC8	74HC74 dual-D flip-flop
IC9-IC12	74LS193 synchronous up/down binary counter
IC13	MP7682JN 6-bit flash A/D converter
IC14, IC15	43256-15 32K $\times$ 8 static RAM, 150 ns
IC16	74LS244 tri-state octal buffer
IC17	74HC688 8-bit magnitude comparator
IC18	74HC4075 triple three-input OR gate
D1, D2	1N4148 switching diode
D3	1N5226B, 3.3-volt Zener diode

### Other components

J1	PC-mount RCA video connector
JU1, JU2	not used
JU3-JU8	single-row 2-pin header
XTAL1	20-MHz crystal



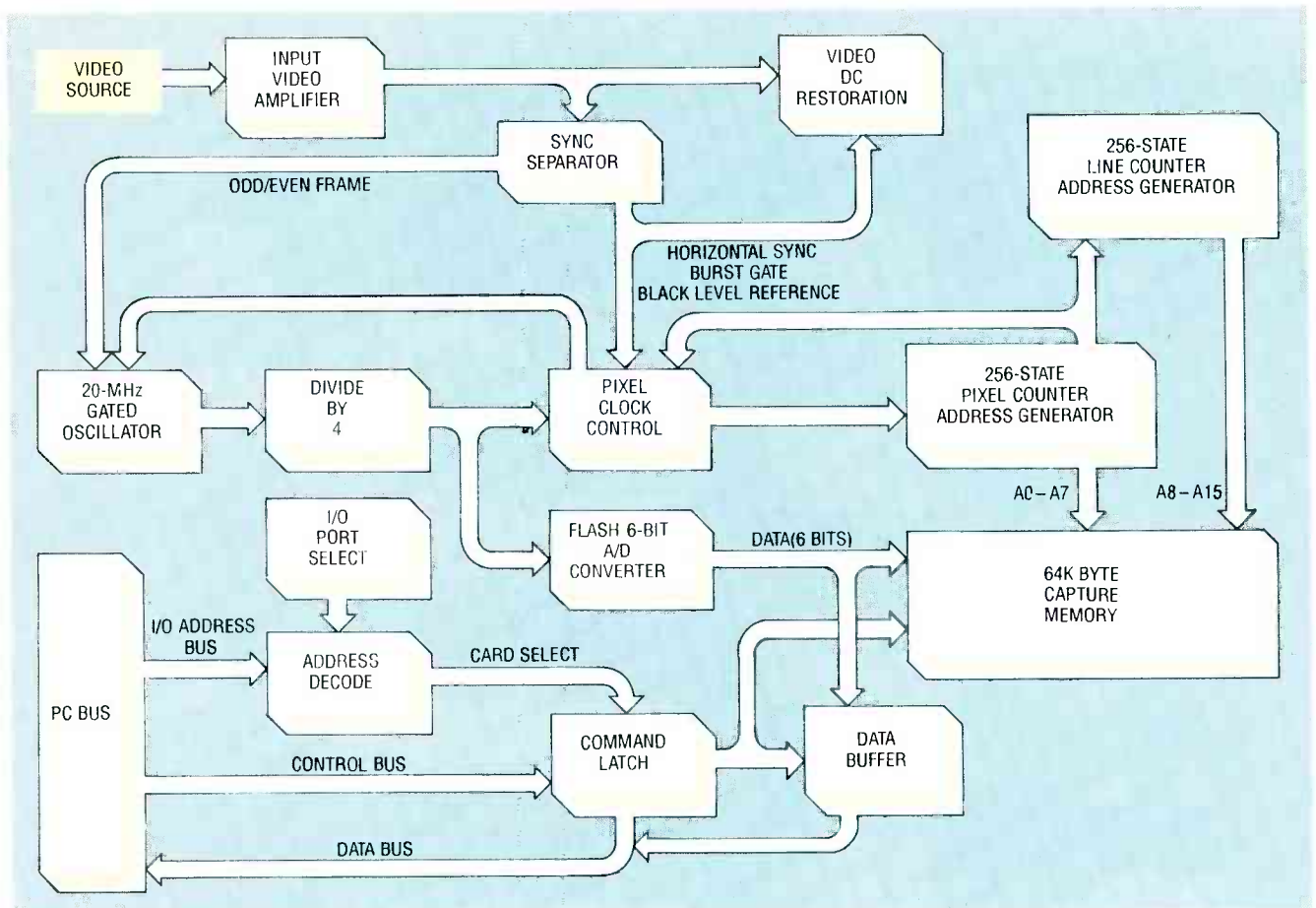

**Fig. 1. BLOCK DIAGRAM.** The frame grabber consists of a video circuit, a clock/counter circuit, a bus interface, the A/D converter, and 64K of static RAM.

clock signal (via pin 6 of IC6) also drives the pixel counters (IC9-IC12) when the second bit (pin 9 of IC19) of the command latch is high.

At this point, the A/D converter's output is enabled and the outputs of the capture memories are disabled, thereby giving the D/A converter control of the local data bus. When a high from the pixel clock is presented to the A/D converter, a conversion is completed. Then, when the pixel clock goes low, the data is transferred to the output buffers of the A/D and presented to the capture memories. When the pixel clock again goes high, the rising edge of that signal strobes the data on the local bus into the capture memories, and simultaneously starts another conversion.

That cycle proceeds until 256 samples have been taken. Then the output of the second pixel counter (pin 13 of IC10) goes low, and that signal resets IC8-b, which causes the gated oscillator

to stop. The circuit remains disabled until the black-level reference signal (at the start of the next horizontal scan line) goes low and then high, which clocks a high into flip-flop IC8-b, and thereby allows the gated oscillator to resume.

The output of the pixel counter is differentiated by the network consisting of D2, C8, and R17.

Otherwise a continuous low would be presented to the reset input of IC8-b, thus causing continuous reset and system lockup after one video line had been captured. The diode prevents the voltage at pin 10 of IC8 from exceeding  $V_{CC} + 0.7$ . The IC specified for IC8 is a 74HC74, which can take a voltage exceeding  $V_{CC}$  by 1.5 volts, as opposed to a 74LS74, which can only take  $V_{CC} + 0.5$  volts.

When the next black-level reference pulse is encountered, the line-capture cycle is repeated. The cycle repeats until 256 lines have been captured, at which point the output of the second line counter (pin 13 of IC12) goes low.

That action resets the enable-capture flip-flop (IC8-a) as well as the command latch (IC19-a, IC19-b). The software can read the contents of the command latch, so that reset provides a convenient means of signalling end-of-capture.

**Ordering Information**  
**The following are available from**  
**IDEC, Inc.**  
**P.O. Box 69**  
**Fountainville, PA 18923**  
**(215) 249-0673**

*Assembled and tested board, software, and User's Manual with one-year warranty..... \$199*  
*Complete kit including PC board, all parts, software, and User's Manual..... \$140*  
*Partial kit including PC board, IC2, IC6, IC7, IC8, IC13, IC19, J1, XTAL1, D3, brackets, screws, jumpers, software, and User's Manual..... \$75*





## Read mode

The next step is for the software to read the captured data into main memory. This is done by setting bit 0 of the command latch low, which enables the capture memories and disables the A/D converter. The counters are again reset by a write to base plus one, and the data read at the data port. Only the lower six bits of the data port are of interest, as the upper two bits reflect the contents of the command latch, and must be masked off by the software. The pixel counters are advanced to the next pixel by strobing bit two of the command latch first low and then high. That sequence must be repeated until all pixels have been read into memory, from where they can be processed, saved to disk, etc.

## Construction

Due to the high frequencies involved, we recommend that you build the frame grabber on a PC board. Patterns are shown in PC Service; if you make your own PC board, remember that you'll have to solder many lands on both sides of the PC board. As an alternative, you may want to purchase a PC board from the source mentioned in the parts list. Kits and assembled versions are also available.

Construction of the board is straightforward and should present no problems. Figure 3 shows where all parts are mounted. When mounting parts, observe the polarities of all diodes, IC's, and electrolytic capacitors.

On the PC board, pads for C23 are shown just above IC7. Mount the capacitor instead between the pad above pin 1 and directly to pin 3 of IC7, as shown in Fig. 4. Doing so lets C23 provide a stable load for the crystal oscillator. Check all solder joints after mounting the components, and then remove all flux residue.

## Installation

First install jumpers as follows:

- JU3: If installed, the computer is the last device on the video cable. Normally installed.
- JU4/JU5: Set both jumpers the same way, installed for sources

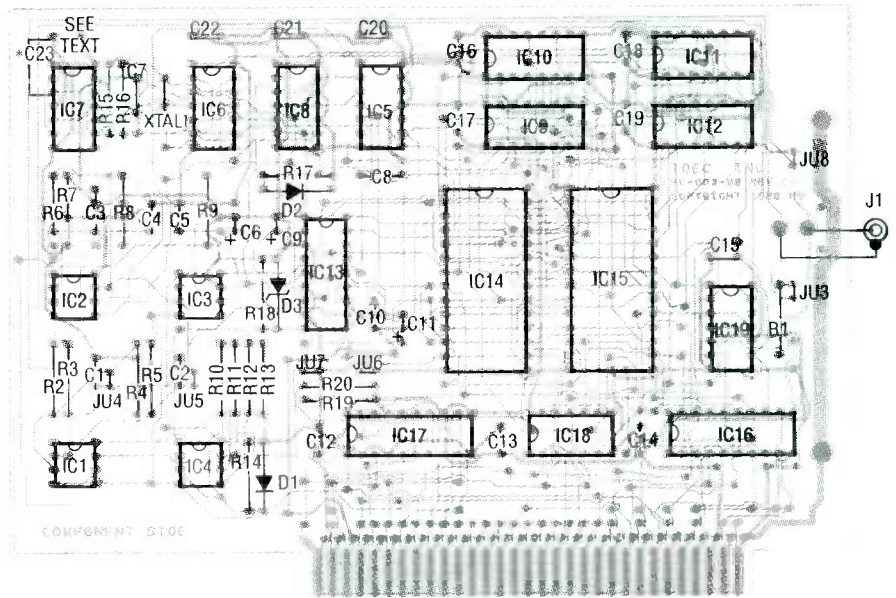

**Fig. 3. PARTS LAYOUT.** Mount all components as shown here. Note the connections for C23.

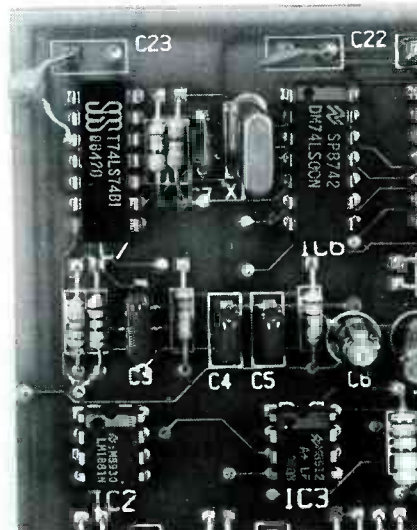

**Fig. 4. C23 MOUNTING.** Connect one leg of C23 to the pad directly above pin 1 of IC7, and the other leg directly to pin 3 of IC7.

with a strong video carrier, uninstalled for normal sources. Normally uninstalled.

- JU6/JU7: Selects I/O port address according to Table 1.
- JU8: Install to ground input cable shield. Normally installed.

Then install the board in an empty 8- or 16-bit expansion slot. Copy the software to a subdirectory of your working disk and then run VSETUP! The program asks you to specify your PC's video adapter and printer. Then you can run the main program, VGRAB.

**TABLE 1—I/O PORT SETTINGS**

I/O Port	JU6	JU7
03F0	Off	On
03E0	On	Off
02F0	Off	Off
02E0	On	On

In bringing up the board for the first time, feed a good, clean RS-170 video signal to the card—not a signal from an inexpensive video modulator.

If you have a problem, be sure that there is valid output from pin 1 of IC4, especially if you have to reset the computer to regain control. The signal there should resemble a standard video signal, with the end of the horizontal-sync pulse at ground and the white level at about 3.3 volts.

The LM1881 is very sensitive to the value of R8 (680K). If solder with water-soluble flux is used, be sure that the area around this resistor is clean, as the flux is conductive and may alter the effective value of the resistor.

## Using VGRAB

As shown in Fig. 5, the software has a friendly user interface with drop-down menus and status panels. The software is available on the RE-BBS (516) 293-2283; download the file called VGRAB.ARC. Going from left to right, the first menu allows

# Radio-Electronics Special—Choose Electronics Hobbyists . . .

## SELECT 5 BOOKS

for only **\$4<sup>95</sup>** values to \$125.70

when you join the  
**ELECTRONICS BOOK CLUB<sup>SM</sup>**

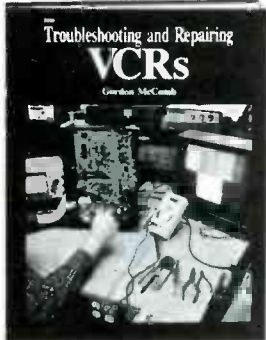
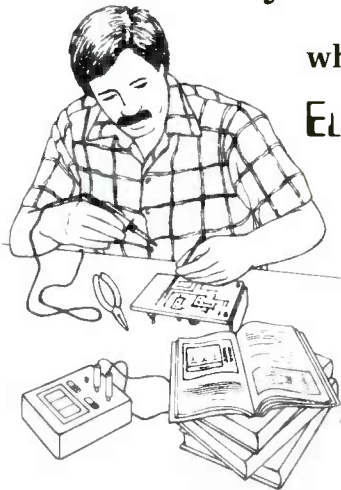

2960 \$27.95  
Counts as 2



1367P \$24.95



2867P \$18.95



2883P \$17.95



2831P \$15.95



804P \$21.95  
Counts as 2



1625P \$22.95



2613P \$17.95



3145 \$19.95



3258 \$27.95  
Counts as 2

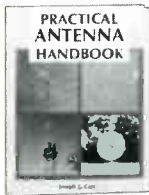

3270 \$32.95  
Counts as 2

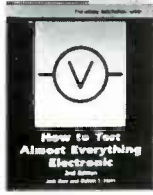

2925P \$9.95

For 25 years, your most complete source for electronics books.

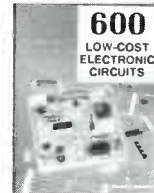

3219 \$27.95  
Counts as 2



1897P \$14.95



3157 \$25.95  
Counts as 2



3165 \$17.95

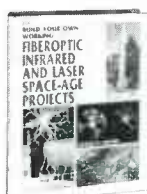

2724P \$16.95



2707 \$26.95  
Counts as 2



3268 \$19.95

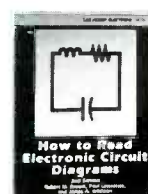

2880P \$14.95

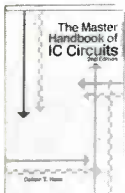

3185 \$34.95  
Counts as 2



1599P \$17.95

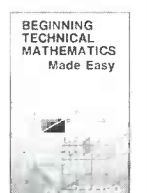

3383 \$14.95



3265 \$22.95

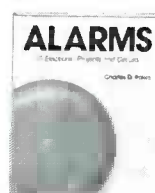

2996P \$13.95



3275 \$22.95



3226 \$22.95



3260 \$22.95

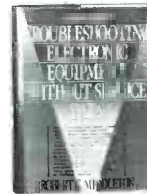

9290 \$36.00  
Counts as 2

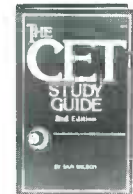

2941P \$15.95

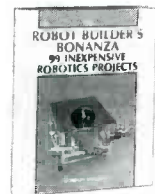

2800P \$16.95

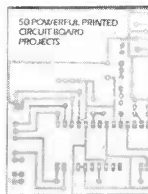

2972 \$23.95

## HOW THE CLUBS

**BIG SAVINGS:** In addition to this introductory offer, you keep saving substantially with members' prices of up to 50% off the publishers' prices.

**BONUS BOOKS:** Starting immediately, you will be eligible for our Bonus Book Plan, with savings of up to 80% off publishers' prices.

**SHOP-AT-HOME CONVENIENCE:** Every 3-4 weeks, you will receive the Book Club News, describing the Main Selections and Alternates, as well as bonus offers and special sales, with scores of titles to choose from.

**AUTOMATIC ORDER:** If you want the Main Selection, do nothing and it will be sent to you automatically. If you prefer another

If card is missing, write to: Electronics Book Club, Blue Ridge Summit, PA 17294-0810.  
All books are hardcover unless number is followed by a "P" for paperback. (Publishers' Prices Shown)



# the club that suits your needs . . . Electronics Engineers & Designers . . .

Take any **3** PROFESSIONAL BOOKS for only \$**4<sup>95</sup>**

when you join the **ELECTRONICS ENGINEERS & DESIGNERS BOOK CLUB<sup>SM</sup>**



2988 \$42.95  
Counts as 2



3279 \$36.95  
Counts as 2



9243P \$12.95



3131 \$26.95

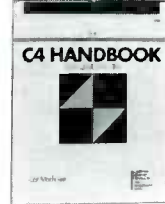

3098 \$44.50  
Counts as 2

values  
to \$168.40

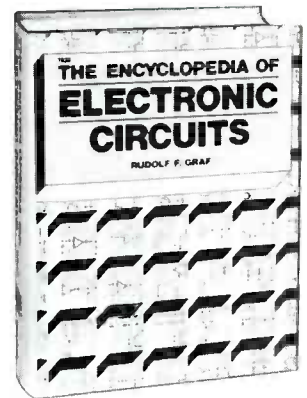

1938P \$29.95

Your source for quality, affordable, and timely authoritative engineering books.



9773 \$44.95



2672 \$49.50

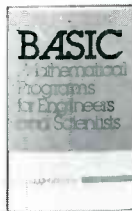

8225P \$19.95

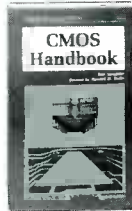

9244P \$18.95

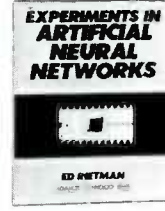

3037 \$24.95



3199 \$52.00  
Counts as 2



9781 \$68.95



9825 \$49.95



9305 \$59.50  
Counts as 2



3375 \$29.95



3241P \$16.95

## WORK FOR YOU!

selection, or no book at all, simply indicate your choice on the reply form provided. You will have at least 10 days to decide. As a member, you agree to purchase at least 3 books within the next 2 years and may resign at any time thereafter. Books purchased for professional purposes may be a tax-deductible expense.

**IRONCLAD NO-RISK GUARANTEE:** If not satisfied with your books, return them within 10 days without obligation!

**EXCEPTIONAL QUALITY:** All books are quality editions from the leading publishers and experts in both the electronics and engineering fields, especially selected by our Editorial Board for timeliness and accuracy to members.

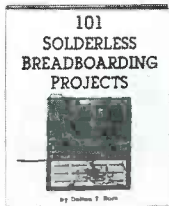

2985 \$24.95

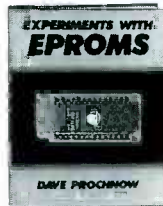

2962P \$17.95



3203 \$44.50  
Counts as 2



9319 \$59.50  
Counts as 2

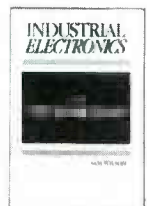

3321 \$24.95



9813 \$39.95

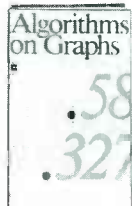

3429 \$29.95

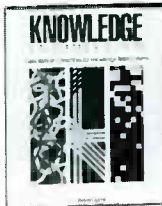

3297 \$39.95  
Counts as 2

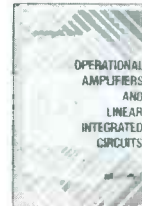

9220 \$46.25  
Counts as 2



9246 \$33.95  
Counts as 2



9245 \$46.95  
Counts as 2

If card is missing, write to: Electronics Engineers & Designers Book Club, Blue Ridge Summit, PA 17294-0860. All books are hardcover unless number is followed by a "P" for paperback. (Publishers' Prices Shown)



THESE SCREEN SHOTS HINT at the versatility of the VGRAB software. Clockwise from the top left, the same image is shown in: VGA mode with 64 shades of gray; EGA mode with 4 gray levels; CGA mode with 2 gray levels; a negative image; a line drawing; and a horizontally flipped image with a black/white threshold condition applied.

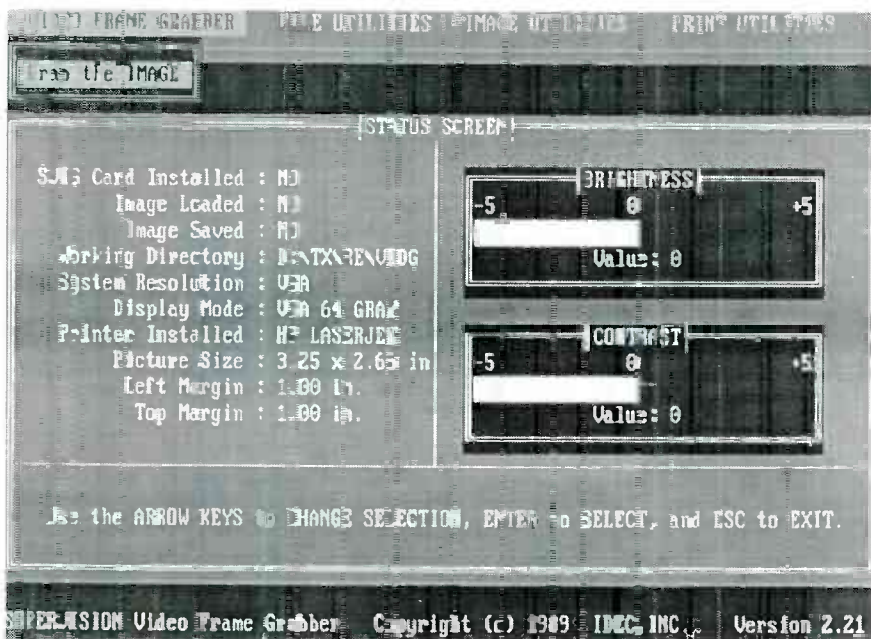

Fig. 5. VGRAB SOFTWARE. The menu bar across the top line provides access to the capture, file, image-manipulation, and print functions.

you to capture the currently displayed image from the board. The next menu contains file utilities

(save, load, etc.). The third menu contains functions for manipulating the image. You can re-

verse it horizontally and vertically, turn it into a negative or line drawing, adjust contrast and brightness, change the display resolution, etc. (The box above shows some examples.) The last menu allows you to set print parameters and print the image.

Images are saved in the TIFF file format, which is just right for importing into desktop publishers (Ventura, PageMaker), and modern word processors (Word, WordStar, etc.) that support the format.

Idec has developed software that interacts with database programs such as Ashton-Tate's dBASE III. These programs allow dBASE III to capture, display, and print images from normal dBASE III record fields, allowing the construction and maintenance of image databases. Contact Idec at the address in the "Ordering Information" box for more information. R-E



# DIGITAL PRESSURE GAUGE

*Now you can take pressure readings the modern way using our electronic pressure gauge.*

**ANTHONY J. CARISTI**

The reading is zero. The same goes for our gauge; pressure is applied to P2 while P1 is exposed to the atmosphere.

When the pressure sensor is at rest, there is no stress on the silicon diaphragm and the values of the resistors are essentially equal. The Wheatstone bridge is thus balanced and its output voltage is virtually zero. During a pressure measurement, any difference in pressure between the two ports of the sensor result in mechanical stress of the silicon diaphragm and a change in the values of the four resistors. Two resistors increase in value and two de-

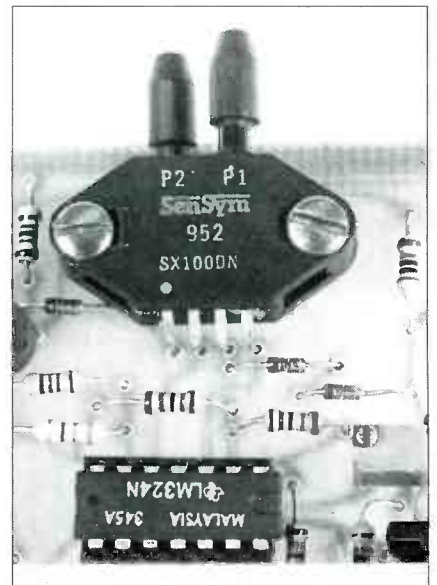

**FIG. 1—HERE IS A CLOSEUP** of the semiconductor pressure sensor.

MOST OF US ARE FAMILIAR WITH AN ORDINARY pressure gauge, such as that used for tires that measures pressure in pounds per square inch (psi). They are usually analog devices with an indicator bar or a moving needle whose movements depend on the specific pressure. However, with the advance of solid-state technology, it is possible to construct an accurate electronic pressure gauge with a resolution as low as 0.1 psi.

Our digital pressure gauge operates from a 9-volt battery, so it is completely portable. The circuit uses only 4 milliamperes, so battery life will be extremely long. A large two-digit LCD is used to display pressure readings, but we'll also show you how to build it with a 3½-digit display.

The full-scale range of the pressure gauge is determined by the selection of the pressure sensor; in this case we have used a 0–100 psi semiconductor sensor, manufactured by Sensym (1255 Reamwood Ave, Sunnyvale CA 94089). Other sensors are available in full-scale ranges of 1, 5, 15, 30, 100, and 150 psi. Using a 15-psi sensor, for example, would result in a display resolution of 0.1 psi with a two-digit readout.

Pressure is measured by connecting a flexible hose between the sensor and source of pressure. If the project is to be used for differential pressure measurements, two hoses must be connected to the sensor and the device under test. Vacuum measurements require only one hose connection.

## The circuit

The sensor is a differential device, which allows two pressure connections, and it measures the difference between the two. The sensor also permits vacuum measurements when one side of the sensor is exposed to the atmosphere and vacuum applied to the other. Pressure and vacuum measurements may be taken on any non-corrosive and non-toxic media such as air, dry gases, etc. The portable nature of the unit allows it to be used almost anywhere, such as for checking tire pressure or a compressed air tank.

The heart of this project is a differential piezoresistive pressure sensor which is constructed using integrated-circuit technology. It consists of four resistors connected in a Wheatstone bridge configuration, which are deposited on a silicon diaphragm that separates two chambers of the sensor housing. Each side of the diaphragm can be exposed to a pressure source by means of "ports" called P1 and P2. Any pressure difference between port P1 and port P2 will be detected by the sensor, providing a differential pressure reading. Figure 1 shows a closeup of the sensor.

The common pressure gauge which many people are familiar with is, in reality, a differential pressure gauge, with atmospheric pressure (14.7 psi) being the reference pressure. Thus, when no pressure is applied to the sensing port of the common gauge,

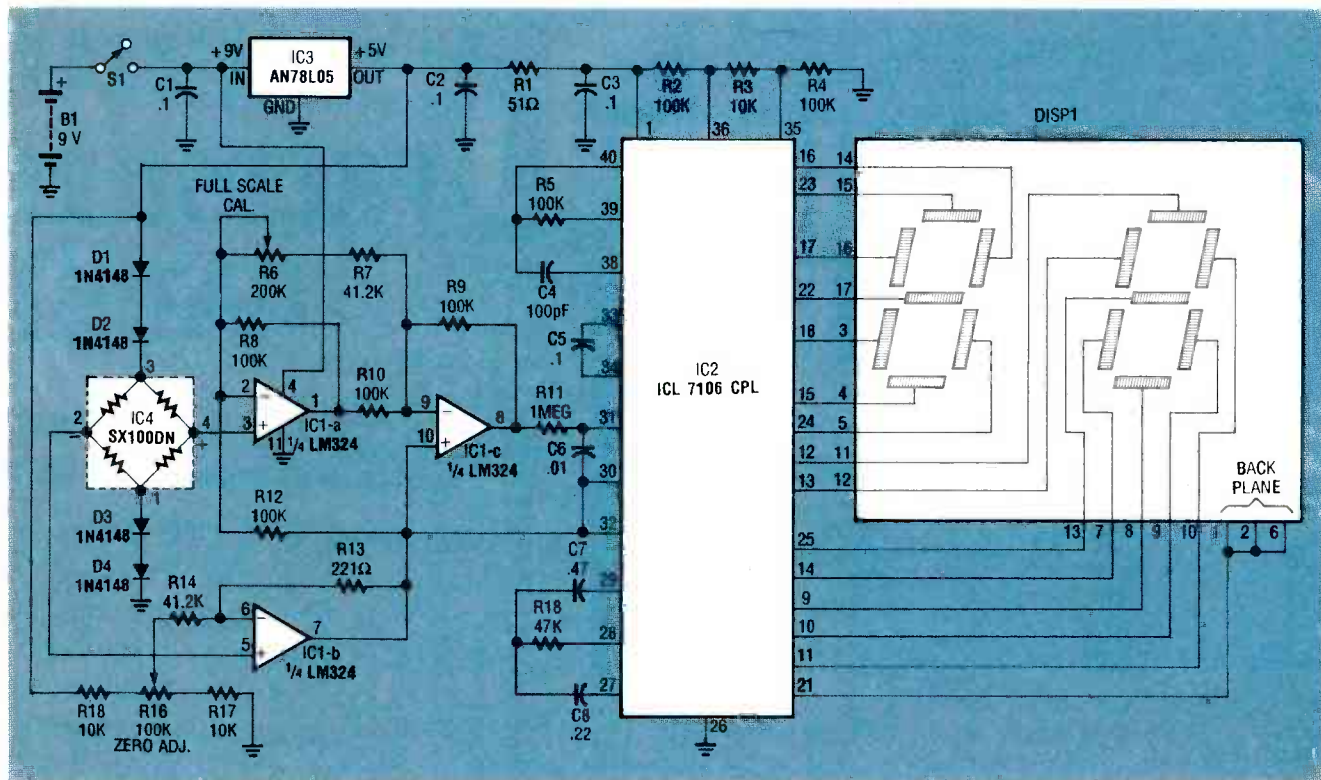

FIG. 2—SCHEMATIC DIAGRAM of the electronic pressure gauge. It uses a Sensym semiconductor pressure sensor.

crease. That causes the Wheatstone bridge to become unbalanced, producing an output voltage which is proportional to the difference in pressure between the two ports of the sensor. That voltage, which in the millivolt range, is amplified and used to provide the drive signal to the display section of the circuit.

The schematic diagram is shown in Fig. 2. In order to preserve the accuracy of the pressure measurement with respect to variations in battery terminal voltage, IC3, a fixed 5-volt regulator, maintains a constant power source which feeds the sensor bridge. A set of four silicon diodes, D1 through D4, has been placed in the circuit to temperature compensate the bridge. That eliminates changes in calibration of the circuit due to ambient temperature effects.

Three sections of IC1, an LM324N quad op-amp, amplify the millivolt output of the bridge to a useful level for the analog-to-digital (A/D) converter circuit that follows.

When there is no pressure applied to the sensor, the voltage between terminals 2 and 4 of the sensor is essentially zero; however, there may be a small output voltage, called zero offset. To compensate for that error, potentiometer R16 allows a small DC voltage to be fed to the amplifier cir-

cuit which negates the offset voltage of the sensor.

When the sensor is exposed to 100 psi, the output of the bridge circuit will generate approximately 34 millivolts. However, there may be variations in output voltage of as much as 30% between different sensors. To compensate for any given sensor, the amplifier gain is adjustable by means of potentiometer R6.

The display section consists IC2, which is a combination A/D converter/7-segment decoder/display driver, capable of driving a 3½-digit LCD (we've used only a two-digit display, DSP1). It is driven by the voltage between pins 7 and 8 of op-amp IC1. The sensitivity of the A/D converter is set by the reference voltage applied between pins 35 and 36. The reference voltage, which is about 238 millivolts, is set by the divider composed of R2, R3, and R4.

In this project only two digits are required since the resolution of the project is 1 psi and full scale is 100 psi. However, note that if you measure exactly 100 psi, the readout will display 00, since the hundreds digit is not present.

Note that for readings greater than 99 psi, or for 0.1 psi resolution, the circuit can be modified to use the most significant and least significant digits

of the A to D chip. In this case you'd need to use a 3½-digit readout, and its decimal place would be illuminated as required. If you wish to use a 3½-digit LCD, Fig. 3 shows the additional connections to the A/D converter that are required. However, note that the 3½-digit display is a 40-pin device that won't fit on the provided PC board. You must either hardwire it or design your own board.

Because of the characteristics of the pressure sensor, the display will read up-scale regardless of which port of the sensor is pressurized. However, you should use the same port for which the project was calibrated. If the project is to be used for vacuum or differential pressure measurements, the display will indicate the pressure difference in psi, with no polarity indication. The A to D converter used in this circuit does have an output terminal to indicate polarity, but it is not used.

### Construction

The project is constructed on a single-sided PC board. A foil pattern is provided in PC Service. The circuit can also be hard wired on a perforated construction board if you wish. The parts-placement diagram is shown in Fig. 4. Note that the LCD readout is mounted on the copper side of the



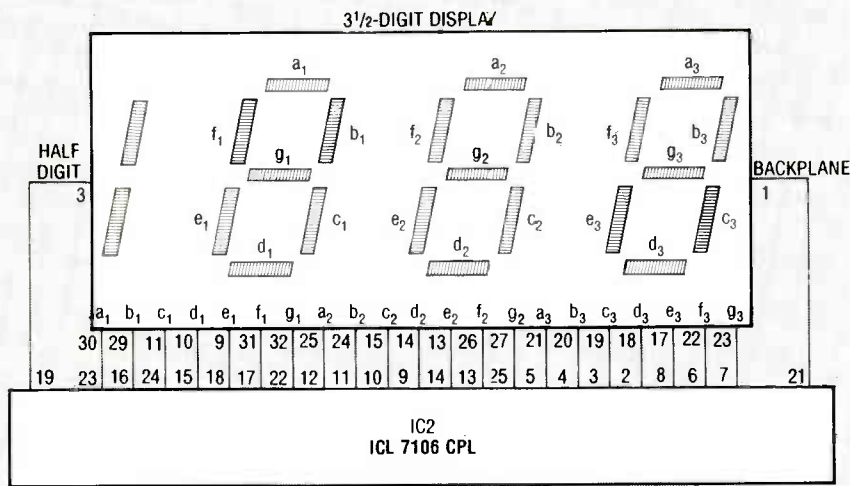

FIG. 3—HERE ARE THE ADDITIONAL CONNECTIONS to the A/D converter that are required for a 3½-digit display. Note that the 40-pin display won't fit on the PC board—you'll have to hardwire it or design your own board.

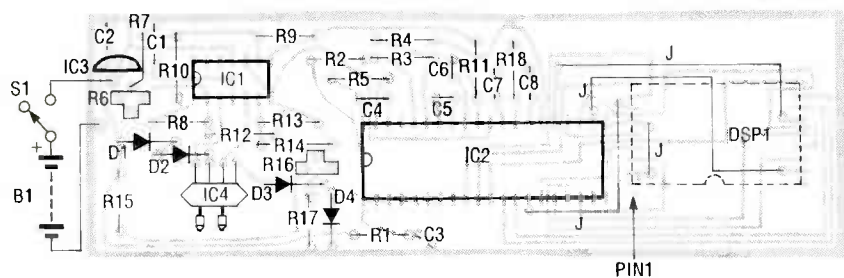

FIG. 4—PARTS-PLACEMENT DIAGRAM. Note that the LCD readout is mounted on the copper side of the board.

board. That allows the relatively flat side of the PC board to be mounted next to the side of a suitable enclosure containing a cutout or window to expose the readout for viewing.

You should use sockets for both of the IC's. Especially for IC2, which is a 40-pin chip and not inexpensive. The cost of a socket is minor compared to the IC itself, and you can never predict when an IC will have to be removed from a PC board. Once the sockets are in place, continue installing components, but do not insert the IC's yet.

The 5-volt regulator, IC3, looks like a small transistor; simply solder it directly to the board, and be sure to watch its orientation. Also be sure that the diodes are properly oriented.

The circuit requires four jumpers; the short jumper wire between pins 2 and 6 of the LCD can be a piece of bare wire, but the other three should be insulated to avoid shorts.

Many of the resistors specified in the parts list are metal-film types which exhibit excellent temperature stability. Since we want the project's

calibration to remain stable with varying temperature, you should not substitute other types of resistors.

The LCD and the pressure sensor are fragile and must be handled carefully to avoid breakage. It is suggested that the readout be mounted to the board last. You may wish to use a socket for the readout, and you can make one by taking an ordinary 18-pin DIP socket and cutting it in half lengthwise. Remember, the socket (and readout) will be placed on the copper side of the board, so you must allow some space between the plastic of the socket and the board itself to allow room for soldering.

Before mounting the LCD, take note of where pin 1 is. If you look at Fig. 5, the black border around it has a marking on one side. Looking at that marking, pin 1 is where you'd normally see it on any ordinary IC.

The pressure sensor may be fastened to the board using two #4 machine screws and nuts, but be very careful not to over-tighten them; it could result in a cracked plastic assembly. Note that one of the terminals

## PARTS LIST

All resistors are ¼-watt, 5%, carbon, unless otherwise indicated.

- R1—51 ohms
- R2, R4, R8–R10, R12—100,000 ohms, 1% metal film
- R3, R15, R17—10,000 ohms, 1% metal film
- R5—100,000 ohms
- R6—200,000 ohms, PC-mount potentiometer
- R7, R14—41,200 ohms, 1% metal film
- R11—1 megohm
- R13—221 ohms, 1% metal film
- R16—100,000 ohms, PC-mount potentiometer
- R18—47,000 ohms

## Capacitors

- C1–C3, C5—0.1 µF, ceramic disc
- C4—100 pF, ceramic disc
- C6—0.01 µF, ceramic disc
- C7—0.47 µF, ceramic disc
- C8—0.22 µF, ceramic disc

## Semiconductors

- IC1—LM324N quad op-amp
- IC2—ICL7106CPL 3½-digit A/D converter (Intersil)
- IC3—AN78L05 5-volt regulator
- IC4—differential semiconductor pressure sensor, SX01DN for 1 psi full scale SX05DN for 5 psi full scale SX15DN for 15 psi full scale SX30DN for 30 psi full scale SX100DN for 100 psi full scale SX150DN for 150 psi full scale (Sensym, 1255 Reamwood Ave., Sunnyvale CA 94089)
- D1–D4—1N4148 silicon diode
- DSP1—two-digit LCD module (DigiKey LCD001)
- Optional—3½-digit module (Digikey LCD002)

## Other components

- S1—SPST toggle or slide switch, N.O.
- B1—9-volt battery
- Miscellaneous: battery clip, enclosure, IC sockets, hose w/fitting, clamps, wire, solder, etc.
- Note: A PC board is available for \$14.95 and a pressure sensor for \$35.00 from A. Caristi, 69 White Pond Road, Waldwick, NJ 07463. Add \$2.50 postage and handling per order.

of the sensor is marked with a small dot. That is pin 1, so be sure to mount it as shown in Fig. 4. The four terminals of the sensor are very fragile, and must be carefully bent into position using a needle-nose pliers to support the leads next to the body of the part. If you attempt to bend the leads with-

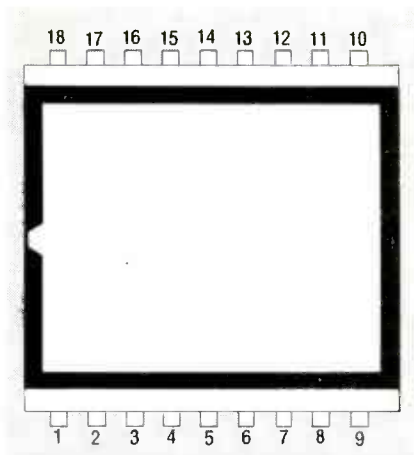

**FIG. 5—THE BLACK BORDER** around the display has a marking on one side. Using the marking as a reference, pin 1 is where you'd normally see it on any ordinary IC.

out such support, you risk breaking the wires.

A suitable pressure hose must be connected to port P2 of the sensor, and secured with a small metal clamp that has been designed to handle high pressures. Such clamps can be obtained from automotive supply outlets. It cannot be over-stressed that pressures greater than 10 psi are substantial, and the hose and clamp must be able to withstand such force.

If you want to use the project to measure tire pressure, you need a hose from a bicycle shop with a fitting at the end that depresses the valve stem during a pressure measurement. You might be able to take an old tire pressure gauge and modify it for use with our digital pressure gauge. As with the pressure-sensor connection, you will need to clamp the valve fitting to the hose.

You may wish to use a normally open pushbutton switch for your project. That will prevent accidentally

leaving the power on and depleting the battery.

Be sure to use a connector clip for the battery to ease replacement when necessary. The battery should be securely mounted in the project's enclosure so that it does not rattle around and break anything.

When you have completed assembly, examine the circuit board very carefully for bad solder connections and inadvertent short circuits, especially between adjacent IC terminals. Bad solder joints often are dull, rough blobs of solder. Correct any problems that you find. Figure 6 shows both sides of the completed unit.

### Checkout

To check out the project you will need a DC voltmeter, as well as a source of air pressure such as a portable air tank. Be sure tank pressure is not over 100 psi. For the preliminary checkout it is not necessary to know the precise pressure of the source, but it should be in the range near the maximum measurement capability of the project.

Before putting IC1 and IC2 in their sockets, set the calibration potentiometers to mid-position. Connect a 9-volt battery, and turn on power.

Measure the voltage across C2; you should obtain a reading between 4.8 and 5.2 volts DC. If you do not obtain the correct reading, do not proceed with the checkout until you troubleshoot the problem. Check IC3 for proper orientation. Check the terminal voltage of the battery to verify that it is delivering at least 7 volts. Disconnect the battery and measure the resistance across C2 to verify that you do not have a short circuit between the 5-volt bus and ground.

When you are satisfied that the 5-volt regulator is operating properly, disconnect the battery from the project and insert the IC's into their sockets. Be sure to follow the orientation as indicated in Fig. 4.

Reconnect the battery to the project and turn the power switch on. No pressure is to be applied to the sensor at this time. The display should indicate a two digit reading, and adjustment of R16 should allow you to set the reading to 00.

If you don't get any display, check that the LCD is properly mounted on the copper side of the board. Check IC2 to be sure that it is properly oriented in its socket. Check the 5-volt regulator to verify that power is being applied the circuit. If your meter is capable of measuring DC current, you can check the current draw from the battery to determine if it is approximately 4 milliamperes, which is the normal current draw of the project.

If you obtain a display but the illuminated segments of the digits are not entirely correct, the most likely cause is open or short circuits at the output connections of IC2 which drive the readout. Disconnect IC2 and the battery from the project and locate the fault using an ohmmeter.

Note that the display may, on occasion, indicate 01 instead of 00. This is not to be construed as a defect in the circuit; it merely means that your zero adjustment is not centered exactly.

When you are satisfied that the zero adjustment of the display is correct, you may apply full pressure to the P2 port of the sensor. When that is done, the readout will indicate some number. Adjust R6 for a display equal to the pressure of the source, if known.

*continued on page 83*

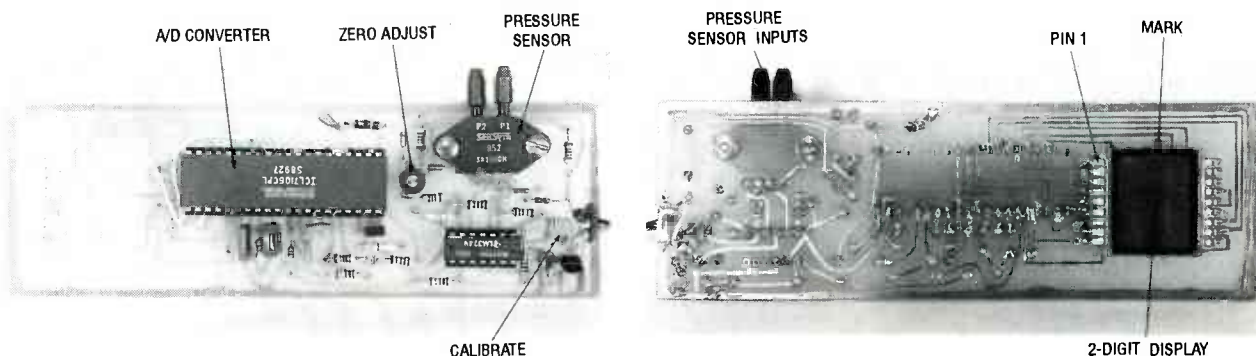

**FIG. 6—HERE ARE BOTH SIDES** of the completed unit. notice how the display goes on the foil side.



LAST MONTH WE DIDN'T GET A CHANCE TO FINISH THE MOTHERBOARD and the motor-controller board. So let's finish up those two boards now, and then continue with the story.

### Construction

Assemble the motherboard by soldering the three edge connectors onto the PC board with the connector pins protruding through the circuit side of the PC board. The schematic is shown in Fig. 1. The circuit side of the board contains the large ground plane.

Figure 2 shows the parts-placement diagram for the motor-controller board. First, solder the IC sockets to the PC board (one can be obtained from TSI or you can make one from the foil pattern provided in PC Service). Next, solder in all remaining components except for the following components that require special installation: R71, R76, R85, R88, R93, C6, C17, C46, C48, C51, D20, and D22.

Capacitors C6, C17, and C46 are tall and have radial leads (both leads stick out of the bottom). In order to keep the height of the motor-controller board at a minimum, we need to mount those capacitors on their side. That can be accomplished by adding 1/8-inch of insulating plastic sleeving to each of the leads before the capacitor is installed. Then solder, trim leads, and bend the capacitor over on its side. A small drop of RTV or epoxy can be added to secure the capacitors to the PC board.

Diodes D20 and D22 must be soldered in series, and then installed as a single component in the location indicated in Fig. 2. Resistors R93 and R1 consists of two 16-ohm, 1/2-watt resistors connected in parallel. The resistors are then installed as a single component as indicated in Fig. 10. Resistors R71, R76, R85, and R88 should have 0.1  $\mu$ F capacitors soldered in parallel with them before installation. The capacitors are identified in Fig. 2 as C48, C49, C50, C51, respectively.

There are some jumpers that must be installed on the solder side of the board. The first one goes from J22 pin 41 to IC1 pin 4. Another goes from J22 pin 47 to IC2 pin 6. Next, two twisted pairs of jumpers, each pair consisting of a length red and black wire twisted together, must also be installed on the solder side of the board. The red wire of the first pair must go from J22 pin 42 to R81, and the black wire goes from J22 pin 45 to R82. The red wire from the second twisted pair goes from J22 pin 38 to R63, and the black wire goes from J22 pin 39 to R64.

### Alignment

Alignment of the motor-controller board consists of adjusting potentiometers R201, R202, and R203. R201 and R202 are used to adjust the speed of the left and right drive motors, respectively, and R203 adjusts the offset voltage to the D/A circuit.

First adjust R201 and R202 to their center position. R203 should be adjusted until the D/A output (pin 7 of IC4-b) is 0 volts when the D/A input is as follows: DA0 = 0, DA1 = 1, DA2 = 1, DA3 = 1, DA4 = 1, and DA5 = 0. The D/A input can be set by temporarily applying +5 volts for a "1" and ground for a "0" when the

Lawn Ranger is a registered trademark of Technical Solutions, Inc.

*This month we discuss the motor-controller board.*

# Build the Lawn Ranger



RAYMOND RAFAELS



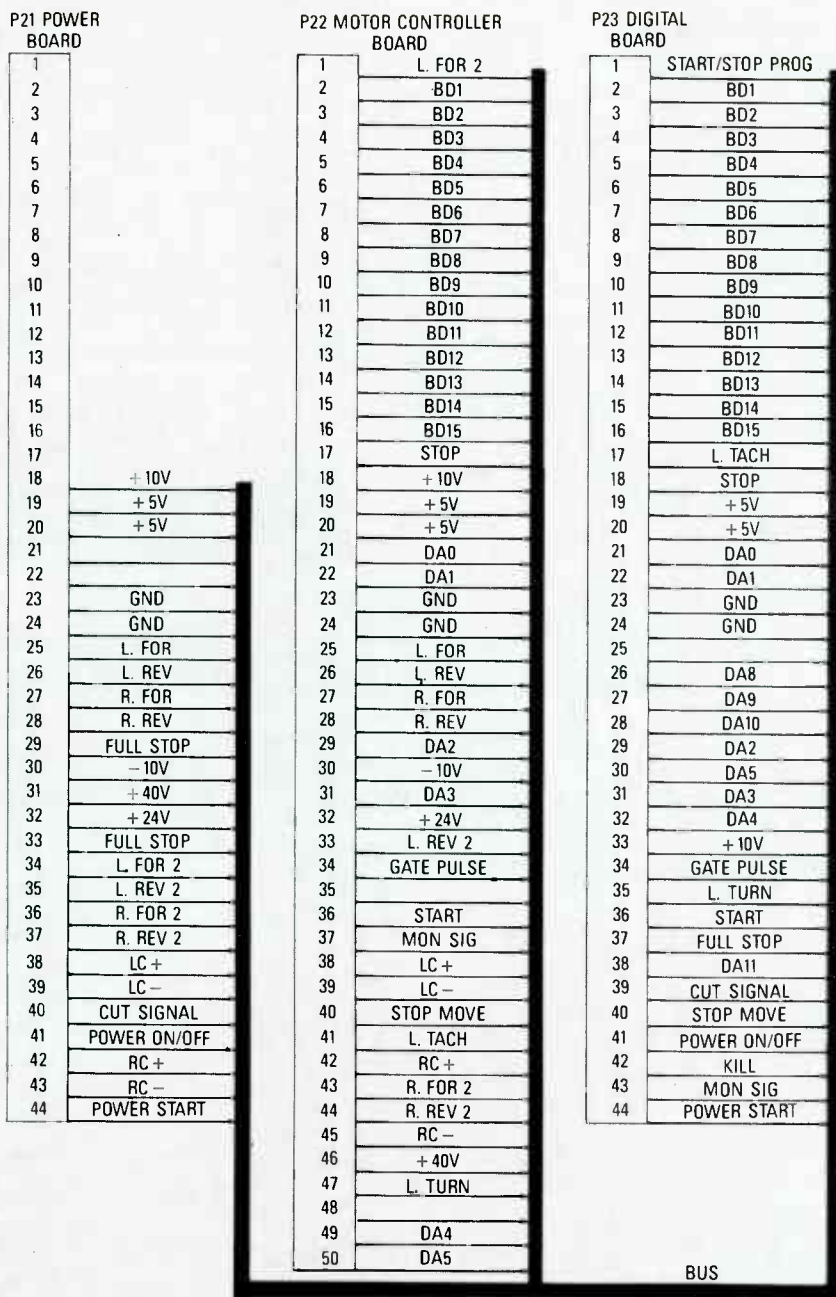

FIG. 1—ALL OF THE INTER-BOARD CONNECTIONS are made via the motherboard.

PC board is disconnected from the motherboard. The same D/A inputs could be established by temporarily blocking (with electrical tape) grass sensors 1-8 after the Lawn Ranger is completely assembled.

### Motor controller test

The best way to test the motor-controller board is after the Lawn Ranger is completely assembled. By blocking grass sensors with your fingers or electrical tape, you can simulate a grass border that the Lawn Ranger can track. As you block different

grass sensors, you can verify that the motor controller is working properly by observing the drive wheels as they change speed and direction.

However, that will have to wait until next month, when we will discuss the construction and operation of the power board. We'll also discuss the manual controller and mechanical frame. Start building your own Lawn Ranger now so you can have fun learning valuable electronic skills and, at the same time, produce a personal robot that can perform useful work while amazing your friends

## Power board

The power board is responsible for providing regulated DC voltages, controlling the power on/off function, switching +24-volts DC to the motors (for forward and reverse rotation), and stopping the cutting motors after power is turned off. Figure 3 shows a photograph of an assembled power board.

Figure 4 shows the block diagram of the power board. The +24-volt DC input power is supplied by two 12-volt lead-acid batteries that are connected in series. The batteries are rechargeable and can be purchased from suppliers of electric wheel chair batteries for about \$35-\$45 a piece.

Three DC/DC converters are used to efficiently convert the +24-volt input to ±10-, +5-, and +30-volts DC. The DC/DC converters can be purchased from Power General directly (see parts list).

The left and right motor power drive circuits energize the drive motors. The circuitry contains a series of power MOSFET's that act as low-resistance (0.035 ohm) switches. The MOSFET switches can turn the motors on and off, as well as apply a reverse voltage to make the drive wheels spin in reverse.

The cutting-motor drive circuitry controls the rate at which the cutting disks spin when they are initially turned on. The amount of current that is sent to the cutting motors is monitored and limited to 15 amps (peak) or approximately 10 amps (average). The circuitry is also used to quickly stop the cutting motors when power is turned off by shorting the motor leads together. That technique is typically referred to as dynamic braking. The shorting of the motor leads causes a reverse magnetic field to be generated inside the motors causing the cutting blades to stop within 3 seconds. A 0.01-ohm resistor (R32) is used to limit the motor current to a safe level during dynamic braking.

### Circuit description

Figure 5 shows a detailed schematic of the power board. The +24-volt battery power is routed through J11 pins 4 and 5 and fuse F1. Relay RY1 is used to connect and disconnect power from the entire robot. Power is switched on by the operator when the ignition key is turned. The momentary ignition switch grounds J21 pin



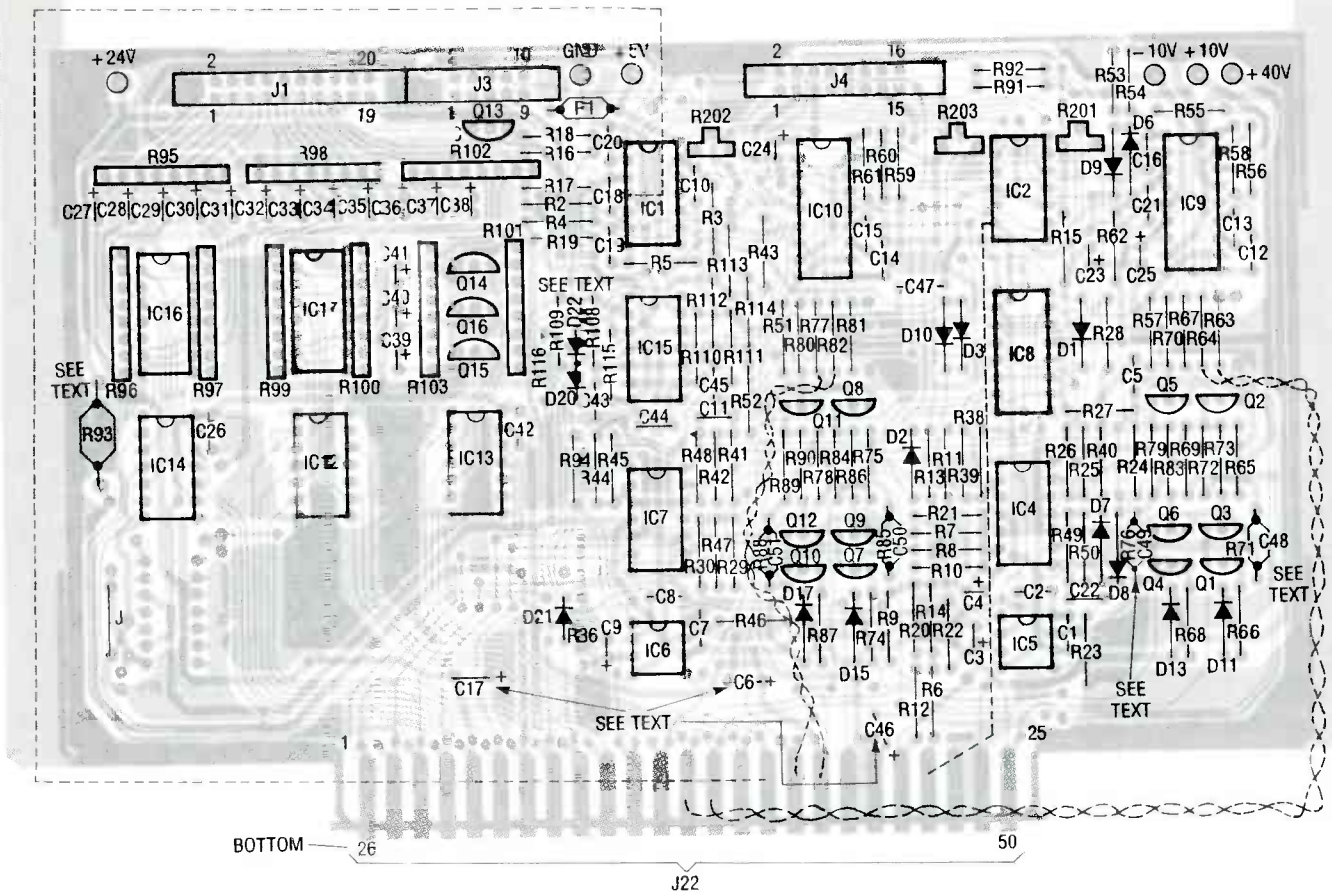

FIG. 2—PARTS-PLACEMENT DIAGRAM for the motor-controller board.

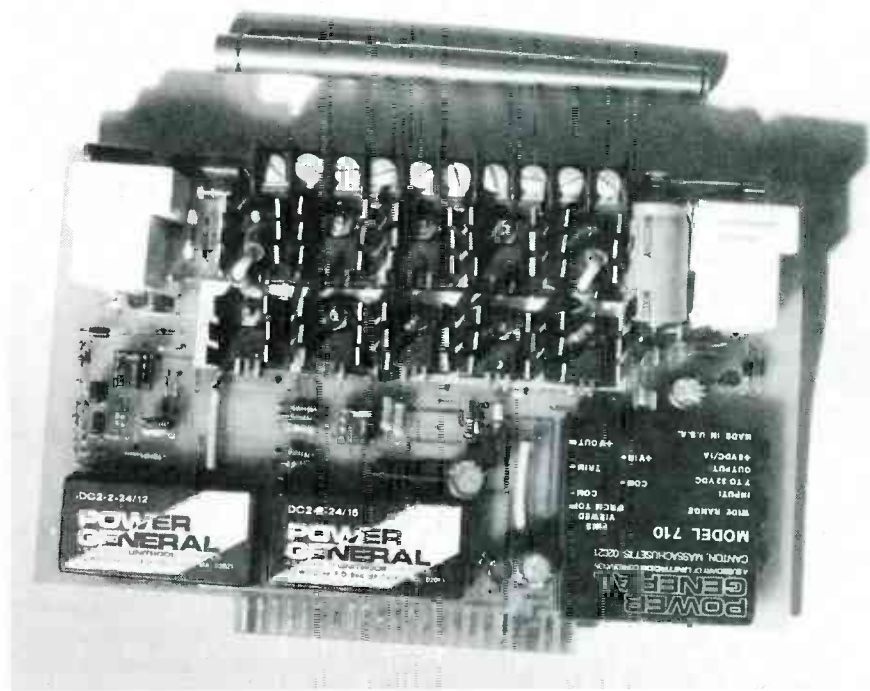

FIG. 3—AN ASSEMBLED POWER BOARD should look similar to this one.

44 and energizes the relay. When the relay switches, the three DC/DC converters will begin to produce the appropriate voltages and the CPU board

will come alive. The CPU board will begin to run diagnostic checks and then place +5 volts on J21 pin 41 in order to turn Q11 on; that keeps the

relay energized after the operator removes the key.

### Forward/reverse motor drive

Transistors Q3–Q6 and Q7–Q10 are power MOSFET's that are used to control the left and right drive motors, respectively. When the left drive motor spins in the forward direction, Q3 and Q5 are turned on and Q4 and Q6 are turned off. Figure 6-a shows the path that current follows when the left drive motor is going forward. On the other hand, if Q3 and Q5 are turned off and Q4 and Q6 are turned on, the current will flow through the motor in the opposite direction causing the motor to spin in reverse (see Fig. 6-b).

### Cutting-motor control

The cutting motor circuitry contains power MOSFET's (Q13 and Q14) for switching, as well as a feedback control system for current limiting. Current limiting allows the cutting motors to come up to speed in a controlled manner by limiting large current spikes when the cut button is pushed. The MOSFET's are con-

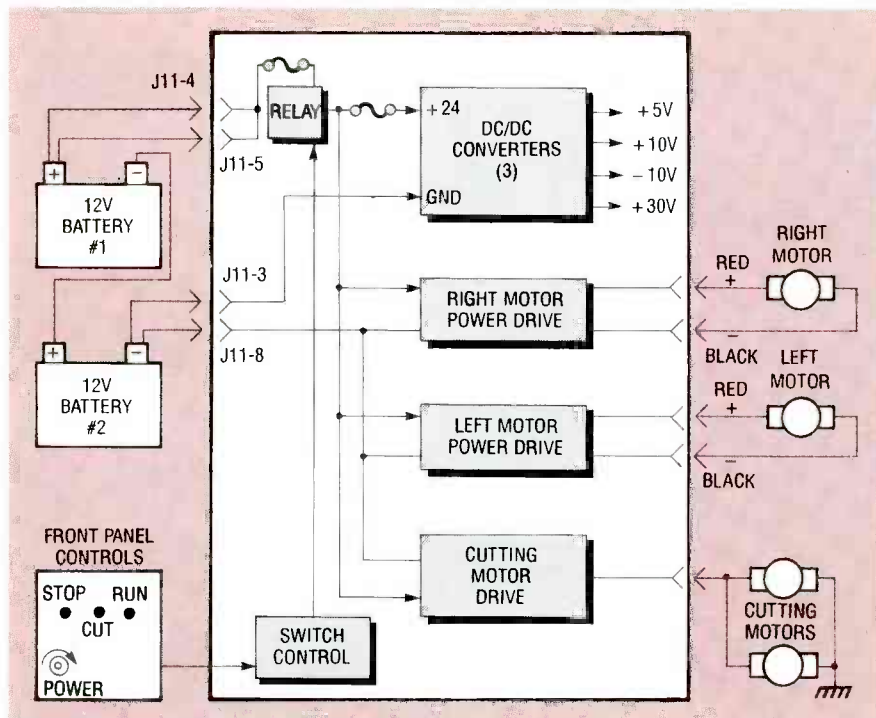

FIG. 4—HERE IS A BLOCK DIAGRAM of the power board.

#### PARTS LIST—POWER BOARD

All resistors are 1/8-watt, 5%, unless otherwise indicated.

- R1—R10, R13—R15, R17, R18, R20—R28, R45—R49—not used
- R11, R44, R50—3300 ohms
- R12—680,000 ohms, 6-pin, 1/4-watt, SIP resistor network
- R16, R19, R32, R43—0.01 ohm, 5 watts
- R29—150,000 ohms
- R30, R31, R34, R35—270,000 ohms
- R33, R36—1 megohm
- R37—147,000 ohms, 1/4-watt, 1%
- R38—10,000 ohms, potentiometer
- R39—82,000 ohms
- R40—100,000 ohms
- R41—27,000 ohms
- R42—22,000 ohms
- R51—R54—560,000 ohms

#### Capacitors

- C1—C5, C7—C13, C16, C17—not used
- C6—1000  $\mu$ F, 35 volts, axial electrolytic
- C14, C15, C23—C26—0.1  $\mu$ F, 50 volts
- C18, C21—100  $\mu$ F, 50 volts, radial electrolytic
- C19, C20—100  $\mu$ F, 16 volts, radial electrolytic
- C22—220  $\mu$ F, 16 volts, radial electrolytic

#### Semiconductors

- IC1, IC2—not used
- IC3—LF412N op amp

- D1, D2, D11—D13, D30, D31—not used
- D3, D4, D16, D17, D20—D24, D33—D38—1N4001 diode
- D5, D14, D18, D19, D32—1N4148 diode
- D6, D15—1N5402 diode
- D7—D10—1N5256B 30-volt Zener diode
- D25—D29—1N4740 10-volt Zener diode
- Q1, Q2, Q12—not used
- Q3—Q10, Q13, Q14—IRFZ42 MOSFET
- Q11, Q15, Q16—293904 NPN transistor

#### Other components

- J11—terminal strip
- RY1—T90N1D12-24 relay (Potter Brumfield)
- RY2—68P-111P-US-DC24 relay (Omron)
- F1—3AG 30-amp fast-blow fuse
- F2—2AG 0.5-amp fast-blow fuse
- MOD1—Model DC2-2-24/12,  $\pm$  12-volt DC converter (Power General)
- MOD2—Model DC2-2-24/15,  $\pm$  15-volt DC converter (Power General)
- MOD1—Model 710, 5-volt DC converter (Power General)

**Miscellaneous:** 3AG fuse holder, 2AG fuse holder, solder posts for the "E" terminals, 18-gauge solid insulated wire, 18-gauge stranded insulated wire, solder, etc.

- #### PARTS LIST—CONTROL PANEL
- S1—S4—momentary pushbutton switch
  - S5—SPDT switch
  - LED1—red light-emitting diode
  - Wire and sheet metal for the panel itself

**Note:** The following equipment can be purchased from Technical Solutions, Inc., P.O. Box 284, Damascus, MD 20872 (301-253-4933): etched and drilled PC boards for CPU Board, Motor Controller Board, Power Board, and Motherboard, \$39 each; programmed EPROM, \$39; grass sensors, \$8.99 each; hand-held manual controller kit, \$39; full kit for CPU Board, \$129 (PC board, EPROM, all parts); full kit for Motor Controller Board, \$169 (PC board and all parts); full kit for Motherboard, \$69 (PC board and all parts); Power Board kit (PC board, and all parts except DC/DC converters), \$149; Detailed drawing package, \$59; Lawn Ranger demo videotape and information package, \$19; complete electronic kit with everything mentioned above, \$757. Please add \$8.00 for S/H. Maryland residents add sales tax.

ected in parallel in order to share the switching load. They are turned on by pull-up resistor R42 and turned off by Q16.

After the MOSFET's are turned on, the +24-volt power supply will be routed to through R32 to pin 5 of relay RY2. As the operator presses the cut button, +5 volts will be applied to J21 pin 4I and Q15 will turn on; that grounds pin 4 of RY2 causing it to switch the +24-volt battery power to the cutting motors. The cutting motors will begin to spin, and as they begin to, the current through resistor R32 will rise sharply; R32 is used as a current monitor and the voltage across it will rise in proportion to the current flow.

Differential amplifier IC3-a amplifies the voltage drop across R32 and feeds it to pin 5 of IC3-b, which is a comparator circuit that compares the current flow with a preset value of 15 amps. When the current through R32 reaches 15 amps, the comparator output (IC3-b pin 7) will swing positive and Q16 will turn on. The power MOSFET's will turn off and the current will stop flowing through the cut-



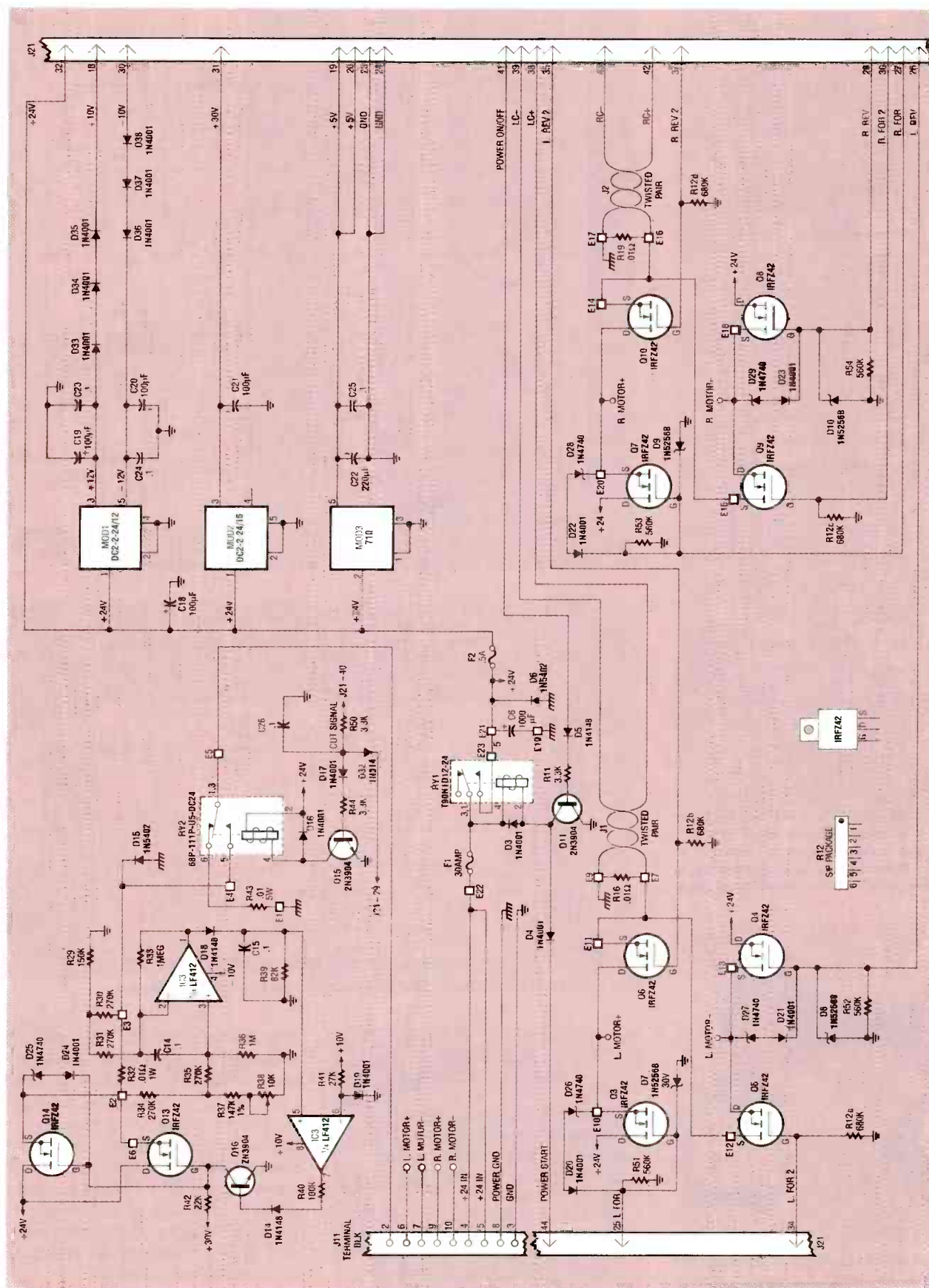

FIG. 5—DETAILED SCHEMATIC of the power board. High-current jumpers have to be installed on the solder side of this board.

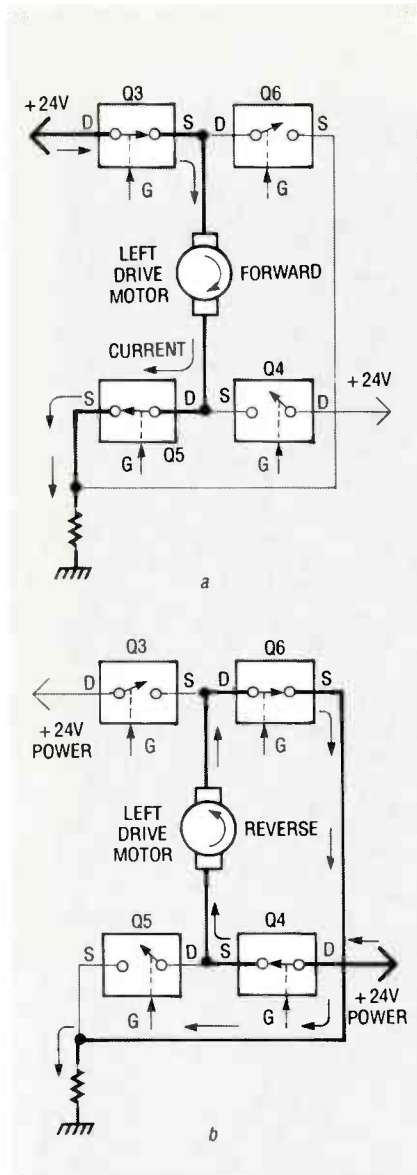

FIG. 6—LOOKING AT *a*, YOU CAN SEE the path that current follows when the left drive motor is going forward. However, in order for the motor to spin in reverse, *b* shows the path that the current must take.



FIG. 7—THE HAND-HELD CONTROLLER allows you to “walk” the mower around the yard to cut a perimeter for it to follow.

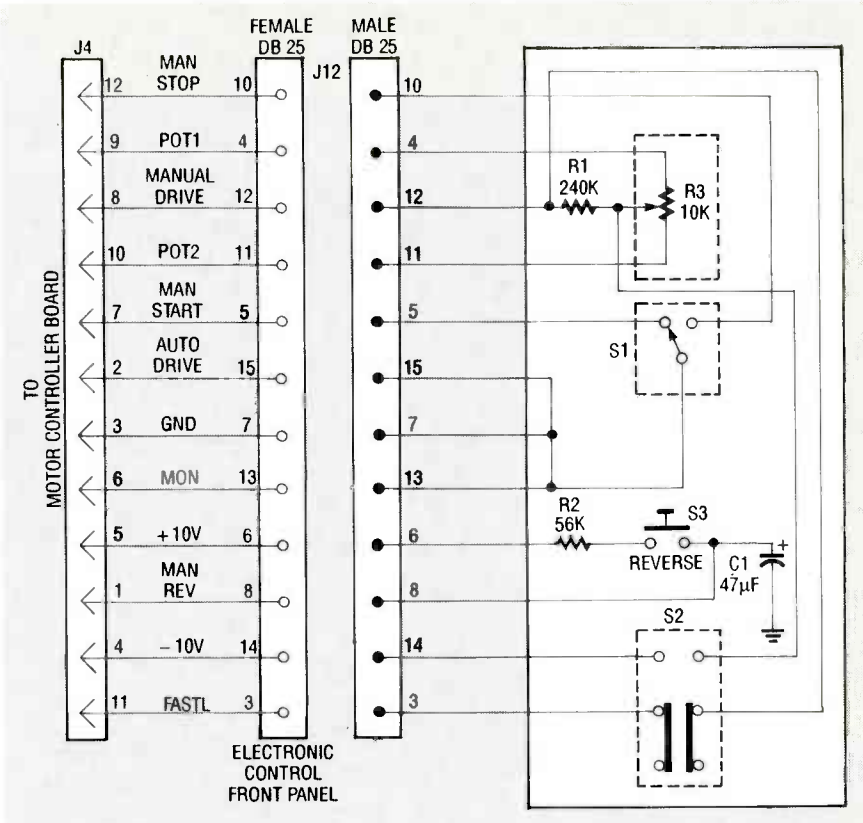

FIG. 8—HERE’S THE SCHEMATIC DIAGRAM of the hand-held controller.

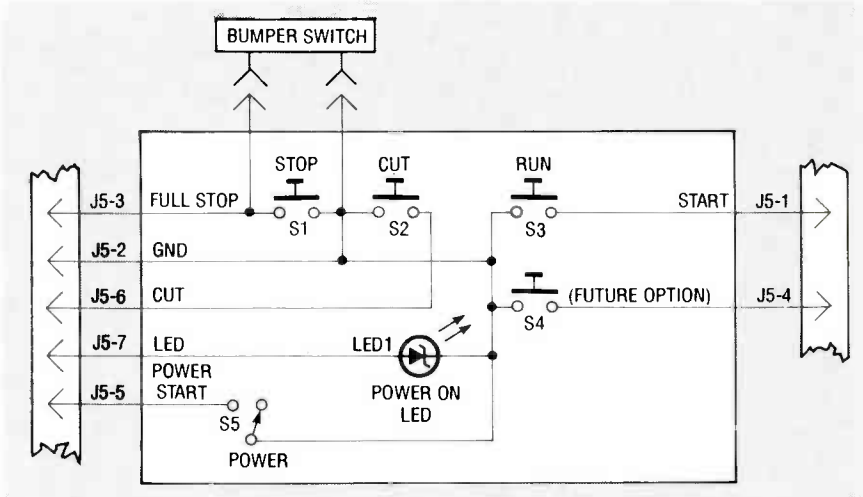

FIG. 9—THE ELECTRONIC CONTROL PANEL must be wired as shown.

**PARTS LIST  
HAND CONTROLLER**

- R1—240,000-ohm resistor
- R2—56,000-ohm resistor
- R3—10,000-ohm potentiometer
- C1—47 µF electrolytic
- S1—SPDT switch
- S2—DPDT slide switch
- S3—momentary pushbutton switch
- Male and female DB-25 connectors, ribbon cable, suitable enclosure

ting motors and R32. That causes the comparator output to swing negative and the MOSFET’s will again turn on causing the current to be applied to the cutting motors. The process is repeated until the cutting motors have reached their maximum velocity. Because the MOSFET’s are turning on and off, instead of supplying full power all at once, the cutting motors will slowly come up to speed in a well-controlled manner.

(Continued on page 80)



# AC POWER

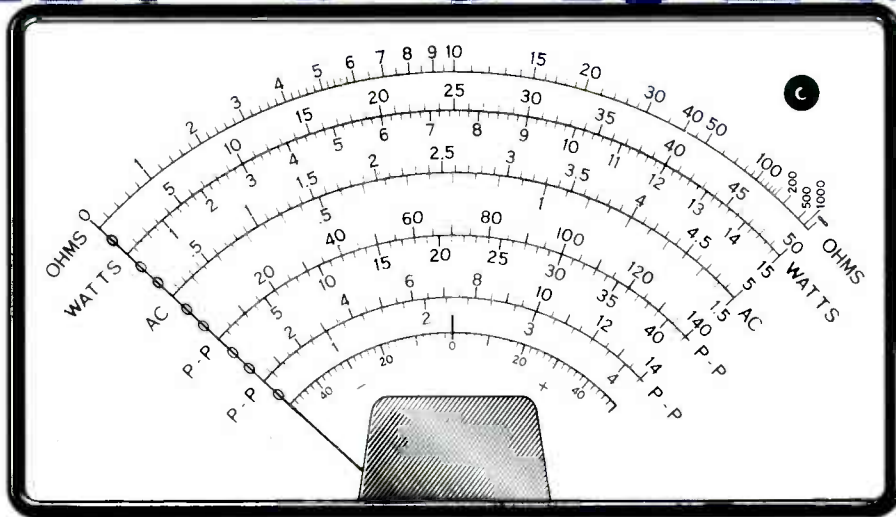

# MEASUREMENT

Learn the principles of measuring power.

HARRY L. TRIETLEY

AC POWER MEASUREMENT: YOU PROBABLY don't think about it very much. Most engineers and technicians normally don't even give it a second thought. Nonetheless, it's an extremely important and pervasive area of electronics, used in a wide variety of fields, include determining RF transmitter power and field strength, radar, motor and generator testing, sonar, stereo, and acoustics, and one area that affects all our daily lives, commercial AC power distribution.

We're all billed using a kilowatt-hour (kWh) meter, and obviously want it to be accurate. Utilities need to measure true usage, because it affects generator loading and fuel consumption. Consumers likewise need to control operating efficiency, peak load usage, and billing. With rising fuel costs and the need for conservation, the subject has become increasingly relevant. AC power isn't always easy to measure, because it's affected by such factors as phase shift and waveform distortion. This article discusses techniques of measuring

AC power, using some special IC's designed for this purpose.

### True power and RMS voltage

Let's review DC power; the power law,  $P = E \times I$ , and Ohm's law,  $E = I \times R$ , produce the 12 equations in Fig. 1. They're for DC only, and omit capacitive and inductive reactances. They're valid for AC if the load is

purely resistive (causing no phase shift), and if E and I are true Root Mean Square (RMS) values. RMS means *the square root of the average of the squares* of a series of voltages or currents. The RMS concept is necessary, because the time-average value of a sinusoidal voltage or current with no DC component is zero. Let's see why, and how this relates to power.

Figure 2-a shows a sinusoidal voltage sampled 16 times, applied across R1 in Fig. 2-b. As each sample varies, the dissipated power is  $P(t) = e^2(t)/R1$ . To find the approximate RMS coefficient for time-average power, the power is found for each sample, and the average of the values is determined. Increasing the number of intervals increases resolution, and improves accuracy.

Table 1 shows the calculations; the average sampled instantaneous power is  $P = 0.503 \times V_{PK}^2/R1 = (0.709 \times V_{PK})^2/R1$ . The letters A-P in Fig. 2 correspond to the same letters in parentheses in the left-hand column of Table 1. The RMS value for

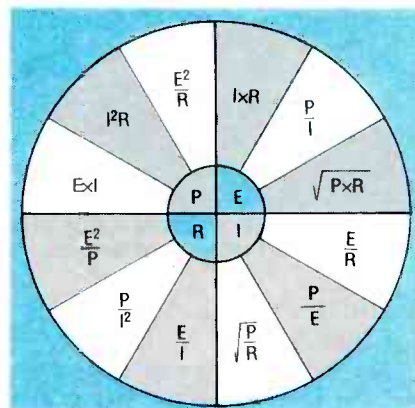

FIG. 1—OHM'S LAW AND THE POWER EQUATION combine to form 12 basic equations for resistive circuits.

**Table 1—DETERMINING THE AVERAGE AND RMS CONVERSION FACTORS**

Sample Angle, deg	Sample Value	Sample Absolute Value	Square of Sample Value
11.25 (A)	0.195	0.195	0.038
33.75 (B)	0.566	0.566	0.320
56.25 (C)	0.831	0.831	0.691
78.75 (D)	0.981	0.981	0.962
112.25 (E)	0.981	0.981	0.962
134.75 (F)	0.831	0.831	0.691
146.25 (G)	0.566	0.566	0.320
168.75 (H)	0.195	0.195	0.038
191.25 (I)	-0.195	0.195	0.038
213.75 (J)	-0.566	0.566	0.320
225.25 (K)	-0.831	0.831	0.691
247.75 (L)	-0.981	0.981	0.962
281.25 (M)	-0.981	0.981	0.962
303.75 (N)	-0.831	0.831	0.691
326.25 (O)	-0.566	0.566	0.320
348.75 (P)	-0.195	0.195	0.038
Sums:	0.000	10.292	8.044

Average conversion factor:  $10.292/16 = 0.643$ .  
 RMS conversion factor:  $8.044/16 = 0.503$ ,  $\sqrt{0.503} = 0.709$ .

value of the samples in Table 1 (the full-wave rectified case) is  $0.643 \times V_{PK}$ . The correct value is  $0.6366 \times V_{PK}$ , an error of only 1.01%. Fig. 3 shows the peak, RMS, and average values for several waveforms, with sketches of each.

One of the more difficult concepts to understand about power is that there are really two separate types of power, instantaneous and time-average. Since DC values are time-invariant, instantaneous and time-average DC powers are always equal. The term used when referring to an RMS value is that of "equivalency." RMS power, in an AC context, is considered "equivalent" to DC power. The major factor for judging this equivalency is what is referred to as the " $I^2R$ " effect, from the power formula.

RMS power yields the same *heat dissipation* in a resistive load as an equal value of DC power. Reactive loads (those with inductance or capacitance) cause a phase angle difference between voltage and current equal to the phase angle of the load impedance. Such a load may have both resistive (real) and reactive (imaginary) components; real " $I^2R$ " power (heat) dissipation occurs *only* in the *real* part, *never* the imaginary part. The imaginary part refers to the energy stored in capacitive electric fields, and inductive magnetic fields.

You should know the meaning of the word "imaginary" in this context; it refers only to the phase difference between voltage and current, *never* that these quantities aren't physically present. As you've probably heard before, "imaginary" voltages and currents are quite capable of causing real shocks.

### Measuring true RMS voltage

You may have heard of "average-responding" and "true RMS" AC meters. Average-responding meters, shown in Fig. 4, are simpler; they rectify and filter AC to give the average value as a DC voltage, that's then scaled to display RMS. Thus, a sine wave with  $V_{PK} = 1$  volt produces 0.6366 volt going into the display, but the display is calibrated to read 0.7071 volt. Because the relationship between RMS and average depends on the waveform, the reading is accurate *only* for sinusoids.

For example, average-responding meters aren't useful for measuring

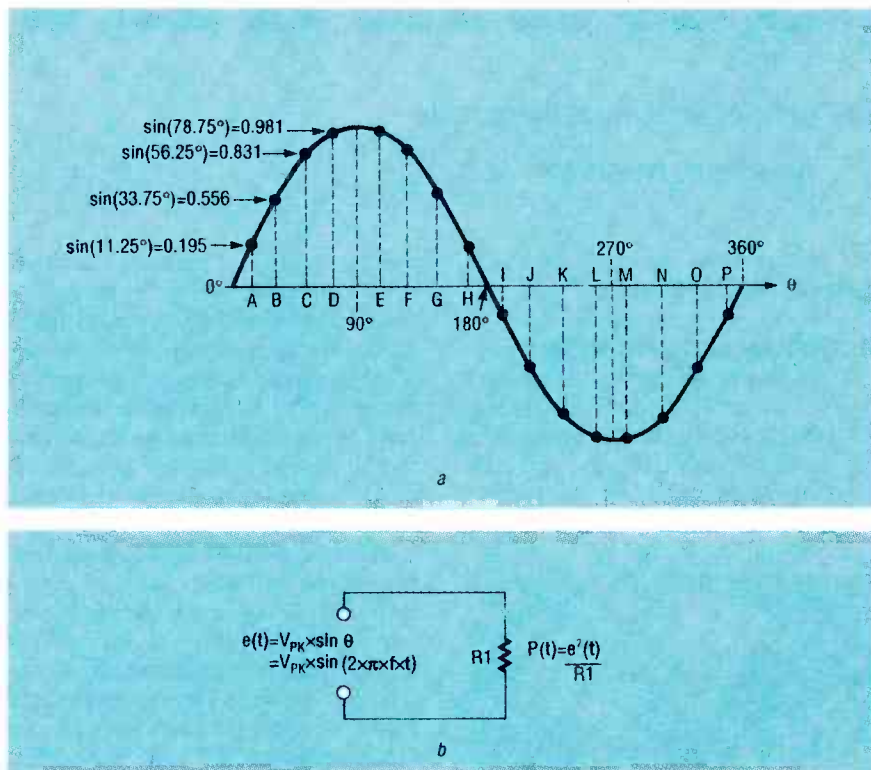

**FIG. 2—A SINUSOID SAMPLED IN 16 EQUISPACED locations in (a) is applied across R1 in (b). This is the first step in the approximate calculation of the RMS conversion factor.**

sinusoidal current is found similarly. If the RMS value for a different wave-shape were desired, the process would be repeated using new samples. This crude approximation gives an RMS value of  $0.709 \times V_{PK}$ , versus a correct value of  $V_{PK} / \sqrt{2}$

$= 0.7071 \times V_{PK}$ , an error of only 0.27461%.

The average or mean value *isn't* just the average of the actual sinusoidal samples, since this is 0 volts, as mentioned earlier. To find the average value, the *average of the absolute*



RMS power in most modern circuits, since nonsinusoidal waveforms are very often used in SCR controllers and variable-speed motor drives, necessitating true RMS measurements. The most common methods are thermal, direct (explicit) computation, and implicit computation. In implementing these approaches, we'll also examine two RMS-to-DC converter IC's that take the work out of true RMS measurement.

### Thermal RMS measurement

Thermal techniques find RMS voltage by exploiting the fact that the real component of power is dissipated as heat in a resistor, as mentioned earlier. In Fig. 5,  $R1 = R2$ ; the measured voltage is amplified, buffered, and/or scaled by A1, and passed to R1. Similarly, R2 is connected to A2, a high-gain differential amplifier producing DC. Matched series-opposing temperature sensors, usually thermocouples, are in physical contact with R1 and R2, and A2 responds to their temperature difference. If R1 is hotter than R2, the output of A2 increases until the temperatures of R1 and R2 are equal. The two temperatures will be equal when the DC output of A2 equals the RMS output of A1.

Although this is a simple approach, accurate measurements using this method are difficult. The main problem is the need for highly accurate thermal matching. Any difference in size, shape, contact, or insulation causes errors. Also, thermal inertia has to be optimized. It has to be slow, to average the AC waveform over its whole cycle. However, excessive inertia causes sluggish measurements.

The Linear Technology LT1088 RMS-to-DC converter has matched pairs of 50- and 250-ohm resistors and diode sensors in a thermal package. The diode has a forward-bias voltage drop temperature coefficient of  $-1.75 \text{ mV per } ^\circ\text{C}$ , and the two sets of internal resistors provide flexibility.

Figure 6 shows the LT1088 in a practical circuit.  $V_{IN}$  comes from an amplifier stage, heating the 50-ohm AC resistor while A1 heats the 50-ohm DC resistor via emitter-follower Q1. The level at pin 9 is 1 volt DC per volt of RMS input, while A2 provides gain adjustment. The maximum input is 4.25 volts for 50 ohms, and 9.5 volts for 250 ohms. Accuracy is 1% up to 50 MHz, with a 3-dB bandwidth for A1 of 300 MHz, and input crest

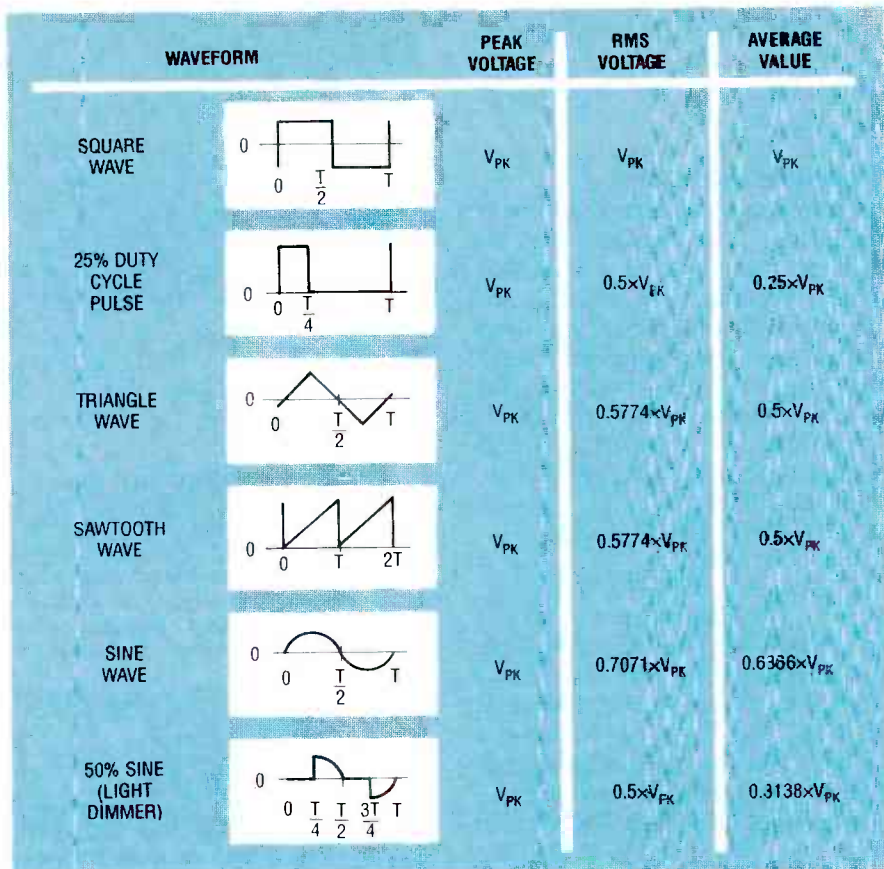

FIG. 3—PEAK, RMS, AND AVERAGE VALUES OF typical waveforms. Listed are a simple square wave (50% duty cycle, 0 volts DC), a periodic pulse train (25% duty cycle, positive-only), a triangle wave (0 volts DC), a sawtooth wave (positive-only), a sinusoid (0 volts DC), and a 50%-sine wave used in light dimmers.

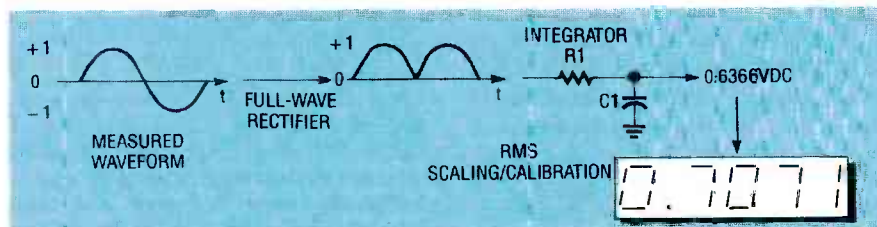

FIG. 4—AN "AVERAGE RESPONDING" AC POWER meter is calibrated to display the equivalent RMS voltage of a sinusoid only.

factors (peak-to-RMS ratio) up to 50:1, making this method highly suitable for RF RMS measurement.

### Direct RMS computation

Direct or explicit RMS computation solves the problem of RMS power measurement electronically. As shown in Fig. 7, the amplified or buffered AC is rectified, squared, averaged, and presented to a circuit that determines the square root of the average, giving the RMS level. The problem here is the dynamic range of the squared signal.

The squaring multiplier produces full-scale output with both X and Y at full scale. Thus, 100% inputs produce 100% output, 10% inputs produce 1%

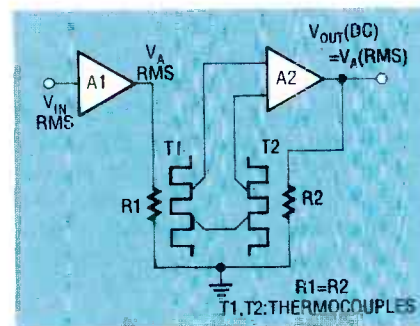

FIG. 5—THERMAL RMS VOLTAGE MEASUREMENT by the power dissipated by R1 and R2. Here,  $R1 = R2$ ; matched temperature sensors contact R1 and R2, and A2 responds to the temperature difference. If R1 is hotter than R2, the A2 output increases until the resistor temperatures are equal, and the DC voltage across R1 equals the RMS voltage across R2.

output, and 5% inputs produce 0.25% output, and so on. Thus, this method isn't suited to voltages varying over a wide range, or waveforms with high crest factors.

### Implicit computation

Implicit computation as shown in Fig. 8 may seem less direct than explicit computation, but it's simpler. There's no square-root needed, and this approach has better dynamic range than is the case in direct RMS computation. Here, A and B in the multiplier/divider are  $V_A$ , and C is  $V_{OUT}$ . Thus  $V_I = (V_{IN})^2/V_{OUT}$ . This voltage is filtered (averaged) to become the output, so

$$V_{OUT} = \text{Avg}[(V_{IN})^2/V_{OUT}]$$

or

$$V_{OUT} = \sqrt{\text{Avg}[(V_{IN})^2]}$$

Analog Devices makes several IC's for implicit RMS-to-DC conversion, such as the general-purpose AD536A, the low-power/low-level AD636, the high-performance AD637, and the low-cost/low-power AD736/7, all used by several manufacturers of true-RMS DVM's. For an in-depth study of RMS-to-DC conversion, you can get a free copy of the *RMS-to-DC Conversion Application Guide* (see the box on page 57).

Figure 9 shows a practical circuit for a low-cost true-RMS meter using an AD536A as IC1. The input is scaled for 200 millivolts RMS at full scale, applied to a buffer amplifier on pin 7 (BUF IN) of IC1, and fed from pin 6 (BUF OUT) to an absolute value precision rectifier on pin 1 ( $V_{IN}$ ). It then passes through a squarer/divider that provides a log output scaled in dB on pin 5.

The final output comes from a current mirror that produces a current of 40  $\mu\text{A}$  DC per RMS volt of input. This current passes through an internal 25K resistor, to produce 1 volt DC/RMS volt of input. There's no offset or gain adjustment, since the AD2026 Digital Panel Meter (DPM) module includes them. If you use your own meter, you can add an output amplifier with gain and offset adjustments.

### Current transformers

Electronic current measurement usually begins by passing a current through a dropping resistor to create a proportional voltage. For currents of tens, hundreds, or thousands of amps, this is impractical, requiring resistors in the milliohm range, or below. Cur-

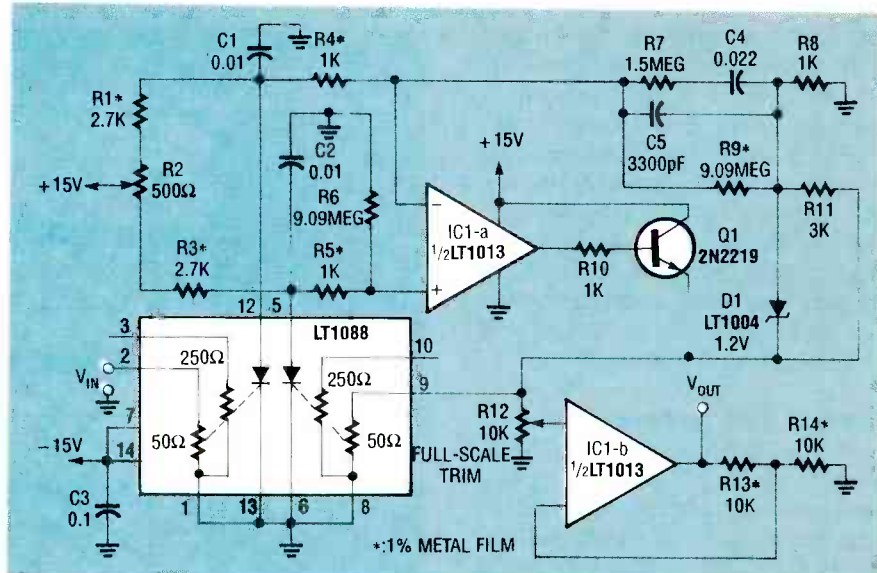

FIG. 6—A PRACTICAL RMS-TO-DC CONVERTER using an LT1088.  $V_{IN}$  heats the 50-ohm AC resistor while A1 and Q1 heat the 50-ohm DC resistor. The level at pin 9 is 1 volt DC per volt of RMS input, and A2 provides gain adjustment. Accuracy is 1% up to 50 MHz, 3-dB bandwidth is 300 MHz for A1, and input crest factors reach 50:1.

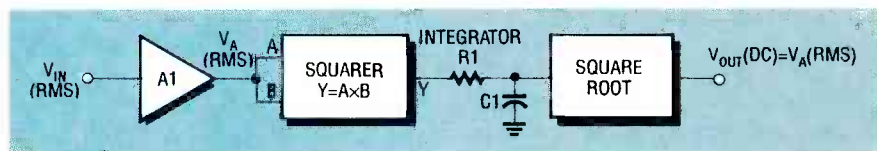

FIG. 7—DIRECT RMS computation; Amplified AC is rectified, squared, and integrated; taking the square root gives true RMS. The squaring multiplier gives full-scale output with both X and Y at full scale.

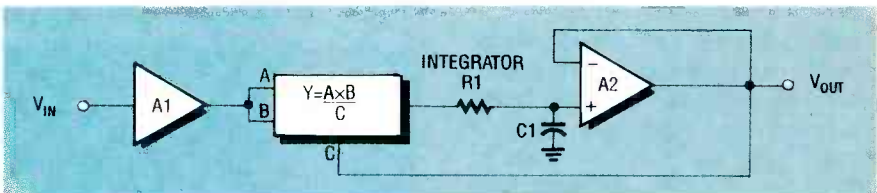

FIG. 8—IMPLICIT RMS COMPUTATION; it may seem less direct than Fig. 7, but it's simpler, as no square-root is needed, and has better dynamic range. Analog Devices makes several IC's for this role; the general-purpose AD536A, the low-power/low-level AD636, the high-performance AD637, and the low-cost/low-power AD736.

rent transformers reduce such high currents to practical levels, using a single winding of N turns on a toroidal core.

The wire carrying the current is threaded through the center of the toroid and becomes a single-turn primary. The secondary current is 1/N times the primary current, and is passed through a dropping resistor to create the proportional voltage. Current transformers generally produce 5 amps out at full-scale primary current.

### Power and phase shifts

Up to this point, we've considered only true RMS measurement. Next, we'll examine the effect of phase shifts on power measurement. Our

discussion will deal only with pure sinusoids. The concept of phase shift has meaning for sinusoids as well as other periodic waveforms of the general form:

$$V(t) = V_{PK} \times \sin[(2 \times \pi \times f \times t) + \theta]$$

Phase shifts are caused by capacitive or inductive reactances. In a pure capacitance, voltage lags current by 90 degrees, while in a pure inductance, current lags voltage 90 degrees. RC or RL circuits produce phase shifts other than 0 degrees or 90 degrees, while pure resistances cause no phase shift at all.

In Fig. 10-a, a charging current starts to flow into the capacitor as the voltage rises, stops when the voltage reaches its peak, and reverses as the voltage falls. If there were no resis-



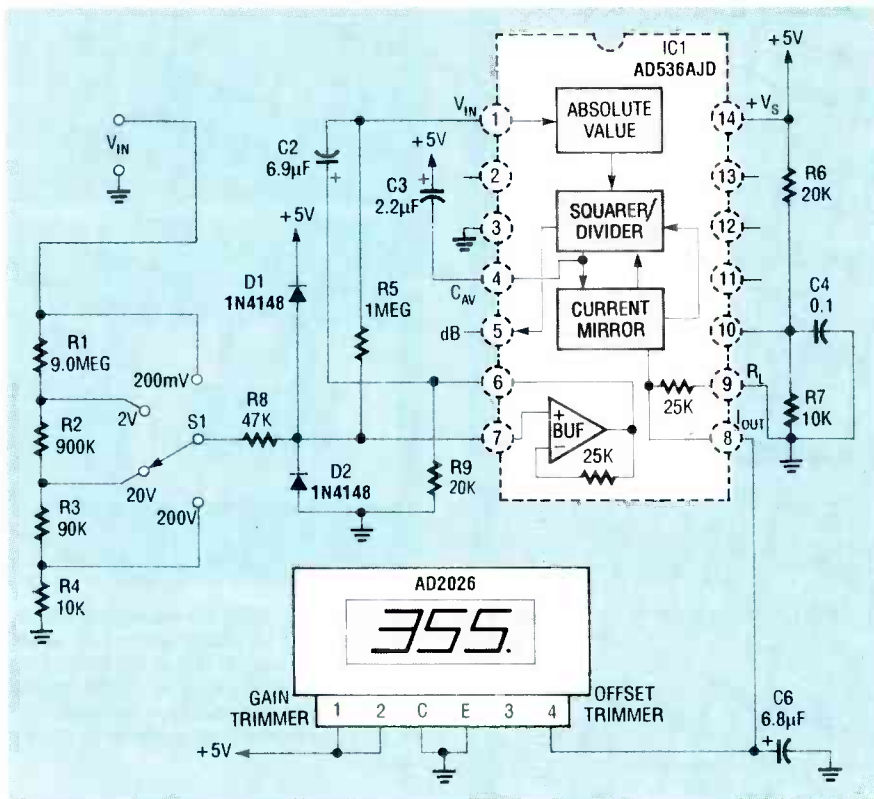

FIG. 9—A CIRCUIT FOR A LOW-COST TRUE-RMS meter using an AD536A. The current mirror sources  $40 \mu\text{A}$  DC per RMS volt of input through an internal  $25\text{K}$  resistor, producing 1 volt DC per RMS volt of input. There's no offset or gain adjustment, since the AD2026 D digital Panel Meter (DPM) module includes them.

tances and thus no power loss, the capacitor would store energy from the inductor part of each cycle, and feed it back the rest of each cycle, the generator acting like a motor. Looking at the waveforms, instantaneous power  $E \times I$  is positive for half a cycle and negative the other half, so no net power is gained or lost.

Figure 10-b illustrates pure inductance. Any change in inductor current induces an EMF opposing the change, so current lags voltage by  $90^\circ$ . Energy is alternately stored in the magnetic field and fed back to the AC source. As in the case of the capacitor, no net power is gained or lost in an ideal inductive circuit with no resistance.

Resistances convert electrical current to heat: Fig. 10-c shows a pure resistance, and Fig. 10-d an RL circuit of under  $90^\circ$  phase shift. In general, power usage for purely sinusoidal circuits is  $P = E \times I \times \cos(\theta)$ , where  $E$  and  $I$  are RMS voltage and current,  $\theta$  is the relative phase,  $\cos(\theta)$  is the Power Factor (PF), and  $E \times I$  is measured in Volt-Amps (VA). Also, at  $\theta = 0$  degrees,  $\text{PF} = 1$ , while at  $\theta = 90$  degrees,  $\text{PF} = 0$ .

Ideal reactive loads don't consume

power, but they increase total current drawn from a source, causing extra loss in the resistance of generators, transformers and power lines. Phase shifts are minimized by adding capacitance to balance inductive loads (motors and transformers). As men-

#### SOURCE INFORMATION

**Burr-Brown Corp.**  
6730 S. Tuscon Blvd.  
Tucson, AZ 85734  
(602) 746-1111

**Analog Devices Corp.**  
1 Technology Way  
P.O. Box 9106  
Norwood, MA 02062-9106  
Wilmington, MA  
(800) 343-0315

**Linear Technology, Inc.**  
970 Fraser Drive  
Burlington, Ontario, Canada,  
L7R3Y3  
(416) 532-3998 or (800) 263-9353

**Marshall Technology**  
(distributor for Linear Technology)  
336 LosCoches Road  
Milpitas, CA 95035  
(408) 943-4600 or (800) 877-5682

tioned earlier, the imaginary component of a joint resistive-reactive load corresponds to the reactive part. The fraction of the total power going into the reactive part of the load is measured in Volt-Amps Reactive (VAR), given by  $\text{VAR} = E \times I \times \sin(\theta)$ . Also, at  $\theta = 0$  degrees,  $\text{VAR} = 0 \text{ VA}$ , while at  $\theta = 90$  degrees, the VAR is maximized, with no power is being resistively dissipated as heat.

#### Measuring phase shift

Phase shift provides a measure of the time difference between two waveforms, by detecting the time between zero crossings; Fig. 11 gives the general layout of a circuit that can be used to measure a time difference. Each comparator flips when its input crosses 0 volts; their polarities are opposite one another. Comparator B sets the flip-flop, while comparator A resets it, both on positive-going transitions.

If the voltage and current are in phase, the transitions will be  $\frac{1}{2}$ -cycle apart, and the flip-flop will be set 50% of the time. Lagging current delays the set, producing longer low and shorter high intervals, while leading current does the opposite. The filter averages the flip-flop output, producing a voltage proportional to phase shift, and rises or falls indicating lead or lag.

This isn't a complete working circuit, as component values depend on input levels, supply voltages, and desired output. Gain and offset adjustments will be needed for calibration; the output stage is a good place to add them. One or both inputs should be transformer-coupled for safety, but remember that transformers add phase shift. Also, the output represents *theta*, not  $\sin(\theta)$ .

#### Measuring true AC power

Now that we've covered true RMS measurement and phase shifts, we could consider a computational circuit for  $E \times I \times \cos(\theta)$ , but that would be complex, and inaccurate for non-sinusoidal waveforms. It's easier to go back to the basic definition of power; at any given instant, power is  $P = E \times I$ . Power is found by integrating (averaging) the  $E \times I$  product over one or more cycles, as shown in Fig. 12-a.

Figure 12-a shows what takes place in an electromechanical wattmeter movement, while Fig. 12-b shows the

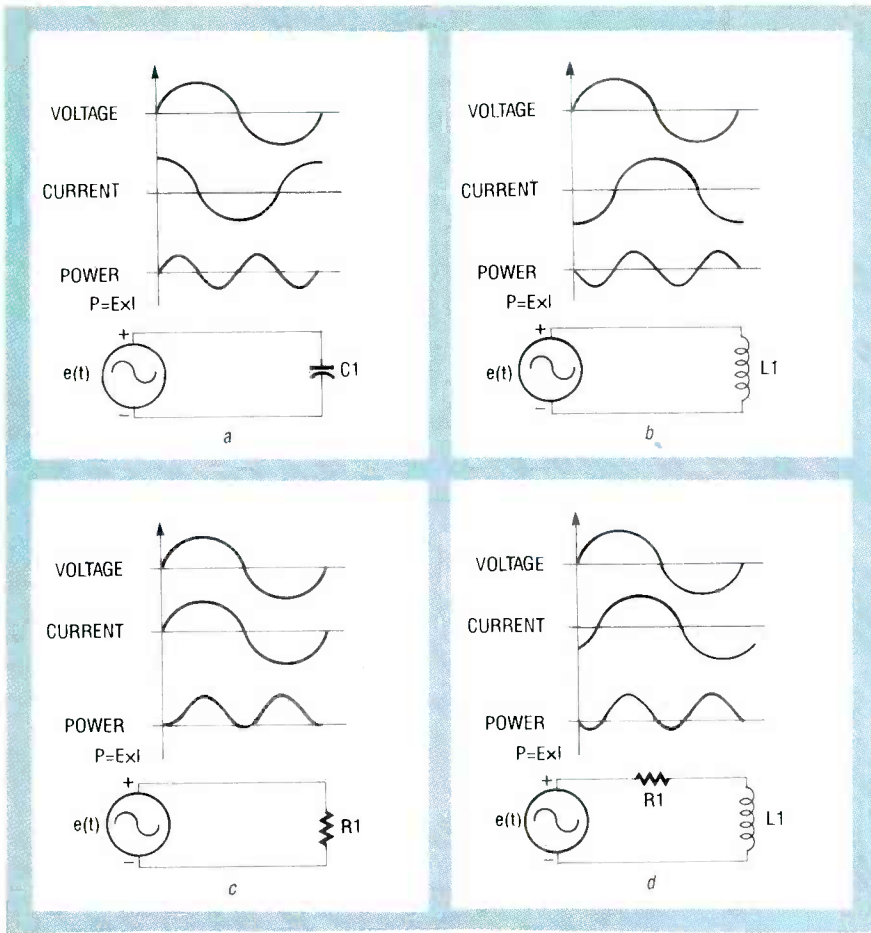

FIG. 10—A PRESENTATION OF VOLTAGE, CURRENT, and power waveforms, for capacitive, inductive, RC, and RL loads (a-d). With a 90° phase shift as in (a) and (b), average power consumption over a complete line cycle is zero. Voltage and current in phase, as in (c), produces maximum power. A 45° phase shift as in (d) reduces average power.

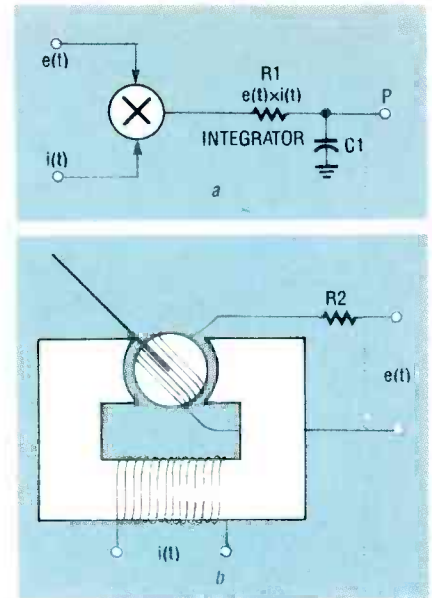

FIG. 12—TRUE POWER MEASUREMENT, UNAFFECTED by phase shifts and waveform distortions, is found by averaging  $e(t) \times i(t)$ . In (a) appears a sketch of the principle, while (b) displays a diagram of an electromechanical wattmeter movement.

Three types of electronic multipliers are used; log/antilog amplifiers, duty-cycle (pulse-width) modulators, and Hall-effect devices. Figure 13 shows the first, that performs multiplication by adding logarithms,  $\log(E \times I) = \log(E) + \log(I)$ , and then takes the antilog, anti-

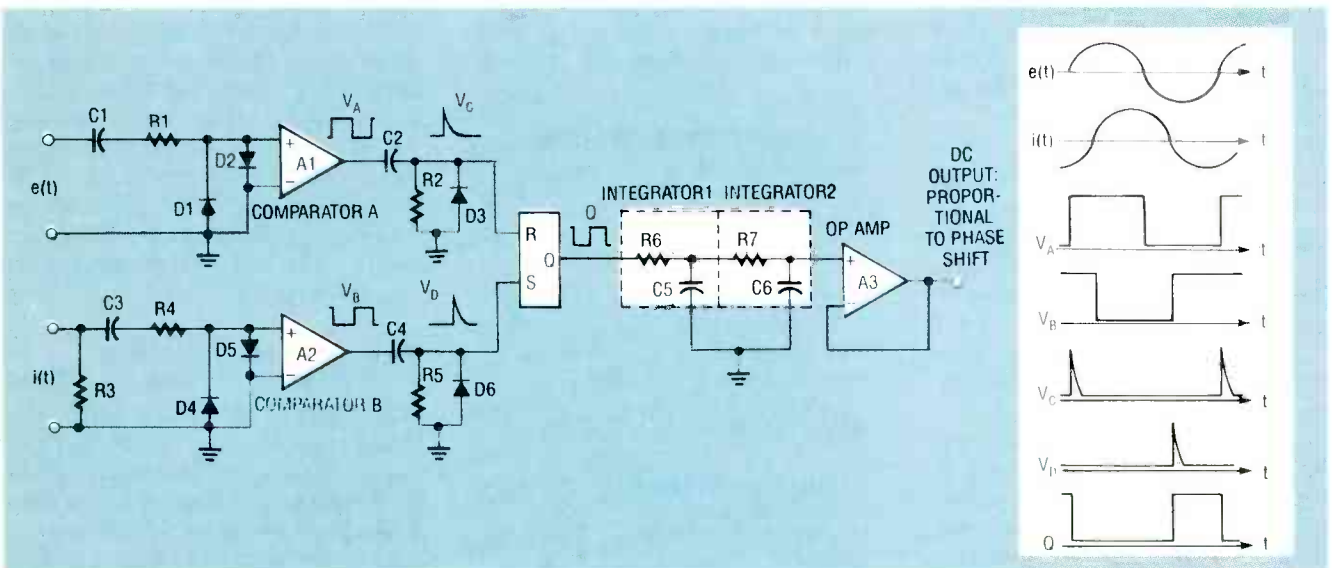

FIG. 11—AN INCOMPLETE CIRCUIT CONCEPT TO measure relative phase shift. By setting and resetting the flip-flop when the current and voltage waveforms cross 0, the relative phase shift can be measured.

movement itself. In the meter, one field is created by E, the other by I, and the attractive force between them is proportional to  $E \times I$ . Filtering is

achieved by the inertia of the meter movement plus mechanical damping; otherwise, the pointer would vibrate rapidly with each cycle.

$\log[\log(E \times I)] = E \times I$ . The final result is integrated to find average power.

The object here isn't to discuss log/antilog amplifiers; that's an article in itself. They all use the log relation



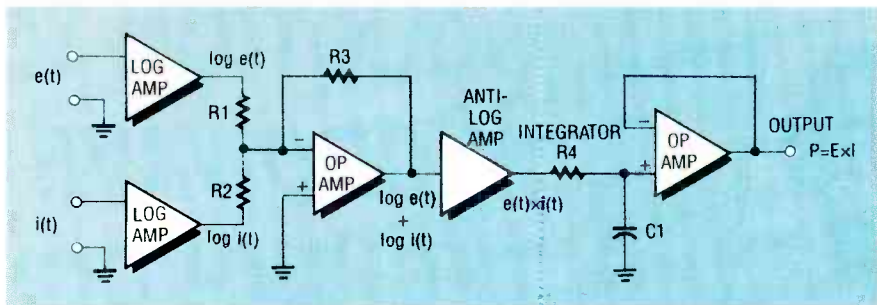

FIG. 13—MULTIPLICATION USING LOG/ANTILOG amplifiers. This circuit is also incomplete, but the log/antilog amplifier exploits the log relation between current through and voltage across the Base-Emitter (BE) junction of a bipolar transistor to find average power.

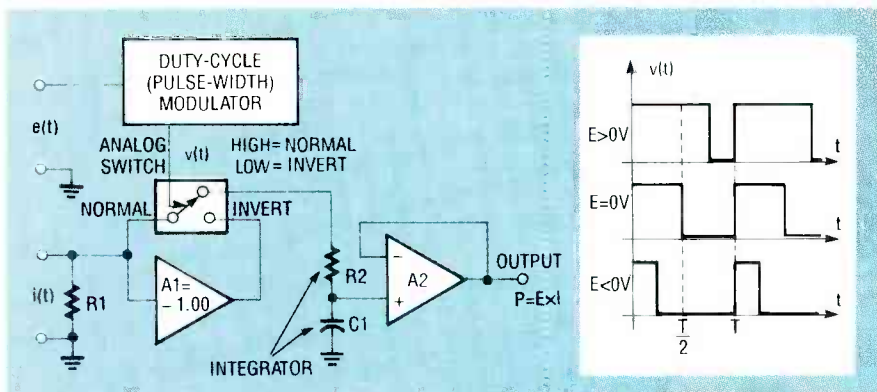

FIG. 14—AN INCOMPLETE DUTY-CYCLE (PULSE-WIDTH) modulator. The voltage input is converted to a duty cycle, modulating the current input to perform modulation.

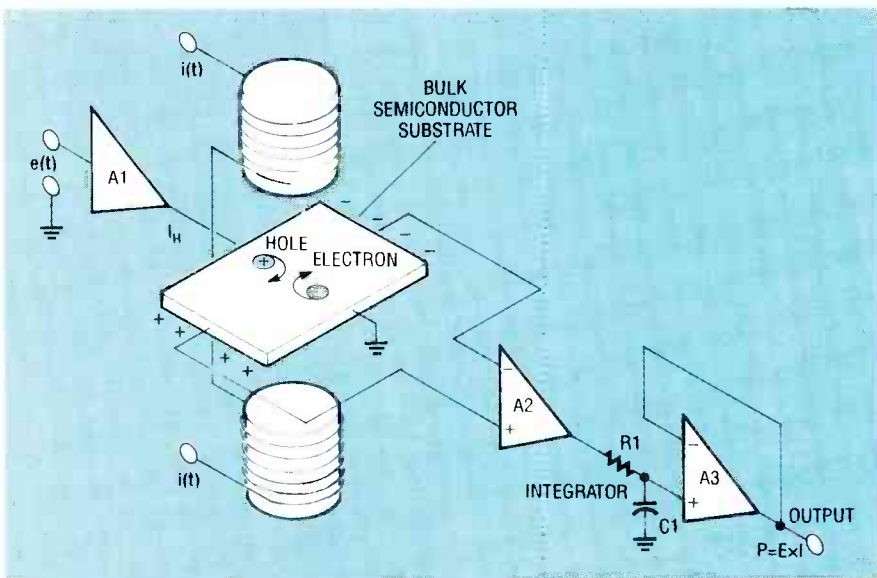

FIG. 15—A HALL-EFFECT DEVICE USED TO PERFORM multiplication, producing an EMF proportional to the product of the semiconductor's current times the magnetic flux density.

between voltage and current in the Base-Emitter (BE) junction of a bipolar transistor. IC multipliers are available that perform the complete log-sum-antilog function internally. Examples include the Analog Devices AD530/630/830, Burr-Brown MPY100 and 4203, and Raytheon RC4200. Their prime advantages are

simplicity, typical frequency response of 400 kHz or higher, accuracy of 0.25–1.0%, and temperature stability of 0.02–0.05%/deg C.

When extreme accuracy is needed at low frequencies such as 50–60 Hz, the duty-cycle (pulse-width) modulator shown in Fig. 14 gives superior performance. At 0 volts in, the pulse-

width modulator produces a 50% duty cycle; its output controls an analog switch that alternately connects non-inverted or inverted inputs to the filter. At 50% duty cycle, the signal fed to the filter spends equal times positive and negative, so the filtered output is 0 volts regardless of the current input.

As the input goes positive, the duty cycle exceeds 50%. The switch spends more time in the normal position and less in the inverted, so the filtered output polarity is the same as that of the input current. Similarly, when the input voltage goes negative, the switch spends more time in the inverted position and the output polarity becomes opposite to that of the input current. The higher the voltage, the higher the duty cycle, and the higher the filtered output. The output is proportional to the product of duty cycle  $\times I$ , or  $e(t) \times i(t)$ .

Unlike the log/antilog circuit, this one isn't available as an off-the-shelf IC, and is more complex to design and build. Its frequency response is also lower, since the duty cycle frequency must be many times higher than that of the inputs. Properly designed, however, it's capable of accuracies lower than 0.1%, limited more by the ability to obtain precise AC calibration sources than the circuitry itself.

Finally, we'll examine Hall effect multipliers, as shown in Fig. 15. A Hall-effect device uses a shaped and doped semiconductor in a magnetic field. As the holes or electrons flow at right angles to the field, they're deflected in a curved path toward the semiconductor edges, inducing an EMF between two edges proportional to the product of flux density  $B$  and current  $i(t)$ ; reversing either reverses the EMF.

In AC power measurement, the power current controls the magnetic field, and the power voltage controls the semiconductor current. The induced EMF is amplified by a differential amplifier, filtered, and scaled. Hall effect devices are very linear, and have a wide bandwidth. Their main drawback is they need temperature compensation to achieve high stability. Clearly, AC power measurement involves much more than multiplying voltage and current. The techniques shown here make possible precise measurement of RMS voltage/current, phase shift, and true power in electronic circuits.

R-E

# INTRODUCTION TO MICROWAVE TECHNOLOGY

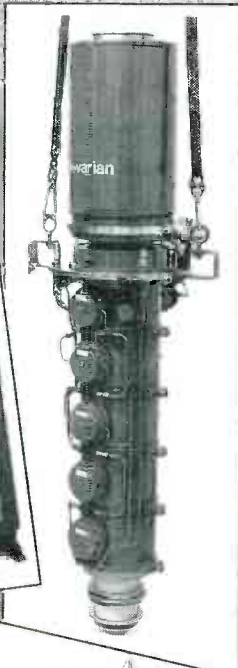
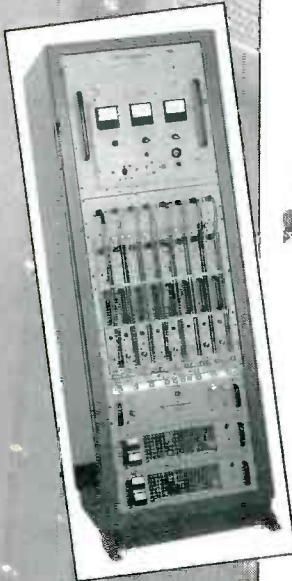
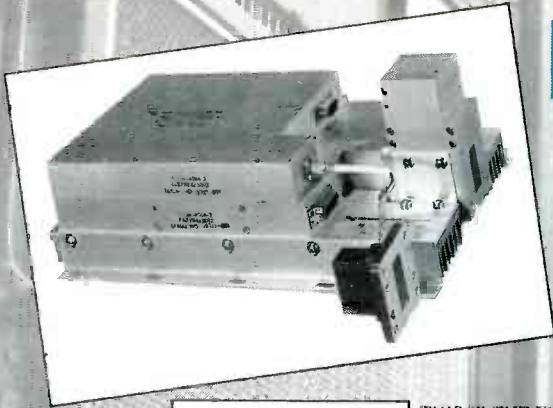

THIS IS THE FIRST IN A SERIES OF ARTICLES dealing with microwave electronics. The word microwave stems from "micro," meaning very small, and "wave," for electromagnetic oscillations; thus, microwaves are very short-wavelength electromagnetic oscillations. The electromagnetic spectrum shown in Fig. 1, is broken into such bands for purposes of both convenience and identification.

Rigorously defined, the microwave region begins above 300 MHz, occupying an upper part of the UHF (300 MHz-3 GHz) band, all of the SHF band (3 GHz-30 GHz), all of the EHF band (30 GHz-300 GHz), and a lower part of the infrared (IR) region. However, there's considerable overlap in physical properties between the UHF and microwave regions. The

UHF region is nominally from 300 MHz-3 GHz, but above about 900 MHz or 1 GHz, UHF and microwave propagation and scattering are very similar.

The definition of exactly where the microwave region begins is further complicated a great deal by both historical precedent, and depends on both the application and the user. For example, the original military definition of the microwave bands for radar and communication systems (circa World War II), used letter designations to define them, as shown in Table 1.

Those definitions used the letters P, L, S, C, X, K, Q, V, and W, in that order, and were originally defined for security and technical reasons. There was no sensible partitioning of the actual frequencies involved. Whatever rationale was originally used to select these bands and labels, both are really of historical interest only.

For that reason, the Dept. Of Defense (DOD) issued updated band designations on May 24, 1970, as shown in Table 2, that used a somewhat less chaotic approach. The band labels went in strict alphabetical order, from A-M, although there were still considerable jumps in the actual frequencies assigned to each. Thus, almost the same entire frequency region is considered microwave, although the new scheme reduces the lower bound by 125 MHz.

As if this weren't ambiguous enough, the Institute of Electrical and Electronics Engineers (IEEE), the major U.S. and international electrical engineering society, has its own designation scheme, as shown in Table 3, now almost universally accepted, although older designations still persist out of habit. The IEEE designations use a combination of some of

*Get to know  
basic microwave  
terminology  
and technology.*



JOSEPH J. CARR

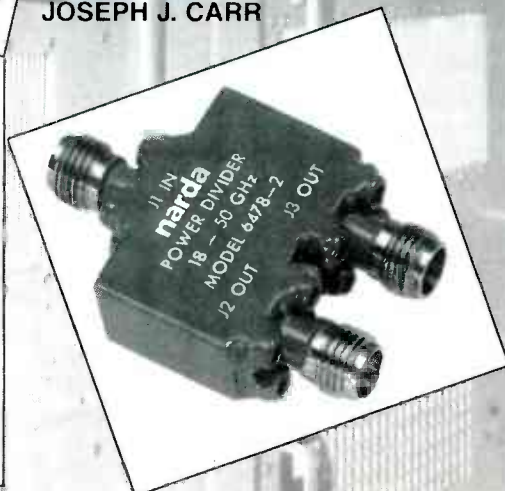
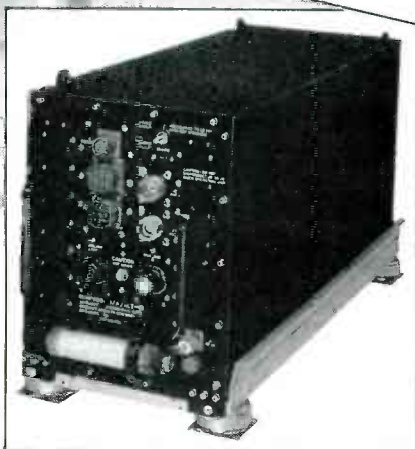



the original World War II band designations, and then add their own lettering. They maintain the HF, VHF, and UHF designations, but above that, use the designations L, S, C, X, Ku, K, Ka, Millimeter, and Submillimeter.

For purposes of this series, the high end of the UHF region will be considered part of the microwave region, since there's no sharp transition in properties from the shortest non-microwave UHF wavelengths to the longest microwave wavelengths. Also, certain applications usually considered strictly in the microwave region sometimes also use UHF (such as long-range radar). For present purposes, our definition includes all frequencies above 500 MHz but below the IR region.

No doubt you're wondering how microwaves differ sufficiently from other frequency ranges of electromagnetic waves to warrant a separate series of articles. Microwave wavelengths approximate the physical size of ordinary electronic components, so components tend to behave differently when this is the case. At microwave frequencies, a half-watt metal film resistor is a complex RLC network with distributed inductance and capacitance, and a much different resistance. Certain characteristics irrelevant at lower frequencies become significant in the microwave region. Components and conductors act increasingly like transmission lines, with reflection, transmission, and cross-talk becoming critical to circuit function.

### Microwave history

Microwave technology was relatively undeveloped until World War II, when huge investments in research and development led to rapid developments in radar and other electronics technologies used in the war. Vacuum tubes of the 1920's and 1930's wouldn't work at the UHF or microwave frequency ranges. The main problems were interelectrode capacitance and electron transit time from cathode to anode. Attempts to reduce electrode size and spacing caused other problems that proved unacceptable in practical circuits.

Interelectrode capacitance was reduced using clever geometries and closer interelectrode spacing (also a factor in transit time). By World War II, operation at 200 MHz was possi-

**TABLE 1—OLD U.S. MILITARY MICROWAVE FREQUENCY BANDS**

BAND DESIGNATION	FREQUENCY RANGE
P	225 MHz–390 MHz
L	390 MHz–1.55 GHz
S	1.55 GHz–3.9 GHz
C	3.9 GHz–6.2 GHz
X	6.2 GHz–10.9 GHz
K	10.9 GHz–36 GHz
Q	36 GHz–46 GHz
V	46 GHz–56 GHz
W	56 GHz–100 GHz

**TABLE 2—NEW U.S. MILITARY MICROWAVE FREQUENCY BANDS**

BAND DESIGNATION	FREQUENCY RANGE
A	100 MHz–250 MHz
B	250 MHz–500 MHz
C	500 MHz–1 GHz
D	1 GHz–2 GHz
E	2 GHz–3 GHz
F	3 GHz–4 GHz
G	4 GHz–6 GHz
H	6 GHz–8 GHz
I	8 GHz–10 GHz
J	10 GHz–20 GHz
K	20 GHz–40 GHz
L	40 GHz–60 GHz
M	60 GHz–100 GHz

**TABLE 3—IEEE/INDUSTRY STANDARD MICROWAVE FREQUENCY BANDS**

BAND DESIGNATION	FREQUENCY RANGE
HF	3 MHz–30 MHz
VHF	30 MHz–300 MHz
UHF	300 MHz–1 GHz
L	1 GHz–2 GHz
S	2 GHz–4 GHz
C	4 GHz–8 GHz
X	8 GHz–12 GHz
Ku	12 GHz–18 GHz
K	18 GHz–27 GHz
Ka	27 GHz–40 GHz
Millimeter	40 GHz–300 GHz
Submillimeter	>300 GHz

ble, 500–800 MHz was achieved by the end of the war, and 800 MHz by the early 1950's. In 1920, Barkhausen and Kurz of Germany achieved oscillation at 700 MHz by manipulating electron transit time. Although the Barkhausen-Kurz Oscillator achieved UHF/microwave oscillations, it was inefficient. Overheating was also a problem, because the grid glowed white hot at high power.

One solution in 1921 by A.W. Hull replaced the grid with a magnetic field, which later evolved into the magnetron, the first practical high-power microwave generator, still used in some radars and microwave ovens today. Unfortunately, it's a narrow-band device, often requiring the designer to make a trade-off, regarding available output power versus frequency agility.

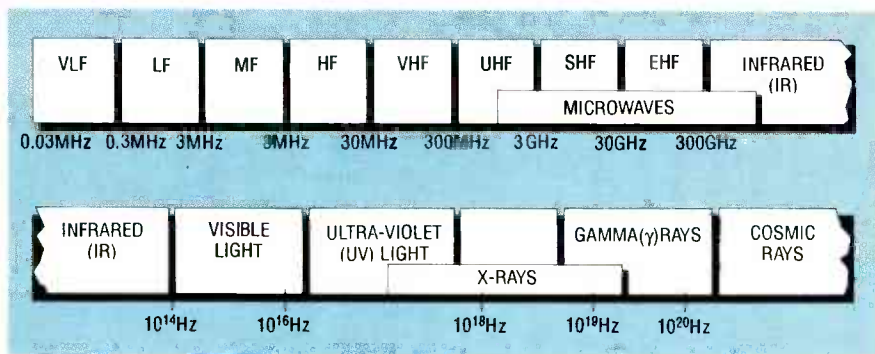

FIG. 1—THE ELECTROMAGNETIC SPECTRUM; the upper end of UHF is considered microwave. Both regions have common properties, and certain microwave applications, like long-range radar, are often UHF. Here, microwaves include all frequencies above 500 MHz and below IR.

The power-vs-frequency dilemma seemed insoluble until 1935, when W.W. Hansen of Stanford Univ., and A.A. Heil and O. Heil exploited transit time by velocity modulating an electron beam. In 1939, W.C. Hahn and G.F. Metcalf proposed the theory of velocity modulation for microwave tubes. A few months later, Russell H. and Sigurd F. Varian extended Dr. Hansen's work, producing the first two-cavity microwave vacuum tube using velocity modulation, known as a reflex klystron. And, in 1944, R. Kompfner invented the helical Traveling-Wave Tube.

Much of the really critical microwave development work during World War II was performed at the Massachusetts Institute of Technology Radiation Laboratory, known as the RadLab. Their reports are still actively used today by many working microwave engineers as references, and can be found—over 45 years later—as standard items in many technical bookstores.

In the 1950's vacuum tubes began to be replaced with bipolar transistors. Although P-N junction semiconductor diodes like the 1N23 were made for low-frequency microwaves during World War II, other solid-state devices simply refused to function at these frequencies. Semiconductor materials exhibit a phenomenon analogous to vacuum tube transit time, called electron saturation velocity.

B.K. Ridley and T.B. Watkins in 1961 and C. Hilsum in 1962 independently predicted that gallium-arsenide (GaAs) would exhibit the transferred-electron effect. In 1963, John B. Gunn of IBM experimented with N-type gallium-arsenide (GaAs), and noted current instability that was due to negative resistance. That observation evolved into the Transferred-Electron Device, or Gunn diode.

Other solid-state microwave devices soon followed. You can now buy DC-to-2-GHz Monolithic Microwave Integrated Circuits (MMIC's) that

produce about 13–20 dB of gain for about \$1. Other solid-state microwave devices operate at 20 GHz or more. All such microwave solid-state devices exploit negative resistance for oscillation and amplification.

Modern electronics designers have a wide variety of solid-state devices to select from, and microwave technology is no longer the poor orphan of electronics. Radar, communications, electronic navigation, and satellite TV links all operate at microwave frequencies. Also, modern medical diathermy, or tissue heating, long ago moved from the 11-meter band to microwave frequencies.

### Wavelength and frequency

Microwaves, like all other electromagnetic waves, exhibit the characteristics of amplitude, propagation at the speed of light in free space, frequency, wavelength, period, and phase (see Fig. 2). **Amplitude** is the measure of intensity, expressed in electric or magnetic field (volts/meter or amps/meter). The speed of light in free space is  $c = 3 \times 10^8$  meters/second = 186,200 miles/second.

**Frequency** is the number of individual oscillations per unit time, as measured in Hertz (Hz), or cycles per second. Figure 2 shows a cycle as one complete reversal of the waveform, e.g., either T1-T3 or T3-T5. The GHz, or  $10^9$  Hz, is the frequency unit most commonly used in microwaves.

**Wavelength** is the interval in distance between identical points on successive cycles of a wave (see Fig. 2). It's measured between identical peaks or zero crossings in a given direction. For all propagating waves, the product of frequency and wavelength is the propagation speed, or  $v = \lambda \times f \sqrt{\epsilon_r}$ .

Here,  $\lambda$  is the wavelength in meters/cycle,  $f$  is the frequency in Hz,  $\epsilon_r$  is the *magnitude* of the complex relative permittivity or dielectric constant of the propagation medium relative to vacuum (unitless), and  $v$  is the propagation speed.

Solving for wavelength:

$$\lambda = c/f\sqrt{\epsilon_r}$$

or frequency:

$$f = c/\lambda\sqrt{\epsilon_r}$$

For microwave signals in air, wavelengths vary from 10 centimeters at 3 GHz to 1 millimeter at 300 GHz. Microwave frequencies above 20 GHz are also called millimeter waves due to their extremely short wavelengths (under 1.5 centimeters). In media

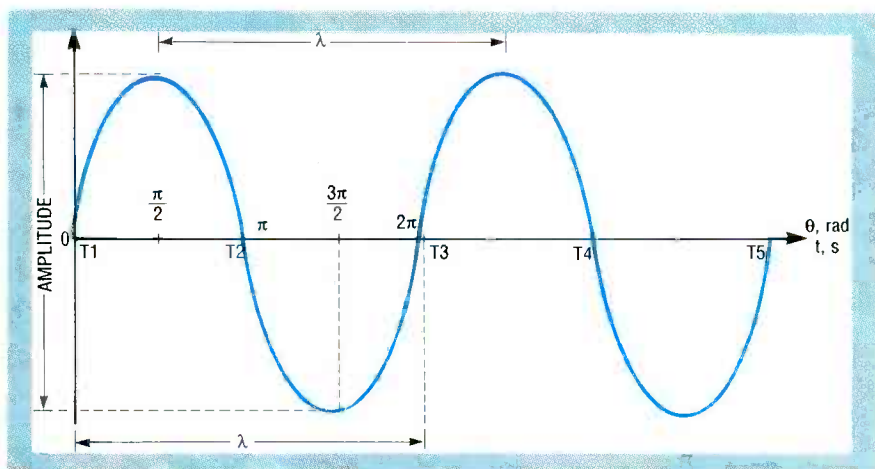

FIG. 2—THE RELEVANT PARAMETERS IN A sinusoidal wave. Microwaves, like all electromagnetic waves, exhibit the characteristics of amplitude, propagation in free space at the speed of light, frequency, wavelength, period, and phase.



other than dry air or vacuum, propagation speed decreases. To maintain constant propagation speed, the wavelength must decrease if frequency is held constant.

The only characteristic quantity that remains perfectly constant in a propagating wave is frequency. When microwave energy passes through a piece of plastic, for example, its speed decreases because  $\epsilon > 1$ , but  $\lambda$  must also decrease to produce the same number of cycles in a given time interval.

Any waveform can be described either temporally (in time) or angularly. As is shown in Fig. 3-a, period is shown to be the reciprocal of frequency  $T = 1/f$ , where  $T$  is the period (in s/cyc), and  $f$  is frequency (in Hz).

The angular description of a sinusoid stems from the fact that it's mathematically generated from a circle, arbitrarily defined as containing  $360^\circ$ . The true, non-arbitrary angular unit is the radian (or rad); to define it, consider a circle. If, as is shown in Fig. 3-b, you bend a line segment one radius long to fit along a sector of the corresponding circle, it subtends a  $57.3^\circ$  angle. If you repeat this as many times as possible over the entire circumference, you'll fit 6.28 radii on the circle in all, or 3.14 radii along a semicircle.

By definition, the number 6.28 is twice the constant pi ( $\pi$ ), or  $2 \times \pi$  radians = 6.28 rad, so  $\pi = 3.14$ . Since  $2 \times \pi$  radians =  $360^\circ$ , then  $\pi$  radians =  $180^\circ$ , or 1 radian =  $57.3^\circ$ . The term phase denotes either Absolute or Relative Phase Angle (APA or RPA). The APA refers to the number of degrees or radians into a given cycle where the instantaneous point of interest is located. In Fig. 3-a, for example, point A' has an APA of  $\pi/2$  radians or  $90^\circ$ .

Relative phase angle (RPA) refers to the phase angle between two signals, whether two voltage signals, two current signals, or voltage and current signals. The waveforms of Fig. 4 aren't coincident (phase angle  $\theta$  isn't  $0^\circ$ ). In this example waveform A is a cosine function, while waveform B is a sine function). These waveforms are of the same frequency, but  $90^\circ$  out of phase with each other. This condition is called a quadrature phase relationship.

### Skin effect

There are several reasons why ordinary lumped components don't work

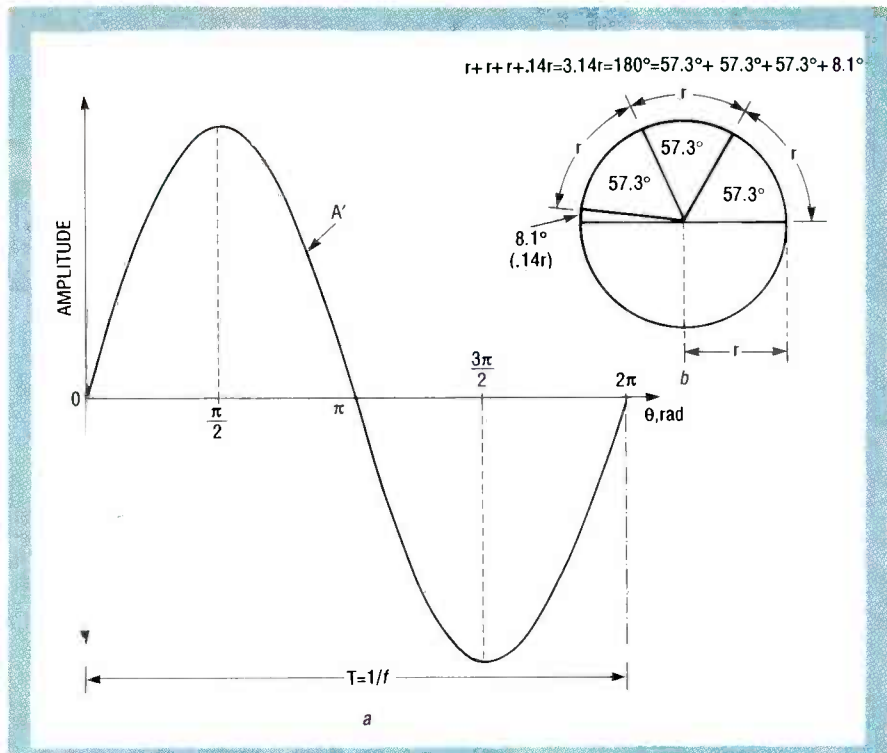

FIG. 3—WAVEFORMS ARE DESCRIBED EITHER temporally or angularly. In (a), the Absolute Phase Angle at A' is  $90^\circ$  or  $\pi/2$  rads. In (b), a radius bent to fit on its circle subtends a  $57.3^\circ$  angle, so 6.28 radii fit in all. Or  $2 \times \pi$  rads =  $360^\circ = 6.28$  rads,  $\pi$  rads =  $3.14$  rads =  $180^\circ$ , or 1 rad =  $57.3^\circ$ , the most basic angular unit.

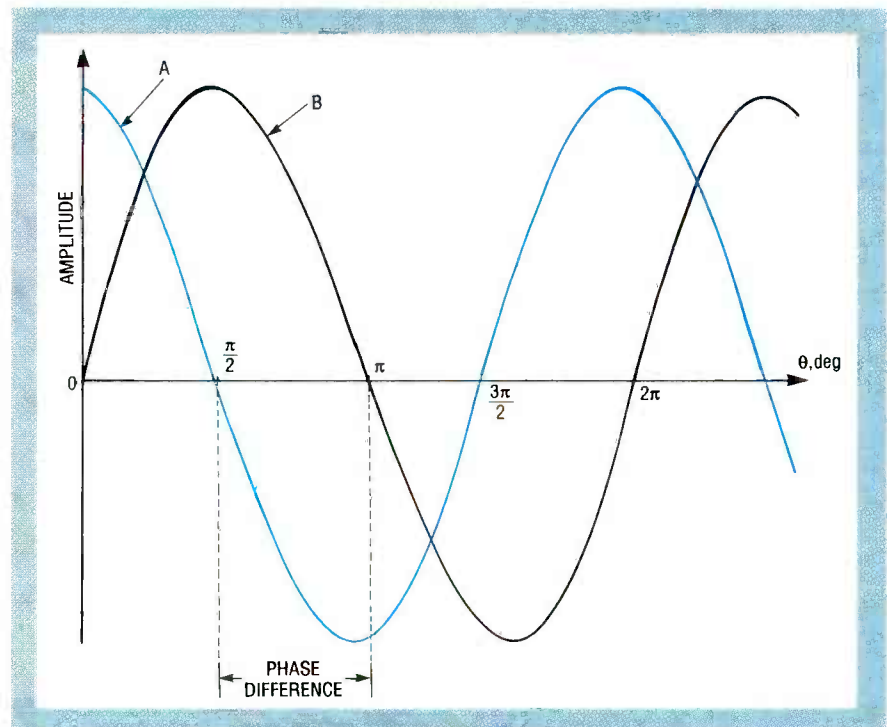

FIG. 4—RELATIVE PHASE ANGLE REFERS TO the phase angle between two signals, whether two voltage signals, two current signals, or voltage and current signals. Here, waveform A is a cosine function, while waveform B is a sine function. They have the same frequency, but are  $90^\circ$  out of phase, called a quadrature phase relationship.

well at microwave frequencies. As mentioned earlier, component size and lead lengths approximate microwave wavelengths. Also, distributed values of inductance and capacitance

become significant here. Finally, there's the skin effect, which occurs when AC tends to flow on the surface of a conductor.

While DC flows throughout the en-

# R-E Engineering Admart

Rates: Ads are 2 1/4" x 2 7/8". One insertion \$950. Six insertions \$925. each. Twelve insertions \$895. each. Closing date same as regular rate card. Send order with remittance to **Engineering Admart**, Radio Electronics Magazine, 500-B Bi-County Blvd., Farmingdale, NY 11735. Direct telephone inquiries to Arline Fishman, area code-516-293-3000. **Only 100% Engineering ads are accepted for this Admart.**

## Surface Mount Chip Component Prototyping Kits—

Only \$49.95



CC-1 Capacitor Kit contains 365 pieces, 5 ea. of every 10% value from 1pf to 33µf. CR-1 Resistor Kit contains 1540 pieces, 10 ea. of every 5% value from 10Ω to 10 megΩ. Sizes are 0805 and 1206. Each kit is ONLY \$49.95 and available for Immediate One Day Delivery!

Order by toll-free phone, FAX, or mail. We accept VISA, MC, AMEX, COD, or Pre-paid orders. Company P.O.'s accepted with approved credit. Call for free detailed brochure.

**COMMUNICATIONS SPECIALISTS, INC.**  
426 West Taft Ave. • Orange, CA 92665-4296  
Local (714) 998-3021 • FAX (714) 974-3420

Entire USA 1-800-854-0547

CIRCLE 176 ON FREE INFORMATION CARD

## FCC LICENSE PREPARATION

The FCC has revised and updated the commercial license exam. The **NEW EXAM** covers updated marine and aviation rules and regulations, transistor and digital circuitry. **THE GENERAL RADIOTELEPHONE OPERATOR LICENSE - STUDY GUIDE** contains vital information. **VIDEO SEMINAR KITS ARE NOW AVAILABLE.**

WPT PUBLICATION  
979 Young Street, Suite A  
Woodburn, Oregon 97071  
Phone (503) 981-5159

CIRCLE 183 ON FREE INFORMATION CARD

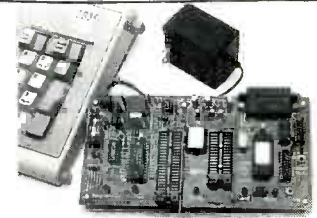

## 6805 MICROCOMPUTER DEVELOPMENT SYSTEM

The MCPM-1 system allows the IBM PC and compatibles to be used as a complete development system for the Motorola MC68705P3, P5, U3, U5, R3 and R5 single chip microcomputers. The system includes a cross assembler, program, a simulator/debugger program and a programming board that connects to a serial port. Price—\$49.00 VISA and MASTERCARD accepted

**TECI** THE ENGINEERS COLLABORATIVE, INC.

RR#3, BOX 8C Barton, Vermont 05822  
Phone (802) 525-3458 FAX (802) 525-3451

CIRCLE 190 ON FREE INFORMATION CARD

ture cross-section of a conductor. AC flows only near the surface, in a narrow cross-sectional band that gets thinner as frequency increases. Current density falls off exponentially from the surface of the conductor towards the center, as shown in Fig. 5. At the critical depth  $\delta$ , called the skin depth, the current density is 1/

$e = 1/2.718 = 0.368 = 36.8\%$ , that of the surface.

Skin depth is defined as

$$\delta = 1/\sqrt{\pi \times f \times \mu \sigma}$$

where  $\delta$  is skin depth (in meters),  $f$  is frequency (in Hz),  $\mu$  is permeability (in henries/m),  $\sigma$  is conductivity (in siemens/meter).

### Microwave components

Because current only flows in a small part of the cross-section of a microwave conductor, instead of through its entire cross-section as at lower frequencies, the AC resistance of a microwave conductor is considerably higher than its DC resistance. Because skin effect is a function of frequency, conductors will perform as they do at DC for very low frequency AC, but may be useless in the microwave range.

For these reasons, microwave circuit design must consider the distributed resistance, inductance, and capacitance for components. In addition, specially designed lumped constant components like thin-film inductors, and chip resistors and capacitors, are necessary. For example, Fig. 6 shows how an inductor

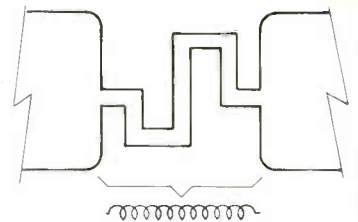

**FIG. 6—MICROWAVE CIRCUIT DESIGN MUST consider distributed resistance, inductance, and capacitance of components. Also, special lumped-parameter parts are used, like thin-film inductors, and chip resistors and capacitors. Here's how an inductor might appear in a microwave circuit on a PC board. Capacitors are similar, but the conductors are separated from one another.**

might be formed in a microwave circuit built onto a PC board. Capacitors are also made similarly, but with the conductors separated from one another.

In our next installment, we'll consider traditional methods of generating RF power. While not specifically microwave technology, that little history lesson will set the stage for your understanding of why vacuum tubes and other early generators fared so poorly at microwaves. **R-E**

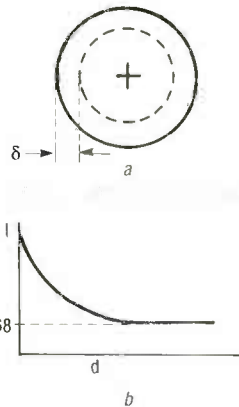

**FIG. 5—THE SKIN EFFECT CAUSES AC TO flow near the surface of a conductor. While DC flows through the cross-section, AC flows only in a narrow band near the surface (a). Current density falls off exponentially toward the center; at the critical (skin) depth  $\delta$ , the current density is 1/e = 36.8%, of that of the surface (b).**



# PC SERVICE

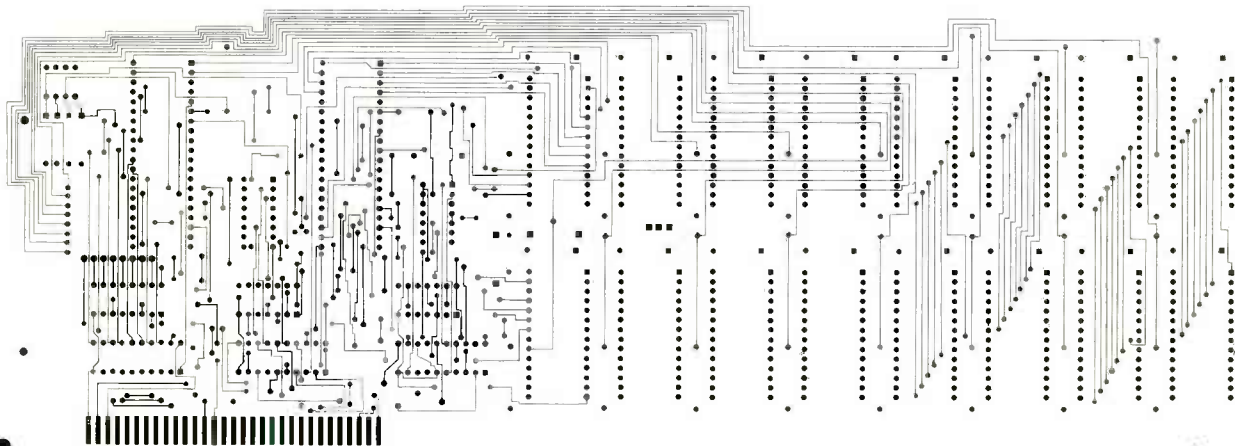

12 $\frac{5}{16}$  INCHES

HERE'S THE SOLDER SIDE of the RAM disk at half the actual size.

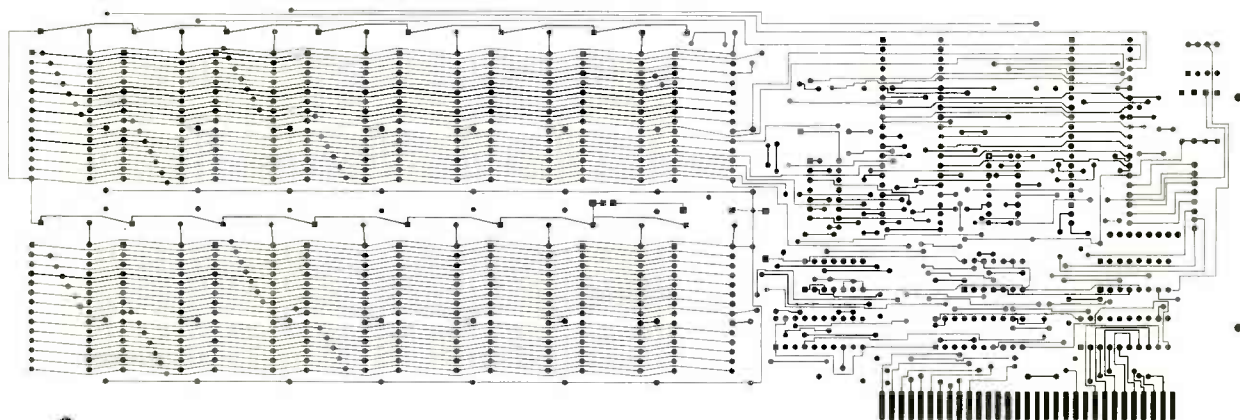

12 $\frac{5}{16}$  INCHES

HERE'S THE COMPONENT SIDE of the RAM disk at half the actual size.

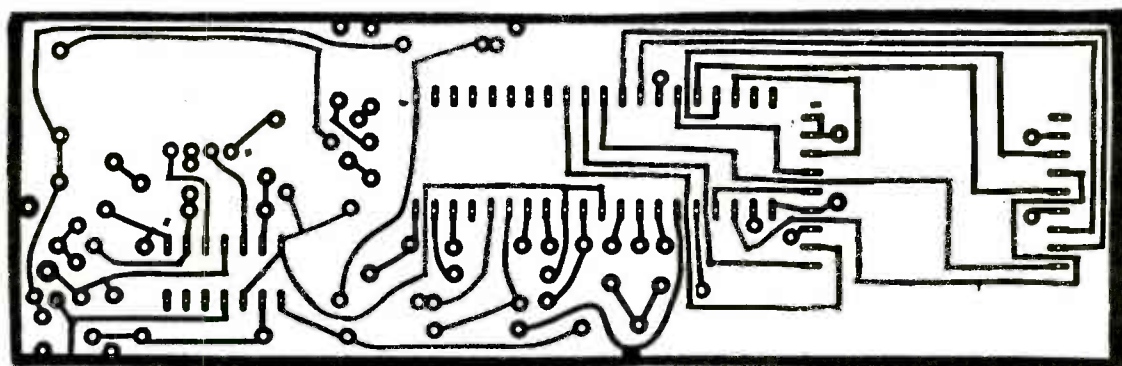

5 $\frac{1}{16}$  INCHES

USE THIS PATTERN for the pressure gauge.

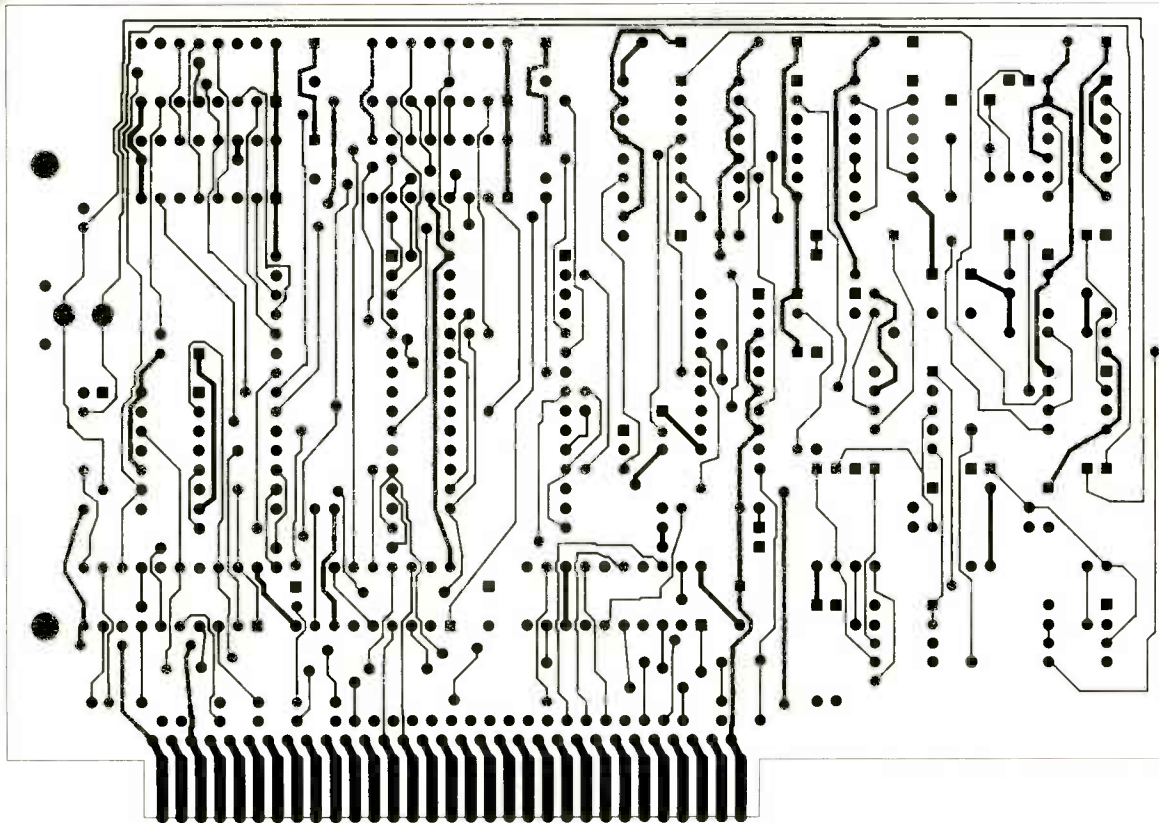

6 INCHES

THIS IS THE SOLDER SIDE of the frame grabber.

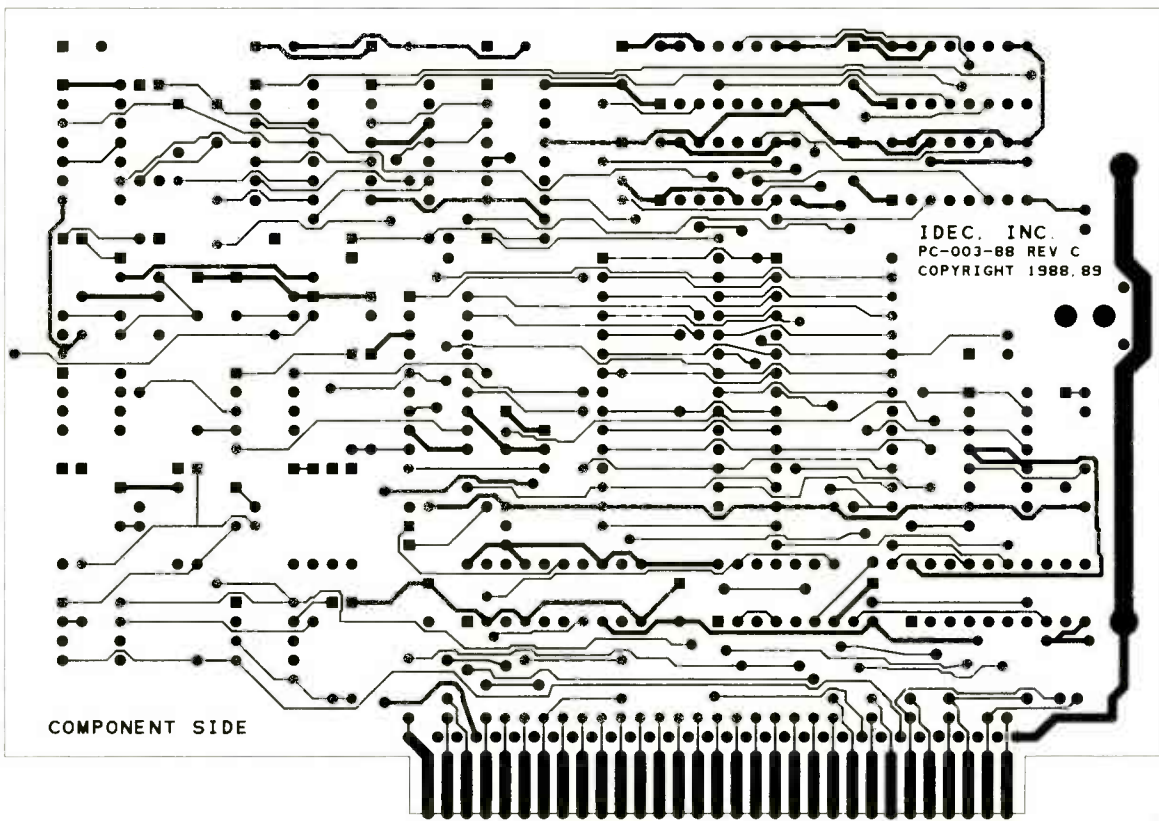

COMPONENT SIDE

6 INCHES

THIS IS THE COMPONENT SIDE of the frame grabber.



# HARDWARE HACKER

Huffman Codes  
Video Line Drivers  
Run Length Encoding  
New Compaction Chips  
Amateur Radio Astronomy

DON LANCASTER

## Data compression

THERE'S A PAIR OF STUPENDOUS NEW high-end compaction breakthroughs for this month, so I thought it might be a good time to go over some of the fundamentals of...

### Data and image compression

You can compact data or an image whenever you want to store it in less space or else transmit it in less time. The process of compaction is sometimes called *compression*, while the reverse process is called *restoration*, *expansion*, or *regeneration*.

A compression scheme is *noiseless* if it does not add anything in the way of artifacts to the output data string. A scheme is *lossless* if nothing gets removed and if the recovered data is *exactly* the same as the input data. Being both lossless and noiseless is obviously important if you're dealing with electronic funds transfer. On the other hand, slight video-image quality variations to that tapioca pudding scene in *Godzilla versus the Night Nurses* will usually not be noticeable. Even to the critical reviewers of this cross-genre classic.

A data compression scheme functions in *real time* if it keeps up with TV frames or movie film, or else if less than one second of delay is needed for a user interaction. The compression is *symmetric* if the same amount of time and hardware is needed for either data compaction or regeneration.

The *compression ratio* is simply how much compaction you gain. If you reduce a 100K textfile to 12.5K, your compression ratio is a big 8:1. Similarly, a 20 percent compression reduces your file size by 5:4.

As you might suspect, a modest

amount of compaction, say 30 percent, is easy to do. Things get sticky fast after that. The higher the compression ratio, the more time and effort that is required to do the job.

Naturally, there is a fundamental limit to the ultimate achievable compression, based upon information theory and on entropy constraints. Because both the English language and typical pictures are extremely *redundant*, these limits are often surprisingly generous.

But do note that the less redundant your information, the more intolerable any errors will become. Further, any simple errors tend to become far more destructive.

For instance, any uncompressed error that misspells a single word can instead totally trash the entire message in your compacted file. This error intolerance, along with the long processing times, are the two serious tradeoffs that get involved in extreme compaction.

Compression schemes which are *content dependent* are often (but not always) more effective than schemes that can accept anything as an input. In general, the more you know about what you want to compress, the more you can squash it. For instance, the compacted data string *alincgburgadd* should not

take you four score and seven years to expand into its full text version, especially if you have got a library handy.

Or, as a second example, you could use a city, state, and a zip code consisting of the single digit 0 for your own town in a local mailing list.

Several popular areas of compression interest include ASCII text strings, fax printouts, delta modulation, disk data formats and full color HDTV video images.

### Text compression

Eight-bit bytes of 256 states are a wasteful way of showing ASCII text letters, which at the most needs 127 characters, and often require only 26. Early *Infocom* text adventures used a scheme that crammed three ASCII characters into a pair of 8-bit bytes, a compression to 67 percent. Which also made snooping for hints real tough. The *Adams* adventures instead used character pairs. The most commonly used occurrences of two characters got placed in unused code slots, again giving you something like a 3:2 compression on the average.

In spelling checkers, the words are usually arranged alphabetically. Since each new word will share many of the initial characters with a previous one, you can provide a leading number instead. For instance, to get from *fixation* to *fixative*, the second word could be coded as *6ve*. You can also use character pairs as well as a trailing byte that could represent the 256 most popular combined ways of ending words, *s*, *ing*, *ly*, *ed*, and so on. When all is said and done, it takes only slightly over 9 bits to represent an average English word in a

### NEED HELP?

Phone or write your **Hardware Hacker** questions directly to:  
Don Lancaster  
**Synergetics**  
Box 809  
Thatcher, AZ 85552  
(602) 428-4073

spelling checker.

Advanced data compaction schemes often are first described in the *Communications of the ACM* from the *Association for Computer Machinery*.

Going to a non-ASCII interpretive code can also help you bunches. For instance, to describe a single curved portion of a PostScript character, six signed integers, seven spaces, and the word *curveto* get involved. For a total of around 42 characters.

In Adobe's Type I Fonts, a special *character string* code gets used, of which 32 entries are commands, and the rest signed numerics of one or two self-spacing bytes. Typically, only six bytes will be needed for the same *curveto* example, giving you a compaction of 6:1 or so. There are more details in Adobe's Type I Font black book. I do have a few of these in stock.

The ASCII letter "e" usually needs eight bytes for transmission. So does an ASCII "z." But the "e" gets used far more often. So, why not set up a code where an "e" needs four bits, while a "z" needs fourteen? On

Symbol "A" that is 20% likely codes as 10.  
 Symbol "B" that is 18% likely codes as 000.  
 Symbol "C" that is 10% likely codes as 011.  
 Symbol "D" that is 10% likely codes as 110.  
 Symbol "E" that is 10% likely codes as 111.

Symbol "F" that is 6% likely codes as 0101.  
 Symbol "G" that is 6% likely codes as 00100.  
 Symbol "H" that is 4% likely codes as 00101.  
 Symbol "I" that is 4% likely codes as 01000.  
 Symbol "J" that is 4% likely codes as 01001.

Symbol "K" that is 4% likely codes as 00110.  
 Symbol "L" that is 3% likely codes as 001110.  
 Symbol "M" that is 1% likely codes as 001111.

**FIG. 1—A HUFFMAN COMPRESSION USES SHORT CODES for often-occurring letters or symbols, and longer codes for those less often used. On the average, your overall message will end up shorter. Here's a simple example code which involves thirteen symbols.**

the average, all of your text messages will end up somewhat shorter.

Such a scheme is called *Huffman coding*. The original horse's mouth document is *A Method for the Construction of Minimum-Redundancy codes*, as found in the September 1952 *Proceedings of the IRE*. An example of a Huffman code appears in Fig. 1.

Huffman codes are based upon making the length of a character code inversely proportional to the popularity of that character's use. The good news here is that a Huffman coding is fairly fast and simple, and often can be applied in combination with other compaction techniques. The bad news is that a variable bit length word can be awkward to handle in an 8-bit or 16-bit micro, and that the total compaction you get is often rather modest and typically in the 20-percent range. Worse, errors under a Huffman coding do tend to trash the entire message, rather than a single word or two.

Variations and improvements on this scheme are known as *modified Huffman codes*. These are in no way limited to ASCII. Any place you have symbols with different probabilities, you can use variable-length codes to your advantage. Often, your message will first get analyzed, and a set of rules in dictionary form will get sent as a prolog. Matching the coding to the message usually gives you the optimum compaction.

### Fax and the printed page

Most fax images and most printer output consists of little bits of black

buried in a sea of white. Obviously, a bitmap that sets aside one bit for each black or white dot is horrendously inefficient most of the time.

One popular way around that which works exceptionally well with black-and-white images is called *run length encoding*. With run length encoding, each successive byte represents *how many* black dots or how many white dots are to follow. For instance, four bytes in a bitmap could only represent 32 pixels. But those same four bytes coded -18- -56- -9- -143- could now represent a string of 226 pixels, a 7:1 compaction. In this case, the first 18 pixels would be black, followed by 56 white ones, followed by 9 black ones, and a final 143 white ones. Figure 2 shows you a simple example of run length encoding.

Should you have lots of picture detail, popular run length encoding schemes will automatically switch back to a bitmap whenever bitmaps are more efficient. The code can also be extended to allow for identical sequential lines.

In PostScript, the first time your descriptive font character is used, that character gets converted into a bitmap and placed into a *font cache*. Repeated use of the same character becomes much faster, since you are now only moving a bitmap using a *BitBlt* operator, rather than generating fancy paths. On up to a certain size, "real" bitmaps are used. Above that size, run length encoding is used to minimize the storage needs. While run length encoding in PostScript is typically six times slower than using a real bitmap, the method is still many hundreds of times faster than using the original character description.

Most modern fax machines use what is known as a *Group III* compression, which is based largely upon run length encoding. One source of circuits and information on Group III compression is *American Micro Devices*, especially their AM95C71 video compression-expansion chip set.

But the best way to compress a fax image is to flush it and use PostScript instead. Besides offering you a ridiculously better image quality, most PostScript superfax images transmit in one-tenth the time and will store in one-tenth the space.

**NEW FROM  
DON LANCASTER**

**HANDS-ON BOOKS**

Hardware Hacker Reprints II	24.50
Ask The Guru Reprints I or II	24.50
CMOS Cookbook	18.50
TTL Cookbook	16.50
Active Filter Cookbook	15.50
Micro Cookbook vol I or II	16.50
Enhancing your Apple I or II	17.50
AppleWriter Cookbook	19.50
Apple Assembly Cookbook	21.50
Incredible Secret Money Machine	10.50
LaserWriter Reference (Apple)	19.50
PostScript Cookbook (Adobe)	16.50
PostScript Ref. Man. (Adobe)	22.50
PostScript Prog. Design (Adobe)	22.50
Type I Font Format (Adobe)	15.50
Real World Postscript (Roth)	22.50

**UNLOCKED SOFTWARE**

LaserWriter Secrets (Ile Mac PC)	29.50
PostScript Show & Tell	39.50
Intro to PostScript VHS Video	39.50
PostScript Beginner Stuff	39.50
PostScript Perspective Draw	39.50
PostScript Technical Illustrations	39.50
PostScript BBS stuff	19.50
Absolute Reset Ile & Ilc	19.50
AppleWriter Laserwriter Utilities	49.50
Enhance I or II Companion Disk	19.50
AppleWriter CB or Assy CB Disk	24.50

FREE VOICE HELPLINE      VISA/MC

**SYNERGETICS**  
 Box 809-RE  
 Thatcher, AZ 85552  
 (602) 428-4073

CIRCLE 83 ON FREE INFORMATION CARD



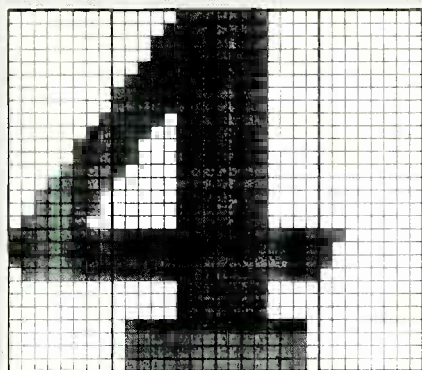

**HORIZONTAL BITMAP CODING:**

```
00 07 F0 00 00 0F F0 00 00 1F F0 00 00 1F F0 00
00 3F F0 00 00 7F F0 00 00 FF C0 00 00 FF C0 00
01 F7 C0 00 03 E7 C0 00 07 C7 C0 00 07 C7 C0 00
0F 87 C0 00 1F 07 C0 00 3E 07 C0 00 3E 07 C0 00
7C 07 C0 00 FF FF FF C0 FF FF FF 80 FF FF FF 80
7F FF FF 00 00 07 F0 00 00 07 F0 00 00 07 F0 00
00 7F FE 00 00 7F FE 00 00 7F FE 00 00 7F FE 00
```

**RUN LENGTH ENCODING:**

```
D7 CC 8C B9 CA 9C 8A C9 BC 8C C8 CC 75 17 C6 52
7C 55 37 C5 53 7C 45 47 C3 55 7C 26 57 C2 65 7C
15 77 C0 F0 A6 0F 09 70 F0 97 01 F0 78 D8 CD 8C
D8 C9 DB 9D B9 DB 9D B0
```

(A zero value means "don't change" unless at the line end.)

**FIG. 2—RUN LENGTH ENCODING IS AN EFFECTIVE compression scheme for black-and-white images. In this example, four-bit bytes representing how many white or black pixels replace the bitmap for a 2:1 compaction.**

**Doing the obvious**

One obvious way to compress files is to not send what you don't need. Eliminating all comments and REM statements from programs at run time is a typical example. So is getting rid of any extra spaces used for pretty printing. In PostScript, careful use of persistent downloads and common dictionaries will very much reduce your individual file sizes.

Another way to really compact certain types of images goes by the name of *delta modulation*. With delta modulation, you transmit only the *changes* between what you have now and what went by previously.

Animation is one obvious example. I've had one of my students do some incredible 4-stroke engine animation on the Apple IIe simply by brute force coding only frame-by-frame changes in successive pictures.

But delta modulation really shines in sound synthesizers. To compact voice or music, you try to anticipate where the sound is going to be in the next sample, and then transmit

only the *difference* between the predicted and exact value.

This is known as *linear predictive coding*, and the sound toolkits on the Macintosh and the Apple IIs include lots more detail. A typical compression is 2:1 or 8:3, depending on the acceptable quality.

I use an even sneakier form of delta modulation to speed up PostScript. Say you have a shipping label or a business letter with a fancy letterhead and a digitized signature. Instead of retransmitting the entire image each time, you simply place the total image into your PostScript printer *once* and then print the first name and address. You then erase *only the name and address*, and then print up your second name and address, repeating the process until your entire mail list or whatever is finished. The same idea works well with forms, or anywhere else a long makeready time can be shared among many different output copies.

**The disk breakthrough**

Most floppy- and hard-disk formats are surprisingly wasteful of space. So there are lots of possibilities here, over and above the obvious of trying to increase the number of tracks or the number of bytes per track.

Knowing exactly how your disk space is organized can often save

**AMATEUR RADIO ASTRONOMY RESOURCES**

**Amateur Radio Astronomers**  
247 North Linden Street  
Massapequa, NY 11758  
(516) 798-8459  
CIRCLE 230 ON FREE INFORMATION CARD

**Nasa Tech Briefs**  
41 East 42nd Street Ste 921  
New York, NY 10017  
(212) 490-3999  
CIRCLE 234 ON FREE INFORMATION CARD

**Astrophysical Journal**  
PO Box 37005  
Chicago, IL 60637  
(317) 753-3347  
CIRCLE 231 ON FREE INFORMATION CARD

**NRAO Observatory**  
PO Box 2  
Greenbank, WV 24944  
(304) 456-2011  
CIRCLE 235 ON FREE INFORMATION CARD

**Bob's Electronic Service**  
7605 Deland Avenue  
Fort Pierce, FL 34951  
(407) 464-2118  
CIRCLE 232 ON FREE INFORMATION CARD

**Science/AAAS**  
1333 H Street North West  
Washington, DC 20005  
(202) 326-6400  
CIRCLE 236 ON FREE INFORMATION CARD

**Jeff Lichtman**  
1425 Parkmont Drive  
Roswell, GA 30076  
(404) 992-4959  
CIRCLE 233 ON FREE INFORMATION CARD

**VLA Astronomy Site**  
P.O. Box 0  
Socorro, NM 87801  
(505) 772-4011  
CIRCLE 237 ON FREE INFORMATION CARD

you bunches of room. As one ancient example, leaving off those last eight invisible bytes of an Apple II HIRES image saved you an entire DOS disk sector per picture.

In ProDOS, a 511-character textfile needs only one sector, while a 513-character one needs *three* sectors; one for the first 512 characters, a second for the new index block now required in your switch from a *seedling* to a *sapling* file, and a third for the final data byte.

In fact, you can save at least one sector anytime you can get your file size just under a multiple of 512. Full details in the *Beneath Apple ProDOS* from *Quality Software*.

On the Mac, removing unused resources from your System files can often free up surprising amounts of disk space. This becomes especially critical on earlier Mac versions with limited RAM.

Similarly, knowing how your disk files are arranged and stored on any system can sometimes save you quite a bit of space. Especially on a disk that is nearly full and needs room for one or two more short files.

Our first major compression chip breakthrough for this month is the IC-105 co-processor from *Infochip Systems*. This one is initially intended for the MS/DOS world and gives you an average of a 3:1 or higher compaction of disk files. And does so while remaining fully noiseless and lossless, and still allowing a full random access. Compression is real time up to 2 megabytes per second, and the decompression blazes along at a 5-megabyte per second rate.

An adaptive algorithm is used that senses the type of data and creates optimum data dictionaries for each type. A *Markoff* scheme is used.

Interestingly enough, you do not have to store these data dictionaries. They will automatically build themselves up during the decompression process. Image compression can go as high as 15:1. The initial cost is in the \$200 range.

The obvious first use for this chip is for tripling the amount of disk storage space on any laptop computer. It will be interesting to see how error-tolerable this new technique is. It should be a real winner if it works reliably enough under real-world noise conditions.

## NAMES AND NUMBERS

### Advanced Micro Devices

PO Box 3453  
Sunnyvale, CA 94088  
(800) 538-8450  
CIRCLE 238 ON FREE INFORMATION CARD

### Association for Computer Machinery

11 West 42nd Street  
New York, NY 10036  
(212) 869-7440  
CIRCLE 239 ON FREE INFORMATION CARD

### Bourns

1200 Columbia Avenue  
Riverside, CA 92507  
(714) 781-5050  
CIRCLE 240 ON FREE INFORMATION CARD

### C-Cube Microsystems

399-A West Trimble Road  
San Jose, CA 95131  
(408) 944-6300  
CIRCLE 241 ON FREE INFORMATION CARD

### Cryptosystems Journal

9755 Oatley Lane  
Burke, VA 22015  
(703) 451-6664  
CIRCLE 242 ON FREE INFORMATION CARD

### IEEE

445 Hoes Lane  
Piscataway, NJ 08885  
(201) 981-0060  
CIRCLE 243 ON FREE INFORMATION CARD

### InfoChip Systems

2840 San Tomas Expressway  
Santa Clara, CA 95054  
(408) 727-0514  
CIRCLE 244 ON FREE INFORMATION CARD

### Maxim

120 San Gabriel Drive  
Sunnyvale, CA 94086  
(408) 737-7600  
CIRCLE 245 ON FREE INFORMATION CARD

### OKI Semiconductor

785 North Mary Avenue  
Sunnyvale, CA 94086  
(408) 720-1900  
CIRCLE 246 ON FREE INFORMATION CARD

### Phillips

2001 West Blue Heron Blvd  
Riviera Beach, FL 33404  
(407) 881-3200  
CIRCLE 247 ON FREE INFORMATION CARD

### PowerTech

0-02 Fair Lawn Avenue  
Fair Lawn, NJ 07410  
(201) 791-5050  
CIRCLE 248 ON FREE INFORMATION CARD

### Quality Software

21601 Marilla Street  
Chatsworth, CA 91311  
(818) 709-1721  
CIRCLE 249 ON FREE INFORMATION CARD

### Rochester Electronics

10 Malcolm Hoyt Drive  
Newburyport, MA 01950  
(508) 462-9332  
CIRCLE 250 ON FREE INFORMATION CARD

### Rogers

One Technology Drive  
Rogers, CT 06263  
(203) 774-9605  
CIRCLE 251 ON FREE INFORMATION CARD

### Samsung

3725 North First Street  
San Jose, CA 95134  
(408) 954-7000  
CIRCLE 252 ON FREE INFORMATION CARD

### Sony

10833 Valley View Street  
Cypress, CA 90630  
(714) 229-4195  
CIRCLE 253 ON FREE INFORMATION CARD

### Stockwell Rubber

4749 Tolbut Street  
Philadelphia, PA 19136  
(800) 523-0123  
CIRCLE 254 ON FREE INFORMATION CARD

### Synergetics

Box 809  
Thatcher, AZ 85552  
(602) 428-4073  
CIRCLE 255 ON FREE INFORMATION CARD

### TecSpec

3 Mine Mountain Road  
Cornwall Bridge, CT 06754  
(203) 672-0123  
CIRCLE 256 ON FREE INFORMATION CARD

### Tektronix

P.O. Box 500  
Beaverton, OR 97077  
(800) 835-9433  
CIRCLE 257 ON FREE INFORMATION CARD

### Tesla Coil Builders Assoc

3 Amy Lane  
Queensbury, NY 12804  
(518) 792-1003  
CIRCLE 258 ON FREE INFORMATION CARD

### Texas Instruments

P.O. Box 809066  
Dallas, TX 75380  
(800) 232-3200  
CIRCLE 259 ON FREE INFORMATION CARD



## The image breakthrough

But the really big development this month is the CL550A chip by C-Cube. This beauty does a full-color video compression from any source to 33:1 and beyond *in real time*, up to and including 60-frame-per-second HDTV! A massive 300:1 parallel pipelining is provided through an unusual architecture. The action in this chip takes place at a previously unheard of ten *billion* operations per second.

The compression is done by making what are known as *Discrete Cosine Transforms*, that involve blocks of 64 pixels. It turns out that certain spatial frequencies and some color shifts are nearly invisible to the human eye, so a careful filtering throws out anything that you aren't going to be able to see anyway.

Best of all, this chip implements what is soon to be an international JPEG (*Joint Photographic Experts Group*) image standard, so it is in no way proprietary.

The obvious uses include genuine multimedia on personal computers, compact full animation on CD-ROM and for squashing the bandwidths needed for HDTV broadcasts to well *under* those currently being used for plain old TV.

C-Cube does have a free technical information packet for you on their products, along with demo boards and software emulators. Projected pricing of their chip is in the \$95 range.

## Video distribution amplifiers

There are lots of times when you

might like to drive more than one video monitor from a single source. Unless you are very careful, you will get disappointing results. Fortunately, there's a brand-new low-cost MAX457 chip from *Maxim* which greatly simplifies this task.

Video is normally routed through shielded cables with a *characteristic impedance*, of 75 ohms or so.

If you do intentionally open or short-circuit a cable, whenever a pulse or other signal gets to the end, it will reflect and bounce back to the source and cause *standing waves*—unless the cable is terminated at both ends by a load equal to its characteristic impedance.

At baseband video frequencies, reflections off a short cable may not be all that bad. As a crude rule, if the cable is ten feet long or less, you can often get away without terminating it. Longer than that, and you will want resistive terminations at both ends, or you will get character smearing and other loss of quality.

Figure 3 shows you the correct way to tie several monitors to a single source. You can use a daisy-chain connection. The monitors inside the chain should all be set to their *high impedance* termination stage. The last monitor in the string should get load terminated.

Note that you cannot simply put a bunch of monitors in parallel, since all their loads will gang up and swamp your source, leaving you with a very washed out picture, poor sync, or even nothing at all.

Figure 4 shows you a dual video driver using the MAX457. Each out-

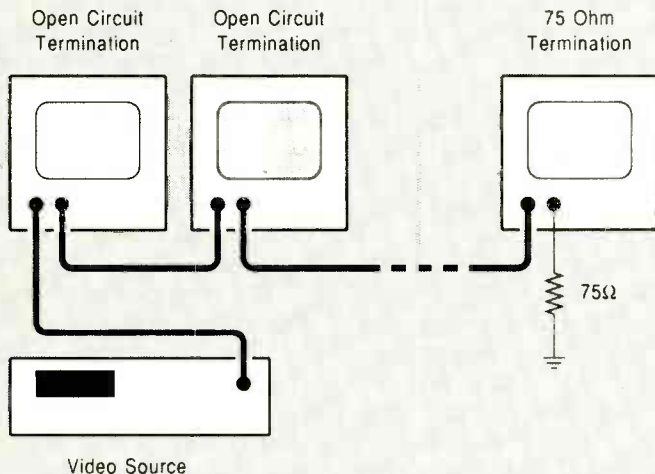

FIG. 3—THE CORRECT WAY TO CONNECT several video monitors to a single source is to daisy chain them. Only the last monitor input should be terminated with a 75-ohm resistor. Never connect cables in parallel!

## DIGITAL VIDEO STABILIZER ELIMINATES ALL VIDEO COPY PROTECTIONS



While watching rental movies, you will notice annoying periodic color darkening, color shift, unwanted lines, flashing or jagged edges. This is caused by the copy protection jamming signals embedded in the video tape, such as Macrovision copy protection. Digital Video Stabilizer: RXII completely eliminates all copy protections and jamming signals and brings you crystal clear pictures.

- FEATURES:**
- Easy to use and a snap to install
  - State-of-the-art integrated circuit technology
  - 100% automatic - no need for any troublesome adjustments
  - Compatible to all types of VCRs and TVs
  - The best and most exciting Video Stabilizer in the market
  - Light weight (8 ounces) and Compact (1x3.5x5")
  - Beautiful deluxe gift box
  - Uses a standard 9 Volt battery which will last 1-2 years.

**WARNING :**  
**SCO**  
**Electronics and RXII dealers do not encourage people to use the Digital Video Stabilizer to duplicate rental movies or copyrighted video tapes. RXII is intended to stabilize and restore crystal clear picture quality for private home use only.**

(Dealers Welcome)

To Order: \$49.95 ea + \$4 for FAST UPS SHIPPING

**1-800-445-9285** or **516-694-1240**

Visa, M/C, COD M-F: 9-6 (battery not included)

SCO ELECTRONICS INC.

Dept. CB48 581 W. Merrick Rd. Valley Stream NY 11580

Unconditional 30 days Money Back Guarantee

**CIRCLE 196 ON FREE INFORMATION CARD**

## CABLE TV DESCRAMBLER



	1 Unit	10 +
Jerrold S.B. ....	\$74	.....\$55
Jerrold SB w/Trimode.....	\$90	.....\$70
Oak N-12 (w/VS).....	\$89	.....\$65
Scientific Atlanta.....	\$109	.....\$75
Pioneer.....	\$109	.....\$75
Panasonic converter.....	\$98	.....\$79
73 channel converter.....	\$79	.....\$59

**We Beat Anyone's Price!**

**30 Days Money Back Quaranty**

**Free Catalog**

Visa, M/C, COD or send money order to:

**US Cable TV Inc.** Dept. KCT8

4100 N. Powerline Rd., Suite F-4

Pompano Beach, FL 33073

**1-800-445-9285**

Please have make and model number of the equipment used in your area ready.

**No Florida Sales!**

It's not the intent of US Cable TV Inc. to defraud any pay TV operator and we will not assist any company or individual in doing so.

**CIRCLE 197 ON FREE INFORMATION CARD**

# Be an FCC LICENSED ELECTRONIC TECHNICIAN!



Earn up to \$30 an hour and more!

Learn at home in spare time. No previous experience needed!

No costly School. No commuting to class. The Original Home-Study course prepares you for the "FCC Commercial Radiotelephone License". This valuable license is your "ticket" to thousands of exciting jobs in Communications, Radio-TV, Microwave, Computers, Radar, Avionics and more! You don't need a college degree to qualify, but you do need an FCC License.

**No Need to Quit Your Job or Go To School**

This proven course is easy, fast and low cost! **GUARANTEED PASS** — You get your FCC License or money refunded. **Send for FREE facts now. MAIL COUPON TODAY!**

## COMMAND PRODUCTIONS

FCC LICENSE TRAINING, Dept. 90  
P.O. Box 2824, San Francisco, CA 94126

Please rush FREE details immediately!

NAME \_\_\_\_\_  
ADDRESS \_\_\_\_\_  
CITY \_\_\_\_\_ STATE \_\_\_\_\_ ZIP \_\_\_\_\_

## LEARN VCR CLEANING/MAINTENANCE/REPAIR

EARN UP TO \$1000 A WEEK, WORKING PART TIME FROM YOUR OWN HOME!



Secrets Revealed!  
NO Special Tools or Equipment Needed.  
**EARN UP TO \$60 AN HOUR AND MORE!**

### THE MONEY MAKING OPPORTUNITY OF THE 1990'S

IF you are able to work with common small hand tools, and are familiar with basic electronics (i.e. able to use voltmeter, understand DC electronics)...

IF you possess average mechanical ability, and have a VCR on which to practice and learn... then we can teach YOU VCR maintenance and repair!

**FACT:** up to 90% of ALL VCR malfunctions are due to simple MECHANICAL or ELECTRO-MECHANICAL breakdowns!

**FACT:** over 77 million VCRs in use today nationwide! Average VCR needs service or repair every 12 to 18 months!

Viejo's 400 PAGE TRAINING MANUAL (over 500 photos and illustrations) and AWARD-WINNING VIDEO TRAINING TAPE reveals the SECRETS of VCR maintenance and repair—"real world" information that is NOT available elsewhere!

Also includes all the info you'll need regarding the BUSINESS-SIDE of running a successful service operation!

#### FREE INFORMATION

CALL TOLL-FREE 1-800-537-0589

Or write to: Viejo Publications Inc.

3540 Wilshire BL. STE. 310

Los Angeles, CA 90010 Dept. RE

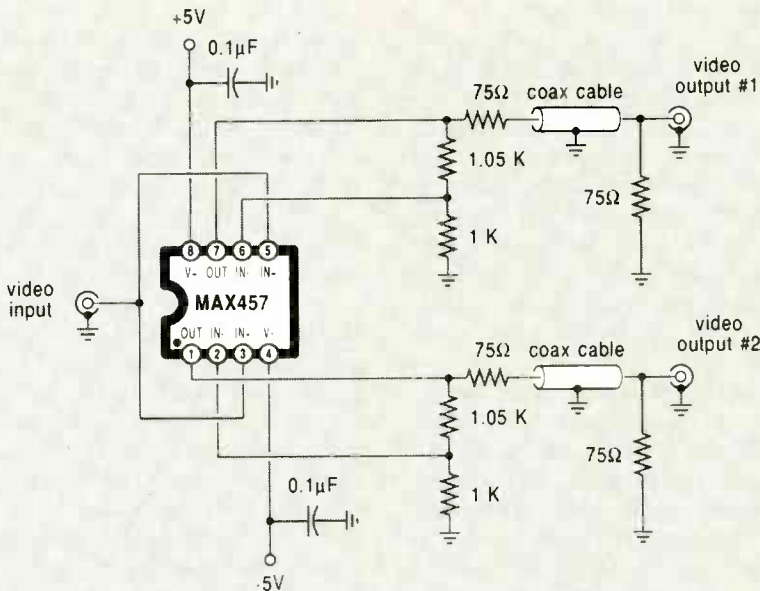

FIG. 4—THIS DUAL VIDEO DRIVER is handy any time you want to use more than one monitor with a VCR or a computer, especially with long cables.

put is an independent 75-ohm source. You can cascade as many of these as you need to.

To make up for the drop across the 75-ohm source resistance, the video gain is set to precisely two. Half of that develops across the source, and half across your terminating load. At a gain of two, the bandwidth is around 30 megahertz, so high-definition stuff can be handled as well as ordinary video.

A split +5, -5 supply is required. Sorry about that, but you do have to somehow suck out current on all your grounded sync tips. Supply current is under 40 mils for the pair of drivers. The normal output level is adjusted to a white level of 2 volts and grounded sync tips. That becomes a standard one-volt video signal after the drop across the source resistor.

### Radio astronomy resources

For our resource sidebar this month, I have chosen to round up some stuff for amateur radio astronomers.

Two of the foremost resources are Bob Sickels and Jeff Lichtman. Bob runs *Bob's Electronic Service* and publishes the *Radio Observer* magazine. He also stocks parts and kits for low-noise amplifiers, microwave electronics, chart recorders, and lots of similar stuff. His free catalog also has a good no-nonsense intro.

Jeff has published three classics in the field which include his fine

*Radio Astronomy Handbook*, his *Solar Radio Astronomy*, and his *Microwave Radio Astronomy*.

A leading amateur astronomy club is apparently the *Society of Amateur Radio Astronomers*. Their \$20 yearly membership includes a newsletter.

Publications providing radio astronomy information in them include *Science*, the *Astrophysical Journal*, *NASA Tech Briefs*, and their discontinued *IEEE Transactions on Radio Astronomy*.

Two radio astronomy sites which welcome visitors are the *NRAO* observatory located in Greenbank, West Virginia, and that *VLA* site in New Mexico.

### New tech literature

Useful new data books for this month include a *Voice Synthesis LSI* and *Telecom LSI* volumes from *OKI*; *Microwave Transistors* from *Phillips*, *High Speed CMOS Logic* from *Samsung*; *Optoelectronics and Image Sensors* from *Texas Instruments*; and *A/D & D/A Converters* from *Sony*.

Toni Patti of the *Cryptosystems Journal* offers some newly revised free Lorenz attractor "Owl's Mask" chaos theory programs when you send him a formatted IBM disk. Included is a powerful set of new 3-D graphics routines. Other free software includes a *Selectrim* trimpot selector from *Bourns*, and a

*continued on page 90*



# COMPUTER DIGEST

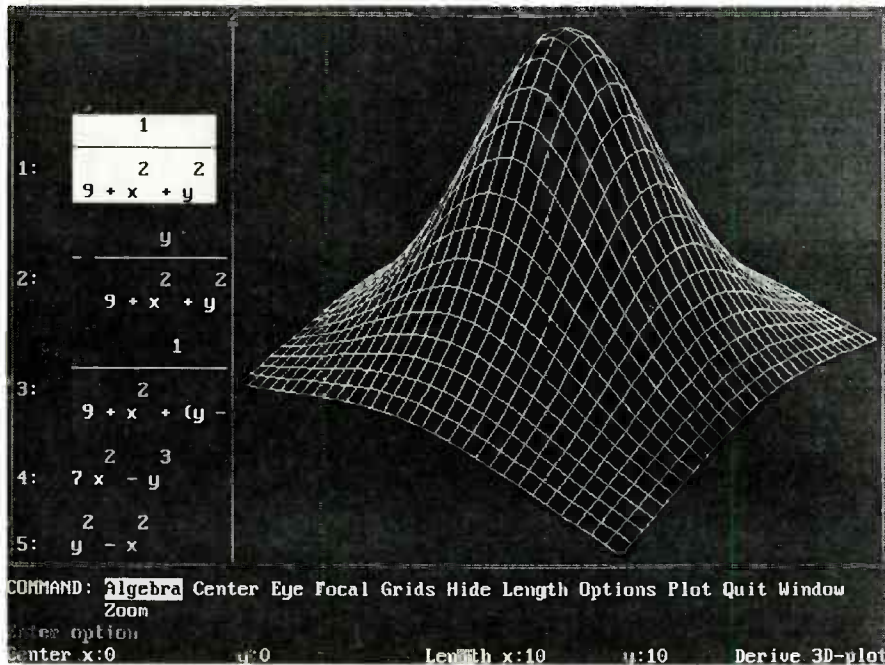

## EDITOR'S WORKBENCH

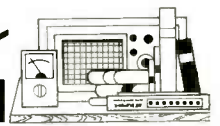

### Low-cost Logic Analyzer

Logic analyzers can inspire fear. They're usually expensive, conceptually difficult, and hard to use. To counteract that trend, Photronics has introduced the LA1 Logic Analyzer, a \$100 device that plugs into your PC. The LA1 is not going to put Tektronix out of business, but it's not even trying to compete. The LA1 is really an educational tool that provides a low-cost, easy-to-use introduction to logic analyzers. It keeps cost down by limiting operating speed to about 100 kHz, and by relying on the PC for its intelligence.

The LA1 consists of a half-length card that plugs into any 8- or 16-bit slot. As shown in Fig. 1, A connector is accessible to the user through the rear bracket; a supplied ten-conductor ribbon cable plugs into the connector. The cable is terminated with color-coded mini-clips that you attach to the circuit under test. Eight lines are for data, one is ground, and the other is for an external clock.

*(Continued on page 78)*

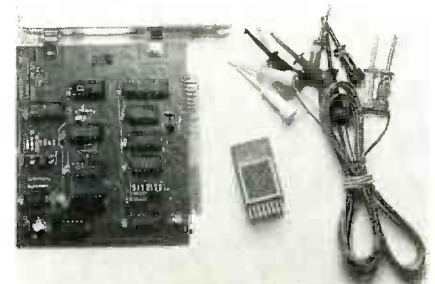

FIG. 1

Last time we outlined the hardware and software comprising the static RAM disk. Unlike a RAM disk allocated from system memory (whether conventional, extended, or expanded), our RAM disk occupies only a few I/O port addresses. And because it contains its own CMOS memory subsystem, our RAM disk can be immunized against power failures.

Now let's talk about how the circuit works, and about how to build and use the SRAM disk.

### Hardware details

The circuit consists of three main sections: a bus interface, a battery backup circuit, and the static RAM array. Figure 1 shows the complete schematic diagram.

The PC bus interface consists of IC3, IC4, and IC5. The latter are a pair of 74LS244's (three-state octal bus drivers) that buffer the address lines. A bi-directional three-state octal buffer

(IC3, a 74LS245) buffers the data lines.

The  $\overline{\text{IOR}}$  (I/O Read) line from the expansion bus drives the data direction input of IC3; the decoding circuitry discussed below drives IC3's gate input (pin 19).

The decoding circuitry consists of IC6, IC7, and several gates in IC9 and IC10. Two outputs from IC6, a 74LS138 3-to-8 line decoder, drive the  $\overline{\text{CS}}$  inputs of the parallel ports (IC1 and IC2). In a multi-board system, the first board uses the two low-order outputs ( $\overline{\text{Y0}}$ ,  $\overline{\text{Y1}}$ ) of IC6; subsequent boards use higher-order outputs. Address lines A0 and A1 select one of four registers (three data ports and one control port) in the selected port (IC1 or IC2). Address lines A2-A4 drive IC6, which provides an output select every four addresses.

For IC6 to be enabled, its  $\overline{\text{G2A}}$  must be driven low. For that to happen, several conditions must be met. First, AEN from the bus

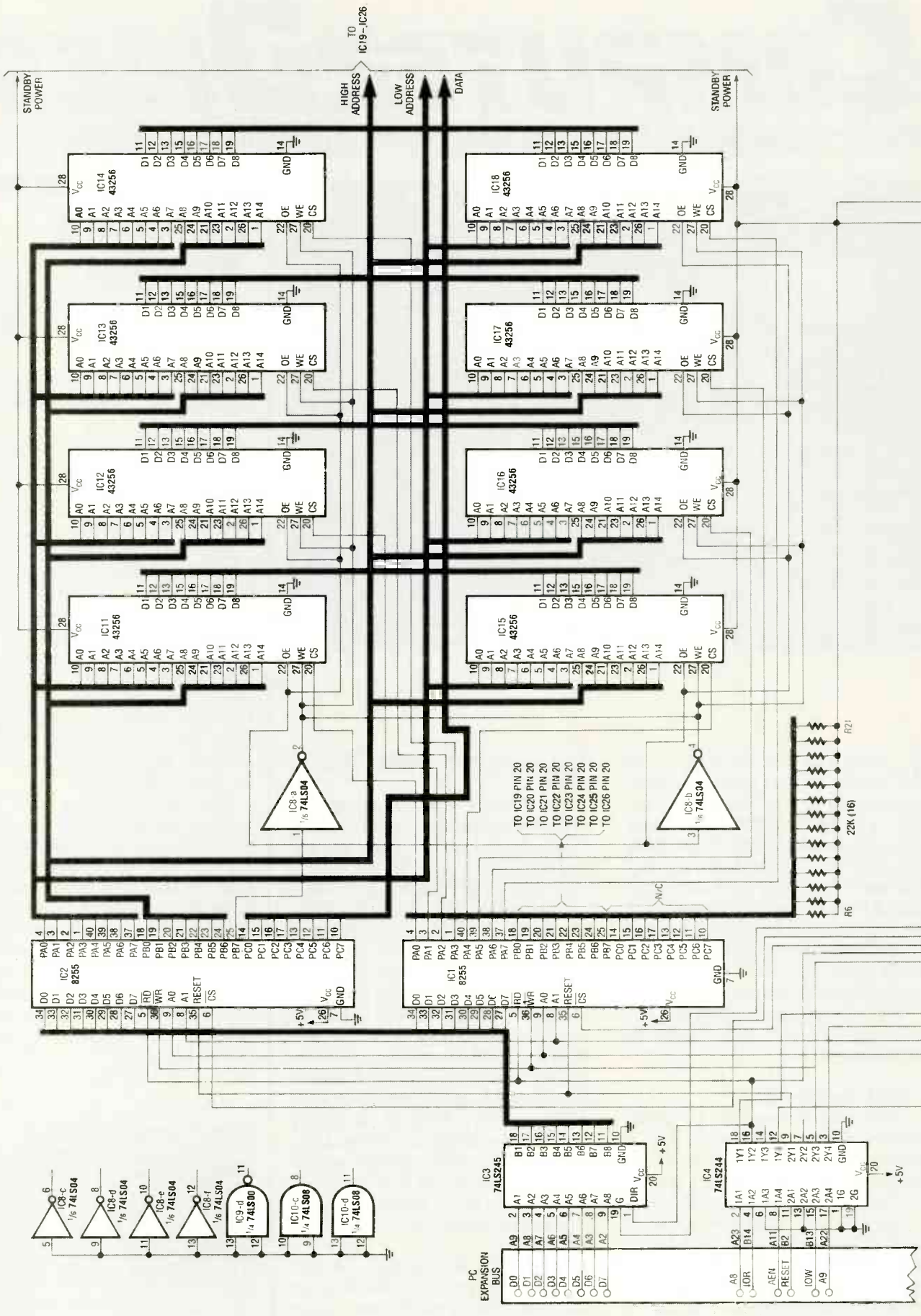

FIG. 1. THE SRAMDISK'S COMPLETE SCHEMATIC.





**TABLE 1—I/O PORT ADDRESSES**

S1-d (256)	S1-c (128)	S1-a (64)	S1-b (32)	Address (decimal)
ON	ON	ON	ON	512
ON	ON	ON	OFF	544
ON	ON	OFF	ON	576
ON	ON	OFF	OFF	608
ON	OFF	ON	ON	640
ON	OFF	ON	OFF	672
ON	OFF	OFF	ON	704
ON	OFF	OFF	OFF	736
OFF	ON	ON	ON	768
OFF	ON	ON	OFF	800
OFF	ON	OFF	ON	832
OFF	ON	OFF	OFF	864
OFF	OFF	ON	ON	896
OFF	OFF	ON	OFF	928
OFF	OFF	OFF	ON	960
OFF	OFF	OFF	OFF	992

side of the board install all resistors, then IC sockets, then capacitors, then the DIP switch and the two header blocks for the backup battery and the decoding block. Then, on the back side of the board, install the six jumpers shown in Fig. 2. Connect a pair of wire-wrap wires to each pin of a two-pin female header; connect the other ends of the two wires to the pads by the  $\overline{CS}$  inputs of IC1 and IC2 (pin 6). Then connect the female header to the desired pair of pins on P1. Choose A+B, C+D, E+F, or G+h, and make sure that the wire from IC2 goes to the lower-order pin (A, C, E, or G). In a multi-board system, use the jumper settings shown in Table 2.

**TABLE 2—BOARD SELECT**

Board	IC2, Pin 6	IC1, Pin 6
1	A	B
2	C	D
3	E	F
4	G	H

The board is a little too tall to fit in an XT-style case. Either use an AT case, or trim the board to a height of about four inches. Doing so will cut through several traces, which can then be replaced by jumper wires. Make sure you don't remove any more than the top eight traces to keep the additional jumpers to a minimum.

If you trim the board, the additional jumpers should be added between the correspondingly numbered pads J1...J8. For ex-

drive the high-order address lines; and port C drives the data lines. The high bit of port B (PB7) functions as a pseudo read/write line that drives the  $\overline{OE}$  lines, and, after inversion by IC8-a and IC8-b, also the  $\overline{WE}$  lines. Last, the A and B ports of IC2 drive the chip-select inputs of the SRAM's, one bit per SRAM. Port C of IC2 is not used in the present design; you could modify our circuit to decode an additional 8 SRAM's or use the port for other things.

**Data retention**

The battery-backup circuitry is quite simple. Five volts from the bus feeds all of the logic and parallel ports. In addition, bus power also feeds the SRAM's and associated chip-select pull-up resistors (R6-R21) via diode D1. When bus power is off, the back-

up battery feeds the SRAM's and pull-ups via D2.

The author successfully used several types of batteries for backup, including a 0.1-Farad capacitor formerly sold by Radio Shack, four AA cells, and a rechargeable cordless phone battery (Radio Shack number 32-173). If you use a rechargeable battery, install a jumper in D2's position.

**Construction**

You can build the circuit on a prototype board with an XT-type bus interface, or you can build it on a PC board. Foil patterns are shown in PC Service; a drilled and etched board with plated-through holes is also available from the source mentioned in the parts list.

As shown in Fig. 2, on the front

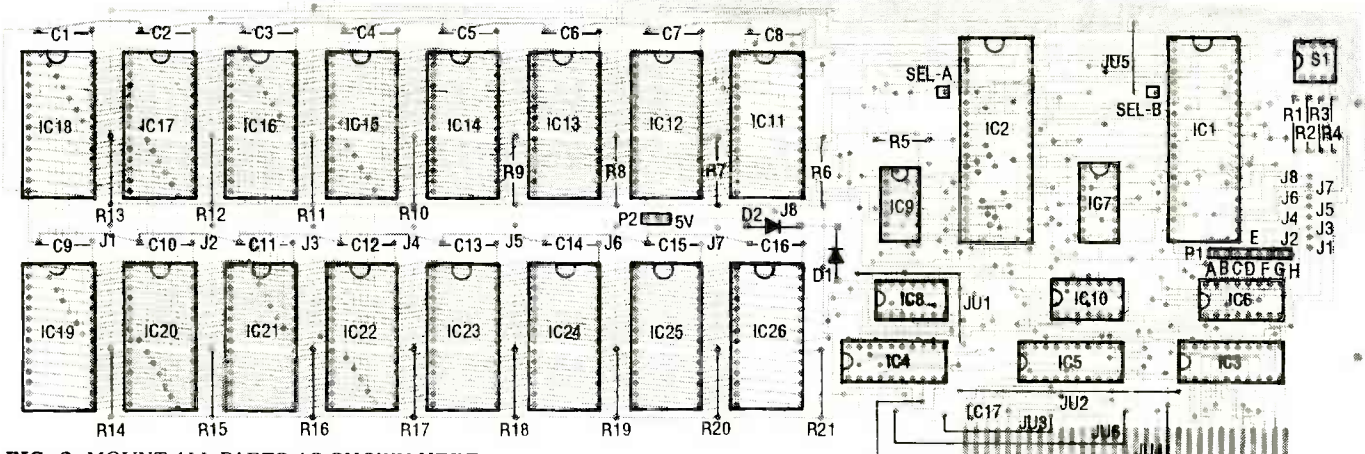

**FIG. 2. MOUNT ALL PARTS AS SHOWN HERE. MAKE SURE THE FOLLOWING VERSION OF THE PARTS LIST RUNS. THERE ARE A FEW DIFFERENCES FROM PART 1.**



## Parts List

All resistors are 1/4-watt, 5% unless otherwise noted.

R1-R5 ..... 4700 ohms  
R6-R21 ..... 22,000 ohms

### Capacitors

C1-C16 ..... 0.01 µF polyester  
C17 ..... 10 µF, 10 volts.  
electrolytic

### Semiconductors

D1, D2 ..... 1N914 switching diode  
IC1, IC2 ..... 8255 Programmable peripheral interface  
IC3 ..... 74LS245 Bidirectional bus buffer  
IC4, IC5 ..... 74LS244 Octal bus driver  
IC6 ..... 74LS138 Three-to-eight line decoder  
IC7 ..... 74LS85 Four-bit comparator  
IC8 ..... 74LS04 Hex inverter  
IC9 ..... 74LS00 Quad NAND gate  
IC10 ..... 74LS08 Quad AND gate  
IC11-IC26 ..... 43256-10 Static RAM

### Other Components

SW1 ..... Four-position DIP switch  
B1 ..... Four AA cells (with holder) (optional)  
J1 ..... 2-position, single-row, 0.1" female header  
J2 ..... 2-position, single-row, 0.1" female header  
P1 ..... 8-position, single-row, 0.1" male header  
P2 ..... 2-position, single-row, 0.1" male header

## Ordering Information

The following are available from  
Hatronics

145 Lincoln Street  
Montclair, NJ 07042  
(201) 783-7264

(201) 245-6614 (BBS, join the  
Hatronics conference)

Bare PC board ..... \$50  
Kit with 0K RAM ..... \$90  
Kit with 128K RAM ..... \$155  
Kit with 256K RAM ..... \$220  
Kit with 512K RAM ..... \$322  
Assembled and tested unit, 0K ..... \$135  
Assembled and tested unit, 256K ..... \$255  
Assembled and tested unit, 512K ..... \$395  
All orders add \$10.00 for shipping and handling.  
New Jersey orders add sales tax (6%).

```

5 CLS
10 PRINT"*****"
20 PRINT"*"
30 PRINT"*          SRAM INITIALIZATION PROGRAM          *"
40 PRINT"*"
50 PRINT"*          COPYRIGHT HATRONICS          *"
60 PRINT"*"
70 PRINT"*****"
80 PRINT" THIS PROGRAM WILL INITIALIZE THE FIRST 32K "
90 PRINT" THIS WILL SET UP THE FAT AND DIRECTORY AREAS "
95 PRINT
97 INPUT" WHAT PORT ADDRESS "; PO%
99 IF PO%=0 THEN GOTO 130
100 PRINT" ARE YOU SURE YOU WANT TO DO THIS ??? Y OR N "
110 AS=INKEY$: IF AS="Y" OR AS="y" THEN GOTO 140
120 IF AS="" GOTO 110
130 PRINT" ABORTED !!!": END
140 DIM S2(16)
150 S2(1)=254:S2(2)=253:S2(3)=251:S2(4)=247
160 S2(5)=239:S2(6)=223:S2(7)=191:S2(8)=127
170 P1A=PO%:P2A=PO%+16:P1B=PO%+1:P2B=PO%+17
175 P1C=PO%+2:P2C=PO%+18:P1D=PO%+3:P2D=PO%+19
180 OUT P1D,128
190 OUT P2D,128
200 OUT P2B,255
210 OUT P2A,255
220 P%=P2A
230 PRINT" INITIALIZING FIRST 32K"
240 IF BA =2 THEN P%=P2B
250 FOR S = 0 TO 127
260 FOR T = 0 TO 255
270 OUT P1A,T:OUT P1B,S+128
280 OUT P1C,0
290 OUT P%,S2(S3):OUT P%,255
300 NEXT T
310 NEXT S
320 PRINT " END INITIALIZATION":END
    
```

ample, run a jumper from J1 under the DIP switch to J1 by C9, from J2 under the DIP switch to J2 by C10, etc.

If you're not going to install all sixteen SRAM's, install the SRAM's in part-number order (IC11, IC12,...IC26).

Check your work carefully for solder bridges and cold solder joints. Fix any problems, and then set S1 to a value unused by any other adapter in your system. Try 768 if you're not sure; that address is reserved by IBM for prototype boards.

Then power down your PC and insert the board into a vacant expansion slot.

### Initialization

Power your PC up; if it doesn't boot normally, power down quickly, check the board again, and correct any mistakes.

Before you can use the board, you must initialize it. Run the BASIC program shown in Listing 1; that program performs a function similar to DOS's FORMAT command. If you don't keep a battery attached to the board,

you'll have to run the BASIC program each time you boot. In that case, you may want to modify the program so that it automatically uses the correct port address and so that it returns to DOS after it finishes executing. In other words, change all END statements to SYSTEM statements. Then you could execute the program from your AUTOEXEC.BAT like this: GWBASIC SFORMAT.

The author is working on an enhancement that will allow the driver to optionally initialize the board each time you boot. Both the initialization program and the device driver are available from the RE-BBS, 516-293-2283, 300/1200, 8N1. The file called SRAMDISK.EXE is a self-extracting ZIP file that contains the BASIC program, the executable version of the device driver, and the source for the device driver. Run SRAMDISK.EXE on a disk with at least 150K of free disk space. Check with the author at the address given in the parts list for the latest version of the initialization program and device  
(Continued on page 80)





# R-E Computer Admart

Rates: Ads are 2 1/4" x 2 7/8". One insertion \$950. Six insertions \$925 each. Twelve insertions \$895 each. Closing date same as regular rate card. Send order with remittance to **Computer Admart**, Radio Electronics Magazine, 500-B Bi-County Blvd., Farmingdale, NY 11735. Direct telephone inquiries to Arline Fishman, area code-516-293-3000. *Only 100% Computer ads are accepted for this Admart.*

## GETTING THE MOST FROM YOUR PRINTER

Getting The Most From Your Printer

ART 71440-17



**BP181**—It is probable that 80% of dot-matrix printer users only ever use 20% of the features offered by their printers. This book will help you unlock the special features and capabilities that you probably don't even know exist. To order your copy **send \$6.95 plus \$1.50 for shipping** in the U.S. to **Electronic Technology Today Inc., P.O. Box 240, Massapequa Park, NY 11762-0240.**

## SECRETS OF THE COMMODORE 64

Secrets of the COMMODORE 64



**BP135**—A beginners guide to the Commodore 64 presents masses of useful data and programming tips, as well as describing how to get the best from the powerful sound and graphics facilities. We look at how the memory is organized, random numbers and ways of generating them, graphics-color-and simple animation, and even a chapter on machine code. Get your copy today. **Send \$5.00 plus \$1.25 for shipping** in the U.S. to **Electronic Technology Today Inc., P.O. Box 240, Massapequa Park, NY 11762-0240.**

**ICs PROMPT DELIVERY!!!**  
SAME DAY SHIPPING (USUALLY)  
QUANTITY ONE PRICES SHOWN for MAY 27, 1990

OUTSIDE OKLAHOMA: NO SALES TAX

DYNAMIC RAM		
1MB	COMP DeskPro 386/20	\$295.00
SIMM	AST Prem386/33Mhz	225.00
SIMM	1Mx9 80 ns	88.00
SIMM	256Kx9 100 ns	30.00
1Mbit	1Mx1 80 ns	8.25
41256	256Kx1 60 ns	4.15
41256	256Kx1 80 ns	3.10
41256	256Kx1 100 ns	2.50
41256	256Kx1 120 ns	2.25
4464	64Kx4 100 ns	3.00
41264*	64Kx4 100 ns	5.95
EPROM		
27C1000	128Kx8 200 ns	\$18.00
27512	64Kx8 200 ns	7.80
27256	32Kx8 150 ns	6.50
27128	16Kx8 250 ns	3.75
STATIC RAM		
62256P-10	32Kx8 100 ns	\$8.25
6264P-12	8Kx8 120 ns	4.50
6116AP-12	2Kx8 120 ns	4.25

OPEN 6 DAYS, 7:30 AM-10 PM. SHIP VIA FED-EX ON SAT.

SAT DELIVERY INCLUDED ON FED-EX ORDERS RECEIVED BY TH 02 08:29 AM FR 01 06:59 PM

MasterCard/VISA or UPS CASH COD MICROPROCESSORS UNLIMITED, INC. 24,000 S. Peoria Ave. BEGGS, OK 74421 (918) 267-4961

No minimum order. Please note prices subject to change. Shipping, insurance extra. up to \$1 for packing materials.

CIRCLE 61 ON FREE INFORMATION CARD



## Serial port setup with sPORTt

**Y**ou can never have enough weapons in the never-ending battle with RS-232 interfaces.

sPORTt is a software-only serial port tester that aids determining correct port settings for PC compatibles. It provides an interactive screen, shown in Fig. 4, in which you can change settings at will, as well as send and receive data. Whatever you type at the keyboard is sent out the current port at the current settings. You can also send a disk file, and receive to a disk file.

The nice things about sPORTt are that you can quickly and easily change settings, and that the

current settings are always visible. For example, if you wonder whether that plotter requires a high on RTS, press F4 to make it high, and then send some data. If that doesn't work, press F4 to turn it back off, and try again. You can follow the same procedure with DTR. The states of the receive signals (CTS, DSR, CD, RI) are constantly displayed as well.

The central portion of the screen contains the Communication Display, in which all sent and received characters are displayed. Each character is displayed according to the current display mode (ASCII, hex, decimal, binary), which you set with F6. Unfortunately, the numeric display modes are a little raw, with no spaces between adjacent characters, which makes the values difficult to read. I'd like to see the display formatted in a DEBUG style, with numbers on the left and ASCII on the right. A "chat" mode, in which keyboard characters (BackSpace, Tab, etc.) were interpreted intelligently would also be nice.

The program currently supports COM1 and COM2; it would be nice if the user could specify a port address, because the "standards" for COM3 and COM4 are

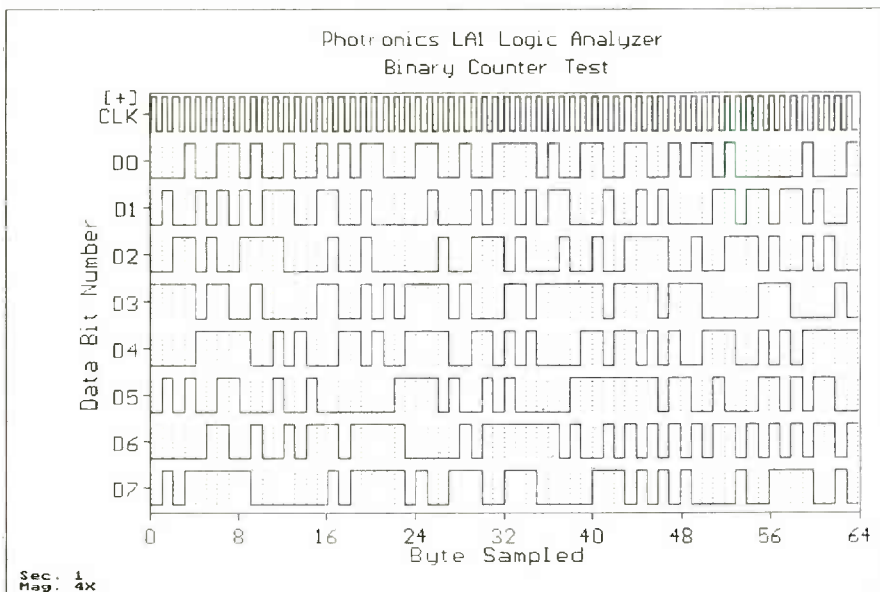
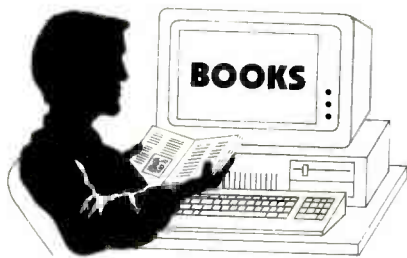

FIG. 4

not universally adhered to, and multi-port serial boards use altogether different addresses.

Using the program is easy, because the single screen is self-explanatory. Printed documentation includes a 40-page three-ring notebook with background information on serial communications, 9-pin, 25-pin, and null-modem wiring diagrams, etc.

At bottom, sPORTt is a handy, easy-to-use diagnostic for PC's. It won't substitute for a fancy external serial-port analyzer, but at \$90, it costs 10% of one of those devices. **CD**



### C: The Complete Reference

C-language aficionados will appreciate McGraw-Hill's comprehensive new reference by the prolific Herbert Schildt. The book is divided into five parts. Part one includes an introduction to C that is as good as some textbooks. Part two includes complete descriptions of all standard library functions. Part three discusses data structures and algorithms common to all types of programming (searching and sorting; stacks, queues, and linked lists; arrays; etc.). Part four discusses programming problems from a higher level, and includes discussions of interfacing with assembly language; porting and debugging, and software engineering. Part five discusses C++, ANSI C, and how the latter differs from the classic K&R version of the language. At 800 pages, the book is about two inches thick, and it's filled with code examples, all of which are available on-disk directly from the author for about \$25. If you're thinking about switching to C, this book will help you get up to speed quickly. If you're already there, it will serve as a valuable reference. **CD**

### ITEMS DISCUSSED

- LA1 Logic Analyzer (\$99.95), Photronics, Inc., 109 Camille St., Amite, LA 70422. (504) 748-7090.

CIRCLE 260 ON FREE INFORMATION CARD

- sPORTt (\$90), Western Hydrologic Systems, 3037 Grass Valley Hwy., #8201, Auburn, CA 95603. (916) 885-2480.

CIRCLE 261 ON FREE INFORMATION CARD

- C: The Complete Reference, 2nd ed. (\$28.95), Herbert Schildt, Osborne McGraw-Hill, 2600 Tenth Street, Berkeley, CA 94710.

CIRCLE 262 ON FREE INFORMATION CARD

### RAM DISK DRIVE

continued from page 77

driver.

The next task is to add the device driver to your CONFIG.SYS file. Until you are sure things are working the way you want, you may want to boot from floppy, not your hard disk. Later, after you arrive at the correct configuration, copy the device driver to your hard disk and edit its CONFIG.SYS.

The device driver line in CONFIG.SYS takes the form:  
device = a:ramdev.sys /768 #16  
S016 %2

The first parameter specifies the board's base address, in this case 768. Next comes the number of SRAM's installed (16), followed by the number of directory entries (016), and last by the number of sectors per allocation unit (2). Each parameter must contain the number of digits shown (three, two, three, and one, respectively). Add a leading zero (or leading zeros) if necessary. In addition, you must prefix the base address with a slash, the number of IC's with a pound sign, the number of directory entries with a dollar sign, and sector number with a percent sign.

Edit the CONFIG.SYS of your boot disk to add the appropriate values, and then reboot. If all is working well, you should be able to use the static ram disk just like any other kind of drive in your computer. **CD**

### LAWN RANGER

continued from page 50

#### Hand-held controller

The hand-held controller allows the operator to manually steer the robot forward and backward. It contains a potentiometer and switches that interface with the electronic control system. The cable from the controller plugs into the electronic control panel located at the rear of the Lawn Ranger. Figure 7 shows a photograph of the hand-held controller, and Fig. 8 shows the schematic diagram.

Potentiometer R3 is used to steer the robot to the left or right. Micro-switch S1 is hand-activated and stops and starts the forward motion of the Lawn Ranger. As the operator squeezes the hand control, S1 closes and allows the robot to move. If the operator opens his hand or drops the controller, the robot will automatically turn itself off. Switch S3 is a momentary pushbutton that is used to activate the cutting motors. An RC delay circuit formed by R2 and C1 slows the Lawn Ranger down before it goes into reverse after the operator pushes the REVERSE button. DPDT slide switch S2 allows the operator to choose either a slow or fast driving speed. As far as the construction of the controller goes, simply install the components as shown in Fig. 8 in a suitable enclosure.

#### Electronic control panel

The electronic control panel is located at the rear of the Lawn Ranger. The control panel consists of a DB-25 female connector (for the manual controller), three momentary push-button switches, a POWER switch (ignition), and a flashing power-on LED indicator. The schematic diagram of the control panel is shown in Fig. 9. The POWER switch is a key-operated ignition switch that supplies power to the robot. The STOP button cuts the power and stops the cutting blades. The CUT button is used to energize the cutting motors. The START button is used to start the automatic cutting operation after the hand-held controller is disconnected.

Next month the Lawn Ranger story will continue. We will be covering the power board and the mechanical assembly. We'll also show you how to thoroughly test each section of the mower. **RE**



# AUDIO UPDATE



LARRY KLEIN,  
AUDIO EDITOR

## The High End Hi-Fi Show

MY BIG EVENT OF THE SEASON IN THE late 1950's was the annual Institute of High Fidelity Music Show at the New Yorker Hotel. Along with hundreds of other early audiophiles, I elbowed my way through crowded corridors for the chance to meet face-to-face such audio luminaries as Vic Brociner, Sol Marantz, Avery Fisher, Rudy Bozak, Gilbert Briggs, and Paul Klipsch. I remember a fellow audiophile who, impressed by the imposing physical and sonic presence of a dozen Klipschorns, asked timidly, "Mr. Klipsh, what would happen if you turned up all these speakers to full volume?" Without missing a beat, Klipsch replied in his characteristic drawl, "My boy, it would permanently damage the structure of the building!"

I encountered no such claims at the recent High End Hi-Fi Show sponsored by *Stereophile* magazine, a publication that caters to the needs, rational and otherwise, of dedicated audiophiles. What I did hear at the High End Show was excellent sound produced by the products of scores of high-end manufacturers.

### Touring the show

A \$25 admission fee covered all three days of the High End Show and included admission to the various panels, discussions, demonstrations, and live music events. I must admit that my tour of the show was far from definitive. Other commitments had limited the time I had available, but part of the blame has to be placed on the show's sprawling layout. Manufacturers' displays were scattered throughout two

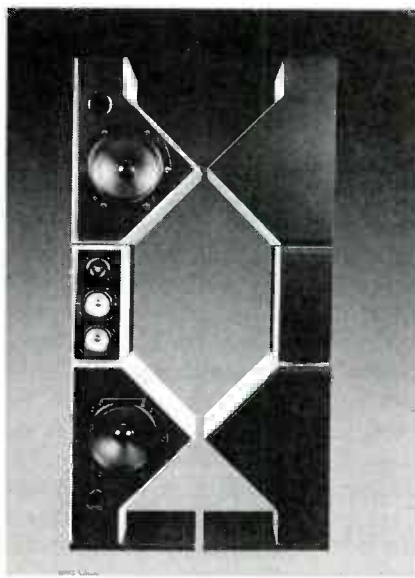

TWO B&W MATRIX 800 SPEAKER systems are shown side by side, with and without their grill covers. Their brilliant sound, impressive size, and distinctive shape are matched only by their \$18,000 price tag.

floors and two mezzanines, and close study of the show directory was required to locate the exhibitors of interest. It turned out that the show organizers had deliberately spaced the exhibitor's rooms both to expedite traffic flow and to prevent sonic conflicts.

### The products

Near the entrance to the show floor was the B&W room, featuring their new Matrix 800 speaker system pictured elsewhere on this page. Note that the photo shows two complete systems side by side, one with its grille cloth on, the other with it off. I was rather startled by the appearance of the speakers, each of

which stands more than 6-feet tall. But I have enough confidence in B&W's engineering integrity to know that the design configuration was neither arbitrary nor specifically designed to impress by its sheer size and strange shape.

How did it sound? In a word: magnificent! Small musical groups came across with a natural quality and balance and an impressive sense of depth and space around the performers. Large orchestral performances were handled at realistic (loud!) concert-hall volumes with no sense of strain and a *substantial* bottom end. The free-field frequency-response specifications of the system are given as 23 Hz to 20 kHz  $\pm 2$  dB, and I don't doubt it for a minute. Few of us would be willing to fit a pair of Matrix 800's into our listening rooms (or to accommodate their \$18,000 cost) but they're a good example of how good a speaker can be when its manufacturer makes an all-out effort.

An interesting contrast to the enormous and expensive B&W Matrix 800 was provided by the diminutive Atlantic Technology Pattern woofer/satellite speaker system. The Pattern system has separate 15-watt amplifiers for each of its two satellites and a single 30-watt amplifier for the dual bass drivers. Each satellite measures 4 inches square and 7 inches high, and consists of two black cubes joined together by a pivot that allows one cube to be rotated 360 degrees relative to the other. The amplifiers are housed inside the bass module, which measures 19 inches long, 12½ inches high, and 8⅝ inches deep.

Get A Complete Course In

## ELECTRONIC ENGINEERING

8 volumes, over 2000 pages, including all necessary math and physics. 29 examinations to help you gauge your personal progress. A truly great learning experience.

Prepare now to take advantage of the growing demand for people able to work at the engineering level.

Ask for our brochure giving complete details of content. Use your free information card number, or write us directly. **\$99.95**, Postage Included. Satisfaction guaranteed or money refunded.



**Banner  
Technical  
Books, Inc.**

1203 Grant Ave.  
Rockford, IL 61103

CIRCLE 67 ON FREE INFORMATION CARD

## SUPER LONG PLAY TAPE RECORDERS

12 Hour Model —  
USES D-120 TAPE  
**\$119.00\***

Modified Panasonic Slimline, high quality AC-DC provide 6 continuous hours of quality recording & playback on each side of cassette for 12 hours total. Includes • Voice level control • Digital counter, etc. TDK D-120 Cassette Furnished.



### PHONE RECORDING ADAPTER

Records calls automatically. All Solid state connects to your telephone jack and tape recorder. Starts recording when phone is lifted. Stops when you hang up. **\$28.50\***

FCC APPROV

**VOX VOICE ACTIVATED CONTROL SWITCH**

Solid state. Self contained. Adjustable sensitivity. Voices or other sounds automatically activate and control recorder. Uses either recorder or remote mike. **\$28.50\***

\*Add for ship & hdg. Phone Adapter & Vox \$1.50 ea. Records \$4.00 ea. Cal. Res. add tax. Mail order. VISA, M.C., COD's OK. Money Back Guarantee. Qty. disc. avail. Dealer inquiries invited, Free data. ©  
**AMC SALES INC.** Dept. A 9335 Lubec St.  
Box 928. Downey, CA. 90241.  
Phone (213) 869-8519  
FAX (213) 923-1478

CIRCLE 108 ON FREE INFORMATION CARD

The Pattern's amplifiers do more than simply feed a chosen signal to its drivers. The bass amplifier includes a dynamic equalizer that enhances the low-base output at reasonable volume levels, but turns it down about 5 dB when a combination of low bass and high volume would tax the 6½-inch woofers' excursion capabilities. The Pattern's highly flexible input arrangement accepts connections from up to three stereo program sources plus wires from the speaker outputs of a separate amplifier or receiver. The sound from the Pattern system was very good, although not quite up to the standard set by B&W's \$18,000 Matrix 800. But for \$500—built-in amplifiers and all—most people would probably consider the Pattern a better buy.

### Accessories

In the past decade, the audio business has been "accessorized" to a fare-thee-well. For the dealer, accessories answer the question of what to sell the audio consumer once he's bought his basic components; for the audiophile, accessories provide an opportunity to be consistently involved in what he perceives as an evolving system. For example, for quite a while it has been possible to buy shock mounts for every component in your system—even the amplifier. Following an opposing theory, "spiking" devices are also available to ensure a firm connection between the components and the surface they are resting upon.

I don't know how many audiophiles are losing sleep over the question of whether to shock mount or to spike, or whether to apply the various clamps, weights, preservatives, and enhancing fluids, but there is one category of accessory seen at the High End Show that I can heartily endorse. Several manufacturers are selling gold-plated RCA-type phono plugs that have been redesigned and machined to provide a constant ground during insertion and withdrawal and to have a clamping action once installed. A great idea. Over the years I've probably blown hundreds of dollars worth of midranges and tweeters because of carelessness and cable problems that would have been prevented by proper plugs.

Very expensive special speaker leads and interconnect cables (we used to call them "phono" cables) were seen in profusion at the show. The manufacturer's claims and quasi-technical explanations for the superior performance of their products ranged from the vaguely possible to the definitely ridiculous—as did the prices. I was told of one speaker cable that sells for approximately \$200 per foot!

I didn't get a chance to check out the Wadia line of outboard digital decoders meant to be connected to CD and DAT players with digital outputs. I must admit that the technical content of the impressive Wadia literature lost me in the section about LaGrangian and Spline decoding polynomials, but their basic claim is simple enough: Critical amounts of information are lost (and displeasing artifacts added) in the D/A-conversion sections of all current CD and DAT players. The Wadia 2000 decoding computer purports to restore the sound to the quality intended by the recording engineers. It's possible, but my CD players sound just fine to me as is. It would seem that I lack both the aural sensitivity and financial wherewithal (\$7,700) to ever be a customer for their top-of-the-line decoder.

### The final word

Consumer hi-fi shows have apparently fallen out of favor in the past decade. Whether the reason is lack of manufacturer support or loss of public interest I can't say, but the *Stereophile* Show is the only one currently scheduled. Perhaps it's just as well, because the hi-fi shows generally had deteriorated to SPL (Sound-Pressure Level) contests where it was difficult to find anyone really knowledgeable about the products shown and impossible to make critical sonic judgments because of the noise leakage from adjacent rooms.

I would guess that the 7,000-or-so attendees at the High End Show were mostly critical music listeners, and the exhibitors, by and large, respected their serious interest both by the choices of the program material and the reasonable levels at which it was played. I regret that I didn't get a chance to cover all the products played and displayed. Maybe next time.

R-E



## DIGITAL PRESSURE GAUGE

continued from page 44

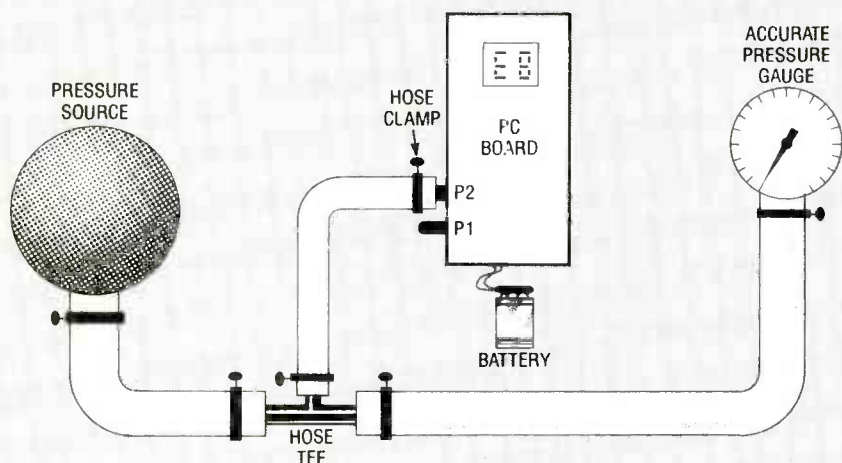

FIG. 7—TO CALIBRATE THE GAUGE, use this setup. Remember that all hose connections must be securely clamped.

### Final calibration

The best way to calibrate your pressure gauge is to compare it to the reading of a known, accurate gauge. Additionally, if you plan to use the gauge to measure pressure which is normally less than full-scale capability, it would be prudent to calibrate it at this pressure level rather than at full scale. Use the setup in Fig. 7, remembering that all hose connections must be securely clamped. The setup allows the pressure source to be applied simultaneously to both gauges.

Adjust R6 so that the digital readout agrees with the reference gauge. After adjustment of R6, remove the pressure from the sensor and check the display, which should read zero. If there is some offset from zero, repeat the adjustment for R16 and R6.

Battery life should be as long as 1 or 2 years if the project is used intermit-

tently. The display will change in appearance when the battery needs to be replaced, and it will disappear altogether when the battery is totally exhausted.

R-E

### ARE YOU IN DEFAULT on a student loan?

If you're in default on a guaranteed student loan (FISL, GSL, Stafford, SLS, or PLUS loan), you may be eligible to pay it back without penalty or collection charges. For information about this special program, call the guarantee agency that holds your loan, or call the U.S. Department of Education's toll-free number:  
(800) 333-INFO

## Assembly Power!



Heath provides an alternative for computer buyers who want to do more than just plug in a ready-made computer. Heath computer kits offer superior performance - and the satisfaction and pride of building a high-power laptop or desktop computer yourself.

Our expert team of computer sales consultants will give you a special price that's sure to fit your budget. Simply call 1-800-753-5454 and ask about any of these unbeatable systems:

- HS-3286 SupersPort 386 SX laptop
- HS-2862 12 MHz 80286 laptop
- HS-3629 32-bit, 25 MHz 80386 desktop

## Heath

1-800-753-5454

(M-F, 8:00 a.m. - 4:30 p.m., EST)

CIRCLE 199 ON FREE INFORMATION CARD

## ATTENTION! ELECTRONICS TECHNICIANS

EARN YOUR **B.S.E.E. DEGREE**



THROUGH HOME STUDY

Our New and Highly Effective Advanced-Placement Program for experienced Electronic Technicians grants credit for previous Schooling and Professional Experience, and can greatly reduce the time required to complete Program and reach graduation. No residence schooling required for qualified Electronic Technicians. Through this Special Program you can pull all of the loose ends of your electronics background together and earn your B.S.E.E. Degree. Upgrade your status and pay to the Engineering Level. Advance Rapidly! Many finish in 12 months or less. Students and graduates in all 50 States and throughout the World. Established Over 40 Years! Write for free Descriptive Literature.

**COOK'S INSTITUTE**  
OF ELECTRONICS ENGINEERING



4251 CYPRESS DRIVE  
JACKSON, MISSISSIPPI 39212

CIRCLE 58 ON FREE INFORMATION CARD

ORDER FROM **JAN** FOR **CRYSTAL CLEAR COMMUNICATION**



- YOUR RELIABLE SOURCE SINCE 1965
- QUICK DELIVERY
- PRICED RIGHT
- EMERGENCY ORDER SERVICE AVAILABLE

FOR FREE CATALOG, CALL OR WRITE:

**JAN CRYSTALS**

P.O. BOX 06017  
FORT MYERS, FL 33906



(813) 936-2397



TOLL-FREE: 1-800-JAN-XTAL (526-9825)

FAX ORDERS: 1-813-936-3750

CIRCLE 104 ON FREE INFORMATION CARD

AUGUST 1990

83

# MARKET CENTER

## FOR SALE

**GREAT buys!** Surplus prices, ICs, linears, transformers, PS, stepping motors, vacuum pump, phototransistor, meters, LSASE, FERTIK'S, 5400 Ella, Phila., PA 19120.

**DESCRAMBLERS.** All brands. Special: Combo Jerrold 400 and SB3 \$165.00. Complete cable descrambler kit \$39.00. Complete satellite descrambler kit \$45.00. Free catalog. MJM INDUSTRY, Box 531, Bronx, NY 10461-0208.

T.V. notch filters, surveillance equipment, brochure \$1.00. D.K. VIDEO, Box 63/6025, Margate, FL 33063. (305) 752-9202.

**TUBES:** "oldest," "latest." Parts components schematics. SASE for list. STEINMETZ, 7519 Maplewood Ave., RE, Hammond, IN 46324.

## CABLE TV DESCRAMBLERS!



## BARGAIN HEADQUARTERS!

• JERROLD • TOCOM • HAMUN  
• SCIENTIFIC ATLANTA • ZENITH  
Oak M35B ONLY \$60  
6 month warranty! We ship C.O.D.!  
Lowest retail/wholesale prices!  
FREE CATALOG:  
Global Cable Network  
1032 Irving St. Suite 109  
S.F., CA 94122

**ORDER TODAY! 800-327-8544**

**ENGINEERING** software, PC/MSDOS. Hobbyists — students — engineers. Circuit design \$49.00, PCB layout \$99.00, Logic simulation \$29.00, FFT analysis \$69.00, Mathematics \$39.00, Circuit analysis \$29.00. Call or write for free catalog. (614) 491-0832, **BSOFT SOFTWARE**, 444 Colton Rd., Columbus, OH 43207.

**RESTRICTED** technical information: Electronic surveillance, schematics, locksmithing, covert sciences, hacking, etc. **Huge selection. Free brochures.** MENTOR-Z, Drawer 1549, Asbury Park, NJ 07712.

**RENTAL movie stabilizer.** Connect between VCRs or to monitor. Satisfaction guaranteed. \$69.95, \$4.00 handling. 1 (800) 367-7909.

**Quality Microwave TV Antennas**

WIRELESS CABLE—1.9 to 2.7 Ghz. 40db Gain (+)  
36-Channel System Complete \$149.95  
12-Channel System Complete \$114.95  
Call or Write for "FREE" Catalog

**Phillips-Tech Electronics**  
P.O. Box 8533 • Scottsdale, AZ 85252  
(602) 947-7700 (\$3.00 Credit all phone orders!)

LIFETIME WARRANTY MasterCard • Visa • COD's Quantity Pricing

**LASERS.** 1mw to 2kw, worlds largest selection of new & used surplus. Free catalog. MWK INDUSTRIES, 1269 Pomona Road, Corona, CA 91720. (714) 278-0563.

**LOTTERY** — IBM computer disk for all lotteries \$10.00. ROBERTS, Box 63/6025, Margate, FL 33063.

**MAGNET** wire 18-38 gauge solderable. Send SASE to SMW DIST., PO Box 1015, Huntington, IN 46750.

**CATALOGS** you can get free over 200. Send \$3.50 to ERIC LIVELY, 3982 Stuart, Bossier, LA 71112.

**ZENITH** descrambler test device. Authorizes all channels for full service. Sold as test aid only! \$69.95 each for info call (407) 768-0278.

**DESCRAMBLERS:** dealers! We have new Z-Tac descramblers, only \$185.00 in 10 lots, with other systems available. 1 (800) 695-CABL.

## CLASSIFIED AD ORDER FORM

To run your own classified ad, put one word on each of the lines below and send this form along with your check to:

**Radio-Electronics Classified Ads**, 500-B Bi-County Boulevard, Farmingdale, NY 11735

**PLEASE INDICATE** in which category of classified advertising you wish your ad to appear. For special headings, there is a surcharge of \$25.00.

( ) Plans/Kits ( ) Business Opportunities ( ) For Sale  
( ) Education/Instruction ( ) Wanted ( ) Satellite Television  
( )

Special Category: \$25.00

### PLEASE PRINT EACH WORD SEPARATELY, IN BLOCK LETTERS.

(No refunds or credits for typesetting errors can be made unless you clearly print or type your copy.) Rates indicated are for standard style classified ads only. See below for additional charges for special ads. **Minimum: 15 words.**

1	2	3	4	5
6	7	8	9	10
11	12	13	14	15 (\$46.50)
16 (\$49.60)	17 (\$52.70)	18 (\$55.80)	19 (\$58.90)	20 (\$62.00)
21 (\$65.10)	22 (\$68.20)	23 (\$71.30)	24 (\$74.40)	25 (\$77.50)
26 (\$80.60)	27 (\$83.70)	28 (\$86.80)	29 (\$89.90)	30 (\$93.00)
31 (\$96.10)	32 (\$99.20)	33 (\$102.30)	34 (\$105.40)	35 (\$108.50)

We accept MasterCard and Visa for payment of orders. If you wish to use your credit card to pay for your ad fill in the following additional information (Sorry, no telephone orders can be accepted):

Card Number

Expiration Date

Please Print Name

Signature

**IF YOU USE A BOX NUMBER YOU MUST INCLUDE YOUR PERMANENT ADDRESS AND PHONE NUMBER FOR OUR FILES. ADS SUBMITTED WITHOUT THIS INFORMATION WILL NOT BE ACCEPTED.**

**CLASSIFIED COMMERCIAL RATE:** (for firms or individuals offering commercial products or services) \$3.10 per word prepaid (no charge for zip code)...**MINIMUM 15 WORDS.** 5% discount for same ad in 6 issues; 10% discount for same ad in 12 issues within one year; if prepaid. **NON-COMMERCIAL RATE:** (for individuals who want to buy or sell a personal item) \$2.50 per word, prepaid...no minimum. **ONLY FIRST WORD AND NAME** set in bold caps at no extra charge. Additional bold face (not available as all caps) 55¢ per word additional. Entire ad in boldface, \$3.70 per word. **TINT SCREEN BEHIND ENTIRE AD: \$3.85 per word. TINT SCREEN BEHIND ENTIRE AD PLUS ALL BOLD FACE AD: \$4.50 per word. EXPANDED TYPE AD: \$4.70 per word prepaid.** Entire ad in boldface, \$5.60 per word. **TINT SCREEN BEHIND ENTIRE EXPANDED TYPE AD: \$5.90 per word. TINT SCREEN BEHIND ENTIRE EXPANDED TYPE AD PLUS ALL BOLD FACE AD: \$6.80 per word. DISPLAY ADS: 1" x 2 1/4"—\$410.00; 2" x 2 1/4"—\$820.00; 3" x 2 1/4"—\$1230.00. General Information:** Frequency rates and prepayment discounts are available. **ALL COPY SUBJECT TO PUBLISHERS APPROVAL. ADVERTISEMENTS USING P.O. BOX ADDRESS WILL NOT BE ACCEPTED UNTIL ADVERTISER SUPPLIES PUBLISHER WITH PERMANENT ADDRESS AND PHONE NUMBER.** Copy to be in our hands on the 10th of the third month preceding the date of the issue. (i.e., Aug. issue copy must be received by May 10th). When normal closing date falls on Saturday, Sunday or Holiday, issue closes on preceding working day. Send for the classified brochure. Circle Number 49 on the Free Information Card.





# CABLE TV DESCRAMBLERS

JERROLD™ Tri-Bi Model	\$105.00	10 Lot	\$85.00
JERROLD™ SB-3 OR 2	\$89.00		\$65.00
Hamlin MLD-1200	\$99.95		\$62.00
Oak N-12 W/V.S.	\$99.95		\$62.00
Oak-M-35-B W/V.S.	\$99.00		\$78.00
OAK E-13	\$99.95		\$58.00
Zenith SSAVI	\$185.00		\$145.00
Eagle PD-3	\$120.00		\$85.00
Scientific Atlanta	\$129.95		\$105.00
SA-Combo's	CALL		\$Call
Tocom	\$350.00		\$295.00
Oak N-12 W/ Auto	\$140.00		\$105.00
Jerrold Starcom CSV	\$139.95		Call

M.D. ELECTRONICS  
WILL MATCH ANY  
ADVERTISED PRICE  
IN THIS MAGAZINE

## \*NEW STARGATE 2000 CABLE CONVERTER



1-\$89.00 10-\$69.00 100-Call

Last channel recall-Favorite channel select-75 channel-Channel scan-Manual fine tune-One year warranty-surge protection-HRC & Standard switchable- and much more. **Call Today!**

INFORMATION(402)554-0417

Orders Call Toll Free  
1-800-624-1150

M.D. ELECTRONICS  
115 NEW YORK MALL  
SUITE 133E  
OMAHA, NE. 68114

M.C.  
VISA  
C.O.D.

CIRCLE 53 ON FREE INFORMATION CARD



### SING WITH THE WORLD'S BEST BANDS!

An Unlimited supply of Backgrounds from standard stereo records! Record with your voice or perform live with the backgrounds. Used in Professional Performance yet connects easily to a home component stereo. This unique product is manufactured and sold Exclusively by LT Sound - Not sold through dealers. Call or write for a Free Brochure and Demo Record.

**LT Sound**, Dept. R.L-3, 7980 LT Parkway  
Lithonia, GA 30058 (404) 482-4724  
Manufactured and Sold Exclusively by LT Sound  
**24 HOUR PHONE DEMO LINE: (404) 482-2485**

PHOTOFACT folders, under #1400 \$4.00. Others \$6.00. Postpaid. LOEB, 414 Chestnut Lane, East Meadow, NY 11554.

TROUBLESHOOT Solid-state relays. Easy to understand guide with diagrams and instructions. Send \$3.00 to: REMCO TECHNOLOGIES, PO BOX 428, Henrietta, NY 14467.

NINTENDO service manuals. Schematics, waveforms, parts lists, troubleshooting tips. Untapped markets nationwide. \$30.00. SPIEL ELECTRONICS, PO Box 50941, Amarillo, TX 79159.

STOP the electronic thieves! Techniques, equipment, laws. Free information. SVS, 198 N. 2nd St., Suite 6, Porterville, CA 93257. (209) 781-2834.

TEST equipment pre-owned now at affordable prices. Signal generators from \$50.00. Oscilloscopes from \$50.00. Other equipment, including manuals available. Send \$1.00 for catalog, refund on 1st order. J.B. ELECTRONICS, 3446 Dempster, Skokie, IL 60076. (708) 982-1973.

T.V. cable descramblers converters. Zenith, Tocom, SA-3, Tri-Bi, Jerrold-400, Hamlin, Oak, wholesale prices to all, examples Tocom \$125.00, Oak RTC-56 with remote \$150.00, COD orders ok, no catalog just great prices. S.A.C., information (702) 647-3799, orders only 1 (800) 622-3799.

SURVEILLANCE countersurveillance equipment catalog \$5.00. EAVESDROPPING DETECTION EQUIPMENT, PO Box 1087, Williamsville, NY 14231.

TOCOM 5503 V.I.P. shutdown? Descramble "all channels" perfectly with deluxe "turnon" module. Easy hookup. \$39.00. MIKE, Box 743, Oldsmar, FL 34677.

**NUTS & VOLTS** P.O. Box 1111-E  
MAGAZINE Placentia, CA 92670  
714-632-7721

**GIVE YOURSELF A BREAK — A PRICE BREAK!**  
NUTS & VOLTS WILL **SAVE YOU MONEY**  
ON ELECTRONIC PARTS & EQUIPMENT  
Plus SHOW YOU WHERE TO FIND UNIQUE,  
UNUSUAL AND HARD-TO-FIND ITEMS.  
SUBSCRIBE TODAY!

Orders Only 800-783-4624

Subscription Rates  
U.S. FOREIGN REQUIRED

3rd Class Mail - USA	One Year	\$12.00
Two Years	\$21.00	
LIFETIME	\$60.00	

1st Class Mail

One Year USA	\$25.00
Canada/Mexico	\$22.00
Air Mail	
Foreign 1yr	\$55.00

A National Publication For The Buying And Selling Of Electronic Equipment

OAK Sigma descrambler, channel 3 output, rare hard-to-find factory equipment, with free documentation, \$150.00. Oak Sigma modification documentation \$20.00 postpaid. Oak VN12-4 (or Hamlin) descramblers with free remote control converter, \$85.00. Eagle remote control converter descrambler combos, \$100.00. Send money order, ship postpaid within 3 days. SURPLUS ELECTRONICS, POB 10009, Colorado Springs, CO 80932.

## PLANS AND KITS

BUILD this five-digit panel meter and square-wave generator including an ohms, capacitance and frequency meter. Detailed instructions \$2.50. BAGNALL ELECTRONICS, 179 May, Fairfield, CT 06430.

MINIATURE FM transmitters! Tracking transmitters! Voice disguisers! Bug detectors! Phone Devices! More! Available in kits or assembled! Catalog \$2.00. XANDI ELECTRONICS, Box 25647, Dept. 60G, Tempe, AZ 85285-5647.

CATALOG: hobby/broadcasting/HAM/CB: Cable TV, transmitters, amplifiers, surveillance devices, computers, more! PANAXIS, Box 130-F8, Paradise, CA 95967.

## REMOTE CONTROL KEYCHAIN

Complete w/mini-transmitter and +5 vdc RF receiver. Fully assembled including plans to build your own auto alarm. Quantity discounts available.

**\$24.95** Check, Visa or M/C  
Add \$ 3 shipping

VISITECT INC./Dept. R (415) 872-0128  
PO BOX 5442, SO. SAN FRAN., CA 94080

SURVEILLANCE transmitter kits! Four models of each; telephone, room, combination telephone/room transmitters tune from 65 to 305 MHz. Catalog with Popular Communications book review of "Electronics Eavesdropping Equipment Design," \$1.00. SHEFFIELD ELECTRONICS, 7223 Stony Island Ave., Chicago, IL 60649-2806.

INVESTIGATORS, experimenters — Quality plans. Micro and restricted devices. Free catalog. Self addressed stamped envelope required KELLEY SECURITY INC., Suite 90, 2531 Sawtelle Blvd., Los Angeles, CA 90064.

CB Tricks II book. Power amplifier design and theory, UHF CB tune ups. Send \$19.95 MEDICINE MAN CB, PO Box 37, Clarksville, AR 72830.

# CABLE TV

## TB-3 (Tri-Bi) or SA-3

### Quantity Prices

10	20
<b>\$48.</b>	<b>\$43.</b>
Each	Each
50	100
<b>\$39.</b>	<b>\$35.</b>
Each	Each

Hours open 10:00 am to 4:00 pm Eastern time  
Minimum order 5 units 55.00 ea.  
Dealers wanted. We ship COD.

### King Wholesale

1-800-729-0036  
Fax number 6173400053

"No one beats the King's prices!"

# DESCRAMBLERS

  
One tree can make  
3,000,000 matches.

  
One match can burn  
3,000,000 trees.



A Public Service of This Magazine  
& The Advertising Council



**NEW HE NE LASER TUBES \$35**  
*Dealer Inquiries Invited. Free Catalog!*  
**MEREDITH INSTRUMENTS:** 6403 N. 59th Ave. Glendale, AZ 85301 • (602) 934-9387  
*"The Source for Laser Surplus"*

**LASERS** Build gunsights, pointers, liteshow, nitelite, lab. Blueprints and instructions \$9.00 each, 3 for \$20.00. Free list. **NIGHTWRITER**, POB 44188, Phoenix, AZ 85064.

**FM wireless microphone, 3 mile range, plans \$4.00.** FM, PO Box 4383, Bloomington, IL 61702-4383.

**STRANGE stuff.** Get the advantage! Laser listener, surveillance, descrambling, underground information. Plans, kits, complete items. Informational package \$3.00 refundable. **DIRIJO/BOND**, Box 212, Lowell, N.C. 28098.

**LASER lighting entertainment systems.** Create your own 3-dimensional laser light shows. Detailed mechanical and electrical schematics, scanning and control operations. \$20.00. **MILLENNIUM**, 877 Saint Charles #5, Thousand Oaks, CA 91360.

**DETECTION** — Surveillance, debugging, plans, kits, assembled devices. Latest high-tech catalog \$5. **DETECTION SYSTEMS**, 2515 E. Thomas, #16-864F, Phoenix, AZ 85016.

**DESCRAMBLING**, new secret manual. Build your own descramblers for **cable and subscription TV**. Instructions, schematics for SSAVI, gated sync, sinewave, (HBO, Cinemax, Showtime, UHF, adult) \$8.95, \$2.00 postage. **CABLETRONICS**, Box 30502R, Bethesda, MD 20824.

**BUILD robot from outer space!** Plans \$11.95, details free. **ROBOT WORKS**, Box 1979, Colorado Springs, CO 80901.

**DIGITAL V.O.M./D.P.M. SALES—SERVICE—PARTS**  
**FLUKE-BECKMAN-SIMPSON-ETC.**  
 U.S. MADE ONLY. QUOTATION PRIOR TO WORK. FAST SERVICE. 90 DAY WARRANTY. STANDARDS TRACEABLE TO NBS SINCE 1948. CALIBRATION CERTIFICATE AVAILABLE.  
**INDUSTRIAL INSTRUMENT WKS. INC.**  
 5745 SALMEN, HARAHAN, LA 70123 504/733-8355

**TRANSFORMERS.** Learn to build your own. Easy. Smart. Send \$1.00 (refundable). **W. CHARLES TECHNOLOGIES**, 28740 S.W. Parkway #A1, Wilsonville, OR 97070.

**ETCH** your own printed circuit boards using the photographic method. The only inexpensive step-by-step process that guarantees professional results. A book that every serious electronics hobbyist should have. Send \$12.95 to **ETCHING INFO**, PO Box 8064, Westfield, MA 01086-8064.

**Computer Kits**  
 80286-12-mhz, 1.2 or 1.44 floppy, 101 Keyboard, 512k, Mono Monitor, Parallel Port, 5 Drive Case, 200 Watt Power Supply, Year Warranty, 100%, IBM Compatible, Free Software  
**Free Catalog**  
 General Technical Systems  
 Quality Computer Systems  
 Post Office Box 2676  
 Lake Ronkonkoma, NY 11779  
 (516) 981-9473

**BUILD** working 68000 single board computer under \$100.00! Complete step-by-step manual includes schematic, circuit board, layout, parts list. Plans incorporate same CPU chip as Macintosh, Amiga, Atari ST; \$24.95. Catalog of robotic and varied CPU projects, \$1.00. **HTC TECHNOLOGIES**, 9 Union Square, Ste. 129, Southbury, CT 06488. (203) 263-3958.

**Phonvu Videophone in a Chip**  
 STILL FRAME TV PICTURE TELEPHONE  
**TRANCEIVER KIT**  
 Sends Slow Scan TV pictures over the phone line in Twelve Seconds  
 Captures any TV Camera, Camcorder VCR, NTSC Video output and holds the display and sends on command  
 Auto Mode allows hands free send and receive. Displays on any TV  
**IC Chip Replaces 150 SSI Dips**  
**15 to 50 Levels of Grey Scale**  
 Serves as:  
 TV FAX  
 Camera  
 Phonvu  
 Tel. Mon.  
 Modulator  
 Use VCR Mod. TV  
 High Res. 50,000 Pixels  
 Videophone Chip 48P DIP and Schematic \$56.95  
 A/D, DRAM, D-Reg. \$21.00  
 PC Board (BARE) \$18.95  
 50 Res. Cap. Diode \$28.75  
 Cabinet (uncut) \$12.75  
 Power Pack \$8.75  
 TV Camera \$189.50  
 Monitor \$118.75  
**Visa and FAX Order (213) 827-1852**  
**PMC Electronics** Box 11148 Marina Del Rey, CA 90292

**FM transmitter 88-108 MHZ kit \$12.95;** Flyback tester assembled \$95.99; S & H 4%. **SIERRA ELECTRONICS**, Box 709, Elfers, FL 34680-0709.

**RECEIVE** all cordless telephones on your police scanner. \$5.00 and SASE gets frequencies. **FREQUENCIES**, PO Box 550, Tiverton, RI 02878.

**VCR amplifier.** Transmits to any TV in the house. Complete unit only \$49.95. Miniature FM transmitter-size of postage stamp, up to 1 mile range, \$29.95. Free info. **CAS ELECTRONICS**, 1525 Aviation Blvd., Suite 136, Redondo Beach, CA 90278.

**UNICORN-YOUR I.C. SOURCE!**

**COLLIMATOR PEN (INFRA-RED)**

- Output: 2.5 mW (max.)
- Current: 90-150 mA
- Operating Voltage: 2.2-2.5V
- Wavelength: 820nm
- Collimation: .18mrad (typ.)
- Size: 11mm diameter

STOCK# PRICE  
**SB1052 \$39.99**

**LASER DIODE (INFRA-RED)**

- Output: 10 mW (max.)
- Current: 90-150 mA
- Operating Voltage: 2.2-2.5V
- Wavelength: 820nm

STOCK# PRICE  
**SB1053 \$9.99**

**LASER DIODE (VISIBLE-RED)**

- Output: 5 mW (max.)
- Current: 65-100 mA
- Operating Voltage: 1.75-2.2V
- Wavelength: 780nm

STOCK# PRICE  
**LS022 \$19.99**

**LASER DIODE (VISIBLE-RED)**

- Output: 5 mW (max.)
- Current: 20 mA
- Operating Voltage: 2.2-3.0V
- Wavelength: 665nm

STOCK# PRICE  
**LS3200 \$129.99**

**EPROMS**

STOCK#	PINS	DESCRIPTION	1-24	25-99	100+
1702	24	256 x 4 1us	3.99	3.79	3.41
2708	24	1024 x 8 450ns	6.49	6.17	5.55
2758	24	1024 x 8 450ns	3.99	3.79	3.41
2716	24	2048 x 8 450ns (25v)	3.29	3.13	2.82
2716-1	24	2048 x 8 350ns (25v)	3.79	3.60	3.24
TMS2716	24	2048 x 8 450ns	6.29	5.98	5.38
27C16	24	2048 x 8 450ns (25v-CMOS)	3.99	3.79	3.41
2732	24	4096 x 8 450ns (25v)	3.79	3.60	3.24
2732A-2	24	4096 x 8 200ns (21v)	3.79	3.60	3.24
2732A	24	4096 x 8 250ns (21v)	3.69	3.51	3.16
2732A-4	24	4096 x 8 450ns (21v)	3.19	3.03	2.73
TMS2532	24	4096 x 8 450ns (25v)	5.79	5.50	4.95
TMS2532P	24	4096 x 8 450ns (25v One Time Programmable)	1.99	1.89	1.70
27C32	24	4096 x 8 450ns (25v-CMOS)	4.19	3.98	3.58
2764-20	28	8192 x 8 200ns (21v)	3.99	3.79	3.41
2764	28	8192 x 8 250ns (21v)	3.79	3.60	3.24
2764A-20	28	8192 x 8 200ns (12.5v)	3.99	3.79	3.41
2764A	28	8192 x 8 250ns (12.5v)	3.29	3.13	2.82
TMS2564	28	8192 x 8 250ns (25v)	6.79	6.45	5.81
27C64	28	8192 x 8 250ns (21v-CMOS)	4.19	3.98	3.58
27128-20	28	16,384 x 8 200ns (21v)	5.79	5.50	4.95
27128	28	16,384 x 8 250ns (21v)	5.09	4.84	4.35
27128A	28	16,384 x 8 250ns (21v)	5.79	5.50	4.95
27C128	28	16,384 x 8 250ns (21v)	5.79	5.50	4.95
27256-20	28	32,768 x 8 200ns (12.5v)	5.29	5.03	4.53
27256	28	32,768 x 8 250ns (12.5v)	4.79	4.55	4.09
27C256	28	32,768 x 8 250ns (12.5v-CMOS)	5.29	5.03	4.53
27512-20	28	65,536 x 8 200ns (12.5v)	7.49	7.12	6.41
27512	28	65,536 x 8 250ns (12.5v)	6.99	6.64	5.98
27C512	28	65,536 x 8 250ns (12.5v-CMOS)	6.99	6.64	5.98
27C1024	32	131,072 x 8 200ns (12.5v-CMOS)	17.99	17.09	15.38
68764	24	8192 x 8 450ns	13.99	13.29	11.96
68766	24	8192 x 8 450ns	14.99	14.24	12.82

10010 Canoga Ave., Unit B-8 • Chatsworth, CA 91311  
 OUTSIDE CALIFORNIA: (800) 824-3432 (Orders Only)  
 IN CALIFORNIA: (818) 341-8833  
 ORDER BY FAX: (818) 998-7975  
 Minimum Order: \$15.00

## COMPUTERS FOR LE\$\$

10 MHz 8088 System..... \$369

- 4.77/10 MHz 8088 Motherboard
- 256 KB RAM (640KB max)
- 150 Watt Power Supply
- Floppy Disk Controller
- One 5.25" 360 KB Floppy Drive
- MonoGraphics Card w/ Parallel Port
- 101 Key Enhanced Keyboard
- Case (3 LEDs ,2 Buttons ,Key-Lock)
- 12" Amber Monochrome Monitor

12 MHz 80286 System..... \$669

- 12 MHz 80286 Motherboard
- 0 Wait State
- 512 KB RAM (4 MB max)
- 200 Watt Power Supply
- Floppy Disk Controller
- One 5.25" 1.2 MB Floppy Drive
- MonoGraphics Card w/ Parallel Port
- 101 Key Enhanced Keyboard
- Case (3 LEDs ,2 Buttons ,Key-Lock)
- 12" Amber Monochrome Monitor

One Year Parts & Labor Warranty  
30 Day Satisfaction Guarantee  
Shipping & Handling Extra  
VISA & M/C add 3% Amex add 4%  
Price & Availability subject to change  
without prior notice

### JINCO COMPUTERS INC.

5122 Walnut Grove Avenue  
San Gabriel, CA 91776  
Tel: (818) 309-1108

CIRCLE 179 ON FREE INFORMATION CARD

## CONSOLIDATED ELECTRONICS



## THE ULTIMATE ELECTRONICS CATALOG

Order your 260 page catalog and price list with over 14,000 money saving electronic parts and equipment! Send \$3.00 in a check or money order, or call 1-800-543-9568 today and use your Mastercard or Visa. Consolidated Electronics, Incorporated  
705 Watervliet Ave., Dayton, Ohio 45420-2599

Name \_\_\_\_\_  
Address \_\_\_\_\_  
City \_\_\_\_\_ State \_\_\_\_\_ Zip \_\_\_\_\_

CIRCLE 70 ON FREE INFORMATION CARD

## K.D. VIDEO

FOR ALL YOUR CABLE TV NEEDS

WE SPECIALIZE IN DEALER PRICING

QTY	1	10	20
Jerrold (Type) SB-3	89.00	56.00	48.00
Jerrold (Type) Tri-Bi	119.00	69.00	65.00
Scientific Atlanta SA-3	129.00	80.00	75.00
Hamlin MLD-1200	99.00	59.00	45.00
Oak N-12 Vari-Sync	99.00	59.00	58.00
Jerrold 550 Converter	99.00	75.00	68.00
Jerrold 400 DRX-3DIC (With Built in SB-3)	169.00	109.00	100.00

1-800-327-3407

Call us for prices on large quantities

K.D. Video PO Box 29538, Mpls., MN 55429

PLANS! Remote control tester \$9.95. Zener diode tester (plug into DMM) \$9.95. Electronic Stethoscope \$9.95. D.E. STENGER, Box 1136, Brooks, Alberta T0J 0J0.

IMAGINE That, is a collection of new ideas and product concepts that have been only partially developed. Innovative, thought-provoking. For designers and hobbyists alike. \$5.35. NIFFY CONCEPTS, Box 1323, Sheboygan, WI 53082-1323.

GARAGE alarm system. AC or battery operated. Detailed installation instructions control panel, keypad, siren, switch, wire \$135.00. Write to: JM INDUSTRIES, 2840 W. Southland Drive, Franklin, WI 53154.

### BUSINESS OPPORTUNITIES

EASY work! Excellent pay! Assemble products at home. Call for information. (504) 641-8003 Ext. 5192.

MAKE \$50/hr working evenings or weekends in your own electronics business. Send for free facts. INDUSTRY, Box 531, Bronx, NY 10461.

YOUR own radio station! AM, FM, TV, cable. Licensed/unlicensed. BROADCASTING, Box 130-F8, Paradise, CA 95967.

MAKE \$75,000 to \$250,000 yearly or more fixing IBM color monitors (and most brands). No investment. Start doing it from your home. (A telephone required.) Information, USA, Canada \$1.00 cash. US funds. other countries \$8.00 RANDALL DISPLAY, Box 2168-R, Van Nuys, CA 91404 USA.

### GET IN NOW ON THE \$12 BILLION A YEAR COMPUTER SERVICE INDUSTRY



LEARN HOW TO CLEAN/  
MAINTAIN/REPAIR PRINTERS...  
EARN UP TO \$45/HR!

VIEJO'S AWARD-WINNING TRAINING VIDEO AND COMPANION TRAINING MANUAL (OVER 300 ACTION-PACKED PAGES) REVEALS SECRETS OF PRINTER REPAIR. WITH YOUR AVERAGE MECHANICAL ABILITY WE CAN SHOW YOU HOW TO REPAIR UP TO 95% OF ALL PRINTERS - START EARNING EXTRA CASH IN DAYS!

• SERIOUS LACK OF TRAINED TECHNICIANS!  
• HUGE UNTAPPED MARKET!

OVER 37 MILLION PC'S IN USE - APPROXIMATELY 85% HAVE A PRINTER ATTACHED - VAST MAJORITY OF PRINTER BREAKDOWNS ARE DUE TO SIMPLE MECHANICAL OR ELECTRO-MECHANICAL FAILURE.

FREE INFO  
CALL 1-800-537-0589

OR WRITE TO: VIEJO PUBLICATIONS  
3540 WILSHIRE BL # 310  
DEPT RE-2 L.A. CA 90010

EARN \$1000's extra as a part-time computer dealer. Where to buy products at big discounts. Who to sell to. Financing without cash. Obtaining free software. Exclusive dealer trade shows. Step-by-step check list. Industry inside knowledge. Written by industry pioneer. Order now, only \$24.95 plus \$4.00 shipping/handling. CA residents add \$1.81 sales tax. CORNERSTONE PUBLICATIONS, Dept BD, PO Box 5151, San Jose, CA 95150. Allow 2-4 weeks.

EASY! Moneymaking one man CRT rebuilding machinery. \$6,500.00 — \$11,900.00. CRT, 1909 Louise, Crystalake, IL 60014. (815) 459-0666.

LEARN to clean/repair fax machines. Huge new market! Earn \$85/hour. No experience necessary. Free details call 1 (800) 537-0589 or write to: VIEJO PUBLICATIONS, 3540 Wilshire Blvd. #310, Dept. FX200, LA, CA 90010.

INVENTORS: We submit ideas to industry. Find out what we can do for you. Call 1 (800) 288-IDEA.

LET the government finance your small business. Grants/loans to \$500,000. Free recorded message: (707) 449-8600. (KS1).

### WANTED

INVENTIONS/new products/ideas wanted: Call TLCI for free information 1 (800) 468-7200 24 hours/day - USA/Canada.

### ANTIQUE RADIO CLASSIFIED

Free Sample!

Antique Radio's  
Largest Circulation Monthly.  
Articles, Ads & Classifieds.  
6-Month Trial: \$13. 1-Yr: \$24 (\$36-1st Class).  
A.R.C., P.O. Box 802-L6, Carlisle, MA 01741

INVENTORS! Confused? Need help? Call IMPAC for free information package. In US and Canada: 1 (800) 225-5800.

### INVENTORS

INVENTORS! Can you patent and profit from your idea? Call AMERICAN INVENTORS CORPORATION for free information. Over a decade of service 1 (800) 338-5656. In Massachusetts or Canada call (413) 568-3753.

## FREE CATALOG!

1-800-648-7938

For all information 1-702-362-9026

JERROLD HAMLIN OAK ETC.

## CABLE TV DESCRAMBLERS

- Compare our low Low Retail Prices!
  - Guaranteed Prices & Warranties!
  - Orders Shipped Immediately!
- REPUBLIC CABLE PRODUCTS INC.  
4080 Paradise Rd. #15 Dept. RE-90  
Las Vegas, NV 89109

### TEST EQUIPMENT ACCESSORIES

LOW cost oscilloscope probes, multimeter test leads. Save over 50%. 1 (800) 772-1519 free catalog. PROBLEMMASTER INC., 4898 Ronson Court, San Diego, CA 92111-5000.

MASTERCARD AND VISA are now accepted for payment of your advertising. Simply complete the form on the first page of the Market Center and we will bill.

### SATELLITE TV

VIDEOCIPHER II manuals. Volume 1 — hardware. Volume 2 — software. Either \$34.95. Volume 3 — projects/software. Volume 5 Documentation or Volume 6 — Experimentation \$44.95 each. Volume 4 — Repair \$99.95. Cable Hacker's Bible — \$34.95. Clone Hacker's Bible — \$34.95. Catalog — \$3.00. CODs: (602) 782-2316. TELECODE, PO Box 6426-RE, Yuma, AZ 85366-6426.



# CABLE TV EQUIPMENT

Converters, Remote Controls, Descramblers, CD Players.



**JERROLD-OAK-SCIENTIFIC ATLANTA-HAMLIN ZENITH MANY MORE CALL TODAY!**

- ✓ Only quality products sold ✓ Easy to use
- ✓ Satisfaction guaranteed ✓ Knowledgeable sales staff
- ✓ Most orders shipped within 24 hours

**CALL FOR YOUR FREE CATALOG**

**MC 1-800-228-7404 VISA**

**MAKE THE CONNECTION**

**WITH NU-TEK ELECTRONICS**

5114 Balcones Wood Dr. #307 Dept. 298  
Austin, TX. 78759

**FREE catalog** — Lowest prices worldwide, save 40 — 60%. Systems, upgrades, parts, all major brands factory fresh and warranted. **SKYVISION, INC.**, 2009 Collegeway, Fergus Falls, MN 56537. 1 (800) 334-6455. MN & International (218) 739-5231.

**VIDEOCYpher II descrambling manual.** Schematics, video and audio. Explains DES, EPROM, CloneMaster, 3Musketeer, pay-per-view (HBO, Cinemax, Showtime, adult, etc.) \$13.95, \$2.00 postage. Collection of software to copy and alter EPROM codes, \$25. **CABLETRONICS**, Box 30502R, Bethesda, MD 20824.

**CABLE TV secrets** — the outlaw publication of the cable companies tried to ban. HBO, Movie Channel, Showtime, descramblers, converters, etc. Suppliers list included. \$9.95. **CABLE FACTS**, Box 711-R, Pataskala, OH 43062.

K.U. band satellite system. Perfect for R.V. or patio use. For information call (317) 742-6346 or write to **NEW HORIZON ELECTRONICS**, 345 Burnett Road, West Lafayette, IN 47906.

## CABLE TV DESCRAMBLER LIQUIDATION!

- Major Makes & Models!
- Will match or beat anyone's prices!
- Dealer discounts at 5 units!
- Examples:  
HAMLIN COMBOS \$44 ea. (Min. 5)  
OAK ADD/ON \$40 ea. (Min. 5)  
OAK M35B \$60 ea. (Min. 5)

**WEST COAST ELECTRONICS**

For Information: 818-709-1758

Catalogs & Orders: 800-628-9656

## DIGITAL ODOMETER REPAIR

**DIGITAL Odometer:** Replacement chips for damaged odometers easy to install in GM, Ford, & Chrysler. All you need is year, model, & last known mileage. (Caution) You will break the law using this product to falsify odometer readings; this product is for repair only! For ordering information send \$2.00 to **CHIP**, PO Box 3302, Saginaw, MI 48605.

★★★★★ PRESENTING ★★★★★

## CABLE TV DESCRAMBLERS

★★★★★ STARRING ★★★★★

### JERROLD, HAMLIN, OAK

AND OTHER FAMOUS MANUFACTURERS

- FINEST WARRANTY PROGRAM AVAILABLE
- LOWEST RETAIL/WHOLESALE PRICES IN U.S.
- ORDERS SHIPPED FROM STOCK WITHIN 24 HOURS

FOR FREE CATALOG ONLY **1-800-345-8927**  
FOR ALL INFORMATION 1-818-716-5914

**PACIFIC CABLE CO. INC.**  
7325H RESEDA BLVD. DEPT. 1000  
RESEDA, CA 91335

## CABLE TV "BOXES"

Converters — Descramblers  
Remote Controls — Accessories

- ★ Guaranteed Best Prices ★
- ★ 1 Year Warranty — C.O.D.'s ★
- ★ Immediate Shipping ★
- ★ FREE CATALOG ★

Call or Write  
**TRANS-WORLD CABLE CO.**  
12062 Southwest 117th Court, Suite 126  
Miami, Florida 33186  
1-800-442-9333

# MARK V ELECTRONICS, INC.

## QUALITY COMPONENTS \* COMPETITIVE PRICES

▲ indicates the level of difficulty in the assembling of our Products. ▲ Beginner ▲▲ Intermediate ▲▲▲ Advanced ★ Fully Assembled

TA-120MK2

TA-802

TA-3600

TR-355A/B

TY-43

SM-222

SM-328

TA-477

SM-666

transformer

SM-100

SM-49

SM-333

AMPLIFIERS		KIT	ASSMB.	MISCELLANEOUS		KIT	ASSMB.
MODEL	DESCRIPTION			MODEL	DESCRIPTION		
TA-28MK2	Digital Voice Recorder ▲▲	\$ 30.00		TY-23B	3 Channel Color Light Controller ▲▲▲▲	\$ 56.04	\$ 74.50
TA-50A/B	Multi-Purpose Melody Generator ▲	17.84	\$ 16.58	TY-25	Stereo Loudspeaker Protector ▲	12.65	18.88
TA-50C	Multi-Purpose Melody Generator ▲	12.65		TY-35	FM Wireless Microphone ▲	9.22	
TA-120MK2	35W Class "A" Main Power Mono Amp ▲▲	27.16	38.81	TY-36	AC/DC Quartz Digital Clock ▲	18.00	25.20
TA-300	30W Multi-Purpose Single Channel Amp ▲	20.00	29.00	TY-38	Sound/Touch Control Switch ▲	12.00	
TA-302	60W Stereo Power Booster (w/case) ▲▲	50.00	70.00	TY-41MKV	Infrared Remote Control Unit w/case ▲▲▲	20.00	35.00
TA-323A	30Wx2 Stereo Pre-main Amp ▲	29.50	38.35	TY-42	Bar/Dot Level Meter ▲	24.15	
TA-377A	Hi-Quality FET Stereo Pre-Amp ▲▲▲	59.95	75.00	TY-43	3 1/2 Digital Panel Meter ▲	29.00	38.00
TA-400	40W Solid State Mono Amp ▲	28.00	34.93	TY-45	20 Steps Bar/Dot Audio Level Display ▲	38.45	46.14
TA-477	120W Mostet Power Mono Amp ▲▲	68.00	85.00	TY-47	Superior Electronic Roulette ▲▲	19.46	27.24
TA-800	80W+80W DC Pre-Main & Power Amp ▲▲	60.92	79.20	SM-222	7 Band Hi-Fi Graphic Equalizer ▲▲▲▲	26.80	38.80
TA-802	80W+80W DC Stereo Main Power Amp ▲▲	45.94	59.72	SM-328	4 Channel Professional Color Light Controller★		150.00
TA-820A	60W+60W OCL DC Pre-Main Stereo Amp ▲	49.39	49.37	SM-333	Audio/Video Surround Sound Processor ▲▲▲	62.00	83.00
TA-1000A	100W Dynamic Class "A" Main Power Mono Amp ▲▲	59.69	80.58	SM-666	Dynamic Noise Reduction ▲	26.00	34.00
TA-1500	100Wx2 Class "A" DC Stereo Pre-Main Amp ▲▲▲	73.70	95.81	<b>METAL CABINETS WITH ALUMINUM PANEL</b>			
TA-2200	FET Super class "A" DC Pre-Amp ▲▲	47.70	58.24	MODEL	H" x W" x D"	MATCHING	PRICE
TA-2400A	Electronic Echo & Reverberation Amp ▲▲▲★		116.80	LG-1273	3" 12" 7"	TA-2800, TA-377A	\$ 20.16
TA-2500	HQ Pre-Amp. w/10 band graphic equalizer ★		90.80	LG-1684	4" 16" 8"	TA-322i, TA-323A, TA-377A	24.64
TA-2800	Hi-FET IC Pre-Amp. w/3 way tone control ▲	48.90	63.57	LG-1924	4" 19" 11 1/2"	TA-802, TA-820A, TA-1500, TA-120MK2, TA-800,	30.00
TA-3000	Stereo Simulator (mono TV / any mono source) ▲	30.20	41.38	LG-1925	5" 19" 11 1/2"	TA-477, TA-800, TA-1500, TA-1000A	33.00
TA-3600	300W HQ Hi-Fi Power Mono Amp ▲	79.00	103.00	LG-1983	2 1/2" 19" 8"	TA-377A, TA-2800, TA-2200, TA-120MK2	26.50
POWER SUPPLIES		KIT	ASSMB.	POWER TRANSFORMERS			
TR-100A	O-15V 2A Regulated DC Power Supply (case/transformer) ▲▲▲	\$ 69.50		MODEL	DESCRIPTION	MATCHING	PRICE
TR-355A	O-15V 5A Regulated DC Power Supply ▲	14.55	20.76	001	56VCT 60VCT 6A	TA-800, TA-802, TA-820A, TA-1000A, TA-1500	\$ 26.00
TR-355B	O-30V 3A Regulated DC Power Supply ▲	14.55	20.76	002	72VCT 3A	TA-322i, TR-503, TA-323A, TA-400	21.00
TR-503	O-50V 3A Regulated DC Power Supply ▲	15.75	22.65	003	80VCT 6A	TA-477	27.00
SM-43	3 1/2 Multi-Functional Led D.P.M. (w/ABS plastic case) ▲▲	\$ 34.50	\$ 43.00	004	48VCT 6A	TR-120 MK2	21.00
SM-48	4 1/2 Hi-Precision D.P.M. ▲▲▲	38.00	48.00	005	52VCT 3A	TR-355B	15.00
SM-48A	4 1/2 Hi-Precision D.P.M. w/ABS plastic case ▲▲▲	41.20	52.00	006	36VCT 5A	TR-355A	14.50
SM-49	3 1/2 Multi-Functional LCD D.P.M. (w/hold function) ▲	36.00	44.50	007	112VCT 8A	TA-3600	42.00
SM-100	150 MC Digital Frequency Counter ▲▲▲	79.00	90.00				
FC-1000A	1 GHz Frequency Counter ★	179.00					

WE ACCEPT MAJOR CREDIT CARDS MONEY ORDERS AND CHECKS — BUSINESS & SHOWROOM HOURS (PACIFIC TIME): MON-FRI 9:30 A.M. - 5:00 P.M. SAT 10:00 A.M. - 5:00 P.M. TERMS: \$10.00 MIN ORDER \$20.00 MIN CHARGE CARD ORDER

WE SHIP UPS GROUND FOR SHIPPING INSIDE USA (MIN \$3.00) FOR SHIPPING OUTSIDE USA ADD 20% (MIN \$5.00) TRANSIT INSURANCE ADD 5% OF TOTAL (OUTSIDE USA ONLY), CA RESIDENTS ADD SALES TAX 6.75% ALL MERCHANDISE

ARE SUBJECT TO PRIOR SALE PRICES ARE SUBJECT TO CHANGE WITHOUT PRIOR NOTICE WE ARE NOT RESPONSIBLE FOR TYPOGRAPHICAL ERRORS

**MARK V ELECTRONICS, INC. — 8019 E. Slouson Ave, Montebello, CA 90640**

CIRCLE 93 ON FREE INFORMATION CARD

## Be a TV/VCR Repair Specialist

Now you can train at home in spare time for a money-making career as a TV/VCR Repair Specialist. No previous experience necessary. No need to quit your job or school. Everything is explained in easy-to-understand language with plenty of drawings, diagrams and photos. We show you how to troubleshoot and repair video-cassette recorders and TV sets, how to handle house calls and shop repairs for almost any make of television or VCR. Tools are included with your course so you can get "hands-on" practice as you follow your lessons step by step. Send for free facts about the exciting opportunities in TV/VCR Repair and find out how you can start making money in this great career.

**MAIL COUPON TODAY**

K03C

**ICS SCHOOL OF TV/VCR REPAIR**, Dept. DE070  
925 Oak Street, Scranton, PA 18515

Please send me full information and color brochure on how I can learn TV/VCR Repair at home in my spare time. I understand there is no obligation and no salesman will visit me.

Name \_\_\_\_\_ Age \_\_\_\_\_  
Address \_\_\_\_\_ Apt. # \_\_\_\_\_  
City/State \_\_\_\_\_ Zip \_\_\_\_\_  
Phone (\_\_\_\_) \_\_\_\_\_

## EDUCATION & INSTRUCTION

**MAGIC!** Four illustrated lessons plus inside information shows you how. We provide almost 50 tricks including equipment for four professional effects. You get a binder to keep the materials in, and a one-year membership in the International Performing Magicians with a plastic membership card that has your name gold-embossed. You get a one-year subscription to our quarterly newsletter "IT'S MAGIC!" Order now! \$29.95 for each course + \$3.50 postage and handling. (New York residents add applicable state and local sales tax). **THE MAGIC COURSE**, 500-B BiCounty Boulevard, Farmingdale, NY 11735.

**BASIC** video cleaning and maintenance. TV one half hour, VCR one hour. \$38.00 each. **JAMES BRADFORD**, PO Box 38359, Detroit, MI 48238.

**ELECTRONIC review** Detailed electronics reviewing for bettering grades, interviews, and promotions. Over 300 pages \$39.95 include \$4.25 shipping. **USER-GRAPHICS**, Education Department, 7136 Everett, Boise, ID 83704-7415.

**LEARN IBM PC assembly language**. 80 programs. Disk \$5.00. Book \$18.00. **ZIPFAST**, Box 12238, Lexington, KY 40581-2238.

### CABLE T.V. CONVERTERS

**WHY PAY A HIGH MONTHLY FEE?**

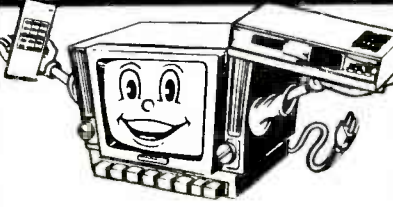

All Jerrold, Oak, Hamlin, Zenith, Scientific Atlanta, Magnavox and all specialized cable equipment available for shipment within 24 hours. For fast service MC / VISA or C.O.D. telephone orders accepted (800) 648-3030 60 Day Guarantee (Quantity Discounts) 8 A.M. to 5 P.M. C.S.T. **CLOSED WEEK-ENDS**. Send self-addressed Stamped envelope (60¢ postage) for Catalog.

**MIDWEST ELECTRONICS INC.**  
P.O. Box 5000  
Suite 311 (R)  
Carpentersville, IL 60110

No Illinois Orders Accepted.

## HARDWARE HACKER

continued from page 72

**PowerMOS** power transistor disk from **Phillips**.

A free sample from **Tektronix**? Welcome to the nineties. They'll be happy to send you a free sample of their new SMT grabbers.

Rounding out the free samples for today are those **Bend-Flex** flexible printed circuits from **Rogers** and the **Conpad** elastomeric battery clip replacements from **Stockwell**.

A **High Current Transistor Design Guide** wall chart is available through **PowerTech**, while **Rochester Electronics** offers an inventory guide to discontinued semiconductors.

**Tec Spec** is an outstanding hacker newsletter chock full of easy-to-build and hands-on stuff, including Van De Graff generators, visible lasers, and do-it-yourself vacuum pumps. A free sample copy of the newsletter is available. Another special-interest newsletter is the **Tesla Coil Builder's Association** quarterly. This one is \$20 per year. **R-E**



**EMINENCE**



**MOTOROLA**

**Polydax**



**PIONEER**

**1-800-338-0531**

### 3-WAY 100W CROSSOVER

12 dB/octave rolloff. 800Hz, 5000Hz crossover points. 8 ohm. 100 watts RMS.



#260-210 **\$12.50** (1-9) **\$9.95** (10-up)

### SPEAKER CONTROL PANEL

Panel with 50 watt L-pads for tweeter and midrange and built-in LED power meter. 5" x 2 1/2" 100 watt version available

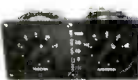

#260-235 **\$14.50** (1-5) **\$12.90** (6-up)

### 12" POLY WOOFER

Super duty. 40 oz. magnet. 100 watts RMS, 145 watts max. 4 and 8 ohm compatible (6 ohm). 2" voice coil. fs = 25 Hz. QTS = 166, VAS = 10.8 cu ft. Response: 25-1500 Hz. Net weight: 9 lbs. Pioneer #A30GU40-51D



#290-125 **\$36.80** (1-3) **\$34.50** (4-up)

### 15" WOOFER

Original Sanyo woofer. Paper cone with vented dust cap and treated cloth surround. 12 oz. magnet. 60 watts RMS, 85 watts max. 8 ohm. Resonance: 26 Hz. Response: 25-2,500 Hz.



#291-155 **\$23.80** (1-5) **\$21.90** (6-up)

### PIONEER HORN TWEETER

Mylar dome. 2.93 oz. barium ferrite magnet. 8 ohm. Response: 1800-20000 Hz. 35W RMS, 50W max. fs = 2000 Hz, SPL = 106 dB. Pioneer #AHE60-51F



#270-050 **\$6.50** (1-9) **\$5.90** (10-up)

### 12" SUB WOOFER

Dual voice coil sub woofer. 30 oz. magnet, 2" voice coils. 100 watts RMS, 145 watts max. fs = 25 Hz. 6 ohm (4 and 8 ohm compatible). SPL = 89 dB 1W/1M. Response: 25-700 Hz. QTS = 31, VAS = 210 cu. ft. Pioneer #A30GU30-55D. Net weight: 6 lbs.



#290-145 **\$39.80** (1-3) **\$36.80** (4-up)

### 15" THRUSTER WOOFER

Thruster by Eminence. Made in USA. Poly foam surround, 56 oz. magnet. 2-1/2", 2 layer voice coil. 150 watts RMS, 210 watts max. 4 ohm. fs = 23.5 Hz. QTS = 33, VAS = 17.9 cu ft. SPL = 94.8 dB 1W/1M. Net weight: 15 lbs.



#290-180 **\$43.50** (1-3) **\$39.80** (4-up)

### GRILL FRAME KIT

With this kit you can make speaker grill frames up to 30" x 40". Kit includes 4 corner pieces, 2 "T" brackets, and 7 frame bars. Grill mounting kit included.



#260-333 **\$8.50** (1-9) **\$7.80** (10-up)

### 18" EMINENCE WOOFER

MADE IN USA

100 oz. magnet, 3" voice coil. 250 watts RMS, 350 watts max. 8 ohm, 30 Hz resonant frequency. 22-2700 Hz response. Efficiency: 95 dB 1W/1M. Paper cone, treated accordion surround. Net weight: 29 lbs.



#290-200 **\$98.90** (1-3) **\$89.50** (4-up)

### TITANIUM COMPOSITE TWEETER

Titanium is deposited on a polymer dome to combine the advantages of both hard and soft dome technologies. 8 ohm. Ferro fluid cooled voice coil. fs = 1200 Hz, SPL = 90 dB 1W/1M. 50 watts RMS, 70 watts max. 4" round. Polydax part #DTW100T12S.



#270-047 **\$27.50** (1-9) **\$24.80** (10-up)

CALL TOLL FREE 1-800-338-0531  
**FREE CATALOG**



340 E. First St., Dayton, Ohio 45402  
Local: 1-513-222-0173  
FAX: 513-222-4644

\* 15 day money back guarantee \* \$15.00 minimum order \* We accept Mastercard, Visa, Discover, and C.O.D. orders \* 24 hour shipping \* Shipping charge = UPS chart rate + \$1.00 (\$3.00 minimum charge) \* Hours: 8:30 am - 6:00 pm EST, Monday - Friday \* Mail order customers, please call for shipping estimate on orders exceeding 5 lbs.



# 13TH ANNIVERSARY SEMICONDUCTOR SALE

Since 1977 we have been supplying Finest Quality components to thousands of satisfied customers worldwide. To celebrate our lucky 13th Anniversary in our new 36,000 square feet facilities, we are offering you one of the broadest lines of Semiconductor products at unbelievably low prices. All items listed below are PRIME First Run products (many with 1990 Date Codes,) obtained directly from respective manufacturers. No 'Seconds', 'Pulls' or 'Rejects'. All ICs listed are in stock, but some quantities are limited.

**This sale will Absolutely end on August 31st, 1990.**

74LSxxx Series				74HCxxx Series				74HCTxxx Series			
Device Type	1-99	Per 100		Device Type	1-99	Per 100		Device Type	1-99	Per 100	
74LS00	\$0.12	\$10.20		74HC000	\$0.14	\$11.80		74HCT00	\$0.12	\$10.00	
74LS01	0.15	13.20		74HC002	0.14	11.80		74HCT02	0.14	11.80	
74LS02	0.15	13.20		74HC003	0.14	11.80		74HCT03	0.14	11.80	
74LS03	0.15	13.20		74HC004	0.14	11.80		74HCT04	0.14	11.80	
74LS04	0.15	13.20		74HC004U	0.14	11.80		74HCT08	0.14	11.80	
74LS05	0.15	13.20		74HC008	0.14	11.80		74HCT10	0.14	11.80	
74LS08	0.15	13.20		74HC10	0.14	11.80		74HCT11	0.14	11.80	
74LS09	0.15	13.20		74HC11	0.14	11.80		74HCT14	0.18	15.20	
74LS10	0.15	13.20		74HC14	0.18	15.20		74HCT20	0.14	11.80	
74LS11	0.15	13.20		74HC20	0.14	11.80		74HCT21	0.14	11.80	
74LS12	0.15	13.20		74HC21	0.14	11.80		74HCT27	0.14	11.80	
74LS13	0.17	14.20		74HC27	0.14	11.80		74HCT30	0.14	11.80	
74LS14	0.18	15.20		74HC30	0.14	11.80		74HCT32	0.14	11.80	
74LS15	0.15	13.20		74HC32	0.14	11.80		74HCT35	0.38	33.20	
74LS20	0.15	13.20		74HC42	0.26	22.20		74HCT36	0.43	37.50	
74LS21	0.15	13.20		74HC73	0.19	16.60		74HCT42	0.26	22.20	
74LS22	0.15	13.20		74HC74	0.19	16.60		74HCT73	0.19	16.60	
74LS26	0.17	14.20		74HC75	0.19	16.60		74HCT74	0.19	16.60	
74LS27	0.15	13.20		74HC85	0.29	25.00		74HCT75	0.19	16.60	
74LS28	0.17	14.20		74HC86	0.19	16.60		74HCT85	0.29	25.00	
74LS30	0.15	13.20		74HC93	0.27	23.60		74HCT86	0.19	16.60	
74LS32	0.12	10.20		74HC107	0.21	18.00		74HCT93	0.27	23.60	
74LS33	0.15	13.20		74HC109	0.21	18.00		74HCT107	0.21	18.00	
74LS37	0.15	13.20		74HC112	0.24	20.80		74HCT109	0.21	18.00	
74LS38	0.15	13.20		74HC123	0.26	22.20		74HCT112	0.24	20.80	
74LS40	0.15	13.20		74HC125	0.22	19.50		74HCT123	0.26	22.20	
74LS42	0.19	16.60		74HC126	0.24	20.80		74HCT125	0.26	22.20	
74LS47	0.35	30.50		74HC132	0.22	19.50		74HCT126	0.24	20.80	
74LS48	0.35	30.50		74HC137	0.26	22.20		74HCT132	0.22	19.50	
74LS51	0.15	13.20		74HC138	0.21	18.00		74HCT137	0.26	22.20	
74LS54	0.15	13.20		74HC139	0.21	18.00		74HCT138	0.21	18.00	
74LS55	0.15	13.20		74HC147	0.32	27.70		74HCT139	0.21	18.00	
74LS73	0.18	15.20		74HC151	0.24	20.80		74HCT147	0.32	27.70	
74LS74	0.15	13.20		74HC153	0.24	20.80		74HCT151	0.24	20.80	
74LS75	0.19	16.60		74HC154	0.24	20.80		74HCT153	0.24	20.80	
74LS76	0.19	16.60		74HC157	0.22	19.50		74HCT154	0.77	67.80	
74LS78	0.19	16.60		74HC158	0.24	20.80		74HCT157	0.22	19.50	
74LS85	0.19	16.60		74HC160	0.29	25.00		74HCT158	0.24	20.80	
74LS86	0.19	16.60		74HC161	0.29	25.00		74HCT160	0.29	25.00	
74LS90	0.24	20.80		74HC162	0.29	25.00		74HCT161	0.29	25.00	
74LS91	0.28	24.00		74HC163	0.29	25.00		74HCT162	0.29	25.00	
74LS92	0.22	19.50		74HC164	0.24	20.80		74HCT163	0.29	25.00	
74LS93	0.24	20.80		74HC165	0.24	20.80		74HCT164	0.24	20.80	
74LS96	0.28	24.00		74HC166	0.26	22.20		74HCT165	0.24	20.80	
74LS107	0.19	16.60		74HC173	0.32	27.70		74HCT166	0.26	22.20	
74LS109	0.19	16.60		74HC174	0.26	22.20		74HCT173	0.32	27.70	
74LS112	0.19	16.60		74HC175	0.26	22.20		74HCT174	0.26	22.20	
74LS113	0.19	16.60		74HC181	0.77	67.80		74HCT175	0.24	20.80	
74LS114	0.19	16.60		74HC182	0.27	23.60		74HCT181	0.77	67.80	
74LS122	0.19	16.60		74HC190	0.29	25.00		74HCT182	0.27	23.60	
74LS123	0.19	16.60		74HC191	0.29	25.00		74HCT190	0.29	25.00	
74LS127	0.19	16.60		74HC192	0.29	25.00		74HCT191	0.29	25.00	
74LS125	0.12	10.20		74HC195	0.26	22.20		74HCT192	0.29	25.00	
74LS126	0.19	16.60		74HC221	0.30	26.40		74HCT193	0.29	25.00	
74LS132	0.21	18.00		74HC222	0.30	26.40		74HCT194	0.26	22.20	
74LS133	0.15	13.20		74HC237	0.29	25.00		74HCT195	0.26	22.20	
74LS136	0.21	18.00		74HC238	0.27	23.60		74HCT221	0.30	26.40	
74LS138	0.22	19.50		74HC240	0.30	26.40		74HCT237	0.29	25.00	
74LS139	0.22	19.50		74HC241	0.30	26.40		74HCT238	0.24	20.80	
74LS145	0.27	23.60					74HCT240	0.30	26.40		
74LS148	0.41	36.00					74HCT241	0.30	26.40		
74LS151	0.22	19.50					74HCT242	0.29	25.00		
74LS152	0.23	19.50					74HCT243	0.29	25.00		
74LS153	0.22	19.50					74HCT244	0.30	26.40		
74LS155	0.22	19.50					74HCT245	0.32	27.70		
74LS156	0.23	19.50					74HCT251	0.27	23.60		
74LS157	0.21	18.00					74HCT253	0.26	22.20		
74LS158	0.22	19.50					74HCT257	0.24	20.80		
74LS160	0.24	20.80					74HCT258	0.27	23.60		
74LS161	0.24	20.80					74HCT259	0.29	25.00		
74LS162	0.24	20.80					74HCT266	0.22	19.50		
74LS163	0.24	20.80					74HCT273	0.30	26.40		
74LS164	0.26	22.20					74HCT280	0.29	25.00		
74LS165	0.24	20.80					74HCT283	0.29	25.00		
74LS166	0.38	33.20					74HCT297	0.66	58.20		
74LS168	0.44	38.80					74HCT299	0.41	36.00		
74LS169	0.44	38.80					74HCT354	0.38	33.20		
74LS170	0.40	35.00					74HCT356	0.33	29.10		
74LS173	0.26	22.20					74HCT365	0.30	26.40		
							74HCT366	0.30	26.40		

### 4xxx CMOS Series

Device Type	1-99	Per 100
4001B	\$0.12	\$10.00
4002B	0.15	12.50
4006B	0.38	33.20
4007UB	0.15	12.50
4008B	0.33	29.10
4009UB	0.27	23.60
4010UB	0.27	23.60
4011B	0.15	12.50
4012B	0.15	12.50
4013B	0.19	16.60
4014B	0.33	29.10
4015B	0.33	29.10
4016B	0.21	18.00
4017B	0.33	29.10
4018B	0.33	29.10
4019B	0.21	18.00
4020B	0.33	29.10
4021B	0.33	29.10

### Z80A/B Series

Device Type	1-99	Per 100
Z80A-CPU	\$0.85	\$7.50
Z80A-DMA	1.70	15.00
Z80A-PIO	0.85	7.50
Z80A-CTC	0.85	7.50
Z80A-SIO/0	1.99	17.50
Z80A-SIO/1	1.99	17.50
Z80A-SIO/2	1.99	17.50
Z80A-SIO/9	1.70	15.00
Z80A-DART	1.14	10.00
Z80B-CPU	1.70	15.00
Z80B-PIO	1.70	15.00
Z80B-CTC	1.70	15.00
Z80B-SIO/0	2.84	25.00
Z80B-SIO/1	2.84	25.00
Z80B-SIO/2	2.84	25.00
Z80B-DART	3.40	30.00



For a FREE copy of our New Catalog (Available Mid October), please circle Reader Service Card.

1803 N.W. Lincoln Way • Toledo, OR 97391

PHONE (All 50 States & Canada): 1-800-325-0101

FAX: (503) 336-4400 • Hours: 6:00 AM - 6:00 PM PST



**Intel Math Coprocessors**

**8088 or 8086 Systems**

8087	5MHz	\$89.95
8087-2	8MHz	\$129.95
8087-1	10MHz	\$169.95

**80286 Systems**

80287	6MHz	\$139.95
80287-8	8MHz	\$209.95
80287-10	10MHz	\$239.95

**80386 Systems**

80387-16	16MHz	\$349.95
80387-20	20MHz	\$399.95
80387-25	25MHz	\$499.95
80387-33	33MHz	\$649.95

**SIP Modules**

41256A9A-80	80ns, 256Kx9	\$54.95
41256A9A-10	100ns, 256Kx9	\$44.95
421000A9A-70	70ns, 1Mx9	\$169.95
421000A9A-80	80ns, 1Mx9	\$124.95
421000A9A-10	100ns, 1Mx9	\$116.95
94000L-80	80ns, 4Mx9	\$499.95
94000L-10	100ns, 4Mx9	\$499.95

**SIMM Modules**

41256A9B-80	80ns, 256Kx9	\$49.95
41256A9B-10	100ns, 256Kx9	\$39.95
421000A8B-10	100ns, 1Mx8	\$109.95
421000A9B-70	70ns, 1Mx9	\$139.95
421000A9B-80	80ns, 1Mx9	\$119.95
421000A9B-10	100ns, 1Mx9	\$113.95
94000S-80	80ns, 4Mx9	\$499.95
94000S-10	100ns, 4Mx9	\$499.95

**NEC V20 & V30 Chips**

UPD70108-5	5MHz, V20 Chip	\$5.25
UPD70108-8	8MHz, V20 Chip	\$6.95
UPD70108-10	10MHz, V20 Chip	\$10.95
UPD70116-8	8MHz, V30 Chip	\$7.95
UPD70116-10	10MHz, V30 Chip	\$13.49

**Dynamic RAMs**

TMS4416-12	120ns, 16Kx4	\$2.25
TMS4416-15	150ns, 16Kx4	\$2.00
4116-12	120ns, 16Kx1	\$1.49
4116-15	150ns, 16Kx1	\$1.09
4116-20	200ns, 16Kx1	\$.89
4164-100	100ns, 64Kx1	\$2.75
4164-120	120ns, 64Kx1	\$2.39
4164-150	150ns, 64Kx1	\$2.15
4164-200	200ns, 64Kx1	\$1.75
41256-60	60ns, 256Kx1	\$5.25
41256-80	80ns, 256Kx1	\$3.75
41256-100	100ns, 256Kx1	\$3.15
41256-120	120ns, 256Kx1	\$2.95
41256-150	150ns, 256Kx1	\$2.59
4164A-80	80ns, 64Kx4	\$5.95
4164A-10	100ns, 64Kx4	\$4.95
4164A-12	120ns, 64Kx4	\$3.95
4164A-15	150ns, 64Kx4	\$3.59
511000P-70	70ns, 1Mx1	\$13.95
511000P-80	80ns, 1Mx1	\$12.95
511000P-10	100ns, 1Mx1	\$12.35
514256P-80	80ns, 256Kx4	\$13.45
514256P-10	100ns, 256Kx4	\$12.95

**Static RAMs**

6116P-3	150ns, 16Kx1 (CMOS)	\$2.79
6264LP-10	100ns, 64Kx1 (CMOS)	\$6.95
6264LP-15	150ns, 64Kx1 (CMOS)	\$4.95
43256-10L	100ns, 256Kx1	\$10.95
43256-15L	150ns, 256Kx1	\$9.95
62256LP-15	150ns, 256Kx1 (CMOS)	\$10.95

**PROTOTYPING PRODUCTS**  
**Jameco Solderless Breadboards**

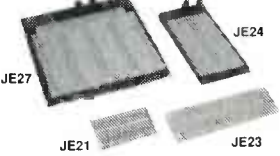

Part No.	Dim. L" x W"	Contact Points	Binding Posts	Price
JE21	3.25 x 2.125	400	0	\$4.95
JE23	6.5 x 2.125	830	0	\$6.95
JE24	6.5 x 3.125	1,360	2	\$12.95
JE25	6.5 x 4.25	1,660	3	\$17.95
JE26	6.875 x 5.75	2,390	4	\$22.95
JE27	7.25 x 7.5	3,220	4	\$32.95

**Oscilloscope Probes**

- Attenuation: x1 / x10
- Capacitance (LF180): 180pF / 22pF; (LF210): 40pF / 17pF

LF180	40MHz Oscilloscope Probe	\$19.95
LF210	100MHz Oscilloscope Probe	\$29.95

**GoldStar 20MHz Oscilloscope and 1GHz Frequency Counter**



GS7020	Oscilloscope	\$399.95
FC7102	Frequency Counter	\$299.95

- Large 6" rectangular display
- High sensitivity: 1 mV/div
- Wide measuring range
- Measured value hold function

**Metex Digital Multimeters**



**General Specs:**

- Handheld, high accuracy • AC/DC voltage, AC/DC current, resistance, diodes, continuity, transistor hFE
- Manual ranging w/ overload protection

M3650, 3650B & M4650 only:		
	Also measure frequency and capacitance	
M4650 only:	Data hold switch • 4.5 digit	
M3610	3.5 Digit Multimeter	\$49.95
M3650	3.5 Digit Multimeter w/Frequency & Capacitance	\$69.95
M3650B	Same as M3650 w/Bargraph	\$74.95
M4650	4.5 Digit w/Frequency, Capacitance and Data Hold Switch	\$99.95

**Multimeter Specials**

M80:	AC/DC voltage, AC/DC current, resistance, diodes, continuity & frequency • Full auto-ranging on DC voltage • High/low semi-auto-ranging for AC/DC current and ohms • Data hold switch • Extra-large display	
M80	3.75 Digit Multimeter	\$59.95
M3900:	AC/DC voltage, AC/DC current, resistance, diodes, continuity, dwell angle and engine RPM • High surge voltage protection	
M3900	3.5 Digit Multimeter	\$59.95

**Prototype Design Stations**

**WM1 & WM2 Features:**

- Removable solderless breadboard
- Variable and fixed DC power supply
- Multi-frequency signal generator
- Analog multimeter
- 8 bicolor LEDs (red & green)
- 8 logic switches
- Logic probe
- Lighted power switch
- Fuse overload protected
- Sturdy ruggedized case

**WM1 Special Features:**

- 4 potentiometers
- Built-in speaker

**WM2 Special Features:**

- Pulse Generator
- Binary coded decimal (BCD) to 7-segment decoder/driver
- DB25 connector
- Frequency counter (1Hz to 1MHz)

**WM1 Analog Prototype Station .....\$199.95**  
**WM2 Digital Prototype Station .....\$249.95**



**A.R.T. EPROM Programmer**

Programs all current EPROMs in the 2716 to 27512 range plus the X2864 EEPROM

**EPP.....\$179.95**

**UVP EPROM Eraser**

Erases all EPROM's • Erases 1 chip in 15 Min. and 8 chips in 21 min. • UV intensity: 6800 UW/CM<sup>2</sup>

**DE4.....\$69.95**



**Soldering and Desoldering Stations**

**60 Watt Analog Display Soldering Station** • Electronic temperature control from 200° to 878°F • Cartridge heating element for a longer life of the soldering tip

**XY1683 .....\$59.95**

**60 Watt Analog Display Soldering Station** • Electronic temperature control from 200° to 878°F • Ceramic heating element for a steady temperature and long life

**XY2660 .....\$89.95**

**60 Watt Digital Display Soldering Station** • Electronic temperature control from 200° to 878°F • Temperature displayed on easy to read 560°H 3-digit LED readout • Nichrome heating element

**XY960 .....\$99.95**

**30 Watt Electronic Temperature Controlled Desoldering Station** • Electronic temperature control from 212° to 842°F • Self-contained high rotary vacuum pump

**XY999 .....\$279.95**

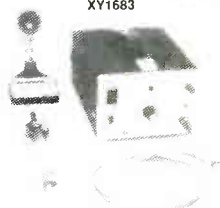

**51-Piece Electronic Tool Kit**

The MS305 provides the tools needed for building, repairing and general maintenance of most electronic equipment. A convenient and durable carry-along combination lock case safely protects and secures this 51-piece tool kit. From the digital multimeter to the desoldering pump this kit is the perfect item for technicians and electronic enthusiasts.



**Tools Included in Kit**

- 10' measuring tape
- Electric tape
- 6" long tweezers
- 7" brush and scraper
- 7" fine point probe
- 7" slotted probe
- Rosin core solder
- 30 watt soldering iron
- Desoldering pump
- Soldering stand
- Stainless steel scissors
- Utility components box
- 8 pcs. hex key wrench
- Digital Multimeter
- Round needle file
- Flat needle file
- 6" adjustable wrench
- Utility knife with extra blade
- Bent needle nose pliers
- Diagonal cutting pliers
- 5.25" needle nose pliers
- 6 piece precision screwdriver set
- Brush
- 10 piece screwdriver set: 5 Slotted & 5 Phillips
- Flat nose pliers
- Carrying case: 17.63"W x 12.5"D x 3.5"H

**MS305.....\$119.95**

**Partial Listing • Over 4000 Components and Accessories in Stock! • Call for Quantity Discounts**

**CIRCLE 114 ON FREE INFORMATION CARD**



Request Jameco's 1990 Catalog for a Complete Listing of Components, Test/Measurement Equipment and Computer Products

**Jameco 20MHz 80386 Desktop Computer Kit**

- Fully IBM Compatible
- Free! Concurrent 386 (Disk Operating System) Software Included
- 4MB RAM Included, Expandable to 8MB on board, 16MB with optional expansion board
- 8/16/20MHz Keyboard Switchable Operation
- AMI BIOS ROMs Included
- Liptop Case w/200 Watt Power Supply
- Conner High-Performance IDE 3.5" 40MB Hard Disk Drive
- Teac 1.2MB Floppy DSHD Disk Drive
- Multi I/O Card with Universal Floppy Controller
- Fujitsu 101-Key (Enhanced) Keyboard



Shown with VGA Option (not included)  
 JE2059 Multiscan Monitor and VGA Card...\$669.90 (See Below)

**JE3551** 20MHz 80386 Compatible Kit.....\$1949.95

**Jameco IBM PC/XT/AT Compatible Cards**

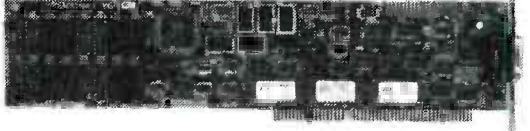

JE1057

- JE1043** 360KB/720KB/1.2MB/1.44MB Floppy Disk Controller Card (PC/XT/AT) .. \$49.95
- JE1050** Monochrome Graphics Card w/Parallel Printer Port (PC/XT/AT) ..... \$49.95
- JE1052** Color Graphics Card w/ Parallel Printer Port (PC/XT/AT) ..... \$49.95
- JE1055** EGA Card w/ 256KB Video RAM (PC/XT/AT).....\$139.95
- JE1057** 8/16-Bit VGA Card w/ 256KB Video RAM (PC/XT/AT).....\$199.95
- JE1060** I/O Card w/ Serial, Game, Printer Port & Real Time Clock (PC/XT) ... \$59.95
- JE1062** RS232 Serial Half Card (PC/XT/AT) ..... \$29.95
- JE1065** I/O Card w/ Serial, Game and Parallel Printer Port (AT).....\$59.95
- JE1077** Multi I/O Card w/ 360KB/720KB/1.2MB/1.44MB Floppy Controller (AT) .. \$99.95

**EGA, VGA & Multiscan Monitor Packages**

Relisys 14" EGA monitor and EGA card package (640 x 350 max. resolution)

**JE1059** EGA Monitor & EGA Card..... \$509.90

Relisys 14" Multiscan monitor and 16-bit VGA card package (640 x 480 max. resolution)

**JE2059** Multiscan Monitor & VGA Card ..... \$669.90

Relisys 14" VGA monitor and 16-bit VGA card package (640 x 480 max. resolution)

**JE2061** VGA Monitor & VGA Card..... \$629.90



JE2061

**IBM PC/XT/AT Compatible Keyboards**



FKB4700

- JE2015** 84-Key Standard AT Style Layout ..... \$59.95
- FKB4700** 101-Key Enhanced Layout with 12 Function Keys ..... \$69.95

**MEI 100-Key Microtype Keyboard**

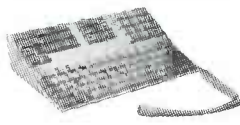

- IBM PC/XT/AT/386 Compatible
- Saves an amazing 60% of the desk space used by equivalent standard keyboards

**MIRU**.....\$129.95

**Jameco Digitizer Tablet**



- AutoCAD 10 template and four-button puck • Resolution: up to 1016 lines per inch • Accuracy: ±.025" • Emulates three of the worlds most popular formats: Summagraphics MM, Summagraphics Bit Pad One, Calcomp 2000 • EEPROM allows custom configuration

**JCAD** Digitizer Tablet \$199.95  
**Stylus** Two Button Stylus .... \$39.95

**Logitech ScanMan Plus Scanner**

- IBM PC/XT/AT Compatible
- 4" Scanning Window
- 400 dpi



**SCANP**.....\$219.95

**Logitech Mouse**



**MSER** Serial Mouse & MouseWare Software ..... \$89.95

**MBUS** Mouse w/Bus Board & MouseWare Software ..... \$99.95

**MPS2** PS/2 Mouse & MouseWare Software ..... \$79.95

**Modems**



9600E Pictured

**External Modems**

- 1200C** Datalronics 1200 Baud ..... \$89.95
- 2400C** Datalronics 2400 Baud ..... \$149.95
- 9600E** Prometheus 9600 Baud ..... \$699.95

**Internal Modems**

- 1200B** Jameco 1200 Baud ..... \$49.95
- 2400B** Jameco 2400 Baud ..... \$99.95

Modems listed above include ProComm Software

**IBM Compatible Cases and Power Supplies**



JE1030

JE2012

- JE1010** Flip-Top Standard PC/XT Case ..... \$39.95
- JE1011** Slide Standard PC/XT Case ..... \$39.95
- JE1030** 150 watt PC/XT Power Supply..... \$59.95
- JE1032** 200 watt Baby AT Power Supply ..... \$89.95
- JE1035** 300 watt AT Power Supply ..... \$139.95
- JE2011** Vertical Case w/300W Pwr. Supply ..... \$269.95
- JE2012** Mini Vertical Case w/200W Pwr. Supply ..... \$169.95
- JE2019** Flip-Top Baby AT Case.....\$69.95

**Floppy Disk Drives**

MF353B



- Mitsubishi MF353B** 3.5" 720KB Internal Drive ..... \$99.95
- Toshiba 356KU** 3.5" 1.44MB Internal Drive .. \$109.95
- Teac FD55B** 5.25" 360KB Internal Drive ... \$89.95
- FD55G** 5.25" 1.2MB Internal Drive .... \$99.95

**MiniScribe Hard Drives**



- MFM M8425** 20MB (68ms) 3.5"HH ..... \$229.95
- M8425XT** 20MB (68ms) 3.5"HH (Kit) ..... \$289.95
- M8425AT** 20MB (68ms) 3.5"HH (Kit) ..... \$339.95

**RLL**

- M8438** 30MB (68ms) 3.5"HH ..... \$249.95
- M8438XT** 30MB (68ms) 3.5"HH (Kit) ..... \$299.95
- M8438AT** 30MB (68ms) 3.5"HH (Kit) ..... \$389.95
- M8450** 40MB (46ms) 3.5"HH ..... \$329.95
- M8450XT** 40MB (46ms) 3.5"HH (Kit) ..... \$369.95
- M8450AT** 40MB (46ms) 3.5"HH (Kit) ..... \$429.95

(Kit) includes Hard Disk Drive, Controller & Cables

**Colorado Memory Systems 40MB Tape Back-Up**

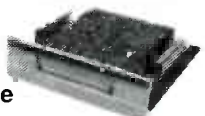

- IBM PC/XT/AT/386 Compatible • Back-up 40MB in 40 minutes • Back-up 60 to 120MB with extended tapes and data compression software • Includes 40MB tape cartridge

- DJ10** 40MB Tape Back-Up..... \$329.95
- KE10** External Enclosure Kit ..... \$149.95
- TB40** 40MB Tape Cartridge ..... \$24.95
- TB60** 60MB Tape Cartridge ..... \$32.95

1355 Shoreway Road, Belmont, CA 94002

**24 Hour Order Hotline**  
 (415) 592-8097

\$50.00 Minimum Order

FAX's (415) 592-2503 or (415) 595-2664  
 Telex 176043 - Ans. Back: Jameco Blmt  
 Data Sheets - 50¢ each  
 For a FREE 48-Page Flier send \$2.00 to cover First Class Postage and Handling  
 © 1990 Jameco Electronics 8/90

**CA Residents Add**

6.25%, 6.75% or 7.25% Sales Tax  
 Shipping - Add 5% plus \$1.50 Insurance  
 (May vary according to weight and shipping method)  
 Terms: Prices subject to change without notice.  
 Items subject to availability and prior sale.

Complete list of terms, warranties is available upon request.  
 IBM is a registered trademark of International Business Machines



Please refer to Mail Key 2 when ordering

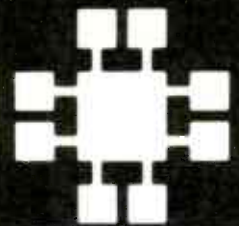

# JDR Microdevices

• 30 DAY MONEY BACK GUARANTEE • 1 YEAR WARRANTY ON ALL PRODUCTS • TOLL-FREE TECHNICAL SUPPORT

**MMC**  
MICROCOMPUTER  
MARKETING COUNCIL  
of the Direct Marketing Association Inc.

**DEVELOPERS' WORLD** JDR caters to the developer with a full line of prototyping & programming products. Request our catalog for the complete line!

## MODULAR PROGRAMMING SYSTEM

MODULES USE A COMMON HOST ADAPTOR CARD--1 SLOT PROGRAMS EPROMS, PROMS, PALS, MORE!

### HOST ADAPTOR CARD \$29.95

- UNIVERSAL INTERFACE FOR ALL PROGRAMMING MODULES!
- SELECTABLE ADDRESSES PREVENTS CONFLICTS
- MOLDED CABLE
- MOD-MAC



### UNIVERSAL MODULE \$499.95

- PROGRAMS EPROMS, EEPROMS, PALS, BI-POLAR PROMS, 8748 & 8751 SERIES DEVICES; 16V8 AND 20V8 GALs (GENERIC ARRAY LOGIC) FROM LATTICE, NS, SGS • TESTS TTL, CMOS, DYNAMIC & STATIC RAMS • LOAD DISK, SAVE, DISK, EDIT, BLANK CHECK, PROGRAM, AUTO, READ MASTER, VERIFY AND COMPARE • TEXT TOOL SOCKET FOR 3" 6"W. IC'S (8-40 PINS)

#### MOD-MUP

MOD-MPL-SOFT CUPL SOFTWARE ..... \$99.95

### EPROM MODULE \$119.95

- PROGRAMS 24-32 PIN EPROMS, CMOS EPROMS & EEPROMS FROM 1K TO 1024K • HEX TO OBJ CONVERTER • AUTO, BLANK CHECK/PROGRAM/VERIFY • VPP 5, 12.5, 12.75, 13, 21 & 25 VOLTS • NORMAL, INTELLIGENT, INTERACTIVE & QUICK PULSE PROGRAMMING ALGORITHMS

#### MOD-MEP

**OTHER MODULES:** PAL PROGRAMMER, DIGITAL TESTER, BI-POLAR PROGRAMMER, MICROPROCESSOR PROGRAMMER FROM \$129.95 TO \$259.95--CALL FOR INFORMATION

### EPROM PROGRAMMER \$129.95

- PROGRAMS 27XX AND 27XXX EPROMS UP TO 27512
- SUPPORTS VARIOUS PROGRAMMING FORMATS & VOLTAGES
- SPLIT OR COMBINE CONTENTS OF SEVERAL EPROMS OF DIFFERENT SIZES
- READ, WRITE, COPY, BLANK CHECK & VERIFY
- SOFTWARE FOR HEX AND INTEL HEX FORMATS

#### MOD-EPROM

#### EPROMS

27128	16384x8	250ns	12.5V	28	4.25
27128A-200	16384x8	200ns	12.5V	28	5.95

PARTIAL LISTINGS ONLY - MANY OTHERS AVAILABLE!

### EPROM ERASERS

#### DATABASE II \$39.95

- SHIRT POCKET SIZE!
- ALL SIZES UP TO 4 AT A TIME
- ERASES MOST EPROMS IN 3 MINUTES

#### DATABASE II

PE-140T SPECTRONICS 9 CHIP ERASER W/TIMER ... \$139.95

### PROTOTYPE CARDS

FR-4 EPOXY GLASS LAMINATE WITH GOLD PLATED EDGE CARD FINGERS AND SILK SCREENED LEGENDS



#### FOR XT

JDR-PR1	WITH +5V AND GROUND PLANE	27.95
JDR-PR2	ABOVE WITH I/O DECODING LAYOUT	29.95
JDR-PR2-PK	PARTS KIT FOR JDR-PR2 ABOVE	8.95

#### FOR AT

JDR-PR10	16-BIT WITH I/O DECODING LAYOUT	34.95
JDR-PR10-PK	PARTS KIT FOR JDR-PR10 ABOVE	12.95

#### EXTENDER CARDS

#### SIMPLIFY PROTOTYPING AND TESTING

EXT-8088	8-BIT FOR 8088 MOTHERBOARDS	29.95
EXT-80286	16-BIT FOR 286/386 MOTHERBOARDS	39.95

## BUILD YOUR OWN 286 SYSTEM FOR UNDER \$650

IT'S A GREAT WAY TO LEARN AND A GREAT WAY TO SAVE! HERE'S JUST ONE OF OUR MOST POPULAR CONFIGURATIONS:

MCT-M286-12	8/12MHZ MINI 286 MOTHERBOARD	\$199.95
MCT-MGP	MONOCHROME GRAPHICS ADAPT	\$49.95
MCT-FDC-HD	360K-1.44MB FLOPPY CONTROLLER	\$49.95
CASE-JR	MINI FLIP-TOP CASE W/150W P.S.	\$149.95
FDD-360	360K 5-1/4" FLOPPY DISK DRIVE	\$69.95
JDR-MONO	MONOCHROME MONITOR (GREEN)	\$69.95
BTC-5060	STANDARD 84-KEY KEYBOARD	\$59.95
TOTAL SYSTEM (OK INSTALLED)		\$649.65

### OPTIONAL COMPONENTS

#### MOTHERBOARDS

MCT-TURBO-10	4.77/10MHZ SINGLE CHIP 8088	\$99.95
MCT-M286-16N	8/16MHZ 286 W/NEAT CHIPSET	\$289.95
MCT-M286-20N	10/20MHZ 286 W/NEAT CHIPSET	\$389.95

#### Littlefoot™

### UPRIGHT CASE \$249.95

SPACE SAVING DESIGN HOLDS ALL SIZES OF MOTHERBOARDS AND INCLUDES A 250 WATT POWER SUPPLY

- MOUNTS FOR 3 FLOPPY AND 4 HARD DRIVES
- TURBO & RESET SWITCH
- LED SPEED DISPLAY

#### CASE-100

CASE-FLIP FLIP TOP CASE FOR 8088 MBS ..... \$39.95

#### POWER SUPPLIES

PS-150	150 WATT SUPPLY FOR 8088'S	\$59.95
PS-200X	200 WATT SUPPLY FOR 8088'S	\$89.95
PS-200	200 WATT SUPPLY FOR 286/386'S	\$89.95

#### KEYBOARDS

BTC-5339	101 KEY ENHANCED KEYBOARD	\$69.95
MAX-5339	101 KEY W/TACTILE FEEDBACK (286)	\$69.95

#### DRIVE CONTROLLERS

MCT-FDC-HD4	4-FLOPPY DISK CONTROLLER	\$59.95
MCT-HDC	HARD DISK CONTROLLER	\$79.95
MCT-AFH	286/386 FLOPPY/HARD CONTROL	\$149.95

#### MEMORY/MULTIFUNCTION CARDS

MCT-RAM	576K RAM CARD (OK)	\$49.95
MCT-IO	MULTI I/O CARD	\$59.95

### 1.44MB FLOPPY DRIVE \$99.95

- ULTRA-HIGH DENSITY
- READ/WRITE 720K DISKS TOO
- BLACK OR BEIGE

FDD-1.44X	BLACK FDD-1.44A BEIGE	
FDD-1.2	5-1/4" DS/HD 1.2MB FLOPPY	\$95.95

### SEAGATE HARD DRIVES

#### 21.4MB KIT \$249

#### 32.1MB KIT \$279

65MS AVG. ACCESSORY KIT INCLUDES INSTRUCTIONS, XT-COMPATIBLE CONTROLLER AND CABLES. CALL FOR PRICES ON OTHER SEAGATE DRIVES



### VGA COMPATIBLE PACKAGE \$499.95

- 720 X 540 MAX RESOLUTION, 640 X 480 IN 16 COLORS, 528 X 480 RESOLUTION IN 256 COLORS
- IBM STYLE MONITOR
- VGA, EGA, CGA, AND MGA COMPATIBLE

#### VGA-PKG (INCLUDES VGA CARD AND MONITOR)

JDR-RGB	14" RGB MONITOR	\$239.95
JDR-AMBER	12" TTL MONOCHROME-AMBER	\$69.95

### 16-BIT VGA DISPLAY ADAPTOR \$199.95

- 640 X 480 RESOLUTION
- 256K VIDEO RAM, EXPANDABLE TO 512K
- 64 LEVELS OF GREY SCALE

#### MCT-VGA-16

MCT-EGA ENHANCED GRAPHICS ADAPTOR \$149.95

MCT-MGMIO MONOGRAPHICS MULTI I/O ..... \$119.95

### 2400 BAUD MODEM \$89.95

- 2400/1200/300 BAUD HAYES COMPATIBLE
- CONFIGURE AS COM1, 2, 3 OR 4
- BUILT-IN SPEAKER • PROCOMM COMMUNICATIONS SOFTWARE

#### MCT-241

MCT-121 1200 BAUD INTERNAL MODEM ..... \$59.95

### DYNAMIC RAMS

PART#	SIZE	SPEED	PINS	PRICE
4164-150	65536x1	150ns	1E	2.49
41256-150	262144x1	150ns	1E	2.59
41256-120	262144x1	120ns	1E	2.95
41256-100	262144x1	100ns	1E	3.15
41256-80	262144x1	80ns	1E	3.75
1 MB-80	1048576x1	80ns	1E	12.95

### 35MHZ DUAL TRACE OSCILLOSCOPE

## \$499.95

- WIDE BAND WIDTH
- VARIABLE HOLDOFF
- 1X/10X PROBES
- FULL 2 YEAR WARRANTY

#### MODEL-3500

#### MODEL-2000

20MHZ VERSION \$389.95

DMM-300	34 RANGES, ±0.25%, TEMP & TRANS TEST	\$79.95
DMM-200	3.5 DIGIT, 22 RANGES, ±0.25% ACCURACY	\$49.95
DMM-100	3.5 DIGIT, 14 RANGES, ±0.5% ACCURACY	\$29.95

ALL JDR INSTRUMENTS PRODUCTS WARRANTED 2 YEARS

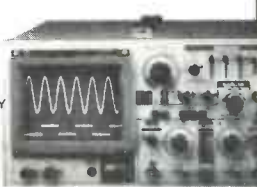

Jim Wharton  
JDR's VP Sales

## JIM'S BARGAIN HUNTERS CORNER

**\$19.95**

### 112 WATT SWITCHING POWER SUPPLY

- OPEN-FRAMED POWER SUPPLY MADE BY DELTA
- +5 @ 10A, +12V @ 3.5A, +12V @ 1.5A, -12 @ 200mA
- MEASURES 5 X 8.5 X 1.97" • WEIGHS 2.3 LBS.

#### PS-DPS-110AP

EXPIRES 7/15/90

UPGRADE YOUR OLD SYSTEM! REQUEST OUR NEW FLYER TO LEARN HOW!

# ORDER TOLL FREE 800-538-5000 KEY CODE 12

CUSTOMER SERVICE TOLL-FREE 800-538-5001 • TECHNICAL SUPPORT TOLL-FREE 800-538-5002

Terms: Minimum order \$10.00. For shipping & handling include \$4.00 for ground and \$5.00 for air. Orders over 1 lb and foreign orders may require additional shipping charges—please contact the sales department for the amount. CA residents must include applicable sales tax. Prices subject to change without notice. We are not responsible for typographical errors. We reserve the right to limit quantities and to substitute manufacturer. All merchandise subject to prior sales. A full copy of our terms is available upon request. Items pictured may only be representative. JDR Microdevices and the JDR Microdevices logo are registered trademarks of JDR Microdevices. IBM, AT, PS/2 are trademarks of International Business Machines.

JDR MICRODEVICES, 2233 BRANHAM LANE, SAN JOSE 95124  
LOCAL (408) 559-1200 FAX (408) 559-0250 TELEX 171-110  
ALSO ORDER VIA OUR BBS (408) 559-0253



CIRCLE 113 ON FREE INFORMATION CARD  
DEALERS CIRCLE 170 ON FREE INFORMATION CARD



www.americanradiohistory.com



QUALITY PARTS • DISCOUNT PRICES • FAST SHIPPING

# ALL ELECTRONICS CORP.

P.O. Box 567 • Van Nuys, CA • 91408

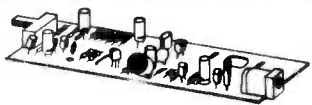
<p><b>THUMBWHEEL SWITCH</b></p> <p>1 pole 10 position decimal encoded switches which interlock to make up desired number or digits. Terminates to 11 pc pins (1 common and 10 poles). Each section measures .31" wide X .20" high X .78" deep. End plates can be added to form a .94" high bezel.</p> <p><b>CAT# SWTH-9 \$1.25 each</b> 10 for \$10.00</p> <p><b>END PLATES - CAT# SW-9EC \$1.00 per set</b></p> 	<p><b>RG 11/U 75 OHM VIDEO CABLE</b></p> <p>100 ft. or 200 ft. rolls of RG 11/U terminated to heavy duty F connectors. Includes 75 ohm terminator and F-61 splicer on one end. New cables manufactured for IBM PC networks. IBM P/N 1501908 COM/SCOPE.</p> <p><b>CAT# RG-11-1 100 ft. roll \$15.00</b> <b>CAT# RG-11-2 200 ft. roll \$27.50</b></p> 	<p><b>INSTRUMENT ENCLOSURES</b></p> <p>High quality molded ABS instrument enclosures. Integrated PC board standoffs and two sets of vertical mounting slots for front and rear sub panels. All enclosures are 6" wide X 6 1/4" deep. Choice of three heights. Includes non-skid rubber feet and hardware. Available in beige, ivory, black, and blue.</p> <p>Panel ht. <b>CAT# 2 1/4" CAT# MB-A \$7.50 each 10 for \$65.00</b> <b>2 5/8" CAT# MB-B \$7.75 each 10 for \$67.50</b> <b>3" CAT# MB-C \$8.00 each 10 for \$70.00</b></p> <p>Please specify color.</p> 	<p><b>SOUND ACTIVATED SWITCH</b></p> <p>PC board with electret mike responds to sounds in immediate vicinity. Originally part of sound activated light organ. Shuts off when sound is not present. Includes hook-up diagram.</p> <p><b>CAT# SAB-2 \$2.50 each</b></p> 
--------------------------------------------------------------------------------------------------------------------------------------------------------------------------------------------------------------------------------------------------------------------------------------------------------------------------------------------------------------------------------------------------------------------------------------------------------------------------------------------------------	-------------------------------------------------------------------------------------------------------------------------------------------------------------------------------------------------------------------------------------------------------------------------------------------------------------------------------------------------------------------------------------------------------------------------------------------	--------------------------------------------------------------------------------------------------------------------------------------------------------------------------------------------------------------------------------------------------------------------------------------------------------------------------------------------------------------------------------------------------------------------------------------------------------------------------------------------------------------------------------------------------------------------------------------------------------------------------------------------------------------	-----------------------------------------------------------------------------------------------------------------------------------------------------------------------------------------------------------------------------------------------------------------------------------------------------------------------------------------------------------

**SWITCHES**

**ITT PUSH BUTTON**  
ITT MDPL series. 3/4" X 1/2" grey rectangular key cap. S.P.S.T. N.O. Push to close. RATED: 0.1 amp switching, 0.25 amp carry current. P.C. mount.



**CAT# PB-8 65¢ each • 10 for \$6.00**  
100 for \$50.00

**SPDT PUSHBUTTON**  
Marquardt# 1843  
Rated 6 amps @ 125/250 Vac. Black plastic pushbutton.

Switch body: .82" X .94" X .65".  
**CAT# PB-18 \$1.65 ea. • 10 for \$15.00**

**PUSHBUTTON SWITCH**  
GC/Thomson# 35-420  
S.P.S.T. normally open momentary pushbutton switch. Red plastic actuator 0.57" diameter. Chrome bezel 0.68" diameter. Threaded bushing mounts in .50" diameter hole. Rated 3 amp @ 250Vac. Solder loop terminals.

**CAT# PB-20 \$1.00 each**

**NICKEL-CAD BATTERIES (RECHARGEABLE)**

AAA SIZE \$1.50 each  
1.2 volts 180 mAh  
**CAT# NCB-AAA**

AA SIZE \$2.00 each  
1.25 volts 500 mAh  
**CAT# NCB-AA**

AA SIZE \$2.20 each  
WITH SOLDER TABS  
**CAT# NCB-SAA**

C SIZE \$4.25 each  
1.2 volts 1200 mAh  
**CAT# NCB-C**

D SIZE \$4.50 each  
1.2 volts 1200 mAh  
**CAT# NCB-D**



**0-6 HOUR AUTO SHUT-OFF TIMER**

M.H. Rhodes, Inc. Mark-Time# 90007  
Timer fits standard 3" deep wallbox. Rated 20 amps @ 125 Vac. Turn knob to desired time. Includes hardware, beige wallplate, and knob. UL and CSA listed. **CAT# TMC-6 \$5.75 each • 10 for \$50.00**

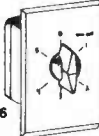

**SPECIAL PURCHASE 210 MFD 330 V PHOTOFLASH CAPACITOR**

Rubicon CE photoflash capacitor. 0.79" dia. X 1.1" high. These are new capacitors that have been prepped with 1.4" black and red wire leads soldered to the terminals.

**CAT# PPC-210 \$2.50 each**  
10 for \$22.50 • 100 for \$200.00  
Large quantities available. Call for pricing.





**LED'S**

**STANDARD JUMBO DIFFUSED T 1-3/4 size**

**RED CAT# LED-1 10 for \$1.50 • 100 for \$13.00**  
**GREEN CAT# LED-2 10 for \$2.00 • 100 for \$17.00**  
**YELLOW CAT# LED-3 10 for \$2.00 • 100 for \$17.00**

**FLASHING LED**  
with built in flashing circuit operates on 5 volts...  
**RED \$1.00 each CAT# LED-4 10 for \$9.50**  
**GREEN \$1.00 each CAT# LED-4Q 10 for \$9.50**

**L.E.D. FLASHER KIT**

Two L.E.D.'s flash in unison when a 9 volt battery is attached. This kit includes a p.c. board, all the parts and instructions to make a simple flasher circuit. A quick and easy project for anyone with basic soldering skills.

**CAT# LEDKIT \$1.75 per kit**



**LED CHASER KIT**

Build this variable speed led chaser. 10 leds flash sequentially at whatever speed you set them for. Easy to build kit includes pc board, parts and instructions. Ideal for special lighting effects, costumes, etc. Operates on 3 to 9 volts. PC board is 5" X 2.25". A great one hour project. **CAT# AEC \$6.50 ea.**



**WALL TRANSFORMERS**

ALL PLUG DIRECTLY INTO 120 VAC OUTLET

12 Vdc @ 500 ma. **CAT# DCTX-125 \$4.50**  
9 Vdc @ 1 amp. **CAT# DCTX-951 \$5.00**  
24 Vac @ 625 ma. **CAT# ACTX-2462 \$3.25**



**XENON TUBE**

1" long flashtube with 3 1/2" red and black leads. Ideal for electronic flash or strobe projects.

**CAT# FLT-2 2 for \$1.00**



**22/44 PIN CONNECTOR**

.156" pin spacing, 0.200" between double rows, gold contacts, P.C. mounting.

**SPECIAL Same as AMP# 2-530655-6. CAT# EBC-1G \$1.00 each • 10 for \$8.00**



**LED HOLDER**

Two piece holder. **CAT# HLED 10 for 65¢**

**LED GRAB BAG**  
50 assorted L.E.D.'s  
Many different shapes, colors, sizes. Round, rectangular, curved, etc.  
**CAT# GRLED \$4.00 per assortment**



**STEPPING MOTOR CONTROLLER KIT**

Learn about stepping motors while building this simple circuit. Includes circuit board and all parts except 12 Vdc power supply.

**CAT# SMKIT \$18.00 each**



**SERVO MOTOR**

3 Vdc servo with potentiometer. Ideal for robotics or remote control model experimentation. Rotates approx. 140 degrees. Pot connected to motor varies from 500 to 3000 ohms.

1.53" X 0.95" X 1.65". 0.87" diameter rubber wheel attached to motor shaft can be used as a capstan or can be easily removed. Prepped with capacitors, chokes and wire leads. **CAT# SVO-2 2 for \$1.00**



**RELAYS**

5-6 VDC SIP REED RELAY  
Electrol "Blue Boy" # BBS1A05A10  
5-6 Vdc, 500 ohm coil, S.P.S.T. normally open reed relay, 0.5 amp contacts. SIP configuration. 1" X .375" X .3".  
**CAT# RRLY-SIP \$1.10 each • 10 for \$10.00**

5 VDC LATCHING RELAY  
Aromat# RSL2D-5V  
Miniature SPDT, dual coil latching relay. 5 Vdc, 170 ohm coils. 1 amp. TTL compatible. UL and CSA recognized.  
0.787" X 0.394" X 0.394"  
**CAT# LRLY-5DC \$2.50 each**



**ELECTRONIC GAME BOARD**

The inner workings of an electronic Scrabble game. Operates on 6 Vdc. 8 digit alpha-numeric readout, 45 button keypad, 14 transistors, 2 I.C.'s, 1 piezo element and other goodies. Top and bottom row of keypad buttons are function keys, middle 3 rows are alphabetic. No instructions available. 6" X 4.45".  
**CAT# ST-4 \$1.75 each 10 for \$15.00**



**OPTO SENSOR**

U shaped package with mounting ears. 1/8" opening. 3/4" mounting ears.

**CAT# OSU-5 50¢ each**  
10 for \$4.50 • 100 for \$40.00



**RECHARGEABLE BATTERY PACK (USED)**

Four AA nickel cadmium batteries connected in series to make a 4.8 volt pack. Batteries are in a 2 X 2 configuration with a 2 pin connector attached. The four batteries can be separated into single AA size solder tab nickel cadmium batteries or resoldered into other configurations.

**SPECIAL SALE PRICE NOW \$3.00 per pack • 10 packs for \$25.00**  
**CAT# NCB-41AAU**

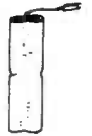

**TIL-99 PHOTO TRANSISTOR**

TO-18 case with window. For wide-angle viewing applications. Spectrally and mechanically compatible with TIL-31B.

**CAT# TIL-99 \$1.00 each • 10 for \$9.00**



**12 VOLT D.C. COIL S.P.D.T.**  
Omron# G2E-184P  
4 amp contacts. 335 ohm coil. Sugar cube size. .61" X .42" X .44 High. P.C. mount with pins on DIP spacing.

**CAT# RLY-787 \$1.50 each**



**TELEPHONE COUPLING TRANSFORMER**

Multi Products International# A19N-HO-1D/1  
Primary: 600 ohm  
Secondary: 600/600 ohm  
0.77" X 0.61" X 0.63" high. 6 p.c. pins on 0.187" centers. Primary inductance: 300 mH min., at 1kHz. 1 volt

**CAT# TCTX-1 \$1.25 ea. • 10 for \$11.00**



**STEPPER MOTOR**

Airpax P/N C82711-M1  
17 Vdc dual coil, permanent magnet stepper. 23.25 ohm coil. 7.5 degrees per step.

**CAT# SMT-6 \$6.00 each**  
10 for \$50.00



## ORDER TOLL FREE 1-800-826-5432



CALL OR WRITE FOR OUR **FREE** 60 PAGE CATALOG WITH OVER 4000 PARTS! OUTSIDE THE U.S.A. PLEASE SEND \$2.00 POSTAGE FOR A CATALOG

MAIL ORDERS TO: **ALL ELECTRONICS** P.O. BOX 567 VAN NUYS, CA 91408

INFO: (818)904-0524  
FAX: (818)781-2653  
MINIMUM ORDER \$10.00  
QUANTITIES LIMITED  
CALIF. ADD SALES TAX  
USA: \$3.50 SHIPPING  
FOREIGN ORDERS INCLUDE SUFFICIENT SHIPPING. NO C.O.D.



# AMAZING SCIENTIFIC & ELECTRONIC PRODUCTS

PARTS ARE  
IN STOCK

PLANS  
PROGRAM AVAILABLE

ASSISTANCE  
KITS

ASSEMBLED

GRA1 — ANTI GRAVITY GENERATOR	\$10.00
LC7 — 40 WATT BURNING CUTTING LASER	\$20.00
RUB4 — HI POWER PULSED DRILLING LASER	\$20.00
BTC5 — 1 MILLION VOLT TESLA COIL	\$20.00
HMCP1 — HI VELOCITY COIL GUN	\$15.00
LLS1 — LASER LIGHT SHOW 3 METHODS	\$20.00
EH1 — ELECTRONIC HYPNOTISM TECHNIQUES	\$8.00
EML1 — LOWER POWERED COIL GUN LAUNCHER	\$8.00
JL3 — JACOB LADDER 3 MODELS	\$10.00
SD5 — SEE IN THE DARK	\$10.00
LEV1 — LEVITATION DEVICE	\$10.00

FMV1K — 3 MILE FM VOICE TRANSMITTER	\$34.50
PFS1K — HAND CONTROLLED PLASMA FIRE SABER	\$49.50
NIG7K — HI FLUX NEGATIVE ION GENERATOR	\$34.50
PG5K — PLASMA LIGHTNING GLOBE	\$49.50
LHC2K — VISIBLE SIMULATED 3 COLOR LASER	\$44.50
HOD1K — HOMING/T RACKING BEEPER TRANSMITTER	\$44.50
LGU6K — 2.5 MW HAND-HELD VISIBLE LASER GUN	\$249.50
BTC3K — 250,000 VOLT TABLE TOP TESLA COIL	\$249.50
IOG2K — ION RAY GUN, project energy without wires	\$129.95
TKE1K — TELEKINETIC ENHANCER/ELECTRIC MAN	\$79.50
VWPM7K — 3 MILE AUTO TELEPHONE TRANSMITTER	\$49.50

**ASSEMBLED IN OUR LABS**

LIST10 — INFINITY XMTR Listen in via phone lines	\$199.50
IPG70 — INVISIBLE PAIN FIELD BLAST WAVE GENERATOR	\$74.50
ITM10 — 100,000 VOLT INTIMIDATOR UP TO 20"	\$99.50
JAT30 — AUTOMATIC TELEPHONE RECORDING DEVICE	\$24.50
PSP40 — PHASOR SONIC BLAST WAVE PISTOL	\$89.50
DNE10 — ALL NEW 26" VIVID COLORED NEON STICK	\$74.50
LGU20 — 5 TO 1MW VISIBLE RED HeNe LASER GUN	\$199.50
BLS10 — 100.00 WATT BLASTER DEFENSE WAND	\$89.50

**EASY ORDERING PROCEDURE** - TOLL FREE 1-800-221-1705 or 24 HRS ON 1-603-673-4730 or FAX IT TO 1-603-672-5406  
VISA, MC, CHECK, MO IN US FUNDS. INCLUDE 10% SHIPPING. ORDERS \$100.00 & UP ONLY ADD \$10.00. CATALOG \$1.00 OR FREE WITH ORDER.

**INFORMATION UNLIMITED**  
P.O. BOX 716, DEPT. R2, AMHERST, NH 03031

## THE ELECTRONIC GOLDMINE

**BATTERY OPERATED BLACK LIGHT KIT**

- \* Detects Invisible Fluorescent Inks, Fluorescent Minerals, etc.
- \* Uses Large Unfiltered U Shaped Black Light Tube



**UNIQUE**

- \* Comes with PC Board, Parts, Tube and Instructions
- \* Operates from Any 9V Battery Source (not Incl.)
- \* Size of Board: 7" x 1.8"

**C6356 \$13.95**

**MINI GEIGER COUNTER KIT**

- \* Detects ALL Types of Radiation
- \* Uses Sensitive Alpha Window Tube
- \* Operates from 9V Battery (not Incl.)
- \* Comes with PC Board, Parts, Tube and Instructions
- \* Size of PC Board: 3" x 1.9"

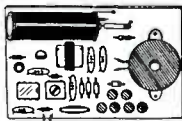

**C6430 \$59.95**

**20W + 20W STEREO AMP KIT**

- \* Boost Car Stereos, Tape Players, Portable Radios, etc.
- \* Features 2 Separate 20W RMS Amps with Level Controls
- \* Operates on Standard 12V Car Battery
- \* Comes with PC Board, Parts and Instructions-you supply speakers
- \* Size of PC Board: 6" x 2.25"

**C6442 \$19.95**

**INFRARED DETECTOR KIT**

- \* Detects ALL Types of Infrared (TV/Car Remotes, LEDs)
- \* Produces Sound and Bright Red LED Output
- \* Operates on 9V Battery (not Incl.)
- \* Comes with PC Board, Parts and Instructions
- \* Size of PC Board: 2.5" x 1.4"

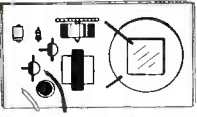

**C6441 \$5.95**

**INFRARED MODULE**

- Small infrared receiver module is sensitive to almost all infrared remote controllers and features high gain. Has only 3 hookup pins. Operates from 9VDC and is very sensitive (it will light an LED or close a low voltage relay from up to 50ft away). Module and hookup diagram only-you provide output device of LED or relay. Size of PC Board: 9" x 3" x .4"

**G514 \$1.29**



**INVERTER TRANSFORMER**

- Small 4 lead transformer to be used with 555 IC circuit to convert 12VDC to 250VAC for strobes fluorescent tubes. Comes with schematic.

**N1703 \$2.00 EACH 100/\$170.00**

**MINIMUM ORDER: \$10.00 plus \$3.00 shipping and handling.**  
We accept MC, Visa and Money Orders.  
**SEND ORDERS TO: The Electronic Goldmine**  
P.O. Box 5408 Scottsdale, AZ 85261  
**PHONE ORDERS: (602) 451-7454**

**CIRCLE 177 ON FREE INFORMATION CARD**

## ADVERTISING INDEX

RADIO-ELECTRONICS does not assume any responsibility for errors that may appear in the index below.

Free Information Number	Page		Page		
108	AMC Sales	82	196	SCO Electronics	71
75	Ace Products	26	185	Sencore	23
107	All Electronics	95	193	Smith Design	19
—	Amazing Concepts	96	83	Synergetics	68
77	B&K Precision	CV4	—	Star Circuits	22
67	Banner Technical Books	82	190	TECI	64
98,195	Beckman Industrial	5, 7	123,180	Test Probes	3
109	C&S Sales	CV3	225-228	Test Probes	3
70	CEI	88	181	Unicorn	87
—	CIE	8	197	U.S. Cable	71
—	Command Productions	72	182	Viejo Publications	72, 88
176	Communications Specialists	64	183	WPT Publications	64
58	Cook's Institute	83			
186	D&D Electronics	13			
—	Damark International	14			
127	Deco Industries	26			
177	Electronic Goldmine	96			
—	Electronics Book Club	36			
121	Fluke Manufacturing	CV2			
188	Global Specialties	17			
—	Grantham College	15			
86,199	Heathkit	25, 83			
191	ICS Computer, Training	13			
178	International Components Corp	91			
113,170	JDR Microdevices	94			
114	Jameco	92, 93			
104	Jan Crystals	83			
179	Janco Computers	88			
—	King Wholesale	86			
202	MD Electronics	86			
93	Mark V. Electronics	89			
61	Microprocessors Unltd.	79			
—	NRI Schools	29, 55			
187	Optoelectronics	21			
184	PMC Electronics	26, 87			
—	Pacific Cable	85, 89			
56	Parts Express	90			
201	Photronics, Inc.	26			
192,200	Print Products	22, 24			
78	Radio Shack	30			

**ADVERTISING SALES OFFICE**

**Gernsback Publications, Inc.**  
500-B Bi-County Blvd.  
Farmingdale, NY 11735  
1-(516) 293-3000  
President: **Larry Steckler**  
Vice President: **Cathy Steckler**

**For Advertising ONLY**  
516-293-3000  
Fax 1-516-293-3115

**Larry Steckler**  
publisher  
**Arline Fishman**  
advertising director  
**Denise Haven**  
advertising assistant  
**Christina Estrada**  
advertising associate  
**Kelly McQuade**  
credit manager

**Subscriber Customer Service**  
1-800-288-0652

**Order Entry for New Subscribers**  
1-800-999-7139  
7:00 AM - 6:00 PM M-F MST

**SALES OFFICES**

**EAST/SOUTHEAST**

**Stanley Levitan**, Eastern Sales Manager  
Radio-Electronics  
259-23 57th Avenue  
Little Neck, NY 11362  
1-718-428-6037, 1-516-293-3000  
Fax 1-718-225-8594

**MIDWEST/Texas/Arkansas/Okla.**

**Ralph Bergen**, Midwest Sales Manager  
Radio-Electronics  
540 Frontage Road—Suite 339  
Northfield, IL 60093  
1-708-446-1444  
Fax 1-708-446-8451

**PACIFIC COAST/ Mountain States**

**Marvin Green**, Pacific Sales Manager  
Radio-Electronics  
5430 Van Nuys Blvd. Suite 316  
Van Nuys, CA 91401  
1-818-986-2001  
Fax 1-818-986-2009

RADIO-ELECTRONICS



# ELENCO & HITACHI PRODUCTS AT DISCOUNT PRICES

**NEW!** RSOs (Real-Time & Storage Oscilloscopes) From HITACHI **NEW!**  
The RSO - its the new solution  
View, Acquire, Test, Transfer and Document Your Waveform Data

<b>4-Channel, 100MS/s Model</b>	<b>Introductory Price</b>
100MS/s (25MS/s on 4 channels simultaneously), 100MHz, 4kw x 1ch., 2kw x 2ch., 1kw x 4ch. VC-6145	\$ 4,695.00
<b>Compact, Full Feature Models</b>	
40MS/s, 100MHz, 4kw x 1ch., 2kw x 2ch.	VC-6045 \$ 3,049.00
20MS/s, 50MHz, 2kw x 2ch.	VC-6025 \$ 2,295.00
<b>Low Cost/High Value Models</b>	
20MS/s, 50MHz, 2kw x 2ch.	VC-6024 \$ 2,049.00
20MS/s, 20MHz, 2kw x 2ch.	VC-6023 \$ 1,749.00

RSOs from Hitachi feature such functions as roll mode, averaging, save memory, smoothing, interpolation, pretriggering, cursor measurements, plotter interface, and RS-232C interface. With the comfort of analog and the power of digital.

## Compact Series Scopes



Delayed Sweep  
Lightweight (13lbs)  
2mV Sens  
3 Yr Warranty

Model V-1065  
Shown

This series provides many new functions such as CRT Readout, Cursor measurements (V-1085/1065/665), Frequency Ctr (V-1085), Sweeptime Autoranging and Trigger Lock using a 6-inch CRT. You don't feel the compactness in terms of performance and operation.

V-660	60MHz Dual Trace	\$1,195
V-665	60MHz Dual Trace w/Cursor	\$1,345
V-1060	100MHz Dual Trace	\$1,425
V-1065	100MHz Dual Trace w/Cursor	\$1,695
V-1085	100MHz Quad Trace w/Cursor	\$2,045
V-1100A	100MHz Quad Trace w/Cursor	\$2,295
V-1150	150MHz Quad Trace w/Cursor	\$2,775



V-422 40MHz Dual Trace \$795

**V-212 Hitachi Portable Scopes**  
**\$435**  
DC to 50MHz, 2-Channel, DC offset function, Alternate magnifier function  
DC to 20MHz Dual Channel V-525 CFT Readout, Cursor Meas. \$1,025  
V-523 Delayed Sweep \$995  
V-522 Basic Model \$895

## 20MHz Elenco Oscilloscope

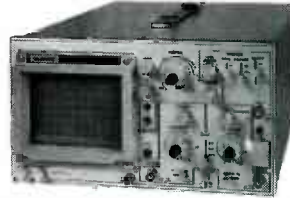

**\$375**  
MO-1251

- Dual Trace
- Component Tester
- 6" CRT
- X-Y Operation
- TV Sync
- 2 p-1 Probes

**FREE DMM**  
with purchase of  
**ANY SCOPE**

**SCOPE PROBES**  
P-1 65MHz, 1x, 10x \$19.95  
P-2 100MHz, 1x, 10x \$23.95

## Elenco 35MHz Dual Trace Good to 50MHz \$495



- MO-1252
- High luminance 6" CRT
  - 1mV Sensitivity
  - 6KV Acceleration Voltage
  - 10ns Rise Time
  - X-Y Operation • Z Axis
  - Delayed Triggering Sweep
  - Includes 2 P-1 Probes

All scopes include probes, schematics, operators manual, and 3 year (2 yrs for Elenco scopes) world wide warranty on parts & labor. Many accessories available for all Hitachi scopes. Call or write for complete specifications on these and many other fine oscilloscopes.

**WE NOW CARRY COMPLETE LINE OF FLUKE MULTIMETERS Models**

- 21F 83
- 23F 85
- 25F 87
- 27F 8050A
- 73 8060A
- 75 8062A
- 77F + More

**CALL FOR SPECIAL PRICING**

**True RMS 4 1/2 Digit Multimeter M-7000 \$135**  
.05% DC Accuracy  
.1% Resistance with Freq. Counter and deluxe case

**10 Function Multimeter CM-365 \$65**  
AC + DC Voltage & Amps  
Resistance to 2000MΩ  
Diode, Logic, & Trans test  
Capacitance to 200uF

**Digital Capacitance Meter CM-1550 \$58.95**  
9 Ranges  
.1pf-20,000uFd  
.5% basic accy  
Zero control with case

**Digital LCR Meter LC-1801 \$125**  
Measures:  
Coils 1uH-200H  
Caps .1pf-200uF  
Res .01-20M

**Function Generator Blox #9600 \$28.95**  
Provides sine, triangle, square wave from 1Hz to 1MHz AM or FM capability

**Triple Power Supply XP-620 Assembled \$65 KIT \$45**  
2 to 15V at 1A,  
-2 to -15V at 1A  
(or 4 to 30V at 1A) and 5V at 3A  
Contains all the desired features for doing experiments. Features short circuit protection, all supplies.

**Wide Band Signal Generators SG-9000 \$129**  
RF Freq 100K-450MHz  
AM Modulation of 1KHz  
Variable RF output  
SG-9500 w Digital Display and 150MHz built-in Counter \$249

**AC Current Meter ST-1010 \$69.95**  
1000 Amps  
Data & Peak hold  
8 Functions  
Deluxe Case

**Decade Blox #9610 or #9620 \$18.95**  
#9610 Resistor Blox 47 ohm to 1M & 100K pot  
#9620 Capacitor Blox 47pf to 10MFD

**Quad Power Supply XP-580 \$59.95**  
2-20V at 2A  
12V at 1A  
5V at 3A  
-5V at .5A  
Fully regulated and short circuit protected  
XP-575 without meters \$39.95

**LEARN TO BUILD AND PROGRAM COMPUTERS WITH THIS KIT!**  
INCLUDES: All Parts, Assembly and Lesson Manual  
Model MM-8000 \$129.00

**Digital Triple Power Supply XP-765 \$249**  
0-20V at 1A  
0-20V at 1A  
5V at 5A  
Fully regulated, Short circuit protected with 2 limit control, 3 separate supplies  
XP-660 with Analog Meters \$175

**GF-8016 Function Generator with Freq. Counter \$249**  
Sine, Square, Triangle Pulse, Ramp. 2 to 2MHz  
Freq Counter .1 - 10MHz  
GF-8015 without Freq. Meter \$179

Starting from scratch you build a complete system. Our Micro-Master trainer teaches you to write into RAMs, ROMs and run a 8085 microprocessor, which uses similar machine language as IBM PC. You will write the initial instructions to tell the 8085 processor to get started and store these instructions in permanent memory in a 2816 E<sup>2</sup> PROM. Teaches you all about input and output ports, computer timers. Build your own keyboard and learn how to scan keyboard and display. No previous computer knowledge required. Simple easy to understand instruction teaches you to write in machine language.  
ROBOTICS KIT FOR ABOVE (MM-8010) \$71.95

**WE WILL NOT BE UNDERSOLD!**  
UPS Shipping: 48 States 5% (\$10 Max) IL Res., 7% Tax

**C & S SALES INC.**  
1245 Rosewood, Deerfield, IL 60015  
(800) 292-7711 (708) 541-0710

**15 Day Money Back Guarantee**  
**2 Year Warranty** Prices subject to change  
**WRITE FOR FREE CATALOG**

CIRCLE 109 ON FREE INFORMATION CARD

# LIVE ACTION

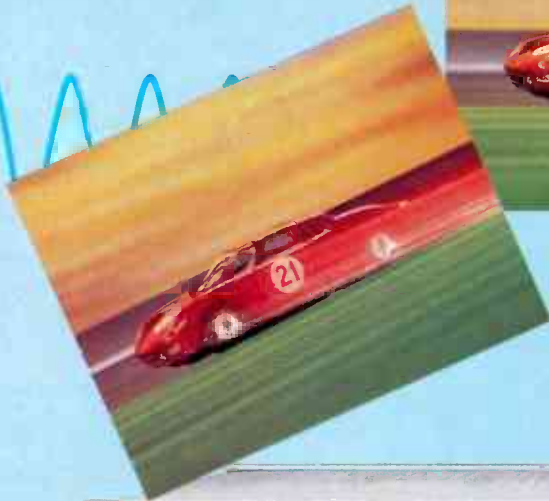

# STOP ACTION, INSTANT REPLAY

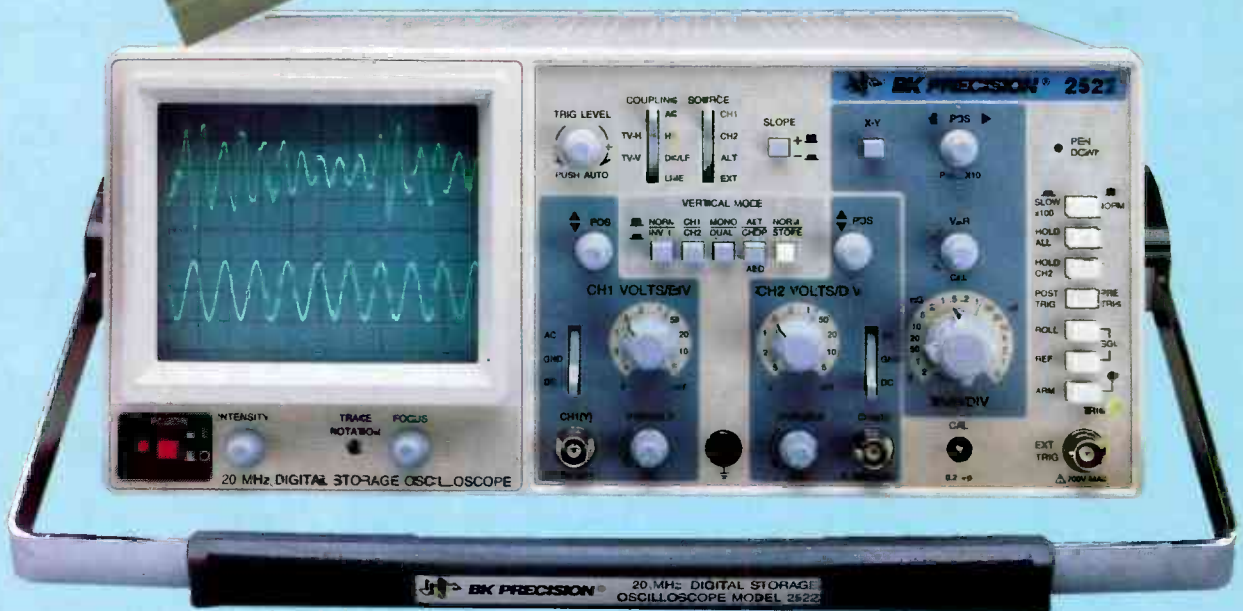

## Catch all the action with the new B&K-PRECISION 2522 Digital/Analog oscilloscope.

The new B&K-PRECISION Model 2522 is a full-feature analog scope for live action and a DSO for stop action.

- Full analog and digital operation.
- 20MHz analog operation.
- 10 MS/second sampling rate on 1 or 2 channels.
- Equivalent time sampling to 20MHz.
- 2k memory per channel.
- Pre-trigger capture.

## NOW \$995

A touch of a button switches the 2522 from analog to digital operation. It's an easy-to-operate scope with the performance you need, at a price you'll like.

Don't let the action pass you by. The 2522 will put you on the fast track for performance and results. For immediate delivery or complete specifications, contact your local B&K-PRECISION distributor.



### **BK PRECISION**

**MAXTEC INTERNATIONAL CORP.**

Domestic and International Sales  
6470 W. Cortland St., Chicago, IL 60635  
312-889-1448 • FAX: 312-794-9740  
Canadian Sales, Atlas Electronics, Ontario

CIRCLE 77 ON FREE INFORMATION CARD