

48783

Radio - 10,000-VOLT PLASMA
POWER SUPPLY

\$2.25 MAR 1988
ISSUE # 100

Electronics®

TECHNOLOGY - VIDEO - STEREO - COMPUTERS - SERVICE

WIRELESS STEREO TRANSMITTER

BUILD A WIRELESS STEREO AUDIO
LINK FOR YOUR LISTENING EASE

THE ULTIMATE CONTROL COMPUTER

BUILD THE CPU MODULE FOR
R-E'S ADVANCED CONTROL SYSTEM

BARGRAPH DISPLAYS

USE ONE IN YOUR NEXT PROJECT
INSTEAD OF AN ANALOG METER

THE BEST ELECTRONICS COLUMNS

★ HARDWARE HACKER ★ VIDEO NEWS
★ AUDIO UPDATE ★ ANTIQUE RADIOS

COMPUTERDIGEST

★ BUILD A PRINTER MULTIPLEXER
★ DESKTOP PUBLISHING

BUILD THE ELECTRONIC TORNADO

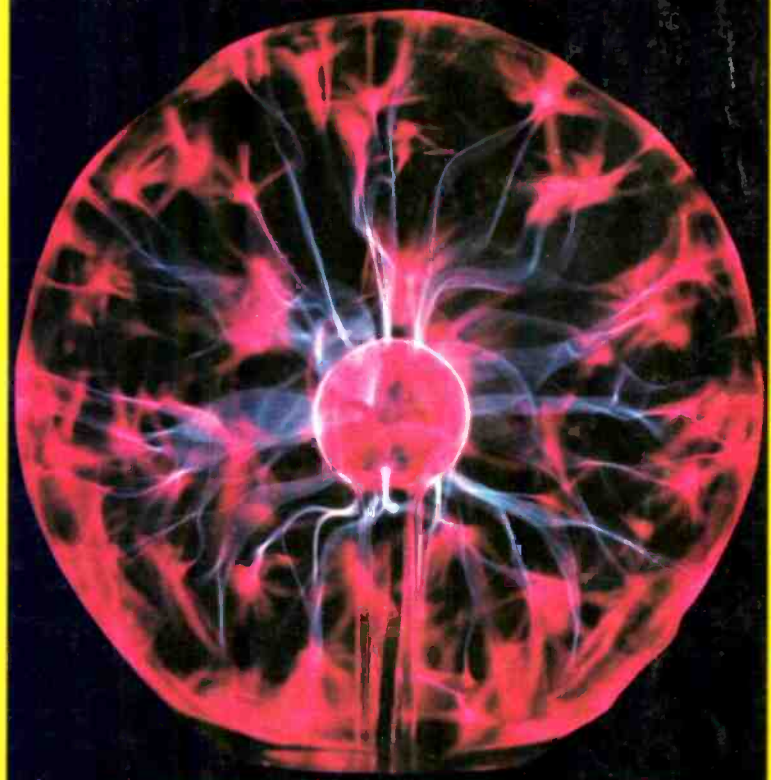

A UNIVERSAL POWER SUPPLY
FOR PLASMA DISPLAY DEVICES

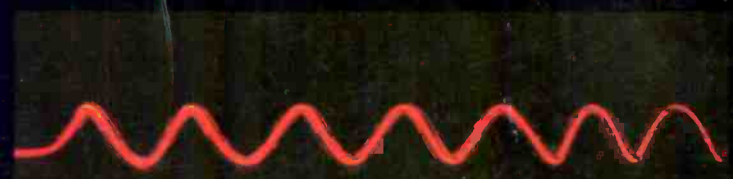

A
GERNSBACK
PUBLICATION



THE ANSWER IS IN TEK DIGITAL STORAGE:

Now! The new 60 MHz Tek 2221 joins the world's best-selling family of digital storage oscilloscopes. All featuring 20 MS/s digitizing along with familiar, full-bandwidth analog operation. It's the best of both worlds in an easy-to-use portable.

Discover the potential. With digital storage you can freeze waveforms. Capture events invisible to nonstorage scopes. Find signals buried in noise. And build a library of reference waveforms.

Digital storage display accuracy enhances your confidence in measurements. And all you have to do is push a button for *real-time* display analysis.

Compare the 2230, 2221 and 2220 to each other—and all others. The new 2221 offers such advanced features as CRT readout and measurement cursors. For even more performance and flexibility, there's the 100 MHz, dual time base 2230 with optional battery-backed memory for saving up to 26 waveform sets. And if it's economy you want, choose the 60 MHz 2220 with many of the same features at an even lower cost.

\$2995
\$3995
\$4995

With each scope you can capture events as narrow as 100 ns at any sweep speed thanks to Tek's proprietary peak detect mode. View events prior to or following a trigger event with pre/post trigger. Store waveforms into 4K records. Automate measurements with optional GPIB and RS-232-C interfaces. And output direct to a printer or plotter.

Tek software is available to help you make the most of the 2230, 2221 and 2220 in system configurations.

Call Tek for a free video brochure or to place an order.

Ask about free digital storage application notes and educational materials. Orders include complete documentation, manuals and 3-year warranty on labor, parts and CRT.

**Call Tek direct:
1-800-426-2200**
for free video brochure for orders/assistance.

| Features | 2230 | ● NEW! 2221 | 2220 |
|--|--|---------------------------------|-------------|
| Analog/Digital Storage BW | 100 MHz | 60 MHz | 60 MHz |
| Maximum Sampling Speed | 20 MS/s | 20 MS/s | 20 MS/s |
| Record Length | 4K/1K (selectable) | 4K | 4K |
| Peak Detect | 100 ns | 100 ns | 100 ns |
| Save Reference Memory | One, 4K Three, 1K | One, 4K | One, 4K |
| Vertical Resolution | 8 bits 10 bits (AVG mode) 12 bits (AVG mode over the bus) | 8 bits 10 bits (AVG mode) | 8 bits |
| CRT Readout/Cursors | Yes | Yes | No |
| GPIB/RS-232-C Options | Yes (\$750) | Yes (\$500) | Yes (\$500) |
| Battery-Backed Memory (save 26 waveform sets) | Yes (inc with GPIB/ RS-232-C) | No | No |
| Price | \$4995 | \$3995 | \$2995 |



Tektronix
COMMITTED TO EXCELLENCE

CIRCLE 92 ON FREE INFORMATION CARD

BUILD THIS

- 43 ELECTRONIC TORNADO**
Universal power supply for driving plasma displays, and more.
Robert Iannini
- 49 ^{Radio}Electronics ADVANCED CONTROL SYSTEM**
Part 2. A look at the CPU module.
H. Edward Roberts, M.D.
- 54 WIRELESS STEREO LINK**
Sends signals to any FM receiver.
William Sheets and Rudolf F. Graf
- 69 PC SERVICE**
Use the direct-etch foil patterns to make the circuit boards for the Electronic Tornado, the Wireless Stereo Link, and the Printer Multiplexer.

TECHNOLOGY

- 63 PROGRAMMABLE LOGIC DEVICES**
Part 2. PLD's for the hobbyist.
Ernest Meyer

CIRCUITS AND COMPONENTS

- 59 USING BARGRAPH DISPLAYS**
Replace those analog meters.
Ray Marston

DEPARTMENTS

- | | |
|--|---|
| <ul style="list-style-type: none">12 VIDEO NEWS What's new in this fast changing field. David Lachenbruch23 EQUIPMENT REPORTS Technology Marketing Inc. PC Weather Pro33 COMMUNICATIONS CORNER Hybrid networks. Herb Friedman | <ul style="list-style-type: none">36 AUDIO UPDATE Debunking myths. Larry Klein71 HARDWARE HACKER Tips, products, and publications. Don Lancaster80 ANTIQUE RADIOS More on antique parts. Richard D. Fitch |
|--|---|

COMPUTER DIGEST

A NEW KIND OF MAGAZINE FOR ELECTRONICS PROFESSIONALS

BUILD A PRINTER MULTIPLEXER
Share your serial printer with up to 4 computers

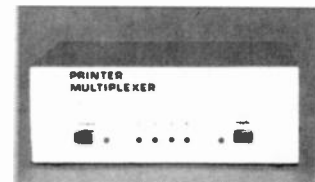

DESKTOP PUBLISHING
Pagemaker and Ventura Publisher face off

PAGE 87

WIRELESS STEREO LINK

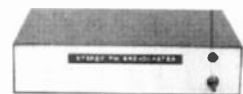

This great little stereo FM multiplexer lets you listen to whatever you want - whatever you want - whatever you want.

WILLIAM SHEETS AND RUDOLF F. GRAF

PAGE 54

AND MORE

- 122 Advertising and Sales Offices**
- 122 Advertising Index**
- 4 Editorial**
- 123 Free Information Card**
- 14 Letters**
- 104 Market Center**
- 26 New Products**
- 6 What's News**

ON THE COVER

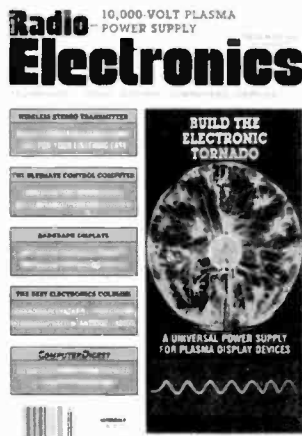

Plasma displays and other unusual lighting devices are all the rage. In the past, to get one of those displays for your home or business meant spending somewhere around \$200. But not anymore! This month, **Radio-Electronics** presents an inexpensive high-voltage supply that's designed to power almost any type of plasma display. It can also be used to drive other innovative lighting devices such as travelling wave tubes and "Devil's Furnaces." To find out more about the power supply and how to use it, turn to page 43.

COMING NEXT MONTH

THE APRIL ISSUE IS ON SALE MARCH 3

BUILD A SURROUND-SOUND-DECODER
Add move-theater sound to your home-video set up.

Radio-Electronics **ADVANCED CONTROL SYSTEM**
Construction details for the CPU module.

COMPUTERDIGEST

Protect your files from prying eyes with encryption.

As a service to readers, RADIO-ELECTRONICS publishes available plans or information relating to newsworthy products, techniques and scientific and technological developments. Because of possible variances in the quality and condition of materials and workmanship used by readers, RADIO-ELECTRONICS disclaims any responsibility for the safe and proper functioning of reader-built projects based upon or from plans or information published in this magazine.

Since some of the equipment and circuitry described in RADIO-ELECTRONICS may relate to or be covered by U.S. patents, RADIO-ELECTRONICS disclaims any liability for the infringement of such patents by the making, using, or selling of any such equipment or circuitry, and suggests that anyone interested in such projects consult a patent attorney.

RADIO-ELECTRONICS, (ISSN 0033-7862) March 1988. Published monthly by Gernsback Publications, Inc., 500-B Bl-County Boulevard, Farmingdale, NY 11735 Second-Class Postage paid at Farmingdale, NY and additional mailing offices. Second-Class mail registration No. 9242 authorized at Toronto, Canada. One-year subscription rate U.S.A. and possessions \$16.97. Canada \$22.97, all other countries \$25.97. All subscription orders payable in U.S.A. funds only, via international postal money order or check drawn on a U.S.A. bank. Single copies \$2.25. © 1988 by Gernsback Publications, Inc. All rights reserved. Printed in U.S.A.

POSTMASTER: Please send address changes to RADIO-ELECTRONICS, Subscription Dept., Box 55115, Boulder, CO 80321-5115.

A stamped self-addressed envelope must accompany all submitted manuscripts and/or artwork or photographs if their return is desired should they be rejected. We disclaim any responsibility for the loss or damage of manuscripts and/or artwork or photographs while in our possession or otherwise.

Radio-Electronics®

Hugo Gernsback (1884-1967) founder
M. Harvey Gernsback,
editor-in-chief, emeritus

Larry Steckler, EHF, CET,
editor-in-chief and publisher

EDITORIAL DEPARTMENT

Art Kleiman, editorial director
Brian C. Fenton, managing editor
Carl Laron, WB2SLR, associate editor
Jeffrey K. Holtzman,
computer editor
Marc Spiwak, associate editor
Robert A. Young, assistant editor
Julian S. Martin, editorial associate
Byron G. Wels, editorial associate
M. Harvey Gernsback,
contributing editor
Jack Darr, CET, service editor
Robert F. Scott,
semiconductor editor
Herb Friedman,
communications editor
Bob Cooper, Jr. satellite-TV editor
Robert Grossblatt, circuits editor
Larry Klein, audio editor
David Lachenbruch,
contributing editor
Don Lancaster,
contributing editor
Richard D. Fitch,
contributing editor
Teri Scaduto, editorial assistant

PRODUCTION DEPARTMENT

Ruby M. Yee, production director
Robert A. W. Lowndes,
editorial production
Andre Duzant, technical illustrator
Karen Tucker, advertising production
Marcella Amoroso, production traffic

CIRCULATION DEPARTMENT

Jacqueline P. Cheeseboro,
circulation director
Wendy Alanko,
circulation analyst
Theresa Lombardo,
circulation assistant

Typography by Mates Graphics
Cover photo by Herb Friedman

Radio-Electronics is indexed in
Applied Science & Technology Index
and *Readers Guide to Periodical Literature*.

Microfilm & microfiche editions are
available. Contact circulation depart-
ment for details.

Advertising Sales Offices listed
on page 120.



Some are famous for missing parts, others for replacing them.



Over the past few years we've made quite a name for ourselves in the electronics industry. Technicians worldwide know that the NTE diamond stands for the highest quality in replacement components.



To distributors, we're known for responsive service, customer satisfaction and a broad product

line that includes flameproof resistors, capacitors and static control products.

With this kind of reputation for quality and service, it's no wonder NTE has become the fastest growing supplier of replacement components in the electronics industry!

See for yourself why NTE is famous for replacement parts. Our Technical Guide and Cross Reference lists more than 3,400 NTE devices cross-referenced to over 228,000 industry part numbers.

To obtain your copy see your local NTE distributor. For their name and location just call us Toll Free.

ONE SOURCE.



ONE CALL.

NTE ELECTRONICS, INC.

44 Farrand Street, Bloomfield, New Jersey 07003
Toll Free 1-800-631-1250 (Except N.J.) • 1-800-624-2624 (N.J. Only)

CIRCLE 71 ON FREE INFORMATION CARD

EDITORIAL

Consumer electronics for the consumer

The consumer-electronics industry doesn't always have its priorities in the right order. If it did, every cable-TV company and TV-set manufacturer would have adopted the EIA standard for a baseband interface between TV sets and peripheral devices. Who needs it? You do! Everyone does!

The industry has no excuse for not knowing how important the standard is. Consumers are making it rather clear what they want. Simply look at the VCR—one of the most successful consumer-electronics products ever. Why is the VCR so successful? Because it provides the ability to time-shift programs and it allows you to watch one channel, while taping another.

Or does it?

Just ask any consumer who has just bought the latest-model VCR with a cable-ready tuner who is upset because he can't tape HBO (which is scrambled by his cable system) while he watches a local news show. How do you tell him that his 6-event timer is of no use if he wants to tape more than one scrambled channel?

Granted, as a reader of **Radio-Electronics**, you would be capable of rigging something up to allow you to tape what you want. But the resulting jumble of patch cords and switch boxes would only be a compromise, not a solution. And don't forget: The great majority of consumers—on whom the success of the electronics industry depends—don't even know how to program their VCR's properly.

The EIA standard (IS-15) for a baseband (audio/video) interface between TV receiving devices and peripherals would answer many of the problems if it were embraced by the industry.

The interface would be implemented as a 21-pin connector that would accept and supply composite video, audio, and RGB video. Any new video device could simply be plugged into the connector, and it would work—no hassles.

From a technical standpoint, the most important feature of the interface is that TV receiver's AGC or Automatic Gain Control would be placed under the control of any signal descrambler. Instead of being connected to its own video detector, the receiver's AGC comparator would be connected to the decoder. It would be the decoder's responsibility to supply the voltage level at which sync tips would have been if they were not suppressed.

The benefits of such an interface would be many. For example, cable-program suppliers could reduce the cost of their decoders, because there would be no need to duplicate the tuning, IF, and remote-control functions. For that reason, they should be the ones to introduce the EIA connector on all of their cable boxes. After all, it is their signal scrambling that is causing most of the current problems.

The real winner would be the consumer, who would be able to make full use of the features that are offered by his cable-ready equipment. He could use his TV's or VCR's remote as they were intended to be used, and use the timer functions to record any scrambled channels.

The introduction of Super VHS has thrown a monkey wrench into the standard because S-VHS compatible equipment requires separate chrominance and luminance signals. That could be overcome, if only the members of the industry would cooperate a little better.

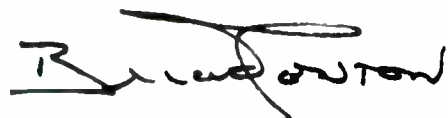

BRIAN C. FENTON
Managing Editor

DB25P
D-Subminiature Plug
CONNECTORS



Jim-pak
electronic components

Attention Hobbyists, Students, Engineers and Electronic Enthusiasts! Over 700 electronic components – 500 Authorized Distributors. Visit a JIM-PAK Distributor and pick-up a FREE 1988 Catalog TODAY!

79
New
Items

Ni-Cad Batteries and Fuses

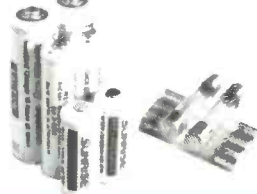

IC Test Clips

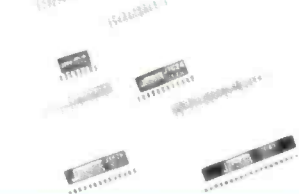

Solderless Breadboards

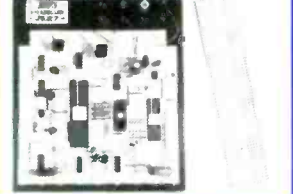

Prototype PC Boards

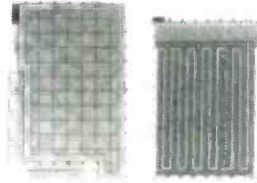

Integrated Circuits

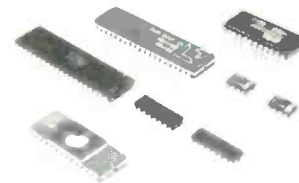

Enclosures



YOUR NEIGHBORHOOD JIM-PAK AUTHORIZED DISTRIBUTOR

| |
|---|
| <p>ALABAMA Birmingham American Electronic Supply Decatur J.L.S. Electronics Dothan Fortes Dist Co Huntsville Carmichael Electronics Mobile W&W Electronics Montgomery AIM Electronics Handley's Elect. Center</p> <p>ALASKA Anchorage Electronic Supply Center Homer A-COM of Alaska</p> <p>ARIZONA Sierra Vista B&S Electronics Tucson Electronic City Yuma Yuma Electronics</p> <p>ARKANSAS Batesville Tanner Electronics Little Rock Arkansas Electronic Supply</p> <p>CALIFORNIA Atascadero Coast Electronics Berkeley Al Lasher's Electronics Chico Electronic Resources Chico Physics Wholesale Chico The Electronics Warehouse Chula Vista Lion Electronics Chula Vista Video Electronics Concord Pacific/Valley Electronics Covina Mar-Vac Electronics Covina G&H/MCO Elect. Supply Cucamonga Ahletronics Dublin Pacific/Valley Electronics Eureka Redwood Electronics Fresno Sparky Electronics Fresno Whitcomb Electronics Fullerton Onas Electronics Fullerton R.F. Electronics Glendale Eagle Electronics Half Moon Bay Strawflower Elec. Radio Shack Hollywood Bull's Electronics Inglewood Ingwood Elect. Lompoc L&H Electronic Emporium Los Osos Coast Electronics Merced Rick's Electronics Milpitas R&D Electronic Parts Modesto Zack Electronics Monterey Zack Electronics Monterey Coast Electronics National City Willy's Electronics Oakland Brit Electronics Oakland Pacific/Valley Electronics Oakland Wenger Electronics Oceanside Electronic Center Oxnard JonVac/Drow Pasadena Dow Radio Redding Radio Mart Sacramento Cal-Centron Electronics Sacramento MarVac's Calif. Radio Electronics Sacramento Sacramento Electronic Supply San Carlos Zack Electronics San Francisco J&H Outlet San Francisco Zack Electronics San Jose Chad Electronics San Jose United Radio and TV San Luis Obispo Coast Electronics San Luis Obispo Mid State Electronics San Rafael Electronics Plus San Ysidro Electronic Center Santa Cruz Santa Cruz Electronics Santa Maria Electronic Parts Supermart Santa Rosa Pacific/Valley Electronics Simi Valley HLS Industries Stockton Cal-Centron Electronics Stockton Raeburn Electronics Torrance Signal Electronics Torrance Torrance Electronics Vallejo Zickat Westminster JK Electronics Whittier Whittier Electronic Co</p> <p>CONNECTICUT Wallingford Iron Town USA Newark ComputerLand Wilmington Whiteside Electronics</p> <p>FLORIDA Clearwater Amateur Electronic Supply Daytona Beach C&S Electronics Del Ray Beach Electronic Parts Outlet Fort Walton Beach Palm Electronics Gainesville Skipper Electronics Hialeah Health/Zenith Miami Dharamdas Sons Miami Lafayette Radio Orlando C&S Electronics Panama City Bay Mar Electronics Pensacola Pensacola Electronics</p> <p>GEORGIA Atlanta A.C.M. Computer Mart Dalton A.C.M. Computer Mart</p> <p>HAWAII Honolulu Electrical Equipment Co. Honolulu Industrial Electronics Honolulu Integrated Circuit Supply Kailua-Kona Sound Computer</p> <p>IDAHO Boise Kimball Electronics Boise Sparky Electronics Pocatello Kimball Electronics Twin Falls Central Electronics</p> <p>ILLINOIS Addison Digital World Beverly B.B.&W. Electronics Barrington Garbandade Barrington Pick's Electronics Barrington Suburban Electronics Barrington Tri-State Elect. Mt. Vernon Laco Electronics Niles Joseph Electronic Peoria Ken's Electronics Peoria Warren Radio South Holland Union Electronic Dist.</p> <p>INDIANA Angola Lukeland Electronics Bloomington Slansifer Radio Chesterton Chesterton Electronics Evansville Hutch & Son Fort Wayne Harvey's Electronic Center Gary Calumet Electronics Gary Meunier Electronics Indianapolis Warren Radio</p> <p>IOWA Ames Electronic Supply, Inc. Clinton R.J.S. Electronics Davenport Union Supply Co. Davenport Warren Radio Des Moines Radio Trade Supply Iowa City Union Supply Co.</p> <p>KANSAS Salina Electronics, Inc. Wichita Amateur Radio Equipment Wichita Lloyd's Radio & Elec. Wichita R.S.C. Electronics</p> <p>KENTUCKY Lexington Radio Electronic Equip. Co. Louisville Peerless Electronic Equip. Co. Paducah Warren Radio Co. Somerset Radio Shack</p> <p>LOUISIANA Baton Rouge Menard Electronics Bossierade Menard Electronics Gretna Pelican Electronics Lake Charles Wholesale Radio & Equip. Metairie Pelican Electronic Supply Shreveport Industrial Electronic Supply Shreveport Southern Electronics</p> <p>MARYLAND Aberdeen Harco Electronics Baltimore BCT Electronics Baltimore Bestvark College Park Mark Electronics Glen Burnie Electronics Plus Kensington Revaco of Maryland Laurel Fairway Electronics Lovale J&M Electronics Suitland Suburban Electronics Towson Baynesville Electronics</p> <p>MASSACHUSETTS Pittsfield Pitshield Radio Equipment Springfield Sydlee Electronic Supply</p> <p>MICHIGAN Wedemeyer Elect. Supply Kinde Distributing Benton Electronic Supply Detroit S&S Electronics Detroit S&S Electronics Flint Tri County Electronics Grand Rapids S&W Electronics Grand Rapids Warren Radio Lansing Fulton Radio Supply Lansing Fulton Radio Supply Livonia Wedemeyer Elect. Supply Livonia Northwest Electronics Livonia Warren Radio Livonia Niles Radio Supply Livonia Saginaw Electronics Livonia Bell Electronics Co. Livonia Tel Van Electronic Supply Livonia Traverse City Electronics Livonia K-40 Electronic Livonia The Electronic Connection</p> <p>MINNESOTA Northwest Radio of Duluth Acme Electronics</p> <p>MISSISSIPPI Hooper Electronic Supply Hooper Electronic Supply Hooper Electronic Supply Hooper Electronic Supply Hooper Electronic Supply</p> <p>MISSOURI Show Me Electronics Show Me Electronics Central Missouri Dist. Co. Show Me Electronics Electronic Supply Co. Inc. Eagle Electronic Dist. Show Me Electronics Show Me Electronics Show Me Electronics Show Me Electronics</p> <p>MONTANA Electronic Service & Dist. ARC</p> <p>NEBRASKA G.L.E. Electronics Scott Electronic Supply Scott Electronics</p> <p>NEVADA Century 23 Computer House</p> <p>NEW JERSEY Bristol Reint. Dist. Chattanooga General Radio (GRS) Jackson Health/Zenith Knoxville Larcac Radio Memphis C&C Electronic Nashville Health/Zenith Nashville Jackson Dist. Smyrna Laraco/Vinelard</p> <p>NEW MEXICO Alamogordo Basin Electronics Albuquerque Electronic City</p> <p>NEW YORK Buffalo Jamesstown Buffalo Johnson City Kingston Kingstons Middletown Middletown Newburgh Newburgh New York N.Y. White Plains Oneonta Oneonta Plattsburgh Plattsburgh Poughkeepsie Poughkeepsie Rochester Rochester Troy Troy Utica Utica</p> <p>NEW YORK (Continued) Radio Equipment Corp Warren Radio Union Electronics Greystone Electronics Greystone Electronics Actra Audio Inc. Taf Electronics Health/Zenith L.M. Electronics Champlain Electronics Greystone Electronics Health/Zenith Trojan Electronic Supply Central Electronics</p> <p>NORTH CAROLINA Greensboro Health/Zenith</p> <p>NORTH DAKOTA Fargo Sir Electronics Mandan John Iverson Company</p> <p>OHIO Akron Warren Radio Bryan Bernie's Electric Canton Electronic Center, Inc. Cleveland Health/Zenith Lancaster Electronic Supply Co. Lima Warren Radio Lima Superior Electronics Lima Health/Zenith Lima Warren Radio Toledo Amateur Electronic Supply Toledo Reso Radio Co. Wickliffe Youngstown</p> <p>OKLAHOMA Muskegee Muskegee Electronic Supply Oklahoma City Radio Supply Oklahoma City RSC Tulsa Sooner Electronics Warr Acres Sooner Electronics Etc.</p> <p>OREGON Beaverton Norvac Electronics Portland Eugene Portland Portland Radio Supply</p> <p>PENNSYLVANIA Chambersburg Sunrise Electronic Dist. Drexel Hill Kass Electronic Dist. Erie Warren Radio Frazier Health/Zenith Philadelphia Health/Zenith Philadelphia Jan Industrial Philadelphia RESCO Philadelphia Steven's Radio Shack Phoenixville General Radio (GRS) Reading Electronic Components State College Computer Center of York</p> <p>RHODE ISLAND Dabbott Electronics Pawtucket</p> <p>SOUTH DAKOTA Rapid City Chris Supply</p> <p>TENNESSEE Bristol Shield's Electronic Supply Chattanooga Shield's Electronic Supply Frazier Townsend Electronics Knoxville Shield's Electronic Supply Knoxville Bluff City Electronics Memphis Warren Radio Memphis Currie's Nashville Eddie Warners Inc. Nashville Electra Dist. Co. Nashville Rarjolph & Rice Smyrna Delint Electronics</p> <p>TEXAS Brownsville George's Electronic Mart Houston George's Electronic Mart Houston Ange Electronics Longview Champion Electronics McAllen George's Electronic Mart McAllen Valley Wide Electronics</p> <p>UTAH Midvale Health/Zenith Ogden Carter Supply Co. Salt Lake City Kimball Electronics</p> <p>VERMONT Burlington Vermont Appliance</p> <p>VIRGINIA Annandale Arcade Electronics Arlington Arlington Electronic Wholesalers Blacksburg Scotty's Radio & TV Bristol Shields Electronic Supply Charlottesville Computer Service Land Charlottesville E.L.R. Electronics Charlottesville Grave's Electronics Hampton Can Electronics Lynchburg Electronic Service Co. Norfolk AVEC Electronics Norfolk Gain Electronics Norfolk Priest Electronics Norfolk Radio Parts Dist. Richmond AVEC Electronics Roanoke AVEC Electronics Roanoke People's Electronics Springfield ABBS Corp Virginia Beach Electronic Equipment Bank Virginia Beach Can Electronics Winchester Stinson Electronics, Inc. Woodbridge E.G.E.</p> <p>WASHINGTON Bellevue A.B.C. Communications Bellingham Cascade Electronics Gig Harbor Northwest Electronics Oak Harbor Sundowner Communications Pullman H&O Electronics Seattle A.B.C. Communications Seattle Amateur Radio Supply Seattle Electronic Supply Co. Spokane Bits, Bytes & Nibbles Tacoma C&G Electronics</p> <p>WEST VIRGINIA Fairmont T.P.S. Electronics Morgantown Electronic Dist. Co. Wheeling Industries</p> <p>WISCONSIN Kenosha Chester Electronic Supply Milwaukee Amateur Electronic Supply</p> <p>FOREIGN Canada: British Columbia/Victoria Fort Micro Systems Ontario: Mississauga National Electronic El Salvador: P.R.E.S.A. Guam: Agaña Marianas Electronics Guatemala: Electronic Pan Americana Panama: Sonite S.A. Panama: Telecomunicaciones S.A. Panama: Tropeleo S.A. Puerto Rico: Hato Rey Microcomputer Store Saudi Arabia: Jeddah Hisham Nwairati Establishment Jeddah Technical Computer Service</p> |
|---|

Jim-pak
electronic components

One-Stop Component Center

1355 SHOREWAY ROAD • BELMONT, CALIFORNIA 94002 • TELEPHONE (415) 595-5936 • FAX (415) 592-2503 • TELEX 176043 • DISTRIBUTOR INQUIRIES WELCOME
CIRCLE 181 ON FREE INFORMATION CARD

MARCH 1988
5

WHAT'S NEWS

Three-dimensional images made from CAT scans

Computer software that makes exceptionally sharp three-dimensional images of a patient's head or body from Computed Tomography (CT) X-ray scans was reported by General Electric scientists at the recent meeting of the Radiological Society of North America held in Chicago.

A physician can easily manipulate those three-dimensional images, turning them this way or that, or "cutting" into the organ being imaged at any angle to view portions of the inside and outside simultaneously on the computer display.

The program allows a physician

to plan an operation by identifying underlying structures via computer simulation. Changes in the images can be made in just about five seconds.

To start the process, the G-E CT-9800 Quick scanner typically takes 50 cross-sectional X-ray "slices" of the head or the body organ to provide the building blocks from which the picture is assembled. The basic block is a cube about a millimeter on a side, known as a volume element, or "voxel." Each voxel is formed by a set of four points located on two adjacent CT scans.

Two new algorithms—sets of mathematical instructions—work on the cubes. One set is called "marching cubes," the other "dividing cubes." The "marching-cubes" set breaks up the entire scan into cubes and identifies those that contain at least a part of the object's surface; the "dividing cubes" set seeks to learn whether the surface of the organ being scanned is inside or outside of each cube. With that information, the program can present a sharp three-dimensional image, made by manipulating some four million voxels.

Sales of video products set records in late 1987

1.9 million color-TV sets were sold to dealers last October, a 6.9% increase over October 1986, reports the Electronic Industries Association (EIA). Monochrome TV-set sales also jumped, with factory sales of 456,000 units (a 32% increase over the previous October), and projection TV-set sales were up 19% over the same month in 1986.

More than 1.5 million VCR's were sold to dealers in October, up 9.3%, and camcorder sales were up by 26.4%. **R-E**

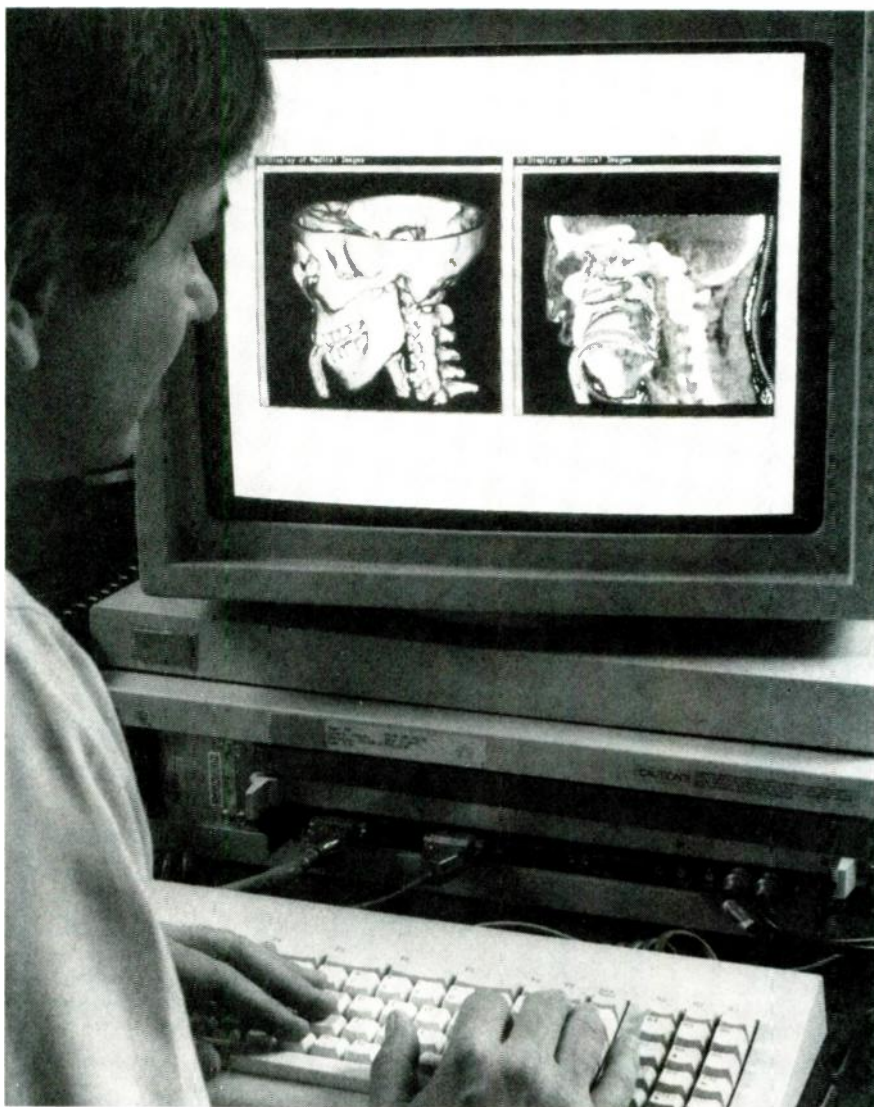

INSIDE AND OUTSIDE VIEWS of the same section of the head of a patient (who is being sedated through a tube inserted in his mouth) are being watched by GE scientist William Lorenzen.

MUST LIQUIDATE! AT FAR BELOW DEALER COST!

FREE GIFT!

Free 5-pc. knife set with your order. This knife set features wood handles, 3-brass rivets, full-tang stainless steel blades. A \$19⁹⁵ value. **FREE WITH YOUR ORDER!** Just ask your order operator, or check box on order form. (while supplies last)

NEC LAP-TOP COMPUTER



A Powerful Lap-Top Personal Computer That Lets You Get The Job Done Wherever It's Convenient!

FACTORY NEW! FACTORY PERFECT!

Built-In Word Processing, Spreadsheet, Filing and Telecommunications--Ready Instantly Wherever You Go!

NEC, one of the nation's top computer maker, recently introduced their State-of-the-Art Multi-Speed Lap Top PC. We offer this discontinued model at **FAR BELOW DEALER COST!**

FEATURES:

- 64K RAM memory stores data.
- 4 Built-In Programs included: Word Star-To-Go, Calc-To-Go, Personal Filer and Telcom
- Built-In 300 Baud Modem with auto dial
- 80 column x 16 line LCD Display.
- Interfaces: Standard Parallel, 232C, Modular phone, CMT
- Powered by 4 'C' Size batteries. (not included)
- **FULL FACTORY WARRANTY!**

Optional peripherals available through NEC include: Memory Expansion, Disk Drive, 1200 Baud Modem, AC Adapter

Manufacturer's Suggested Retail \$995.00

DAMARK PRICE:

\$298

Order No. B 618 140156
Insured Ship-Hand \$11.50

Heath/Zenith ROBOT



FACTORY NEW! FACTORY PERFECT!

*Join the Hi-Tech World With Hero Jr.! The Only Robot with "Personality"!
Ideal For That Person That Has Everything!*

Heath no longer makes this factory assembled model. They decided to produce the kit version. So we bought remaining inventory & offer them to you at an **OUT OF THIS WORLD SAVINGS!** Easy to program, Hero Jr.'s dynamic personality allows him to sing songs, play games, tell nursery rhymes, speak out people & even talk in Rob-ish, a unique robot language! Powered by two 6 volt rechargeable batteries. Hero Jr. performs tasks at room or by wireless remote control.

FEATURES:

- Software packages include: Song Rhymes & Phrases, Animal Blackjack, Tic-Tac-Toe, Special Occasions
- Plug-in wall charger
- Senses: on-board light sensor, Ultrasonic sensor, Motion, Sound, Speech
- Synthesizer, Internal Clock
- Speaks 18 English Phrases, sings songs, plays games, tells nursery rhymes, & talks

Manufacturer's Suggested Retail \$1078.85

DAMARK PRICE:

\$248

Order No. B 618 100926
Insured Ship-Hand \$18.75

FULL FACTORY WARRANTY!

CASIO 3" BLACK & WHITE TV



3" High Resolution Black & White LCD Screen! Sophisticated Electronic Tuning! FULL FACTORY WARRANTY!

A distributor goofed and ordered too many of these superior pocket televisions. As a result, we were able to obtain the overstock and can now offer them to you at a **LOW LIQUIDATION PRICE!** You won't believe your eyes when you see your favorite shows in crisp clear black & white on this Casio Pocket Television. Keep it in your purse, your briefcase, or your coat pocket. On a plane, in a car, on the bus, in a taxi or even at the game.

Other Fine Features:

- Improved resolution big screen clarity
- 3" Black & White LCD TV screen
- Electronic tuning
- Built-in speaker
- 90-day full factory parts and labor warranty
- Comes with Soft carrying case, AC adapter, batteries, ear phones

Manufacturer's Suggested Retail \$149.95

DAMARK PRICE:

\$58

Order No. B 618 100355
Insured Ship-Hand \$3.00

SEIKO WATCH/PC TERMINAL



This Space-Age Watch Interfaces With Your PC Allowing You to Carry Important Information Wherever You Go -- Right At Your Fingertips!

Seiko, a leading manufacturer of watches, decided to liquidate this high tech model. As a result we can offer them to you at a **LOW, LOW LIQUIDATION PRICE!**

FEATURES:

- 5 Functions: Time, Calendar, Data Memo, Schedule Alarm, Weekly Alarm, World Time
- Includes RS232C cable for simple hook-up
- 2K RAM memory stores phone number, appointment times, key dates, any kind of information!
- **FULL FACTORY WARRANTY!**

Manufacturer's Suggested Retail \$150.00

DAMARK PRICE:

\$48

(IBM) Order No. B 618 100883 (Comm) Order No. B 618 100891 (Apple IIE) Order No. B 618 100909 (Apple IIC) Order No. B 618 100917
Insured Ship-Hand \$5.00

Pulser COMPACT DISC BY YAMAHA



Step Into The Future of Sound!

Turn Your Stereo Into a State-of-the-Art Sound System with Pulser, MADE BY YAMAHA! This unit has many of the features found only on the most expensive CD players!

A major Canadian retailer ordered too many of these top-of-the-line Pulser Compact Disc Players (private label) made by Yamaha. As a result, we were able to obtain the overstock and can offer them to you at a **LOW LIQUIDATION PRICE!**

FEATURES:

- 3-Beam Laser pickup
- 3-Programable memories
- Digital Filtering
- Motorized front-loading
- Soft touch control door
- Dual speed audible track search
- Hi-speed program search
- 4-digit LEE multi-function readout
- Index search

Manufacturer's Suggested Retail \$298.00

DAMARK PRICE:

\$128

Order No. B 618 102129
Insured Ship-Hand \$8.50

FOR FASTEST SERVICE

CALL TOLL FREE

1-800-533-3379



NAME _____
ADDRESS _____
CITY _____ ST _____ ZIP _____
PHONE _____

CHECK/MONEY ORDER

VISA MASTERCARD CARD NO. _____

CHECK HERE FOR FREE GIFT WITH YOUR FIRST ORDER

EXP. DATE _____

SUB TOTAL _____

in MN add 6% sales tax

TOTAL _____

DELIVERY TO 48 U.S. STATES ONLY
CORPORATE OFFICE (612) 560 5415

Send To: DAMARK INTERNATIONAL, INC., 7714 Brooklyn Blvd., Minneapolis, MN 55443

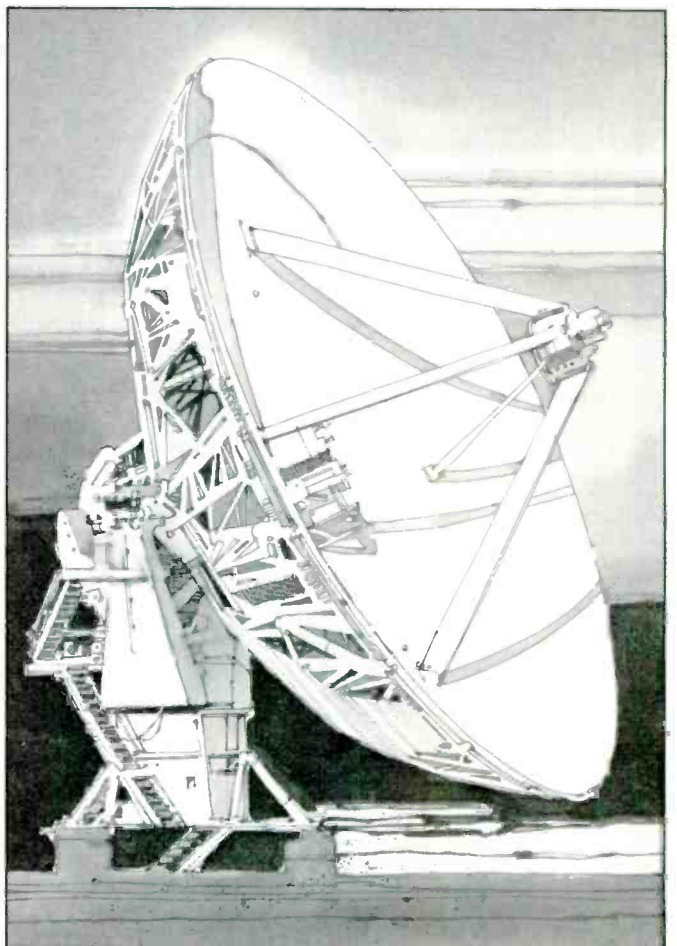
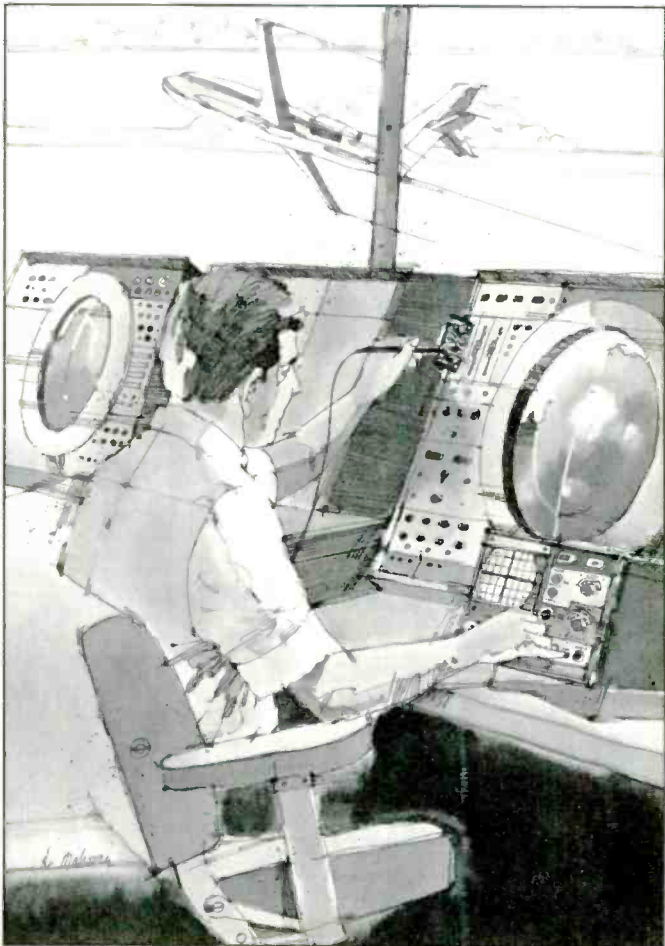
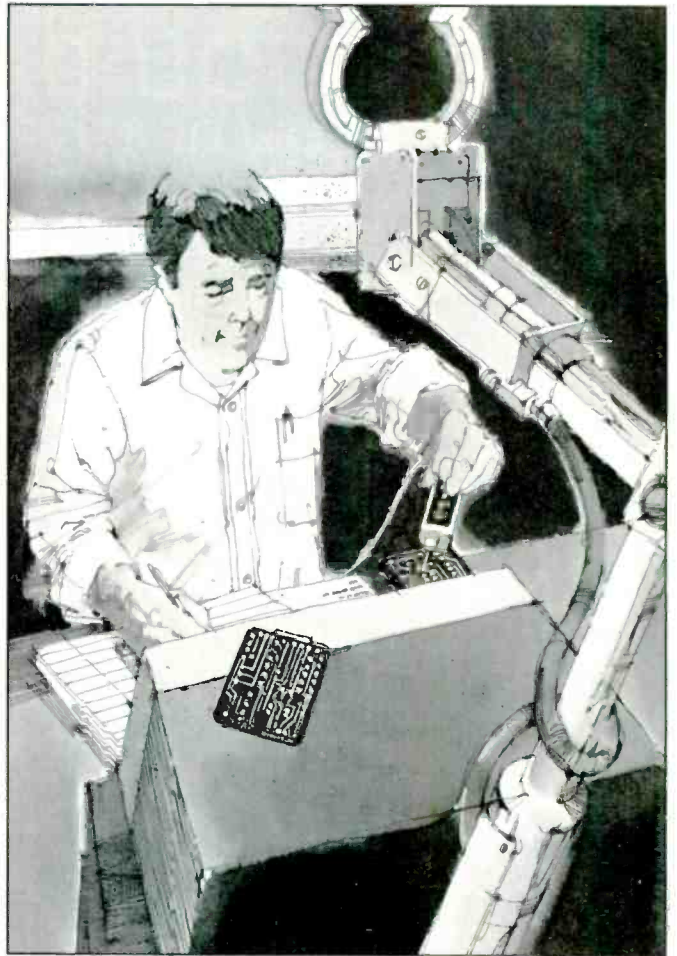

CIE MAKES THE WORLD OF ELECTRONICS YOURS.

Today's world is the world of electronics. To be part of it, you need the right kind of training, the kind you get from Cleveland Institute of Electronics, the kind that can take you to a fast growing career in business, aerospace, medicine, science, government, communications, and more.

Specialized training.

You learn best from a specialist, and that's CIE. We're the leader in teaching electronics through independent study, we teach only electronics and we've been doing it for over 50 years. You can put that experience to work for you just like more than 25,000 CIE students are currently doing all around the world.

Practical training.

You learn best with practical training, so CIE's Auto-Programmed® lessons are designed to take you step-by-step, principle-by-principle. You also get valuable hands-on experience at every stage with sophisticated electronics tools CIE-designed for teaching. Our 4K RAM Microprocessor Training Laboratory, for example, trains you to work with a broad range of computers in a way that working with a single, stock computer simply can't.

Personalized training.

You learn best with flexible training, so we let you choose from a broad range of courses. You start

with what you know, a little or a lot, and you go wherever you want, as far as you want. With CIE, you can even earn your Associate in Applied Science Degree in Electronics Engineering Technology. Of course, you set your own pace, and, if you ever have questions or problems, our instructors are only a toll-free phone call away.

The first step is yours.

To find out more, mail in the coupon below. Or, if you prefer, call toll-free 1-800-321-2155 (in Ohio, 1-800-523-9109). We'll send a copy of CIE's school catalog and a complete package of enrollment information. For your convenience, we'll try to have a representative contact you to answer your questions.

CIE Cleveland Institute of Electronics 1776 East 17th St., Cleveland, Ohio 44114

YES! I want to get started. Send me my CIE school catalog including details about the Associate Degree Program. I am most interested in:

- | | |
|--|---|
| <input type="checkbox"/> computer repair | <input type="checkbox"/> television/high fidelity service |
| <input type="checkbox"/> telecommunications | <input type="checkbox"/> medical electronics |
| <input type="checkbox"/> robotics/automation | <input type="checkbox"/> broadcast engineering |
| <input type="checkbox"/> other _____ | |

Print Name _____

Address _____ Apt _____

City _____ State _____ Zip _____

Age _____ Area Code Phone No _____

Check box for G.I. Bulletin on Educational Benefits **ARE-80**
 Veteran Active Duty **MAIL TODAY!**

VIDEO NEWS



DAVID LACHENBRUCH,
CONTRIBUTING EDITOR

• **VCR ownership breaks 50%.** Last year saw two major landmarks in video: more than 50% of U.S. households owned at least one VCR, and just about the same percentage were wired for cable TV. That's according to the A.C. Nielsen Co., which reported that a July 1987 survey showed that 50.9% of U.S. homes had VCR's and that 49.5% are now wired for cable. America's top VCR markets are Anchorage and Fairbanks Alaska where 70.6% and 69.1%, respectively, of households owned VCR's as of May 1987. The July survey showed that Las Vegas was third with 63.4%, followed by San Francisco-Oakland, Sacramento-Stockton, Los Angeles, Washington D.C., and Salt Lake City, all with penetration above 60%.

• **Video Telephones.** Commercially available videophones that send monochrome slow-scan pictures over standard telephone lines could begin to be a significant product category this year. The first "consumer-priced" model, introduced in the United States by Mitsubishi, carries a suggested list price of \$399, as opposed to the previous model aimed at the business market at \$1,450. Mitsubishi's *VisiTel* has a built-in video camera with $\frac{2}{3}$ -inch pickup and a 4 $\frac{1}{2}$ -inch monochrome monitor. It attaches to any telephone line with a standard modular plug. The system paints a complete picture in 5 $\frac{1}{2}$ seconds and automatically stores the last three images for recall. Since the image is transmitted half duplex, voice and video can't be sent at the same time. The company estimates it will sell 100,000 to 150,000 consumer videophones in the U.S. this year and up to 500,000 in 1989.

It won't be all clear sailing for videophones, however. The new product is getting off to the same kind of start as many other consumer electronic products—in the middle of a dispute over standards. Mitsubishi's standards are backed by Panasonic and NEC, which are developing their own compatible phones. But there is formidable competition on the way from Sony and Nippon Telephone & Telegraph (NTT), which have their own non-compatible system that is said to be cheaper but requires a longer time to

send a picture. We may see a repeat of the Beta-VHS wars.

• **A new/old brand name.** A major new brand of TV sets, VCR's and stereo equipment has been introduced in the United States. It's Philips, the dominant brand in Europe, which is sold in many countries throughout the world, but, with a few exceptions, never in the U.S. (**Radio-Electronics** December 1987). The first Philips line is an upscale group of large-screen direct-view monitor-receivers and projection TV sets, audio components, and VCR's, introduced by North American Philips, which now is completely owned by Philips of the Netherlands. The first video products look familiar because they strongly resemble similar ones previously introduced under the Magnavox brand, which is also owned by North American Philips. Company officials say, however, that that is only a temporary condition and promise that the Philips line will be "innovational."

• **Projection progress.** A projection TV screen that also serves as a flat loudspeaker has been introduced in Japan by Matsushita, parent of Panasonic. Matsushita set its computers to work and developed a reflective lenticular screen for displaying video pictures, measuring 70 inches diagonally, with woofers, midrange speakers, and tweeters built right into the screen's surface using the "Audio Flat Speaker" (AFS) principle developed by Matsushita. The screen in its own cabinet is three inches deep and weighs about 220 pounds, including the supporting stands.

In Denmark, meanwhile, a major manufacturer of translucent screens for rear-projection TV sets announced that it has developed a giant version, to be available in sizes as large as 120-inches, diagonal measurement. Scan Screen of Copenhagen, supplier to many U.S. projection-TV systems, says the new screens have wide viewing angles, and good brightness and contrast. Scan Screen's previous largest size was 67 inches. It's now also developing an in-between size of 82 inches.

HANDHELD DIGITAL IC COMPARATOR/TESTERS FEATURE 20 CHANNEL LOGIC MONITOR

B&K-PRECISION's Model 550 and 552 IC Comparator Tester/Logic Monitors test IC's by comparison to a known good reference in one simple operation. As logic monitors, they simultaneously indicate the logic states of up to 20 IC pins. They test most 14 to 20 pin, 54 and 74 Series TTL (Model 550) or 4000 and 74C Series CMOS (Model 552) devices. Both models are available from distributors at \$395. Contact your local distributor or: B&K-PRECISION, Maxtec Int., 6460 W. Cortland St., Chicago, IL 60635. (312) 889-9087.



LOGIC/PULSER PROBES HELP LOCATE DIGITAL FAULTS IN LAB OR IN FIELD SERVICE

B&K-PRECISION now offers logic and pulser probes to fill the needs of engineers and technicians. The DP-21 is a 20 MHz probe that also displays pulse presence and logic status. Both LED and audible logic state indicators are featured. The DP-31 pulser probe can be used alone or with a logic probe or scope. It produces a 10µs pulse at 0.5 or 400 PPS rates and features an external square wave and synchronizing terminal. Both probes are multi-family compatible. The DP-21 is \$32. The DP-31 is \$33. Contact your local distributor or: B&K-PRECISION, Maxtec Int., 6460 W. Cortland St., Chicago, IL 60635. (312) 889-9087.

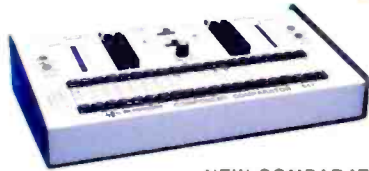

NEW COMPARATOR

ADDS IC/COMPONENT TESTING TO SCOPE

Test virtually any type of passive or active component or module with B&K-PRECISION's new 541 Component Comparator. The 541 is designed for use with the 540 component tester or virtually any x-y oscilloscope. It is well suited for both in-circuit and out-of-circuit tests. It's fast and easy to use. Unlike single function testing, the 541 can be used on series, parallel or series/parallel circuits. \$395. Contact your local distributor or: B&K-PRECISION, Maxtec Int., 6460 W. Cortland St., Chicago, IL 60635. (312) 889-9087.



NEW COMPONENT TESTER LOCATES FAULTS ON UNPOWERED BOARDS IN FIELD OR PLANT

The new Model 540 component tester is an extremely cost effective, highly flexible trouble-shooting aid that can assist in rapidly locating faults on unpowered boards. Faults can be traced to the component level without specific circuit knowledge. Individual components can also be tested. Test results are displayed as a curve on a built-in CRT display. Curve tracing allows matching of components. Two channels allow production testing against known good boards. Ideal for field service or production testing. \$995. Contact your local distributor or: B&K-PRECISION, Maxtec Int., 6460 W. Cortland St., Chicago, IL 60635. (312) 889-9087.



PROGRAMMABLE IC TESTER TESTS TTL, CMOS, RAM AND ROM IC'S, IN OR OUT-OF-CIRCUIT

Called the "first cost-effective way to test IC's both in and out-of-circuit," the new B&K-PRECISION Model 560 fills the void between basic component testers and costly ATE systems. Over 1500 different 14 to 24 pin devices can be tested, including TTL and CMOS digital IC's, RAMs and ROMs. The 560 speeds testing, simplifies diagnostics and doesn't require prior test skills. Plain-English user prompts guide every step of operation. Test results are displayed as positive "pass" or "fail." Test results can be fed to a printer. Applications include incoming inspection, QC, production line testing and troubleshooting faulty products. \$3,500. Contact your local distributor or: B&K-PRECISION, Maxtec Int., 6460 W. Cortland St., Chicago, IL 60635. (312) 889-9087.

B&K-PRECISION has what you need for fast, cost-effective IC or board testing.

Check it out!

- Programmable in/out-of-circuit IC tester
- Portable curve-tracing component tester
- Portable IC comparator tester/logic monitors
- Benchtop IC component comparator tester
- Multi-family compact pulser probes
- Memory-mode multi-family logic probes

Whether your needs are for production board testing, incoming inspection or field service B&K-PRECISION has you covered with time saving, accurate digital test products.

The Model 560 Programmable In/Out-of-circuit IC Tester is the first cost-effective way to rapidly test IC's both in and out-of-circuit. Punch up the number you need from a resident memory of over 1500 TTL, CMOS IC's, RAM's and ROM's.

The Model 540 Component Tester locates faults on unpowered boards, down to the component level. Curve-tracing method also allows fast comparison of components or boards.

The Model 541 Component Comparator is a companion instrument for use with your scope or the 540. It tests IC's, semiconductors, capacitors, inductors, transformers and more.

The Models 550 and 552 IC Comparator Tester/Logic Monitors are hand-held portables for TTL and CMOS applications. In-circuit dynamic tests compare a known-good IC to an on-board IC. A 20-character logic monitor is built-in.

The B&K-PRECISION digital test line-up is rounded out by convenient and economical pulser and logic probes.

For immediate delivery, or complete specifications and applications information, call your local distributor or B&K-PRECISION.



BK PRECISION

MAXTEC INTERNATIONAL CORP.
6460 West Cortland St. • Chicago, IL 60635 • 312-889-9087

International Sales, 6460 W. Cortland St., Chicago, IL 60635

Canadian Sales, Atlas Electronics, Ontario

South and Central American Sales, Empire Exporters, Plainville, NY 11803

LETTERS



AUDIO SCRAMBLING SYSTEM

I've needed a secure communications system for years, and your "Audio Scrambling System" (January 1988 *Radio-Electronics*) is the only device I've found that didn't cost megabucks. But I've had some trouble getting it going. Were there any circuit changes?

I need several units, so I want to purchase pre-made PC boards. Where can I buy them? The article stated that there was a source for PC boards in the parts list, but it wasn't there.

TIM CATLIN
Chicago, IL

If your project used a PC board made from our template there is no circuit change. If you built the circuit using Fig. 5 in January as a reference, however, make the following corrections: Delete the connection between IC4-a, pin 2 and IC4-d, pin 12. Add a connection between IC4-a, pin 13 and IC4-d pin 12. The schematic should then be correct.

An etched and drilled PC board is available postpaid for \$8.00 from Wavelink Laboratories, P.O. Box 199, Trumbull, CT 06611. Connecticut residents must add appropriate sales tax.—Editor

THE BLUE BOX

Herb Friedman's article, "The Blue Box and Ma Bell," (*Radio-Electronics*, November 1987) may be interesting reading for many people who need to study simpler circuits. It also reflects on a time when the latent computer hacker was a phone-phreak. Please let me add a few details.

The Red Box that he describes was really a Black Box. The Red Box



FIG. 1

was a 2.2-kHz pulsed oscillator for imitating the "new" tones generated by single-slot pay phones. If all you wanted was free calls, that was the safest, surest way. The real reason why the phone company had coronaries over Blue Box use was due to its almost limitless control over the trunk lines. It rivaled the power some hackers get by intentionally logging into a secured computer system.

Please note that it was necessary to send a 2.6-kHz tone to disconnect from the central office at the end of the call route. Only then did you send the multi-frequency tones. Ma Bell also took care to use a different *Touch-Tone* pad matrix so that the oscillators could not just be re-tuned. Centralized Automatic Message Accounting (CAMA) was common knowledge.

The criminal element utilized the technical prowess of phone-

phreaks with a device called the "Cheese Box," which tied two phone lines together. The criminal called one number (reserved for him only) and waited for someone to call the other, public number. The box connected them automatically. All calls to the Cheese Box came through free through Black Box technology. Nobody but true phreaks and the curious used Blue Boxes, because Ma Bell's fury against that particular box was well recognized.

Technical information in this letter came from papers published by the Youth International Party Line between 1972 and 1974. Regards to all who remember.

H.M.S.
New Jersey

MORE BLUE BOX

I read Herb Friedman's article, "The Blue Box and Ma Bell," (*Radio-Electronics*, November 1987) with considerable interest. Long a reader about phone-phreaking (not a practitioner), the story contained enough of the specifics to make the technique clear to me without explaining how to build a Blue Box. As the article mentioned, toll-phreaking can be detected and traced (using AMA) much more readily with today's ESS series CO switches.

Back in 1974 I subscribed to a publication called *Telephone Electronics Line*. After receiving six or seven issues of this modest little monthly, lightning struck in the form of a threatening letter from Pacific Bell noting that they had seized the publishers, their equipment, and their subscriber list! As a subscriber, I was put on notice that if I ever entertained thoughts of phreaking, I would be prosecuted to the full extent of the law.

Eliminate Costly Guesswork And Interpretation Errors In LCR Testing!



- **Completely Analyze Capacitors**
From 1pf to 20F for value, leakage, Dielectric absorption and ESR.
- **Thoroughly Test Inductors**
From .1uH to 20H for value, opens and shorts even to one shorted turn!
- **Dynamically Test For Resistance**
Measure resistances up to 1,000 Megohms, and leakage down to 1 microamp with 1,000 volts applied potential.
- **Good/Bad Tests Eliminate Guesswork**
Exclusive good/bad readout gives you easy to read, reliable tests to internal EIA and industry standards.
- **100% Portable**
Works all day on one charge for testing in the field or on the bench.

LC77 AUTO-Z™
Capacitor-Inductor Analyzer
\$1895 Patented

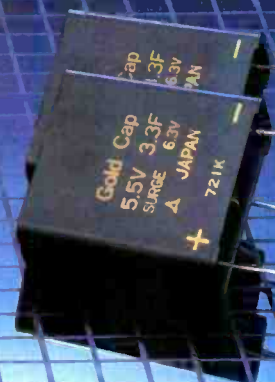

THE 2 STANDARD

SENCORE

Call 1-800-843-3338 today.
In Canada call 1-800-851-8866 today.

100% American Made CIRCLE 183 ON FREE INFORMATION CARD



data systems

COMPUTER with Monitor and Software

IBM PC/XT Compatible System.

First-Quality, Factory New!



For Home, School, Or Office!

Includes MS-DOS Operating System, Two Program Disks, User's Guide, Quick-Reference Guide, and Owner's Manual.

- 512K Random Access Memory.
- Two 5 1/4" 360K Drives.
- 12" Monochrome Monitor.
- IBM Style 84-Key Keyboard.
- MS-DOS 3.2 Operating System with User's Guide and 2 Disks.
- Parallel Interface.
- 4 Expansion Slots.
- Hercules Graphics Compatible.
- Color Card Included.



Zenith—The Quality Goes In Before the Name Goes On. For decades, Zenith has been making fine electronics for home and business. Products built to perform and to last. They have put their experience to work to develop the 157-2 Personal Computer. Now you can order this IBM compatible computer at a price that's

almost 50% less than what you could pay for a comparable system. Why buy a no-name clone when you can own a Zenith? This kind of quality, at such a LOW price, makes this a computer deal you can't afford to pass up!

Zenith Data Systems are made by skilled engineers to exacting specifications. The Zenith Model 157-2 Computer is expandable to 640K RAM. A hard disk drive can be added with addition of controller card. The MS-DOS Disk operating System is the most widely used system available. Order one or more Zenith Computers for your home or business today!

90-Day Limited Manufacturer's Warranty.

IBM and IBM PC/XT are registered trademarks of International Business Machines Corp.

List: **\$1499.00**

Value Priced At

\$799

Item H-3270-7344-054
S/H: \$49.50 each

To Order Toll-Free: 1-800-328-0609

Credit Card customers can order by phone, 24 hours a day, 7 days a week.

Authorized Liquidator
1405 Xenium Lane N/Minneapolis, MN 55441-4494

Send ___ Zenith Computer(s) Item H-3270-7344-054 at \$799 each, plus \$49.50 each for insured shipping, handling. (Minnesota residents add 6% sales tax. Sorry, no C.O.D. orders.)

PLEASE CHECK: VISA M/C DISCOVER AMERICAN EXPRESS

My check or money order is enclosed. (No delays in processing orders paid by check.)

Acct. No. _____ Exp. / _____

Name _____

Address _____ Apt # _____

City _____

State _____ ZIP _____

Phone _____

Sign Here _____

Actually, my sole goal then was adding an extension phone or two to my house phone—which, as you know, was illegal at that time. A simple method of escaping detection was to disconnect the bell. For ring detectors, there were circuits utilizing light-sensitive resistors coupled to NE-2's, along with transistor-actuated relays. Due to their isolation and high impedance, they were undetectable by the local switchman. How times have changed!

Thanks for a great article!
CLIFFORD C. BARBER
Arlington Heights, IL

A SPECIAL THANK YOU

You probably get a lot of "thank you for a great magazine" letters, but this is a special one. I'm not just thanking you for a good publication, but for producing a magazine that helped make me what I am today.

I've subscribed to **Radio-Electronics** since 1978, when I was in eighth grade. I've carefully read each issue and built many of the projects. They were my motivation to learn about transistors, op-amps, lasers, and computer technology. I played with the 76477 sound generator. I build a robot. I learned to program in BASIC. **Radio-Electronics** inspired me to learn and do so much!

That interest in electronics took me to college, where I just completed a degree in Electrical Engineering (analog design). Looking back, I remember "first" courses—like an introduction to transistor amplifier design—where most of the other students had to ask questions like "Excuse me, Professor, but what's the emitter again?"

Years of reading and doing, experimenting and hacking, had laid down for me a basic, practical foundation of knowledge which made it easier to learn the more rigorous theoretical material to come. Almost none of my peers had any experience. Only one even knew the resistor color code! I had it easy.

Finally, the extra practical experience I gained in part from reading **Radio-Electronics**, combined with my college theoretical background, has made me a more de-

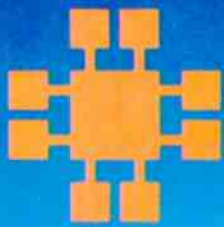

JDR INSTRUMENTS™

Complete customer satisfaction... superior service... friendly, knowledgeable personnel... quality merchandise... providing the best values in leading edge technology.

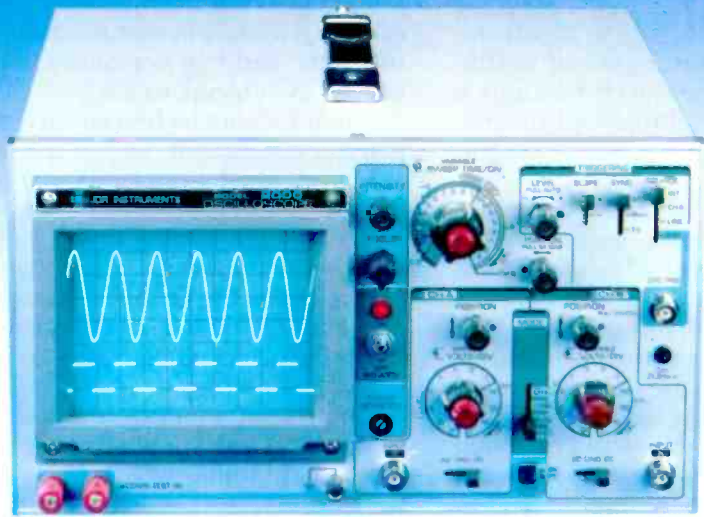

BEAT THE PRICE INCREASE!

349.95

20 MHz OSCILLOSCOPE

Save \$40 if you buy before April 1st when our price goes up to 389.95. This model makes frequency calculation and phase measurement quick and easy. Service technicians appreciate the TV Sync circuits for viewing TV-V and TV-H and accurate synchronization of the video signal, Blanking, VITS, and V/H sync pulses. A component tester for fast troubleshooting.

DMM-300

\$79.95

3.5 DIGIT DMM/MULTITESTER

This full function 3.5 digit DMM offers highly accurate performance and a host of added features like audible continuity, capacitance, transistor, temperature, and conductance to help you do the job—fast. Temperature probe, test leads and battery included.

- Basic DC accuracy: plus/minus 0.25%
- DC voltage: 200mv–1000v, 5 ranges
- AC voltage: 200mv–750v, 5 ranges
- Resistance: 200 ohms–20M ohms, 6 ranges
- Capacitance: 2000pf–20 μf, 3 ranges
- Transistor Tester: 0°–2000°F
- Conductance: 200ns
- Fully overload protected
- Input Impedance: 10M ohm.

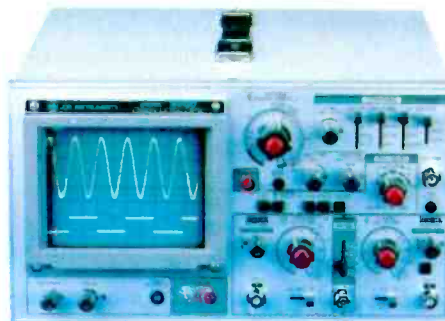

MODEL 3500

\$499.95

35 MHz DUAL TRACE OSCILLOSCOPE

Wide bandwidth and exceptional 1mV/DIV sensitivity make this a powerful tool for engineers or technicians at a remarkable price. Delayed triggering allows any portion of a waveform to be isolated and expanded for closer inspection. Variable Holdoff allows stable viewing of complex waveforms.

- Exceptionally bright 5" CRT
- Delayed and single sweep modes
- Z axis intensity modulation
- X-Y operation • TV sync filter
- Fast 10ns rise time

DMM-100

\$29.95

3.5 DIGIT POCKET SIZE DMM

Perfect for the field service technician. Shirt pocket size without compromising features or accuracy. Large, easy to read 1 1/2" LCD display. Fully overload protected for safety. 2000 hour battery life with standard 9v cell. Probes and battery included.

- Basic DC accuracy: plus/minus 0.5%
- DC voltage: 2v–1000v, 4 ranges
- AC voltage: 200v–750v, 2 ranges
- Resistance: 2k ohms–2M ohms, 4 ranges
- DC current: 2mA–2A, 4 ranges
- Input impedance: 10M ohm
- Fully overload protected
- Approx. 5" x 3" x 1". Under 7 ozs.



DMM-200

\$49.95

3.5 DIGIT FULL FUNCTION DMM

Get highly accurate performance at a very affordable price. Rugged construction, 20 amp current capability and 22 ranges make it a perfect choice for serious field or bench work. Low battery Indicator and tilt-stand. Probes and 2000 hour battery included.

- Basic DC accuracy: plus or minus 0.25%
- DC voltage: 200mv–1000v, 5 ranges
- AC voltage: 200mv–750v, 5 ranges
- Resistance: 200 ohms–20M ohms, 6 ranges
- AC/DC current: 200μA–20A, 6 ranges
- Input impedance: 10M ohm
- Fully overload protected
- Approx. 7" x 3 1/2" x 1 1/2". Wt. 11 ozs.

DPM-1000

\$54.95

3.5 DIGIT PROBE TYPE DMM

Custom 80 pin LSI chip provides accuracy and reliability in such a compact size. Autoranging, audible continuity and data hold feature help you pinpoint the problem quickly. Case and batteries included.

- Basic DC accuracy: plus/minus 1%
- DC voltage: 2v–500v, autoranging
- AC voltage: 2v–500v, autoranging
- Resistance: 2k ohms–2M ohms, autoranging
- Fully overload protected
- Input impedance: 11M ohm
- Approx 6 1/2" x 1" x 3/4". Under 3 ozs.



CIRCLE 59 ON FREE INFORMATION CARD

- ★ 2 YEAR REPLACEMENT WARRANTY
- ★ 30 DAY MONEY BACK GUARANTEE
- ★ TOLL FREE TECHNICAL SUPPORT
- ★ NEXT DAY AIR SHIP AVAILABLE

COPYRIGHT 1987 JDR MICRODEVICES



JDR INSTRUMENTS, 110 KNOWLES DRIVE, LOS GATOS, CA 95030
RETAIL STORE: 1256 SOUTH BASCOM AVE, SAN JOSE, CA (408) 947-8881

ORDER TOLL FREE 800-538-5000

sirable—and saleable!—engineer to industry. Managers would be willing to kill to find good engineers with *practical* experience. They're few and far between, straight out of college.

If you're a **Radio-Electronics** reader, surely you already know that you're learning practical electronics with each issue. If you're a student who's planning to go to a four-year college for a degree, I promise you've already made the best start. Keep reading, doing, and learning, and you'll be far ahead of the rest!

Thanks again to everyone on your staff for a great magazine.

DAVE JENNINGS
Venice, CA

R-E ROBOT PARTS

We have been following the "R-E Robot" construction series and must congratulate you on the time and effort which have obviously been put into that project.

Part 11 (**Radio-Electronics**, October 1987) refers to Sprague Elec-

tric Company's UDN2952W for the servo driver of Fig. 4. Unfortunately, due to manufacturing difficulties (ground connection at pin 4) we had to discontinue that device this past June. Happily, the redesigned part, UDN2954W, is available. In addition to slightly reduced cost and improved performance, the new part includes a few added features—adjustable current trip and internal PWM current control.

The rather high value (1 ohm) for your current-sensing resistor, R11, equates to a typical motor current of less than 850-mA, including the worst-case startup current. That agrees with your text. At that low current rating, the UDN2952B dual in-line package, or the now preferred UDN2953B would be much more economical. With the new UDN2953B/54W, R11 would have to be only 0.29 ohms for an 860-mA load current.

F. RAYMOND DEWEY, *Technical Information Coordinator*
Sprague Electric Company
Worcester, MA

MORE THANKS FOR SMT

I want to thank you for your timely presentation on surface-mount components in the November 1987 issue of **Radio-Electronics**. I am involved in training for a major manufacturer of state-of-the-art mobile communications products, and I've personally witnessed the change to SMT.

When training technicians to repair our equipment, I often spend at least as much time familiarizing the technician with surface-mount repair as I do with troubleshooting electronic circuitry. In future training sessions, I will refer to the November issue to aid in breaking down the usual initial resistance to a new technology.

For today's electronic technician, a thorough knowledge of surface-mount soldering and removal techniques, and typical failures encountered, will go a long way toward solving most electronics problems in a minimum amount of time.

JIM W. MARION
NEC America, Inc.

R-E

HITACHI COMPACT SERIES



V-1065 DC to 100MHz With Cursor Readout
\$1545⁹⁵ Save \$250!

- 6" CRT with Internal Graticule
- Dual Channel X-Y Display
- Sweep Time Autoranging
- 400V High Input Voltage Protection
- TV Sync Trigger Circuit
- Bandwidth Limiter • Trigger Lock
- Delayed Sweep • Single Sweep
- CRT Readout • ±3% Accuracy

V-1060 DC to 100MHz
\$1295⁹⁵ Save \$200!

V-665 DC to 60MHz
With Cursor Readout.
\$1145. Save \$150!

V-660 DC to 60MHz
\$945⁹⁵ Save \$150!

Instant Hard Copy!! From Oscilloscopes

POLAROID®
DS-34
CAMERA



Save \$135! \$290.

- 5", 6" and 7" Hoods (Available separately @ \$51 ea. Please Specify size)
- Pistol Grip For Ease of Operation
- Works on Any Make of Oscilloscope
- Three Full Year Warranty

Dual Channel 6" CRT Scopes

V-425 DC to 40MHz, CRT Readout
\$845. Save \$150!

V-423 DC to 40MHz, Single Time Base Delayed Sweep
\$745. Save \$250!

V-422 DC to 40MHz, DC Offset
\$795. Save \$130!

V-225 DC to 20MHz, CRT Readout
\$720. Save \$75!

V-223 DC to 20MHz, Delayed Sweep
\$695. Save \$100!

V-222 DC to 20MHz, DC Offset
\$515. Save \$200!

V-212 DC to 20MHz
\$440. Save \$175!

Dual Channel Mini-Portable Scopes

V-509 DC to 50MHz, Delayed Sweep
\$1195. Save \$250!

V-209 DC to 20MHz
\$822. Save \$175!

Quad Channel Multi-Function Scopes

V-1150 DC to 150MHz, Delayed Sweep
\$2600. Save \$350!

V-1100AU DC to 100MHz, Delayed Sweep
\$2175. Save \$315!

Digital Storage Scope

V-6020 1MHz Sampling, Dual Channels
\$1750. Save \$200!

NTSC Waveform Monitors

V-079 6" CRT
\$1625. Save \$125!

V-099 3.5" CRT
\$950. Save \$300!

NTSC Vector Scopes

V-069 6" CRT
\$1825. Save \$125!

V-089 3.5" CRT
\$1284. Save \$400!

PROBES INCLUDED WITH ALL HITACHI SCOPES AT NO EXTRA CHARGE!



WM. B. ALLEN
SUPPLY COMPANY

ALLEN SQUARE
300 Block North
Rampart Street
New Orleans
Louisiana 70112

TOLL FREE 800 535-9593 • LA 800 462-9520
NEW ORLEANS 504 525-8222 • FAX 504 525-6361
• American Express • Visa • MasterCard •
928 pg Catalog **FREE** with your order

Contemporary Electronics Series

The fast, easy and low cost way to meet the challenges of today's electronic innovations. A unique learning series that's as innovative as the circuitry it explains, as fascinating as the experiments you build and explore.

From digital logic to the latest 32-bit microprocessor, the McGraw-Hill Contemporary Electronics Series puts you into the electronic picture one easy step at a time. Fifteen unique Concept Modules, sent to you one every 4-6 weeks, give you a handle on subjects like optoelectronics, robotics, integrated circuits, lasers, fiber optics and more.

Each Concept Module goes right to the heart of the matter. You waste no time on extraneous material or outdated history. It's a fast, efficient, and lively learning experience... a non-traditional approach to the most modern of subject matter.

Unique Interactive Instruction

With each module, you receive a McGraw-Hill Action Audio Cassette. Each tape is a dynamic discussion that drives home the key facts about the subject. Your learning

With your first module, you get this solderless breadboarding system. You'll use it throughout the series to build electronic circuits and bring concepts to life.

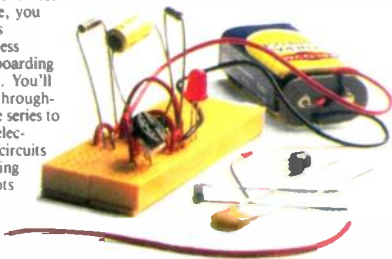

experience is reinforced through interaction with vividly illustrated text, audio cassettes, and actual electronic experiments. Indexed binders preserve backup material, notes, and tapes for convenient referral.



Perform Experiments in Contemporary Electronics

Throughout your series, laboratory experiments reinforce every significant point. This essential experience... dynamic, hands-on demonstrations of theory in practice... will help you master principles that apply all the way up to tomorrow's latest VLSI (Very Large Scale Integrated) circuitry.

In your very first module, you'll use integrated circuits to build a digital oscillator, verifying its operation with a light emitting diode (LED). You'll learn to identify passive and active components, understand concepts common to all electronic circuits.

For Anyone Interested in Electronics

The Contemporary Electronics Series is designed for anyone from hobbyist to professional. It's for you if you're looking for new fields of interest... if you're a teacher who

wants an update in contemporary circuits... a manager or supervisor in an electronics plant... a doctor, an engineer, a chemist who finds electronics playing an increasingly important role in your work. It's even for electronics engineers or technicians who feel their training needs freshening up. It's the quickest, most convenient, probably least expensive way to do it. And the only one that gives you hands-on experience.



15-Day No-Risk Trial

To order your first module without risk, send the card today. Examine it for 15 days under the terms of the order form and see how the Contemporary Electronics Series gets you into today's electronics. If card has been used, write us for ordering information.



McGraw-Hill
Continuing Education Center
3939 Wisconsin Ave.
Washington, D.C. 20016

IF YOU WANT A BETTER COMPUTER BUILD IT YOURSELF.

Heath makes building the powerful 386 computer quick, fun, easy... and a great value.

Now you can own the fastest, most powerful home computer available today- at an affordable cost. Just by building it yourself.

Introducing the Heathkit H-386 Desktop Computer. With its powerful 32-bit processor, 16 MHz computing speed and "zero wait" technology,



the H-386 can breeze through complex calculations in seconds.

Every INTEL 80386 micro-processor used in our H-386 is 100% tested for all functions. And you get superb graphics because one video port provides dazzling 640-by-480 color on Zenith's new flat



screen monitor and another port drives EGA, CGA and TTL monochrome monitors. Both ports automatically emulate common video formats for easy system configuration.

Designed for people using large spreadsheets, CAD/CAM or other computation-intensive applications, or anyone who simply wants to own the newest, most powerful hardware on the market, the Heathkit H-386 can be assembled easily and quickly. One or two evenings is all it takes, and no special tools or equipment are required.

In the bargain, you get the satisfaction of having built a powerful computer system all by yourself, and the confidence that this exciting product will deliver all

the performance and dependability you expect. At a significant savings over comparable off-the-shelf brands.

What's more, all Heathkit products are backed by a newly extended, limited one-year warranty, highly respected manuals and technical consultation service.

So if you want a better computer, build it yourself. Impress your friends.

And save money at the same time.



To order the new Heathkit H-386 Desktop Computer, simply call toll-free 1-800-253-0570. Ask for operator 303. Use your Visa, MasterCard or Heath Revolving Charge. Or call 616-982-3614 for the Heath/Zenith Computers and Electronics store location nearest you.

For more information on all our quality kits, send now for your free four-color Heathkit catalog. Write Heath Company, Dept. 020-634, Benton Harbor, MI 49022.

Prices, product availability and specifications are subject to change without notice.

Heathkit®

Heath
Company

Heathkit is a registered trademark of Heath Company, a subsidiary of Zenith Electronics Corporation.

©1987, Heath Company.

CIRCLE 86 ON FREE INFORMATION CARD

EQUIPMENT REPORTS

Technology Marketing Inc. PC Weather Pro

A computer-controlled
home weather station

CIRCLE 39 ON FREE INFORMATION CARD



MANY ELECTRONICS PROFESSIONALS and hobbyists have interests that go beyond electronics and computers. One of the more common is weather monitoring and forecasting. If you, too, want to know more about the weather than what you can learn by simply looking out the window or turning on a radio, then you'll love the new *PC Weather Pro* from Technology Marketing Inc. (400 Kruse Way Place, Bldg. 2, Suite 120, Lake Oswego, OR 97035, 503-635-3966).

PC Weather Pro is a combination

of hardware and software that monitors and tracks local weather conditions and reports them on your PC-compatible computer. You can monitor and record indoor and outdoor temperatures, wind speed and direction, wind chill, barometric pressure, and rainfall. And you can set things up to be virtually automatic. So although you still may not be able to do anything about the weather, at least you'll know what the weather is doing to you!

The *PC Weather Pro* system con-

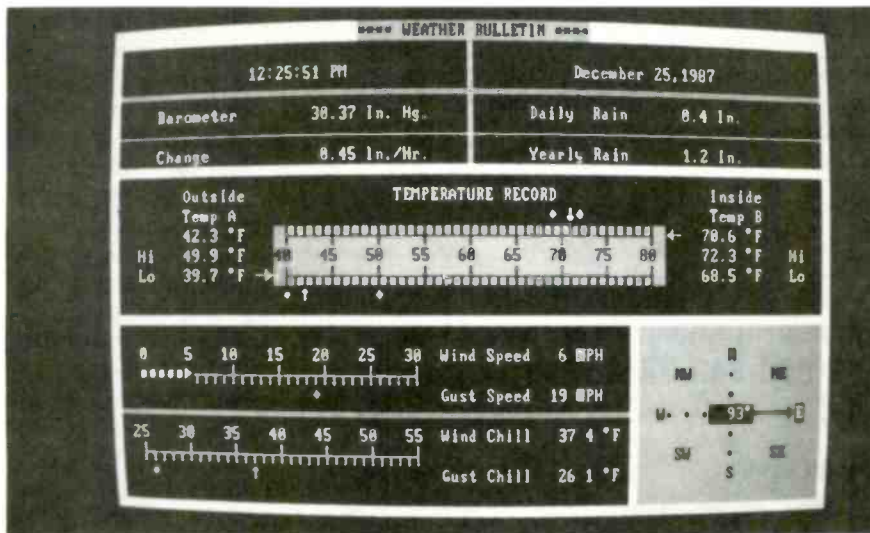

FIG. 1

TALK IS CHEAP.

Have you heard? For less than \$90 your AT or XT-compatible computer can talk! All it needs is the HV-2000 Computer Voice Kit from Heathkit.

Reading letters, transcriptions and computerized instruction can be easier and quicker than you ever thought possible. Computer games gain a new dimension. Your computer can even entertain children with stories and songs.

\$89.95

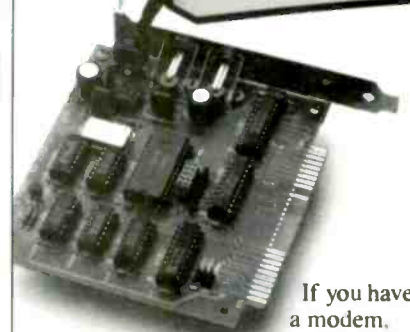

If you have a modem, the HV-2000

Computer Voice will allow your computer to recite reference and research information from time-sharing services. Or, speak radio transmitted ASCII information.

The HV-2000 Computer Voice Card, containing speech synthesizer and audio amplifier, plugs into any AT or XT-compatible computer's expansion slot. An external speaker is also included. Versatile, Heath-developed software gives you a wide variety of voices and easy interface to high and low level languages.

The HV-2000 Computer Voice. At less than \$90, talk IS cheap. To order, call toll-free 1-800-253-0570. Ask for operator 303. Use your Visa, MasterCard or Heath Revolving Charge card. Or call 616-982-3614 for the nearest store location.

Heathkit®

Heath
Company

Benton Harbor, MI 49022

Prices, product availability and specifications are subject to change without notice.

© 1987 Heath Company

CIRCLE 86 ON FREE INFORMATION CARD

The SC61 Waveform Analyzer™

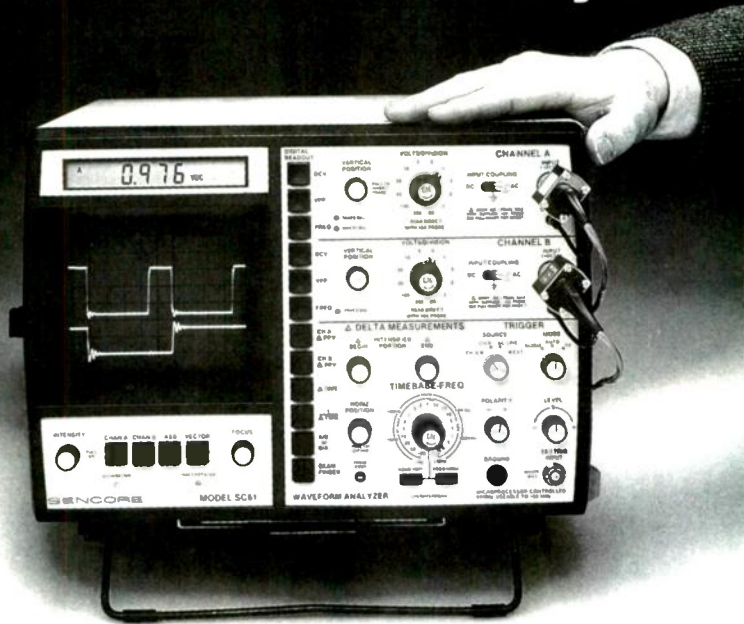

\$3,295 Patented

Here's what we say:

With just one probe hookup you can confidently analyze any waveform to 100 MHz, 10 times faster, 10 times more accurately, absolutely error-free — guaranteed or your money back.

Here's what our customers say:

"The SC61 gives the most information with a minimum of probe-swapping and knob turning."

Patrick Lyman
Biomedical Electronics
Los Angeles, CA

"In my use of the SC61 Waveform Analyzer, it has reduced the amount of time in half in fixing communications equipment."

Jeff Williams
Computer/Communications Repair
Madison, TN

"We have a small shop and need all the short cuts, time saving equipment we can get. Sencore passes with flying colors. Every tech should try their techniques with the SC61 Waveform Analyzer. Does what it should and more."

Bill Humble, Jr.
VCR, Audio and CB Repairs
Yulee, FL

**Discover What The SC61 Waveform Analyzer
Can Do For You! Call Today 1-800-843-3338.**

In Canada Call 1-800-851-8866.

100% American Made

SENCORE

3200 Sencore Drive, Sioux Falls, SD 57107 605-339-0100 In SD Only

CIRCLE 184 ON FREE INFORMATION CARD

sists of an anemometer and wind vane to report wind speed and direction, two temperature probes, and a rain sensor. Those items are attached by cables to a half-slot plug-in circuit card for a PC-compatible computer. An AC adapter, and a 5¼-inch floppy disk that contains the *PC Weather Pro* display software are also included with the system.

Installation

Getting *PC Weather Pro* up and running is relatively straightforward. Installing the anemometer/wind-vane assembly is the most difficult part—because it's usually done more than 20 feet in the air, above the peak of the rooftop, so that buildings and trees, etc. won't interfere with the proper and accurate measurement of the wind. We would strongly recommend hiring someone to carry out the installation if you are not equipped with the proper tools or experience. Even if you are properly equipped, it's still a good idea to have a helping hand. Besides the obvious safety advantages, it will be much easier to calibrate the wind vane if you have a helper.

The anemometer, which is usually the least accurate part of any home weather station, is factory calibrated to ensure accuracy within ± 1 mph. The wind vane, however, is calibrated by the user during the installation procedure. If calibrated correctly, it is accurate to within ± 1 degree.

The rain sensor is usually mounted near the anemometer and wind vane, away from any obstructions, and in an area where falling leaves won't cause any problems. The sensor is a tipping-bucket type. Whenever one-tenth of an inch of water enters the funnel, a small "bucket" inside the unit tips over, emptying the water, and tripping a small switch.

The cables supplied with the wind assembly and the rain sensor are 40 feet long, and extension cables are available to lengthen the cables to over 200 feet.

Two temperature probes are included with *PC Weather Pro*, each with an 11-foot cable. Typically, one sensor is mounted indoors, and the other outdoors. Mounting the temperature probes is not too dif-

ficult, because the probes don't have to be installed on the roof, and they can be calibrated easily indoors, before they are installed. (The calibration is performed using boiling water and ice water as temperature references.) Of course, the outdoor probe still requires a cable run, and the proper mounting place is critical for meaningful measurements.

The PC board is installed in your PC just like any other expansion card. A solid-state pressure transducer, which is the barometric sensor, is located on the board.

Once the sensors are mounted and the board is installed in the computer, the cables from the anemometer, the wind vane, the rain sensor, and the two temperature probes are routed and plugged into the appropriate jacks on the rear of the card. The AC adapter is also plugged into the card; it keeps the on-board real-time clock running even when the computer is turned off.

PC Weather software

The PC Weather software is the user interface to the instruments. It's a menu-driven, memory-resident program that is very easy to use. The main menu offers 11 main functions. For example, choosing D will display a weather-data summary screen, such as that shown in Fig. 1.

Each of the functions shown in that summary—BAROMETRIC, RAINFALL, TEMPERATURE, and WIND—has its own, more detailed, screen. For example, the WIND bulletin shows the present, high, and average wind speed in mph, kph, knots, meters/sec, feet/sec, the time that the high wind speed was recorded, and the present and lowest wind-chill recorded.

Other selections available from the main menu include an ALARM menu, a PLOT menu, and an OPTIONS-SET menu.

From the ALARM menu, you can set an on-board piezoelectric buzzer to sound when a certain condition is met. For example, you could set the alarm to sound when the wind speed rose over 30 mph, or when the indoor temperature dropped below 50°F. The alarms will sound even when the comput-

continued on page 42

DOES YOUR DIGITAL CAPACITANCE METER DO THIS?

FULL 4 DIGIT 0.5 INCH LCD DISPLAY COMPLETELY AUTORANGING WITH 10 RANGE MANUAL CAPABILITY

AND THIS
RANGE OF 0.0 pF to 1 FARAD (9999 mF)
0.5% BASIC ACCURACY UP TO 100 uF

AND THIS
READS DIELECTRIC ABSORPTION

AND THIS
EXTENDED PSEUDO 5 DIGIT
RESOLUTION ON SOME RANGES ONLY

AND THIS
ABILITY TO ZERO LARGE CAPACITANCE
VALUES UP TO 99.99 uF

AND THIS
CALCULATES TRUE CAPACITANCE
IF CAPACITOR IS LEAKY

AND THIS
DIODE CLAMP AND FUSED
PROTECTED INPUT
DISCHARGE RESISTOR IN OFF
POSITION AT TERMINAL INPUTS.
POWERED BY 9V BATTERY

**ONE YEAR PARTS &
LABOUR WARRANTY**

FOR ONLY THIS



AND THIS
IDENTIFIES TRANSISTORS (NPN, PNP)
AND THEIR LEADS (E, B, C, ETC.)

AND THIS
TESTS ZENER DIODES AND RECTIFIERS
UP TO 20V ZENER WITH AC ADAPTOR,
ZENER VOLTAGE WITH 9V BATTERY
DEPENDS ON ITS CONDITION

AND THIS
AUTOMATICALLY CALCULATES LENGTHS
OF CABLES IN FEET, METRES, MILES,
KILOMETRES (THEORETICAL RANGE
OF 9,999 MILES)

AND THIS
ABILITY TO SORT CAPACITORS IN
MANY DIFFERENT MODES

AND THIS
ABILITY TO READ LEAKY CAPACITANCE
(INSULATION RESISTANCE OR CURRENT)

AND THIS
CALCULATES TIME CONSTANTS WITH
USER DEFINED RESISTANCE VALUES

AND THIS
HOLD FUNCTION FREEZES DISPLAY

SHIPPING INSTRUCTIONS:

All units shipped out F.O.B. Buffalo NY via United Parcel Service (except Hawaii & Alaska) unless otherwise indicated (in which case shipments will be F.O.B. Canada)

\$169.95

MODEL
MC300 Approx. Size
7" x 4" x 1 1/2"
DAETRON
a division of Bergeron Technologies Inc
935 THE QUEENSWAY, BOX 641
TORONTO, ONTARIO M8Z 5Y9
CANADA (416)676-1600

| PLEASE SEND ME | U.S. FUNDS |
|---|----------------------------|
| (QUANTITY) MC300(S) @ \$169.95 | \$ _____ |
| CARRYING CASE \$ 16.95 | \$ _____ |
| AC ADAPTOR \$ 9.95 | \$ _____ |
| SHIPPING AND HANDLING @ \$5.00 PER INSTRUMENT | \$ _____ |
| <input type="checkbox"/> CHECK <input type="checkbox"/> MONEY ORDER | \$ _____ |
| <input type="checkbox"/> VISA <input type="checkbox"/> MASTERCARD | TOTAL \$ _____ |
| _____ CARD NO | _____ SIGNATURE |
| _____ EXPIRY DATE | _____ TELEPHONE |
| _____ NAME | _____ ADDRESS |
| _____ CITY | _____ STATE _____ ZIP CODE |

DEALER ENQUIRIES INVITED

CIRCLE 188 ON FREE INFORMATION CARD

Buy five MOVIE TIME CONVERTERS at the advertised price and get one

FREE



V-7200

MOVIE TIME

72 Channel Wireless Remote Cable Converter

with *VOLUME and *MUTE controls — Fine Tuning — *AUDIO and *VIDEO outputs — 2/3 or 3/4 switch — 90-minute Sleep Timer

*No. Vol. or A/V output EVERYTHING V-7200 79.95 V-7500 109.95

V-7800

78 Ch. Wireless Remote. Parental Control built-in. 10d3 Amp. Favorite Channel Memory. Fine Tuning 89.95

CALL

Tel.: 1-305-652-1981
1-800-843-9845

| COUPON | | | |
|---|-----------------|-------|-------|
| NAME | ADDRESS | | |
| _____ | _____ | _____ | _____ |
| CITY | STATE | ZIP | |
| TELEPHONE 1 | Exp Dt | | |
| COD <input type="checkbox"/> AMEX <input type="checkbox"/> CHECK <input type="checkbox"/> SIG | Am Ex | | |
| _____ | _____ | _____ | _____ |
| QTY | ITEM | PRICE | TOTAL |
| _____ | _____ | _____ | _____ |
| Send to | Shipping | 5.50 | |
| MOVIE TIME | FL 5% Sales Tax | _____ | |
| 20203 NE 15 Ct | TOTAL | _____ | |
| Miami, FL 33179 | _____ | | |

CIRCLE 189 ON FREE INFORMATION CARD

NEW PRODUCTS



CIRCLE 10 ON FREE INFORMATION CARD

VISUAL TELEPHONE Mitsubishi Electric Sales America has announced the *VisiTel*, the first still-frame visual telephone designed specifically for home use. The unit features a built-in video camera and a 4.5-inch monitor. It allows the user to send and receive freeze-frame black-and-white video "snapshots" over standard telephone lines. The *VisiTel* works in tandem with any home telephone equipped with a modular phone plug. Easy to hook up, the unit simply plugs into a standard AC outlet and the home phone jack.

The user is in control of the outgoing image at all times. To send an image, the user simply posi-

tions himself in front of the camera, reviews the image on the screen, and pushes a *send* button to transmit the image to another *VisiTel* user. Transmissions take only 5 seconds and as many transmissions as desired can be made. Normal telephone rates apply to all calls.

The *VisiTel* will automatically store the last three received images for ready recall. Those images can be reviewed at will by pressing a *view/pose* button.

The *VisiTel* has a suggested retail price of \$399.00.—Mitsubishi, Visual Telcom Division, 3350 Scott Boulevard, Building 49, Santa Clara, CA 95054.

amp AC direct card is also optional, for feeding 5 amps AC or 600 volts rms directly into the meter.

In addition to the AC capabilities, there is a meter-relay option on the model 320-WS and the model 420-WS, which feature

front-end programmability. Triplett has taken the TTL output from a standard meter and fed it to a comparator section to initiate the meter relays. The end user can then turn external circuits on and off through the relay contacts.

While most of the meters in the line can be customized by Triplett, VU designs are offered as finished meters. The VU meter fits into audio/video-monitoring equipment and meets standard VU ballistics.

The bargraph draws 500 μ A from a 5-volt power supply. The backlit models use 5-volt DC bulbs, which require approximately 250 mA per bulb. Additional specifications include: accuracy of plus or minus 1% of scale; a maximum response time of 200 ms; linearity of plus or minus 1/2 segment; input impedance of 1 megohm, and an operating temperature of 0° to 50°.

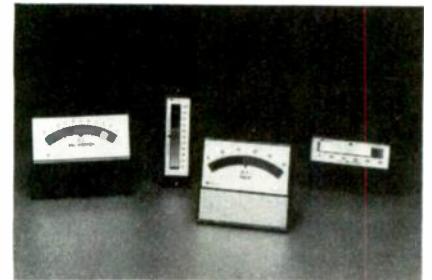

CIRCLE 11 ON FREE INFORMATION CARD

Prices on the new LCD bargraphs range from \$110.00 to \$135.00 for the standard meter; \$200.00 to \$250.00 with meter relay; \$150.00 to \$175.00 with the 5-amp AC direct card, and \$110.00 to \$135.00 for the VU meter.—Triplett Corporation, One Triplett Drive, Bluffton, OH 45817.

CALL-BACK CONTROLLER. Black Box offers a controller that, when installed between a modem and a telephone-company interface, provides total protection against unauthorized dial-up access to a serial computer.

LCD BARGRAPHS. Triplett's new line of LCD bargraph meters have both AC and DC measurement capabilities. The I6-style line has an optional AC average signal-conditioning card that allows direct hookup of the meter, eliminating the need for external filtering. A 5-



CIRCLE 12 ON FREE INFORMATION CARD

Preprogramming of access codes and corresponding telephone numbers into the *Call-Back* controller allows only users with valid access codes to be "called back" at their assigned numbers. Even if a hacker *did* break the access code, the controller would divert dial-up access to a pre-programmed phone number. That alerts the user to the fact that someone has broken the first access code to the system and is trying to break into his or her files.

The *Call-Back* controller is available either as 1-line (price \$450.00) or 2-line (price \$695.00) units.—**Black Box Corporation**, P. O. Box 12800, Pittsburgh, PA 15241.

SUPER-VHS CAMCORDER. JVC's *GF-S1000HU* uses its new format with full-size S-VHS cassettes, which have 6-hour recording capability. It incorporates the new 3/8-inch field-storage CCD image sensor with 360,000 effective picture elements (pixels); the image sensor achieves horizontal resolution of 450 lines and contributes to the 8-lux low-light sensitivity. It also incorporates the Super Double-Azimuth 4-head system that fur-



CIRCLE 13 ON FREE INFORMATION CARD

ther enhances the picture quality in both SP and EP modes.

To match the Super-VHS pictures, the Depth-Multiplex sound-recording system has a more than 80-dB dynamic range and frequency response of 20 to 20,000 Hz. In recording, the *GF-S1000HU* detects whether an S-VHS or regular VHS cassette had been loaded and automatically switches to the appropriate mode; manual override also enables regular VHS recording on S-VHS tape. In playback, it

automatically detects the mode in which the recording was made and switches the circuitry accordingly. Those recordings can also be played back on decks of the corresponding format.

The *GF-S1000HU* is priced at \$2495.00.—**JVC**, 41 Slater Drive, Elmwood Park, NJ 07407.

LASER PRINTER. The Sharp Electronics' model *JX-9300* is a six-page-per-minute compact laser printer that allows users to take

Nobody Offers YOU Better Prices on HITACHI SCOPES Now at 1987 Prices...Order Today!



40TH YEAR ANNIVERSARY SALE!

SPECIAL HITACHI SCOPES!

| Model V-660 Scope | Model V-665 Scope | Model V-1060 Scope |
|---|--|--|
| DC to 60 MHz Dual channel, delayed sweep, CRT readout, sweep time autoranging, trigger lock | DC to 60 MHz Dual channel, delayed sweep, CRT readout, cursor readout, sweep time autoranging, trigger lock | DC to 100 MHz Dual channel, delayed sweep, CRT readout, sweep time autoranging, trigger lock |
| REG. \$1095 \$960 40th Year Special | REG. \$1395 \$1185 40th Year Special | REG. \$1495 \$1340 40th Year Special |



Model V-1065 Scope
DC to 100 MHz Dual channel delayed sweep, CRT readout, cursor readout, sweep time autoranging, trigger lock
REG. \$1795 \$1590
40th Year Special

ORDER TODAY and SAVE!

Send for FREE 480 page "Industrial Products Catalog". I understand it is FREE with any order or if requested on company letterhead. (Otherwise, \$4.95 to cover catalog and shipping costs.)

ORDER TOLL FREE
1-800-323-5925
IN ILLINOIS
312-297-4200
Our 40th Year

Joseph Electronics



HITACHI Model V-212
SAVE Up to 40%* Dual Trace-DC to 20 MHz 6" CRT - 1mv Sensitivity - Vert. Deflection, Ch1, CH2, Chop, Add (Diff) - XY Mode.

REG. \$615
***40% Discount \$369**

HITACHI Model V-422
Dual Trace - DC to 40MHz; 1mv Sensitivity - DC Offset for DMM Output - 6" PDA CRT - Vert. Mode Trigger

REG. \$925
40th Year Special \$685

CRT READOUT MODELS

| Model V-1100A | Model V-1150 |
|---|---|
| DC to 100 MHz, Quad Channel, Delayed Sweep. | DC to 150 MHz - Delayed Sweep, Quad Channel 8 trace |
| REG. \$2490 | REG. \$2950 |

\$1995 40th Year Special
\$2575 40th Year Special

SPECIAL HITACHI Model V-6020



1 MHz sampling Dual Channels Usable as both a conventional oscilloscope and a digital storage scope
REG. \$1950
\$1695
40th Year Special

ALL HITACHI SCOPES INCLUDE FULL 3 YEAR FACTORY WARRANTY

JOSEPH ELECTRONICS, INC. Dept. R
8830 N. Milwaukee Ave. Niles, IL 60648

Rush merchandise per attached order. I understand rated accounts are shipped open account; otherwise send per credit card. Include \$10.00 per Scope for shipping and handling.

Visa Master Card Discover
 Check Money Order Rush Catalog

Card No. _____ Exp. Date _____

Name _____

Company _____

Street Address _____

City _____ State _____ Zip _____

IL Res. 7% Tax

CRYSTEK

The pulse of dependable communications

Reliability & Quality
From Start To Finished Product

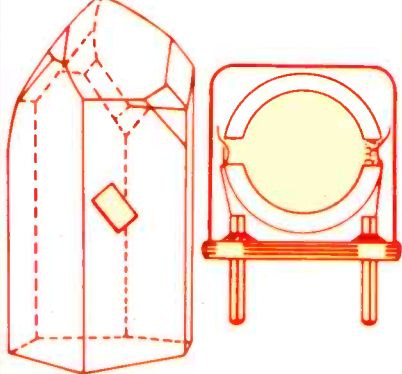

QUARTZ CRYSTALS/OSCILLATORS FOR ELECTRONIC — INDUSTRIAL

- Micro-Processor Control
- Computers/Modems
- Test/Measurement
- Medical

COMMUNICATIONS-REPLACEMENT

- Mobile/2-way/Channel Elements
 - Pagers
 - Marine
 - Aircraft
 - Telemetry
 - Monitors/Scanners
- AMATEURS**

- CB
- Hobbist
- Experimenter

- COST EFFECTIVE
- MODERATE PRICING
- FAST DELIVERY



The Pulse of Dependable Communications

Crystek Crystals offers their new 16 page FREE catalog of crystals and oscillators. Offering state-of-the-art crystal components manufactured by the latest automated technology. Custom designed or "off the shelf," Crystek meets the need, worldwide. Write or call today!

CRYSTEK CRYSTALS

2351/2371 Crystal Dr. • Ft. Myers, FL 33907
P.O. Box 06135 • Ft. Myers, FL 33906-6135

TOLL FREE 1-800-237-3061
(813) 936-2109 - TWX 510-951-7448

CIRCLE 187 ON FREE INFORMATION CARD

full advantage of the graphics generated by much of today's software. It offers 300 × 300 dpi resolution, and the standard 396K memory is expandable to 1.5M. Resident typefaces are the Courier and line-printer fonts, both available in bold, condensed, pica, elite, and italic. Other fonts can be added through downloading or plug-in font cartridges.



CIRCLE 14 ON FREE INFORMATION CARD

A single paper tray holds up to 100 sheets of plain paper; a legal-size tray is optional, and a manual

insert slot allows letterhead, overhead transparencies, and other special sheets to be fed as needed. The model JX-9300 is priced at under \$2400.00.—Sharp Electronics Corporation, Sharp Plaza, Mahwah, NJ 07430.

PHONO CARTRIDGES. Shure Brothers has a new line of phono cartridges, the VST Special Edition Series.



CIRCLE 15 ON FREE INFORMATION CARD

The model VST V (left in photo) features a "Micro-Ridge" tip geometry for exceptional high-frequency reproduction, and Shure's exclusive "Dynamic Stabilizer". That assembly acts as a shock absorber to help make warped records playable again, while reducing arm-cartridge resonance and eliminating static. The model VST V is priced at under \$200.00.

#1 IN CABLE BOXES

JERROLD CORDLESS CABLE TV BOX

MODEL DRZ/450



- 66 channels
- On/off switch
- Automatic fine tuning
- A/B switch option
- Compatible with descramblers

\$69⁹⁵ / 10 Lot

\$79.95/1-9

CORDLESS CABLE TV BOX

- 72 channels
- Parental control
- Remote fine tuning
- On/off switch
- Compatible with descramblers

MODEL DRX3-105/400
\$59⁹⁵ / 10 Lot

Write for
FREE CATALOG
136 page



\$69.95/1-9

JERROLD CORDLESS CABLE TV BOX

MODEL STARCOM-CVS

\$99⁹⁵ / 4 Lot

\$109.95/1-3



- Volume control
- 68 channels
- Automatic fine tuning
- On/off switch
- Compatible with descramblers

SHIPPING CHARGES
For Orders Add
\$25-100 \$6.50
\$100-500 \$8.50
\$500-750 \$10.50
\$750 and up \$20.00

Send Check, Money Order, or
C.O.D. or Call Toll Free

800-223-0826
in N.Y. State (212) 865-5580

OMNITRON ELECTRONICS

770 Amsterdam Ave., New York, NY 10025



ADD 5% FOR CREDIT CARDS

CIRCLE 110 ON FREE INFORMATION CARD

Now from NRI comes the first course of its kind . . . anywhere!

Learn to use, program, and service today's digital electronic music equipment as you build your own computer-controlled music center



Now NRI puts you at the heart of the most exciting application of digital technology to date! With NRI's new at-home training in Electronic Music Technology, you get hands-on experience with the equipment that's revolutionizing the music industry—Atari ST Series computer with built-in MIDI ports, Casio CZ101 digital synthesizer with advanced MIDI capabilities, and ingenious MIDI software that links computer keyboard to synthesizer keyboard—all yours to train with and keep.

This year, over \$1.5 billion worth of digital electronic music instruments—keyboards, guitars, drum machines, and related equipment—will be sold in the U.S. alone. Who's buying this new-tech equipment? Not just progressive musicians and professional recording technicians, but also thousands of people who have never touched a musical instrument before. And there's good reason why.

Something called MIDI (Musical Instrument Digital Interface) has suddenly transformed musical instruments into the ultimate computer peripherals . . . and opened up a whole new world of opportunity for the person who knows how to use, program, and service this extraordinary new digital equipment.

Now NRI's breakthrough Electronic Music Technology course puts you at the forefront of this booming new technology with exclusive hands-on training built around a MIDI-equipped computer, MIDI synthesizer, and MIDI software you keep.

Dynamic New Technology Opens Up New Career Opportunities for You

The opportunities are unlimited for the person who's trained to take advantage of today's electronic music phenomenon. Now you can prepare for a high-paying career as a studio technician,

sound engineer, recording engineer, or road technician . . . even start your own new-age business providing one-stop sales and service for musicians, technicians, and general consumers alike. Or simply unleash your own musical creativity with the breakthrough training and equipment only NRI gives you.

Only NRI Gives You an Atari ST Computer, Casio Synthesizer, and Innovative MIDI Software You Train With and Keep

The Atari ST Series computer included in your course becomes the heart of your own computer-controlled music center. With its tremendous power, superior graphics capabilities, and built-in MIDI interface, the 16/32-bit Atari ST has almost overnight become the computer of choice for today's most knowledgeable electronic musicians.

The Casio CZ101 digital synthesizer, also included in your training, is the perfect complement to your Atari ST. The polyphonic, multitimbral CZ101—which stores up to 32 voices internally—"communicates" with your ST computer through MIDI, bringing life to virtually any sound you can imagine.

Plus, you get ingeniously designed MIDI software that opens up amazing new creative and technical possibilities . . . you actually build your own 4-input audio mixer/amplifier . . . and you test the electronic circuits at the core of today's new-tech equipment with the hand-held digital multi-meter included in your course.

No previous experience necessary—in electronics or music!

No matter what your background, NRI gives you the skills you need

to take advantage of today's opportunities in electronic music technology.

With your experienced NRI instructor always available to help, you master the basics of electronic theory step by step, gaining the full understanding of electronics that's now so essential for technicians and musicians alike. You move on to analyze sound generation techniques, digital logic, microprocessor fundamentals, and sampling and recording techniques . . . ultimately getting first-hand experience with today's explosive new technology as you explore MIDI, waveshaping, patching, sequencing, mixing, special effects, and much more.

Plus, even if you've never been involved with music before, NRI gives you enough basic training in music theory and musical notation to appreciate the creative potential and far-reaching applications of today's electronic music equipment.

Send Today for Your FREE Catalog

For all the details about NRI's innovative new training, send the coupon today. You'll receive a complete catalog describing NRI's Electronic Music Technology course plus NRI courses in other high-tech, in-demand electronics fields.

If the coupon is missing, write to NRI School of Electronics, McGraw-Hill Continuing Education Center, 3939 Wisconsin Avenue, Washington, DC 20016.

| | | |
|--|--|-----------|
| NRI School of Electronics McGraw-Hill Continuing Education Center 3939 Wisconsin Avenue Washington, DC 20016 | | |
|  | | |
| ✓ CHECK ONE FREE CATALOG ONLY | | |
| <input type="checkbox"/> Electronic Music Technology | <input type="checkbox"/> Computers and Microprocessors | |
| <input type="checkbox"/> TV/Video/Audio Servicing | <input type="checkbox"/> Basic Electronics | |
| Name _____ | (Please Print) | Age _____ |
| Street _____ | | |
| City _____ | State _____ | Zip _____ |
| NRI is accredited by the Accrediting Commission of the National Home Study Council 3-038 | | |

The other two cartridges in the VST Series are the model *VST III* (right in photo) and the model *VST III-P*, (center in photo) sister units that both feature the distortion-reducing Shure hyperelliptical tip. The model *VST III*, designed for standard 1/2-inch headshell mounting, shares the Dynamic Stabilizer design with the model *VST V*, while the model *VST III-P* is optimized for P-mount applications. The model *VST III* and the model *VST III-P* are priced in the \$100.00

range.—**Shure Brothers Incorporated**, 222 Hartrey Avenue, Evanston, IL 60202-3696.

HF TRANSCEIVERS. Kenwood offers two new models: the *TS-140S* (shown) and the *TS-680S*. The model *TS-140S* is an all-band, all-mode, 100-watt HF transceiver with a general-coverage receiver section. The model *TS-680S* is an all-band, all-mode 100-watt HF transceiver that includes a ten-watt, six-meter section.



CIRCLE 16 ON FREE INFORMATION CARD

Both models feature a programmable band marker that is particularly useful for staying within the limits of one's ham license and prevents out-of-band operation, and a Morse-code beeper status indicator.

Other features include dual digital VFO's, 31 memory channels (10 of which can store, receive, and transmit frequencies separately for repeater or cross-band operation), programmable scanning, and automatic selection of USB or LSB, and more.

The model *TS-140S* has a suggested retail price of \$899.95; the suggested retail price of the model *TS-680S* is \$999.95.—**Kenwood**, 2201 E. Dominguez Street, Long Beach, CA 90810.

VIDEO COMMAND CENTER. The Video Link *Cockpit II* is a IR remote "unifier" that includes two aimable infrared turrets. Those rotatable turrets allow the amplified infrared signals to be directed anywhere in the user's room, and allow the device to be placed in the most convenient location for simplified operation.

The *Cockpit II* is a table-top unit that stores several remote controllers in a molded tray. A solid-state amplifier is built in to boost the infrared signals' strength, for additional convenience, and also for flexibility.



CIRCLE 17 ON FREE INFORMATION CARD

The *Cockpit II* has a suggested retail price of \$49.95.—**Video Link**, 12950 Bradley Avenue, Sylmar, CA 91342. R-E

★ CABLE TV SPECIALS ★

CONVERTERS

| | | |
|------------|---|----------|
| | JRX-3 DIC—36 Channel Corded Remote ... | \$129.95 |
| | JSX-3 DIC—36 Channel Set Top | \$129.95 |
| | SB-3 — 'The Real Thing' | \$109.95 |
| | SB-M-Refurbished | \$89.95 |
| | DRZ-3D1C—68 Channel Wireless with Decoder | \$199.95 |
| ZENITH: | Z-TAC Cable Add-On | \$189.95 |
| VIEW STAR: | EVSC-2010—60 Channel Wireless— with Parental Lockout | \$ 99.95 |
| | EVSC-2010 A-B—Same as above with A-B Switch | \$109.95 |
| | View Star 2501—60 Channel Wireless | |
| | with Volume | \$119.95 |
| | Unika MR-702—72 Channel Wireless with Parental Lockout | \$89.95 |

MISCELLANEOUS

| | | |
|----------------------|--|----------|
| OAK: | N-12 Mini-Code | \$ 89.95 |
| | N-12 Mini-Code Vari-Sync | \$99.95 |
| | N-12 Mini-Code Vari-Sync Plus Auto On-Off .. | \$149.95 |
| OAK: | Sine-wave Anti-Jammer Kit | 49.95 |
| JERROLD: | 400 & 450 Handheld Transmitters | \$ 29.95 |
| HAMLIN: | MLD-1200 | \$ 99.95 |
| NEW ITEMS: | Ripco Tape Copy Stabilizer | \$109.95 |
| | Scientific Atlanta SA-3 | \$129.95 |
| GENERAL INSTRUMENTS: | VCU Amplified Video Switch Signal Amplifier | \$59.95 |

ALL UNITS GUARANTEED. QUANTITY PRICES AVAILABLE.

UNITED ELECTRONIC SUPPLY

P.O. BOX 1206 • ELGIN, ILLINOIS 60121 • 312-697-0600

CIRCLE 197 ON FREE INFORMATION CARD

COMMUNICATIONS CORNER



HERB FRIEDMAN,
COMMUNICATIONS EDITOR

Hybrid networks make signals invisible

AS DIGITAL SIGNALS BECOME increasingly more intertwined with the common telephone system, a device you're more likely to run across in both the design and maintenance of a communications system is the *hybrid network*, which is often called a *hybrid coil*. Those of you who are up on your telephone technology are certain to recognize that the hybrid network is part of the common telephone, where it's called the

induction coil. Others, who enjoy listening to call-in radio and TV programs, will certainly recognize it as the device that allows the studio audio to be mixed with the telephone signal, without having the station's audio system break into howling caused by positive feedback. And if you didn't know how the caller and callee were mixed without feedback, you'll find out now, because this month's subject is the hybrid network.

(And those of you who are amateur radio operators and are familiar with, and have cursed the hybrid-network telephone patch, will also find out why your particular patch sounds so bad.)

The reason we're getting into hybrid networks, which is really part of the telephone system and broadcast call-in equipment, is because it is absolutely necessary for interleaving digital data and communications into the dial-up tele-

NEW RUGGEDIZED SCOPE PROBES

Just a phone call away.

\$35 P6103

50 MHz 10x
Compensation Range
15 to 35 pF

\$58 P6109

150 MHz 10x
Compensation Range
18 to 22 pF

These new passive voltage probes can be used with any oscilloscopes having matching compensation ranges.

Screw in tips mean easy repair, no downtime.

To order call toll free **1-800-426-2200**

VISA and MasterCard accepted.

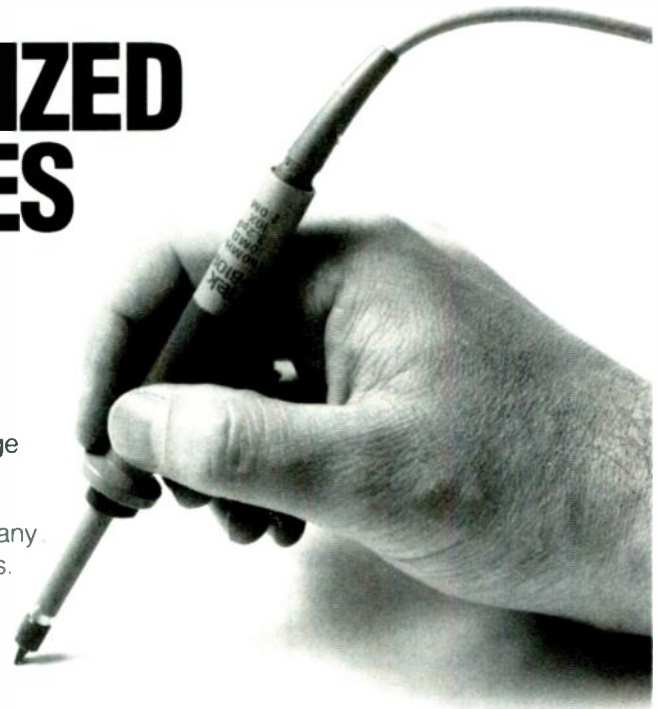

Tektronix
COMMITTED TO EXCELLENCE

Free Famous hi-tech catalog



A very special guide to what the exciting world of computer and electronics kit-building can do for you.

The informative Heathkit Catalog shows you more than 450 exciting electronic products that will challenge, instruct, and entertain you. You'll find countless kits that you can build and enjoy, from computers and robots to color tv's and a variety of home products. And each is backed by our years of experience and our promise, "We won't let you fail."

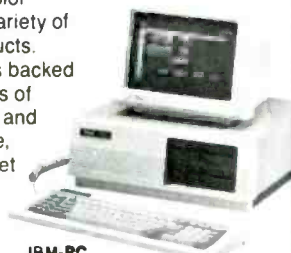

IBM-PC Compatible Expandable Computers



HERO® 2000 Educational Robot and Courseware



Precision Test Instruments

Electronic Keyless Doorlock



PackKit Multi-Mode TNC



Send NOW for your FREE Heathkit Catalog.

Send to: Heath Company, Dept. 020-632
Benton Harbor, Michigan 49022

Name _____

Address _____

City _____ State _____ Zip _____

A subsidiary of Zenith Electronics Corporation CL-784R3

Heathkit
Heath
Company

RADIO-ELECTRONICS

phone. Long-haul circuits require distortion-free amplification to get signals error-free from one part of the country to another. Normally, the amplification is provided in the connecting wires between central offices, or within the signal equipment. For example, a single pair of wires carries your voice or digital data to a central office, but between central offices—where the amplification is done—there are actually two pairs of wires: one for the transmitted signal, the other for the received signal.

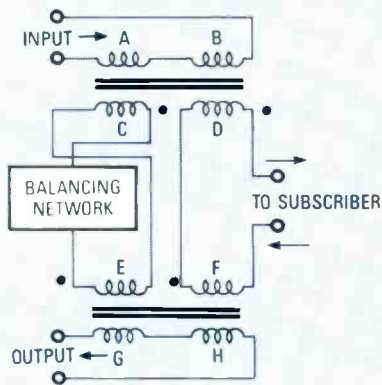

FIG. 1

Two inputs, one output

Figure 1 shows a *communications hybrid network*. It's described as a communications hybrid because it is completely different from the audio-mixing hybrid network found in movie- and TV-production studios. Everything we say this time out refers only to a communications hybrid that resembles Fig. 1.

Notice that there are actually two transformers, T1 and T2. They might be individual units, as they

often are in an inexpensive hybrid phone patch, or they might both be enclosed in a single metal "can," as they are in a telephone.

Let's assume that the hybrid shown in Fig. 1 is the one at your local telephone office. Signals— analog or digital—from a distant source are fed into the INPUT and eventually exits at the SUBSCRIBER terminals, which are in turn connected to the wires that connect to your home telephone.

NOISE REDUCTION FOR UNDER \$10.

- MIXING CONSOLES
- SWITCHES
- MICROPHONE CONNECTORS
- SNAKE CABLES
- BATTERY CONTACTS



- ALL PLUGS & JACKS (CLR, PHONE, PHONO, DIN, MIDI, ETC.)
- PATCHBAYS
- FADERS, POTS
- TERMINAL STRIPS
- SPEAKER TERMINALS

CRAMOLIN®

Even the finest equipment in the world cannot guarantee noise-free operation. One "dirty" connection anywhere in the electrical path can cause unwanted noise or signal loss.

"MORE THAN A CONTACT CLEANER"

CRAMOLIN® is a fast-acting, anti-oxidizing lubricant that cleans and preserves all metal surfaces, including gold.

When applied to metal contacts and connectors, **CRAMOLIN®** removes resistive oxides as it forms a protective molecular layer that adheres to the metal surfaces and maintains maximum electrical conductivity.

CRAMOLIN® - USED BY THOSE WHO DEMAND THE BEST:

- | | | | |
|-----------------|-----------------|-----------|-------------|
| Bell & Howell | Hewlett Packard | MCI(Sony) | Nakamichi |
| Boeing | John Fluke Mfg. | Motorola | RCA |
| Capitol Records | McIntosh Labs | NASA | Switchcraft |
| | | | SINCE 1956 |

CAIG LABORATORIES IMC

1175-O Industrial Ave., (P.O. Box J) - Escondido, CA 92025-0051 U.S.A. * (619) 743-7143

When someone in your family gets cancer, everyone in your family needs help.

Nobody knows better than we do how much help and understanding is needed. That's why our service and rehabilitation programs emphasize the whole family, not just the cancer patient.

Among our regular services we provide information and guidance to patients and families, transport patients to and from treatment, supply home care items and assist patients in their return to every day life.

Life is what concerns us. So you can see we are even more than the research organization we are so well known to be.

No one faces cancer alone.

AMERICAN CANCER SOCIETY

Signals originating in your home pass into the subscriber connections and exit via the network's output. No signal on the subscriber line can exit from the network's input, nor can any signal on the input or output mix or crosstalk with each other.

The entire system depends on phase coherence throughout the network, which is accomplished by the device labeled BALANCING NETWORK. That is simply a "black box" whose reactance and resistance exactly matches that of the subscriber circuit from the network to the telephone equipment.

Phase matching

Notice that T1 and T2's four secondary windings are identified by a dot that indicates their phasing. The hybrid network won't work if the phasing is incorrect.

Now let's follow some signals through the hybrid network. Assume that a signal is applied to the input. Its current flows through primary windings A and B, inducing current in windings C and D.

The current flowing in B induces a current that flows through D, F, and Z_L (the load); so the input signal appears at the load.

The current through F induces a current in H. Meanwhile, the input current through C also flows through E and the balancing network, which is a mirror image of Z_L . The current through E induces a current into G, which is exactly the same value but 180° out of phase with the current induced in H; so the current in G cancels the current in H and, in result, no part of the input signal appears at the hybrid's output.

Now let's work the other way. A signal originates at the subscriber's input, causing current to flow in D and F. F induces a current in H that also flows through G and on to the output. The current in G induces a current in E that flows through the balancing network and also C.

Winding C induces a signal in A which is equal to and 180° out of phase with the signal induced by the subscriber signal from D to B,

so that no part of the subscriber signal appears in the network's input.

It's magic

That's the whole magic of hybrid networks. "Aha," you say, drawing your .357-magnum pen and getting set to write in and protest our taking a three-day subject (in school) and converting it into a few paragraphs, "if hybrids keep the input from the output, why do we hear ourselves when we speak into the telephone?"

That's a matter of psychology. Back in the early days of telephones, people could not hear what they said—the transmitter and receiver were isolated—so they tended to shout, louder, and Louder, and LOUDER. After a while, the telephone people decided to feed back a small part of the transmitted signal (from the telephone's microphone) into the receiver (earphone) so the user could hear that the equipment was, in fact, working properly. The feedback is called *sidetone*. R-E

HAMEG

Instruments

HM 205-2
the new Digital Storage Oscilloscope
with 5 MHz sampling rate and $2 \times 1024 / 8$ bit storage
realtime bandwidth DC-20 MHz **\$888.00**

HM 8148
the new intelligent Graphic Printer
firmware for time, date, interval, linear interpolation
zooming function **\$788.00**

DSO Software
with 13 programs
incl. IEEE BUS card
\$480.00

call toll free
(800) 247-1241
HAMEG, Inc.
88-90 Harbor Road · Port Washington, N.Y. 11050
Phone (516) 883-3837 · Telex (023) 497.4606

CIRCLE 62 ON FREE INFORMATION CARD

AUDIO UPDATE

Debunking audio myths.



LARRY KLEIN,
AUDIO EDITOR

ANY AREA OF HUMAN CONCERN inevitably creates its own peculiar collection of half-truths, illusions, confusions, and eventually, myths. Mythology prevails when rational scientific answers are not available, not understood, or not respected because they don't account for subjectively-observed phenomena. And, in particular, I shouldn't overlook those myths that are deliberately promoted as an aid to selling a product. Since mythology has frequently been used to promote high-fidelity equipment, let's take a close look at some of the most popular of the current audio myths.

Myths and legends

● **Sound quality is a matter of taste:** The idea behind this hogwash is that everyone hears differently, and therefore, there are legitimate differences in sonic taste. I can illustrate the flaw in that argument by setting up an imaginary experiment. Suppose that I were to make a perfect tape recording of the sound of the cover of this issue of *Radio-Electronics* being shredded by the blades of an electric fan. When played back over a perfect audio system, the tape will sound identical to the original when heard by *any* given pair of ears. Some listeners might prefer the sound of some other magazine being shredded, but that's not the point. In other words, we are all listening to the same objective reality, and even though each of us samples it somewhat differently, our ultimate reference standard is the original live sound.

Of course, due to age, accident, or lack of training, not all of us hear

TABLE 1
WHAT THE EAR HEARS

| Increase in power | Decibels | Effect on listener |
|-------------------|----------|------------------------------------|
| 2 | +3 dB | Barely discernible |
| 4 | +6 dB | Definite increase in volume |
| 10 | +10 dB | As if the volume level was doubled |

equally well. For example, if someone's hearing cuts off at about 8 kHz, he or she is probably is not going to hear the difference between two sound components, one of which has a peak at 12 kHz and the other a dip at 12 kHz. But since the hearing of most listeners is good to perhaps 15 kHz (particularly at the higher volume levels), the prudent equipment designer tries to provide a flat response to at least that frequency, and usually substantially higher.

Taste *is* a factor when dealing with subtle nuances of sound. I define "nuance" as the sort of sonic differences that might occur between two good seats in the same concert hall. Such differences are a legitimate matter of taste. But a preference for boomy bass or shrill, peaky treble (achieved by setting the bass and treble controls for maximum boost) is not a matter of taste; rather, it indicates a lack of taste. Time and experience will frequently—but not always—help moderate such inclinations.

● **I don't have a trained ear, so I don't really need a good system:** That statement is most often heard

from an older person. A psychologist on the lookout for hidden messages would probably find: 1) "I don't want to spend a lot of money;" 2) "Don't embarrass me with a lot of technical gobbledegook that I don't understand." My response (without gobbledegook) is that as one becomes accustomed to the sound of a quality audio system, the ability to appreciate good sound improves. It would therefore be a mistake to put money in a low-quality system that will ultimately prove unsatisfactory.

If you have a friend to whom you want to demonstrate the value of high-fidelity sound, you can easily provide a bit of the "ear training" he says he lacks. Play a *good* recording of the kind of music he likes, first with the treble turned down to simulate the performance of a typical low-cost system, and then with a *flat* response. Depending on the kind of music being played, you could point out the newly-audible presence of the higher harmonics ("overtones" might be a better word), or the improved naturalness in the sound of the tambourine, castanets, etc.

● **Sensitivity is the most important FM tuner rating:** It may be, but only if the user is in the distant deep-fringe area of the desired stations, and in any case, a better antenna will usually do more to reduce background hiss than an extra microvolt of tuner sensitivity. For most listeners, multipath noise and distortion, and "break-through" from other stations, are the more pressing problems. To what degree you will suffer from the effects of multipath and break-through is determined not by sensitivity but by the a tuner's performance in the areas of *Capture Ratio*, *AM Rejection*, and *Alternate-Channel Selectivity*.

● **A receiver that plays loudly with the volume control barely cracked open has lots of power:** A sports car that surges away from a standing start by a mere touch on the accelerator may indeed have enormous power reserve. But an analogous performance by an amplifier has nothing to do with power; it simply means that the amplifier's volume control has been selected for a "fast" taper, probably in the hope of creating a false impression of "greater" output power. Although such a volume control provides more signal with less rotation than a control having a conventional "audio" taper, its action has no bearing on the *total* amount of power available from the amplifier.

● **The bigger the magnet in a woofer, the better its performance:** It is true that all other factors being equal, the greater the magnetic flux in the voice-coil gap of a speaker the greater its efficiency. However, too large a magnet for a given design will result in *decreased* bass output compared to a woofer with a smaller magnet of appropriate size. The reason is that the heavier magnet overdamps the voice coil and inhibits woofer-cone movement at the low frequencies.

The use of a large speaker in a box too small for the speaker will—for different reasons—also produce less bass.

● **Amplifiers with "Lateral Feedback" are superior to those with "Gamma-Plus" circuits:** I've invented "Lateral Feedback" and "Gamma-Plus" as typical examples of an advertising/promotional effort to create sales-enhancing myths. In

the years that I worked as an editor, I wondered why so many manufacturers of perfectly fine products seemed compelled to paint their lilies with gimmicky claims. Now that I'm spending some of my time helping manufacturers and advertising agencies wield the paint brush, I can appreciate the problem: How do you differentiate this year's product from that of your competition—and from your own products of last year?

During the time when a component-category is undergoing rapid evolution, it's not too difficult to build a significant advance in performance or features into succeeding models. But genuine competitive advantages are very hard to come by when a product category has matured. That's when we begin to hear about "Lateral Feedback" to eliminate "side-slip" distortion, "Gamma-Plus" circuits, etc. If all that makes you nervous, be reassured that the vast majority of the gimmicks do no harm, even if they do no good and aren't very meaningful.

● **A 100-watt amplifier can play twice as loud as a 50-watt amplifier:** That is a tough myth to dispel because, on its face, it seems so logical; but as shown in Table 1, the human ear does not respond linearly to increases in power. A doubling of power (a 3-dB increase) is audible, but is certainly not heard as "twice as loud."

Psychoacousticians have found that for a sound be perceived as twice as loud, an increase of 10-dB (or 10 times the power) is required. But since the *average* output level of a stereo system reproducing typical program material ranges from 0.25 watt to perhaps 10 watts, the occasional need for 10-times the power remains within the capabilities of many systems. Things only begin to get hairy (or fuzzy) when the listener is driving the amplifier into clipping by trying to play program material having a wide dynamic range through medium- to low-efficiency speakers. The solutions for the loss in clarity, openness, and low-bass impact can be found in either a new amplifier with at least 6 dB (4 times) the power of the existing amplifier, or speakers with 3 to 6 dB greater efficiency—or both.

R-E

Put a
test lab in
your tool pouch.



The Fluke 8060A 4½-digit handheld multimeter.

It's the best tool you could add to your tool pouch, because it lets you troubleshoot more ... with less.

This portable, powerful instrument has a unique combination of features not available in any other handheld DMM.

A simple push of a button on the Fluke 8060A lets you measure frequencies to 200 kHz, make relative offset measurements, convert voltages to direct reading decibels, or conduct audible continuity tests. Plus the 8060A offers wideband True RMS ac measurement capability to 100 kHz.

So say goodbye to your part-time counters, oscilloscopes, continuity testers, calculators and power supplies. And welcome a full-time professional that'll be there when you need it.

You'll find that for troubleshooting everything from motor controls to data communications equipment, the Fluke 8060A is the best multimeter value going.

Find out more by calling our toll-free hotline 1-800-227-3800, ext. 229, day or night. Outside the U.S. call 1-402-496-1350, ext. 229.

FROM THE WORLD LEADER
IN DIGITAL MULTIMETERS.

FLUKE®

© 1986 Fluke

CIRCLE 121 ON FREE INFORMATION CARD

SELECT 5 BOOKS for only \$3⁹⁵

(values to \$121.75)
and get a Free Gift!

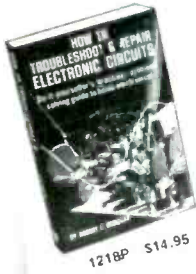
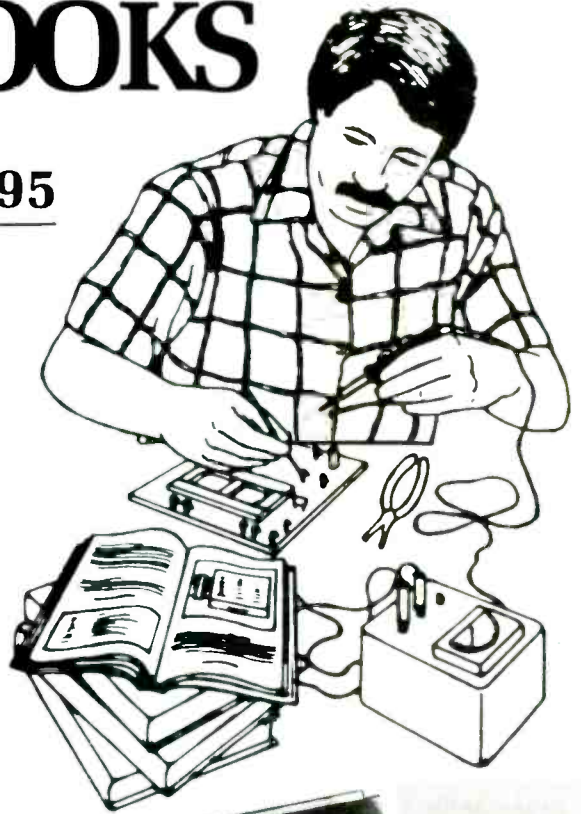

1218P \$14.95



2758 \$24.95



1663P \$17.95



1370P \$15.50

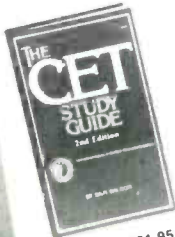

2941 \$21.95



1788 \$18.95

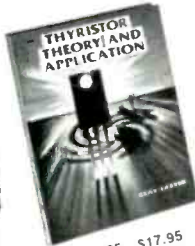

2665 \$17.95

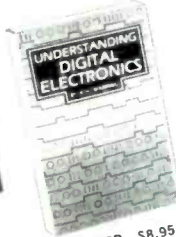

1593P \$8.95



1734 \$18.95



1420 \$17.95



1909P \$16.95



1492 \$14.95

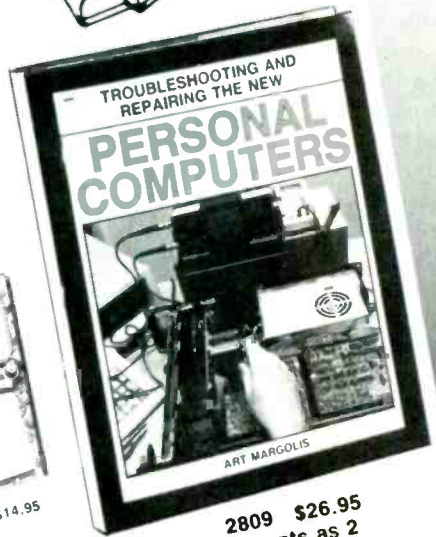

2809 \$26.95
Counts as 2

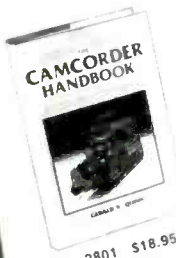

2801 \$18.95



1625P \$14.95



1777P \$18.95

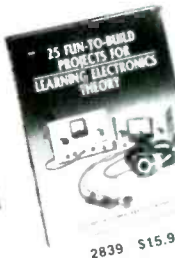

2839 \$15.95



1498P \$11.95

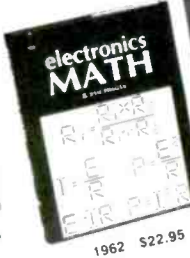

1962 \$22.95



1199P \$16.95



1583P \$13.50



1671P \$16.95

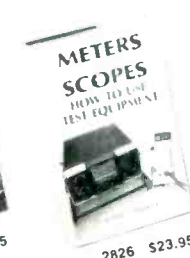

2826 \$23.95



1553 \$15.95



1835 \$15.95

Compare this offer with any other book club for Price • Quality • Benefits • Selection!

An Absolute No-Risk Guarantee

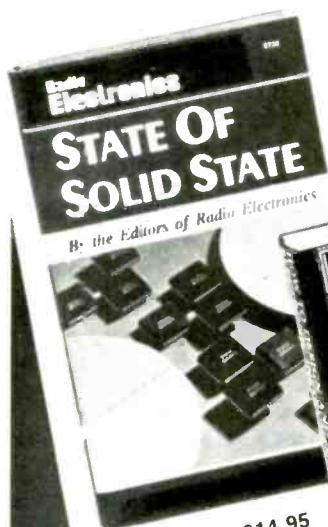

2733 \$14.95

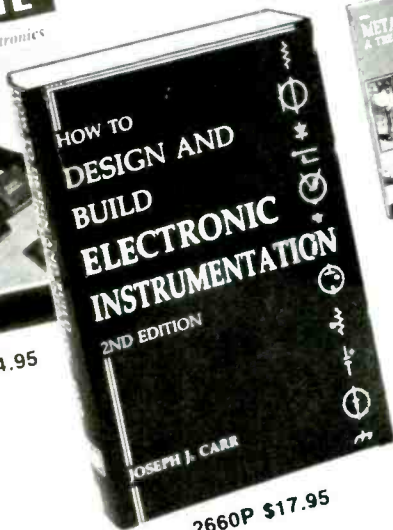

2660P \$17.95



2706 \$15.95



2922 \$24.95



1532P \$14.95



2701P \$17.95



1337P \$7.95



2790 \$18.95



1897P \$13.95

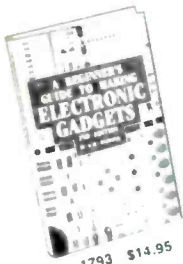

1793 \$14.95



2809 \$23.95



2715 \$16.95



2832 \$23.95



2753P \$16.95



1604P \$16.95



2625 \$23.95

FREE when you join!

Handy, Pocket Sized
Resistor and Inductor
Color Code Calculator



Membership Benefits • Big Savings. In addition to this introductory offer, you keep saving substantially with members' prices of up to 50% off the publishers' price. • **Bonus Books.** Starting immediately, you will be eligible for our Bonus Book Plan, with savings of up to 80% off publishers' prices. • **Club News Bulletins.** 14 times per year you will receive the Book Club News, describing all the current selections—mains, alternates, extras—plus bonus offers and special sales, with hundreds of titles to choose from. • **Automatic Order.** If you want the Main Selection, do nothing and it will be sent to you automatically. If you prefer another selection, or no book at all, simply indicate your choice on the reply form provided. As a member, you agree to purchase at least 3 books within the next 12 months and may resign at any time thereafter. • **Ironclad No-Risk Guarantee.** If not satisfied with your books, return them within 10 days without obligation! • **Exceptional Quality.** All books are quality publishers' editions especially selected by our Editorial Board.



ELECTRONICS BOOK CLUB

Blue Ridge Summit, PA 17294-0810

Please accept my membership in the Electronics Book Club[®] and send the 5 volumes listed below, plus my FREE Resistor And Inductor Color Code Calculator (502E), billing me \$3.95 plus shipping and handling charges. If not satisfied, I may return the books within ten days without obligation and have my membership canceled. I agree to purchase at least 3 books at regular Club prices (plus shipping and handling) during the next 12 months and may resign any time thereafter.

| | | |
|--|--|--|
| | | |
| | | |

Name _____
Address _____
City _____
State/Zip _____ Phone _____
Signature _____

Valid for new members only. Foreign applicants will receive special ordering instructions. Canada must remit in U.S. currency. This order subject to acceptance by the Electronics Book Club[®]. Signature of parent or guardian required for all new members under 18 years of age. RE-388 B

EQUIPMENT REPORTS

continued from page 25

er is turned off thanks to the AC power supply.

The PLOTTING function allows you to plot on screen (or on a graphics printer using the PC's print-screen function) the data that has been gathered and logged for a given day. Data can be logged and stored on disk automatically.

Once a file is opened, data is stored once every 30 minutes. Of course, to write to disk, the computer has to be running.

Memory registers on the *PC Weather Pro* board store maximum temperature, wind speed, etc., but they are not stored to disk.

In operation

In use, we found the *PC Weather Pro* hardware to work without a hitch—once we got it

installed. We ran into a few problems during installation that were cleared up with a new troubleshooting guide. While that new troubleshooting manual was very clear and well written, the basic installation, operation, and software reference guides were not well thought out. The necessary information is in them, but not always easy to find. But our major complaint with the manuals is not the information they contain, but what they leave out.

For example, there is no mention of the format of the data that is logged to disk. So while it is possible to use the supplied software to look at plots of various functions on a particular day, there is no automatic way to look at longer trends. To be truly useful, the software should allow you to look at longer-term trends, to help with future forecasts.

To be fair, the people at Technology Marketing seem more than willing to help out wherever they can. And, although it we didn't get to see it before press time, they are about to release a full tool and utility kit that answers our complaints. Among other features, the utility kit will allow you to port the data logged by *PC Weather Pro* to such programs as *dBase* or *Lotus*.

Since the software runs in the background (in a "terminate and stay resident" mode), you can expect occasional problems with other memory resident software. Interestingly enough, we didn't run into such problems. We did, however, run into a compatibility problem with a word processor.

Despite those negative points, we were very pleased with *PC Weather Pro*. We've been waiting a long time for someone to integrate weather sensors with the data-logging capabilities of a computer, and Technology Marketing, Inc. has done a fine job.

PC Weather Pro costs \$575. A lower-cost version, which does not include the rain gauge and comes with a simpler software package (that doesn't offer data logging or plotting) is available for \$375. Those prices really stand out when *PC Weather Pro* is compared to other systems on the market that offer similar functions—but cost ten times more. R-E



SEEK PROFESSIONAL HELP Servicing electronic equipment isn't always easy, especially if you're doing it in the field. At Chemtronics we can help with over 200 specially engineered products for the maintenance, repair and production of high technology equipment. Call today for our latest problem solving catalog.

Chemtronics
Keeping pace with advanced technology

Chemtronics Inc. 681 Old Willets Path Hauppauge, NY 11788 516-582-3322 Telex 968567

BUILD THIS

ELECTRONIC TORNADO

**PLASMA
DISPLAY
POWER
SUPPLY**

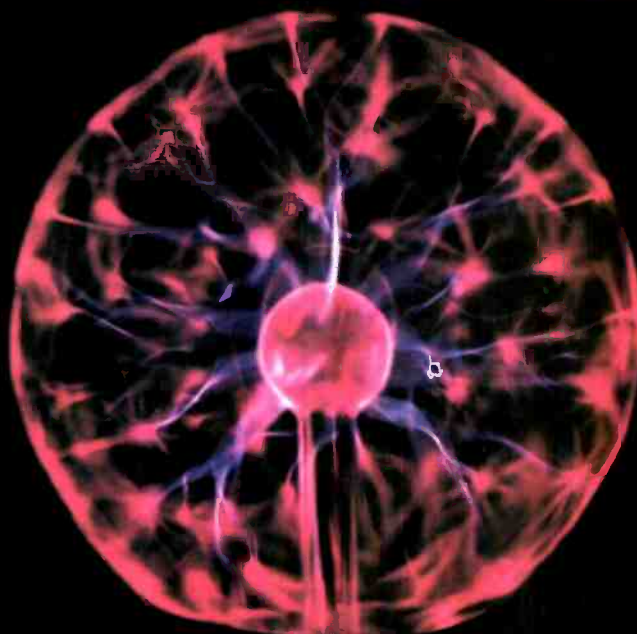
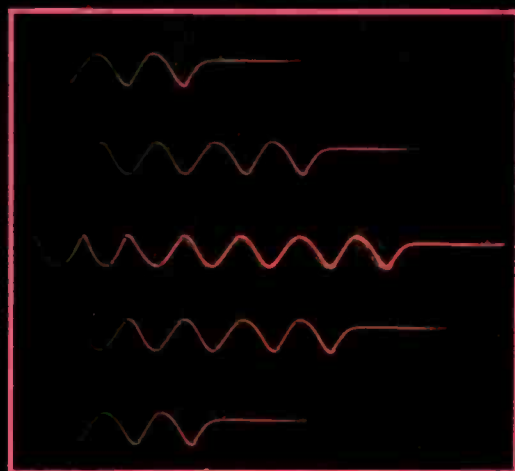

A universal power source for an Eye-of-the-Storm-like display, and other unusual plasma and neon lighting devices.

ROBERT IANNINI

You no longer need to go to a local discotheque to see the latest in unusual lighting effects. Whether it's an Eye-of-the-Storm-like display, a Devil's Furnace, or travelling-wave neon lamps, you can now buy them for your own home at the larger department stores and high-tech boutiques. Only problem is, they usually cost big bucks—in the neighborhood of \$200; but you can certainly can build them for much less if you have the special kind of power supply that's needed. And that's where our universal plasma power supply comes in: it can drive all three kinds of displays—you simply connect the desired display device to the universal plasma power source.

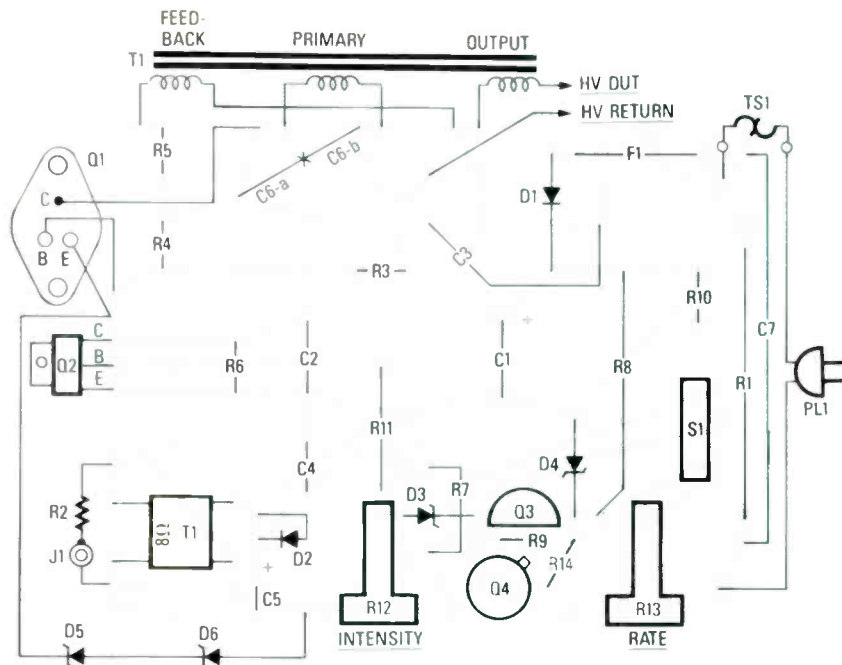

FIG. 2—THE CURVED LINES IN THIS PARTS LAYOUT indicate components that span across other components. That is possible because most of the small-size parts are end-mounted. Capacitor C7 can be placed on top or under the PC board.

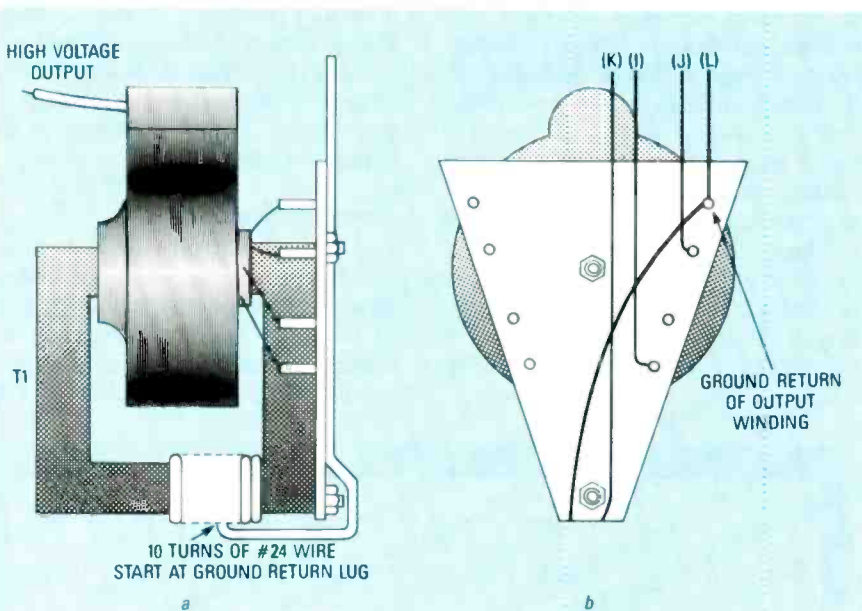

FIG. 3—THE FEEDBACK WINDING, as shown in a, is wound directly over T1's core. Its leads, as shown in b, are routed under T1's mounting plate. The letters in b that identify the wires are the same as those used by the manufacturer; they match the connections shown in Fig. 5.

through thermal safety switch TS1 (which is mounted on the device's heat sink), is rectified by diode D1, and filtered by capacitor C1. Resistor R1 limits the surge current of D1 and C1. Fuse F1 is a *slo-blo* type that allows C1 to charge, yet opens (at 1 amp) if a catastrophic fault exists in the circuit. Thermal switch TS1 turns the device off when the temperature of Q1 exceeds 200°F. (It is necessary

when operating the unit in a high-powered mode, or may be required to comply with local electrical codes.) The rectified voltage across C1 is approximately 160-volts DC.

Transistor Q1 is connected as a Hartley-type oscillator. It is biased into conduction when base current is first applied through R3. Feedback to Q1's base is obtained by a tertiary feedback winding on T1 that is in-

PARTS LIST

Resistors

- R1—10 ohms, 3 watts
- R2—10 ohms, ¼ watt
- R3, R10—47,000 ohms, 1 watt
- R4, R5—200 ohm, 3 watt, wirewound
- R6—1000 ohms, 1 watt
- R7, R14—¼ watt
- R8, R15—18,000 ohms, 3 watt, wirewound
- R9—4700 ohms, ¼ watt
- R11—2200 ohms, ¼ watt
- R12—5000-ohm trimmer potentiometer
- R13—1-Megohm trimmer potentiometer

Capacitors

- C1—170 μ F, 330 volts, electrolytic
- C2, C7—0.1 μ F, 400 volts, paper
- C3—.001 μ F, 10 kV, ceramic
- C4—220-1000 μ F, 25 volts, electrolytic (see text)
- C5—1 μ F, 50 volts, electrolytic
- C6-a, C6-b—0.01 μ F, 1 kV, polypropylene (see text)

Semiconductors

- Q1—MJ8501, NPN high voltage transistor
- Q2—D40D5, NPN power transistor
- Q3—2N2222, NPN transistor
- Q4—2N2646, UJT transistor
- D1—IN4007 rectifier diode
- D2—IN914 small-signal diode
- D3—1N5234, Zener diode
- D4—D6—1N4749, Zener diode

Other components

- F1—1-amp, *slo-blo* fuse
- J1—Phono jack
- PL1—Polarized power plug
- S1—SPDT PC-mounting slide switch
- TS1—Thermal switch
- T1—Ferrite transformer (see text)
- T2—Miniature audio transformer, 8-ohm primary, 1000-ohm secondary

Miscellaneous: Printed circuit materials, insulating board, TO-3 mounting kit, 6-32 nylon screw and nut, mica washer, insulated alignment tool, wire, solder, sheet aluminum, cabinet, etc.

Note: The following parts are available from: Information Unlimited, PO Box 716, Amherst, NH 03031: An etched and drilled PC board (\$5.50): Transformer T1 (\$29.50): 0.01 μ F, 1 kV, polypropylene capacitor (\$2 each): A complete kit containing T1 and all other components as well as the enclosure (\$59.50). Add 5% of the total order for postage and handling.

Plasma globes and custom neon tubes are available from Strattman Design, 791 Tremont St. No. E517, Boston, MA 02118. Tel. 617-266-8821. Write or phone for specific information and prices.

phase with T1's primary winding. The positive feedback is what causes Q1 to oscillate. Base current is limited by resistors R4 and R5.

The resonant frequency of T1 is such that the circuit oscillates at a frequency of approximately 20–25 kHz. A resonating capacitor, C6, tunes the primary of T1 to a smooth, soft waveform, while R15 provides the load impedance that is sometimes necessary when the supply powers very small display tubes and globes.

Since the power supply uses a ground circuit that is common to the AC powerline, capacitor C3 is provided to prevent a hazardous condition should polarized line-cord plug PL1 be defeated.

The gain of Q1 determines the output voltage. The gain is controlled by the conductance of transistor Q2, which is determined by the bias applied to Q2's base through the INTENSITY control, R12. Diode D3 prevents any offset voltage that may occur at the beginning of the turn-on cycle from turning on Q2. Capacitor C2 bypasses any high-frequency signal that might be developed across Q2, while Zener diodes D5 and D6 limit Q2's instantaneous collector-emitter voltage to 48 volts.

The control signal applied to Q2's base—which determines the instantaneous system-output voltage—is determined by the ramp voltage produced by unijunction-transistor oscillator Q4. The period of the ramp is determined by capacitor C4 and the setting of the RATE control, R13. The value of C4 should be in the range of 220–1000 μF . A mid-value of 500 μF is suggested as an initial value. Although 500 μF probably will work out best for most applications, you can experiment to determine the exact value for the kind of display that you prefer.

The ramp voltage is applied through the MODE switch, S1, to emitter-follower Q3, which serves as a buffer-amplifier whose relatively high input impedance isolates C4 from variable resistor R12. The voltage produced by Q3 across R12 corresponds to the ramp voltage, thereby providing a relatively linear change in Q1's power output.

Proper biasing of Q2 by R12 is the point of conduction just as the ramp voltage starts to increase. That provides a minimum or zero tube or globe display that steadily increases

as the ramp waveform builds. If R12 is adjusted for a "hold off" bias so Q2's conduction does not start until the ramp is well underway, the overall period of the output voltage, and therefore the display, is reduced.

Audio control

An audio signal can be substituted for the ramp control voltage by setting S1 so that Q3's base connects through R9 to D2 rather than to C4. An audio signal, say from a transistor radio, that is applied to J1 will then provide the control signal for Q2, and the system's output voltage will more or less correspond to the amplitude of the audio signal.

Normally, resistor R2 isn't necessary unless the audio signal is so strong that it swamps the unit and produces an output that appears to be on most of the time. You only have to install R2 if R12 has little effect on the output when audio is used as the control signal.

As a general rule, the 1- μF capacitor specified for C5 in the Parts List will be satisfactory, but you can experiment with different values to get the plasma or neon display you prefer.

If you have no need for either automatic ramp control by Q4, or audio control via J1, then you can install the shorting jumper indicated in Fig. 1 by the dashed line connecting R8 to R12. With the jumper installed, the brightness of a plasma-bulb display, or the brightness and maximum length of a neon display is determined only by R12.

The display

The plasma arc—the visual display—is created by the electric current flowing through the gas in the tube. In a plasma bulb, the gas can be argon, neon, krypton, or any combination thereof. The colors generated are determined by the specific kind and ratio of gasses. In a neon tube the gas is, of course, neon. When electric current is applied to the gas, the atoms become energized to a level where both electrons and positive-charged atoms are produced. They emit light spontaneously upon returning to their initial energy state. As the electric current is reduced, the display shortens because there is insufficient energy to cause further ionization. Increasing the ionization energy causes the end of the display in a neon tube to lengthen because there are a greater number of free charges. In simple quantitative terms, the number of charges produced in the tube is directly related to the input energy. A smaller-volume tube would theoretically produce a longer discharge for a given ionization energy and vice versa. (That explanation neglects the change in the dynamic impedance of the system due to a change in the volume of gas.)

Construction

Although we provide details for construction of the universal plasma power source prototype shown, keep in mind that a complete kit that includes the cabinet and all prefabricated metal parts is available from the

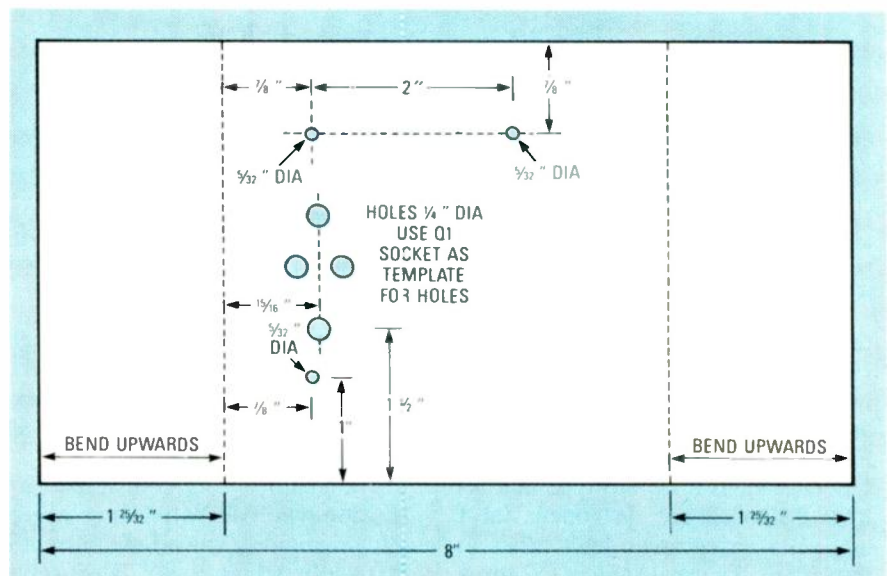

FIG. 4—THIS IS THE TEMPLATE for the metal frame. The holes for Q1 should correspond to the particular socket you use.

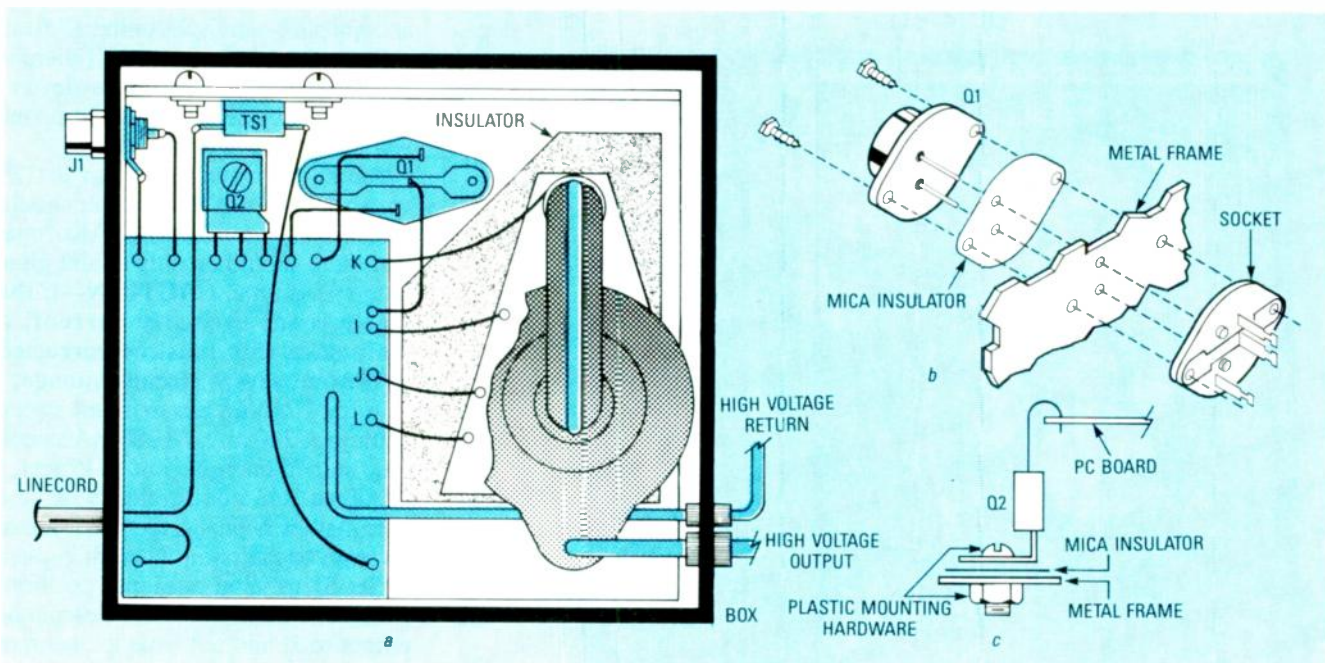

FIG. 5—THE ASSEMBLY ON THE METAL FRAME should correspond very closely to the view shown in a. Note in particular how the letter-identified wires from T1 connect to the PC board. If TS1's mounting screws interfere with the frame's installation in its cabinet, eliminate the screws and secure TS1 to the frame with epoxy cement.

source given in the Parts List, which is located on page 45.

The first step is to make the PC board using the template shown in PC Service. Then, using Fig. 2 as a guide, install all board-mounted components. But note that the components are mounted somewhat differently than usual: except for D1, D3, D4, and R1, all components are mounted on end; that is, they stand vertically on the PC board. Although Fig. 2 shows diodes D5 and D6 external to the board, they actually span across the board. They are positioned about ¼-inch above the board and are located between T1 and C4.

Note that although the leads from Q2 are soldered to the PC board, during final assembly Q2 will be folded downwards so it can be heat-sunk to a metal frame. Be sure to leave sufficient lead length—about ½-inch—so the fold can be made without stressing the leads or the board.

In reality, C6-a and C6-b do not exist. There should be only one capacitor, C6, a 0.005- μ F, 1-kV tubular capacitor connected across T1's primary winding. Unfortunately, that value isn't among the easiest to locate, so you can substitute the more easily obtained series-connected 0.01- μ F, 1-kV capacitors, shown in Figs. 1 and 2 as C6-a and C6-b. They are both end mounted, and are con-

nected together at the top after they are installed on the board. Finish up by using an RTV type adhesive such as G.E.'s Silicon II to cement a sheet of insulating material to the underside of the PC board.

When the PC board is completed, you can set it aside and move on to transformer T1.

A feedback coil

Although the T1 specified in the Parts List is supplied completely assembled, it requires the addition of feedback coil, which, as shown in Fig. 3-a, is nothing more than 10 turns of No. 24 solid, insulated wire wound around T1's core. Bear in mind that if you substitute a different transformer for the model specified the required feedback winding might have more or less turns. Also, a substitute transformer should have a primary inductance between 2 and 3 mH. If your T1 has pin connections that interfere with its installation, simply cut them short.

Figure 3-b shows letter-coding for the connections of the particular model T1 specified in the Parts List. The letters only serve as a reference when assembling the project; more on that later. (The letters are the same as those used for identification by the kit supplier given in the Parts List.)

Take note that since T1's terminals extend through its own support

bracket, they must be insulated from the metal frame that is used as a chassis. The insulation can be a strip of epoxy PC material from which the copper foil has been etched. (The insulator is supplied in the complete kit of parts.)

The frame

The metal frame chassis, which is called a *mounting plate* in the instructions packaged with the complete kit, also serves as the heat sink for Q1 and Q2, which is why thermal-switch TS1 is installed on the frame. If the frame gets excessively hot, TS1 opens and turns the power supply off. Since TS1 is self-resetting, it automatically restores power when the heat sink cools.

Figure 4 shows the measurements for a metal frame made from ¼-inch aluminum. The indicated holes are for the mounting screws used for Q1, Q2, and T1. The precise layout of the diamond-pattern holes for Q1 will be determined by the particular kind of socket you use; but regardless of the kind or design of the socket, make Q1's holes ¼-inch, and deburr them with a knife or deburring tool before installing the socket.

Make certain you drill all holes before bending the side flanges upwards on the fold marks.

Figure 5 shows how the project is

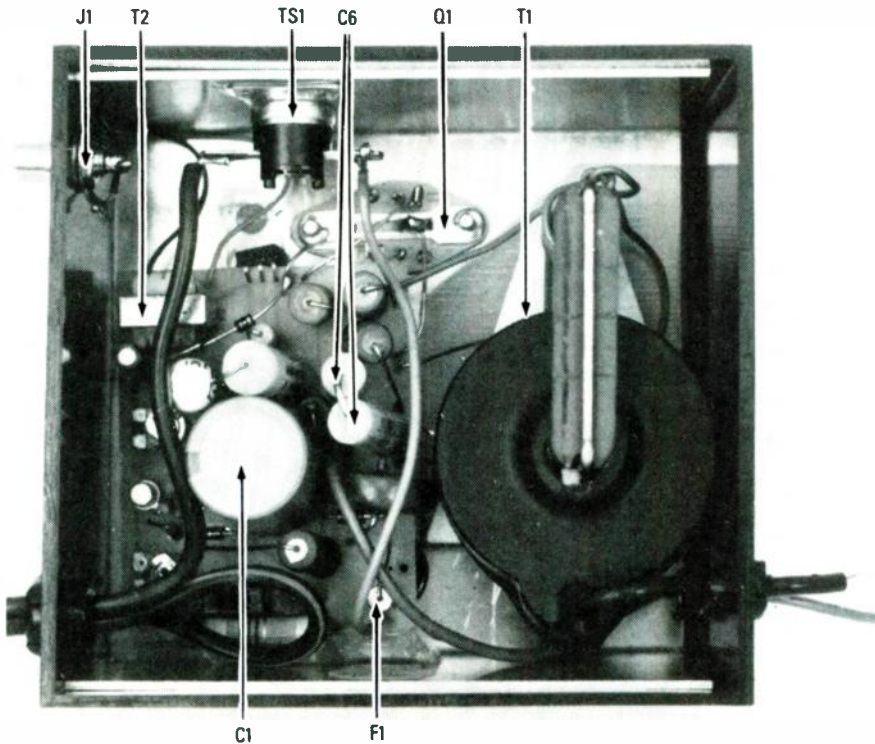

FIG. 6—THE ACTUAL PROTOTYPE. Notice that it is virtually a duplicate of the layout shown in Fig. 5.

assembled. Figure 5-a shows that TS1 is secured to the metal frame with screws and nuts. If you have somehow made the frame a smidgen oversize so the mounting screws prevent the chassis from being installed in its cabinet, you can eliminate the screws and use epoxy glue to cement TS1 to the chassis. Its location is not precise, but it should be reasonably close to the top of the enclosure (away from Q2).

Figure 5-b shows how Q1 is installed on the metal frame using an insulating socket. However, note from Fig. 5-c that Q2 does not use a socket; it is insulated from the frame only by a mica insulator, so a Nylon screw and nut must be used as the mounting hardware.

Finally, use RTV adhesive to cement the PC board to the metal frame. The board must be spaced off the frame because one end is lifted by Q2's mounting; use a stack of rubber grommets for the spacers.

The enclosure

Although the project should not be installed in an enclosure until tested, prepare the enclosure so it is ready as soon as the tests are completed. For safety, the (4½-inch wide × 4¾-inch long × 2¾-inch high) enclosure must be made of plastic; ½-inch thick will be ideal. (An appropriate

enclosure is supplied with the kit.)

Fabricate a cover from perforated aluminum that will snap onto the top of the cabinet, but be certain to drill access holes for R12, R13, and S1 before bending the sides of the cover. Also, if you plan on using a plasma globe, assemble a base large enough to support the globe, and place the power supply within the base box.

Do not pre-size a plasma-globe base before you obtain the globe. Since plasma globes range in size from 7 to 22 inches, you must be certain the base has the proper dimensions to fully support the globe.

Checkout

Before applying power, very carefully check the insulation between the metal frame and the connections to Q1, Q2, and T1. Also, check for continuity between PL1's ground lug (the larger one) and the circuit's common (ground) point. Make certain the circuit ground is not connected to PL1's "hot" terminal.

Next, set R13 fully clockwise, R12 fully counterclockwise, and S1 so its handle points toward R10. Then connect T1's output lead to a neon tube, bank, or sign.

Plug the unit into a variable, current-metered AC supply, such as a metered variac. If that kind of equip-

ment is unavailable we suggested connecting a 60-watt light-bulb ballast in series with the power cord. If there is a catastrophic failure in the device, the light bulb will turn on and drop the voltage at PL1 to a safe value.

Slowly turn the variac up to 120 volts and note that its ammeter should indicate only 50–60 mA. Also note that there should be only a faint glow in the neon tube. **CAUTION—if the meter reads excessive current, a fault exists that must be corrected to prevent severe circuit damage.**

Adjust R12 for a maximum sweep reading of 200 mA. At 200 mA a neon tube should energize out to 15 feet.

Adjust R13 counterclockwise and note that the neon sweep speed should increase to the point where it ceases.

Set S1 to its AUDIO input position. Connect a transistor radio's earphone output to J1 and note that the neon or plasma display intensity should respond to the audio sound level.

If everything checks out, install the unit in its enclosure, using strain relief clamps or devices where the line-cord, high-voltage, and high-voltage-return wires pass through the enclosure. Figures 6 and 7 show the completed prototype unit.

Special Instructions

Although the unit can power up to 30 feet of neon tubing, best results are obtained by connecting 10–15-foot sections in parallel because maximum sweep travel is usually limited to 15 feet.

The high-voltage-return wire is intended for connection to the end of larger neon displays. It is not necessary for single electrode-ended tubes such as used for visual audio enhancement. Do not ground the high-voltage return if unused; simply tie-wrap the wire and make sure there are no exposed strands.

Do not allow the power-supply unit to run without being connected to a display tube or globe.

Neon displays

- Set R13 fully clockwise, R12 fully counterclockwise, and S1 to INTERNAL (so that Q3 is fed by Q4).

- Lay out the intended neon sign on a clear non-conductive bench. (Not necessary for pre-installed displays).

- Connect the high-voltage return (the ground wire) to the far end of display. Note that the wire is only

continued on page 82

Build REACTS: THE RADIO-ELECTRONICS ADVANCED CONTROL SYSTEM

This month we take an in-depth look at the CPU board's circuitry.

Part 2 AS WE SAID last time, the REACTS 7000 uses an operating system that is compatible with the CP/M operating system. The version we use is an enhanced SB-80 from Lifeboat Associates. Special utilities have been added to the basic DOS (Disk Operating System) in order to make robotics/control applications easy to implement.

A number of the systems commands are known as *intrinsic*—i.e. they are part of the basic system. Examples of in-

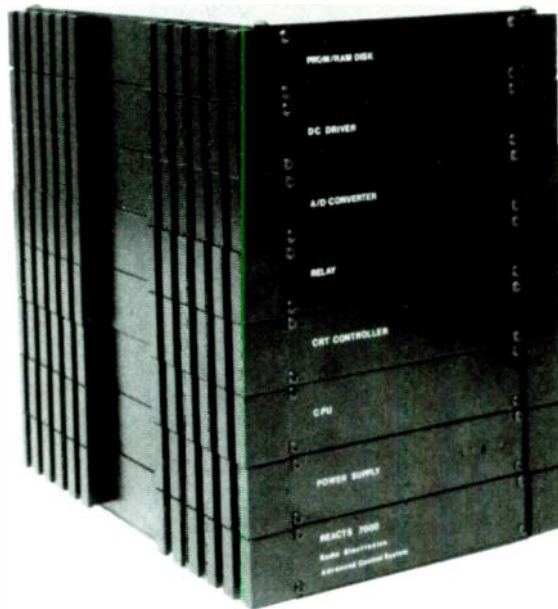

H. EDWARD ROBERTS M.D.

trinsic commands are: DIR, which lists the directory of a disk drive; DEL, which deletes files; SAVE, which saves files; and BATCH, which can be used to chain together a number of different commands. Of course, there are many more, but that gives you an idea of some of the commands if you aren't familiar with CP/M or MS-DOS.

Additionally, the operating system includes a number of utilities such as CONFIG, RBURN, and FORMAT, etc. Utilities are programs that have been added to the basic operating system. The following is an explanation of some of the utilities included with the REACTS DOS:

- **CONFIG:** Used to change different parameters of the DOS such as, disk-drive assignments, boot drive, serial-port parameters, I/O assignments, etc. If the changes are to be made permanent, a new boot PROM can be burned using RBURN described below.

- **RBURN:** is a utility that allows you to create a custom PROM disk on a 32K ROM. Using that utility, you can create a PROM disk as easily as you create a floppy disk.

- **FORMAT:** That allows the formatting of the REACTS 3.5-inch floppy disk if a disk controller and disk are included in the system.

That gives you some idea of what can be done with the CP/M operating system. There are a number of excellent books on CP/M for those who want to get more information. In addition, a detailed manual is included with the operating system sold by the source mentioned elsewhere in this article.

It is important to note that you don't have to have an operating sys-

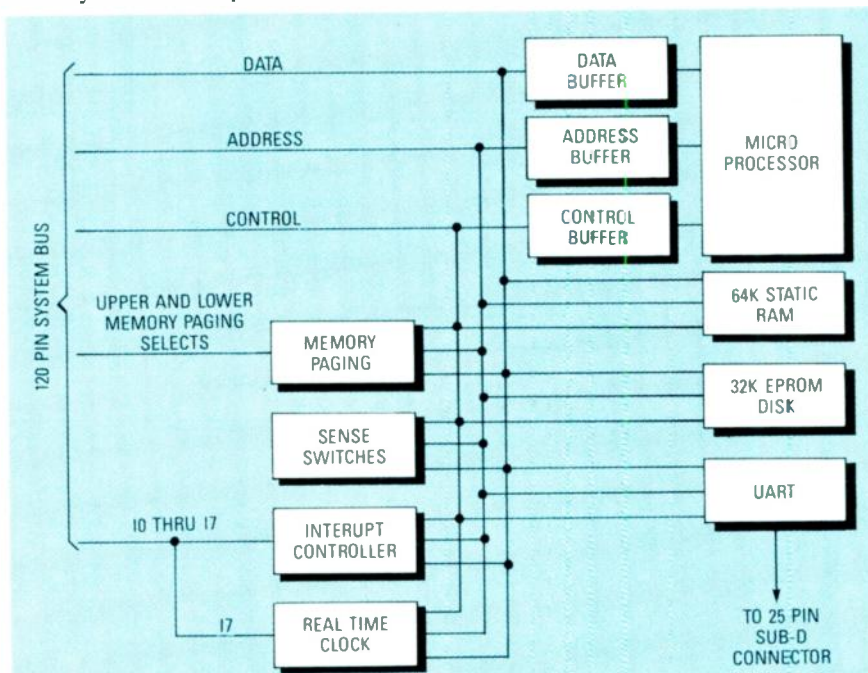

FIG. 1—THE ORGANIZATION OF THE REACTS CPU board is shown here in block-diagram form.

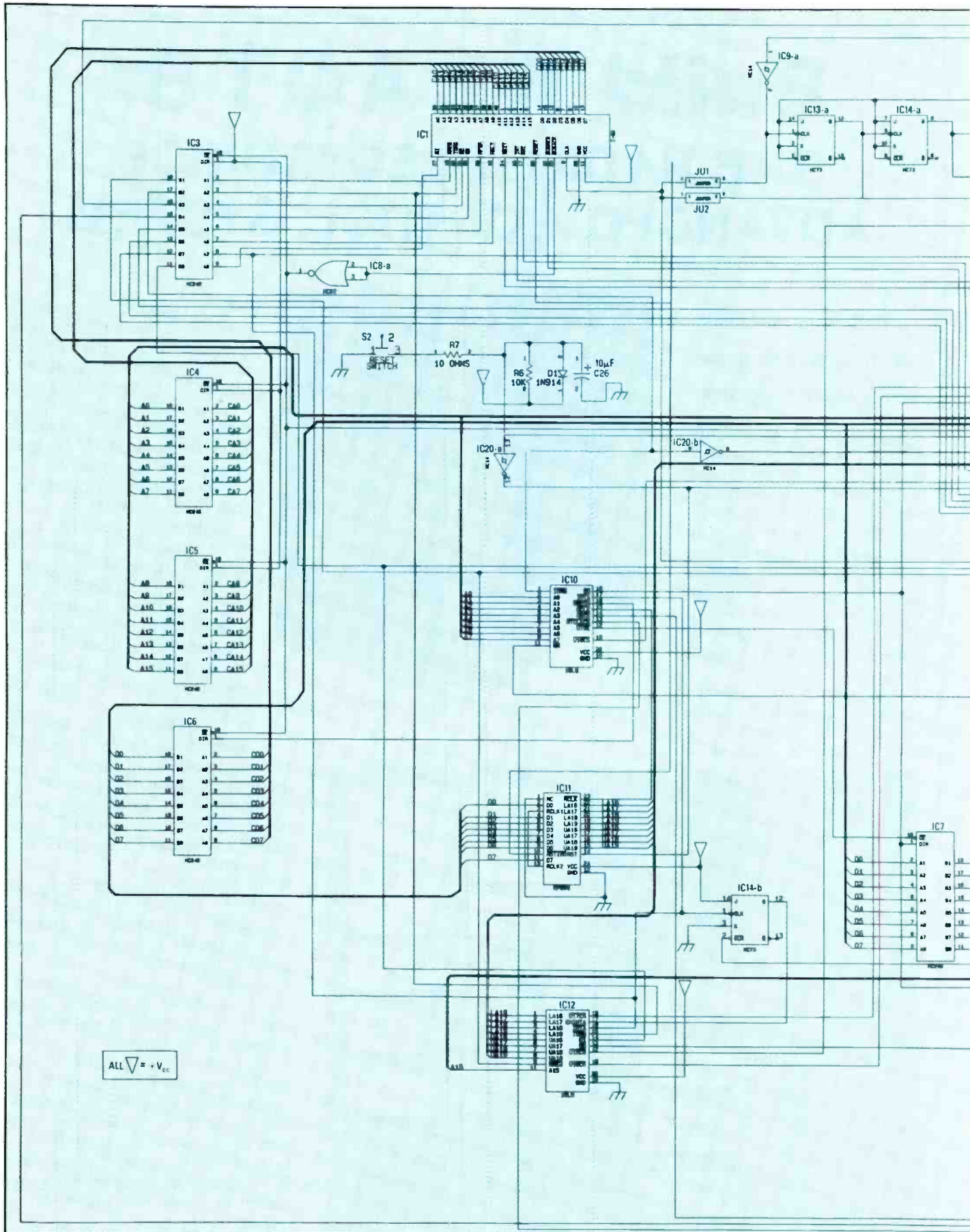

FIG. 2—THE REACTS CPU is built around the powerful Z80 microprocessor. Note that all of the bypass capacitors (C1—C25, C27—C29) have been eliminated from this schematic for clarity.

TABLE 1—I/O PORTS

| Subsystem | I/O Port(s) Used |
|----------------------|------------------|
| Sense Switches | 187 |
| Real Time Clock | 192 thru 207 |
| Memory Paging | 210 |
| Interrupt Controller | 216 thru 217 |
| UART | 212 thru 215 |

tem to make the system function. If you are familiar with assembly-language programming and have your own cross assembler, you can create a custom system from scratch.

Theory of operation

The REACTS 7000 CPU is relatively conventional in organization. Figure 1 shows an overall block diagram of the system. The schematic is shown in Fig. 2. Note that because of its large size, the print had to be reduced in scale.

As already discussed, the processor used in the computer is a CMOS version of the Z80 (IC1). An on-board crystal oscillator provides the necessary clock signals for the system. Jumpers JU1 and JU2 are used to select between an 8-MHz (JU1 installed) or 4-MHz (JU2 installed)

clock frequency. Other major subsystems on the central-processor module includes a set of eight sense switches, an interrupt controller, a Universal Asynchronous Receiver/Transmitter (UART), two 32K static RAM chips, a 32K boot PROM-disk, bus buffers, and the memory-paging capability that allows the addressing of up to one megabyte of system RAM. Also, an optional real-time clock is plugged in as a daughter board on the CPU module. All of those components must communicate with the Z80 processor; most of that communications takes place via the I/O ports. We will look at that in more detail later.

In our system each subsystem is hard-wired to a predetermined I/O port address; the addresses for the subsystems are shown in Table 1. Those addresses are known to the operating system, and communication occurs automatically in most cases. If required, an application program can also bypass the operating system and communicate directly with any subsystem. We will talk more about how to bypass the operating system in future articles.

The microprocessor

The Z80 processor is inherently capable of addressing up to 64K bytes of memory. Additionally, the Z80 can address up to 256 eight-bit I/O ports. The following is a discussion of how I/O operations take place in the system.

Whenever the computer executes an I/O command, it notifies the rest of the system by raising the system bus' \overline{MREQ} line high. (Pin definitions for the system bus are given in Table 2). When that occurs, the lower 8 address lines contain the address of the I/O device. The \overline{RD} (read) and \overline{WR} (write) lines tell the system whether that is an input or output; i.e. if the read line is low the system is requesting an input, if the write line is low, the data on the bus is an output. Incidentally, the memory-read or -write system operates in exactly the same manner, except the \overline{MREQ} line is low for memory operations.

In summary, in order for a device that uses I/O-port addressing to be selected, the \overline{MREQ} line must be high. Additionally, it must have an address that matches the address on the lower address lines (A0-A7), and the \overline{IORQ} signal must be correct for that particular channel. If all those conditions are met when inputting, the correct data will be placed on the data bus by the inputting device and then sent to the processor. For an output, the processor will place the correct data on the bus.

Sense switches

As stated in Part 1, the sense switches can be thought of as a "poor-man's keyboard." They allow you to input data to the system without connecting any other device. That's useful in a minimal system where size, space, and/or cost prevent using a more sophisticated input device.

Those switches are hard-wired to input channel 187. If you are writing a program in BASIC you simply type the following line:

```
120 S = INPUT 187
```

That would be read by the interpreter to mean input the data on channel 187 and store it as variable S. Since there are eight switches, up to 256 unique instructions could be supplied to the computer with those switches. Indeed, if you really like to work, you could input all of the standard ASCII codes using only the sense switches.

TABLE 2—BUS DEFINITIONS

| Left Bus | | Right Bus | |
|----------|-------------------|-----------|-----------------------|
| Pin No. | Function | Pin No. | Function |
| 1 | CASE GND | 31 | DGND |
| 2 | VCC | 32 | VCC |
| 3 | INT 0 | 33 | +12V |
| 4 | INT 1 | 34 | -12V |
| 5 | INT 2 | 35 | A0 |
| 6 | INT 3 | 36 | A1 |
| 7 | INT 4 | 37 | A2 |
| 8 | INT 5 | 38 | A3 |
| 9 | INT 6 | 39 | A4 |
| 10 | INT 7 | 40 | A5 |
| 11 | CA 0 | 41 | A6 |
| 12 | CA 1 | 42 | A7 |
| 13 | CA 2 | 43 | A8 |
| 14 | INT 8 | 44 | A9 |
| 15 | INT 9 | 45 | A10 |
| 16 | INT 10 | 46 | A11 |
| 17 | INT 11 | 47 | A12 |
| 18 | INT 12 | 48 | A13 |
| 19 | INT 13 | 49 | A14 |
| 20 | INT 14 | 50 | A15 |
| 21 | INT 15 | 51 | LA16 |
| 22 | RESERVED | 52 | LA17 |
| 23 | RESERVED | 53 | LA18 |
| 24 | RESERVED | 54 | LA19 |
| 25 | +12V (PWR) | 55 | UA16 |
| 26 | +12V (PWR) | 56 | UA17 |
| 27 | GND (PWR) | 57 | UA19 |
| 28 | GND (PWR) | 58 | UA19 |
| 29 | VCC | 59 | VCC |
| 30 | CASE GND | 60 | DGND |
| 1 | DGND | 31 | CASE GND |
| 2 | VCC | 32 | VCC |
| 3 | DO | 33 | 4 MHZ |
| 4 | D1 | 34 | 2 MHZ |
| 5 | D2 | 35 | 1 MHZ |
| 6 | D3 | 36 | RESERVED |
| 7 | D4 | 37 | RESERVED |
| 8 | D5 | 38 | RESERVED |
| 9 | D6 | 39 | RESERVED |
| 10 | D7 | 40 | RESERVED |
| 11 | IOM | 41 | RESERVED |
| 12 | RESERVED | 42 | RESERVED |
| 13 | RESERVED | 43 | RESERVED |
| 14 | \overline{WR} | 44 | RESERVED |
| 15 | \overline{RD} | 45 | \overline{WAIT} |
| 16 | \overline{RFSH} | 46 | \overline{BREQ} |
| 17 | \overline{INTA} | 47 | BACK |
| 18 | \overline{INTR} | 48 | $\overline{RESET IN}$ |
| 19 | RESERVED | 49 | RESET OUT |
| 20 | RESERVED | 50 | RESERVED |
| 21 | RESERVED | 51 | RESERVED |
| 22 | \overline{NMI} | 52 | RESERVED |
| 23 | \overline{HALT} | 53 | RESERVED |
| 24 | SIO (CLK) | 54 | RESERVED |
| 25 | UNREG PWR | 55 | RESERVED |
| 26 | GND (± 12) | 56 | GND (± 12) |
| 27 | -12V | 57 | RESERVED |
| 28 | +12V | 58 | RESERVED |
| 29 | VCC | 59 | VCC |
| 30 | DGND | 60 | CASE GND |

In addition, the four rightmost switches are used by the REACTS' disk-operating system at power-up. The setting of those switches select the console device, the serial port's baud rate, and which disk drive the system should boot from. A common use of the sense switch would be to automatically load and execute a program at power up.

Interrupt controller

The Z80 processor has two interrupt inputs—a nonmaskable and a maskable interrupt. Indeed, one of the reasons that the Z80 has become so popular as a controller is the power of its interrupt system.

A CMOS version of the industry standard 8259 interrupt controller (IC2) was added to the REACTS CPU. That provides us with eight additional vectored (i.e. prioritized) interrupt inputs. Those interrupts are brought out to the system bus and can be used by any of the other modules. Complete control of the interrupt system can be made under software control. Communication with the interrupt subsystem is made through I/O ports 216 and 217. Future articles will show you how to exploit interrupts. For now, let's just say that the interrupt system adds real power to the REACTS computer. In addition, many programming requirements can be simplified by using interrupts.

The UART

A standard RS-232 serial port is included on the REACTS CPU board. The serial port's communication parameters, baud rate, number of stop bits, word length, parity, etc., are configured by the Z80 through an 8252 UART (IC18). The 8252 also converts the parallel data from the system into a serial data train for use with serial communications systems. The cts (Clear To Send) line is configured—always high (for send-only or full-duplex applications) or floating—via jumpers JU3 and JU4. The serial port can be used to interface the computer module to a terminal, modem, or any other device that requires serial data input/output. The operating system communicates with the 8252 UART through I/O ports 212, 213, 214, and 215. The CRT controller we will build later on does not use that port, which means that it is normally available for any other purpose. But if we use an external termi-

Sources

The following items are available from DataBlocks, Inc., 579 Srowhill Road, Glenwood, GA 30428. Or call (800) 652-1336; in Georgia call (912) 568-7101: DP-CPU—design package of schematics and instructions, \$10.00; PC-CPU—PC board for CPU module (includes DP-CPU design package, \$37.00; PC-CLK—PC Board for clock, \$18.00; SYS-PROM—the REACTS operating system (enhanced SB-80) installed on a 32K UV-erasable PROM (includes operating system documentation), \$44.00; REC-CPU—complete kit of parts, PC boards, IC's, connectors, for CPU module (does not include clock or system PROM), \$147.00; REC-CLK—complete clock subsystem including all parts, PC boards, NiCd battery, and connectors, \$43.00; and REC-SYS—All of the above, \$218.00. An Elpac power supply is also available for \$49.00. Please add \$10.00 postage and handling per order. GA residents must add appropriate sales tax.

nal or computer as the controlling device, that port is used as the communication port.

Memory paging

System memory paging is performed via I/O port 210. The four least-significant data bits select the lower 32K page while the four most-significant data bits select the upper 32K page. That allows us to literally change the contents of the system memory in about 10 microseconds. That is equivalent to a DMA (Direct Memory Access) transfer rate of approximately 10 gigabytes-per-second, which is fast by any standard, or of being able to move the entire contents of a 40-megabyte hard disk in 4 milliseconds. The basic REACTS system will support more than 1 megabyte of additional memory.

The memory-paging system is implemented using three custom PAL (Programmable Array Logic) IC's (IC10-IC12). Those can be purchased from the supplier mentioned in the Sources box.

Static RAM

Two 32K static CMOS RAM IC's (IC15 and IC17) provide 64K of system memory for the computer, and that is just the basic memory on the CPU module. Static memory IC's are

somewhat expensive, but their use makes battery powering easy. That's because static RAM doesn't have any of the traps associated with multiple processor systems—we don't have to make sure that the memory is in any special configuration to power down or to perform DMA's.

System disk

As we discussed earlier, even the most minimal REACTS system includes a disk operating system. That is because the CP/M P drive is a 32K UV-erasable PROM that is included on the CPU module (IC16). That PROM is set up to allow for the BIOS (Basic Input/Output System software) as well as drive P to be installed. There is enough storage available on that prom disk to store the BASIC interpreter and a decent sized user program. That means that for some applications, no other system hardware, such as a disk, needs to be added to the basic CPU module; only your interface hardware is required.

In a future article we will provide the construction plans for a PROM programmer as well as for a large RAM/PROM disk system.

Real-time clock

In many applications a real-time clock will be desirable and perhaps even mandatory. The real-time clock used by REACTS can be programmed to operate in a twelve or twenty-four hour time-keeping format. It can provide single or repeated interrupts to the processor with a resolution of 0.1 second. It includes an automatic calendar function (that accounts for leap years), and it includes a NiCd battery for back up. I/O ports 192 through 207 are used to configure and set the clock. The interrupt output of the real-time clock is connected to system interrupt 7.

The clock interfaces with the main CPU board via a 16 pin connector. (Note that the rest of the clock circuit will be shown in a future installment of this series.) The use of an interface circuit makes the clock optional and keeps the system cost to a minimum in systems where the clock is not needed.

Next time

That's all we have room for this time. Next time we will get our hands dirty and show you how to build the CPU module. R-E

WIRELESS STEREO LINK

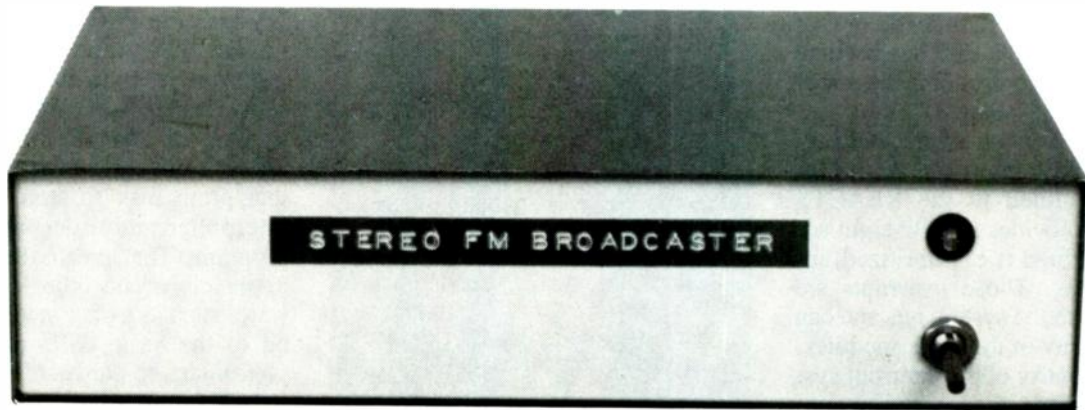

This great little stereo FM transmitter lets you listen to whatever you want, whenever you want, wherever you want.

WILLIAM SHEETS and RUDOLF F. GRAF

YOU'RE WATCHING THE BEST BOXING match you've seen in years on your cable-television sports channel. The fighters are really slugging it out. Now the dog decides he has to go out and he's not going to wait. What do you do? You connect the television's audio to our FM broadcaster, put on your *Walkman* stereo tuned to a frequency near 88 MHz, and take the dog out without missing a punch.

In this article we'll show you how to build a low-cost, low-power stereo FM transmitter that can broadcast about 100 feet in a typical residential environment. Its signal is received on an unused FM channel, just as if it were any other FM station.

The idea of a radio transmitter for use with a home-audio system is not new. Those who were into electronics in the 1950's will remember the "phono oscillators" that were used to broadcast phonograph records to a nearby AM radio. Today, however, modern-IC devices make it possible

to build a high-fidelity stereo FM transmitter that doesn't need much "tweaking" to get it working. Also, all of the necessary parts are available from the source that is listed in the Parts List.

FM transmitter

Whereas the old phono oscillator could only broadcast a mono signal, stereo requires two audio channels—one for left audio and one for right audio. An FM stereo signal has the frequency spectrum shown in Fig. 1. The main channel of the audio baseband (50 Hz to 15 kHz) is the sum of the left- and right-channel (L + R) audio. A monophonic receiver is able to receive that, and everyone is happy. Also, a *stereo difference* channel (L - R) is generated. That channel is the difference between the left and right signals. The (L - R) signal modulates a 38-kHz subcarrier, whose sideband products are transmitted along with the main audio.

The 38-kHz carrier is suppressed in accordance with FCC technical standards for stereo-FM modulation (the reason for that is beyond the scope of this article). But the 38-kHz subcarrier is necessary for reception of the L - R signal, so it must be supplied in some way at the stereo FM receiver. It is reconstructed in the receiver by using a 19-kHz pilot carrier sent along by the transmitter. The 19-kHz pilot carrier represents 10% of the full-modulation amplitude.

A block diagram of our FM stereo transmitter is shown in Fig. 2: The left and right audio inputs are fed into a matrix consisting of two halves of an LM1458 dual operational amplifier. One half of the IC uses a summing configuration to algebraically add the two audio waveforms to create the main-channel audio. It has a gain of -1 for each input, so each input contributes equally to the output of the op-amp. The output is the algebraic sum (L + R) of the left and right chan-

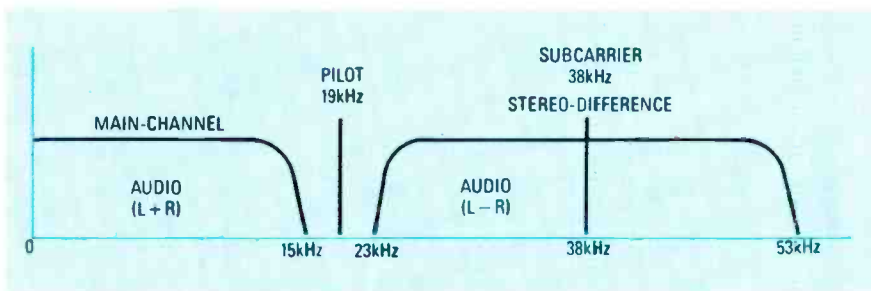

FIG. 1—THE FREQUENCY SPECTRUM of an FM-stereo signal, and the MPX transmitter must duplicate this signal in order for an FM receiver to pick it up.

nels. The other half of the LM1458 is set up to algebraically subtract the two inputs to create the stereo-difference channel. The right input is subtracted from the left input to form the $L - R$ signal. Note that if the inputs are the same, the $L - R$ output would be zero.

The difference ($L - R$) signal is fed to a balanced modulator, an MC1496 IC. That modulator produces sum and difference frequencies of the audio and subcarrier input. Both the audio input and the subcarrier input are suppressed by the IC—only the sum and difference frequencies appear at the output. A balance control is used to set the correct DC voltage on the IC to achieve maximum 38-kHz subcarrier suppression. (If a 1-kHz audio signal ($L - R$) and a 38-kHz subcarrier are mixed in that stage, a signal having

only 37- and 39-kHz components appears at the ($L - R$) subcarrier output. If the audio signal is 10 kHz, we have 28- and 48-kHz components in the output.)

The 38-kHz signal is derived from a 76-kHz oscillator and a CD4027 dual flip-flop. One flip-flop divides the frequency by 2, producing a 38-kHz square wave; the other flip-flop divides the 38-kHz square wave by 2 to obtain a 19-kHz square wave. Both the 38- and the 19-kHz square waves are converted to sine waves by passing the signal through a tuned circuit.

The $L + R$ signal, the $L - R$ subcarrier signal, and the 19-kHz pilot signal are fed to a summing amplifier whose output is a composite multiplex (MPX) signal that is fed to a Voltage-Controlled Oscillator (VCO) operating at the low end of the FM

broadcast band. Controls are provided to adjust each component of the MPX signal to its correct level.

To ensure stability, the VCO is powered by a Zener-regulated power source and its output is fed to a buffer-amplifier that isolates the VCO from the antenna-output connector. The antenna should be about 12 inches long, and any piece of wire will do.

Circuit details

The schematic is shown in Fig. 3. The left- and right-audio inputs are connected to J1 and J2. Capacitors C1 and C2 couple audio to R2 and R4 (input resistors for the $L + R$ channel) and R11 and R12 (input resistors for the $L - R$ channel). Resistor R3, connected between R2 and R4, is used to set the ratio of gains for the L and R signals to exactly 1:1. Ideally, if R2 is equal to R4, then R3 is set at the midpoint. Resistor R6 sets the stage gain to about one (unity gain).

The $L - R$ difference amplifier is IC1-b. Resistors R8, R10, and R11 form an adjustable network similar in function to R2, R3, and R4. Signals from the right channel are coupled by R12 and R13. A network made up of resistors R14, R15, and capacitor C3 is used to bias both op-amp sections at half the supply voltage. Since the gain of IC1-b, as seen from the non-invert-

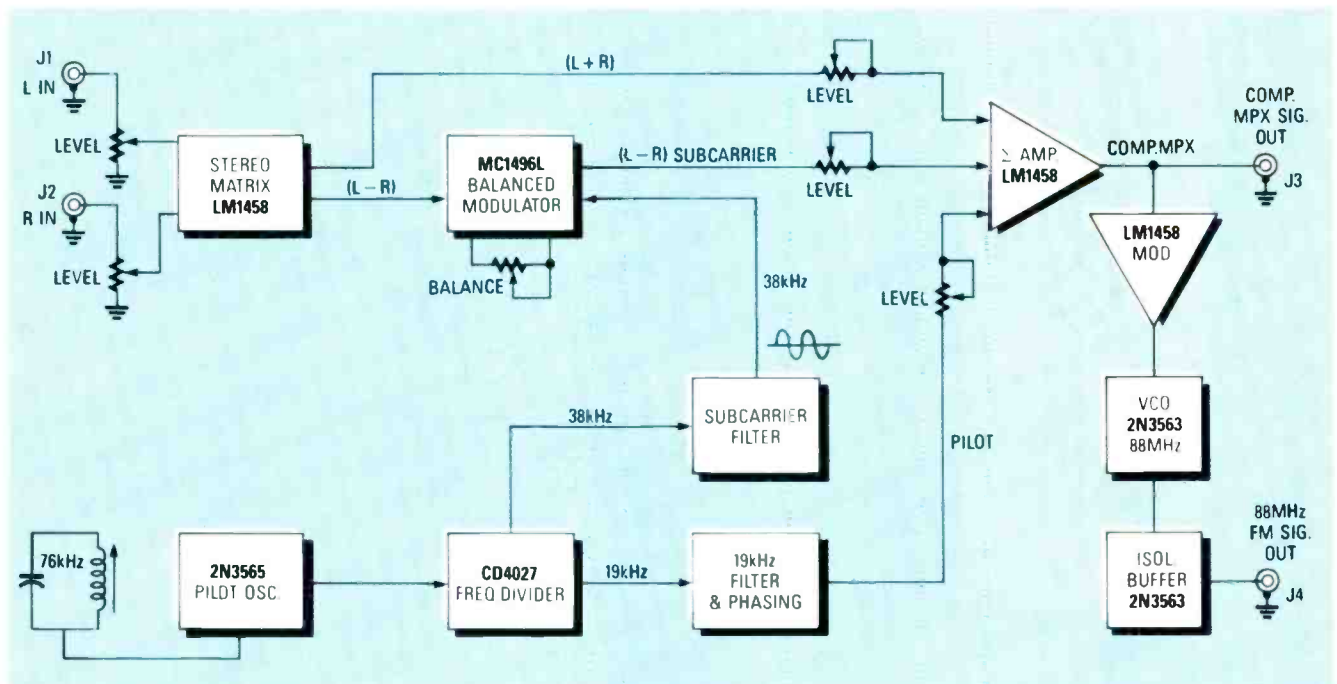

FIG. 2—THIS BLOCK DIAGRAM of the stereo FM transmitter will make it easier to understand how it actually works.

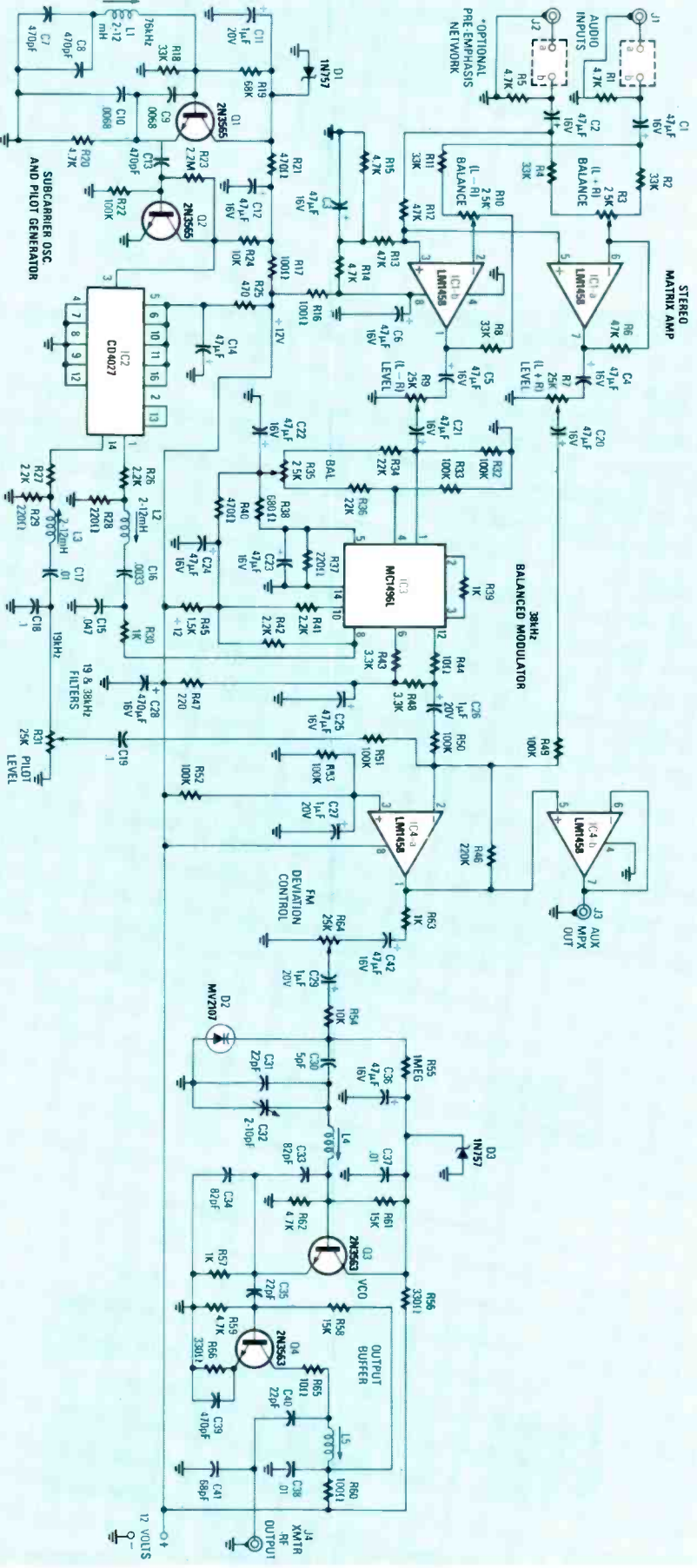

FIG. 3—THIS STEREO FM TRANSMITTER is capable of transmitting a stereo signal up to a hundred feet.

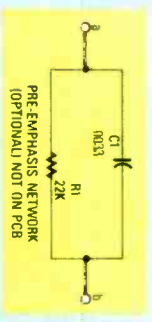

FIG. 4—THIS PRE-EMPHASIS NETWORK can be added to the audio inputs of the MPX transmitter, if necessary.

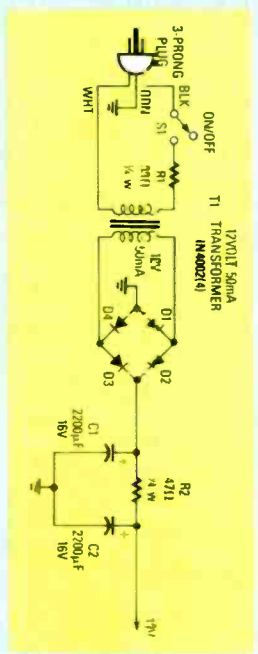

FIG. 5—THIS POWER SUPPLY can be used if you do not want to power the transmitter with batteries.

PARTS LIST— MPX TRANSMITTER

All resistors are ¼-watt, 10% unless otherwise noted

R1, R5, R14, R15, R20, R59—4,700 ohms
 R2, R4, R8, R11, R18—33,000 ohms
 R3, R7, R9, R10, R31, R35, R64—25,000 ohm potentiometer
 R6, R12, R13—47,000 ohms
 R16, R17, R60—100 ohms
 R19—68,000 ohms
 R21, R25, R40—470 ohms
 R22, R32, R33, R49—R53—100,000 ohms
 R23—2.2 Megohms
 R24, R54—10,000 ohms
 R26, R27, R41, R42—2,200 ohms
 R28, R29, R37, R47—220 ohms
 R30, R39, R57, R63—1,000 ohms
 R34, R36—22,000 ohms
 R38—680 ohms
 R43, R48—3,300 ohms
 R44, R65—10 ohms
 R45—1,500 ohms
 R46—220,000 ohms
 R55—1 Megohm
 R56, R66—330 ohms
 R58, R62—15,000 ohms

Capacitors

C1—C6, C12, C14, C20—C25, C36,

C42—47 μ F, 16 volt radial-lead electrolytic (PC-mounting type)
 C7, C8—470 pF (silver mica or NPO)
 C9, C10—0.0068 μ F, Mylar
 C11, C26, C27, C29—1 μ F, 20 volt radial-lead electrolytic
 C13, C39—470 pF, ceramic 20%
 C15—0.047 μ F, Mylar 10%
 C16—0.0033 μ F, Mylar 10%
 C17—0.01 μ F, Mylar 10%
 C18, C19—0.1 μ F, Mylar 10%
 C30—5 pF, silver mica or NPO
 C28—470 μ F, 16-volt radial lead electrolytic
 C31, C35, C40—22 pF, silver mica or NPO
 C32—2–10 pF trimmer capacitor
 C33, C34—82 pF, silver mica or NPO
 C37, C38—0.01- μ F disc
 C41—68 pF, silver mica or NPO

Semiconductors

IC1, IC4—LM1458N op-amp
 IC2—CD4027 dual JK flip flop
 IC3—LM1496N balanced modulator
 D1, D3—1N757 9.1 volt Zener diode
 D2—MV2107 varactor diode
 Q1, Q2—2N3565 NPN transistor
 Q3, Q4—2N3563 NPN transistor

Other components

L1–L3—2–12 mH variable inductor (No. Country Radio, P/N 212103)
 L4, L5—5-½ turns #22 enameled wire on Cambion blue 8-32 \times ¼ slug (see text)
 J1–J4—RCA jack

Miscellaneous—1 on/off switch, 1 LED and a 1K resistor for an optional pilot light, 1 cabinet, hardware, shielded wire, power-supply components if needed, components for Fig. 8 if needed.

Note: The following items are available from North Country Radio, P.O. Box 53, Wykagyl Station, New Rochelle, NY 10804: **FC board and all components that mount on it including all resistors, capacitors, semiconductors, L1–L3, cores and wire for L4 and L5 (LED and 1K resistor, power-supply components, cabinet, on/off switch, and phono jacks NOT included) \$57.50 + \$2.50 S/H. PC board only \$14.00 + \$2.50 S/H. NY residents must include sales tax.**

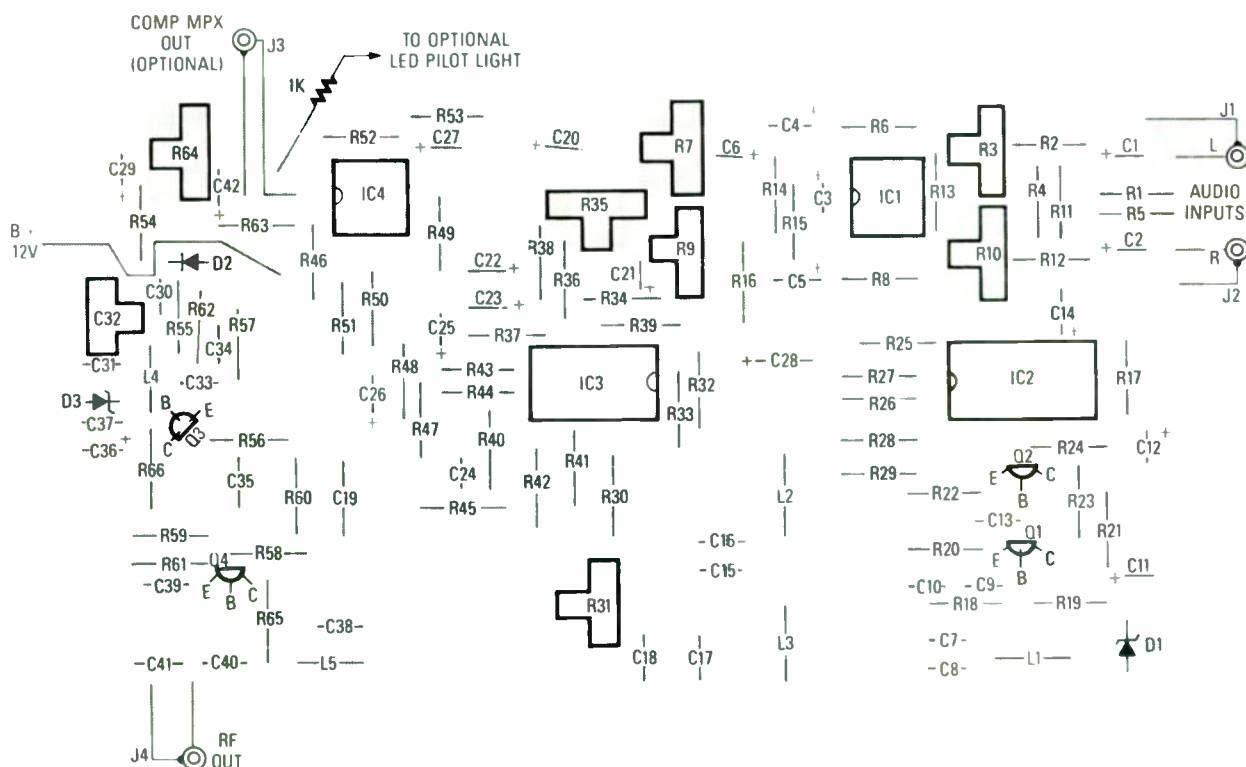

FIG. 6—FOLLOW THIS PARTS-PLACEMENT diagram when you are constructing the MPX transmitter.

ing input (pin 3), would be 2 if R11 is equal to R8 and R10 is at midpoint, R12 and R13 divide the input signal

by 2. Resistor R10 is set so that when the left and right inputs are exactly equal (shorted together with a clip

lead), the output from IC1-b (measured across R9) is exactly zero. That fulfills the necessary condition that

the L-R signal be equal to 0 when both inputs are identical.

As we discussed earlier, the transmitter must generate a pilot signal at 19 kHz and a 38-kHz subcarrier signal. Oscillator Q1's output is 76 kHz. The frequency-determining network is formed by capacitors C7-C10, and inductor L1, which is adjustable and used to set the oscillator frequency to exactly 76 kHz. The oscillator signal is coupled by C13 to buffer-amplifier Q2. Resistors R22-R24 bias Q2, while C12 and R17 provide filtering to remove 76-kHz components from the B+ line. The collector of Q2 provides a negative going pulse train to IC2, a dual JK flip-flop. That flip-flop divides the 76-kHz signal by 2 to get 38 kHz, and again by 2 to get 19 kHz. The 38-kHz and 19-kHz signals are square waves. Since we need sine waves, two filters (L2, C15, C16) and (L3, C17, C18) provide harmonic filtering to pass only the fundamental frequencies. Resistor R30 couples the 38-kHz sine wave (about 1 volt p-p) to modulator IC3. The pilot-level control, potentiometer R31, couples a variable-level 19-kHz signal via capacitor C19 to the output-summing circuit. Phase adjustment of the subcarrier and the pilot is achieved by adjusting L2 and L3, respectively.

The subcarrier (L-R) component of the MPX signal is produced by IC3, a balanced modulator. IC3 produces an output that is the sum and difference of the two input frequencies at pin 1 (L-R audio) and pin 8 (38 kHz), without feedthrough of either input to the output. Level-control R9 feeds (L-R) audio through C21 to pin 1 of IC3. Resistors R32-R36 are an adjustable DC-bias network, and C22 grounds the wiper of R35 for AC signals. Resistor R44 is an auxiliary level-set resistor that is nominally 10 ohms, however, it may be increased up to 2.2K if an excess level is present at IC3 pin 12. Note that R43 should be within 10% of the value of the sum of R44 and R48. (The level-setting adjustment was not needed in our prototype but it is handy to have available.)

Output circuit IC4 is a summing amplifier having a gain of 2. Components R52, C27, and R53 bias the op-amp at half the supply voltage. The L+R audio from the wiper of level-control R7 is coupled via C20 to R49. The L-R subcarrier is coupled via C26 to R50. The 19-kHz pilot signal

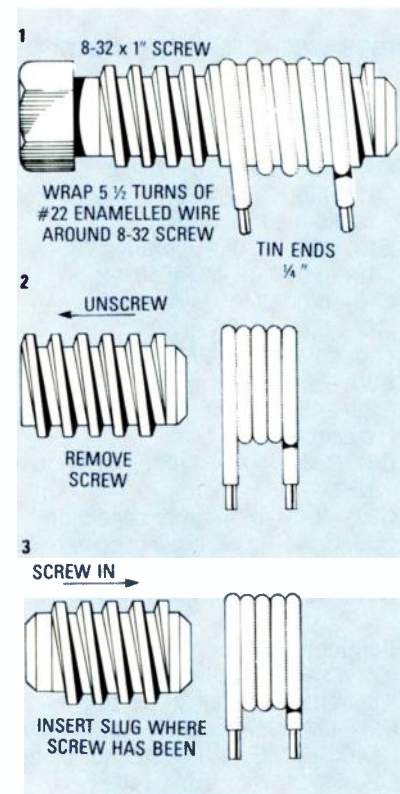

FIG. 7—COILS L4 AND L5 must be hand wound on an 8-32 screw.

from R31 is coupled to R51. Those three signals are summed and amplified, and appear at IC4-a pin 1. Voltage-follower IC4-b provides an AUX MPX OUT for test purposes and a composite MPX signal if needed for experimental purposes.

The MPX signal is coupled through C29 and R54 to varactor diode D2 (a voltage-variable capacitor). Transistor Q3 and its associated components make up an 88-MHz Colpitts-type oscillator. A composite MPX signal from R64 modulates the capacitance of D2, which in turn modulates the frequency of the oscillator. Level-control R64 sets D2 so that a ± 75 -kHz peak deviation is obtained with about 0.5 volts p-p at the left and right inputs. Varactor D2 is coupled to the oscillator tank circuit through C30. As the capacitance of D2 varies, it modulates the frequency of oscillator Q3, which is set by C32 to an unused channel around 88 MHz.

Transistor Q4 is a low-gain buffer-amplifier whose primary purpose is to isolate the oscillator (Q3) from the effects of variable loading caused by the antenna. Resistor R65 suppresses a tendency toward unwanted UHF oscillation. A matching circuit for a 50-ohm output load or antenna is made up of L5, C40, and C41. The output

level of that matching circuit is 100-120 millivolts rms into 50 ohms, or about 1/4 milliwatt.

We did not need any audio pre-emphasis, because the received signal sounded good without it. For those who require pre-emphasis, the optional circuits in Fig. 4 can be added to the audio inputs.

About 50 milliamperes at 12 volts is required to power the transmitter. A schematic for a suitable power supply is shown in Fig. 5. It can be assembled using point-to-point wiring on a terminal strip, or by any other appropriate method. Otherwise, 8 AA penlight cells can be used as the power source.

Construction

A PC layout is provided in PC Service. A drilled and plated PC board is available from the source listed in the Parts List, and construction should begin with the mounting of all fixed resistors and diodes. See Fig. 6 for the component placement. Next, install all of the capacitors, being sure to observe the polarity of the electrolytics. Then install the potentiometers, transistors, and IC's. Finally, install coils L1, L2, and L3 (and be careful when handling the coils because they are wound with fine wire and are somewhat delicate).

You must hand-wind coils L4 and L5. As shown in Fig. 7, they consist of 5-1/2 turns of #22 enameled wire wound on an 8-32 screw thread. After you wind the wire, remove the screw and replace it with a Cambion blue slug. They are manufactured by Midland Ross, Cambion Division (One Alewife Pl., Cambridge MA 02140). Note that the wire and slugs for the two coils are included in the kit from the source mentioned in the Parts List. Otherwise, ferrite slugs salvaged from an old CB radio or TV set might work as cores. After being adjusted, the slug can then be held in place with a dab of Q-dope or hot-melt glue.

After all of the components are installed, carefully check your work for shorts, opens, and poor solder joints. Also, check for correct component orientations, since incorrect orientation may cause irreversible damage to the IC's and other circuitry.

That's all we have room for in this installment. Next time we will show you how to check out and align your wireless transmitter. **R-E**

USING BARGRAPH DISPLAYS

LED Bar-graph displays are now being used to replace moving-coil meters. This month we take a look at how they can be used.

RAY MARSTON

BAR-GRAPH DISPLAYS ARE INEXPENSIVE and often superior alternatives to analog moving-coil meters. They are immune to inertia and sticking problems, so they are fast-acting, and unaffected by vibration or position.

Their scales can easily be given any desired shape, such as a vertical or horizontal line, an arc, or a circle. In a given display, individual LED colors can be mixed to emphasize particular sections of the display. Over-range detectors can be activated from the driver IC's to sound an alarm and/or flash the entire display.

Bar-graph displays have better linearity than conventional moving-coil meters, with typical linear accuracies of 0.5%. Scale definition depends on the number of LED's used, although a 10-LED display provides adequate resolution for just about any practical purpose.

LM3914 Dot/bar-driver IC's

The LM3914 family of dot/bar-graph driver IC's are manufactured by National Semiconductors. Each

type is capable of directly driving up to 10 LED's, or several IC's can be cascaded to drive as many as 100 LED's in either the dot or bar mode. The family comprises three devices: the linear scaled LM3914, the log-

scaled LM3915, and the semi-log LM3916.

All three device types use the same basic internal circuitry. Fig. 1 shows the internal circuit of the linear-scaled LM3914, together with its connections

for operating as a 10-LED voltmeter, having a 0-1.2-volt scale. The IC contains ten voltage comparators, each with its non-inverting terminal connected to a specific tap on a precision voltage divider. All inverting terminals are wired in parallel and driven by a unity-gain buffer. The buffer's input (pin 5), is protected against overload voltages to ± 35 volts. The output of each comparator can sink up to 30 mA. The sink currents are internally limited; the limit can be externally pre-set by resistor (R1).

The IC also contains a floating 1.2-volt reference source connected between pins 7 and 8. In Fig. 1, the voltage reference is shown externally connected via pins 6, 7, 8, and 4 to the internal voltage divider. The IC also contains a dot/bar se-

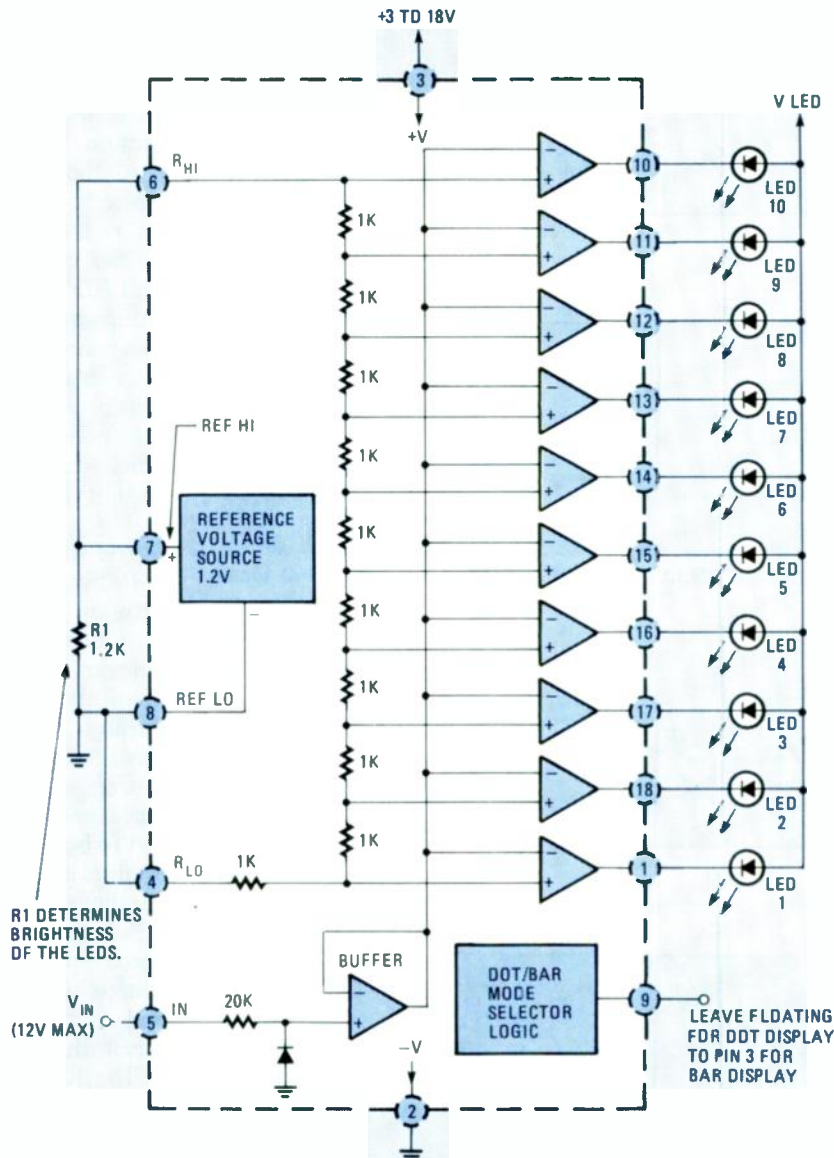

FIG. 1—INTERNAL CIRCUITRY OF THE LM3914, with connections for making a 10-LED 0-1.2-volt linear meter having a dot or bar display.

lector (pin 9) network so that the dot or bar mode can be set externally.

How it works

Assume that the device is set for bar-mode operation and that, as already shown, the 1.2-volt reference is applied across the internal resistive voltage divider. Thus, 0.12 volt is applied to the inverting or reference input of the first comparator, 0.24 volt to the next, 0.36 volt to the next, and so on. If a slowly rising input voltage is applied to pin 5, the following sequence of actions then take place:

- When the input voltage is zero, the outputs of all ten comparators are disabled and all LED's are off.
- When the input voltage reaches the 0.12-volt reference value of the first comparator, its output conducts and turns on LED 1.
- When the input reaches the 0.24-volt reference value of the second comparator, its output also conducts and turns on LED 2; LED's 1 and 2 are both on.
- As the input voltage is further increased, progressively more and more LED's are turned on, until eventually the last comparator conducts and all ten LED's (the full-scale display) are illuminated.

A similar kind of operation takes place when the LM3914 logic is set for dot-mode operation, except that only one LED turns on at any given time. At zero volts, no LED's are on, and above 1.2 volts only LED 10 is on.

Some finer details

In Fig. 1, R1, which is connected between pins 7 and 8 (the output of the 1.2-volt reference), determines the amount of current that will flow through the LED's. The current through each LED is roughly ten times the output current of the 1.2-volt source, which can supply up to 3 mA; that allows LED currents of up to 30 mA to be set by R1. If, for example, a total resistance of 1.2K, (equal to the parallel value of R1 and the 10K of the IC's internal voltage divider) is placed across pins 7 and 8, the 1.2-volt source will therefore conduct 1 mA and each LED will conduct 10 mA, when illuminated.

The IC's internal 10-stage voltage divider is floating, meaning that both ends are available externally for maximum versatility. It can be powered from either the internal reference voltage, or from an external source. If, for

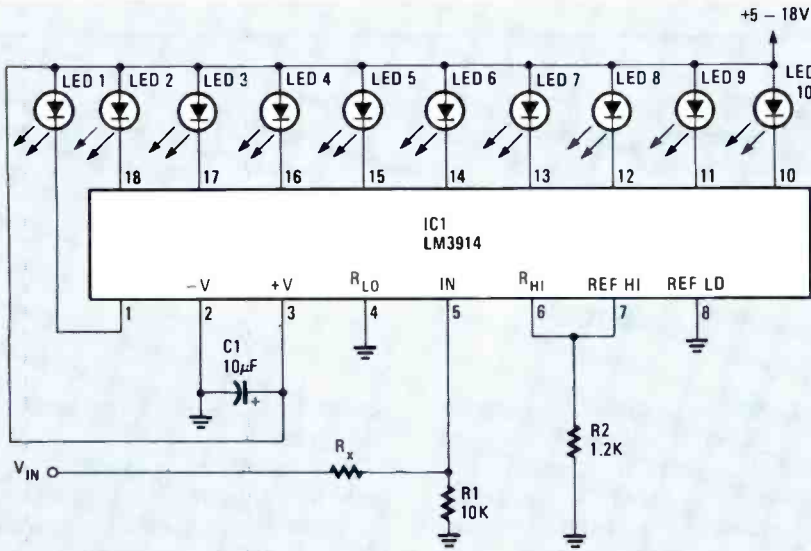

FIG. 2—THE FULL-SCALE DISPLAY CAN BE ADJUSTED from 1.2-to 1000 volt.

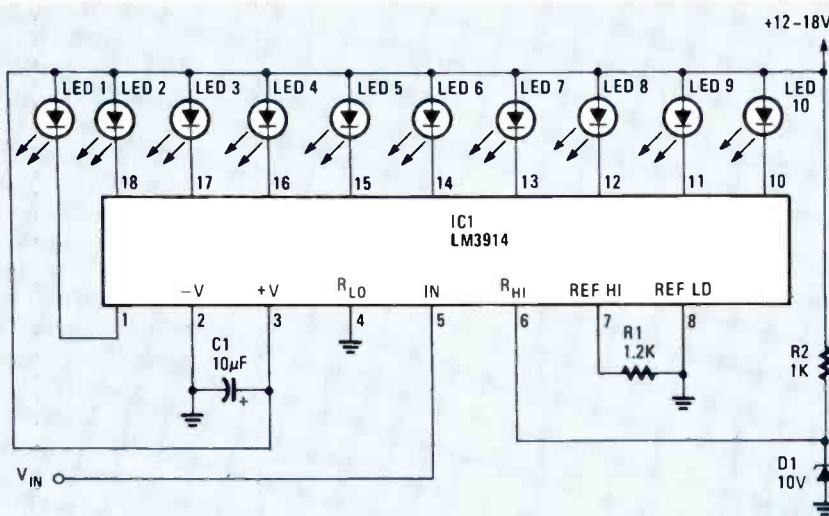

FIG. 3—AN EXTERNAL REFERENCE VOLTAGE CAN BE USED to make a 10 volt full-scale display meter.

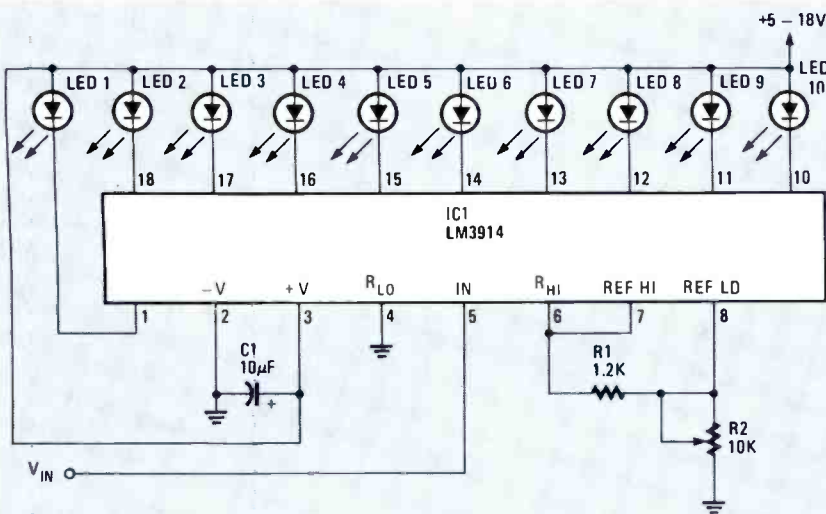

FIG. 4—A VARIABLE-RANGE DOT-MODE VOLTMETER can be made by using a 10K potentiometer to set the full-scale display.

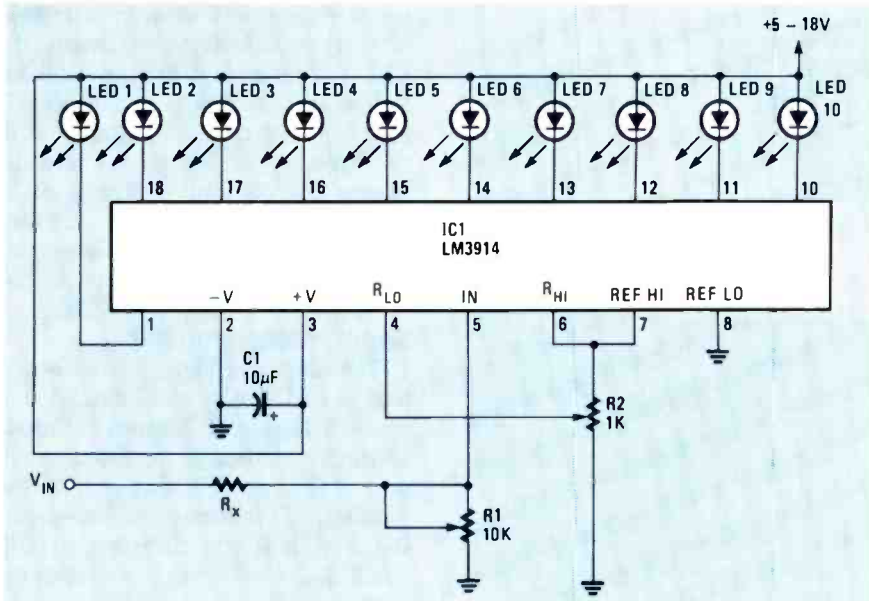

FIG. 5—THIS EXPANDED-SCALE DOT-MODE voltmeter will only display inputs between 10–15 volts.

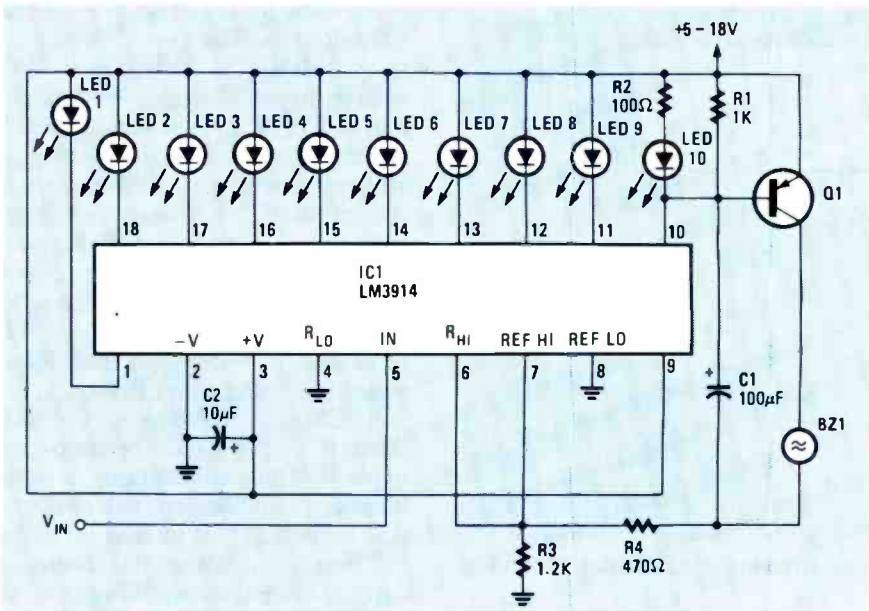

FIG. 6—AN OVER-RANGE ALARM CAN BE ADDED to sound a buzzer and flash the entire display when the full scale display is illuminated.

example, the top of the network is connected to a 10-volt source and the low end is connected to ground, the IC will function as a voltmeter, having a 0–10-volt scale. However, if the low end of the network is connected to a 5-volt source, the IC will function as a restricted-range voltmeter, having a 5–10-volt scale. The only constraint on using the internal divider is that its supply voltage must not exceed a voltage that is 2 volts less than the IC's supply voltage (which is limited to 25-volts maximum).

The IC's internal reference voltage produces a nominal output of 1.28

volts (its limits are 1.2 to 1.34 volts), but as we'll show later, it can be externally programmed to produce effective reference values up to 12 volts. Also, by wiring pin 9 to pin 3, the IC will operate in the bar mode. (If pin 9 is left floating, it will operate in the dot mode.)

The major difference between the three members of the LM3914 family of IC's is in the resistance values used for the internal 10-stage voltage divider. In the LM3914, all resistors in the divider have equal values, so the device has a linear display of ten equal steps, which makes the LM3914 well-

sued for most applications. In the LM3915, the resistors are logarithmically weighted, which results in a log display that spans 30 dB in ten steps of 3 dB, making it suitable for signals having a wide dynamic range. In the LM3916, the resistors are weighted in a semi-log fashion which produces a display that is specifically suited to VU-meter applications.

Practical applications

Let's move on now and take a look at some practical applications, paying particular attention to the linear LM3914.

Figures 2 through 5 show various ways of using the LM3914 IC to make 10-LED dot-mode voltmeters. Note that pin 9 in all of the circuits is left floating to provide dot-mode operation, and a 10µF capacitor is wired directly between pins 2 and 3 to ensure circuit stability.

Figure 2 shows the connections for making a variable-range (1.2- to 1000-volt full-scale) voltmeter. The low ends of the internal reference (pin 8) and the divider (pin 4) are grounded, and their top ends (pins 7 and 6) are joined together, so the meter has a basic full-scale sensitivity of 1.2 volts. However, variable ranging is provided by the R_X - R_1 voltage divider at the input (V_{in}). For example, when R_X is zero, the full-scale display is 1.2 volts, but when R_X is 90K the full-scale display is 12 volts. Resistor R_2 is wired across the internal reference voltage, and sets the on current of all LED's to about 10 mA.

Figure 3 shows how to make a fixed-range 0- to 10-volt meter. An external 10-volt Zener, D_1 , connected to the top of the internal divider provides the reference voltage. The supply voltage to that circuit must be at least two volts greater than the Zener diode's reference voltage.

Figure 4 shows how the internal reference of the IC can be made to effectively provide a variable voltage, thereby allowing the meter's full-scale-display value to be set anywhere in the range of 1.2–10 volts. The 1-mA current (determined by R_1) of the floating 1.2-volt internal reference flows to ground via R_2 , and the resulting R_2 voltage raises the reference voltage (pins 7 and 8) above zero. If, for example, R_2 is set to 2.4K, pin 8 will be at 2.4 volts, while pin 7 is 3.6 volts. R_2 thus enables the voltage at pin 7, which is connected to the top of

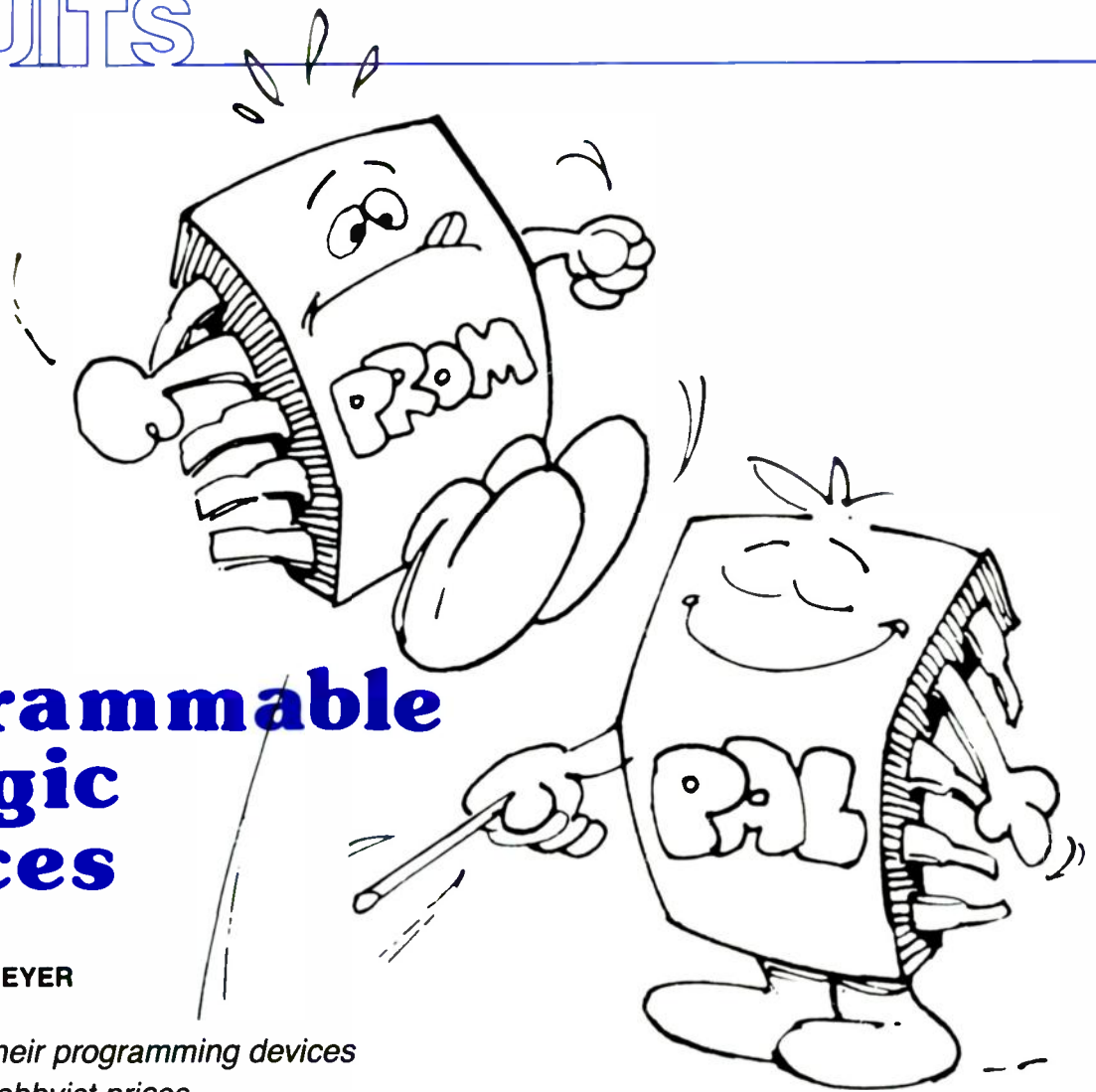

Programmable Logic Devices

ERNEST MEYER

Both PLD's and their programming devices are available at hobbyist prices.

Part 2 LAST TIME OUT WE looked at the early history of programmable logic because it gave us an understanding of how easily programmable IC's can be used. And to make practice conform to theory, we even designed and blew an actual PLD (Programmable Logic Device) just to demonstrate how it might be done by a hobbyist.

As we continue our journey through programmable-logic history, we will go a little way beyond the technology actually available to most hobbyists. However, because the field is developing so rapidly it won't be long before even the most sophisticated devices find their way into common digital projects.

Of course, while being able to program a PLD will naturally make it easier for you to use more sophisticated devices as they appear in the marketplace. Even now the PLD's available to hobbyists can replace

more than a half-dozen conventional parts. Indeed, PLD's are already so complex they warrant the use of software for device design and verification, which is a fancy way of saying "creating a fusemap."

As with everything else, there is both a hard and easy way to do things. In this article we'll program PLD's the easy way by using inexpensive software that will run on any standard IBM-PC or compatible.

Software to design hardware

A considerable number of programs are presently available that will help you design a programmable IC: We looked at the earliest program, Monolithic Memories' PALASM, in the previous part of this series.

The idea of PALASM was to make programmable-logic design more accessible to digital designers working in small design houses. Previously, the large programmable-logic dis-

tributors (such as Harris and Signetics) had sought to sell only to "captive" markets—large companies like IBM and AT&T. In that way, one service-support engineer could be assigned to each large customer, thereby providing efficient service at a low cost to the distributor. (Harris and Signetics reasoned that providing adequate support for many smaller companies would be too expensive.)

With PALASM, however, even the smallest design house could easily use programmable logic, so reckoning that it would boost the company's sales of programmable IC's, Monolithic Memories made the software available free of charge to qualified businesses.

The strategy worked, and Monolithic Memories rapidly became the largest programmable-logic distributor in the world at that time. The other players in the market were quick to follow suit. For example, Sig-

netics, the company that had pioneered the commercialization of PLD's, realized it was losing market share to the newcomer, and released its own design software toolkit, called AMAZE. Signetics also provided its software free of charge to digital-design houses.

However, as we discussed in Part I, the FPLD architecture from Signetics has both a programmable AND plane and a programmable OR plane, whereas Monolithic Memories' PAL architecture has only a programmable AND plane. As a consequence, PALASM cannot program FPLD's, and AMAZE cannot program PAL's. (Which is why MMI and Signetics gave away rather than sold their software—anyone using the software had to use the corresponding IC's.)

It is therefore hardly surprising that some independent software companies seized on the opportunity to provide a software tool for both device types. Assisted Technologies developed the first universal PLD design tool, CUPL, which is now sold by PCAD (1290 Parkmore Ave., San Jose, CA). Indeed, many of the design examples you get with CUPL still have the name Assisted Technologies on them.

The software ABEL, developed by Data I/O (10525 Willows Rd. NE, Redmond, WA 98073), does much the same thing as CUPL, but is much easier to use, although it is a great deal more expensive (around \$1,000) than hobbyist-versions of CUPL.

Getting started

A starter kit version of CUPL is available for \$50 from JDR Micro-devices (110 Knowles Drive, Los Gatos, CA 95030). In addition to the software, the kit contains one each of four ready-to-program PAL's: the 16L8, 16R8, 16R6, and the 16R4; their characteristics are shown in Table 1. Keep in mind that the starter-kit CUPL can only program those four devices. The supplied PAL's are actually manufactured by Texas Instruments, but they are functionally identical to the same parts from Monolithic Memories.

How the software works

All the software tools for programmable logic design have a similar structure, whose basic design flow is shown in Fig. 1. As you can see, there are a number of different ways where-

TABLE 1

| FUNCTION | 16L8 | 16R4 | 16R6 | 16R8 |
|---|------|------|------|------|
| DEDICATED INPUTS | 10 | 8 | 8 | 8 |
| DEDICATED REGISTERED OUTPUTS (TRI-STABLE) | — | 4 | 6 | 8 |
| BI-DIRECTIONAL COMBINATIONAL OUTPUTS (TRI-STABLE) | 8 | 4 | 2 | — |

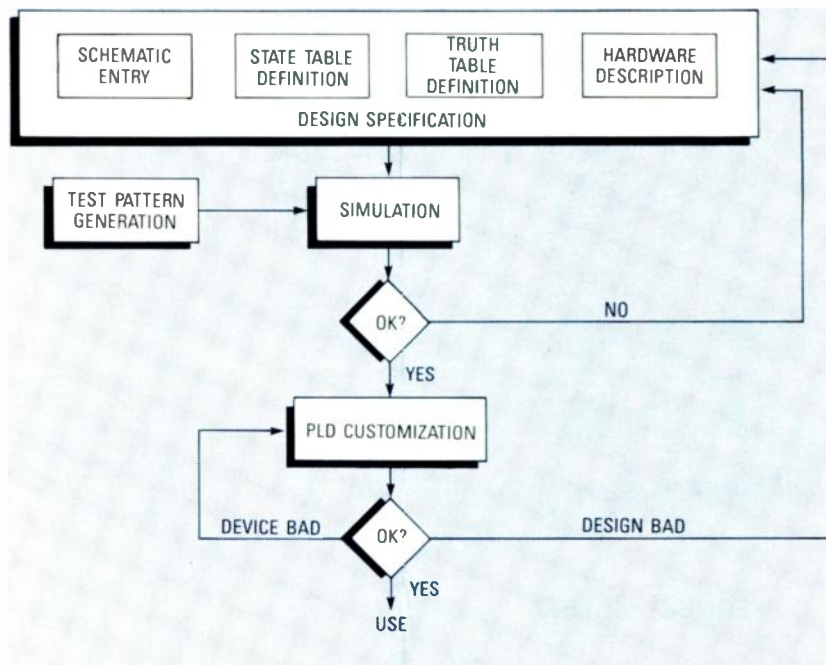

FIG. 1—THE FIRST STEP IN SPECIFICATION ENTRY can be done by schematic, state-table definition, truth-table definition, or a description of the hardware itself.

by the first step—the design specification entry—can be done: by schematic, state-table definition, truth-table definition, or a description of the hardware itself. In the commercial world, engineers like to use a schematic-entry system, whereby the logic-circuit schematic is entered in the computer and the software is then able to derive the fuse map from the schematic.

The most commonly used drafting software used to generate fuse maps is the DASH drafting software from Data I/O's subsidiary, FutureNet. Both ABEL and AMAZE accept data from DASH, while CUPL accepts schematics designed on PCAD's design system, PCAD-CAE1. Since DASH and CAE1 cost \$25,000 and \$7,500 respectively, they are beyond the budget of most hobbyists.

Although PALASM, AMAZE, CUPL, and ABEL do not accept schematics by themselves, hobbyists can use the design-entry systems ac-

tually built into the software and enter a high-level description of the logic in a text-form input file.

CUPL

CUPL is the highest language, hence, it's the easiest for the hobbyist to use. Using an ordinary word processor, such as WordStar or XyWrite, you can create a logic-description file. CUPL then performs both automatic logic minimization of the file and compiles a documentation file having the extension .PLD. For example, if we described a logic description of a two-bit counter in CUPL format and told CUPL to give it the name DIVIDER, CUPL would create a disk file DIVIDER.PLD.

There are separate fields in the input file: *header information* (included at the top of all the files created by CUPL, so you can make sense of your old printouts), *notes*, *pin labels*, and *logic description*. In CUPL, you don't include the part number in the

gates, making the IC big enough to contain an entire 32-bit floating-point accelerator. (Available from Intel, 1900 Prarie City Rd., Fulsom, CA, and Altera Corp. 3515 Monroe, Santa Clara, CA). Unfortunately, the sheer size of that IC really places it beyond the capabilities of standard ABEL and CUPL software. Stand-alone design systems priced at around \$5000, which both include schematic entry, have been developed by Intel and Altera Corp. for that massive chip.

Even more

An even larger IC, the X3090, from Xilinx (2069 Hamilton Ave., San Jose, CA 95125), which uses multiplexers instead of fuses, contains about 9,000 equivalent gates, and the device can be configured "on the fly" with standard logic levels. Just to confuse things, people still refer to the internal connections—the multiplexers—as fuses. Design systems for the X3090 are presently priced in excess of \$20,000, although prices are destined to drop.

The Xilinx X3090 is just one part with the new architectures that are just emerging in PLD technology. Another IC with unusual architecture is the 39V18 from Lattice Semiconductor (5555 Northeast Moore Ct., Hillsboro, OR 97124). The 39V18 is unique in that it was specially designed to emulate all the standard PLD architectures. Fuses in all the macros enable them to be configured like any of the macros in a range of PLD's; thus, one Lattice part can be a direct-pin replacement for a large number of PLD's in existing designs.

Beating the equivalent gate

We have previously alluded to *equivalent gates*. In essence, the density of customizable components is measured by the number of 2-input NAND gates that would be required to perform the same function for the largest circuit that can be configured in a programmable IC. However, that measurement can be very misleading. The logic in the macros, and their interconnection, really determines the power of a PLD.

For example, a 16R8, which contains eight flip-flops, is perfect for a complex function requiring eight counting stages. A 16L8, which contains about 50 less gates, also contains eight macros, but it does not contain any flip-flops in the macros:

Two macros are needed to make a flip-flop. Therefore, at most, the 16L8 can contain a 4-bit counter—half the size of the 16R8.

But, then you must wonder, why is the equivalent gate count of the 16L8 so high? Well, the large *fan-in* into each of the macros—there are eight separate summing inputs into each macro—enables the building of very large sums-of-product terms. Functions that need gates with a large number of inputs therefore fit particularly well into a PLD. Bus decoding and state machines both fall into that category.

A 16L8 can provide eight bus-decoding functions at the same time. If a circuit has an 8-bit bus that turns on eight peripherals at eight separate and distinct addresses, then all eight addresses can be decoded by one IC. That accounts for the high equivalent-gate count. An equivalent SSI implementation could require as many as 14 quad 2-input NAND-gate devices.

In view of the particular suitability of PLD architectures to bus decoding, some manufacturers have enhanced the power of the programmable-plane structure by combining standard logic functions into the programmable IC's. Harris Corp. (Semiconductor Section, PO Box 883, Melbourne, FL 32901), the company that pioneered programmable logic, was the first to take that architectural path. Harris' 82C339 combines a multiplexed bus interface with a summing plane that acts as a programmable comparator. As a consequence, the device can produce four decoded outputs from a 16-bit bus multiplexed onto eight signal lines, as implemented by the 8088 (the microprocessor in the IBM-PC). Intel has made a special PLD called the BIC (*Bus Interface Controller*), which contains eight bidirectional latches, with the control-logic lines for the latches fed by a conventional programmable AND plane.

Registered PLD's are good for state machines. The output of state-machine devices depend on the previous input as well as the current input. Since a 16R8 contains eight flip-flops, the device can record eight states, with one flip-flop putting out a high logic level for each *on* state. Each flip-flop's output can be fed back into the array and logically combined with the other flip-flop states and the current inputs to switch the device into the next state.

Monolithic Memories, Altera, and Signetics have all made *programmable sequencers* containing a large number of extra "buried" flip-flops to contain "buried states" (states that do not cause any change at the outputs). .MDNM/

Altera and Monolithic Memories have taken the alternative approach of combining a programmable AND plane and a PROM into one device, in which PROM outputs can be fed back into the PLD portion. The PLD can combine that data and the inputs to produce a new address in the PROM to go to. Up to 256 states are supported by those IC's. Unfortunately, CUPL is not capable of programming those state machines as yet, although ABEL can program some of them. With time, of course, all of those devices will come within the reach of the hobbyist.

Process technology

We have already tracked the development of new PLD architectures, from the very first programmable device to the most recent innovations. To make things easier to follow, in the course of our discussion we side-stepped the advances in process technology (how the devices are manufactured), although they have also been very important in PLD development.

Originally, PLD's were all made using TTL (*Transistor-Transistor-Logic*). Modern variations of TTL are very fast, but all types of TTL devices use a great deal of power. MOS technology, which uses electric fields rather than current to switch the gates, uses much less power and packs higher densities of transistors into ever smaller areas of silicon. Most modern devices are CMOS. As a matter of fact, except for the programmable sequencer from Signetics, all the advanced architectures we have discussed in this article use CMOS technology.

In the first part of this article we discussed the difference between single- and dual-level metal. Typically, densities higher than 2,000 gates, and I/O delays of less than 45 nanoseconds (speeds higher than 15 MHz) are not possible with single-level metal. In some situations, I/O delay is very important.

Different fuses

We also discussed different fuse technologies. As you might re-

member, nichrome and polysilicon fuses were the first types to be used. Nichrome fuses are still in use. Currently, tungsten, and sometimes titanium, are added to the fuse material because they burn out more cleanly. Also, the electric field across the vacated space left by a vaporized fuse can cause *metal migration*. In other words, over time the metal ions are magnetically dragged back into the fuse cavity; that is, the fuses can actually grow back. Thankfully, *grow back* is relatively rare with modern technology and standard operating conditions.

With some modern PLD's, the reverse of metal growback—called *avalanche-induced migration*—is actually used to remove the fuse. Also, lower temperatures can be used with avalanche-induced migration, which increases device reliability. Further, the fuses in some modern PLD's are fashioned in a *bow-tie* shape rather than the traditional *hourglass*. The sudden narrow taper at the point of fuse burnout in bow-tie fuses reduces the rate of metal migration.

Besides traditional fuse technologies, several newer processes are now used for manufacturing PLD's, which allow the device to be re-programmed.

Those erasable PLD's (usually called EPLD's) use the same technology as EPROM's in that they don't use fuses at all, but rather contain *floating gates*. Those are small semi-conducting regions between the two

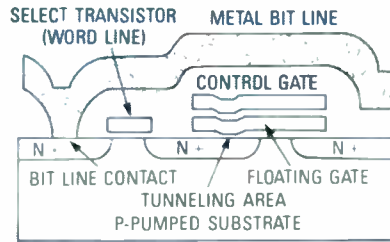

FIG. 3—THE STRUCTURE OF a floating gate. A charge on the floating gate creates a small electrical field that acts as a conducting link between the two metal levels.

metal levels. The electrical characteristics of the floating gate are very carefully selected so that its polarity is not affected by normal +5-volt conditions. But the floating gate can be charged up in the high-voltage programming mode. The charge creates a small electrical field that acts as a conducting link between the two metal levels. On the other hand, uncharged gates do not act as a connection. Figure 3 shows the structure of a floating gate.

EPLD's are usually programmed at a higher voltage level than standard PLD's (which reduces the rate the charge can leak off a charged gate), placing them beyond the reach of most inexpensive PLD programmers.

EPLD's, like EPROM's, contain small *windows* that allow them to be wiped clean by exposure to ultraviolet

light. Thus EPLD's can be re-programmed by the circuit designer.

In the most recent PLD technology developments, EPLD's have largely been replaced by EEPLD's, which are like EEPROM's. Since "E-squared" devices, as they are called, use electricity rather than ultraviolet light for the cleaning procedure, they don't need windows, thus making the package less expensive, even though the silicon is more difficult to make. Lattice Semiconductor uses E-squared for the 39V18.

EPLD and EEPLD technologies allow the factory to check that the devices are fully functional before shipping by programming and checking a pattern. If there's an error, the PLD can be wiped clean and re-programmed. Also, designers can reuse the same device for different circuits when prototyping. Similarly, hobbyists can use the same device over and over, in different projects.

Conclusion

PLD's are becoming commonplace in a diverse variety of applications. In computers, PLD's are particularly suitable for use in the state machines that control such system-level operations as start-up sequences, interrupt handling, control transfer, I/O arbitration, and peripheral-processor control. In the consumer world, programmable logic has found its way into video/audio control systems, washing machines, toys, automobile dashboards, and even traffic lights and elevators. Programmable logic is also common in military and aerospace applications, as well as in hospital equipment, nautical navigation systems, and telecommunications.

Quite possibly, in the near future a single PLD might provide all the circuits for any kind of device because PLD implementation avoids the process of "gluing" circuits using custom IC fabrication. By using a PLD instead of a custom IC, virtually any logic circuit can be almost instantly refabricated by simply creating a new fuse map and using it to blow a new device.

Figure 4 shows some of the materials that can be used by the average hobbyist and technician to design and create custom PLD circuits. **Radio-Electronics** will soon feature an article on how you can use that equipment to design and blow useful experimenter PLD circuits. **R-E**

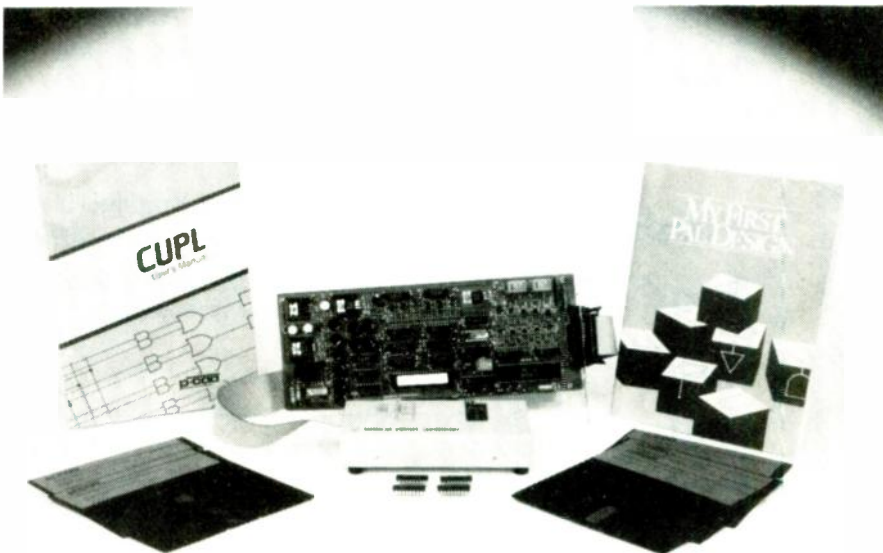

FIG. 4—A PLD PROGRAMMER CARD and an inexpensive PAL introduction kit containing four different PLD's and a simplified version of CUPL are all you need to get started in PLD design. Both are available at JDR Microdevices.

Your Career in *ELECTRONICS* or *COMPUTERS*

Add *prestige and earning power* to your technical career by earning your Associate or Bachelor's Degree in electronics or computers—through independent home study.

No commuting to class. Study at your own pace, while continuing on your present job. Learn from easy-to-understand lessons, with help from your Grantham instructors when you need it.

Grantham College of Engineering is a specialized institution catering to adults who are employed in electronics and allied fields such as computers. These fields are so enormous that opportunity for advancement is always present. Promotions and natural turn-over make desirable positions available to those who are *prepared to move up!*

An important part of being prepared to *move up* is holding the proper college degree, but the absolutely essential part is *really knowing your field*. In electronics or computers, Grantham can prepare you in both ways. But don't expect to really know your field *or* earn that college degree without hard work. Any degree that's worth your while can't be had without giving effort to the task. Of course it's what you learn in the process, as much or more than the degree itself, that makes you stand out above the crowd — that places you and your career in an enviable position, prestige-wise and financially.

Why not "go for it"? Go for the knowledge, and the degree will follow naturally. Be a "can do" person, with the right credential to put your best "moving-up" foot forward!

Put Professional Knowledge and a
COLLEGE DEGREE
in your Technical Career through
HOME STUDY

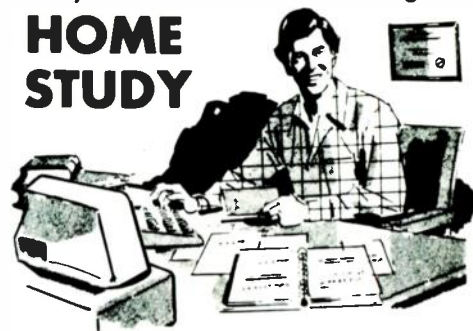

Accredited by the
Accrediting Commission of the National Home Study Council

Grantham College of Engineering
10570 Humbolt Street
Los Alamitos, California 90720

Write for our free catalog
(see coupon below) or phone
(213) 493-4421 (no collect calls)
and ask for our "degree catalog."

Grantham offers two B.S. degree programs — one with major emphasis in **ELECTRONICS** and the other with major emphasis in **COMPUTERS**. Either program can be completed by correspondence (also known as "distance education.") An A.S. degree is awarded along the way in each B.S. program, but the B.S. program is not complete without the A.S. part. Our catalog gives complete details.

Now in Our 38th Year

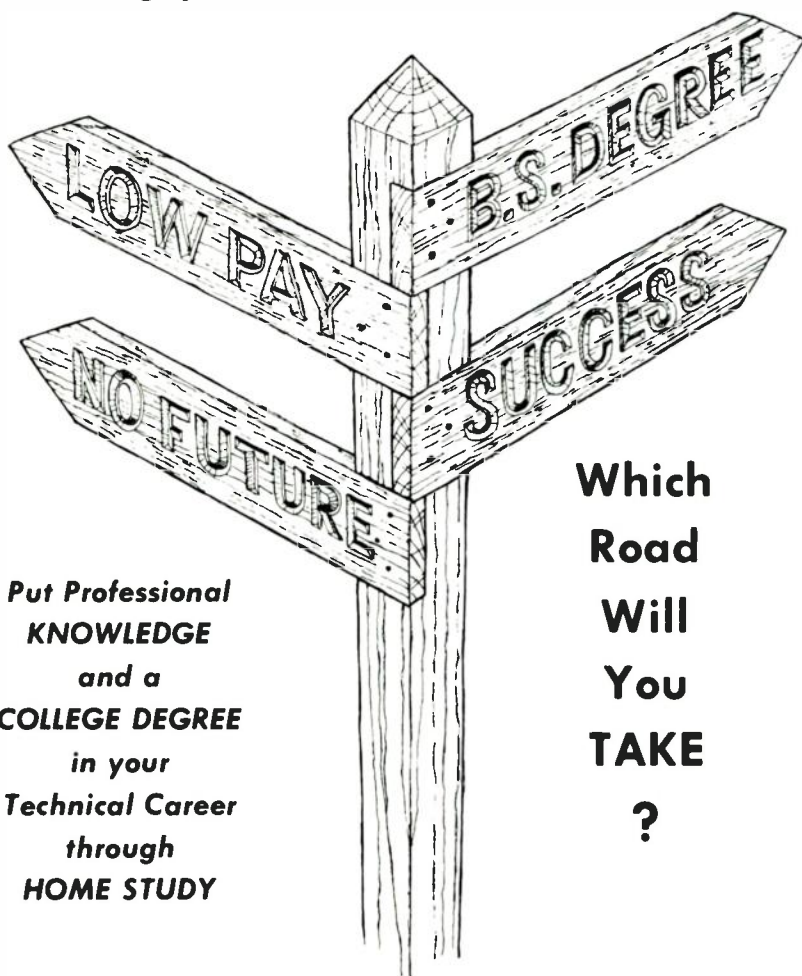

**Which
Road
Will
You
TAKE
?**

**Put Professional
KNOWLEDGE
and a
COLLEGE DEGREE
in your
Technical Career
through
HOME STUDY**

Grantham College of Engineering
P.O. Box 539, Los Alamitos, CA 90720

Please mail me your free catalog which explains your distance-education (home study) degree programs.

NAME _____

ADDRESS _____

CITY _____

STATE _____

ZIP _____

R-03-88

PC SERVICE

One of the most difficult tasks in building any construction project featured in *Radio-Electronics* is making the PC board using just the foil pattern provided with the article. Well, we're doing something about it.

We've moved all the foil patterns to this new section where they're printed by themselves, full sized, with nothing on the back side of the page. What that means for you is that the printed page can be used directly to produce PC boards!

Note: The patterns provided can be used directly only for *direct positive photoresist methods*.

In order to produce a board directly from the magazine page, remove the page and carefully inspect it under a strong light and/or on a light table. Look for breaks in the traces, bridges between traces, and in general, all the kinds of things you look for in the final etched board. You can clean up the published artwork the same way you clean up your own artwork. Drafting tape

and graphic aids can fix incomplete traces and doughnuts, and you can use a hobby knife to get rid of bridges and dirt.

An optional step, once you're satisfied that the artwork is clean, is to take a little bit of mineral oil and carefully wipe it across the back of the artwork. That helps make the paper translucent. Don't get any on the front side of the paper (the side with the pattern) because you'll contaminate the sensitized surface of the copper blank. After the oil has "dried" a

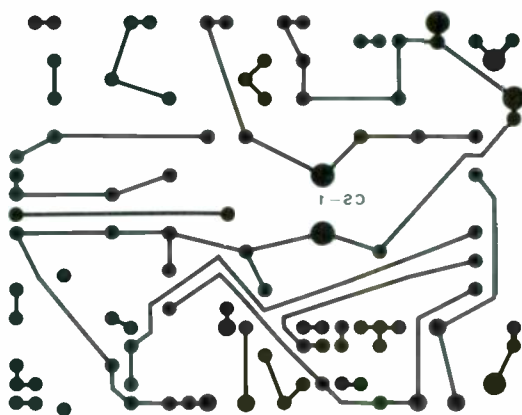

3 INCHES

PLASMA DISPLAY power-supply PC board.

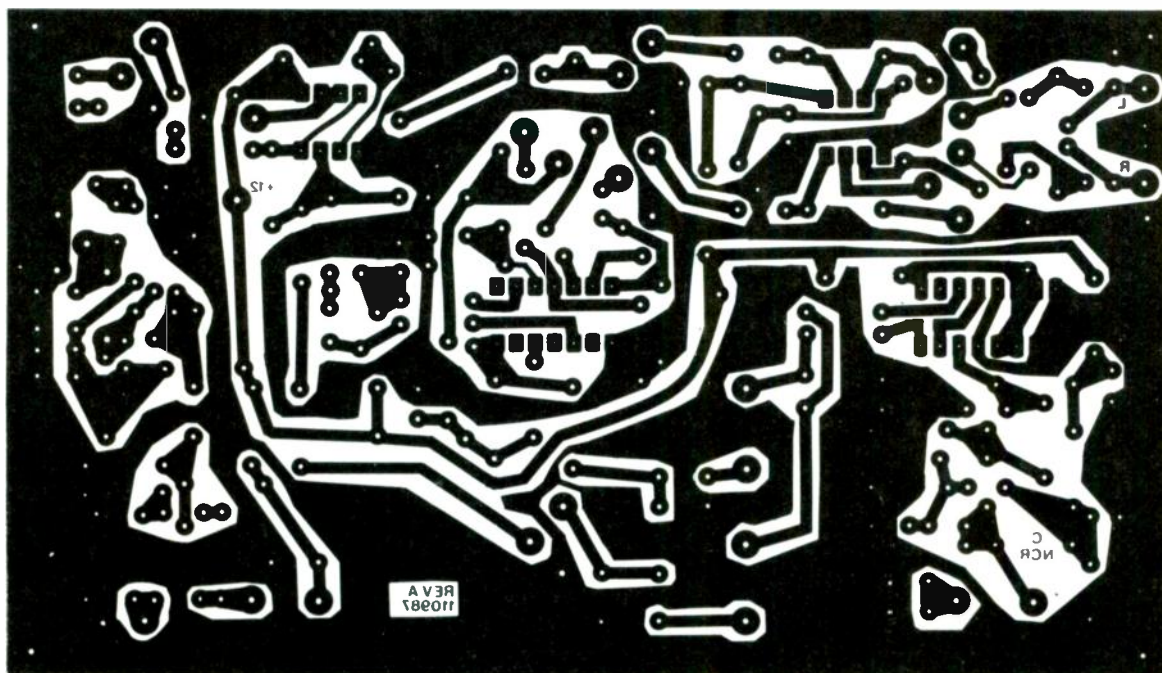

6 INCHES

BUILD THE FM WIRELESS LINK using this PC board.

PC SERVICE

bit—patting with a paper towel will help speed up the process—place the pattern front side down on the sensitized copper blank, and make the exposure. You'll probably have to use a longer exposure time than you are used to.

We can't tell you exactly how long an exposure time you will need as it depends

on many factors but, as a starting point, figure that there's a 50 percent increase in exposure time over lithographic film. But you'll have to experiment to find the best method for you. And once you find it, stick with it.

Finally, we would like to hear how you make out using our method. Write and tell

us of your successes, and failures, and what techniques work best for you. Address your letters to:

Radio-Electronics
Department PCB
500-B Bi-County Blvd.
Farmingdale, NY 11735

MORE PC BOARDS ON PAGE 83

HARDWARE HACKER

Using Posistors
More on superconductors
Monitors for the Apple IIgs
New video integrated circuits
IBM to Apple communications

DON LANCASTER

Tips, products, and publications

LET'S START OFF WITH SOME UPDATES on things we've covered previously, and an opportunity for creative hackers. I have found two more places to get information on those new superconductor developments we looked at last month. Check into the Materials Research Society. Those folks have videotapes and superconductor-conference proceedings available, some priced as low as \$15.

While this next item is certainly not hacker priced at \$750 per year, see if you can't con someone else into subscribing to the brand new Superconductors Update Package from Chemical Abstracts. That is probably the ultimate source for current superconductor info.

You'll find a story on page 177 of the October issue of *EDN* that gives you more uses and ideas for the digital EEPROMs we looked at two columns ago.

If you have any electronic high-tech design that can in any way involve home furnishings, textiles, or clothing, there are prototype grants worth up to \$10,000 now available through the Innovative Design Fund. Contact them directly for rules and whatever.

We'll repeat our usual reminder that this is your column and you can get technical help from me at Synergetics; see the Need Help box elsewhere in this article. The big goodie this month involves reasonably priced hacker video IC's. But first...

What is a Posistor?

A Posistor is one trade name for a non-linear resistor whose resistance changes with temperature in a very unusual way. As Fig. 1 shows

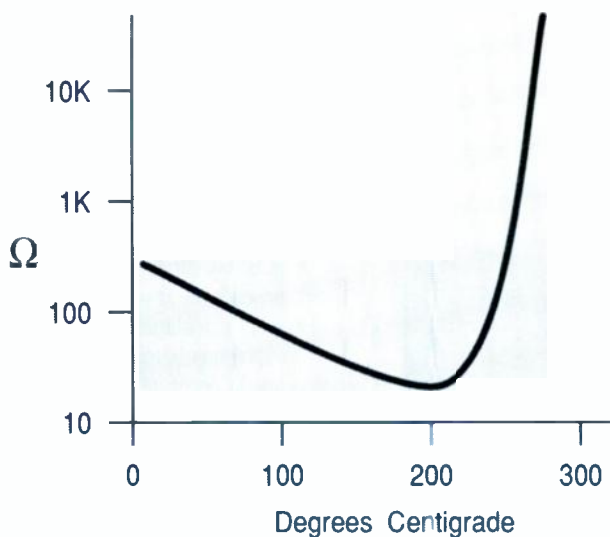

FIG. 1—RESISTANCE VERSUS TEMPERATURE curve for a typical Posistor. Above the critical temperature, the resistance sharply increases and the current dramatically drops.

us, the resistance at first decreases gradually with increasing temperature, up to a certain point known as the critical temperature. Above that point, the resistance will instead dramatically increase with temperature.

Those devices are available in a wide variety of sizes with various critical temperatures. Posistors are usually made from barium titanate

that has been doped with strontium to adjust the critical temperature. Like most resistors, they are bipolar devices that conduct equally well in either direction.

Another name for a Posistor is a PTC Switching Thermistor. Two of the primary sources of those products include Murata-Erie and Midwest Components. To get started with them, check out Murata-Erie's new short form catalog 61-05 or else Midwest's Thermistors, Thermal Switches, and Varistors catalog.

Despite their very low cost, their simple circuitry, and their mind-blowing uses, Posistors do not seem to have aroused much hacker interest to date. Yet, they are ideal components that are quite easy to experiment with.

NEED HELP?

Phone or write your Hardware Hacker questions directly to:
Don Lancaster

Synergetics
Box 809
Thatcher, AZ 85552
(602) 428-4073

Take any one of these HANDBOOKS ELECTRONICS and CONTROL

- your one source for engineering books from over 100 different publishers
- the latest and best information in your field
- discounts of up to 40% off publishers' list prices



322/910

Publisher's Price \$110.00

ANTENNA ENGINEERING HANDBOOK, Second Edition

Edited by R. C. Johnson and H. Jasik

- 1,408 pages, 946 illustrations
- covers all types of antennas currently in use with a separate chapter devoted to each
- provides detailed data on physical fundamentals, operating principles, design techniques, and performance data
- up-to-the-minute information on antenna applications
- a must for those involved in any phase of antenna engineering

Publisher's Price \$64.50

STANDARD HANDBOOK OF ENGINEERING CALCULATIONS, Second Edition

By T. G. Hicks

- 1,468 pages, 793 illustrations, 499 tables
- puts more than 1,100 specific calculation procedures at your fingertips
- every calculation procedure gives the exact, numbered steps to follow for a quick, accurate solution
- virtually all procedures can be easily programmed on your PC or calculator
- uses USCS and SI units in all calculation procedures

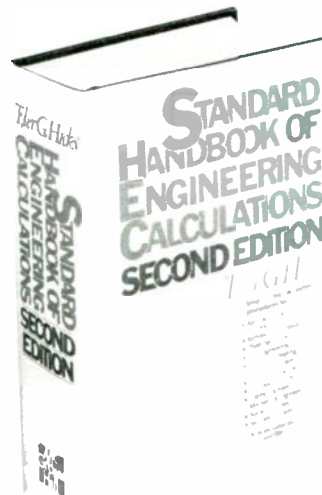

287/35X

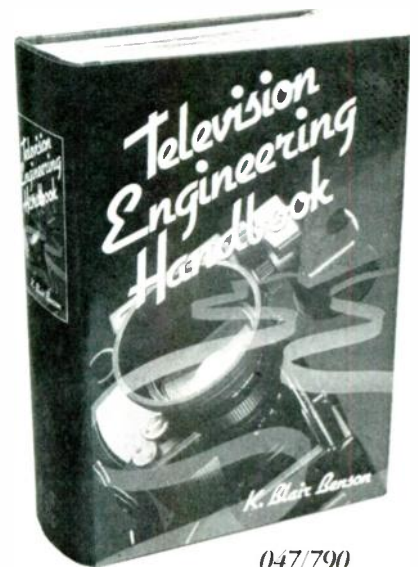

047/790

Publisher's Price \$89.50

TELEVISION ENGINEERING HANDBOOK

Edited by K. B. Benson

- 1,478 pages, 1,091 illustrations
- packed with all the technical information today's engineer needs to design, operate, and maintain every type of television equipment
- extensive coverage of receivers, broadcast equipment, video tape recording, video disc recording, and the latest technological advances
- provides television system and industry standards for the U.S. and other countries
- the most comprehensive book on the subject of television engineering

for only \$14.95 – when you join the ENGINEERS' BOOK CLUB®

values up to \$110.00

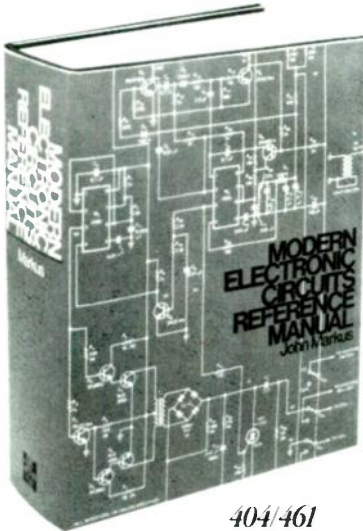

404/461

Publisher's Price \$82.50

MODERN ELECTRONIC CIRCUITS REFERENCE MANUAL

By J. T. Markus

- 1,264 pages, 3,666 circuit diagrams
- a handy, desktop reference with 103 chapters organized by "family" grouping
- filled with predesigned and use-tested circuits to save you production time and money
- includes concise summaries of all the recent applications notes, journal articles, and reports on each circuit, efficiently organized and indexed for the practicing engineer



4 reasons to join today!

1. Best and newest books from ALL publishers! Books are selected from a wide range of publishers by expert editors and consultants to give you continuing access to the best and latest books in your field.

2. Big savings! Build your library and save money, too! Savings range up to 40% off publishers' list prices.

3. Bonus books! You will immediately begin to participate in our Bonus Book Plan that allows you savings up to 70% off the publishers' prices of many professional and general interest books!

4. Convenience! 14-16 times a year (about once every 3-4 weeks) you receive the Club Bulletin FREE. It fully describes the Main Selection and alternate selections. A dated Reply Card is included. If you want the Main Selection, you simply do nothing — it will be shipped automatically. If you want an alternate selection — or no book at all — you simply indicate it on the Reply Card and return it by the date specified. You will have at least 10 days to decide. If, because of late delivery of the Bulletin you receive a Main Selection you do not want, you may return it for credit at the Club's expense.

As a Club member you agree only to the purchase of three additional books during your first year of membership. Membership may be discontinued by either you or the Club at any time after you have purchased the three additional books.

Publisher's Price \$86.50

STANDARD HANDBOOK FOR ELECTRICAL ENGINEERS, Twelfth Edition

Edited by D.G. Fink and H.W. Beaty

- 2,416 pages, 1,388 illustrations, 430 tables
- the essential reference for all electrical engineers
- ranges from basic circuits and measurements to advanced topics, such as power distribution and telecommunications
- fully updated to cover all recent advances and developments
- written and compiled by 115 contributors — all experts in their fields

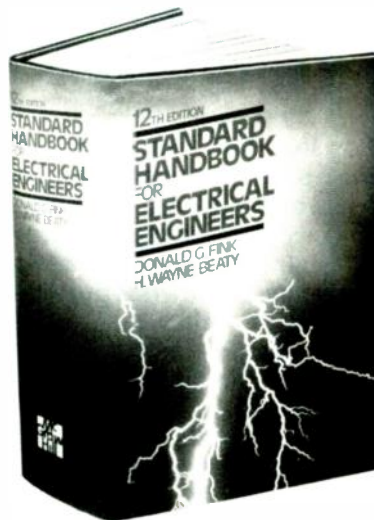

209/758

FOR FASTER SERVICE IN ENROLLING CALL TOLL FREE 1-800-2-MCGRAW

McGraw-Hill Book Clubs
Electronics and Control Engineers' Book Club®
 P.O. Box 582
 Hightstown, NJ 08520-9959

Please enroll me as a member of the Electronics and Control Engineers' Book Club® and send me the book I have chosen for only \$14.95, plus local tax, postage, and handling. I agree to purchase a minimum of three additional books during my first year as outlined under the Club plan described in this ad. Membership in the club is cancellable by me or McGraw-Hill any time after the three book purchase requirement has been fulfilled. A shipping and handling charge is added to all shipments.

I wish to order the following book:

- ANTENNA ENGINEERING HANDBOOK (322-910)
- MODERN ELECTRONIC CIRCUITS REFERENCE MANUAL (404-461)
- STANDARD HANDBOOK FOR ELECTRICAL ENGINEERS, 12th (209-758)
- TELEVISION ENGINEERING HANDBOOK (047-790)
- STANDARD HANDBOOK OF ENGINEERING CALCULATIONS (287-35X)

Signature _____

Name _____

Address Apt # _____

City State Zip _____

This order subject to acceptance by McGraw-Hill. Offer good only to new members. Foreign member acceptance subject to special conditions.

E33924

So what good are Posistors?

There are several basic ways of using a Posistor. If you apply a fixed voltage, your Posistor will rapidly heat up to its transition temperature and will stay at that temperature. Thus, you have an all solid-state single-piece temperature regulator.

Unlike a thermostat, there is no mechanical hysteresis or any dead band present, and the switching can be exactly repeated.

And, unlike the thermistors and thermocouples, the very non-linear resistance change forms a sudden and well defined switching point. On the other hand, that critical temperature is a fixed property of the Posistor, so you cannot adjust it like you could a more traditional controller.

If you instead apply an input current, you end up with a time delay circuit, for the Posistor will slowly heat up towards its critical temperature and then effectively switch itself off. The time delay depends on both the current and the amount of heatsinking.

If you place a load in series with

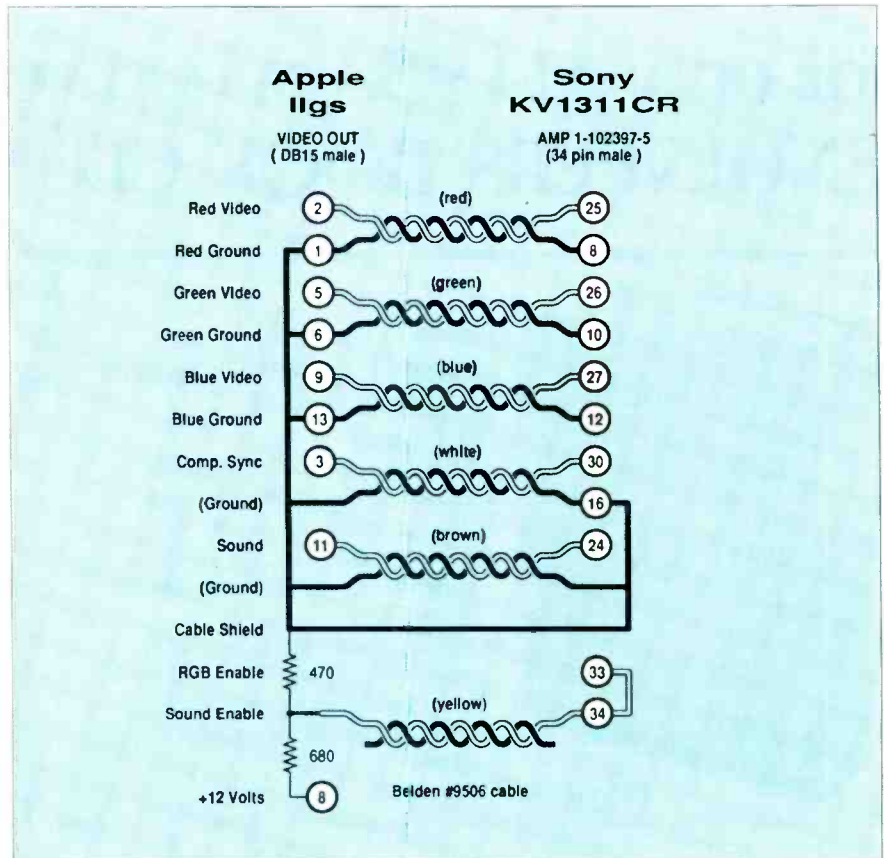

FIG. 2—AN INTERFACE CABLE to go between the Apple IIgs computer and the Sony KV1311-CR linear RGB monitor/receiver

NEW FROM DON LANCASTER

HANDS-ON BOOKS

| | |
|---------------------------------|-------|
| Ask the Guru Reprints | 24.50 |
| CMOS Cookbook | 15.50 |
| TTL Cookbook | 15.50 |
| TV Typewriter Cookbook | 15.50 |
| Active Filter Cookbook | 15.50 |
| Micro Cookbook vol I or II | 15.50 |
| Enhancing your Apple vol I | 15.50 |
| Enhancing your Apple vol II | 15.50 |
| Applewriter Cookbook | 19.50 |
| Apple Assembly Cookbook | 21.50 |
| Incredible Secret Money Machine | 7.50 |
| Postscript Ref. Man. (Adobe) | 22.50 |
| Postscript Cookbook (Adobe) | 16.50 |

UNLOCKED SOFTWARE

| | |
|-------------------------------------|-------|
| Absolute Reset IIe & IIc | 19.50 |
| Applewriter/Laserwriter Utilities | 49.50 |
| Postscript Show & Tell (IIe/Mac/PC) | 39.50 |
| Postscript Technical Illustrations | 39.50 |
| Intro to Postscript VHS Video | 39.50 |
| Apple Ram Card Disassembly Script | 24.50 |
| Enhance vol I Companion Disk | 19.50 |
| Enhance vol II Companion Disk | 19.50 |
| Assembly CB Companion Disk | 19.50 |
| Applewriter CB ProDOS C. Disk | 24.50 |

FREE VOICE HELPLINE

VISA/MC

SYNERGETICS

Box 809-RE
Thatcher, AZ 85552
(602) 428-4073

CIRCLE 83 ON FREE INFORMATION CARD

the Posistor, you can create an overload-protector circuit. When the load attempts to draw too much current or if the Posistor overheats, the Posistor goes into a high-resistance state, thus protecting the load from damage.

If the Posistor is not powerful enough, you can amplify its output suitably with a relay or a Triac. Companion heaters can also be used to control larger loads.

Let's quickly look at some real world uses: A flat-panel heater may be combined with a Posistor so as to automatically heat liquid-crystal displays whenever your ambient temperature gets down too low. A Posistor can be used as an air-flow detector by arranging things so moving air cools the Posistor well below its critical temperature, while a lack of enough air flow will cause the device to exceed the critical temperature.

A Posistor in series with the starting winding of a motor will power the starting winding for only several seconds until the Posistor overheats and limits the current to a low value. Therefore,

the device can replace the bulky and unreliable centrifugal switches used in many induction motors.

Alternately, a different Posistor in series with the main motor winding will protect that winding from mechanical or input overload. If the current gets too high, the Posistor overheats, and then limits the current. Resetting is automatic and takes place a few seconds after the overload stops.

Various other safety circuits are possible. Those include using a Posistor to sense the temperature of a battery being charged, to protect hi-fi speaker systems, to prevent thermal runaway in an electronic circuit, to sense the liquid level in a tank, or as a freeze alarm in solar panels.

Some TV sets use degaussing coils, needed to prevent any stray magnetic fields from trashing the color convergence. A Posistor in series with a degaussing coil will let the coil run for only a few seconds only when the power is first applied.

I am now looking into using a Posistor as a heater for a cheap

Kroy Kolor fusion machine, and separately to control the glue pot on a thermal-binding machine.

It does look like the simplicity of a Posistor gets traded off against the inability to adjust it over a wide temperature range.

Tellyawhat—for this month's contest, just dream up an unusual use for a Posistor. A paper design is just fine. The best twenty entries will receive a free book, while the best one of all gets an all-expense-paid (FOB Thatcher, AZ) *tinaja* quest for two.

As usual, send your entries to me at the address in the Need Help box, and not to the **Radio-Electronics** editorial offices. Fair enough?

What monitors are available for the Apple IIgs?

Many help-line callers seem to be after alternates to the stock Apple linear RGB monitor that is used with the IIgs.

The stock video monitor is exceptionally sharp and works very well. On the other hand, it costs \$500, is strictly limited to the linear RGB systems, lacks a handle, and has video-noise problems for any "night people" using very low brightness and contrast settings.

We'll first note that you must use a linear RGB monitor to tap the full performance from your IIgs. The digital, or the TTL color monitors common to the IBM world simply will not do.

Buying an unseen monitor on price alone is insane. So, rule number one is to not buy any monitor unless you can see exactly how it will look when running your programs on your system.

Several help-line callers have asked about using the Amiga monitor. Apparently that can be done, but only with some circuit modifications. My spies report that the blanking widths of the color channels on the IIgs are too narrow to suit the Amiga. Please let me know if you have a solution on this particular interface.

The real winner seems to be the Sony *KV1311-CR* monitor receiver. The praise lavished on this machine by the help-line callers was enough for me to actually go out and buy one.

What you get is a 13-inch, \$400-

NAMES AND NUMBERS

Chemical Abstracts Service

PO Box 3012
Columbus, OH 43210
(800) 848-6538

Computer Shopper

Box F
Titusville, FL 32781
(305) 269-3211

EDN Magazine

275 Washington St
Newton, MA 02158
(617) 964-3030

Innovative Design Fund

866 United Nations Plaza
New York, NY 10017
(212) 748-0486

Materials Research Society

9800 McKnight Rd., Ste 327
Pittsburgh, PA 15237
(412) 367-3003

Maxim

510 Pastoria Ave
Sunnyvale, CA 94086
(408) 737-7600

Midwest Components

1981 Port City Blvd.
Muskegon, MI 49443
(616) 777-2602

Mini-Circuits

PO Box 350166
Brooklyn, NY 11235
(718) 934-4500

Murata-Erie

2200 Lake Park Dr
Smyrna, GA 30080
(404) 436-1300

NASA Tech Briefs

41 E 42nd St. Ste 921
New York, NY 10017
(212) 490-3999

Payphone Exchange

PO Box 22134
Knoxville, TN 37933
(615) 690-9530

Rochester Electronics

10 Malcolm Hoyt Dr
Newburyport, MA 01950
(617) 462-9332

Synergetics

Box 809
Thatcher, AZ 85552
(602) 428-4073

Views of Imagineering

100198 W Berry Dr
Littleton, CO 80127
(303) 973-8408

street-price do-everything machine. It is a television receiver with 196 channels of off-the-air and cable capability, including a handy remote control. On the side is a fancy panel that has inputs for composite video, digital RGB, linear RGB, audio, and even for teletext! Outputs include video, audio, VCR editing, and hi-fi multiplexed sound.

A special cable is required to interface the DB-15 connector on the IIgs to the 34-pin DIP header connector on the monitor receiver. Figure 2 shows you the details for that cable. You can also get a cable for \$20 from the folks at Redmond Cable.

If you use the ready-to-go cable, be very careful to plug it in correctly. To keep the cost down, the connector is neither keyed nor idiot-proofed.

So how good is it?

The picture quality and color is every bit as good as the stock Apple monitor. But, since there are

only 192 or 200 scan lines on the IIgs video, the 13-inch display tends to break up characters into individual dot lines. Thus, I feel the original monitor has a higher perceived character readability, that is particularly noticeable when word processing.

On the other hand, 13 inches is often too small to be pleasant for such activities as group VCR watching. So, I guess one problem with the *KV1311-CR* monitor is that the screen is both too big and too small.

By the way, this is strictly an NTSC set, with the usual 15735-Hz horizontal scanning. It is not suited for EGA or other uses that require a higher scanning rate.

Rumor has it that the low street price is caused by it being a discontinued model, and that something better is now in the works. But "something better" is always in the works. And probably much more expensive.

One big warning: One person

Be an FCC LICENSED ELECTRONIC TECHNICIAN!

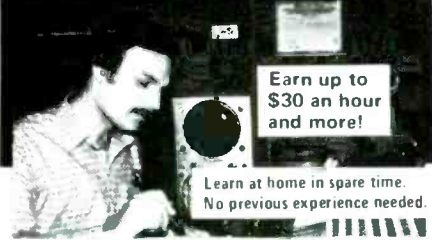

No costly school. No commuting to class. The Original Home-Study course prepares you for the "FCC Commercial Radio-telephone License". This valuable license is your "ticket" to thousands of exciting jobs in Communications, Radio-TV, Microwave, Computers, Radar, Avionics and more! You don't need a college degree to qualify, but you do need an FCC License.

No Need to Quit Your Job or Go To School This proven course is easy, fast and low cost! **GUARANTEED PASS** - You get your FCC License or money refunded. **Send for FREE facts now. MAIL COUPON TODAY!**

COMMAND PRODUCTIONS
 FCC LICENSE TRAINING, Dept 90
 P.O. Box 2223, San Francisco, CA 94126
 Please rush FREE details immediately!

NAME _____
 ADDRESS _____
 CITY _____ STATE _____ ZIP _____

NEW SUPER LONG PLAY TAPE RECORDERS
 12 Hour Model — \$105.00*
 USES D-120 TAPE

Modified Panasonic Slimline, high quality, AC-DC Recorders provide 6 continuous hours of quality recording & playback on each side of cassette for a total of 12 hours. Built-in features include: • Voice level control, • Digital counter, etc. TDK DC 120 Cassette Furnished.

PHONE RECORDING ADAPTER
 Records calls automatically. All Solid state connects to your telephone jack and tape recorder. Starts recording when phone is lifted. Stops when you hang up. **\$24.50*** FCC APPROVED

VOX VOICE ACTIVATED CONTROL SWITCH
 Solid state. Self contained. Adjustable sensitivity. Voices or other sounds automatically activate and control recorder. Uses either recorder or remote mike. **\$24.95***

*Add for ship & hdg. Phone Adapter & Vox \$1.50 ea. Recorders \$4.00 ea. Cal. Res. add tax. Mail order. VISA, M/C, COD's OK. Money Back Guarantee. Qty. disc. avail., Dealer Inquiries invited, Free data.

AMC SALES INC. Dept 9335 Lubec St., Box 928, Downey, CA (213) 90421 Phone 869-8519

bought the monitor for his *I/c* and tried using the composite NTSC video input. He was appalled when he found all his 80-column text was hopelessly smeared. There simply is no color monitor available anywhere that can attractively display 80 column text from an NTSC-coded composite-color-video input. The reason, of course, is that there is not enough bandwidth available in the NTSC encoding to allow display of more than 45 or so characters, maximum, across the screen. That is why you go RGB in the first place.

So, yes you can use this monitor receiver with a *I/c* or a *I/e*. But your 80 column text will only be legible and pleasant when you have added an a third-party RGB card.

The smallish speaker in the *KV1311-CR* does sound bunches better than the tiny Apple speaker, but it is not in the least suitable for serious music-synthesis use. You can take an audio output off the earphone jack for further amplification and/or better speakers.

It is nice to have a "real" volume control handy, compared to the front panel firmware setting. A pair of snap-on feet allow you to angle the display for monitor use or to flatten it for TV watching.

There's also no handle, a major defect that the monitor receiver shares with the original Apple unit. The center of gravity of both

of the monitors is in a very unexpected place, making either of them very easy to drop.

Anything new in video?

I've just gotten word on two new Maxim IC's that will have all sorts of hacker video uses. Those are so new that I do not even have the pinouts yet, but here goes...

Figure 3 shows the new MAX455, a single-chip, \$10, multiplexing video amplifier. What that jewel does is let you select one of eight video inputs and route them to a driver amplifier that can directly drive a 75-ohm cable. The channel selection is done by inputting a binary one-of-eight code. The channel-select lines can be any length at all without causing serious problems.

Channel isolation can be as high as 70 dB's That borders on broadcast quality. Circuits of two and four input channels are also offered.

One obvious use would be as a home-video control center. Inputs could come from your TV set, cable, VCR, and such. The outputs could be routed any way you like.

Maxim has also made the output video driver separately available as the MAX452, shown in Fig. 4. Its cost is around \$3, and it can easily drive long lengths of 75-ohm coax. The bandwidth can be as high as 50 megahertz.

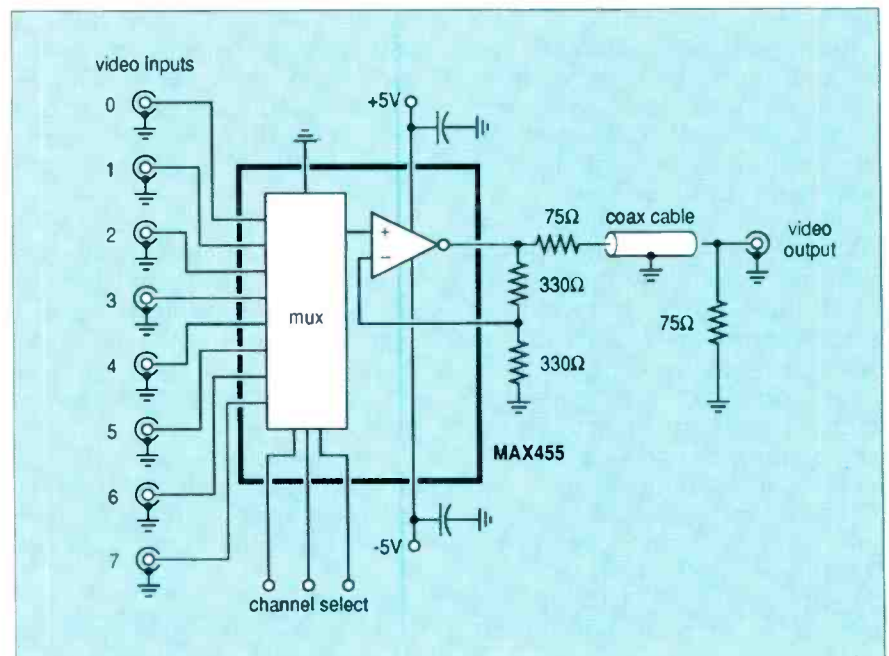

FIG. 3—AN EIGHT POSITION, single-IC video selector and driver.

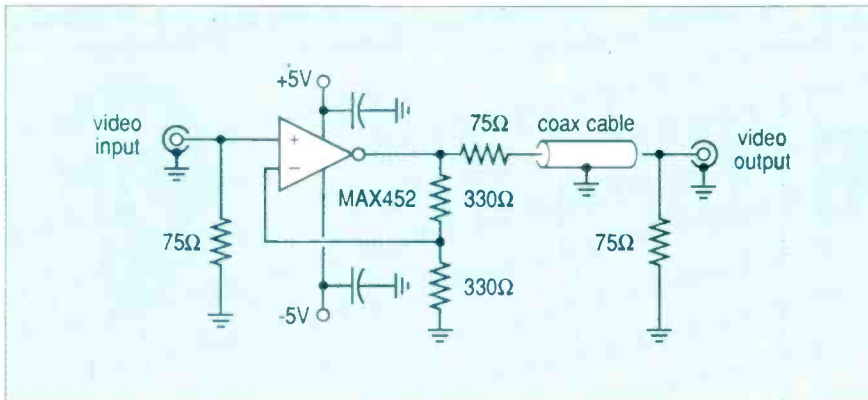

FIG. 4—THE VIDEO DRIVER is available separately as the MAX452.

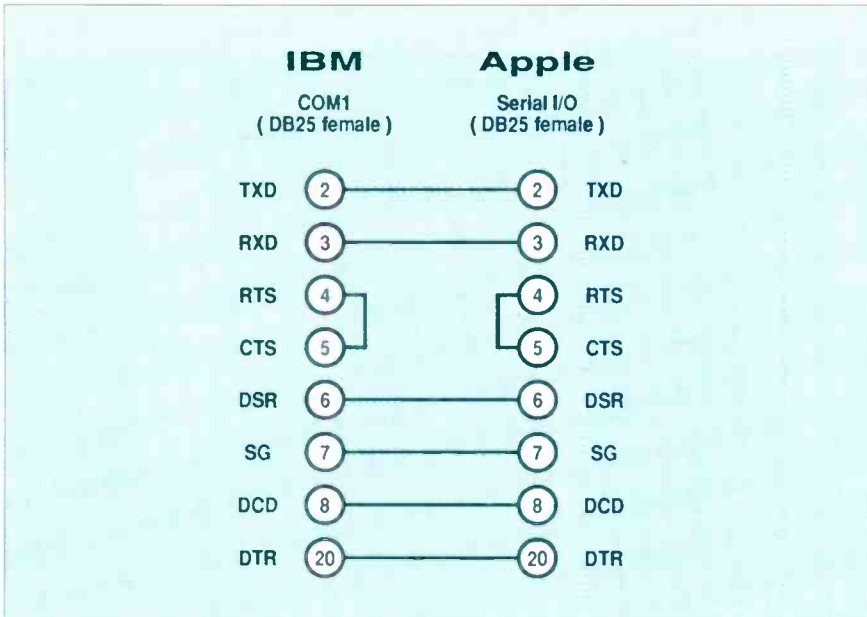

FIG. 5—AN INTERFACE for Apple to IBM text-file exchanges.

One warning: Despite their apparent power and simplicity, those are advanced hacker components. You absolutely *must* use double-sided printed-circuit layouts with large ground-plane areas. Shielding and guarding of inputs and outputs is mandatory. A good oscilloscope is a must. High-quality decoupling capacitors *must* be used directly at the supply pins.

In short, wide-bandwidth video circuits will only work if you treat them with respect.

Can An Apple IIc and an IBM PC exchange text files?

You can exchange text files from most any computer to most any other by using serial communication ports and then sending the characters from one machine to another.

Figure 5 shows a simple adaptor that I built to let you get between

an IBM PC and an Apple IIc, IIe, or IIgs. You build that adaptor for about \$5 worth of parts. It plugs directly into the COM-1 port of the IBM or clone machine.

Be sure to use two female DB-25 connectors. A pair of soldered No. 12 wire loops can be used to hold the connectors together.

At the IBM end, you need a card that gives you the COM-1 serial interface. You also usually will need some sort of a telecommunications software package. I use *PC-Talk*.

On a IIc, I prefer the ProDOS *Applewriter*, v2.0 or v2.1. That package lets you send, receive, or edit text! all within one single program. To receive, you use the [Q]-1 command. To transmit, you use [P]-NP. An ordinary printer cable, such as might be used between the IIc and an *Imagewriter I*, is
(Continued on page 103)

ATTENTION! ELECTRONICS TECHNICIANS

EARN YOUR
**B.S.E.E.
DEGREE**

THROUGH HOME STUDY

Our New and Highly Effective Advanced-Placement Program for experienced Electronic Technicians grants credit for previous Schooling and Professional Experience, and can greatly reduce the time required to complete Program and reach graduation. No residence schooling required for qualified Electronic Technicians. Through this Special Program you can pull all of the loose ends of your electronics background together and earn your B.S.E.E. Degree. Upgrade your status and pay to the Engineering Level. Advance Rapidly! Many finish in 12 months or less. Students and graduates in all 50 States and throughout the World. Established Over 40 Years! Write for free Descriptive Literature

**COOK'S INSTITUTE
OF ELECTRONICS ENGINEERING**

4251 CYPRESS DRIVE
JACKSON, MISSISSIPPI 39212

CIRCLE 58 ON FREE INFORMATION CARD

Technicians,
Get Serious
About Your
Profession



Being a certified electronics technician lets people know that you are a professional in your field. It tells them that you are serious about your work and can perform up to CET standards.

Now you can order the "Study Guide for the Associate-Level CET Test" from the International Society of Certified Electronics Technicians. It includes material covering the most often missed questions on the Associate CET exam. 8 1/2" x 11", paperback, 60 pages.

For More Information Contact:

IS CET, 2708 W. Berry, Fort Worth, TX
76109; (817) 921-9101

NAME _____
ADDRESS _____
CITY _____ STATE _____
ZIP _____
_____ copies @ \$5 (+ \$1 postage.)
_____ send material about IS CET
and becoming certified.

ANTIQUE RADIOS

Servicing antique radios

IN JANUARY, WE BEGAN TO LOOK AT VOICE-coil problems and their cures. Let's finish up that discussion now before moving on.

An off-center voice coil is usually caused by some kind of damage to the cone itself. Often, recentering or repairing the cone will also recenter the voice coil. An off-center cone is usually caused when the cone's outer edge works loose from its frame. That can be caused by the speaker being dropped—or, more likely, the outer edge just came loose from a combination of vibration and the glue drying out.

So how do you repair an off-center coil? Often, simply re-gluing the speaker's surround to its frame will cure the problem. While some early technicians suggested forcing a warped cone into position with wrinkled-up newspaper loosely inserted between the frame and the back of the cone, it usually eliminated the scratchy-sound but resulted in a thin, tinny sound—one lacking in bass.

Hard to get

One of the first things learned when you get into antique radios is that few, if any, of the parts we mention are available at your modern electronics supply store. That is especially true for resistors and capacitors, and you can create serious problems in an antique radio if you don't make the proper parts substitution. For example, because of the high voltages used in tube radios, for use in those radios, a resistor's wattage rating is every bit as important as its resistance value.

Although the term *resistor*

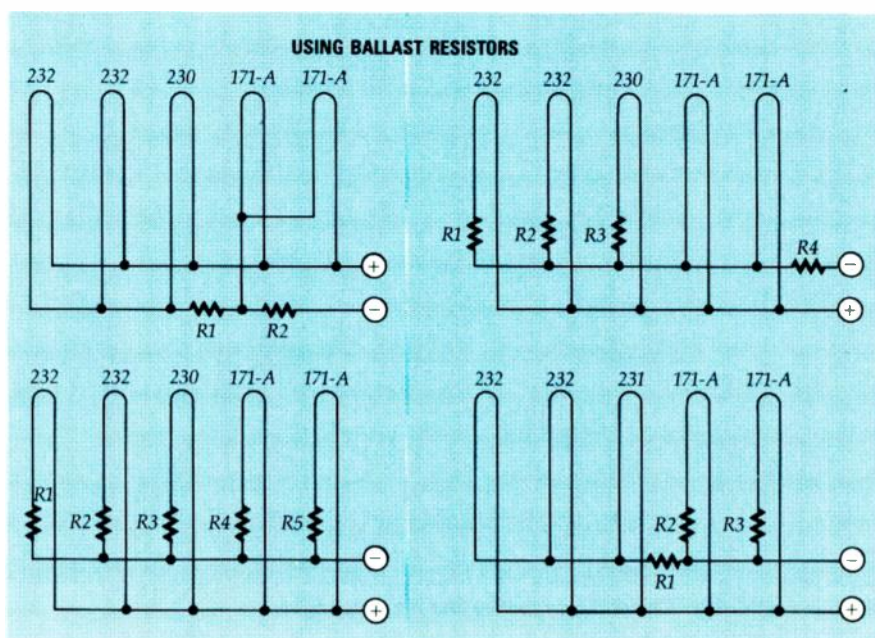

FIG. 1

might bring to mind a small round piece of carbon having colored bands that indicate its value, tolerance, and perhaps its voltage rating, in antique radios the term resistor can mean the usual fixed-value carbon and wirewound types, rheostats, potentiometers, ballasts, and line-cord resistors. In fact, early carbon resistors didn't use color bands to indicate the resistance value.

Generally, the color of the body was the first digit, a color dot on one end was the second digit, and a dot in the center of the resistor was the zero-multiplier. A brown body, green end, and an orange dot was a 15,000 ohm resistor. As a general rule, a carbon resistor's tolerance was 20%, and you estimated the power rating. Small resistors were ½-watt, anything

larger was 1-watt or 2-watt—you simply hoped you guessed the rating correctly. If tolerance was important, the usually unmarked end was painted silver for 10% and gold for 5%.

Ballast resistors and ballast tubes (a resistor mounted inside a glass tube) are resistive devices specifically designed to control the filament voltage applied to one or more tubes. They were necessary because many antique radios used tubes that required different operating voltages and/or currents. The ballast resistors equalized the filament voltages so that, for example, applying 10 volts to one tube didn't result in the destruction of other tubes that might require only 5-volts filament power.

Figure 1 shows some of the ways



RICHARD D. FITCH,
CONTRIBUTING EDITOR

that ballast resistors were connected. Depending on the particular design, antique radios might use from one to maybe five resistors to control filament voltages; so be sure to check the ballast resistors when substituting tubes in very early radios. The substitute tube's filament voltage and current has to be the same as the tube that is being replaced. If not, you'll have to calculate the value of a new ballast resistor. (Popular early tubes like the 71 have a 5-volt, .025-ampere filament, as do similar tubes like the 01A, 00A, 40, and 12A. Those tubes can be interchanged without changing the value of the ballast resistor.)

Rheostats are two-terminal, wirewound variable resistors that were commonly used in the filament circuit; they permitted the owner to easily correct for the natural decrease over time in the output voltage of the battery that powered the filaments. When the control finally reached its end—or zero resistance—the battery voltage could no longer be compensated and the owner knew that it was time to go out and replace the battery.

An interesting note about rheostats is that their wattage rating is reduced as the resistance is reduced. That is why those devices appear to burn out at the end of least resistance.

Next time

In the next installment of this column we'll cover the tubes used in antique radios, the old-fashioned "condenser" (what we now call a capacitor), and then we'll show you how we go about restoring an antique radio—which is the ultimate goal of the antique-radio hobbyist.

By now, most of you are familiar with the people and businesses who have indicated they have antique radio parts or information available, because every few months I include a list of them in the column. If you need assistance even faster than that, simply send me a SASE. I'll do my best to try to help you out, but please keep in mind that I don't sell parts or information on radios. I can only try and help you locate a source for what you need.

R-E

HITACHI SCOPES AT DISCOUNT PRICES!

20MHZ



Model V212 \$475

Model V-212 20MHZ Dual Channel (1mV Sens.) \$475
 Model V-422 40MHZ Dual Channel (1mV Sens.) \$699
 Model V-425 40MHZ Dual Channel (with cursor) \$825
 Model V-660 60MHZ Dual Channel (Delayed Sweep) \$990
 Model V-1060 100MHZ Dual Channel (Delayed Sweep) \$1,375
 All above scopes have a 3 year warranty on parts and labor

100MHZ



Model V1060 \$1,375

15-25%
OFF LIST
PRICE

ELENCO PRODUCTS AT DISCOUNT PRICES!



MO-1253
40MHZ
Dual Trace
12KV HV
Delayed Sweep
\$550



20MHz DUAL TRACE OSCILLOSCOPE

35MHz DUAL TRACE OSCILLOSCOPE

\$349 MO-1251

\$498 MO-1252

Top quality scopes at a very reasonable price. Contains all the desired features. Elenco's 2 year guarantee assures you of continuous service. Two 1x, 10x probes, diagrams and manual included. Write for specs.
 100MHz test probes, switchable 1x, 10x, Ref. (Complete w/ 5 accessories) Fits most scopes \$22



MULTIMETER with
CAPACITANCE AND
TRANSISTOR
TESTER

Model
CM-1500A \$58

Reads Volts, Ohms,
Current, Capacitors,
Transistors &
Diodes W/Case



TRUE RMS 4 1/2
DIGIT MULTIMETER

Model
M-7000C
\$135

.05% DC Accuracy
.1% Resistance
with Freq. Counter
& Deluxe Case



Auto Ranging
plus
Manual Ranging
3 1/2 Digit Meter
28 Functions
Fully protected

M-1180 7% Acy \$36.95
M-1182 .25% Acy \$39.95
M-1181 .1% Acy \$42.95

GF-8016 FUNCTION GENERATOR
with Freq. Counter



\$239

- Sine, Square, Triangle
- Pulse, Ramp, .2 to 2MHz
- Frequency .1 thru 10MHz

GF-8015 without Freq. Meter \$179

10MHZ OSCILLOSCOPE



\$239

Model
S-3000

- 10MHz DC or AC
- Triggered Sweep
- Calibrated Vert & Hor
- Reads Volts & Freq

BREADBOARD

Model
9436
Shown

9430 1,100 pins \$15
9434 2,170 pins \$25
9436 2,860 pins \$35

DIGITAL TRIPLE POWER SUPPLY



Model
XP-785
\$239

0-20V @ 1A
0-20V @ 1A
5V @ 5A

Fully Regulated, Short Circuit Protected with 2
Limit Cont. 3 Separate Supplies

XP-680 with Analog Meters \$169.50

DIGITAL LCR METER



\$138

Model
LC-1800
Measures:
Inductors,
Capacitors,
Resistors

50MHZ LOGIC PROBE
20 nsec with memory
LP-700



\$23

Logic Pulsar
LP-600 \$23

QUAD POWER SUPPLY



Model
XP-580
\$59.95

2-20V @ 2A
12V @ 1A
+5V @ 3A
-5V @ .4A

Fully regulated
and short
circuit protected

Model XP-575 without meters \$49.95

MULTI-FUNCTION COUNTERS



F-1000
1.2GH \$259

F-100
120MH \$179

Frequency, Period, Totalize, Self Check with High-Stabilized Crystal Oven Oscillator, 8 Digit LED Display

C&S SALES INC., 1245 Rosewood Dr. Deerfield, IL 60015
800-292-7711 312-541-0710 ASK FOR CATALOG



15 DAY MONEY
BACK GUARANTEE

2 Year Limited Guarantee! Add 5% for Postage (\$10 max), IL Res., 7% Tax

CIRCLE 109 ON FREE INFORMATION CARD

Get A Complete Course In

ELECTRONIC ENGINEERING

8 volumes, over 2000 pages, including all necessary math and physics. 29 examinations to help you gauge your personal progress. A truly great learning experience.

Prepare now to take advantage of the growing demand for people able to work at the engineering level.

Ask for our brochure giving complete details of content. Use your free information card number, or write us directly. \$99.95, Postage Included. Satisfaction guaranteed or money refunded.

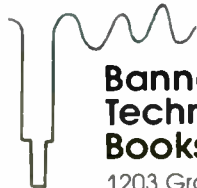

Banner Technical Books, Inc.
1203 Grant Ave.
Rockford, IL 61103

CIRCLE 185 ON FREE INFORMATION CARD

32 Ways to Help You Qualify for the Job You Want

Free Facts about Career Diplomas and Degrees

Now at home in your spare time, without any previous experience, you can train for a money-making career...even get a Specialized Associate Degree. Call or send for free information on the career field that interests you most and how to train for it.



CALL TOLL-FREE 1-800-228-5300 Dept. DES28
CALL ANYTIME—24 hours a day 7 days a week
No cost. No obligation. No salesman will visit.
OR MAIL COUPON TODAY

ICS International Correspondence Schools
SINCE 1891 Dept. DES28, Scranton, PA 18515

Send free facts on how I can study at home for the career I have chosen. No obligation. No salesman will visit. **CHECK ONE CAREER ONLY.**

ASSOCIATE IN SPECIALIZED BUSINESS DEGREE PROGRAMS

- Business Management
- Accounting
- Business Management with option in Marketing
- Business Management with option in Finance

ASSOCIATE IN SPECIALIZED TECHNOLOGY DEGREE PROGRAMS

- Mechanical Engineering Technology
- Civil Engineering Technology
- Electrical Engineering Technology
- Electronics Technology

CAREER DIPLOMA PROGRAMS

- Computer Programming
- High School
- Catering/Gourmet Cooking
- Microcomputer Repair
- Auto Mechanics
- Bookkeeping
- Hotel/Restaurant Management
- Drafting
- Air Conditioning & Refrigeration
- Electronics
- Electrician
- Police Sciences
- Art
- Small Business Management
- Wildlife Forestry Conservation
- Diesel Mechanics
- Gun Repair
- Motorcycle Repair
- Surveying & Mapping
- TV VCR Repair
- Veterinary Assistant
- Travel Agent
- Photography
- Journalism Short Story Writing

Name _____ Age _____
Address _____ Apt. # _____
City/State _____ Zip _____
Phone () _____

A Subsidiary of National Education Corporation

PLASMA DISPLAY

continued from page 48

used if the display does not completely ignite or is weak.

- Connect the high-voltage output (the black HV lead) to the beginning of the display. *CAUTION: Always route that lead away from any conductive object. The lead must be short and direct.*
- Set R13 fully clockwise (longest trace time). Set R12 fully counterclockwise (minimum display). Set S1 to its INTERNAL position.
- Connect the device to a polarized power outlet and adjust R12 for a full-length neon display. (It will take several trace periods to obtain the correct setting.)
- Adjust R13 for the desired speed of the trace time. Note that a point on the control will cause the system to shut down. Maximum speed occurs right after that point.
- Allow the unit to cycle for about an hour. Remove power and check the temperature of power transistor Q1. It

The length of the display that can be operated will vary considerably. The kind of gas, the diameter of the glass tubing, and stray capacitance can greatly effect operation. It might be necessary to experiment when energizing larger displays.

Modulation effect

Set S1 to its AUDIO position and feed in a signal from the 8 ohm output of a radio or a stereo. Adjust the radio's volume for a display that seems to track the intensity of the sound.

Special note

The output energy of this device is 25 kHz at approximately 10,000 volts. For safe operation, adequate insulation of the output lead is mandatory for safe operation. Silicon or teflon insulation having a rating of at least 25 kV is recommended. Route the output lead so it isn't near any conductive objects, and splices should be sealed in high voltage putty or silicon rubber. R-E



FIG. 7—THE COMPLETED DISPLAY should resemble this author's prototype. Be sure that the globe base you select can support the size of plasma globe that you intend to use.

should only be warm to the touch. If it is running hot, it may be necessary to decrease the setting of R12.

University Microfilms International reproduces this publication in microform: microfiche and 16mm or 35mm film. For information about this publication or any of the more than 13,000 titles we offer, complete and mail the coupon to: University Microfilms International, 300 N. Zeeb Road, Ann Arbor, MI 48106. Call us toll-free for an immediate response: 800-521-3044. Or call collect in Michigan, Alaska and Hawaii: 313-761-4700.

Please send information about these titles

Name _____

Company/Institution _____

Address _____

City _____

State _____ Zip _____

Phone () _____

University
Microfilms
International

BUY BONDS

PC SERVICE

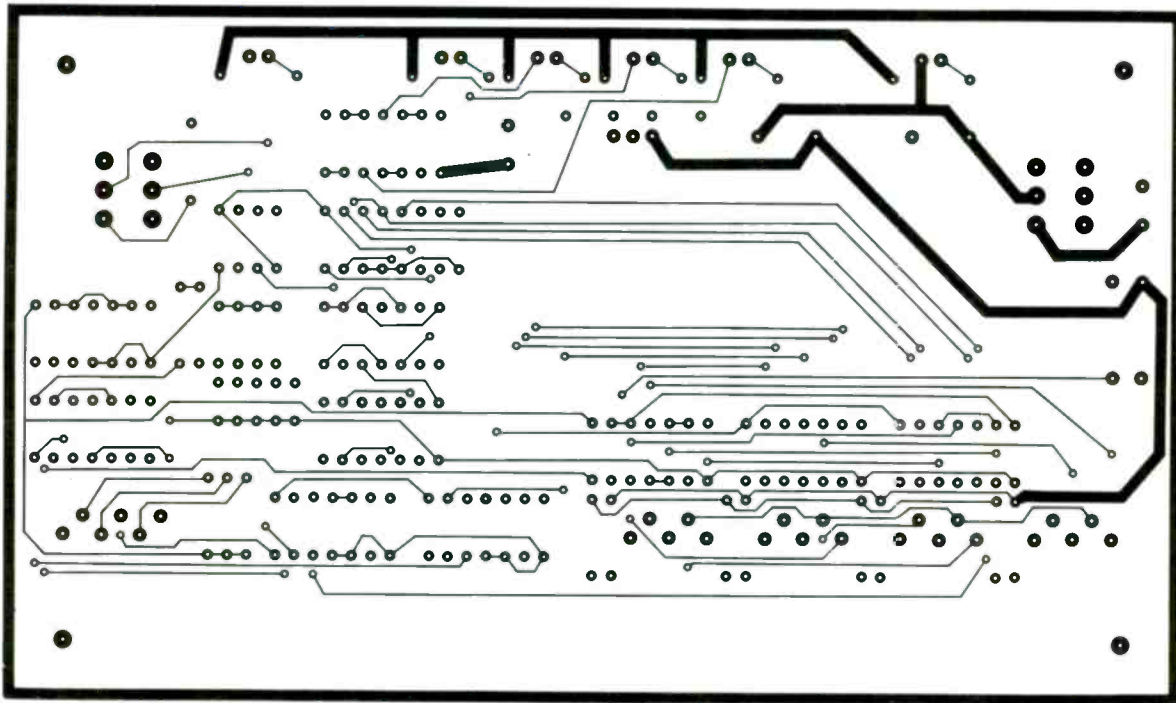

6-1/8 INCHES

SOLDER SIDE of the printer multiplexer board.

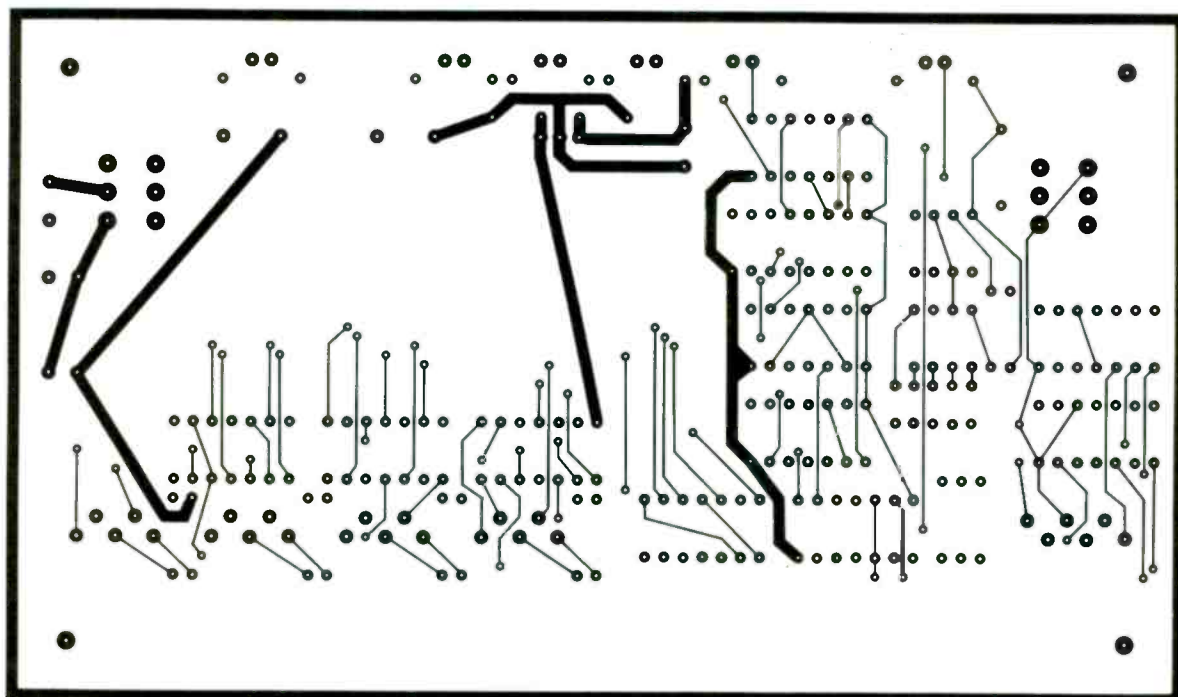

6-1/8 INCHES

COMPONENT SIDE of the printer multiplexer board.

PC SERVICE

Radio-Electronics mini-ADS



ANOTHER EXAMPLE OF KENWOOD ADVANCED TECHNOLOGY. The CS-8010 Digital Storage Oscilloscope uses A/D converters with a vertical resolution of 8 bits and 10 megasamples per second, achieving an effective storage frequency of 400kHz. Also a 2048-word deep memory for both channels, 20MHz Real Time, and high intensity CRT (12kV). Contact your Kenwood Distributor or **KENWOOD USA CORPORATION, COMMUNICATIONS & TEST EQUIPMENT GROUP**, P.O. Box 22745, Long Beach, CA 90801-5745. (213) 639-4200.

CIRCLE 102 ON FREE INFORMATION CARD



FREE TOOL & INSTRUMENT CATALOG. The 1988 General Catalog contains 116 pages of test instruments, precision hand tools, tool cases, soldering equipment and much more. Over 5,000 quality products for testing, repairing and assembling electronic equipment are shown in full color with detailed descriptions, pricing and a 100% satisfaction guarantee. **CONTACT EAST**, P.O. Box 787, No. Andover, MA 01845. Call (800)-225-5370 or in MA (617)-782-2000.

CIRCLE 55 ON FREE INFORMATION CARD



DECODE NEARLY ANY SINGLE LEVEL GATED PULSE SIGNAL. New circuit works with Hamlin, Jerrold, Sylvania, and Eagle systems. Decodes In-band, Out-band, AM or FM reference. Complete educational kit including P.C. board, parts, case, and 40 page gated pulse theory booklet is only **\$47.00** plus **\$3.00** shipping. Order no. 1PFD-1K. **ELEPHANT ELECTRONICS INC.** P.O. Box 41865-R, Phoenix, AZ 85080. (602) 581-1973

CIRCLE 120 ON FREE INFORMATION CARD

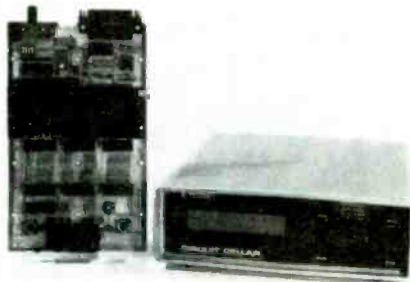

BUILD STEVE CIARCIA'S NEW SUPER IC TESTER Tests over six hundred 7400-series TTL, L, S, H, C, HC, HCT, F, AS, and ALS devices, 4000-series CMOS and PALs. Identifies unmarked chips and bad IC pins. User definable test sequence and user expandable ROM library. Tester operates standalone with LCD display, or with IBM PC or terminal. Partial kit—**\$99**. Full board kit—**\$179**. CCI, 4 Park St., Suite 12, Vernon, CT 06066. (203) 875-2751.

CIRCLE 52 ON FREE INFORMATION CARD



PANASONIC CABLE CONVERTERS, Wholesale and Retail. Scientific Atlanta and Pioneer Cable Converters in stock. Panasonic model 130N 68 channel converter **\$79.95**, Panasonic Amplified Video Control Switch Model VCS-1 **\$59.95**. Scientific Atlanta Brand new Model #8528 550MHZ 80 Channels Converter **\$89.95**. Video Corrector (MACRO, COPYGUARD, DIGITAL) ENHANCER **\$89.95**. We ship to Puerto Rico, Caribbean countries, & So. Amer. Write or call **BLUE STAR IND.**, 4712 AVE. N, Dept 105, Brooklyn, NY 11234. Phone (718) 258-9495.

CIRCLE 85 ON FREE INFORMATION CARD

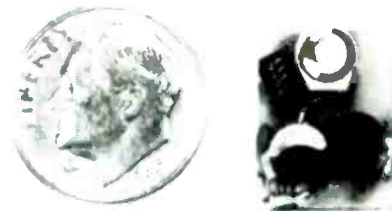

THE MODEL WTT-20 IS ONLY THE SIZE OF A DIME, yet transmits both sides of a telephone conversation to any FM radio with crystal clarity. Telephone line powered - never needs a battery! Up to ¼ mile range. Adjustable from 70-130 MHz. Complete kit **\$29.95** + **\$1.50** S + H. Free Shipping on 2 or more! COD add **\$4**. Call or send VISA, MC, MO. **DECO INDUSTRIES**, Box 607, Bedford Hills, NY 10507. (914) 232-3878.

CIRCLE 127 ON FREE INFORMATION CARD



ZENITH SSAV1 from **\$169**, UHF INPUT, reconditioned. Level II modules available for SSAV1s. UHF SSAV1 project handbook **\$6.50** ppd. Sylvania 4040 **\$169**. Z-TAC, N-12, MLD-1200s. Converters, amplifiers and accessories. Satellite components. Radar speed guns for car/boat racing, bowling, skiing; baseball, etc, from **\$275** used. Professional police models. IBM-compatible computer systems from **\$895**. Catalog **\$1**. **AIS SATELLITE, INC.**, P.O. Box 126-E, Dublin, PA 18917. (215) 249-9411.

CIRCLE 81 ON FREE INFORMATION CARD



SURPLUS ELECTRONICS, ELECTRICAL, SCIENCE and computer parts and equipment at wholesale prices. **FREE CATALOG** featuring some of the biggest deals and lowest prices in America (and Canada). Wholesale and bulk pricing for dealers, distributors, exporters, manufacturers and volume users. Catalog request taken only by mail and must be on company letterhead. **SURPLUS TRADERS**, PO BOX 276, ALBANY, VT 05440. (514) 739-9328



DESIGNED SPECIFICALLY TO HOLD I.C. board for fast, simple, construction. Easy front to backside of board movement. Multi position head, rubber lined jaws, solid oak construction, finish tolerates cleanup with alcohol. Full refund if not completely satisfied. Send **\$21.50** each to: **ALLENS ELECTRONICS**, P.O. Box 235, Ephrata, WA 98823

CIRCLE 195 ON FREE INFORMATION CARD

Radio-Electronics mini-ADS



FREE CATALOG OF HARD-TO-FIND TOOLS is packed with more than 2000 quality items. Your single source for precision tools used by electronic technicians, engineers, instrument mechanics, schools, laboratories and government agencies. Also contains Jensen's line of more than 40 tool kits. Send for your free copy today! **JENSEN TOOLS INC.**, 7815 46th St., Phoenix, AZ 85044. (602) 968-6231.

CIRCLE 115 ON FREE INFORMATION CARD



DEC. R-E ARTICLE ON MACRO SCRUBBER, the original parts as mentioned MAK-1. All components shown on parts list and much more. Silk screened and etched P.C. board, power supply, IC sockets, precut jumpers, power jack, plug and pre-drilled enclosure. \$52.95 & 3.00 S/H. Order today from: **THE HOBBY HELPER**, P.O. Box 308, Bridgewater, MA 02324, or call (617) 339-1026. Visa/MC accepted.

CIRCLE 70 ON FREE INFORMATION CARD

INTERNATIONAL VIDEO IMPORTERS

ARE YOU TIRED of paying outrageous fees? Then let us provide you with a Converter or Descrambler that will entertain you, and your family for hours. For your **FREE CATALOG** write: **INTERNATIONAL VIDEO IMPORTERS**, 8867 Highland Rd., Baton Rouge, LA 70808, or call on our 24-hour **HOTLINE** (800) 634-0477. We also offer Security and Survival books—for full list send large (#10) S.A.S.E.

CIRCLE 199 ON FREE INFORMATION CARD

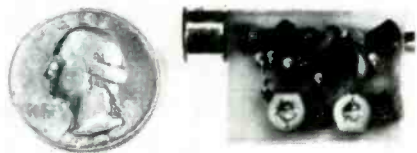

SIMPLY SNAP THE WAT-50 MINIATURE FM TRANSMITTER on top of a 9v battery and hear every sound in an entire house up to 1 mile away! Adjustable from 70-130 MHZ. Use with any FM radio. Complete kit \$29.95 + \$1.50 S + H. Free shipping on 2 or more! COD add \$4. Call or send VISA, MC, MO. **DECO INDUSTRIES**, Box 607, Bedford Hills, NY 10507. (914) 232-3878.

CIRCLE 127 ON FREE INFORMATION CARD



CABLE TV CONVERTERS AND DE-SCRAMBLERS. Large selection of top quality merchandise. Low prices. Quantity discounts. We ship COD. Most orders are shipped within 24 hrs. Send \$2.00 for catalog. **CABLETRONICS UNLIMITED**, P.O. Box 266 Dept. R, S. Weymouth, MA 02190 (617) 8435191

CIRCLE 186 ON FREE INFORMATION CARD



APPLIANCE REPAIR HANDBOOKS—13 volumes by service experts; easy-to-understand diagrams, illustrations. For major appliances (air conditioners, refrigerators, washers, dryers, microwaves, etc.), elec. housewares, personal-care appliances. Basics of solid state, setting up shop, test instruments. \$2.65 to \$5.90 each. Free brochure. **APPLIANCE SERVICE**, P.O. Box 789, Lombard, IL 60148. (312) 932-9550.

CIRCLE 84 ON FREE INFORMATION CARD

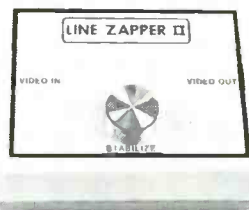

DECODE THE NEW VIDEO TAPE COPY PROTECTION SCHEME. Bothered by brightness changes, vertical jittering and video noise while watching rented tapes? Stop it with the **LINE ZAPPER**. New kit removes copy protection that often interferes with normal television operation. Complete KIT only \$59.95. Assembled with 1 year warranty \$99.95. Add \$4.00 shipping per unit. **ELEPHANT ELECTRONICS**, Box 41865-L, Phoenix AZ 85080. (602)581-1973. Allow 6 weeks for delivery.

CIRCLE 182 ON FREE INFORMATION CARD

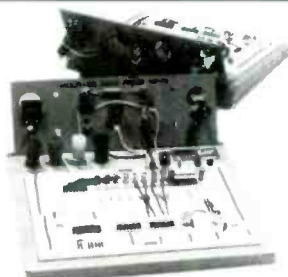

X-TRA EDGE SOLDERLESS BREAD-BOARDS. Four (4) models, each includes the Multi-use Edge Panel for mounting components which don't fit the 0.1" DIP size bread-board spacing. Transistors, SCRs, Triacs, Regulators, Heat Sinks, Switches, Lamps, Fuses, Pots, Buzzers, etc. Models include 810, 1620, 2230 and 2940 tie-points. Priced at \$16.95, \$34.95, \$49.95 and \$59.95. **CHENESKO PRODUCTS**, 21 Maple St., Centereach, NY 11720, 516-736-7977, Fax: 516-732-4650

CIRCLE 193 ON FREE INFORMATION CARD



PROGRAMMABLE TIMERS. The PTS27 and PTS31 LCD Timer Modules are an ideal replacement for microprocessor dedicated timers as well as mechanical time switches. With programming capabilities of up to three on/off time settings per day for the PTS31 and two on/off weekday, one Saturday and one Sunday time setting for the PTS27; they are both a cost effective approach to automating equipment and controls. Contact **DAKOTA DIGITAL**, RR5 Box 179E, Sioux Falls, SD 57107 (605) 332-6513.

CIRCLE 198 ON FREE INFORMATION CARD

COMPUTER DIGEST

VOL. 5 NO. 3 MAR. 1988

A NEW KIND OF MAGAZINE FOR ELECTRONICS PROFESSIONALS

BUILD A PRINTER MULTIPLEXER

Share your serial printer
with up to 4 computers

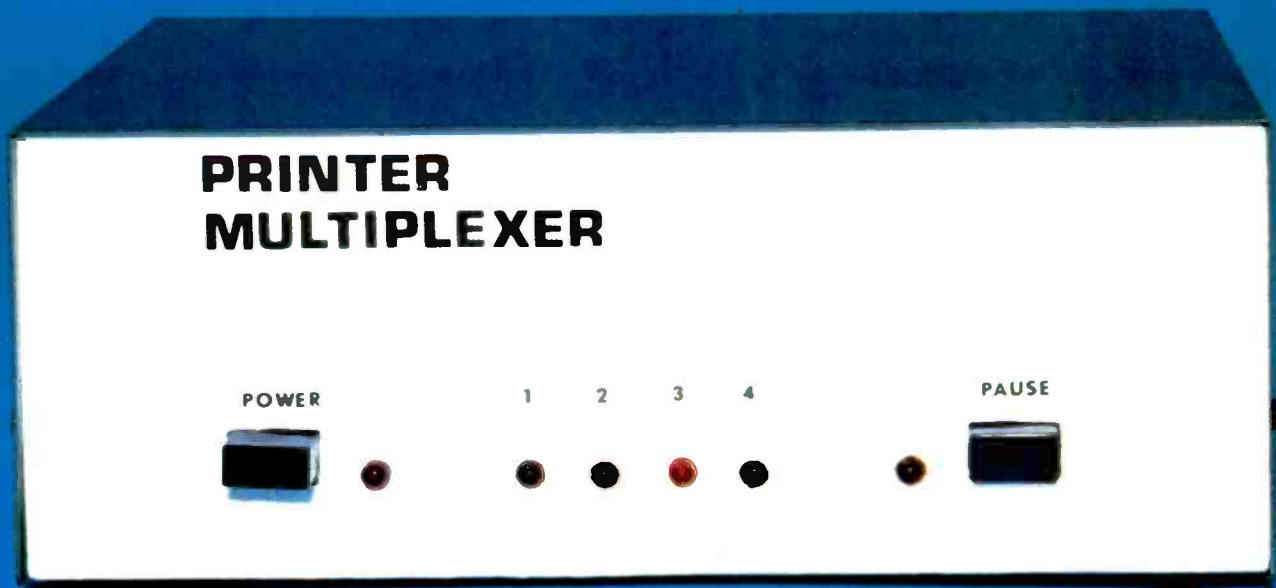

DESKTOP PUBLISHING

Pagemaker and Ventura Publisher face off

CONTENTS MARCH

1988

Vol. 5 No. 3



93 BUILD A SERIAL-PRINTER MULTIPLEXER
An economical multiplexer you can build

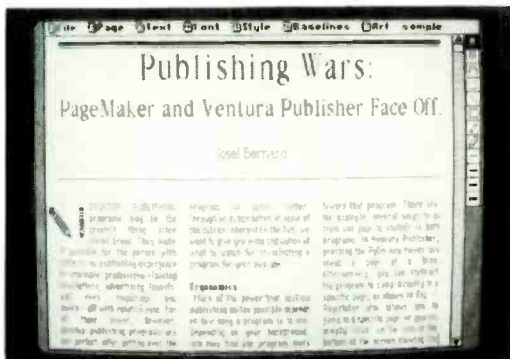

98 DESKTOP PUBLISHING
PageMaker and Ventura Publisher face off

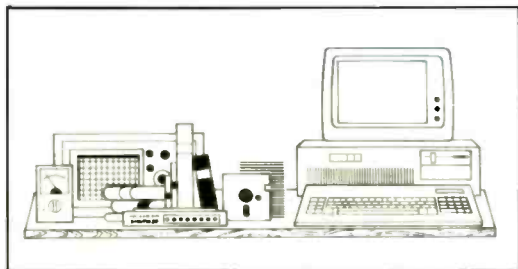

89 EDITOR'S WORKBENCH
A replacement motherboard and flip-top case for the AT, more on Turbo Pascal, and a file exchange system.

Note: CD CLASSROOM

We'll continue next month with more on building the PT-68K

COMPUTER DIGEST

Larry Steckler,
EHF, CET: publisher & editor in chief

Art Kleiman,
editorial director
Brian C. Fenton,
managing editor
Jeff Holtzman
technical editor
Byron G. Wels,
associate editor
Carl Laron,
associate editor
Robert A. Young,
assistant editor
Teri Scaduto
editorial assistant
Ruby M. Yee,
production director
Karen Tucker,
production advertising
Robert A. W. Lowndes,
production associate
Marcella Amoroso
production assistant
Andre Duzant,
technical illustrator
Jacqueline P. Cheeseboro
circulation director
Arline R. Fishman,
advertising director

ComputerDigest
Gemsback Publications, Inc.
500-B Bi-County Blvd.
Farmingdale, NY 11735

ADVERTISING SALES 516-293-3000

Larry Steckler
Publisher

NATIONAL SALES

Joe Shere
1507 Bonnie Doone Terrace
Corona Del Mar, CA 92625
714-760-8697

Cover Photography by Herb Friedman
and Jeff Holtzman

EDITOR'S WORK- BENCH

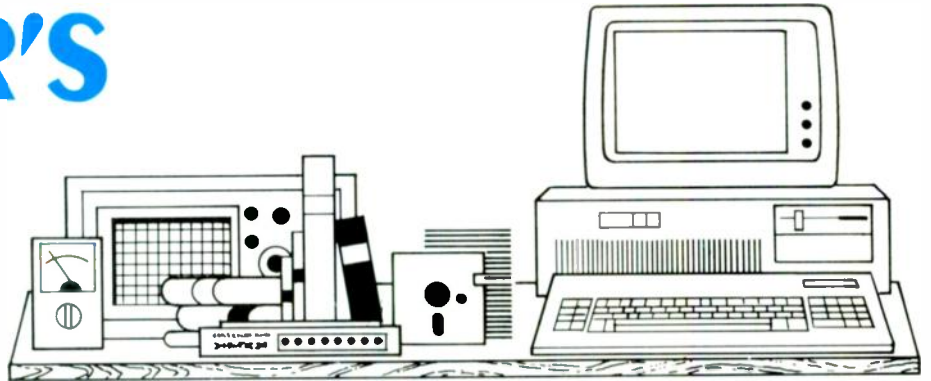

Baby AT Motherboard, Flip-Top Case from JDR Microdevices

Accelerator cards was our theme in the November 1987 issue. We examined a number of products, ranging from an inexpensive clock-speed enhancer to a 80386-based replacement motherboard that cost \$1500.

One product category we inadvertently neglected was the Baby AT motherboard, which packs the computing power of an AT onto a board that is the size and shape of a standard XT motherboard. By swapping your PC's motherboard with a Baby AT motherboard, you can thereby increase the performance of your machine without using an expansion slot.

There are several other advantages to a replacement motherboard. First of all, a well-designed board is, generally speaking, more reliable than an accelerator card, because all components (both hardware and software) have been selected to run at the correct speed.

The second advantage is more subtle: It provides you with a means of gradually upgrading your entire system, not just your CPU, as is the case with accelerator cards. The reason is that you can plug in your eight-bit memory card and disk controllers when you make the swap. Then, later, as your budget permits, you can add sixteen-bit components to further increase performance.

JDR Microdevices markets a high-quality dual-speed (8 and 10 MHz) Baby

AT motherboard that sells for under \$400. It has an on-board clock/calendar (with back-up battery), built-in set-up routines, terminals for connecting an external reset switch, speaker, keylock, and LED: speed indicator, and a math coprocessor socket. The support IC's are the Chips & Technologies set; the BIOS was written by Award Software.

The board comes without RAM, but with sockets for as much as one megabyte of RAM. You can install four banks of 64K DRAM's, two or four banks of 256K DRAM's, or two rows of both kinds of IC's. With four banks of 256K IC's, you can divide the RAM between DOS and extended memory equally (512K/512K), or as 640K (DOS) and 384K (extended). The extended memory can be used as a RAM disk, a disk cache, or directly by applications software (AutoCAD, for example) that knows how to use it. You can use standard 150-ns IC's at the 8-MHz speed; operation at 10 MHz requires 120-ns IC's. The faster DRAM's presently cost about 30% more than the slow ones.

The board comes with a slender manual that details connector pins, DIP switch settings, RAM-size selection, memory map etc. It does not provide detailed installation instructions, but that should be no problem for readers of **Computer Digest**.

The BIOS supports several types of floppy disks, including both 360K and 1.2M 5-1/4 inch diskettes, and 720K and 1.4M 3-1/2 inch diskettes. You can boot from any disk in a supported format. Numerous hard-disk formats are also supported by it.

The built-in set-up program allows you to set the clock/calendar, select hard- and floppy-disk type, primary video adapter, memory configuration, and default speed. If the set-up program detects an error, it so informs you, and allows you either to re-configure or to continue.

According to the manual, you should be able to switch speed via a hot key, but actually speed switching is accom-

plished through the set-up program or by an auxiliary program. A RAM-resident version of the speed-select program is also provided.

To install the board, remove all expansion cards from your PC, then remove its motherboard. Install RAM on the Baby AT motherboard, and then install the board itself. Last, re-install your expansion cards. The motherboard has eight slots: two are eight-bit XT slots, and six are sixteen-bit AT slots. Many eight-bit cards will fit in a sixteen-bit slot, but some won't because the board extends all the way down to a line that is parallel to the edge connector that plugs in the motherboard. Another problem will occur when you decide to upgrade your disk controller or expansion memory cards. AT cards are higher than PC/XT cards, so you'll need a new case.

After installing your hardware, everything works as before, only faster. The 8-MHz clock provides performance similar to a standard 8-MHz IBM PC AT, and the 10-MHz is about 25% faster than that. That's about four and five times, respectively, the speed of a standard PC.

Flip-top case

If you need a case for a standard-size motherboard (to mount the Baby AT motherboard, for example) we highly recommend JDR's Junior AT-style flip-top case. It sells for about \$150, includes a 150-watt power supply, and space for three half-height drives. The case also includes all necessary mounting hardware, and a decorous front panel with keylock, three LED indicators (labeled Power, Turbo, and Hard Disk), a momentary-action switch (labeled Reset), and a non-momentary switch (labeled Turbo).

We especially like the case because it is three inches narrower than a standard XT case, yet it provides easy access to the motherboard and disk-drive bays. Because the bays are stacked vertically, disk drives do not block access to the motherboard. The lowest bay is not accessible

through the front panel; normally you'd mount a hard disk there and two floppies (or one floppy and a tape backup unit) above.

The flip-top is highly convenient, especially if you do much testing, or otherwise need to get at your PC's innards very often. Another great convenience is the fact that you can completely remove the front panel, further increasing access to the guts of the machine.

The case is predrilled for a standard XT-style motherboard; plastic mounting hardware is included. The front-panel mounted components (speaker, LED's, etc.) all have long leads attached, and the leads are terminated in push-on Berg-type connectors. The only problem we've found is that the speaker connector is only two pins wide, instead of the standard four.

In addition to the two motherboard connectors, the power supply provides five connectors for disk drives, eliminating the unreliable Y connector often used to expand older PCs.

We've used the Baby AT motherboard and the flip-top case for several weeks beside our stock XT, and have experienced only one problem: We've been spoiled by speed. Working on the XT has become intolerable. ♦♦♦



Turbo Pascal 4.0 and Turbo Professional 4.0

Debugging tools for Turbo Pascal were reviewed in the December 1987 issue. As our review was being written, Borland announced a new version of Turbo Pascal. We finally managed to get a copy, and we are, to say the least, impressed. The compiler itself is faster, it produces faster code, and much leaner code. For example, the following program compiles under 3.0 to an 11K COM file, and under 4.0 to a 2K EXE file:

```
program hello;
begin
  writeln('Hello')
end.
```

Turbo 4.0 comes on three floppy disks; a 600-page manual describes the program. The disks contain several demonstration programs, a program useful for converting programs written in the pre-

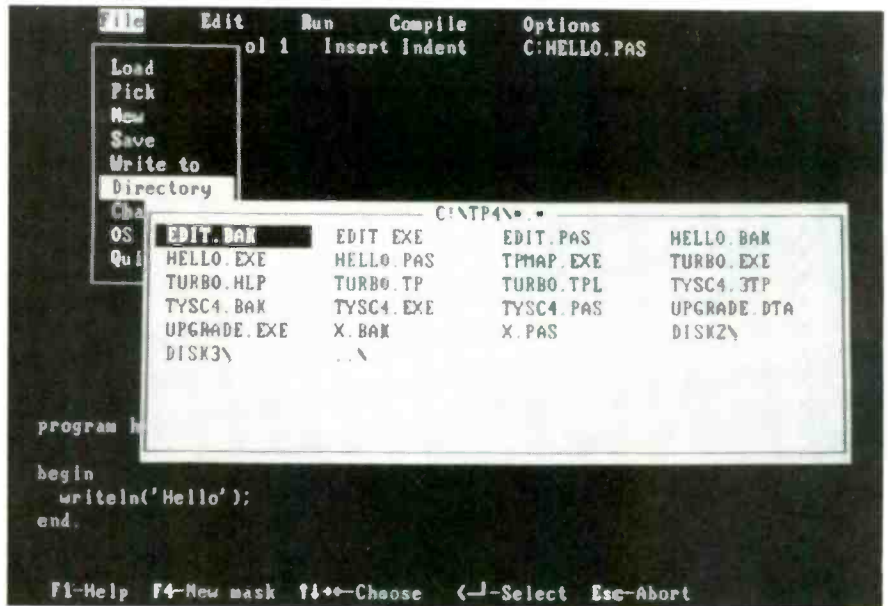

FIG. 1

vious version of the compiler, two versions of the compiler (the familiar integrated environment and a traditional command-line activated one), and quite a bit more.

Changes in the compiler include the ability to link "units" at compile time. A unit is a collection of routines that (usually) perform related tasks. For example, separate units are provided that provide screen handling, printer I/O, floating-point math, etc. Unused units need not be included in the run-time file, so, for example, you don't have to carry the floating-point library around in every program you write. You can create your own units for any specialized applications programs.

Pascal purists may object, but the new Turbo includes many non-standard extensions to the language. For example, there are now five integer data types (shortint, integer, longint, byte, word),

there are many hardware-dependent functions and procedures, including greatly expanded support for graphics.

The work environment still includes a configurable WordStar-like editor, but, as shown in Fig. 1, drop-down menus are now used to accomplish various tasks, and extensive on-line help is available at any time.

Turbo 4.0's only shortcoming, and one that we expect will be remedied in 1988, is lack of a debugger. (The debuggers discussed in the December issue will not work with 4.0 files.) However, compiled programs can be debugged using Periscope (also reviewed in the December issue of **Computer Digest**) or other third-party debuggers.

Turbo Professional 4.0

The first company to market an add-on product for Turbo 4.0 is Turbo Power Software (who also markets a debugger

| Dec | Chr | Binary | Oct | Hex | Ascii | Key | AuxKey | Color | Foregrnd | Backgrnd | Menu |
|-----|-----|----------|-----|-----|-------|-----|--------|----------|----------|----------|---------|
| 0 | | 00000000 | 000 | 00 | MUL | | ^Break | | Black | Black | Invis |
| 1 | Q | 00000001 | 001 | 01 | SOH | ^A | | Blue | Black | Black | Dim End |
| 2 | B | 00000010 | 002 | 02 | STX | ^B | | Green | Black | Black | Dim |
| 3 | V | 00000011 | 003 | 03 | ETX | ^C | ^g | Cyan | Black | Black | Dim |
| 4 | + | 00000100 | 004 | 04 | EOT | ^D | | Red | Black | Black | Dim |
| 5 | ^ | 00000101 | 005 | 05 | ENQ | ^E | | Magenta | Black | Black | Dim |
| 6 | ^ | 00000110 | 006 | 06 | ACK | ^F | | Brown | Black | Black | Dim |
| 7 | . | 00000111 | 007 | 07 | BEL | ^G | | Lt Gray | Black | Black | Dim |
| 8 | Q | 00001000 | 010 | 08 | BS | ^H | | Dk Gray | Black | Black | Invis |
| 9 | o | 00001001 | 011 | 09 | HT | ^I | | Lt Blue | Black | Black | Int End |
| 10 | Q | 00001010 | 012 | 0A | LF | ^J | | Lt Green | Black | Black | Intense |
| 11 | Q | 00001011 | 013 | 0B | VT | ^K | | Lt Cyan | Black | Black | Intense |
| 12 | Q | 00001100 | 014 | 0C | FF | ^L | | Lt Red | Black | Black | Intense |
| 13 | Q | 00001101 | 015 | 0D | CR | ^M | | Pink | Black | Black | Intense |
| 14 | Q | 00001110 | 016 | 0E | SO | ^N | | Yellow | Black | Black | Intense |
| 15 | Q | 00001111 | 017 | 0F | SI | ^O | ShTab | White | Black | Black | Intense |
| 16 | Q | 00010000 | 020 | 10 | DLE | ^P | AltQ | Black | Blue | Black | Dim |
| 17 | Q | 00010001 | 021 | 11 | DC1 | ^Q | AltW | Blue | Blue | Black | Dim End |
| 18 | Q | 00010010 | 022 | 12 | DC2 | ^R | AltE | Green | Blue | Black | Dim |
| 19 | Q | 00010011 | 023 | 13 | DC3 | ^S | AltR | Cyan | Blue | Black | Dim |
| 20 | Q | 00010100 | 024 | 14 | DC4 | ^T | AltT | Red | Blue | Black | Dim |

FIG. 2

for version 3). Turbo Professional 4.0 is a rewritten version of a similar set of routines developed for version 3; the new version includes many enhancements, excellent documentation, and several useful demo programs (for example, the RAM-resident programmer's reference shown in Fig. 2). Source code for all demos is included in the Turbo Professional 4.0 package.

Turbo Professional 4.0 includes several pre-compiled units that enhance or complement the units provided by Borland. (Again, all source code is included.) Those units provide many of the routines programmers end up writing for themselves or simply doing without. The new units provide extended string and screen handling, DOS and BIOS support, support for building your own interrupt service routines and RAM-resident programs, and much more. One example program shows you how to create a RAM-resident program using only thirty lines of code!

Separate utilities include a screen-generator that lets you create menus by "painting" them on the screen; the program then generates the appropriate Turbo Pascal source code for you. Other utility programs include a file sorter, a difference finder, several snazzy demos that show off Turbo Professional Windowing capabilities, as well as several useful RAM-resident "desktop accessories". Those "accessories" include such things as a programmer's calculator, the afore-mentioned reference chart, a keyboard macro program, and more.

All in all, Turbo Professional is a great piece of software; it should be useful to beginners and professionals alike. In fact, we like it enough to recommend it highly. ♦♦

Interchange File Exchange System

If you are considering the purchase of an IBM PS/2 but have put it off because your present library of 5¼-inch diskettes won't work with the new 3½-inch drive, take heart. Systems Manufacturing Technology (1145 Linda Vista Dr., San Marcos, CA 92064) has an elegant solution called *Interchange*. That product will allow you to exchange files between any two PC-compatible computers, in either direction, regardless of disk size or format.

Instead of using a diskette to transfer files from one machine to another, *Interchange* communicates files and data between the two computers via the parallel-printer ports. File exchange is not limited to disk-drive type, and data may be transferred from floppy or hard disk on one computer to floppy or hard disk

Products Evaluated

- Baby AT Motherboard, MCT-BATMB (\$379.95), and Junior AT-style flip-top case, (\$149.95), JDR Microdevices, 110 Knowles Drive, Los Gatos, CA, 95030, (800) 538-5000, (408) 866-6200.

CIRCLE 42 ON FREE INFORMATION CARD

- Turbo Pascal 4.0 (\$99.95 or upgrade for \$39.95), Borland International, 4585 Scotts Valley Drive, Scotts Valley, CA 95066, (800) 543-7543.

CIRCLE 43 ON FREE INFORMATION CARD

- Turbo Professional 4.0 (\$99.95), Turbo Power Software, 3109 Scotts Valley Drive, Suite 122, Scotts Valley, CA 95066, (408) 438-8608.

CIRCLE 44 ON FREE INFORMATION CARD

- Interchange (\$39.95), Systems Manufacturing Technology, 1145 Linda Vista Dr., San Marcos, CA 92064, 619-744-3590.

CIRCLE 45 ON FREE INFORMATION CARD

on the other with no restrictions as to destination or disk type. Data exchanges from a RAM disk to any other type of storage device can also be made using *Interchange*.

Interchange is a communications system that operates almost exactly like a modem. The *Interchange* package consists of nothing more than a parallel interface cable and a software program called

COPYX. When the cable is installed between the parallel-printer ports of the two computers and the software is run, file transfers between the two machines can be made very easily.

To initiate a file transfer, the COPYX program is first loaded into the computer that is to receive the file, causing an *Interchange* status screen to appear on the monitor and also sets up the system as the destination computer. Next, the COPYX software is loaded into the computer that contains the file to be sent, thereby establishing the communications link. The *Interchange* software comes on both a 5¼- and a 3½-inch diskette so that it can be used in systems having either type of drive.

Once the communications link is established, to transfer a file all you need to do is enter the file name and its destination; wild cards are permitted for source file names. If no destination is assigned, an identical file path is created by the software on the receiving disk for the file transfer.

Because *Interchange* sends data in parallel format, as opposed to the serial format used during a modem exchange, file transfers proceed at an extremely high speed; as a result an entire one-megabyte directory can be transferred in just under a minute.

Priced at \$39.95, *Interchange* is an excellent package that is economical and easy to use. —TJ BYERS. ♦♦



"There's a time and a place for color graphics, young man, but this isn't it."

R-E Computer Admart

Rates: Ads are 2 1/4" x 2 7/8". One insertion \$825. Six insertions \$800 each. Twelve insertions \$775. each. Closing date same as regular rate card. Send order with remittance to **Computer Admart**, Radio Electronics Magazine, 500-B Bi-County Blvd., Farmingdale, NY 11735. Direct telephone inquiries to Arline Fishman, area code-516-293-3000. **Only 100% Computer ads are accepted for this Admart.**

Why waste your time formatting disks?

Preformatted disks save you time and money!

Memorex • Nashua • 3M
5 1/4" (from 48c) • 5 1/4" HD • 3 1/2" • 3 1/2" HC
Call toll-free TODAY!

1-800-321-4668

In Colorado (303) 234-0871.
Open 8:00 to 5:30 Mountain Time,
Monday—Friday.

ALF

ALF Products, 1315F Nelson St.
Denver, CO 80215

CIRCLE 190 ON FREE INFORMATION CARD

SPECIAL EPROM PROGRAMMER



APROTEK 1000
ONLY
\$225.00

COMPLETE WITH
PERSONALITY
MODULE

117 AC POWER-RS-232 CONNECT
6 BAUD RATES - HANDSHAKE TO HOST
ALLOWS READ, WRITE, VERIFY & COPY

Comes complete with IBM-PC, Apple IIe, or CPM
(Specify Computer) Driver Program on Disc.

Programs the following 5 Volt 24 or 28 pin
devices: 2716 series through 27512, 25xx series,
68764 plus others. Please Specify Personality
Module desired with order. Additional Personality
Modules only \$15.00 ea. Full 1 year warranty.

TO ORDER: CALL 1-800/962-5800 OR WRITE
AFROTEK

1071-A AVENIDA ACASO Add
C/MARILLO, CA 93010 \$4.00 Shipping-USA
Info: (805) 987-2454 VISA or MC Add 3%
We Accept Govt., School & Large Corp. P.O.s

CIRCLE 203 ON FREE INFORMATION CARD

PC Compatible CASH DRAWERS



M-S CASH DRAWER

10711 Flower St., Stanton, CA 90680
(800) 544-1749

In California call:

(714) 821-1133

CIRCLE 192 ON FREE INFORMATION CARD

COMPUTER ASSEMBLY MANUALS



Eliminate
Guesswork!
Build with
Confidence!

BIG BLUE SEED for IBM™ BUILDERS!

Parts list, placement diagrams, instructions, mods, for assembling over 90 IBM-compatible bare cards. Latest version with guides for 640K, Turbo, AT & Baby AT MthBds. **\$17.95**

APPLE™ BUILDERS NEED APPLE SEED!

Instructions for assembling over 90 Apple-compatible bare cards including II+ & IIe MthBds. For ALL Apple enthusiasts and hobbyists **\$14.95**

SAVE 10% - ORDER TWO OR MORE MANUALS OVER 40 BARE IBM & APPLE CARDS IN STOCK
(MthBds - Disk - Video - Burner - MultiFn - I/O - Modem - Proto - etc)

Check/Money-order, VISA/MasterCard to:
NuScope Associates*, Dept RE
In U.S.A. In CANADA
P.O. Box 790 P.O. Box 742, Stn B
Lewiston, NY 14092 Willowdale, Ont. M2K 2R1
*A Division of Kosmic MicroTech Inc.

CIRCLE 72 ON FREE INFORMATION CARD

Motion Control & Data Acquisition



on your IBM PC or Apple II
and all compatibles

Smart 2 Axis Motion Controller: For many types of motors & encoders. New I.C. (from HP) allows changes & monitoring on the fly. Optically Isolated. W/SOFTWARE

Four Axis Stepper Driver: With SOFTWARE & motor for instant automation. \$95.

Fast A/D Board: With programmed gain, 650 KHz, 4 Inputs, \$220. Complete Scope hardware & SOFTWARE \$500. Also: 12 Bit A/D, Relay Driver, Real Time Clock. Circuit developers Project Book \$25.

How do you do it? Use our Local Applications Bus, **LAB 40**. One host adapter (\$150) supports up to 8 boards, like those above, on a 50 ft. ribbon cable.

Please call (415) 755-1978 for free literature.

Computer Continuum

75 Southgate Ave., Suite 6
Daly City, CA 94015 (415) 755-1978

coldblue™



A Ventilation System designed to extend the life of the IBM® PC, or PC/XT. Coldblue™ fits inside the PC to reduce operating temperatures up to 27° by directing airflow onto the boards. The choice of users worldwide because it really works! Fits clones too. One year warranty. **\$185**. Mandrill Corp., PO Box 33848, San Antonio, TX 78265 (800) 531-5314, (512) 341-6155. Dealers' inquiries welcome.

CIRCLE 191 ON FREE INFORMATION CARD

ICs PROMPT DELIVERY!!!

SAME DAY SHIPPING (USUALLY)
QUANTITY ONE PRICES SHOWN FOR DEC. 27, 1987

OUTSIDE OKLAHOMA NO SALES TAX

| DYNAMIC RAM | | | |
|-------------|----------|--------|---------|
| 1Mbit | 1048Kx1 | 100 ns | \$32.00 |
| 1Mbit | 256Kx4 | 100 ns | 28.00 |
| 51258 | * 256Kx1 | 100 ns | 6.75 |
| 4464 | 64Kx4 | 150 ns | 4.15 |
| 41256 | 256Kx1 | 150 ns | 5.65 |
| 41256 | 256Kx1 | 100 ns | 5.15 |
| 41256 | 256Kx1 | 120 ns | 4.25 |
| 41256 | 256Kx1 | 150 ns | 3.95 |
| 41264 | + 64Kx4 | 120 ns | 5.25 |
| EPROM | | | |
| 27C1000 | 128Kx8 | 150 ns | \$37.95 |
| 27C512 | 64Kx8 | 200 ns | 15.50 |
| 27256 | 32Kx8 | 250 ns | 6.50 |
| 27128 | 16Kx8 | 250 ns | 6.25 |
| STATIC RAM | | | |
| 43256L-12 | 32Kx8 | 120 ns | \$11.70 |
| 5565PL-15 | 8Kx8 | 150 ns | 3.30 |

OPEN 6 1/2 DAYS, 7:30 AM-10 PM SHIP VIA FED-EX ON SAT.

SUNDAYS & HOLIDAYS SHIPMENT OR DELIVERY, VIA U.S. EXPRESS MAIL
SAT DELIVERY INCLUDED ON MasterCard VISA or UPS CASH COU
FED-EX ORDERS RECEIVED BY: Factory New, Prime Parts 2100
THRU FR: 10:00 AM \$4.18 MICROPROCESSORS UNLIMITED, INC.
FR: \$1.10 \$0.25 BEGGOS, OK, 74421 24,000 S. Peoria Ave.
No minimum order. Please note that prices are subject to change. Shipping & insurance in the U.S. up to \$1 for packing materials. Orders received by 8 PM CST can usually be delivered the next morning, via Federal Express Standard Air in \$4.00, or guaranteed next day Priority One in \$10.00.

CIRCLE 61 ON FREE INFORMATION CARD

CALL NOW AND RESERVE YOUR SPACE

- 6 x rate \$800.00 per each insertion.
- Fast reader service cycle.
- Short lead time for the placement of ads.

Call 516-293-3000 to reserve space. Ask for Arline Fishman. Limited number of pages available. Mail materials to: Computer Admart, RADIO-ELECTRONICS, 500-B Bi-County Blvd., Farmingdale, NY 11735.



CSS-5152 Graphics Printer (Epson)

- 100% IBM Compatible
- IBM Parallel Interface, 80 cps
- IBM PC Graphics Compatible
- Order Cable No. 5152, \$10
- Discount on 2 or more

\$149

For more information on our products, send a self-addressed stamped envelope to:

Computer Surplus Store

715 Sycamore Drive
Milpitas, CA 95035
Tel. Orders: 408-434-1060
FAX: 408-434-0931

CIRCLE 202 ON FREE INFORMATION CARD

BUILD A SERIAL PRINTER MULTIPLEXER



Build a serial printer multiplexer for a fraction of what commercial units cost.

PAUL RENTON

Many a small business has more computers than printers. The reason why purchasing a separate printer for each user is unjustified is because few users actually print all day long. Besides, buying separate printers can be expensive.

The biggest problem of printer sharing is how to hook things up. Many people simply switch cables, but that's inconvenient, and wastes time. Others use some sort of mechanical switch, but that's also inconvenient, because the user must get up and physically push a button or turn a knob.

Another approach is to use a device called a printer multiplexer. The device connects the computer to the printer automatically, eliminating the need to switch cables or press buttons.

The multiplexer presented here allows you to connect as many as four computers to the same serial (RS-232) printer. The multiplexer works by scanning each computer's output port sequentially. As soon as one computer begins a print job, the multiplexer locks onto that computer and allows data to flow from computer to printer. Meanwhile, the busy lines to the other computers' output ports are asserted. When the print job is done, the multiplexer releases the busy lines, and resumes scanning.

One special feature of our printer multiplexer is the PAUSE button, which can be used to halt data flow from the computer to the printer. As long as that button on the unit is pressed, no computer will be able to send data to the printer.

How it works

To accomplish multiplexing the printer multiplexer uses hardware handshaking. Handshaking is the term used to describe what prevents the computer from sending data to the printer when the printer is not ready for it. Generally speaking, there are two types of handshaking: software and hardware. There are several varieties of each type of handshaking, but XON/XOFF and busy line, respectively, are the most common.

In the XON/XOFF method, the printer sends control characters to the computer to indicate when it is able to accept data, and when it is not. To use that type of handshaking, the printer multiplexer would have to be microprocessor controlled. We wanted a simple and inexpensive method of printer sharing, so software handshaking is not used.

In the busy-line method, the printer controls the state of its Data Terminal Ready line (which is usually pin 20 of a 25-pin D connector). In general, if DTR is high (+12 volts), then the printer can accept data. If DTR is low (-12 volts), then the printer cannot accept data. Unfortunately, some printers interchange the meanings of high and low. Our design does not allow for busy-line polarity selection, however, modifying the multiplexer to do so is a relatively simple task.

In the multiplexer, if the printer holds its own DTR line low (indicating that it's busy), then all DTR lines going to the computers are also held low. When the printer is ready to accept data, the DTR line of the currently selected

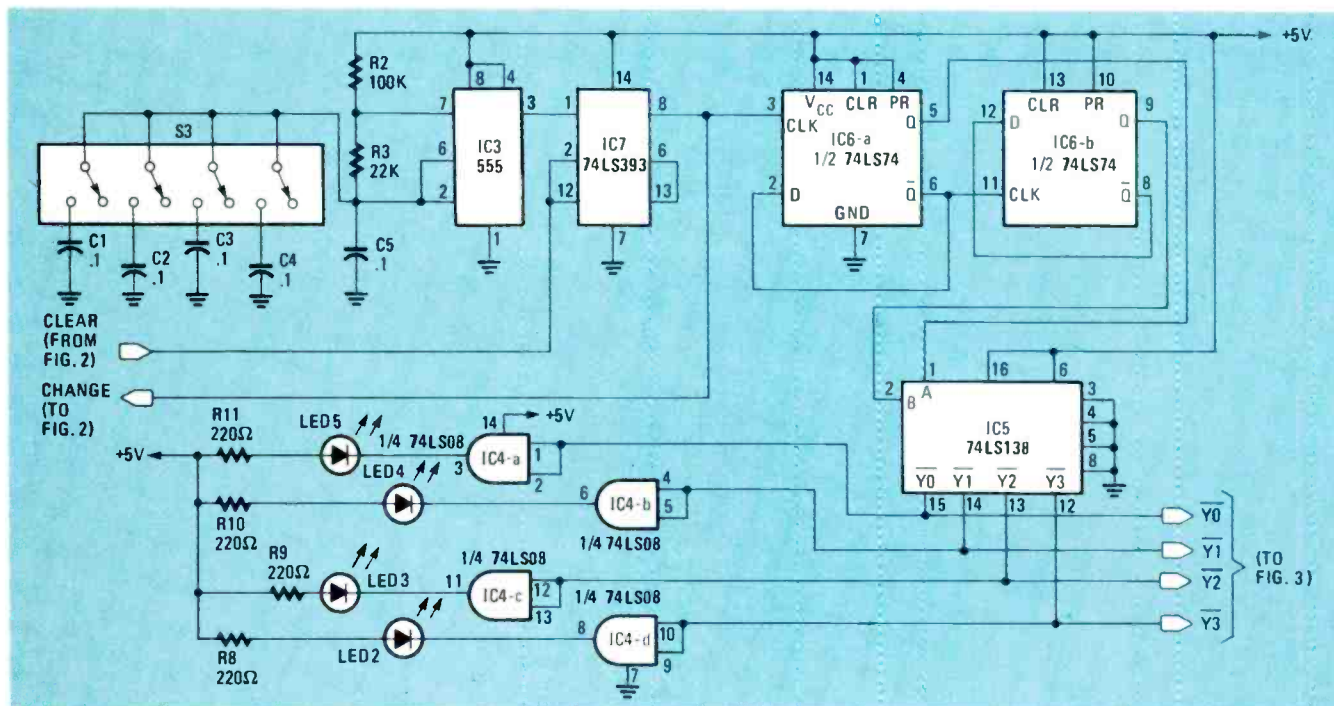

FIG. 1—SEQUENTIAL SCANNING CIRCUIT: As long as no signal is present at the CLEAR input, the outputs of IC5 are asserted one after the other.

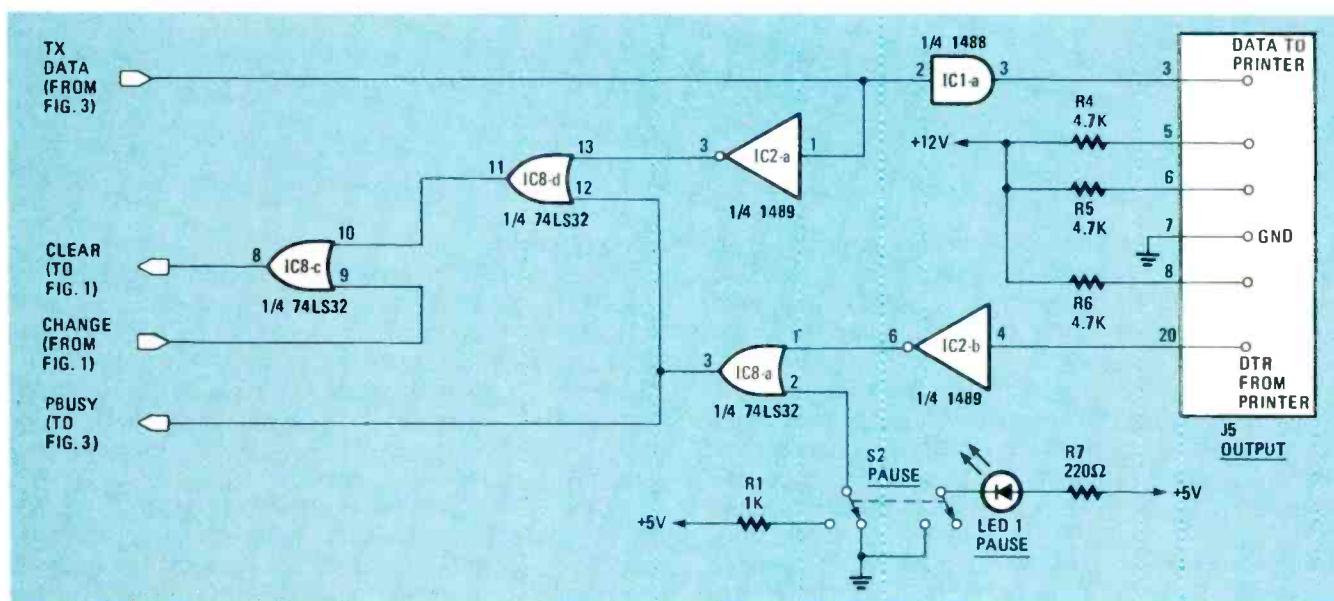

FIG. 2—PAUSE GENERATOR: This circuit causes scanning to stop whenever data is received at TX DATA, when the printer is busy (i.e., pin 20 of J5 is low), when the PAUSE switch is pressed, or when IC8 (shown in Fig. 1) changes state.

computer is released, and the DTR lines of the unselected ports remain low.

Computer-port selection is done with a 555 timer and three other IC's, as shown in Fig. 1. The 555 (IC3) runs in the astable mode; its rate determines how often the multiplexer switches ports. The values shown for R2, R3, and C5 cause a pulse to be generated about once every second. One second should be enough time for most applications, but the DIP switch (S3) allows additional capacitance to be added to the timing circuit; doing so increases the delay to two, three, four, and five seconds,

as each section of the switch is closed. Variable time delay was provided to ensure that a computer was not cut off in the middle of a print job. If five seconds does not allow enough time, resistor values could be increased to further increase the time delay.

Whatever the delay, the timer clocks IC7, a 74LS393 8-bit counter. After 128 counts, pin 8 of IC7 goes high, and that clocks IC6-a, half of a 74LS74, and it in turn drives IC6-b, the other half. The Q outputs of both flip flops are decoded by IC5, a 74LS138 3-to-8 line decoder. The active output of that IC selects the current computer. The

outputs labeled \bar{y}_0 through \bar{y}_3 are used to generate the DTR signals and thereby to determine the active port.

The selected computer port is indicated on the front panel via LED₂–LED₅. The 74LS138 outputs are simply buffered by IC₄, a 74LS08. As scanning continues, each LED lights up in turn.

The preceding description shows how the multiplexer cycles through the four ports. But how does it select one and stop the counting?

An input port is selected by way of the clear inputs (pins 2 and 12) of the 74LS393, which are used to inject a time delay in the switching sequence. If those inputs are brought high, then the counter resets and starts counting from zero again. So if it's continually cleared, it will never count 128 pulses, the flip-flops in IC₆ will not change state, and neither will IC₅.

Actually there are three reasons why IC₇ might be prevented from counting: when data is being sent from a computer, when the printer is busy, or when the pause function is engaged. As shown in Fig. 2, that is accomplished by using several OR gates (and some inverters).

As the computer sends data, the first bit of that data, which appears after buffering (by circuits discussed below) at the TX Data input of Fig. 2, will cause the clear lines to go high, resetting the counter. That signal is ORed with the DTR signal and with the output of the PAUSE button.

Thus, the counter will also be reset whenever the printer's DTR line goes low (indicating printer is busy); or the pause line goes high (indicating pause button is pressed).

In Fig. 3, IC₉-a, IC₉-c, and IC₉-d combine the data inputs from each port into the single signal that drives TX Data (shown in Fig. 3). The buffers in IC₁₁ convert the incoming RS-232 signals to TTL levels; the buffers in IC₁₀ convert the outgoing TTL signals to RS-232 levels.

The power supply, shown in Fig. 4, supplies ± 12 volts to power the 1488 line drivers. The power supply also provides +5 volts for the remaining circuits.

Construction details

It's easiest to build the multiplexer on a small double-sided PC board, patterns for which are shown in PC Service. You can also purchase your own from the source mentioned in the Parts List.

If you choose to make your own, here's a helpful technique that was suggested by a friend who works in a PC board factory. This technique allows you to etch the two sides of the board so that they are aligned correctly. If they're not, drilling the board can result in holes that are centered on one side of the board, but do not go through the center of the pad on the other side. In fact, with severe misalignment, traces can be cut!

Rather than etching a single 0.062-inch board with the

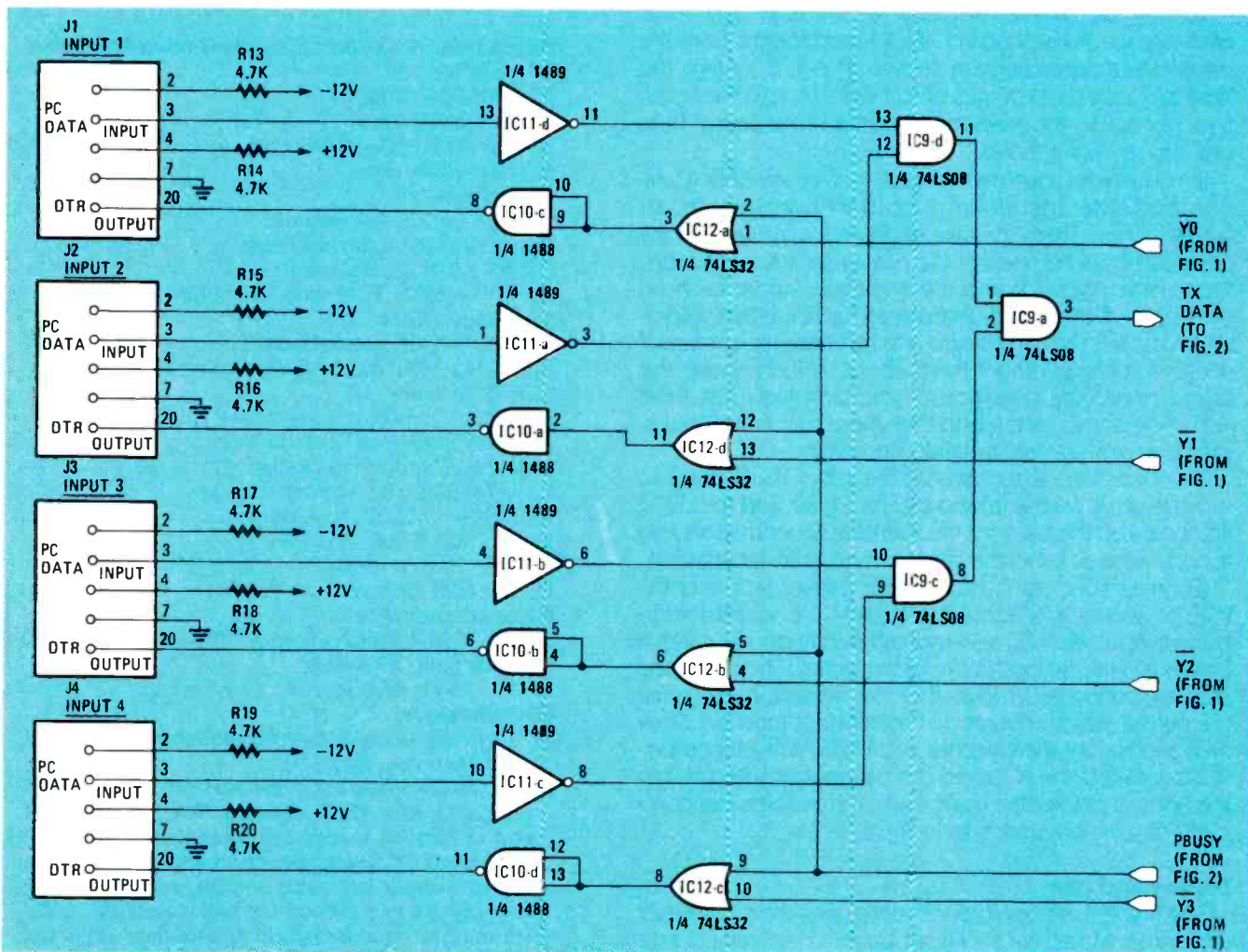

FIG. 3—THE DATA INPUTS of the four channels are ANDed together by IC₉-a, IC₉-c, and IC₉-d to drive the pause generator that is shown in Fig. 2.

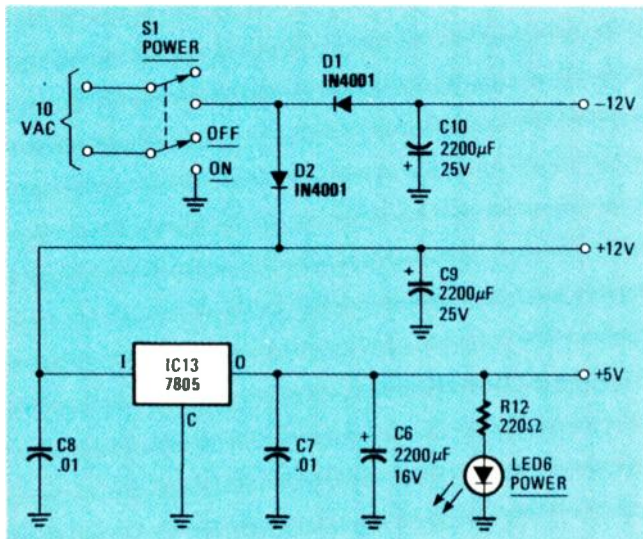

FIG. 4—THE MULTIPLEXER'S POWER SUPPLY: Mount IC13 on a small heatsink.

appropriate patterns on both sides, etch two 0.031-inch boards, one with the component-side patterns, and one with the foil-side patterns. When the two boards are placed back to back, you have a double-sided board with the standard 0.062-inch thickness.

To drill the boards, first drill feedthrough holes near each corner of each board. (Pick feedthroughs from the parts-placement diagram shown in Fig. 5.) Align the boards, insert short pieces of stiff wire through the holes, and then solder the wires to both sides of the board. Then drill the remaining holes.

If you made your own board, before mounting any components install and solder jumpers in all feedthroughs. Then, for ease of assembly, mount all discrete components, except the power-supply capacitors, the voltage regulator, and the switches. Solder each on both sides of the board. Then install the IC's, either soldering them directly to the board or with wirewrap sockets. If you use sockets, mount them about ¼ inch above the board, to provide clearance for soldering. Now install the remaining components, and then make sure that all polarized components are installed correctly.

The next step is to prepare the case. You'll need to provide holes on the front panel for S1, S2, and the LED's, and holes on the back for the five RS-232 connectors and the power jack. Label the case with dry-transfer lettering.

Connect (but don't mount) the power jack and the RS-232 connectors. Input jacks J1-J4 are wired identically; output jack J5 is wired differently, so be careful! Solder all wires to both sides of the board. Then, after the jacks are connected, mount them to the case, making sure the output jack is mounted in the correct location. Now wire and mount the switches and LED's. With all components installed, the PC board can be mounted. Secure it to the bottom of the case using ¾-inch standoffs. The complete assembly appears as in Fig. 6.

Testing and use

The first test is done before connecting the multiplexer to a printer. Make sure the PAUSE button is disengaged, and then apply power. The POWER LED should light up, as should one of the four port-indicator LED's. If that does

not happen immediately, remove power and make sure all parts were installed in the correct locations, with the correct orientation, and that all solder joints are good. When the board is debugged, resume testing.

With no printer connected, the first port-indicator LED should remain lit, indicating that the scanning circuitry is in the pause state, because the multiplexer's ready input (pin 20 of J5) is simply floating.

Now connect a printer and one or more computers to the multiplexer. Be sure that the printer is on, has paper loaded, and is on line. The computer should be configured for the printer's baud rate, number of start and stop bits, and DTR handshaking.

The port-indicator LED's should light up sequentially now, indicating that the multiplexer is checking the input ports for data to print. Engage the PAUSE button. The LED that is currently lit should remain so. Now release the PAUSE button; scanning should resume.

Now try printing something from a computer. As the sequencer reaches the port that the computer is connected to, it should lock onto that port, and the printer should begin to print. Printing can be suspended at any time by simply pressing the pause button. Of course, if your printer has any memory of its own, printing may

PARTS LIST

All resistors are ¼-watt, 5% unless otherwise noted.

- R1—1000 ohms
- R2—100,000 ohms
- R3—22,000 ohms
- R4-R6, R13-R20—4700 ohms
- R7-R12—220 ohms

Capacitors

- C1-C5—0.1 μF, disk ceramic
- C6—220 μF, 16 volts, electrolytic
- C7, C8—0.01 μF, disk ceramic
- C9, C10—2200 μF, 16 volts, electrolytic

Semiconductors

- IC1, IC10—1488, quad RS-232 line driver
- IC2, IC11—1489, quad RS-232 line receiver
- IC3—555, timer
- IC4, IC9—74LS08, quad AND gate
- IC5—74LS138, 3-to-8 line decoder
- IC6—74LS74, dual RS flip-flop
- IC7—74LS393, 8-bit binary counter
- IC8, IC12—74LS32, quad OR gate
- IC13—7805, 5-volt regulator
- D1, D2—1N4001 rectifier
- LED1-LED6, standard

Other components

- S1, S2—DPDT switch (Thorsen 35-491 or equivalent).
- S3—four pole DIP switch
- J1-J5—25-pin D connector

Miscellaneous

- 10-volt AC wall-mount power transformer, matching jack, case, hardware, etc.

Note: The following are available from Renton Products, P.O. Box 16271, Seattle, WA 98116: etched and drilled PC board, \$19; complete kit of parts (including PC board, punched and painted case, power supply, all components, and hardware), \$89; completely assembled and tested unit, \$129. Washington residents add appropriate sales tax. All orders add \$3 shipping and handling.

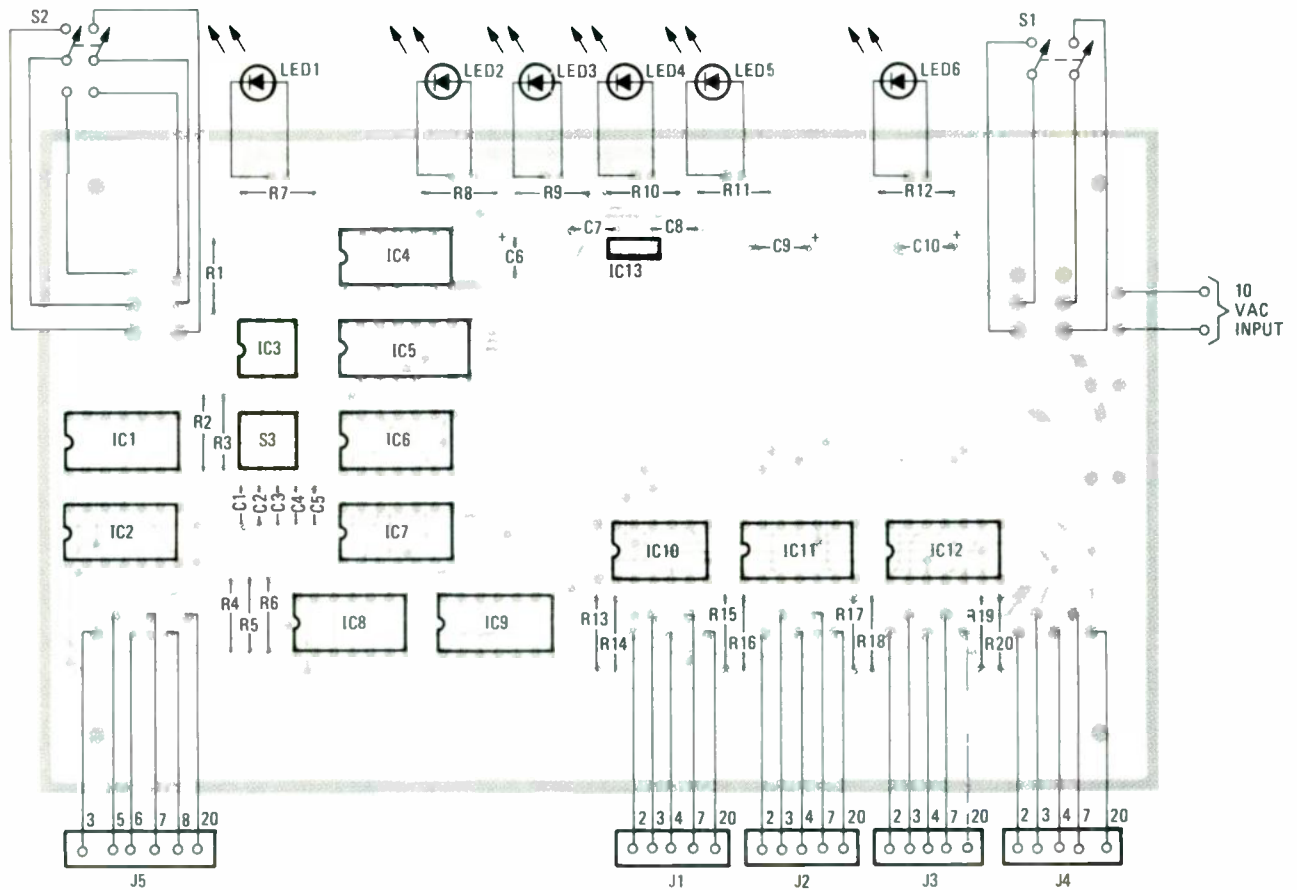

FIG. 5—MOUNT ALL COMPONENTS as shown here.

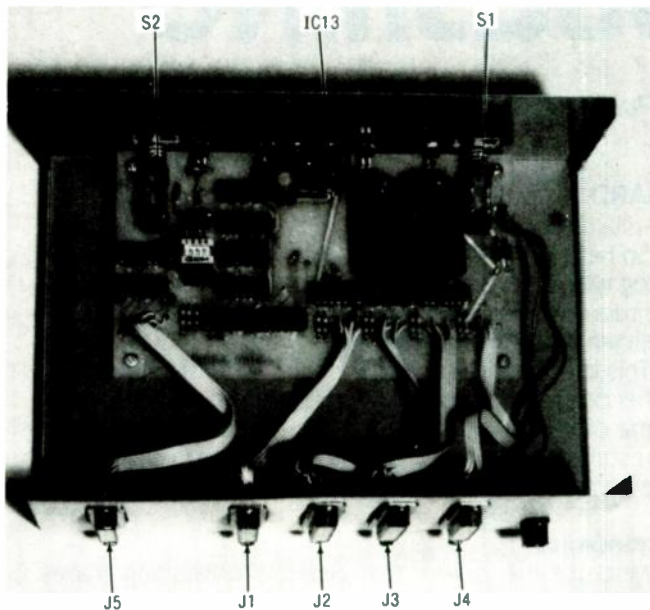

FIG. 6—THE FINAL ASSEMBLY looks like this.

continue for some time until the contents of that memory are exhausted. When the PAUSE button is released printing should resume.

Start a print job from the second computer before the first is finished. When the first computer is done the multiplexer will resume scanning. As it reaches the second computer's port, it should lock onto it and the printer should begin printing.

Cable notes

The multiplexer should be located with respect to the printer and the computers so that overall cable length is minimized. If a print buffer is being used, for all computers to benefit from it, it should be connected between the multiplexer and the printer.

Each of the multiplexer's input ports is configured so that it appears as a printer port. Data is received on pin 3, and pin 2 (which would be used to transmit data back from the printer to the computer) is simply held at a low RS-232 level. Pin 4 is the Data Set Ready signal; it is pulled high to 12–15 volts through a 4.7K resistor. Many computers require that pin to be high before they will transmit data.

The serial port of the IBM PC (and compatibles) is configured so that a cable with pin-for-pin connections (pin two to pin two, pin three to pin three, etc.) would be used with a modem. To connect a printer to a PC, a "null modem" cable must be built. The wiring is shown in Fig. 7. Or you could rewire the multiplexer's input ports so that a "straight" cable could be used.

The port from the multiplexer to the printer should be wired up with a straight cable. However, check your printer's documentation just to be sure.

Problems and solutions

You may have problems using the multiplexer with some software packages. For example, a CAD program might output some data, do some calculations, and then output some more data. During the calculations, the mul-

continued on page 102

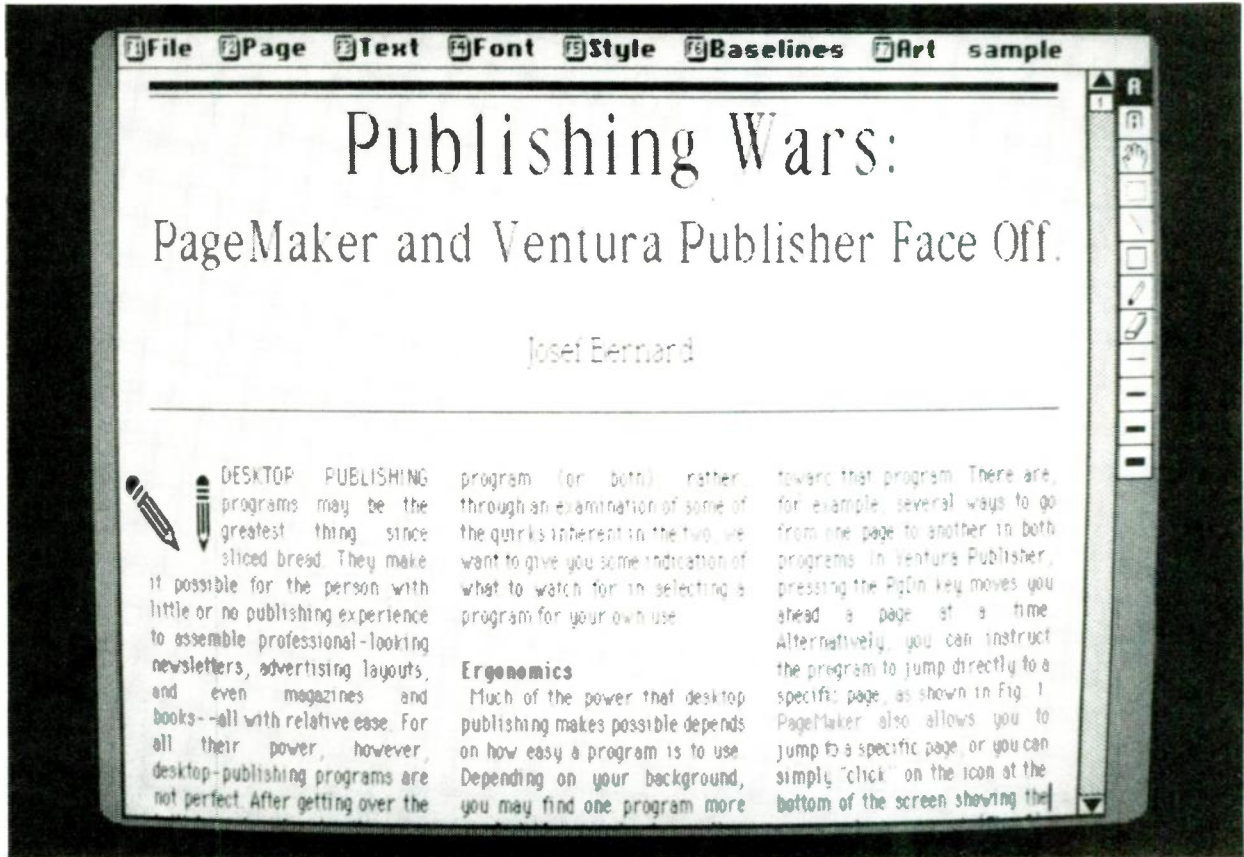

DESKTOP PUBLISHING

PageMaker and Ventura Publisher face off.

JOSEF BERNARD

In February we introduced you to desktop publishing packages. Now it's time to take an in-depth look at how two heavyweights—PageMaker and Ventura Publisher—fare in head-to-head competition.

Desktop publishing programs may be the greatest thing since sliced bread. They make it possible for the person with little or no publishing experience to assemble professional-looking newsletters, advertising layouts, and even magazines and books—all with relative ease. For all their power, however, desktop-publishing programs are not perfect. After getting over the initial wonder of seeing the pages of his publication appear like magic on the screen of his monitor, the desktop publisher soon begins to discover a number of “little things” that prevent him from doing exactly what he wants to.

In spite of those small things, each is a top-of-the-line program whose sheer number of features can make it overwhelming and difficult to work with. But that power is what makes those programs the first choice for many: Just about anything you need is there—if you can find it. Of course there are significant differences between them, and those differences can greatly affect your attitude toward, and use of, either package.

program (or both); rather, through an examination of some of the quirks inherent in the two, we want to give you some indication of what to watch for in selecting a program for your own use.

Ergonomics

Much of the power that desktop publishing makes possible depends on how easy a program is to use. Depending on your background, you may find one program more

toward that program. There are, for example, several ways to go from one page to another in both programs. In Ventura Publisher, pressing the PgDn key moves you ahead a page at a time. Alternatively, you can instruct the program to jump directly to a specific page, as shown in Fig. 1. PageMaker also allows you to jump to a specific page or you can simply “click” on the icon at the bottom of the screen showing the

So here is one user's view, based on several months of living with both programs. Two versions—1.0 and 1.1—of Ventura Publisher were used; the later one corrects many deficiencies of the earlier.

This is not intended to be a comprehensive review of either program (or both); rather, through an examination of some of the quirks inherent in the two, we want to give you some indication of what to watch for in selecting a program for your own use.

Ergonomics

Much of the power that desktop publishing makes possible depends on how easy a program is to use. Depending on your background, you may find one program more comfortable or easier to use than the other.

PageMaker, for example, runs under Microsoft Windows, and it has features that seem natural for users already used to working in that environment. And because it got its start on Apple's Macintosh, PageMaker, even on a PC-based system, will feel comfortable to a Macintosh user.

Ventura Publisher, on the other hand, runs under Digital Research's GEM (Graphics Environment Manager) en-

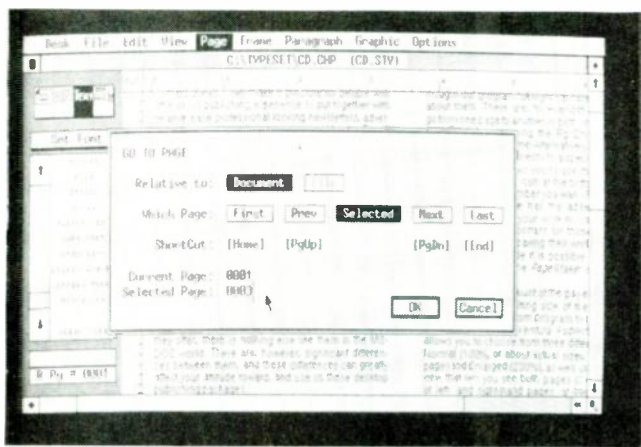

FIG. 1—THE “GO TO PAGE” DIALOG BOX in Ventura allows you to jump to any page in a document.

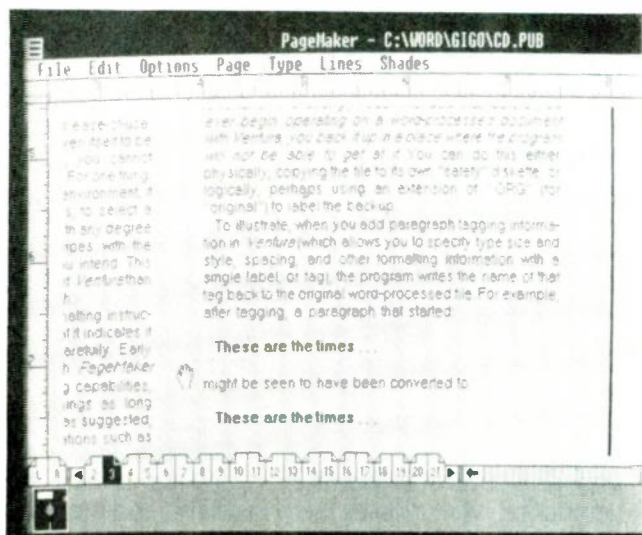

FIG. 2—CLICK ON THE DESIRED PAGE ICON in the lower left corner of the screen to go to that page in PageMaker. The current version of your publication is automatically saved for you. The “grabber hand” between the two columns of text provides an easy way of changing the view.

environment. GEM and Windows provide similar working environments, but they differ enough from one another so that once you establish a preference for one, switching to the other requires some effort.

Getting around in a program provides a good example of how established preferences (and well-thought-out program design) can affect your feelings toward that program. There are, for example, several ways to go from one page to another in both programs. In Ventura Publisher, pressing the PgDn key moves you ahead a page at a time. Alternatively, you can instruct the program to jump directly to a specific page, as shown in Fig. 1. PageMaker also allows you to jump to a specific page, or you can simply “click” on the icon at the bottom of the screen showing the page number you want (Fig. 2). (See the glossary elsewhere in this section for definitions of click and other mouse-related terms.) The click method in PageMaker has the added advantage of automatically saving the current page to disk before jumping to the new page—and that’s especially important for those who aren’t as conscientious about periodically saving their work as they should be. It’s possible to work with either method, but the PageMaker system is more convenient.

On-screen views

In both quantity and quality, page views—the amount of a page you can see on-screen—also differ from program to program, as do the resulting sizes of the characters and graphic images. Ventura Publisher, for example, allows you to choose from three different page views: Normal (100%, or about actual size), Reduced (entire page), and Enlarged (200%), as well as a Facing Pages view that lets you see both pages of a spread—a pair of left- and right-hand pages—at once. Views can be selected by picking an item from a menu, or by using a Control-key combination from the keyboard. The latter can be annoying for left-handed mouse users, because you must let go of the mouse, move your hand to the keyboard, press the appropriate keys, and then find the mouse again.

With a high-resolution, full-page vertical-screen monitor—a \$1000+ investment, as shown in Fig. 3—those three views might be enough. On an ordinary PC-type screen, however, you can usually see only a portion of a page at one time. At 100% and 200% magnifications, the only ones at which ordinary type sizes can be read, you must scroll blindly around the page to find what you want to see. Scrolling becomes laborious if you don’t know where a particular piece of text is located, because Ventura Publisher requires you to use separate vertical and horizontal scroll bars to move the page around in the screen’s field of view.

PageMaker provides you with more view-size choices, and with a more convenient system for working with them. In addition to allowing you to view pages at the three magnifications used by Ventura, PageMaker permits you to examine a page at 50% and 75% magnifications, which are frequently useful for getting an overall picture of a page while still being able to make out many of the details on it.

Moving around PageMaker’s screen is simpler than moving around Ventura’s. It can be accomplished in several ways. There are, for those who are comfortable with them, scroll bars that, in effect, move the electronic page



FIG. 3—A HIGH-RESOLUTION FULL-SCREEN MONITOR will permit you to view more of your work more legibly than a mono or EGA monitor. Such monitors generally cost \$1000 and more, but are a necessity for serious desktop publishing work.

beneath the screen window. There is also what Aldus calls a "grabber hand," which was shown back in Fig. 2. The hand seems to grab onto the page and slide it in the direction you move your mouse. The grabber hand permits movement in any direction, so it is considerably more convenient than combining separate horizontal and vertical movements via scroll bars.

A third type of screen movement relates another way in which PageMaker allows you to change page-size view. Besides the ability to select page views from menus and with Control-key combinations, PageMaker also has a simple "pcint-and-click" method of going from one size to another. Just by clicking on a page you are automatically switched to the next larger or smaller view, depending on the current view.

Further, the point where you click will become the center of the new view. To see a close-up, then, of a particular portion of a full-page view, all you have to do is to click where you want to more detail—and that certainly speeds things up. Version 1.1 of Ventura offers a similar feature: When you change views using a Control-key combination, the part of the screen on which the mouse pointer rests becomes the center of the new view.

Another comment on Ventura Publisher's ease-of-use: Ventura (especially in Version 1.0) has proven itself to be somewhat less than trustworthy. That is, you cannot always depend on it to do what you tell it to. For one thing, possibly as a result of its GEM operating environment, it is difficult, especially at low magnifications, to select a portion of text, or to operate on a graphic, with any degree of accuracy. It usually takes several swipes with the mouse to select precisely the material you want. The problem was worse in the original version of Ventura than in the updated one, but it exists in both.

Further, Ventura frequently seems to ignore formatting instructions, or to apply formatting contrary to what it indicates it is using, so you have to check your copy carefully. Early reviews praised Ventura Publisher for its global formatting capabilities, indicating that it was perfect for long articles and books. On the other hand, it was suggested that PageMaker was better suited to relatively short publications such as newsletters. However, in view of the fact that Ventura must be checked every step of the way for proper adherence to your instructions, whatever value this feature may pretend to offer is lost. (*Although global reformatting is not foolproof, Ventura offers better management of long documents: the ability to link "chapter" files together to create a multi-part document, and the ability to create tables of contents and indexes.*—Editor)

File Handling

The files created by both Ventura Publisher and PageMaker can be large, especially if much fancy formatting and graphics are involved. Each program handles files in a different way. Ventura breaks a publication up into a number of small files (Fig. 4), each containing information pertinent to a different aspect of that publication—captions, graphics, body text, etc. The total size of those files is not much greater than that of the simple text and graphics files by themselves.

Fortunately, Ventura keeps track of what's stored where and finds things automatically as needed. The package

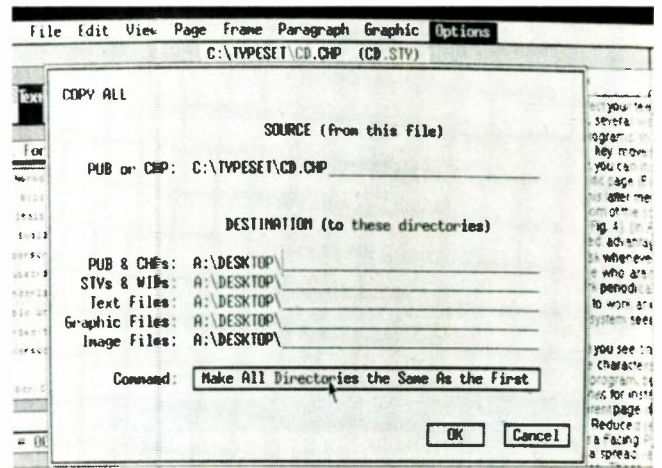

FIG. 4—A NUMBER OF SEPARATE FILES comprise a Ventura publication. Each file contains a different type of information, including text, graphics, format, etc.

includes a utility that will automatically find all the files related to a particular publication so they can be copied for backup or for transfer to another system.

By contrast, PageMaker puts everything required for a publication into a single file. Depending on the amount of formatting involved, even a single-page publication appears to require a minimum of almost 150K, and file sizes can rapidly approach—and exceed—the capacity of a 360K diskette. Special methods are required to transfer or backup such files.

One of the files that Ventura incorporates into a publication is the original text file. Unlike PageMaker, which imports a copy of a document file and leaves the original untouched, Ventura uses the original file, and modifies it as you edit and format it. The problem is that if you don't have a separate backup copy of your file, it's easy to modify it in ways you don't intend, possibly losing information. For example, while in Ventura, if you delete several paragraphs of text with the intention of bringing them into your publication somewhere else, you won't be able to unless you have a separate backup copy. For that reason, we strongly recommend that before you ever begin working on a document with Ventura, you back it up in a place where the program will not be able to get at it. You can do so by copying the file to a "safety" diskette, or perhaps by creating an additional copy on your hard disk with an .ORG extension (for original).

To illustrate: When you add paragraph-tagging information (which allows you to specify type size and style, spacing, and other formatting information) to a Ventura publication, the program writes the name of that tag back to the original text file, which can be in a number of different formats, including WordStar, XYwrite, DCA, etc. For example, a paragraph that begins:

These are the times . . .

might be converted to:

BODY TEXT = These are the times . . .

Ventura's ability to recognize and pick up tagging information from those embedded labels can be convenient if you intend to specify formatting as you write or edit with your word processor. It is, however, a nuisance if you want to print out the word-processed (not the Ventura) version of your document. In addition, Ventura doesn't

always recognize that embedded tagging information. In fact, it frequently seems to ignore it, or to carry over the embedded labels into the document as if they were text and not formatting information. That makes putting such formatting information into a text file—and trusting that it will make it through into your publication—a risky business, at best.

Graphics

Both Ventura Publisher and PageMaker are able to create simple graphics (lines, circles, boxes, etc.), and both can import graphics from AutoCAD, PC Paintbrush, and other CAD and draw/paint programs. Ventura and PageMaker offer comparable drawing facilities, and each has its own special touches. Pagemaker's graphics toolbox is shown in Fig. 5.

For example, besides serving to separate columns or to set off artwork in a publication, lines can be used for special effects. For example, if you use a radical (square root) sign, you may want to extend a line over the entire part of the mathematical expression included under that sign. Hyphens or dashes probably won't do the job, but a custom-drawn rule will.

Here, another facet of Ventura's imprecision shows itself. It turns out that Ventura works in much larger increments than PageMaker. That is, in PageMaker you can draw a line of any length, or extend or shorten a line to any length, and position it anywhere on the screen. The only restricting factor seems to be the resolution of the display being used.

Ventura, though, has definite ideas about such things. You can draw a line of this length or that, but not of any length in between (Fig. 6). Similarly, you can move the line to here or there, but not to an intermediate position. The quantum of movement seems to be only about the width of a character, but that's enough to frustrate many dreams of perfect composition.

Imported artwork is another story. In general, you can place a graphic image or digitized photograph anywhere you like, and, because it is a whole, any imprecision in placement will not affect its content. Within limits, either program even allows you to change the size and aspect (height-to-width) ratio of an image.

Both Ventura and Pagemaker have definite restrictions on the graphics programs (and devices, in the case of scanned images) from which they can import images. If you plan to incorporate graphics into a publication, check—before you get too deeply involved and it's too late—to make sure that the graphics material is compatible with the desktop publishing program you want to use.

Image format can also be a problem. AutoCAD, for example, can save drawings in several different formats. Ventura can use several of them; PageMaker allows you to select from several others. Of course, formats that PageMaker and Ventura can use are different.

Further, some of the acceptable formats do not translate completely when they are converted from the original AutoCAD format, and some special effects may get lost. That's not always important, but it may be critical in your application.

Also, one of the formats accepted by Ventura is not available in early versions of AutoCAD, only in the most recent ones. So be aware of what you're going to have to work with before you reach the point of no return.

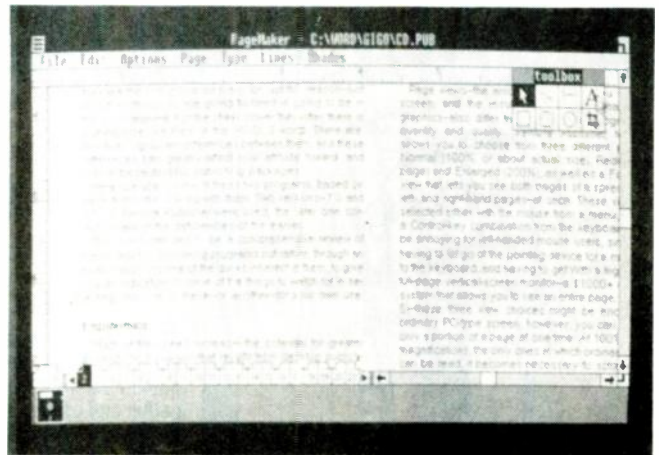

FIG. 5—PAGEMAKER PROVIDES A GRAPHICS TOOLBOX (shown in the upper right corner) that allows you to create lines, circles, and boxes, and to crop and scale graphics images.

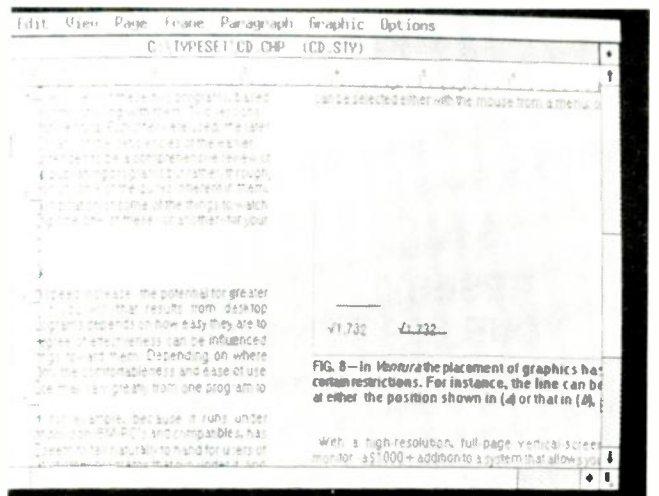

FIG. 6—PLACING GRAPHICS IN VENTURA is imprecise. For example, it was impossible to extend the line over the mathematical expression in the box properly. Either it is too high (left) or too low (right).

It's up to you

Just as there are those who feel that PageMaker is unquestionably superior to Ventura, there are no doubt a number of Ventura users who deride PageMaker as being too "Macintosh-y," too inconvenient, and too time-consuming. They may, for instance, be accustomed to using scroll bars to maneuver about the screen, and they may feel that any other system is awkward and perhaps even "unprofessional." And Ventura does have a number of specialized features that simply don't exist in PageMaker.

So to decide which program is best for you, you have to consider the type of publication you will produce, and the programs (word processor and graphics) you will use to create it. We mentioned some difficulties with AutoCAD earlier; another example is Microsoft Word: present versions of both PageMaker and Ventura can not accept formatting information contained in Word's style sheets. As for the missing features—can you work without them or around them?

You may come to the conclusion that neither program is suitable for your purposes, and that another will serve you better. But whatever you decide, we hope that the information presented here will give you some idea of what's available and the kinds of problems to expect. ♦♦♦

R-E Engineering Admart

Rates: Ads are 2¼" × 2⅞". One insertion \$825. Six insertions \$800 each. Twelve insertions \$775 each. Closing date same as regular rate card. Send order with remittance to **Engineering Admart**, Radio Electronics Magazine, 500-B Bi-County Blvd., Farmingdale, NY 11735. Direct telephone inquiries to Arline Fishman, area code-516-293-3000. *Only 100% Engineering ads are accepted for this Admart.*

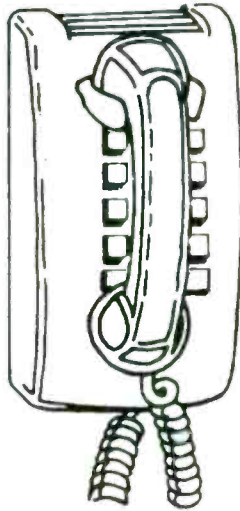

CALL NOW AND RESERVE YOUR SPACE

- 6 × rate \$800.00 per each insertion.
- Fast reader service cycle.
- Short lead time for the placement of ads.

Call 516-293-3000 to reserve space. Ask for Arline Fishman. Limited number of pages available. Mail materials to: Engineering Admart, RADIO-ELECTRONICS, 500-B Bi-County Blvd., Farmingdale, NY 11735.

MIDI PROJECTS

MIDI Projects

BP182—MIDI interfacing enables any so equipped instruments, regardless of the manufacturer, to be easily connected together and used as a system with easy computer control of these music systems. Combine a computer and some MIDI instruments and you can have what is virtually a programmable orchestra. To get your copy send \$6.95 plus \$1.00 for shipping in the U.S. to **Electronic Technology Today Inc.**, P.O. Box 240, Massapequa Park, NY 11762-0240.

117 PRACTICAL IC PROJECTS BUILD YOU CAN

2645T—117 PRACTICAL IC PROJECTS YOU CAN BUILD..... \$10.95. Dozens of fully-tested, ready-to-build circuits you can put together from readily-available, low cost IC's! There are a total of 117 IC circuits ranging from an audio mixer and a signal splitter to a tape-deck amplifier and a top-octave generator organ! From TAB Books. To order your copy send \$10.95 plus \$2.75 shipping to **Electronic Technology Today Inc.**, P.O. Box 240, Massapequa Park, NY 11762-0240



FCC LICENSE PREPARATION

The FCC has revised and updated the commercial license exam. The **NEW EXAM** covers updated marine and aviation rules and regulations, transistor and digital circuitry. **THE GENERAL RADIOTELEPHONE OPERATOR LICENSE - STUDY GUIDE** contains the necessary preparation for **ONLY \$25.00.**

WPT PUBLICATIONS
979 Young Street, Suite A
Woodburn, Oregon 97071
Phone (503) 981-6122

CIRCLE 180 ON FREE INFORMATION CARD

Circuit Board Layout Made Easy!

Create and Revise P-C-B Artwork on your IBM or Compatible

- User Friendly
- Supports Microsoft Mouse
- Economical
- 2X artwork on printer
- On-line Help Screen

Requirements: IBM or compatible PC - 256K memory - CGA card - IBM graphics compatible printer.

ONLY \$99.00



2145 Highland Ave. Ste. 201
Birmingham, Al. 35205
(205) 933-1122

DEMD DISK \$10.00

CIRCLE 201 ON FREE INFORMATION CARD

PRINTER MULTIPLEXER

continued from page 97

tipler's timer may time out, in which case the multiplexer would resume scanning. It might then lock onto another port and mix up print jobs.

Another problem might be using a word-processor in a single-sheet mode, wherein the software pauses after printing each page and then allows you to insert a new sheet of paper. Again, during the pause, the multiplexer could resume scanning.

The solution in both cases would be to increase the timeout period. First try closing the sections of the DIP switch; if that doesn't help, you can increase resistor values, capacitor values, or both, in the 555 circuit.

Another less-desirable approach is to press the multiplexer's PAUSE button when you need to change sheets of paper. You could also take the printer off line.

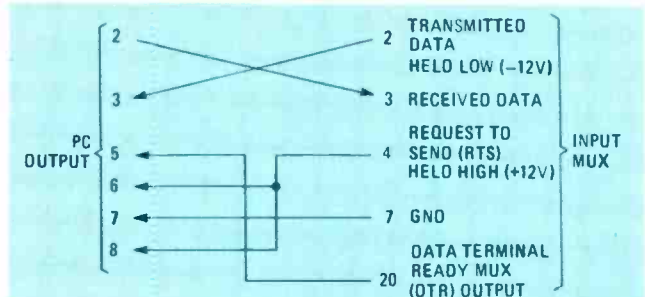

FIG. 7—HOW TO CONNECT THE MULTIPLEXER to an IBM PC or compatible.

Some programs may tell you that the printer is not ready if the DTR line is low. That could happen if a second print job were started before a first ended. In that case you may find that it is necessary to instruct your program to print several times until the multiplexer gets around to checking your port. ♦♦

HARDWARE HACKER

continued from page 79

used between the *IIC* and the adaptor.

It is very important that both ends are speaking the same data rate and format. A good starting point is 1200 baud, no parity, and two stop bits. You can speed things up later after you get the basic process working.

Note particularly the treatment of pins 4 and 5. The COM-1 port uses the CTS and RTS auxiliary handshake signals, while their use and support on the Apple side is very rare.

Should you elect to use a communications program on the *IIC* end, you should also cross pins 2 to 3, 3 to 2, 6 to 20, and 20 to 6.

What's new this month?

There's an interesting RF/IF Signal Processing Handbook available free from the Mini-Circuits people. Among other products, they have some very low-cost (99

cents!) and ultra-wideband linear amplifiers available.

One possible source for oddball or discontinued IC's is Rochester Electronics. Stock here is catch as catch can.

You might want to see if you can qualify for a free subscription to the *NASA Tech Briefs*. This monthly magazine has all sorts of interesting ideas, some electronic, others just high tech. More often than not, their ideas "just barely miss", but with a little thinking and rework, there can be a gold mine here.

News and Views of Imagination is a very interesting newsletter with lots of future oriented ideas in the electronics, computing, and related engineering fields.

There's also a publication called the *Payphone Exchange* if you are at all interested in the commercial payphone business. These days, most anyone can install their own private pay telephone just about anywhere they want to.

Turning to my own products, I've now got a complete set of au-

tographed and bound *Ask the Guru* reprints from my sister column over in *Computer Shopper* magazine. Those mostly involve Apple-II computing and desktop publishing, plus several hacker goodies not found elsewhere.

And, if you might be thinking of converting your hardware hacking into a source of nickels, be sure to check out my *Incredible Secret Money Machine* book. Write or call, and I'll be happy to send you more info on these and others. R-E



"Using a metal detector in this weather isn't as dumb as you think! We're looking for the snow plow!"

When someone in your family gets cancer, everyone in your family needs help.

Nobody knows better than we do how much help and understanding is needed. That's why our service and rehabilitation programs emphasize the whole family, not just the cancer patient.

Among our regular services we provide information and guidance to patients and families, transport patients to and from treatment, supply home care items and assist patients in their return to everyday life.

Life is what concerns us. So you can see we are even more than the research organization we are so well known to be.

No one faces cancer alone.

AMERICAN CANCER SOCIETY

87" HI-TECH SALE

Cobra Stun Gun generates 45,000 volts of stopping power, the Cobra also delivers a burst of high intensity light directly into an attacker's eyes. Chances are that his optic nerves will be so overloaded with excess light energy that he will not be able to see you let alone continue the attack. If he does, the Cobra delivers its painful bite, leaving him dazed and confused. \$49.95. With NiCad battery & charging kit \$59.95 + \$3.74 shp.

Centron Security Light

The Centron security light puts unwelcome visitors in the spotlight... instantly! This smart lighting system's infrared sensors guard your yard or driveway when you're away or home alone. It senses the presence of people or cars by changes in temperature patterns and instantly floods the area with bright light. It guides your guest to your door and scares away would-be prowlers \$55.00 plus \$4.99 shipping.

Remote Control Pen.

Not only is it a hand-some high quality ball point writing pen, but a powerful remote-control device. Effective at distances up to 75 yds, the Remote Control Pen is perfect for turning on or off any 120 volt appliance or alarm system. Think of the possibilities. \$39.00 shipping \$3.74.

The Private Eye Motion Detector.

Alarm warns you to the presence of an intruder but the intruder doesn't know he has been detected. No wires just plug it in and it works. Information travels from the detector to the receiver via the electrical system. \$63.00 shipping \$5.40

World's smallest dialer \$49.95 Alcohol Breath Analyzer \$59.00
Levitor \$79.95 Telemonitor 2000 \$175.00
Pistol Cross Bow \$59.95 Remote Car starter..... \$225.00
All products ready to use and Guaranteed
ORDERS CALL TOLL FREE 1-800-624-1150 For information
or free catalog call 402-554-0383 or write
United Imports & U.S. Mfg. Order by December 15th
68446 Pacific St. Omaha, Nebraska 68106 and we guarantee delivery
by the 24th M.C. VISA

CIRCLE 53 ON FREE INFORMATION CARD

UNGAR UTC 100 Electronic Soldering System

**SPECIAL
\$55.95**



- One Year Warranty
- U.L. Listed

The UTC combines accurate closed loop temperature control with economy. Easily calibrated at the station without disassembly, the CMOS-safe unit is fully grounded from tip to plug and meets military specs. System comes equipped with a macro iron, burn resistant cord and replaceable ceramic heater.

List
\$74.25

w.s. JENKS & Son



1933 Montana Ave. NE
Washington DC 20002
(202) 529-6020

TOLL-FREE
1-800-638-6405

CIRCLE 66 ON FREE INFORMATION CARD

MARCH 1988

MARKET CENTER

PLANS AND KITS

HI-FI speaker systems, kits and speaker components from the world's finest manufacturers. For beginners and audiophiles. Free literature. **A&S SPEAKERS**, 3170 23rd Street, San Francisco, CA 94110. (415) 641-4573.

VOICE disguisers! FM bugs! Telephone transmitters! Phone snoops! More! Catalog \$1.00 (Refundable): **XANDI ELECTRONICS**, Box 25647, Dept. 60Y, Tempe, AZ 85282.

BUILD this five-digit panel meter and square-wave generator including an ohms, capacitance and frequency meter. Detailed instructions \$2.50. **BAGNALL ELECTRONICS**, 179 May, Fairfield, CT 06430.

CRYSTAL radio sets, plans, kits, catalog \$1.00. **MIDCO**, 660 North Dixie Highway, Hollywood, FL 33020.

TOP quality imported, domestic kits, surplus, discount electronics, computer components. **FREE** catalog. **TEKTRASONIX**, 1120 Avenue of the Americas, 11th suite 4038, New York, NY 10036.

MINIATURE electronic devices, like James Bond's. Catalog \$2.00. **F & P ENTERPRISES**, Box 51272, Palo Alto, CA 94303-L.

STRANGE stuff. Plans, kits, new items. Build satellite dish \$69.00. Descramblers. Bugging information adult toys. Informational photo package \$3.00 refundable. **DIRIJO CORPORATION**, Box 212, Lowell, NC 28098.

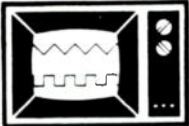

FINALLY!

An interesting and worthwhile project. This **EASY-TO-BUILD** circuit lets you use any regular TV set as a simple **OSCILLOSCOPE**. Build for less than \$10. **NO MODIFICATIONS TO TV!** Single or dual trace. Send for **FREE CATALOG** of other plans and kits.

DETAILED PLANS: \$4.95
TV-SCOPE
PENN RESEARCH, Box 3543
Williamsport, PA 17701

THE DECODER. National monthly technical newsletter covering Satellite/Cable descrambling systems. Includes: news, schematics, modifications, reviews, tips and more!!! \$18.00 per year. Sample \$2.00. **TELECODE**, Box 6426, Yuma, AZ 85364-08740.

FREE microprocessors, memory chips, etc. Free education in computers—12/14 free electronic magazines. For info write **MICRO SAT CORPORATION**, 2401 N.E. Cornell, Hillsboro, OR 97124.

SCRAMBLING news. Monthly interesting informative. Sample \$3 (refundable). \$24.95/yr. **SHOJIKI ELECTRONICS CORP.**, 1327R Niagara St., Niagara Falls, NY 14303. CODs (716) 284-2163.

REMOTE CONTROL KEYCHAIN



Complete w/mini-transmitter and +5 vdc RF receiver. Fully assembled including plans to build your own auto alarm.

\$19.95 Check, Visa or M/C 30 days return

VISITECT INC. (415) 872-0128
PO BOX 5442, SO. SAN FRAN., CA 94080

FREE power supply, connectors (\$8.95 value) with assortment #103 (February 1984 article) has printed circuit, TOKO coils, transistors, IC's, diodes \$25.00 five/\$112.50 shipping \$2.00. **JIM RHODES, INC.**, P.O. Box 3421, Bristol, TN 37625.

MUSIC on hold circuit. Add to any phone. Plans \$10.00. Catalog \$2.00. **LESTRONICS**, Box 2321-R, St. Louis, MO 63114.

FREE catalog 99-cent kits—audio, video, tv, computer parts. **ALLKIT**, 434 W. 4th St., West Islip, NY 11795.

CLASSIFIED AD ORDER FORM

To run your own classified ad, put one word on each of the lines below and send this form along with your check to:

Radio-Electronics Classified Ads, 500-B Bi-County Boulevard, Farmingdale, NY 11735

PLEASE INDICATE in which category of classified advertising you wish your ad to appear. For special headings, there is a surcharge of **\$23.00**.

() Plans/Kits () Business Opportunities () For Sale
 () Education/Instruction () Wanted () Satellite Television
 ()

Special Category: \$23.00

PLEASE PRINT EACH WORD SEPARATELY, IN BLOCK LETTERS.

(No refunds or credits for typesetting errors can be made unless you clearly print or type your copy.) Rates indicated are for standard style classified ads only. See below for additional charges for special ads. **Minimum: 15 words.**

| | | | | |
|--------------|--------------|--------------|--------------|--------------|
| 1 | 2 | 3 | 4 | 5 |
| 6 | 7 | 8 | 9 | 10 |
| 11 | 12 | 13 | 14 | 15 (\$42.75) |
| 16 (\$45.60) | 17 (\$48.45) | 18 (\$51.30) | 19 (\$54.15) | 20 (\$57.00) |
| 21 (\$59.85) | 22 (\$62.70) | 23 (\$65.55) | 24 (\$68.40) | 25 (\$71.25) |
| 26 (\$74.10) | 27 (\$76.95) | 28 (\$79.80) | 29 (\$82.65) | 30 (\$85.50) |
| 31 (\$88.35) | 32 (\$91.10) | 33 (\$94.05) | 34 (\$96.90) | 35 (\$99.75) |

We accept MasterCard and Visa for payment of orders. If you wish to use your credit card to pay for your ad fill in the following additional information (Sorry, no telephone orders can be accepted.):

Card Number _____

Expiration Date _____

Please Print Name _____

Signature _____

IF YOU USE A BOX NUMBER YOU MUST INCLUDE YOUR PERMANENT ADDRESS AND PHONE NUMBER FOR OUR FILES. ADS SUBMITTED WITHOUT THIS INFORMATION WILL NOT BE ACCEPTED.

CLASSIFIED COMMERCIAL RATE: (for firms or individuals offering commercial products or services) \$2.85 per word prepaid (no charge for zip code)...**MINIMUM 15 WORDS**. 5% discount for same ad in 6 issues; 10% discount for same ad in 12 issues within one year; if prepaid. **NON-COMMERCIAL RATE:** (for individuals who want to buy or sell a personal item) \$2.30 per word, prepaid....no minimum. **ONLY FIRST WORD AND NAME** set in bold caps at no extra charge. Additional bold face (not available as all caps) **50¢ per word additional**. Entire ad in boldface, \$3.40 per word. **TINT SCREEN BEHIND ENTIRE AD: \$3.55 per word. TINT SCREEN BEHIND ENTIRE AD PLUS ALL BOLD FACE AD: \$4.15 per word. EXPANDED TYPE AD: \$4.30 per word prepaid**. Entire ad in boldface, \$5.15 per word. **TINT SCREEN BEHIND ENTIRE EXPANDED TYPE AD: \$5.40 per word. TINT SCREEN BEHIND ENTIRE EXPANDED TYPE AD PLUS ALL BOLD FACE AD: \$6.25 per word. DISPLAY ADS:** 1" x 2 1/4"—\$320.00; 2" x 2 1/4"—\$640.00; 3" x 2 1/4"—\$960.00. General information: Frequency rates and prepayment discounts are available. **ALL COPY SUBJECT TO PUBLISHERS APPROVAL. ADVERTISEMENTS USING P.O. BOX ADDRESS WILL NOT BE ACCEPTED UNTIL ADVERTISER SUPPLIES PUBLISHER WITH PERMANENT ADDRESS AND PHONE NUMBER.** Copy to be in our hands on the 12th of the third month preceding the date of the issue. (i.e., Aug. issue copy must be received by May 12th). When normal closing date falls on Saturday, Sunday or Holiday, issue closes on preceding working day. Send for the classified brochure. Circle Number 49 on the Free Information Card.

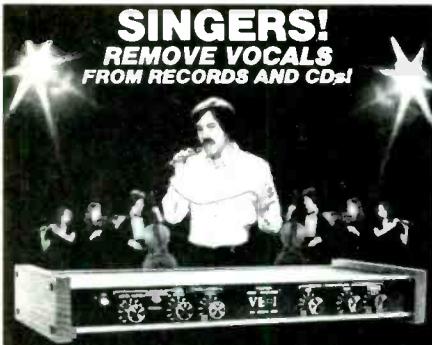

SINGERS! REMOVE VOCALS FROM RECORDS AND CDs!

SING WITH THE WORLD'S BEST BANDS!
An Unlimited supply of Backgrounds from standard stereo records! Record with your voice or perform live with the backgrounds. Used in Professional Performance yet connects easily to a home component stereo. This unique product is manufactured and sold Exclusively by LT Sound - Not sold through dealers. Call or write for a Free Brochure and Demo Record.

LT Sound, Dept. RL-3, 7980 LT Parkway Lithonia, GA 30058 (404) 482-4724
Manufactured and Sold Exclusively by LT Sound
24 HOUR PHONE DEMO LINE: (404) 482-2485

THREE phase Inverter, output will drive **gyro** at 26vac 400 Hz. Telescope drive inverter 117vac output at sidereal rate. 6 digits portable sidereal clock. Kit form or completed units. Free flyer. **SHLEGG ELECTRONICS, P.O. Box 795, Oshawa, Ontario, L1H 7N1 Canada.**

R-DAP digital audio recorder/player. Record and playback :10 seconds of audio on a self contained 256K Ram. Complete kit including microphone and speaker. Detailed documentation \$59.95 plus \$1.00 postage. **DJ INC., Suite 108, 217 East 85th Street, New York, NY 10028.**

NEW video tape repair kit. Permanently repair your VHS or Beta tapes. Easy instructions. \$8.95. **ELI CARSON COMPANY, P.O. Box 1219-R, Culver City, CA 90232.** California residents add 6 1/2% sales tax.

DESCRAMBLING, new secret manual. Build your own descramblers for cable and subscription TV. Instructions, schematics for SSAVI, gated sync, sinewave. (HBO, Cinemax, Showtime, etc.) \$8.95, \$1 postage. **CABLETRONICS, Box 30502R, Bethesda, MD 20814.**

VIDEOCIPHER II technical manuals, 120+ pages. Volume 1—hardware, Volume 2—software. Either \$29.95 both \$49.95. Catalog—\$3.00. **MICROTRONICS, Box 6426, Yuma, AZ 85364-0840.**

FOR SALE

RESTRICTED technical information: Electronic surveillance, schematics, locksmithing, covert sciences, hacking, etc. **Huge selection. Free brochure MENTOR-Z, 135-53 No. Blvd., Flushing, NY 11354**

DESCRAMBLERS All brands. Special combo Jerrold 400 and SB3 \$165. Complete cable descrambler kit \$39.00 Complete satellite descrambler kit \$45. Free catalog. **MJ INDUSTRY, Box 531, Bronx, NY 10461-0531.**

TEST equipment, reconditioned. For sale. \$1.25 for catalog. **WALTER'S, 2697 Nickel, San Pablo, CA 94806. (415) 724-0587.**

TUBES, new, unused. Send self-addressed, stamped envelope for list. **FALA ELECTRONICS, Box 1376-2, Milwaukee, WI 53201.**

PHOTOFACT folders, under #1400 \$3.00. Others \$5.00. Postpaid. **LOEB, 414 Chestnut Lane, East Meadow, NY 11554.**

TI-99/4A software/hardware bargains. Hard to find items. **Huge selection. Fast service. Free catalog. DYNA, Box 690, Hicksville, NY 11801.**

FREE CATALOG
FAMOUS "FIRESTIK" BRAND CB ANTENNAS AND ACCESSORIES. QUALITY PRODUCTS FOR THE SERIOUS CB'er. SINCE 1962
FIRESTIK ANTENNA COMPANY
2614 EAST ADAMS
PHOENIX, ARIZONA 85034

THE end connection—new and used cable equipment. Available at quantity prices, also surplus electronic equipment and hobby kits available for video and other uses. **JOHN, 1-(419) 243-7856.**

SATELLITE & cable equipment. We have those hard to find units ready to go. Tired of junk that doesn't work properly? Try our 10 day satisfaction guarantee & 90 day warranty (wholesale only) **HI TECH ELECTRONICS, PO Box 42423, Detroit, MI 48242, (313) 722-9381.**

CABLE TV converters. Scientific Atlanta, Jerrold, Oak, Zenith, Hamlin. Many others. "New" Video Hopper "The Copy Killer." Visa, M/C & Amex 1 (800) 826-7623. **B&B INC., 10517 Upton Circle, Bloomington, MN 55431.**

CABLE-TV converters and descramblers. Low prices, quality merchandise, we ship C.O.D. Send \$2.00 for catalog. **CABLETRONICS UNLIMITED, P.O. Box 266, South Weymouth, MA 02190, (617) 843-5191.**

SEMICONDUCTOR and transmitting tube, quotation sent on request. **TSUTOM YOSHIHARA, C1-105 Deguchicho-34, Suita, Osaka 564, Japan.**

TUBES new, unused. Send self-addressed, stamped envelope for list. **FALA ELECTRONICS, Box 1376-2, Milwaukee, WI 53201.**

LASERS, components and accessories. Free catalog. **M.J. NEAL COMPANY, 6672 Mallard Court, Orient, OH 43146.**

MICRO MART

508 Central Ave. Westfield, N.J. 07090 (201) 654-6008

| | | |
|---|--|---|
| <p>TTL SERIES</p> <p>7400 25 74396 60 7401 25 74393 9.00 7402 25 74324 20 7403 25 74543 55 7404 25 74544 55 7405 30 74872 25 7406 30 74872 25 7407 25 74872 25 7408 30 74872 25 7409 30 7410 7411 25 74LS00 20 7412 25 74LS00 20 7413 25 74LS00 20 7414 25 74LS00 20 7415 25 74LS00 20 7416 25 74LS00 20 7417 25 74LS00 20 7418 25 74LS00 20 7419 25 74LS00 20 7420 25 74LS00 20 7421 25 74LS00 20 7422 25 74LS00 20 7423 25 74LS00 20 7424 25 74LS00 20 7425 25 74LS00 20 7426 25 74LS00 20 7427 25 74LS00 20 7428 25 74LS00 20 7429 25 74LS00 20 7430 25 74LS00 20 7431 25 74LS00 20 7432 25 74LS00 20 7433 25 74LS00 20 7434 25 74LS00 20 7435 25 74LS00 20 7436 25 74LS00 20 7437 25 74LS00 20 7438 25 74LS00 20 7439 25 74LS00 20 7440 25 74LS00 20 7441 25 74LS00 20 7442 25 74LS00 20 7443 25 74LS00 20 7444 25 74LS00 20 7445 25 74LS00 20 7446 25 74LS00 20 7447 25 74LS00 20 7448 25 74LS00 20 7449 25 74LS00 20 7450 25 74LS00 20 7451 25 74LS00 20 7452 25 74LS00 20 7453 25 74LS00 20 7454 25 74LS00 20 7455 25 74LS00 20 7456 25 74LS00 20 7457 25 74LS00 20 7458 25 74LS00 20 7459 25 74LS00 20 7460 25 74LS00 20 7461 25 74LS00 20 7462 25 74LS00 20 7463 25 74LS00 20 7464 25 74LS00 20 7465 25 74LS00 20 7466 25 74LS00 20 7467 25 74LS00 20 7468 25 74LS00 20 7469 25 74LS00 20 7470 25 74LS00 20 7471 25 74LS00 20 7472 25 74LS00 20 7473 25 74LS00 20 7474 25 74LS00 20 7475 25 74LS00 20 7476 25 74LS00 20 7477 25 74LS00 20 7478 25 74LS00 20 7479 25 74LS00 20 7480 25 74LS00 20 7481 25 74LS00 20 7482 25 74LS00 20 7483 25 74LS00 20 7484 25 74LS00 20 7485 25 74LS00 20 7486 25 74LS00 20 7487 25 74LS00 20 7488 25 74LS00 20 7489 25 74LS00 20 7490 25 74LS00 20 7491 25 74LS00 20 7492 25 74LS00 20 7493 25 74LS00 20 7494 25 74LS00 20 7495 25 74LS00 20 7496 25 74LS00 20 7497 25 74LS00 20 7498 25 74LS00 20 7499 25 74LS00 20 7500 25 74LS00 20</p> | <p>74LS SERIES</p> <p>74LS00 25 74LS00 20 74LS01 25 74LS01 20 74LS02 25 74LS02 20 74LS03 25 74LS03 20 74LS04 25 74LS04 20 74LS05 25 74LS05 20 74LS06 25 74LS06 20 74LS07 25 74LS07 20 74LS08 25 74LS08 20 74LS09 25 74LS09 20 74LS10 25 74LS10 20 74LS11 25 74LS11 20 74LS12 25 74LS12 20 74LS13 25 74LS13 20 74LS14 25 74LS14 20 74LS15 25 74LS15 20 74LS16 25 74LS16 20 74LS17 25 74LS17 20 74LS18 25 74LS18 20 74LS19 25 74LS19 20 74LS20 25 74LS20 20 74LS21 25 74LS21 20 74LS22 25 74LS22 20 74LS23 25 74LS23 20 74LS24 25 74LS24 20 74LS25 25 74LS25 20 74LS26 25 74LS26 20 74LS27 25 74LS27 20 74LS28 25 74LS28 20 74LS29 25 74LS29 20 74LS30 25 74LS30 20 74LS31 25 74LS31 20 74LS32 25 74LS32 20 74LS33 25 74LS33 20 74LS34 25 74LS34 20 74LS35 25 74LS35 20 74LS36 25 74LS36 20 74LS37 25 74LS37 20 74LS38 25 74LS38 20 74LS39 25 74LS39 20 74LS40 25 74LS40 20 74LS41 25 74LS41 20 74LS42 25 74LS42 20 74LS43 25 74LS43 20 74LS44 25 74LS44 20 74LS45 25 74LS45 20 74LS46 25 74LS46 20 74LS47 25 74LS47 20 74LS48 25 74LS48 20 74LS49 25 74LS49 20 74LS50 25 74LS50 20 74LS51 25 74LS51 20 74LS52 25 74LS52 20 74LS53 25 74LS53 20 74LS54 25 74LS54 20 74LS55 25 74LS55 20 74LS56 25 74LS56 20 74LS57 25 74LS57 20 74LS58 25 74LS58 20 74LS59 25 74LS59 20 74LS60 25 74LS60 20 74LS61 25 74LS61 20 74LS62 25 74LS62 20 74LS63 25 74LS63 20 74LS64 25 74LS64 20 74LS65 25 74LS65 20 74LS66 25 74LS66 20 74LS67 25 74LS67 20 74LS68 25 74LS68 20 74LS69 25 74LS69 20 74LS70 25 74LS70 20 74LS71 25 74LS71 20 74LS72 25 74LS72 20 74LS73 25 74LS73 20 74LS74 25 74LS74 20 74LS75 25 74LS75 20 74LS76 25 74LS76 20 74LS77 25 74LS77 20 74LS78 25 74LS78 20 74LS79 25 74LS79 20 74LS80 25 74LS80 20 74LS81 25 74LS81 20 74LS82 25 74LS82 20 74LS83 25 74LS83 20 74LS84 25 74LS84 20 74LS85 25 74LS85 20 74LS86 25 74LS86 20 74LS87 25 74LS87 20 74LS88 25 74LS88 20 74LS89 25 74LS89 20 74LS90 25 74LS90 20 74LS91 25 74LS91 20 74LS92 25 74LS92 20 74LS93 25 74LS93 20 74LS94 25 74LS94 20 74LS95 25 74LS95 20 74LS96 25 74LS96 20 74LS97 25 74LS97 20 74LS98 25 74LS98 20 74LS99 25 74LS99 20 7500 25 74LS00 20</p> | <p>LINEAR</p> <p>NE 556 50 LM 3090 50 LM 3090 40 LM 3090 30 LM 3090 20 LM 3090 10 LM 3090 5 LM 3090 2.5 LM 3090 1.25 LM 3090 .625 LM 3090 .3125 LM 3090 .15625 LM 3090 .078125 LM 3090 .0390625 LM 3090 .01953125 LM 3090 .009765625 LM 3090 .0048828125 LM 3090 .00244140625 LM 3090 .001220703125 LM 3090 .0006103515625 LM 3090 .00030517578125 LM 3090 .000152587890625 LM 3090 .0000762939453125 LM 3090 .00003814697265625 LM 3090 .000019073486328125 LM 3090 .0000095367431640625 LM 3090 .00000476837158203125 LM 3090 .000002384185791015625 LM 3090 .0000011920928955078125 LM 3090 .00000059604644775390625 LM 3090 .000000298023223876953125 LM 3090 .0000001490116119384765625 LM 3090 .00000007450580596923828125 LM 3090 .000000037252902984619140625 LM 3090 .00000001862647149230596923828125 LM 3090 .000000009313235746152984619140625 LM 3090 .0000000046566178730762697265625 LM 3090 .0000000023283089365381323574619140625 LM 3090 .00000000116415446826967816178730762697265625 LM 3090 .000000000582077234134839089365381323574619140625 LM 3090 .000000000291038617071719195446826967816178730762697265625 LM 3090 .0000000001455193085353585977234134839089365381323574619140625 LM 3090 .000000000072759654267679296471719195446826967816178730762697265625 LM 3090 .000000000036379827133839623085353585977234134839089365381323574619140625 LM 3090 .0000000000181899135669311719195446826967816178730762697265625 LM 3090 .0000000000090949567816178730762697265625 LM 3090 .00000000000454747839089365381323574619140625 LM 3090 .000000000002273739446826967816178730762697265625 LM 3090 .0000000000011368719195446826967816178730762697265625 LM 3090 .00000000000056935977234134839089365381323574619140625 LM 3090 .000000000000284679816178730762697265625 LM 3090 .0000000000001423399089365381323574619140625 LM 3090 .00000000000007116995446826967816178730762697265625 LM 3090 .0000000000000355824739446826967816178730762697265625 LM 3090 .00000000000001779123697265625 LM 3090 .00000000000000889589365381323574619140625 LM 3090 .000000000000004447946826967816178730762697265625 LM 3090 .0000000000000022239739446826967816178730762697265625 LM 3090 .00000000000000111198697265625 LM 3090 .0000000000000005589365381323574619140625 LM 3090 .00000000000000027946826967816178730762697265625 LM 3090 .00000000000000013973446826967816178730762697265625 LM 3090 .0000000000000000698697265625 LM 3090 .000000000000000034934839089365381323574619140625 LM 3090 .00000000000000001746719195446826967816178730762697265625 LM 3090 .0000000000000000087335977234134839089365381323574619140625 LM 3090 .00000000000000000436679816178730762697265625 LM 3090 .000000000000000002183399089365381323574619140625 LM 3090 .0000000000000000010916995446826967816178730762697265625 LM 3090 .000000000000000000545849567816178730762697265625 LM 3090 .0000000000000000002729247839089365381323574619140625 LM 3090 .00000000000000000013646239446826967816178730762697265625 LM 3090 .000000000000000000068231198697265625 LM 3090 .000000000000000000034115934839089365381323574619140625 LM 3090 .000000000000000000017057967265625 LM 3090 .0000000000000000000085289365381323574619140625 LM 3090 .00000000000000000000426446826967816178730762697265625 LM 3090 .00000000000000000000213223446826967816178730762697265625 LM 3090 .0000000000000000000010661198697265625 LM 3090 .0000000000000000000005330934839089365381323574619140625 LM 3090 .000000000000000000000266546826967816178730762697265625 LM 3090 .000000000000000000000133273446826967816178730762697265625 LM 3090 .00000000000000000000006653697265625 LM 3090 .0000000000000000000000332684839089365381323574619140625 LM 3090 .000000000000000000000016634239446826967816178730762697265625 LM 3090 .0000000000000000000000083171198697265625 LM 3090 .0000000000000000000000041585934839089365381323574619140625 LM 3090 .0000000000000000000000020792967265625 LM 3090 .00000000000000000000000103964839089365381323574619140625 LM 3090 .000000000000000000000000519824239446826967816178730762697265625 LM 3090 .0000000000000000000000002599121198697265625 LM 3090 .0000000000000000000000001299560934839089365381323574619140625 LM 3090 .000000000000000000000000064978046826967816178730762697265625 LM 3090 .000000000000000000000000032489023446826967816178730762697265625 LM 3090 .00000000000000000000000001624451198697265625 LM 3090 .00000000000000000000000000812225934839089365381323574619140625 LM 3090 .000000000000000000000000004061121198697265625 LM 3090 .00000000000000000000000000203055934839089365381323574619140625 LM 3090 .00000000000000000000000000101527967265625 LM 3090 .00000000000000000000000000050763934839089365381323574619140625 LM 3090 .00000000000000000000000000025381967265625 LM 3090 .00000000000000000000000000012690934839089365381323574619140625 LM 3090 .0000000000000000000000000000634546826967816178730762697265625 LM 3090 .0000000000000000000000000000317273446826967816178730762697265625 LM 3090 .000000000000000000000000000015863697265625 LM 3090 .00000000000000000000000000000793184839089365381323574619140625 LM 3090 .000000000000000000000000000003965934839089365381323574619140625 LM 3090 .000000000000000000000000000001982967265625 LM 3090 .0000000000000000000000000000009914839089365381323574619140625 LM 3090 .00000000000000000000000000000049574198697265625 LM 3090 .000000000000000000000000000000247873934839089365381323574619140625 LM 3090 .00000000000000000000000000000012393697265625 LM 3090 .0000000000000000000000000000000619684839089365381323574619140625 LM 3090 .000000000000000000000000000000030974198697265625 LM 3090 .0000000000000000000000000000000154870934839089365381323574619140625 LM 3090 .000000000000000000000000000000007743546826967816178730762697265625 LM 3090 .000000000000000000000000000000003871773446826967816178730762697265625 LM 3090 .00000000000000000000000000000000193588697265625 LM 3090 .00000000000000000000000000000000096794198697265625 LM 3090 .000000000000000000000000000000000483970934839089365381323574619140625 LM 3090 .00000000000000000000000000000000024198697265625 LM 3090 .000000000000000000000000000000001209934839089365381323574619140625 LM 3090 .0000000000000000000000000000000006049</p> |
|---|--|---|

TENMA TEST EQUIPMENT



#72-455

TENMA Audio Generator

A precision audio generator suitable for use in all audio applications.

Features: ■ Generates sine and square waveforms ■ Six step and continuously variable attenuators ■ External sync input ■ Comes complete with test leads and owners manual

#72-455

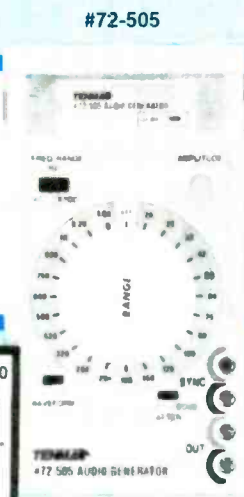

#72-505

TENMA Hand Held Audio Generator

The audio generator is ideal for field/bench service of audio equipment, car stereo, etc.

Features: ■ Wide frequency range ■ Sine wave or square wave output ■ Sync output ■ Continuously variable and 20dB fixed output attenuators ■ Low battery indicator ■ Comes complete with test leads and owners manual

#72-505

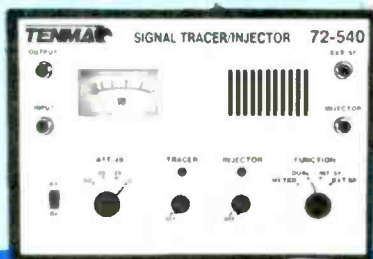

#72-540

TENMA Signal Tracer/Injector

Troubleshoots audio circuits from input to speaker.

Features: ■ Variable level 1KHz injection signal ■ VU level meter ■ Switchable detector for troubleshooting AM circuits ■ Speaker test output ■ Output provided for oscilloscope or other measurements ■ Comes complete with test probe and owners manual

#72-540

NEW



#72-555

TENMA AC Clamp Adaptor

Works with almost any DMM to provide an easy way to measure AC current.

Features: ■ Measures AC current without cutting wires ■ Measures up to 1000 amps AC ■ Safety wrist-strap provided ■ Comes complete with test leads (banana plug) and owners manual

#72-555

NEW



#72-580

TENMA Digital Light Meter

Provides a highly accurate and convenient way to measure light levels.

Features: ■ 3 1/2 digit LCD display ■ Data hold function ■ Low battery indicator ■ Output provided for recorder ■ Comes complete with carrying case, protective lens cap and instruction manual

#72-580

NEW

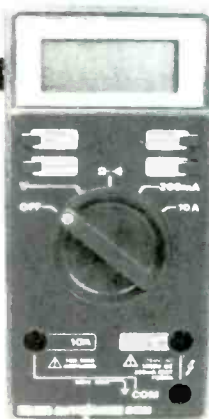

#72-560

TENMA Autorange DMM

New rotary dial design permits rapid selection of functions. Meter automatically selects proper range for most accurate reading.

Features: ■ 3 1/2 digit LCD display ■ Autorange/manual selector ■ Data hold: Holds display reading after meter is removed from circuit ■ Memory: Removes stored measurement from future readings ■ Audible continuity tester ■ Low battery indicator ■ Switchable Lo/Hi power ohms ■ Comes complete with test leads, carrying case and owners manual

#72-560

NEW

**For A Wide Variety of Electronic Parts
Call Toll Free 1-800-543-4330**

In Ohio, 1-800-762-4315 — In Alaska and Hawaii, 1-800-858-1849



MCM ELECTRONICS

858 E. CONGRESS PARK DR.
CENTERVILLE, OH 45459

A PREMIER Company

PLESSY S.A.W. filters, SY323 for tri-mode de-scramblers, Feb/87 Radio-Electronics \$19.95US 10-\$11.95US, M.C.I. ELECTRONICS, 306-176 Berry Road, Toronto, Canada M8Y 1W5.

MICROWAVE antennas, multichannel 1.9-2.7 Ghz dual polarity. From only \$49.95. "Best in the west!" GALAXY ELECTRONICS. Call 1 (602) 939-1151.

MANUALS for test equipment. 1000's in stock. Write for availability and price. JBM, 7061 Hayvenhurst #207, Van Nuys, CA 91406.

VCR eating tapes? Poor rewind? Repair part for 1982-86 Hitachi, RCA, Sears. 10 minute install! \$14.95. VIDEO DOCTOR, 607 S. Riverside, Medford, OR 97501.

CB RADIO OWNERS!

We specialize in a wide variety of technical information, parts and services for CB radios 10-Meter and FM conversion kits, repair books, plans, high-performance accessories. Over 12 years of satisfied customers! Catalog \$2

CBC INTERNATIONAL
P.O. BOX 31500RE, PHOENIX, AZ 85046

CALL & listen to room & telephone conversations. \$88.00 guaranteed. C.O.D. (918) 683-9589 \$3.00 catalog. LISTEN, 603 Elgin, Muskogee, OK 74401.

TEST equipment calibration and repair. Most types and manufacturers. Certifications traceable to N.B.S. AMBER LABS, 5950 Daley St., Goceta, CA 93117, (805) 687-1771.

SAMS Photofact folders #800- #2000 \$2000.00 B&K 1077 \$100.00 Happy Days Juke box used video. ARCADE GAMES, (913) 545-3685 after 7:00 pm.

INTRODUCING 101 new and improved screwdriving bits! Free details. Write: SHOCKEY'S, Dept. 57, 5841 Longford, Dayton, OH 45424. (513) 236-2983.

TUBES

• RECEIVING • SERVICE • ANTIQUE

The Most Complete Range of Domestic and Foreign Tubes In The World
— Over 2000 Types —
...at 75-90% OFF

Send \$2 for Consumer Product Catalog and receive FREE 1/4 or 1/2 Watt Resistor Kit

Steven

Mail Order Electronics Corp.

P.O. Box 698, Melville, NY 11747

1-800-833-6693

In NYS (516) 752-0060

SCANNER owners send \$3 for 230 California police codes and definitions. KIRK PETERSON, 6375 Conlon, El Cerrito, CA 94530.

CABLE TV. We carry a full line including units for Tocom and Pioneer. Tocom turn-ons, technically correct, recordable, auto sensing. DELUXE ELECTRONICS, 1432 Heim, Orange, CA 92665 (714) 998-6866.

CABLE TV equipment S.A., Jerrold, Zenith, Hamlin, Oak, Eagle filters remotes and more. Best prices C.O.D.'s accepted dealers needed. Ours work where others failed and we guarantee it! TRANS-WORLD CABLE, Co. (218) 543-6671.

SUPERCONDUCTORS National Bureau of Standards research publication shows how to process Barium, Yttrium, Copper Oxides into high temperature superconducting ceramics. \$14.95. CABLETRONICS, Box 30502R, Bethesda, MD 20814.

HACKER'S handbook, \$12.95, \$1 postage. Computer underground, \$14.95, \$1 postage. CABLETRONICS, Box 30502R, Bethesda, MD 20814.

TUBES, name brands, new, 80% off list. KIRBY, 298 West Carmel Drive, Carmel, IN 46032.

COMPONENTS! IC's, capacitors, resistors, etc. Lowest prices! Example: 10µf 25V Tantalum capacitor—19¢. Free catalog. CRC ELECTRONICS, 1354 S.E. 27th Pl., Bellevue, WA 98005. (206) 747-9636.

IS it true...jeeps for \$44 through the government? Call for facts! 1-(312) 742-1142, ext. 4673.

NUTS & VOLTS MAGAZINE P.O. Box 1111-E Pleasanton, CA 94570 714-832-7721

GIVE YOURSELF A BREAK — A PRICE BREAK!
NUTS & VOLTS WILL **SAVE** YOU MONEY ON ELECTRONIC PARTS & EQUIPMENT. **PLEASE SHOW US WHERE TO FIND UNIQUE, UNUSUAL AND HARD-TO-FIND ITEMS.**

SUBSCRIBE TODAY!

A National Publication For The Buying And Selling Of Electronic Equipment

| | |
|----------------------|-----------------------|
| Subscription Rates | U.S. (incl. shipping) |
| 3rd Class Mail - USA | One Year \$10.00 |
| Two Years | \$18.00 |
| Life | \$100.00 |
| 1st Class Mail | |
| One Year USA | \$18.00 |
| Canada, Mexico | \$20.00 |
| Air Mail | \$20.00 |
| Foreign | \$30.00 |

VCR's vhs minor repairs manual, parts replacement, maintenance, good for consumers too, parts number, suppliers, no technical, simple, practical, useful \$14.95. USA ASSOCIATES, Box 2168, Van Nuys, CA 91404.

ELECTRONIC Liquidators, thousands of parts, kits, hardware. Send \$3.50 for catalog. Box 27656, Lansing, MI 48901.

**At KELVIN...
Price, Service
& Quality for
over 42 years.**

B & K · FLUKE · UNGAR
HITACHI · WELLER
BECKMAN · DREMEL
STANLEY · MAKITA
X-ACTO · KEPRO · XCELITE



LISA HADAR
EXECUTIVE VP, CPA

METERS/OSCILLOSCOPES

| | | | |
|---------|------|------------------|---------|
| B & K | 2120 | 20Mhz Dual Trace | \$ 395* |
| Beckman | 9020 | 20Mhz Dual Trace | 425 |
| Hitachi | V212 | 20Mhz | \$365 |
| Fluke | 73 | 3 1/2" Digit DMM | |
| Fluke | 75 | 3 1/2" Digit DMM | |
| Fluke | 77 | 3 1/2" Digit DMM | |

*PLUS Shipping & Insurance. Prices subject to change without notice.

WE HAVE IT ALL...

• COMPONENTS • TOOLS • KITS • SECURITY • SEMI-CONDUCTORS • ELECTRICAL SUPPLIES • SOLDER EQUIPMENT • KELVIN KITS • TSM KITS • DRAFTING SUPPLIES

Volume Quotes, Industrial & School Bids Welcome.

ORDER TOLL FREE FOR INQUIRES & N.Y.S.
1-800-645-9212 516-349-7620

KELVIN
ELECTRONICS

NEW ADDRESS:
7 Fairchild Avenue • Plainview, NY 11803 • FAX: 516-349-7830

VISA/MASTER CARD ACCEPTED

CALL 1 - 800 - 85 - A M C O M

Z - T A C ADD - ON CABLE DE-SCRAMBLER M A C R O C A T

AMCOM is one of the countries leading authorities on Z-Tac equipment. We sell any quantity from 1-500 units from current stock for immediate delivery. Call us last, we'll beat anyone's price.

NEW Super Z-TAC \$229.00
Works On Model ST-1065-1600

| | | |
|------------|------------|----------|
| ANTI-FLASH | 1 - Unit | \$169.00 |
| UPDATE | 5 - Unit | 145.00 |
| INFO | 10 - Unit | 120.00 |
| | 20 or more | Call |

| | | |
|------------|---------------------|---------|
| SSAVI UNIT | WPOWER SUPPLY | \$35.00 |
| SSAVIZ-TAC | ORIGINAL PWR SUPPLY | 15.00 |

Before you buy any device which eliminates copyguard protection, check this one out. Our engineers guarantee this unit to be the best, or we'll eat it on national TV, from the Hollywood schematics, complete and automatic elimination of the new macrovision copyguard done with digital components.

| | |
|------------------------|----------|
| Assembled and Tested | \$109.00 |
| Kit includes all parts | 49.95 |

VIDEO STORE DEALERS CALL FOR QUANTITY

DEALERS WANTED!! EXCELLENT WHOLESALE PRICES ON MACROCAT AND Z-TAC ADD - ONS

Most Advanced Trimode Add-On Unit \$109.00

| LINEAR | C M O S | T T L | RARE SATELLITE IC CHIP |
|-------------|------------|--------------------------------------|--|
| LM 318 90 | CD 4002 20 | 74LS04 25 | MM5321 IS A CAMERA SYNC GENERATOR SUPPLY'S SYNC FUNCTIONS, ALLOWS FOR COMPLETE COLOR INFORMATION. ONLY \$10.50 |
| LM 319 90 | CD 4011 15 | 74LS74 25 | |
| LM 324 25 | CD 4013 25 | 74LS123 45 | |
| LM 359 125 | CD 4015 25 | | THE "BLASTER" UHF PREAMP Boost Signals by 25db w /1.5 NF Kit \$25.00 |
| LM 564 175 | CD 4017 35 | | |
| LM 565 75 | CD 4018 50 | | CABLE TV FILTERS CH #2 CH #D ONLY \$12.00 |
| NE 592 75 | CD 4024 40 | | |
| MC 1310 100 | CD 4027 35 | | |
| MC 1330 75 | CD 4040 55 | | |
| MC 1350 25 | CD 4053 50 | | |
| MC 1458 25 | CD 4066 25 | | |
| LM 1406 75 | CD 4069 20 | | |
| LM 1889 100 | CD 4071 20 | | |
| | CD 4081 25 | | |
| | CD 4082 20 | | |
| | CD 4520 50 | | |
| | CD 4526 75 | | |
| | | WE BUY EXCESS IC'S SEND US YOUR LIST | |



AMCOM
P.O. BOX 68391
Virginia Beach, VA 23455
804-456-5505(Tech Info)
1-800-85-AMCOM(Orders Only)

UPS DAILY
COD, MASTERCARD, VISA
AMERICAN EXPRESS
ACCEPTED

SHIPPING FOB VA
CALL US. WE BUY
EXCESS INVENTORY

Be a TV/VCR Repair Specialist

Now you can train at home in spare time for a money-making career as a TV VCR Repair Specialist. No previous experience necessary. No need to quit your job or school. Everything is explained in easy-to-understand language with plenty of drawings, diagrams and photos. We show you how to troubleshoot and repair video-cassette recorders and TV sets, how to handle house calls and shop repairs for almos: any make of television or VCR. Tools are included with your course so you can get "hands-on" practice as you follow your lessons step by step. Send for free facts about the exciting opportunities in TV VCR Repair and find out how you can start making money in this great career. **MAIL COUPON TODAY**

ICS SCHOOL OF TV VCR REPAIR, Dept. DEO28
 (SINCE 1981) Scranton, Pennsylvania 18515

Please send me full information and color brochure on how I can learn TV/VCR Repair at home in my spare time. I understand there is no obligation and no salesman will visit me.

Name _____ Age _____
 Address _____
 City/State/Zip _____
 Phone () _____

VIDEOCYPERII descrambling manual. Schematics, video and audio, DES, Cloning, Muskatereing, Eprom codes. (HBO, Cinemax, Showtime, adult channels) \$12.95, \$1 postage. **CABLETRONICS**, Box 30502R, Bethesda, MD 20814.

CABLE TV Secrets—the outlaw publication the cable companies tried to ban. HBO, Movie Channel, Showtime, descramblers, converters, etc. Supplier's list included \$8.95. **CABLE FACTS**, Box 711-R, Pataskala, OH 43062.

EDUCATION & INSTRUCTION

F.C.C. Commercial General Radiotelephone license. Electronics home study. Fast, inexpensive! "Free" details. **COMMAND**, D-176, Box 2223, San Francisco, CA 94126.

AMAZING SCIENTIFIC & ELECTRONIC PRODUCTS

PLANS—Build Yourself—All Parts Available In Stock

- LC7—BURNING CUTTING CO₂ LASER \$ 20.00
- RUBA—PORTABLE LASER RAY PISTOL 20.00
- TCC1—3 SEPARATE TESLA COIL PLANS TO 1.5 MEV 20.00
- I0G1—I0N RAY GUN 10.00
- GRA1—GRAVITY GENERATOR 10.00
- EML1—ELECTRO MAGNET COIL GUN/LAUNCHER 6.00

KITS

- MFT1K—FM VOICE TRANSMITTER 3 MI RANGE 49.50
- VWPMSK—TELEPHONE TRANSMITTER 3 MI RANGE 39.50
- BTC3K—250.00 VOLT 10-14" SPARK TESLA COIL 199.50
- LHC2K—SIMULATED MULTICOLOR LASER 39.50
- BLS1K—100,000 WATT BLASTER DEFENSE DEVICE 69.50
- ITM1K—100,000 VOLT 20" AFFECTIVE RANGE INTIMIDATOR 69.50
- PSP4K—TIME VARIANT SHOCK WAVE PISTOL 59.50
- PTG1K—SPECTACULAR PLASMA TORNAO GENERATOR 149.50
- MNP1K—SEE IN DARK KIT 199.50

ASSEMBLED

- PG70K—MULTICOLOR VARIABLE MODE PLASMA GLOBE 7 199.50
- BTC10—50,000 VOLT—WORLD'S SMALLEST TESLA COIL 44.50
- LGU40—1MW HeNe VISIBLE RED LASER GUN 199.50
- TAT20 AUTO TELEPHONE RECORDING DEVICE 24.50
- GPV10—SEE IN TOTAL DARKNESS IR VIEWER 349.50
- LIST10—SNOOPER PHONE INFINITY TRANSMITTER 169.50
- IPG70—INVISIBLE PAIN FIELD GENERATOR—MULTI MODE 74.50

• CATALOG CONTAINING DESCRIPTIONS OF ABOVE PLUS HUNDREDS MORE AVAILABLE FOR \$1.00 OR INCLUDED FREE WITH ALL ABOVE ORDERS

PLEASE INCLUDE \$3.00 PH ON ALL KITS AND PRODUCTS PLANS ARE POSTAGE PAID. SEND CHECK, MO, VISA, MC IN US FUNDS

INFORMATION UNLIMITED
 P.O. BOX 716 DEPT. RE, AMHERST, NH 03031

Pay TV and Satellite Descrambling NEW... VOL. 2 ... NEW

Picks up where VOL. 1 ended. Introductory price \$12.95
 VOL. 1 \$14.95 KDS Hackers Handbook \$9.95 Experiments with Videocypher Cloning muskatereing \$14.95 Cable TV Security design \$12.95 Build Satellite Systems Under \$600 \$12.95 Any 3 of preceding \$27. All \$ \$40. 7month manuals Tap \$14.95 2 Bag \$19.95 Both \$29.95 Scrambling News \$24.95 yr Free sample with order Catalog \$1

Shojiki Electronics Corp. 1327A Niagara St., Niagara Falls, NY 14303. COD's 716-284-2163

SUPERFAST Morse Code supereasy. Subliminal cassette. \$10. Learn Morse Code in 1 hour. Amazing new supereasy technique. \$10. Both \$17. Moneyback guarantee. Free catalog: SASE. **BAHR**, 2549-E1 Temple, Palmbay, FL 32905.

MICROPROFESSOR 16 bit trainer, 8088 C.P.U., 8 bit data bus, 4.77MHz, 59-key, full-size keyboard, Centronics parallel interface. Design, write, debug, and execute assembly language programs. **ETRONIX**, 5326—9th Ave. N.E., Seattle, WA 98105 1-(800) 426-1044.

MICROPROFESSOR 8 bit trainer, Z-80 C.P.U., 158-instruction set, 8K monitor ROM, enter programs in assembly, machine, basic, or forth. **ETRONIX**, 5326—9th Ave. N.E., Seattle, WA 98105 1-(800) 426-1044.

FCC Commercial General Radiotelephone License Correspondence Course. 60 individual lessons for \$89.50. Payment plan. Results guaranteed! Details free. **AMERICAN TECHNICAL INSTITUTE**, Box 201, Cedar Mountain, NC 28718.

SURVEILLANCE devices schematic diagrams portfolio. Unique rewarding, 37 different, \$20pp. **POLTEX**, Box 2337, Sunnyvale, CA 94087.

PACKET of old electrical medical device reprints \$35. **HANK ANDREONI**, 250-E So. Lyon, Hemet, CA 92343.

Cable TV Converters Why Pay A High Monthly Fee?

Jerrold Products include "New Jerrold Tri-Mode," SB-3, Hamlin, Oak VN-12, M-35-B, Zenith, Magnavox, Scientific Atlanta, and more. (Quantity discounts) 60 day warranty. For fast service C.O.D. orders accepted. Send SASE (60 cents postage) or call for info (312) 658-5320. **MIDWEST ELECTRONICS, INC.**, 5143-R W. Diversey, Chicago, IL 60639. MC/Visa orders accepted. No Illinois orders accepted. Mon.-Fri. 8 A.M.-5 P.M. CST

WANTED

INVENTORS! AIM wants—ideas, inventions, new products, improvements on existing products. We present ideas to manufacturers. Confidentiality guaranteed. Call toll free 1-(800) 225-5800 for information kit.

INVENTIONS, ideas, new products wanted! Industry presentation/national exposition. Call free 1-(800) 288-IDEA. Canada, 1-(800) 528-6060. X831.

COMPUTER repairs. Flat rate. Commodore C64 \$44.95, 1541 \$49.95, 1571 \$54.95, SX64 \$64.95, Atari 800XL \$49.50, 130XE \$65.00, 1050 \$85.00, 810 \$70.00. Includes most parts. ST's \$89.95 plus parts. \$5.00 shipping. **MIDTOWN**, 27 Midway Plaza, Tallmadge, OH 44278, (216) 633-0997.

NATIONAL'S INS, 8060 CPU, any quantity. P.A.L., Box 760, Sumas, WA 98295. (604) 854-3463. FAX: (604) 852-8296.

WANTED excess inventories of I.C.s, disk drives, circuit boards, computers, etc. **WESTERN TECH**, (818) 882-1355 (CA).

PRINTED CIRCUIT BOARD LAYOUTS

GUARANTEED low pricing for single, double sided artwork layouts, (704) 464-1164. **PCBAL**, RT-3, Box 662-H, Conover, NC 28613.

VIDEO TAPE COPYGUARD

Eliminate the latest copyguard problems
units from \$59⁹⁵ to \$169⁹⁵

Deluxe Electronics (714) 998-6866
 1432 Main Wy., Orange, Ca. 92665

BUSINESS OPPORTUNITIES

EARN thousands with your own part time electronics business. I do. Free proof, information. **INDUSTRY**, Box 531, Bronx, NY 10461.

EASY, lucrative. One man CRT rebuilding machinery. Free info: (815) 459-0666 **CRT**, 1909 Louise, Crystalake, IL 60014.

MECHANICALLY inclined individuals desiring ownership of small electronics manufacturing business—without investment. Write: **BUSINESSES**, 92-R, Brighton 11th, Brooklyn, NY 11235.

START your own highly profitable video taping business. Complete information \$5.00. **DJ AYERS**, 179 Hoffman Avenue, Elmont, NY 11003.

BURGLAR alarms-booming business get started now. Information \$2.00. **DYNAMIC SECURITY**, P.O. B. 1456-A, Grand Rapids, MI 49501.

PC board design, prototyping, and manufacture plotting services; schema, smartwork, EEdesigner supported call **TOM** (201) 586-4469.

BIG PROFITS ELECTRONIC ASSEMBLY BUSINESS

Start home spare time investment knowledge or experience unnecessary. **BIG DEMAND** assembling electronic devices. Sales handled by professionals. Unusual business opportunity

FREE! Complete illustrated literature
 BARTA RE-O Box 248
 Walnut Creek Calif. 94597

INVENTORS

INVENTORS! Can you patent and profit from your idea? Call **AMERICAN INVENTORS CORPORATION** for free information. Over a decade of service. 1-(800) 338-5656. In Massachusetts or Canada call (413) 568-3753.

DESCRAMBLER MODULE

COMPLETE cable-TV decoder in a mini-module. Latest technology upgrade for Jerrold SB-3 or Radio-Electronics Feb. 1984 project. Versatile, sophisticated, and low cost. For literature, **SOUTHTECH DISTRIBUTING**, (813) 529-2190.

SCIENTIFIC ATLANTA & SB-3

SCIENTIFIC Atlanta Models 8500—8550, remote included...\$240.00 **SB-3's**...\$74.00. **TRI-BI's**...\$95.00. **SA-3's**...\$99.00. **Zenith (Z-Tac) Descramblers**...\$169.00. **N-12 (Vari-sync)**...\$89.00. **M-35 B (Vari-sync)**...\$99.00. **Hamlin MLD-1200's**...\$89.00. **80-channel converters**...\$95.00. **Dealer discount** on (5) units. **Call...N.A.S. INTERNATIONAL**, (213) 631-3552.

TEST EQUIPMENT

PHILIPS "SBC" line of service quality instruments Scopes, Signal Generators, Power Supplies, DMMs, Logic Probes and Pulsers, Scope Probes. **Brand-new fully guaranteed low cost**. Before you purchase let us mail you our free illustrated flyer. **PURBYTRON INSTRUMENTS**, 117 North Ridge St., Port Chester, NY 10573, (914) 937-6376.



NATIONAL SEMICONDUCTOR • PANASONIC MACHINE • EVC, INC. • INTERSIL • AD EAC, INC. • J. V. MILLER • ADV. ENGINEER E. F. JOHNSON • ATLANTIC SEMICONDUCTOR

256K (262,144 x 1) DRAM 150NS \$5.70/1; \$39.95/9

JODES • DIAMOND TOOL • UNGAR • E.S. • CW INDUSTRIES • AMDEK • G.E. ICAR • YAGEO • J. V. MILLER • LUXO SC CHEMICALS • ARIES • PLESSEY



Factory Firsts

INTEGRATED CIRCUITS

7400 TTL

| | | | | | | | | | |
|------|------|------|------|------|------|------|------|------|------|
| 7400 | 7401 | 7402 | 7403 | 7404 | 7405 | 7406 | 7407 | 7408 | 7409 |
| 7410 | 7411 | 7412 | 7413 | 7414 | 7415 | 7416 | 7417 | 7418 | 7419 |
| 7420 | 7421 | 7422 | 7423 | 7424 | 7425 | 7426 | 7427 | 7428 | 7429 |
| 7430 | 7431 | 7432 | 7433 | 7434 | 7435 | 7436 | 7437 | 7438 | 7439 |
| 7440 | 7441 | 7442 | 7443 | 7444 | 7445 | 7446 | 7447 | 7448 | 7449 |
| 7450 | 7451 | 7452 | 7453 | 7454 | 7455 | 7456 | 7457 | 7458 | 7459 |
| 7460 | 7461 | 7462 | 7463 | 7464 | 7465 | 7466 | 7467 | 7468 | 7469 |
| 7470 | 7471 | 7472 | 7473 | 7474 | 7475 | 7476 | 7477 | 7478 | 7479 |
| 7480 | 7481 | 7482 | 7483 | 7484 | 7485 | 7486 | 7487 | 7488 | 7489 |
| 7490 | 7491 | 7492 | 7493 | 7494 | 7495 | 7496 | 7497 | 7498 | 7499 |

74500 TTL

| | | | | | | | | | |
|-------|-------|-------|-------|-------|-------|-------|-------|-------|-------|
| 74500 | 74501 | 74502 | 74503 | 74504 | 74505 | 74506 | 74507 | 74508 | 74509 |
| 74510 | 74511 | 74512 | 74513 | 74514 | 74515 | 74516 | 74517 | 74518 | 74519 |
| 74520 | 74521 | 74522 | 74523 | 74524 | 74525 | 74526 | 74527 | 74528 | 74529 |
| 74530 | 74531 | 74532 | 74533 | 74534 | 74535 | 74536 | 74537 | 74538 | 74539 |
| 74540 | 74541 | 74542 | 74543 | 74544 | 74545 | 74546 | 74547 | 74548 | 74549 |
| 74550 | 74551 | 74552 | 74553 | 74554 | 74555 | 74556 | 74557 | 74558 | 74559 |
| 74560 | 74561 | 74562 | 74563 | 74564 | 74565 | 74566 | 74567 | 74568 | 74569 |
| 74570 | 74571 | 74572 | 74573 | 74574 | 74575 | 74576 | 74577 | 74578 | 74579 |
| 74580 | 74581 | 74582 | 74583 | 74584 | 74585 | 74586 | 74587 | 74588 | 74589 |
| 74590 | 74591 | 74592 | 74593 | 74594 | 74595 | 74596 | 74597 | 74598 | 74599 |

74LS00 TTL

| | | | | | | | | | |
|--------|--------|--------|--------|--------|--------|--------|--------|--------|--------|
| 74LS00 | 74LS01 | 74LS02 | 74LS03 | 74LS04 | 74LS05 | 74LS06 | 74LS07 | 74LS08 | 74LS09 |
| 74LS10 | 74LS11 | 74LS12 | 74LS13 | 74LS14 | 74LS15 | 74LS16 | 74LS17 | 74LS18 | 74LS19 |
| 74LS20 | 74LS21 | 74LS22 | 74LS23 | 74LS24 | 74LS25 | 74LS26 | 74LS27 | 74LS28 | 74LS29 |
| 74LS30 | 74LS31 | 74LS32 | 74LS33 | 74LS34 | 74LS35 | 74LS36 | 74LS37 | 74LS38 | 74LS39 |
| 74LS40 | 74LS41 | 74LS42 | 74LS43 | 74LS44 | 74LS45 | 74LS46 | 74LS47 | 74LS48 | 74LS49 |
| 74LS50 | 74LS51 | 74LS52 | 74LS53 | 74LS54 | 74LS55 | 74LS56 | 74LS57 | 74LS58 | 74LS59 |
| 74LS60 | 74LS61 | 74LS62 | 74LS63 | 74LS64 | 74LS65 | 74LS66 | 74LS67 | 74LS68 | 74LS69 |
| 74LS70 | 74LS71 | 74LS72 | 74LS73 | 74LS74 | 74LS75 | 74LS76 | 74LS77 | 74LS78 | 74LS79 |
| 74LS80 | 74LS81 | 74LS82 | 74LS83 | 74LS84 | 74LS85 | 74LS86 | 74LS87 | 74LS88 | 74LS89 |
| 74LS90 | 74LS91 | 74LS92 | 74LS93 | 74LS94 | 74LS95 | 74LS96 | 74LS97 | 74LS98 | 74LS99 |

74C00 CMOS

| | | | | | | | | | |
|-------|-------|-------|-------|-------|-------|-------|-------|-------|-------|
| 74C00 | 74C01 | 74C02 | 74C03 | 74C04 | 74C05 | 74C06 | 74C07 | 74C08 | 74C09 |
| 74C10 | 74C11 | 74C12 | 74C13 | 74C14 | 74C15 | 74C16 | 74C17 | 74C18 | 74C19 |
| 74C20 | 74C21 | 74C22 | 74C23 | 74C24 | 74C25 | 74C26 | 74C27 | 74C28 | 74C29 |
| 74C30 | 74C31 | 74C32 | 74C33 | 74C34 | 74C35 | 74C36 | 74C37 | 74C38 | 74C39 |
| 74C40 | 74C41 | 74C42 | 74C43 | 74C44 | 74C45 | 74C46 | 74C47 | 74C48 | 74C49 |
| 74C50 | 74C51 | 74C52 | 74C53 | 74C54 | 74C55 | 74C56 | 74C57 | 74C58 | 74C59 |
| 74C60 | 74C61 | 74C62 | 74C63 | 74C64 | 74C65 | 74C66 | 74C67 | 74C68 | 74C69 |
| 74C70 | 74C71 | 74C72 | 74C73 | 74C74 | 74C75 | 74C76 | 74C77 | 74C78 | 74C79 |
| 74C80 | 74C81 | 74C82 | 74C83 | 74C84 | 74C85 | 74C86 | 74C87 | 74C88 | 74C89 |
| 74C90 | 74C91 | 74C92 | 74C93 | 74C94 | 74C95 | 74C96 | 74C97 | 74C98 | 74C99 |

INTEGRATED CIRCUITS

4000 CMOS

| | | | | | | | | | |
|------|------|------|------|------|------|------|------|------|------|
| 4000 | 4001 | 4002 | 4003 | 4004 | 4005 | 4006 | 4007 | 4008 | 4009 |
| 4010 | 4011 | 4012 | 4013 | 4014 | 4015 | 4016 | 4017 | 4018 | 4019 |
| 4020 | 4021 | 4022 | 4023 | 4024 | 4025 | 4026 | 4027 | 4028 | 4029 |
| 4030 | 4031 | 4032 | 4033 | 4034 | 4035 | 4036 | 4037 | 4038 | 4039 |
| 4040 | 4041 | 4042 | 4043 | 4044 | 4045 | 4046 | 4047 | 4048 | 4049 |
| 4050 | 4051 | 4052 | 4053 | 4054 | 4055 | 4056 | 4057 | 4058 | 4059 |
| 4060 | 4061 | 4062 | 4063 | 4064 | 4065 | 4066 | 4067 | 4068 | 4069 |
| 4070 | 4071 | 4072 | 4073 | 4074 | 4075 | 4076 | 4077 | 4078 | 4079 |
| 4080 | 4081 | 4082 | 4083 | 4084 | 4085 | 4086 | 4087 | 4088 | 4089 |
| 4090 | 4091 | 4092 | 4093 | 4094 | 4095 | 4096 | 4097 | 4098 | 4099 |

74500 TTL

| | | | | | | | | | |
|-------|-------|-------|-------|-------|-------|-------|-------|-------|-------|
| 74500 | 74501 | 74502 | 74503 | 74504 | 74505 | 74506 | 74507 | 74508 | 74509 |
| 74510 | 74511 | 74512 | 74513 | 74514 | 74515 | 74516 | 74517 | 74518 | 74519 |
| 74520 | 74521 | 74522 | 74523 | 74524 | 74525 | 74526 | 74527 | 74528 | 74529 |
| 74530 | 74531 | 74532 | 74533 | 74534 | 74535 | 74536 | 74537 | 74538 | 74539 |
| 74540 | 74541 | 74542 | 74543 | 74544 | 74545 | 74546 | 74547 | 74548 | 74549 |
| 74550 | 74551 | 74552 | 74553 | 74554 | 74555 | 74556 | 74557 | 74558 | 74559 |
| 74560 | 74561 | 74562 | 74563 | 74564 | 74565 | 74566 | 74567 | 74568 | 74569 |
| 74570 | 74571 | 74572 | 74573 | 74574 | 74575 | 74576 | 74577 | 74578 | 74579 |
| 74580 | 74581 | 74582 | 74583 | 74584 | 74585 | 74586 | 74587 | 74588 | 74589 |
| 74590 | 74591 | 74592 | 74593 | 74594 | 74595 | 74596 | 74597 | 74598 | 74599 |

74LS00 TTL

| | | | | | | | | | |
|--------|--------|--------|--------|--------|--------|--------|--------|--------|--------|
| 74LS00 | 74LS01 | 74LS02 | 74LS03 | 74LS04 | 74LS05 | 74LS06 | 74LS07 | 74LS08 | 74LS09 |
| 74LS10 | 74LS11 | 74LS12 | 74LS13 | 74LS14 | 74LS15 | 74LS16 | 74LS17 | 74LS18 | 74LS19 |
| 74LS20 | 74LS21 | 74LS22 | 74LS23 | 74LS24 | 74LS25 | 74LS26 | 74LS27 | 74LS28 | 74LS29 |
| 74LS30 | 74LS31 | 74LS32 | 74LS33 | 74LS34 | 74LS35 | 74LS36 | 74LS37 | 74LS38 | 74LS39 |
| 74LS40 | 74LS41 | 74LS42 | 74LS43 | 74LS44 | 74LS45 | 74LS46 | 74LS47 | 74LS48 | 74LS49 |
| 74LS50 | 74LS51 | 74LS52 | 74LS53 | 74LS54 | 74LS55 | 74LS56 | 74LS57 | 74LS58 | 74LS59 |
| 74LS60 | 74LS61 | 74LS62 | 74LS63 | 74LS64 | 74LS65 | 74LS66 | 74LS67 | 74LS68 | 74LS69 |
| 74LS70 | 74LS71 | 74LS72 | 74LS73 | 74LS74 | 74LS75 | 74LS76 | 74LS77 | 74LS78 | 74LS79 |
| 74LS80 | 74LS81 | 74LS82 | 74LS83 | 74LS84 | 74LS85 | 74LS86 | 74LS87 | 74LS88 | 74LS89 |
| 74LS90 | 74LS91 | 74LS92 | 74LS93 | 74LS94 | 74LS95 | 74LS96 | 74LS97 | 74LS98 | 74LS99 |

74C00 CMOS

| | | | | | | | | | |
|-------|-------|-------|-------|-------|-------|-------|-------|-------|-------|
| 74C00 | 74C01 | 74C02 | 74C03 | 74C04 | 74C05 | 74C06 | 74C07 | 74C08 | 74C09 |
| 74C10 | 74C11 | 74C12 | 74C13 | 74C14 | 74C15 | 74C16 | 74C17 | 74C18 | 74C19 |
| 74C20 | 74C21 | 74C22 | 74C23 | 74C24 | 74C25 | 74C26 | 74C27 | 74C28 | 74C29 |
| 74C30 | 74C31 | 74C32 | 74C33 | 74C34 | 74C35 | 74C36 | 74C37 | 74C38 | 74C39 |
| 74C40 | 74C41 | 74C42 | 74C43 | 74C44 | 74C45 | 74C46 | 74C47 | 74C48 | 74C49 |
| 74C50 | 74C51 | 74C52 | 74C53 | 74C54 | 74C55 | 74C56 | 74C57 | 74C58 | 74C59 |
| 74C60 | 74C61 | 74C62 | 74C63 | 74C64 | 74C65 | 74C66 | 74C67 | 74C68 | 74C69 |
| 74C70 | 74C71 | 74C72 | 74C73 | 74C74 | 74C75 | 74C76 | 74C77 | 74C78 | 74C79 |
| 74C80 | 74C81 | 74C82 | 74C83 | 74C84 | 74C85 | 74C86 | 74C87 | 74C88 | 74C89 |
| 74C90 | 74C91 | 74C92 | 74C93 | 74C94 | 74C95 | 74C96 | 74C97 | 74C98 | 74C99 |

T1 I.C. SOCKETS

SOLDER TAIL DIP SOCKETS

• Single beam
• Low profile
• YOUR CHOICE TIN OR GOLD

TIN PLATED SOLDER TAIL

Part No. Description Pkg. 10 100 1000

| | | | | |
|------|--------|----|-----|------|
| 9220 | 10 Pin | 10 | 100 | 1000 |
| 9221 | 14 Pin | 10 | 100 | 1000 |
| 9222 | 18 Pin | 10 | 100 | 1000 |
| 9223 | 22 Pin | 10 | 100 | 1000 |
| 9224 | 26 Pin | 10 | 100 | 1000 |
| 9225 | 30 Pin | 10 | 100 | 1000 |
| 9226 | 34 Pin | 10 | 100 | 1000 |
| 9227 | 38 Pin | 10 | 100 | 1000 |
| 9228 | 42 Pin | 10 | 100 | 1000 |
| 9229 | 46 Pin | 10 | 100 | 1000 |
| 9230 | 50 Pin | 10 | 100 | 1000 |

Memory

Part No. Description Pkg. 10 100 1000

| | | | | |
|------|---------|----|-----|------|
| 9231 | 1Kbit | 10 | 100 | 1000 |
| 9232 | 2Kbit | 10 | 100 | 1000 |
| 9233 | 4Kbit | 10 | 100 | 1000 |
| 9234 | 8Kbit | 10 | 100 | 1000 |
| 9235 | 16Kbit | 10 | 100 | 1000 |
| 9236 | 32Kbit | 10 | 100 | 1000 |
| 9237 | 64Kbit | 10 | 100 | 1000 |
| 9238 | 128Kbit | 10 | 100 | 1000 |
| 9239 | 256Kbit | 10 | 100 | 1000 |
| 9240 | 512Kbit | 10 | 100 | 1000 |

GOLD INLAY SOLDER TAIL

Part No. Description Pkg. 10 100 1000

| | | | | |
|------|--------|----|-----|------|
| 9241 | 10 Pin | 10 | 100 | 1000 |
| 9242 | 14 Pin | 10 | 100 | 1000 |
| 9243 | 18 Pin | 10 | 100 | 1000 |
| 9244 | 22 Pin | 10 | 100 | 1000 |
| 9245 | 26 Pin | 10 | 100 | 1000 |
| 9246 | 30 Pin | 10 | 100 | 1000 |
| 9247 | 34 Pin | 10 | 100 | 1000 |
| 9248 | 38 Pin | 10 | 100 | 1000 |
| 9249 | 42 Pin | 10 | 100 | 1000 |
| 9250 | 46 Pin | 10 | 100 | 1000 |
| 9251 | 50 Pin | 10 | 100 | 1000 |

WIRE WRAP DIP SOCKETS

• Standard profile
• Universal mounting and packaging capabilities
• 80% Through G21 use
• 90% Mount flat in lead hole
• Wire on top profile leads to free placement of 315 pin grid with a free provision of 320 pin boards for off card automatic assembly
• YOUR CHOICE TIN OR GOLD
• 100% TEST INSTRUMENTS QUALITY

TIN PLATED WIRE WRAP

Part No. Description Pkg. 10 100 1000

| | | | | |
|------|--------|----|-----|------|
| 9252 | 10 Pin | 10 | 100 | 1000 |
| 9253 | 14 Pin | 10 | 100 | 1000 |
| 9254 | 18 Pin | 10 | 100 | 1000 |
| 9255 | 22 Pin | 10 | 100 | 1000 |
| 9256 | 26 Pin | 10 | 100 | 1000 |
| 9257 | 30 Pin | 10 | 100 | 1000 |
| 9258 | 34 Pin | 10 | 100 | 1000 |
| 9259 | 38 Pin | 10 | 100 | 1000 |
| 9260 | 42 Pin | 10 | 100 | 1000 |
| 9261 | 46 Pin | 10 | 100 | 1000 |
| 9262 | 50 Pin | 10 | 100 | 1000 |

Silicon resistors

DIGI KEY Part No. Description Pkg. 10 100 1000

| | | | | |
|------|----------|----|-----|------|
| 9263 | 100 Ohm | 10 | 100 | 1000 |
| 9264 | 200 Ohm | 10 | 100 | 1000 |
| 9265 | 500 Ohm | 10 | 100 | 1000 |
| 9266 | 1K Ohm | 10 | 100 | 1000 |
| 9267 | 2K Ohm | 10 | 100 | 1000 |
| 9268 | 5K Ohm | 10 | 100 | 1000 |
| 9269 | 10K Ohm | 10 | 100 | 1000 |
| 9270 | 20K Ohm | 10 | 100 | 1000 |
| 9271 | 50K Ohm | 10 | 100 | 1000 |
| 9272 | 100K Ohm | 10 | 100 | 1000 |

A/D/D/A

Part No. Description Pkg. 10 100 1000

| | | | | |
|------|--------|----|-----|------|
| 9273 | 8 Bit | 10 | 100 | 1000 |
| 9274 | 10 Bit | 10 | 100 | 1000 |
| 9275 | 12 Bit | 10 | 100 | 1000 |
| 9276 | 14 Bit | 10 | 100 | 1000 |
| 9277 | 16 Bit | 10 | 100 | 1000 |
| 9278 | 18 Bit | 10 | 100 | 1000 |
| 9279 | 20 Bit | 10 | 100 | 1000 |
| 9280 | 22 Bit | 10 | 100 | 1000 |
| 9281 | 24 Bit | | | |

256K STATIC

32K x 8 \$1295
150ns

256K DRAM

41256 \$349
150ns

STATIC RAMS

| | | | |
|--------------|---------|--------------------|-------|
| 2112 | 256x4 | (450ns) | 2.99 |
| 2114 | 1024x4 | (450ns) | .99 |
| 2114L-2 | 1024x4 | (200ns)(LOW POWER) | 1.49 |
| TMM2016-100 | 2048x8 | (100ns) | 1.95 |
| HM6116-4 | 2048x8 | (150ns)(CMOS) | 1.19 |
| HM6116-3 | 2048x8 | (150ns)(CMOS) | 1.85 |
| HM6116LP-4 | 2048x8 | (200ns)(CMOS)(LP) | 1.85 |
| HM6116LP-3 | 2048x8 | (150ns)(CMOS)(LP) | 1.90 |
| HM6116LP-2 | 2048x8 | (120ns)(CMOS)(LP) | 2.45 |
| HM6264LP-15 | 8192x8 | (150ns)(CMOS)(LP) | 3.95 |
| HM6264LP-12 | 8192x8 | (120ns)(CMOS)(LP) | 4.49 |
| HM43256LP-15 | 32768x8 | (150ns)(CMOS)(LP) | 12.95 |
| HM43256LP-12 | 32768x8 | (120ns)(CMOS)(LP) | 14.95 |
| HM43256LP-10 | 32768x8 | (100ns)(CMOS)(LP) | 19.95 |

DYNAMIC RAMS

| | | | |
|--------------|-----------|------------------------|-------|
| 4116-250 | 16384x1 | (250ns) | .49 |
| 4116-200 | 16384x1 | (200ns)(25V) | .89 |
| 4116-150 | 16384x1 | (150ns) | .99 |
| 4116-120 | 16384x1 | (120ns) | 1.49 |
| MK4332 | 32768x1 | (200ns) | 6.95 |
| 4164-150 | 65536x1 | (150ns) | 1.79 |
| 4164-120 | 65536x1 | (120ns) | 1.99 |
| MCM6665 | 65536x1 | (200ns) | 1.95 |
| TMS4164 | 65536x1 | (150ns) | 1.95 |
| 4164-REFRESH | 65536x1 | (250ns)(PIN 1 REFRESH) | 3.95 |
| TMS4416 | 16384x4 | (150ns) | 3.95 |
| 41128-150 | 131072x1 | (150ns) | 5.95 |
| TMS4464-15 | 65536x4 | (150ns) | 4.95 |
| 41256-150 | 262144x1 | (150ns) | 3.49 |
| 41256-120 | 262144x1 | (120ns) | 3.95 |
| 41256-100 | 262144x1 | (100ns) | 4.95 |
| HM51258-100 | 262144x1 | (100ns)(CMOS) | 6.95 |
| 1MB-120 | 1048576x1 | (120ns) | 31.95 |
| 1MB-100 | 1048576x1 | (100ns) | 34.95 |

EPROMS

| | | | |
|----------|---------|----------------------|-------|
| 2708 | 1024x8 | (450ns)(25V) | 4.95 |
| 2716 | 2048x8 | (450ns)(25V) | 3.49 |
| 2716-1 | 2048x8 | (350ns)(25V) | 3.95 |
| TMS2532 | 4096x8 | (450ns)(25V) | 5.95 |
| 2732 | 4096x8 | (450ns)(25V) | 3.95 |
| 2732A | 4096x8 | (250ns)(21V) | 3.95 |
| 2732A-2 | 4096x8 | (200ns)(21V) | 4.25 |
| 27C64 | 8192x8 | (250ns)(12.5V CMOS) | 4.95 |
| 2764 | 8192x8 | (450ns)(12.5V) | 3.49 |
| 2764-250 | 8192x8 | (150ns)(12.5V) | 3.69 |
| 2764-200 | 8192x8 | (200ns)(12.5V) | 4.25 |
| MCM68766 | 8192x8 | (350ns)(21V)(24 PIN) | 15.95 |
| 27128 | 16384x8 | (250ns)(12.5V) | 4.25 |
| 27C256 | 32768x8 | (250ns)(12.5V CMOS) | 7.95 |
| 27256 | 32768x8 | (250ns)(12.5V) | 5.95 |
| 27512 | 65536x8 | (250ns)(12.5V) | 11.95 |
| 27C512 | 65536x8 | (250ns)(12.5V CMOS) | 12.95 |

xxV=Program Voltage

★★★★ HIGH-TECH ★★★★★

MCT-ATFH-RLL \$199

FLOPPY/HARD CONTROLLER FOR AT
IMPROVE THE SPEED AND STORAGE
CAPACITY OF YOUR AT COMPATIBLE

- * RLL (RUN LENGTH LIMITED) ENCODING PUTS 50% MORE DATA IN THE SAME SPACE AS PREVIOUS METHODS WITH A CORRESPONDING INCREASE IN DATA TRANSFER
- * SUPPORT FOR 2 RLL DRIVES SUCH AS ST-238 OR ST-277
- * PLUS SUPPORT FOR 2 FLOPPY DRIVES
- * ACCOMMODATES 1.2M, 720K & 360K DRIVES IN BOTH 5 1/4" & 3 1/2" SIZES

★★★★ SPOTLIGHT ★★★★★

8000

| | | | | | |
|--------------|-------|--------|-------|--------|-------|
| 8031 | 3.95 | 8203 | 14.95 | 8255-5 | 1.59 |
| 8035 | 1.49 | 8205 | 3.29 | 8259 | 1.95 |
| 8039 | 1.95 | 8212 | 1.49 | 8259-5 | 2.29 |
| 8052AH BASIC | 34.95 | 8216 | 1.49 | 8257 | 2.25 |
| 8080 | 2.49 | 8224 | 2.25 | 8272 | 4.39 |
| 8085 | 1.95 | 8228 | 2.25 | 8274 | 4.95 |
| 8086 | 6.49 | 8237 | 3.95 | 8275 | 16.95 |
| 8088 | 5.99 | 8237-5 | 4.75 | 8279 | 2.49 |
| 8088-2 | 7.95 | 8243 | 1.95 | 8279-5 | 2.95 |
| 8155 | 2.49 | 8250 | 6.95 | 8282 | 3.95 |
| 8155-2 | 3.95 | 8251 | 1.29 | 8283 | 3.95 |
| 8741 | 9.95 | 8251A | 1.69 | 8284 | 2.25 |
| 8748 | 7.95 | 8253 | 1.59 | 8286 | 3.95 |
| 8749 | 9.95 | 8253-5 | 1.95 | 8287 | 3.95 |
| 8755 | 14.95 | 8255 | 1.49 | 8288 | 4.95 |

8200

| | | | |
|--------|-------|--------|-------|
| 8203 | 14.95 | 8255-5 | 1.59 |
| 8205 | 3.29 | 8259 | 1.95 |
| 8212 | 1.49 | 8259-5 | 2.29 |
| 8216 | 1.49 | 8257 | 2.25 |
| 8224 | 2.25 | 8272 | 4.39 |
| 8228 | 2.25 | 8274 | 4.95 |
| 8237 | 3.95 | 8275 | 16.95 |
| 8237-5 | 4.75 | 8279 | 2.49 |
| 8243 | 1.95 | 8279-5 | 2.95 |
| 8250 | 6.95 | 8282 | 3.95 |
| 8251 | 1.29 | 8283 | 3.95 |
| 8251A | 1.69 | 8284 | 2.25 |
| 8253 | 1.59 | 8286 | 3.95 |
| 8253-5 | 1.95 | 8287 | 3.95 |
| 8255 | 1.49 | 8288 | 4.95 |

intel MATH COPROCESSORS

| | | | |
|--------|----------|----------|----------|
| 8087 | \$99.95 | 80287-8 | \$249.95 |
| 8087-2 | 159.95 | 80287-10 | \$309.95 |
| 80287 | \$179.95 | 80387-16 | \$499.95 |

TOLL FREE
800-538-5000
U.S. AND CANADA

74LS00

| | | | | | |
|---------|-----|---------|------|---------|-------|
| 74LS00 | .16 | 74LS112 | .29 | 74LS241 | .69 |
| 74LS01 | .18 | 74LS122 | .45 | 74LS242 | .69 |
| 74LS02 | .17 | 74LS123 | .49 | 74LS243 | .69 |
| 74LS03 | .18 | 74LS124 | 2.75 | 74LS244 | .69 |
| 74LS04 | .16 | 74LS125 | .39 | 74LS245 | .79 |
| 74LS05 | .18 | 74LS126 | .39 | 74LS251 | .49 |
| 74LS08 | .18 | 74LS132 | .39 | 74LS253 | .49 |
| 74LS09 | .18 | 74LS133 | .49 | 74LS257 | .39 |
| 74LS10 | .16 | 74LS136 | .39 | 74LS258 | .49 |
| 74LS11 | .22 | 74LS138 | .39 | 74LS259 | 1.29 |
| 74LS12 | .22 | 74LS139 | .39 | 74LS260 | .49 |
| 74LS13 | .26 | 74LS145 | .99 | 74LS265 | .39 |
| 74LS14 | .39 | 74LS148 | .29 | 74LS273 | .79 |
| 74LS15 | .26 | 74LS148 | .99 | 74LS279 | .39 |
| 74LS20 | .17 | 74LS151 | .39 | 74LS280 | 1.98 |
| 74LS21 | .22 | 74LS153 | .39 | 74LS283 | .59 |
| 74LS22 | .22 | 74LS154 | 1.49 | 74LS290 | .89 |
| 74LS27 | .23 | 74LS155 | .59 | 74LS293 | .89 |
| 74LS28 | .26 | 74LS156 | .49 | 74LS299 | 1.49 |
| 74LS30 | .17 | 74LS157 | .35 | 74LS322 | 3.95 |
| 74LS32 | .18 | 74LS158 | .29 | 74LS323 | 2.49 |
| 74LS33 | .28 | 74LS160 | .29 | 74LS365 | .39 |
| 74LS37 | .26 | 74LS161 | .39 | 74LS367 | .39 |
| 74LS38 | .26 | 74LS162 | .49 | 74LS368 | .39 |
| 74LS42 | .39 | 74LS163 | .39 | 74LS373 | .79 |
| 74LS47 | .75 | 74LS164 | .49 | 74LS374 | .79 |
| 74LS48 | .85 | 74LS165 | .65 | 74LS375 | .95 |
| 74LS51 | .17 | 74LS166 | .95 | 74LS377 | .79 |
| 74LS52 | .29 | 74LS169 | .95 | 74LS390 | 1.19 |
| 74LS74 | .24 | 74LS173 | .49 | 74LS393 | .79 |
| 74LS75 | .29 | 74LS174 | .39 | 74LS541 | 1.49 |
| 74LS76 | .29 | 74LS175 | .39 | 74LS624 | 1.95 |
| 74LS83 | .49 | 74LS191 | .49 | 74LS640 | .95 |
| 74LS85 | .49 | 74LS192 | .69 | 74LS645 | .99 |
| 74LS86 | .22 | 74LS193 | .69 | 74LS670 | .89 |
| 74LS90 | .39 | 74LS194 | .69 | 74LS682 | 3.20 |
| 74LS92 | .49 | 74LS195 | .69 | 74LS683 | 2.40 |
| 74LS93 | .39 | 74LS196 | .59 | 74LS783 | 22.95 |
| 74LS95 | .49 | 74LS197 | .59 | 25LS251 | 2.80 |
| 74LS107 | .34 | 74LS221 | .59 | 26LS31 | 1.95 |
| 74LS109 | .36 | 74LS240 | .69 | 26LS32 | 1.95 |

7400

| | |
|-------|------|
| 7400 | .19 |
| 7402 | .19 |
| 7404 | .19 |
| 7406 | .29 |
| 7407 | .29 |
| 7408 | .24 |
| 7410 | .19 |
| 7411 | .25 |
| 7414 | .49 |
| 7416 | .25 |
| 7417 | .25 |
| 7420 | .19 |
| 7422 | .19 |
| 7432 | .29 |
| 7438 | .29 |
| 7442 | .49 |
| 7445 | .69 |
| 7447 | .89 |
| 7473 | .34 |
| 7474 | .33 |
| 7475 | .45 |
| 7476 | .35 |
| 7483 | .50 |
| 7485 | .59 |
| 7486 | .35 |
| 7489 | 2.15 |
| 7490 | .39 |
| 7493 | .35 |
| 74121 | .29 |
| 74123 | .49 |
| 74125 | .45 |
| 74130 | .35 |
| 74131 | 1.55 |
| 74153 | .55 |
| 74154 | 1.49 |
| 74157 | .55 |
| 74159 | 1.65 |
| 74161 | .79 |
| 74164 | .85 |
| 74166 | 1.00 |
| 74175 | .89 |
| 74367 | .65 |

LINEAR

| | | | |
|---------------|------|---------|------|
| LM071 | .69 | LM567 | .79 |
| LM072 | 1.09 | NE570 | 2.95 |
| LM074 | 1.35 | NE592 | .98 |
| LM082 | .99 | LM723 | .49 |
| LM084 | 1.49 | LM733 | .98 |
| LM301 | .34 | LM741 | .29 |
| LM309K | 1.25 | LM747 | .69 |
| LM311 | .89 | MC1330 | 1.69 |
| LM317K | 3.49 | MC1350 | 1.19 |
| LM317T | .69 | LM1458 | .35 |
| LM330 | 1.49 | LM1488 | .49 |
| LM319 | 1.25 | LM1496 | .85 |
| LM320 see7900 | | ULN2003 | .79 |
| LM324 | 3.49 | XR2206 | 3.95 |
| LM324A | .34 | RC2211 | 2.95 |
| LM331 | 3.95 | LM2917 | 1.95 |
| LM334 | 1.19 | CA3046 | .89 |
| LM335 | 1.79 | CA3146 | 1.29 |
| LM336 | 1.75 | MC3373 | 1.29 |
| LM338K | 4.49 | MC3370 | 1.95 |
| LM339 | 5.99 | MC3480 | 8.95 |
| LM340 see7800 | | MC3487 | 2.95 |
| LF353 | .59 | LM3900 | .49 |
| LF356 | .99 | LM3911 | 2.25 |
| LF357 | .99 | LM3909 | .98 |
| LM358 | 3.95 | LM3915 | 1.59 |
| LM380 | .89 | MC4024 | 3.49 |
| LM383 | 1.95 | MC4044 | 3.99 |
| LM386 | .89 | RC4136 | 1.25 |
| LM393 | .45 | RC4558 | .69 |
| LM394H | 5.99 | LM12600 | 1.49 |
| LM394 | 4.20 | 75107 | 1.49 |
| TL497 | 3.25 | 75110 | 1.95 |
| NE555 | .29 | 75150 | 1.95 |
| NE556 | .49 | 75154 | 1.95 |
| NE558 | .79 | 75188 | 1.25 |
| NE564 | 1.95 | 75189 | 1.25 |
| LM565 | .95 | 75451 | .39 |
| LM566 | 1.49 | 75452 | .39 |
| NE590 | 2.50 | 75477 | 1.25 |

H-TO-5 CAN. K-TO-3. T-TO-220

CMOS/HIGH SPEED CMOS

| | | | | | |
|------|------|---------|------|----------|------|
| 4001 | .19 | 4066 | .29 | 74HC154 | 1.09 |
| 4011 | .19 | 4069 | .19 | 74HC157 | .55 |
| 4012 | .25 | 4070 | .29 | 74HC244 | .85 |
| 4013 | .35 | 4081 | .22 | 74HC245 | .85 |
| 4015 | .29 | 4093 | .49 | 74HC273 | .69 |
| 4017 | .49 | 14411 | 9.95 | 74HC373 | .69 |
| 4018 | .69 | 14497 | 6.95 | 74HC700 | .25 |
| 4020 | .59 | 4503 | .48 | 74HC702 | .25 |
| 4021 | .69 | 4511 | .69 | 74HC704 | .27 |
| 4023 | .25 | 4518 | .85 | 74HC708 | .25 |
| 4024 | 1.29 | 4528 | .79 | 74HC732 | .27 |
| 4025 | .25 | 4538 | .95 | 74HC774 | .45 |
| 4027 | .39 | 4702 | 9.95 | 74HC738 | .55 |
| 4028 | .65 | 74HC00 | .21 | 74HC739 | .55 |
| 4040 | .69 | 74HC02 | .21 | 74HC761 | .79 |
| 4042 | .59 | 74HC04 | .25 | 74HC724 | .89 |
| 4044 | .69 | 74HC10 | .25 | 74HC725 | .99 |
| 4046 | .69 | 74HC12 | .35 | 74HC723 | .99 |
| 4047 | .69 | 74HC14 | .35 | 74HC737 | .99 |
| 4049 | .29 | 74HC32 | .35 | 74HC734 | .99 |
| 4050 | .29 | 74HC74 | .35 | 74HC739 | .99 |
| 4051 | .69 | 74HC86 | .45 | 74HC793 | .99 |
| 4052 | .69 | 74HC138 | .45 | 74HC797 | 1.19 |
| 4053 | .69 | 74HC139 | .45 | 74HC7400 | .99 |
| 4060 | .69 | 74HC151 | .59 | 74HC7406 | 1.49 |



Visit our retail store located at 1256 S. Bascom Ave. in San Jose, (408) 947-8881

JDR Microdevices
110 Knowles Drive, Los Gatos, CA 95030
Toll Free 800-538-5000 • (408) 866-6200
FAX (408) 378-8927 • Telex 171-110

PLEASE USE YOUR CUSTOMER NUMBER WHEN ORDERING
TERMS: Minimum order \$10.00. For shipping and handling include \$2.50 for UPS Ground and \$3.50 for UPS Air. Orders over 1 lb. and foreign orders may require additional shipping charges—please contact our sales department for the amount. CA. residents

20 MEG HARD DISK DRIVE ON A CARD \$349!

BARGAIN HUNTERS CORNER

TANDON

5 1/4" FULL HEIGHT DS/DD, 360K DISK DRIVE

\$69.95

SPECIAL ENDS 2/29/88

CAPACITORS

| TANTALUM | | 1.0µF | | 35V | |
|----------|-----|-------|-----|-----|-----|
| 6.8 | 15V | .42 | 2.2 | 35V | .75 |
| 10 | 15V | .45 | 4.7 | 35V | .26 |
| 22 | 15V | .99 | 10 | 35V | .69 |

OISC

| | | | | | |
|------|-----|-----|-------|-----|-----|
| 10µF | 50V | .05 | 001µF | 50V | .05 |
| 22 | 50V | .05 | 005 | 50V | .05 |
| 33 | 50V | .05 | 01 | 50V | .07 |
| 47 | 50V | .05 | 05 | 50V | .07 |
| 100 | 50V | .05 | 12 | 10 | 10 |
| 220 | 50V | .05 | 1 | 50V | .12 |

MONOLITHIC

| | | | | | |
|------|-----|-----|------|-----|-----|
| 01µF | 50V | .14 | 1µF | 50V | .18 |
| 04µF | 50V | .15 | 47µF | 50V | .25 |

ELECTROLYTIC

| RADIAL | | AXIAL | | | |
|--------|-----|-------|------|-----|------|
| 1µF | 25V | .14 | 1µF | 50V | .14 |
| 4.7 | 50V | .11 | 10 | 50V | .16 |
| 10 | 50V | .11 | 22 | 16V | .14 |
| 47 | 35V | .13 | 47 | 50V | .19 |
| 100 | 16V | .15 | 100 | 35V | .29 |
| 220 | 35V | 20 | 70 | 50V | .29 |
| 470 | 25V | 30 | 1000 | 16V | .29 |
| 2200 | 16V | .70 | 2200 | 16V | .70 |
| 4700 | 25V | 1.45 | 4700 | 16V | 1.25 |

BYPASS CAPACITORS

| | | | |
|----|------------------|-----|---------|
| 01 | 1/4 CERAMIC DISC | 100 | \$5.00 |
| 01 | 1/4 MONOLITHIC | 100 | \$10.00 |
| 1 | 1/4 CERAMIC DISC | 100 | \$6.00 |
| 1 | 1/4 MONOLITHIC | 100 | \$12.00 |

SOLDER STATION

- UL APPROVED
- ADJUSTABLE HEAT SETTING W/ TIP TEMP
- READOUT
- QUICK HEATING & RECOVERY
- RANGE: 200°-900 F

\$49.95

EXTENDER CARDS FOR IBM

EXT-8088 \$29.95
EXT-80286 \$39.95



WIREWRAP

PROTOTYPE CARDS
FR-4 EPOXY GLASS LAMINATE
GOLD-PLATED EDGE-CARD FINGERS



XT

BOTH CARDS HAVE SILK SCREENED LEGENDS & MOUNTING BRACKET

IBM-PR1 WITH -5V AND GROUND PLANE \$27.95
IBM-PR2 AS ABOVE WITH DECODING LAYOUT \$29.95

AT

IBM-PRAT LARGE -5V & GROUND PLANES \$29.95

SOLDERLESS BREADBOARDS

| | | |
|-----------|-----------------|-------|
| WBU-D | 100 TIE POINTS | 2.95 |
| WBU-T | 630 TIE POINTS | 6.95 |
| WBU-204-3 | 1360 TIE POINTS | 17.95 |
| WBU-204 | 1660 TIE POINTS | 24.95 |
| WBU-206 | 4390 TIE POINTS | 29.95 |
| WBU-208 | 3220 TIE POINTS | 39.95 |

PAGE WIRE WRAP WIRE

PRECUT ASSORTMENT IN ASSORTED COLORS \$27.50
100ea: 5.5", 6.0", 6.5", 7.0"
250ea: 2.5", 4.5", 5.0"
500ea: 3.0", 3.5", 4.0"

SPOOLS

| | | | |
|----------|---------|-----------|---------|
| 100 feet | \$4.30 | 250 feet | \$7.25 |
| 500 feet | \$13.25 | 1000 feet | \$21.95 |

Please specify color: Blue, Black, Yellow or Red

RESISTOR NETWORKS

| | | | |
|-----|--------|-------------|------|
| SIP | 10 PIN | 9 RESISTOR | .69 |
| SIP | 8 PIN | 7 RESISTOR | .59 |
| DIP | 16 PIN | 8 RESISTOR | 1.09 |
| DIP | 16 PIN | 15 RESISTOR | 1.09 |
| DIP | 14 PIN | 7 RESISTOR | .99 |
| DIP | 14 PIN | 13 RESISTOR | .99 |

VOLTAGE REGULATORS

| | | | |
|-------|------|--------|------|
| 7805T | .49 | 7812K | 1.39 |
| 7808T | .49 | 7905K | 1.69 |
| 7812T | .49 | 7912K | 1.49 |
| 7815T | .49 | 7810S | .49 |
| 7905T | .59 | 7911S | .49 |
| 7908T | .59 | 7910S | .69 |
| 7912T | .59 | 7912S | 1.49 |
| 7915T | .59 | LM323K | 4.79 |
| 7805K | 1.59 | LM338K | 6.95 |

WHY THOUSANDS CHOOSE JDR

- ★ QUALITY MERCHANDISE COMPETITIVE PRICES
- ★ MOST ORDERS SHIPPED IN 24 HOURS
- ★ FRIENDLY, KNOWLEDGEABLE STAFF
- ★ MONEY BACK GUARANTEE (ASK FOR DETAILS)
- ★ TOLL FREE TECHNICAL SUPPORT
- ★ EXCELLENT CUSTOMER SERVICE



36 PIN CENTRONICS

| | | |
|-----------|-------------------|------|
| IDCEN36 | RIBBON CABLE | 3.95 |
| CEN36 | SOLDER CUP | 1.85 |
| IDCEN36 F | RIBBON CABLE | 4.95 |
| CEN36PC | Rt Angle PC Mount | 1.85 |

DISCRETE

| | | | |
|----------|-----|---------|------|
| 1N751 | .15 | 4N28 | .69 |
| 1N414825 | 1µ | 4N33 | .89 |
| 1N400410 | 1µ | 4N37 | 1.19 |
| 1N5402 | .25 | MCT-2 | .59 |
| KB902 | .55 | MCT-6 | 1.29 |
| 2N2222 | .25 | TIL-111 | .99 |
| PN2222 | 10 | 2N3906 | 10 |
| 2N2907 | .25 | 2N4401 | .25 |
| 2N3055 | .79 | 2N4402 | .25 |
| 2N3904 | 10 | 2N4403 | .25 |
| 4N26 | .69 | 2N6045 | 1.75 |
| 4N27 | .69 | TIP31 | .49 |

DATARASE

- ERASES 2 EPROMS IN 10 MINUTES
- VERY COMPACT, NO DRAWER
- THIN METAL SHUTTER PREVENTS UV LIGHT FROM ESCAPING



\$34.95

SOCKET-WRAP I.D.™

- SLIPS OVER WIRE WRAP PINS
- IDENTIFIES PIN NUMBERS ON WRAP SIDE OF BOARD
- CAN WRITE ON THE PLASTIC; SUCH AS AN IC #

| PINS | PART # | PCK OF | PRICE |
|------|-----------|--------|-------|
| 8 | IDWRAP 08 | 10 | 1.95 |
| 14 | IDWRAP 14 | 10 | 1.95 |
| 16 | IDWRAP 16 | 10 | 1.95 |
| 18 | IDWRAP 18 | 5 | 1.95 |
| 20 | IDWRAP 20 | 5 | 1.95 |
| 22 | IDWRAP 22 | 5 | 1.95 |
| 24 | IDWRAP 24 | 5 | 1.95 |
| 28 | IDWRAP 28 | 5 | 1.95 |
| 40 | IDWRAP 40 | 5 | 1.95 |

PLEASE ORDER BY NUMBER OF PACKAGES (PCK OF)

IDC CONNECTORS/RIBBON CABLE

| DESCRIPTION | ORDER BY | CONTACTS | | | | | |
|-----------------------------|----------|----------|------|------|------|------|------|
| | | 10 | 20 | 26 | 34 | 40 | 50 |
| SOLDER HEADER | IDHxxS | .82 | 1.29 | 1.68 | 2.20 | 2.58 | 3.24 |
| RIGHT ANGLE SOLDER HEADER | IDHxxSR | .85 | 1.35 | 1.76 | 2.31 | 2.72 | 3.39 |
| WIREWRAP HEADER | IDHxxW | 1.86 | 2.98 | 3.84 | 4.50 | 5.28 | 6.63 |
| RIGHT ANGLE WIREWRAP HEADER | IDHxxWR | 2.05 | 3.28 | 4.22 | 4.45 | 4.80 | 7.30 |
| RIBBON HEADER SOCKET | IDSxx | .63 | .89 | .95 | 1.29 | 1.49 | 1.69 |
| RIBBON HEADER | IDMxx | ... | 5.50 | 6.25 | 7.00 | 7.50 | 8.50 |
| RIBBON EDGE CARD | IDExx | .85 | 1.25 | 1.35 | 1.75 | 2.05 | 2.45 |
| 10' GREY RIBBON CABLE | RCxx | 1.60 | 3.20 | 4.10 | 5.40 | 6.40 | 7.50 |

FOR ORDERING INSTRUCTIONS SEE D-SUBMINIATURE CONNECTORS BELOW

SPECTRONICS CORPORATION EPROM ERASERS

| Model | Timer | Chip Capacity | Intensity (uW/cm²) | Unit Cost |
|---------|-------|---------------|--------------------|-----------|
| PE 140 | NO | 9 | 8,000 | .89 |
| PE 140T | YES | 9 | 8,000 | 1.39 |
| PE 240T | YES | 12 | 9,600 | 1.89 |

LIGHT EMITTING DIODES

| FND 357(359) | COM CATHODE | 362" | 1.25 |
|--------------|------------------|------|-------|
| FND-500(503) | COM CATHODE | 5" | 1.49 |
| FND-507(510) | COM ANODE | 5" | 1.49 |
| MAN-72 | COM ANODE | 3" | .99 |
| MAN-74 | COM CATHODE | 3" | .99 |
| TIL-313 | COM CATHODE | 3" | .45 |
| TIL-311 | 4x7 HEX W/ LOGIC | 270" | 10.95 |

LED DISPLAYS

| JUMBO RED | T1 1/2 | 10 | .09 |
|---------------|--------|----|-----|
| JUMBO GREEN | T1 1/2 | 14 | .12 |
| JUMBO YELLOW | T1 1/2 | 14 | .12 |
| MOUNTING P-DW | T1 1/2 | 10 | .09 |
| MINI RED | T1 | 10 | .09 |

DIFFUSED LEDS

| | | | |
|---------------|--------|----|-----|
| JUMBO RED | T1 1/2 | 10 | .09 |
| JUMBO GREEN | T1 1/2 | 14 | .12 |
| JUMBO YELLOW | T1 1/2 | 14 | .12 |
| MOUNTING P-DW | T1 1/2 | 10 | .09 |
| MINI RED | T1 | 10 | .09 |

3 VOLT LITHIUM BATTERY \$1.95
HOLDER \$1.49



The JDR system was well engineered. Parts did fit together well, and everything worked perfectly the very first time I flipped on the power... A real genius could probably find everything he'd need at JDR to build a revolutionary new computer.

Steve Kosek - Chicago Tribune

D-SUBMINIATURE CONNECTORS

| DESCRIPTION | ORDER BY | CONTACTS | | | | | | |
|-----------------------|----------|----------|------|------|------|------|------|------|
| | | 9 | 15 | 19 | 25 | 37 | 50 | |
| SOLDER CUP | MALE | DBxxP | .45 | .59 | .69 | .69 | 1.35 | 1.85 |
| | FEMALE | DBxxS | .49 | .69 | .75 | .75 | 1.39 | 2.29 |
| RIGHT ANGLE PC SOLDER | MALE | DBxxPR | .49 | .69 | ... | .79 | 2.27 | ... |
| | FEMALE | DBxxSR | .55 | .75 | ... | .85 | 2.49 | ... |
| WIREWRAP | MALE | DBxxPWW | 1.69 | 2.56 | ... | 3.89 | 5.63 | ... |
| | FEMALE | DBxxSww | 2.76 | 4.27 | ... | 6.84 | 9.95 | ... |
| IDC RIBBON CABLE | MALE | IDBxxP | 1.39 | 1.99 | ... | 2.25 | 4.25 | ... |
| | FEMALE | IDBxxS | 1.45 | 2.05 | ... | 2.35 | 4.43 | ... |
| HOODS | METAL | MHOODxx | 1.06 | 1.15 | 1.25 | 1.25 | ... | ... |
| | GREY | HOODxx | .39 | .39 | ... | .39 | .69 | .75 |

ORDERING INSTRUCTIONS: INSERT THE NUMBER OF CONTACTS IN THE POSITION MARKED 'C' OF THE ORDER BY PART NUMBER LISTED. EXAMPLE: A 15 PIN RIGHT ANGLE MALE PC SOLDER WOULD BE DB15SR

MOUNTING HARDWARE 59C

IC SOCKETS/DIP CONNECTORS

| DESCRIPTION | ORDER BY | CONTACTS | | | | | | | | |
|--------------------|-----------|----------|------|------|------|------|------|------|------|------|
| | | 8 | 14 | 16 | 18 | 20 | 22 | 24 | 28 | 40 |
| SOLDERTAIL SOCKETS | xxST | 11 | 11 | 12 | 15 | 18 | 15 | 20 | 25 | 30 |
| WIREWRAP SOCKETS | xxVW | 59 | 69 | 69 | 99 | 109 | 139 | 149 | 169 | 199 |
| ZIF SOCKETS | ZIFxx | ... | 4.95 | 4.95 | ... | 5.95 | ... | 5.95 | 6.95 | 9.95 |
| TOOLED SOCKETS | AUGATxxST | 62 | 79 | .89 | 1.09 | 1.29 | 1.39 | 1.49 | 1.69 | 2.49 |
| TOOLED VW SOCKETS | AUGATxxVW | 1.30 | 1.80 | 2.10 | 2.40 | 2.50 | 2.90 | 3.15 | 3.75 | 5.40 |
| COMPONENT CARRIERS | ICCRxx | 49 | 59 | 69 | 99 | 99 | 99 | 99 | 1.09 | 1.49 |
| DIP PLUGS (IDC) | IDPxx | 95 | 49 | 59 | 1.29 | 1.49 | ... | .85 | 1.49 | 1.59 |

FOR ORDERING INSTRUCTIONS SEE D-SUBMINIATURE CONNECTORS ABOVE

CALL FOR VOLUME QUOTES COPYRIGHT 1987 JDR MICRODEVICES

CIRCLE 176 ON FREE INFORMATION CARD

25 PIN D-SUB GENDER CHANGERS \$7.95



EMI FILTER \$4.95

LINE CORDS

| | |
|------------------------------|-----------------|
| 2 conductor 39c | 3 conductor 99c |
| 3 conductor w/ female socket | \$1.49 |

MARCH 1988

64K DRAM 4184 150ns **\$179**

256K DRAM 41256 150ns **\$349**

MONITOR STANDS

- MODEL MS-100** **\$12.95**
 • TILTS & SWIVELS • STURDY PLASTIC CONSTRUCTION
- MODEL MS-200** **\$39.95**
 • TILTS AND SWIVELS • BUILT-IN SURGE SUPPRESSOR
 • BUILT-IN POWER STATION INDEPENDENTLY CONTROLLED UP TO 5 120 VOLT AC OUTLETS • UL APPROVED



NASHUA DISKETTES

- BOXES OF 10**
- | | | | |
|-------------------|---------|--------------------------|---------------|
| 5 1/4" DS DD 360K | \$9.95 | 5 1/4" DS/DD SOFT SECTOR | |
| 5 1/4" DS HD 1.2M | \$24.95 | 49¢ ea | 39¢ ea |
| 3 1/2" DS QD 720K | \$16.95 | BULK QTY 50 | BULK QTY 250 |

- 5 1/4" DISKETTE STORAGE FILE** **\$8.95**
- HOLDS 70 5 1/4" FLOPPIES
 - STURDY, ATTRACTIVE SMOOKED ACRYLIC CASE
 - COMPLETE WITH HINGED DIVIDERS
- VERSION FOR 3 1/2" FLOPPIES AVAILABLE \$9.95**



2 WAY SWITCH BOXES **\$39.95**

- CONNECT 2 PRINTERS TO 1 COMPUTER OR VICE VERSA
- SERIAL & PARALLEL MODELS AVAILABLE
- ALL LINES SWITCHED
- GOLD PLATED CONNECTORS & QUALITY SWITCHES

6' INTERFACE CABLES

- MEETS FCC REQUIREMENTS 100% SHIELDED
- | | |
|---------------------------------|---------|
| IBM COMPATIBLE PARALLEL PRINTER | \$9.95 |
| CENTRONICS (MALE TO FEMALE) | \$15.95 |
| CENTRONICS (MALE TO MALE) | \$14.95 |
| IBM COMPATIBLE MODEM CABLE | \$7.95 |
| RS232 SERIAL (MALE TO FEMALE) | \$9.95 |
| RS232 SERIAL (MALE TO MALE) | \$9.95 |
| COILED KEYBOARD EXTENDER | \$7.95 |

JOYSTICK **\$19.95**

- SET X-Y AXIS FOR AUTO CENTER OR FREE MOVE-MENT
- FIRE BUTTON FOR USE WITH GAME SOFTWARE
- INCLUDES ADAPTOR CABLE FOR IBM



SWITCHING POWER SUPPLIES

- PS-135** **\$59.95**
 • FOR IBM XT COMPATIBLE
 • UL APP. 135 WATTS
 • -5V 15A, -12V 4.2A
 • 5V 5A, -12V 5A
 • ONE YEAR WARRANTY
- PS-150** 150W MODEL **\$69.95**
- PS-200** **\$89.95**
 • FOR IBM AT COMPATIBLE
 • 200 WATTS
 • -5V 22A, -12V 8A
 • -5V 5A, -12V 5A
 • ONE YEAR WARRANTY
- PS-A** **\$49.95**
 • FOR APPLE TYPE SYSTEM
 • -5V 6A, -12V 3A
 • -5V 1A, -12V 1A
 • APPLE CONNECTOR
- PS-1558** **\$34.95**
 • 75 WATTS, UL APPROVED
 • BY POWER SYSTEMS
 • -5V 7A, -12V 3A
 • -12V 250mA, 5 300mA



MONITORS

SAMSUNG MONOCHROME

- IBM COMPATIBLE TTL INPUT
 - 12" NON-GLARE, LOW DISTORTION, AMBER SCREEN
 - RES. 720 x 350
 - SWIVEL BASE
 - 1 YEAR WARRANTY
- \$129.95**



MULTISYNC BY NEC **\$549.95**

- ORIGINAL CGA, EGA, VGA COMPATIBLE MONITOR
- AUTO FREQUENCY ADJUSTMENT
- RESOLUTION AS HIGH AS 800 x 560

EGA BY CASPER **\$399.95**

- 15.75, 21.85 KHZ SCANNING FREQUENCIES
- RES. 640 x 200 350
- 14" BLACK MATRIX SCREEN
- 31mm DOT PITCH
- 16 COLORS FROM 64

RGB BY CASPER **\$279.95**

- COLOR GREEN/AMBER SWITCH
- RES. 640 x 240
- RGB/IBM COMPATIBLE
- 14" NON-GLARE SCREEN
- 39mm DOT PITCH
- CABLE FOR IBM PC INCLUDED

MONOCHROME BY SAKATA **\$69.95**

- IBM COMPATIBLE TTL INPUT
- 12" NON-GLARE GREEN SCREEN
- CABLE FOR IBM PC INCLUDED

TOLL FREE

800-538-5000
U.S. AND CANADA

20MB HARD DISK ON A CARD



- SAVES SPACE AND REDUCES POWER CONSUMPTION
 - IDEAL FOR PCs WITH FULL HEIGHT FLOPPIES
 - LEAVES ROOM FOR A HALF LENGTH CARD IN ADJACENT SLOT
- \$349**

RITEMAN II PRINTER



- 160 CPS DRAFT, 32 CPS NLQ MOOE
 - SUPPORTS EPSON/IBM GRAPHICS
 - 9 x 9 DOT MATRIX
 - FRICTION AND PIN FEEDS
 - VARIABLE LINE SPACING & PITCH
- \$219.95**
- IBM COMPATIBLE PRINTER CABLE** **\$9.95**
REPLACEMENT RIBBON CARTRIDGE **\$7.95**

DISK DRIVES

5 1/4" SEAGATE HARD DISK DRIVES

- | | | |
|---------|----------------------------|-------|
| ST-225 | HALF HEIGHT 20MB 65ms | \$259 |
| ST-238 | HALF HEIGHT 30MB 65ms (RL) | \$299 |
| ST-251 | HALF HEIGHT 40MB 40ms | \$469 |
| ST-277 | HALF HEIGHT 60MB 40ms (RL) | \$649 |
| ST-4038 | FULL HEIGHT 30MB 40ms | \$559 |
| ST-4096 | FULL HEIGHT 80MB 28ms | \$895 |

1/2 HEIGHT FLOPPY DISK DRIVES

- | | |
|------------------------------------|----------|
| 5 1/4" TEAC FD-55B DS DD 360K | \$99.95 |
| 5 1/4" TEAC FD-55F DS QUAD 720K | \$119.95 |
| 5 1/4" TEAC FD-55G DS HD 1.2M | \$129.95 |
| 5 1/4" FUJITSU M2551A DS DD 360K | \$89.95 |
| 5 1/4" FUJITSU M2553K DS HD 1.2M | \$119.95 |
| 5 1/4" DS DD 360K | \$69.95 |
| 5 1/4" DS HD 1.2M | \$109.95 |
| 3 1/2" MITSUBISHI DS DD (AT OR XT) | \$129.95 |

DISK DRIVE ACCESSORIES

- | | |
|----------------------------------|--------|
| 1/2 HT MOUNTING HARDWARE FOR IBM | \$2.95 |
| MOUNTING RAILS FOR IBM AT | \$4.95 |
| "Y" POWER CABLE FOR 5 1/4" FDDs | \$2.95 |
| 5 1/4" FDD POWER CONNECTORS | \$1.19 |

DRIVE ENCLOSURES WITH POWER SUPPLIES

- | | | |
|----------|--------------------------|----------|
| CAB-2SV5 | DUAL SLIMLINE FOR 5 1/4" | \$49.95 |
| CAB-1FH5 | FULL HEIGHT FOR 5 1/4" | \$69.95 |
| CAB-2SV8 | DUAL SLIMLINE FOR 8" | \$209.95 |
| CAB-2FH8 | DUAL FULL HEIGHT FOR 8" | \$219.95 |

EASYDATA MODEMS

All models feature auto-dial/answer/redial on busy, power up self test, touchtone or pulse dialing, built-in speaker, Hayes and Bell Systems 103 & 212A compatible, full or half duplex, PC Talk III Communications software with internal models and more.



INTERNAL

- | | | |
|-----|---------------------|----------|
| 12H | 1200 BAUD 1/2 CARD | \$69.95 |
| 24B | 2400 BAUD FULL CARD | \$179.95 |

EXTERNAL

- (NO SOFTWARE INCLUDED)
- | | | |
|-----|-----------|----------|
| 12D | 1200 BAUD | \$119.95 |
| 24D | 2400 BAUD | \$219.95 |

COMPUTER CASES

Attractive, sturdy steel cases fit the popular sized motherboards and include speakers, faceplates, expansion slots and all necessary hardware.



- | | |
|---------------------------|----------------|
| XT STYLE FLIP-TOP | \$34.95 |
| XT STYLE SLIDE-TOP | \$39.95 |
| AT STYLE SLIDE-TOP | \$89.95 |
- FRONT PANEL KEYLOCK AND LED INDICATORS
- JR. AT STYLE FLIP-TOP** **\$149.95**
- INCLUDES 180 WATT POWER SUPPLY
 - FRONT PANEL KEYLOCK AND LED INDICATORS

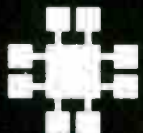

Visit our retail store located at 1256 S. Bascom Ave. in San Jose, (408) 947-8881

JDR Microdevices

110 Knowles Drive, Los Gatos, CA 95030
 Toll Free 800-538-5000 • (408) 866-6200
 FAX (408) 378-8927 • Telex 171-110

PLEASE USE YOUR CUSTOMER NUMBER WHEN ORDERING

TERMS: Minimum order \$10.00. For shipping and handling include \$2.50 for UPS Ground and \$3.50 for UPS Air. Orders over 1 lb. and foreign orders may require additional shipping charges—please contact our sales department for the amount. CA. residents must include applicable sales tax. All merchandise is warranted for 90 days unless otherwise stated. Prices are subject to change without notice. We are not responsible for typographical errors. We reserve the right to limit quantities and to substitute manufacturer. All merchandise subject to prior sale. A full copy of our terms is available upon request. Items pictured may only be representative.

COPYRIGHT 1987 JDR MICRODEVICES

THE JDR MICRODEVICES LOGO IS A REGISTERED TRADEMARK OF JDR MICRODEVICES. JDR INSTRUMENTS AND JDR MICRODEVICES ARE TRADEMARKS OF JDR MICRODEVICES. IBM IS A TRADEMARK OF INTERNATIONAL BUSINESS MACHINES CORPORATION. APPLE IS A TRADEMARK OF APPLE COMPUTER.

ALL MCT PRODUCTS CARRY A 1 YEAR WARRANTY

INTERFACE CARDS

FROM MODULAR CIRCUIT TECHNOLOGY

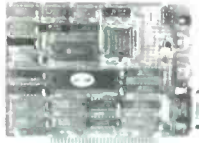

MCT-CG

DISPLAY CARDS

MCT-MGP MONOCHROME GRAPHICS \$5995

TRUE HERCULES COMPATIBILITY SUPPORTS LOTUS 123
SOFTWARE DRIVER ALLOWS COLOR GRAPHICS PROGRAMS TO RUN ON A MONOCHROME MONITOR PARALLEL PRINTER PORT

MCT-EGA ENHANCED GRAPHICS ADAPTOR \$14995

100% IBM COMPATIBLE PASSES IBM EGA DIAGNOSTICS
256K OF VIDEO RAM ALLOWS 640 x 350 IN 16 OF 64 COLORS
COMPATIBLE WITH COLOR AND MONOCHROME ADAPTORS

MCT-CG COLOR GRAPHICS ADAPTOR \$4995

COMPATIBLE WITH IBM COLOR GRAPHICS STANDARDS
SHORT SLOT SUPPORTS RGB, COLOR & COMPOSITE MONOCHROME
640 320 x 200 RESOLUTION, LIGHT PEN INTERFACE

MULTIFUNCTION CARDS

MCT-MF MULTIFUNCTION \$7995

ALL THE FEATURES OF 6PACK AT HALF THE PRICE!
0.384K DYNAMIC RAM USING 4164s
SERIAL, PARALLEL, GAME PORTS, CLOCK CALENDAR

MCT-MGMIO MONOGRAPHS I/O \$11995

TOTAL SYSTEM CONTROL FROM A SINGLE SLOT
2 FLOPPY CONT. SERIAL, PARALLEL, GAME PORT, CLOCK CAL
RUN COLOR GRAPHICS SOFTWARE ON A MONOCHROME MONITOR

MCT-MIO MULTI I/O FLOPPY \$7995

A PERFECT COMPANION FOR OUR MOTHERBOARDS
SERIAL, PARALLEL, GAME PORT, CLOCK CALENDAR
SUPPORTS UP TO 2 360K FLOPPIES, 720K WITH DOS 3.2

MCT-IO MULTI I/O CARD \$5995

USE WITH MCT-FH FOR A MINIMUM OF SLOTS USED
SERIAL PORT, CLOCK CALENDAR WITH A BATTERY BACK-UP
PARALLEL PRINTER PORT ADDRESSABLE AS LPT1 OR LPT2

MCT-ATMF AT MULTIFUNCTION \$13995

ADD UP TO 1MB (800KB) OF RAM TO THE AT
USER EXPANDABLE TO 1.5 MB OF MEMORY (ZERO K INSTALLED)
INCLUDES SERIAL PORT AND PARALLEL PORT

MCT-ATIO AT MULTI I/O \$5995

USE WITH MCT-ATMF FOR A MINIMUM OF SLOTS USED
SERIAL, PARALLEL AND GAME PORTS
USES 16450 SERIAL SUPPORT CHIPS FOR HIGH SPEED OPERATION

MCT-RAM MEMORY CARDS \$5995

A CONTIGUOUS MEMORY SOLUTION IN A SHORT SLOT
USER SELECTABLE CONFIGURATION AMOUNTS UP TO 576K USING
64K & 256K RAM CHIPS (ZERO K INSTALLED)

MCT-EMS EXPANDED MEMORY CARD \$12995

2 MB OF LOTUS INTEL MICROSOFT COMPATIBLE MEMORY FOR XT
CONFORMS TO LOTUS INTEL EMS USER EXPANDABLE TO 2 MB
EXPANDED CONVENTIONAL MEMORY, RAMDISK AND SPOOLER

MCT-FDC FLOPPY DISK CONTROLLER \$2995

QUALITY DESIGN OFFERS 4 FLOPPY CONTROL IN A SINGLE SLOT
INTERFACES UP TO 4 FDDs TO AN IBM PC OR COMPATIBLE
SUPPORTS BOTH DS DD AND DS QD WITH DOS 3.2

MCT-HDC HARD DISK CONTROLLER \$7995

HDD CONTROL FOR WHAT OTHERS CHARGE FOR FLOPPY CONTROL
SUPPORTS 16 DRIVE SIZES INCLUDING 5, 10, 20, 30 & 40 MB
DIVIDE 1 LARGE DRIVE INTO 2 SMALLER, LOGICAL DRIVES

MCT-FH FLOPPY/HARD CONTROLLER \$13995

SYSTEM STARTED FOR SLIGHT SATISFY IT WITH THIS TIMELY DESIGN
INTERFACES UP TO 2 FDDs & 2 HDDs, CABLING FOR 2 FDDs & 1 HDD
SUPPORTS BOTH DS DD & DS QD WITH DOS 3.2

MCT-ATFH AT FLOPPY/HARD CONTROLLER \$14995

FLOPPY/HARD DISK CONTROL IN A TRUE AT DESIGN
SUPPORTS UP TO 2 360K 720K 1.2MB FDDs
AS WELL AS 2 HDDs USING STANDARD CONTROL TABLES



1/2 HEIGHT HARD DISK DRIVES

40 MB \$469
60 MB \$649

Drives are Seagate models ST-251 (40 MB) & ST-277 (60 MB RLL) 5 1/4" half heights
FAST 40ms access time!

1/2 HT HARD DISK SYSTEMS

20 MB \$289
30 MB \$329

Systems include Seagate 1/2 height hard drive, drive controller, cables & instructions. All drives are pre-tested & warranted for 1 year.

IBM COMPATIBLE MOTHERBOARDS

FROM MODULAR CIRCUIT TECHNOLOGY

MCT-TURBO TURBO 4.77/8 MHz \$9995

4.77 OR 8 MHz OPERATION WITH 80286-2 & OPTIONAL 8087-2 CO-PROCESSOR
FRONT PANEL LED SPEED INDICATOR AND RESET SWITCH SET SUPPORTED
CHOICE OF NORMAL TURBO MODE OR SOFTWARE SELECT PROCESSOR SPEED

MCT-ATMB 80286 6/8 MHz \$37995

8 SLOT (2 EIGHT BIT, 6 SIXTEEN BIT) AT MOTHERBOARD
HARDWARE SELECTION OF 6 OR 8 MHz
1 WAIT STATE
KEYLOCK SUPPORTED, RESET SWITCH, FRONT PANEL LED INDICATOR
SOCKETS FOR 1 MB OF RAM AND 80287
BATTERY BACKED CLOCK

MCT-BATMB MINI 80286 \$38995

REPLACEMENT BOARD FOR XT STYLE CHASSIS
OPERATE AT 6-10 MHz, WITH UP TO 1MB ON-BOARD MEMORY (ZERO K INSTALLED)
SOCKET FOR 80287 MATH CO-PROCESSOR
BATTERY BACKED CLOCK
8 SLOTS, 2 EIGHT BIT, 6 SIXTEEN BIT
USES CHIPS & TECHNOLOGY CHIP SET FOR RELIABILITY AND SMALL SIZE

IBM COMPATIBLE KEYBOARDS

FULL ONE YEAR WARRANTY



MCT-5339 \$7995

IBM ENHANCED STYLE LAYOUT
SOFTWARE AUTONSENSE FOR XT OR AT COMPATIBLES
LED INDICATORS
AUTO REPEAT FEATURE
SEPARATE CURSOR PAD

MCT-5060 \$5995

IBM AT STYLE LAYOUT
SOFTWARE AUTONSENSE FOR XT OR AT COMPATIBLES
LED INDICATORS
AUTO REPEAT FEATURE

MCT-5150 XT STYLE LAYOUT \$4995

MCT-5151 KB5151™ EQUIV. \$6995

WHY BUY A SYSTEM FROM JDR?

- BUILD IT YOURSELF AND SAVE!
- MONEY BACK GUARANTEE (ASK FOR DETAILS)
- LEARN ABOUT THE INNER WORKINGS OF A COMPUTER
- YOU CAN ASSEMBLE A SYSTEM IN ABOUT 2 HOURS WITH A SCREWDRIVER & OUR EASY-TO-FOLLOW INSTRUCTIONS
- MOST ORDERS SHIPPED IN 24 HOURS
- QUALITY COMPONENTS AND COMPETITIVE PRICES
- TOLL FREE TECH SUPPORT IN THE U.S. AND CANADA

BUILD YOUR OWN 256K XT COMPATIBLE

- MOTHERBOARD
- 256K OF MEMORY
- 135 WATT POWER SUPPLY
- FLIP-TOP CASE
- XT STYLE KEYBOARD
- 360K FLOPPY DRIVE
- DRIVE CONTROLLER
- MONOCHROME MONITOR
- GRAPHICS ADAPTOR

FOR ONLY \$494⁰¹

ANYONE CAN BUILD A SYSTEM IN ABOUT 2 HOURS USING A SCREWDRIVER AND OUR EASY-TO-FOLLOW INSTRUCTIONS!



DEVELOPMENT TOOLS

FROM MODULAR CIRCUIT TECHNOLOGY

MCT-EPROM PROGRAMMER \$12995

PRO 3RAMS 27xx & 27xx EPROMS UP TO 27512 AND VOLTAGES
SUPPORTS VARIOUS PROGRAMMING FORMATS AND VOLTAGES
SPLIT OR COMBINE CONTENTS OF SEVERAL EPROMS OF DIFFERENT SIZES

READ, WRITE, COPY, ERASE CHECK AND VERIFY SOFTWARE FOR HEX AND INTEL HEX FORMATS

MCT-EPROM-4 4 GANB PROGRAMMER \$18995

MCT-EPROM-10 10 GANB PROGRAMMER \$29995

MCT-PAL PAL PROGRAMMER \$26995

MCT-MP PROCESSOR PROG. \$19995



PARTIAL LISTING ONLY-CALL FOR A FREE CATALOG!

COPYRIGHT 1987 JDR MICRODEVICES

CIRCLE 178 ON FREE INFORMATION CARD

MARCH 1988

115

What's New at AMERICAN DESIGN COMPONENTS?

"The Source" of the electro-mechanical components for the hobbyist.

We warehouse 60,000 items at American Design Components - expensive, often hard-to-find components for sale at a fraction of their original cost!

You'll find every part you need - either brand new, or removed from equipment (RFE) in excellent condition. But quantities are limited. Order from this ad, or visit our retail showroom and find exactly what you need from the thousands of items on display.

OPEN MON. - Sat., 9-5

THERE'S NO RISK.

With our full 90-day warranty, any purchase can be returned for any reason for full credit or refund.

ADAM COMPUTER

(Less printer)
No wiring necessary (just plugs together).
Hook-up diagram included. Includes: Keyboard, 1 cassette digital data drive, 2 game controllers, power supply, & one cassette. Capable of running CP/M, has built-in word processor.

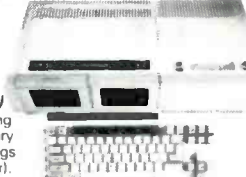

Item #7410 Complete - \$99.00

ADAM 5 1/2" DISK DRIVE

Gives your Adam fast, reliable data storage & retrieval. Can hold up to 160K bytes of information. Uses Industry-standard SS/DD disks. Connects directly to your Adam memory console. Comes w/disk drive power supply. Disk Manager disk and owner's manual.
Mfr - Coleco, model 7817
Item #12830 Like New - \$199.00



Adam/Coleco Vision Accessories . . .

Data Drive - Item #6641 \$19.95

Printer Power Supply - Item #6642 \$14.95

ASCII Keyboard - Item #6643 \$19.95

Controllers (Set of 4) - Item #7013 \$9.95 RFE

Adam Cassettes - (Consisting of Smart Basic, Buck Rogers & blank cassette.) Item #7786

BAKER'S DOZEN - \$19.95

Adam Link Modem (Software incl.) - Item #12358 \$29.95

Auto-Dialer Address Book - Item #12365 \$19.95

Disk Drive Power Supply - Item #14603 \$14.95

Adam Daisy Print Wheel - Item #13305 \$3.95

Adam Ribbon Cartridge - Item #13306 \$3.95

ColecoVision to Adam Expansion Kit - Item #9918 \$59.95

Expansion Module #2 - Play arcade-quality driving & racing games on your ColecoVision. Incl. Turbo cartridge. Item #13146 \$39.95 New

Roller Controller - Gives full 360° game control. Hi-speed action of an arcade. Can be used w/ the Adam. Incl. Slither cartridge. Item #13147 \$39.95 New

Super Action Controller Set - Gives you individual control of 4+ on-screen players. Incl. Baseball cartridge. Item #13148 \$39.95 New

3 1/2", 20 Mb, HALF HT. HARD DISK DRIVE

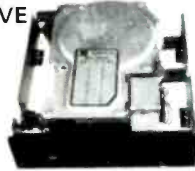

Fits standard 5 1/4" spacing. High speed, low power.
Mfr - Lapine #LT200/2000
Item #15853 \$199.00 New

Fans . . .

115 CFM MUFFIN® FANS



115 VAC, 60 Hz., 21W., 28A.; 3100 RPM; 5-blade model; aluminum housing. Can be mtd. for blowing or exhaust. Dim.: 4 1/4" sq. x 1 1/2" deep
NEW - Mfr. IMC Item #1864 \$12.95
USED - Mfr. Centaur/Howard Item #5345 \$5.95

27 CFM MINI FANS



115VAC; 50/60Hz.; 12W. Low noise level fans, can be mounted for blowing or exhaust.

1" Thin - Contains 9 plastic blades. Dim.: 3 3/4" sq. x 1" deep Mfr - Toshiba #U92018 Item #10960 \$7.95 New

1 1/2" Standard - Contains 7 metal blades. Mfr - Rotron #SU2A1 Item #5970 \$7.95 New

COMPUTER & GAME EQUIPMENT

INTEGRATED CIRCUITS . . .

Static Rams . . .

| | | | | | |
|----------|------------------|--------|------------|------------------|--------|
| 2114-45 | 1024 x 4 (450ns) | \$.99 | HM6116LP-3 | 2048 x 8 (150ns) | \$1.89 |
| 2148-55 | | 3.49 | HM6116LP-4 | 2048 x 8 (200ns) | 1.85 |
| 2149 | 1024 x 4 (45ns) | 2.49 | 6147P | | 2.95 |
| 2167S-45 | | 3.95 | 6167P-6 | | 4.50 |

Dynamic Rams . . .

| | | | | | |
|----------|--------------------|--------|-----------|---------------------|--------|
| 4116-200 | 16,384 x 1 (200ns) | \$.69 | TMS4416 | 16,384 x 4 (150ns) | \$3.75 |
| 4116-250 | 16,384 x 1 (250ns) | .49 | 4464-150 | 65,536 x 4 (150ns) | 4.95 |
| 4164-150 | 65,536 x 1 (150ns) | 1.25 | 8118 | 16,384 x 1 (120ns) | .49 |
| TMS4164 | 65,536 x 1 (150ns) | 1.95 | 41256-150 | 262,144 x 1 (150ns) | 2.95 |

Eproms . . .

| | | | | | |
|----------|------------------|--------|-----------|--------------------|--------|
| 2708 | 1024 x 8 (450ns) | \$4.95 | 2764-250 | 8192 x 8 (250ns) | \$3.55 |
| 2716 | 2048 x 8 (450ns) | 3.49 | MCM68766 | 8192 x 8 (350ns) | 15.95 |
| TMS2532 | 4096 x 8 (450ns) | 5.95 | 27128A-25 | 16,384 x 8 (250ns) | 5.00 |
| 2732 | 4096 x 8 (450ns) | 3.95 | 27128-250 | 16,384 x 8 (250ns) | 4.25 |
| 2732A-25 | 4096 x 8 (250ns) | 3.95 | 27C256 | 32,768 x 8 (250ns) | 7.95 |
| 27C64 | 8192 x 8 (250ns) | 4.95 | 27256 | 32,768 x 8 (250ns) | 5.95 |
| 2764 | 8192 x 8 (450ns) | 2.95 | 27512 | 65,536 x 8 (250ns) | 11.55 |
| 2764A-25 | 8192 x 8 (250ns) | 3.55 | | | |

Linear Devices . . .

| | | | | | |
|-----------|--------|---------|--------|----------|--------|
| LH0002CN | \$5.35 | LM319N | \$1.07 | LM380N | \$.80 |
| LM101CLH | 2.65 | LM324N | .35 | LM380N-8 | .98 |
| LH0070 OH | 3.55 | LM334Z | 1.05 | LM381N | 1.16 |
| TL071CP | 3.53 | LM336Z | .98 | LM383T | 1.34 |
| TL072CP | .71 | LM337MP | 1.03 | LM385Z | 1.70 |
| LM301N | .32 | LM337T | 1.34 | LM386N-4 | .80 |
| LM307N | .41 | LM338K | 3.55 | LM389N | .90 |
| LM310N | 1.16 | LM339N | .44 | LM393N | .41 |
| LM311N | .41 | LF347N | .90 | LF398N | 2.15 |
| LM317K | 2.65 | LM348N | .62 | LF411CN | .71 |
| LM317LZ | .62 | LM350K | 3.55 | TL494CN | 1.75 |
| LM317MP | .80 | LF353N | .53 | TL496CP | 1.34 |
| LM317T | .90 | LF356N | .80 | TL497ACN | 1.97 |
| LM318N | 1.07 | LM358N | .44 | NE555V | .26 |

15 Mb 5 1/4" FULL HT. HARD DISK DRIVE



(IBM® PC/XT Compatible)
Removed from working equipment. Tested & formatted.
Mfr - CMI model CM5619
Item #14511 \$199.00

5 1/4" FLOPPY DISKETTES



Single side/single density; 16 hard sectors. Mfr - Xerox #11R61630 Item #14537
Pack of 10 \$9.95 New

STEPPING MOTORS for ROBOTICS

Precision steppers with increments from 1 to 7.5 degrees. Speeds up to 5,000 steps.

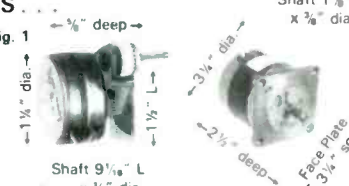

Stall Torque oz/in Type Mfr. & Part No. Fig Price

| | | | | | | | |
|------|-----|-----|-----|----|-------------------|---|-------------|
| 5431 | 1 | 5 | 17 | PM | N.A. Phillips | 1 | \$9.95 ea. |
| | | | | | A82310-M2 | 2 | \$14.95 |
| 5275 | 1.8 | 1.8 | 72 | PM | Superior Electric | 2 | \$19.95 ea. |
| | | | | | 2 0 MQ61-FF-6201B | 2 | \$37.50 |
| 7630 | 1.8 | 3.0 | 200 | PM | Superior Electric | 2 | \$34.50 ea. |
| | | | | | MO92-FT-402 | 2 | \$59.50 |

10 Mb, 5 1/4", HALF HT. HARD DISK DRIVE



(IBM® Compatible)
Shock mounted, high speed, low power. Mfr - Tandon TM252
Item #13250 \$159.00
Controller Card for above Item #10150 \$89.00

MAGNIFYING LAMP

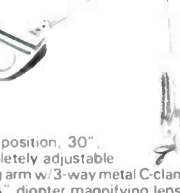

Multi position, 30" completely adjustable swing arm w/3-way metal C-clamp. Has 4" diopter magnifying lens, w/ruler. Porcelain lamp socket, & on/off switch; uses up to a 60W bulb. Color: Beige. UL listed.
Item #13136 \$24.95 New

12", HIGH RES. TTL MONITOR



12 VDC/110 VAC (w/built-in power supply). Green phosphor. Schematic supplied.
Mfr - Capetronic #DS-1030;
Item #6811 \$19.95 New

Protect your Printer/Typewriter with our DIABLO CLEANING KIT



For printers & typewriters w/print wheel, spindle, & metal ball type print elements. Good for 5 cleanings. Incl.: platen cleaner, type/print element cleaner, sound shield cleaner, plus buffers & cloths.
Mfr - Diablo Supplies #9R87106 Item #15419
3sets \$14.95 New

GIANT ZOOM LENS



Variable focal length (9.5 to 10.5") High-quality precision lens system. Consists of: symmetrical lens with iris, 2 additional front elements (one movable & the other fixed). Focal length adjusts: 9.5 to 10.5" F 5.6 lens max. aperture variable F 5.6 to F 11.
Dim.: 4 1/4" L x 4 3/4" dia.
Mfr - Schneider Optics
Item #9349 \$29.95 New

BATTERIES - FANS - BLOWERS

NEC V20 & V30 CHIPS

Replace the 8086 or 8088 in Your IBM-PC and Increase Its Speed by up to 40%! Price

| Part No. | Price |
|--------------------------------------|---------|
| UPD70108-5 (5MHz) V20 Chip | \$ 8.75 |
| UPD70108-8 (8MHz) V20 Chip | \$10.75 |
| UPD70108-10 (10MHz) V20 Chip | \$29.95 |
| UPD70116-8 (8MHz) V30 Chip | \$13.75 |
| UPD70116-10 (10MHz) V30 Chip | \$29.95 |

7400

| Part No. | 1-9 | 10-1 | Part No. | 1-9 | 10-1 |
|----------|------|------|----------|------|------|
| 7400 | 29 | 19 | 7485 | 65 | 55 |
| 7402 | 29 | 19 | 7486 | 45 | 35 |
| 7404 | 29 | 19 | 7489 | 2.05 | 1.95 |
| 7405 | 35 | 25 | 7490 | 49 | 39 |
| 7406 | 39 | 29 | 7493 | 45 | 35 |
| 7407 | 39 | 29 | 74121 | 45 | 35 |
| 7408 | 35 | 25 | 74123 | 55 | 45 |
| 7410 | 29 | 19 | 74125 | 55 | 45 |
| 7414 | 49 | 39 | 74126 | 69 | 59 |
| 7416 | 39 | 29 | 74143 | 3.95 | 3.85 |
| 7417 | 39 | 29 | 74150 | 1.35 | 1.25 |
| 7420 | 35 | 25 | 74154 | 1.35 | 1.25 |
| 7430 | 35 | 25 | 74158 | 1.59 | 1.49 |
| 7432 | 39 | 29 | 74173 | 85 | 75 |
| 7438 | 39 | 29 | 74174 | 59 | 49 |
| 7442 | 45 | 35 | 74175 | 49 | 39 |
| 7445 | 79 | 69 | 74176 | 99 | 89 |
| 7446 | 89 | 79 | 74181 | 1.95 | 1.85 |
| 7447 | 89 | 79 | 74189 | 1.95 | 1.85 |
| 7448 | 2.05 | 1.95 | 74193 | 79 | 69 |
| 7472 | 89 | 79 | 74196 | 1.85 | 1.75 |
| 7473 | 39 | 29 | 74221 | 69 | 59 |
| 7474 | 39 | 29 | 74273 | 1.95 | 1.85 |
| 7475 | 49 | 39 | 74365 | 65 | 55 |
| 7476 | 45 | 35 | 74367 | 65 | 55 |

74LS

| | | | | | |
|---------|------|----|---------|------|------|
| 74LS00 | 29 | 19 | 74LS165 | 75 | 65 |
| 74LS02 | 29 | 19 | 74LS166 | 99 | 89 |
| 74LS04 | 35 | 25 | 74LS173 | 59 | 49 |
| 74LS05 | 35 | 25 | 74LS240 | 69 | 59 |
| 74LS06 | 1.09 | 99 | 74LS175 | 49 | 39 |
| 74LS07 | 1.09 | 99 | 74LS189 | 4.59 | 4.49 |
| 74LS08 | 29 | 19 | 74LS191 | 59 | 49 |
| 74LS10 | 29 | 19 | 74LS193 | 79 | 69 |
| 74LS14 | 49 | 39 | 74LS221 | 69 | 59 |
| 74LS27 | 35 | 25 | 74LS240 | 69 | 59 |
| 74LS30 | 29 | 19 | 74LS243 | 69 | 59 |
| 74LS32 | 35 | 25 | 74LS244 | 69 | 59 |
| 74LS42 | 49 | 39 | 74LS245 | 89 | 79 |
| 74LS47 | 99 | 89 | 74LS259 | 99 | 89 |
| 74LS73 | 39 | 29 | 74LS273 | 89 | 79 |
| 74LS74 | 35 | 25 | 74LS279 | 49 | 39 |
| 74LS75 | 39 | 29 | 74LS322 | 4.05 | 3.95 |
| 74LS76 | 55 | 45 | 74LS365 | 49 | 39 |
| 74LS85 | 59 | 49 | 74LS366 | 49 | 39 |
| 74LS86 | 35 | 25 | 74LS367 | 49 | 39 |
| 74LS90 | 49 | 39 | 74LS368 | 49 | 39 |
| 74LS93 | 49 | 39 | 74LS373 | 79 | 69 |
| 74LS123 | 59 | 49 | 74LS374 | 79 | 69 |
| 74LS125 | 49 | 39 | 74LS393 | 89 | 79 |
| 74LS138 | 49 | 39 | 74LS590 | 6.05 | 5.95 |
| 74LS139 | 49 | 39 | 74LS624 | 2.05 | 1.95 |
| 74LS154 | 1.09 | 99 | 74LS629 | 2.95 | 2.85 |
| 74LS157 | 45 | 35 | 74LS640 | 1.09 | 99 |
| 74LS158 | 55 | 45 | 74LS645 | 1.09 | 99 |
| 74LS163 | 59 | 49 | 74LS670 | 1.09 | 99 |
| 74LS164 | 59 | 49 | 74LS688 | 2.39 | 2.29 |

74S/PROMS*

| | | | |
|--------|------|---------|------|
| 74S00 | 29 | 74S188* | 1.49 |
| 74S04 | 29 | 74S189 | 1.69 |
| 74S06 | 35 | 74S196 | 2.49 |
| 74S10 | 29 | 74S240 | 1.49 |
| 74S32 | 35 | 74S244 | 1.49 |
| 74S74 | 45 | 74S253 | 79 |
| 74S85 | 1.79 | 74S287* | 1.49 |
| 74S86 | 45 | 74S288* | 1.49 |
| 74S124 | 2.75 | 74S373 | 1.49 |
| 74S174 | 79 | 74S374 | 1.49 |
| 74S175 | 79 | 74S472* | 2.95 |

74F

| | | | |
|--------|----|--------|------|
| 74F00 | 29 | 74F139 | 69 |
| 74F04 | 29 | 74F157 | 69 |
| 74F08 | 29 | 74F193 | 2.95 |
| 74F10 | 29 | 74F240 | 99 |
| 74F32 | 29 | 74F244 | 99 |
| 74F74 | 39 | 74F253 | 69 |
| 74F86 | 39 | 74F373 | 99 |
| 74F138 | 69 | 74F374 | 99 |

CD-CMOS

| | | | |
|--------|------|----------|------|
| CD4001 | 19 | CD4076 | 59 |
| CD4008 | 69 | CD4081 | 25 |
| CD4011 | 19 | CD4082 | 25 |
| CD4013 | 29 | CD4093 | 35 |
| CD4016 | 29 | CD4094 | 35 |
| CD4017 | 49 | CD40103 | 2.49 |
| CD4018 | 59 | CD40107 | 49 |
| CD4020 | 59 | CD40109 | 79 |
| CD4024 | 49 | CD4510 | 69 |
| CD4027 | 35 | CD4511 | 69 |
| CD4030 | 29 | CD4520 | 75 |
| CD4040 | 65 | CD4522 | 79 |
| CD4049 | 29 | CD4538 | 79 |
| CD4050 | 29 | CD4541 | 89 |
| CD4051 | 59 | CD4543 | 79 |
| CD4052 | 59 | CD4553 | 4.95 |
| CD4053 | 49 | CD4555 | 79 |
| CD4063 | 1.49 | CD4559 | 7.95 |
| CD4066 | 29 | CD4566 | 2.49 |
| CD4067 | 1.29 | CD4583 | .39 |
| CD4069 | 25 | CD4584 | .39 |
| CD4070 | 25 | CD4585 | .39 |
| CD4071 | 25 | MC14411P | 8.95 |
| CD4072 | 25 | MC14490P | 4.49 |

MICROPROCESSOR COMPONENTS

| MISCELLANEOUS CHIPS | | 6500/6800/68000 Cont. | | 8000 SERIES Cont. | |
|-------------------------------|-------|-----------------------|--------|-------------------------|-------|
| Part No. | Price | Part No. | Price | Part No. | Price |
| D765AC | 4.95 | 6845 | 3.95 | 8228 | 2.95 |
| WD9216 | 6.95 | 6850 | 1.95 | 8237-5 | 4.95 |
| 95H93 | 9.95 | 6852 | 1.49 | 8243 | 2.25 |
| Z80, Z80A, Z80B SERIES | | MC68000L8 | | 8250A | 6.49 |
| Z80 | 1.25 | MC68000L10 | 13.95 | 8250B (For IBM) | 6.95 |
| Z80-CTC | 1.79 | MC68010L10 | 16.95 | 8251A | 1.89 |
| Z80 DART | 4.95 | MC68020RC12B | 49.95 | 8253-5 | 1.95 |
| Z80-PIO | 1.79 | MC68881RC12A | 149.95 | 8254 | 4.95 |
| Z80A | 1.69 | | | 8255A-5 | 1.89 |
| Z80A-CTC | 1.79 | 80031 | 3.95 | 8257-5 | 1.95 |
| Z80A-DART | 4.35 | 80331 | 9.95 | 8259-5 | 2.25 |
| Z80A-PIO | 1.69 | 8035 | 1.95 | 8272 | 4.95 |
| Z80A SIO/O | 5.75 | 8073 | 9.95 | 8279-5 | 2.95 |
| Z80B | 3.49 | 8080A | 2.95 | 8741 | 5.95 |
| Z80B-CTC | 3.95 | 8085A | 2.49 | 8742 | 29.95 |
| Z80B-PIO | 4.29 | 8086 | 5.95 | 8748 (25V) | 7.95 |
| | | 8086-2 | 6.95 | 8748H (PMOS) (21V) | 9.95 |
| | | 8087 (5MHz) | 129.95 | 8749 | 8.95 |
| | | 8087-1 (10MHz) | 229.95 | 8751 | 39.95 |
| | | 8087-2 (8MHz) | 169.95 | 8755 | 14.95 |
| | | 8088 | 6.49 | DATA ACQUISITION | |
| | | 8088-2 | 8.95 | ADC0804LCN | 3.19 |
| | | 8116 | 4.95 | ADC0808CCCN | 5.95 |
| | | 8155 | 4.49 | ADC0809CCCN | 3.95 |
| | | 8155-2 | 3.95 | ADC0816CCCN | 11.95 |
| | | 8203 | 5.95 | ADC1205CCJ-1 | 19.95 |
| | | 8212 | 1.49 | DAC0808CCCN | 1.95 |
| | | 8224 | 2.25 | DAC1008LCN | 4.95 |
| | | | | AY-3-1015D | 4.95 |
| | | | | AY-5-1013A | 2.95 |

MICROPROCESSOR SALE!

| Part No. | Price |
|---|-----------|
| 8052AHBASIC CPU w/BASIC Interpreter | \$ 29.95 |
| MC6800L8 32-Bit MPU (8-Bit Data Bus) | \$ 19.95 |
| MC68701 8-Bit EPROM Microcomputer | \$ 14.95 |
| MC68705P3S 8-Bit EPROM Microcomputer | \$ 14.95 |
| MC68705U3L 8-Bit EPROM Microcomputer | \$ 10.95 |
| 80286-10 16-Bit Hi Performance MPU | \$ 99.95 |
| 80287-8 Math Co-processor (8MHz) | \$ 299.95 |
| 80287-10 Math Co-processor (10MHz) | \$ 329.95 |
| 80387-16 Math Co-processor (16MHz) ^{ARRAY} | \$ 494.95 |

DYNAMIC RAMS

| Part No. | Price |
|---|-------|
| 4116-15 16384 x 1 (150ns) | .89 |
| 4128-20 131 072 x 1 (200ns) (Poggyback) | 3.25 |
| 4164-120 65536 x 1 (120ns) | 2.25 |
| 4164-150 65536 x 1 (150ns) | 1.95 |
| 4164-200 65536 x 1 (200ns) | .99 |
| TMS4416-12 16384 x 4 (120ns) | 3.49 |
| 8118 16384 x 1 (120ns) | .49 |
| 41256-100 262 144 x 1 (100ns) | 5.95 |
| 41256-120 262 144 x 1 (120ns) | 4.95 |
| 41256-150 262 144 x 1 (150ns) | 4.95 |
| 50464-15 65536 x 4 (150ns) (4464) | 4.95 |
| 511000P-10 1048576 x 1 (100ns) 1 Meg. | 34.95 |
| 514256P-10 262 144 x 4 (100ns) 1 Meg. | 29.95 |

STATIC RAMS

| | |
|--|-------|
| 2016-12 2048 x 8 (120ns) | 1.69 |
| 2018-45 2048 x 8 (45ns) | 6.95 |
| 2102-2L 1024 x 1 (250ns) Low Power | 1.95 |
| 2114N 1024 x 4 (450ns) | .99 |
| 2114N-2L 1024 x 4 (200ns) Low Power | 1.49 |
| 21C14 1024 x 4 (200ns) CMOS | .49 |
| 2149 1024 x 4 (45ns) | 2.49 |
| 5101 256 x 4 (450ns) CMOS | 1.95 |
| 6116P-3 2048 x 8 (150ns) CMOS | 1.89 |
| 6116LP-3 2048 x 8 (150ns) LP CMOS | 1.95 |
| 6264LP-12 8192 x 8 (150ns) CMOS | 3.45 |
| 6264P-15 8192 x 8 (150ns) CMOS | 3.75 |
| 6264LP-15 8192 x 8 (150ns) LP CMOS | 3.75 |
| 6514 1024 x 4 (350ns) CMOS | 3.49 |
| 43256-15L 32 768 x 8 (150ns) Low Power | 11.95 |

EPROMS

| | |
|---|-------|
| TMS2516 2048 x 8 (450ns) 25V | 6.95 |
| TMS2532 4096 x 8 (450ns) 25V | 6.95 |
| TMS2532A 4096 x 8 (450ns) 21V | 5.95 |
| TMS2564 8192 x 8 (450ns) 25V | 9.95 |
| TMS2716 2048 x 8 (450ns) 3 Voltage | 9.95 |
| 1702A 256 x 8 (11ns) | 6.99 |
| 2708 1024 x 8 (450ns) | 4.95 |
| 2716 2048 x 8 (450ns) 25V | 3.75 |
| 2716-1 2048 x 8 (350ns) 25V | 4.25 |
| 27C16 2048 x 8 (450ns) 25V (CMOS) | 5.49 |
| 2732 4096 x 8 (450ns) 25V | 3.95 |
| 2732A-20 4096 x 8 (200ns) 21V | 4.25 |
| 2732A-25 4096 x 8 (250ns) 21V | 3.95 |
| 27C32 4096 x 8 (450ns) 25V (CMOS) | 5.95 |
| 2764-20 8192 x 8 (200ns) 21V | 4.25 |
| 2764-25 8192 x 8 (250ns) 21V | 3.75 |
| 2764A-25 8192 x 8 (250ns) 12.5V | 3.95 |
| 2764-45 8192 x 8 (450ns) 21V | 2.95 |
| 27C64-15 8192 x 8 (150ns) 21V (CMOS) | 6.49 |
| 27128-20 16384 x 8 (200ns) 21V | 6.95 |
| 27128-25 16384 x 8 (250ns) 21V | 5.95 |
| 27128A-25 16384 x 8 (250ns) 12.5V | 5.25 |
| 27C128-25 16384 x 8 (250ns) 21V (CMOS) | 6.95 |
| 27256-20 32 768 x 8 (200ns) 12.5V | 4.95 |
| 27256-25 32 768 x 8 (250ns) 12.5V | 5.95 |
| 27C256-25 32 768 x 8 (250ns) 12.5V (CMOS) | 7.95 |
| 27512-20 65536 x 8 (200ns) 12.5V | 13.49 |
| 27512-25 65536 x 8 (250ns) 12.5V | 11.95 |
| 68764 8192 x 8 (450ns) 25V | 13.95 |

COMMODORE CHIPS

| Part No. | Price |
|----------|-------|
| LAG570 | 10.95 |
| WD1770 | 11.95 |
| S13052P | 2.49 |

Worldwide • Since 1974

• QUALITY COMPONENTS • COMPETITIVE PRICING
• PROMPT DELIVERY

Mail Order Electronics - Worldwide
Jameco
ELECTRONICS

PROTOTYPING PRODUCTS

Jameco Solderless Breadboard Sockets

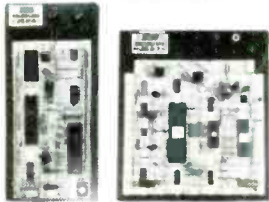

| Part No. | Dim. L x W | Contact Points | Binding Posts | Price |
|----------|---------------|----------------|---------------|---------|
| JE20 | 6 1/2 x 3 1/2 | 200 | 0 | \$ 2.29 |
| JE21 | 3 1/2 x 2 1/8 | 400 | 0 | \$ 4.49 |
| JE22 | 6 1/2 x 1 3/8 | 630 | 0 | \$ 5.95 |
| JE23 | 6 1/2 x 2 1/8 | 830 | 0 | \$ 7.49 |
| JE24 | 6 1/2 x 3 1/8 | 1,360 | 2 | \$14.95 |
| JE25 | 6 1/2 x 4 1/8 | 1,660 | 3 | \$22.95 |
| JE26 | 6 1/8 x 5 3/8 | 2,390 | 4 | \$27.95 |
| JE27 | 7 1/2 x 7 1/2 | 3,220 | 4 | \$37.95 |

Jameco General Purpose Prototype PC Boards

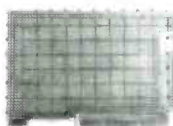

- Wire Wrap
- Component Testing
- Point-to-Point Wiring
- 31/62 Connection

JE415 (6 1/2" No Pads, PC/XT) \$14.95
JE417 (6 1/2" Plated w/Pads, PC/XT) \$19.95

Extender Board

JE421 (4 1/2" Extender, 31/62 Connector) . . . \$19.95

DATA BOOKS

| | | |
|--------|-----------------------------------|---------|
| 30003 | National Linear Data Book (82) | \$19.95 |
| 30005 | Logic Data Book - Vol. II (84) | \$19.95 |
| 30009 | Intersil Data Book (87) | \$14.95 |
| 21398 | CMOS Cookbook (86) | \$14.95 |
| 210830 | Intel Memory Handbook (87) | \$17.95 |
| 230843 | Intel Microsystem Hndbk. Set (87) | \$24.95 |

MUFFIN/SPRITE-STYLE FANS

| | | |
|--------|--------------------------------------|---------|
| TA450S | Ion Industries 14 68 sq 50 cmj | \$11.95 |
| SU2A1 | E/G&G Roltron (3 125 square, 34 cmj) | \$11.95 |

NEW! Switching Power Supply

+5V@5A, +12V@1A x 2

Regulated 110VAC/220VAC
Switchable - 40 watt - Size 8 1/2" L x 3" W x 2 1/4" H - Weight 1.1 lbs - Data included

PSCC07 \$14.95

Jameco Computer Power Protection



| | | |
|--------|----------------------|----------|
| JE1190 | Power Base | \$29.95 |
| JE1191 | 6-Outlet Power Strip | \$11.95 |
| JE1192 | 300 Watt Back-Up | \$299.95 |
| JE1193 | 500 Watt Back-Up | \$399.95 |

IBM AND APPLE COMPATIBLE DISPLAY MONITORS

Franklin 12" Green Monochrome

- Apple II, II+, IIe, IIc Compatible
- Composite video output - 18MHz
- Resolution: 800 lines at center

SMON \$59.95



12" Amber Monochrome -

TTL Input, High Resolution (PC/XT/AT)

AMBER \$109.95

14" RGB Color - CGA Compatible Amber/Green/Color Switchable. 640 x 200 Resolution (PC/XT/AT)

TTX1410 \$279.95

14" EGA Color - EGA/CGA Compat. 720 x 350 (max.) resolution (PC/XT/AT)

TE5154 \$399.95

14" Ultrascan Color - CGA/EGA/PGC/VGA Compatible. 800 x 560 (max.) Resolution (PC/XT/AT)

4375M \$579.95



IBM PC/XT/AT Compatible Cards

| | | |
|--------|---------------------|----------|
| JE1050 | Mono Graphics Card | \$ 59.95 |
| JE1052 | Color Graphics Card | \$ 49.95 |
| JE1055 | EGA Card | \$149.95 |

JAMECO COMPUTER KITS

FREE! PC Write Word Processing Software Included!

Jameco's IBM™ AT Compatible Mini-286 6/8/10/12 MHz Kit!

| Part No. | Description | Price |
|-------------|--|--------------------|
| JE1043 | 1.2M/360K Floppy Control | \$ 49.95 |
| JE1015 | XT/AT Style Keyboard | \$ 59.95 |
| 41256-120 | 512K RAM (18 Chips) | \$ 89.10 |
| JE1012 | Baby AT Flip-Top Case | \$ 69.95 |
| JE1032 | 200W Power Supply | \$ 89.95 |
| JE1022 | 5 1/4" High Density Disk Drive (Zero-K RAM-incl. Award BIOS ROM) | \$109.95 |
| JE1003 | Baby AT Motherboard (Zero-K RAM-incl. Award BIOS ROM) | \$399.95 |
| EGA Monitor | TE5154 \$399.95 | Reg. List \$868.80 |
| EGA Card | JE1055 \$149.95 | SAVE \$68.85! |
| | (not included) | |

JE1008 IBM™ AT Compatible Kit \$799.95

Jameco's 4.77/8MHz Turbo IBM PC/XT Compatible Kit

| | | |
|-----------|--|----------|
| 4164-150 | 128K RAM (18 Chips) | \$ 35.10 |
| 41256-150 | 512K RAM (18 Chips) | \$ 77.10 |
| JE1010 | Flip-Top Case | \$ 34.95 |
| JE1015 | XT/AT Style Keyboard | \$ 59.95 |
| JE1030 | 150 Watt Power Supply | \$ 69.95 |
| JE1020 | 5 1/4" DSDD Disk Drive | \$ 89.95 |
| AMBER | 12" Amber Monitor | \$109.95 |
| JE1001 | 4.77/8MHz Turbo Motherboard (Zero-K RAM - Includes Award BIOS ROM) | \$104.95 |
| JE1071 | Multi I/O with Controller and Graphics | \$119.95 |

Regular List \$695.85
SAVE \$95.90!

JE1005 (IBM™ PC/XT Turbo Compatible Kit) . . . \$599.95

Jameco's IBM PC/XT/AT Compatible Motherboards

• Award BIOS ROM Included

| | | |
|--------|-------------------|----------|
| JE1000 | 4.77MHz (PC/XT) | \$ 89.95 |
| JE1001 | 4.77/8MHz (PC/XT) | \$104.95 |
| JE1003 | 6/8/10/12MHz (AT) | \$399.95 |

Additional Add-Ons Available!

COMPUTER PERIPHERALS



Seagate 20, 30 & 40MB Half Height Hard Disk Drives

| | | |
|---------|----------------------------|----------|
| ST225 | 20MB Drive only (PC/XT/AT) | \$269.95 |
| ST225K | 20MB w/Controller (PC/XT) | \$319.95 |
| ST23E | 30MB Drive only (PC/XT/AT) | \$299.95 |
| ST238K | 30MB w/Cont. (PC/XT/AT) | \$339.95 |
| ST251 | 40MB Drive only (PC/XT/AT) | \$469.95 |
| ST251AT | 40MB w/Cont. Card (PC/XT) | \$549.95 |
| ST251AT | 40MB w/Cont. Card (AT) | \$589.95 |



Jameco PC/XT & AT Compatible Disk Drives

| | | |
|--------|----------------------------|----------|
| JE1020 | 360K Black Bzl. (PC/XT/AT) | \$ 89.95 |
| JE1021 | 360K Beige Bzl. (PC/XT/AT) | \$ 89.95 |
| JE1022 | 1.2MB Beige Bzl. (AT) | \$109.95 |

DATATRONICS

2400/1200/300 Modems



- Hayes command compatible - Bell 103/212A compatible - Auto-dial/auto-answer - FCC approved - 1-year warranty - The 1200H & 2400S include Max/Mile Communication Software - The 1200C & 2400E do not include software

| | | |
|-------|------------------------------|----------|
| 1200H | 1200/300 Baud Internal Modem | \$ 79.95 |
| 2400S | 2400/1200/300 Internal Modem | \$174.95 |
| 1200C | 1200/300 Baud External Modem | \$119.95 |
| 2400E | 2400/1200/300 External Modem | \$219.95 |

Jameco Extended 80-Column Card for Apple IIe



- 80 Col/64K RAM - Doubles amount of data your Apple IIe can display as well as its memory capacity - Ideal for word processing - Complete with instructions

JE864 \$49.95

ADD12 (Disk Drive II+, IIe) \$99.95

Additional Apple Compatible Products Available

ZUCKERBOARD

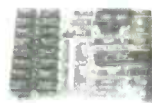

TANDY 1000 Expansion Memory Half Card

- Expand the memory of your Tandy 1000 (128K Version) to as much as 640K! Also includes DMA controller chip

| | | |
|-------|----------------------------------|----------|
| TE512 | Includes 512K RAM | \$119.95 |
| TANC | Plug-in Clock option chip (only) | \$39.95 |

20Meg Hard Disk for Tandy 1000/SX

| | | |
|--------|---|----------|
| T20MB | 20MB Hard Disk Drive Board for Tandy 1000 | \$494.95 |
| SX20MB | 20MB Hard Disk Drive Board for Tandy 1000SX | \$499.95 |



Accessories for Commodore VIC-20, C-64 & C-128

| | | |
|---------|--|---------|
| JE232CM | (Pictured) | |
| JE232CM | (RS232 Intec. VIC-20, C-64 and C-128 in 64 mode) | \$39.95 |
| CPS10 | (C-64 Power Supply) | \$39.95 |
| CPS128 | (C-128 Power Supply) | \$59.95 |

U.S. Funds Only
Shipping: Add 5% plus \$1.50 Insurance
(May vary according to weight)

California Residents:
Add 6%, 6 1/2% or 7%
Sales Tax
FAX 415-592-2503
3/88



Data Sheets - 50¢ each
Prices Subject to Change

Send \$1.00 Postage for a
FREE 1988 CATALOG

Telex: 176043

© 1988 Jameco Electronics

1355 SHOREWAY RD., BELMONT, CA 94002 • FOR ORDERS ONLY 415-592-8097 • ALL OTHER INQUIRIES 415-592-8121

**SEND FOR
FREE
1987 CATALOG**
OUR NEW MAILING
ADDRESS IS:
P.O. BOX 567
VAN NUYS, CA 91408
800-826-5432

QUALITY PARTS * DISCOUNT PRICES * FAST SHIPPING!

ALL ELECTRONICS CORP. ALL ELECTRONICS CORP.

BLACKLIGHT ASSEMBLY

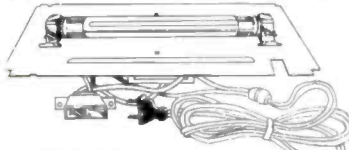

Complete, functioning assembly includes ballast, on-off switch, power cord, sockets and F4T5-BL blacklight. Mounted on a 7 1/8" X 3 1/8" metal plate. Use for special effects lighting or erasing EPROMS.

CAT# BLTA \$10.00 EACH

1mA METER

Modutec 0-1 mA signal strength meter with KLM logo. 1/4" X 1 3/4" X 7/8" deep.



CAT# MET-2 \$2.00 each

NI-CAD CHARGER/TESTER

DELUXE universal charger and tester for almost every size Ni-cad battery available.



CAT# UNCC-N \$15.00 each

RECHARGEABLE NI-CAD BATTERIES

- AAA SIZE 1.25V 180mAh \$2.25
- AA SIZE 1.25V 500mAh \$2.00
- AA with solder tabs \$2.20
- C SIZE 1.2V 1200mAh \$4.25
- SUB-C SIZE solder tab \$4.25
- D SIZE 1.2V 1200mAh \$4.25

COMPUTER GRADE CAPACITORS

1,400 MFD 200 VDC

2" dia. X 3" high
CAT# CG-1420 \$2.00

7,500 MFD 200 VDC

3" dia. X 4 3/4" h.
CAT# CG-75 \$4.00

22,000 MFD 25 VDC

2" dia. X 4 3/4" h.
CAT# CG-22 \$2.50

72,000 MFD 15 VDC

2" dia. X 4 3/8" h.
CAT# CG-130 \$3.50

TRANSISTORS

2N2222A

3 for \$1.00

PN2222A

4 for \$1.00

2N2904

3 for \$1.00

2N2905

3 for \$1.00

2N3055

\$1.00 each

PN3569

10 for \$1.00

WALL TRANSFORMER

11.5 Vdc
1.95 AMP.
Input:
120 Vac



SIZE: 3 3/4" X
2 7/8" X 2 5/8"
CAT# DCTX-11519
\$6.50 each

A/B SWITCH

JVC# PU53593-2
High quality
A/B
switch.
Measures:
3 3/4" X 1 7/16" X 1".
75 OHMS IN/OUT
CAT# ABS-2 \$3.50 each



13.8 VDC REGULATED POWER SUPPLY

Solid state, fully regulated 13.8 Vdc power supplies. Both feature 100% solid state construction, fuse protection and LED power indicator. UL listed.

2 AMP CONSTANT, 4 AMP SURGE
CAT# DVP-412 \$22.50 each

3 AMP CONSTANT, 5 AMP SURGE
CAT# DVP-512 \$30.00 each



ELECTRET CONDENSER MIKE

Mouser# 25LMO44 Highly sensitive mini microphone. 6" wire leads. 0.39" dia. X 0.27" high. Omni directional. Operates on 2-10 Vdc @ less than 1 mA. 1K impedance. 50 to 8 K Hz range.
CAT# MKE-1 \$1.00 EACH

SLIM LINE FAN

TOYOS# TF92115A New 115 Vac cooling fan. 3 5/8" square X 1" deep. Metal housing. 5 blade impeller.
CAT# SCPE-115 \$8.50 each
10 for \$75.00



2K TO TURN

Multi-turn pot Spectrol# MOD 534-7161
CAT# MTP-10-2 \$5.00 each



VENTED PROJECT CASE

Bopla #BO 718L Vented top and bottom. Black plastic with removable end panels.
9" X 8 1/2" X 8"
CAT# MB-718 \$12.50 each



6-12 VDC MOTOR

Mebuchi # RS-5505 Permanent magnet motor. 1 7/16" dia X 2 1/4" long 2,600 RPM @ 6 Vdc-200 mA 5,300 RPM @ 12 Vdc
CAT# DCM-7 \$3.00 each



LED'S

Standard Jumbo Diffused T 1-3/4 Size

RED 10 for \$1.50
100 for \$13.00
CAT# LED-1 1000 for \$110.00

GREEN 10 for \$2.00
100 for \$17.00
CAT# LED-2 1000 for \$150.00

YELLOW 10 for \$2.00
100 for \$17.00
CAT# LED-3 1000 for \$150.00

FLASHING LED

w/ built in flashing circuit operates on 5 Volts...

RED CAT# LED-4 10 for \$9.50
GREEN \$1.00 each
CAT# LED-4G 10 for \$9.50

BI-POLAR LED

Lights RED one direction, GREEN the other. Two leads.
CAT# LED-6 2 for \$1.70

LED HOLDERS

Two piece holder.
CAT# HLED 10 for 65c

CLIPLITE LED HOLDER

Makes L.E.D. look like a fancy indicator

CLEAR CAT# HLDCL-C
RED CAT# HLDCL-R
GREEN CAT# HLDCL-G
YELLOW CAT# HLDCL-Y
4 of one color \$1.00



48 KEY ASSEMBLY



NEW T.I. KEYBOARDS. Originally used on computers, these keyboards contain 48 S.P.S.T. mechanical switches. Terminates to 15 pin connector.
Frame 4" X 9"
CAT# KP-48 \$3.50 each

PUSHBUTTON PHONE

Spectra-phone Model# OP-1 1 piece telephone with rotary (pulse) output. Operates on most rotary or touch tone systems. Features fast minute redial and mute button. Includes coil cord with standard modular plug. IVORY.
CAT# PHN-1 \$8.50 EACH
2 FOR \$15.00



RELAYS

12 VDC-4PDT

P.C. mount 5 amp contacts 150 ohm coil
Size: 1 1/4" X 1 3/4" X 7/8"
CAT# APRLY-12PC \$3.50
10 for \$30.00



10AMP SOLID STATE

Control: 3-32 Vdc Load: 10 AMPS, 120 Vac
Size: 2 1/2" X 3/4" X 7/8"
CAT# SSRLY-10A \$9.50
10 for \$85.00



25 AMP SOLID STATE

OPTO 2# 240D25 TTL compatible. INPUT: 3-32 VDC OUTPUT: 25 AMPS @ 240 VAC
SIZE: 2 1/2" X 3/4" X 7/8"
CAT# SSRLY-2524 \$15.00 each



THIRD TAIL LIGHT

Sleek high-tech lamp assembly. Red lens is 2 3/4" X 5 1/2" mounted on a 4" high pedestal with up-down swivel adjustment. Has 12V replaceable bulb.
CAT# TLB \$3.95 each



SOUND EFFECTS BOARD

P.C. board with 2 1/4" speaker, 2 LEDs, IC, battery snap, other components 2 3/8" X 3". When switch is pushed board beeps and leds light. Operates on a 9V battery (not included)
CAT# ST-3 \$1.25 each



XENON FLASH TUBE

3/4" long X 1/8" dia.
CAT# FLT-1 2 for \$1.00



VIC 20 MOTHERBOARD

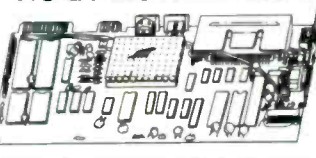

26 IC's including 6502A and 6560. 2 ea. 6522, 2 ea. 8128, 2 ea. 901486, 3 ea. 2114. Not guaranteed but great for replacement parts or experimentation.
CAT# VIC-20 \$15.00 each

SWITCHING POWER SUPPLY

Compact, well regulated switching power supply designed to power Texas Instruments computer equipment.

INPUT: 14-25 vac @ 1 amp

OUTPUT: +12 vdc @ 350 ma.

+5 vdc @ 1.2 amp

-5 vdc @ 200 ma.

SIZE: 4 3/4" square.

Includes 18 Vac @ 1 amp wall transformer designed to power this supply.

CAT# PS-TX \$5.00 / set
10 for \$45.00



LIGHT ACTIVATED MOTION SENSOR

This device contains a photocell which senses sudden change in ambient light. Could be used as a door annunciator or modified to trigger other devices. 5 1/2" X 4" X 1". Operates on 6 Vdc. Requires 4 AA batteries (not included).

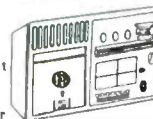

CAT# LSMD \$5.75 per unit

TRANSFORMERS

5.6 VOLT- 750ma

CAT# TX-56 \$3.00

12 V.c.t.-1amp

CAT# TX-121 \$4.00

12 V.c.t.-2amp

CAT# TX-122 \$4.85

12 V.c.t.-4amp

CAT# TX-124 \$7.00

18 VOLT-650ma

CAT# TX-186 \$2.00
10 for \$18.00

24 V.c.t.-1amp

CAT# TX-241 \$4.85

24 V.c.t.-2amp

CAT# TX-242 \$6.75

24 V.c.t.-3amp

CAT# TX-243 \$9.50

24 V.c.t.-4amp

CAT# TX-244 \$11.00

SWITCHES

MINIATURE TOGGLE SWITCHES

rated 5 Amps S.P.D.T. (ON-ON)

Non threaded brushing P.C. mount.

CAT# MTS-40PC 75c each

10 for \$7.00

S.P.D.T. (ON-ON)

Solder lug terminals.

CAT# MTS-4 \$1.00 each

10 for \$9.00

D.P.D.T. (ON-ON)

Solder lug terminals.

CAT# MTS-8 \$2.00 each

10 for \$19.00

MINI PUSH BUTTON

S.P.S.T. momentary. Push to make 1/4" brushing. Red button.

CAT# MPB-1 35c each

10 for \$3.00

POLARITY SWITCH

Designed to control an external coaxial relay on a satellite t.v. system. Ideal for parts. Contains a 5 Vdc relay and many other parts on a P.C. board.

CAT# RPDS \$1.75 each 10 for \$15.00



STORES:

LOS ANGELES
905 S. VERMONT AVE.
LOS ANGELES, CA 90006
(213)380-8000
VAN NUYS
6228 SEPULVEDA BLVD.
VAN NUYS, CA 91411
(818)997-1806

MAIL ORDERS TO:

ALL ELECTRONICS
P.O. BOX 567
VAN NUYS, CA 91408
TELEX
TWX-51010163
ALL ELECTRONICS
Foreign Customers
Send \$1.50 postage
for FREE Catalog!!

TOLL FREE

800-826-5432
INFO:(818)904-0524
FAX:(818)781-2653
QUANTITIES LIMITED
MINIMUM ORDERS \$10.00
CALIF. ADD SALES TAX
USA: \$3.00 SHIPPING
NO C.O.D.I
FOREIGN ORDERS:
INCLUDE SUFFICIENT
SHIPPING



SOUND AND VIDEO MODULATOR

Ti# UM1381-1. Designed for use with T.I. computers. Can be used with video cameras, games or other audio/video sources. Built in A/B switch enables user to switch from T.V. antenna without disconnection. Operates on channel 3 or 4. Requires 12 Vdc. Hook up diagram included.
CAT# AVMOD \$5.00 each



TELEPHONE COUPLING TRANSFORMER

STANCOR # TTCP-8
600 ohms c.t. to 600 ohms c.t. P.C. board mount. 3/4" X 5/8" X 3/4"
CAT# TCTXS \$2.50 each



Radio Shack Parts Place™

PARTS FOR PROJECTS ARE NEIGHBORHOOD CLOSE

Save With Hotline Order Service

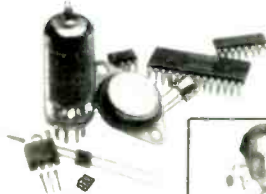

Over 200,000
Substitutions
Available



Your Radio Shack store manager can instantly phone in a special order for a wide variety of parts and accessories not shown in our catalog—tubes, ICs, phono styli, diodes, crystals and much more. No postage or handling charges, no minimum order! Please give us a try!

Audio Amp With Speaker

11⁹⁵

- Makes an Excellent Test Amp
- Perfect for Computer-Sound Output

Dozens of uses—get one for your test bench. Ready-to-use audio amplifier features a high-gain IC design and 200-mW output. Rotary on/off volume control. 1/8" input jack and 1/8" output jack for connecting an external speaker or headphone. Battery extra. #277-1008



Sale! Voice-Synthesizer Team



9⁹⁵

Speech Synthesizer. Cut 23%. Easy to interface with most computers. Requires 3.12 MHz crystal. Reg. 12.95. #276-1784 Sale 9.95



11⁸⁸

Text-to-Speech IC. 30% Off. Use with synthesizer chip (above) for RS-232 hookup. Req. 10 MHz crystal. Reg. 16.95. #276-1786 Sale 11.88

12-Tune Melody Synthesizer IC

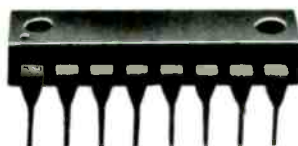

- With On-Chip Audio Preamp
- Programmed With 12 Tunes

UMC3482. Just the thing for musical doorbells, games, clocks, telephone music-on-hold and novelty applications. Tunes include Happy Birthday, Oh My Darling Clementine, London Bridge, Home Sweet Home, Row-Row-Row Your Boat, more. Operates on 1.5 VDC. 16-pin DIP with data and circuit examples. #276-1797 2.99

Irresistables

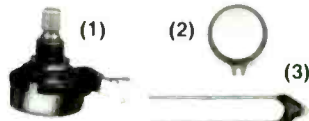

- (1) 5-Watt, 25-Ohm Rheostat. For lots of projects. #271-265 2.99
- (2) Knob for Above. 1/4" shaft. With red insert. #274-433 Pkg. 2/99c
- (3) Thermistor. Resistance changes with temperature. #276-110 1.99

Hard-to-Find Parts

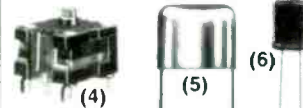

- (4) 335 pF Variable Cap. Two-section, PC-mount. #272-1337, 4.95
- (5) 6-50 pF Trimmers. Low peaking, PC-mount. #272-1340 Pkg. 2/1.59
- (6) TV Colorburst Crystal. Precision 3.579545 MHz standard. #272-1310 1.69

Antennas

Replacements for cordless phones, walkie-talkies and portable radios.

| Sections | Extends to | Cat No | Each |
|----------|------------|----------|------|
| 5 | 30 1/2" | 270-1401 | 2.99 |
| 4 | 34 3/8" | 270-1402 | 3.49 |
| 3 | 39 1/2" | 270-1403 | 3.59 |
| 5 | 28" | 270-1405 | 2.99 |
| 5 | 15 1/2" | 270-1406 | 2.59 |
| 5 | 13" | 270-1407 | 2.59 |
| 6 | 72" | 270-1408 | 3.99 |
| 6* | 17 3/4" | 270-1409 | 2.49 |

*#270-1409 has L-mounting bracket.

Builders' Helpers

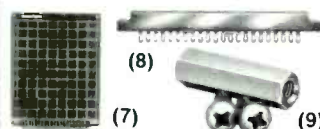

- (7) Plug-In PC Board With Ground Plane. #276-188 4.99
- (8) 44-Position Card-Edge Socket. #276-1551 2.99
- (9) PC Board Standoffs With Screws. #276-195 Pkg. 4/99c

Test Lead Sets



- (10) Set of Ten Color-Coded Test Cables. Gator clips. #278-1156, 3.99
- (11) Coiled 6-Foot Leads. Probe at one end, banana plug at the other. #278-750 Pair/4.39
- (12) Mini-Clip Jumper. 20" long. #278-016 Pair/3.49

FM Receiver IC



Combines RF, mixer, IF and demodulator in a single IC. Makes receiver projects a cinch to build; and with 70KHz IF, no coils are required. Built-in mute circuit reduces spurious reception. With application notes. #276-1304 5.95

Buzzer & Lamps



- (13) Tri-Sound Siren/Buzzer. Three different, extra-loud 80 db sounds. Requires 3 VDC. #273-072 5.95
- (14) Super-Bright Red LED. 300 mcd at 20 mA. #276-066 1.19
- (15) 12V Flashing Lamps. Yellow, red, green. #272-1097, Pkg. of 3/99c

Classy Touches



- (16) Aluminum Chassis Box. With screws 2 1/4 x 2 1/8 x 1 1/8". #270-235 1.79
5 1/4 x 3 x 2 1/8". #270-238 2.49
4 x 2 1/8 x 1 1/8". #270-239 1.99
- (17) Heavy-Duty Toggle Switch. DPDT, 10 amps at 125 VAC. UL. #275-1533, 1.79
- (18) Lighted Pushbutton Switch. SPST, 5 amps at 250 VAC. UL. #275-678, 5.95

AC Spike Protectors

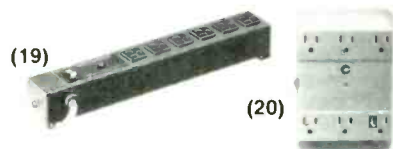

- (19) Power Strip. Built-in noise filter and circuit breaker. Lighted on/off switch. Rated 15 amps at 120 VAC. UL listed. #61-2780 29.95
- (20) Cordless Power Outlet. Plugs Into wall. With circuit breaker, noise filter. Rated 13 amps at 120 VAC. UL listed. #61-2786 24.95

Solderless Breadboard



Especially Designed for Students, Hobbyists, Designers

Our finest! The 2 1/4 x 6 1/2" universal board is mounted on a 4 x 7" "stay-put" steel base with rubber feet. Accepts DIPs, discrete components and up to 22-gauge wire. Has 640 plug-in tie points and three binding posts for external power connections. #276-169 19.95

Bench LCD Multimeter



99⁹⁵

Low As
\$15 Per
Month*

The 31-segment analog bar graph display makes input peaks and trends easier to follow. With autoranging, autopolarity, min/max hold, transistor checker (h_{FE}), diode checker, buzzer continuity checker. Measures AC/DC voltage/current, resistance. Batteries extra. #22-195

Over 1000 Items in stock: Binding Posts, Books, Breadboards, Buzzers, Capacitors, Chokes, Clips, Coax, Connectors, Fuses, Hardware, ICs, Jacks, Knobs, Lamps, Multitesters, PC Boards, Plugs, Rectifiers, Resistors, Switches, Tools, Transformers, Wire, Zeners, More!

*Revolving credit from Radio Shack. Actual payment may vary depending on your account balance.

Radio Shack®

A DIVISION OF TANDY CORPORATION

Prices apply at participating Radio Shack stores and dealers

CIRCLE 78 ON FREE INFORMATION CARD

NEW

Only NRI gives you a 27" high-resolution stereo color TV you build to prepare you for today's video servicing careers.



You Build a 27" Stereo TV

During the assembly process of your state-of-the-art Heath/Zenith 27" TV, you learn to identify and work with components and circuits as they actually appear in commercial circuitry. Then through tests, adjustments, and experiments you quickly master professional troubleshooting and bench techniques.



Inside Your TV

The Heath/Zenith 27" TV has all the features that allow you to set up *today* your complete home video center of the future. Flat screen, square corners, and a black matrix to produce dark, rich colors . . . even a powerful remote control center that gives you total command of video and audio operating modes.

NRI has purposely designed your training around equipment that has the same high-tech circuitry you'll encounter in commercial equipment. That means your training is real-world training.

Your NRI Training

Has Another Special Element

Also built into your NRI training is the enormous experience of our development specialists and instructors. Their long-proven training skills and personal guidance come to you on a one-to-one basis. Always available for consultation and help, these instructors ensure your success both during your training and after graduation.

Step Into the Future Today

The richest reward gained from your NRI Video/Audio training is a firm grip on the future. Now is the time to act. Send the post-paid card to us today. You will receive our 100-page catalog free. It's a fascinating explanation of our training methods and materials. (If someone has used the card, write to us at the address below.)

Become one of America's most sought-after technicians . . . put your talents and spare time to work for you in the "explosive-growth" world of home entertainment electronics.

Train in state-of-the-art video/audio servicing and become a fully qualified service professional the uniquely successful NRI way. It's hands-on training, at home . . . designed around the latest electronic equipment you build and keep as part of your training.

The High-Tech Revolution in the Home Is Just Starting

Sweeping changes are taking place in our homes, changes brought about by the phenomenal growth of home entertainment electronics. Already available are high resolution TV, TVs with stereo sound, simultaneous multi-channel viewing, projection TV, Camcorders, 8 mm video cassettes, and compact disc players.

And the revolution has spread to the business sector as tens of thousands of companies are purchasing expensive high-tech video equipment used for employee training, data storage, even video conferencing.

Join the Future or Be Left Behind

Today the consumer electronics industry represents a whopping \$26 billion opportunity for the new breed of consumer electronics technician.

Today's consumer electronics revolution is creating huge servicing and repair mar-

kets that are just starting to boom.

Here is your chance to become a fully qualified professional the way tens of thousands have trained with NRI.

Totally Integrated Hands-On Training

Since NRI training is built around "learn by doing," right from the start you conduct important experiments and tests with your professional digital multimeter. You assemble the remarkable NRI Discovery Lab and perform a complete range of demonstrations and experiments in the process.



NRI's commitment to you goes beyond providing you with equipment appropriate to the latest technology. Best of all, we ensure that in the learning process you acquire the very skills that will make you a professional service technician on the job.

NRI School of Electronics

McGraw-Hill Continuing

Education Center

3939 Wisconsin Avenue, NW

Washington, DC 20016



SCOPE 3 1/2 Digital Multimeters



Model DVM-638
\$8750

- Test leads included
- 11 function, 38 ranges
- Logic level detector
- Audible visual continuity
- Capacitance and conductance measurement

Model DVM-636
\$6750

- 8 function, 37 ranges
- Capacitance measurement

SCOPE 3 1/2 Digit Capacitance Meter



Model DCM-602
\$5995

- Test leads included
- 8 ranges with full scale values to 2000 uF
- LSI circuit
- Crystal time base
- Frequency range 800 Hz to 8Hz

SCOPE Pocket Sized Audio Signal Generator



Model RC-555
\$5995

- Test leads & 9V battery included
- Low distortion sine-wave signal
- 46 step selected frequency
- x1 range 20 Hz to 1.5 KHz
- x100 range 2 KHz to 150 KHz

SCOPE 4 1/2 Digit LCD Bench Digital Multimeter



Model DVM-6005
\$21995

- Test lead set 6, "D" size batteries included
- 0.4" high characters
- Conversion period: 500 milliseconds
- Automatic, negative polarity

Mini-Meters with Maxi-Specs

SCOPE 3 1/2 Digit LCD with 8 Full Functions

Model DVM-632

\$4495
OUR PRICE

Measures only 5 3/8" x 2 3/16" x 1 1/4"

- Deluxe test leads included
- 0.5% accuracy
- Transistor gain test
- Audible continuity checking & diode test
- 10 Amp measurement

Zippered Carrying Case CC-30 **\$450**



SCOPE 3 1/2 Digit LCD

Measures only 5" x 2 3/4" x 7/8"



Model DVM-630

\$2995

OUR PRICE

- Test leads included
- 0.5% accuracy
- 6 functions, 19 ranges
- Automatic zero adjust
- Low battery indication

Zippered Carrying Case CC-30 **\$450**

ASK FOR FREE CATALOG. Money orders, checks accepted. C.O.D.'s require 25% deposit.



| Service & Shipping Charge Schedule Continental U.S.A. | |
|---|---------|
| FOR ORDERS | ADD |
| \$25-\$100 | \$4.50 |
| \$101-\$250 | \$6.00 |
| \$251-500 | \$8.00 |
| \$501-750 | \$10.50 |
| \$751-1,000 | \$12.50 |
| \$1,001-1,500 | \$16.50 |
| \$1,501-2,000 | \$20.00 |
| \$2,001 and up | \$25.00 |

Fordham
260 Motor Parkway, Hauppauge, NY 11788

Toll Free **800-645-9518**
In NY State 800-832-1446