

Radio- Electronics

48783

ELECTRONICS
IN THE 21st CENTURY

\$2.95 MAY 1987
IN CANADA \$3.75

GERNSBACH
PUBLICATION

2001
**ELECTRONICS IN
THE NEXT CENTURY**
INTRODUCTION
by *Arthur C. Clarke*
THE ROBOT
by *Isaac Asimov*
THE HOME OF THE FUTURE
COMMUNICATIONS
TRANSPORTATION
MEDICAL TECHNOLOGY
NEW ENERGY SOURCES
ARTIFICIAL INTELLIGENCE
SOLID-STATE TECHNOLOGY

**NEW LIFE FOR OLD
CAR RADIOS**
Convert them for
in-home use

**CONTROL
YOUR HOME
BY TELEPHONE**
With R-E's Phonlink

**WHAT'S NEW
IN SOLDERING**
Hi-tech materials
and techniques



NOW GET SCOPE, COUNTER AND DMM INPUT ALL AT ONCE THROUGH ONE PROBE!

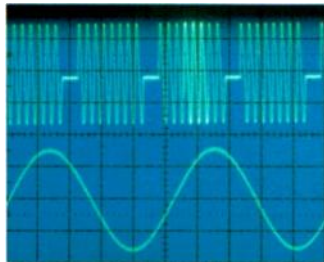

Gated frequency measurement. B sweep triggering during the intensified portion of the A sweep. Intensified portion frequency is measured with the counter/timer/DMM.

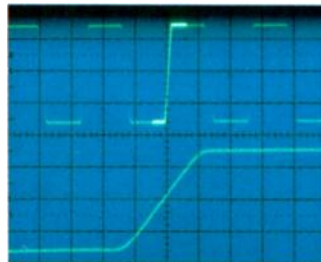
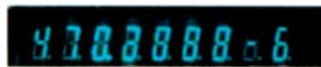

Delay time measurement. Delay time from the start of A sweep to the start of the B sweep is measured with crystal accuracy.

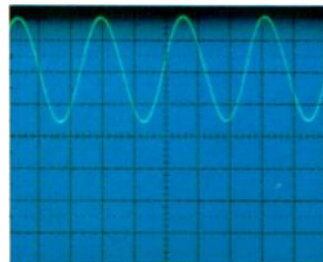

Channel 1 dc volts measurement. The average dc component of a waveform is measured directly through channel 1 with direct digital fluorescent readout.

The Tek 2236 combines 100 MHz, dual timebase scope capability with counter/timer/DMM functions integrated into its vertical, horizontal and trigger systems. For the same effort it takes to display a waveform you can obtain digital readout of frequency, period, width, totalized events, delay time and Δ -time to accuracies of 0.001%.

The same probe is used to provide input for the CRT display and the digital measurement system, resulting in easy set-up, greater measurement confidence and reduced circuit loading. Probe tip volts can also be measured through the Ch 1 input.

Precision measurements at the touch of a button.

Auto-ranging frequency, period, width and gated measurements are push-button-simple. And the 2236 offers an independent floating 5000 count, auto-ranging multimeter with side inputs for DC voltage mea-

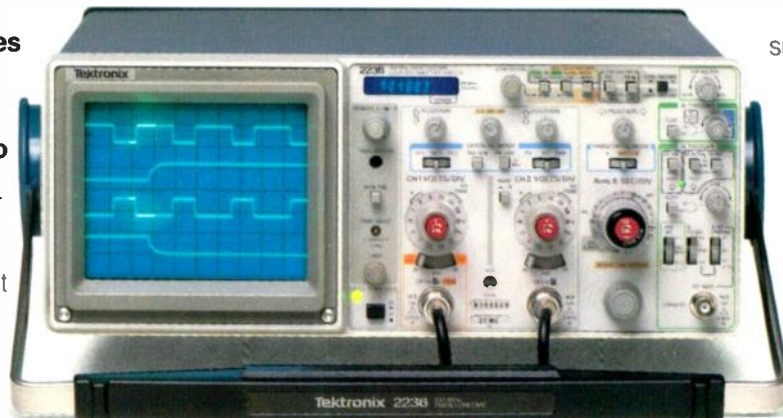

Bandwidth	100 MHz
No of Channels	2 + Trig. View
Max. Sweep Speed	5 ns/div
Digital Readout Features	Direct Ch 1 Voltage Meas. 0.5% DC; 2.0% AC RMS Resistance: .01 Ω to 200 Meg Ω Continuity/Temp: Audible/C $^{\circ}$ or F $^{\circ}$ Totalizing Counter: — 1 counts to 8,000,000 Direct Freq. Meas: 100 MHz to 0.001% acc. Period, Width Meas: 10 ns with 10 ps max. resolution
Timing Meas. Accuracy	.001% (delay and Δ -time with readout)
Trigger Modes	P-P Auto, Norm, TV Field, TV Line, Single Sweep
Weight	7.3 kg (16.2 lb)
Price	\$2650
Warranty	3-year including CRT (plus optional service plans to 5 years)

surements to 0.1%.

A built-in, auto-ranging ohmmeter provides resistance measurements from 0.01 Ω to 2G Ω — as well as audible continuity. Automatic diode/junction detection and operator prompts serve to simplify set-up and enhance confidence in your measurements.

The 2236: scope, counter, timer, DMM plus a 3-year warranty — all for just \$2,650.

Contact your nearest distributor or call Tek toll-free. Technical personnel on our direct-line will answer your questions and expedite delivery. Orders include probes, 30-day free trial and service worldwide.

Call Tek direct:

1-800-433-2323 for video tape or literature,

1-800-426-2200 for application assistance or ordering information.

In Oregon, call collect:
1-627-2200

Tektronix
COMMITTED TO EXCELLENCE

SPECIAL FEATURE

ELECTRONICS IN THE NEXT CENTURY

- 81 LOOKING INTO THE FUTURE
- 85 THE FUTURE OF ARTIFICIAL INTELLIGENCE
- 91 THE AUTOMOTIVE WORLD OF THE 21st CENTURY
- 97 SOLID-STATE TECHNOLOGY IN 2001
- 99 THE ROBOT IN THE 21st CENTURY
- 102 COMMUNICATIONS IN 2001
- 107 ENERGY TECHNOLOGY IN THE 21st CENTURY
- 112 MEDICAL TECHNOLOGY IN THE 21st CENTURY
- 115 THE HOME OF THE FUTURE

BUILD THIS

- 62 R-E ROBOT
Part 6. Steven E. Sarns
- 39 PHONLINK INTERACTIVE REMOTE CONTROL
Control your home by phone. Gene Roseth
- 45 MINIATURE WIDEBAND AMPLIFIER
For DC to UHF. John Clawson
- 67 PC SERVICE

TECHNOLOGY

- 8 VIDEO NEWS
Inside video. David Lachenbruch
- 47 SOLDERING
Old techniques and new technology.
Vaughan D. Martin
- 51 LEARNING ABOUT LORAN
Navigation by radio. David J. Sweeney
- 77 SATELLITE TV
Videocipher descrambling. Bob Cooper, Jr.
- 74 AUDIO UPDATE
Surround Sound, Part 2. Larry Klein
- 125 SERVICE CLINIC
Funny pictures. Jack Darr
- 127 COMMUNICATIONS CORNER
Curing RFI. Herb Friedman

CIRCUITS AND COMPONENTS

- 42 NEW LIFE FOR
OLD CAR RADIOS
Conversion for home use.
Gary McClellan
- 59 TESTING
SEMICONDUCTORS
Part 4. Thyristor testing.
TJ Byers
- 121 DESIGNER'S NOTEBOOK
Generating trigger pulses.
Robert Grossblatt
- 123 DRAWING BOARD
A memory system.
Robert Grossblatt
- 129 STATE OF SOLID STATE
Long-interval timer.
Robert F. Scott

COMPUTERS

- 133 COMPUTER DIGEST
- 135 EDITOR'S WORKBENCH
- 138 THE MC68000, PART 2.
- 141 A LOOK INSIDE THE 6502
- 144 COMPUTER-CONTROLLED
ROBOT

EQUIPMENT REPORTS

- 24 Universal V-7640 Remote-
Control Stereo-TV Tuner

DEPARTMENTS

- 128 Advertising and Sales Offices
- 128 Advertising Index
- 120 Antique Radio Clubs
- 10 Ask R-E
- 129 Free Information Card
- 20 Letters
- 107 Market Center
- 36 New Products
- 6 What's News

COVER 1



At one time or another, most of us have sat back and wondered about what shape the future will take. We at Radio-Electronics are no different. To satisfy our curiosity, we asked experts in medical electronics, robotics, artificial intelligence, energy, transportation, communications, semiconductors, and other fields to share with us their visions of the year 2001. This month, in some of the most important articles ever published in Radio-Electronics, we share those visions with you.

NEXT MONTH

THE JUNE ISSUE IS
ON SALE MAY 3

BUILD A DIGITAL TACHOMETER

Digital circuits make it accurate and inexpensive.

ALL ABOUT FLIP-FLOPS

Bone up on basic digital logic.

VCR TAPE CALIBRATION

Locate your favorite selections easily.

TROUBLES WITH YOUR TV?

Case histories reveal troubleshooting techniques.

NEW LIFE FOR OLD CAR RADIOS

Part 2. Adding a shortwave converter

AND MUCH MORE!

Radio-Electronics

Hugo Gernsback (1884-1967) founder
M. Harvey Gernsback,
editor-in-chief, emeritus

Larry Steckler, EHF, CET, editor-in-chief
and publisher

EDITORIAL DEPARTMENT

Art Kleiman, editorial director
Brian C. Fenton, managing editor
Carl Laron, WB2SLR, associate editor
Jeffrey K. Holtzman,
assistant technical editor
Robert A. Young, assistant editor
Julian S. Martin, editorial associate
Byron G. Wels, editorial associate
M. Harvey Gernsback,
contributing editor
Jack Darr, CET, service editor
Robert F. Scott,
semiconductor editor
Herb Friedman,
communications editor
Bob Cooper, Jr. satellite-TV editor
Robert Grossblatt, circuits editor
Larry Klein, audio editor
David Lachenbruch,
contributing editor
Richard D. Fitch,
contributing editor
Teri Scaduto, editorial assistant

PRODUCTION DEPARTMENT

Ruby M. Yee, production director
Robert A. W. Lowndes,
editorial production
Andre Duzant, technical illustrator
Karen Tucker, advertising production
Geoffrey S. Weil, production traffic

CIRCULATION DEPARTMENT

Jacqueline P. Cheesebore,
circulation director
Wendy Alanko,
circulation analyst
Theresa Lombardo,
circulation assistant

Typography by Mates Graphics

Radio-Electronics, Gernsback Publications, Inc., 500-B Bi-County Blvd., Farmingdale, NY 11735. 516-293-3000

Radio-Electronics is indexed in *Applied Science & Technology Index* and *Readers Guide to Periodical Literature*.

Microfilm & Microfiche editions are available. Contact circulation department for details.

Advertising Sales Offices listed on page 128.

As a service to readers, RADIO-ELECTRONICS publishes available plans or information relating to newsworthy products, techniques and scientific and technological developments. Because of possible variances in the quality and condition of materials and workmanship used by readers, RADIO-ELECTRONICS disclaims any responsibility for the safe and proper functioning of reader-built projects based upon or from plans or information published in this magazine.

Since some of the equipment and circuitry described in RADIO-ELECTRONICS may relate to or be covered by U.S. patents, RADIO-ELECTRONICS disclaims any liability for the infringement of such patents by the making, using, or selling of any such equipment or circuitry, and suggests that anyone interested in such projects consult a patent attorney.



More Functions. Smaller Budget.

Beckman Industrial Circuitmate™ DMMs put hFE, Logic, Capacitance, Frequency and True RMS In Your Hand. For Less.

Get more, for less. It's a simple definition of value. For DMMs, value means finding the combination of capabilities that meets your needs at the right price. Without losing sight of accuracy and reliability. If you want more functions at a low price, Beckman Industrial's Circuitmate™ Digital Multimeters are the best value around.

From the pocket-sized DM20L to the DM850, with true RMS capability and accuracy to 0.05% ± 1 digit, Circuitmate DMMs give you the functions you need.

For instance, the DM20L puts both a Logic Probe, a transistor gain function (hFE), and a full range of DMM functions in the palm of your hand. For only \$69.95.

Then there's the DM25L. Where else does \$89.95 buy you a Logic Probe, capacitance measurement, transistor gain function (hFE), and 24 DMM ranges including resistance to 2000 megohms? Nowhere else.

When high accuracy counts, there's the DM800 with a 4 1/2 digit display. The DM800

DM20L Pocket-Size w/Logic \$69.95*

TTL Logic Probe: 20MHz
Hi/lo/off indications
Detects 25nS pulse widths

hFE (NPN or PNP):
1 range (1000)

DMM: Input Impedance—
10 Megohms
DCA/ACA-5 ranges
(200µA to 2A)

Ohms-8 ranges (200 ohms
to 2000 Megohms)

Continuity beeper



also gives you frequency counting. A full-function DMM, and more, doesn't have to cost over \$169.95. If it's a Circuitmate DM800.

Or, for a few dollars more, get true RMS (AC coupled) to let you accurately measure non-sinusoidal AC waveforms, and all the capability of the DM800, in the DM850.

Of course, there's a whole range of Circuitmate DMMs and service test instruments, including the DM78 autoranger that

DM850 True RMS

4 1/2 digits DCV accuracy
is .05% +3 digits

True RMS

Frequency counter to
200KHz

Data Hold display
capability

Continuity beeper

Built-in ball

Anti-skid pads

Price: DM850 (True
RMS) . . . \$219.95*
DM800 (Average)
. \$169.95*

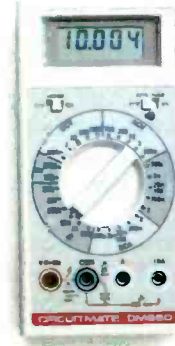

fits in a shirt pocket, yet gives you a full size 3 1/2 digit, 3/8" readout. Not to mention a complete line of accessories like test leads, current clamps, even probes that can extend your DMMs range and sensitivity. All designed to work flawlessly with your Beckman Industrial Circuitmate DMM.

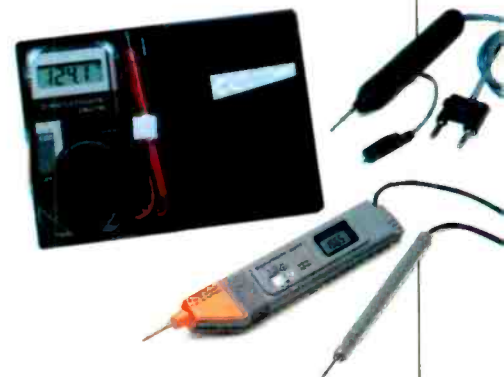

See your Beckman Industrial distributor and discover more DMM performance. For less.

*Suggested list price (\$US) with battery, test leads and manual.

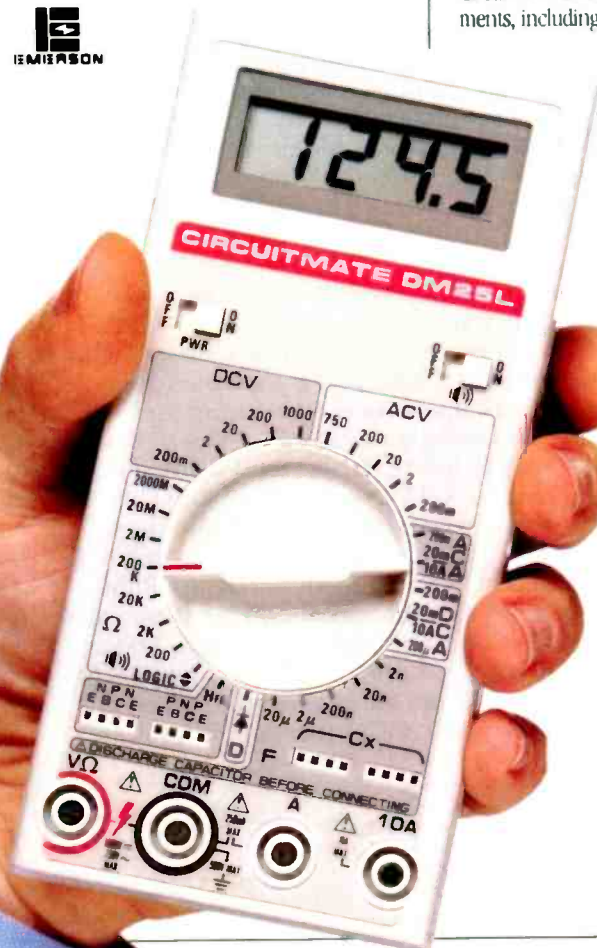

DM25L Capacitance, Logic, hFE \$89.95*

TTL Logic Probe: 20MHz
Hi/lo/off indications
Detects 25nS pulse widths

Capacitance: 5 ranges
(2nF to 20µF)

hFE (NPN or PNP):
1 range (1000)

Continuity beeper

Built-in ball

Anti-skid pads

In Service Instruments
Were The One.

Beckman Industrial™

Beckman Industrial Corporation, Instrumentation Products Division
A subsidiary of Emerson Electric Company
630 Paicote Street, Brea, CA 92621
(714) 671-4800 • FAX: (714) 671-4874 • TLX: 188790
© 1986 Beckman Industrial Corporation

EDITORIAL



Welcome to the twenty-first century.

Welcome to this very special issue of Radio-Electronics. We're taking you on a journey to the year 2001 to show you how electronics will dramatically change the way we live.

Although two of the world's most notable science-fiction writers—Arthur C. Clarke and Isaac Asimov—have contributed to this special section, we haven't cooked up a flight of imagination. Instead, we offer a realistic vision of the future—a vision based on what's happening in the research and development labs today.

Do you ever wonder what kind of car you'll be driving in 2001? Donald E. Petersen, the Chairman and Chief Executive Officer of Ford Motor Company has. He has been working along with Ford engineers to determine how today's new developments—and tomorrow's new technology—will be used in the car of the the twenty-first century. I can't wait to test drive it.

Will advances in artificial intelligence give us machines that truly think? We asked George H. Heilmeier, a Senior Vice President and Chief Technical Officer at Texas Instruments, what he thought. And his experience leads him to some interesting conclusions about the progress in artificial intelligence we can expect.

How will that progress affect robots? Will human-like robots take care of the everyday tasks we find so tedious? The potential is certainly there but, as Isaac Asimov points out, the impact on our society could be devastating. On the other hand, robots could and free us to be truly human!

Advances in artificial-intelligence and robotics will never come about without advances in semiconductor technology. By the year 2001, we'll be producing three-dimensional integrated circuits, according to Bob L. Gregory, the Director of Microelectronics at Sandia National Labs.

All the technologies I've mentioned may seem a little far from home, but in the twenty-first century, they'll be very close to home—in your *Smart*

House. Imagine never having to run extra wires to distribute video and audio signals. Imagine a house that adjusts automatically to the way you live. Imagine being able to control any appliance from anywhere in the house—or anywhere out of the house. David J. MacFadyen, President of the NAHB National Research Center tells us about the home of the future. And he should know—he's working today on a prototype for tomorrow.

Are you amazed at the way video has changed in recent years? Products like VCR's and affordable video cameras have transformed the way we view and use video. Well, it will continue to change. The Third Age of Video—described by Charles N. Judice, an engineer at Bell Communications Research—will bring video power to the people.

The topic of energy hasn't been making headlines in recent times, but that will change as new, exciting technologies are refined. Can you imagine having an energy plant in your basement that produces all the power you need and more? Dr. Stephen Kuznetsov, the Director of Engineering at Power Silicon and Monolithic Technologies, can imagine it. He's been the Chairman of the IEEE Committee on Energy Development since 1985 and he's had his hands on some pretty exciting stuff.

As you can see, I wasn't kidding when I said that this is a very special issue. An issue like this one doesn't happen very often, and it doesn't come about without the help of a great many people. I'd like to thank the authors for sharing their experience and their visions. I'd like to thank some of the people in the background who helped make this possible: Bill Selover at Ford, Ken Geremia at the National Association of Home Builders, Stephanie Oliver and Teri Rolfes at Honeywell, Chris Ford at Xerox, The Research and Public Relations departments at NASA, Westinghouse, General Electric and Hewlett Packard, Texas Instruments, Bellcore, Fonar, the people at Mates Graphics, and, of course, the editorial and production staffs of Gernsback Publications.

BRIAN C. FENTON
Managing Editor

ONE FOR ALL,



AND ALL FROM ONE.

An extensive line of capacitors for both standard and high voltage applications from NTE Electronics.

NTE, the name you've come to trust for all your replacement semiconductor needs, now has a line of subminiature aluminum electrolytic capacitors.

These quality capacitors are available with both radial and axial leads and are dependable over a broad temperature range. Ratings include capacitance of 0.1 μF to 10000 μF , tolerance of $\pm 20\%$ (-10% to $+50\%$ for the high voltage line), and voltage range of 6.3 to 100 volts (160 to 450 for the high voltage line), making them ideal for the most demanding applications.



LOOK FOR THE FULL LINE OF QUALITY NTE REPLACEMENT PARTS AND PRODUCTS:

- Transistors
- Thyristors
- Integrated Circuits
- Rectifiers and Diodes
- High Voltage Multipliers and Dividers
- Optoelectronic Devices
- Zeners
- Microprocessors and Support Chips
- Memory ICs
- Thermal Cut-Offs
- Bridge Rectifiers
- Unijunctions
- RF Transistors
- Microwave Oven Rectifiers
- Selenium Rectifiers
- Flameproof Resistors
- Wire Ties
- Electrolytic Capacitors
- Static Control Products

For more information or the name of your local distributor, call or write NTE.



NTE ELECTRONICS, INC.

44 Farrand Street, Bloomfield, New Jersey 07003 (Outside N.J.) 1-800-631-1250 • (N.J. only) 1-800-624-2624

CIRCLE 71 ON FREE INFORMATION CARD

WHAT'S NEWS

FCC extends privileges of Novice amateurs

The FCC (Federal Communications Commission) has moved to greatly extend the opportunities of radio amateurs (hams) in the Novice class. A Novice ham is a person who has learned to send and receive 5 words per minute of International Morse code, and has passed an examination that consists of a code-proficiency test and a series of questions dealing with simple radio techniques and U.S. radio laws and regulations.

In the past, Novices could communicate only in Morse code on the HF (*High Frequency*) bands and were limited to parts of four of the main frequency bands allotted to amateurs. The new regulations permit voice communication on additional bands, and all permitted modes of communication (including digital) in two of the VHF (*Very High Frequency*) bands. Under the new rules, single-sideband voice and digital communications are permitted on the 28-MHz band as well as all modes in parts of the 220–225-MHz VHF and the 1240–1300-UHF band.

This means that Novices will be able to talk with their friends locally or use voice to communicate with hams in distant countries. Novices with computers will be able to use their radios to communicate between computer-equipped amateurs, instead of having to use a modem and the regular telephone lines. They can even take part in the increasingly popular packet-radio activity, in which numbers of messages are collected and sent in batches from one computer to another.

The new privileges will not only give the Novice more scope within which to work, but by increasing the volume and complexity of his activities, may motivate him to

study to go on to more-advanced stages of amateur activity, which he can do by taking more advanced examinations.

Improved semiconductors have new silicon "skins"

A new approach in packaging that can produce semiconductor power devices that are smaller, lighter, cheaper, and more efficient is being pioneered by General Electric scientists. The process, now being applied to thyristors, can equally be applied to other semiconductor power devices, according to Dr. C.A. Neugebauer, manager of the Semiconductor Packaging Program of the GE Research Center at Schenectady, NY.

Thyristors are power semiconductors that function as switches controlling the flow of electric power. They can be as large as a saucer or as small as a shirt button. They control the current in electrical devices ranging from electric locomotives to the speakers in automobile audio systems.

The largest power semiconductor devices available today—which measure roughly five inches in diameter—are based on a thin layer of silicon about 0.015-inch thick. This wafer is tightly enclosed within a "skin" of tungsten, molybdenum, or other refractory (high melting temperature) metal, which ensures good electrical and thermal contact. The assembly is then sealed airtight and watertight within a large metal-and-ceramic enclosure.

The GE process replaces the thyristor's refractory metal "skin" with silicon, highly doped to maximize its conductive properties. The doped silicon "skin" is attached tightly to the wafer by a low-pressure, diffusion-bonding technique.

Once the wafer is processed, it

is packaged in another simple silicon compound—glass—a material much less bulky, heavy, and expensive than the ceramic enclosures heretofore used.

Dr. Neugebauer believes that by adding a metallization step before glass sealing the new technology could be used in packaging conventional integrated circuit devices—particularly for applications where size and weight must be kept down.

Radar remote sensing

Erhan Kudecki, assistant professor in the Department of Electrical and Computer Engineering at the University of Illinois, Urbana-Champaign, is using radar backscatter to study atmospheric disturbances. The atmosphere is, like a vast ocean, in constant agitation. Phenomena such as currents, waves, and turbulence are as common in the atmospheric fluid as they are in ocean waters. Ion, their velocity can be deduced from the frequency shift of the returned signal; a method similar to the way police radar determines the speeds of moving vehicles.

Since resolution is limited by the radar antenna's beam width, atmospheric/ionospheric radar studies require an extremely narrow beam, so the studies are made using the radar at Jicamarca, Peru, whose football-field size antenna provides a beam width of about one degree. (It can resolve fluctuations that are the equivalent of whitecaps on the surface of an ocean.)

Using special high-resolution radar techniques, Kudecki is now studying the dynamic processes of low-atmosphere narrow-turbulent layers—the layers that are well known to air travelers. Perhaps the research will eventually lead to a truly "smooth" flight. **R-E**

the fourth law of robotics

A robot shall make learning fun for man and thereby improve the quality of life for mankind.



A robot is a robot is a robot... was a robot. Until HERO 2000.

HERO 2000 is much more than a robot. It's a walking, talking 16-bit computer. With 64K ROM and 24K RAM expandable to more than half a megabyte. And a fully articulated arm with five axes of motion. Yours to program. Command. Modify and expand. Total system access and solderless experimenter boards provide almost limitless possibilities. Its remote RF console with ASCII keyboard gives total control. Available with three self-study courses. Backed by Heath Company, world leader in electronic kits.

Build your own HERO 2000. Or buy it assembled. Have fun learning skills that translate directly to the world of work.



HERO[®] 2000

the
knowledge
builder

FREE. Send today for latest Heathkit Catalog.

Heathkit[®]
Heath
Company

A subsidiary of Zenith Electronics Corporation.



Mail coupon today to receive a **FREE** Heathkit Catalog featuring HERO 2000.

Mail to: Heath Company
Dept. 02C-538
Benton Harbor, Michigan 49022

Name _____

Address _____

City _____ State _____

Zip _____

RO-141

CIRCLE 86 ON FREE INFORMATION CARD

VIDEO NEWS



DAVID LACHENBRUCH,
CONTRIBUTING EDITOR

● **Super VHS.** A new home VCR system capable of better-than-broadcast quality has been developed by JVC. It is due to appear on the Japanese market this summer, and possibly on the American market shortly thereafter. In a surprise news conference in Tokyo, JVC demonstrated a Super-VHS recorder with a high quality monitor, playing back a picture with 430 lines of horizontal resolution. Compare that with the 230–240 lines provided by today's home VCR's and the 330 lines of resolution in an optimum broadcast picture.

JVC did not say how it achieved that picture quality, but at least part of the improvement is due to a wider bandwidth, using the "high-band color" approach of broadcast VTR's. However, the system is believed to use some special image processing as well. The Super-VHS recorder is not "backward compatible;" that is, cassettes recorded in Super VHS can't be played back on standard VHS recorders, but the new-type recorder can play back standard VHS cassettes, and the Super VHS machine can be switched to record in the standard VHS format.

Super VHS uses a tape with a specially formulated oxide coating—not metal tape like the 8mm cassette. The new cassette shell is the same size as a standard VHS cassette, but it contains special notches to automatically adjust a Super-VHS recorder. The Super-VHS recorder will sell for 20 to 30 percent more than a comparable standard VHS recorder, according to JVC, and the cassettes are also expected to sell at some premium. The final specifications for the Super-VHS system had not been developed at press time, but were said to be imminent. The new system is not designed to replace the standard VHS format. JVC said it was developed because of the imminence of improved broadcasting systems, such as Enhanced Definition TV (see the story in "Video-News" in the April, 1987 issue of **Radio-Electronics**).

● **More giant tubes.** The ranks of large-sized direct-view tubes are swelling, too. This column has noted a number of new giant tubes in the past, and now we can add a 31-inch size,

manufactured by Matsushita. That large tube will be used in models of that company's Panasonic and Quasar color sets soon.

Suddenly the big-screen customer is faced with a bewildering choice. Anyone who wants a picture larger than 22 inches can consider tubes measuring 25, 26, 27, 28, 30, 31, or 35 inches, not to mention the super high-end, and super-high cost, 41-inch picture tube described in this column last January (**Radio-Electronics**, January 1987).

● **Biggest rear-projection TV.** Kloss Video, headed by Henry Kloss, the father of consumer projection TV, has unveiled its first rear projection system. That set, naturally enough, is the largest shown to date. The new system has a translucent screen with a diagonal measure of five feet, yet it's only 30-inches deep (and six feet high!) so that it can easily fit through a door. The deluxe set features Dolby surround-sound, and is supplied with its own rear speakers. The unit's electronics were built by ITT in Germany and include the broadcast-type Faroudja image-processing system. The tubes and optics, built by Kloss Video, are the same type used in the company's computer-monitor projection system. The entire system, which includes a remote-controlled cable tuner and MTS stereo, lists for \$4,295.

● **Stereo-TV's growth.** According to EIA's latest forecast, some 28 percent of color sets and 22 percent of VCR's sold this year will have built-in MTS stereo/multichannel sound. Of an anticipated 18-million color sets sold this year, the EIA believes that 5 million will have MTS and that another 4 million will be stereo adaptable. In addition, 2.9 million of 12,450,000 table-model VCR's will have MTS sound.

In 1986, according to EIA, Americans bought 3-million MTS-stereo TV sets and 1.2-million MTS-stereo VCR's. EIA also sees the sale of LCD color sets increasing this year to 70,000 units, up from 14,000 sets sold in 1986, and monochrome LCD-TV sales growing to 525,000, up from 65,000 in 1986.

R-E

NEW! Turbo Scan™ Scanners

Communications Electronics,™ the world's largest distributor of radio scanners, introduces new lower prices to celebrate our 16th anniversary.

NEW! Regency® TS2-LA

Allow 30-120 days for delivery after receipt of order due to the high demand for this product.

List price \$499.95/CE price \$319.95
12-Band, 75 Channel • Crystalless • AC/DC
Frequency range: 29-54, 118-174, 406-512, 806-950 MHz.

The Regency TS2 scanner lets you monitor Military, Space Satellites, Government, Railroad, Justice Department, State Department, Fish & Game, Immigration, Marine, Police and Fire Departments, Aeronautical AM band, Paramedics, Amateur Radio, plus thousands of other radio frequencies most scanners can't pick up. The Regency TS2 features new 40 channel per second Turbo Scan™ so you won't miss any of the action. Model TS1-LA is a 35 channel version of this radio without the 800 MHz. band and costs only \$239.95.

Regency® Z60-LA

List price \$299.95/CE price \$184.95/SPECIAL
8-Band, 60 Channel • No-crystal scanner
Bands: 30-50, 88-108, 118-136, 144-174, 440-512 MHz.

The Regency Z60 covers all the public service bands plus aircraft and FM music for a total of eight bands. The Z60 also features an alarm clock and priority control as well as AC/DC operation. Order today.

Regency® Z45-LA

List price \$259.95/CE price \$159.95/SPECIAL
7-Band, 45 Channel • No-crystal scanner
Bands: 30-50, 118-136, 144-174, 440-512 MHz.

The Regency Z45 is very similar to the Z60 model listed above however it does not have the commercial FM broadcast band. The Z45, now at a special price from Communications Electronics.

Regency® RH250B-LA

List price \$699.95/CE price \$329.95/SPECIAL
10 Channel • 25 Watt Transceiver • Priority
The Regency RH250B is a ten-channel VHF land mobile transceiver designed to cover any frequency between 150 to 162 MHz. Since this radio is synthesized, no expensive crystals are needed to store up to ten frequencies without battery backup. All radios come with CTCSS tone and scanning capabilities. A monitor and night/day switch is also standard. This transceiver even has a priority function. The RH250 makes an ideal radio for any police or fire department volunteer because of its low cost and high performance. A 60 Watt VHF 150-162 MHz. version called the **RH600B-LA** is available for \$439.95. A UHF 15 watt version of this radio called the **RU150B-LA** is also available and covers 450-482 MHz. but the cost is \$439.95.

Bearcat® 50XL-LA

List price \$199.95/CE price \$114.95/SPECIAL
10-Band, 10 Channel • Handheld scanner
Bands: 29.7-54, 136-174, 406-512 MHz.

The Uniden Bearcat 50XL is an economical, handheld scanner with 10 channels covering ten frequency bands. It features a keyboard lock switch to prevent accidental entry and more. Also order part # **BP50** which is a rechargeable battery pack for \$14.95 or the new double-long life battery pack part # **BP55** for \$29.95, a plug-in wall charger, part # **AD100** for \$14.95, a carrying case part # **VC001** for \$14.95 and also order optional cigarette lighter cable part # **PS001** for \$14.95.

Regency
RH250



MODEL TS-2

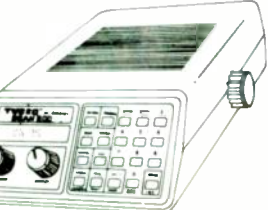

MODEL HX 1500

CIRCLE 79 ON FREE INFORMATION CARD

NEW! Scanner Frequency Listings

The new Fox scanner frequency directories will help you find all the action your scanner can listen to. These new listings include police, fire, ambulances & rescue squads, local government, private police agencies, hospitals, emergency medical channels, news media, forestry radio service, railroads, weather stations, radio common carriers, AT&T mobile telephone, utility companies, general mobile radio service, marine radio service, taxi cab companies, tow truck companies, trucking companies, business repeaters, business radio (simplex) federal government, funeral directors, veterinarians, buses, aircraft, space satellites, amateur radio, broadcasters and more. Fox frequency listings feature call letter cross reference as well as alphabetical listing by licensee name, police codes and signals. These Fox directories are \$14.95 each plus \$3.00 shipping. State of Alaska-RL019-1, State of Arizona-RL025-1, Baltimore, MD/Washington, DC-RL024-1; Buffalo, NY/ Erie, PA-RL009-2, Chicago, IL-RL014-1; Cincinnati/ Dayton, OH-RL006-2, Cleveland, OH-RL017-1, Columbus, OH-RL003-2, Dallas/Ft Worth, TX-RL013-1, Denver/Colorado Springs, CO-RL027-1; Detroit, MI/ Windsor, ON-RL008-3; Fort Wayne, IN/Lima, OH- RL001-1, Hawaii/Guam-RL015-1, Houston, TX-RL023-1; Indianapolis, IN-RL022-1, Kansas City, MO/ KS-RL011-2, Long Island, NY-RL026-1, Los Angeles, CA-RL016-1, Louisville/Lexington, KY-RL007-1, Milwaukee, WI/Waukegan, IL-RL021-1; Minneapolis/St Paul, MN-RL010-2, Nevada/E. Central CA-RL028-1 Oklahoma City/Lawton, OK-RL005-2; Orlando/Daytona Beach, FL-RL012-1, Pittsburgh, PA/Wheeling, WV-RL029-1, Rochester/Syracuse, NY-RL020-1; San Diego, CA-RL018-1, Tampa/St Petersburg, FL-RL004-2; Toledo, OH-RL002-3. Regional directories which cover police, fire ambulance & rescue squads, local government, forestry, marine radio, mobile phone, aircraft and NOAA weather are available for \$19.95 each. RD001-1 covers AL, AR, FL, GA, LA, MS, NC, PR, SC, TN & VI. RD002-1 covers IL, IN, KY, MI, OH & WI. New editions are being added monthly. For an area not shown above call Fox at 800-543-7892 or in Ohio 800-621-2513.

Regency® HX1500-LA

List price \$369.95/CE price \$224.95
11-Band, 55 Channel • Handheld/Portable
Search • Lockout • Priority • Bank Select
Sidelit liquid crystal display • EAROM Memory
Direct Channel Access Feature • Scan Delay
Bands: 29-54, 118-136, 144-174, 406-420, 440-512 MHz.

The new handheld Regency HX1500 scanner is fully keyboard programmable for the ultimate in versatility. You can scan up to 55 channels at the same time including the AM aircraft band. The LCD display is even sidelit for night use. Includes belt clip, flexible antenna and earphone. Operates on 8 1.2 Volt rechargeable Ni-cad batteries (not included). Be sure to order batteries and battery charger from the accessory list in this ad.

Bearcat® 100XL-LA

List price \$349.95/CE price \$194.95/SPECIAL
9-Band, 16 Channel • Priority • Scan Delay
Search • Limit • Hold • Lockout • AC/DC
Frequency range: 30-50, 118-174, 406-512 MHz.

The world's first no-crystal handheld scanner now has a LCD channel display with backlight for low light use and aircraft band coverage at the same low price. Size is 1 3/8" x 7 1/2" x 2 1/8".

Included in our low CE price is a sturdy carrying case, earphone, battery charger/AC adapter, six AA Ni-cad batteries and flexible antenna. Order your scanner now.

★★★ SPECIAL SAVINGS COUPON ★★★

Save even more with this special coupon. As long as your order is prepaid with a money order, you'll get extra special pricing on items listed in this coupon. This coupon must be included with your prepaid order. Credit cards and quantity discounts are excluded from this offer. Offer valid only on prepaid orders mailed directly to Communications Electronics Inc., P.O. Box 1045 - Dept. R1, Ann Arbor, Michigan 48106-1045 U.S.A. Coupon expires June 15, 1987. Coupon may not be used in conjunction with any other offer from Communications Electronics Inc. Be sure to add shipping & handling fees listed in this ad.

RH250B-R1 Regency 25 W. VHF Transceiver	\$299.95
RH600B-R1 Regency 60 W. VHF Transceiver	\$388.95
RU150B-R1 Regency 15 W. UHF Transceiver	\$399.95
UC102-R1 Regency 1 W. VHF 2 channel trans	\$119.95
HX1500-R1 Regency 55 channel scanner	\$219.95
Z60-R1 Regency 60 channel scanner	\$164.95
Z45-R1 Regency 45 channel scanner	\$149.95
BC100XL-R1 Bearcat 16 channel scanner	\$179.95
BC800XL-R1 Bearcat 40 channel scanner	\$269.95
BC800XL-R1 Super Special...6 or more	\$264.95
BC210XL-R1 Bearcat 20 channel scanner	\$169.95
BC50XL-R1 Bearcat 10 channel scanner	\$108.95
RD55-R1 Uniden Radar Detector	\$97.95

★★★ SPECIAL SAVINGS COUPON ★★★

Bearcat® 800XL-LA

List price \$499.95/CE price \$299.95/SPECIAL
12-Band, 40 Channel • No-crystal scanner
Priority Control • Search/Scan • AC/DC
Bands: 29-54, 118-174, 406-512, 806-912 MHz.
The Uniden 800XLT receives 40 channels in two banks. Scans 15 channels per second. Size 9 1/4" x 4 1/2" x 12 1/2".

OTHER RADIOS AND ACCESSORIES

Panasonic RF-2600-LA Shortwave receiver	\$179.95
RD55-LA Uniden Visor mount Radar Detector	\$98.95
NEW! BC 70XL-LA Bearcat 20 channel scanner	\$169.95
BC 145XL Bearcat 16 channel scanner	\$102.95
BC 140 Bearcat 10 channel scanner	\$92.95
BC-WA-LA Bearcat Weather Alert™	\$49.95
PC22-LA Uniden remote mount CB transceiver	\$99.95
PC55-LA Uniden mobile mount CB transceiver	\$59.95
NEW! R1080-LA Regency 30 channel scanner	\$129.95
NEW! R1090-LA Regency 45 channel scanner	\$149.95
NEW! INF1-LA Regency Informant scanner	\$249.95
UC102-LA Regency VHF 2 ch 1 Watt transceiver	\$124.95
P1405-LA Regency 5 amp regulated power supply	\$69.95
P1412-LA Regency 12 amp reg power supply	\$164.95
MA549-LA Drop-in charger for HX1200 & HX1500	\$84.95
MA518-LA Wall charger for HX1500 scanner	\$14.95
MA553-LA Carrying case for HX1500 scanner	\$14.95
MA257-LA Cigarette lighter cord for HX12/1500	\$19.95
MA917-LA Ni-Cad battery pack for HX1200	\$34.95
SMMX7000-LA Svc man for MX7000 & MX5000	\$19.95
B-4-LA 1 2 V AAA Ni-Cad batteries (set of four)	\$9.95
B-8-LA 1 2 V AA Ni-Cad batteries (set of eight)	\$17.95
FB-E-LA Frequency Directory for Eastern U.S.A	\$14.95
FB-W-LA Frequency Directory for Western U.S.A	\$14.95
ASD-LA Air Scan Directory	\$14.95
SRF-LA Survival Radio Frequency Directory	\$14.95
TSG-LA "Top Secret" Registry of U.S. Govt. Freq	\$14.95
TIC-LA Techniques for Intercepting Comm	\$14.95
RRF-LA Railroad frequency directory	\$14.95
EEC-LA Embassy & Espionage Communications	\$14.95
CIE-LA Covert Intelligence, Elect Eavesdropping	\$14.95
A60-LA Magnet mount mobile scanner antenna	\$35.95
A70-LA Base station scanner antenna	\$35.95
USAMM-LA Mag mount VHF/UHF ant w/ 12 cable	\$39.95
USAK-LA 3/4 hole mount VHF/UHF ant w/ 17 cable	\$35.95
USATLM-LA Trunk lip mount VHF/UHF antenna	\$35.95

Add \$3.00 shipping for all accessories ordered at the same time. Add \$12.00 shipping per shortwave receiver. Add \$7.00 shipping per scanner and \$3.00 per antenna.

BUY WITH CONFIDENCE

To get the fastest delivery from CE of any scanner, send or phone your order directly to our Scanner Distribution Center™. Michigan residents please add 4% sales tax or supply your tax ID number. Written purchase orders are accepted from approved government agencies and most well rated firms at a 10% surcharge for net 10 billing. All sales are subject to availability, acceptance and verification. All sales on accessories are final. Prices, terms and specifications are subject to change without notice. All prices are in U.S. dollars. Out of stock items will be placed on backorder automatically unless CE is instructed differently. A \$5.00 additional handling fee will be charged for all orders with a merchandise total under \$50.00. Shipments are F.O.B. Ann Arbor, Michigan. No COD's. Most products that we sell have a manufacturer's warranty. Free copies of warranties on these products are available prior to purchase by writing to CE. Non-certified checks require bank clearance. Not responsible for typographical errors.

Mail orders to: Communications Electronics,™ Box 1045, Ann Arbor, Michigan 48106 U.S.A. Add \$7.00 per scanner for R.P.S./U.P.S. ground shipping and handling in the continental U.S.A. For Canada, Puerto Rico, Hawaii, Alaska, or APD/FPO delivery, shipping charges are three times continental U.S. rates. If you have a Discover, Visa or Master Card, you may call and place a credit card order. Order toll-free in the U.S. Dial 800-USA-SCAN. In Canada, order toll-free by calling 800-221-3475. FTCC Telex anytime, dial 825333. If you are outside the U.S. or in Michigan dial 313-973-8888. Order today. Scanner Distribution Center™ and CE logos are trademarks of Communications Electronics Inc. † Bearcat is a registered trademark of Uniden Corporation ‡ Regency and Turbo Scan are registered trademarks of Regency Electronics Inc. AD #010487-LA/R1 Copyright © 1987 Communications Electronics Inc.

For credit card orders call
1-800-USA-SCAN

**COMMUNICATIONS
ELECTRONICS INC.**

Consumer Products Division
P.O. Box 1045 □ Ann Arbor, Michigan 48106-1045 U.S.A.
Call 800-USA-SCAN or outside U.S.A. 313-973-8888

ASK R-E

WRITE TO:

ASK R-E
Radio-Electronics
500-B Bi-County Blvd.
Farmingdale, NY 11735

NEEDS DC-TO-DC CONVERTER

I have a 1939 Pontiac sedan in which I'd like to install a 12-volt air conditioner, CB radio, and a stereo tape system. To use those 12-volt accessories, I need a 6-volt to 12-volt converter designed for a 30-amp load. There are such converters available on the market, but they deliver hardly enough current to power a radio. How can I add the accessories and still retain the 6-volt electrical system?—W. H., Venus, TX

Why not use the approach that was used to operate 12-volt radios and similar equipment in police, fire, and other emergency vehicles before 12-volt electrical systems became the international standard? Install a separate 12-volt electrical system: alternator, regulator, and battery. We'll bet the parts can be installed under the hood with room to spare. And everything can be purchased from a used-parts dealer. If you're not sure what you're doing, turn the job over to an experienced automotive electrician.

TIMING LIGHT MODIFICATION

I have a high-quality ignition timing light that must be connected directly to a sparkplug wire. How can I build an inductive pickup to trigger the light?—H. A., Glen Mills, PA.

Instruments that require a direct connection to the spark plug for triggering tend to be fairly simple. Figure 1-a shows the circuit of a direct-trigger timing light. The strobe tubes used in timing lights, electronic photoflash units, and similar devices require several thousand volts for triggering. In the Fig. 1-a circuit, the trigger voltage is taken from the car's ignition circuit by a direct connection to a spark plug.

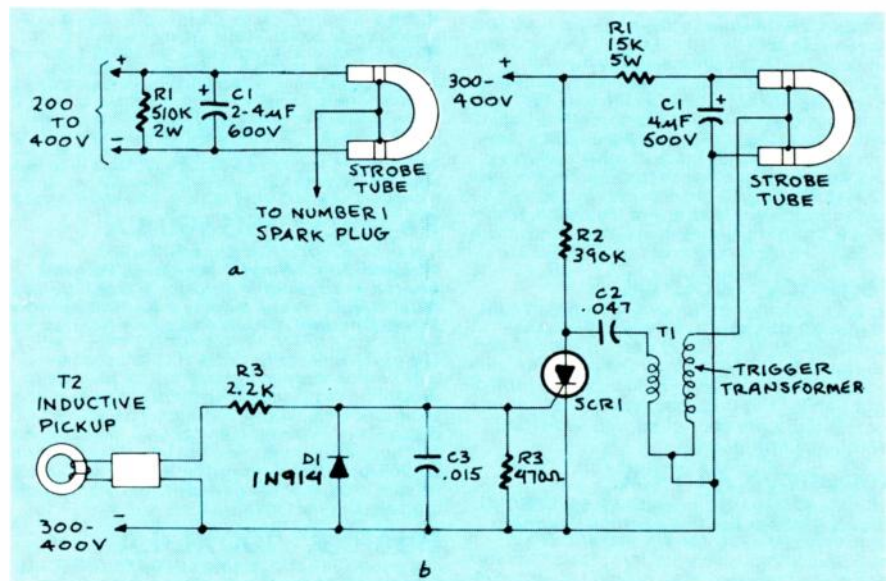

FIG. 1

A circuit using an inductive pickup is a bit more complex, as shown in Fig. 1-b. There a trigger transformer is used to develop the high-voltage pulse for triggering. The triggering circuit consists of T1, C1, SCR1, inductive pickup coil T2, and the waveshaping components in the SCR's gate circuit.

When the sparkplug fires, it induces a pulse in pickup coil T2 that triggers the SCR gate. The SCR fires and discharges C2 through the primary of T1. The secondary of T1 feeds a high-voltage pulse to the trigger electrode of the flash tube. That pulse causes the gas—usually neon or xenon—to ionize. The ionized gas provides a low-resistance path for C1 to discharge, thereby creating a brilliant flash of light. Resistor R1 limits current from the supply as the tube fires. When C1 is fully discharged, the strobe tube cuts off and returns to its "high-resistance" state. The current through R2 is not enough to sustain conduction through

SCR1, so it cuts off and remains off until it is re-triggered by a gate pulse.

110-VOLT DEVICES ON 220?

Can you tell me how to modify electronic equipment (stereos, tape recorders, turntables, and CB's) that is designed for 117-volt, 60-Hz use so that it can operate on 220-volt, 50-Hz lines?—S. M., North Hollywood, CA.

Most power transformers are rated for 50/60 Hz operation, so most can be used with either frequency. However, domestic audio gear uses motors designed for 60-Hz operation only and will therefore run off-speed at 50 Hz. Some manufacturers may be able to supply you with adapters or equipment modifications for 50-Hz operation; contact them directly. Also, the transformer may run somewhat hotter, so make sure that there is ample ventilation.

Power transformers with a 2:1
continued on page 21

Train at home for one of these 38 Career Opportunities

GET A SPECIALIZED ASSOCIATE DEGREE OR CAREER DIPLOMA AT HOME IN SPARE TIME



Send for free facts and find out what career training in the field of your choice could do for you—no obligation to buy anything now or ever. Now at home in spare time, you can train for a new career...even get your Specialized Associate Degree...to help you get a better job. Find out everything you need to know about any one of these career programs—with no obligation to buy anything and no salesman will visit you. Just check the one program that interests you most. You will receive free facts, color brochure and information on employment opportunities in the field you choose. Send for free information today. See how easy it is to train at home for a new career or advancement on your present job.

Get Your Degree at Home... Without Attending College

Now a Specialized Associate Degree can be yours and you never have to set foot inside a college classroom! You learn at home, the hours you choose, without interrupting job or social life. You study the same subjects taught in major colleges and universities. And if you have completed college classes, seminars, military or other training, we may be able to start you with advanced standing toward your degree. International Correspondence Schools is an accredited member of the National Home Study Council, Washington, D.C. Many ICS graduates have gone on to outstanding careers as presidents of companies, industry leaders, famous

scientists, etc. Yet every one of them started by doing what you can do right now: SENDING FOR INFORMATION!

Could a Career Diploma Change Your Life?

The facts show that specialized career training has helped thousands of people make more money, get better jobs, even start new careers. And it's not just the money alone, but the fun of working at a job you really like with people you really enjoy. A Career Diploma could be your first step. SEND FOR FREE FACTS NOW.

Open Book Exams

Your ASB or AST Degree or Career Diploma is given for what you learn—not for what you memorize. We send lessons and training materials to your home. You decide when



you are ready to take each open book exam. Then mail it to your instructor. Complete evaluations are returned with your score plus page references to look up answers to the questions you missed.

This method of open book exams has proven so successful that it is now being used by major colleges and universities all over the country.

An Ideal Way to Learn

Our Graduates tell us they like home study because it's so convenient and easy to do. You choose your own study hours, go as fast or slow as you want. You waste no time traveling to and from class. You never have to miss a paycheck. Yet skilled instructors are ready to help you whenever you ask.

FIRST FOLD HERE

FIRST FOLD HERE

NO POSTAGE NECESSARY when you mail this ENTIRE Postage-Paid ad

To Mail—Fold ad in following manner:

1. Remove entire page—tear or cut on dotted line to left.
2. Fold page in half on 1st fold line.
3. Fold page again on 2nd fold line.
4. Tape or glue the 3 open sides and drop in the mailbox today.

Rush me free facts and full information on how I can study at home for the career I have chosen. I understand I am under no obligation and no salesman will visit. Write the name of the course that interests you most in the box below.

ASSOCIATE IN SPECIALIZED BUSINESS DEGREE PROGRAMS

- Business Management
- Accounting
- Business Management with option in Finance
- Business Management with option in Marketing

ASSOCIATE IN SPECIALIZED TECHNOLOGY DEGREE PROGRAMS

- Mechanical Engineering Technology
- Civil Engineering Technology
- Electrical Engineering Technology
- Electronics Technology

CAREER DIPLOMA PROGRAMS

- Computer Programming
- High School
- Catering/Gourmet Cooking
- Medical/Dental Office Assistant
- Microcomputer Repair
- Auto Mechanics
- Bookkeeping
- Hotel/Restaurant Management
- Drafting
- Veterinary Assistant
- Travel Agent
- Air Conditioning & Refrigeration
- Electronics
- Secretary
- Electrician
- Police Sciences
- Art
- Small Business Management
- Interior Decorating
- Wildlife Forestry Conservation
- Legal Secretary
- Diesel Mechanics
- Fashion Merchandising
- Gun Repair
- Motorcycle Repair
- Surveying & Mapping
- Fitness & Nutrition
- TV/VCR Repair
- Child Day Care
- Legal Assistant

Dept. DES47

These courses are offered by ICS and North American Correspondence Schools.

Fill out completely:
The course I am interested in is

Name _____ Age _____
Address _____ Apt. # _____
City/State/Zip _____
Phone () _____

INTERNATIONAL CORRESPONDENCE SCHOOLS

SECOND FOLD HERE

NO POSTAGE NECESSARY IF MAILED IN THE UNITED STATES

BUSINESS REPLY MAIL
FIRST CLASS Permit No. 1000 Scranton, PA

Postage will be paid by addressee

INTERNATIONAL CORRESPONDENCE SCHOOLS
NORTH AMERICAN CORRESPONDENCE SCHOOLS
925 Oak St.
Scranton, PA 18508-9989



4752A

REMOVE AND MAIL ENTIRE PAGE

REMOVE AND MAIL ENTIRE PAGE

SECOND FOLD HERE

Crack The Code

TRI-MODE CABLE TV DESCRAMBLER PARTS

We stock the exact parts, PC board and AC adaptor for *Radio Electronics* February 1987 article on building your own TRI-MODE CABLE TV DESCRAMBLER.

#301 PARTS PACKAGE \$39.95

Includes all the original resistors, capacitors, diodes, potentiometers, transistors, integrated circuits, LED's, Toko coil (E520HN-3000023) and Plessey SAW filter (SY323).

#302 PC BOARD \$12.95

Original 5 X 8.8 etched & drilled silk-screen PC board used in article.

#304 AC ADAPTOR \$12.95

Original (14 to 18 volt DC @ 200ma) AC adaptor used in article.

SPECIALS

Add \$2.50 shipping & handling — \$4.50 for Canadian orders.
We also offer quantity discounts on 5 or more units.

BOTH #301 and #302 \$49.00

ALL THREE #301, #302, and #304 \$59.00

FREE

Reprint of *Radio Electronics* Article (February 1987) on building your own TRI-MODE CABLE TV DESCRAMBLER.

60-CHANNEL

CABLE CONVERTER

WITH INFRARED REMOTE CONTROL

SC-60R CONVERTER

\$69.95

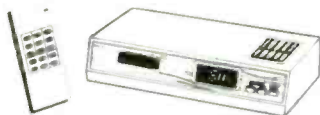

Add \$3.50 Shipping and Handling
\$4.50 on Canadian Orders

Thousands of these converters sold nationally for \$119.95.

We offer you this same type of converter for only \$69.95.

All converters are NEW, with Full manufacturer's WARRANTY.

FEATURES:

- Full 60 Channel Capability
- Cordless Infrared remote control
- Ultra-Stable Synthesized tuning
- Microprocessor controlled PLL
- Works on all TV models. Specify channel 3 or channel 2 output.
- Standard/HRC Switch for compatibility with all Cable Systems
- Will work with all types of external descramblers

**ORDER TOLL FREE
1-800-227-8529**

Inside MA: 617-695-8699
VISA, MASTERCARD OR C.O.D.



Not available to Massachusetts residents due to state law.

**J & W
ELECTRONICS, INC.**

P.O. BOX 800 • MANSFIELD, MA 02048

© Copyright 1986 by J & W Electronics, Inc.

CIRCLE 65 ON FREE INFORMATION CARD

LETTERS

LETTERS
RADIO-ELECTRONICS
MAY 1987



LETTERS
RADIO-ELECTRONICS
500-B BI-COUNTY BOULEVARD
FARMINGDALE, NY 11735

DESCRAMBLING DIFFICULTIES

First of all, I would like to thank you for being the best magazine of its kind available.

I have been following descrambling articles because it's gratifying to "outsmart" the manufacturers in the cat-and-mouse game of program and channel encoding. The February 1987 issue came as a Godsend because my cable company uses the Tri-mode system.

I had no problem building the project, but it just doesn't work on my cable system.

Although the circuit appears to be working correctly—because it works on a friend's system in another cable company's area—on my cable system the N/S LED stays lit on all scrambled channels, no matter what adjustments are made to R14 and L1. When I tune my converter to channel 3, I can get LED1 and 2 to light at different times, but channel 3 is *non-scrambled*.

A friend of mine asked an engineer from my cable company about the **Radio-Electronics** Tri-mode article. The engineer said

that they did, in fact, use a tri-mode system, but that the **Radio-Electronics** circuit won't work because my cable system doesn't hide their sync information where your article says it is (65.75 MHz). Therefore, the descrambler won't work even though my cable system uses a tri-mode system and outputs on channel 3.

My desperate question is: How can I figure out where the sync information is hidden, and can I modify the circuit or build a new one to work on their system?

68 Testing Problems



An A P Products™ brand 68 Pin Chip Carrier Test Clip

- Allows safe, convenient testing of Plastic Leaded Chip Carrier (PLCC) style ICs.
- All four sides of test clip open simultaneously for fast and easy attachment to PLCC being tested.
- Stays securely clamped to PLCC until removed.
- Helical compression springs and insulating contact combs ensure contact integrity during testing.

One Solution

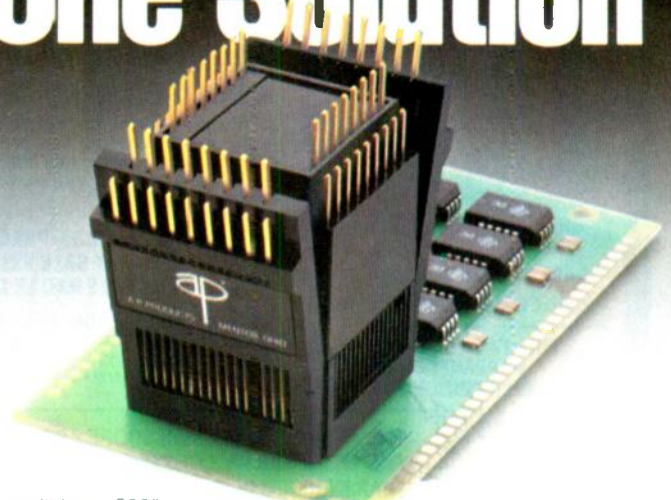

- Permits testing of ICs with as little as .200" row to row spacing between devices.
- Probe access points are immediately visible for fast and safe individual lead testing
- Staggered contact rows on .100" centers facilitate probe attachment and help prevent accidental shorting of adjacent probes
- Industry standard .025" square contact pins on the .100" centers easily accept single row female socket connectors
- Available with tin plated leads and gold plated leads

For information contact a local authorized A P Products Prototype & Test Devices distributor. For immediate response telephone 800 321-9668 or (216) 354-2101 in Ohio.

We Solve Problems.

Associated Electronics/3M

A P Products Prototype & Test Devices
9325 Progress Parkway, P.O. Box 540
Mentor, Ohio 44060

CIRCLE 76 ON FREE INFORMATION CARD

3M

Please do not use my name or city if you print this question. NAME AND ADDRESS WITHHELD We're looking into it. Stay tuned for more information.—Editor

PC SERVICE

I have made several printed-circuit boards using the layouts in the PC-service section of **Radio-Electronics**. The first attempts, using oiled paper, produced a poor image when using the photo process, with sunlight as the light

source for making the exposure.

I realized later that by buying 3M's PCC overhead projection transparency material (available from most stationary stores), and putting it in an ordinary photocopier, the layout could be copied directly onto a clear sheet of plastic. That produced much better results in terms of time and image clarity.

I have a question: Is the layout for the pulse descrambler that was missing in the January 1987 issue

going to be presented in a future issue?

BRIAN FENTIMAN
Nelson, BC Canada

The layout appeared with the next part of the article. See PC Service in the March 1987 issue.—Editor

SUPPLIER WANTED

Help! Help!

I have been building audio circuits from your magazine's plans for many years. Often, I buy just the printed-circuit boards, stuffing them with high-quality low-tolerance parts, and then designing my own cabinet and panel layouts.

My problem is that I cannot find a supplier for precision sealed-type potentiometers. I have tried all of the suppliers in my area, and have written to many of the ones listed in your magazine. Can you help me find a supplier, or a manufacturer, who will sell me those parts in small quantities? (The type of pots that I'm looking for appear frequently in ads for Adcom and Bryston preamps in audio magazines.) Thank you very much for your help.

JOHN CARROLL
PO Box 67,
Haverford, PA 19041

ON PATENT APPLICATIONS

As a strong advocate of doing patent work yourself, I commend the article, "How to Apply for a patent" in the January 1987 **Radio-Electronics**. However, it contains some serious errors.

First, the article states that "applying for a patent is a relatively simple task." Nothing could be farther from the truth: The courts have repeatedly stated that a patent application is one of the most complex, demanding documents that we can prepare. It takes a lot of time and care if the job is to be done correctly.

Second, be advised that the correct Zip Code of the Copyright Office is 20559, not 20540.

Third, the article implies that patents are arranged in the Patent Depository Libraries by numerical order only. However, in the Sunnysvale, CA Patent Depository Library, patents are also classified by subject matter. Also, the article

continued on page 20

B&K-PRECISION SCOPE SAVINGS PLUS FREE COBRA RADAR DETECTOR! ONLY FROM JOSEPH ELECTRONICS



Model 2120

Sale \$438 Reg. \$470
+ FREE COBRA RADAR DETECTOR

2120 20MHz DUAL-TRACE OSCILLOSCOPE

Professional quality at a breakthrough price. 6" CRT with internal graticule. 2kV accelerating voltage. 1mV sensitivity; TV sync coupling H and V; add and subtract; X-Y operation; CH1 output; calibration source; selectable +/- slope; compact low profile design. Complete with probes.



Model 1570 A

Sale \$1308 Reg. \$1464
+ FREE COBRA RADAR DETECTOR

1570A 80MHz QUAD-TRACE OSCILLOSCOPE

1mV sensitivity to full 80 MHz bandwidth. 500 V sensitivity to 40 MHz; rectangular CRT with internal graticule and scale illumination. 12 kV accelerating voltage V Mode displays four signals unrelated in frequency. Alternate timebase/calibrated delayed sweep. 20 MHz bandwidth limiter. Video sync separators. Lighted pushbutton function switching. Two probes included.



Model 2520

Sale \$1798 Reg. \$1990
+ FREE COBRA RADAR DETECTOR

2520 20MHz DIGITAL STORAGE/ANALOG DUAL-TRACE SCOPE

The features of digital storage and analog operation in one instrument. 20MHz real time and storage bandwidth; 2 megosample/sec sampling rate; equivalent time sampling; plot output; pre-trigger; trace hold; expansion of stored waveform. Complete with probes.

ADDITIONAL B&K-PRECISION SCOPES AT SALE PRICES PLUS FREE RADAR DETECTOR!!!

100 MHz Model 1590A Reg. 1886.00 SALE 1698.00
QUAD-INPUT, 8 TRACE, 6" CRT, 1mV SENS., WITH PROBES
20 MHz Model 1524 Reg. 767.00 SALE 688.00
DUAL-TRACE, 6" CRT, 1mV SENS., V MODE, WITH PROBES

FULL TWO YEAR FACTORY WARRANTY ON ALL B&K PRECISION SCOPES



BUY ANY B&K-PRECISION SCOPE ABOVE AND GET A \$99.95 COBRA TRAPSHOOTER RADAR DETECTOR FREE!!!

Sensitive superheterodyne radar detector. Compact Size—3 1/8" x 1 1/4" x 4 1/4" D. Highway/City Switch. Alarm Signal Indicator. "No False" Circuitry. Deluxe Mounting Bracket for Visor or Dash.



Cobra TRAPSHOOTER

Free radar detector offer valid only on scopes featured at prices shown.

HURRY! QUANTITIES LIMITED AT ABOVE SALE PRICES!

ORDER TOLL-FREE 1-800-323-5925

IN ILLINOIS: 312-297-4200

Order Handling Charges
Value: \$0-999 \$1000-2499 \$2500-UP
Add: \$10.00 \$15.00 \$20.00

VISA • MASTERCARD • DISCOVER • Phone Orders Welcomed!
Open Account to Rated Companies Illinois Residents Add 7% Tax

SINCE 1947

Joseph Electronics

8830 N. Milwaukee
Niles, IL 60648

You'll find 116 pages of tremendous discount prices on 25 leading instrumentation lines in JOSEPH'S TEST EQUIPMENT CATALOG. WRITE FOR YOUR FREE COPY TODAY.

Increase your knowledge about all aspects of electronics

An absolutely no-risk guarantee.

Select 5 Books for only \$3⁹⁵ and get a Free Gift!

values to \$125.75

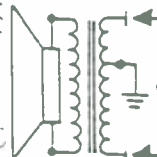

 2707 \$24.95	 2755 \$17.95	 2645 \$16.95	 1777P \$18.95	 2725 \$21.95	 2655P \$16.95	 1793 \$14.95	 1625 \$24.95
 1536 \$14.95	 1199P \$16.95	 1909P \$14.95	 1992 \$14.95	 2710 \$27.95 Counts as 2	 2675 \$22.95	 1532P \$14.95	 1370 \$26.95
 1665P \$17.95	 1663 \$24.95	 1503P \$15.95	 1996P \$11.95	<p>Membership Benefits • Big Savings. In addition to this introductory offer, you keep saving substantially with members' prices of up to 50% off the publishers' prices. • Bonus Books. Starting immediately, you will be eligible for our Bonus Book Plan, with savings of up to 80% off publishers' prices. • Club News Bulletins. 14 times per year you will receive the Book Club News, describing all the current selections—mains, alternates, extras—plus bonus offers and special sales, with hundreds of titles to choose from. • Automatic Order. If you want the Main Selection, do nothing and it will be sent to you automatically. If you prefer another selection, or no book at all, simply indicate your choice on the reply form provided. • Ironclad No-Risk Guarantee. If not satisfied with your books, return them within 10 days without obligation! • Exceptional Quality. All books are quality publishers' editions especially selected by our Editorial Board.</p>			
 1123P \$9.95	 2753 \$23.95	 1965 \$15.95	 2625 \$23.95				
 2665 \$17.95	 1957 \$21.95	 2790 \$18.95					
 2720 \$32.50 Counts as 2	 1999 \$21.95	 1977P \$18.95					

(Publisher's Prices Shown)

FREE when you join
A Handy, Pocket-Sized Resistor and Inductor Color Code Calculator

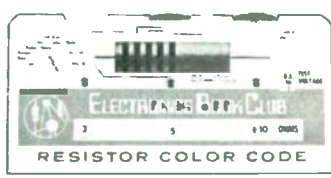

ELECTRONICS BOOK CLUB
P.O. Box 10, Blue Ridge Summit, PA 17214

Please accept my membership in the Electronics Book Club and send the 5 volumes circled below, plus my FREE Resistor & Inductor Color Code Calculator, billing me \$3.95 plus shipping and handling charges. If not satisfied, I may return the books within ten days without obligation and have my membership canceled. I agree to purchase at least 3 books at regular Club prices (plus shipping/handling) during the next 12 months, and may resign any time thereafter.

1123P	1199P	1370	1503P	1532P	1536	1625	1663	1665P	1777P
1793	1909P	1957	1965	1977P	1992	1996P	1999	2625	2645
2655P	2665	2675	2707	2710	2720	2725	2753	2755	2790

Name _____
Address _____
City _____
State/Zip _____ Phone _____

Valid for new members only. Foreign applicants will receive ordering instructions. Canada must remit in U.S. currency. This order subject to acceptance by the Electronics Book Club.
RE-587

1987 ELECTRONICS BOOK CLUB, Blue Ridge Summit, PA 17214
All books are hardcover editions unless numbers are followed by a P for paperback

CIRCLE 176 ON FREE INFORMATION CARD

MAY 1987

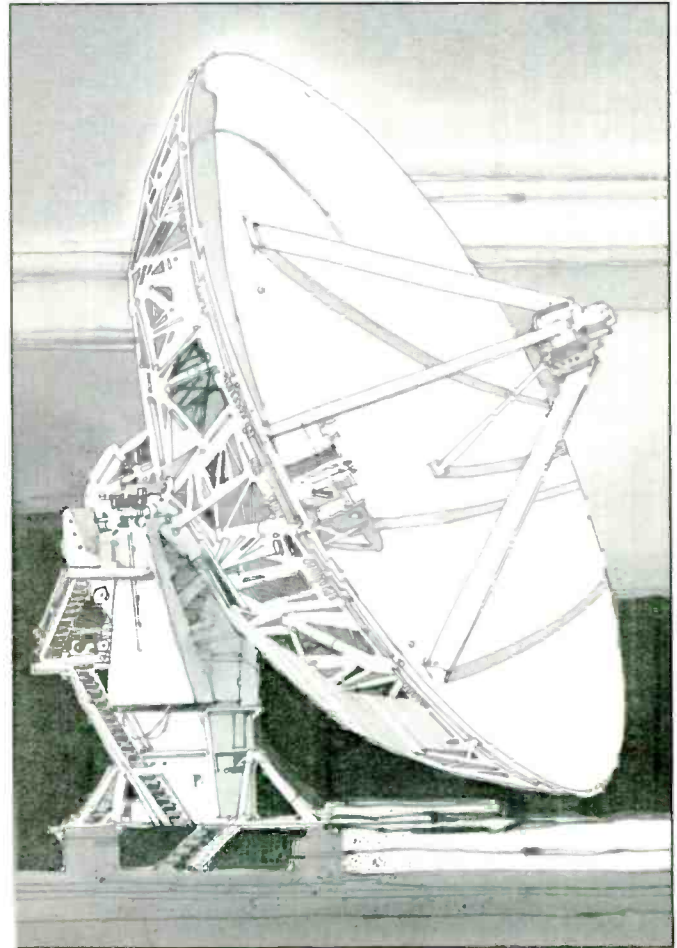
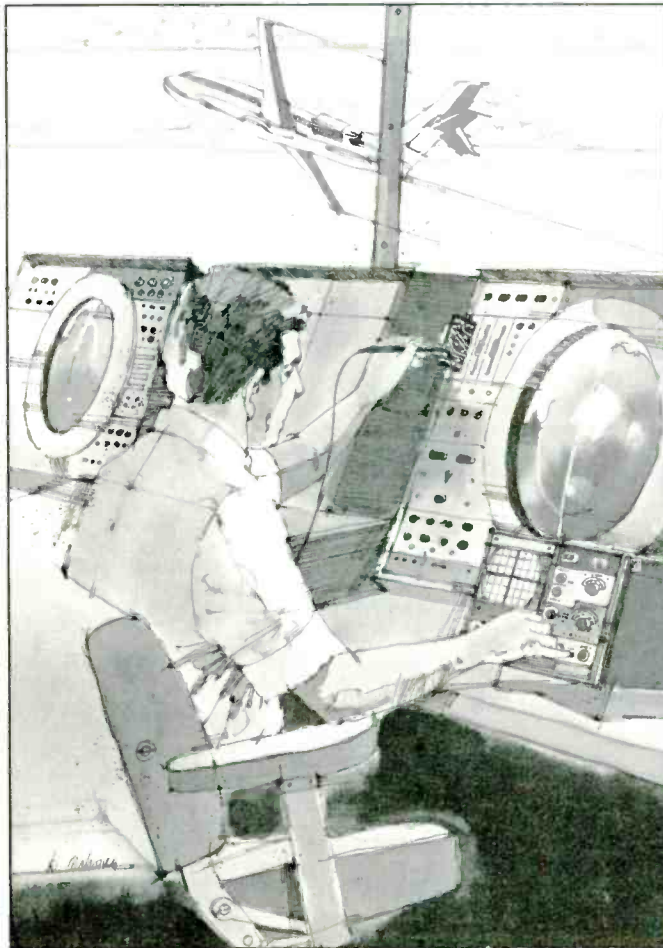
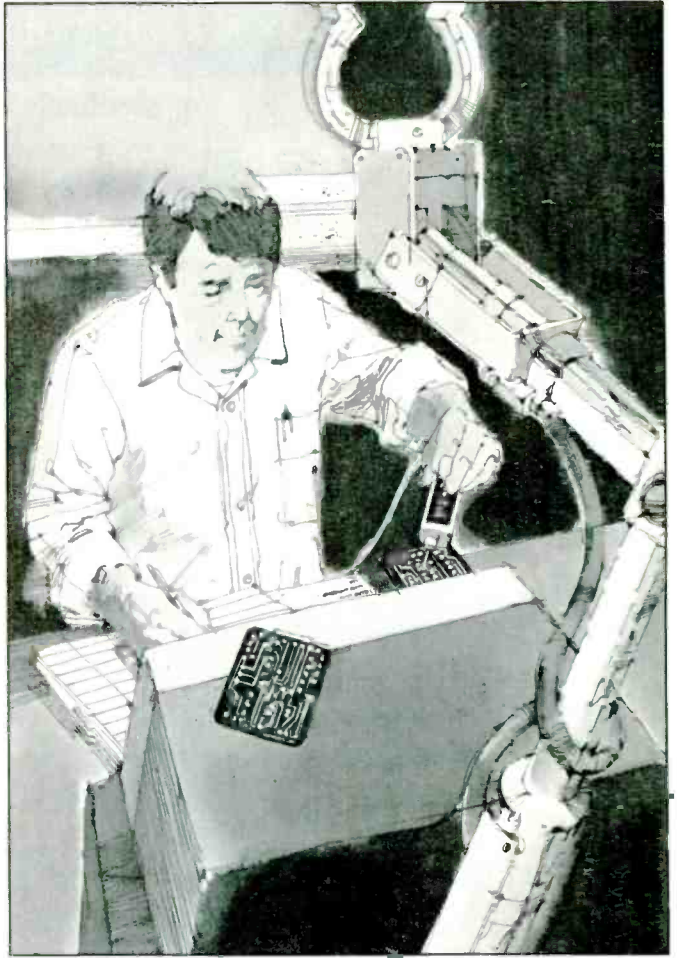

CIE MAKES THE WORLD OF ELECTRONICS YOURS.

Today's world is the world of electronics. To be part of it, you need the right kind of training, the kind you get from Cleveland Institute of Electronics, the kind that can take you to a fast growing career in business, aerospace, medicine, science, government, communications, and more.

Specialized training.

You learn best from a specialist, and that's CIE. We're the leader in teaching electronics through independent study, we teach only electronics and we've been doing it for over 50 years. You can put that experience to work for you just like more than 25,000 CIE students are currently doing all around the world.

Practical training.

You learn best with practical training, so CIE's Auto-Programmed® lessons are designed to take you step-by-step, principle-by-principle. You also get valuable hands-on experience at every stage with sophisticated electronics tools CIE-designed for teaching. Our 4K RAM Microprocessor Training Laboratory, for example, trains you to work with a broad range of computers in a way that working with a single, stock computer simply can't.

Personalized training.

You learn best with flexible training, so we let you choose from a broad range of courses. You start

with what you know, a little or a lot, and you go wherever you want, as far as you want. With CIE, you can even earn your Associate in Applied Science Degree in Electronics Engineering Technology. Of course, you set your own pace, and, if you ever have questions or problems, our instructors are only a toll-free phone call away.

The first step is yours.

To find out more, mail in the coupon below. Or, if you prefer, call toll-free 1-800-321-2155 (in Ohio, 1-800-523-9109). We'll send a copy of CIE's school catalog and a complete package of enrollment information. For your convenience, we'll try to have a representative contact you to answer your questions.

CIE Cleveland Institute of Electronics
1776 East 17th St. Cleveland, Ohio 44114

YES! I want to get started. Send me my CIE school catalog including details about the Associate Degree Program. I am most interested in:

- | | |
|--|---|
| <input type="checkbox"/> computer repair | <input type="checkbox"/> television/high fidelity service |
| <input type="checkbox"/> telecommunications | <input type="checkbox"/> medical electronics |
| <input type="checkbox"/> robotics/automation | <input type="checkbox"/> broadcast engineering |
| <input type="checkbox"/> other _____ | |

Print Name _____

Address _____ Apt _____

City _____ State _____ / Zip _____

Age _____ Area Code Phone No _____

Check box for G.I. Bulletin on Educational Benefits **ARE-60**

Veteran Active Duty **MAIL TODAY!**

LETTERS

continued from page 14

doesn't mention that computer searching is now widely available; the system allows inventions to be searched back for about 10 years by key words, rendering the patent-classification system partly irrelevant.

Fourth, the article mentions that in addition to design, plant, and

utility patents, there are "materials patents" and "structure patents." Despite over twenty-five years experience as a patent examiner and as a patent lawyer, I have never heard of "materials" or "structure" patents. Utility patents can be used to protect five statutory classes of inventions: compositions, articles, machines, processes, and new uses.

Fifth, the sample claims to the circuit shown are highly improper and would be instantly rejected by

any examiner. Claim 1 would be rejected as "incomplete" because it's simply a list of parts without the necessary interconnections. Claims 2 and 3 would be rejected as "functional," because they tell what the invention does, rather than what it is.

Sixth, the article states that ten claims may be submitted in a patent application. Untrue; twenty claims, including three independent claims, may be submitted for the \$170 filing fee.

Seventh, the fees given are wrong. The filing fee is now \$170 (not \$150); the issue fee is now \$280 (not \$250); and the maintenance fees are now \$225, \$445, and \$670 (rather than \$200 each). Also, the article fails to note that to be entitled to pay those "small entity" fees, the applicant must submit a "Small Entity Declaration" when the application is filed; otherwise, an applicant would have to pay double the above fees.

Last, but not least, the article recommends my book, *Patent It Yourself*, but the 1979 McGraw-Hill version listed is now out of print. *Patent It Yourself*, in a totally revised and tripled-in-size version is currently published by Nolo Press, Berkeley, CA; if not available locally, call 800-992-6656 (800-445-6656 in CA).

DAVID PRESSMAN,
Patent Lawyer,
San Francisco, CA

CABLE TV SPECIALS CONVERTERS

JERROLD:	JRX-3 DIC—36 Channel Corded Remote	*149.⁰⁰
	JSX-3 DIC—36 Channel Set Top	*129.⁰⁰
	SB-3—'The Real Thing'	*119.⁰⁰
	SB-3A-4 port	\$99.⁹⁹
ZENITH:	Z-TAC Cable Add-On	*199.⁰⁰
VIEW STAR:	EVSC-2010—60 Channel Wireless— with Parental Lockout	\$ 99.⁰⁰
	EVSC-2010 A-B—Same as above with A-B Switch	*109.⁰⁰
	View Star 2501—60 Channel Wireless	
	with Volume	*119.⁰⁰

MISCELLANEOUS

OAK:	N-12 Mini-Code	\$ 89.⁰⁰
	N-12 Mini-Code Vari-Sync	*109.⁰⁰
	N-12 Mini-Code Vari-Sync Plus Auto On-Off . .	*165.⁰⁰

JERROLD: 400 & 450 Handheld Transmitters \$ 29.⁰⁰

HAMLIN: MLD-1200 \$ 99.⁰⁰

NEW ITEMS: Ripco Tape Copy Stabilizer \$149.⁹⁵

Scientific Atlanta Call for Price

OAK: E-13 Mini-Code Substitute \$ 79.⁹⁵

E-13 Mini-Code W/Vari-Syn \$ 89.⁹⁵

ALL UNITS GUARANTEED. QUANTITY PRICES AVAILABLE.

UNITED ELECTRONIC SUPPLY

P.O. BOX 1206 • ELGIN, ILLINOIS 60121 • 312-697-0600

REVERSING MOTORS

I have some easy hints for C.S. of Ft. Worth, TX, who wanted to reverse a small AC motor. (See "Ask R-E" in the Feb. 1987 issue of *Radio Electronics*.—Editor)

The type of motor that he probably has is an *induction motor*, made with "shaded poles" in the stator. Those are heavy-copper "shorted turns" embedded in the pole-pieces. The shorted turns produce a "lagging" magnetic affect, causing the induced current in the armature to produce magnetic effects that result in its "rotation" in a certain direction. You might say that a "rotating magnetic field" was set up in the stators.

A fan-motor of that type has a shaft sticking out one end-bell, the other end-bell is closed. All that

continued on page 22

ASK-R-E

continued from page 10

step-down ratio are usually used on foreign equipment brought to this country, and, by hooking them up backwards, to power 117-volt equipment in areas where 220-volt, 50-Hz is standard. One source of converter transformers is Signal Transformer Co., 500 Bayview Ave., Inwood, NY 11696. Ask for data on their M4L-2 line of power transformers.

WHAT'S A GATE-TURNOFF RECTIFIER?

While browsing through a stack of old magazines, I came across an article in the August 1964 issue of *Electronics World* on gate-turnoff controlled rectifiers. The article included a circuit (shown in Fig. 2) to demonstrate use of the device. Where can I obtain additional information on the device?—S. W. W., Pinehurst, GA.

Gate turn-off switches, called GTO's, are SCR's that can be turned on as well as off by an ap-

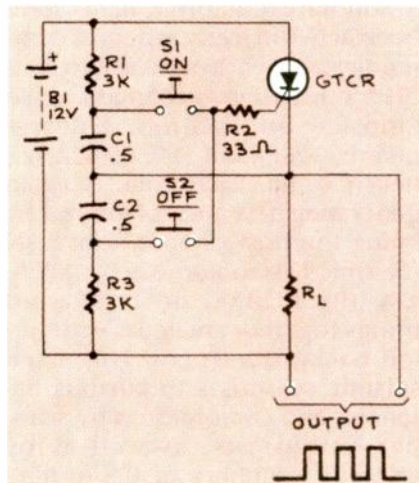

FIG. 2

propriate gate signal. The turn-off feature makes the devices particularly useful in DC circuits.

For information on GTO's write to Motorola, P.O. Box 20912, Phoenix, AZ 85036. Ask for data sheets and application notes on the MGT01000 series of devices. Also, write to Amperex Electronics Corp., Slatersville, RI 02876 and request copies of Technical Publication 004 (*Basic GTO Drive Circuits*) and 005 (*Understanding GTO Data as an Aid to Circuit Design*). R-E

Now test and restore every CRT on the market . . . without ever buying another adaptor socket or coming up embarrassingly short in front of your customer . . . or your money back



with the new improved CR70 "BEAM BUILDER"™
Universal CRT Tester and Restorer
Patented \$995

Have you ever?

Thrown away a good TV CRT, data display CRT, or scope CRT that could have been used for another two or three years because you had no way to test or restore it?

Lost valuable customers because you advised them that they needed a new CRT when another technician came along and restored the CRT for them?

Lost the profitable extra \$35 or more that you could have gotten for restoring a CRT while on the job and locked in the profitable CRT sale later?

Avoided handling profitable trade-ins or rentals because you were afraid you'd have to replace the picture tube when you could have restored it?

Had a real need to test a CRT on the job, but didn't have the right adaptor socket or setup information in your setup book?

If any of these things have happened to you CALL TODAY, WATS FREE, 1-800-843-3338, for a FREE 15 day Self Demo.

"BEAM BUILDER" is a trademark of Sencore, Inc.



Call Today Wats Free 1-800-843-3338

SENCORE

3200 Sencore Drive
Sioux Falls, SD 57107
605-339-0100 In SD Only

*innovatively designed
with your time in mind.*

CIRCLE 195 ON FREE INFORMATION CARD

LETTERS

continued from page 20

has to be done to reverse the direction is to disassemble the motor (don't disconnect any wires), swap the end-bells around, and turn the armature end-for-end so that the shaft that stuck out on the left now sticks out on the right. What is effectively done here is that the stator is *flipped* 180°; its

magnetic field now rotates in the *opposite* direction with respect to the armature, causing it to rotate in the opposite direction from what it did originally.

GARDINER E. WYMAN
Malden, IL

THE WETNESS ALARM

"How to Apply for a Patent," in the January 1987 issue of *Radio-Electronics*, was a very informative article.

In the sample patent applica-

tion, the author used a circuit for a battery-powered wetness alarm. I am curious as to where he obtained the information for that circuit. I have used that same circuit for the past several years in my homemade moisture detectors, and until I read Mr. Sweeney's article I was contemplating manufacturing them on a small scale.

If the information is not confidential, would you please let me know who has the patent on that circuit and when it was applied for? I have seen Japanese moisture detectors using the same circuit. I have never spoken to a patent attorney, but question whether it's possible to patent so basic a circuit.

DANIEL K. ARNOLD
Glastonbury, CT

The circuit was provided only for illustration. As stated in the caption for circuit, it "...might be patentable...." As for the circuit itself, if you asked the average technician to design a "wetness alarm," that's how he would do it—Editor

ELENCO PRODUCTS AT DISCOUNT PRICES!

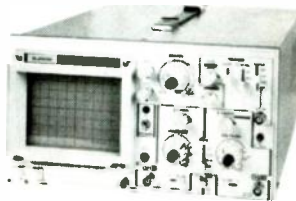

20 MHz DUAL TRACE OSCILLOSCOPE
\$349 MO-1251

TWO
100 MHZ
SWITCHABLE
PROBES
INCLUDED

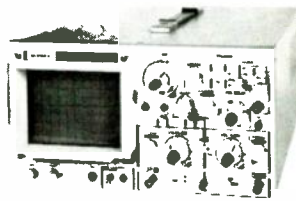

35 MHz DUAL TRACE OSCILLOSCOPE
\$498 MO-1252

Top quality scopes at a very reasonable price. Contains all the desirable features. Elenco's 2 year guarantee assures you of continuous service. Two 1x, 10x probes, diagrams and manual included. Write for specifications.

MULTI METER with CAPACITANCE and transistor tester
\$65 Model CM-1500
Reads Volts, Ohms, Current, Capacitors Transistors & Diodes

TRUE RMS 4 1/2 DIGIT MULTIMETER
\$135 Model M-7000
05% DC Accuracy
1% Resistance with Freq. Counter & Deluxe Case

AUTO RANGING plus MANUAL RANGING
3 1/2 DIGIT METER
28 FUNCTIONS
FULLY PROTECTED
M-1180 .7% ACY \$36.95
M-1182 .25% ACY \$39.95
M-1181 .1% ACY \$42.95

GF-8016 Function Generator with Freq. Counter
\$219
• Sine, Square, Triangle, Pulse, Ramp, .2 to 2 MHz
• Frequency .1 thru 10 MHz
GF 8015 without Freq. Meter \$169

10 MHz OSCILLOSCOPE
\$199 S-3000
10 MHz DC or AC Triggered Sweep
Calibrated Vert & Hor
Reads Volts & Freq

BREDBOARD
Shown 9436
9430 1,100 pins \$15
9434 2,170 pins \$25
9436 2,860 pins \$35

Triple Power Supply XP-660
\$149.50
0-20V @ 1A
0-20V @ 1A
5V @ 5A
Fully Regulated, Short Circuit Protected with 2 Limit Cont. 3 Separate Supplies.

50 MHz LOGIC PROBE
\$23
20 nec with memory
LP-700

LOGIC PULSER
\$25
2 us pulse @ 1A
LP-600

3 Amp Power Supply XP-650
\$119.50
0-40V @ 1.5A
0-20V @ 3A
Fully regulated, short circuit protected current limit control

DIGITAL LCR METER
Model LC-1800
Measures: Inductors Capacitors, Resistors
\$148
Inductors .1μH to 200 H
Capacitor .1Pf to 200μf
Resistor .01Ω to 20M Ω
Ranges 6 ind, 7 cap, 7 res

C&S SALES INC., 8744 W. North Ter. Niles, IL 60648
800-292-7711 (312) 459-9040



15 DAY MONEY BACK GUARANTEE

ASK FOR CATALOG

2 Year Limited Guarantee! Add 5% for Postage (\$10 max.), IL Res., 7% Tax

CIRCLE 109 ON FREE INFORMATION CARD

SEISMIC DISCUSSION NET

Southern California hams have been active in every aspect of communications with networks to handle traffic and to exchange diverse kinds of information. One repeater, W6FXN/R (145.460 MHz), near Covina, California, is again generating new areas of interest by being the host of an official SDN (Seismic Discussion Net) at 10:30 P.M. (local time) on Fridays. It brings together amateurs with varied backgrounds, ranging from seismic scientists to curious listeners, and is monitored by scanner enthusiasts, as well as by amateur members of California's Office of Emergency Services.

The net collects and discusses data derived from homebrew seismic-motion detectors and from the telemetry of the many low-power 160-175 MHz VHF U.S. Geological Survey seismic detectors located throughout Southern California. Those detectors, as well as special laser devices, were seen in 1986 on KCET-TV, Channel 28, Los Angeles, during a WNET-TV-produced educational broadcast series called *Innovation*; and again on KCET this month (January) on *The Nature of Things*. The SDN un-

officially convenes the remaining six nights of the week as the Micro-SDN with reduced levels of participation.

Apart from SDN traffic, with 25 to 100 amateur stations reporting perceived intensity and direction of local quakes (whenever significant quakes are felt), epicenters and damaged areas have been estimated or pinpointed long before the commercial news media have been able to report the quake locations.

SDN participation has come from hams in San Diego, San Bernardino, Riverside, Orange, and Los Angeles counties, despite the late hour of the night. Some of those amateurs use personal computers to process data about daily seismic motion, and to report calculated shift results on the air. Even WA6WZO, the Southwestern Division ARRL Director, has become interested and involved in that interesting application of a ham net. The SDN was also the topic of passing conversation at the September ARRL National Convention in San Diego.

Beyond that, the W6FXN/R machine (a repeater) automatically transmits telemetry tones when either local or distant seismic motion in excess of 3.5 on the Richter scale is detected in the local area. Thanks to that system, Southern California hams (especially veterans of the 1971 Sylmar disaster) really know what's shaking.
KEITH HIGGINS, WA6IYL
Lakewood, CA

CAMCORDER

Well, you've done it again, and this time I had to write and tell you about it. It was Friday evening when my wife and I decided it was time to buy our first camcorder. Saturday afternoon the March issue arrived with that great Camcorder Buyer's Guide.

After poring over the features model by model we came up with a list of exactly what we really needed and wanted. We went shopping that same afternoon and not only found what we wanted but, by knowing specifically what we needed, we got a great buy. Thanks.

FRED JONES
Dyersburg, TN

R-E

Walk "tough dog" troubles out of any TV & VCR in half the time . . . or your money back

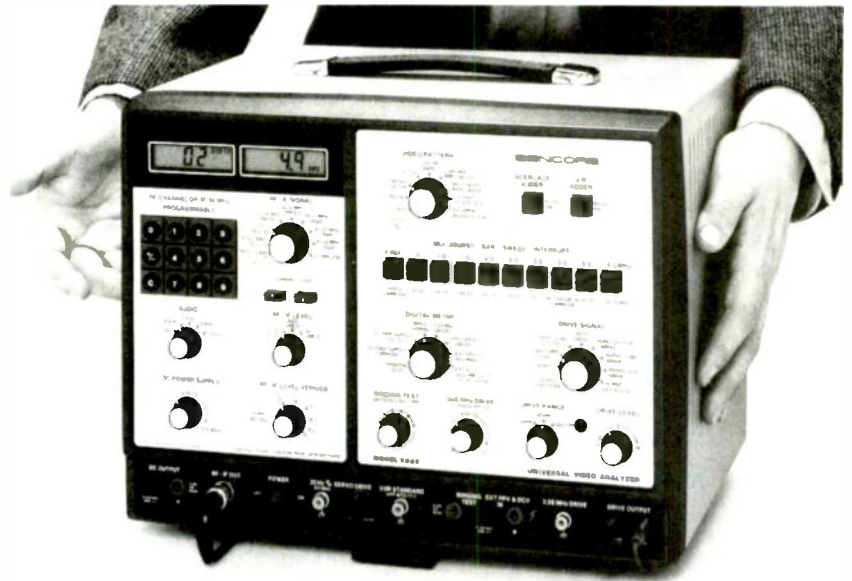

with the exclusive, patented,
VA62 Universal Video Analyzer . . . \$3,295

Would you like to?

Reduce analyzing time: Isolate any problem to one stage in any TV or VCR in minutes, without breaking a circuit connection, using the tried and proven signal substitution method of troubleshooting?

Cut costly callbacks and increase customer referrals by completely performance testing TVs & VCRs before they leave your shop? Own the only analyzer that equips you to check all standard and cable channels with digital accuracy? Check complete, RF, IF, video and chroma response of any chassis in minutes without taking the back off the receiver or removing chassis plus set traps dynamically right on CRT too? Simplify alignment with exclusive multiburst pattern?

Reduce costly inventory from stocking yokes, flybacks, and other coils and transformers, for substitution only, with the patented Ringing Test. Run dynamic proof positive test on any yoke, flyback, and integrated high voltage transformer . . . in- or out-of-circuit?

Protect your future by servicing VCRs for your customers before they go to your competition? Walk out "tough dog" troubles in any VCR chrominance or luminance circuit — stage-by-stage — to isolate problems in minutes? Have proof positive test of the video record/play heads before you replace the entire mechanism?

Increase your business by meeting all TV and VCR manufacturers' requirements for profitable warranty service work with this one universally recommended analyzer?

To prove it to yourself, CALL TODAY, WATS FREE, 1-800-843-3338, for a FREE Self Demo . . . or learn how the VA62 works first by calling for your free simplified operation and application instruction guide, worth \$10.00.



Call Today Wats Free 1-800-843-3338

SENCORE

3200 Sencore Drive
Sioux Falls, SD 57107
605-339-0100 In SD Only

*innovatively designed
with your time in mind.*

CIRCLE 196 ON FREE INFORMATION CARD

EQUIPMENT REPORTS

Universal Wireless Remote Control and Stereo TV Tuner

Get the latest television
features on any TV set!



CIRCLE 9 ON FREE INFORMATION CARD

STEREO TELEVISION, OTHERWISE known as MTS (Multichannel Television Sound), is the hottest thing to happen to the television industry since the introduction of color. Although stereo broadcasts have been authorized for only about three years, more than one third of all TV sets sold this year will include built-in stereo decoders.

Wireless remote control is another hot feature that has been selling more and more TV sets recently. The convenience of remote

ACHIEVE INSTANT SUPERTECH STATUS

THE PATENTED (pending) EDS-59C SEMIANALYZER® WILL CUT YOUR TROUBLESHOOTING TIME DRAMATICALLY—GUARANTEED!*

CHECKS CONDITION, POLARITY, AND NUMBER OF JUNCTIONS OF SEMICONDUCTORS IN CIRCUIT.

DISPLAYS PARAMETERS IN PLAIN ENGLISH ON BRIGHT LED DISPLAY.

BEEPS DIFFERENT TONES FOR IMPORTANT CIRCUIT CONDITIONS.

CHECKS ZENER DIODES IN-CIRCUIT.

CHECKS CAPACITORS FOR LEAKAGE AND VOLTAGE BREAKDOWN.

BUILT-IN AMPLIFIER FINDS NOISY OR INTERMITTANT COMPONENTS.

TWO-YEAR LIMITED WARRANTY ON PARTS AND LABOR.

MADE IN THE U.S.A.



EDS-59C **\$489**
SEMIANALYZER®

* WE GUARANTEE THAT THE EDS-59C SEMIANALYZER WILL MAKE YOU A FASTER, LESS-FRUSTRATED "SUPERTECH", OR YOUR MONEY BACK. TRY ONE FOR 60 DAYS, AND IF IT DOESN'T EARN ITS KEEP, SHIP IT BACK FOR A FULL REFUND.

ELECTRONIC DESIGN SPECIALISTS, INC.
P.O. Box 9609, Coral Springs, FL 33065

VISA/MASTER CARD ORDER LINE
TOLL-FREE 1-800-544-4150
Florida 305-726-7416

CIRCLE 202 ON FREE INFORMATION CARD

control is something that's become commonplace in only a few short years.

But what if you already own a perfectly good TV that you bought before MTS was approved by the FCC? And what if you decided against buying a remote-controlled TV because you thought the convenience wasn't worth the cost? Are you destined to be frustrated and angry every time you see the stereo logo on NBC, or every time you have to get up from your easy chair or sofa to change channels?

Universal		V-7640																					
OVERALL PRICE	■	■	■	■	■	■	■	■	■	■	■	■	■	■	■	■	■	■	■	■			
EASE OF USE	■	■	■	■	■	■	■	■	■	■	■	■	■	■	■	■	■	■	■	■			
INSTRUCTION MANUAL	■	■	■	■	■	■	■	■	■	■	■	■	■	■	■	■	■	■	■	■			
PRICE/VALUE	■	■	■	■	■	■	■	■	■	■	■	■	■	■	■	■	■	■	■	■			
	1	2	3	4	5	6	7	8	9	10													
	Poor			Fair			Good			Excellent													

You don't have to trash your present TV to get stereo sound and the convenience of wireless remote control—you can add those latest features to any TV set by using an outboard unit such as the V-7640 from Universal Security Instruments (10324 S. Dolfield Road, Owings Mills, MD 21117).

The V-7640 has a 140-channel tuner that can be used for either standard TV or cable frequencies, and you can easily switch back and forth between the two. Well, not really. The ANTI/CABLE CONTROL switches the input frequencies to which the tuner will be sensitive, but it doesn't select a different set of inputs. In other words, if you want to watch both cable and standard VHF TV, you'll need an external A-B switch. However, the antenna/cable inputs do include a separate 300-ohm UHF antenna input, so you can switch between cable and UHF without using an external switch.

In most situations, the setup just described shouldn't cause too many problems, because most cable systems carry all standard VHF stations, and the recent "Must Carry" rules require your cable company to supply an A-B switch to

Exclusive, triple patented dynamic cap and coil analyzing . . . guaranteed to pinpoint your problem every time or your money back



with the all new LC75 "Z METER 2"
Capacitor Inductor Analyzer
Patented \$995

The "Z METER" is the only LC tester that enables you to test all capacitors and coils dynamically — plus, it's now faster, more accurate, and checks Equivalent Series Resistance (ESR) plus small wire high resistance coils.

Eliminate expensive part substitution and time-consuming shotgunning with patented tests that give you results you can trust every time. Test capacitor value, leakage, dielectric absorption, and ESR dynamically; with up to 600 volts applied for guaranteed 100% reliable results — it's exclusive — it's triple patented.

Save time and money with the only 100% reliable, in- or out-of-circuit inductor tester available. Dynamically test inductors for value, shorts, and opens, automatically under "dynamic" circuit conditions.

Reduce costly parts inventory with patented tests you can trust. No more need to stock a large inventory of caps, coils, flybacks, and IHVTs. The "Z METER" eliminates time-consuming and expensive parts substituting with 100% reliable LC analyzing.

Turn chaos into cash by quickly locating transmission line distance to opens and shorts to within feet, in any transmission line.

Test troublesome SCRs & TRIACs easily and automatically without investing in an expensive second tester. The patented "Z METER 2" even tests SCRs, TRIACs, and High-Voltage Diodes dynamically with up to 600 volts applied by adding the new SCR250 SCR and TRIAC Test Accessory for only \$148 or FREE OF CHARGE on Kick Off promotion.

To try the world's only Dynamic LC Tester for yourself, CALL TODAY, WATS FREE, 1-800-843-3338, for a FREE 15 day Self Demo.



Call Today Wats Free 1-800-843-3338

SENCORE

3200 Sencore Drive
Sioux Falls, SD 57107
605-339-0100 In SD Only

*innovatively designed
with your time in mind.*

CIRCLE 197 ON FREE INFORMATION CARD

CRYSTEK

The pulse of dependable communications

Reliability & Quality
From Start To Finished Product

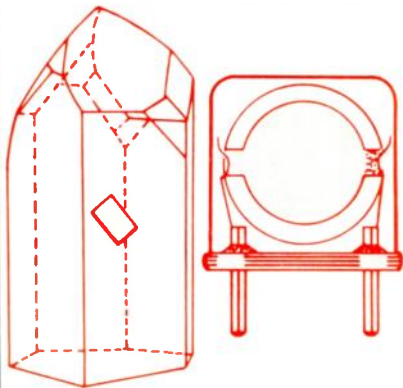

QUARTZ CRYSTALS/OSCILLATORS

FOR
ELECTRONIC — INDUSTRIAL

- Micro-Processor Control
- Computers/Modems
- Test/Measurement
- Medical

COMMUNICATIONS-REPLACEMENT

- Mobile/2-way/Channel Elements
- Pagers
- Marine
- Aircraft
- Telemetry
- Monitors/Scanners

AMATEURS

- CB
- Hobbist
- Experimenter

- COST EFFECTIVE
- MODERATE PRICING
- FAST DELIVERY

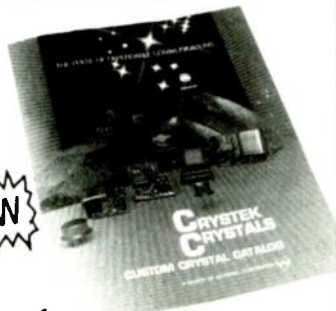

The Pulse of Dependable Communications

Crystek Crystals offers their new 16 page FREE catalog of crystals and oscillators. Offering state-of-the-art crystal components manufactured by the latest automated technology. Custom designed or "off the shelf." Crystek meets the need, worldwide. Write or call today!

CRYSTEK CRYSTALS

2351/2371 Crystal Dr. • Ft. Myers, FL 33907
P.O. Box 06135 • Ft. Myers, FL 33906-6135

TOLL FREE 1-800-237-3061
(813) 936-2109 - TWX 510-951-7448

you at cost. We would like to have seen two separate inputs, though—if only for an easy way to select another RF source, such as a video game.

The V-7640 has an RF output that is switch-selectable between Channels 3 and 4, and a video output for use with a monitor or a TV with a video input jack. Speaker outputs are also available on the rear panel, but, unfortunately, line-level audio outputs are not. According to the manufacturer, line-level outputs have been added to newer units. But the older unit may still be on your dealer's shelves, so check before you buy!

A pair of speakers, in die-cast metal enclosures, is included with the V-7640. They are designed to be mounted on the sides of your TV set—a set of Velcro fasteners is included for that purpose. The speaker magnets are well shielded, so they won't cause any picture distortion or damage to your picture tube. If you're used to listening to your TV set's built-in speaker, you're sure to be happy with what you'll hear from the V-7640. If you don't want to give up your set's built-in speaker, you can use it for "filling in," because audio is fed via the RF output to your TV.

Although the dbx logo is not on the unit's front panel, the dbx noise-reduction system that is part of the MTS specification is used—at least according to the manufacturer. The IC part numbers were not readable in our unit. From our test site, about 30 miles east of New York City, we didn't have any complaints with noise on stereo broadcasts. (We used a roof-mounted antenna.)

A switched power outlet is available for remote on/off control of your TV. That output has a hefty 500-watt capacity, so you can use the V-7640 with even an "ancient" tube-type TV!

Remote control features

If you don't have a remote-controlled TV, you'll be happy with many of the features of the V-7640. The handheld infrared remote control lets you either scan sequentially up and down through the channels, or access a particular channel directly. A memory

feature lets you teach the tuner your favorite channels so you can automatically skip blank channels—or channels you rarely watch—when you scan.

Other functions on the remote unit include: fine tuning, SAP (Second Audio Program)/main channel selection, MTS/synthesized stereo selection, antenna/cable selection, volume up and down, volume mute, and TV on/off.

While it is nice to have those features included on the remote, we think they should also be included on the main unit. Unfortunately SAP/main selection, channel scan, and a TV on/off are the only functions offered there.

The handheld infrared remote control unit is high-powered, so it doesn't have to be aimed directly at the base unit for it to work. It can be operated comfortably with one hand, but if we had our choice, we'd be tempted to change the keyboard layout somewhat. We might be tempted to change the buttons themselves—the 23 small rubber keys provide poor tactile feedback. Fortunately, a red LED indicates when a button is pushed.

The instruction manual that's supplied with the V-6740 is more than adequate in its descriptions of the unit's features and functions. In addition, clear hookup diagrams cover several installations that might confuse many consumers—using your TV and the V-7640 along with a VCR that is not cable-ready, for example.

The V-7640 completely lives up to its manufacturer's claims. That's the good news. The bad news is that you have to pay a rather steep \$399 for that performance.

The V-7640 probably is of most value to owners of non-stereo high-end monitors or projection TV sets. For them, buying the tuner is preferable to scrapping a \$700-\$4000 unit. But if you presently own a small-screen TV set or are considering buying a new set in the near future, we recommend passing on the V-7640 and looking into a stereo-equipped TV set instead; with discounts, 19- or 20-inch stereo TV sets often can be purchased for only about \$100 or more.

R-E

COMPUTER COMICS



"Experience? I suppose one could say so."



"Get with it, Dad! My generation will have artificial intelligence to back us."



"Hangnail, eh? I'll switch you to a slide rule for as day or two."

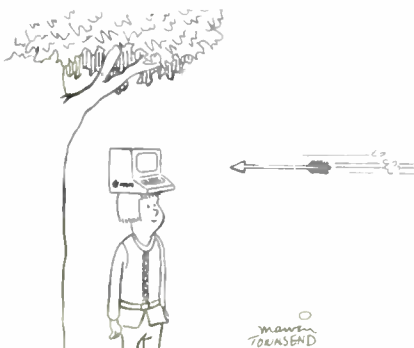

Analyze defective waveforms faster, more accurately, and more confidently — every time or your money back

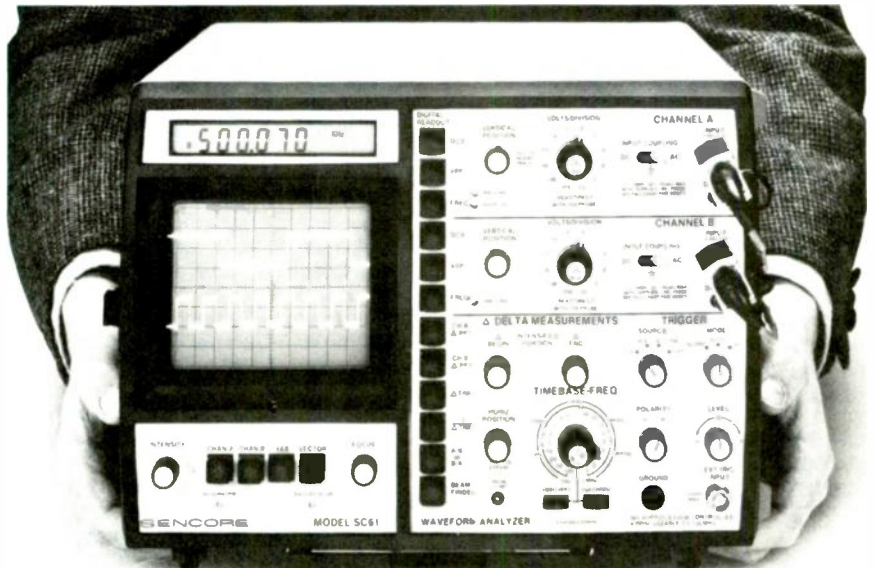

with the SC61 Waveform Analyzer
Patented \$2,995

If you value your precious time, you will really want to check out what the exclusively patented SC61 Waveform Analyzer can do for you. 10 times faster, 10 times more accurate, with zero chance of error.

End frustrating fiddling with confusing controls. Exclusive ultra solid ECL balanced noise cancelling sync amplifiers, simplified controls, and bright blue dual trace CRT help you measure signals to 100 MHz easier than ever.

Accurately and confidently measure waveforms from a tiny 5 mV all the way to a whopping 3,000 V without hesitation with patented 3,000 VPP input protection — eliminates expensive "front end" repairs and costly equipment downtime.

Make only one circuit connection and push one button for each circuit parameter test: You can instantly read out DC volts, peak-to-peak volts and frequency 100% automatically with digital speed and accuracy. It's a real troubleshooting confidence builder.

Confidently analyze complex waveforms fast and easily. Exclusive Delta measurements let you intensify any waveform portion. Analyze glitches, interference signals, rise or fall times or voltage equivalents between levels; direct in frequency or microseconds.

Speed your digital logic circuit testing. Analyzing troublesome divide and multiply stages is quicker and error free — no time-consuming graticule counting or calculations. Simply connect one test lead to any test point, push a button, for test of your choice, for ERROR FREE results.

To see what the SC61 can do for your troubleshooting personal productivity and analyzing confidence, CALL TODAY, WATS FREE, 1-800-843-3338, for a FREE 15 day Self Demo.



Call Today Wats Free 1-800-843-3338

SENCORE

3200 Sencore Drive
Sioux Falls, SD 57107
605-339-0100 In SD Only

*innovatively designed
with your time in mind.*

CIRCLE 198 ON FREE INFORMATION CARD

Radio-Electronics mini-ADS

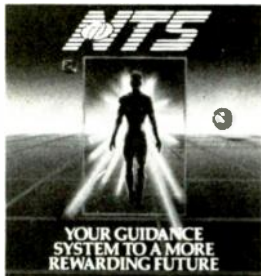

A CAREER START FOR THE 21ST CENTURY. Since 1905, National Technical Schools has helped people build successful careers. Enter the 21st Century through home study courses in Robotics, Computer Technology and Servicing, Microprocessors, Video Technology, Basic Electronics, Transportation Technology, Climate Control Technology or TV and Radio Servicing. For a FREE catalog, call 1-800-B-BETTER. Or write **NTS/INDEPENDENT TRAINING GROUP**, 456 West M. L. King Jr. Blvd. L.A., CA 90037.

CIRCLE 186 ON FREE INFORMATION CARD



THERMOPROBE—QUICKLY IDENTIFIES DEAD PC BOARD COMPONENTS. Locates dead resistors, transistors, IC's, diodes, and transformers without direct contact, in seconds. Operating active components radiate heat, dead components don't. **Thermoprobe** is sensitive to 1/25°F change in temperature. A must for your workbench or field service. Order #209TM. ONLY \$21.95 + \$3.00 shipping, NY Res. add tax (no COD's). **BUYUS, INC.**, Dept. RE587 10 White Birch Dr., Ossining, NY 10562, Visa or Mastercard (914) 762-4799.

CIRCLE 53 ON FREE INFORMATION CARD

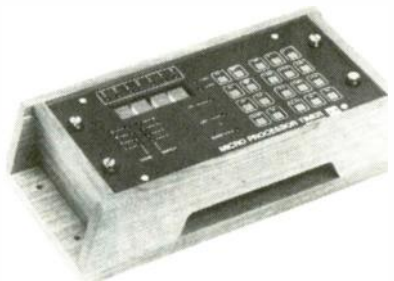

MICROPROCESSOR - TIMER KIT (K1682R) for home and industry. Controls lighting, heating, solar, hot water, etc. Has 4 output relays, 20 program capacity. Front-plate, quality components, and cadesign - \$165. Other kits: power supply, 0-24V adjustable output (K2623R) \$74. FM transmitter (K1771) \$11.55. Three tone chime (K2569) \$17.50. Add \$3.00 for S&H. We have 95 more kits. Send \$3.00 for catalog: **HOBBY ELECTRONICS, P.O. Box 1339, Claremont, NH 03743.** (603) 543-0033.

CIRCLE 190 ON FREE INFORMATION CARD



THE MODEL WTT-20 IS ONLY THE SIZE OF A DIME, yet transmits both sides of a telephone conversation to any FM radio with crystal clarity. Telephone line powered - never needs a battery! Up to 1/4 mile range. Adjustable from 70-130 MHz. Complete kit \$29.95 + \$1.50 S + H. Free Shipping on 2 or more! COD add \$4. Call or send VISA, MC, MO. **DECO INDUSTRIES, Box 607, Bedford Hills, NY 10507.** (914) 232-3878.

CIRCLE 127 ON FREE INFORMATION CARD

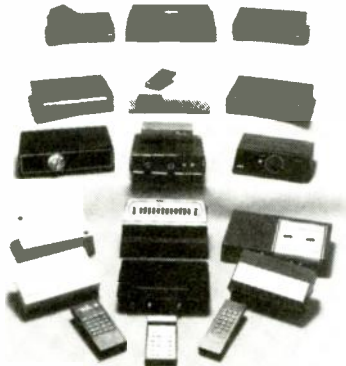

CABLE TV CONVERTERS AND DE-SCRAMBLERS. Large selection of top quality merchandise. Low prices. Quantity discounts. We ship COD. Most orders are shipped within 24 hrs. Send \$2.00 for catalog. **CABLETRONICS UNLIMITED, P.O. Box 266 Dept. R, S. Weymouth, MA 02190 (617) 843-5191**

CIRCLE 189 ON FREE INFORMATION CARD

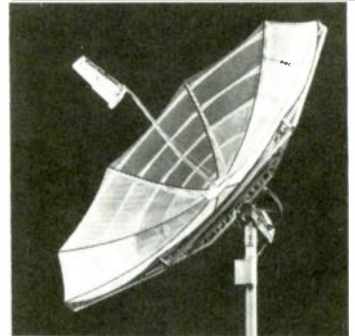

IF YOU'RE TIRED OF MONTHLY CABLE BILLS \$25.00-\$100.00 a month or just want more and better television then it's time for a Satellite Antenna System from Advance Video. Prices start at \$795. + S/H with 2 yrs. warranty. 200 channels available. Call 1 800-223-1127 toll free. The best product, the best prices. Visa/MasterCard accepted. **ADVANCE VIDEO, 10636 Main St. #111, Bellevue, WA 98004.**

CIRCLE 203 ON FREE INFORMATION CARD

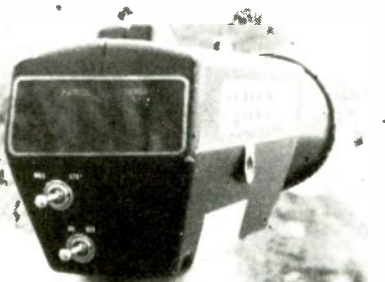

RADAR SPEED GUNS. Professional (used by police). From \$275. Used for clocking speeds in baseball, car/boat racing, bowling, skiing, etc. **ZENITH SSAVI \$169 +**. Reconditioned, original UHF equipment. Satellite components. Surplus TV equipment: N-12, SB-3, Hamlin 1200, Ztac, etc. Converters, amplifiers, TV accessories. Catalog & coupon \$1. SSAVI modification/troubleshooting handbook \$6.50 ppd. **AIS SATELLITE, INC., P.O. Box 1226-M, Dublin, PA 18917.** 215-249-9411.

CIRCLE 81 ON FREE INFORMATION CARD

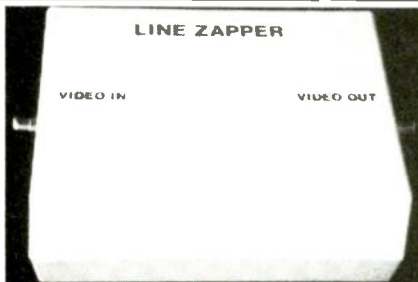

DECODE THE NEW VIDEO TAPE COPY PROTECTION SCHEME. Bothered by brightness changes, vertical jumping and jittering while watching recent movie releases? Stop it with the **LINE ZAPPER**. New kit detects and removes selected lines of video that have been modified and often interfere with normal television operation. Order your KIT today only \$69.95 plus \$2.00 S & H. **ELEPHANT ELECTRONICS, Box 41865-L, Phoenix, AZ 85080.** Visa/MC orders (602) 581-1973. Allow 6 weeks for delivery.

CIRCLE 120 ON FREE INFORMATION CARD



"SODDER" WITH THE NEW BUTANE POWERED PORTASOL. No matter how you spell it Portasol is the handiest soldering iron around. Seven inches long. Variable power: 10 to 60 watts, 60 minutes use per refill. Only \$31.95 + \$2.00 P&H. Replacement tips: 1.2, 2.4 (standard), 3.2, 4.8mm, \$8.50 + .50. Butane: \$3.50 + .50. VA add 4% tax. Quantity discounts/dealers invited. Visa/MC orders: (703) 323-8000. Mail Ck/Money-order to: **PORTASOL, 4358 Harvester Farm Lane, Fairfax, VA 22032.**

CIRCLE 208 ON FREE INFORMATION CARD

Radio-Electronics mini-ADS

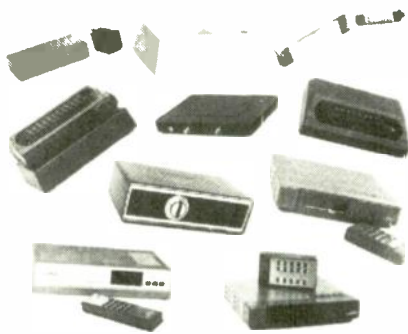

CABLE TELEVISION CONVERTER, descrambler and wireless remote control video equipment accessories. Catalog free. **CABLE DISTRIBUTORS**, 116 Main Road, Washington, AR 71862.

CIRCLE 209 ON FREE INFORMATION CARD

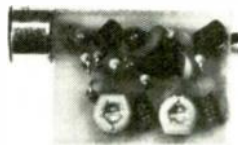

SIMPLY SNAP THE WAT-50 MINIATURE FM TRANSMITTER on top of a 9v battery and hear every sound in an entire house up to 1 mile away! Adjustable from 70-130 MHz. Use with any FM radio. Complete kit \$29.95 + \$1.50 S + H. Free shipping on 2 or more! COD add \$4. Call or send VISA, MC, MO. **DECO INDUSTRIES**, Box 607, Bedford Hills, NY 10507. (914) 232-3878.

CIRCLE 129 ON FREE INFORMATION CARD



FREE TOOL & INSTRUMENT CATALOG packed with over 5,000 quality products for testing, repairing and assembling electronic equipment. A full selection of test instruments plus precision hand tools, tool cases, soldering equipment and much more. Products are shown in full color with detailed descriptions, pricing and a 100% satisfaction guarantee. **CONTACT EAST**, PO Box 786, No. Andover, MA 01845. Call (800) 225-5370 or in MA (617) 682-2000.

CIRCLE 55 ON FREE INFORMATION CARD



SCIENTIFIC ATLANTA super Spring sale. Now available Scientific Atlanta 8500 and 8550 cable converters. Perfect reception on all channels. Sale price 8500 or 8550 \$225.00 Hand remotes \$20.00. Call now to insure your order. Sale ends May 31, 1987. Also, brand new, "Key Circuits" for this equipment. Dealers welcome. C.O.D. accepted. **V.I.P. ELECTRONICS**, P.O. Box 628, Forstdale, R.I. 02824, (617) 755-9778.

CIRCLE 207 ON FREE INFORMATION CARD



TUNABLE NOTCH FILTER—for elimination of any TV, FM, or VHF signal. Can be tuned precisely to ANY signal within these ranges: *MODEL 26-Ch's. 2-6 plus FM [54-108 Mhz] *MODEL 1422-Ch's. 14(A)-22(I) [120-174 Mhz] *MODEL 713-Ch's. 7-13 [174-216 Mhz] Highly selective 60dB notch. Send \$30 each. Quantity prices as low as \$14. **STAR CIRCUITS**, P.O. Box 8332, Pembroke Pines, FL. 33084

CIRCLE 94 ON FREE INFORMATION CARD



NEW: PANASONIC VIDEO SWITCHER. Record a cable channel while viewing any one of your 4 video options, another cable channel, 2nd VCR, TV games, video camera, etc. No need to use your cable converter for channel selection VCS-1 gives your cable ready TV or VCR full control of your viewing. Comptable with all scrambled and one way addressable systems. \$85.00 Guaranteed. Free Catalog. (402) 331-4957 **M.D. ELECTRONICS**, 5078 So. 108th #115, Omaha, NE 68106. We accept MC. Visa. C.O.D.

CIRCLE 205 ON FREE INFORMATION CARD

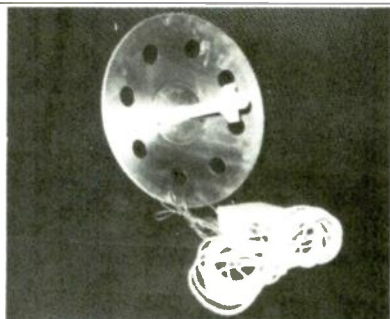

MICROWAVE ANTENNAS \$69.95. Now including shipping and Lifetime warranty. We Repair all types of Downconverters. Cable Converters and equipment available! **Panasonic 450 MHz** wireless converter \$79.95 plus shipping. Coax cable, T.V. parts, accessories, connectors, T.V. amplifiers. Write for free information or call for prices. **BLUE STAR IND.**, Dept. 105-RE 5-87, 4712 Ave. N, Brooklyn, N.Y. 11234 (718) 258-9495 Ext. RE

CIRCLE 85 ON FREE INFORMATION CARD



APPLIANCE REPAIR HANDBOOKS—13 volumes by service experts: easy-to-understand diagrams, illustrations. For major appliances (air conditioners, refrigerators, washers, dryers, microwaves, etc.). elec. housewares. personal-care appliances. Basics of solid state, setting up shop, test instruments. \$2.65 to \$5.90 each. Free brochure. **APPLIANCE SERVICE**, PO Box 789, Lombard, IL 60148. 1-(312) 932-9550.

CIRCLE 84 ON FREE INFORMATION CARD



SEE IN TOTAL DARKNESS - BUILD THIS AMAZING IR VIEWER. Applications include; night surveillance, IR photography, laser tracking, fibre optic observations, hi-temp thermal viewing, IR alarms, IR communications & controls, IR astronomy & microscopy, document examination, painting & stamp authentication etc. Kit \$189 delivered. (Dealers wanted) Catalog \$1. 514-739-9328. **OCTE ELECTRONICS**, Box 840, Champlain, N.Y. 12919

CIRCLE 130 ON FREE INFORMATION CARD

NEW PRODUCTS

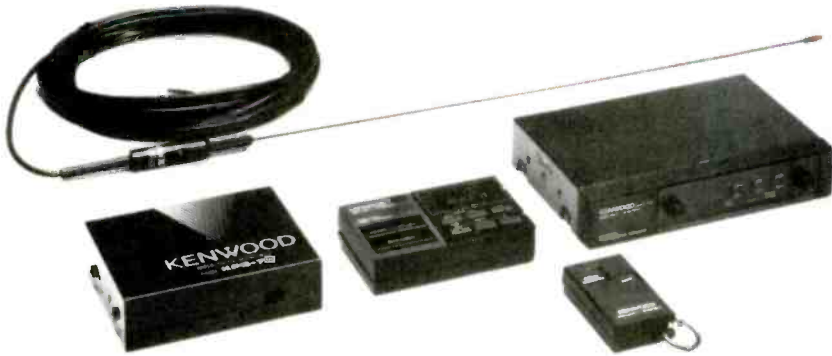

CIRCLE 30 ON FREE INFORMATION CARD

CAR-SECURITY SYSTEMS, the Kenwood model *KPC-70* (shown) and the model *KPC-50* are comprehensive alarm systems.

The model *KPC-70* consists of a central processing module, a control/test module, a small remote-

control unit, shock and motion sensors, and a 100-dB siren. With that system, all doors, windows, the hood, and the trunk are automatically secured. With the exception of the control/test module, the model *KPC-50* includes the

same features as the model *KPC-70* plus more.

In addition, the systems' motion and shock sensors are able to detect unauthorized use or break-ins due to impact. Should a break-in occur, the siren sounds, the parking lights flash, and the starter circuit is disabled. The duration of the alarm is automatically set for 30 seconds; however, a duration of 2 minutes, 60 seconds, or 15 seconds can be programmed by the user. Once the alarm-cycle is complete, the system re-arms.

The model *KPC-70* has a suggested retail price of \$549.00; the model *KPC-50* has a suggested retail price of \$349.00.—**Kenwood U.S.A., Inc.**, P.O. Box 6213, Carson, CA 90744

Send Purchase Order
Check, Money Order, or C.O.D.
or Call Toll Free
800-223-0826
in N.Y. State (212) 865-5580

#1 IN CABLE BOXES SPECIAL!

JERROLD CORDLESS CABLE TV CONVERTERS

MODEL STARCOM-460

\$99⁹⁵

ANY QUANTITY

- Volume control
- 68 channels
- Mute control
- Automatic fine tuning
- Instant channel recall
- Programmable to go on at a particular channel and off automatically
- Compatible with descramblers



*ADD \$5.00 FOR VISA OR MASTER CARD

JERROLD CORDLESS CABLE TV CONVERTER

MODEL DRX3-105/400

\$69⁹⁵

- 58 channels
- Remote channel changing
- Remote on/off switch
- Remote fine tuning



JERROLD CORDLESS CABLE TV CONVERTER

MODEL DRZ/450

- 6E channels
- Automatic fine tuning
- A/B switch option

\$69.95/ 10 lot
\$79.95 ea.



JERROLD CORDED CABLE TV CONVERTER

MODEL JRX3-105

\$49.95

- 36 channels
- push button



"THE RABBIT" VIDEO MULTIPLYING SYSTEM

TR-7000

\$51⁹⁵

12 up

\$59.95/6-11

\$69.96/1-5



IT'S LIKE HAVING A VCR IN EVERY ROOM

■ MASTER CARD ■ VISA

OMNITRON ELECTRONICS

770 Amsterdam Ave., New York, NY 10025

SHIPPING CHARGES

For Orders	Add
\$25-100	\$6.50
\$100-500	\$8.50
\$500-750	\$10.50
\$750 and up	\$20.00

Write for
FREE CATALOG
136 L-2120

CIRCLE 110 ON FREE INFORMATION CARD

MAKE MONEY



IN ELECTRONICS

You say you're *already* trained in electronics but that you're *not* making enough money?? Well then, maybe you don't have an accredited bachelor's degree to prove that your education is *up to snuff!* Check out the Grantham Independent-Study B. S. Degree Program. It could make a *dollars and sense* difference in your electronics career.

Grantham offers this program, complete but without laboratory, to electronics technicians whose objectives are to upgrade their level of technical employment. Since the field of electronics is so enormous, opportunity for advancement is always present. Promotions and natural turnover make desirable positions available to the man who is ready to *move up*.

Grantham College of Engineering
10570 Humbolt Street
Los Alamitos, California, 90720

**This booklet
FREE!**

This free booklet explains the Grantham B.S. Degree Program, offered by independent study to those who work in electronics.

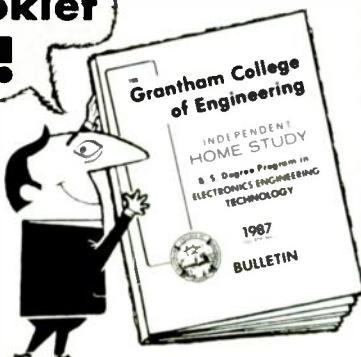

for **FREE Booklet CLIP COUPON** and mail in envelope or paste on postal card.

Do You REALLY Want to Make More Money?

Yes it does take *work* and a few sacrifices to climb up the electronics ladder to where the bigger money is. But, if that's where you want to be, then that's what you must do — *work* harder at learning and getting the right credentials, even if it takes a few sacrifices. A *B. S. degree* and the knowledge that rightly goes along with it can give you powerful ladder-climbing equipment in your search for *success in electronics*.

The accredited Grantham non-traditional B.S. Degree Program is intended for mature, fully-employed workers who want to upgrade their electronics careers.

Put Professional Knowledge and a COLLEGE DEGREE in your Electronics Career through Independent Home Study

Study materials, carefully written by the Grantham College staff for independent study at home, are supplied by the College. Your technical questions related to these materials and the lesson tests are promptly answered by the Grantham home-study teaching staff.

Recognition and Quality Assurance

Grantham College of Engineering is accredited by the Accrediting Commission of the National Home Study Council, as a degree-granting institution.

All lessons and other study materials, as well as communications between the college and students, are in the English language. However, we have students in many foreign countries; about 80% of our students live in the United States of America.

Grantham College of Engineering R-5-87
10570 Humbolt Street, Los Alamitos, CA 90720

Please mail me your free catalog which explains your B.S. Degree independent-study program.

Name _____ Age _____

Address _____

City _____ State _____ Zip _____

Our guaranteed savings plan.

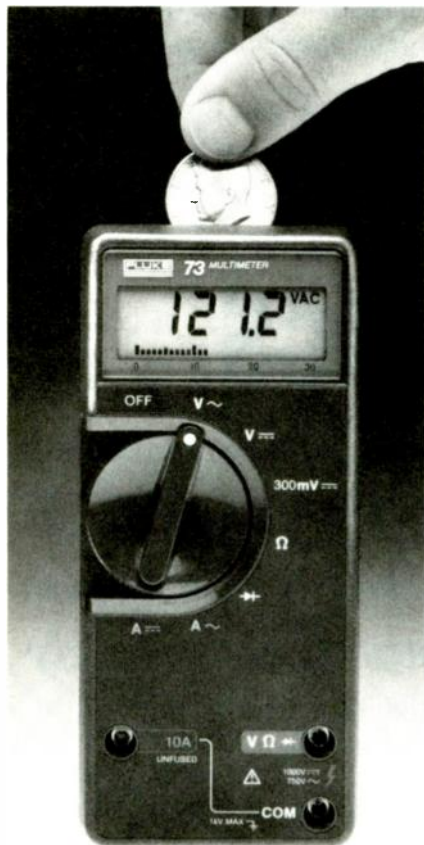

Fluke 70 Series Analog/Digital multimeters are like money in the bank. Buy one, and you're guaranteed to save both time and money.

Money, because you get longer battery life and longer warranty coverage — 3 years vs. 1 year or less on others.

And time, because 70 Series meters are easier to operate and have more automatic measurement features.

So before buying any meter, look beyond the sticker price. And take a closer look at the new low-priced \$79 Fluke 73, the \$109 Fluke 75, and the deluxe \$145 Fluke 77. In the long run, they'll cost less, and give higher performance, too.

And that, you can bank on.

For a free brochure, and your nearest distributor, call toll-free **1-800-227-3800, ext. 229.**

FROM THE WORLD LEADER IN DIGITAL MULTIMETERS.



© 1985 Fluke
CIRCLE 121 ON FREE INFORMATION CARD

TVRO ELECTRONICS SYSTEM, the Pico Products *Little MAC*, is a no-frills system consisting of the *HR-100* C/Ku-band satellite receiver and the *MAC-100K* manual actuator/controller.



CIRCLE 31 ON FREE INFORMATION CARD

The model *HR-100* has a 950–1450-MHz block input, a video-invert switch for complete Ku-band function, an AFC tracking range of ± 11 MHz, tunable audio (single channel), detent channel selection, defeatable AFC, a 70-MHz IF loop, an < 8 -dB C/N threshold, fine-tuning range of ± 4 MHz from 70 MHz, an IF bandwidth of 26 MHz (-2 dB), and a low differential gain and phase for good video and audio response. (The receiver can also operate as a slave unit to Pico's full-featured model *HR1000* stereo remote-control receiver, an added convenience.)

The *MAC-100K* manual actuator/controller features a three-digit LED display to indicate relative satellite position. Up and Down control-buttons allow users to easily position the antenna to view all the satellites in the Clarke Belt, including the hybrid C/Ku-band satellites. The model *MAC-100* also has built-in overload safeguards that prevent antenna wraparound. There is a 36-volt DC power supply available for easy and effective installation with most actuator motors using either reed- or Hall-effect position sensors.

The complete *Little MAC* TVRO electronics system is priced at \$700.00.—Pico Products, Inc., 103 Commerce Blvd., Liverpool, NY 13088.

HAND-HELD CB, the Midland model *75-7900*, is electronically tuned, has 40 channels, and is equipped with a dual-conversion super-heterodyne receiver and a transmitter with selectable RF-output levels of one or five watts as required.

The model *75-790* also has an ad-



CIRCLE 32 ON FREE INFORMATION CARD

justable squelch control, an automatic noise-limiter, separate LED's for transmit and receive, and a condenser microphone. An analog meter measures received-signal strength, transmit power, and battery condition. Instant Channel 9 selection is also provided.

The model *75-790* operates on 12- or 15-volts DC. A charger jack for nicad batteries and a vinyl carrying case are included. The suggested retail price is \$149.95.—Midland International, 1690 North Topping, Kansas City, MO.

CORDLESS HEADPHONE SYSTEM, the Nady Systems cordless headphone system consists of a model *IRH-210* integral personal infrared



CIRCLE 33 ON FREE INFORMATION CARD

stereo headphone/receiver, and a model *IRT-520* infrared transmitter. The transmitter plugs in to any stereo-radio or tape-deck headphone jack. An infrared signal representing the audio is then transmitted to a sensor on top of the personal receiver. The range is about 35 feet, and any number of

infrared receivers can be used in the room. The suggested list price for the system is \$99.95. (The model *IRH-210*, receiver is available separately at \$59.95.)—Nady Systems, 1145 65th Street, Oakland, CA 94608.

CD CHANGER, the *DiscJockey*, model *CDP-C5F*, offers an alternative to magazine changer systems with a built-in 5-disc carousel that reduces disc-to-disc access time and simplifies overall operation.

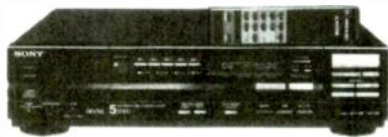

CIRCLE 34 ON FREE INFORMATION CARD

One to five discs can be loaded in the front-loading carousel drawer of the unit for up to six hours of continuous music playback. Once loaded, a disc-skip function allows disc-to-disc changes in approximately 2-3 seconds.

The model *CDP-C5F* has a sug-

gested retail price of \$450.00.—**Sony Corporation of America**, 9 West 57th St., New York, NY 10019.

OMNIDIRECTIONAL ANTENNA, the model *7403-II*, for FM use, incorporates a weighted base, which provides stability and tip resistance. The gain control is located on the front and is easily accessible. The pilot light is in keeping with the shape of the overall antenna.

The model *7403-II* uses a separate outboard 12-volt DC power supply that is UL listed. That supply provides filtered DC for the antenna's amplifier. The power supply, which contains a transformer, may be located some distance from the antenna, and an outlet may be selected that will position the power supply away from any TV set, or other device that would be adversely affected by proximity to the transformer.

Due to its well-filtered power supply, the antenna adds little 60-Hz hum to received signals. There are relatively uniform gain characteristics over the 88- to 108-MHz

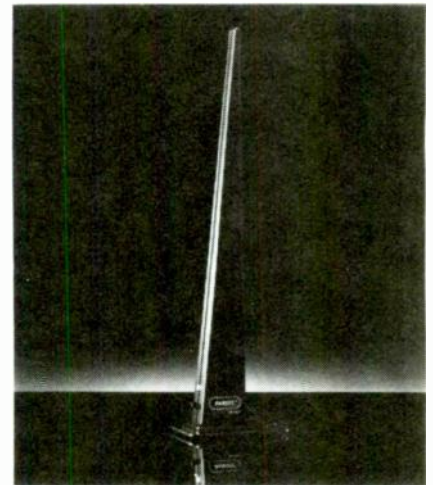

CIRCLE 35 ON FREE INFORMATION CARD

band, with no sharp peaks or valleys in the response curve.

The omnidirectional characteristics of the model *7403-II* refer to both lateral and vertical signal orientation. The antenna provides uniform sensitivity within ± 6 dB.

The model *7403-II* has a suggested list price of \$75.00.—Parsec Electronics, Inc., 130 W. 42nd Street, New York, NY 10036.

CONNECTION PROTECTION

SWITCHES & RELAYS
EDGE CONNECTORS
PLUGS & SOCKETS
POTENTIOMETERS
CONNECTING CABLES
TERMINAL STRIPS
GOLD PLATED CONNECTORS
BATTERY CONTACTS



CRAMOLIN®

Even the finest equipment in the world cannot guarantee noise-free operation. One "dirty" connection anywhere in the electrical path can cause unwanted noise or signal loss.

"MORE THAN A CONTACT CLEANER"

CRAMOLIN® is a fast-acting, anti-oxidizing lubricant that cleans and preserves all metal surfaces, including gold.

When applied to metal contacts and connectors, **CRAMOLIN®** removes resistive oxides as it forms a protective molecular layer that adheres to the metal surfaces and maintains maximum electrical conductivity.

CRAMOLIN® - USED BY THOSE WHO DEMAND THE BEST:

Bell & Howell	Hewlett Packard	MCI(Sony)	Nakamichi
Boeing	John Fluke Mfg.	Motorola	RCA
Capitol Records	McIntosh Labs	NASA	Switchcraft

SINCE 1958

CAIG LABORATORIES INC.

1175-O Industrial Ave., (P.O. Box J) - Escondido, CA 92025-0051 U.S.A. • (619) 743-7143

CIRCLE 184 ON FREE INFORMATION CARD

Video Cable Assembly Kit:

OPT 2r 10 pcs 2 ft F to RCA Connector
[for tv or video dubbing]

OPT 3 10 pcs 3 ft. 59U "F to F"
[ideal length for VCR to TV monitor]

OPT 6 10 pcs 6 ft. 59U "F to F"
[ideal length for VCR to TV monitor]

OPT 10 10 pcs 10 ft. 59U "F to F"

OPT 20 5 pcs 20 ft. 59U "F to F"

OPT 50 5 pcs 50 ft. 59U "F to F"

ALL ASSEMBLIES DISPLAY PACKAGED!!

50 pieces total! Packaged Kit!

MANY OTHER LINES AVAILABLE—62AU, 58U, 8U
[telephone accessories, speaker wire, etc.]

CUSTOM LENGTHS BASED ON QUANTITY!!!

CALL FOR LITERATURE & PRICING!!

OPTIMA ELECTRONICS
2022 TIGERTAIL BLVD.
DANIA, FLORIDA 33004

Toll Free: 1-800-327-0224

In Florida: 305-920-355C

CIRCLE 210 ON FREE INFORMATION CARD

Train for the Fastest Growing Job Skill in America

Only NRI teaches you to service all computers as you build your own fully IBM compatible microcomputer

With computers firmly established in offices—and more and more new applications being developed for every facet of business—the demand for trained computer service technicians surges forward. The Department of Labor estimates that computer service jobs will actually *double* in the next ten years—a faster growth rate than for any other occupation.

Total systems training

No computer stands alone... it's part of a total system. And if you want to learn to service and repair computers, you have to understand computer

systems. Only NRI includes a powerful computer system as part of your training, centered around the new, fully IBM PC compatible Sanyo 880 Series computer.

As part of your training, you'll build this highly-rated, 16-bit IBM compatible computer system. You'll assemble Sanyo's "intelligent" keyboard, install the power supply and disk drive, and interface the high-resolution monitor. The 880 Computer has two operating speeds: standard IBM speed of 4.77 MHz and a remarkable turbo speed of 8 MHz. It's confidence-building,

real-world experience that includes training in programming, circuit design and peripheral maintenance.

***No experience necessary—
NRI builds it in***

Even if you've never had any previous training in electronics, you can succeed with NRI training. You'll start with the basics, then rapidly build on them to master such concepts as digital logic, microprocessor design, and computer memory. You'll build and test advanced electronic circuits using the exclusive NRI Discovery Lab®, professional digital multimeter,

Learn Computer Servicing Skills with NRI's "Hands-On" Training . . .



Using NRI's unique Action Audio Cassette, you are talked through the operation and practical application of your hand-held digital multimeter—the basic, indispensable tool for the computer specialist.



You'll set up and perform electronics experiments and demonstrations using your NRI Discovery Lab. You'll even interface the lab with your computer to "see" keyboard-generated data.



After you build this digital logic probe, you'll explore the operation of the Sanyo detached "intelligent" keyboard and its dedicated microprocessor.

NEW!

Train with the newest Sanyo 880 Series Computer—it's fully IBM-compatible and runs almost twice as fast as the IBM PC!

Your NRI total systems training includes all of this: NRI Discovery Lab[®] to design and modify circuits • Four-function digital multimeter with walk-you-through instruction on audio tape • Digital logic probe for visual examination of computer circuits • Sanyo 880 Series Computer with "intelligent" keyboard and 360K double-density, double-sided disk drive • High resolution monochrome monitor • 8K ROM, 256K RAM • Bundled software including GW BASIC, MS DOS, WordStar, CalcStar • Reference manuals, schematics, and bite-sized lessons.

and logic probe. Like your computer, they're all yours to keep as part of your training. You even get some of the most popular software, including WordStar, CalcStar, GW Basic and MS DOS.

Send for 100-page free catalog

Send the post-paid reply card today for NRI's 100-page,

full-color catalog, with all the facts about at-home computer training. Read detailed descriptions of each lesson, each experiment you perform. See each piece of hands-on equipment you'll work with and keep. And check out NRI training in other high-tech fields such as Robotics, Data Communications, TV/Audio/Video Servicing, and more.

If the card has been used, write to NRI Schools, 3939 Wisconsin Ave., N.W., Washington, D.C. 20016.

NRI SCHOOLS

McGraw-Hill Continuing Education Center
3939 Wisconsin Avenue, NW
Washington, DC 20016



We'll Give You Tomorrow.

IBM is a Registered Trademark of International Business Machine Corporation.

as You Build Your Own Sanyo 880 Computer System.

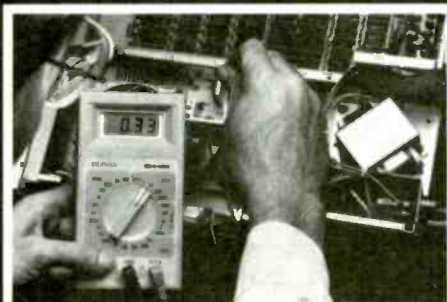

The power supply is assembled in the main unit of the computer. You check out keyboard connections and circuits with the digital multimeter included for training and field use.

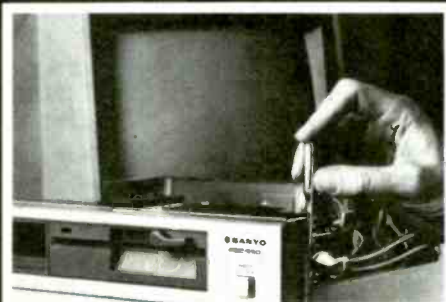

Next, you install the disk drive. You learn disk drive operation and adjustment, make a copy of MS-DOS operating disk and begin your exploration of the 8088 CPU.



Using the monitor, you focus on machine language programming, an indispensable troubleshooting tool for the technician. You continue by learning BASIC language programming.

Regency "Scanner Answer" Giveaway

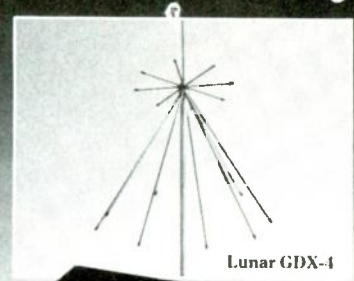

Here's your chance to win a complete monitoring package from Regency Electronics and Lunar Antennas. 18 scanners in all will be awarded, including a grand prize of the set-up you see above: the Regency HX1500 handheld, the Z60 base station scanner, the R806 mobile unit, and a Lunar GDX-4 Broadband monitoring/reference antenna.

55 Channels to go!

When you're on the go, and you need to stay tuned into the action, take along the Regency HX1500. It's got 55 channels, 4 independent scan banks, a top mounted auxiliary scan control, liquid crystal display, rugged die-cast aluminum chassis, covers ten public service bands including aircraft, and, it's keyboard programmable.

Compact Mobile

With today's smaller cars and limited installation space in mind, Regency has developed a new compact mobile scanner, the R806. It's the world's first microprocessor controlled crystal scanner. In addition, the R806 features 8 channels, programmable priority, dual scan speed, and bright LED channel indicators.

Base Station Plus!

Besides covering all the standard public service bands, the Regency Z60 scanner receives FM broadcast, aircraft transmissions, and has a built-in digital quartz clock with an alarm. Other Z60 features include 60

channels, keyboard programming, priority control, digital display and permanent memory.

Lunar Antenna

Also included in the grand prize is a broadband monitoring/reference antenna from Lunar Electronics. The GDX-4 covers 25 to 1300 MHz, and includes a 6 foot tower.



ELECTRONICS INC.
7707 Records Street
Indianapolis, IN 46226

Grand Prize (1 awarded)

- 1—Regency Z60 Base station scanner
- 1—Regency HX1500 Handheld scanner
- 1—Regency R806 Mobile scanner
- 1—Lunar GDX-4 Antenna

First Prize (5 awarded)

- 1—Regency Z60 Base station scanner
- 1—Regency R806 Mobile scanner

Second Prize (5 awarded)

- 1—Regency HX1500 scanner

Contest rules: Just answer the questions on the coupon, (all answers are in the ad copy) fill in your name and address and send the coupon to Regency Electronics, Inc., 7707 Records Street, Indianapolis, IN 46226. Winners will be selected from all correct entries. One entry per person. No purchase necessary. Void where prohibited by law. Contest ends June 30, 1987.

1. The Regency Z60 is
 - a digital alarm clock an FM radio
 - a scanner all of the above
2. The Regency R806 is the world's first _____ controlled crystal scanner.
3. The Regency HX1500 features
 - 55 channels Bank scanning
 - Liquid crystal display all of the above
4. The Lunar GDX-4 antenna covers _____ to _____ MHz.

Name: _____

Address: _____

City: _____ State: _____ Zipcode: _____

I currently own _____ scanners.

Brands owned: _____



Send in a photo (like this one of Mike Nikolich and his Regency monitoring station) and receive a free gift from Regency. Be sure to include your name, address and phone number.

BUILD THIS

PHONLINK INTERACTIVE REMOTE CONTROL

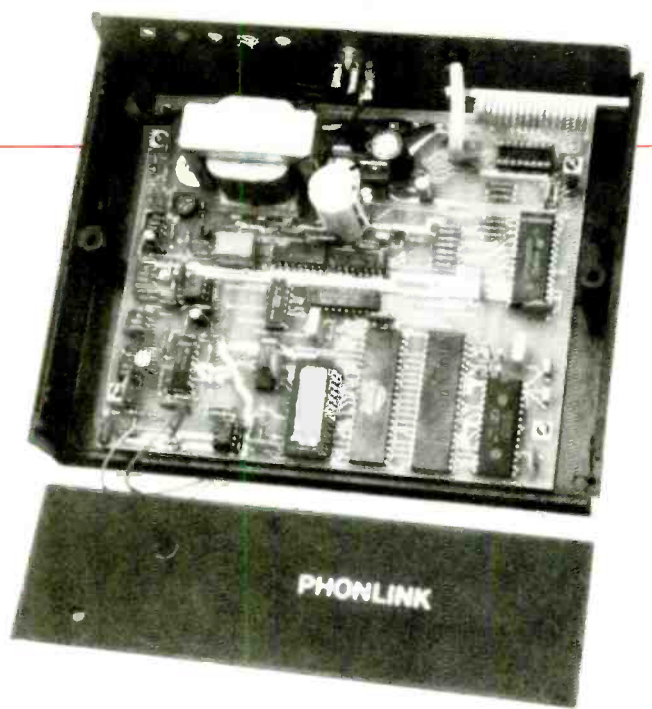

Rule the world by telephone!

GENE ROSETH

IF YOU'VE EVER WANTED TO CONTROL AN electronic device, or monitor an electrically measurable quantity from a remote location by telephone, you've probably found that devices to do so are expensive and hard to come by. However, we've got an inexpensive, easy-to-build, yet highly versatile device that both hobbyists and professionals will find useful. It allows you to control as many as eight devices, and it allows you to monitor as many as eight analog or digital quantities, including local temperature. A built-in speech synthesizer reports all values aurally.

A few simple examples will show how useful the controller can be. Suppose you're about to leave work and head home for the day. You pick up the telephone, dial your home, and wait for the controller to respond by saying *activated*. After you enter the access code, the unit gives verbal guidance as you: (1) disable the burglar alarm, (2) turn on the hot tub, (3) enable the garage-door opener, (4) check the house temperature (with the built-in thermometer), (5) turn on the air conditioning, and (6) obtain the state of charge of your solar-energy system. Finally, you activate the built-in microphone for a few seconds to listen for strange sounds.

More technical applications might require transmission of remotely generated analog or digital data using the internal A/D converter. Values are expressed via the built-in speech synthesizer.

How it works

The flowcharts shown in Fig. 1, Fig. 2, and Fig. 3 illustrate the overall function of

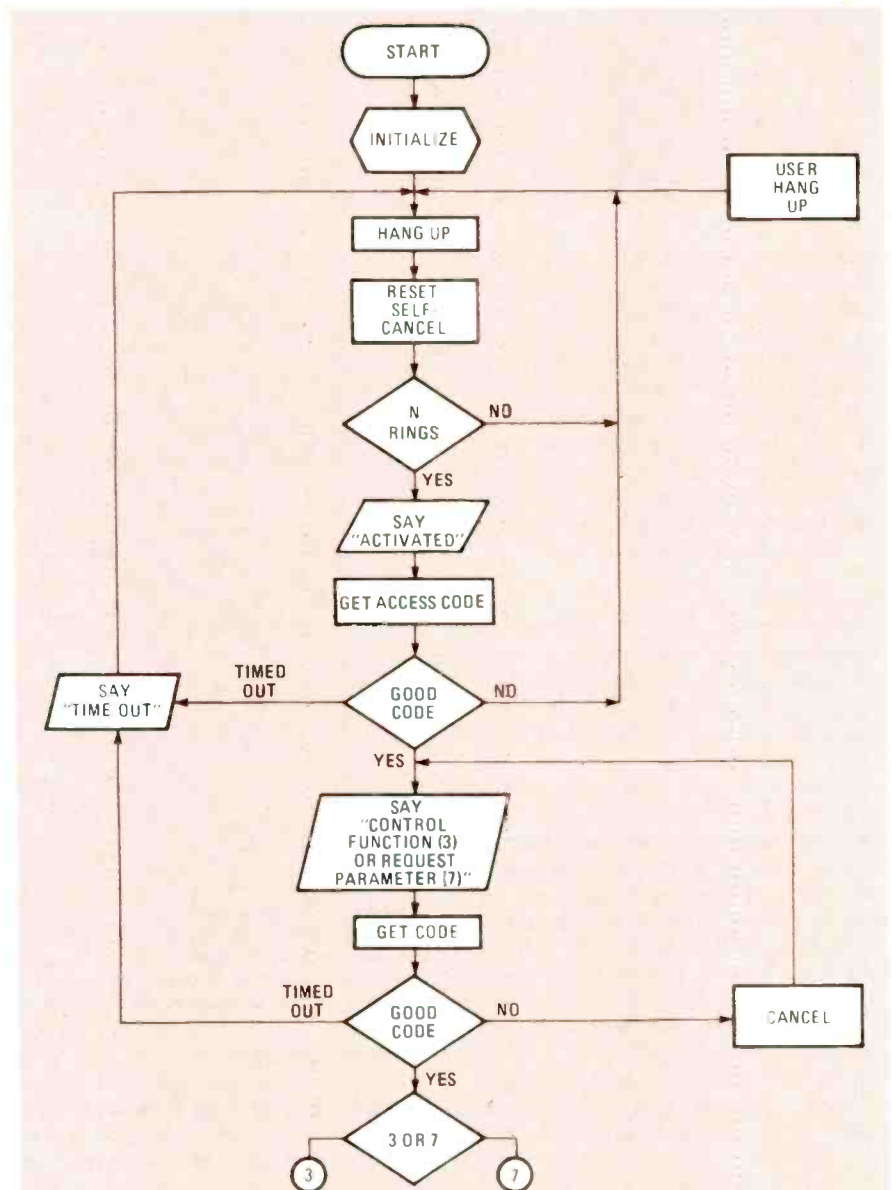

FIG. 1—FLOWCHART OF THE CONTROLLER'S MAIN LOOP: After initialization, the program gets a user-entered code and then transmits data to the user or turns the remote circuits on or off.

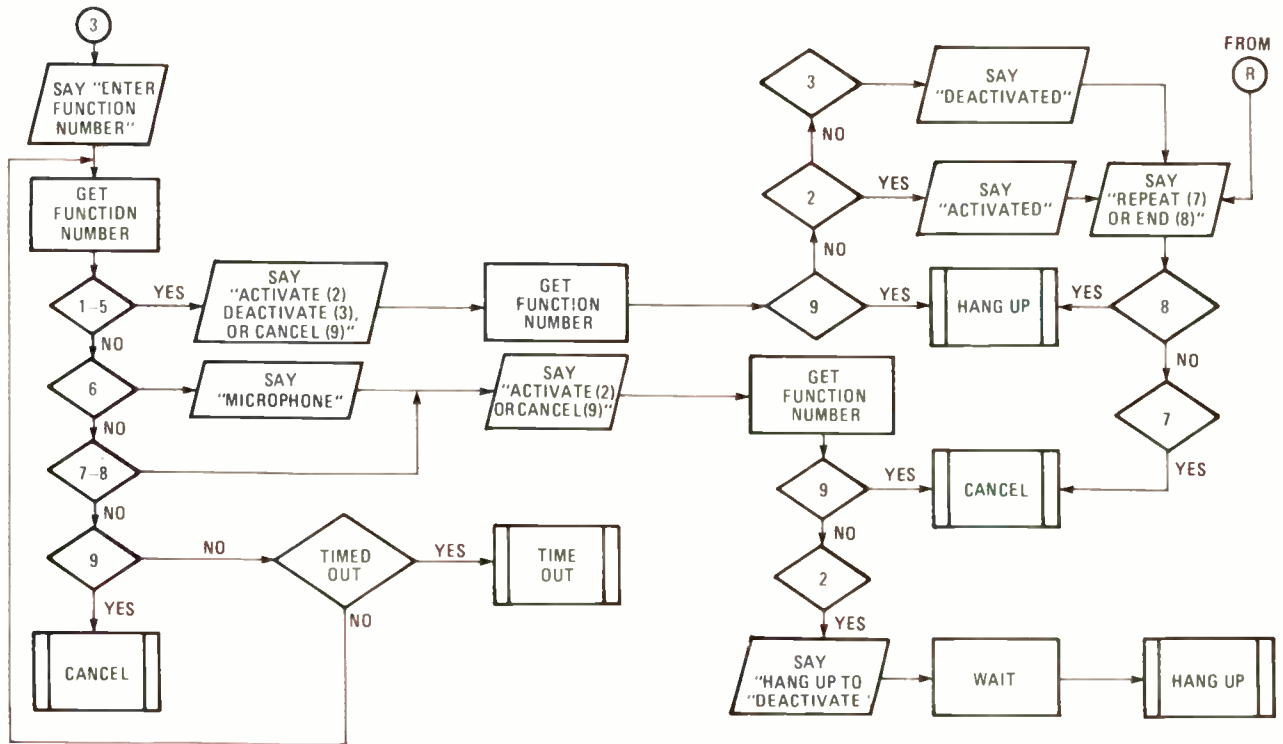

FIG. 2—THE OUTPUT-CONTROL LOOP: The program gets a function choice from the user and performs the desired action. Code 9 initiates the Cancel function.

the controller. In general, Fig. 1 shows the initialization, get-access-code, and get-function-code sequences. The valid function codes are 3 and 7; the functions initiated by pressing those numbers are illustrated in Fig. 2 and Fig. 3, respectively. Code-3 functions allow you to control the devices connected to your controller; Code-7 functions allow you to monitor electrical quantities. With that overall breakdown in mind, let's examine each flowchart in sequence.

Initialization

Referring back to Fig. 1, after the microprocessor performs its power-up initialization routine, it ensures that the phone is on-hook (hung-up). Then the routine enters a loop in which it looks for a succession of incoming rings. The number of rings is determined by a jumper on the PC board (either 3 or 10). After detecting the ring sequence, the unit connects itself to the phone line and indicates that it is working by speaking the word *activated*. It then awaits the proper access code, a three-digit code that the caller must provide in order to gain entry to the system. It should be noted at this point that the controller will work only with *Touch-Tone* phones.

If an improper access code is detected or if an excessive delay is encountered, the system hangs up and returns to the wait loop. But if the caller is granted access, the controller requests entry of a digit (3 or 7). If the user enters a 3, the controller enters the loop outlined in Fig. 2.

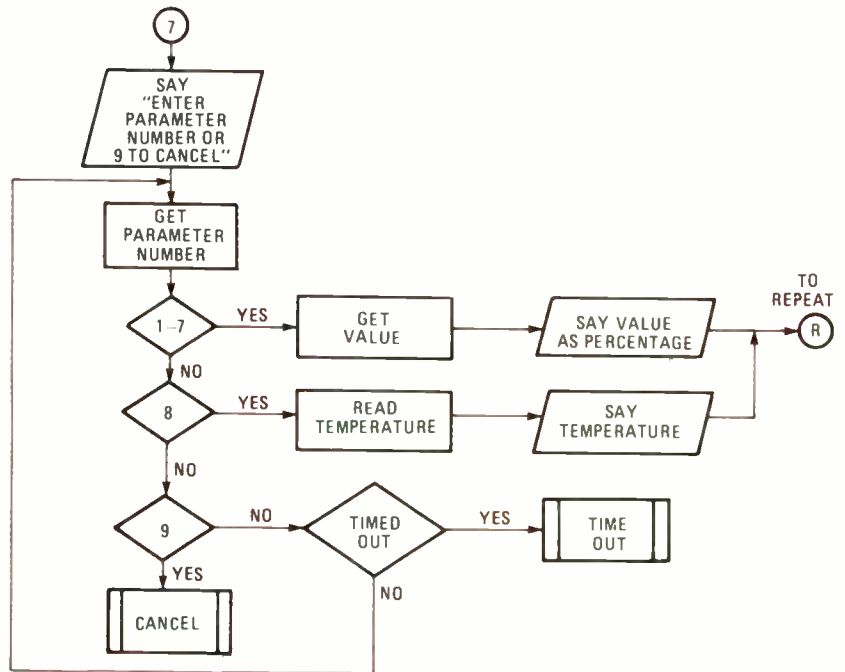

FIG. 3—THE INPUT-CONTROL LOOP: A choice of Code 1—Code 7 causes the program to report the corresponding analog value as a percentage of five volts. Local temperature will be reported when Code 8 is chosen. Code 9 cancels operation.

Controller outputs

Functions 1-5 correspond to digital outputs of the PIO (IC2). If the user presses the button corresponding to one of those functions, then he must choose, by pressing the appropriate button, to turn that function on or off. The controller will respond *activated* or *deactivated* as appro-

priate. Then the user will be able to repeat the sequence or hang up.

Function 6 corresponds to the built-in microphone, and functions 7 and 8 correspond to two "self-canceling" functions. Each of those functions is activated manually, and de-activated when you hang up or after a period of about five minutes.

PARTS LIST

All resistors are 1/4-watt, 5% unless otherwise noted.

R1—100,000 ohms
 R2—250 ohms, 1%
 R3—10,000 ohms, 1%
 R4, R17, R24, R27, R32, R34, R35—10,000 ohms
 R5—R9, R19, R36, R40, R42, R44, R46, R48, R50, R52, R55—33,000 ohms
 R10, R15, R38—47,000 ohms
 R11, R12, R14—1000 ohms
 R13, R20, R21—220,000 ohms
 R16, R28, R54—1 megohm
 R18, R25—22,000 ohms
 R22—330,000 ohms
 R23, R30, R31, R33—100,000 ohms
 R26—100 ohms
 R29—150 ohms, 1/2-watt, 5%
 R37—470 ohms
 R39, R41, R43, R45, R47, R49, R51—51,000 ohms
 R53—39,000 ohms
 R56—150 ohms

Capacitors

C1, C6, C13—C15, C17—C21—0.1 μ F, ceramic disc
 C2, C8, C10—1 μ F, 16 volts, electrolytic
 C3, C4—0.022 μ F, ceramic disc

C5, C11—10 μ F, 16 volts, electrolytic
 C7—2.2 μ F, 16 volts, electrolytic
 C9, C26—33 μ F, 16 volts, electrolytic
 C12—0.1 μ F, 200 volts, disc
 C16—4700 μ F, 16 volts, electrolytic
 C23—470 μ F, 16 volts, electrolytic
 C24, C25—22 pF, disc

Semiconductors

IC1—TMP284COOP, CMOS Z80 (Toshiba)
 IC2—8255A, PIO
 IC3—SP0256-AL2, speech synthesizer
 IC4—74C04, hex CMOS inverter
 IC5—74C02, quad CMOS NOR
 IC6—27C64, 8K CMOS EPROM
 IC7—74C32, quad CMOS OR gate
 IC8—ADC0809CCN, A/D converter
 IC9—LM234Z, precision current reference
 IC10—M-956, DTMF decoder (Teltone)
 IC11, IC22—unused
 IC12, IC15—TLC271, op-amp
 IC13—LM324, quad op-amp
 IC14—4066, quad analog switch
 IC16—IC19—4N32A, opto-isolator
 IC20—LM7805CK, five-volt regulator, TO3 case
 IC21—LM7805CT, five-volt regulator, TO220 case

BR1—200 volts, 1/2 amp
 BR2—50 volts, 1/2 amp
 D1, D3—D5—1N914, switching diode
 D6—D8—1N5245B, 15-volt, 1/2-watt Zener diode

Q1—2N2222, NPN small-signal transistor

Other components

F1—125 volts, 1/2 amp, pigtail leads
 MIC1—Electret microphone (Radio Shack 270-092B or equivalent)
 RY1—Relay, five volts, 70 mA, (Radio Shack 275-243 or equivalent)
 S01—16-pin DIP socket
 S02—34-pin edge-card connector
 T1—12.6 volts, 0.6 amp (Tria F-158XP)
 XTAL1, XTAL2—3.58 MHz

Note: The following items are available from STG Associates, 2705-B Juan Tabo Blvd. N. E., #117, Albuquerque, NM 87112: Complete kit of parts, including cabinet, PC board, and programmed EPROM (KPL-1), \$195; etched, drilled, and silk-screened PC board (KPL-2), \$36; programmed EPROM (KPL-3), \$19; printout of source code (KPL-4), \$8. Add 5% for postage and handling. New Mexico residents add appropriate sales tax.

WARNING

PLEASE NOTE THAT, ALTHOUGH THE CONTROLLER presented here has been designed to meet the interface requirements of the telephone system, it is not FCC type-approved. Connection of such a device to your operating company's line is subject to the regulations of that company. It is your responsibility to ascertain the pertinent regulations for your area.

as desired; the eighth is connected to the built-in temperature-reference. IC9 (an LM334). The speech synthesizer (IC3, an SP0256), the DTMF (*Dual-Tone Multi-Frequency*) decoder (IC10, an M-956), and the built-in microphone all interface to the telephone line via an analog switch (IC14, a 4066), several op-amps and opto-isolators.

Software

As anyone who has ever designed a microprocessor-based device is all too aware, the majority of work is embodied in the software. The controller's software is written in Z80 assembly language, and, due to space limitations, is not discussed here in detail (there are about 1800 lines of source code). However, both object code (contained in EPROM) and source code are available from the source noted in the Parts List.

That's all the space we have now. Next time, we'll present more complete circuit details. We'll also show you how to build the controller and offer some interfacing tips. Until then, why not use the time to gather parts or to order the kit offered by the supplier?

R-E

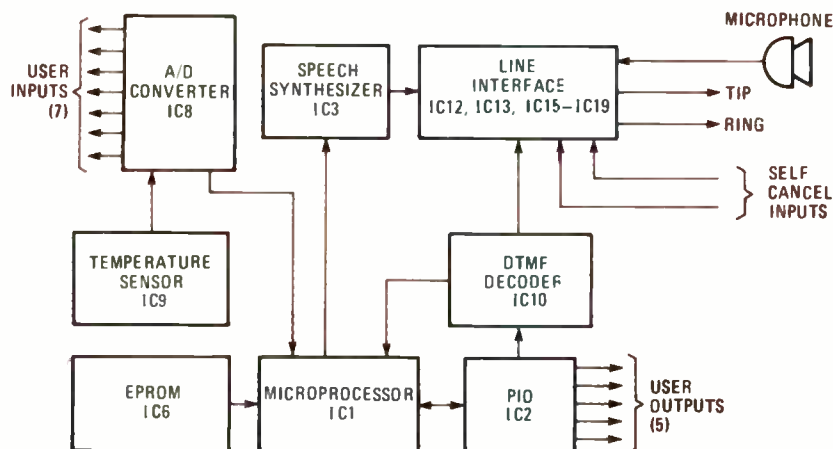

FIG. 4—BLOCK DIAGRAM OF THE CONTROLLER: an analog switch (IC14, not shown) connects the internal microphone, the speech synthesizer, or one of the self-cancel inputs to the phone line.

(Another on-board jumper selects hang-up or time-out.) The automatic hang-up feature would be useful, for example, if you wanted to listen to the sounds picked up by the microphone and just hang up when you were through, without having to explicitly deactivate the function and then hang up. The Hang-up and Cancel routines indicated in Fig. 2 are implemented as jumps to the similarly named routines in Fig. 1.

Controller inputs

If the user had entered a Code 7 from the main loop, he would then enter another code to select the quantity to be reported by the controller. If the user enters Code 1—Code 7, the controller states the value as a percentage of 0–5 volts. Obviously, you'll have to correlate that

percentage with the output of your device. If the user enters Code 8, the controller responds with the ambient temperature (in degrees Celsius). Code-9 here (as in the output-function loop) cancels the current operation, returns to the main loop, and allows the user to choose between inputs and outputs (3 or 7).

Circuit overview

A block diagram of the system hardware is shown in Fig. 4. The microprocessor is a CMOS Z80; the program code is stored in an 8K-byte EPROM (a 27C64). The PIO (*Parallel Input/Output*) is an 8255A, which contains three 8-bit ports that interface most of the remaining circuits to the microprocessor. The A/D converter (IC8, an ADC0809) has eight analog inputs. Seven are available for use

NEW LIFE

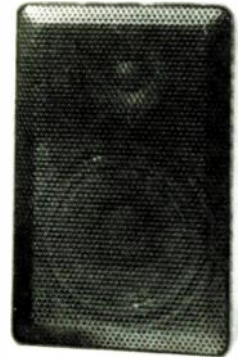

FOR OLD CAR RADIOS

*Here's how to convert a car radio into a high-quality receiver for your home.
You can add shortwave capabilities too!*

GARY McCLELLAN

ARE YOU LOOKING FOR AN EXCELLENT radio receiver for your home, den, or dorm room that outperforms the best table-type radios in station-pulling power and sound quality? Are you looking for a receiver that doesn't cost a lot and that can be customized to suit your needs and your specific installation? Does finding such a receiver sound too good to be true?

This month, we'll show you that it's not too good to be true. We'll show you how to turn an unused car radio into a high performance receiver for your home. In the second installment of this two-part article, we'll show you how to build a simple but excellent converter that will open the world of shortwave radio listening to you, and let you hear news, music, and cultural events direct from Europe, Asia, and other distant places!

Converting a car radio is quick and easy to do. If you're a beginner at electronics construction, then it makes for an excellent first project. If you're an experienced hobbyist, then you'll enjoy using your experience to build a truly customized receiver. When you're finished, you're sure to wonder why you never tried before!

The skeptical reader will ask why anyone would go through the bother of building a power supply and cabinet so he could use a radio intended for automotive use in his home. There are several good reasons. Car radios are designed to get the best possible reception on the crowded AM and FM bands. They are also expected to provide quality sound from

small speakers and work with poor antennas. And to top that off they are expected to work for years without any repairs. Few table radios can meet those requirements!

So what kind of performance can you expect to get by converting a car radio for home use? First, because of the environment that such radios are built for, you'll find that you have an incredibly rugged radio. You'll probably notice better sensitivity and selectivity than you're used to with an ordinary table radio. You'll also notice that car radios are generally well-shielded, which reduces interference.

Many car radios also have desirable "extra" features that you'll probably not find on any table radio you now own. Auto-reverse cassette players are common and electronic tuning with memory presets and a digital clock are becoming standard on high-end models.

Choosing a radio

Perhaps the most difficult part of converting a car radio for home use is choosing the radio you're going to use. The chances are that you have a perfectly useable radio in your garage or under your workbench right now! If you don't, you might want to visit some local garage sales. Every year, a huge number of car radios are replaced with newer models—especially after Christmas, Father's Day, and Graduation Day. And most are replaced not because they don't work, but because they don't have a cassette player, electronic tuning, etc.

Since there is a glut of surplus car radios, you can afford to be a bit fussy about the set you choose for conversion. Here are some suggestions worth keeping in mind as you hunt:

First, choose a late model solid-state car radio. Old tube-type sets and solid-state sets from the 1960's may be good collector's items, but they're not good radios to convert. They draw too much current, and they'll probably need repairs. Worse yet, if you can't do the repairs yourself, having someone else do the job could end up a costly proposition.

Imported models are best—they're small and easy to mount in a cabinet. Watch for pushbutton AM/FM stereo receivers at the least, and don't pass up any AM/FM stereo electronically tuned unit with a cassette player, if the price is right.

If you're interested more in shortwave reception than FM stereo reception, pick up a pushbutton-type AM radio with analog tuning. Those radios are especially inexpensive and will work well with the shortwave converter that we'll describe next time.

Think twice before you buy a radio that is damaged or doesn't work. Repairing a compact car radio can be a time consuming job, and getting replacement parts can be a nightmare! So stay away from "fixer uppers" unless you have the technical know-how.

Don't worry about minor problems such as missing knobs or broken plugs. Those parts are easily replaced, if neces-

sary. Try an auto supply store or strip the parts from another radio that isn't worth fixing.

Now, how much should you pay for your radio? That depends on its features and its condition. Here are some rough guidelines: You should be able to pick up a pushbutton AM car radio for \$3 to \$5 and a top-of-the-line receiver for about \$35. But prices vary from one part of the country to another. Be sure to shop around at various garage sales, flea markets, etc. to get a feel for the prices.

After all of that, you may be thinking of buying a new car radio for converting. We certainly understand the temptation to do so, but try to resist it. If you buy a high-quality car radio—like the Sparkomatic SR315 AM/FM stereo cassette receiver shown at the beginning of this article—it will certainly make an excellent home radio. But install it in your car. After all, that's what it was built for! Convert your *old* radio for use in your home!

Identifying the connections

The first thing to do after finally choosing the radio is to check it out by hooking it up to a power source, speaker(s), and an antenna. Before you can do that, of course, you have to know the function of each wire coming out of the radio and where it should be connected. If you buy a used radio, you'll typically find a bundle of unmarked, colored wires, hacked off a few inches from the case. Or your radio may have a connector block. If you're lucky, there may be a chart pasted on top of the receiver that identifies each colored wire or connector pin. If you're not lucky, you'll have to do a little detective work.

You'll need an ohmmeter, a pencil, and some paper to start. Write down the color of each wire along the left margin of the paper, or draw a sketch of the connector and each pin. You'll first want to find the ground connections: Turn the radio's power switch off, set your ohmmeter on the lowest resistance range, and connect the ground probe to the radio's case. Touch the other ohmmeter probe to each of the leads or pins, and write down on your chart the ones that read zero ohms. Those are the ground connections.

Next you'll want to find the power connection. That can be a bit tricky, so be careful. Leave the ground probe connected to the case, and touch the other probe to one of the non-ground connections. Turn the radio power switch on and off as you watch the ohmmeter scale. If the resistance reading drops each time the switch is turned on, you found the power connection. You probably won't find the power lead on the first try, so continue until you do. When you find the proper

lead, leave the power switch on and leave the probe connected to it. Then remove the ohmmeter's ground lead from the case and touch it to the other leads or pins. If there is one that reads zero, you have found a hookup for a power antenna. Add the identified connections to your chart.

Note that electronically tuned radios have an extra power lead that supplies power to the radio's preset-station memory and clock even when the receiver and car power is turned off. If you have that type of radio, here's how to find that power lead: Reconnect the ohmmeter's ground lead to the radio's case and touch the other probe to the remaining unidentified connections. One of the connections will give a low value and then increase to a high value. That is the memory power lead. Disregard any connection that gives a low value continuously, or that starts at a low value and rises to infinity (over 20K ohms). Add the proper lead to your list of identified connections.

The final step is to locate the speaker connections. That may also be tricky, so be careful. On some radios it is easy to confuse the memory power with a speaker connection. On other radios, the internal circuitry may confuse the unwary. If there are just two connections left, you are in luck; these are most likely for the speakers. A quick check with your ohmmeter should give a low reading that rises to infinity (over 20K ohms). In that case, skip the rest of this discussion and go directly to the construction section.

Deluxe radios with fader controls and high-power outputs have more complicated speaker connections. Refer to Fig. 1 for the typical output circuitry of those radios. The chances are that if there is nothing on the receiver to indicate a high-power output, then the circuitry is similar to that shown in Fig. 1-a. If a sticker on the radio states "Bridging output—do not ground speakers," its circuit is probably like that shown in Fig. 1-b. Use your ohmmeter to measure between any two (as yet unidentified) connections. Anytime you measure 40 ohms, you have found a fader control, so connect those two points together. The other speaker connections are either ground (as in Fig. 1-a) or another output (as in Fig. 1-b). Usually the wire for the other output in a bridging configuration is coded the same color, but with a stripe added, or it's a pin on the opposite side of the connector block.

Once you've identified all the connections, you can start to build the power supply for your radio.

Building the power supply

Building a power supply to convert your car radio for home use is relatively easy because few parts are required and there is nothing critical about the construction. Our supply delivers about 14 volts at 1.5 amps, which should be enough for just about any car radio, even a high-powered electronically tuned receiver like the Sparkomatic unit. Figure 2 shows the power supply's schematic.

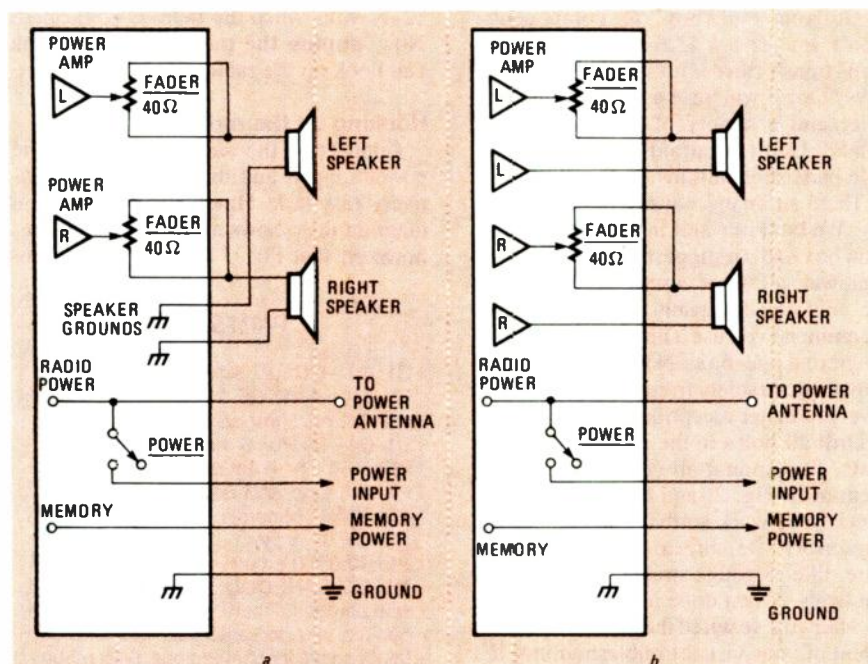

FIG. 1—TYPICAL CAR STEREO RADIOS have outputs like those shown here. In a, the speaker outputs are single-ended. Bridging outputs, like those shown in b, are often found on high-powered radios.

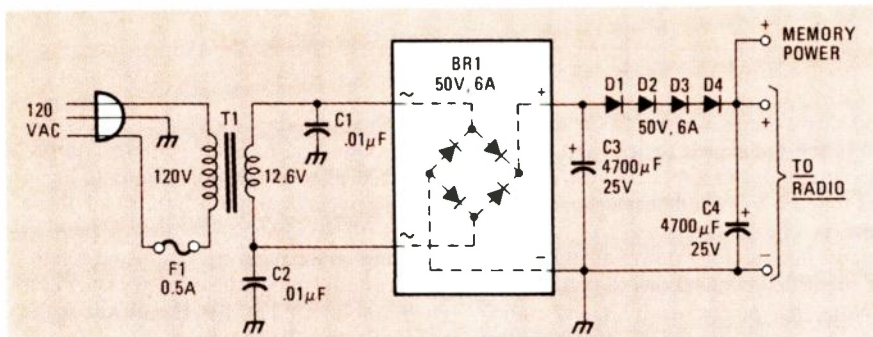

FIG. 2—A SIMPLE POWER SUPPLY will give excellent performance. This is a perfect time to use some of those components you've been salvaging for years!

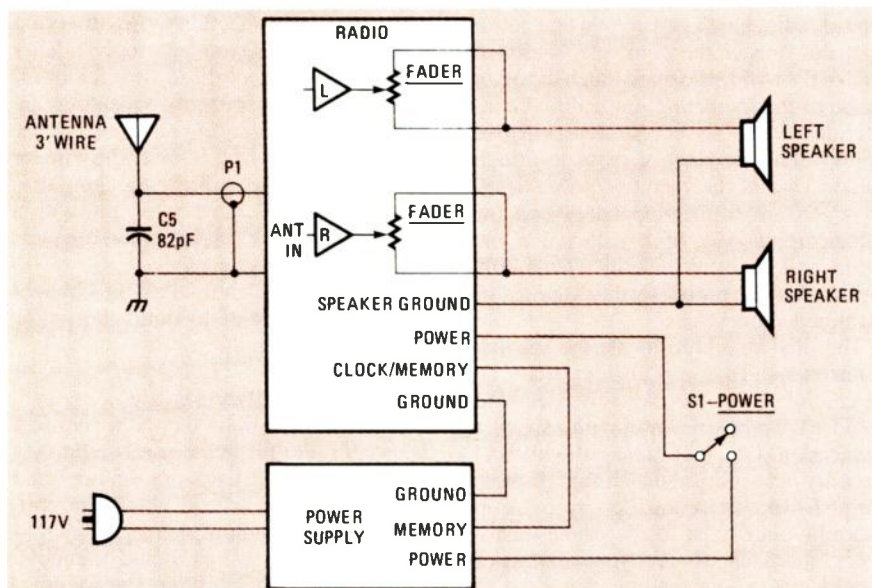

FIG. 3—THE FINAL HOOKUP. Note that the radio shown here uses single-ended outputs. If yours uses a bridging output, refer to Fig. 1-a for the proper wiring diagram.

One of the best things about the supply is that it gives you the perfect opportunity to raid your "junkbox" for components. Don't you have a 12.6-volt, 3-amp filament transformer left over from the tube days? Don't you have a spare bridge rectifier and a supply of filter capacitors handy? Don't be afraid to make reasonable parts substitutions in the supply.

There are many ways to build the supply. We built our unit into a small aluminum box and we suggest you do the same. That way, all wires carrying line voltages are enclosed for safety. In addition, we recommend you use a three-wire line cord to ground the box. Not only does this provide extra safety from shock, but it will give you better reception!

Drill all holes in the box to mount the parts, then mount all components. Wire them as in Fig. 2, and be sure to double check your work so that you can correct any errors. Be sure to use fairly heavy wire, like 18-gauge stranded, for the output leads. When done install fuse F1.

After you've wired the unit and are confident of your visual troubleshooting, it's time to plug the supply into an AC outlet and to measure the output voltage. It

should be in the 16–18 volt range. The output will drop to a more acceptable 12–14 volts when the radio is connected. Now, **unplug the power supply** so you can hook up the radio.

Hooking up the radio

Connecting the radio to speakers, the power supply, and the antenna is a relatively easy task. Figure 3 is a connection diagram that shows all the details. Note, however, that Fig. 3 shows speaker con-

PARTS LIST

- C1, C2—0.01 µF, 50V ceramic disc
- C3, C4—4700 µF, 25V axial electrolytic
- C5—82 pF, 500V ceramic disc
- D1–D4—50 PIV, 6 amps, silicon
- BR1—50 PIV, 6 amps, bridge rectifier
- F1—0.5 amp 3AG fast-blow fuse
- PL1—Male Motorola type plug
- S1—SPST rocker
- T1—12.6V, 3 amps
- MISCELLANEOUS: three-wire line cord with plug, aluminum box, 3 feet stranded hookup wire for antenna, #18 stranded hookup wire for connections, 6-32 mounting hardware, cabinet, speakers, etc.

nections for radios with single-ended outputs. If your radio uses a bridging output, connect your speakers as shown in Fig. 1-b. For testing purposes, you can use any speakers you have handy. After you're satisfied everything's working properly, you can splurge on high-quality units. Note that if your radio is not an electronically tuned type, you can ignore the memory power connection.

The last step is to assemble and install a simple antenna. Cut a 3-foot length of stranded hookup wire and solder it, and one lead of C5 (an 82-pF disc capacitor) to the center conductor of PL1, a Motorola-type plug. The other leg of C5 should be soldered to the shield of PL1. Be sure to slip insulated tubing over the leads of C5 so they don't short the center conductor and the shield. Finish by connecting the antenna to the radio.

Checkout and installation

Now comes the big moment. Connect the power plug to an AC outlet and turn on the radio power switch. There should be a soft thump from the speakers and you should hear noise when the volume is turned up. If you hear nothing, or smell something, pull the power plug **immediately** and check your work. Once you hear noise, try tuning a station on your newly converted car radio and enjoy!

If your car radio is analog tuned, it will be necessary to peak the antenna trimmer for best AM reception. Usually that adjustment will be found next to the antenna jack, but some receivers hide it next to the tuning knob or inside the cassette compartment. To make this adjustment, tune in a weak station near 1400 kHz, then peak the trimmer for maximum volume.

Once your radio passes checkout you are ready to put it in a cabinet of your choice! While the cabinet you use is entirely up to you, here are some ideas to get you started: We've used everything from a junked cable TV converter to an old stereo cabinet purchased at a garage sale. In another conversion, a monaural receiver was built directly into a small bookshelf speaker, providing a nice table radio for the kitchen. In yet another conversion, the radio was built into a room divider, along with two flush-mounted speakers. Use your imagination and you can make something that is truly unique.

Once you have chosen your enclosure, cut the mounting holes for the radio and power supply, then mount them in place. Extend the antenna wire (preferably vertically) then staple in place. Finish up by connecting the speakers, then turn on the power and enjoy your handiwork!

While you should be happy with the results, you may still want something more. Then watch for the next and final installment of this article for step-by-step instructions on how to build a shortwave converter to use with your radio. **R-E**

Miniature Wideband Amplifier

JOHN CLAWSON

From DC to 450 MHz, 20-dB gain in the palm of your hand.



FROM DC THROUGH TO THE MOBILE RADIO and TV frequencies, there's always need for some amount of additional amplification. In particular, when it comes to TV reception just a *smidgen* extra gain can make the difference between looking at a snowstorm or a decent picture having rock-stable color.

Often, obtaining enough of a signal for a good TV picture means using some kind of deep-fringe antenna and a preamplifier. The problem is, however, that *stable* preamplifiers don't come cheap unless you build them yourself, and even then you might spend countless days, nights, and weekends getting one to work without producing more *spuri* (spurious signals) than it does TV signal.

But spurious signals are nonexistent in the wideband high-frequency amplifier shown in the photographs; yet it rivals commercial units in both performance and reliability—but without their formidable price tags. While a commercial counterpart might easily sell for \$100 or more, our version, shown in Fig. 1, can be built for about \$12. How can a commercial-quality amplifier be built so inexpensively? The answer to that question is found in a new breed of integrated circuit, the Signetics NE5205, a UHF amplifier with a fixed gain of 20 dB.

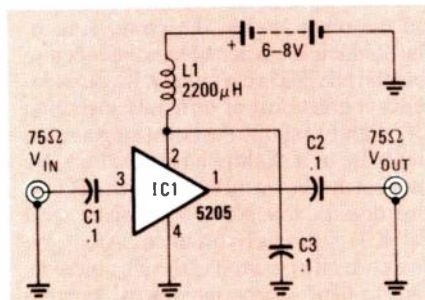

FIG.1—EXCEPT FOR THE COUPLING and decoupling capacitors, IC1 is a complete wideband amplifier having a fixed gain of 20 dB to 450 MHz. No external compensation is required.

Signetics offers the NE5205 in two kinds of housings: the TO-46 metal can shown in Fig. 2-a, and the SO-8 DIP shown in Fig. 2-b. Unlike earlier monolithic amplifiers, the NE5205 does its job without external compensation networks and matching transformers. What's left is an experimenter's dream: an inexpensive black-box amplifier that can be plugged into practically any circuit. Put into other words, a gain-block.

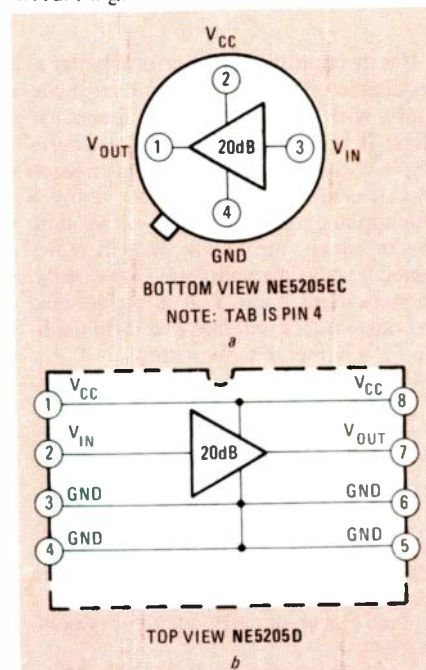

FIG. 2—THE NE5205 IS AVAILABLE in two configurations: a pinout for a conventional TO-46 metal can whose tab provides the ground connection is shown in a. An SO-8 DIP pinout is shown in b. The grounded metal case of the TO-46 version extends the response from 450 MHz to 650 MHz.

Before going into construction details, let's go over some of the NE5205's specifications, because they will give you a better feeling for the IC and its performance.

Let's start with amplification, because how well the NE5205 does that job will greatly influence how it is used. To begin with, there's 20 dB of fixed insertion gain that is essentially ruler-flat to 450 MHz. The grounded case of the TO-46 version extends the response to -3 dB at 650 MHz. Unlike some theoretical or optimized values, 20 dB is a real-world figure that is not swamped in a sea of noise. For example, the NE5205 can be used as a 50- or 75-ohm line amplifier; yet even with such a low impedance it preserves a remarkably low $+4.8$ dB NF (Noise Figure) at 75 ohms, $+6.0$ dB at 50 ohms. Input and output VSWR (Voltage Standing Wave Ratio) for both impedances remains below 1.5:1 to 450 MHz.

Twenty decibels is a hefty boost, but as Murphy's Law would have it, with 20 dB of gain available you will undoubtedly need 21 dB. How, then, do you provide the extra gain? As shown in Fig. 3, simply cascade two NE5205s for a total gain of 40 dB. Notice the conspicuous absence of compensation. Although providing a total of 40 dB gain, the amplifier is still our basic wideband amplifier circuit; only an extra IC, a choke, and two capacitors have been added.

Also notice that again we are saved from circuit complexities by using only AC coupling capacitors rather than reactive networks. That is amazing, considering that chaining even the most docile conventional high-frequency amplifier can often severely strain stability.

Circuit operation

Referring back to Fig. 1, the wideband amplifier uses only five components. External signals enter pin 3 of IC1 via AC coupling capacitor C1. Following amplification, the boosted signals from IC1 pin 1 are coupled to the output by capacitor C2. Capacitor C3 decouples the DC power supply while RF current is isolated from the power supply by RF choke L1.

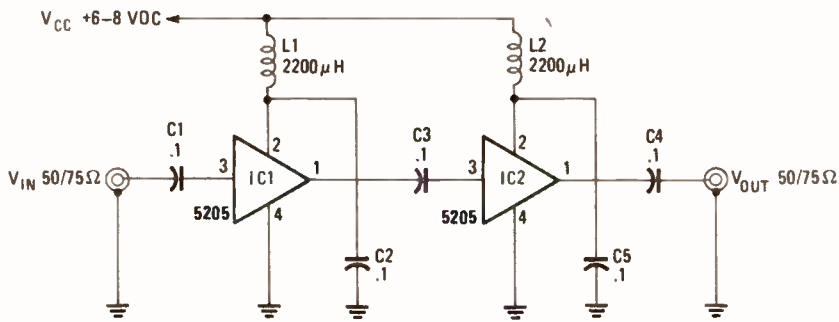

FIG. 3—SINCE THE NE5205 FUNCTIONS as a gain block, two or more can be easily cascaded to provide additional amplification. In this circuit, which uses two NE5205s, the overall gain is 40 dB.

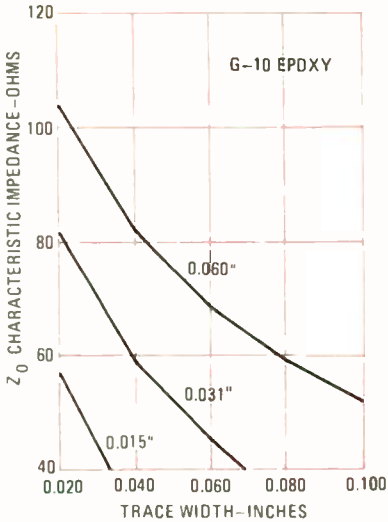

FIG. 4—USE THIS CHART to determine microstrip trace width for various impedances and thicknesses of G-10 epoxy board.

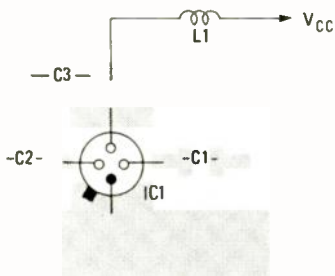

FIG. 5—THIS IS THE COMPONENT LAYOUT for the basic amplifier. All components are on the soldering side of the board.

The NE5205's low current consumption of 25 mA at 6 volts DC makes battery-powered operation a reality. (Although the device is rated for a 6- to 8-volt power supply, 6 volts is recommended for normal operation.) Six volts provides an internal bias of 3.3 volts, which permits a 1.4-volt peak-to-peak output swing for video applications.

Construction

Below 150 MHz, just about any kind of point-to-point wiring assembly can be used if the leads are made as short as possible, if you don't run the output and input wires close together, and if you remember to ground the metal case.

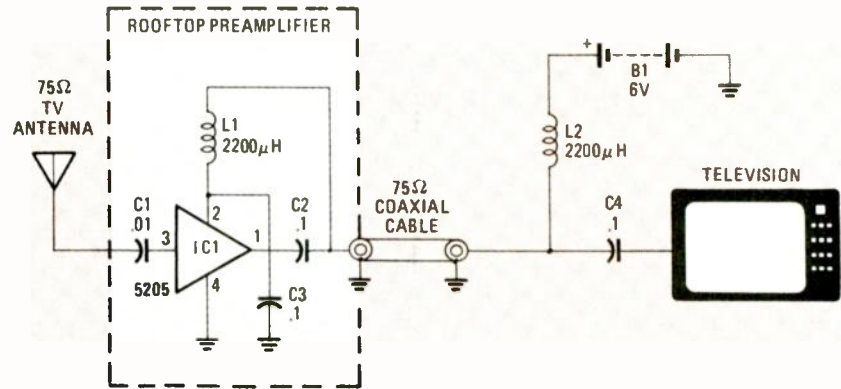

FIG. 6—IF THE POWER SUPPLY is fed through the signal-carrying coaxial cable, the amplifier can be mounted in a weatherproof enclosure directly at the antenna.

But the amplifier will perform better at frequencies above 30 MHz, and most certainly with fewer problems above 150 MHz, if built on a microstrip. A *microstrip* is a microwave low-loss transmission line. It consists of a conductor above a groundplane, analogous to a two-wire line in which one of the lines is represented by the groundplane. Obviously, printed-circuit board that is copper-clad on both surfaces will make an ideal medium for a homebrew microstrip.

Full-scale PC patterns for the micro-

PARTS LIST

IC1—NE5205EC wideband high frequency amplifier (Signetics)

C1, C2, C3—.1 μ F, multilayer ceramic chip capacitor, 10%, 100-WVDC (Stetter Electronics KEFQ1210 or equivalent)

L1—RF choke, 2200 μ F, 10%, Ferrite core (Digi-Key M8153 or equivalent)

Miscellaneous: PC board and materials, case (when needed), etc.

Note. The following are available from John Clawson, P.O. Box 225, Tillamook, OR 97141: NE5205EC, \$6; set of three 0.1- μ F chip capacitors, \$3. Shipping and handling \$3 per total order. Foreign orders add \$4.50. U.S. funds only. Oregon residents add appropriate sales tax. Check or M.O. only.

strip are given in PC Service. The recommended printed-circuit board material is double-clad 0.060-inch G-10 epoxy board. The pattern shown is intended for 75-ohm operation. For alternate impedances (Z_0) or different thicknesses of G-10 board, you will need to change both the input and the output trace widths; refer to the chart shown in Fig. 4, which shows the characteristic impedance vs. signal-trace width required for various G-10 thicknesses. For example, a 50-ohm Z_0 (characteristic impedance) and a 0.031-inch G-10 board requires a signal trace width of approximately 0.050-inch.

Since IC1's TO-46 case is grounded, don't be concerned about providing an insulated hole through the groundplane. You can leave the underside copper complete and simply drill a $\frac{1}{16}$ -inch hole through from the top side of the board.

If you want to expand the foil pattern to include another NE5205, keep all new signal paths short and as straight as possible. The groundplane should be extended beyond each edge of any added traces by no less than the trace width.

The parts-placement pattern is shown in Fig. 5. Prior to assembling the etched and drilled PC board, be sure that all circuit traces are free from residue, burrs, and obstructions.

Except for one lead of RF choke L1, all components are mounted directly on the soldering side of the board. L1 is attached by soldering one lead to the V_{CC} plane and the other lead to the power source. The $\frac{1}{16}$ -inch diameter hole is intended to hold the NE5205 very snugly. If you experience a great deal of difficulty installing IC1, slightly enlarge the hole using a small round file or a slightly larger drill bit. Be sure that the metal flange on the TO-46 case doesn't touch the V_{CC} plane, and that IC1 is properly oriented. After you have correctly positioned the IC, solder its leads to their appropriate traces, keeping length to an absolute minimum. Then make a good electrical connection be-

continued on page 69

Soldering: OLD TECHNIQUES & NEW TECHNOLOGY

It takes a more than just solder to make reliable connections.

VAUGHN D. MARTIN

SOME CLAIM IT WAS GUGLIELMO MARCONI himself who said "Soldering is an art"—as he used a blowtorch and a five-pound bar of lead to assemble the transmitter that finally broadcast a radio signal across the *big pond*. While we no longer use a plumber's blowtorch for precision soldering, it often appears that we haven't progressed to anything that is significantly better. More times than we care to remember, the causes of defects in projects,

retrofits, and upgrades have been directly traced to poor solder connections: either too much or too little solder, cold solder joints, or simply the wrong kind of solder, de-oxidizer, or wetting agent.

So it is in the spirit of "Soldering is an art" that we'll take a close look at soldering techniques: everything from assembling a simple "one-evening" commercial kit to making repairs using conductive plastic.

Conventional soldering techniques

Exactly what is soldering, anyway? Conventional soldering is the bonding together of two or more metal parts with a tin-lead alloy (the solder itself). It is the least expensive, yet most reliable method of connecting electronic components. In a good solder joint, solder molecules actually mix with the molecules of the metal being soldered—what is called *wetting*.

The tools for making solder connec-

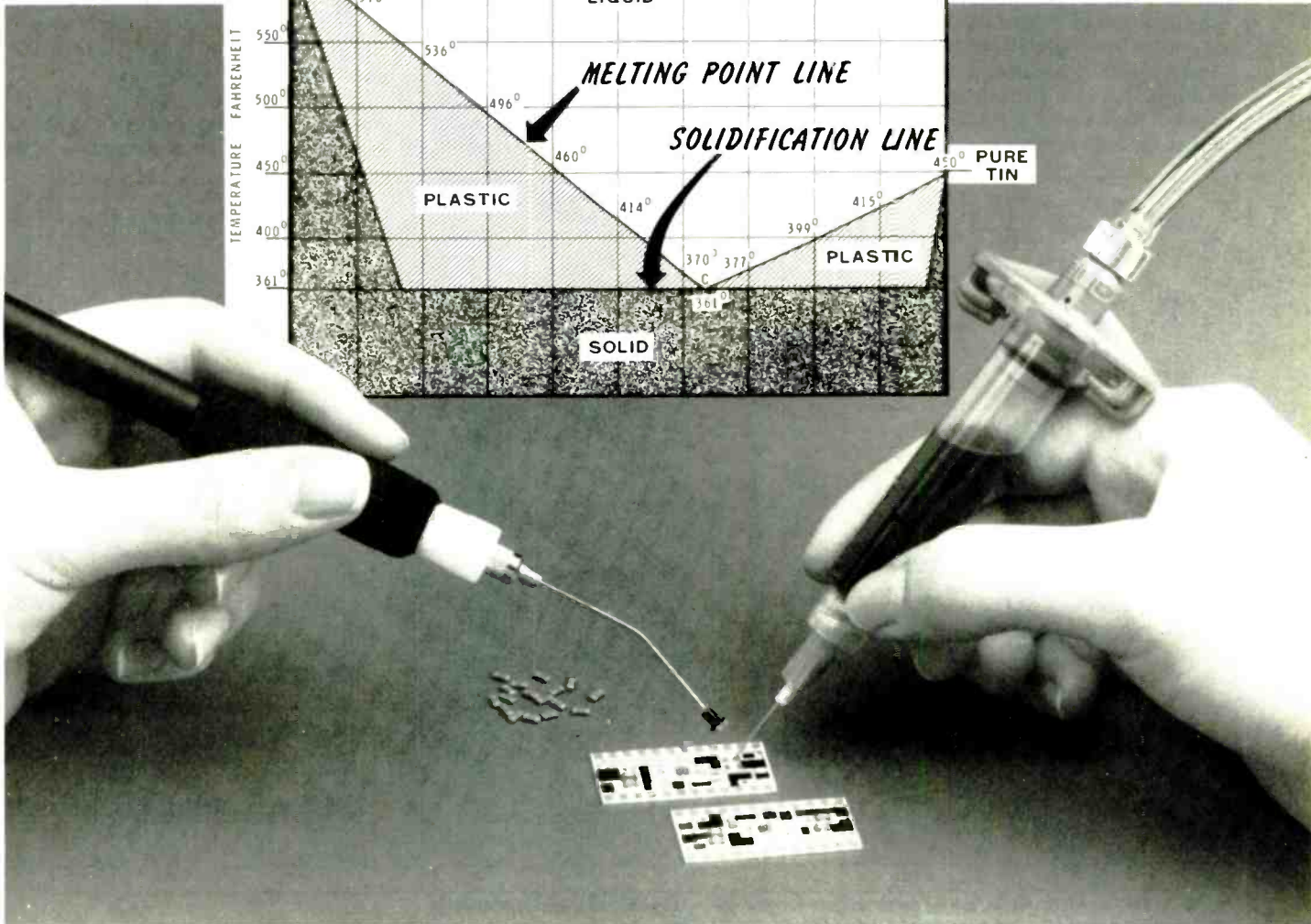
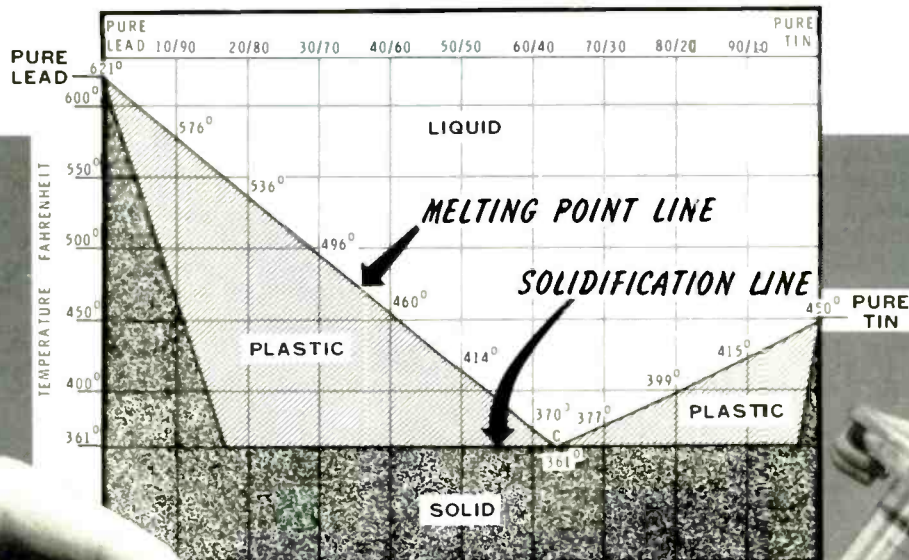



FIG. 1—ADJUSTABLE-HEAT soldering irons allow you to adjust the tip-temperature adjustment. Other soldering irons have a single controlled tip-temperature.

tions to electronics equipment come in a variety of styles, sizes, and shapes of *guns*, *irons*, and *pencils*—a soldering pencil being a low-wattage, usually pencil-size soldering iron. Although most have fixed tip-temperatures, some, such as the unit shown in Fig. 1, have a means whereby the tip-temperature can be adjusted or optimized for a particular solder or purpose.

In addition to controlled tip-temperature, many irons allow the user to substitute various shapes and types of tips: everything from large tips for soldering to a metal chassis to needle-point models for heating a hairline printed-circuit trace. Figure 2 shows several commonly available shapes and variations.

How to solder

How do you use those tools to make a *guaranteed* reliable connection—one that will last forever and a day? Figure 3 shows a four-step approach to soldering terminals and printed-circuit boards.

Begin with a wet sponge. Heat the soldering tip, wipe it off on the sponge, and apply solder to the cleaned tip. That is called "tinning" the tip—it inhibits oxidation. For terminal lugs (Fig. 3-a) and relatively thick or wide printed-circuit foils (Fig. 3-b), place the soldering tip against the foil or against the terminal, and against the component's lead; then apply solder. Apply heat long enough to allow the solder to flow evenly and uniformly over the joint. Then remove the iron and be sure not to move the component until the solder cools. For hairline traces, the latest recommended technique (Fig. 3-c) is to place the solder against the component lead and the foil and then squash the iron down on the solder until there is a good flow. (That way there is less chance of overheating causing a hairline trace to lift off the PC-board.)

When soldering conventional components such as resistors and capacitors it's a good idea to bend their leads to keep them from moving when the soldering iron is removed; you'll find that it's well worth the extra time.

If you soldered the joint correctly, it will be smooth and shiny like the joint on the right in Fig. 4. If not, the joint will resemble one of the "cold" solder joints shown in Fig. 5-a and Fig. 5-b. Cold

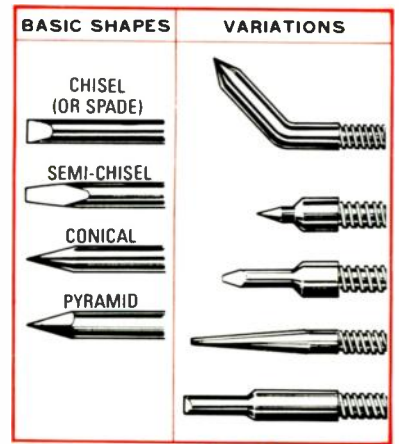

FIG. 2—SOLDERING-IRON TIPS are available in a wide variety of sizes and shapes. They come as complete tips, interchangeable elements, or tips for interchangeable elements.

joints are poor conductors. They are characterized by either a crystalline, grainy texture (Fig. 5-a), or by blobs and uneven solder flow (Fig. 5-b).

Integrated circuits require extra care when soldering. Typically, they have closely spaced pins on 0.100" centers, and it's easy to bridge across two (or more) pins if just a bit of excess solder is applied, or if the tip of the soldering iron spans two pins or traces. To avoid the problem, use extra-thin solder (what is usually called "wire gauge"), a small soldering pencil, and great care.

Except for some specialized solders that we'll get to later, one of the principle ways to ensure a good connection is by

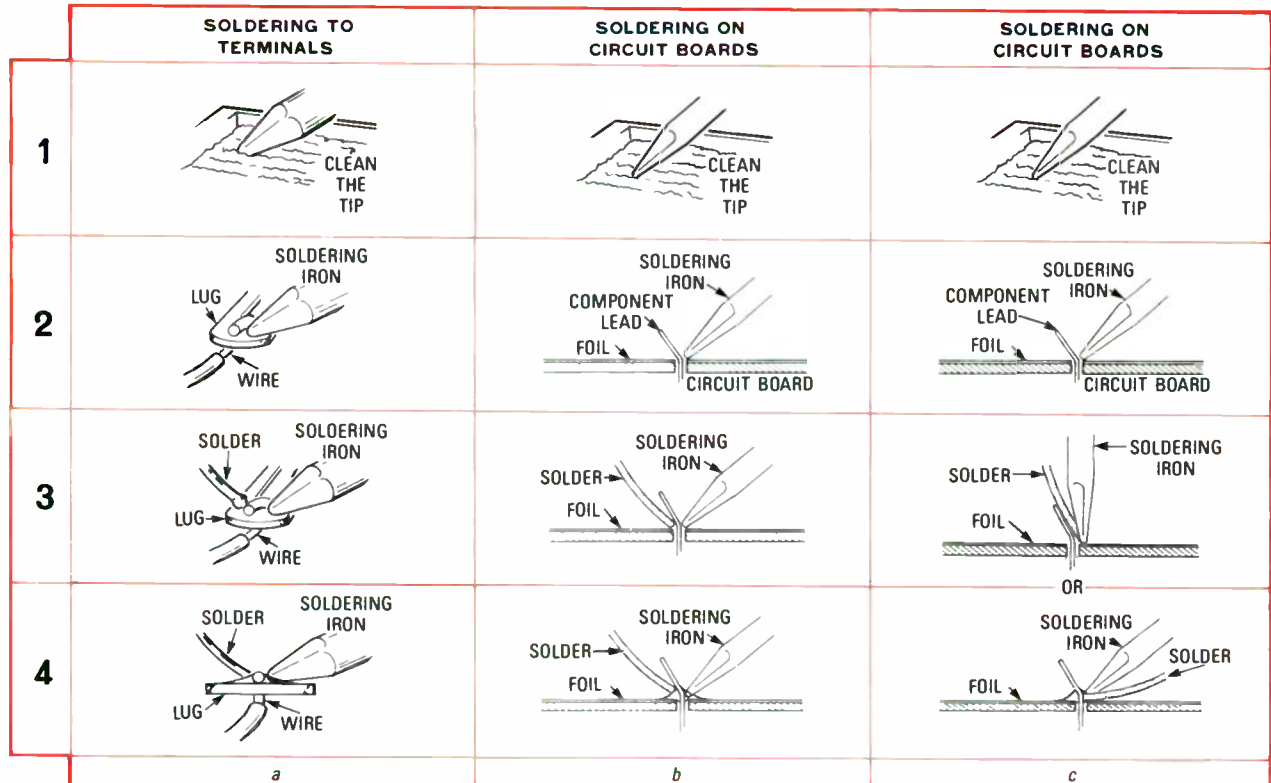

FIG. 3—ALTHOUGH IT'S USUAL to heat the material to which solder will be applied (a and b), the heat is applied to the solder (c) when soldering hairline printed-circuit traces.

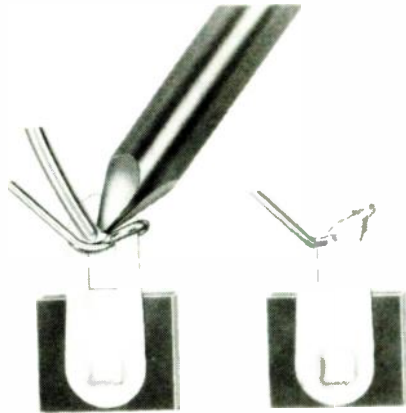

FIG. 4—A PROPERLY-SOLDERED terminal connection looks like this.



FIG. 5—A COLD SOLDER JOINT may resemble a or b. One is as bad as the other.



FIG. 6—SOLDER-REMOVAL BRAID is available in several widths to accommodate everything from hairline printed-circuit traces to old-fashioned terminal lugs.



FIG. 7—A SOLDER-SUCKER removes solder from a one-surface component-mounting hole or a plated-through connection.

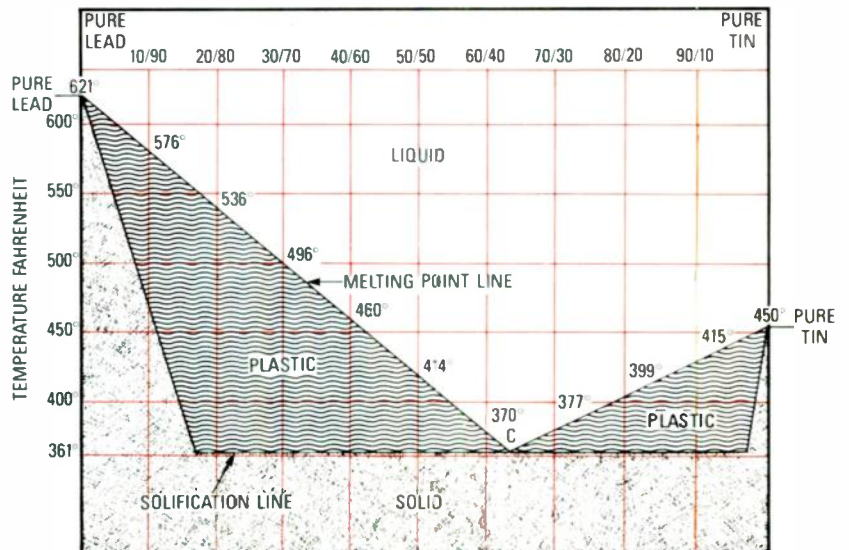

FIG. 8—A SOLDER'S MELTING POINT is determined by its composition. Eutectic solder goes from solid to liquid without passing through a plastic state.

applying a "flux" to the surfaces or wires to be soldered either before or during the application of heat.

Flux is a chemical that is used to remove surface oxides from metal before it is soldered—because oxidation interferes with the adhesion of solder. It is available in powder, paste or liquid form. Many solders contain a core of flux so that the flux is applied continuously during soldering.

Occasionally, you will bridge a solder gap or make a cold joint. Usually, it's next to impossible to salvage the connection, or even to avoid further damage, unless the solder is removed first.

Solder removal

There are two ways to remove unwanted solder so that you can start over. You can use a product generically called solder-removal braid—available under several trade names—which is a resin-flux coated braid that absorbs molten solder. As shown in Fig. 6, it comes in different widths tailored for wicking everything from hairline PC-board traces to old-fashioned terminal lugs. Alternately, you can use a "solder sucker" (Fig. 7), a device that uses a vacuum to literally suck solder off a connection.

Conventional solder

As shown in Fig. 8, conventional solder is an alloy of tin and lead that melts at a lower temperature than either tin or lead by itself. The actual temperature at which solder melts it depends on the relative percentages of tin and lead in the solder. Solder with 37% tin and 63% lead yields the lowest melting point, but you will find that most solder is 40% tin and 60% lead.

Incidentally, the term "eutectic" is sometimes used to describe a particular solder alloy. Eutectic simply means the lowest possible melting point of an alloy.

For example, the 37/63 solder previously mentioned is eutectic tin-lead solder—no solder can melt at a lower temperature.

Plastic solders

Now let's look at plastic solders. Some require heating to make them hard; others, the epoxies, generally do not. They are hardened not by heat, but by adding a catalyst or a hardener—a great advantage when you're working with heat-sensitive semiconductors.

Many epoxies have excellent strength and wettability, even with non-metallic substrates, and they are good conductors of electricity. Emerson and Cumming's Econobond Solder 56C has a resistance of 2×10^{-4} ohms/cm; Aremco-Bond 556 has a resistance of 5×10^{-4} Ohms/cm. The latter yields bonded shear strength of 3,000 to 4,000 psi within a temperature range after curing of -60°C to $+200^{\circ}\text{C}$ (-76°F to $+392^{\circ}\text{F}$).

TRA-CON, Inc. 55 North St., Medford, MA 02155, produces 56 different kinds of premixed resins and hardeners. Applications range from replacing conventional solder to repair of PC-board delaminations or blistering.

Indium solder

One of the most exciting breakthroughs in soldering technology is the use of indium, a semi-precious, non-ferrous, silvery-white metal having a brilliant luster. It is softer than lead—you can scratch it with your fingernail—and it is extremely malleable and ductile, even at temperatures approaching absolute zero. It retains its shape when bent, and its softness and plasticity make it particularly suitable for gaskets, seals, and solders. In particular, indium's ability to work into the oxide skin of other metals improves their electrical and thermal conductivity while inhibiting corrosion.

Indium is often combined with other metals to produce a "specialty solder" for joining and sealing applications where conventional solders fail. Indium-based solders are strong, thermally conductive, electrically conductive, easily bondable, resistant to fatigue, resistant to leaching, and resistant to acid and alkaline corrosion.

Because indium solder's melting point is considerably less than that of conventional solder (Indalloy #136 melts at 136°F), it is particularly well-suited for soldering heat-sensitive components.

Also, indium solder's low vapor pressure ideally suits it to vacuum-soldering environments where high-vapor-pressure solder could accumulate on, and thereby ruin other components.

Indium solders are non-toxic, and those with gold, or bismuth and tin are good candidates to replace poisonous lead and cadmium solders in toys and cookware.

Epoxy substitute

Because indium solder is easier to remove than epoxy and plastics, it is often substituted when there's a possibility that repairs or design changes might have to be made to joints and fabrications.

When indium is combined in an alloy, it will wet glass, mica, quartz, glazed ceramics and certain metallic oxides; and it will form a sub-oxide layer that increases its adhesion. To avoid interfering with the sub-oxide layer, flux cannot be used with indium solder. If you want to solder a metallic substance to a nonmetallic substance, precoat the former with solder containing flux; then completely remove the flux before soldering the metallic substrate.

Indalloys #1 and #4 have the best wetting qualities on non-metals, while Indalloys #3 and #290 produce stronger connections. However, because of the silver they contain, they have slightly less wettability.

Bond strengths between 300 psi and 700 psi can be attained with non-metallic substances if they are properly prepared for soldering. To solder the non-metallic substrates, clean them thoroughly with a strong alkaline cleaner, rinse with distilled water, and again with an electronic grade acetone or methanol. Heat glass, quartz, or glazed ceramics to 350°C (662°F) and cool. Heat one non-metallic substrate and the solder to 20- to 30°C higher than the solder's melting point, then gently rub the solder into the substrate with a nickel metallic felt, or a similar applicator. Cool the coated substrate, bring it into contact with the second, and apply heat until the solder flows.

Incidentally, you will find that an ultrasonic soldering iron is sometimes effective in wetting some non-metallic surfaces.



FIG. 9—THE HEAT FROM A MATCH is enough to melt a bar of indium fusible-alloy solder.



FIG. 10—INDIUM SOLDER CREAMS, featuring oxide-free spherical powders, are available in various alloys that are specifically packaged for dispensing, screening, and stenciling.

Fusible alloys of indium

A fusible alloy is an alloy of bismuth that contains tin, lead, cadmium, gallium, or indium, and which expands upon solidification. Such alloys have low melting temperatures compared to most indium alloys, but their poor wettability keeps them from being widely used as solders. Normal melting temperatures of fusible alloys range from 40°C to 150°C (104°F to 302°F). This means that you can melt Indalloy fusible alloys, and keep them molten, on an ordinary hotplate. For special applications, you can even get Indalloys that melt as low as 10.7°C (51.3°F). Figure 9 shows an ordinary match melting a bar of Indalloy fusible alloy.

Surface-mounted devices

No discussion of soldering would be complete without mentioning techniques for soldering SMD's (Surface-Mounted Devices). SMD's are not only much smaller than conventional ones—they don't have wire leads. Instead, they have what appears to be a semiconductor substrate with a small metal ridge along the edges. Surface mounted devices are

mounted to a PC board by precise vacuum placement, then robotically or vapor-soldered in place.

Solder creams make precision, automated soldering possible by allowing precise placement of tiny, predetermined amounts of solder and flux on the conductors of PC boards, thick- and thin-film circuits, and flexible circuits. Or, as shown in Fig. 10, solder creams can be dispensed manually from a syringe on to a substrate. The intended use of soldering creams determines their viscosity, powder mesh size, metal content, and packaging.



FIG. 11—A COMBINED CREAM DISPENSER and vacuum-operated component-holding device simplifies the positioning and soldering of SMD and other micro-miniature components.

An alternative to the manual dispenser shown in Fig. 10 or automated techniques is the Model 1000 DV manufactured by EFD Inc., East Providence, R.I. 02914; that unit is shown in Fig. 11. The instrument provides both a cream dispenser and a vacuum parts holder. Figure 12 shows how the vacuum holder and cream dispenser are used to install an SMD.

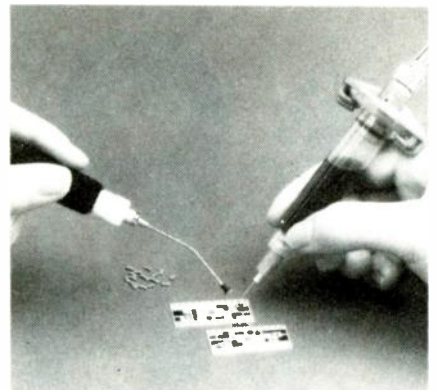

FIG. 12—IT TAKES TWO HANDS to position an SMD device on a PC-board: one for the cream dispenser, the other for the vacuum holder.

Before reflowing solder cream, be sure to cure it to avoid spattering and solder-balling. Substrate type, flux type, the metal content of your solder, and the amount of solder cream deposited on the board will determine the appropriate curing parameters.

Conclusion

Now that you know all the various possibilities available when soldering, your only problem will be figuring out which one is the best to use for a particular application.

Learning About Loran

Though unseen, Loran has lit the way for travelers for 47 years. Now, thanks to improved technology and dropping costs, even sportsmen and weekend sailors can use the system.

DAVID J. SWEENEY

DURING WORLD WAR II, WHEN BATTLESHIPS struggled with the gray Atlantic, clouds usually blocked the sun and stars and thereby hid the navigator's only references for finding his position. If he had one, he turned on his Loran receiver and watched two horizontal lines glow green while the cathode ray tube warmed up. In minutes he would synchronize his receiver and know his position within a few miles. Then he might hold the bulkhead for balance against the rolling sea and reflect on his warm feelings for radio signals.

The signals originated on far-away solid ground from Loran transmitters. Like radar, another system developed during the war, Loran correlates radio-wave travel time with distance. Unlike radar, Loran uses several remotely operated transmit-

ters. The Loran user measures the difference in time between pulses received from those stations, then refers to a Loran chart to plot his geographic position.

Loran is an acronym for *LONG RANGE* Navigation. Needed for military shipping and aircraft operations, Loran evolved from requirements described by the Army Signal Corps Technical Committee on October 1, 1940. Now, some 47 years later, Loran has developed into Loran-C, which operates on 100 kHz—a frequency that provides ground-wave coverage over extremely long distances, thereby supplying signals worldwide so that ships and aircraft can find their way to commercial ports and airfields. The worldwide system is operated by the U.S. Coast Guard and foreign governments.

Figure 1 shows the Loran-C coverage

around the continental United States. The shading indicates areas of good reception; in other areas, reception is unreliable or inaccurate. To close the mid-continental gap, the 1986 House Committee on Appropriations recommended \$43 million for five new Loran-C transmitters to provide nationwide signals for aircraft and fresh-water navigation.

Typical of just about everything else electronic, prices for Loran receivers have dropped sharply, so that both sportsmen and weekend sailors have been able to join the corps of Loran-C users. In fact, the Loran-C accuracy now available to sport fishermen so greatly surpasses that available during Loran's early days it has dramatically changed the charter-fishing industry. A charter-boat captain often maintains Loran-C data for specific loca-



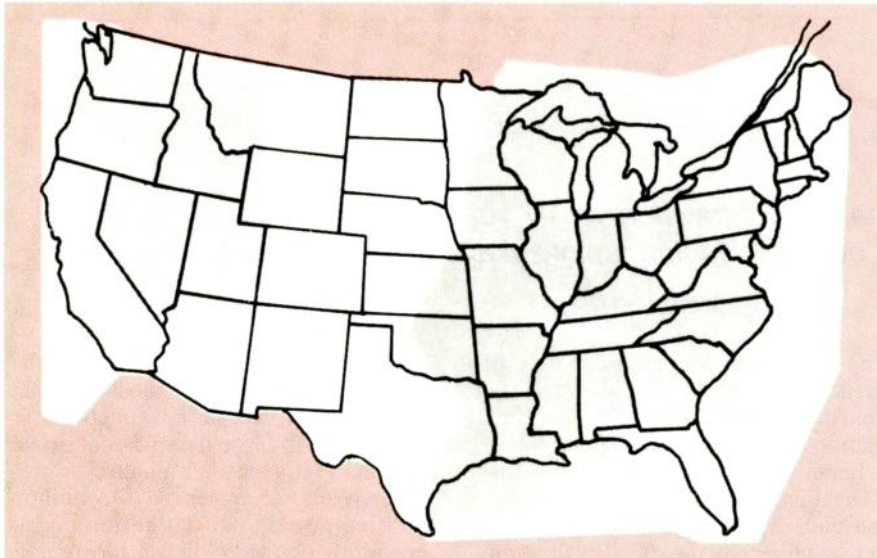

FIG. 1—USABLE LORAN SIGNALS cover much of the contiguous U.S., but a broad area in the midwest is outside the coverage provided by the coastal and Great Lakes chains.

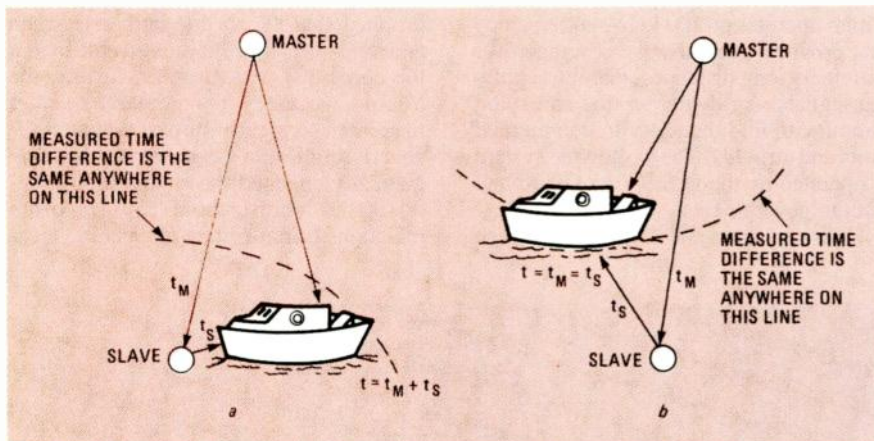

FIG. 2—LOCATION IS DETERMINED by the time difference between signals received from a master and those from its associated slave station(s).

tions, called "waypoints," where quantities of fish, crabs, or lobster are known to forage. The ability to find "hot spots" within a few feet in miles of open sea was impractical before Loran-C. Now it is a marketing tool.

Besides fishermen, aircraft pilots have successfully used Loran-C, and the government is currently approving it on a selective basis for commercial aviation. In November, 1985, the Federal Aviation Administration approved the first Loran-C approach at Hanscom Field in Bedford, Massachusetts, and later approved a non-precision Loran-C approach for Runway 15 at Burlington, Vt. At the time this article was prepared, the next Loran-C approach was scheduled for Portland, Oregon. In addition to guidance on approach, Loran-C aircraft receivers equipped with computers and data bases help pilots make decisions throughout a flight.

The data bases built into some Loran-C receivers contain the positions of all 6500 U.S. public airports, and many standard aviation routes. The data might also in-

clude the airport's name, and the city and state where it's located, and the radio frequencies for the tower, approach control, and ground controller. To get a "fix" on his position, all the pilot has to do is turn on the Loran-C receiver, which then determines his position and compares it with the positions in the data base. Identification of the closest airport, direction, and estimated time of arrival is available instantly.

World War II equipment, based on vacuum tubes and primitive by today's standards, validated the Loran technique for navigation, and initiated development of the system presently used. The circuits in modern equipment include conventional RF and IF amplifiers as well as digital logic, thereby using computers with Loran-C signals to calculate travel times, tracking errors, and distances to prestored waypoints.

Although it's basically the same method that began in 1940, the on-board computer makes it automatic, accurate to 50 feet, and inexpensive: prices start at about \$500 (to \$4000 for a top-of-the-line unit).

LORAN HISTORY

LORAN DEVELOPMENT PROGRESSED IN stages. By June, 1942, the first two high-power (100-kW peak) transmitters had been installed and tested in stations at Montauk Point, Long Island, and Fenwick Island, Delaware. The system designers established synchronization between the two stations by designating the station at Montauk as master. That meant that any drift in pulse-repetition rate or frequency at the master would be tracked by the slave station; it represented one of the key operating characteristics of the Loran system. On June 13, 1942, a Loran receiver flew in a Navy blimp from Lakehurst, New Jersey for a full-scale demonstration. Later that month, the USS Manasquan, a Coast Guard weather ship, carried another receiver on an extended long-range observation trip. The frequencies 1.95 MHz and 7.5 MHz were used. The tests were successful and the results reached high into Army and Navy command levels. Loran had arrived.

The introduction of Loran service occurred during the summer of 1942 when the military decided to build chains in the North Atlantic and the Aleutian areas. The equipment cost was \$1,250,000 (in 1942 dollars). By 1943, the use of sky waves from Loran signals became established as a feasible method for measuring position. "Sky-wave Synchronized Loran" (usually called SS Loran), which was usable only at night when the upper atmosphere provided the necessary reflections, enabled navigation over ranges on the order of 1200-1500 miles from the transmitting stations. With that range capability, navigation deep into central Europe—deeper into enemy territory than possible using any other existing system—became feasible. Transmitting stations in North Africa and Scotland provided navigation for bombers flying into enemy territory. Loran systems later spread to the Pacific coast and to the China-Burma-India theatre where they helped pilots fly over the Assam Hump (the Himalayas) in late 1944. Loran chains in the Pacific were planned for covering as much of the advance to Japan as possible. They also covered the supply routes from Hawaii and the U.S.

The U.S. Coast Guard, as an operating agency for the Navy, constructed, installed, and ran the Loran stations that were under the cognizance of the Chief of Naval Operations. The Coast Guard's association with Loran began in 1942. As part of its task to build and operate the ground stations, the Coast Guard began a training program on ground-station equipment and enough men were trained so that the stations could be taken over by the Coast Guard in January 1943. Training and station manning were handled by the Coast Guard throughout the war and afterwards. By November, 1945, about 70 million square miles of the Earth's surface was served at night by Loran chains. Since the war, Loran has continued to develop and has moved to 100 kHz, where it's called Loran-C.

Heathkit



A completely mobile, programmable, electro-mechanical robot, HERO® 2000 is capable of interacting with its environment free of external control.



Hams! Get the latest in amateur radio technology including high-speed Packet Radio Communication.



Powerful new IBM-PC compatible Heathkit computers are yours to build easily and save with, or to buy assembled.



Build from our full line of precision test instruments and see how they can increase your troubleshooting effectiveness.



New Digital Rain Gauge records rainfall accurately and reads out inside your home in 100ths of an inch.

Your guide to everything that's new in electronics, computers and technical education. Over 400 items. Discover fascinating kits to build, enjoy and learn with, as well as assembled high tech products for home, business and hobby.

Get our famous High Tech Catalog

FREE

Heathkit

Heath
Company

Heath Company
Dept. 020-534
Benton Harbor, Michigan 49022

MAIL COUPON TODAY and receive the latest issue of the Heathkit Catalog free of charge

Name _____

Address _____

City _____ State _____

CL-783BR3 Zip _____

Loran

There are two kinds of modern Loran: The Loran-A and its replacement, Loran-C. The primary difference between the two is the operating frequencies. Loran-A operates in the 1.8-2.0 MHz range, while Loran-C operates at 100 kHz, a frequency that suffers less from skywave interference and thereby provides more reliable groundwave service. Hence, Loran-A was gradually phased out as coastal Loran-C was phased in during the mid 1980's.

Loran-A and C operates by measuring the difference in arrival time between pulses broadcast by at least two stations located hundreds of miles apart. For example, the Great Lakes Loran-C system employs four transmitters located in Indiana, Minnesota, New York, and Florida.

A Loran receiver locks to the pulses and converts them to map coordinates. Then the user simply correlates the coordinates with a map having the coordinates for various Loran systems.

Loran-C ground stations provide navigation signals 24 hours a day, every day. To use the signals, a navigator needs a Loran receiver and charts (or a computer data base) calibrated with Loran time-difference lines. The receiver measures the difference in arrival time between a radio-frequency pulse from a master station and one from a slave station. The slave transmits after it synchronizes with the master's signal: It waits a precisely fixed time period called a *coding delay* and then tracks any drift in both the master station's pulse-repetition rate and its frequency of operation.

A Loran system—which is called a "Loran chain"—consists of three to five land-based transmitting stations that serve a specific geographic area. Within a chain, only one station is a master, the others are slaves, but each master and slave combination—called a "pair"—transmits a distinctive pulse rate.

In the early Loran systems, the navigator required data from two separate master/slave Loran chains in order to determine his precise location. In the Loran-C system, only one master station is required because it works in conjunction with two to four secondary (slave) stations.

Because the master and each slave generates a unique pulse-repetition rate, a navigator can distinguish one master/slave pair from another. Often, the signals from several chains can be received within a given area and the navigator must select those being the most reliable at the time of reception.

In most modern Loran receivers, a computer compares the received signals with a prestored data base and automatically selects the best chain for the area. So-called "second-generation" receivers measure the signals from more than one

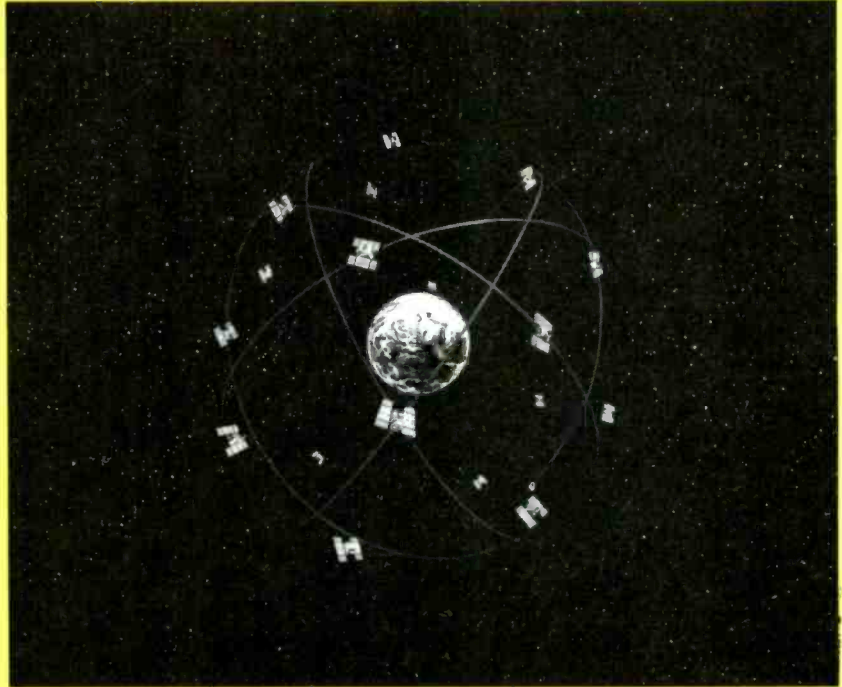

The NAVSTAR satellites are arranged as a constellation around the Earth.

Although Loran-C is extremely effective, it doesn't cover the entire world. Even in the U.S. there are broad areas—such as our Midwest—that are not yet fully serviced by Loran-C.

But if everything goes according to schedule, within a few years virtually every inch of the globe will be serviced by a satellite-generated GPS (Global Positioning System).

GPS, a spin-off from the NAVSTAR satellite-positioning system being deployed by the Department of Defense, consists of 18 satellites arranged as a constellation around the earth. Although the satellites are intended for military applications, each radiates a signal that will be made available without charge for civilian applications. It is those signals that are used for the GPS network.

Similar to conventional Loran-C, GPS works by measuring the timing of signals. Using spread-spectrum transmitting techniques, each satellite broadcasts a signal telling where it was at the time of transmission. (For more information on spread-spectrum communications, see the April, 1987 issue of *Radio-Electronics*.) The GPS receiver decodes the signal to determine the distance to the satellite. By integrating the data from two satellites the receiver knows it is on a particular great circle. By integrating the signal from a third satellite the receiver can calculate its exact location on the circle to better than 300 feet.

A major complication is that the receiver must know the precise time the signals are received, because when dealing with satellites on an *is-was* basis the timing accuracy must be better than a millionth of a second. Since such accuracy is simply

not economically feasible in civilian equipment, the timing signal is obtained by measuring the distance to a fourth satellite, and then having the receiver's computer do the complex calculations needed to synchronize the receiver and satellite clocks.

Although the receiver determines its position in latitude and longitude, the data can be integrated with an electronic map—a local area shown in detail on a display device—that uses a block cursor or other form of marker to indicate the receiver's position. In this way, either the map, the marker, or both can scroll to indicate the movement of the vehicle, ship, or aircraft.



A USER'S position is indicated by a block cursor on this electronic map.

It is conceivable that waypoints could be programmed into the receiver so that ETA and direction displays, or an alarm or a synthesized voice warning of an upcoming turn, would be generated.

In short, just about anything that can be done using Loran-C can be done with GPS—only more accurately.

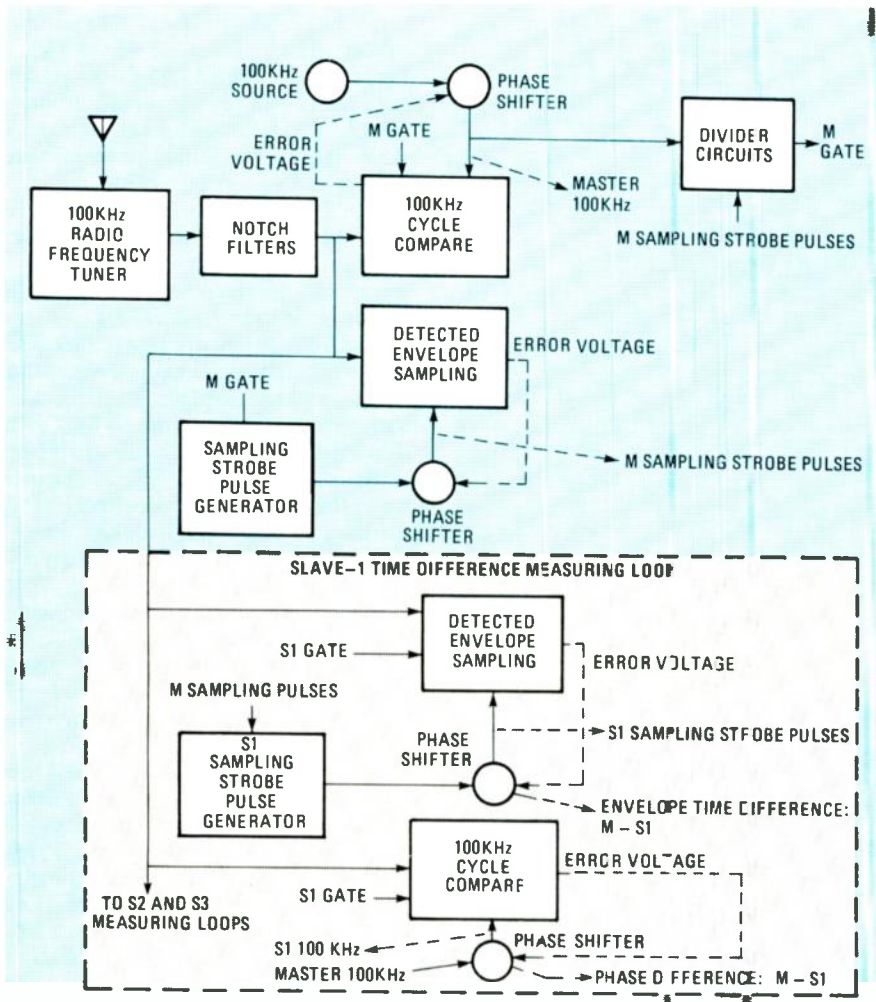

FIG. 5—A KEY TO THE ACCURACY of Loran is the receiver's ability to track its local oscillator to that of the master station through a 100-kHz Cycle Compare circuit—actually a conventional phase-locked loop.

Once the master is detected, the receiving equipment establishes a zero reference for time measurement and counts microseconds until it receives each slave.

Rounded pulses

If a Loran signal were suddenly broadcast as pulses of 100 kHz it would contain a squarewave component, and the bandwidth would spread into the fourth and fifth harmonics of 100 kHz causing interference. Further, the useable range of the signals would be reduced. At the receiver, the pulse's rise time would be distorted and the reference to specific 100 kHz cycles would not be possible.

To obtain the precision needed in Loran-C measurements, the transmitting equipment shapes the 100-kHz pulse as shown in Fig. 4. The rise time of a Loran-C pulse increases gradually and results in a precisely-defined envelope. Sampling gates compare the phase of each pulse by sampling at a specific point along the pulse's leading edge. The sampling point, derived from the shape of the pulse envelope, occurs within the first few cycles of 100 kHz and thus avoids the possibility of



FIG. 6—By combining a computer with user-programmed memory, a relatively inexpensive Loran receiver such as this Heath Model 2980 Personal Loran can display location, bearing and time to waypoints, and even off-course direction.

sampling a sky wave that arrives at the antenna some time later.

Because the pulse shape eliminates high-frequency components in the transmitted signal, the signal's bandwidth is a

relatively narrow 90–110 kHz. If a source of radio energy near the receiver operates on a frequency that would interfere, the Loran-C's narrow-band design allows notch filtering to eliminate the interfering frequency without filtering the navigation signal. Since receivers can be made very sensitive by using narrow-band amplifiers, the RF section of the Loran-C receiver is effective on ground-wave signals originating thousands of miles away, and thus reduces the cost for servicing a great portion of the earth.

Loran-C equipment functions

A Loran-C receiver is analogous to an array of cogged wheels and gears that slowly turn and grind away at numbers planned by the system designer. As one wheel rotates, driven by some outside force, all the wheels turn as the entire system adjusts.

Elsewhere in the system, additional forces operate on a subset of the wheels, and the difference between those wheels, and other wheels drive still more wheels, and so on.

Fortunately, Loran-C is completely electronic. Instead of cogged wheels, a Loran-C receiver contains complex arrays of time-measuring circuits that comprise a precise, automatic-tracking system.

Space prevents showing a complete schematic of a Loran-C receiver. Instead, Fig. 5 contains an overall functional block diagram. The figure is adequate for understanding the functions of the nested phase-lock loops and for appreciating how reference signals, gate voltages, and sampling strobe pulses lock to Loran-C radio signals and measure the time differences between groups of 100-kHz pulses.

The tuner amplifies an input from an antenna and usually contains notch filters to eliminate unwanted signals close to the frequency of the Loran-C signals. Although the notch filters are shown as a separate section, they are actually integrated with the tuner. The input to the blocks labeled 100 kHz Cycle Compare and Detected Envelope Sampling consists of pulses from the Loran-C stations—time-ordered Master, Secondary-X, Secondary-Y, etc. The receiver controls the compare function with sampling gate voltages that are coincident with a received pulse group. Since the receiver derives the timing of those gates from the strobes that sample the pulse envelopes, the sampling gate timing automatically tracks the reception of the 100-kHz transmissions.

The receiver develops its strobe and gate voltages from a 100-kHz oscillator that is phase and frequency locked to the master station. To lock to the master, the receiver performs the functions shown in the top portion of Fig. 5. A 100-kHz Cycle

continued on page 69

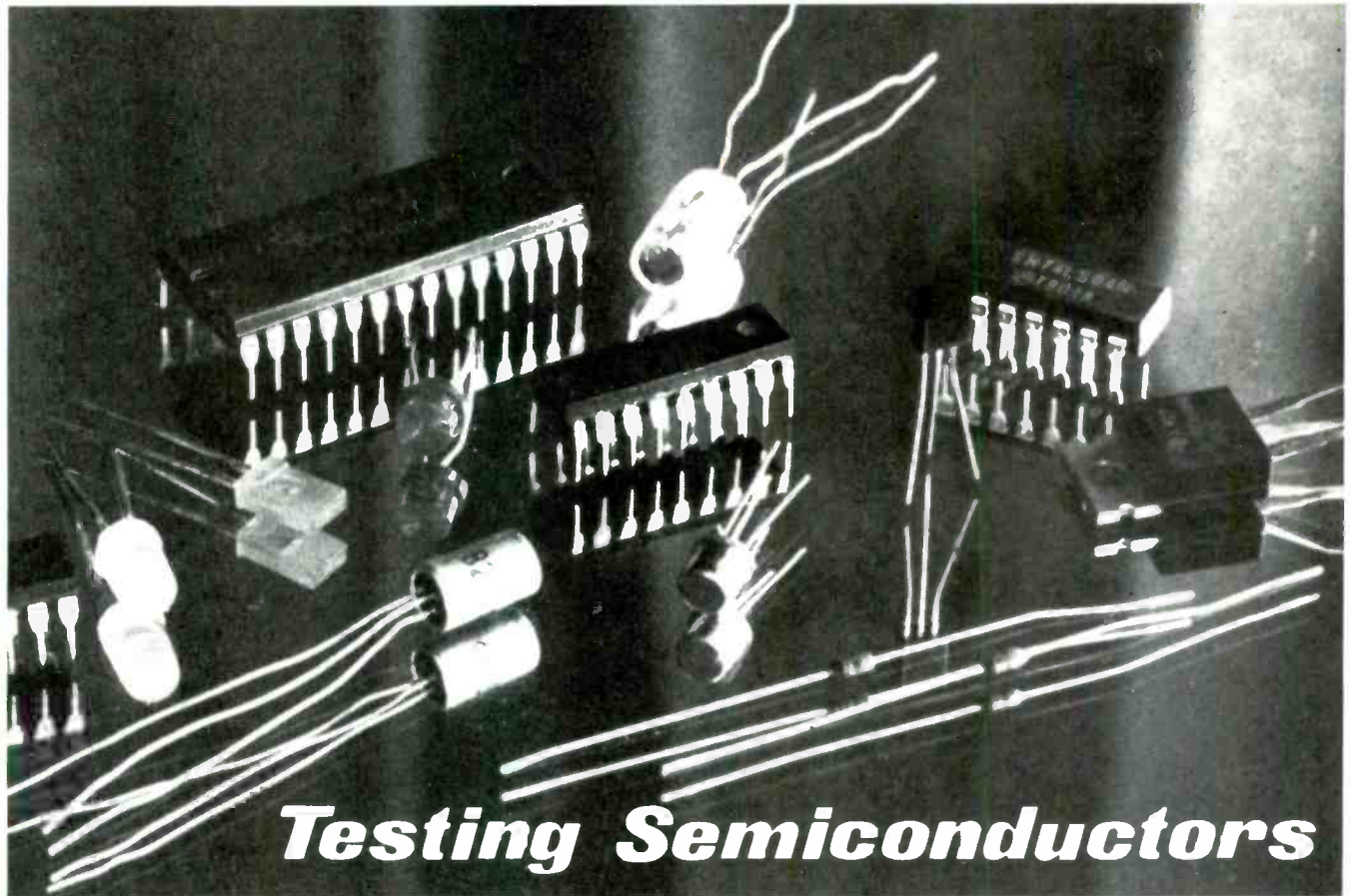

Thyristors are basically a family of electronic switches and triggers; even their tests are related.

TJ BYERS

Part 4 THE NEXT SERIES OF semiconductors we will explore is a group of devices called *thyristors*. Thyristors are multi-layer devices used primarily for power control and trigger applications. The thyristor family includes the Diac, Shockley diode, SCR, Triac, and the unijunction transistor.

Thyristors find wide application in 60-Hz power control and DC power-supply applications. Modern light dimmers, for example, use thyristors as the active control element. Let's begin our discussion with the best known member of the thyristor family, the SCR.

Silicon-controlled rectifier

The SCR is essentially a PNP Shockley diode with a control element added. It is a three-terminal device consisting of a cathode, a control gate, and an anode. A transistor analogy of the SCR is shown in Fig. 1-a and Fig. 1-b.

Figure 1-a shows two transistors connected in a loop, or feedback configuration; what happens to one affects the other. Imagine that a positive voltage

is applied to the terminal labeled "anode" and a negative voltage is applied to the terminal labeled "cathode." There is no conduction from anode to cathode.

If a positive voltage (or current) is applied to the "gate" terminal, Q2 will conduct. Q1's base will be pulled effectively to the voltage on Q2's base, and Q1 will conduct. With Q1 and Q2 conducting, current flows from anode to cathode.

Even if the gate voltage is removed, the current from Q1's collector will be applied to Q2's base, thereby keeping Q2 "turned on," which in turn keeps Q1 turned on through the Q2-collector/Q1-base connection. Hence, anode to cathode conduction is maintained.

Figure 1-b shows the internal construction of a four-layer NPN device, an SCR, that will perform the same as the two-transistor circuit shown in Fig. 1-a. When the SCR is forward-biased (the anode voltage being positive with respect to the cathode) the device acts as a switch. With no voltage applied to the gate electrode, the SCR remains in an off condition; that is, no current flows. But apply a small current to the gate and the SCR triggers: It now conducts current in a manner similar to a bipolar diode. As long as the SCR remains forward-biased, current will continue to flow—even if the gate current is removed. Current flow can only be stopped by removing the cathode-to-anode voltage or by reverse-biasing the SCR. With the SCR conducting, the gate cannot be used to control the SCR.

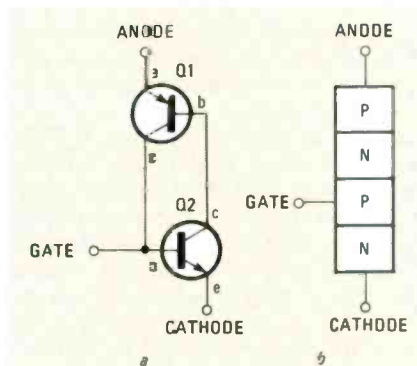

FIG. 1—THE SCR IS A FOUR-LAYER device having the electrical equivalent of two self-feeding transistors.

The secret to the SCR's success lies in the ratio between the control current and forward conducting-current. An SCR with an anode current of 100 amperes can be controlled by a gate current as small as 50 mA.

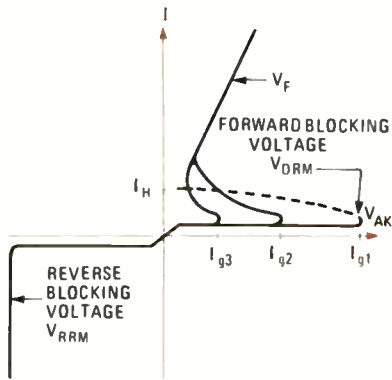

FIG. 2—The CHARACTERISTIC SCR function curve shows the forward blocking-voltage (V_{DRM}) limit.

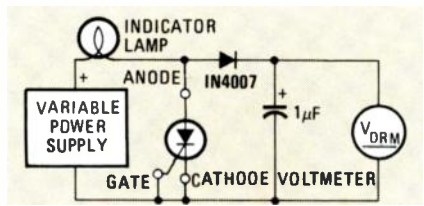

FIG. 3—THE INDICATOR LAMP in this V_{DRM} test configuration serves the dual role of indicator and load.

Breakdown voltage

There are four static parameters very basic to SCR applications. The first is the forward blocking-voltage, or V_{DRM} . The forward blocking-voltage determines how much voltage can be applied in the forward-biased mode without exceeding the voltage limits of the SCR. If the V_{DRM} of the device is exceeded, the SCR conducts just as if a trigger current had been applied to the gate. A typical SCR voltage to current curve is plotted in Fig. 2.

A circuit for testing V_{DRM} is shown in Fig. 3. V_{DRM} is tested by applying an increasing voltage across the SCR in the forward direction and noting the reading on the meter. The voltage will continue to rise until V_{DRM} is reached. At that point, the gate junction goes into avalanche, the current being generated by leakage flows through the SCR, and it fires.

You must watch the meter carefully, because after the SCR fires the reading will creep downward as the charge across the capacitor bleeds off through the meter's resistance.

The reverse blocking voltage (V_{RRM}) is the amount of voltage the SCR can sustain in the reverse-biased mode. Like its diode counterpart, the SCR goes into avalanche when V_{RRM} is exceeded. Since V_{RRM} occurs on the Zener portion of the curve,

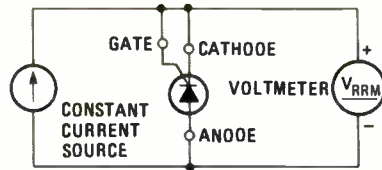

FIG. 4— V_{RRM} IS MEASURED using a constant-current source.

excessive reverse voltage does not trigger the SCR mechanism. The test configuration for V_{RRM} is shown in Fig. 4.

Leakage currents may, of course, be taken during the test by inserting an ammeter in series with the anode lead. The values of I_{DRM} and I_{RRM} can be measured. Typical leakage figures fall within the 10 μ A to 200 μ A range, depending on the ambient temperature.

Some manufacturers list the values V_{DRM} and V_{RRM} as V_{FBO} and V_{RSOM} , respectively. Those values are taken to mean the highest repetitive voltages that the SCR will sustain under 60-Hz operating conditions, and are the textbook definitions given to thyristor testing. They are by no means standard, only vintage, and not in common usage today. Absolute, non-repetitive breakdown values are listed separately. We mention them only because they might appear in application notes and books presently in your reference library.

Gate control

The third SCR parameter is the gate-control current, or I_{GT} . The gate current controls the forward-bias voltage at which the SCR fires. As the anode-to-cathode voltage across the device decreases, a larger I_{GT} is required to fire the SCR, as shown in Fig. 2. The value of I_{GT} is also dependent on the value of I_{anode} , which is governed by the load. Consequently, different circuit configurations require different trigger currents.

To test for I_{GT} , simply insert a current meter in series with the gate and increase the gate current until the SCR triggers: That is your I_{GT} value. Manufacturers most often specify I_{GT} with a resistive load of 100 ohms and an anode voltage of 7.

Although the criteria for turn-on have been described in terms of current, it is also important to consider the voltage aspect of SCR triggering. Basically, the gate is a P-N silicon diode junction and displays the same characteristic forward-voltage drop. While the value of V_G (gate voltage for triggering) varies from device to device, it normally falls between 0.5 volts and 1.0 volts. The gate also displays the classic reverse breakdown characteristics, V_{RGM} . Both V_{GT} and V_{RGM} are measured using the methods we examined last month for diodes.

Since the junction leakage currents and the current gain of the "transistor" ele-

ments within the SCR increase with temperature, the magnitude of I_{GT} decreases as temperature increases. Likewise, V_{GT} exhibits a voltage drop as temperature increases. Consequently, measurements taken at a specific temperature don't reflect the SCR's parameters at all temperatures, and it is important that SCR gate drivers be engineered to deliver sufficient current and voltage to the gate at the lowest anticipated ambient temperature.

Latch and hold characteristics

Once the thyristor has fired, the control voltage can be removed. Certain conditions must exist, however, if the SCR is to continue conducting after the gate current is removed.

It is necessary to have sufficient current flowing through the four layers to raise the loop gain to unity: Referring to our analogy in Fig. 1, we can take that to mean that the current flowing through the collector of Q1 must be high enough to sustain the saturation voltage of Q1. Otherwise, the self-feeding process can't sustain itself.

In order for the SCR to turn off, the anode-cathode current must be reduced below the latch level. The current level at which the SCR drops out of conduction is referred to as the "holding current," I_H .

I_H is tested by first forcing the SCR into conduction by applying gate current while holding the anode current (I_{anode}) above the threshold level. The anode current is then reduced until the SCR stops conducting. The last I_{anode} value noted just before conduction stops is equal to I_H . Depending on the type of SCR under test, I_H may vary from a few microamperes to several milliamperes.

Triacs

The Triac is a three-terminal multi-layer switch that operates much like an SCR. Unlike the SCR, the Triac is bidirectional and will conduct current in either direction when triggered. The Triac also differs from the SCR in that either a positive or negative current at the gate can trigger conduction, regardless of the polarity across the device.

Essentially, the Triac is two SCR's wired in inverse parallel (back to back). Through a clever manipulation of silicon geometries, the two gates behave as one and the anodes and cathodes share opposing terminations. That is, the cathode of one is connected to the anode of the other.

Because the Triac is a bilateral switch, the terms anode and cathode have no meaning. The Triac is symmetrical in all respects and the terminals are simply assigned the labels MT1 and MT2, meaning Main Terminal 1 and Main Terminal 2. The gate, designated G, is common to both main terminals and is used for triggering the device. To avoid confusion, it has become standard practice to specify all currents relative to MT1.

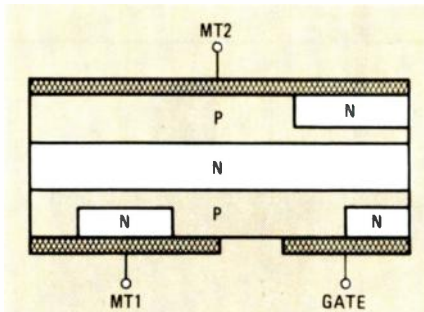

FIG. 5—A TRIAC BASICALLY HAS a symmetrical structure.

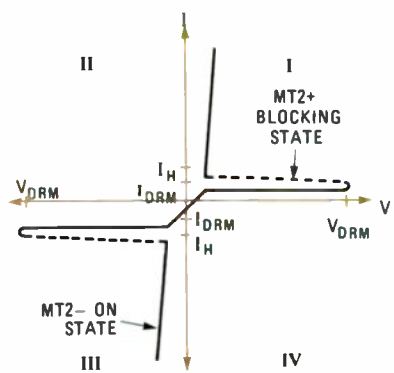

FIG. 6—THE SYMMETRY OF A TRIAC can be seen in its function curve. Compare quadrants I and III.

The internal structure of a Triac is shown in Fig. 5, and its voltage-current characteristics (without any gate current) are shown in Fig. 6. The first quadrant of the graph, identified by I, is the region where MT2 and the gate are positive with respect to MT1. Quadrant III shows MT2 and the gate negative with respect to MT1.

The relative gate sensitivity of a Triac depends on the physical structure of a particular device.

Gate voltage, too, is different for a Triac than for an SCR. Because the Triac is a five-layer device as opposed to the SCR's four layers, the gate-region parameters become very complex. As a rule of thumb, gate voltages for a Triac range from 2.5 to 3.5.

Testing Triacs

Testing of Triacs is done using the same test circuits that are used for SCR's. In fact, several of the terms used to describe SCR characteristics are also used to define Triac characteristics. V_{DRM} , for example, is the forward blocking-voltage. The holding current is labeled as I_H and the triggering current is still defined by I_{GT} .

V_{DRM} is tested in both directions, which eliminates the V_{RRM} test altogether. The test is performed using the circuit shown in Fig. 3. Remember to leave the gate lead open and to take measurements in both directions by reversing the connections to the main terminals. Should a discrepancy exist, the actual V_{DRM} voltage is the lower of the two mea-

sured values. Gate sensitivity is measured in all four quadrants.

SCR switching characteristics

In addition to their traditional role of power control, thyristors are being used in a wide variety of other applications where the switching characteristics of the device are important. That includes both the turn-on and turn-off requirements of the thyristor

While the criteria for turn-on has been largely described in terms of current, we must consider the thyristor as being a charge-controlled device. The gate-pulse requirements depend on the time required for the anode to reach the latching value, a parameter known as the "turn-on time," and listed as t_{gt} . The turn-on time consists of two stages: a delay time t_d and a risetime t_r as shown in Fig. 7.

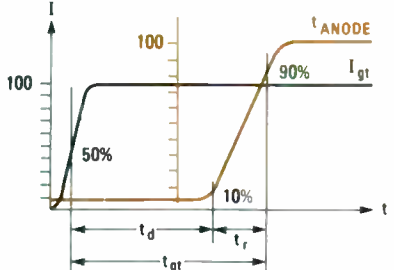

FIG. 7—AN SCR's TURN-ON time is composed of delay time t_d and rise time t_r .

The risetime is the time interval required for the anode current to reach 90 percent of its maximum value. It is measured between the 10-percent and 90-percent points. The risetime is influenced primarily by the off-state voltages. The greater the anode voltage, the larger the regenerative gain within the thyristor, and the faster the anode current is achieved.

Delay time is the amount of time that the anode current must be maintained before the gate signal can be removed. Delay time increases slightly as the peak off-state voltage increases. Its value is primarily related to the magnitude of the gate-trigger current and displays an inverse relationship. The greater the gate-trigger current the shorter the delay time.

Unlike the previous tests in this series, t_{gt} is a dynamic test that must be performed using an oscilloscope and a pulse generator. The basic elements of the test circuit are shown in Fig. 8.

The oscilloscope is triggered by the pulse generator as the pulse is applied to the gate. The sweep is adjusted to display the rise of the anode current and the trigger pulse with respect to time. The total turn-on time, t_{gt} , is defined as the time interval between the 50% point on the leading edge of the trigger pulse and the 90% point of the anode current, as recorded in Fig. 7.

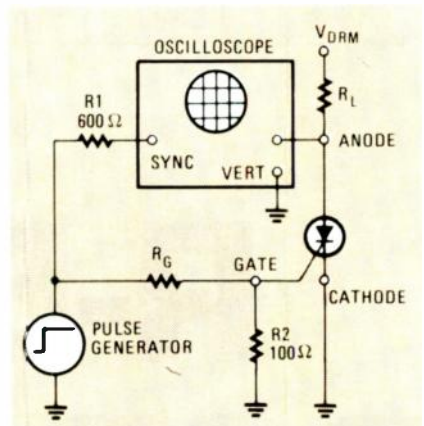

FIG. 8—AN OSCILLOSCOPE and a pulse generator are all that are needed for a t_{gt} test circuit.

dv/dt

A very special—and important—thyristor parameter is something called dv/dt . Simply stated, dv/dt is a turn-on effect that is created when a voltage is applied suddenly to the anode. The effect is the result of internal capacitance inherent in the SCR's design.

When applying a voltage to the anode of an SCR, we are in effect charging the internal capacitor that exists between the anode and the gate. If the applied voltage exceeds the gate's trigger current, I_{GT} , during the charging of the internal capacitance, the SCR switches on. The device then conducts, and the gate has no control over the current flow.

The way to counteract the effect is to apply the voltage slowly enough so that I_{GT} is never exceeded. We do that by increasing the rise time of the anode voltage. In other words, we slow down the rate at which the voltage is applied.

Turn-off characteristics

SCR turn-off is usually done through interruption of the anode current. Once the anode current ceases, a period of time must elapse before the SCR can again block a forward voltage. Turn-off time, t_q , is governed by the amount of time it takes for the stored charge inside the SCR to dissipate and re-establish forward blocking.

In actual practice, there can be a wide difference in the stored charge between SCR's with similar voltage and current ratings because the charge is partially dependent on the absolute value of the applied voltage. For example, although an SCR might be rated 1000 PRV, it can be used in circuits where the applied voltage is a small percentage of $PRV_{(max)}$, say 50 volts, or in circuits where the applied voltage is near the absolute maximum rating of 1000 volts. Normally, variations in the discharge time can be ignored.

So much for this session. Next time we'll begin a study of dynamic measurements.

R-E ROBOT

An in-depth look at the robot's control electronics.

Part 6 THIS MONTH WE TURN our attention to the robot's control electronics. All of the power and control circuits for the unit are located on a single control PC board. That includes the regulated power supplies, a "sleep" circuit to periodically start the robot's activities, a 16-channel 8-bit analog-to-digital converter, digital I/O as required, and the controllers for the two drive motors. The control board has a user connector, PL1, with 8 digital outputs, 4 digital inputs, and 8 analog inputs. A pinout of the user connector is shown in Table 1.

In addition, a simple 8-bit "RERBUS" (*R-E Robot BUS*) expansion bus, PL3, provides a method of integrating more elaborate projects into the robot's architecture. A pinout of the RERBUS connector is shown in Table 2.

Control architecture

There is an old Chinese proverb that says: "There are more ways than one to skin a cat... as long as you kill it first." So it is with the design of a sophisticated electronics project like the R-E Robot. We know many of the capabilities that we would like in the finished unit. We may even know the specific circuit-design approach that we will use. We also probably have several "gray areas" where not enough time has been spent at the test bench to convince ourselves that our first attempt will work.

There is also the future to consider: How are unforeseen changes in the design of the robot or its applications going to be accommodated? We are faced with a multitude of design decisions that will determine the character of the electronics.

The architectural design of the elec-

tronics can be divided into two philosophies: One is to build it all on one board; the other is to adopt a bus-oriented approach. The main advantage of the single-board approach is minimized cost. However, all risks are greater with that approach. Errors in design as well as adding future options or upgrades will all

TABLE 1—USER-CONNECTOR PIN OUT (PL1)

Pin number	Function
1	+ 5 volts
2	+ 5 volts
3	analog channel 0
4	analog channel 7
5	analog channel 1
6	analog channel 3
7	analog channel 6
8	analog channel 5
9	analog channel 2
10	DO out
11	analog channel 4
12	D4 out
13	battery (unswitched)
14	D1 out
15	robot awake
16	D2 out
17	D4 in
18	D3 out
19	D5 in
20	D5 out
21	D6 in
22	D6 out
23	D7 in
24	D7 out
25	ground
26	ground

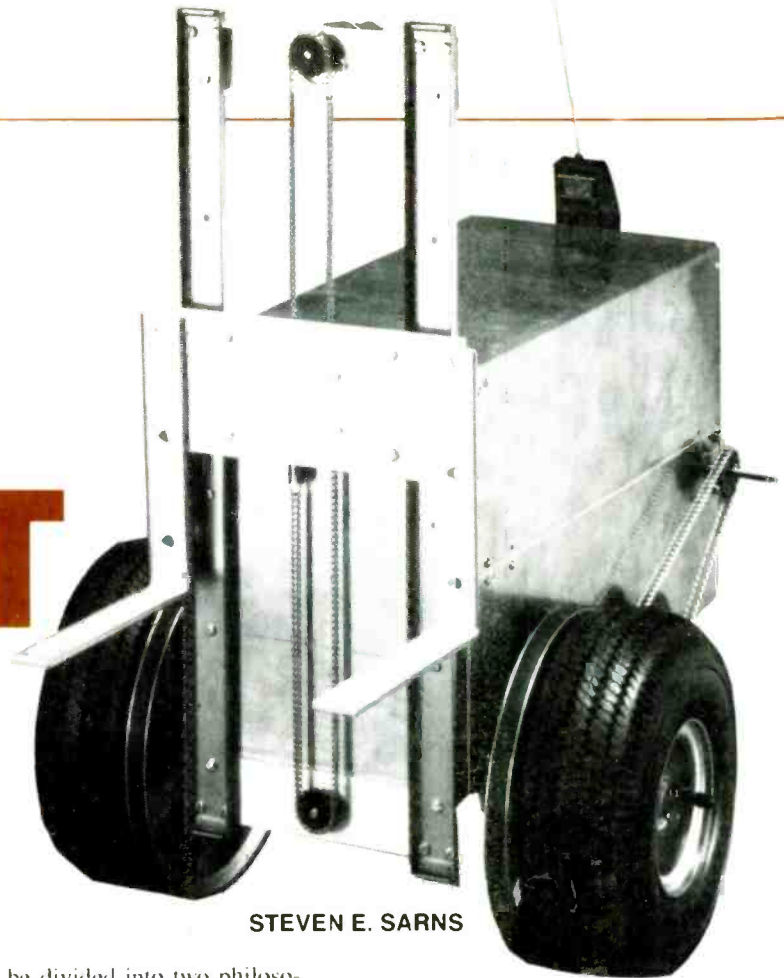

STEVEN E. SARNS

TABLE 2—RERBUS PIN OUT (PL3)

Pin number	Function
1	+ 5 volts
2	+ 5 volts
3	WR
4	D7
5	RD
6	D6
7	A1
8	D5
9	A0
10	D4
11	A2
12	D3
13	A3
14	D2
15	analog channel 15
16	D1
17	analog channel 14
18	D0
19	ground
20	ground
21	high-current ground (SPG)
22	high-current ground (SPG)
23	battery (switched)
24	battery switched)

require a complete re-design. The bus approach will allow future expansion, but at an increased total system price (more boards to build).

The design approach used in the robot is therefore a combination of those two approaches. A single control board has

PARTS LIST

All resistors 1/4-watt, 5%, unless otherwise noted

R1, R4, R6, R7—not used
 R2, R12, R16, R18–R20, R22, R23, R26–R28, R30, R34, R36, R37, R39, R41, R44—10,000 ohms
 R3—62,000 ohms
 R5, R9—15,000 ohms
 R8—4700 ohms
 R10—220 ohms
 R11, R35, R42, R43—1000 ohms
 R13, R14—1 megohm
 R15, R38—47 ohms
 R17, R24, R40—100 ohms
 R21, R29—0.1 ohms, 5 watts, 1%
 R25, R31–R33—100,000 ohms

Capacitors

C1, C2, C4, C5, C13–19, C22, C25, C27, C31—0.1 μ F, monolithic ceramic
 C3—100 pF, 50 volts, ceramic disc
 C6, C10, C21, C30—2.2 μ F, 50 volts, ceramic disc
 C7—0.002 μ F, 50 volts, ceramic disc
 C8—330 pF, 50 volts, ceramic disc
 C9—0.047 μ F, 50 volts, ceramic disc
 C11, C12—2200 μ F, 25 volts, electrolytic
 C20, C23, C24, C26—10 μ F, 16 volts, electrolytic
 C28, C29—not used

Semiconductors

IC1, IC2—4051 multiplexer
 IC3, IC6—74LS541 octal buffer/line driver
 IC4—74LS377 octal D-flip-flop
 IC5—ADC0804 8-bit A/D converter
 IC7, IC8—74LS374 octal D-flip-flop
 IC9—L296 switching regulator (SGS)
 IC10—74LS645 octal three-state bus transceiver
 IC11—74LS125 quad three-state buffer
 IC12—74LS266 quad 2-input exclusive NOR gate
 IC13, IC14—8253 programmable interval timer
 IC15—74LS32 quad 2-input OR gate
 IC16—74ALS520 8-bit comparator
 IC17—74LS164 8-bit serial-in/parallel-out shift register
 IC18—74LS393 dual 4-bit binary ripple counter
 IC19—74LS138 1-of-8 decoder
 IC20—LM358 dual op-amp
 IC21—74LS259 8-bit addressable latch
 IC22—ULN2003 Darlington array
 IC23, IC25—4046 PLL
 IC24—74LS00 quad 2-input NAND gate
 IC26—4060 14-stage ripple counter
 IC27—4078 8-input NOR/OR gate
 IC28, IC29—dual D-flip-flop
 IC30—LM340-12 12-volt regulator

Q1, Q5—2N3906 PNP transistor
 Q2, Q6—TIP29A NPN transistor
 Q3, Q7—2N3772 NPN transistor
 Q4—2N3904 NPN transistor
 SCR1—C106Y1 (GE) SCR
 D1, D3, D4, D9, D10—1N4001 rectifier
 D2, D5, 1N5400 rectifier
 D6, D7—1N4148 switching diode
 D8—1N754 6.8-volt Zener diode
 D11—8R05 Schottky diode (SGS)

Other Components

L1—300 μ H
 RY1–RY5—DPST relay, 12-volt coil, Fujitsu FBR-631D012 or equivalent
 PL1, PL3—26-conductor plug, dual row, 0.025-inch spacing
 PL2, PL6—10-conductor plug, dual row, 0.025-inch spacing
 PL4—60-conductor right-angle plug, dual row, 0.025-inch spacing
 PL5—2-conductor plug, single row, 0.025-inch spacing
 TS1—6 connector terminal strip
 B1—see text

Miscellaneous: PC board, IC sockets, heat sinks (Thermalloy 601 or equivalent for IC9, Thermalloy 286 or equivalent for IC30), mounting hardware, nuts, bolts, wire, solder, etc.

been designed that provides (together with the RPC—Robotic Personal Computer) all of the functions required by the basic robot. The control board also provides two easy expansion opportunities—the user and RERBUS connectors—in addition to the RPC computer bus.

Before we get to the actual construction of the control board, let's look at some of the control and power circuits in detail. Refer to the schematic in Fig. 1 as we proceed. Note that the power and ground connections for the IC's are not shown in the schematic; where applicable, they are listed in Table 3.

Power supplies

Power-supply considerations are one of the toughest problems in robot design. Questions like the following must be considered and answered: Should the battery charger be onboard or remote? Should multiple supplies be provided? What range of DC inputs are to be accommodated? Should the power supplies be on a separate board?

The design we have chosen is an attempt to provide maximum flexibility for the user yet still use just a single, economical control board.

The 5-volt DC supply is the first section

we will focus on. The expected current draw is about 3 amperes. If we use a linear regulator, more battery power will be wasted as dissipated heat than will be delivered to the computer and control circuitry; efficiency will be 21% at best! A switching regulator is called for.

The new SGS L296 switching regulator is ideal for our application; further, it is easy to use. The input voltage range is 8- to 50-volts DC, which allows us to use either one, two, or three 12-volt auto batteries in series to power the robot. The IC is capable of supplying a 5-amp output with full short-circuit and crowbar protection. The crowbar feature provides peace of mind. If anything in the power-supply circuit should fail and put more than 5.5 volts on the 5-volt DC bus, the SCR will trigger, short-circuiting the bus to ground.

Speaking of ground, our design requires some special considerations. We will be switching up to 30 amperes at the motor controllers while trying to measure analog inputs as low as 20 mV. Meanwhile, our microprocessor system will be cooking along at 8 MHz. As you can see, we have created an ideal breeding ground for glitches, spikes, ground loops, cross coupling, and other mysterious bugs that can bring our system to its knees. Therefore, the concept of a "Single Point Ground" (SPG) must be understood and used in our design.

If we simply connect everything labeled "ground" together on our PC layout, we will have ignored the fact that even the copper interconnections have

TABLE 3—IC POWER AND GROUND CONNECTIONS

IC number	Device type	Power pin number	Ground pin number
IC1, IC2	4051	16	8
IC3, IC6	74LS541	20	10
IC4	74LS377	20	10
IC5	ADC0804	20	10
IC7, IC8	74LS374	20	10
IC10	74LS645	20	10
IC11	74LS125	14	7
IC12	74LS266	14	7
IC13, IC14	8253	12	24
IC15	74LS32	14	7
IC16	74ALS520	20	10
IC17	74LS164	14	7
IC18	74LS393	14	7
IC19	74LS138	16	8
IC20	LM358	8	4
IC21	74LS259	16	8
IC23, IC25	4046	16	8
IC24	74LS00	14	7
IC26	4060	16	8
IC27	4078	14	7
IC28, IC29	74LS74	14	7

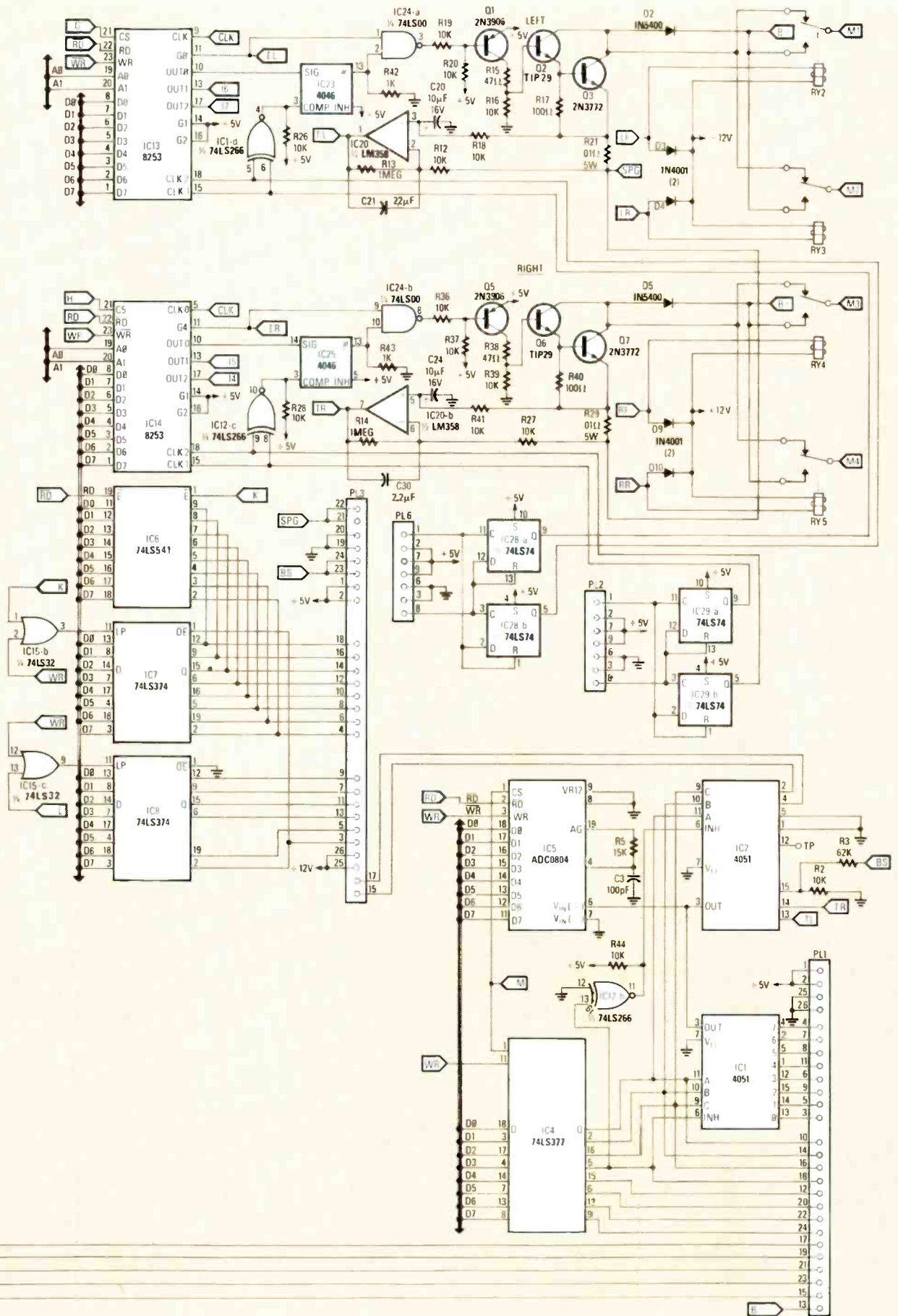

some, albeit small, resistance. In a normal, all-digital system, a few hundredths of a milliamp flowing through a resistance of a few hundredths of a milliohm will not produce enough voltage drop to affect the operation of the circuit. However, if we are dealing with amperes instead of milli-amperes, the problem becomes much more serious. We must identify the traces that carry large currents and connect those directly to some common point. That point is the single point ground, noted as SPG on the schematic. If we follow that rule throughout the design, the opportunities for ground-related problems are greatly decreased.

In our design, all of the points labeled SPG are tied together only at the single-point ground and nowhere else. In the future you modify the circuit or add some peripheral device or circuit to the system, remember to return all high-current grounds to the SPG. Frequently, it is tempting to do otherwise. For instance, when mounting a regulator that uses a TO-220 package, it is tempting to connect the tab to the chassis and to connect the chassis to ground at some other point. Don't do it! Insulate the tab and tie the ground pin directly to the single point ground.

A 12-volt DC linear regulator, IC30, is also provided to supply power for the optional disk drives and as an independent supply for the relays. Having an independent supply for the relays prevents the inductive kickback that occurs when the relays are released from affecting the operation of the computer system. If the regulator is used only to power the relays, it can be mounted on the PC board with minimal heat sinking; if it will also power disk drives, the regulator should be mounted on the robot chassis to ensure adequate heat dissipation. We'll look at that again when we get to the actual construction of the board.

The 12-volt regulator specified in the Parts List is rated for a maximum input of 35 volts. If more than two 12-volt batteries in series are used to power the robot, a voltage-dropping resistor must be placed in series with the regulator's input to ensure that the rating is not exceeded.

Sleep circuit

To conserve battery power, a sleep circuit has been added to the robot that will shut it down when certain conditions are met. The circuit includes a timing mechanism to periodically wake up the robot.

The sleep circuit is built around IC26, a 4060 14-stage counter. The counter is clocked by its internal oscillator. Resistor R34 and capacitor C23 determine the clock frequency; with the values shown in Fig. 1 that frequency is 10 Hz.

A 4078 8-input OR gate, IC27, monitors the outputs of the 4060. Any time that all of the counter's outputs are all

low, the OR gate activates the main power relay, RY1. Activating that relay connects the batteries to the power converters and energizes the robot's electronics and computer system. When one or more of the counter outputs are high, however, the OR gate de-activates the main power relay.

During normal operation, IC16 continuously resets the counter anytime the control board is addressed. That keeps the counter outputs all at zero, and as a result the main power relay is continuously activated. If the reset signal is removed, however, the counter advances, causing the main power relay to be de-energized. Therefore, the robot can be put to "sleep" simply by not addressing the control board. Once asleep, the robot will awaken when the counter outputs all return to zero. In the interim, if the control board is addressed by the RPC, a pulse will appear at the base of Q4, resetting the counter. It is also possible to externally awaken the robot via the user connector, PL1. Whatever method is used, when the robot is awakened the RPC will load all of the operating software and execute a pre-defined software routine.

You can adjust the duration of the sleep period by increasing or decreasing the clock frequency. The 10-Hz rate of the circuit shown in the schematic will cause the robot to be energized about once every hour, using specified components.

During the sleep mode, the main power relay is de-energized and the only current flowing from the battery is the power for the sleep circuit (a couple of milliamps) and leakage currents in the motor controllers (a few microamps). Therefore, the battery life during sleep is limited more by the battery's internal leakage than by the robot's power drain.

The RPC interface

The RPC is clocked at 8 MHz. A typical I/O access cycle at that clock rate will take only 12 ns, which is far too fast for many peripheral IC's to respond. A wait-state generator therefore must be included to slow the I/O access cycle.

The wait-state generator on the control board consists of IC16, a 74ALS520 decoder; IC17, a 74LS164 shift register; IC12, a 74LS266 exclusive NOR gate; and IC11, a 74LS125 three-state buffer. When an address within its range is detected by IC16, the wait-state generator immediately places a not-ready (\overline{RDY}) signal on the RPC bus. After about 1 μ s, the shift register's output goes high, placing a ready (\overline{RDY}) signal on the bus. That 1- μ s interval is now the access time for the control board.

Digital I/O

Digital I/O is the first requirement of our robotic system. We will need digital outputs to enable the two motor controllers, four more to set forward or reverse

SOURCES

The following are available from Vesta Technology, 7100 W 44th St., Wheatridge, CO 80033 (303-422-8088): Bare RE-Robot controller board, \$41; assembled and tested RE-Robot controller board, \$200; bare RPC board, \$41; assembled and tested RPC, fully populated for the robot function, \$294. Add \$8.00 shipping per board ordered. Colorado residents add appropriate sales tax. Mastercard and Visa accepted.

direction of each motor, and one for an audio "beep." Four more digital outputs will be required to select the analog-multiplexer channel. Four digital inputs will be required to monitor the status of the motor controller's terminal-count outputs. Beyond that, additional digital inputs and outputs should be provided for future applications.

It is vital that the direction-control relays, RY2-RY5, not be enabled on power-up. Otherwise, the robot will set off on an uncontrolled jaunt until the RPC completes its power-on initialization sequence, loads the application software, and assumes control. That process could take as long as 30 seconds. That means that IC21, the latch used to store the direction data, must have a clear pin. The 74LS259 used for that application meets that criteria; it is an addressable latch with clear. The reset output from the switching regulator initializes all outputs to zero upon power up. An added advantage of the addressable latch is that each data-bit address is independent of the others. That simplifies software because now a record will not have to be kept of the state of the latch and a bit mask created to change only one bit while leaving the other bits unchanged.

The analog-multiplexer-address latch, IC4, should operate on parallel data rather than independent bits. A 74LS377 was chosen for that application because its design allows for direct connection to the data bus without additional gates. The outputs of the latch are available at the user connector, PL1. Note that the upper four bits, Q4-Q7, can be used without restriction. However, the state of the lower four bits (Q0-Q3) will change anytime an analog-to-digital conversion is made.

Digital inputs are implemented using IC3, a 74LS541 bus buffer. That device has two enable pins, which allows for direct connection to the RPC bus. One enable pin is controlled by a chip-select signal generated by the RPC, the other by the \overline{RD} line.

When we continue next time, we'll look at the analog-to-digital converter, the RERBUS interface, and more. R-E

PC SERVICE

BECAUSE THE CIRCUIT BOARD FOR THE robotics-control computer will not fit on the pages of Radio-Electronics, the component side is shown here half sized. The solder side of the board will be shown next month. For those interested in receiving full-size photostats of both sides of the board, simply send a self-addressed, stamped envelope to:

Radio-Electronics
Dept PC
500-B Bi-County Boulevard
Farmingdale, NY 11735

THE SOLDER SIDE of the robot computer is shown half size. It is not a mirror image. The component side was shown last month.

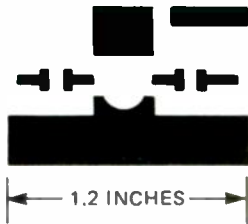
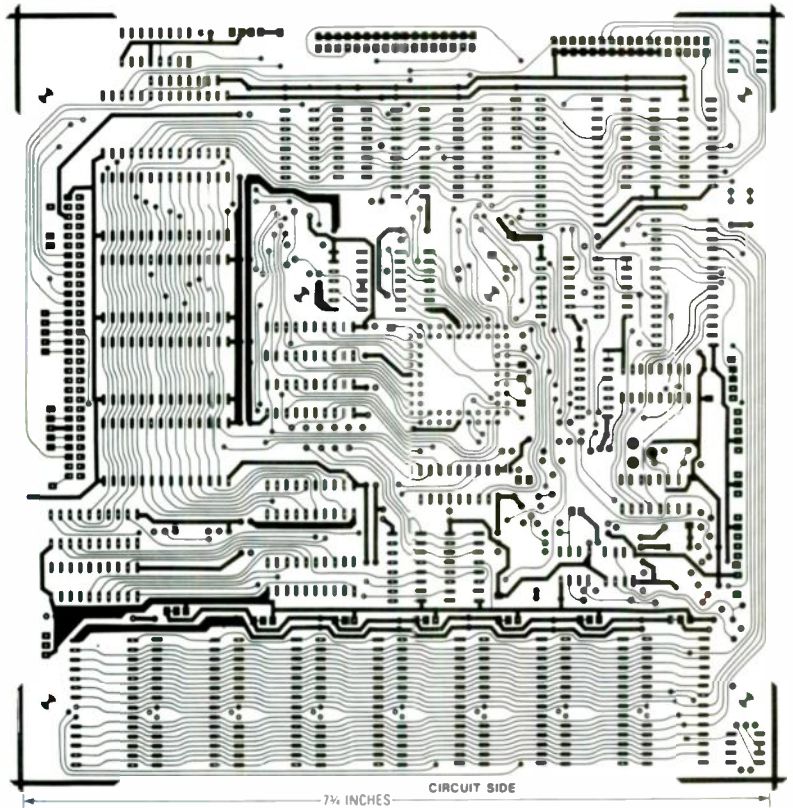

SOLDER-SIDE DIRECT-ETCH FOIL PATTERN for the wideband amplifier. The story begins on page 45.

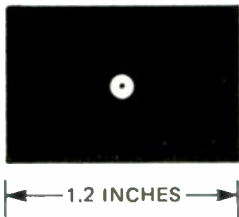

COMPONENT-SIDE DIRECT-ETCH FOIL PATTERN for the wideband amplifier.

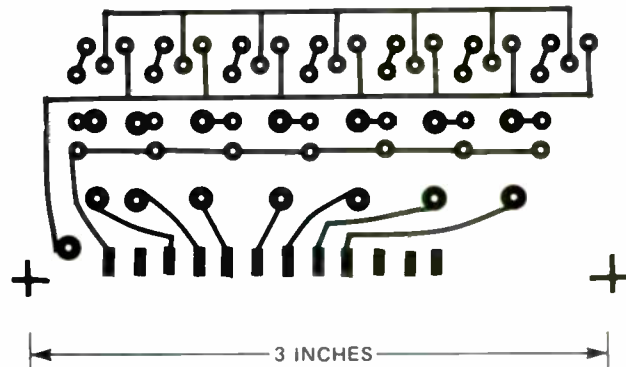

COMPONENT-SIDE DIRECT-ETCH FOIL PATTERN for the C64 Armatron controller. Don't forget to install the jumper!



SOLDER-SIDE DIRECT-ETCH FOIL PATTERN for the C64 Armatron controller. The story begins on page 144.

**PC
SERVICE**

WIDEBAND AMPLIFIER

continued from page 46

tween the NE5205 case and the groundplane. If you prefer, electrically-conductive epoxy may be used for that.

Capacitors C1, C2, and C3 are 0.1- μ F surface-mounted high-frequency ceramic chips. A small drop of quick-drying adhesive such as *Crazy Glue* will hold them stationary during soldering. Solder coupling capacitors C1 and C2 to their respective pads on the input and output signal traces. Bridge the gap between V_{CC} and the small ground plane with decoupling capacitor C3 and solder it into place.

The last step in the assembly portion of the project is to strap the top and bottom ground planes together. Don't run long wires to do that. A better, and a far easier way to accomplish the task is with inexpensive, self sticking 1/4-inch copper tape; the kind used in making stained-glass windows. (The tape can be purchased at most craft centers.) Wrap the tape around the edge of the board to the top and bottom ground planes and then flow-solder the tape to the copper foils.

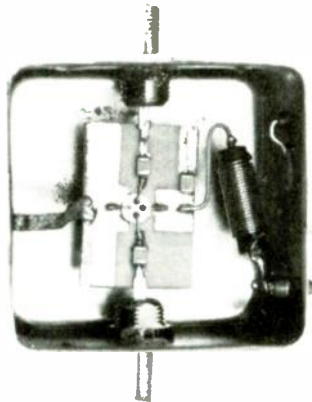

FIG. 7—THE AMPLIFIER CAN BE BUILT into existing equipment, or made part of a stand-alone device, such as this CATV amplifier.

Applications

The amplifier can be used in a wide variety of applications, such as a CATV line amplifier, a 70-MHz satellite amplifier, or a composite video amplifier. The circuit can also improve the operation of 2- to 160-meter amateur radio equipment; AM, FM, CB, and shortwave radios; 50-ohm test equipment; frequency counters; and oscilloscopes. By using a phantom power source on the signal lead, it can even be used as a rooftop antenna pre-amplifier, such as shown in Fig. 6. Your application will determine whether or not a case is needed. The board either can be incorporated in a piece of existing equipment or mounted in an RF-tight case (see Fig. 7) for stand-alone use. **R-E**

LEARNING ABOUT LORAN

continued from page 58

Compare circuit generates an error voltage when the phase of the receiver's 100-kHz signal is incorrect relative to the phase of the master 100-kHz signal. The error voltage causes a phase shift to occur until the phase of the receiver's 100-kHz signal becomes correct relative to the master. If the master frequency drifts, the error voltage becomes continuous in one direction and eventually a feedback to the receiver's oscillator will adjust the frequency to match the master. Locked to the master, the 100 kHz becomes the reference for the the strobe and the gate timing throughout the receiver. In the Detected Envelope Sampling circuit, an error voltage is generated when the master strobe pulses do not occur at the correct time relative to the received master pulses. The error voltage is fed to the Phase Shifter circuit in the loop and causes it to change the strobe timing until M Strokes occur at the correct time.

The master strobe pulses and the master 100-kHz signals are input to the slave time-difference measuring circuits where similar phase-locked loops generate error voltages and phase shifts to lock on to the slave stations. Counters are used to measure the amount of phase shifting until the signals lock to the slave and generate the time difference measurement. The strobe-pulse phase shift produces time difference measurements down to 10 microseconds, while the 100-kHz phase shift produces the 0-10 microsecond measurement.

The receiver converts the outputs from the Slave Time Difference Measurement circuits for display, and for further processing with geographic data bases

Programmable data integration

Because the Loran positioning is based on time intervals, a computerized receiver can easily integrate user-input data to determine virtually anything having to do with time, location, and speed. For example, the new Heath model 2980 Personal Loran receiver (shown in Fig. 6) permits the user to store predetermined waypoints. Using the data obtained from Loran-C signals, the receiver will display the distance between waypoints, required heading, and travel time. The display can indicate the Loran chain number, the signal-strength status of the master and secondary stations in a chain, the boat's speed, distance to home, bearing to waypoint, even which direction you might be off course. While the data in Heath's model 2980 is entered by the user, as previously mentioned, there is nothing to prevent waypoint data from being permanently stored in the receiver's memory for instant recall whenever needed. **R-E**

COMB

Authorized Liquidator



12-BAND RADIO

World-Wide Listening Excitement... is yours with this incredible Magnavox Model D1835 Multiband Radio that's portable! Due to an overstock, it's yours at a **LOW liquidation price!**

- A Number of Listening Choices: 9 Short Wave Bands, Plus Long Wave and Local AM/FM Bands.
- Lets You Tune-In Overseas Broadcasts and Listen to Action All Over the World. Plus Receive Local Music, News, Weather, and Sports Broadcasts.
- Lightweight. Easy to Carry Anywhere.
- Compact. Fits in Your Purse or Attache.
- Large Rotary Tuning Knob.
- LED Slide Rule Tuning Indicator.
- Dynamic 3" Diameter Speaker.
- Telescoping 29 1/2" L FM/SW Antenna.
- Band Selector. Volume/Tone Controls.
- Uses 4 "AA" Cells (Not Included). Size: 5"H x 7 3/4"W x 1 1/2"D. FCC Registered.

90-Day Limited Factory Warranty On Parts/Labor.

Mfr. List Price **\$69.95**

Liquidation Priced At **\$44**

Item H-2397-7127-509

Shipping, handling: \$4.50 ea.



Credit card members can order by phone, 24 hours a day, 7 days a week.

Toll-Free: 1-800-328-0609

Sales outside the 48 contiguous states are subject to special conditions. Please call or write to inquire.

SEND TO: Item H-2397

C.O.M.B. Direct Marketing Corp.

1405 Xenium Lane N/Minneapolis, MN 55441-4494

Send ___ Magnavox Multiband Radio(s) Item H-2397-7127-509 at \$44 each, plus \$4.50 each for ship, handling (Minnesota residents add 6% sales tax. Sorry, no C.O.D. orders.)

My check or money order is enclosed. (No delays in processing orders paid by check.)

PLEASE CHECK: VISA MasterCard DISCOVER AMERICAN EXPRESS

Acct No. _____ Exp. / _____

PLEASE PRINT CLEARLY

Name _____

Address _____

City _____

State _____ ZIP _____

Phone _____

Sign Here _____

COMB COMB COMB

Join the Electronics and Control Engineers' Book Club®

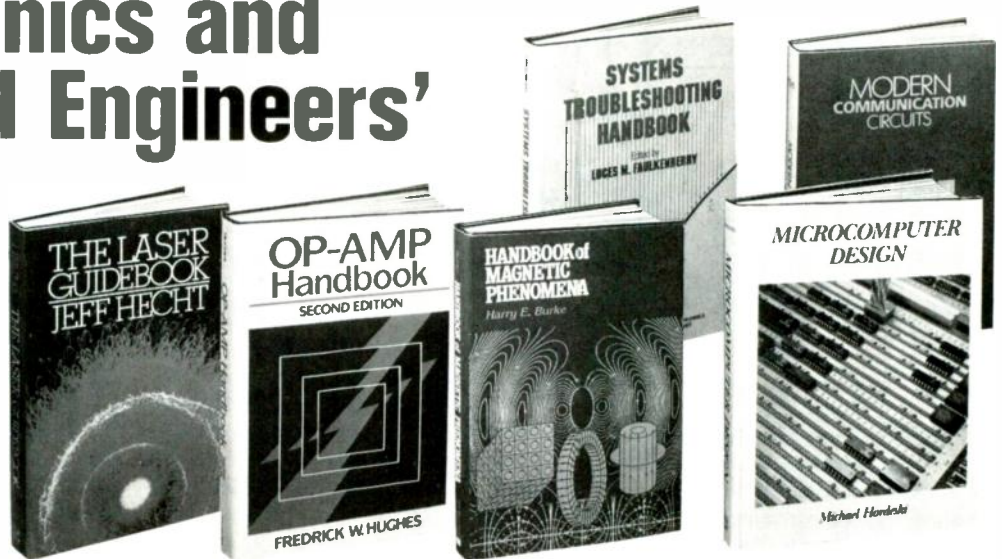

Get the competitive edge with the *newest* and the *best* information in your field . . . with books from all the leading publishers

ADVANCED DIGITAL COMMUNICATIONS: Systems and Signal Processing. Edited by K. Feher. 768 pp., 436 illus. Emphasizes the newest advances and developments in telecommunications systems and networks. Chapters on subjects such as ISDN, speech coding algorithms, digital speech interpolation systems and interference are all written by international authorities to give you on-the-job expertise.
583801-X Pub. Pr., \$59.95 Club Pr., \$42.50

ELECTRONICS ENGINEERS' HANDBOOK, Second Ed. Edited by D. G. Fink & D. Christiansen. 2,272 pp., 2,189 illus. This updated and enlarged edition covers all the latest knowledge in the field, including new advances in integrated circuits, pulsed and logic circuits, laser technology, telecommunications, and much more.
209/812 Pub. Pr., \$89.00 Club Pr., \$61.50

DESIGNING ELECTRONIC CIRCUITS. By R. G. Middleton. 351 pp., 192 illus. Covers virtually every category of circuits commonly used. This practical manual provides the basic design procedures, tables and formulas vital to effective electronic circuit design. Plus over 60 start-to-finish procedures are featured along with scores of computer programs to help you design and analyze electronic circuits.
583673-4 Pub. Pr., \$36.95 Club Pr., \$27.50

THE LASER GUIDEBOOK. By J. Hecht. 368 pp., 109 illus. This book covers the operating principles, characteristics and applications of all commercially available lasers. It will help you find the specific laser that best meets your requirements.
277/338 Pub. Pr., \$49.50 Club Pr., \$37.50

MICROPROCESSOR HANDBOOK. Edited by J. D. Greenfield. 656 pp., 222 illus. This first-ever handbook helps you select the best microprocessor, enables you to understand the operation of a microprocessor you are now using and provides easily accessed coverage of the most popular 8 and 16-bit microprocessors currently available.
583636-X Pub. Pr., \$44.95 Club Pr., \$28.50

SYSTEMS TROUBLESHOOTING HANDBOOK. Edited by L. M. Faulkenberry. 415 pp., 282 illus. Ten leading experts share their most effective fault-isolation techniques as well as solutions to problems they commonly encounter when troubleshooting microprocessors, robotic control systems, PCs, fiber optics systems and other complex electronic systems and equipment.
583699-8 Pub. Pr., \$44.95 Club Pr., \$33.75

MICROCOMPUTER DESIGN. By M. Hordeski. 406 pp., illus. Emphasizes the most current, cost effective methods for developing, debugging and testing all types of microprocessor products, including software and hardware.
583683-1 Pub. Pr., \$29.95 Club Pr., \$20.95

New Members!
Take any one of these great professional books for only **\$289** as a premium with your first selection!

Spectacular values up to **\$110.00**

ANTENNA ENGINEERING HANDBOOK, Second Ed. Edited by R. C. Johnson and H. Jasik, with contributions by 57 recognized authorities. 1,408 pp., 946 illus. This widely acclaimed Handbook gives you the guidance you need to solve problems in antenna design and application.
322/910 Pub. Pr., \$110.00 Club Pr., \$68.00

CONTEMPORARY ELECTRONICS CIRCUITS DESKBOOK Compiled By H. Helms. 272 pp., 442 circuit diagrams. Packed with clearly reproduced circuit diagrams, all proven-in-action, covering the entire spectrum of electronics technology. Each diagram includes a title, a brief description, type numbers or values for significant components and a citation of the original source.
279/802 Pub. Pr., \$31.50 Club Pr., \$23.50

POWER INTEGRATED CIRCUITS: Physics, Design, and Applications. Edited by P. Antognetti. 544 pp., 410 illus. This comprehensive book offers an exceptionally thorough overview of the state of the art in design and technology—including the latest design advances in voltage regulators, audio amplifiers, power MOS devices, BiMOS power ICs, and improved transistor structures.
021/295 Pub. Pr., \$49.50 Club Pr., \$35.50

AUTOMATIC CONTROL SYSTEMS, Fifth Ed. By B. C. Kuo. 736 pp., illus. Provides an overview of automatic control systems, including in-depth coverage of classical control techniques, optimal control theory, and analog and digital control system design. This updated edition discusses the latest ideas on the use of computers to design control systems and as components of such systems.
583706-4 Pub. Pr., \$44.95 Club Pr., \$33.50

OP-AMP HANDBOOK, Second Ed. By F. W. Hughes. 320 pp., 231 illus. Organized for on-the-job reference, this handbook covers all facets of op-amps, from stability and protection to signal processing using op-amps. Includes a collection of over 60 practical circuits for a variety of applications, procedures, and experiments.
583651-3 Pub. Pr., \$33.95 Club Pr., \$24.75

CHOOSING AND USING CMOS. By M. J. Walsh. 304 pp., 155 illus. Offers a comprehensive overview of the semiconductor technology used . . . gives practical advice on circuit techniques to make your job easier. Specifications, characteristics and applications are included.
679/576 Pub. Pr., \$35.50 Club Pr., \$24.95

MCGRAW-HILL CONCISE ENCYCLOPEDIA OF SCIENCE AND TECHNOLOGY. Editor-in-Chief S. P. Parker and the Staff of the McGraw-Hill Encyclopedia of Science and Technology. 2,065 pp., 1,600 illus. This volume serves every need for understanding today's science and technology. Written by over 3,000 of the world's topmost experts, including 19 Nobel Prize winners, it covers 75 disciplines from Acoustics to Zoology.
454/825 Pub. Pr., \$98.50 Club Pr., \$49.25

MICROPROCESSORS IN INSTRUMENTATION AND CONTROL. By S. A. Money. 246 pp., 148 illus. Provides the design procedures and applications data you need to create effective, high quality microprocessor-based systems. There is thorough coverage of programming, arithmetic and logic operations, parallel input-output, serial input-output, hardware design, analog/digital conversion and much more.
427/070 Pub. Pr., \$39.50 Club Pr., \$29.50

MODERN COMMUNICATION CIRCUITS. By J. Smith. 557 pp., 434 illus. Using realistic examples, this book presents time-saving approximation techniques for analyzing and designing virtually every kind of communications circuit imaginable. Includes particularly thorough coverage of the phase-lock loop.
587/303 Pub. Pr., \$45.95 Club Pr., \$32.50

HANDBOOK OF MAGNETIC PHENOMENA. By H. E. Burke. 423 pp., 221 illus. A straightforward guide to over 60 magnetic phenomena. Topics include Ampere's Law, Biot-Savart and toroidal fields, spinning electric charges, magnetic hysteresis, magnetic field measurement, magnetic resonance, galvanomagnetic effects, and more.
583760-9 Pub. Pr., \$49.50 Club Pr., \$37.50

MODERN ELECTRONIC CIRCUITS REFERENCE MANUAL. By J. Markus. 1,264 pp., 3,666 circuit diagrams. Complete with values of components and suggestions for revisions—plus the original source of each circuit in case you want additional performance or construction details.
404/461 Pub. Pr., \$82.50 Club Pr., \$61.50

TELEVISION ENGINEERING HANDBOOK.—By K. B. Benson. 1,478 pp., 1,091 illus. Packed with the technical information and know-how you need to design, operate and maintain every type of TV equipment in current use.
047 790 Pub. Pr., \$89.50 Club Pr., \$62.50

OPERATIONAL AMPLIFIERS AND LINEAR INTEGRATED CIRCUITS, Third Ed. By R. F. Coughlin and F. F. Driscoll. 450 pp., illus. A detailed practical guide to the op amp and its successor, the linear IC. A variety of applications and design procedures are covered.
583754-4 Pub. Pr., \$34.95 Club Pr., \$25.95

THE ENCYCLOPEDIA OF ELECTRONIC CIRCUITS. By R. Graf. 760 pp., 1,256 illus. This large volume provides circuits for virtually every type of application in 98 different categories. Each has a clear and concise explanatory text accompanying it.
583265-8 Pub. Pr., \$50.00 Club Pr., \$39.95

CONTROL SYSTEM DESIGN: An Introduction to State-Space Methods. By B. Friedland. 513 pp., illus. Covers feedback control, dynamics of linear systems, frequency-domain analysis, linear observers, linear, quadratic optimum control, random processes, and many other topics.
224/412 Pub. Pr., \$44.95 Club Pr., \$33.50

INTRODUCTION TO RADAR SYSTEMS. By M. I. Skolnik. 2nd Ed., 698 pp., 244 illus. Covering every radar fundamental and all important changes, this EE text exposes you fully to the systems themselves—and to their applications! Topics include radar equation, CW and frequency-modulated radar, MTI, pulse-doppler, tracking radar, receivers, displays, duplexers, noise, and more.
579/091 Pub. Pr., \$51.95 Club Pr., \$38.95

TROUBLESHOOTING ELECTRONIC EQUIPMENT WITHOUT SERVICE DATA By R. G. Middleton. 303 pp., 162 illus. and tables. Packed with charts, diagrams, and case histories, this practical handbook shows you how to pinpoint defective electronic circuitry when no service data is available.
583134-1 Pub. Pr., \$27.95 Club Pr., \$19.95

STANDARD HANDBOOK OF ENGINEERING CALCULATIONS T. G. Hicks, Editor in Chief. 2nd Ed., 1,468 pp., 1,292 illus. and tables. Now revised, updated, and considerably expanded, this huge handbook provides more than 5,100 step-by-step procedures for solving the kinds of engineering problems you encounter most frequently in your work.
287/35X Pub. Pr., \$64.50 Club Pr., \$49.50

Be sure to consider these important titles as well!

FUNDAMENTALS OF LOGIC DESIGN & SWITCHING THEORY. By A. D. Friedman.
583601-7 Pub. Pr., \$26.95 Club Pr., \$21.50

68000 MICROPROCESSOR: ARCHITECTURE, SOFTWARE & INTERFACE TECHNIQUES. By W. A. Triebel & A. Singh
583613-0 Pub. Pr., \$34.95 Club Pr., \$26.95

DESIGNING DIGITAL FILTERS. By C. S. Williams
583627-0 Pub. Pr., \$36.55 Club Pr., \$27.95

APPLICATIONS IN ARTIFICIAL INTELLIGENCE. By S. J. Andriole.
583715-3 Pub. Pr., \$49.95 Club Pr., \$37.50

THE FOURIER TRANSFORM AND ITS APPLICATIONS, Second Ed., Revised. By R. N. Bracewell
070/156 Pub. Pr., \$48.95 Club Pr., \$33.95

DIGITAL FILTERS AND SIGNAL PROCESSING. By L. B. Jackson.
583710-2 Pub. Pr., \$32.95 Club Pr., \$26.50

MICROPROCESSOR SUPPORT CHIPS. By T. J. Byers
095/183 Pub. Pr., \$44.50 Club Pr., \$35.25

INDUSTRIAL ROBOTICS. By M. P. Groover; R. N. Nagel and N. G. Odrey.
249/89X Pub. Pr., \$39.95 Club Pr., \$28.95

THE MCGRAW-HILL COMPUTER HANDBOOK. By H. Helms.
279 721 Pub. Pr., \$86.50 Club Pr., \$54.50

MICROLITHOGRAPHY: PROCESS TECHNOLOGY FOR IC FABRICATION. By D. Elliott
193/045 Pub. Pr., \$42.00 Club Pr., \$29.50

RC ACTIVE FILTER DESIGN HANDBOOK. By F. W. Stephenson
583350-6 Pub. Pr., \$44.95 Club Pr., \$33.75



Why YOU should join now!

- **BEST AND NEWEST BOOKS IN YOUR FIELD** — Books are selected from a wide range of publishers by expert editors and consultants to give you continuing access to the best and latest books in your field.
- **BIG SAVINGS** — Build your library and save money too! Savings ranging up to 40% or more off publishers' list prices — usually 20% to 30%.

BONUS BOOKS—You will immediately begin to participate in our Bonus Book Plan that allows you savings up to 70% off the publishers' prices of many professional and general interest books!

■ **CONVENIENCE**—12-14 times a year (about once every 3-4 weeks) you receive the Club Bulletin FREE. It fully describes the Main Selection and Alternate Selections. A dated Reply Card is included. If you want the Main Selection, you simply do nothing—it will be shipped automatically. If you want an Alternate Selection—or no book at all—you simply indicate it on the Reply Card and return it by the date specified. You will have at least 10 days to decide. If, because of late delivery of the Bulletin you receive a Main Selection you do not want, you may return it for credit at the Club's expense.

As a Club member you agree only to the purchase of three books (including your first selection) during your first year of membership. Membership may be discontinued by either you or the Club at any time after you have purchased the first selection plus two additional books.

Other McGraw-Hill Book Clubs:
Architects' Book Club • Byte Book Club • Chemical Engineers' Book Club
• Civil Engineers' Book Club • Mechanical Engineers' Book Club

For more information, write to:
McGraw-Hill Book Clubs, P.O. Box 582, Hightstown, New Jersey 08520-9959

MAIL THIS COUPON TODAY

McGraw-Hill Book Clubs
Electronics and Control Engineers'
Book Club®
P.O. Box 582, Hightstown, New Jersey, 08520-9959

Please enroll me as a member and send me the two books indicated, billing me for the \$2.89 premium and my first selection at the discounted member's price, plus local tax, shipping, and handling charges. I agree to purchase a minimum of two additional books during my first year of membership as outlined under the Club plan described in this ad. A shipping and handling charge is added to all shipments.

Write Code No. of
\$2.89 selection here

Write Code No. of
first selection here

Signature _____

Name _____

Address/Apt # _____

City _____

State _____ Zip _____

This order subject to acceptance by McGraw-Hill. All prices subject to change without notice. Offer good only to new members.

E33844

AUDIO UPDATE

The Resurgence of surround sound, Part 2



LARRY KLEIN,
AUDIO EDITOR



FIG. 1

EVEN THE BEST HIGH-FIDELITY SYSTEMS seldom achieve a level of sonic realism that would convince a critical listener that he was hearing a live performance. The heart of the problem is the acoustic differences between live sound and sound that is reproduced in a living room.

There are few sonic similarities between the two listening environments. The sheer size of most live-performance venues means that the musical sounds reflected and re-reflected from the walls, floor, and ceiling reach a listener's ears substantially later than the sounds coming directly from the performers. Time delays of more than 50 milliseconds between the direct and the reflected sounds are not uncommon. And when the performing environment is both large and hard-surfaced, the reflections multiply, blend, and can take up to several seconds to die away. Furthermore, all that reflected, reverberant energy—which can account for more than 80 percent of the total sound impinging on the audience—strikes the listener from many different directions.

In a home listening room, the

sound originates from a more-or-less flat plane whose width is roughly defined by the location of the two speakers. Of course, sonic reflections also occur within a home listening room, but the nearness of the walls means that most reflections have a fairly short delay time, and that the *recorded* reverberant sounds—which under live conditions would normally be heard from the sides and rear—all come from the front. It is this disparity between the large-hall ambience in the recording and the relatively small acoustic environment of the listening room that causes contradictory (and therefore unrealistic) information to be delivered to our ears.

In addition, the brain constructs an image of an acoustic environment based on similarities and differences in phase, timing, amplitude, and frequency that occur among the sounds reaching our two ears. Those factors must have a "natural" relationship among one another in order for the reproduced sound to seem real.

Recreating hall ambience

Late last year I was approached by Yamaha to help introduce their

DSP-1 Digital Sound Field Processor; that unit is shown in Fig. 1. After hours of listening to the *DSP-1* and study of its technical literature, I told Yamaha that I would be pleased to participate. To my ears, the *DSP-1* appeared to be a genuine advance in the science and art of recreating concert-hall realism in the home.

Yamaha's approach to eliminating contradictory and unrealistic sonic messages first involved an acoustic analysis of a large number of live-music acoustic environments. An analysis system was developed based on a critically configured and closely spaced array of four microphones feeding a specially programmed computer. To produce the required data the microphone cluster was located in a typical or preferred listening location in the environment under analysis, and a sonic impulse test signal was provided by a starter's pistol fired from the stage.

The four microphones captured—each from its own slightly different perspective—the initial direct impulse and the subsequent complex array of early and late-arriving reflections impinging from all directions. The individual signals picked up by each of the four microphones were computer analyzed for their relative strength, timing, and frequency-attenuation, and the data that was gathered was stored for subsequent use. In order to encompass a wide range of performing venues, Yamaha's engineering team recorded the acoustic characteristics of numerous large and small performing environments in the U. S., Europe, and Japan.

Packaging the data

Yamaha ultimately embodied their accumulated data (which includes as many as 88 early reflections for each quadrant) in the *DSP-1* Digital Sound Field Processor. The infra-red remote module of the *DSP-1* allows the user to choose—while seated in his favorite listening chair—any of twelve different fixed acoustic environments, including three concert halls, two churches of different sizes, a recital chamber with a high-ceiling, a jazz club, a rock-concert environment, a disco, a stadium, a warehouse loft, and a pavilion like a large sports center.

The data, which is stored digitally, is called up and processed by three Yamaha-designed VLSI IC's. With the same sampling rate (44 kHz) and quantization (16-bit linear) as a CD player, the *DSP-1* has a dynamic range of 94 dB and 0.006 percent distortion.

Each of the fixed environments can have its major acoustic characteristics individually varied within wide limits by the *DSP-1*'s remote. Once an optimum modified setting is found for a particular recording, the new program can be placed in one of sixteen non-volatile memories and recalled at will by pushing a button on the remote. The chosen programs—and the precise degree of their modifications—are all displayed on the *DSP-1*'s front-panel readout

Setting up the *DSP-1*

In addition to the normal stereo amplifier and front speakers (whose signal is unaffected by the processing), four additional channels of amplification and four additional speakers are required for the full *DSP-1* setup. The new speakers can be small bookshelf units, but should have a reasonably full-range response. The two additional front speakers are usually located above and flanking the normal front systems. The two rear speakers should be located at or near the rear of the room and also somewhat above ear level.

Each of the new speakers is fed a basically full-range signal separately modified by digital processing to have the sonic characteristics typical of that heard from its respective room quadrant in

the chosen performance environment. For example, the signals fed to the rear speakers have been individually processed to include the delays, reverberation density, liveness, etc. appropriate to reflections from the rear of the hall.

Keep in mind also that processing in the digital domain ensures that the noise and distortion of a conventional processor are notably absent from the *DSP-1*. In fact, the sound provided by any one of the *DSP-1*'s four channels by itself will appear balanced and clean.

Final thoughts

What you've just read is at best a once-over-lightly description of the *DSP-1*'s signal-treatment techniques and capabilities. Space limitations prevent me from discussing the three video surround-sound functions (one of which has the Dolby decoding parameters) that work sonic wonders for stereo video tapes and *LaserVision* video disks. I've also not mentioned the *DSP-1*'s sixteen digital special-effects facilities with front-panel recording inputs. These include echo, chorusing, flanging, pitch change, panning, phasing, and tremelo effects, all of which should be of interest to small recording studios and those making their own studio demo tapes.

I've heard the *DSP-1* in action in five different environments including my own home. It seemed to work marginally better in some environments than in others, but in every case it was able to make a decided improvement in the reproduction realism of some already excellent audio systems. I was not surprised to find that it is possible to produce unnatural effects by choosing an inappropriate environment for a performance; say, a small jazz ensemble in a large church. This is not a flaw in the *DSP-1*; a live jazz group playing in that type of environment would sound echoey and blurred.

Purists may object to adding a synthesized acoustic environment to a recorded performance—which already has its own built-in acoustics—and playing it in a live listening room. However, Yamaha's use of four additional speakers, and the carefully con-

continued on page 126

SUPER LONG PLAY TAPE RECORDERS

10 Hour Model — \$95.00*
14 Hour Model — \$159.00*

Modified Panasonic Slimline high quality AC-DC Recorders provide 5 or 7 continuous hours of quality recording & playback on each side of cassette for a total of 10 or 14 hours depending on model. Built-in features include • Voice level control • Digital counter, etc. TDK DC 180 Cassette Furnished.



PHONE RECORDING ADAPTER

Records calls automatically. All Solid state connects to your telephone jack and tape recorder. Starts recording when phone is lifted. Stops when you hang up. \$24.50* FCC APPROVED



VOX VOICE ACTIVATED CONTROL SWITCH

Solid state. Self contained. Adjustable sensitivity. Voices or other sounds automatically activate and control recorder. Uses either recorder or remote mike. \$24.95*



*Add for ship & hdg. Phone Adapter & Vox \$1.50 ea. Recorders \$4.00 ea. Cal. Res. add tax. Mail order, VISA, M/C, COD's OK Money Back Guarantee. Qty. disc. avail. Dealer Inquiries invited. Free data. © AMC SALES, Dept. A 9335 Lubec St., Box 928, Downey, CA (213) 90241 Phone 869 8519

CIRCLE 108 ON FREE INFORMATION CARD

Be an FCC LICENSED ELECTRONIC TECHNICIAN!



Learn at home in spare time. No previous experience needed.

No costly school. No commuting to class. The Original Home-Study course prepares you for the "FCC Commercial Radio-telephone License". This valuable license is your "ticket" to thousands of exciting jobs in Communications, Radio-TV, Microwave, Computers, Radar, Avionics and more! You don't need a college degree to qualify, but you do need an FCC License.

No Need to Quit Your Job or Go To School
This proven course is easy, fast and low cost! GUARANTEED PASS — You get your FCC License or money refunded. Send for FREE facts now. MAIL COUPON TODAY!

COMMAND PRODUCTIONS

FCC LICENSE TRAINING, Dept 90
P.O. Box 2223, San Francisco, CA 94126

Please rush FREE details immediately!

NAME _____

ADDRESS _____

CITY _____

STATE _____

ZIP _____

you get
it all with

satellite TV week®

the only up-to-date
and reliable . . .
weekly program guide,
time-zoned, for the
satellite TV viewer

ACCURATE

There are over

100 CHANNELS

of programs available, with
each programmer making
numerous and continuous
programming changes . . .

UP TO DATE

You will need a

WEEKLY GUIDE

if you want an accurate
guide!

EASY TO USE

You will need a

TIME-ZONED

guide if you want an
understandable guide.

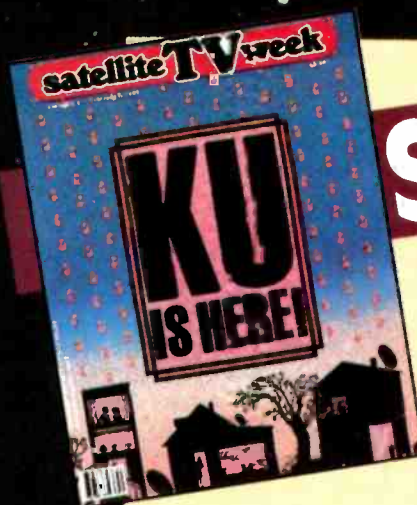

H2502



H2502

SAVE 50%

START MY WEEKLY SUBSCRIPTION NOW!

\$48/52 ISSUES \$89/104 ISSUES \$100/52 ISSUES
PUERTO RICO/HAWAII/CANA
MEXICO (U.S. FUNDS)

NAME _____

ADDRESS _____

CITY _____

STATE _____

ZIP _____

MC VISA _____
EXP. DATE

PAYMENT ENCLOSED

CARD NO. _____

SIGNATURE _____

CIRCLE 185 ON FREE INFORMATION CARD

FREE SAMPLE

**SEND A FREE
SAMPLE TODAY!**

NAME _____

ADDRESS _____

CITY _____

STATE _____

ZIP _____

FOR FASTER SERVICE CALL 800-345-8876

FOREIGN CALLS
707-725-1185

SATELLITE TV



BOB COOPER, JR.,
SATELLITE-TV EDITOR

Zombies, zits, and zoweee!

MORE AND MORE STATIONS ARE scrambling their signals all the time (as shown in Table 1), and an entire new language is building up around the fast-moving world of satellite descrambling. IC creators are coining new words and adapting old, often unused words to describe their products and to stay up to date and be conversant in the rapidly emerging technology. One needs a daily-updated dictionary in one's word processor.

Zombie is a case in point. Many experimenters digging into their Videocipher 2000 descrambling modules have experienced an unfortunate accident; they have "zapped" (in the traditional sense of zapping) their boards either by accidentally unhooking the battery that retains factory-inserted memory or by shorting the battery line. When either happens, the master microprocessor (U7) forgets everything the factory taught it, so you have a "brain dead" unit.

A Zombie update takes a brain-dead unit and corrects the error. It restores the VC2000 to its original operational state, even with its original authorization number (provided the original factory sticker is still on the descrambler module). This means that those who worry about zapping their modules now have a way to recreate the original factory authorization. From that point on, the restored-as-factory-new module can be recreated by cloning, musketeering, or whatever process the user wishes. The cost is around \$200, through a Canadian company that specializes in bringing brain dead units back to life. That's where the term 'Zombie' comes from.

TABLE 1—VIDEOCIPHER-SCRAMBLED STATIONS

Date	Station/Network
Scrambled since November 1985	Viewer's Choice (F3-T5, G1-T16)
Scrambled since November 1985	Request TV (G1-T12)
Scrambled since January 15, 1986	Home Box Office (G1-T1, G1-T23, F3-T13)
Scrambled since January 15, 1986	Cinemax (G1-T19, F3-T13)
Scrambled since March 1986	WOR Superstation (G1-T15)
Scrambled since May 27, 1986	Showtime (G1-T5, F3-T10, G1-T14)
Scrambled since July 1986	The Movie Channel (G1-T10, G1-T14)
Scrambled since July 1986	Cable News Network (G1-T7, W4-T16, W3-T5)
Scrambled since July 1986	Headline News (G1-T8)
Scrambled since August 1986	American Exxtasy (S1-T3)
Scrambled since October 1986	SelecTV (S1-T13)
December 1986	WGN-Chicago (G1-T3)
February 1987	KTVT-Dallas (T303-T22)
April 1987	CBN Cable Network (G1-T11, F3-T8)
April 1987	USA Network (G1-T21, F3-T9)
April 1987	ESPN (G1-T9)
Early 1987	Satellite Broadcast Networks (Primetime 24)
Early 1987	Netlink USA: KUSA - Denver (ABC) KMGH - Denver (CBS) KCNC - Denver (NBC) KRMA - Denver (PBS) KWGN - Denver (Ind.)
July 1987	Lifetime (F3-T17)
Precise date not set	The Disney Channel (G1-T4, G1-T24)
Precise date not set	Tempo (F3-T6)
Precise date not set	VH-1 Video Hits (F3-T15)
Precise date not set	MTV (F3-T11)
Precise date not set	Nickelodeon (F3-T1, F4-T4)
Precise date not set	Nashville Network (G1-T2)
Precise date not set	Arts & Entertainment (F3-T24)
Precise date not set	WTBS Superstation (G1-T8)
Precise date not set	Playboy Channel (F4-T24)
Precise date not set	American Movie Classics (F4-T10)
Precise date not set	Bravo (F4-T2)

ZITS is an acronym for Zero Information Turn-on System; it is the creation of a European anti-scrambling consortium. It sprang upon the U.S. descrambling industry as a surprise in mid-January. ZITS upset some applicarts; to see why, let's review other descrambling schemes.

1. Clone IC's depend upon someone's unit being authorized

for some group of services. Its internal ID number is then copied and used to clone additional units. They all work off the same ID number. This is a form of programmer-billing-dilution. The primary danger of cloning is that if any unit in the clone-family is compromised (i. e., detected), all units in that same family can be turned off.

2. Musketeer IC's violate the ad-

dressing security of Videocipher for program "tiers." If a musketeer IC is inserted into a Videocipher that has been legally authorized for a service (CNN, for example), the musketeer IC causes the unit to receive *all* home-authorized services, without additional payments. The danger in musketeer IC's is that if many people use that approach, their single-service-subscriptions will stand out in a computer search of home-dish subscribers like red flags. Un-

doubtedly, many will be ferreted out and possibly turned off.

ZITS is a unique, new approach that sends software writers scurrying for their textbooks. It's a two-IC operation. First a technician removes the U30 GI IC (which is soldered to the board) and replaces it with a socket. Next he plugs in a master authorization IC for several seconds. That IC loads into the circuitry the current month's authorization key. That IC is then removed and a ZITS IC is inserted

into the socket. That's it; from then on, the descrambler receives all home-directed services (they come on 'instantly') and some of the cable-only services such as WOR (GI, TR15).

ZITS works by copying a data-stream authorization number. If you call up the ZITS IC on-screen number, it has none; it says it is unit number 0000. Internally, it has keyed off of the data stream and a number it has captured. If the particular ID number it first captured later becomes inoperative, the ZITS IC then searches for and grabs a new authorization number from the current data stream.

The user of a ZITS IC has several advantages that musketeer and cloners do not. The IC purports to stand outside of the authorization stream; it is not on record with any program supplier and it has no ID number that can be isolated. Therefore the unit cannot be turned off, except by accident and then only for as long as it takes the ZITS IC to locate and capture a new authorization number.

That's the good news. The bad news is that the European creators of the ZITS IC will not allow their IC's to be sold or used inside the United States. (There is a very open and above-ground descrambler piracy problem in Europe.)

But the IC's are sold elsewhere in lots of 100, with an authorization key for the current month and one for the coming month. This means that the dealer has two months or less in which to sell, install and self-authorize his 100 IC's. Additional-month authorization IC's are also available for a fee.

Buyers to date have had to produce iron-clad proof that they are neither citizens nor residents of the U. S. Early sales activity has been in the Caribbean and Central America, with a few groups going into Canada.

Sellers of competitive IC's, musketeers in particular, have cried foul. They maintain that the individual unit IC's are clone-able, and that, although master authorization IC's may not be copied (they are good for a month at a time and then expire), a person who purchases a set of 100 user ZITS IC's

continued on page 132

SEND COOP \$20



and HE WILL SEND YOU \$63!

NOPE - not a new fangled 'chain letter'. TVRO pioneer Bob Cooper, Jr. has put together the most useful 'Data-pack' possible to bring you up to full speed on satellite television scrambling. It will cost you \$20 to receive all of the following valuable information:



1) YOU RECEIVE the 3 'current issues' of **CSD Magazine**; literally, 'the bible' of the home dish industry. The most complete insider look at the new equipment, scrambling strategies, worldwide satellite explosive growth anywhere. You receive 3 issues starting with the now-current issue. A great introduction to TVRO! This is an **\$18 value**.

2) YOU RECEIVE the current plus two recent back issues of **SCRAMBLE-FAX**, the hot-news 'Newsletter' that details the rapid changes taking place in scrambling, who is scrambling, how; who is working to break scrambling, their progress to date. This is a **\$30 value**.

3) YOU RECEIVE the special 180 page **COMMEMORATIVE EDITION OF Coop's Satellite Digest**, the full, unabridged history of home satellite television. This is the handiest, one-source reference recording the home dish industry, a **\$15 value**.

YOU RECEIVE all of the facts, all of the history, and all of the current, hard-to-find news about TVRO and scrambling. From Coop; the industry's most authoritative information source. Send your check or money order to the address below, or, with your Visa or Mastercharge card handy, call in your order to 305/771-0505 weekdays between 9 AM and 4 PM. Join the Coop team and learn ALL the facts today!

CSD/Coop's Satellite Digest

P.O. Box 100858/Ft. Lauderdale, Fl. 33310
- Telephone 305-771-0505 -

SCRAMBLE-FAX HOTLINE? Call 305-771-0575 for 3 minute update NOW!

Radio- Electronics

2001

**ELECTRONICS IN
THE NEXT CENTURY**

INTRODUCTION

by Arthur C. Clarke

THE ROBOT

by Isaac Asimov

THE HOME OF THE FUTURE

COMMUNICATIONS

TRANSPORTATION

MEDICAL TECHNOLOGY

NEW ENERGY SOURCES

ARTIFICIAL INTELLIGENCE

SOLID-STATE TECHNOLOGY

ELECTRONICS IN 2001

81 LOOKING INTO THE FUTURE

A tradition started by Hugo Gernsback lives on.
Arthur C. Clarke

85 THE FUTURE OF ARTIFICIAL INTELLIGENCE

Computers that reason like humans are on the horizon.
George H. Heilmeier
Senior Vice President and Chief Technical Officer
Texas Instruments

91 THE AUTOMOTIVE WORLD OF THE 21st CENTURY

"A better idea" for 2001.
Donald E. Petersen
Chairman of the Board and Chief Executive Officer
Ford Motor Company

97 SOLID-STATE TECHNOLOGY IN THE 21st CENTURY

Gigabit memories and 3-D IC's are just some of the advances we may see by the 21st Century.
Bob L. Gregory
Director of Microelectronics
Sandia National Laboratory

99 THE ROBOT IN THE 21st CENTURY

Robots and society.
Isaac Asimov

102 COMMUNICATIONS IN 2001: THE THIRD AGE OF VIDEO

New technologies will let us watch what we want, when we want it.
Charles N. Judice
Manager, Wideband Services Division
Bell Communications Research

107 ENERGY TECHNOLOGY IN THE 21st CENTURY

New technologies will bring us new ways of obtaining electric power.
Stephen Kuznetsov
Director of Engineering
Power Silicon and Monolithic Technologies Corporation.

112 MEDICAL TECHNOLOGY IN THE 21st CENTURY

Dramatic new diagnostic and treatment techniques.
Ray Fish, Ph.D., M.D.
University of Illinois, Urbana

115 THE HOME OF THE FUTURE

Calling it a "Smart" house will be an understatement.
David J. MacFadyen
President
NAHB Research Foundation

119 ABOUT THE AUTHORS

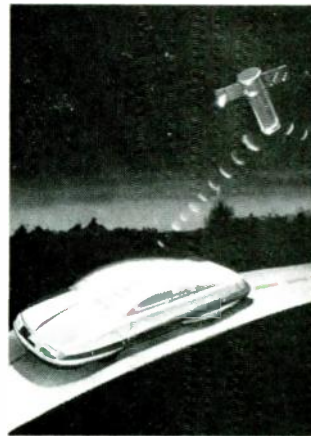

THE HOME OF THE FUTURE
Photo: The Authors

Hugo Gernsback had a special talent for anticipating forthcoming technology. This special section, written by today's experts, pays tribute to that talent, as we anticipate the role electronics will play in our lives as the next century begins.

LOOKING

ARTHUR C. CLARKE

THIS SPECIAL ISSUE OF THE MAGAZINE he founded gives me a chance to pay tribute to the memory of Hugo Gernsback, who was a major influence in shaping my life. And not only mine—there must be thousands of engineers and scientists all over the Western world whose careers he boosted into orbit.

The very first science-fiction magazine I ever saw was the November 1928 issue of Gernsback's *Amazing Stories*, and the magnificent cover by Frank R. Paul has haunted me ever since. It shows the planet Jupiter, dominating the sky of its largest satellite, Ganymede. The main feature was the Great Red Spot, but what was truly amazing about that painting was the depiction of minor atmospheric details—eddies and cyclonic storms—which no Earth-based telescope could have shown in 1928. They were revealed almost 50 years later by an almost miraculous feat of electronics, when the *Voyager* spacecraft radioed back the first detailed images of Jupiter and its satellites. Gernsback would have been delighted, but not surprised.

It is difficult to think of any technological development in the field of electrical or electronic engineering that he did not anticipate, in countless articles, but above all in his serial *Ralph 124C41+*. This story of "Thrilling Adventures in the Year 2660" ran from the April 1911 to March 1912 issue of *Modern Electrics*, a remote ancestor of this journal, and the neat pun in the title applies perfectly to Gernsback himself.

The tale's most remarkable forecasts is this careful description of radar:

It has long been known that a pulsating polarized ether wave, if directed on a metal object, could be reflected in the same fashion as a light ray. ...

If, therefore, a polarized wave gener-



ELECTRONICS IN
THE 21ST CENTURY

Jan. 4, 2001

Dear Sue,

I'm sure glad I ran away from the Back to Basics commune—why did our parents raise us in that relic of the past? This world of the 21st century is far more challenging. Today I went to the Office Training Center. When I told the job counselor that I had secretarial experience, she laughed and said, "That's all done by expert systems in workstations. Your entry-level job these days is learning to manage an electronic office!"

The counselor sent me to a trainer, who handed me my next surprise—an electronic notebook. It looks like a pocket calculator but instead of a numeric keypad, it has a speaker, a microphone, and two keys, ON/OFF and COMMAND. You do everything using your voice and the notebook's electronic memory. Before I could try it out, the trainer dragged me to the workstation and showed me where the notebook hooks up. At first glance, that workstation looked much like those stations back at our commune. It had a monitor screen, microprocessor, copier, and laser printer. But I saw no alphanumeric keyboard—just a keypad with control keys. Then I noticed that the telephone, the rolodex files, and the dictionaries were missing. As I should have guessed, everything's electronically integrated into the workstation. A phone call is made simply by request. There's no telephone headset, but privacy's no problem because phased-array speakers focus the sound. An eavesdropper would have to lean right next to you to hear the conversation.

You've probably guessed that speech-recognition systems and natural-language programs have progressed far beyond the limited-vocabulary models we had at the commune. You can carry on a natural conversation with this workstation—no memorized commands. I could have simply dictated this letter and the system would have automatically sent it to you via electronic mail—that is, if you were linked to the electronic-mail network. It's just as well, though; I'm still fond of this old typewriter, and it look's like I won't have many more chances to use it.

I still wondered how people write long reports without a standard keyboard. The trainer explained that the expert report generator and expert writer make it easy. Most of the data you need is already in memory. You tell the report generator who you need to write to and what about. It asks you questions, you answer, and it generates your report for you. The only people who still use keyboards, the trainer said, are professional writers and editors, who polish and tailor documents for special audiences.

After seeing how much the workstation could do, I asked what they needed an office manager for. The trainer told me that, in spite of all the advances in expert systems, the brainy workstation of 2001 is still dumb when compared to a human. The office manager must review the reports that the expert system churns out, answer the expert-system queries, and make the decisions that only humans can make—decisions requiring judgment, creativity, and empathy. I learned to operate the workstation in a day. The hard part will be learning to think like a manager. But aren't challenges what life's all about? Why hide back at that commune, Sue? Come join me in the 21st century.

Love,





AS I RECALL THE FUTURISTIC PREDICTIONS of a quarter century ago, by 1987 we were all to have a few family helicopters in our backyards, ready to waft us to work or play. I sometimes think back to those prognostications while fighting my way to work through freeway traffic at 20 miles an hour.

I've devoted much of my career to predicting and developing technologies that will be needed ten or fifteen years in the future. Early on, I learned to predict not what *should* be, but what is *likely* to be. If Artificial-Intelligence (AI) technologies were still in the laboratory—as they were for about 25 years—I would have serious misgivings about outlining their future in the workaday world. Just a few years ago, however, real-world applications began to proliferate.

We know of several hundred applications that have been performing vital

THE FUTURE OF ARTIFICIAL INTELLIGENCE

GEORGE HEILMEIER

Computers so clever that they appear to think like humans will revolutionize the ways in which we solve problems.

functions in commerce and industry for a year or more, and we have reason to believe that another three or four thousand applications are in development. Almost

50,000 people attended Texas Instruments' Artificial Intelligence Symposium-by-Satellite in June, 1986; any time a seminar on a technology can attract

MAY 1987

phone, converting those sound waves into computer-digestible data, and then recognizing the word by comparing it with stored vocabularies and by considering it in the context of words that come before and after, can take tens of thousands of bits of RAM.

Fortunately, we've entered the era of "computational plenty." Back in the 1960's, we had to devote almost 100% of our computational resources just to do the number crunching. By the 1990's, perhaps 10% will be devoted to that; 90% will handle the interfacing.

Earlier, I mentioned that we're developing a single IC that will perform the essential functions of an AI computer (called a Lisp machine). In 1986, Texas Instruments announced the world's first 4-megabit IC—an IC that can hold and manipulate four million bits of information. Three of those IC's can be placed side-by-side on a dime without covering all of it.

That's the kind of computing power—complex, compact, dependable, and inexpensive—that we have at our disposal today to create expert systems as easy to deal with as human experts.

Think of it: No more "computerese" to master, no more frustrating protocols, no more wading through incomprehensible operating manuals. Just sit down and start talking, then sit back and listen. Imagine having a computer tell you "You don't have to do it my way, I'll be glad to do it your way." By the year 2001 I think it will come about.

Then, Arthur C. Clarke's dream of HAL the Computer will be a working reality—minus, of course, HAL's one serious flaw.

Toward the unknown

Alan Turing, the great computer pioneer, was once asked whether computers would ever be able to think. He answered "I compute so."

My answer is different: "Absolutely not; but they'll be so clever you'll think they're thinking."

In truth, whether computers will ever be able to think is a philosophical debate, not a scientific one. The important thing is that we have already conclusively demonstrated—in hundreds of applications—that computers can help humans think more effectively.

Artificial intelligence is helping us break out of the narrowly restricted world of conventional computing. Conventional computers are really giant calculators that solve problems with blazing speed, provided that humans have thoroughly structured the approaches to the problems, have provided unambiguous rules, and have input precise and certain data. Conventional computers deal wretchedly with unstructured problems, ambiguity, and uncertainty. A conventional computer can be thrown into chaos if you tell it "maybe," "probably," "my best estimate is....," or maybe "I'll supply that bit of data later."

Yet most of the important thinking humans do is based on imperfect structures, ambiguity, and uncertainty. Clearly, all planning for the future is beset by those characteristics. Expert systems are already helping us handle such problems with great power. Other facets of AI, such as natural-speech input and output, will soon make that powerful help available to everyone.

It has been estimated that conventional computers are presently doing the work of five-trillion people. Since the population of the world is about 5 billion, each of us has an average of a thousand servants working for us somewhere. If you've ever had hassles about a miscalculated bill, you've probably concluded that a few of your servants are idiots, but that's a small price to pay for all the other good, low-priced help.

AI computers, including millions of small ones imbedded in useful products, may never supply that *quantity* of help, but they'll supply help of a much higher *quality*. Conventional computers made us more efficient, but AI computers will make us more effective.

It's the fashion, in articles like this, to end with a detailed picture of the future wonders that will arise from the new technologies. I'm not going to do that. Instead, I would like you to spend some time dreaming of the possible wonders that AI might bring. Those future wonders will take many forms and shapes, each of which will be tailored and adapted to the user's level of intelligence, knowledge, needs, and wants. If you would like, you can consider this a challenge, or perhaps a thought experiment.

Most of the building blocks are available today. Some of those are embryonic, a few are awaiting birth, and others are in their adolescence. Your challenge is to extrapolate the power of those technologies into the future, add your own vision, and assemble your own wondrous intelligent colleagues.

After all, it will remain forever the province of humankind to dream greater and greater dreams.

An epilogue

Years ago, when people still felt it their duty to illustrate the computer's lack of common sense, the following story made the rounds:

A new user told the computer: "I have two watches. One is erratic, and runs as much as a minute fast or slow. The other won't run at all. Which should I use?"

The computer answered "The one that is stopped."

Puzzled at that answer, the user asked a human expert the grounds for the computer's decision.

"Obviously," said the expert, "you can never be sure the erratic watch is correct, but the stopped watch is precisely correct twice a day."

In a few years, if you give the same problem to an AI system, it will give you the better answer, explain its rationale, offer to fix the stopped watch and adjust the other, and suggest six improvements in their designs.

The new age has already dawned. I hope you look forward to it as enthusiastically as I do.

R-E

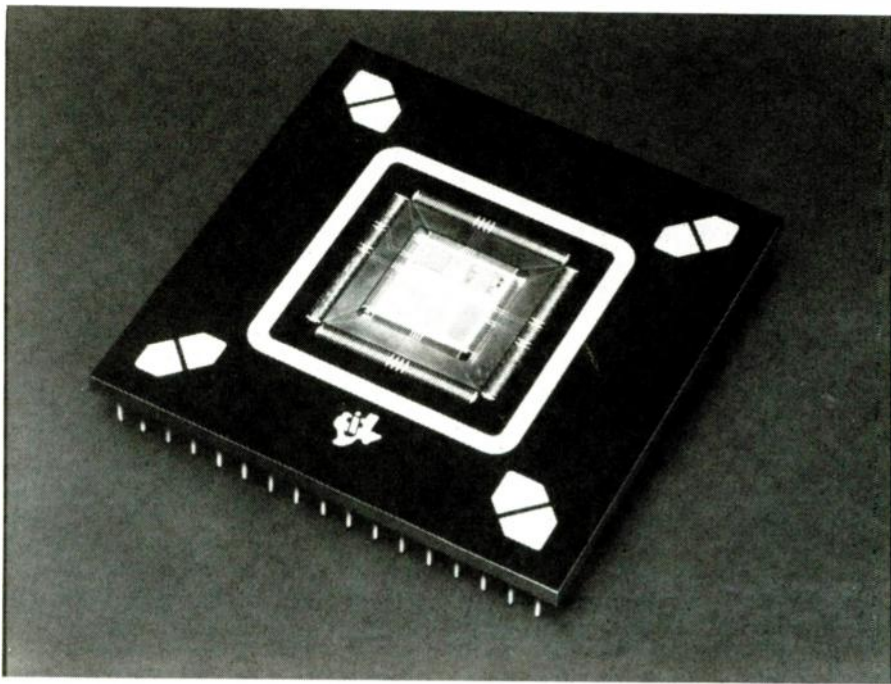

THE EXPLORER "MEGACHIP"—arguably the most complex IC ever developed—replaces several cubic feet of Lisp machine circuitry. It's the key development that will permit the use of expert systems wherever they're needed, including in jet and helicopter cockpits.

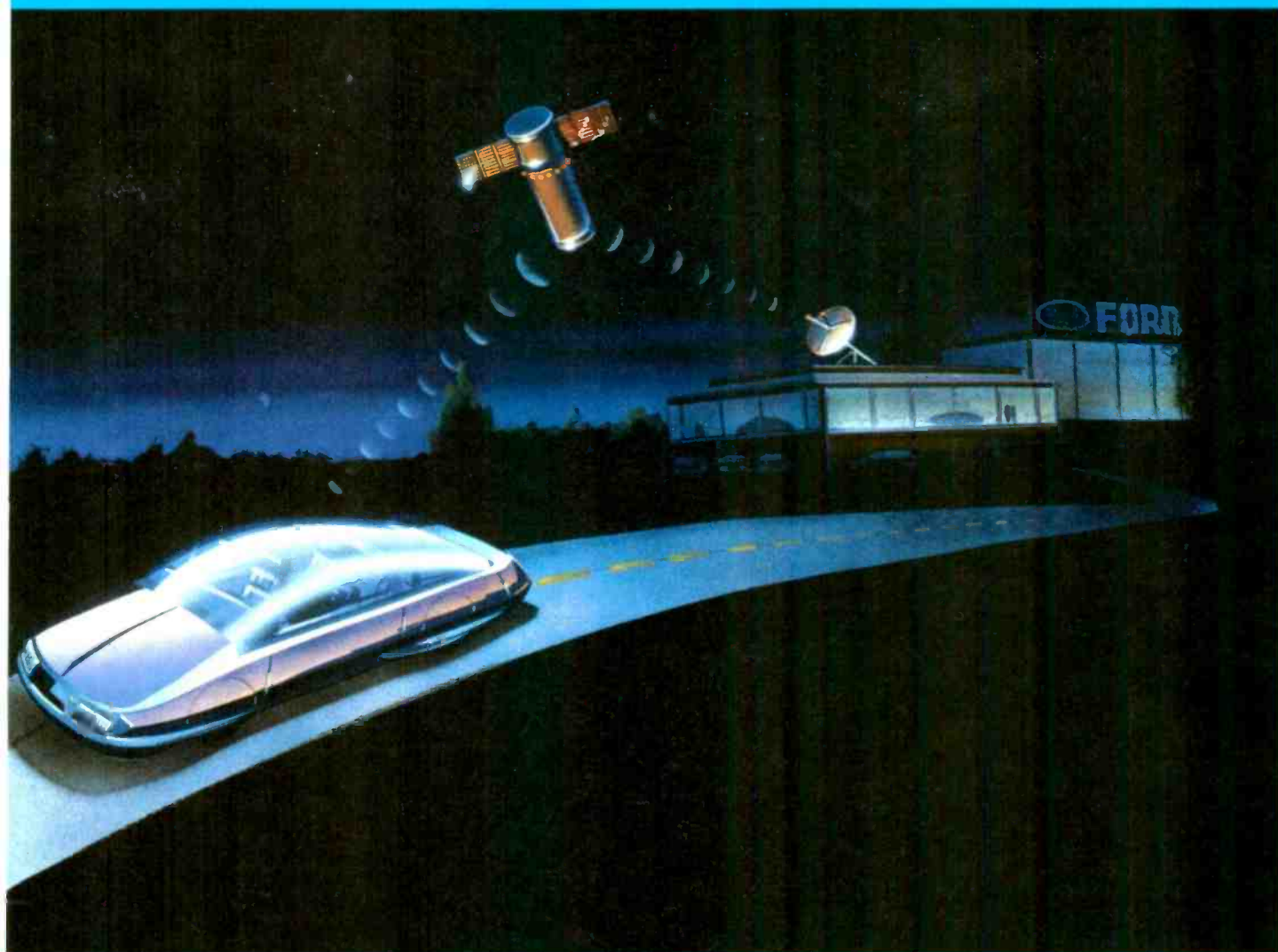

THE AUTOMOTIVE WORLD OF THE 21st CENTURY

You're invited to test drive Ford's new 2001 model

Donald E. Petersen

ANY ATTEMPT TO DESCRIBE THE FUTURE is a hazardous exercise at best. By definition, it's an excursion into a world of fantasy. But fantasy can range from chimerical nonsense to a common-sense projection of a rational vision.

What follows here is the latter: a reasonable extrapolation of current automotive trends and technologies reaching out 14 years; a vision of the future of the automobile firmly based on technologies now emerging. Product planners and creative thinkers at Ford Motor Company have devoted considerable energies looking beyond conventional planning horizons—and into the 21st century.

When you think about it, 14 years ahead is not all that distant. Consider the fact that 14 years back was 1973—the year of the first OPEC-inspired energy crisis. To some of us, that doesn't seem very long ago at all.

Based on what we've learned since that time, however, it's safe to make one all-important prediction about the future: The businesses that survive into the 21st century will be the ones that have become obsessively customer-centered. We will realize the importance of producing products that meet the customers' demand for quality and supply their precise needs. We will learn, more skillfully than ever, to tap

the remarkable reserves of talent, energy, and unique ideas that the people who work in our plants and offices can bring to their jobs. We will discover new and more productive ways to energize that crucial resource and use it.

In the process of looking ahead, teams of Ford futurists have identified dozens of technologies that can be applied to our future vehicles—to their designs, to their onboard features, to the materials used in them, and to the way that they are manufactured. The technologies can provide automatic navigational guidance, security-alert protection, and adaptive peripheral vision systems.

For the driver, those technologies would mean on-board, direct-to-satellite communications links with dealer service departments allowing automatic diagnosis of any developing problems; high-efficiency air-purification systems; automatic passive-restraint systems; electronic light-emitting surfaces; auxiliary electrical power systems using photovoltaic cells integrated into the roof; and special glass coatings that reduce vision distortion from rain, repel dust, and retard formation of condensation.

Our vision of the future features modular construction of the automobile—using modules that can be easily reconfigured for urban use, for family vacations, or for long-distance travel.

But rather than just listing the features of the future car, let me invite you to imagine what it would be like to enter the showroom of a Ford dealer featuring the newly introduced 2001 model.

A future vision

As you enter the showroom, your first glimpse of the car conveys its strikingly aerodynamic appearance. As you move closer, you notice that its appearance results from more than just the "clean" basic shape. There are no apparent door handles, rear-view mirrors or antennas. The glass, which comprises all of the vehicle above the belt line, is flush with the lower body and shaped with compound curves to conform to the car's smooth aerodynamic form.

A Customer Information Specialist (CIS) introduces herself and explains the vehicle's overall Airflow Management System—which includes such automatic features as variable ride-height control, variable skirts and spoilers that cancel all induced lift, and variable air inlet/outlet ducts—all under the coordinated control of a central electronic command system.

She points out the wide tires that blend into smooth, disc-like, body-colored wheels and explains how the tire-reinforcing cords are continuous with, and flow into the molded plastic wheels, resulting in a perfectly balanced, light-weight, high-performance integral element.

As you stroll around the car, you wonder at the apparent lack of turn-signal indicators, side marker lamps, or tail/brake lights. The CIS explains that all of those functions are now accomplished by electronic light-emitting surfaces, which have been integrated into the glass and selected body areas, and are almost invisible unless they are lighted.

When lighted, the areas become highly visible and vary in intensity, color, and shape to clearly communicate the driver's intent and the vehicle's operating condition, such as its rate of deceleration or acceleration. She illustrates her explanation by activating the left turn signal. Instantly, you see a large, bright, flashing

yellow arrow appear on the bottom left region of the rear window area.

To open the car door, the CIS demonstrates the Keyless Entry feature, which is activated by a coded sequence of touches to sensitive areas on the side window. In response to the proper code, the door automatically opens; an exterior handle is no longer needed.

Now that the door is open, the CIS invites you to slide into the driver's seat. The seat momentarily feels alive as it automatically adjusts to conform to your body, like a fluid-filled bean-bag chair.

She continues by explaining that the Automatic Total Contour Seat is part of an overall Individual Occupant Accommodation package that also provides individually selectable climate control and audio programming for each occupant.

The CIS points out that in place of rear-view mirrors, there are multiple electronic cameras that are individually programmable for the best direction and size of field. Those cameras are small and "look out" through the glass, so they are almost impossible to detect.

They display on a 3-segment screen located on the upper rim of the Driver Information Module and portray the environment behind and to both sides of the car. There are absolutely no blind spots, and the system senses non-visible infrared radiation; it works equally well at night and during inclement weather.

She points out that the same technology also operates a forward-looking infrared system that provides driver vision during heavy fog, rain, or snow conditions in the form of a heads-up display on the windshield where driver attention focuses.

The CIS now invites you to watch a short video presentation that illustrates some of the car's construction details.

Modular construction

The holographic video show introduces the automobile as a breakthrough in the development of modular construction. You watch as 3-D representations of the vehicle's basic building blocks appear out of nowhere and slowly rotate into correct positions, while a voice explains the advantages of that modular assembly.

You learn that the basic vehicle module is an occupant-protecting "cage" constructed of heat-treated alloy steel preforms that are bonded together with structural adhesives to form an incredibly strong and resilient structure. The narrator states that two-, four-, and six-passenger modules are available.

Front and rear-end modules attach to the central occupant cocoon with what appear to be about a dozen bolts. The integrated engine/transmission powertrain is itself a sub module that can be installed in either a front or rear module. For applications where 4-wheel drive is required, or where "dual power" is con-

sidered an asset, a powertrain module may optionally be installed in both the front and the rear.

Required tailoring of parameters such as suspension rates, damping characteristics, and brake proportioning is accomplished by appropriate programming of the central electronic control system.

The steering is also under electronic control—which automatically orchestrates complex 4-wheel steering responses to completely normal driver inputs. That effectively extends the performance range of the vehicle during any radical maneuvers.

The video show concludes by showing how the completed assembly of modules—which is basically a drivable vehicle—is skinned by large plastic panels which are corrosion-proof, damage-resistant, and easily replaced if required. A full-length, smooth plastic underpan reduces air turbulence under the vehicle and provides some drag-free "ground effects" road handling.

The CIS points out that additional modules will be introduced from time to time as market research uncovers new consumer needs. She emphasizes that all modules will be readily interchangeable, and it is even possible to rent a module and temporarily reconfigure the vehicle for short-term purposes such as vacations.

Flying the simulator

The CIS suggests that you spend a few minutes in the dealer's vehicle simulator which will demonstrate the operation of various features. She explains that the simulator is based on aerospace flight-simulator technology.

Upon entering it and closing the door you are amazed at how life-like the experience is. The CIS joins you on the passenger side and gives you an operator authorization code that's needed to activate the simulator.

Of course, the conformable seat has already adjusted to you, but you've experienced that earlier. You adjust the Adaptive Peripheral Vision sensors and the sound system to your preference. You notice that the sound system couples low-frequency response to your body directly through your seat, greatly enhancing the realism.

The CIS explains that you can now make several more personal-preference adjustments. The first is Climate Control. You select a temperature of 68° F, whereupon she reaches for her individual Occupant Accommodation control pad and selects a temperature of 72° F for her side.

Now you begin to "drive" the simulator while the CIS uses a special control to call up a range of road surfaces. As you begin to acquire a feel for the "vehicle," she suggests that you experiment with the driver-preference controls which determine effective suspension-spring rates

and damping characteristics. Also, you experiment with the controls that program the steering effort, steering sensitivity, and simulated road-feel feedback. You converge on a combination of settings which feels best for you.

Since you are now "driving" the simulator in a more spirited fashion, the CIS asks if you would like to experiment with the instrument format. You sequentially review each of the 12 basic pre-programmed information formats as they appear on the colored flat-panel display of the Driver Information Module. Ultimately, you opt for an electronic representation of a few basic analog gauges augmented by a variable color bar-chart which graphically displays that all of the vehicle's critical systems are operating within their normal range.

As you really extend yourself at simulated high speed along a twisting road, you feel the conformable seat grip you tighter. Also, the instrumentation display simplifies to an easier-to-read, less-distracting format.

After several minutes of that, you do manage to find the limit and spin-out. You shut off the simulator and remark to the CIS how useful that experience was to you. You had no previous idea that a "road car" could be stably controlled at such high rates of lateral acceleration. You mention that you will probably now be a better driver should an emergency situation arise. She agrees and explains that the simulator has been used effectively for advanced driver training. But now it's time to try the real thing.

21st-century automotive service

On your way to the parking area where the demonstrator vehicle is parked, you pass by the dealer's service area and the CIS introduces you to the service manager. He describes the recent changes that have occurred in his department.

First, the new vehicle's central control-system contains a self-diagnostic feature that pinpoints the source of virtually all problems. Because of the car's highly modular construction, the preferred repair technique is to replace the offending module. In most cases, that can be accomplished in a couple of hours. The modules that are removed will be repaired either at the dealer's facility or at regional service centers, or they will be returned to a factory where they will be completely re-manufactured and reissued.

Continuing his explanation, the Service Manager informs you that redundant systems and "limp home" features make it highly unlikely that the vehicle would ever break down on the road. If it should occur, however, its on-board direct-to-satellite, two-way communication system will automatically contact the nearest dealer. The dealer system will analyze failure data and determine whether the



INSIDE THE CAR OF THE FUTURE. Navigation screens will keep you from getting lost, and satellite telephone hookups will put you in touch with the outside world from the start to finish of every journey.

problem can be fixed in the field using replacement modules in inventory.

If the problem is not field-correctable, a service van will drop off a loaner vehicle and transport your car back to the dealer's service department for repair.

When the Service Manager finishes his explanation, you ask about the "two-way satellite communication system" and "on-board navigation system"—two features you had not heard about before. The CIS assures you that the demonstrator contains both systems and that they will be explained during the test drive.

Driving the demonstration vehicle

As you slide into the driver's seat in the demonstrator, the CIS hands you the driver ID card that she programmed in the simulator. That card also contains the authorization code for this vehicle. Inserting the card in a slot in the Driver Information Module, you start the engine while all driver-adjustable systems automatically adjust to your preference.

It's a cold fall day—well below the 68°F setting of your Individual Occupant Accommodation control, and you're aware that you are being bathed by a gentle stream of warm air. The CIS explains that that is a Quick Heat feature, which uses energy from an auxiliary electrical power system that generates electricity using photovoltaic cells integrated into the roof glass. It stores that power in a high-energy-density solid-electrolyte battery.

As you pull out of the dealer's lot, the CIS begins to explain the communication and navigation systems. She informs you that the demonstrator you are driving has automatically established contact with a geosynchronous orbiting satellite.

She switches on the navigation system, and a map of the dealer's neighborhood appears on a flat-panel display on the right side of the Driver Information Module. A flashing dot indicates the exact location of your car. As she dials-down the resolution, the neighborhood map "zooms" to a full-city map; but the position of your car

is still readily apparent. She points to the map and suggests that you head for a nearby freeway.

She then programs the navigation system to guide you to the freeway entrance by using audible commands, and a pleasant voice instructs you: "Turn right at the next intersection and move into the left-turn lane for access to the freeway entrance ramp." The same instructions appear on the screen, superimposed over the map display.

You also learn that navigation is only one function provided by the satellite link. She pushes another button and the map is replaced by a display of local information topics including: hotels/motels, restaurants, route selection, amusements, museums, and local events.

The CIS continues by explaining the Security Alert feature. You learn that sensors integrated into the window glass and in other key locations can detect any attempt to break into or steal the car. When the sensors are stimulated, the communication and navigation systems will automatically link up with a central Customer Security Services facility operated as a customer service. The police department closest to the car will be notified and given the car's exact location. The system can also be activated manually for any necessary emergency assistance.

By now you have reached the freeway-entrance ramp. As you accelerate to the 70 mph speed limit, the CIS introduces you to the Automatic Guidance feature. You learn that this feature uses the navigation system in conjunction with data from on-board sensors to provide totally automatic vehicle guidance on certain of our interstate highways.

This particular highway has been "mapped," so the CIS shows you how to engage the guidance feature while continuing to explain that within a few years, a complete interstate "grid" of highways will be "mapped" and reserved exclusively for automatic-guidance-equipped vehicles.

As the automatic system takes over, you release the controls and observe that the demonstrator vehicle tracks smoothly down the center of the lane at a constant 70 mph. As you gradually close in on a slower-moving car ahead in your lane, the demonstrator automatically signals for a lane change and pulls smoothly to the left, passing the slower vehicle.

The CIS explains that even when the vehicle is not being automatically guided, constantly operating features of the guidance system will prevent unsafe lane changes and passing maneuvers. The system will also detect upcoming road hazards, such as an ice patch, and help the driver to respond appropriately. In an emergency, that constantly operating system will take over so that it is almost impossible for the car so equipped to hit another object.

Your demonstrator completes its pass, signals for a lane change and pulls into the right lane while smoothly avoiding a piece of truck-tire tread lying in the road between lanes. The CIS suggests that you take the upcoming exit ramp, so you switch off the automatic guidance system and notice that it does not relinquish control until you conclusively demonstrate that you are back in command.

The road back to the dealership is lightly traveled and twisting so you engage in a mild version of the performance driving you enjoyed in the simulator. The demonstrator confirms all of your simulator impressions. You try to skid to a stop, but your car refuses to lock its wheels. It just stops rapidly, but smoothly, while maintaining your full steering control. You try to spin the wheels on gravel when accelerating away from construction at an intersection, but you can't do it. The car just accelerates smoothly, automatically determining the maximum rate it can attain.

Nearing the dealership, you pass a road-repair crew generating a cloud of dust and spreading hot tar on the road's shoulder. As you pass this scene, you real-

ize that you did not detect the expected odor of tar. "The air-purification system filtered it out," the CIS explains. You also remark that no dust stuck to the windshield even when you stopped momentarily in the dust cloud. "It's electrostatically repelled," she explains, and she also mentions that the windshield has a special coating inside and out which reduces vision distortion from rain and greatly retards the formation of any condensation on the glass surfaces.

As you near the dealership, the CIS explains that this car can electronically communicate with others. Soon, all new vehicles on the road will have that feature. That capability also functions as an adjunct to audible horns and sirens, and is a particularly useful way for emergency vehicles to warn near-by drivers, particularly in urban areas where sirens are used less often.

Placing your order

As you return to the showroom, the CIS accompanies you to an interactive Vehicle Specification Selection and Order Coordinating Terminal where you work out the exact combination of features and options you wish to order.

She helps you to consider the relative virtues of the various powertrain options. You select a higher horsepower unit for rear module/rear drive installation. That basic engine adapts to various fuels—including gasoline and alcohol. You select gasoline, since that's the prevalent fuel in your area.

The CIS mentions that a hydrogen-fueled powertrain with high-performance capabilities is in the final stages of development and suggests that you may be interested in trading in your gasoline-fueled powertrain and upgrading to the hydrogen unit in a couple of years.

When you finish the specification process, the CIS explains that your order is now being entered, analyzed, and scheduled at the factory. Just as she finishes her explanation, the terminal displays a message that your order has been placed and your car will be delivered to your dealer—exactly 15 days from now.

After thanking the CIS for her help, she invites you to tour the manufacturing complex where your car will be constructed. The complex is only about 120 miles away, and a tour takes about half a day. That sounds great to you, and it is conveniently arranged.

21st-century manufacturing

The first stop on your tour of the manufacturing complex is a small auditorium where your tour guide explains that you will see a short film that explains some of what you'll see later. You learn that all engineering and manufacturing processing is now accomplished on an integrated, computer-driven engineering, design,

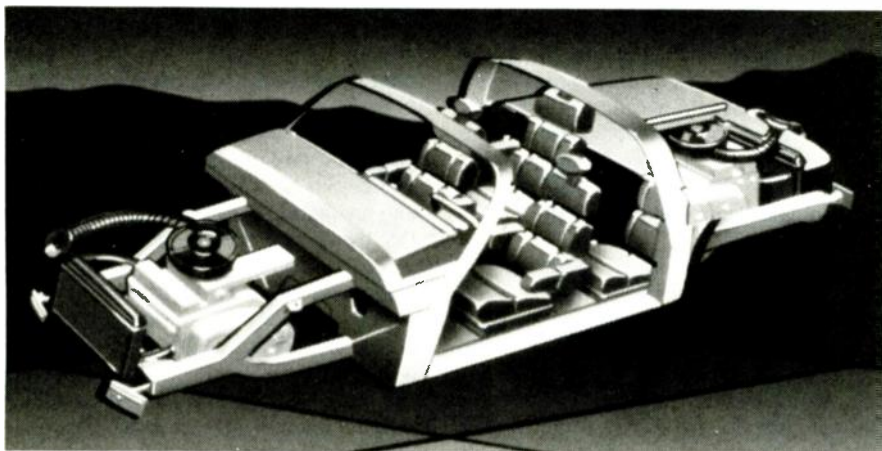

MODULAR CONSTRUCTION will allow your car to be custom built and upgraded as new modules are introduced. You'll also be able to rent modules to temporarily reconfigure your car—to take a family vacation, for example.

processing and testing network that ties together all design and production centers. Even key suppliers are tied into selected parts of this network.

The film presents an overview of the manufacturing complex. You learn that the central Vehicle Final Assembly facility is responsible for assembling completed modules and sub-assemblies into a finished automobile. Those modules are supplied on a just-in-time basis from a ring of surrounding plants which use highly automated but flexible processes to manufacture, and remanufacture, a variety of components. Those factories are operated by a highly trained staff.

Not all manufacturing operations are represented at the complex you will tour. Engine blocks, steel structural pre-forms and major glass components are all supplied to the module-fabrication plants from central facilities. The film concludes by presenting those operations.

You see one-piece aluminum engine block/cylinder head/transmission case casting with ceramic inserts being processed by evaporative-casting techniques. You watch large pieces of thin glass being laminated to transparent plastic and molded into complex shapes which are lightweight but shatterproof.

The film's concluding sequence shows steelmaking in which plasma melting techniques are used to produce carefully controlled, high-purity alloy steel, which is cast into a thin slab requiring minimum hot rolling before it is cold-rolled into a finished sheet. Some of the sheet steel is electrolytically coated with a nickel alloy for outstanding corrosion resistance and is supplied in that form to other Ford manufacturing locations. Other sheet material is roll-formed into a structural preform which is cut to length, stretch-formed and selectively heat-treated by lasers.

The real tour starts in the Powertrain Module Factory. There you watch as robots that, in your guide's words, can "see," "learn" and "think for themselves," perform the complex task of assembling a high specific output, high

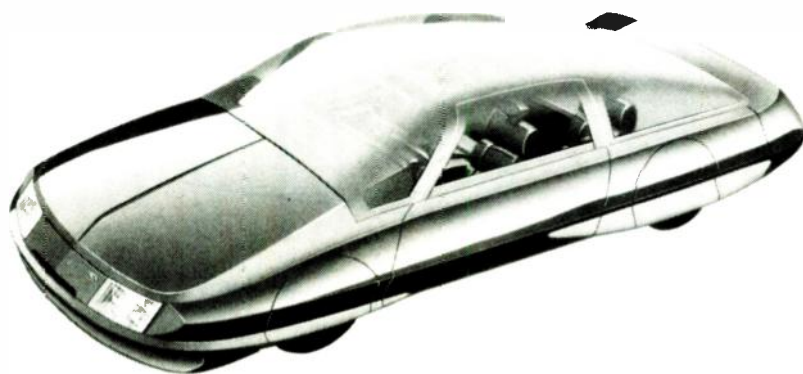

THE ALL-GLASS TOP OF FORD'S 2001 MODEL is flush with the body, giving the car excellent aerodynamic performance.

RPM, internal combustion engine within a "monoblock" casting which also houses the integral Continuously Variable Ratio transmission.

The highly automated assembly process makes it difficult for you to see all of the operations, but you are able to visually confirm your tour guide's claim that many of the engine's internal components are fabricated from high performance plastic composite materials.

The guide also points out that the engine's various covers and "pans" are installed with structural adhesives and are not removable in the field.

As you study the finished powertrain modules at the end of the assembly line, you notice that they are all fully integrated units, devoid of any "hung-on" accessories. For control purposes, a single electrical umbilical is provided to plug into the vehicle's central control-system.

Your next stop is the Greenhouse Fabrication Factory where you watch large formed-glass pieces being unloaded from trucks onto a line for Magnetic Vacuum Sputter Deposition. That process, your guide explains, is used to deposit multiple thin films of exotic materials to insulate the car's interior from the sun.

That, you are told, allows smaller/lighter air conditioning systems and prevents degradation of the car's interior ma-

terials from ultraviolet radiation. The coatings also impart cosmetic color to the glass, control glare, and reduce the tendency to fog. In other operations, various sensors and antennas required for features such as keyless entry, intrusion detection and satellite communication are integrated into the greenhouse structure.

You next visit the Exterior Panel Fabrication Factory where large panels are injection-molded from high performance thermoplastics or formed from reinforced thermoset plastic composites with finished color gel coats in large presses.

Your tour also includes stops at the Suspension Module Assembly plant and the various structural module fabrication plants where you watch robots apply fast-curing structural adhesives to bond elements into an integral structure.

All modules leave their various assembly plants complete with all sensors, actuators and control electronics and a single electrical power-distribution bus.

Your tour ends at the Final Vehicle Assembly plant where all modules arrive on a coordinated, just-in-time basis and are assembled by robots, with minimum human assistance, into a completed vehicle. A comprehensive computer-directed final checkout procedure completes the manufacturing process.

On your drive home from the plant tour, you think about the seven days remaining until you take delivery. You can hardly wait!

R-E

Well, there you have it. A look at 21st century transportation technology, materials, and manufacturing processes as we at Ford Motor Company now anticipate them to be. To me, it's a fascinating prospect. But getting from here to there will be even more fascinating. While I expect to be happily retired and playing golf in Palm Springs when 2001 comes around, what we do for the remainder of this decade and into the 1990's will determine whether or not this scenario comes anywhere near reality. And, as I noted at the outset, how we treat our customers and how we treat our own people will make all the difference.—Donald E. Petersen

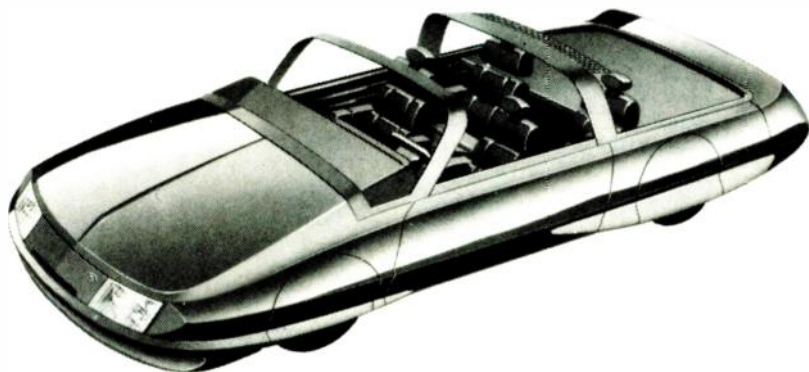

THE INTERIOR OF FORD'S FUTURISTIC automobile is revealed in this photo by the removal of the glass top.

Apr. 4, 2001

Dear Sue,

I'm still glad I left the Back to Basics commune, but I admit that being raised there does have some advantages. Although I may struggle with today's technology, at least I know how to read and write! That, along with my experience on the commune newsletter, got me my new job: researcher for *Telecommute*, an electronic magazine.

When I say I'm a researcher, I don't mean I run around town visiting libraries. I sit at my office workstation, tell the expert-system researcher what information I need, and let it dig out the data from the online databanks we subscribe to.

Although *Telecommute* is transmitted electronically, the editor designs it to be read as hardcopy rather than videotex. Subscribers scan the magazine on their home terminals and print out only the articles they want to read more closely.

Such on-demand printing is common. In fact, books printed on printing presses are considered antique curios, of interest mainly to rare-book collectors. (That library of books at the commune may be worth a lot of money some day!) High-speed laser printers can print out full-color illustrations and double-sided copy, then adhesive-bind the pages.

The editor told me that when high-resolution screens displayed type as clear as print on glossy magazine stock, many people said that paper books and magazines would vanish altogether. That still has not happened—certain types of communication, such as those requiring analysis, can be more easily read and understood as hardcopy. Even for casual reading, many prefer it to book disks that are read on portable book screens.

My first research assignment was to dig up background for an article on bootleg TV-art. Subscription TV-art displayed on high-resolution flat-screen TV's has become popular. A TV-art reproduction—French impressionist—hangs on my wall at home. The quality doesn't match that of the original, of course, but it's about the same as the print reproduction; it doesn't need to be mounted or framed, and I can change it whenever I want to just by requesting another selection from the catalog. Video artists found a new market selling to the subscription art services. But now, because hackers have downloaded popular artworks onto optical disk and sold bootleg copies, some artists are demanding improved safeguards.

Doing research on that article gave me my first taste of how the expert-system researcher works. One feature I particularly like is the databank guide. I request information from the guide, and give it search parameters, and it becomes an instant librarian. It designs a search pattern, then collects, catalogs, and electronically "shelves" the results. It can search international foreign-language sources and run them through its translator. I found that sources originally written in Japanese, Russian, Chinese, Arabic, and Swahili can give a broad perspective.

I can learn more in one week researching electronically than in months researching in library books. Sometimes I complain about information overload, but then I remind myself what life was like back home. With electronic research, printing on-demand, and art broadcast on TV, 2001 offers plenty of mental stimulation. Sue, admit it—don't you find life in your Back to Basics commune just a little dull?

Love,



SOLID STATE TECHNOLOGY IN THE 21st CENTURY

One gigabit in three dimensions.

B. L. GREGORY

FOURTEEN YEARS AGO THE INTEGRATED-circuit industry introduced the 1-kilobit MOS Dynamic RAM (DRAM). Although the DRAM has reached the 1 megabit level—a tenfold increase—it took five generations of development since 1973 to get there. In retrospect, each step in the development of 1-megabit DRAM's is obvious, yet few people in 1973 would have been able to chart the advances in both the processing and the equipment that made the progress of the last 14 years possible.

What made it difficult, back in 1973, to see 14 years into the future is that prognostications are really limited by what we already know. It's relatively easy to predict the next generation of technology because it's usually based on existing knowledge and production equipment. The problem of getting there is largely one of execution. It's predicting the third generation that becomes difficult because key pieces of technology or equipment normally do not exist, or at best we surmise what direction technology will take based on what is already known. Beyond the third generation, predictions become very inexact; at their best they are *guesstimates* that must be solely based on extrapolations of past rates of progress.

What does the extrapolation process show us about the future? Between the late 1950's and early 1970's, chip complexity doubled every year; a pace that was difficult to sustain. In the early seventies it slowed to a factor of four increases every three years. Indications are that, as we approach the existing technical limits, the rate of change will slow even further in the decade of the nineties. But even with slower progress, extrapolation predicts that in the year 2001 it will be possible to fabricate a 1-gigabit chip (1000 million bits) having a minimum feature size of

less than 0.25 micron and an area approximately ten times larger than today's largest chips.

Another approach to prediction is to identify fundamental limits. This can take the form of limits in feature size due to lithographic or other patterning constraints. It can take the form of practical

limits on the thinness of gate oxides necessary for high reliability. The limit can become even more fundamental and relate the energy involved in a semiconductor device's switching action, or the charge stored on a storage capacitor, to the fundamental thermal noise present in the device's elements; or the energy might be related to the charge produced spontaneously in a device when it is transisted by a high-energy particle. For example, without the shielding effect of the Earth's atmosphere on cosmic rays, we would not be able to use our present complex integrated circuits because of induced logic and memory upsets.

We can attempt to predict the evolutionary equipment that will set the major limits in future manufacturing processes. If, for example, we knew the capability and availability of future generations of optical lithographic (photographic) equipment we would eliminate a major unknown in our predictions—assuming that optical systems will still be used for manufacturing chips.

But there is hazard in that kind of thinking, because it is based on the existing technology that uses an optical process to improve two-dimensional (2-D) chip density by making the features smaller. The existing 2-D technology might easily be superseded in two generations. For exam-

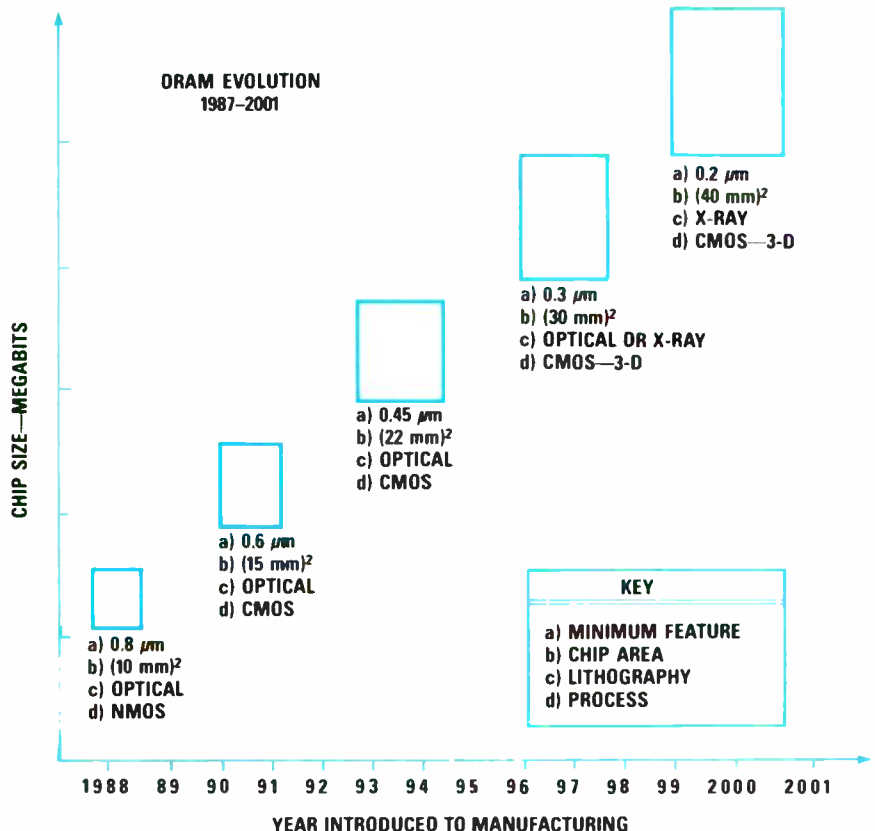

FIG. 1—THE PROJECTED EVOLUTION OF DRAM to the year 2001. The major breakthrough is expected to occur when the chip structure can be made three-dimensional.

ple, the introduction of three-dimensional (3-D) technology would allow us to work within the depth of a chip (in connected layers, so to speak) so that the overall active density of the chip would be increased without requiring smaller features. Or, the chip might contain its own testing system capable of bypassing faulty memory circuitry, thereby permitting larger chips to be built at greater yields—meaning fewer and fewer rejects caused by faulty memory.

But enough said about the difficulties—on to the predictions! The most complex chips in 2001 will be DRAM's. NMOS (negative-channel MOS) technology, which is used for both DRAM's and CPU's, will have given away to CMOS for a variety of reasons, among the most important being lower power requirements and improved submicron performance. Although new architectures will reduce CMOS power to minuscule levels, the higher density of the 1-gigabit chip will nevertheless concentrate what little heat there is per individual cell, so new, more efficient, concentrated cooling techniques will be employed to provide for the power dissipation required in a 1-gigabit chip.

The chip itself will have 3-D circuitry, employing both horizontal (2-D) and vertical (3-D) devices, multilevel 3-D devices, and several layers of electrical and optical interconnections. In a sense, the chip will resemble a modern commercial building having some office complexes on a single floor (2-D), others occupying several floors (3-D), horizontal raceways for communication wiring (2-D), and vertical raceways or the elevator shaft (3-D) for interfloor wiring. To the process engineer of 2001, the processes of 1987 probably will appear as primitive as a 10-micron metal gate and a high-threshold PMOS appears to us today.

Referring to Fig. 1, from what it is possible to conceive from present technology, we have extrapolated the limits, processes, and equipment that are likely in the evolution of DRAM's from the present to the 1-gigabit chip of 2001. Because it is a density-related 3-D system, we expect that X-ray lithography (synchrotron source) will be required in the late 1990's in order to continue DRAM evolution.

Other silicon products

The DRAM is a high-volume, cost-sensitive product. Decisions made concerning its technology are not automatically relevant to low-volume, high-value ASIC (Application-Specific IC) chips. An ASIC chip is an ultra-high-density device containing a complete system made to order for a specific application. Stretching the imagination, one ASIC chip might comprise all the electronics of a personal computer system: the CPU, DRAM, and support systems. More likely, an ASIC

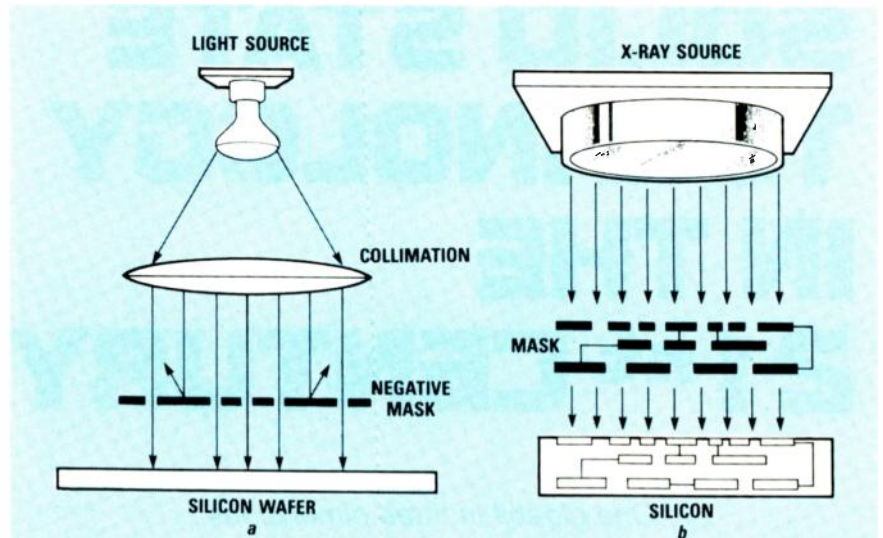

MULTILAYER, OR 3-D PROCESSING will sharply increase the active area per chip. As shown in a, in conventional optical processing a mask provides the surface pattern for a silicon chip. In 2001, 3-D processing, such as the X-ray system shown in b, will result in a multilayered chip having individual elements interconnected by metallic and/or optical paths.

might contain the entire electronic system for an automobile: Everything from a voice synthesizer warning that the doors aren't closed to the computerized ignition system. Similarly, one or two ASIC's might comprise a complete cellular telephone, something that presently takes a bagful of components, of which many are already multi-function integrated circuits.

Even today a schism is developing between the technologies used to manufacture DRAM's and ASIC's. Although the DRAM process is continuing on an optical-lithography path, high-performance high-density ASIC's, called VHSIC's, are being produced by direct-write E-beam lithography. Other techniques for manufacturing ASIC's and VHSIC's that are still in the early stages of development include laser-assisted deposition/etching, and focused-ion beams. The advanced ASIC line of 2001:

- a) will not use any form of mask or reticle.
- b) will use a combination of E-beam, laser and ion-beam processing.
- c) will depend on extensive computer resources for design, simulation, processing and testing.
- d) will be designed using innovative techniques to achieve high levels of tolerance against both hard and soft faults.

New materials

Because compound semiconductors provide greater speed, and because speed is the key to performance in VLSI (Very Large Scale Integration) circuits, it is more than likely that 2001 won't be a silicon world. Right now, new classes of synthetic compound semiconductors are being developed in research labs and universities around the world. In particular, there is a great deal of effort going into improving the materials-technology of

gallium arsenide (GaAs), which is considered by many to be the most mature of the compound semiconductors. By 2001, the compound semiconductors will be extremely fast, and single-gate switching in just a few picoseconds will be possible.

Although it would normally be difficult to take advantage of such speed in complex IC's due to the parasitic resistances and capacitances present in large chips, the shorter paths of three-dimensional structures will maintain the higher speed by reducing the signal delay between devices (because they will be within the same structure).

In 2001, the major impact of high-speed compound semiconductors will be in devices that successfully combine optical and electronic signal processing; devices that combine ultra-fast analog-to-digital conversion with digital signal-processing to make possible digital video transmission and reconstruction at greatly reduced bandwidth. Also, compound semiconductor devices will be standard in monolithic circuits, in integrated optical arrays of various sorts, and in high-performance communications. However, compound semiconductors will not have succeeded in the semiconductor memory market. There, silicon will continue to be the unquestioned leader, although the current wasteful approach to memory fabrication will be eliminated in 2001—we throw away approximately one-half the silicon we make due to defects. In 2001, on-chip fault-compensation will allow us to use *all* the chips.

Although we anticipate that silicon will still be the material of choice for memory, the search for different, higher-density memory materials will continue. Should a new memory material be created, the predictions in this article will most likely prove to be too conservative. **R-E**

ROBOTS IN THE YEAR 2001 may take on a more human appearance, and act as personal "servants." We'll still be covering new technology then—you can bet on it.

ISAAC ASIMOV

AT PRESENT, ROBOTS (WHICH MAY BE defined most briefly as computerized machines) are extremely simple. They are, essentially, merely computerized arms performing very few motions over and over again.

Research is under way, however, to add to the capabilities of such robots—to give them the equivalent of visual, auditory, and tactile senses—to let them modify their behavior according to what they see, hear, and touch—to make them responsive to spoken orders and to let them speak in return—to grant them mobility.

By the year 2001, it might well be that at least some of those characteristics will have been imparted to robots, so that they can perform tasks of increased complexity. Robots will improve not only in their capacity, but they will certainly increase in numbers as well. There may be well ten times as many robots in action in 2001 as there are today.

The social impact of robots

Today, robots are used almost entirely in factories; they are "industrial robots." However, attempts are being made to design robots of vaguely human form that would be able to do tasks in the home, acting essentially as servants, since they will be running the household appliances, and even greeting visitors. Such "personal robots" may well exist by 2001.

But robots do not exist in isolation. They are accompanied by social and economic problems. If, in 2001, there are many more and much better robots in existence, then it is reasonable to suppose that the social and economic problems will intensify enormously.

The most obvious problem is that arising from the fact that robots will replace human beings in many kinds of work. They are doing so now, but they will be doing so to a much greater extent in 2001. In fact, the economic dislocations that may result, and the popular resentment that will grow, may be an important factor in inhibiting the entry of robots into society. Robots might not increase in numbers or in abilities as rapidly as they would if human suffering did not have to be taken into account.

Since the advantages of robots are so great that the pressure for their use will be overwhelming, society will have to make that use more nearly possible by attacking the problem of human displacement and unemployment. By 2001, social con-

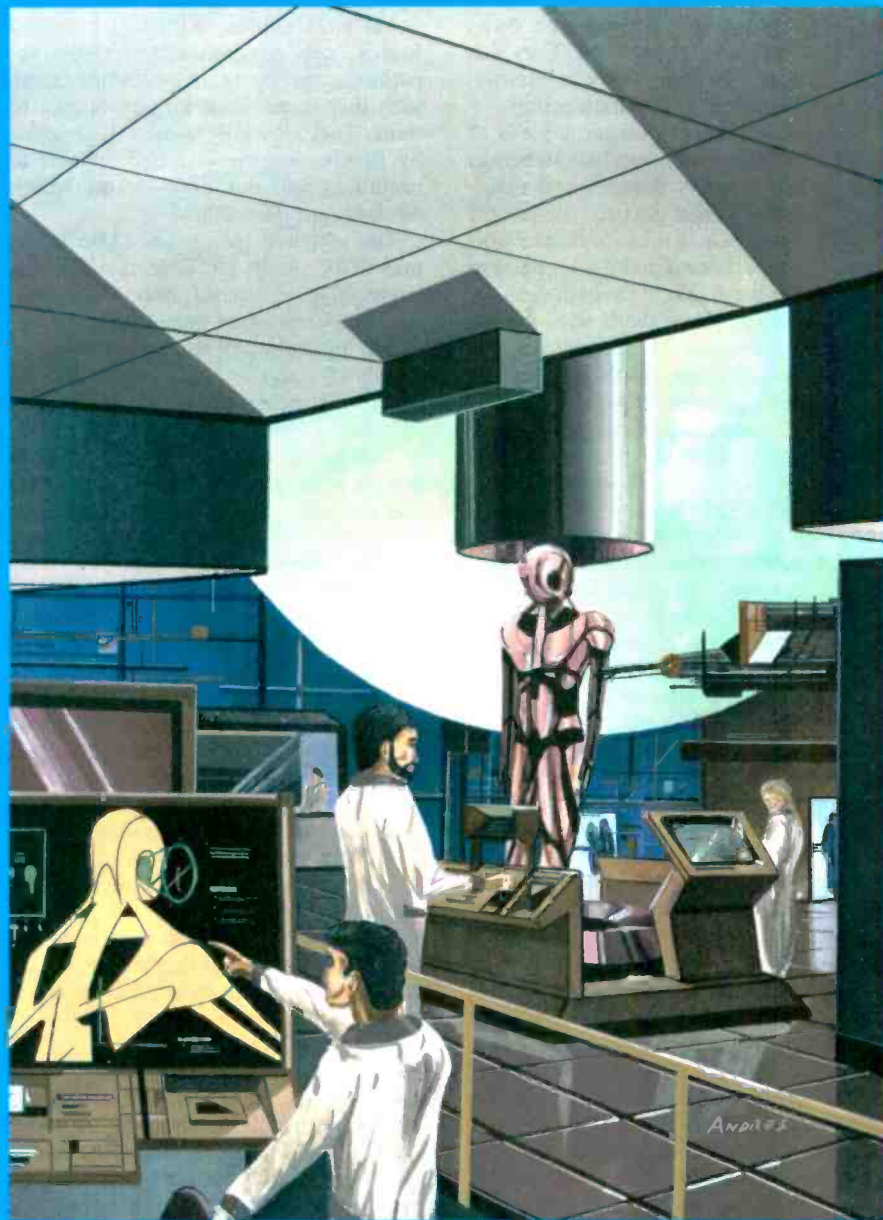

THE ROBOT IN THE 21ST CENTURY

At present, robots are simple, computerized arms with limited capabilities. That will change as the 21st century begins.

cerns, in that respect, will be as prominent a part of the human scene as the robots themselves are.

It might be asked, of course, whether robots are really so necessary that it is worthwhile disrupting society for their

sake. What are the advantages of robots that are so great?

For one thing, robots may be used in jobs that are too dangerous for human beings—under conditions of considerable heat or cold, or in environments where

poison gases or radioactive contaminations are a possibility. They can also do work that is too filthy or unpleasant to be popular with human beings.

Then, too, they can do some kinds of work more efficiently than human beings can. When properly powered and maintained, robots do not get tired, do not get bored, do not take dislikes to other workers or to supervisors, and do not need to take coffee-breaks, visit the bathroom, or stop for lunch. They work with greater meticulousness and reproducibility.

All that is obvious, but there is another point that is, perhaps, easy to miss.

Throughout history, human beings have sought help in doing the heavy labor that needs to be done. Animals were hitched to the plough or set to turning millstones, dragging carts or chariots, and carrying human beings. Levers, wheels, inclined planes, and ever more complex combinations of those simple devices were devised to do work more easily. Sources of energy other than human and animal muscle were looked for—the wind, flowing water, and, most of all, burning fuel.

However, when all that could be done in the way of the use of animals and machines was done, there still remained jobs that, because of their complexity, had to be done by human beings. Yet a great many of those jobs, although too complex for animals and machines, were far too simple to make use of the full potential of even ordinary human brains.

The repetitious work done in factories and offices, the endless tightening of bolts or filing of papers, the alphabetizations and hammerings, had to be done by human beings under conditions that did not engage the brain except to a most limited extent. The brain, largely unused, loses much of its capacity, as unused muscles will. A brain that has no occasion to think, becomes unused to thinking, and ends by being unable to think.

It was customary in pre-industrial times to think of the peasants and serfs, who made up at least 90 percent of the human race, as sub-human and brutish, little better than the animals they lived and worked with. To some extent, that was justified—but the serfs were not born so; they were made so by the nature of the work they did all their lives, work that never engaged the mind.

In today's industrial time—in the United States, for instance—we are far less inclined to despise the "lower classes." We attempt to educate everyone to some extent, and we maintain the belief that since all human beings are human beings then everyone has an opinion that ought to be considered. It follows that opinion polls merely present numbers and have nothing to say about the quality of thought behind the opinions. It also follows that we allow every human being an equal vote in political contests.

Yet most people, even in the United States, are condemned to those repetitious, stultifying, non-mind-engaging jobs that leave them largely unable to think. They are easily swayed by slogans, by illogic, and by distorted appeals to prejudice and emotion—all of which weakens our democracy.

The potential for change came in the mid-1970's, with the developments that led to small, cheap, yet enormously capable computers. That meant that computerized machines could be made sufficiently compact and affordable, and yet sufficiently capable to be profitably used in industry. The robots had come!

That meant that, for the first time in human history, there existed a machine that could perform the dull and reptitious tasks that hitherto only human beings could do. For the first time, the possibility arose that human beings might be freed from the necessity of doing work that stultified the human brain and made it so much less useful than it could be.

After all, is it not plain that work which is so dull and repetitive that a robot can do it is beneath the dignity of human endeavor? If a human being is forced to do it, you make a robot out of him or her. Robots, then, can free human beings to be human.

Put that way, it sounds very good—but it is not that easy. Those human beings who are replaced by robots are precisely those whose brains have been rendered flaccid by unuse; and they may have lost the capacity to turn their brains again to use. What are we to do with them?

We might argue, of course, that advances in technology that wipe out jobs have always created new jobs in numbers far greater than those that had been wiped out. There's no reason to suppose that that won't be true of the coming of robot technology too. The work involved in designing, manufacturing, maintaining, and coordinating robots will require vast numbers of qualified people.

Re-educating society

The key word, however, is "qualified." It will be insufficient to tell those who have lost their jobs to robots simply to take one of the new jobs that have become available. They are not qualified. There will arise the absolute necessity of an expensive program of retraining and re-education. And for those who are too old or too damaged by the life-work that has been forced on them, there must be the task of finding work they can do or of giving them financial assistance.

The age of robots, which will be well along in the year 2001, will therefore, as a direct result, be also an age of huge educational projects designed to correct the harm done human beings by a non-robotic economy and to create the people who can fill the jobs that have been opened by the robotic economy.

It is clear, however, that that problem is a transitional one. It belongs only to the period of the change-over from a non-robotic economy to a robotic one.

Presumably, the new generation born to a robotic economy will, from the start, do only work that robots cannot do, work that engages the human brain much more fully than hitherto. It should be a thinking generation, rich in creativity.

But is that possible? Might it not be that cleverness, ingenuity, and creativity are but rare properties and that most human beings are, after all, only fit for the kind of dull jobs a non-robotic economy would afford them? We can't tell until we try, but at least there is historical precedent in favor of the fact that we may be underestimating the capacity of human beings generally.

In ancient and medieval times, the ability to read and write belonged only to a very few people—philosophers, scribes, merchants, and so on. Most people did not have the opportunity to learn how to read and write and it was generally thought that they could not do so, even if one attempted to teach them. Literacy was a rare faculty.

But as the world grew industrialized, it became more and more important for people, generally, to be literate. Industrial nations established the principle of universal education, and built free public schools for the purpose and, behold, most people in such nations are literate as a result. Almost all of us can read and write with some facility. Those of us who cannot suffer more from an imperfect education than from innate lack of ability.

So it may well be that the generations brought up in the 21st Century into a robot-economy will display widespread creativity, more widespread than we, with our experience of a non-robotic economy only, are likely to credit.

To be sure, it means that in the year 2001, we will be struggling with the establishment of an entirely new philosophy of education. Until now, the notion of mass education has meant one teacher for many students (since it is all too difficult to find capable teachers). It has also meant a standardized curriculum in which everyone learns in the same way at the same speed. No allowance is made for individual differences, with the result that most students are either confused, bored, or resentful of the learning that is forced on them.

Fortunately, the coming of a robotic economy means the coming of a generally computerized economy, for robots themselves are the products of computers. Libraries will be computerized and the computer outlet, which may be present in nearly every home by 2001, will make it possible for people generally (adults as well as children) to satisfy their curiosity in any field.

We all love to learn, if we are given a chance, provided that the learning is in a field in which we are interested. After all, the human brain is particularly proficient in learning, and anything for which an organism is well adapted is pleasant to do.

Therefore, in addition to school where basics are learned, and where students learn how to deal with human interactions and those subjects that require such interaction, there will also be time at home where youngsters can pursue their own inquiries and explore his or her own interests and potentialities. In a sense, each child (and adult, too) will have a private tutor in the form of an advanced and interactive computer that can guide curiosities, supply answers, and even suggest new avenues of questioning.

In 2001, then, we will be looking forward to a world in which human beings will, almost automatically, find themselves delightful ways of life, some in science, some in art, or music, or literature, or government, or industry, or show business.

We will be looking forward to a far richer and happier world, and we will be learning to be grateful to the faithful, hard-working robots who will have taken the weight of all the dreadful hack-work from our shoulders and our minds, and will be doing the dull work of the world in order that we might do the interesting work.

Humans vs. Robots

But will the robots stay where they are put? Surely, they (and computers in general) will continue to be improved, will continue to be made more versatile, and given additional powers. They will be able to take over more complex jobs.

Will humanity be engaged in a hopeless race; climbing the mountains of complexity and creativity, with the inexorable robots always close behind, until we despairingly reach the highest peak of all, only to be pushed off by the robots? In other words, will robots and computers finally replace human beings altogether, simply because they will become more intelligent and capable than humans?

I don't think so. Such fears are based on the assumption that intelligence is a rather simple thing, a unitary phenomenon; that all objects that show intelligence show an identical kind of intelligence, so that direct comparison is possible.

That can't be so. Intelligence comes in various varieties and the greatest geniuses, transcendent in one way (Einstein in physical concepts, Mozart in music, Shakespeare in writing) may be quite ignorant, or even foolish in other fields. It is not enough, then, to say "intelligent," one must say "intelligent in this or that way."

It seems to me, then, that robotic intelligence is widely different from human

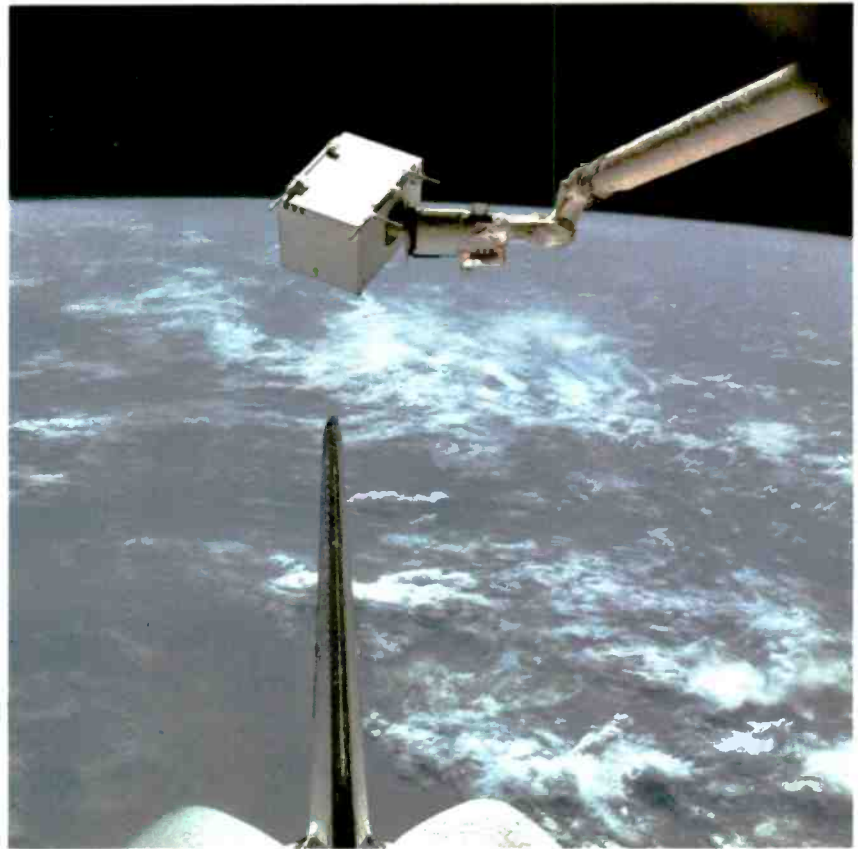

PERHAPS THE WORLD'S MOST FAMOUS ROBOT. The Space Shuttle's remote manipulator system holds a monitor to detect contaminants around the orbiter's cargo bay.

intelligence. If we measure intelligence simply by the ease with which we solve mathematical problems, then the simplest pocket commputer is already far more intelligent than we.

But, then, the human brain is not adapted for number crunching. We can't possi-



THE TROIKABOT can carry out complex three-dimensional assembly tasks. We might see this Westinghouse robot in a future space station.

bly do any but the simplest arithmetical operations in our head. For anything else, we use our fingers, or an abacus, or Arabic numerals written on paper, or a slide-rule, or a computer.

What the human brain is good at are such things as insight, fantasy, imagination, and creativity. The human brain has the ability to look at a problem as a whole and guess the answer. It can take insufficient data and work out the probable result. (I can write an essay such as this one at top speed without ever stopping for conscious thought over the problem of which word comes after which word, or how to structure a paragraph.)

Can we teach robots those human ways of thought? Probably we can't, because we don't know how we think. (I don't know how an essay comes out of me without conscious thought, so I can't program a robot to do it. What directions can I possibly give it?)

Even if we learned how to program robots to think humanly, why should we? We have humans to think humanly. What we want are robots who think robotically, who have capacities that we don't have.

In short, in 2001, we will be looking forward to a world in which robots and humans, two different varieties of intelligence, will cooperate, rather than compete. Together we will advance far more rapidly, than either of us could, separately.

R-E

COMMUNICATIONS IN 2001-

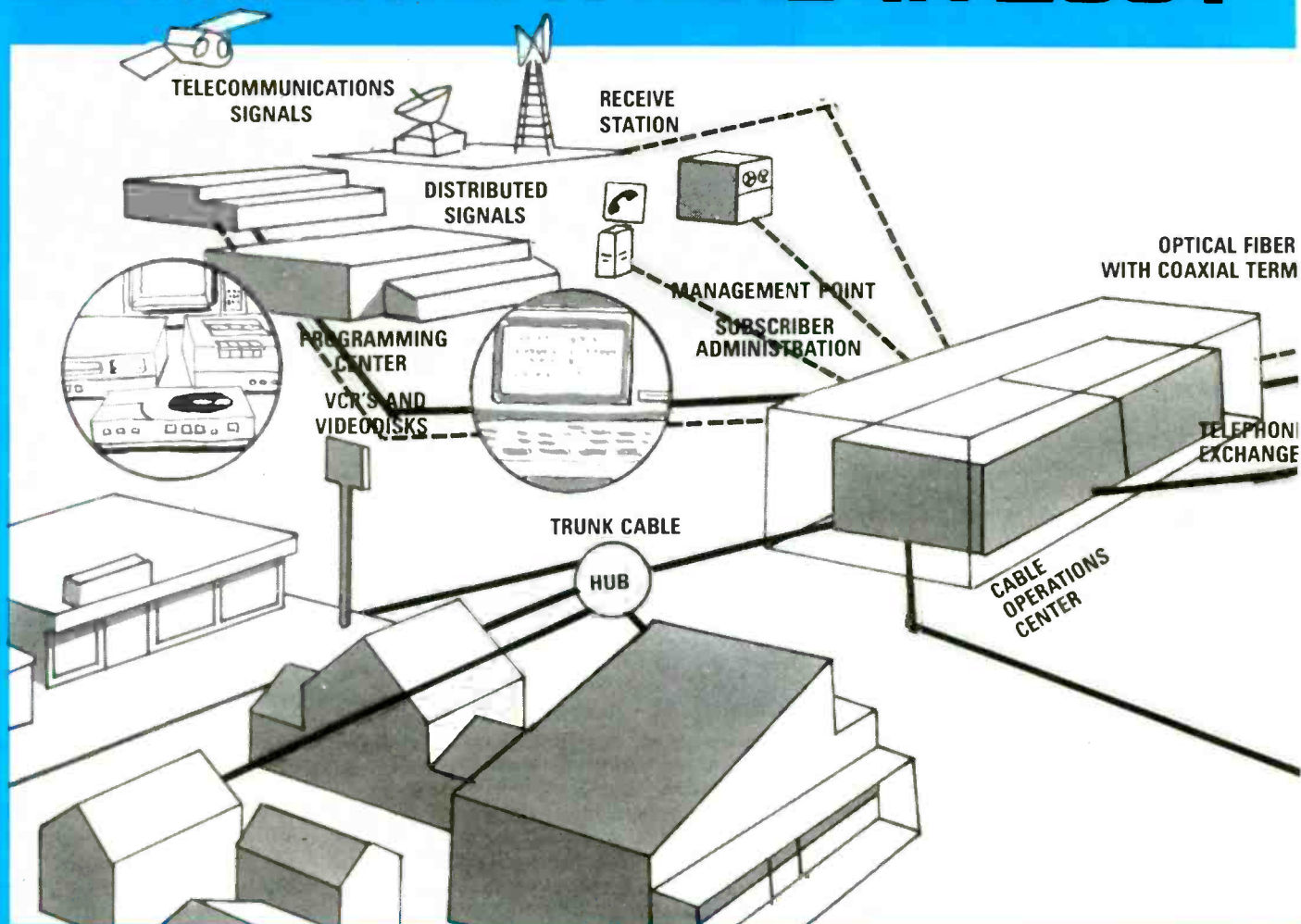

Interactive VCR's? Movies on demand? They're coming—soon!

CHARLES N. JUDICE

IMAGINE YOURSELF IN THIS SCENARIO: You'd like to switch jobs, and, to learn more about companies in the area that need people with your expertise, you type "companies within 50 miles employing physicists" into your TV. In two days, an hour and a half of video programming describing seven local corporations is downloaded to your VCR automatically.

Or suppose your daughter has a thyroid problem. Her pediatrician recommends a local surgeon, but you would like comments from former patients. You type "former patients of Dr. Wellbeing who have had thyroid disorders" into your TV. In five days it informs you that "the material you requested on thyroid patients has arrived."

Or suppose you're a young mother taking care of your newborn son and studying

for your master's degree in electrical engineering. While the baby sleeps, you are taking Lesson 12 of the digital signal-processing course being taught at Princeton. Your VCR recorded the lesson last night. In addition, your questions regarding DSP chips were received by Professor Billings this morning.

Each of those scenarios is likely to be realistic in the Third Age of Video—a time in which television audiences might very well consist not of groups of 20 million watching one program, but of groups of ten or fewer watching 20 million programs. Advertising, rather than being the province of relatively few of America's half a million corporations, will be accessible to virtually any company. We are talking about "Video Power to the People"—a time when most anyone can be a producer as well as a consumer of video—and it's about as close to realization as personal computing was in the early days of the first personal computer, the MITS *Altair*.

Bellcore research

Scientists at Bell Communications Research (Bellcore) have been researching

the devices, systems, and services we envision for the Third Age of Video. We want to understand what role telephone companies, as distributors of information, might play. That there will be a role—and an important one—can hardly be doubted. Even pessimists predict that within 20 years, it will be no more expensive to build high-speed fiber-optic telephone-switching systems than it is to build our current systems. However, the new systems will handle many times the volume of information that our systems do today.

The fiber-optics based communications network of the Third Age of Video will have the information-carrying capacity of cable-TV networks, as well as the telephone network's ability to connect any node in the network to any other node. In fact, experiments in Europe, Canada, and Japan are already being conducted to explore the possibilities of such wideband communications systems. In Biarritz, France, for example, 1500 telephone subscribers have video-telephone service, video-library service, and other advanced features provided through a fiber-optic distribution system.

The Third Age of Video

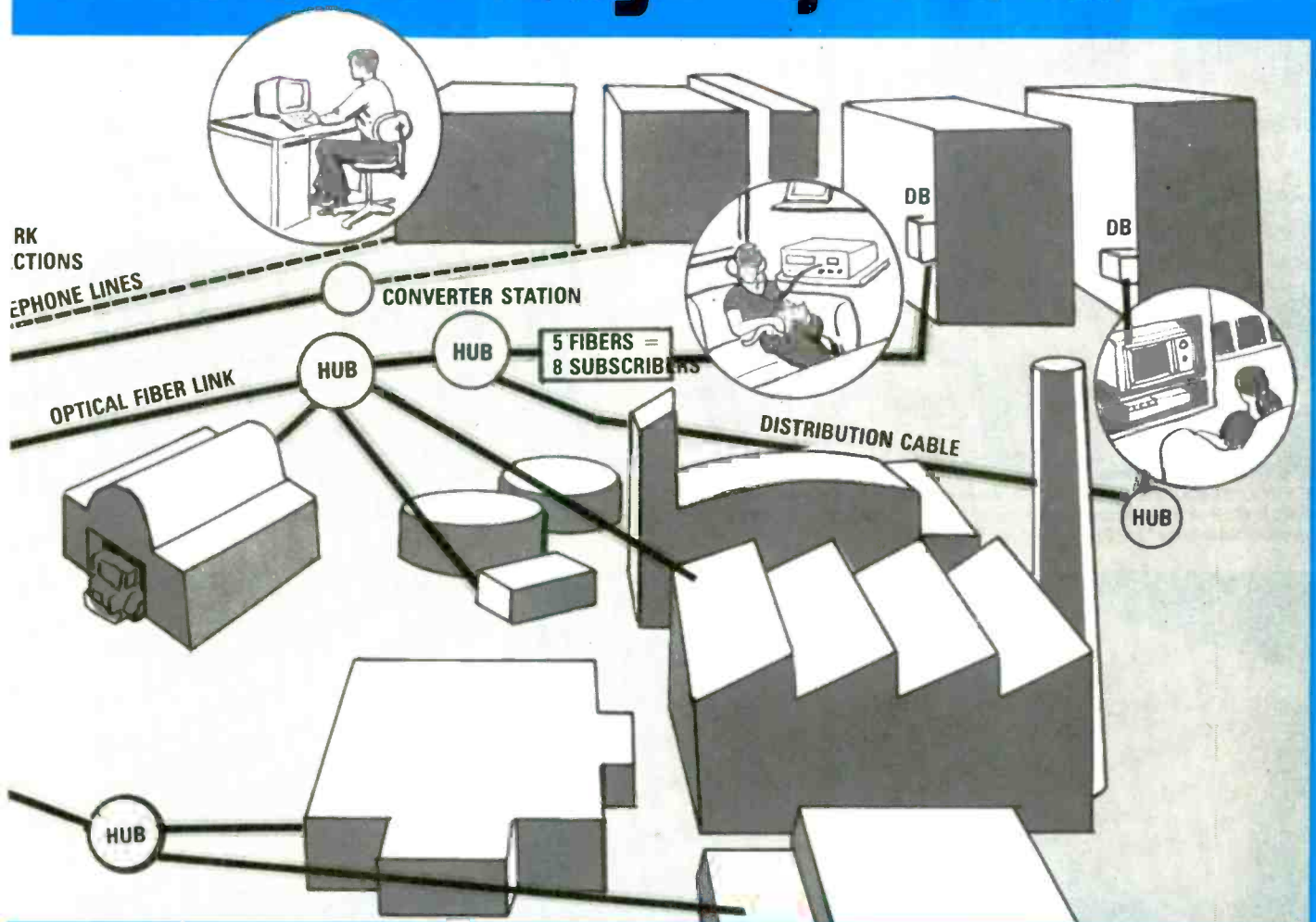

Third-age prototype

To test the feasibility of those ideas, Bellcore engineers developed an experimental machine that delivers the type of integrated video services that we believe will be important to consumers. We wanted to give the viewer as much control over what he watched on TV as he now has over who he talks to on the telephone.

So we built a machine called a Video Resource Manager (VRM), and installed it for three months in my New Jersey home. One of the most useful services experimented with was what we called the "intelligent VCR." It comprised an up-to-date list of TV programming available on a particular day, and for the next month. From any of four television sets, my family could either watch the current program, or, by pressing a button, have the VRM record the show for later viewing. (See Fig. 1).

Playback required only a selection from one of several on-screen lists. All of the usual VCR functions, such as fast-forward, freeze-frame and search, were available from the keypad as well. We multiplexed the output of a Touch-Tone telephone pad onto an RG59 coaxial cable

that also carried the audio and video signals from the VRM to the remote TV set. Key presses were de-multiplexed and interpreted at the VRM independently for each of six users. Every action taken by the VRM was then recorded for later analysis in our ongoing evaluation of the service.

In addition to the intelligent VCR, users had a movies-on-demand service that allowed them to browse through listings of movies organized by title, subject, and rating. Although that particular service was not as conveniently implemented as the intelligent VCR, at that time, it suggested a new approach to introducing videotex into the home.

In fact, until now, videotex has been a solution looking for a problem. But by integrating a database service with entertainment video, we believe we may have found the path leading to the Third Age—that is, Moviebrowser, a natural photo-videotex application.

Still-image composer

Researchers in the United Kingdom and Japan have been experimenting with the notion of photo-videotex. And engi-

neers at Bellcore have been busy, too. We have built a still-image composer that can snap pictures of ordinary video images and place them at arbitrary places in arbitrary sizes on a composite screen. Such capabilities can be provided over cable-distribution facilities by adding a frame buffer to the home videotex system.

In addition, we built a system that allows you to create slide-show like sequences; each frame may be associated with an audio sequence. The system is multi-user, and uses Winchester-type hard disks to store digital audio whose quality matches that of the compact disc. The technologies are here today and can be made available inexpensively in sufficient volume to be economically viable.

TV production

The obstacle to that sort of proliferation of television production has not been a lack of ideas, but of access to the tools of the trade. Until recently, video production has been restricted to professionals, due to the cost of the necessary specialized equipment. However, simple VHS-format editors are now sufficiently inexpensive that high-school curricula include video



THE VIDEO RESOURCE MANAGER (VRM) was installed in the author's home for three months for testing. It allowed us to share video resources among four TV sets via remote control. The remote controllers were based on *Touch-Tone*-like keypads.



FIG. 5—DEMOCRATIC TV (DTV) MUST BE EASY TO USE, unlike current Videotex systems. Developers are working on new ways of getting information from the system, including the Macintosh-like interface shown here.

production as an elective along with photography. Special-effects processors that mix multiple video streams are being researched at Bellcore, to determine the extent to which microelectronics can reduce the cost of such components.

For example under study is an RGB video-image combiner that can take four NTSC or RGB inputs and combine them into a single high-definition or 525-line RGB composite-video output. With sufficient demand, cost could be reduced to the point where the equipment would be affordable by semi-professionals.

In the fourth edition of the *Video Source Book*, there are more than 35,000 listings of video material categorized by business/industry, children/juvenile, fine

arts, general interest/education, health/science, instruction/how-to, movies/entertainment and sports/recreation. The Third Age of Video will change our habits from shopping for one title out of several thousand in the local video store to requesting that one of several *hundred thousand* titles be downloaded to your VCR. The technology is available today and could compete as an alternative to video-store shopping.

Democratic TV

Consider a new service that we call Democratic TV (DTV). How would it work? You turn the TV set on and select a DTV service. Your videotex controller connects you to a computer in the cable

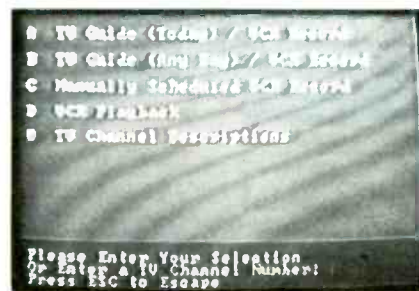

a

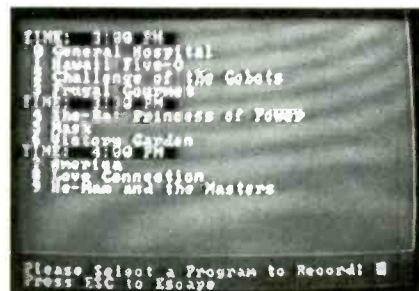

b

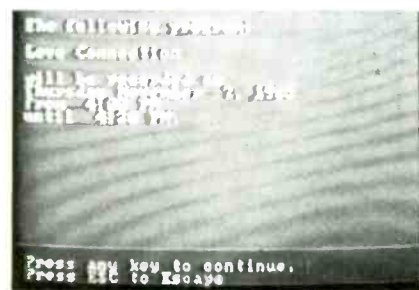

c



d

THE VRM COMBINED VIDEOTEX-LIKE SERVICES with remote-VCR control. From any location we could, using on-screen guides, choose one of several television services (a), obtain a listing of current shows (b), set up for delayed recording (c), and obtain a listing of current movies (d).

head-end. The ensuing dialogue would depend on the sophistication of the service offered. It might proceed as follows:

DTV System: *Thanks for calling. Select a subject category.*

Subscriber: *Baseball.*

DTV System: *Select an event.*

Subscriber: *Last night's little-league game.*

DTV System: *Currently being offered not later than 10 pm on Friday at \$3.50 to 17 other subscribers. We do not expect sufficient interest to permit earlier broadcast.*



a



b

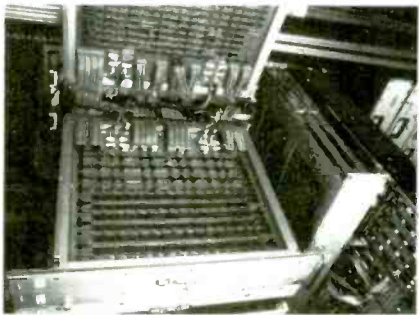

c



d

STILL-IMAGE VIDEO EDITING is another application of third-age video technology. For example, various images can be superimposed (a) on one another. A standard video terminal can be used to browse through an electronic "book" of video "snapshots" (b). Semi-professional TV production using equipment like that shown here (c) can be used to combine several video signals into a single output (d). The input signals may be either NTSC or RGB; the output may be in either the standard 525-line or the upcoming high-definition format.

Do you still wish to subscribe?

Subscriber: *If by Wednesday, yes. If not, any baseball game will do.*

DTV System: *Conditional order taken. Anything else?*

Subscriber: *Display movie listings.*

The basic idea is to use software and

hardware technologies to take maximum advantage of existing limited-distribution networks. Movies would be distributed on the CATV network; control signals would be transported on the telephone network.

A key element of the architecture is the VCR. It is important because the capacity of CATV networks is limited, and more so if you attempted to provide video-on-demand service to a typical system of 5000 subscribers. The reason is that most people watch TV at the same time (7–10 pm), and if half of a 35-channel CATV system were devoted to DTV service, only 18 people would get to watch what they wanted. However, with intelligent VCR's (to which programs could be down-loaded during off-peak hours) 180 people could watch their program choice with at worst a one-day wait from the time it was ordered.

DTV technology

Exactly what do we mean by Democratic TV? To begin with, your TV set would be interfaced to a controller that makes using the service easy for the subscriber and manages all the electrical signals needed to make it work. We believe that earlier attempts at a service like that failed because the user interface was poor.

Furthermore, electronic home information (videotex) experiments in this country have been generally unsuccessful. At home, people will not pay much for information—they're used to getting it free. However, people will and do pay for entertainment, as evidenced by the popularity of VCR's, cable TV, and stereo equipment and programming. Democratic TV couples videotex with an entertainment service to give people more control over their viewing choices. That control is the key to launching the Third Age of Video—and in a sense it has already begun: Impulse Pay-Per-View schemes are under trial nationally.

After a delivery system for still-image and full-motion video is made available at the community level, more people will have the opportunity to produce video programming, including, for example, the fifteen-minute sermon by a local rabbi or minister, excerpts from the town-council meeting discussing hazardous waste sites, a visit to the high school by one of NASA's astronauts, and a walk through a local park. The difference between the scenarios described and today's cable systems is in the scale of viewer options and their control over them.

The technology for the Third Age of Video exists and awaits deployment—admittedly a large task. But it seems overwhelmingly likely that, by 2001, the strikingly superior quantity and quality of audio and video transmissions available through fiber-optic cable will have generated so great a demand that the Third Age will not only be upon us, it already will have become commonplace. **R-E**

As the preceding article makes clear, the way we use video communications in the twenty-first century will be quite different from the way we use it today. Technology will also dramatically change the video we watch and the way we view it. What are some of the possibilities?

Large hang-on-the-wall screens will finally become a reality. We'll see multi-image projection rooms with 360-degree viewing screens and holographic displays. We'll also have spherical viewing rooms that will let us experience video like we never have before. They will take advantage of new video tape that contains computerized codes for the room's master control system—to vary room temperature, aromas, vibration, etc. to enhance the realism of what we view.

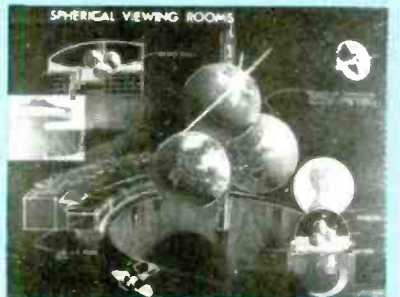
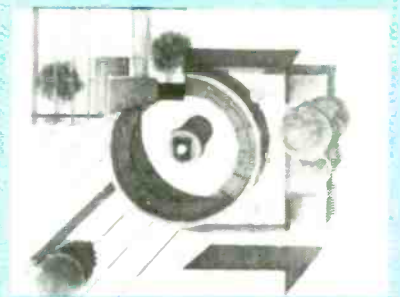
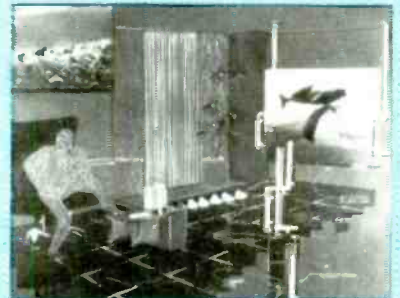

July 4, 2010

Dear Sue,

Your letter posed a tough question: How has the technology I've been describing affected people's lives? I know you feared the worst—I remember those horror stories we were raised on in the Back to Basics commune, about individual liberty being destroyed by computer integration. You thought that my enthusiastic letters meant I had been brainwashed, right? I admit the technology of the 21st century dazzled me. I saw instant-information, and it seemed that instant information meant instant solutions.

I no longer expect instant solutions. But I still believe that the technologies I've written you about—integrated electronic offices and electronic information access—offer the average person increased opportunities. Here's what I've discovered.

First, the integrated electronic office: Office automation shifted people's attitudes toward work in several ways. Back in the early 1990's, automation caused rough times for white-collar workers, with massive layoffs, similar to the blue-collar layoffs of the 1980's. Public pressure forced government and industry to establish free retraining centers, like the one I trained at when I first left the commune. Today, people and companies plan on changes in jobs and careers. Such changes often demand continuing education. Industry leaders increased support to community colleges and continuing education programs. Tax laws now allow deductions for any education expenses.

Next, electronic access to information: Ease of access poses a subtle danger because now people are more easily informed, but not necessarily more knowledgeable. With information so easy to get, people take its accuracy for granted. Hand someone a copy of Mein Kampf with a biography of Hitler on the back cover and they'll likely take one look, then toss it in the garbage. They can see from the context the writer's prejudices. Show that same person an out-of-context extract from the book in a databank—how are they to guess the author was a deranged fanatic?

But people are finding answers to that problem, too. Schools now train students to analyze data for the degree of accuracy. And to discourage those who might deliberately plant lies in databanks, a new law requires databank publishers to disclose the source and entry date for all information.

The benefits of electronic information access outweigh the hazards. Scientific and technological research is thriving. Geography is no longer a barrier. Because people can access translations from all over the world, they learn to understand other cultures better. Will we someday understand each other enough to solve our disagreements with reason instead of force? On a personal level, when people get the information they want faster, they think faster, make decisions faster, and act faster. People find fewer barriers between their dreams and their goals.

Speaking of which, I've got to go now. My home workstation just arrived and my neighbors have gathered to welcome me to the ranks of telecommuters with a terminal-warming party. Sue, I think you really wanted to ask, "Have the new technologies isolated and diminished people or made them mere chunks of data in gigantic databanks, as our parents feared?" I hope I've shown you that, instead, people have found new ways to come together, to broaden their interests and skills, and to better understand each other and their world.

Love,



A look at five new technologies that may dramatically effect the ways we generate electric power as the 21st century begins.

Dr. STEPHEN B. KUZNETSOV

OVER THE NEXT DECADE AND A HALF, several dramatic changes will occur in the ways that American households obtain electric power. Those changes will come about because of the development of practical, commercially-feasible small power-generating systems for consumer use.

The technology is being developed now. When that development is complete, millions of consumers will have access to resources that will allow them to generate their own power efficiently and reliably.

In this article, we will examine five new power technologies that could be in mass production by 2001, profoundly affecting our everyday lives. Three of the technologies generate DC and AC electric power; a fourth conditions the electric power produced by the consumer for practical use; and the fifth is one of the most efficient energy-storage inventions known to modern civilization.

Private power production

The inventions and technologies described here are ones truly designed for a new age as they are used to produce rather than consume electric power. Further, the generators we'll describe here all use renewable energy sources in performing their tasks. Finally, their installation, use, and maintenance in a home/consumer situation requires no specialized skills or additional training.

For the consumer, there will be many incentives for turning to self-generated electric power. In the past, the government has encouraged the use of solar, geothermal, and wind energy, and it is likely to do so in the future. For example, since 1978, owners of home power-generating equipment have been guaranteed a fair selling price for the electricity they produced. Utilities are required to purchase any excess electricity, up to a limit of 80 megawatts, at the prevailing rate. By 2001, that rate could be \$0.12 a kilowatt-hour, or more, potentially making private power-generating systems a very attractive investment.

The energy-technology industry is undergoing explosive growth. Almost 4000 new manufacturers spring up in this coun-

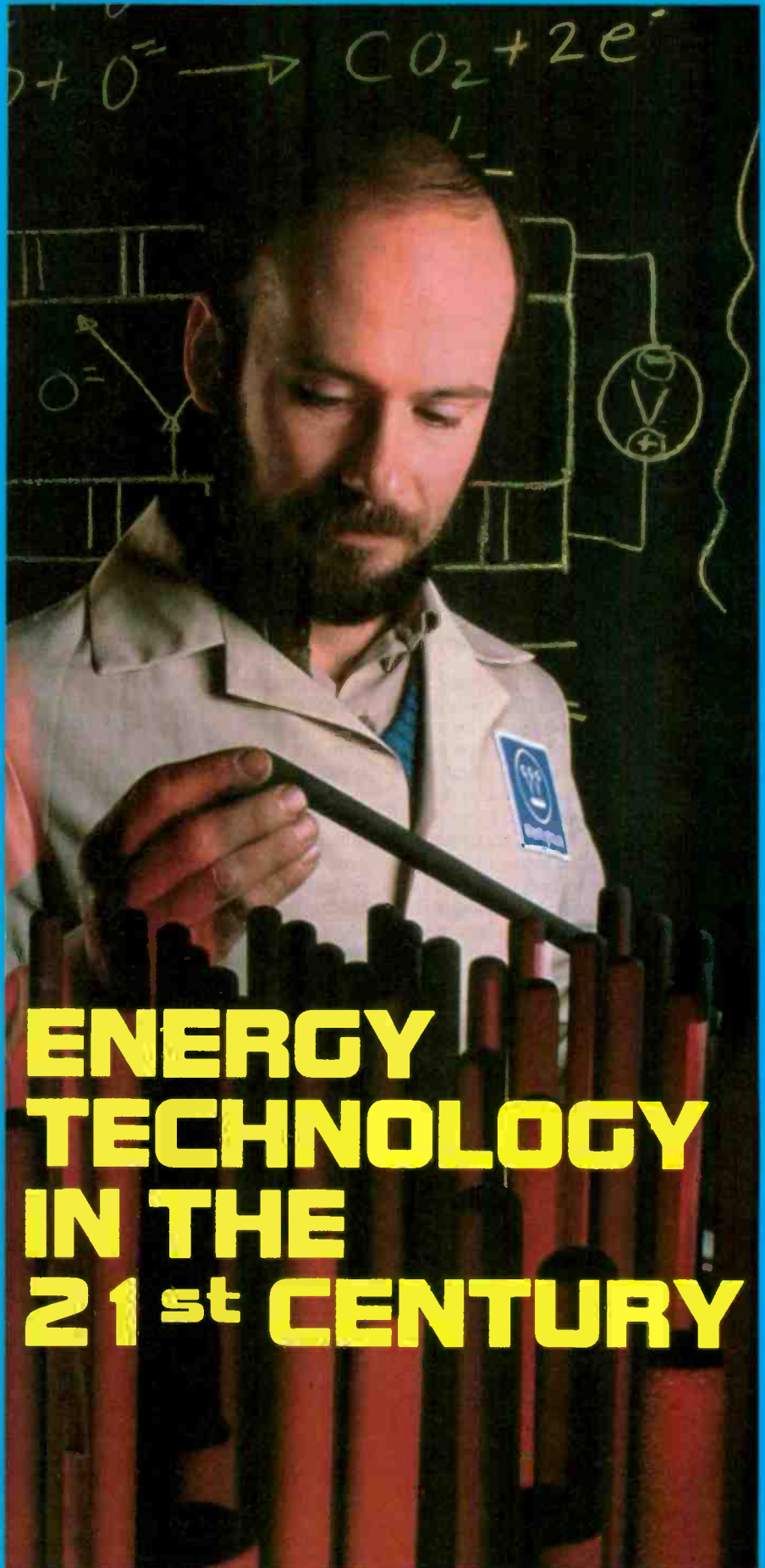

ENERGY TECHNOLOGY IN THE 21st CENTURY

try every year; and if current trends continue, that rate is likely to triple by 2001. Unlike traditional energy-equipment manufacturers, which have concentrated on large-scale power generation exclusively, the new manufacturers are concentrating on technologies that are suitable for small-scale applications. Many are appropriate for use by individual home owners.

One key to making home power-generation practical is to make the technology less intimidating. That can be done in part, by using microprocessors. With microprocessor-controlled systems, you won't need to be an engineer to maintain a small generating unit. Instead, a microprocessor—perhaps aided by voice-recognition and speech-synthesis systems—can guide you through most maintenance and repair operations.

Many consumers already have turned over the operation of some home energy-generating equipment to microprocessors. That equipment ranges from hot-water boilers to automatic fireplace lighters. In most installations, however, all equipment is controlled by a single, central processor—that is, the personal computer.

By 2001, we will be in the midst of what is called the DIRAC (*Decentralized/Indirect-Radiated Automatic Control*) era. Then, each piece of energy-producing equipment, be it a rooftop generator, a basement storage-unit, or a hidden power-conditioner, will be controlled by its own microprocessor. No fiber-optic or hard-wire link will be needed for coordination, because each piece of equipment will be able to react autonomously to conditions for peak performance. Some have even speculated that, by 2001, each wall socket in the home will be equipped with microprocessors that will monitor all appliances and control the distribution of power in the room following voice instructions and sensor information.

A new vocabulary

Man has always speculated about the future. In past centuries it was fashionable among scientists and others to consider the changes that might come about in 100 years. As the pace of technological advance quickened, perceptions altered and visionaries began thinking in terms of 50 years for significant changes in lifestyles to be realized. Now, 15 years, or less, seems safer.

With the dramatic changes in energy technology will come a new language of sorts. In particular, five new "words" will become familiar to everyone from age 2 to 92 (the anticipated life expectancy in 2001). Those words will be:

- LIMPET—*Linear Induction Machine Programmed Electric Turbine*
- SUPERSEA—*SUPER*conducting *Self-Excited Armature*

- CAVET—*Closed-cycle Advanced Vapor Electro-Turbogenerator*
- FC—*Fuel Cell*
- PC—*Power Conditioner*

If you doubt that to be true, think about the blank stares that the terms micro-processor, personal computer, RAM, ROM, or even LCD would have drawn from many in 1972, and the knowing smiles they now generate.

LIMPET—a linear generator

Roughly 15 years ago the *Linear Induction Motor* (LIM) was introduced as a replacement for conventional electric motors in high-speed mass transit. LIM-powered trains built in the U.S. achieved record-breaking ground-transportation speeds of over 250 miles-per-hour in 1974. At present, the world record is 320 miles-per-hour for a linear-induction levitated train. However, it is predicted that by 2001, the greatest use of linear induction may be for electric-power generation for homes and farms.

The LIMPET is a relative of the LIM of the 1970's, although the mechanics behind the technique originally were conceived by Leonardo da Vinci in the 14th century. The device uses wind energy, a classic renewable-energy source, to generate continuous AC electric power at 60 hertz in a way that's dramatically different from current conventional wind-energy systems. Currently, wind-energy systems all use rotary-turbine motion and a rotary generator in one form or another. Two schemes are commonly used: Either the generator is directly attached to the propeller, or alternately, it is geared to the blading through a long shaft, allowing the generator to be mounted on the ground. The result is the windmill, long a fixture in rural America.

By 2001 those windmills will have virtually disappeared. In their place will be

one or more LIMPET's, like the one shown in Fig. 1, mounted on the roof of a barn or an estate house.

The LIMPET has a number of attractive characteristics. For example, its low profile (6 inches or less) means that it is unobtrusive and environmentally benign; as to other dimensions, the unit shown measures roughly 38 inches wide and 20 inches deep. Other advantages are its use of a renewable energy source and the elimination of the gyroscopic forces associated with large rotary turbines.

The principals behind the LIMPET are shown in Fig. 2. It generates electricity using a bladed "venetian blind" system mounted on a conductive movable belt. The armature consists of an array of copper coils wound on a steel core. Wind striking the blades causes the belt to move and 60-Hz electricity to be generated in a manner analogous to the way electricity is generated in a rotary system. The electricity is generated anytime the belt is moving at a speed between 1 and 25 feet-per-second.

Current prototype LIMPET's have a power density of about 50 watts/pound. That means that a unit capable of producing 10 kilowatts will weigh 200 pounds. Mounting a 200-pound unit on your roof is not a particularly easy task, but by 2001 lighter units, perhaps using aluminum belts and blades, will be available. While those units will have lower power outputs, on the order of 2 kilowatts or so, for many applications that is all that is needed. If higher capacity is required, two or more units can be used.

A sea of energy

The LIMPET is just one of several power-generation technologies currently under investigation; we'll examine two others, the CAVET and the fuel cell, later on in this article. However, no matter what



FIG. 1—THIS PROTOTYPE LIMPET GENERATOR, installed on a rooftop in Maryland, is but six inches high.

generating technology is used, one of the most significant problems in making decentralized power-production practical is energy storage.

An answer to that problem may lie in the use of the element niobium—or, more precisely, a wire made of a niobium-tin alloy. That's because that wire has an extraordinary property: Its electrical resistance drops to near zero at the lower temperatures.

Over the past twenty years, scientists at the United States National Labs have experimented with niobium-tin wire. Among other things, they have found that a supercooled electromagnetic coil made of that wire can be used to "store" a DC current for up to several days. That discovery is at the heart of a technology dubbed SUPERSEA. A cross section of a superconducting armature is shown in Fig. 3. Primarily, it consists of a magnetic coil and a miniature refrigerator; there are no moving parts.

Currently, several U.S. and Canadian companies are investigating the use of superconductive energy-storage coils for residential use. Niobium-tin wire, which previously was expensive and difficult to obtain, has been produced recently in larger quantities—though it's still only appropriate for winding miniature electromagnets. Such electromagnets are of limited utility: a 2- x 3-foot electromagnet, for instance, would be capable of storing 4000 kilojoules of energy. In practical terms, that is enough energy to power an appliance that draws 11 kilowatts, such as a large electric range, for one hour. A practical superconducting armature for a typical home is expected to weigh 250–300 pounds. However, by 2001, the price of niobium-tin wire is expected to drop dramatically. If that happens, household units could cost as little as \$3000–\$5000.

Some have pointed out that SUPERSEA is an appropriate name for the technology as it provides for a "sea of reserve energy" sitting (in the basement of the house) and ready to leap into action when called for. When the technology is mature, the owner of a large roof-top solar array will no longer be concerned about using the energy at mid-day. Instead, 95% of the energy generated at mid-day will be available at 6 P.M. to cook, light, or entertain with. The availability of SUPERSEA technology will greatly increase the practicality of using climate dependent solar and wind technologies.

SUPERSEA has only one apparent drawback: It is capable of storing energy in the form of direct current (DC) only. In the presence of AC, the wire loses its superconducting properties. That problem can be solved through the use of a power conditioner, which can convert DC to 60-Hz AC to power all of the appliances in your home.

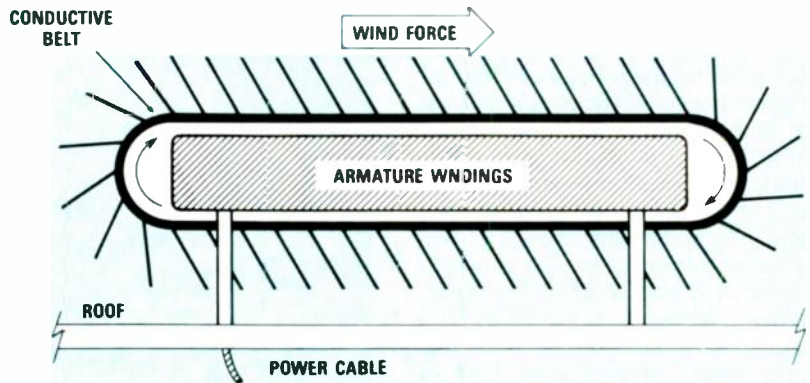

FIG. 2—ALTHOUGH LEONARDO DA VINCI first proposed the concept behind the LIMPET in the 14th century, it is expected that those devices will become an important source of energy by 2001.

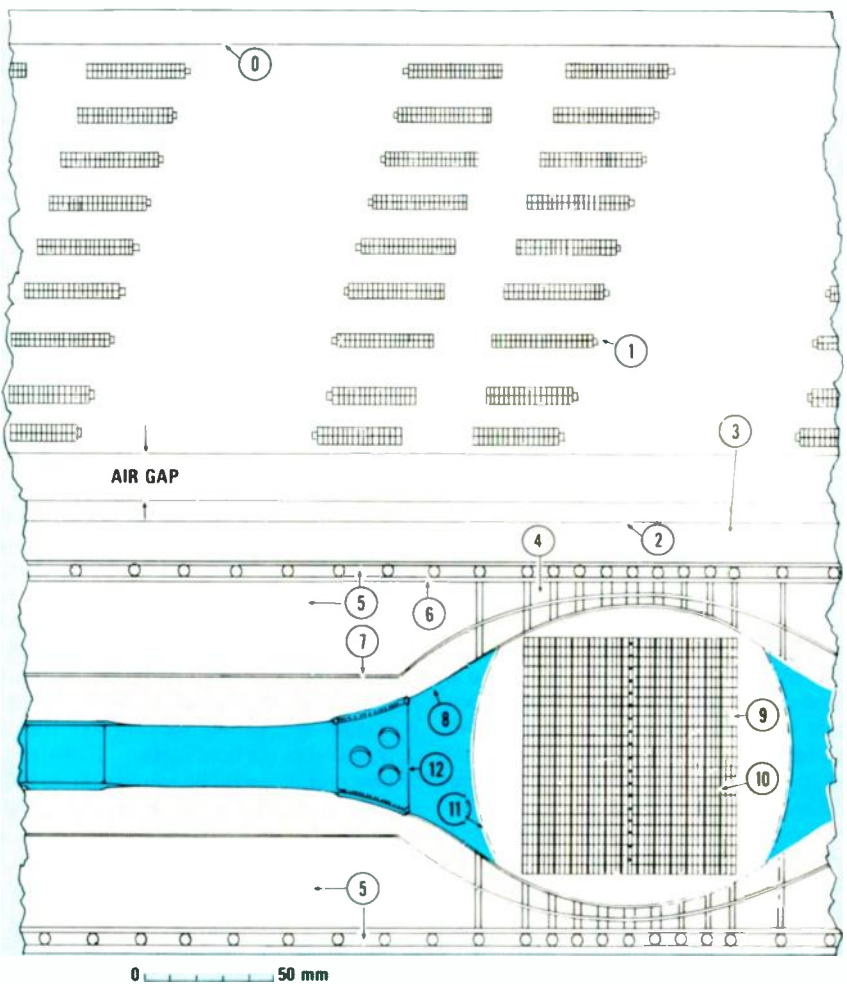

FIG. 3—SUPERSEA ARMATURE. Armature shield (0); armature conductors (1); rotor damper shields (2); ambient temperature damper (3); compression spacers (4); vacuum (5); heat shield (6); liquid-helium containment vessels (7); rotor-torque transfer banding (8); Nb-Ti field winding (9); cooling ducts (10); field-winding containment block (11); rotor torque transfer coupling (12).

Power conditioner

All the power technologies now under investigation seem to share one common feature: they all seem to operate best at some frequency other than 60 Hz. The task of translating frequencies produced by home generating or storage equipment

to 60 Hz, which will likely still be the standard for home appliances, will be handled by a PC (Power Conditioner). The PC of the year 2001 will be able to handle three tasks efficiently and quietly:

- conversion from DC power to 60-hertz AC.

- inversion from low-frequency AC to 60-hertz AC.
- cycloconversion from high-frequency AC to 60-hertz AC.

In contrast to the power electronics of 1987, which requires completely separate units to perform each of those tasks, by 2001 it is expected that integrated power conditioners capable of performing all three tasks will become available. Advances in semiconductor technology will play a large role in making that possible.

Currently, it is possible to obtain power-handling components such as MOSFET's and thyristors in IC form. However, it is not possible to obtain different types of devices on a single substrate. That will soon change: Manufacturers are closing in on producing arrays of 6 or 12 power-handling devices of different type on a single substrate. When that has been accomplished, a complete, versatile 20-kW power conditioner may be available on a single 4-by-6-inch board. That board should retail in the \$100-\$150 range and be, at first glance, almost indistinguishable from a plug-in computer board. Of course, the power conditioner will handle about 1000 times more power.

By the year 2001, it is also speculated that home power-conditioner IC's will use something other than a silicon or gallium-arsenide substrate. Newer substrate materials, such as indium-phosphate, may dominate the IC industry by then. Potential advantages in using other substrates for power devices is faster power-conditioning speeds and lighter appliances.

The CAVET

These days, roof-mounted arrays of photovoltaic cells are becoming commonplace. But by 2001, owners of such installations will have discovered one of their key drawbacks: The crystalline and amorphous silicon materials that make up those cells degrade somewhat under constant exposure to the sun. Future repair, maintenance, or replacement costs can greatly offset any economic advantages offered by photovoltaic cells.

However, another solar technology, called CAVET, that may be less expensive in the long run for residential applications is under investigation. In that technology, a solar-thermal heat exchanger is coupled to a closed-cycle vapor turbine that directly drives a miniature alternator. CAVET offers the added advantage of producing high-frequency AC rather than DC. The system is shown in Fig. 4.

The CAVET of 2001 will be a combination heat exchanger, bladed turbine, and brushless alternator. Aside from the rooftop heat exchanger, residential units capable of generating about 20 kW will measure around 10 cubic feet; that's no larger than a standard room air conditioner. The analogy to an air conditioner can be carried one step further, since the two share

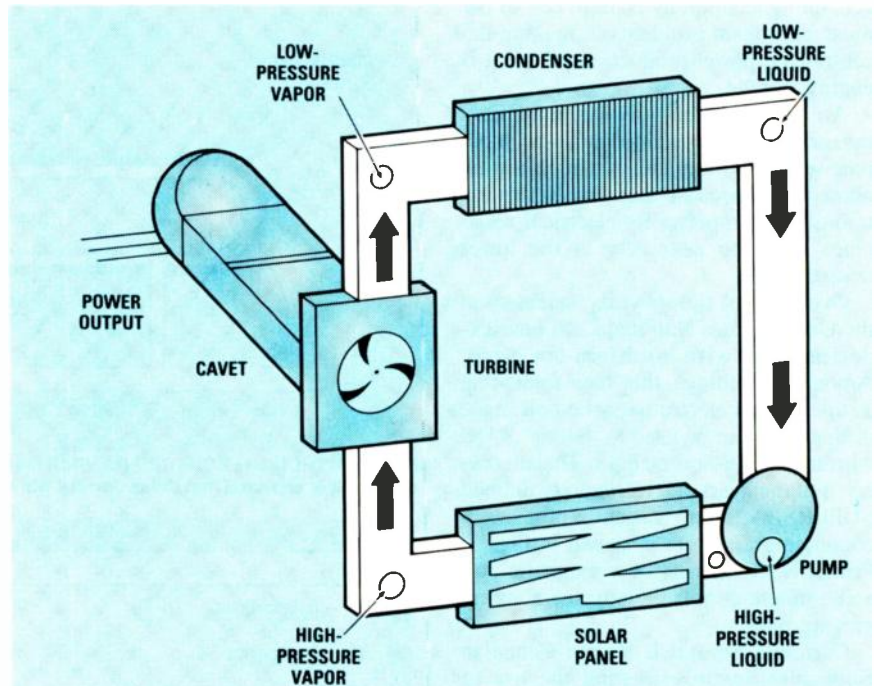

FIG. 4—LIKE SOLAR CELLS, the CAVET uses solar energy to provide low-cost electric energy. Aside from the roof-mounted heat exchanger, all of the components can be mounted within a cabinet no larger than a standard room air conditioner.

many features. However, in essence, all of the functions are reversed.

Like a photovoltaic solar-cell array, the CAVET's heat exchanger is located on the roof of a house or other structure to collect solar energy. Its advantage over photovoltaic cells is that the exchanger is built from a corrosion-resistant metal, such as aluminum.

One manufacturer of roof tiles, in anticipation of CAVET technology, has already started producing roof-installation kits for new construction. The aesthetically designed house of the year 2001 could have a grid-like heat-exchanger placed on the roof support structure, above the truss layout. Above that array, special opaque interlocking roof tiles are installed as the final surface. To the casual observer, it would be impossible to determine if the house incorporated a CAVET system because the heat exchanger is hidden from sight under the roof. The vapor turbine and the alternator are located inside the attic.

Though the turbine is designed to turn at a constant rate of 7200 rpm, it is expected that it will be nearly silent. That's because, by the turn of the century, magnetic levitation bearings will be standard in all home appliances, including the CAVET. Through the use of such bearings, the shafts will be supported by a cushion of magnetic flux. Further, moving parts within the generator will be maintained in a vacuum to eliminate the friction losses caused by air.

The electrical portion of the system is a synchronous induction generator designed to output 120-Hz AC. While de-

signed to be synchronous at 7200 rpm, on days of reduced sunlight, power generation is possible at speeds as low as 6500 rpm. A line frequency of 120-Hz was chosen because it allows for generating equipment that is significantly lighter in weight than 60-Hz equipment. A power conditioner can be used to drop the frequency to 60 Hz.

The CAVET of the year 2001 will use vanadium-cobalt magnetic steel and an inconel rotor; it is expected to have a power density of 4-kW/pound. Currently, one experimental CAVET has achieved a power density of 5-kW/pound, but at a speed of 26,000 rpm. Its rotor has no mechanical contact with bearings, brushes, etc; all linkages are magnetic.

A number of university research groups have built prototype CAVET systems. In the case of one prototype, the absence of a large roof area led to the use of sidewalk heat as the source for the solar thermal energy. Consequently, the heat exchanger was cast in the concrete, about ½-inch below the top surface. As you can see, with a little ingenuity, endless variations are possible.

Advanced fuel cells

High-temperature Solid-Oxide Fuel Cell (SOFC) systems show great promise for the economical production of electricity and heat in a variety of commercial, residential, and industrial applications. If that promise is fulfilled, the misconception that fuel cells are suitable only for space or military applications will be permanently dispelled.

Relying on a readily available source of

heat, such as natural gas. SOFC technology is based upon the ability of a stabilized element, such as zirconia, to operate as a solid electrolyte at high temperatures. The operation of an SOFC is shown in Fig. 5. The cell conducts oxygen ions from an air electrode (cathode) where they are formed through a zirconia-based electrolyte to a fuel electrode (anode). At the anode, the ions react with fuel gas (CO, H₂, or any mixture, such as steam-reformed natural gas) and deliver electrons to an external circuit to produce electricity. The fuel cell operates at temperatures near 1000°C and is a highly efficient source of both heat and electric power that does not require the presence of a turbine or rotating generator.

Some of the advantages of fuel cells over battery- or solar-powered systems are that they are:

- air cooled—they require no cooling water.
- adaptable—gaseous or liquid fuels can be used.
- simple—they can be installed quickly.
- quiet and reliable—there are no moving parts to create noise or wear out.
- modular—efficiency can be realized in small as well as large units.
- readily sited—they can be located in populated areas, eliminating added transmission costs.

While the above advantages are generally available from all types of fuel cells, the solid-oxide fuel cell, a key contender for prominence in the year 2001, has a number of additional advantages over other fuel-cell systems. For instance, operating at temperatures of 1000°C, it shows promise of attaining higher overall system efficiency than other fuel cell systems. Furthermore, the solid-oxide fuel cell produces higher quality exhaust heat. At temperatures of about 600°C to 1000°C, that exhaust can be used to pre-heat incoming air and fuel, to generate steam that can be used to drive a turbine and produce yet more electric power, or to provide heating for a plant or a factory.

The high operating temperature of the SOFC makes catalysts unnecessary, simplifying fuel processing and system design. Equally important, the use of a solid-state electrolyte eliminates material corrosion and electrolyte loss.

The technology is apt to see use in areas from Alaska to Arizona for underground, roof-top, or surface-mounted systems. With added benefits of the ruggedness of the technology and the low cost of materials, the SOFC systems, when fully commercialized, could serve in a wide range of power and heat applications.

A number of U.S. firms have started investigating the commercial applications of solid-oxide technology for electric-power generation systems. Widespread commercialization will depend on developing robotic manufacturing plants

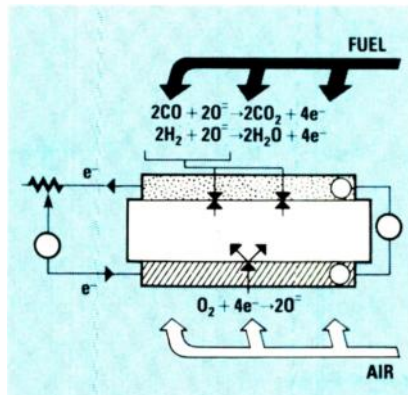

FIG. 5—IN THE SOLID-OXIDE FUEL CELL a continuous chemical reaction is used to produce electrical energy.

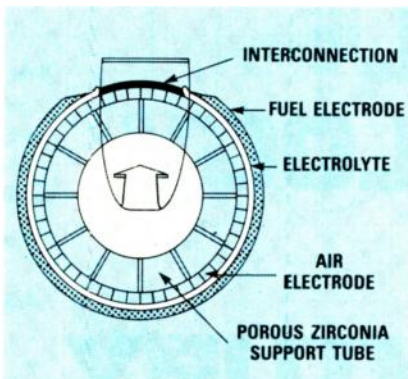

FIG. 6—STATE-OF-THE-ART FUEL CELL. Developed by Westinghouse, this cell has produced power outputs as high as 32 watts. For higher outputs, cells can be bundled in a variety of configurations.

that can produce relatively small size cells rapidly and at low cost. The objective is the introduction of readily-affordable residential products by the mid 1990's. Those could range from a small 1-kW energy system to a 200-kW home plant.

The structure of a state-of-the-art solid-oxide electrolyte fuel cell developed by Westinghouse is shown in Fig. 6. It features a porous, zirconia 12-mm O.D. support tube overlaid with a porous air electrode of modified lanthanum maganite (about 1.0-mm thick). A gas-tight electrolyte of yttria-stabilized zirconia, about 50-microns thick, covers the air electrode, except in an area about 9-mm wide along the entire active cell length. That strip of exposed air electrode is covered by a thick (30 microns), dense layer of lanthanum chromite. That layer serves as the electric contacting area to an adjacent cell and is called the cell interconnection. The fuel electrode, a nickel-zirconia cermet, is about 150-microns thick and covers all the electrolyte surface except for a gap about 1-mm wide along the interconnection in order to prevent internal cell shorting.

With state-of-the-art units like the one shown, a peak power of about 0.2 watts per square centimeter of cell surface area

can be obtained. The theoretical open-cell voltage at 1000°C is about 1 volt. Thousands of the cells have been built and tested in single-, double-, and triple-cell configurations. Testing has been done at temperatures ranging from 700–1100°C, at fuel efficiencies of 55% to 85%, and air and pure oxygen efficiencies of 25%. With air, a typical output is 0.63-volt at 26 amps; peak power is 16.4 watts. With pure oxygen, peak-power levels of over 32 watts have been obtained.

Also, a 24-cell SOFC generator has been designed, built, and tested. Peak-power levels of 384 watts and peak-current levels of 80 amps were obtained from that unit. The efficiency was 45%. The insulation package was capable of holding the average cell operating temperature above 1000°C for currents of as much as 50 amps or more; that is, the unit is thermally self-sustaining.

Westinghouse is actively engaged in designing, building, and testing a 5-kW generator. That unit contains 324 cells and will include design features of much larger-size generators. Over the next fifteen years, a standard fuel-cell generator will be developed that is expected to contain 500–1000 cells, with a cost of approximately \$5.00 per cell.

Small experimental units are being sold to a number of customers around the world. A host of U.S. high-tech firms are currently pursuing inexpensive, larger units. Those larger units will be used for continuous power production and be custom engineered for various applications from 50–200 kW. Natural gas is expected to be the fuel of choice for most residential and commercial customers.

Widespread use of the fuel-cell units is expected to begin in the mid 1990's. A study by the IEEE Power Generation Committee estimates that 150,000–300,000 residential and light commercial fuel-cell units, using both solid-oxide and phosphoric acid, will be installed in homes and businesses by 2001.

In conclusion

In this article, we've explored some promising power-generation technologies. The LIMPET and the CAVET use classic renewable-energy sources and can be installed, operated, and maintained by the average homeowner. Coupled with a power conditioner and a SUPERSEA power-storage armature, either technology could completely fulfill its owner's electric-power requirements. Natural-gas-fed fuel cells could be used where higher generating capacities are needed to provide power for individual residences, factories, or even entire communities. They also can provide a reliable, efficient source of heat. When used in larger-scale applications, fuel cells offer an attractive alternative to more costly and more dangerous technologies. **R-E**

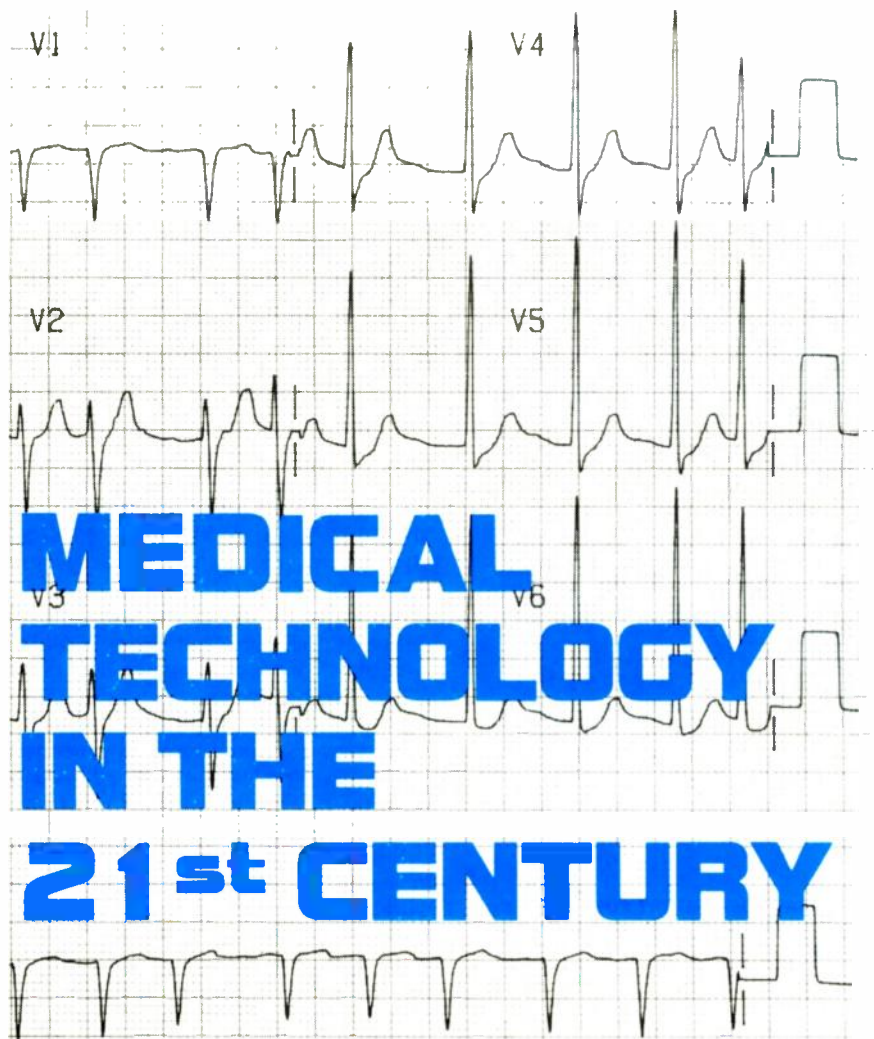

By 2001, the advances discussed here will dramatically affect the ways in which doctors examine, diagnose, and treat patients.

RAY FISH, Ph.D., M.D.

FOR ALMOST THE ENTIRE HISTORY OF modern medicine, the focus has been on diagnosing and fighting disease. Whether it was Dr. Ignatz Semmelweis trying with little success to persuade his peers to wash their hands before examining patients, or Sir Alexander Fleming using penicillin mold to fight the "wee beasties," the object was to keep disease out of the body, or to correct by surgery the medical misfortunes of fate.

Modern science, in particular, electronics, gives us the added tools to fight the afflictions that slip by our defenses: those that do not respond to natural or chemically-derived drugs; those that at present cannot be diagnosed through the sensitive fingers and knowledge of a physician; those which destroy body tissue and parts.

With ever-increasing frequency we see diagnostic and surgical techniques recently thought to be impossible-to-attain

become commonplace. For example, using a device known as a CAT or CT (Computerized Axial Tomography) scanner, we can now look deep inside body tissues without intrusion—meaning there is no surgical procedure. Also, thousands of people who just a few short years ago would die from the complications caused by defective heart valves are now literally ticking away because of a mechanical heart valve that looks not much different from a small door.

It's only a little more than 10 years since diagnostic devices such as the CAT scanner, and mechanical body-part replacements such as the heart valve, have become commonplace. But we expect progress will continue at an even faster pace—some say a logarithmic pace—and medical practices in the year 2001 will be quite different from those of today. And that will be due mainly to the advances in medical electronics.

A larger role

The steadily increasing and aging population has caused an increased demand for medical services of every kind. Complicating the delivery of those services, medical care providers must deal with a highly mobile population. For example, it is not uncommon for an elderly person with chest pain to be thousands of miles away from home, or from the hospital where he or she was last treated. The doctor treating the patient for the chest pain might find abnormalities on his or her ECG (ElectroCARDioGraphic report) and chest X-ray, but often no previous ECG's or X-rays are available for comparison.

In the year 2001, electronically-stored records will provide the information needed for optimum care. X-rays, electrocardiograms, ultrasound and sonar images, and even simple pen-and-ink medical records will routinely be stored as digitized records, making their access via telephone, radiophone, or satellite as easy as ordering a large pie from the local pizza parlor.

Some people will carry copies of their medical records on wallet-size digital discs having a standard format readable by any hospital computer. Others will have their entire medical history stored on a programmable pinhead-size optical memory chip that is concealed under a dental filling. In the event of an accident, a laser-scanner aimed at a bicuspid, an incisor, or even dentures will spew out the patient's medical history.

Increased abilities

If optical memories implanted in a tooth seems like the stuff of Star Wars, bear in mind that almost anything the brain can conjure is now technically feasible: In general, only excessive costs stand in their way. Often, an idea must be temporarily set aside because its cost, or what the patient must pay for its use, will be so great that agencies that control which hospital can have what equipment will simply not authorize its use, or its coverage by health-maintenance plans. However, as the average patient becomes more aware of the life-giving value of the high-technology devices, even high costs will no longer restrain their use in generally-available medical care, because once the value of a technological advance is proven, it is demanded. For example, the CAT scanner did not exist outside the laboratory before 1973. Although physicians were quick to see the value of these million-dollar machines, government cost-containment regulations prevented many hospitals from buying them. Now the technology is expected *and demanded* by both doctor and patient. Thus, the existence of new technology creates a demand for its use, regardless of cost, if the technology is truly useful and can help save lives.

Mending a broken heart

About 1.5 million Americans have a heart attack every year; more than a third of those die. By the year 2001, that figure will decrease dramatically.

A heart attack occurs when one of the arteries that supplies the blood to the heart muscle becomes blocked. Actually, the blockage of the inside of the arterial wall builds up over many years. When the blockage is nearly complete a blood clot can easily form, which results in a sudden total blockage. With its blood supply cut off, the heart muscle supplied by the artery dies in a few hours.

At present, except for a new electronic imaging technique called DSA (*Digital Subtraction Angiography*), we get arterial information through *catheterization*, a procedure whereby a tube is actually passed into the arterial system and the heart. While catheterization is a common procedure, there is still a small—though generally insignificant—element of risk. Unfortunately, it is not insignificant to the affected person. To totally eliminate the element of risk to the patient, by 2001 all arterial examinations will be electronic and non-intrusive, therefore risk-free.

Because arterial examinations will be non-intrusive, it will be possible to screen the population early in life—before heart problems develop—to determine those most at risk, and thereby take preventive measures—such as a special or modified diet—before heart illness strikes.

Medical imaging

When the CAT scanner was first introduced some 12 years ago, some vocal and well-publicized people said it was an extravagant plaything. In the 12 years since its introduction, it has become a necessary part of medical practice.

A conventional X-ray is literally a "shadowgraph" that gives prominence to the densest structures, such as bones. It is made by passing an X-ray beam through a body to a sheet of film on the opposite side. Softer tissues in front of, or behind a bone are overwhelmed by the image from the bone. Also, small variations in tissue density are often lost because of the amount of radiation needed to penetrate the body and expose the X-ray film. CAT (and CT) scanners overcome the shadowing and definition problems by using a pinpoint-focused X-ray beam that rotates once around the body. Rather than exposing a film, the energy that passes through the body is electronically detected as individual bursts of exposure, called "points," by a detector that tracks along with the source of the X-ray emissions. A typical scan might consist of data representing 150,000 or more points. A computer assembles the point data into an image suitable for display on a TV screen. The softer tissue is no longer shadowed, and even minor variations in tissue density

can be seen.

CAT scanning detects tumors at an early stage, often when they can be successfully removed through surgery. On the other hand, CAT scanning also prevents unneeded surgery in cases where the indications for surgery would be unsure without the scan. For example, a person who has received a head injury in an automobile accident may have physical signs that suggest bleeding in the head, which requires immediate surgery. But the physical signs may really be due to the effects of drug ingestion (which also caused the accident). A CAT scan will prevent unnecessary surgery by showing there is no bleeding in the head.

In the year 2001 there will be additional imaging technologies and techniques that will detect and evaluate the medical and surgical treatment of many conditions which are now diagnosed and managed only with great difficulty.

One new technology sure to be in common use in 2001, but which is now in its infancy and not generally available, is MRI (*Magnetic Resonance Imaging*). MRI has been called NMR (*Nuclear Magnetic Resonance*), but many people prefer to use the term MRI because it does not suggest the presence of nuclear radiation. Actually MRI (or NMR) places the person in mixed magnetic and radio wave fields; no ionizing or nuclear radiation is used. The magnetic- and radio-wave fields cause spinning of nuclei in the body being scanned. When a field is removed, the nuclei stop spinning and emit detectable radio waves. From those emissions both tissue density and the presence of tissues of certain chemical compositions can be determined.

In contrast, conventional X-ray devices and CAT scanners are sensitive to only the density of tissues. Thus, MRI is useful for detecting differences in chemical composition that would not show up on conventional X-rays or CAT scans. For example, the demyelination present in multiple sclerosis can be imaged by MRI.

Standard X-ray studies will still be performed in the year 2001, but they will be improved in two ways. First, the images will not be stored on bulky film negatives or microfilm. In 2001, the image itself will originate as a digital TV or a computer image and will be stored digitally, with thousands of images occupying less space than a single conventional X-ray film. Second, the image will be super-high resolution; essentially, digitally-enhanced. The detail will make today's X-rays look as if they were developed in pea soup

Artificial organs

Although the development of artificial organs is in its infancy now, by 2001 we expect that artificial organs not presently available will prolong and greatly improve the quality of life for many individuals.

Such devices will include the internal artificial heart, kidney, ear, and pancreas, among others.

Because many organ functions such as the heart and pancreas are timed or quantified, they are likely to be under electronic rather than chemical control, requiring some form of power that will be generated by implanted ultra-long-life batteries or rechargeable energy cells. Rechargeable internal batteries will be recharged through the skin itself by induction.

In the year 2001, electrical stimulation of various body parts will restore or improve lost functions. For example, stimulation of the diaphragm will improve breathing in persons with paralysis of the diaphragm, and many persons will regain the use of weak and paralyzed arms and legs through electronic stimulation of damaged muscles.

Computer-processed signals from intact muscles and the brain, as well as voice commands, will stimulate what were previously paralyzed limbs. In the case of brain waves, computers will carry the electrical brain waves around damaged nerves to muscle tissue, and even to artificial limbs which will be, themselves, operated by computers.

In instances where it will be impossible to stimulate unresponsive or atrophied muscles, voice commands and other actions of the severely physically handicapped will program internal computers, which will, in turn, control external and internal bionic devices (artificial limbs and organs that can "think," or which respond to natural stimuli.)

Personal robotic devices in the year 2001 will understand and perform complex functions such as "open the door." The person will not have to give a series of commands such as "approach the door, take out the key, move the key upward," A single voice command, the flex of a healthy muscle, perhaps the quiver of a finger, or even a brain wave generated by the thought, will initiate a complex series of muscle stimuli and robotics that will result in a series of pre-programmed mechanical movements by artificial limbs, whether it be extracting a key from a pocket and opening a door, or opening a frozen dinner for the microwave oven. In short, medical electronics will enable what we presently think of as totally physically handicapped persons to care for themselves, and to perform useful work.

More accurate diagnosis

Although brain waves, artificial organs, robotic limbs, and electronic muscles are spectacular and attention-grabbing, the real nitty-gritty of medicine remains *diagnosis*: the sifting and focusing of hundreds, possibly thousands of bits and pieces of information.

In the year 2001, using data gathered from a world-wide network, local on-line

diagnostic computers will help physicians diagnose and treat patients. For example, it is often difficult for a doctor who has never treated nor seen malaria make the diagnosis. A computer, however, can recognize the disease in possibly minutes if it can automatically search throughout the world for matching symptoms. In 2001, a touch of a button will be all that's needed to initiate a world-wide search on all forms of disease and illness.

Because computers can correlate information from X-rays, CAT and MRI scans, surgical treatment involving the precise localization of tumors and other structures, or even laser-scalpel "bloodless surgery," will be computer-aided.

The computer will even be used for conventional illnesses and treatment. In the year 2001, a typical serious illness such as a heart attack might be computer-aided from diagnosis to treatment.

While walking on a country road you feel a severe, heavy chest pain. Before losing consciousness you are able to press the medical emergency button on your personal transmitter. A satellite in space relays your location and your medical records to the nearest available ambulance. Within minutes, a paramedic starts CPR while another connects sensing electrodes to your chest. No heartbeat is seen on a monitor, so pacing electrodes are placed on the front and back of your chest. Mild pacemaker shocks cause your heart to start beating again.

The paramedics start an I-line (intravenous) for medication, and a non-intrusive A-line (arterial) sensor for computer-aided diagnosis and observation. In the event your personal security transmitter is not programmed with your medical history, a laser-scanner aimed at your teeth by the ambulance's computer will read your medical records from the implanted optical memory. Its information, your electrocardiogram, and A-line blood chemistry data is telemetered to the hospital.

You are brought to the Emergency Department where a diagram of your heart's circulation is obtained non-intrusively through a cardiac imager.

As you awake, the physician tells you not to worry. You have started to have a heart attack, but the process can probably be reversed. A clot has formed in one of your coronary arteries. However, the clot may dissolve with suitable chemical treatment. If not, it will probably be in position to be burned clear with a laser scalpel later on.

Meanwhile, he reassures you about the twitching and pain in your chest. As soon as the blood supply is returned to your heart muscle the pacemaker will no longer be needed.

The computer display above your bed shows a continuous stream of data derived from automatic blood sampling, as well as the medical history that was transmitted



A COMPUTERIZED TOMOGRAPHY SCANNING system combines an advanced X-ray scanning system with a powerful computer to allow doctors to study almost any structure within the human body. Its use often permits patients to avoid exploratory surgery or other painful diagnostic techniques.

by your personal-security transmitter, or which was read from the optical memory concealed in your tooth. On inspecting the data, the physician says that it will not be possible to dissolve the clot because he sees on the monitor that you had gallbladder surgery a few weeks before, and the healing tissues at the surgery site are still partially held together by clotted blood. It would be too risky to put a substance which dissolves clots into your system.

The diagram of your coronary circulation showing the blockage is transmitted by computer or fax machine to a cardiologist several miles away, who determines that even a laser-bore cannot clear the clot, and that bypass surgery is needed.

In surgery, electronic monitors continually sense through your intact skin the amount of oxygen, sugar, and carbon dioxide in your blood. The electrical activity of your heart and your blood pressure are continuously recorded.

The electrical activity of your brain which results from stimuli applied to your legs is monitored to help determine the depth of anesthesia. Because you are paralyzed as well as asleep, a respirator controls your breathing. The function of the respirator is guided in part by the blood levels of oxygen and carbon dioxide measured through your intact skin.

A segment of vein from your leg, or its plastic equivalent, is used to bypass the blocked segment of your coronary artery. The blood flow through the bypass graft is measured with an ultrasound or sonar imaging, which displays a cross-sectional image of the graft. The velocity and turbulence of blood flow at each point in the graft is indicated.

The blocked coronary artery has been successfully bypassed. Only slight damage has been suffered. Your heart attack has been undone. The pacemaker is no longer needed.

After surgery you are taken to the Intensive Care Unit. Automated monitoring of your blood pressure, respiratory rate, electrocardiogram, and mental function continues. In addition, your blood sugar, electrolytes, oxygen, and carbon dioxide are monitored. Those parameters are used to control the amounts of oxygen, fluid, and respiratory support given to you. Abnormal heart rhythms are detected and treated with drugs and electrical shocks applied to your chest. The protocol for such treatment is decided by a computer.

After a few days in Intensive Care you are ready for telemetry monitoring. Cardiac arrhythmias (fibrillation) are considered much less likely, but it is wise to provide monitoring for several more days. A few days after your surgery, you are transferred to a portion of the hospital, where you receive more intensive physical and psychological rehabilitation.

All during your hospital stay, a system of interconnected computers has kept track of your vital functions, body chemistries, medication intake, and your respiratory and physical conditions. Your psychological condition has been judged and recorded in the computer system by nurses and physicians. Your respiratory function has been evaluated by automated spirometers and respiratory therapists. Your physical condition has been judged by physical therapists. The computer system has watched for deterioration of your condition on a minute-by-minute basis, has scheduled your treatments and evaluations, has prevented drug interactions, and has charted your progress.

A month later you are walking on the same country road you were on when you had your heart attack. Your chest is sore from the surgery, pacemaker, and electrical shocks. You wonder how much further into the future it will be before science finds a way to treat heart attacks without so much pain.

R-E

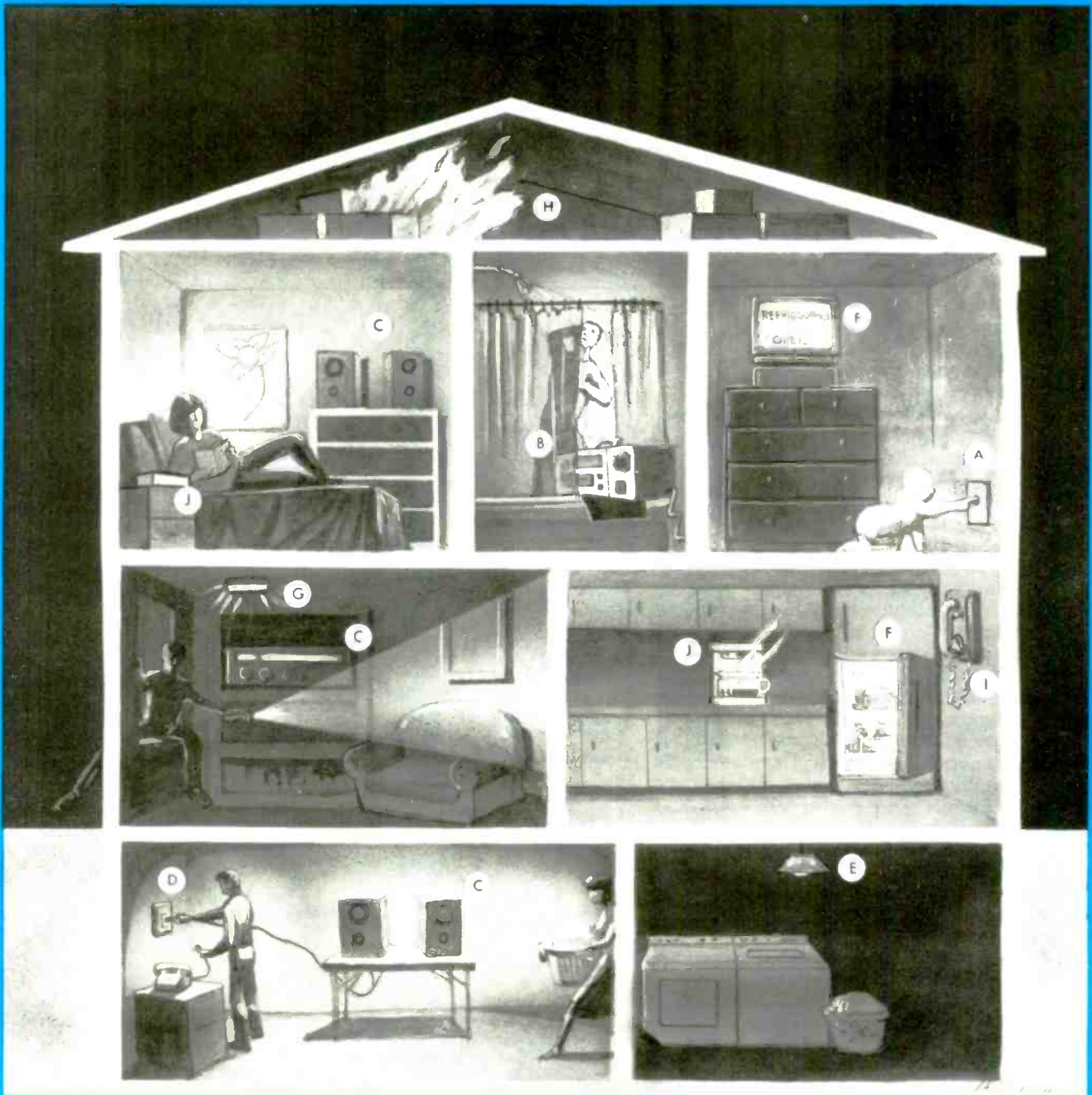

A smart house will prevent electrocution (A,B), allow the distribution of signals without running additional wires (C), using any outlet (D). Sensors will automatically turn off lights in empty rooms (E), and display the status of the house on any TV (F). Security features will protect the house from theft (G) and fire (H). The entire system can be operated remotely (I), and any device in the house can be operated from any point in the house (J).

David J. MacFadyen

THE INFORMATION AGE PROMISES TO change the way we live far more dramatically than the changes wrought by the industrial revolution. Here in 1987, we can see the leading edge of those changes and the technologies on which they'll ride. Our hardware—microelectronics, optics, and more—is advancing rapidly.

THE HOME OF THE FUTURE

Your home of the 21st century will be a Smart House.

The way we use that hardware—for expert systems and other artificial-intelligence approaches—is also progressing at an amazing rate.

The effects of new communications and control technologies have been seen in our factories and aircraft for more than a decade. We're only beginning to see

similar effects in our cars, our high-rise buildings and, perhaps most dramatically, our offices. The mail is no longer fast enough or reliable enough for business communications. Within seconds an electronic message can be delivered across the country reliably and without error. Voice mail can provide the same speed and con-

venience that electronic mail has clearly established.

In 1987, we're still waiting for the information age to come into our homes. It hasn't yet because much of the technology we'll need is too new. And to get it into our homes, we have to contend with the regulatory environment and the disaggregate nature of the building industry. However, the NAHB Research Foundation, a subsidiary of the National Association of Home Builders, has come up with a realistic plan for the future that allows new homes to fully accommodate the coming information age. Its *Smart House* project demonstrates how new technology can be used in our homes in the 21st century. Let's see what we can expect.

A *Smart House* will have three systems that will make its appliances—and the house itself—more “user-friendly” and efficient: a *closed-loop power system*, a *high-speed data-transmission system*, and a *logical central control system*. A *Smart House* will provide DC power as well as AC, so that new motor-driven appliances can be designed for more efficient and effective operation.

The concept of closed-loop power is not new but, until recently, we didn't have the technology to implement it. The home of the future will use it extensively. Appliances will indicate, via a communications link, how much energy they need. For instance, an electric range will tell the central controller how much current it needs to heat a burner. When the energy is supplied, the appliance must confirm, via the communications link, that the correct amount of energy is being received.

Closed-loop power systems will benefit us in three ways:

- Human electrocution will be eliminated. If an appliance cannot signal for energy, none will be provided. A finger in an electrical socket has no way of sending the electronic signal that's needed to start power flow.
- House fires caused by electrical faults and gas leaks will be eliminated. If an appliance requests a specific amount of energy, and the central controller detects that a different amount is being supplied (because of leakage between the controller and the appliance), the controller will act to ensure safety.
- Appliances can be monitored and controlled from any point in the house. A simple interface will let you do the same thing from a remote location, over the telephone lines.

The ability to control any powered appliance at any point in the signal path will allow for *logical control* instead of the traditional hard control of devices. Wall switches will no longer physically open or close a circuit path to control the power flow to an outlet or an overhead light. Instead, they will send signals to a central controller for action. The central control-

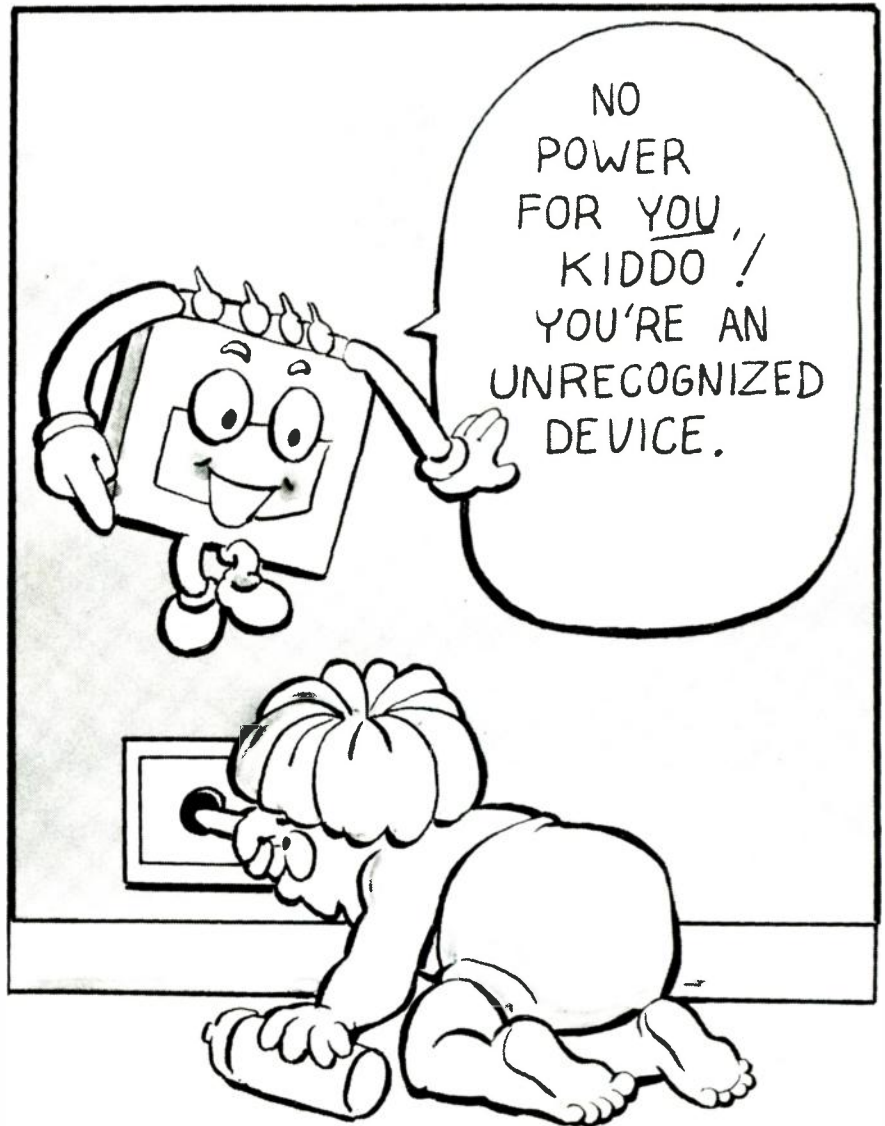

SMART HOUSE OUTLETS ARE SAFE. In a closed-loop power system, no electrical power is delivered to an outlet unless it is requested by an appliance.

ler will act based on your previously programmed instructions. For example, you can tell your central controller not to turn on any lights unless it is dark in the room, the room is occupied, and the wall switch is turned on. As you can see, we won't be using only wall switches. Other devices—such as occupancy detectors, photocells, temperature transducers, etc.—will be used throughout the house to let the central controller know what's going on.

The high-speed data-communication capability in the *Smart House* will make it easy to distribute audio, video, and control signals. And instead of increasing the complexity of your home, it will make many things much simpler.

For example, it will be much easier to deal with portable devices. A single plug configuration will be used by all appliances. You'll be able to plug your tele-

phone into any outlet. When you plug in your television set, you won't have to worry about the antenna or cable connections—they'll be made automatically through the same outlet. You'll be able to put speakers anywhere in the house and use them with a stereo, radio, television, or other audio equipment without several separate runs of speaker wire.

Using DC power

We now use alternating current in our homes, even though the vast majority of products that we use need direct current to operate. There is a good reason for using AC—it's the only economical way to transmit electric power over long distances. Unfortunately, it means that many products—radios, televisions, computers, etc.—require separate power supplies to convert AC to DC.

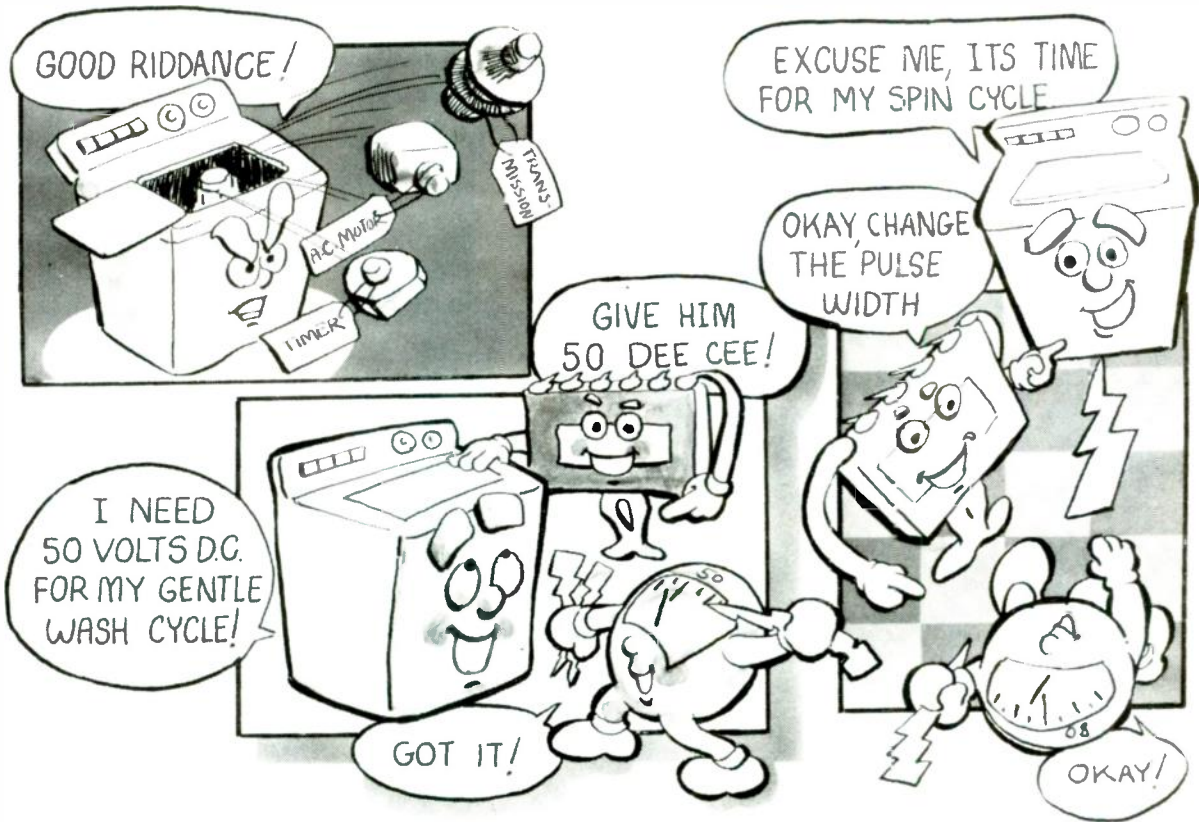

DC POWER WILL BE USED IN A SMART HOUSE along with AC. That will allow many appliances to be designed for more efficient and reliable operation.

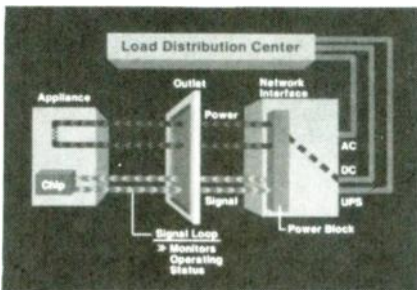

THE SIGNALING LOOP is used to continually monitor the appliance interface. If any problem is detected, (such as the device drawing too much current), power to the appliance will be cut immediately.

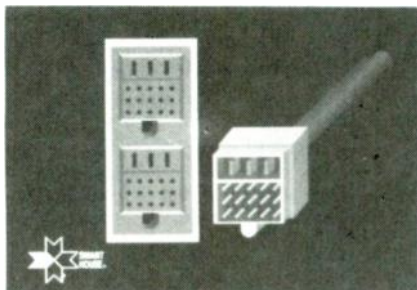

A SMART HOUSE POWER OUTLET will also be used for distributing video, audio, power, and more. There will never be a need to run additional wiring!

When you use DC in your home, your light bulbs will last five to twenty times longer. You won't need different wattage bulbs. You'll be able to vary the light output easily—and without flicker. The switch from AC induction motors to brushless DC motors will make your appliances more efficient and reliable, and provide variable speed with ease.

Our heating and cooling systems will be matched to how we actually live in our homes. The *Smart House* won't use temperature sensors alone to determine how to heat and cool itself. It will know when the first person wakes up in the morning, when everyone has gone to bed at night, or if no one is in the house at all! If you go out of town for a few days, it will set back the water heater, and lower the temperatures to a safe level—and reset everything to normal in time for your expected return. Of course, if you're going to extend your vacation, you can simply phone ahead to let your house know!

You'll be able to use your TV set to display the status of any or all appliances—it will look at the signal path to determine that a light is on in the basement, that the washing machine is on its final rinse cycle, or that there is movement in the baby's room.

If you choose to add an electrical rear-door lock, you could use the TV to tell you whether the back door is open or closed, locked or unlocked. If you add a *Smart House* compatible touch screen or handheld remote control to your TV set, you'll be able to send commands to the lights, the washing machine, or the rear door to control them from any location where that TV set is plugged in.

Even the lowly vacuum cleaner will be redesigned to take advantage of access to the *Smart House* communications path. If the telephone or doorbell rings while you're vacuuming your rugs, the vacuum cleaner will shut itself off so that you can hear. And like most other appliances, the vacuum cleaner will be designed to run on a DC brushless motor that could match the power supplied to the cleaning requirement. It will clean better, and like other *Smart House* appliances, it will cost less to operate, last longer, and need less maintenance than what you use today.

Virtually every product that attaches to the various wiring systems of a home today will be changed to take advantage of the *Smart House* technology, which will offer a vastly improved array of home products and a better way of living for all of us.

ABOUT THE AUTHORS



ARTHUR C. CLARKE

Arthur C. Clarke, born in Minehead, England in 1917, displayed an early fascination with science, writing, and astronomy. As a youth he wrote for his school's magazine, studied and charted the moon using a telescope he built from a cardboard tube and old lenses, and was an avid sci-fi buff. Clarke transformed those childhood interests into a career as one of the world's foremost science-fiction writers.

Clarke was first published professionally while serving in the Royal Air Force in the early 1940's. In an article published in 1945, he predicted a global satellite communications system based upon three satellite stations in synchronous orbit around the Earth. Although his idea was met with skepticism by the scientific community of the time, the orbit path he described—now known as the "Clarke Belt"—is the one currently used for communications satellites.

Attending college on an ex-serviceman's grant, Clarke received a Bachelor of Science degree in physics and applied and pure mathematics in 1948. A prolific writer, he is highly regarded for scientific accuracy as well literary style. His science-fiction writing includes *Prelude to Space*, *Earthlight*, *Childhood's End*, and several short story collections. Clarke's non-fiction works on space and undersea exploration are well-respected in scientific circles. He has won several prestigious writing awards, including a *Hugo*—the science-fiction writing award named for Hugo Gernsback.

Clarke is best known, however, for "2001: A Space Odyssey" and "2010: Odyssey Two." Both films, on which he collaborated with Stanley Kubrick, were inspired by Clarke's short story "The Sentinel."

Interestingly, since the mid-1950's Clarke has chosen to make his home in the technologically backward tropical country of Sri Lanka. Seldom leaving that tropical island, he keeps up with the latest in science through journals, and depends largely upon letter-writing and shortwave radio for communications with the world at large.



ISAAC ASIMOV

Born in Petrovichi, Russia in 1920, Isaac Asimov emigrated to New York with his parents in 1923, and considers himself "Brooklyn-bred." He was accepted to Columbia University at the age of 15 and earned his Bachelor of Science degree in 1939 and his Ph.D. in chemistry in 1948.

Dr. Asimov began writing science-fiction at the age of eleven and had his first short story published in Hugo Gernsback's *Amazing Stories* in 1938. His first science-fiction novel, *Pebble in the Sky*, was published in 1950. Since then, he's gone on to write about almost every subject under the sun, ranging from math and physics to the Bible and Shakespeare.



DAVID J. MacFADYEN,
President, NAHB Research
Foundation, Inc.

Mr. MacFadyen joined the NAHB Research Foundation, in January of 1983. He has more than 20 years experience in building technology, new-product development, codes and standards, energy conservation, and research management.

Mr. MacFadyen has held many other high-level posts and has published a number of papers. He has degrees from Northwestern University and the Massachusetts Institute of Technology.



DONALD E. PETERSEN

Chairman of the Board
and
Chief Executive Officer,
Ford Motor Company

When Donald E. Petersen was elected president and chief operating officer of Ford Motor Company on March 13, 1980, the *New York Times* noted that, "Not since the founder, Henry Ford, has the company had a top manager with an extensive technical background in product development." The *Times* also referred to him as "the first of a new wave of top auto executives who are more concerned about products and production systems than financial analysis."

It was, perhaps, an educational background that combined business administration with engineering that helped set him apart. After graduating magna cum laude and a member of Phi Beta Kappa, Tau Beta Pi (honorary engineering society) and Sigma Xi Scientific Research Society (natural sciences) from the University of Washington in 1946 with a degree in mechanical engineering, he went on to Stanford University where he received his MBA in 1949.

When he first applied for a job at Ford in 1949, he expressed a primary interest in what he called "product planning." At that time the auto industry had not yet formalized that function. In his early years with the company, Mr. Petersen helped establish the product-planning office.

Since becoming chairman, Mr. Petersen has devoted considerable energies toward defining the corporate culture at Ford in ways that enhance the creative process, teamwork, trust, innovation and personal fulfillment.

In the 21st century scenario that follows, Mr. Petersen draws upon the creative ideas of a number of Ford's planners, thinkers and visionaries who have constructed a hypothetical automotive world, based on a projection of today's technologies into the future. It incorporates ideas from Ford's Project "T-2008," a team effort designed to anticipate the elements of 21st century transportation.



GEORGE H. HEILMEIER
Senior Vice President
and
Chief Technical Officer
Texas Instruments

George H. Heilmeyer received the B.S. degree in Electrical Engineering with distinguished honors from the University of Pennsylvania, Philadelphia, and the M.S.E., M.A., and Ph.D. degrees in solid-state materials and electronics from Princeton University.

Dr. Heilmeyer has received many major awards, including the IEEE David Sarnoff Award, the IEEE Frederik Philips Award, the Secretary of Defense Distinguished Civilian Service Medal (twice), the Eta Kappa Nu Award as the Outstanding Young Electrical Engineer in the U.S., the 26th Arthur Fleming Award as the Outstanding Young Man in Government, and the IEEE Founders' Medal in 1986.

Among Dr. Heilmeyer's numerous professional achievements, he holds 15 U.S. patents.



CHARLES N. JUDICE
Bell Communications Research, Inc.

Charles Judice is currently division manager of the Wideband Services Research Division at Bell Communications Research Inc. (Bellcore). His division is responsible for developing new telecommunications services, including multi-media teleconferencing, information and video browsing expert systems, integrated video services, and visual communications processing, among others.

The Wideband Services Division builds prototypes of advanced services and systems using state-of-the-art software and video technologies. Those prototypes will be used in field trials.

Mr. Judice holds eight patents in image processing and image retrieval and has written more than 30 papers and technical articles on those subjects. He did his undergraduate work in physics at Manhattan College, and received master's and doctorate degrees from Stevens Institute.



BOB L. GREGORY
Director of Microelectronics
Sandia National Laboratory

Dr. Bob Lee Gregory joined Sandia National Laboratories in 1963 as a staff member in the Radiation-Physics Department. He is a Fellow in the IEEE and has been an active participant in the annual IEEE Nuclear and Space-Radiation Effects Conference. During 1973-1974, he served as Member-at-Large for the IEEE Radiation-Effects Committee. He has served on the IEEE Solid-State Circuits Council and is a past Associate Editor of the IEEE *Journal of Solid-State Circuits* and of *Solid-State Electronics*. He is currently an Associate Editor of the IEEE *Circuits and Devices Magazine* and on the Board of the IEEE *Spectrum*.

Dr. Gregory received his B.S., M.S., and Ph.D. degrees in Electrical Engineering from Carnegie Institute of Technology in 1960, 1961 and 1963 respectively.



STEPHEN KUZNETSOV
Director of Engineering
Power Silicon and Monolithic
Technologies Corp.

Prior to his current position, Dr. Stephen Kuznetsov served as the Washington D.C. representative for Research and Development for the Westinghouse Corporation.

In 1984 Dr. Kuznetsov served as the Science and Technology Advisor to the Senate Subcommittee on Energy Research and Development. Since 1985, he has been Chairman of the IEEE Committee on Energy Development.

Dr. Kuznetsov holds Electrical Engineering degrees from Carnegie-Mellon University and the University of London.



RAY FISH Ph.D. M.D.
University of Illinois, Urbana

Dr. Ray Fish, a frequent contributor to *Radio-Electronics*, is an Adjunct Assistant Professor of Biomedical and Electrical Engineering at the University of Illinois at Urbana. He is also a Clinical Instructor at that university's Medical School and an Emergency Physician at the Burnham Hospital Trauma Center at Champaign IL.

Dr. Fish received his B.S. and M.S. degrees in electrical engineering from the University of Illinois at Urbana. He received a Ph.D. in biomedical engineering from Worcester Polytechnic Institute and Clark University and his M.D. from the University of Chicago.



HEDY OLIVER

Winner, Honeywell
Futurist Awards Competition

Hedy Oliver was a technical communications major at California State University-Northridge when she won Honeywell's Futurist Award for 1986. The Futurist Awards Competition is held annually to discover how college students think technology will advance, and how those advances will affect society.

Oliver is currently a Product Information Analyst at Unisys Inc., specializing in office automation. Oliver has resumed her studies at Northridge on a part-time basis, and plans to graduate this spring.

ANTIQUE RADIO CLUBS

THE FOLLOWING IS A LIST OF RADIO CLUBS, COURTESY OF *ANTIQUE RADIO CLASSIFIED* (9511 Sunrise Blvd., J-23, Cleveland, OH 44133), for those interested in the history of radio, or in the collecting of antique radio or radio-related equipment. Most of the clubs publish their own bulletins or newsletters, and many sponsor conventions and flea markets in their areas throughout the year. Those clubs are a good way to meet fellow collectors who share your antique-radio interests.

Most clubs invite out-of-state membership. Most clubs have some dues or membership requirements; contact the individual clubs for more information on that. Also, while the information presented here is as accurate as possible, several of the clubs have not provided their current status. When writing to any of the clubs, please mention that you saw its name in **Radio-Electronics**.

Antique Wireless Association, Inc.—C/O Bruce Roloson, Box 212, Penn Yan, NY 14527. Publishes *The Old Timer's Bulletin* on a quarterly basis. Sponsors regional conventions as well as an annual conference in September at Canandaigua, New York.

Antique Radio Club of America, Inc.—C/O William Denk, 81 Steeplechase Rd., Devon, PA 19333. Publishes *The Antique Radio Gazette* on a quarterly basis. Sponsors several regional chapters of A.R.C.A. as well as an annual convention, usually in June, in a different part of the country each year.

Antique Radio Club of Illinois—C/O Randy Renne, 1020 Idlewild Dr., Dixon, IL 61021. Publishes *ARC/News* on a quarterly basis. Sponsors meets throughout the year in addition to the large "Radio-Fest" meet in August of each year.

Antique Radio Club of Schenectady—C/O Jack Nelson, 915 Sherman St., Schenectady, NY 12303.

Arizona Antique Radio Club—C/O Lee Sharpe, 2224 West Desert Cove Rd., No. 205, Phoenix, AZ 85029. Publishes *Radio News* on a quarterly basis.

Arkansas Radio Club—P.O. Box 4403, Little Rock, AR 72214.

British Vintage Wireless Society—C/O Robert Hawes, 63 Manor Rd., Tottenham N17, London OJH, England. Publishes *Vintage Wireless* on a monthly basis.

Buckeye Antique Radio and Phonograph Club—C/O Steve Dando, 627 Deering Dr., Akron, OH 44313. Publishes its *Soundings* newsletter on a quarterly basis.

Sponsors several informal meets at collector's homes throughout the year, plus exhibits at area shopping malls.

California Historical Radio Society—CHRS, P.O. Box 1147, Mountain View, CA 94041. Publishes the *CHRS Official Journal* and the *CHRS Newsletter*; both appear four times a year. Sponsors conventions and flea markets.

Houston Vintage Radio Association—C/O Ron Taylor, 12407 Mullins, Houston, TX 77035. Publishes the *Houston Vintage Radio News* and also the *Grid Leak* on a frequent basis. Yearly activities include a Spring show and public auction, swapfests, a picnic, and a banquet.

Indiana Historical Radio Society—C/O E.E. Taylor, 245 N. Oakland Ave., Indianapolis, IN 46201. Publishes the *IHRS Bulletin* on a quarterly basis. Sponsors at least four swap meets per year in various areas of Indiana, including the well-attended Auburn, Indiana meet, held in the Fall.

Long Island Antique Radio Society—160 S. Country Rd., East Patchogue, NY 11772

Michigan Antique Radio Club—C/O Jim Clark, 1006 Pendleton Dr., Lansing, MI 48917. Sponsors two swap meets in the Lansing, Michigan area.

Mid-America Radio Club—C/O Robert Lane, 1444 E. 8th, Kansas City, MO 64106.

Mid-Atlantic Antique Radio Club—C/O Joe Koester, 249 Spring Gap South, Laurel, MD 20707. Publishes a newsletter for members. Sponsors monthly meets.

Niagara Frontier Wireless Association—C/O Larry Babcock, 8095 Centre Lane, E. Amherst, NY 14051. Publishes the *NFWA Chronicle* on a quarterly basis. Conducts swap meets and meetings four times a year in the Buffalo, New York area.

Northwest Vintage Radio Society—Box 02379, Portland, OR 97202

Puget Sound Antique Radio Association—C/O N.S. Braithwaite, 4415 Greenwood Ave. N., Seattle, WA 98103. Publishes the *Horn of Plenty* monthly. Holds swap meets and meetings in the Seattle, Washington area.

Rocky Mountain Wireless Association—16500 W. 12th Dr., Golden, CO 80401.

Sacramento Historical Radio Society—5724 Gibbons Dr., Sacramento, CA 95608.

Southern California Antique Radio Society—C/O Floyd Paul, 1545 Raymond Ave., Glendale, CA 91201. Publishes the *California Antique Radio Gazette* on a quarterly basis. Holds four swap meets and meetings at various locations in Southern California.

Society of Wireless Pioneers—P.O. Box 530, Santa Rosa, CA 95402. Publishes the *Sparks Journal* on a quarterly basis.

Vintage Radio and Phonograph Society—P.O. Box 165345, Irving, TX 75016. Publishes *The Reproducer* approximately six times a year. Sponsors radio meets in Dallas, Texas area.

Whippany Vintage Radio Club—217 Ridge Wale Ave., Florham Park, NJ 07932. R-E

DESIGNER'S NOTEBOOK



ROBERT GROSSBLATT,
CIRCUITS EDITOR

Trigger pulses

SEE IF THIS SOUNDS FAMILIAR: YOU have put a circuit design on paper and have made a working breadboard. But as soon as you assemble the final version of the circuit the only thing it does is drain the

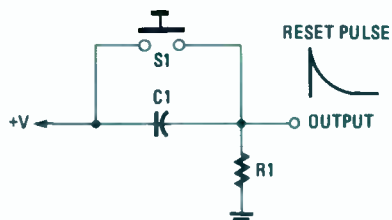

FIG. 1

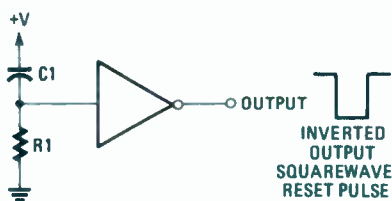

FIG. 2

battery. There are many reasons for that kind of problem, among them are wiring errors, bad printed-circuit traces, and intermittent components—and they should be the first things you check when things go wrong.

If those seem okay, the next thing you should check out is

something that's often overlooked: *the state of the circuit when the power is first applied.* The more complex a circuit is, the more critical it is to make sure everything is set to a known state at power up. The parts needed to do that can be anything from a simple RC network to a separate active circuit designed to insure a specific start-up condition.

Most digital circuits need a pulse of predetermined length to set all the clocks, counters, latches, and so forth to a known state. The most basic way to generate a pulse is to use the circuit shown in Fig. 1, which consists of resistor R1, capacitor C1, and normally-open momentary-switch S1.

When the power is applied, capacitor C1 charges, and then discharges through resistor R1. As shown, the circuit produces a positive-going pulse. A negative-going pulse is attained by simply reversing the power connections. The circuit is reset closing S1.

The simple RC pulse-generator shown in Fig. 1 will be adequate for designs that aren't particularly fussy about the shape or height of the reset pulse. Although the exact shape of the pulse will depend on the specific RC values, in some

way it will resemble the shape shown in Fig. 1.

But suppose you need a pulse that resembles a clean squarewave with a wider width. The easiest way to generate such a pulse is to add a gate to the circuit of Fig. 1 and build a half-monostable; such a circuit is shown in Fig. 2. Although an inverter is shown in Fig. 2, you can use any kind of gate if you connect the inputs together. When the power is first applied to the half-monostable, it will change state and stay that way until the voltage at its input falls below the threshold voltage for the logic family. If you're using a CMOS device, that would be half of the power supply voltage. Then the half-monostable changes state again. The result is a clean pulse, whose width is determined by the value of R1 and C1. A close approximation of the pulse width is:

$$\text{Pulse Width} = .77RC$$

You can use almost any kind of gate (it can be inverting or non-inverting) but Schmitt triggers are the best. They have considerable gain, and their hysteresis will guarantee a squarewave. A hex inverter is also a good choice for the circuit because it will make six half-monostables. That isn't as silly as it sounds because you can daisy-chain the individual circuits to get delayed pulses. Use the circuit shown in Fig. 3 if you need a series of pulses in a particular sequence and you have to be able to set different widths for each pulse.

Half-monostables are edge-triggered devices, so if you plan on daisy-chaining several circuits

continued on page 128

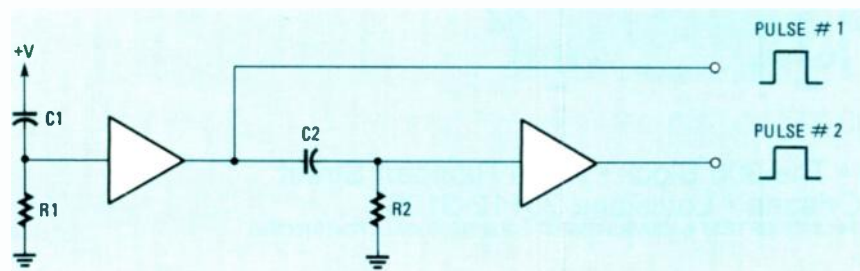

FIG. 3

USING THE RE-BBS

To access the RE-BBS, you need a personal computer and a modem capable of communicating at 300 or 1200 baud. Set the modem for 8 data bits, 1 stop bit, and no parity. (Other formats will work, but you may be unable to upload and download files.) You'll also need a communications program that runs on your computer and can control your modem. If you have an IBM-PC and a modem, but no communications program, get a friend to download the QMODEM.ARC file for you. It contains a user-supported communications program and complete documentation.

The BBS runs 24 hours a day, seven days a week. To sign on the first time, dial 516-293-2283. If your system is working properly, you'll be presented with an identifying message. Type in the requested information. At that point you'll be able to access some, but not all of the BBS. After the Sysop verifies your account, you'll be able to access all relevant areas of the BBS.

You can do several things on the RE-BBS: send and receive messages, and upload and download files. Sending messages is simple, and only requires you to type at your keyboard. Receiving messages is also simple, but to save messages, your communications program must allow you to set up a capture buffer.

Uploading and downloading files is easy after you get the hang of it; just follow directions, and remember always to start the transmitter before starting the receiver.

Because of our background and interests, the RE-BBS will be oriented toward IBM-PC's and compatibles. But you can access the RE-BBS with any computer (or ASCII terminal) and modem, so if your interest lies in Apples, Ataris, Commodores, Sinclairs, etc., feel free to participate. If you have public-domain software of interest to other owners of your type of machine, feel free to upload it. The contents of the BBS will in large part be determined by what you post there, so if you feel your machine is being neglected, do something about it!

On the RE-BBS, any file whose name ends in the three letters ARC (like QMODEM.ARC) is an archive file. An archive file is a group of related files that are collected together and compressed in order to save space and download time. Archive files are useful only to owners of IBM-PC's or compatibles. You use a program called ARC.EXE to add to, delete or extract from, list the contents of, etc., an archive.

Similar to archive files are library files, which have the file type .LBR (e. g., HIDDEN.LBR). Like archive files, libraries are also composed of compressed, inter-related programs and data files, but they are incompatible with .ARC files. So an additional utility is necessary to process library files; one such utility is LSWEET, for Library SWEEP. Library files are used on both CP/M and IBM BBS's, and versions of LSWEET are available for both types of system. And, although you can unpack a

CP/M library file on an IBM-PC, you can't run the .COM files! Nor can you run .COM files from a CP/M library on an IBM!

A method of compressing and de-compressing files is popular on CP/M and some IBM BBS's. On IBM BBS's the file-compression program is usually called SQ.COM (for squeezing) or something similar, and the de-compression program is usually USQ.EXE (for unsqueezing). SQ and USQ work only on individual files; a squeezed file always has a Q in the second position of the file type (e. g. RID-DLES.TQT). USQ automatically restores the proper file name.

For maximum flexibility, you'll need copies of ARC.EXE, SQ.COM, USQ.EXE, and LSWEET.EXE. A version of each has been posted on the RE-BBS. If you can't find programs with those exact names, check the directory listing carefully; many of those programs also contain version numbers in their names (e. g., LSWP103.EXE).

A related utility for IBM's, which is based on a popular public-domain CP/M utility, is called PCSWEEP. It allows multi-file copying, deleting, etc. In addition, it can squeeze and unsqueeze files, and process library files. It's biggest limitation is that it can't process archive files.

Don't hesitate to upload your own programs, and don't hesitate to participate in the various conferences we've set up. If you're working on a project of general interest, share your thoughts. If you need help—ask. Somebody's bound to help.

HITACHI AT LOW COST



HITACHI V-680 OSCILLOSCOPE
60MHz, CRT readout, 3 channels, 6 traces, Delayed sweep, cursor measured value readout and scale factor, Display function, Frequency readout, Ref/Δ, Ch 1 range, Ch 2 range-and much more!
USER NET \$1490.00
OUR PRICE: **\$1369.**

HITACHI V-212 OSCILLOSCOPE
20MHz, Extremely portable, 1MV/Div. sensitivity, ±3% Accuracy, Dual channels, TV sync, XY mode
USER NET \$615.00
OUR PRICE: **\$428.**

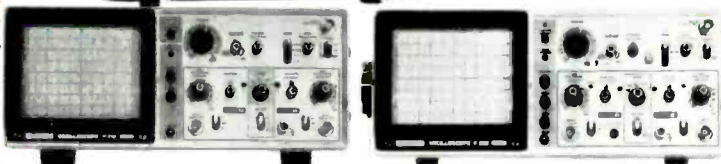

HITACHI V-222 OSCILLOSCOPE
20MHz, 1MV/Div. sensitivity, D.C. offset for DMM output, CH1 output, X1-X10mag., TV sync, XY mode
USER NET \$715.00
OUR PRICE: **\$509.**

HITACHI V-209 OSCILLOSCOPE
20MHz, Battery operated, Super mini-portable 1MV/Div. sensitivity, auto focus, 3 power sources (AC, DC and External), self-charging, TV sync, XY mode, WITH FRONT COVER!
USER NET \$1013.00
OUR PRICE: **\$815.**

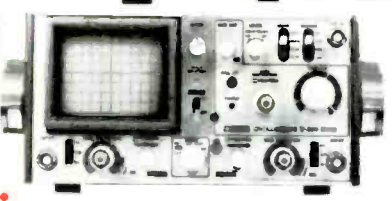

WM. B. ALLEN SUPPLY COMPANY, INC.

Allen Square • The 300 Block • North Rampart Street
New Orleans • Louisiana 70112-3106

WM. B. ALLEN CARRIES 18 LINES OF TEST & MEASUREMENT EQUIPMENT—CALL FOR PRICING

Call TOLL-FREE 800 535-9593

Louisiana 800-462-9520 Local (504) 525-8222

ALL MAJOR
CREDIT CARDS
HONORED

ALL MAJOR
CREDIT CARDS
HONORED

DRAWING BOARD



ROBERT GROSSBLATT,
CIRCUITS EDITOR

Which memory?

WE RECENTLY SPENT A LOT OF TIME TALKING about the different kinds of memory: what they were, how they worked, and how to use them. The two basic types of RAM, static and dynamic, each have characteristics that are particularly useful for specific applications. Which type of memory you should use depends on the kind of circuit that you want to put together. As with most things in life, there's a trade-off involved; you have to weigh the amount of memory you need against the amount effort you will have to put into the design of the circuit.

There's no getting around the fact that static RAM is a whole lot easier to use than dynamic RAM. When you put data in a static RAM, you can forget about it. Just about the only thing you have to do to guarantee that the data will be there when you want it is to keep the power turned on; and if you refer to our previous discussion of low-power CMOS memory (see *Drawing Board* in the July 1985 issue of *Radio-Electronics*), you'll see that there are ways of making sure your data is there even when the power is turned off.

One of the oldest rules of circuit design is summed up very neatly in Grossblatt's fifth law: "Always keep brain damage to a minimum." But you'll occasionally run afoul of Grossblatt's twelfth law, which is: "There's no such thing as too much memory." It's sad, but true, that there comes a time in the life of every circuit designer when they're forced by circumstances to turn away from the relatively hassle-free world of static RAM and enter the hassle-full world of dy-

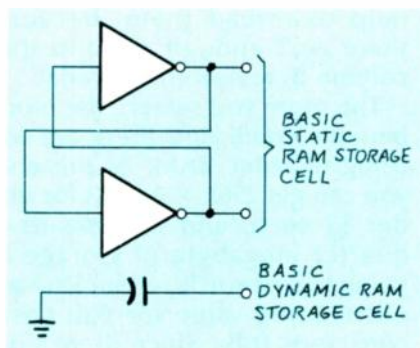

FIG. 1

namic RAM. If your circuit needs megabytes of memory, if your power supply starts heating up, or if you're just running out of board space, you'll find it impossible to meet all of your storage requirements with static RAM.

The characteristic that makes dynamic RAM such a hassle to use is also the same one that makes it so attractive. Of course, I'm talking about *refreshing*. Before we get into the nuts and bolts of circuit design, let's spend a bit of time examining the anatomy of a standard dynamic RAM.

The basic memory cells in a dynamic RAM are much smaller and less complex than those of a static RAM, which results in more storage for the same size package. Since it's one thing to describe the difference between the two of them, but another thing to actually see them side by side, Fig. 1 shows how the complexity of a typical static RAM cell compares with that of a dynamic RAM cell. Whereas the static RAM usually consists of two cross-coupled inverters, the dynamic RAM, as you can see from Fig. 1, is nothing more than a small capacitor directly on the IC's sub-

strate. (By using techniques such as address multiplexing, we can increase the number of directly-addressable cells without increasing the size of the IC's package. We'll get to that subject later.)

When a chip designer sits down to work out the internal circuitry of an IC, there are a few basic rules he follows, and one of them is to minimize the number of passive components. The space on an IC's substrate is limited, and passive components take up a lot of room. It's true that a small capacitor takes up less room on the substrate than the transistors needed to make the two inverters found in a static RAM cell, but the operative word there is "small."

Small means short

We have all used capacitors for temporary storage, but if you look over your old designs you'll notice that most stand-alone storage capacitors have values in the microfarad range; they are usually the electrolytic type. The reason for using large-value capacitors is simple—you want the longest time constant you can possible get. Although the exact value of the capacitors used for dynamic RAM varies from IC to IC, you can get an approximate idea of that value by considering that the integrity of the data stored there can only be guaranteed for 2 milliseconds!

Since the data will disappear in 2 milliseconds, the circuit-designer must provide memory-support circuitry that will periodically read out the data in every single cell and write it back in. That process, known as *refresh*, is a basic fact of dynamic RAM life, and any circuit

that makes use of dynamic RAM has to deal with it.

A more-general fact of electronic life is that you can't do realistic design work without paperwork, and that's especially true with dynamic RAM since the timing requirements are very strict. If you don't have any data books or sheets for dynamic memory it's a good idea to get some before you follow this discussion any further. The dynamic RAM manufacturers listed in Table 1 is a good start. They all have a variety of dynamic RAM types in their semiconductor stable, and if you call or write they'll tell you how to get their data sheets.

When we talked about memory the last time, we went into considerable detail about RAM anatomy (see *Drawing Board*, August 1985). We found out everything there was to know about RAM theory, but never took the practical side of things past a demonstrator circuit. In a later column we covered memory organization and bank switching (August 1986, page 73). If you've kept those issues it would

TABLE 1—RAM MANUFACTURERS

National Semiconductor
2900 Semiconductor Drive
Santa Clara, CA 95051
408-721-5000

NEC Electronics USA, Inc.
Communications Dept.
Microcomputer Div.
One Natick Executive Park
Natick, MA 01760

Mostek Corp.
1215 West Crosby Road
Carrollton, TX 75006
214-466-6000

help to reread them, because there isn't enough room in this column to review the material.

The more you search, the more benefits you'll find there are for using dynamic RAM. At present, you can get 256k × 1 RAM for under \$2 each, and that means a quarter megabyte of storage is going to cost you less than \$16—an outstanding value for you cost-conscious folk. Since there's no doubt that the 1-megabyte IC's will eventually show up in the mail

order houses, if you know how to design around them you can save both money and board space.

Over the next few months we'll put together a memory system using dynamic RAM. Since everybody has their own applications for memory, we'll keep the system as general as possible. Once we get it up and working, we'll talk about customizing it for particular uses. If you have questions about the circuit or ideas for its use, drop me a note and I'll get back to you. If your idea has a broad appeal, we'll spend some time talking about it in the column. Now, let's get to work.

Designing RAM

As you probably know by now, the first step in any design is to make a list of the design goals. You can't start wiring up stuff without a clear idea of what you want, so here's what we're aiming at:

1. Our memory system will have 64k of storage.
2. The storage will be in 4164 dynamic RAMs.
3. The system will be expandable beyond 64k.
4. The system will be independent of the host circuit.

If you go through the mail order ads, you'll see that 64k RAM's come in several types. The differences have to do with the access speed, packaging, temperature range, and so on. The design we'll be putting together is geared to 150-nanosecond RAM, and that's the only consideration you have to keep in mind. Mil-spec stuff is great, but there's no sense in paying for something you're not going to use.

Figure 2 shows the pinouts of a standard 4164 dynamic RAM. Notice that there is no indication for the function of pin 1. Most 4164's have no connection to pin 1, others have a RFSH input on pin 1, which is connected to an internal counter that is used for incrementing refresh addresses. Mostek introduced the refresh feature in 1980; some manufacturers adopted it and some didn't. We won't be using it, but if you happen to have a device with a RFSH input on pin 1, tie pin 1 high to disable the refresh.

continued on page 131

DOES YOUR DIGITAL CAPACITANCE METER DO THIS?

FULL 4 DIGIT 0.5 INCH LCD DISPLAY COMPLETELY AUTORANGING WITH 10 RANGE MANUAL CAPABILITY

AND THIS
RANGE OF 0.0 pF to 1 FARAD (999.9 mF)
0.5% BASIC ACCURACY UP TO 100 uF

AND THIS
READS DIELECTRIC ABSORPTION

AND THIS
EXTENDED PSEUDO 5 DIGIT
RESOLUTION ON SOME RANGES ONLY

AND THIS
ABILITY TO ZERO LARGE CAPACITANCE
VALUES UP TO 99.99 uF

AND THIS
CALCULATES TRUE CAPACITANCE
IF CAPACITOR IS LEAKY

AND THIS
DIODE CLAMP AND FUSED
PROTECTED INPUT.
DISCHARGE RESISTOR IN OFF
POSITION AT TERMINAL INPUTS.
POWERED BY 9V BATTERY

**ONE YEAR PARTS &
LABOUR WARRANTY**

FOR ONLY THIS



AND THIS
IDENTIFIES TRANSISTORS (NPN, PNP)
AND THEIR LEADS (E, B, C, ETC.)

AND THIS
TESTS ZENER DIODES AND RECTIFIERS.
UP TO 20V ZENER WITH AC ADAPTOR,
ZENER VOLTAGE WITH 9V BATTERY
DEPENDS ON ITS CONDITION

AND THIS
AUTOMATICALLY CALCULATES LENGTHS
OF CABLES IN FEET, METRES, MILES,
KILOMETRES (THEORETICAL RANGE
OF 9,999 MILES)

AND THIS
ABILITY TO SORT CAPACITORS IN
MANY DIFFERENT MODES

AND THIS
ABILITY TO READ LEAKY CAPACITANCE
(INSULATION RESISTANCE OR CURRENT)

AND THIS
CALCULATES TIME CONSTANTS WITH
USER DEFINED RESISTANCE VALUES

AND THIS
HOLD FUNCTION FREEZES DISPLAY

SHIPPING INSTRUCTIONS:

All units shipped out F.O.B. Buffalo NY via United Parcel Service (except Hawaii & Alaska) unless otherwise indicated (in which case shipments will be F.O.B. Canada)

PLEASE SEND ME		U.S. FUNDS
(QUANTITY) MC300(S) @	\$169.95	\$ _____
CARRYING CASE	\$ 16.95	\$ _____
AC ADAPTOR	\$ 9.95	\$ _____
SHIPPING AND HANDLING @ \$5.00 PER INSTRUMENT		\$ _____
[] CHECK [] MONEY ORDER		\$ _____
[] VISA [] MASTERCARD	TOTAL	\$ _____
[] CARD NO. _____		
EXPIRY DATE _____	SIGNATURE _____	
NAME _____		
ADDRESS _____		
CITY _____ STATE _____	ZIP CODE _____	

\$169.95

MODEL
MC300
DAETRON

Approx. Size
7" x 4" x 1 1/2"
a division of Bergeron Technologies Inc
7686 KIMBEL STREET, UNIT 5
MISSISSAUGA, ONT., CANADA
L5S 1E9 (416) 676-1600

DEALER ENQUIRIES INVITED

CIRCLE 177 ON FREE INFORMATION CARD

SERVICE CLINIC

Funny pictures

EVERY ONCE IN WHILE, WE GET A SET with some very peculiar symptoms. One classic case was a set with a very unusual picture: Taking a closer look at it, it appeared to be negative! See Fig. 1.

That gave me an idea, and one look at the video-detector diode told me that I was on the right track. The soldering job on that component was not up to "professional standards." The joints were dull and "blobby;" in other words, they were a mess.

Encouraged, I checked the detector diode against the schematic. Sure enough, it had been installed backwards. The video signal coming from the detector was inverted; that fact was quickly confirmed using an oscilloscope. Removing, reversing, and re-installing the diode corrected the polarity problem.

However, things still did not look quite right. On a hunch, I decided to check the video alignment. Hooking the set up to a sweep generator and examining the response curve with an oscilloscope yielded an interesting result: The video-IF amplifier was as out-of-alignment as it could be. The response curve resembled nothing that I had ever seen before.

The reason for that soon became apparent. Just about every tunable component in the video IF had been "diddled" with. Some slugs were perfectly aligned with the tops of the cans; others were screwed down as far as they could go. Once the set was aligned to the manufacturer's specifications, everything worked fine.

Generally, a full sweep align-



FIG. 1

ment of a set is not needed and most of the time your sweep generator just sits on the bench. But every once in a while it becomes indispensable. If a set with signs of diddling comes across your bench, one of the first things you should do is check the alignment. It only takes a few minutes, but often it can lead you right to the cause of the problem.

A lot of weird effects and funny pictures can be caused by misalignment. In one case that I recall vividly, a set with no picture came into the shop. After opening the back of the set, it soon became obvious that someone with little expertise had been there first. Out came the trusty sweep generator and soon the reason for the missing picture was revealed. The video-carrier frequency had been "adjusted" so that it fell completely outside the video pass-band. After things were set right, the set worked perfectly; at least it did until the next time that the diddler got inside of it!

Intermittents

Now it's time for me to hold forth once again on a subject that is "dear to my heart"—the intermittent TV set. Actually, "bane of



JACK DARR,
SERVICE EDITOR

my existence" would be a more apt description! Though I have to admit that they serve a purpose: They give me plenty of material for this column.

Intermittents come in all shapes, sizes and colors; they can crop up in the picture, the sweep, the color, or any other section of the TV set. There are as many kinds of intermittents as there are beans in a beanbag. Therefore, the most important tool you can have when dealing with intermittents is patience.

First of all, really *look* at the symptoms and figure out where in the TV set the problems lie. Second, always suspect solder joints, no matter how "good" they look upon first inspection.

Here's one classic that points out what I mean: Troubleshooting an intermittent in a set eventually led me to a terminal strip that served as the main distribution point for the B+. But the joints there seemed to be perfect; they were shiny, clean, textbook-like examples of proper soldering technique. There was no way that those joints could be the cause of the problem.

Want to bet?

Continuing, all indications eventually led me back to the terminal strip. I finally decided to stop being lazy and resolder the connections. As soon as I started melting the first joint, a stream of smoke appeared. That beautiful solder joint was made using a non-conductive "liquid solder!" Cleaning, tinning, and soldering the connections properly restored operation to normal.

Of course, solder joints are the

Put Your Electronic Skills to Work in ROBOTICS NOW!

BECOME A
ROBOT VEHICLE PILOT/TECH

Financial Aid Placement Assistance



**HIGH PAY
HIGH TECH
EXCITING CAREERS**

Electronic, Hydraulic & Robotic Skills Taught.

Call or Write for
FREE BROCHURE TODAY.

Ask About Our
Correspondence Course
(713)690-0405

UNDERWATER VEHICLE TRAINING CENTER
10046 Chickasaw, Houston, TX 77041

CIRCLE 213 ON FREE INFORMATION CARD

only cause of intermittents. Capacitors and resistors can do their part to make you crazy, too.

With capacitors, the older wax types, the kind with the brown-paper cases, should be especially suspect. The connections to the leads on those have a tendency to become intermittent with age. I have a soldering tool with a slotted end on my workbench that comes in very handy in spotting capacitors with that problem. Slipping the slot over the leads of the capacitor and twisting it almost always causes the intermittent to appear, usually at the moment the leads are moved even slightly.

With resistors, look for signs of overload. A sure giveaway is a uniform grayish color. Resistors that bear that coloration have been subjected to a drastic overload and no longer have a value that bears any resemblance to the original.

In some of the more severe cases, burned resistors will even break in two or disintegrate completely. The good point to that, I guess, is that then the problem is no longer intermittent! **R-E**

AUDIO UPDATE

continued from page 75

trolled signals sent to them, appears to mostly "swamp out" the contribution of the listening room, and the control flexibility built into the *DSP-1* can adjust for the normal range of recorded program acoustics.

After one listens to the *DSP-1* for a time, switching it out is almost a painful experience. The sound field collapses into the normal front speakers with a distressing loss of depth and liveness.

I don't know how many of my readers are prepared to spend the \$1,500 or so that a four-channel power amplifier, four good small speakers, and the *DSP-1* would cost, but for those dedicated to the search for sonic realism it is money well spent. For more information on the *DSP-1* and its associated equipment, write to Yamaha Electronics Corp., Dept. RE, 6660 Orangethorpe Ave, Buena Park, CA 90622. **R-E**

TEST INSTRUMENTS

High Quality
Lowest Prices
Off-The-Shelf

New! MINI-METERS w/MAXI-SPECS

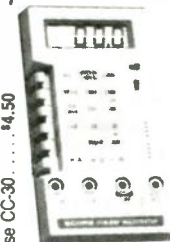

SCOPE 3 1/2 Digit LCD with 8 Full Functions

Model DVM-632 \$4495
Deluxe test leads included • 0.5% accuracy • Transistor gain test • Audible continuity checking & diode test • 10 Amp measurement

Zippered Carrying Case CC-30.....\$4.50



SCOPE 3 1/2 Digit LCD Multimeter

Model DVM-630 \$2995
Test leads included • 0.5% accuracy • 6 functions, 19 ranges • Automatic zero adjust • Low battery indication • Measures 5" x 2 3/4" x 7/8"



B & K 20 MHz Dual Trace

Model 2120
Probes included • 20 and 26 MHz band widths • TVV and TVH • X-Y operation • Trace rotation: adjustable front panel • Channel 1 output

Phone orders accepted.



SCOPE 3 1/2 Digit Capacitance

Model DCM-602 \$6995
Test leads included • 8 ranges with full scale values to 2000 uF • LSI circuit • Crystal time base • Frequency range 800 Hz to 8 Hz



SCOPE 3 1/2 Digital Multimeters

Model DVM-638 \$7995
Test leads included • 11 function, 38 ranges • Logic level detector • Audible visual continuity • capacitance and conductance measurement.



Model DVM-634

• 7 function, 32 ranges • Transistor measurement

Model DVM-636

• 8 function, 37 ranges • Capacitance measurement



SCOPE Pocket Sized Audio Signal Generator

Model RC-555 \$699
Test leads & 9V battery included • Low distortion sine-wave signal • 46 step selected frequency • x1 range 20 Hz to 1.5 KHz/x100 range 2KHz to 150 KHz

HITACHI 35 MHz Dual Trace Oscilloscope



Model V-355 \$59995
(Reg. \$899.95)
Probes included • Thin, lightweight, compact • Large 6" rectangular, internal graticule CRT • Autofocus

FORDHAM Sweep Function Generator



Model FG-801 \$21995
(Reg. \$289.95)
Test leads included • 7 frequency ranges, 0.2 Hz to 2 MHz • Accuracy to ± 5%

FORDHAM 550 MHz Frequency Counter



Model FM-8 \$16995
(Reg. \$249.95)
Completely assembled, pre-tested, precalibrated • High intensity 8-digit LED display



SCOPE 4 1/2 Digit LCD Bench Digital Multimeter
Model DVM-6005 \$19995

Test lead set & 6 "D" size batteries included • 0.4" high characters • Conversion period: 500 milliseconds • Automatic, negative polarity

Ask for our **FREE** Catalog

TOLL FREE 800-645-9518

In New York State 800-832-1446

Service & Shipping Charge Schedule Continental U.S.A.

FOR ORDERS	ADD	FOR ORDERS	ADD
\$25 100	\$4 50	\$751 000	\$12 50
\$101 250	\$6 00	\$1 001 1500	\$16 50
\$251 500	\$8 00	\$1 501 2 000	\$20 00
\$501 750	\$10 50	\$2,001 and up	\$25 00

COMMUNICATIONS CORNER



HERB FRIEDMAN
COMMUNICATIONS EDITOR

Think ferrite

THE MOST DEVILISH FORM OF RFI (radio frequency interference) is not what we do to others, but what we do to ourselves. I have probably spent more time filtering my own transmitter out of my own receiving and high-fidelity equipment than I have spent filtering RF from an FM-broadcast transmitter out of the local hospital's EKG machine. I have also spent, and wasted, many an hour trying to get my computer's *bleeps* and *bloops* out of my telephone.

The problem itself has a very reasonable explanation: Each wire external to the shielding of a metal equipment cabinet or a chassis functions as an antenna. If the local transmitter is a low-power unit in your backyard, every wire in the house, even shielded wires, will receive some part of the radiated signal. If anything causes the RF to be detected, you have RF interference.

Shielded wires in themselves are often no solution because rarely is the shield totally effective at RF frequencies. Depending on the overall length of the wire, one end of the shield might be grounded for RF while the opposite end, which indicates ground when checked with an ohmmeter, is actually "hot" to RF. We'll show you why that is so in a future column.

Move the same transmitter and its antenna a few hundred feet away and the RFI is eliminated because the signal received by the wiring is simply too weak to do any damage. On the other hand, a 50,000-watt broadcast station a mile or so away can radiate so much RF into the wiring that we

can consider the station to be a local transmitter, capable of interfering with receivers, high-fidelity gear, telephones, and even computers. As a general rule, the four consumer-equipment wires most sensitive to RFI from local transmitters are the AC line cord, coaxial-cable antenna connections, microphone cable, and audio and video line-level cables.

The ferrite ring

Virtually any external wire, shielded or not, can be RFI suppressed by using a ferrite choke; all that's required is to loop the wire around a ferrite ring.

Perhaps the easiest filter to make, yet one of the most effective, is the line-cord filter shown in Fig. 1. It is simply a ferrite ring

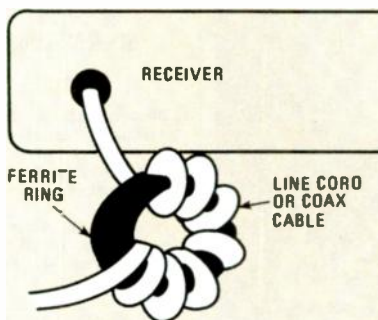

FIG. 1

through which the line cord is wrapped as many as seven times. The filter is equally effective with either conventional two-wire zip cord or three-wire-with-ground line. To provide clearance for the seven turns of line cord, as well as for heat dissipation, the ring must be almost 2.5 inches in diameter, and a little more than 0.5-inch

thick. It must also be effective over a rather broad frequency range. An Amidon type FT-240-75 ring meets those requirements. The 240 part of the specification means the ring is 2.4 inches in diameter. The 75 means that the ring is made of a type 75 material; the characteristics of that material allow the resulting filter to have maximum effect over a 1-MHz through 50-MHz range, but the filter will attenuate noise to 200 MHz.

To prevent capacitive coupling between the input and output leads, push the turns close together so there is as much space as is possible between the first and last turns. Then tape the turns down with common plastic tape so they can't change position.

The scheme can also be used with coax antenna lead, or even a shielded microphone lead. Simply wrap seven turns around an FT-240-75 ring and tape the turns to keep the input and output separated. The ferrite choke will keep RFI from traveling down the shield of the coax or microphone cable into the receiving or the amplifying equipment.

If the interference comes from radio frequencies below 1 MHz it might be necessary to use two chokes in series. As that arrangement can get very bulky, first try adding two turns per ring, for a total of nine.

When dealing with audio cables and thin microphone wire, it isn't necessary to use a large ring because there's no dissipation to worry about; all you need is a ring large enough to allow you to wind up to seven turns. For conventional microphone and audio

Rely on JAN for 3-WAY Help

1. **TECHNICALLY CORRECT**
Crystals to Your Specs
2. **QUICK TURNAROUND**
with huge inventory, prompt
service and Emergency Order
Plan
3. **LOW PRICES**

QUARTZ CRYSTALS FOR
Two-Way — Industry — Marine
Amateurs — CB — Microprocessor
Scanners

For Free Catalog
Call or Write

JAN CRYSTALS
P.O. Box 06017
Ft. Myers, FL 33906
(813) 936-2397



Since
1965



CALL 1-800-237-3063
FREE (Except Florida)

CIRCLE 104 ON FREE INFORMATION CARD

TRANS-AM

ELECTRONICS

383 CANAL ST NYC, NY 10013
(212) 226-3893



LED CHASER KIT

An electronic kit designed to help learn the basics of digital IC circuits. 10 leds chase in one direction at variable speeds.

\$8.95

16 LED BACK AND FORTH KIT

More challenging, more fun! Both come with instructions. Specify red yellow or green. Works on 9VDC

\$14.95



RIGHT ANGLE LED

Clear red leds packaged 200 per bag. A closeout special while they last.

9.95/200pcs

PROJECT BOX

A 4" x 6" x 3" metal box with 4 RCA jacks on one end and rubber feet. Comes apart with screws. Very well made.

3.95



HEAVY DUTY SIREN

Weatherproof 12 VDC Siren 5" high impact ABS white plastic. Swivel base. Uses 500 MA.

14.95

RECTANGULAR LEDS

Diffused red leds. Very bright. 100 per bag.

5.95/100pcs



WALL TRANSFORMERS

All plug directly into 120 VAC outlet.

6 vdc @ 500 ma 3.95

12 vdc @ 300 ma 2.95

12 vdc @ 930 ma 4.95

14 vdc @ 500 ma 3.95

Terms: \$10 minimum order. Add 2.50 for shipping. In NYS add 8.25% tax. Call in order or mail in order with check, Visa/MC/Amex OK. All items subject to prior sale.

CIRCLE 191 ON FREE INFORMATION CARD

cables, you could try a ring with a 1.4-inch diameter.

Actually, for audio circuits you might even get by with a single turn, as shown in Fig. 2. But it pays to use extra turns. If a single turn

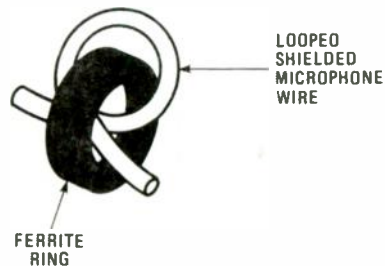

FIG. 2

suppresses, but doesn't eliminate the interference, keep adding turns. Just keep in mind that there must be some separation between the input and output leads.

Ferrite rings are reasonably priced. The FT-240 is \$8, while the FT-140 is only \$3. You can get a complete price list along with a ferrite coil-form catalog by writing to Amidon Associates, Inc., 12033 Otsego St., North Hollywood, CA 91607.

R-E

Pay Less For The Best

WTCPR
Controlled
Output
Soldering
Station
\$76.00

Weller®

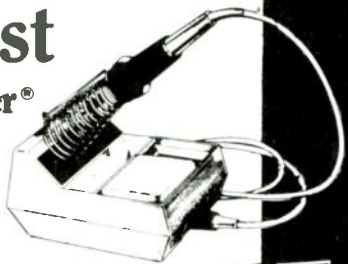

Universal Soldering Kit
List \$28.22 SALE \$22.48

Includes dual heat soldering gun with 3 soldering tips, wrench, flux brush, soldering aid tool & solder in plastic carrying case. 8200PK

Professional Soldering Kit
List \$38.29 SALE \$30.50

Includes soldering gun with pre-tinned heavy copper tip, 2 spare tips, wrench, flux brush, soldering aid tool & solder in plastic carrying case. D550PK

Weller®



Xcelite® Service Master
Roll Kit
List \$95.71 SALE \$76.99

Includes 23 tools in plastic-coated canvas case 6" long nose plier, 5" diagonal plier, 6" adjustable wrench, regular and stubby handles, 9 regular nutdrivers, 3 stubby nutdrivers, nos. 1 & 2 Phillips screwdrivers, 3/16" & 1/4" slotted screwdrivers, reamers and 7" extension 99SM

Send now for your
**FREE catalog of
electronic tools &
test equipment**

W.S. JENKS & Son



1933 Montana Ave. NE
Washington DC 20002

TOLL-FREE 1-800-638-6405

Try the

**Radio
Electronics**

bulletin board
system

(RE-BBS)
516-293-2283

The more you use it the
more useful it becomes.

We support 300 and 1200
baud operation.

Parameters: 8N1 (8 data
bits, no parity, 1 stop bit) or
7E1 (7 data bits, even parity,
1 stop bit).

Add yourself to our user files
to increase your access.

Communicate with other R-E
readers.

Leave your comments on R-E
with the SYSOP.

RE-BBS
516-293-2283

DESIGNER'S NOTEBOOK

continued from page 121

you'll have to pay attention to the polarity of the pulses. If necessary, you can use a small-signal transistor as a flip-flop to convert positive pulses to negative.

When you're working with a complex design, you should pay as much attention to the reset as you do to any other part of the circuit. Its timing can be very critical, and if it's off the mark you may get intermittent operation.

More complex reset problems require more complex solutions. You can find dedicated IC's that are designed specifically to generate pulses of one kind or another, but they are often expensive, hard to find, and difficult to use. Half-monostables are simple, cheap, and easy to use. The next time you find yourself looking for some way of generating a variety of pulses, use a hex inverter and wire up a couple of half-monostables. Chances are they'll do the job with a minimum of fuss and bother. R-E

STATE OF SOLID STATE



ROBERT F. SCOTT,
SEMICONDUCTOR EDITOR

Long-time timer

FOR MOST OF THE PAST DECADE, THE mention of a monolithic timer immediately brought to mind the 555; the best-known and most widely produced timer IC. Although the 555 is a practical device for delay times ranging from a few milliseconds to several minutes, it becomes less reliable as the delay interval is increased. That's because the time interval is determined by an RC product, and long time intervals can require a very large-value capacitor, which usually means an electrolytic type.

But when accuracy is required you cannot use an electrolytic capacitor. For one thing, electrolytics are low precision devices; their value can drift with time. Finally, an electrolytic capacitor's inherent high leakage-current makes it impossible to use a high value of resistance in the circuit.

But, though not as well known, a timer IC that is especially designed for long-time applications has been around since the early 1970's; it is the ZN1034E from Ferranti Electronics. When used as a stand-alone device, that IC can provide timed intervals ranging from 1 second to 19 days, although the RC time constant is only 220 seconds.

The ZN1034E includes an internal voltage regulator, an oscillator, and a 12-stage binary counter. The total delay time provided by the counter is 4095 times the period of the oscillator. Therefore, we can use moderate values of resistance and capacitance in the RC timing network and obtain periods that are many times longer than those possible with just the basic oscillator. With precision components with low temperature coefficients,

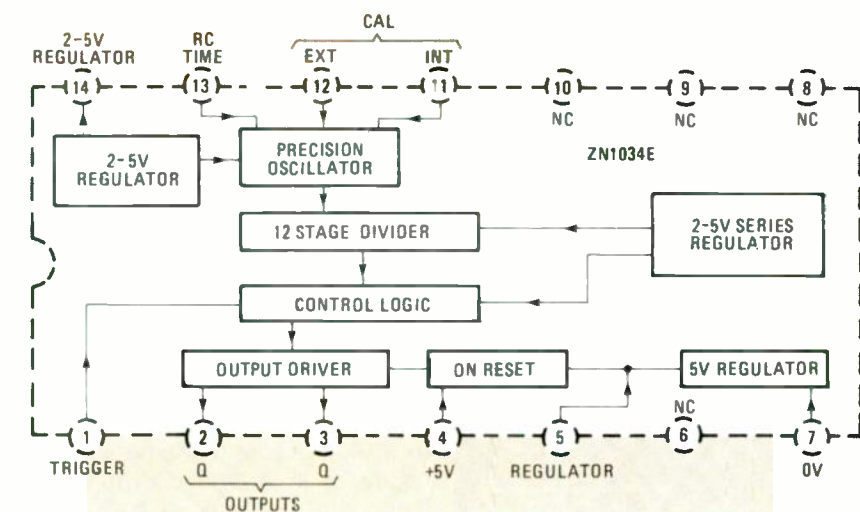

FIG. 1

the repeatability of timed periods is accurate to within 0.01% and the temperature drift in the timed period can be held to within 0.01% per degree Centigrade.

The ZN1034E comes in a 14-pin DIP package. A pinout and block diagram of the IC are shown in Fig. 1. Figure 2 shows a basic circuit for the device that is suitable for practical experimentation. Note that when you use a 5-volt power supply, only pin 4 is tied to the positive rail; pin 5 should not be connected. For supplies of from 6-450 volts DC, pins 4 and 5 are tied to the positive rail through dropping resistor R_D , as shown. The internal 5-volt regulator connected to pin 5 insures that +5 volts is supplied to the internal circuitry. Resistor R_D must drop a voltage equal to $V_{supply} - 5$ volts. Its value is derived from $(V_{supply} - 5) \div I$, where I is the load current plus the current drawn from either of the outputs.

The control logic times-out after 4095 cycles of the oscillator and delivers high and low output pulses at pins 2 and 3. The output at pin 3 is normally high and goes

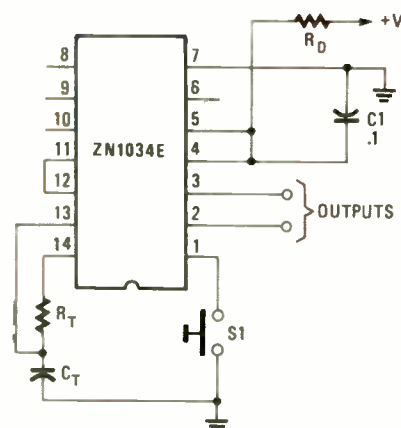

FIG. 2

low at the end of the timed interval. The complementary output at pin 2 is normally low and goes high at the end of the timed interval.

LOOK SPECIAL INTRODUCTORY OFFER
Mention This Ad
And Take **15% OFF** PRICES LISTED BELOW

***5-1/4" FLOPPY DISKS**
Software excess, erraced,
Guaranteed. DSDD, with New labels
& sleeves. \$33.50/100
LARGE QTY. PRICES AVAILABLE

*Infrared Goggles (AN/PAS5) . . . \$399.95
*CHARZ-T Infrared Monocular \$1,999.00

**COMPLETE 1Mw LASER TUBE
& POWER SUPPLY KIT**

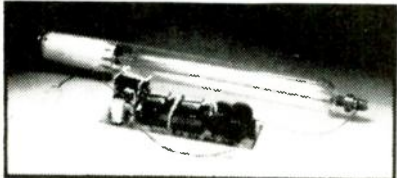

*Assembly Must Conform to Gov't Specs.
JUST \$129.90

*2Mw Laser Tube (uncased) . . . \$139.95
*5 Mw Laser Tube (uncased) . . . \$159.95
*7 to 25 Watt Laser Diode . . . \$14.88

AIR CONTROL
*Used Muffin Fan, speed
control, Fan Cord, & Grill!
All for just... **\$10.00**

*Jacobs Ladder/Tesla Coil Kit. . . \$19.88

BNF Enterprises
119r FOSTER St.
Peabody MA 01960
(617) 531-5774
36 Page Catalog
Free!
Customer Pays All Shipping Charges.

CIRCLE 187 ON FREE INFORMATION CARD

**Technicians,
Get Serious
About Your
Profession**



Being a certified electronics technician lets people know that you are a professional in your field. It tells them that you are serious about your work and can perform up to CET standards.

Now you can order the "Study Guide for the Associate-Level CET Test" from the International Society of Certified Electronics Technicians. It includes material covering the most often missed questions on the Associate CET exam. 8 1/2" x 11", paperback, 60 pages.

For More Information Contact:

IS CET, 2708 W. Berry, Fort Worth, TX 76109; (817) 921-9101

NAME _____
ADDRESS _____
CITY _____ STATE _____
ZIP _____
_____ copies @ \$5 (+ \$1 postage.)
_____ send material about IS CET
and becoming certified.

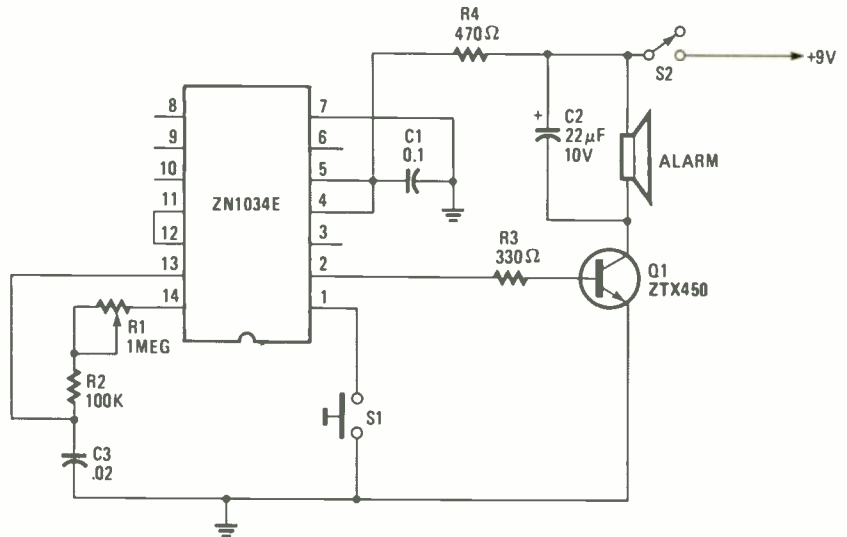

FIG. 3

The timing period, in seconds, is obtained from the formula:

$$T = KR_1C_1$$

where R_1 and C_1 are the values of the resistor and capacitor respectively, and K is a multiplying factor determined by the resistance connected across pins 11 and 12. When pins 11 and 12 are connected together only an internal resistance of 100K is across those pins and the value of K is 2736. Connecting a 50K, 150K, or 300K resistor across those pins will provide multiplication factors of 2500, 4100, or 7500 respectively.

Resistor R_1 can range from 5K to 5 megohms, but its value should be kept between 50K and 1 megohm for best performance and linearity. For best performance the value of C_1 should be greater than 0.01 μF , but smaller values can be used when the timed interval must be short. With values below 0.01 μF , the timed interval is not linear with respect to the RC time constant. The manufacturer suggests 3900 pF as the minimum value for C_1 . Table 1 shows convenient R_1 and C_1 values for timed periods ranging from 1 second to 19 days.

The timing period is initiated by momentarily grounding pin 1. In Fig. 2, that is done using a momentary pushbutton switch, S1. Alternatively, if pin 1 is grounded, the timing period can be initiated by applying power to the circuit.

Figure 3 shows how the ZN1034E can be used as an interval timer

TABLE 1— R_T AND C_T VALUES

R_T (ohms)	C_T (μF)	Timed period	
		A	B
39K	0.01	1 sec	2.92 sec
220K	0.1	1 min	2.75 min
100K	1.0	5 min	12.5 min
1.2 Meg	1.0	55 min	2.5 hrs
1.2 Meg	10	9.1 hrs	25 hrs
3.3 Meg	10	1 day	2.8 days
2.2 Meg	100	1 week	19 days

A) Pins 11 and 12 tied together
B) 300K resistor connected between pins 11 and 12

providing delays of 1 to 11 minutes. Timing resistor R_1 consists of two resistors, R_1 and R_2 , in series. Because R_1 is a fixed value of 100K, the total range of R_1 is 100K to 1.1 megohms. Timing starts when S1 is pressed. The alarm sounds at the end of the timed interval and continues until S2 is opened. Transistor Q2, a Ferranti ZTX450, is an NPN medium-power (1 watt) silicon transistor with a $V_{\text{C(BC)}}$ of 60 volts and an $I_{\text{C(max)}}$ of 1 ampere.

The ZN1034E's data sheet has circuits for a number of other applications, gives interfacing ideas, and shows how to cascade two timers to provide delays up to 1 year with an accuracy of 6 minutes. (Such long-timed periods can be used for time-lapse photography and for controlling automatic watering systems for lawns and greenhouses.) Data sheets and further details on the ZN1034E can be obtained from Ferranti Electric Inc., 87 Modular Ave., Commack, NY 11725.

R-E

DRAWING BOARD

continued from page 124

If you're used to dealing with static memory, the first feature of the 4164 you should notice is that there are only 8 address pins, A0

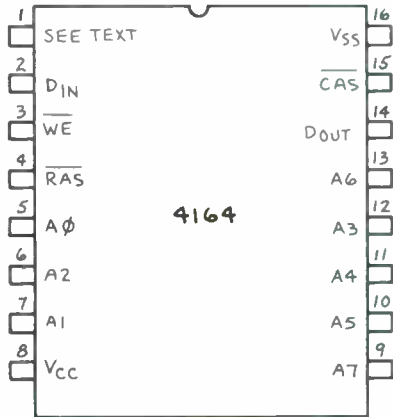

FIG. 2

through A7. Ordinarily, this wouldn't be enough for decoding the 65,536 memory cells on the substrate, but you'll remember that I had mentioned the notion of "address multiplexing" earlier in this column. The address pins are used in conjunction with RAS, (Row Address Strobe) and CAS, (Column Address Strobe) to provide a complete address. When you want to access a particular location in the IC, the row address is presented to the address pins and the RAS pin is strobed, which causes the partial address to be internally latched in the IC. The column address is then presented to the same address pins and the CAS pin is strobed to internally latch the remainder of the complete address.

And if all that wasn't enough, the issue of refresh has to be dealt with as well. And there are other, well, peculiarities, of dynamic RAM that I haven't even mentioned.

The logical glue that has to be added to the board before it can be used for anything is what made me call our project a "system." But the complications don't really make anything any harder, only more interesting.

Next month we'll start to get our hands dirty. R-E

OPPORTUNITY CALLING FROM NRI

Start your own telephone/ cellular radio service & repair business

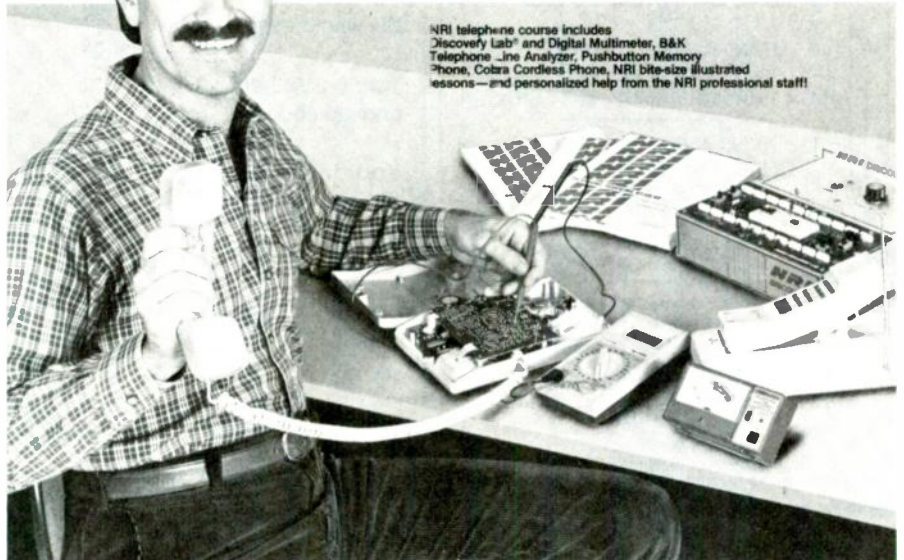

NRI telephone course includes Discovery Lab® and Digital Multimeter, B&K Telephone Line Analyzer, Pushbutton Memory Phone, Cordless Phone, NRI bite-size illustrated lessons—and personalized help from the NRI professional staff!

New Bootstrap Industry Lets You Be Your Own Boss

Since the breakup of AT&T, things aren't the same in the telephone business. Now there's a perfect new business opportunity for thousands of independents who have been trained to service, install and repair old phones, plus all the new cordless and cellular mobile car phones, that are becoming more and more popular. NRI's training and start-up equipment offer you the option of starting your own bootstrap business or cashing in on the jobs being created by the new telephone technologies.

NRI shows you how you can make a good living in telephone servicing, with a practical combination of electronic fundamentals and hands-on experience with all types of phones in use today in homes and offices—cord, cordless and cellular.

Learn troubleshooting—with cordless and memory phones you keep!

The heart of NRI telephone training is eight

Action Learning kits. You master the "reason-why" theory, then you move immediately into "hands-on" practices. Using a digital multimeter and a telephone line analyzer, you'll test every function of a telephone line, zeroing in on the problem spots and correcting them.

As an NRI student, you learn at home, at your convenience. Without rigid night-school schedules or classroom pressures. NRI's tested "bite-size" lessons lead you step-by-step toward your goal of independence as a telephone service expert.

Send coupon for FREE catalog

Find out for yourself exactly what this new NRI training can do for you. NRI's free catalog gives you all the facts on training for Telephone Servicing & Repair or other technical fields such as Microcomputers, TV/Audio/Video System Servicing and Communications Electronics. If coupon has been removed, write to NRI Schools, 3939 Wisconsin Ave., Washington, DC 20016.

For Career courses approved under GI bill,
 check for details.

McGraw-Hill Continuing Education Center
3939 Wisconsin Avenue, Washington, DC 20016

We'll give you tomorrow.

CHECK ONE FREE CATALOG ONLY

<input type="checkbox"/> Telephone Servicing	<input type="checkbox"/> Color TV, Audio, and Video System Servicing	<input type="checkbox"/> Industrial Electronics
<input type="checkbox"/> Computer Electronics with Microcomputers	<input type="checkbox"/> Electronics Design Technology	<input type="checkbox"/> Basic Electronics
<input type="checkbox"/> Data Communications	<input type="checkbox"/> Digital Electronics	<input type="checkbox"/> Small Engine Servicing
<input type="checkbox"/> Robotics & Industrial Controls	<input type="checkbox"/> Communications Electronics	<input type="checkbox"/> Appliance Servicing

Name (Please Print) _____ Age _____

Street _____ () _____

City/State/Zip _____ Accredited by the National Home Study Council! Phone _____ 000-000

SEE YOUR DEALER TODAY



FROM



HERE'S A TIP THAT'S PERFECT!

AM/FM AUTO RADIO AND CB

'Firestik' II

GOLDEN SERIES

BARE-HANDS TUNABLE "NO TOOLS NEEDED" HIGH PERFORMANCE ANTENNAS

ALSO ANTENNAS FOR CORDLESS TELEPHONES MONITOR SCANNERS

Dealer & Distributor Inquiries Invited SEND FOR FREE CATALOG

'Firestik' Antenna Company 2614 East Adams Phoenix, AZ 85034

Name _____ Street _____ City _____ State _____ Zip _____

Serving the CB and Communications Market Since 1962.

5-YEAR REPLACEMENT WARRANTY

CIRCLE 100 ON FREE INFORMATION CARD

MOVING?

Don't miss a single copy of Radio - Electronics. Give us:

Six weeks' notice

Your old address and zip code

Your new address and zip code

ATTACH LABEL HERE

name (please print) _____ address _____ city state zip code _____

Mail to: Radio-Electronics SUBSCRIPTION DEPT., P.O. BOX 51866, BOULDER, COLO. 80321-1866

SATELLITE TV

continued from page 78

plus the master authorization IC's could copy an additional 100, 1,000 or any number of additional user IC's. The ZITS people say "Yes, but. . ." The "but" means they would have to sell the copies in a month. And the "but" also means they are working on making their customer IC's copy-proof.

The ZITS approach was apparently first developed by European software people who were working on breaking both S/A-B-MAC and Oak Orion technology. The Oak Orion system is in use by Europe's Sky Channel service on Ku band. The B-MAC or a variation of it (C-MAC, etc.) is thought to be pending by several programmers in Europe, and B-MAC is also in use in Australia. The ZITS appearance in the North American market caught US software enthusiasts by surprise. It could signal the start of a software-technology exchange on a worldwide basis.

Those who have seen the ZITS IC work have observed that a stand-alone descrambler, one created outside of the GI factory, cannot now be long in coming. Indeed, in Europe, a consumer descrambler has been on the market for several months. It has a motherboard and a master housing; inside are five slots that will accommodate up to five totally unrelated descrambling circuits. The units now being offered, openly, in Europe are equipped with a pair of plug-in boards to decode the two systems now used there.

In the last 90 days, the focus of scrambling has changed from scrambling to descrambling. The makers of Videocipher continue, as this is written, to maintain that, through software and hardware changes, the holes in the initial version of Videocipher can be closed. Those who have broken into Videocipher have new confidence with each passing day that nothing done by the operators of GI is beyond their decoding abilities. There is no foreseeable end to this game yet, but the battle seems to reach impossible new heights with each passing day. R-E

ATTENTION! ELECTRONICS TECHNICIANS

EARN YOUR B.S.E.E. DEGREE



THROUGH HOME STUDY

Our New and Highly Effective Advanced-Placement Program for experienced Electronic Technicians grants credit for previous Schooling and Professional Experience. and can greatly reduce the time required to complete Program and reach graduation. No residence schooling required for qualified Electronic Technicians. Through this Special Program you can pull all of the loose ends of your electronics background together and earn your B.S.E.E. Degree. Upgrade your status and pay to the Engineering Level. Advance Rapidly! Many finish in 12 months or less. Students and graduates in all 50 States and throughout the World. Established Over 40 Years! Write for free Descriptive Literature.

COOK'S INSTITUTE OF ELECTRONICS ENGINEERING



347 RAYMOND ROAD P.O. BOX 20345 JACKSON, MISSISSIPPI 39209

Get A Complete Course In

ELECTRONIC ENGINEERING

8 volumes, over 2000 pages, including all necessary math and physics. 29 examinations to help you gauge your personal progress. A truly great learning experience.

Prepare now to take advantage of the growing demand for people able to work at the engineering level.

Ask for our brochure giving complete details of content. Use your free information card number, or write us directly. \$89.95, Postage Included. Satisfaction guaranteed or money refunded.



Banner Technical Books, Inc.

1203 Grant Ave. Rockford, IL 61103

CIRCLE 214 ON FREE INFORMATION CARD

COMPUTER DIGEST

VOL. 4 NO. 5

MAY 1987

A NEW KIND OF MAGAZINE FOR ELECTRONICS PROFESSIONALS

THE MC 68000 COMPUTER

Hardware highlights

CONTROL A ROBOT

With your Commodore 64

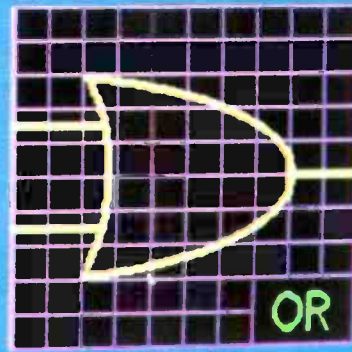
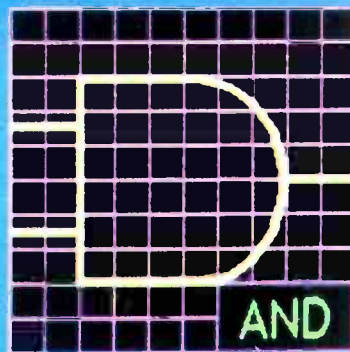
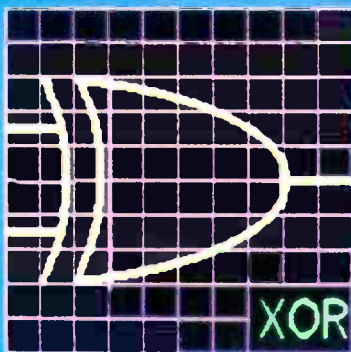
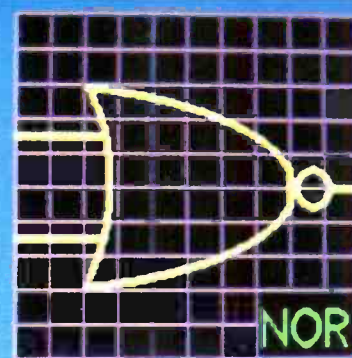
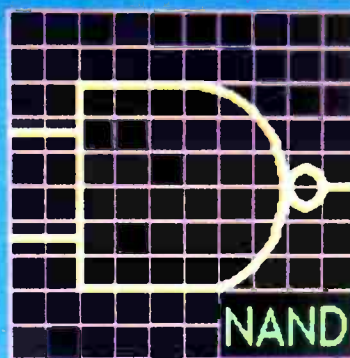
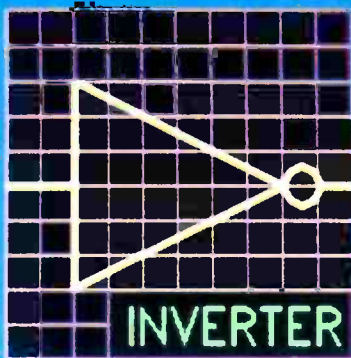

Tseng Labs

EVA/480

HARDWARE REVIEW

An enhanced graphics adapter
from Tseng Labs

CONTENTS MAY 1987

Vol. 4 No. 5

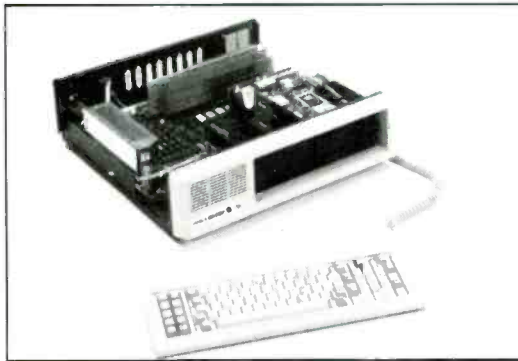

138 THE MC 68000
Part 2. Hardware highlights

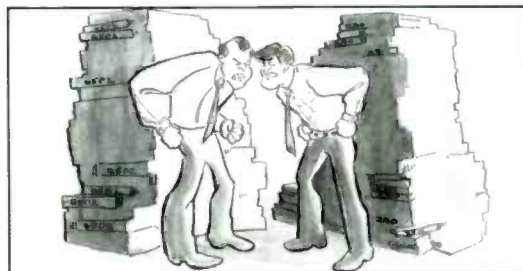

141 A LOOK INSIDE THE 6502
But which 6502?



144 COMPUTER-CONTROLLED ROBOT
Put your Commodore 64 to work!

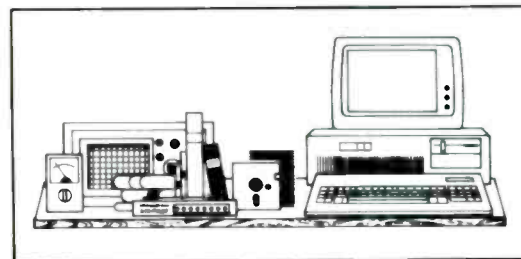

135 EDITOR'S WORKBENCH
Hardware: Tseng Labs' EVA/480
Software: CompDes—Computer Aided
Circuit Design
Books: Roger's Version by John Updike

RADIO-ELECTRONICS

134

COMPUTER DIGEST

Larry Steckler,
EHF, CET: publisher & editor in chief

Art Kleiman,
editorial director
Brian C. Fenton,
managing editor
Jeff Holtzman
technical editor
Byron G. Wels,
associate editor
Carl Laron,
associate editor
Robert A. Young,
assistant editor
Teri Scaduto
editorial assistant
Ruby M. Yee,
production director
Karen Tucker,
production advertising
Robert A. W. Lowndes,
production associate
Geoffrey S. Weil,
production assistant
Andre Duzant,
technical illustrator
Jacqueline P. Cheeseboro
circulation director
Arline R. Fishman,
advertising director

ComputerDigest
Gernsback Publications, Inc.
500-B Bi-County Blvd.
Farmingdale, NY 11735

ADVERTISING SALES 516-293-3000

Larry Steckler
Publisher

NATIONAL SALES

Joe Shere
1507 Bonnie Doone Terrace
Corona Del Mar, CA 92625
714-760-8967

Cover Photo by Herb Friedman

EDITOR'S WORK- BENCH

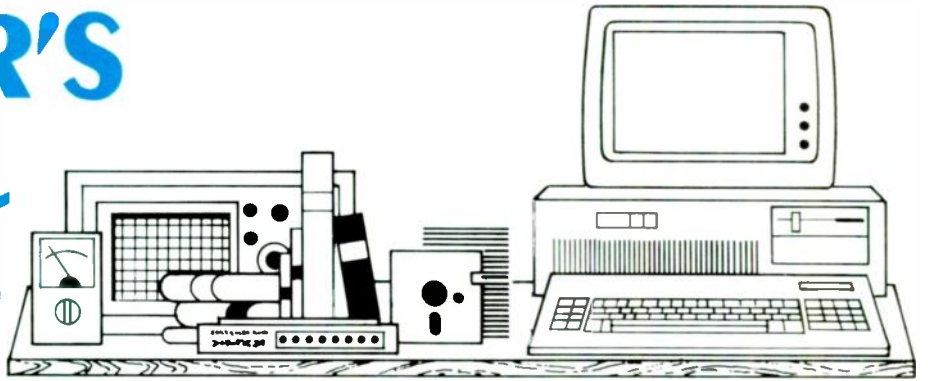

Editor's Workbench is the place where we set to try out the latest hardware and software, and where we have occasion to wax philosophical. This month we examine a high-quality graphics board, a circuit design program, and a thought-provoking novel by John Updike.



TSENG LABS' EVA/480

Every time IBM introduces a new display adapter, the R & D labs of the companies that supply IBM-compatible equipment go into high gear in order to find out how IBM built theirs, and how it can be improved upon. Of course, the first major success in this regard was the Hercules company, whose monochrome display adapter was compatible with IBM's original model.

However, no one (including IBM) believed at first that "serious" users of PCs would want to work on color displays, mainly because quality color monitors cost three or more times what a good monochrome monitor cost. But it turns that there are many legitimate uses for a high-quality color display, and that many PC users are willing to pay for it. So, in the fall of 1984, IBM introduced the Enhanced Graphics Adapter (EGA), which finally brought a more-or-less reasonably priced high-quality color-graphics system to the IBM-PC.

Since then, dozens of companies, American and foreign, have introduced EGA clones. By shopping around, you can purchase an EGA monitor-and-card combination for about \$600—that is about \$400 less

than IBM's original price for the EGA card alone.

What does an EGA card have to offer? The most important benefit, as shown in Table 1, is that vertical resolution, in modes 15 and 16, is almost twice that of the old Color/Graphics Adapter (CGA). This means that, connected to an appropriate monitor, you now get resolution near that of Hercules' monochrome card. Finally you can read text in color without going blind.

In addition, the EGA has provision for as many as four RAM-based character sets that programs like Microsoft Word and Lotus Manuscript use to display boldface and italic characters, and other special effects.

But the EGA is not called an enhanced graphics adapter for nothing. Where it really shines is in graphics modes when working with programs like AutoCAD and Dr. Halo II. With the old CGA, higher-resolution modes meant fewer on-screen colors. For example, you can get 16 colors on a standard color monitor, but only in text modes 0, 1, 2, and 3. You get only four colors (or four shades of gray) on the screen in graphics

modes 4 and 5, whose resolutions are limited to 320 × 200. At the highest CGA resolution (640 × 200) you get only two colors (in mode 6).

On the other hand, with an EGA card and an appropriate monitor, you can get 16 (out of 54 total) colors on screen simultaneously, at a resolution of 640 × 350. That's about 90% of the resolution of the Hercules monochrome card.

The EVA/480

In order to provide not merely lower cost, but also added value, several EGA manufacturers have introduced EGA cards with all the standard IBM features, plus some of their own. One of the best such cards, the EVA/480, is made by Tseng Laboratories, Inc. (10 Pheasant Run, Newtown, PA 18940). Its name comes from Tseng's view of the card as an Enhanced Video Adapter; the 480 refers to the maximum number of scan lines available from the card. Note that 480 lines is more than twice that of the standard CGA, and more than that of a Hercules mono card. In fact, total

TABLE 1—IBM-PC DISPLAY MODES

Mode	Type	Resolution (H × V)	Remarks
0	Text	320 × 200	40 × 25 text, 16-grey
1	Text	320 × 200	40 × 25 text, 16-color
2	Text	640 × 200	80 × 25 text, 16-grey
3	Text	640 × 200	80 × 25 text, 16-color
4	Graphics	320 × 200	4-grey
5	Graphics	320 × 200	4-color
6	Graphics	620 × 200	2-color (black and white)
7	Text	720 × 350	80 × 25 monochrome

Modes 8–12 are unavailable in normal use

13	Graphics	320 × 200	16-color
14	Graphics	640 × 200	16-color
15	Graphics	640 × 350	4-color mono display
16	Graphics	640 × 350	16 of 64 colors

Modes 13–16 are for use only with the EGA

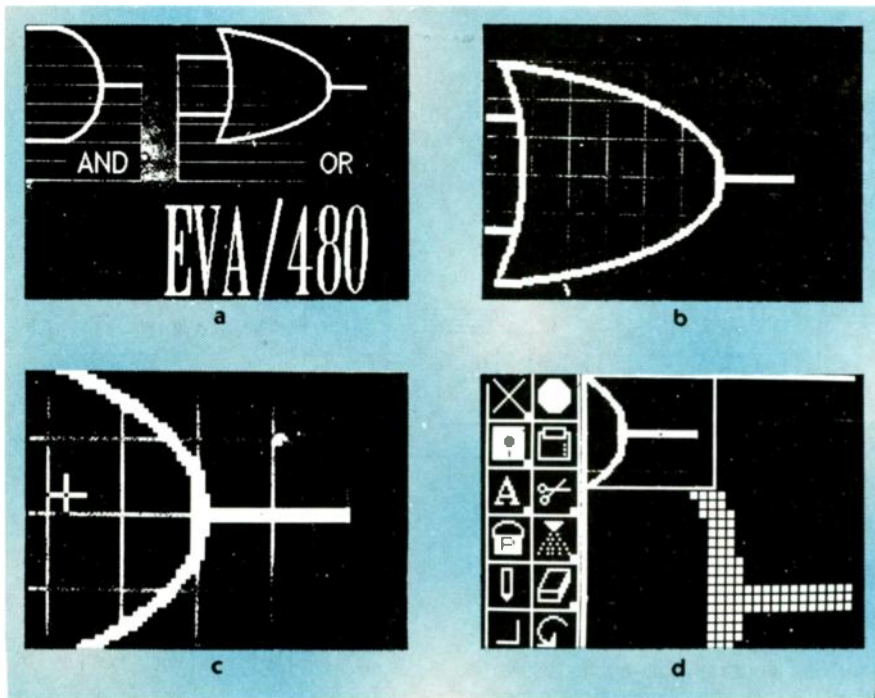

FIG. 1

resolution is about 22% greater than the Hercules card.

What good are those extra lines? For one, they can be used to produce high-quality graphic images, like the ones shown on our cover. Further, they make working with AutoCAD in color a joy. In addition, in text modes, they allow you to get more information on the screen. How would you like to work with Lotus 1-2-3 or Symphony and have 132 columns of text on the screen? In fact, the board supports a number of text formats: 80 x 25, 132 x 25, 132 x 28, 132 x 44, 80 x 43, and even 80 x 60. Patchable programs (like WordStar) can be modified easily to take advantage of the denser formats; however, most programs will use only the upper left corner of the screen in those formats.

An optional plug-in daughterboard provides complete downward compatibility with both CGA and Hercules monochrome standards. A parallel port is included with the board, as is print spooling software.

The EVA/480 can work with a number of display adapters—in fact, just about any IBM-compatible display adapter, color or monochrome. To take advantage of the EGA modes, of course, an EGA-compatible monitor (like Amdek's excellent Color 722) must be used. To take advantage of the 480-line graphics modes or text displays with more than 43 lines, a NEC Multisync or compatible monitor must be used.

Tseng Labs includes some very useful software with the package: the MacPaint-like drawing/painting program, Dr. Halo II; drivers for Lotus 1-2-3 and Symphony; a font editor, so you can create and use your own custom-character sets; a replacement for ANSI.SYS that allows you to take advantage

of the EVA/480's enhanced video modes; and a program for setting the video mode. A custom driver that allows AutoCAD to use the 480-line mode is also available, and works fairly well.

Hardware zoom and pan

One feature of the EVA/480 that is new to the world of moderately priced PC-based graphics design is its hardware zoom and pan features. You'll be completely amazed at how fast those features work if you've ever seen them implemented in software. The photos (Fig. 1-a, Fig. 1-b, and Fig. 1-c) indicate the three levels of zoom (2x, 4x, 8x) available at the push of a button. Figure 1-d shows Dr. Halo II's bit-mapped edit mode. Both zoom and pan occur instantaneously. We hope that Autodesk (or someone else) will write a complete driver for AutoCAD that takes full advantage of the EVA/480.

In conclusion, if you're in the market for a high-quality, yet reasonably priced graphics system for the IBM-PC, the combination of an EVA/480 and a NEC Multisync monitor is simply the best you can get for under \$1500. We found no compatibility problems and recommend it highly.

We'd like to offer our sincere thanks to the following companies, without whose assistance this review would have been impossible: Tseng Labs for the EVA/480 (\$680), NEC Home Electronics (1255 Michael Drive, Wood Dale, IL 60191) for a Multisync monitor (\$899), Amdek Corporation (2201 Lively Blvd., Elk Grove Village, IL 6007), for a Color 722 monitor (\$799), Orchid Technology (45365 Northport Loop West, Fremont, CA 94538) for a TinyTurbo accelerator board (\$695), and JDR Microdevices (110 Knowles Drive, Los Gatos, CA

95030) for an 80287 math co-processor (\$199.95). Incidentally, NEC is marketing the EVA/480 separately as the Multisync GB-1 (\$649). Prices quoted are current list; often they're heavily discounted. Shop around.



CompDes—Computer-aided circuit design

Almost any kind of electronics calculation or circuit design can be worked out using a scientific calculator. Unfortunately, if you want to try many different combinations of component values, the job can become a tedious, time-consuming chore as you keep punching in new data.

A faster and a more convenient way to handle both calculations and circuit design is with *CompDes*, a program that runs on the IBM-PC and compatibles, from Esoft Software, P.O. Box 072134, Columbus, OH 43207. Although *CompDes* is described as a "Computer-aided circuit-design program," in actual fact it consists of seven more-or-less independent functions:

1. A calculator for basic electrical quantities (resistance, current, voltage, and power).

2. A calculator for electronic circuits (inductive and capacitive reactance, parallel and serial impedance conversions, resonant frequency parameters, bypass capacitor values).

3. A circuit designer for self-biasing Class A transistor amplifiers, a transistor Schmitt trigger, and several DC power supplies.

4. A designer for passive and active (operational-amplifier) pi- and T-filter: low pass, high pass, band pass, band-elimination, variable band pass, Wien-Bridge notch, and Twin-Tee notch.

5. A communications calculator for microstrip, VSWR, RF air-core inductors, decibel ratios, and strip-lines.

6. A calculator for balanced, T, H, lattice, pi, and bridged-T attenuators.

7. A list of definitions and the non-graphic symbols of various electrical, electronic, transistor, and integrated circuit quantities.

All functions are selected through main and sub-menus. For example, if the *Filter Design* function is selected from the main menu, the screen then displays a sub-menu allowing you to choose passive or active filters. A sub-sub-menu allows you to choose one of eight passive or six active filters.

Some of the functions, such as the basic

electricity calculations, could probably be done faster and more conveniently in your head; however, a major convenience of the basic electricity calculations is a function that instantly calculates the value of any number (within reason) of parallel resistors.

No Graphics

Whether working a simple Ohm's Law calculation or designing a band-elimination filter or a microwave stripline, only the calculated values are displayed; there are no graphics, such as a screen representation of an amplifier or a regulated three-terminal power supply. The displayed values must be referenced to illustrations in the 42-page user's manual.

If you should want to work a problem or design using several different parameters, it's possible to make a "hardcopy" so that the various calculations and designs can be compared. Also, a hardcopy makes it easy to correlate the screen-displayed values with the circuit(s) in the user's manual.

You can print at the completion of each calculation or design either the input data, the resultant data, or design values. They are then used with the appropriate schematic shown in the manual.

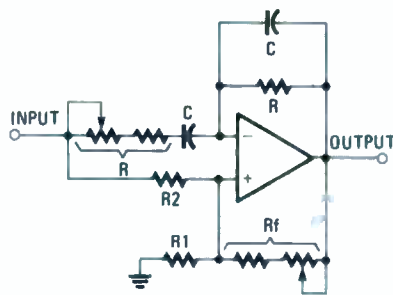

FIG. 2

For example, Fig. 2 is a Wien-Bridge filter as shown in the user's manual. Calculated values shown on the screen or hardcopy are simply correlated with the circuit shown in the manual.

Depending on the particular kind of calculation or design, if there can be some doubt as to the available value to use, the program will calculate either the value with up to three-decimal accuracy, or suggest a "nearest common value."

Often, the user can select some parameters in advance, thereby enabling the calculation or design to be "juggled" so that a commonly-available capacitor value can be used. The suggestion(s) are based on the assumption that it is easier to work with standard resistor than capacitor values.

Limitations

There are limitations on the range of calculations that may be entered. For example, capacitor and inductor input values are limited to seven places, including the decimal point. Capacitors may range from .000001

μF to 1000000 μF , while inductors may range from is .000001 henries to 1000000 henries. The frequency range is 1 to 99000000 Hz. Calculated values can, of course, exceed the limitations on the input data.

CompDes obviously is not the type of program that will be found in everyone's software library. But for what it is, it works well, and is certainly worth the \$49.95 (postage included) price. But we must call your attention to two things that can be confusing if you don't know what's going on. The first concerns the calculation for "wire size" vs. the ampacity of various size wires. The calculated wire size was greater than the National Electrical Code's recommended ampacity in the category generally used for "home" wiring. Under the code, 15 amperes (maximum) calls for #14 copper wire: *CompDes* suggested #12 wire—somewhat overly conservative. (We understand that that will be corrected, but if you get a version that calls for a "conservative" wire size you know why.)

The second confusion is caused by those who believe that there is such a thing as 100% IBM-compatibility. *CompDes* is intended for the IBM-PC/XT/AT/PCjr and their true clones—those using the 8088 CPU. It did not work with a V20 CPU, which has been touted as a faster substitute for the 8088. (Only heaven knows what other software isn't V20-compatible.)

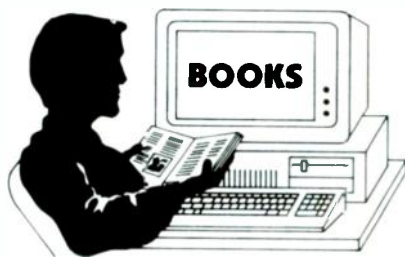

ROGER'S VERSION BY JOHN UPDIKE

No special issue on Technology in the Year 2001 would be complete without some discussion of the effect that technology has on those who use it. And one book that is sure to get you thinking about numerous topics ranging from computers to religion is called *Roger's Version*, by John Updike (Alfred A. Knopf, New York: 1986).

The hero of the book, Roger Lambert, is a professor of divinity and a former minister. One day he is accosted by a young born-again computer-science student, Dale Kohler, who wants to prove the existence of God using computers. Dale wants the Divinity School to underwrite the project.

Roger is challenged by the fervent young man, and their discussions range from early Christian history to astrophysics to number systems to social-welfare programs.

For example, the Lamberts have Dale to Thanksgiving dinner. In the course of their conversation, Roger's wife Esther asks Dale to explain his work in computer science. He discusses the basic differences between raster and vector displays, and goes on to discuss one of the bigger problems confronting computer science these days: "You look at this table now in front of you, there's a tremendous amount of visual information, I mean, a terrifying amount, if you take into account, say, the sheen on that turkey skin, and the way it's folded, and the way the water in the glass refracts that bowl, and the way the onions are a different kind of shiny from the bowl, . . . The Japanese do an amazing job with that sort of thing—glass balls floating around in front of checkerboards and translucent cylinders and so forth. It means you have to calculate through the pixels . . ."

Dale is not afraid to tackle cosmology, either: "The total energy . . . and the expansion rate of the Big Bang had to be initially in precise balance . . . for galaxies lasting billions of years to exist at all is statistically very strange. . . Energy density at the time of the Big Bang had to equal the expansion rate to one part in ten to the fifty-fifth power . . . Now if that's not a miracle, what is?"

Roger is less than enamored both with Dale's zealous religious beliefs and his almost compulsive theorizing about the universe, its origin, how it works, and why it exists at all. The drama of the book centers around the contrast between Dale's enthusiasm, on the one hand, and Roger's self-centered, almost cynical complacency, on the other.

Dale and Roger (and most of the subsidiary characters) are interesting because Updike does not make stereotypes of them. You might expect, for example, a divinity professor to have a "religious" attitude toward life, mankind, and his work. But Roger's attitudes toward all three is about as dry as that of any bookkeeper. Yet there is a human side to him, so you're really unable simply to dismiss him.

The book contains long stretches of theoretical argumentation about many topics, but balancing them are the interactions between Roger's wife and Dale, Roger and his niece (Dale's friend), Dale and Roger's son, etc. The centerpoint thus produced keeps you from getting bogged down.

Updike is a novelist, of course, but he shows a surprising grasp of many of the topics discussed. He acknowledges receiving help from several leading computer scientists

Undoubtedly, specialists will find points for debate. But Updike must be admired for being able to encompass so wide a range of subject matters. In addition, the characters are so real that occasionally you feel like stopping an argument to participate.

If you're interested in technology and in how effects us, check out *Roger's Version*—you won't be disappointed. ♦♦♦

The MC 68000 Part 2

Hardware highlights of the MC 68000 computer.

TIM AND HANS SCHRADER,
MANFRED KOENIG,
HAGEN VOELZKE

Last time (in the March issue) we gave an overview of the hardware and software that are available for the MC 68000. This time we'll discuss the overall function of the circuits on the motherboard, and, due to lack of space, focus our attention on one of the more innovative of those circuits, the programmable address decoder.

For those of you just joining us, here's a brief synopsis of what the MC68000 computer is and what it can do. As its name suggests, the computer is based on the 68000 microprocessor. The computer can run several operating systems, including CP/M-68K, OS-9, and others. The computer has an EPROM-based system monitor, so it can be booted, and programs can be run, without a disk drive or formal operating system.

The motherboard can hold 128k or 512k of memory; eight expansion slots allow memory expansion almost to the limit of the 68000—16 megabytes! The motherboard contains a built-in disk controller for 8-inch, 5¼-inch, and 3½-inch disk drives, and a SASI port for a hard disk drive. It also contains a CRT controller (the 6845) and ports for several types of keyboards. In addition, serial, parallel (user), and parallel (printer) ports are built-in.

To keep cost down, you can use inexpensive IBM-PC clone components for most major system devices: case, power supply, keyboard, monitor, disk drives. In fact, a usable system can be put together for about \$1500. In addition, you can purchase, separately or in combination, a blank motherboard (with BIOS EPROM's), a thick manual (with complete schematics, parts-list, assembly instructions, BIOS listing, troubleshooting hints, etc.), and much expansion software, as well as applications programs and programming languages. See the Sources box for more information.

In addition, for those who want to see what they're getting into before making any significant cash outlay, *ComputerDigest* will provide, at nominal cost, a packet of information consisting of schematics, parts list, and circuit description. Watch these pages (and our BBS) for more information.

Speaking of the BBS, which now has a section dedicated to the

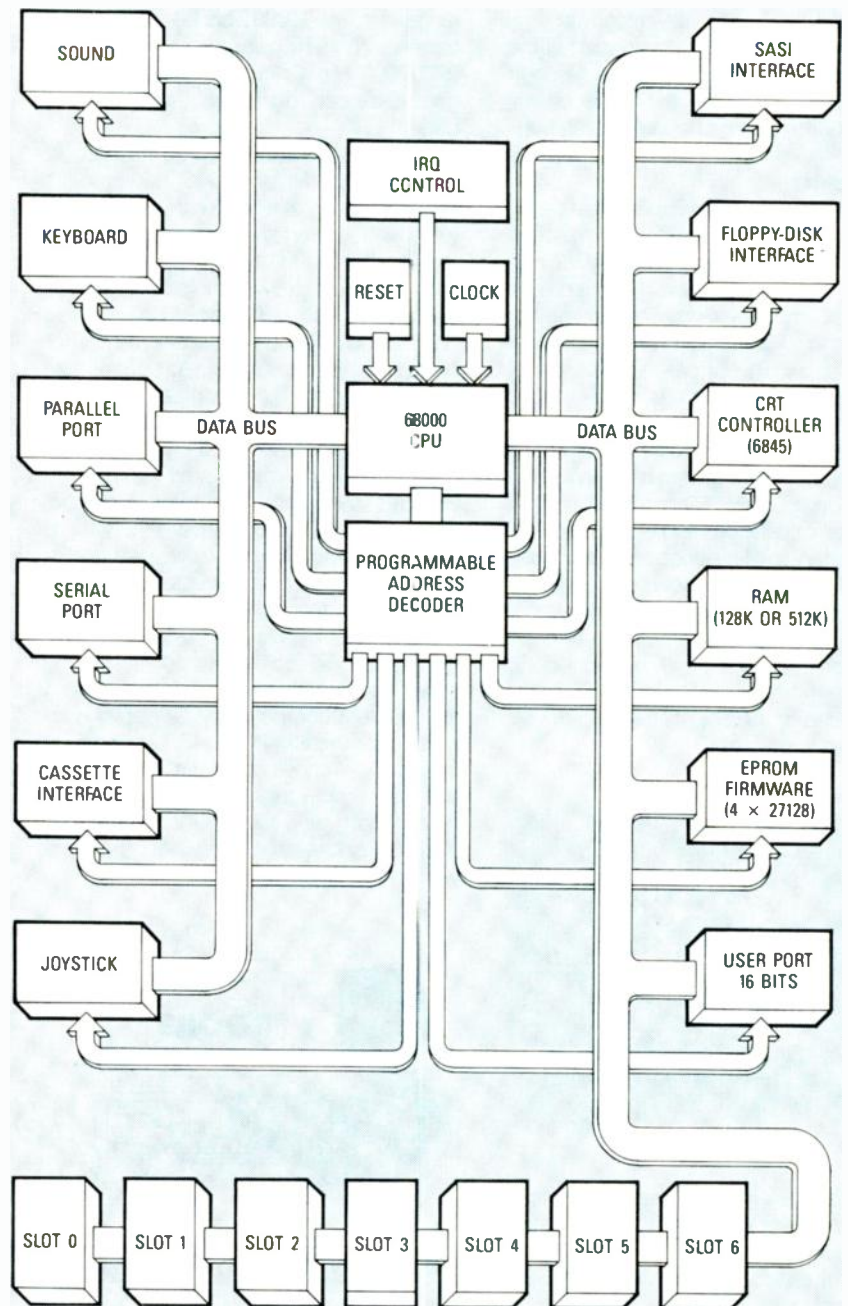

MC 68000, we've posted a number of public domain (CP/M-68K) programs there that will allow you to start learning 68000 programming. Call 516-293-2283 with your modem set for 1 start bit, 8 data bits, and 1 stop bit, at 300 or 1200 baud.

Circuit overview

As you can see in the block diagram shown above, the motherboard contains most of the interface circuitry that personal-computer buffs are used to adding via peripheral interface cards, including serial and parallel ports, SASI hard-disk interface, floppy-disk interface, CRT controller, etc.

Not shown in the block diagram are the details of how all the subsections fit together. In fact, it would take all the space occupied by this issue of *ComputerDigest* just to present schematics, not to mention circuit description! However, if you're interested in all the gory details, see the Sources box for information on the MC 68000 handbook.

Buses

The MC 68000 has three buses: address, data, and control. The address and control lines from the microprocessor are buffered by two sets of IC's, one feeding all on-board IC's, the other feeding the expansion slots. In a like manner, the data bus is fed to various circuits via four sets of buffers. One set drives the on-board dynamic RAM, one drives the major LSI components (serial- and parallel-interface IC's, CRT controller, and BIOS EPROM's), one drives the expansion bus, and the last drives all remaining circuitry.

Address decoder

One of the chief attractions of the 680xx family is the set of 32-bit address and data registers shared by all members of that family. The 68000 in particular has 24 external address lines that allow access to 2^{24} (16 megabytes) of memory. As shown in Fig. 1, the MC 68000 computer uses only three IC's to decode the entire address space: two 74LS138's (IC49, and IC50) and one 2149 static RAM (IC52). The address-decoder RAM has a very fast access time (less than 50 ms) and is organized as 1024 four-bit nibbles.

Dividing 2^{24} by 1024 yields 16,384, the size of each "segment" of memory. Each segment is defined by one four-bit location in the address-decoder RAM; the select signals that correspond to each segment are indicated in Table 1.

There are several advantages to that design: (1) Bus contention due to simultaneous decoding of several devices is avoided easily; (2) Specific memory segments can be "write-protected" or forced to generate a BERR (Bus Error); (3) Unpopulated memory locations can be forced to generate a BERR if accessed, thereby allowing appropriate microprocessor/peripheral handshaking; (4) The address decoder can be programmed during power-up to accommodate varying amounts of RAM automatically; (5) Memory locations can be shifted or made to appear at several places in the address space of the microprocessor; that feature is necessary during the power-up stage, when the address-decoder RAM contains random data—but more on that below; (6) Great flexibility is achieved at

TABLE 1—SELECT SIGNALS

Signal	Function	Signal	Function
F0	Internal RAM	F8	Slot select 0
F1	I/O	F9	Slot select 1
F2	EPROM's (disk)	FA	Slot select 2
F3	EPROM's (monitor)	FB	Slot select 3
F4	SASI port	FC	Slot select 4
F5	DTACK timeout	FD	Slot select 5
F6	Bus error	FE	Slot select 6
F7	EXT	FF	Slot select 7

low cost, minimal hardware, and minimal PC-board real estate.

Additional logic combines select outputs and control signals to generate the control-bus signals \overline{VMA} , EXT, \overline{VPA} , DTACK and BERR.

I/O addressing

Unlike the 80xx family, which has an I/O space that is separate from the regular address space, the 68xxx family divides one space for both I/O and memory. In the MC 68000 computer, that space begins at \$FE0000; it is divided into five main 16k sections, beginning at \$FE0000, \$FE4000, \$FE5000, \$FE6000, and \$FE7000.

The first block (\$FE0000) is dedicated to the SASI hard-disk controller. In addition, I/O expansion is addressed at addresses \$FE0007, \$FE000F, \$FEC017, etc.

The second block (\$FE4000) is used by the CRT controller, its color look-up table, and the RS-232 interface, a 2661 Enhanced Programmable Communications Interface (EPCI).

The two eight-bit VIA's (6522's) are addressed at alternate addresses beginning at \$FE5000. In general the "A" ports are dedicated for system use; the "B" ports are available for the user.

The FDC (floppy-disk controller), a Western Digital 1793, is addressed at \$FE6000. Its five registers (Status, Track, Sector, Data, and Hardware) are addressed at even addresses (\$FE6000, \$FE6002, \$FE6004, \$FE6006, and \$FE6008, respectively).

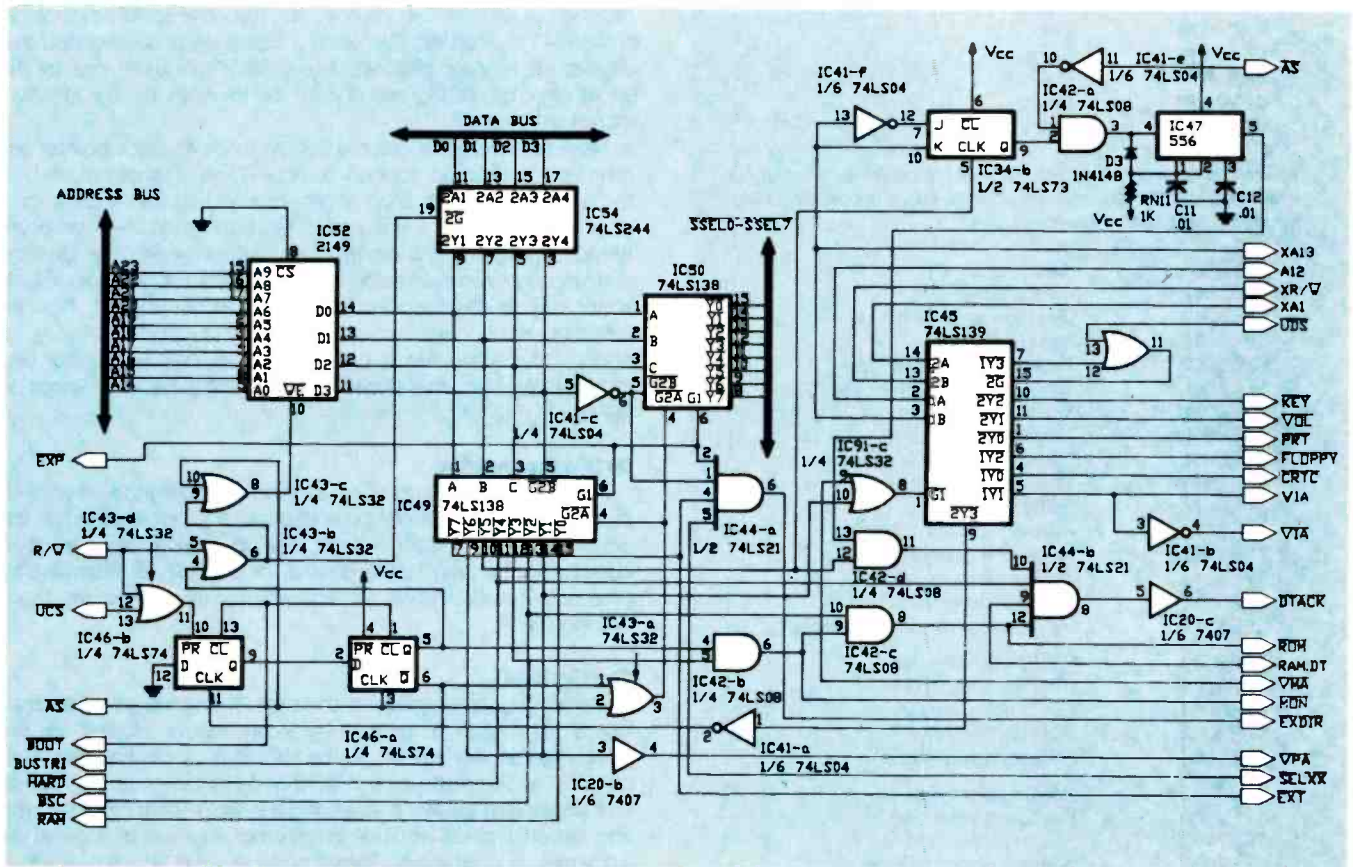

FIG. 1—THE MC68000's programmable address decoder.

SOURCES

Computer Express (687 S.W. 15th, Corvallis, OR 97330) 503-757-2983 is the major supplier of hardware and software for this machine in this country.

For those interested in running the multi-user, multi-tasking operating system OS-9 (whose most famous incarnation is on Radio Shack's Color Computer), the OS-9 Users Group, 1715 East Fowler Ave., Suite R-237, Tampa, FL 33612 has an interesting monthly newsletter

as well as many volumes of public-domain software.

Last, as we go to press, it is unclear who will be handling the licensing arrangements for OS-9. In any case, if you're interested in OS-9, you should contact the company that wrote it, Microware (1866 N. W. 114th Street, Des Moines, IA 50322, 515-224-1929). They sell a number of applications and systems software packages, including compilers, screen editors, etc.

TABLE 2—I/O SPACE

Address	Function
\$FE0001	SASI data port
\$FE0003	SASI status port
\$FE0005	SASI select strobe
\$FE0007	I/O expansion 0
\$FE000F	I/O expansion 1
\$FE0017	I/O expansion 2
\$FE001F	I/O expansion 3
\$FE0027	I/O expansion 4
\$FE002F	I/O expansion 5
\$FE0037	I/O expansion 6
\$FE003F	I/O expansion 7
\$FE4000	CRTC address register
\$FE4002	CRTC data register
\$FE4011	EPCI data register
\$FE4013	EPCI status register
\$FE4015	EPCI mode register
\$FE4017	EPCI command register

Note: Each logical color can be mapped to one of sixteen physical colors.

\$FE4001	Color 0
\$FE4003	Color 1
\$FE4005	Color 2
\$FE4007	Color 3
\$FE4009	Color 4
\$FE400B	Color 5
\$FE400D	Color 6
\$FE400F	Color 7

Note: The following locations indicate the contents of the upper VIA. Odd-numbered addressed (not shown) contain corresponding registers in the lower VIA.

\$FE5000	Data register B
\$FE5002	Data register A
\$FE5004	Direction register B
\$FE5006	Data register A
\$FE5008	Timer 1 low counter byte
\$FE500A	Timer 1 high counter byte
\$FE500C	Timer 1 lower latch
\$FE500E	Timer 1 high latch
\$FE5010	Timer 2 low counter byte
\$FE5012	Timer 2 high counter byte
\$FE5014	Shift register
\$FE5016	Auxiliary control register
\$FE5018	Peripheral control register
\$FE501A	Interrupt flag register
\$FE501C	Interrupt release register
\$FE501E	Data register A (no handshake)
\$FE6000	FDC status register
\$FE6002	FDC track register
\$FE6004	FDC sector register
\$FE6006	FDC data register
\$FE6008	FDC hardware register
\$FE7000	Printer output port
\$FE7000	Keyboard input port
\$FE7002	Sound output port
\$FE7002	Activate address decoder

Several latches occupy the space beginning at \$FE7000. The Centronics-compatible parallel port is written to at \$FE7000; the keyboard is read from that location. The sound output port resides at \$FE7002; a read to that location triggers the mode that allows the programmable address decoder to be programmed. Programming can only be done from the EPROM system monitor, not from RAM; otherwise the system will crash.

I/O space usage is summarized in Table 2.

Address decoding hardware

Referring back to Fig. 1, you can see how the hardware implements the decoding discussed above. One of the 74LS138's (IC50) generates Slot Select signals 0-7; the other (IC49) provides various decoding signals, including that for the hard disk. In addition, a 74LS139 provides further decoding for many of the I/O functions discussed above (keyboard, sound, etc.)

As stated earlier, the address-decoder RAM cannot be used for its normal purpose directly after power up, because the contents of the RAM cannot be predicted beforehand. Therefore the address decoder is switched out of circuit at power up and during a Reset operation. That is accomplished through the two D flip-flops contained in IC74, and the $\overline{BOO1}$ signal, which is generated at power up or by pressing the Reset switch.

The $\overline{BOO1}$ signal clears the two flip-flops (IC46-a and IC46-b), so all select signals remain high, as do the enable lines of the two 74LS138's (IC49 and IC50). In addition, the write-enable (\overline{WE}) signal of the 2149 is disabled. Eventually a select signal is generated that enables the monitor EPROM's. Two EPROM's are used; one for the upper eight bits (IC13), and one for the lower (IC11). The EPROM's are not shown here.

Now the microprocessor is free to fetch its stack pointer and reset vectors (from locations 0-3 and 4-7) in the usual manner. Later the address-decoder RAM is programmed so that access to all pages will generate a \overline{BERR} signal. Next, the hardware (on-board RAM, I/O, EPROM's, disk interfaces, etc.) is configured. Then, when a write occurs to an even address, IC46-a is set, and that sets IC46-b, which enables the decoders (IC49, IC50) and RAM (IC52). Now the EPROM's are no longer active, and during the next bus cycle, the address decoder RAM is used. A special EPROM-monitor subroutine is supplied that allows programming the address-decoder RAM.

Data acknowledge

Half of a 556 dual timer (IC47-a) is used to generate a timed \overline{DTACK} pulse, should a peripheral be addressed and not respond. In that way the microprocessor will not lock up waiting for an acknowledge pulse. The timed signal is used, for example, to determine the presence of autostart EPROM's, and when an unused expansion slot is addressed.

Conclusions

That's all we have space for this time. Where we go from here is largely up to you. If there is significant reader interest, we will publish additional articles on the MC 68000, including one dedicated to a discussion of the BIOS and system-monitor EPROM's. **The important point:** If you build a system, want more information, or get involved with one in any other way—let us know about it, by mail or on the BBS. There's nothing we'd like better than to promote this machine—so show us you're interested! 



The evolution of the 6502 microprocessor mirrors 15 years of microcomputer history.

LES SOLOMON

In the beginning was the 8080, and it wasn't bad—but it was expensive. Enter the 6502 and a single-board computer called the Apple I. Then enter the Commodore PET, the KIM-1 (and its cousins); then enter the Apple II. They all used the 6502, with its 8-bit data bus and its 16-bit address bus. In the late 1970's, the 6502 was alive and doing well.

Then came the 8088 (heart of the IBM-PC). It has 20 address lines, so it can address a megabyte of memory; and it has a 16-bit internal data bus. Its big brothers have 16-bit external data buses, and the ability to address even more memory.

The 6502 crowd saw all that power and wanted it. Rumor followed rumor about the new 16-bit 6502, called the 6516. But year after year the 6516 was not released, even though a magazine article published complete pre-production specifications for it! No one knew for sure whether anyone was even working on it!

At long last, in 1982, a CMOS version of the 6502 was released. In truth, however, not one but three companies each released its own version of the 65C02; a fourth would soon join the fray. Although the four versions are all based on the venerable 6502, they're slightly incompatible with each other. Any program that uses only the basic 6502 instruction set should run on any of the CMOS versions; but any program that takes advantage of the enhancements offered by one CMOS version may or may not run on the others.

Eventually a 16-bit version of the 6502 was released. Actually (things are never simple), there are two versions: the 65816 and the 65802. The '802 is pin-for-pin compatible with the original 6502; the '816 is not, but allows access to 16 megabytes of memory. Both are CMOS IC's, and both have emulation modes that are totally compatible with the 6502.

In this article our author delineates the differences between the 6502 and the various CMOS versions of the IC; we've also added some material to show how the 16-bit versions of the processor compare with the 8-bit versions.—Editor

The 65C02 microprocessor used in the Apple IIc microcomputer is identified as if it were just a CMOS version of the 6502 used in the Apple II, II+, and IIe computers. However, investigation reveals that four different versions of the 65C02 are manufactured; each version is enhanced in a different way than the others.

All are hardware-interchangeable, in their conventional 40-pin packages; the differences are in their instruction sets. The instruction set of each is a superset of the original 6502's instruction set. This means that software written for one processor may—or may not—work with another version.

How it started

The original 6502 was created by the Western Design Center, who sold the design to several semiconductor houses (Rockwell, Commodore, GTE, and NCR). Each company now owned its own version of the 65C02, so each could enhance it or not as desired. Each chose to keep the 40-pin DIP configuration and to enhance the instruction set, each in its own way.

There are 56 instructions and 161 op codes in the basic 6502. Those instructions are not stored in the microprocessor in a ROM, but in an instruction-decoding matrix that can hold as many as 256 (16 × 16) 8-bit op codes. When the matrix receives a particular combination of binary data (1's and 0's), it "steers" the signals to the correct portion of the processor. In that way, each op code can perform its unique function. However, when a semiconductor as complex as a microprocessor is designed, the instruction-set matrix has a number of unused positions. Those unused (and unidentified) positions in the matrix are usually ignored by the conventional user—but not by others.

Undocumented op codes

All op codes are stored in a PLA (Programmable Logic Array) that is microprogrammed during manufacture. The PLA ensures that instructions are fetched from memory via the data bus, latched into the instruction register, and then decoded (along with timing and interrupt signals) to generate control signals for the various registers. So, from a functional standpoint, the instruction register is where the software meets the hardware; in essence, it runs the whole show.

As previously mentioned, the instruction register can have as many as 256 different 8-bit combinations. However, note that the NMOS 6502 and Commodore's bare-bones 65C02 use only 151 of the 256 possible slots. But what happens to the other, unused, 105 slots?

When a manufacturer designs a microprocessor, he makes sure that everything covered by the pertinent specifications is included in the IC. That includes microprogramming the instruction decoder to accept the IC's standard instruction set.

THE 65816

In many ways, the 65816 stands in relation to the 6502 as the 8088 stands to the 8080. First, it has a 16-bit internal data bus, but an 8-bit internal data bus. This means that all 16-bit memory accesses take two clock cycles, effectively reducing its potential speed by a factor of two. Second, the register structure of the 65816 closely expands upon that of the 6502, in that all the 8-bit registers have been extended to 16 bits. In addition, a new register, called the direct-page register (D), has been added; it allows quick access (as to page zero) to any 256-byte page in the first 64K of the address space.

One big improvement in the register structure is that the stack pointer is now sixteen bits, so the stack can be located anywhere in the first 64K of the address space, rather than being stuck on page one (\$000-\$0FF), as with the 6502. And, of course, it can have a depth greater than 256 bytes.

The mode (native or 6502 emulation) is set by a new bit (M) in the processor status register. Several new instructions (SEP and REP) allow you to manipulate individual bits in the status register.

Address modes available include all the original 6502 modes, the NCR 65C02 modes, and Rockwell's additional 65C02 mode, as well as eight new 65816 modes.

The 65816 has the three hardware interrupts of the 6502 (Reset, NMI, and IRQ), and a new one, called Abort, which may be used to implement a virtual-memory system. As in the 6502, the interrupt vectors are located in the highest locations of the first 64K of memory.

Software interrupts include the old BRK instruction, as well as a new COP instruction, used for interfacing a co-processor IC. In addition, two instructions adapted from the 6800 family, WAI (wait) and STP (stop), halt the processor until a hardware interrupt occurs (NMI or IRQ), or until the processor is reset, respectively.

For more information on the 65816 and the 65802 (as well as the 6502 and the various 65C02's), an excellent starting point is *65816/65802 Assembly Language Programming*, written by Michael Fischer, and published by Osborne McGraw-Hill (1986).

But what about the unused slots in the matrix? Often, because they're not specified for use by any particular instruction, those portions of the matrix are fabricated at random, so they may or may not contain data that can function as an op code.

The bulk of those undocumented op codes will be useless. However, it's likely that one or more of the unused slots contains a workable op code. But it's impossible to predict where in the matrix it might be found (i.e., no one knows its hexadecimal code), what it is, or what it does.

Hacking the 6502

Since the first microprocessor was used in the first microcomputer, there has been a software underground whose prime objective is to try to find undocumented yet useful op codes in the unused portion of the instruction-decoding matrix. Because the codes in the unused decoding-matrix slots are essentially random,

they may or may not appear in all microprocessors of a given type—even those made by the same manufacturer.

Finding undocumented op codes is not easy. Hackers write reams of machine-language software and use special hardware and software techniques to try to discover them. And, although their success rate has not been high, hackers did find a number of new and useful op codes in the 6502 (and in other microprocessors). The problem is, of course, that you could only be sure that a program using undocumented op codes would run on one machine—your own!

Even so, some of the useful undocumented op codes were used in private software to save many lines of programming code. However those unique programs might not run on a different computer—even with one that used the same microprocessor from the same manufacturer. For that reason some manufacturers include a warning in their documentation that they're "not responsible for undocumented op codes."

When a microprocessor was second-sourced by a different manufacturer, many undocumented op codes simply didn't make the manufacturing transition and disappeared. But there are companies that specialize in second-sourcing a device, "warts and all," to maintain the undocumented op codes.

In any case, several very handy undocumented op codes were discovered. Some of the "new" op codes greatly reduced the number of lines of code required, and increased system speed. Others allowed various forms of bit manipulation that made graphics faster. However, since the processor was already in production, those op codes remained "underground" and were unused by the general programming public.

The point is that semiconductor manufacturers maintain a log of undocumented op codes and what each does. So it's possible that, in creating a CMOS 6502, a manufacturer saw a way to enhance its version of the microprocessor by incorporating one or more undocumented op codes.

The new 65C02's

One manufacturer, Commodore Semiconductor, diffuses a "plain vanilla" 65C02 which is just a CMOS version of the 6502. It runs all the conventional 6502 op codes.

GTE's version adds eight new instructions to the 56 of the original 6502, for a total of 64 instructions and 178 op codes. The NCR version includes GTE's new instruction set, but adds two of its own (for a total of 66 instructions and 178 op codes). Rockwell's 65C02 has not only GTE's and NCR's new instructions, but four more. The new instructions of all manufacturers are shown in Table 1; Table 2 compares the number of instructions and op codes of each manufacturer's version of the 65C02.

New address modes

It should be obvious that Rockwell's 65C02 is the most enhanced of the 65C02's: It has 12 more instructions and 49 more op codes than the original 6502. It has so many more op codes than the original because Rockwell also added three new addressing modes to the 65C02.

The first of the new modes is called Indexed Absolute Direct (ABS,X). The contents of the second and third instruction bytes are added to the X register. The 16-bit result is a memory address containing the effective address. The only instruction to use this mode is a JMP instruction (JMP(ABS,X)).

The second new addressing mode is called Zero Page Relative Addressing (ZPREL). It's used for bit-testing a zero-page location with a mask value specified as part of the instruction. The op codes \$0F, \$1F, \$2F, . . . \$EF, \$FF use the ZPREL mode.

The third addressing mode is called Indirect (IND). The second byte of the instruction contains a zero-page address serving as the indirect pointer. This mode is not used by any new instructions, but by several old ones, including ADC, AND, CMP, EOR, LDA, ORA, SBC, and STA. Table 1 contains a complete chart of all op codes for all versions (to date) of the 6502 and 65C02. Thanks goes to Rockwell for permission to adapt and print it here.

TABLE 1—6502 OP CODES

MSD	LSD															
	0	1	2	3	4	5	6	7	8	9	A	B	C	D	E	F
0	BRK Implied 1 7	ORA (IND, X) 2 6			TSB ZP 2 5	ORA ZP 2 3	ASL ZP 2 5	RMB0 ZP 2 5	PHP Implied 1 3	ORA IMM 2 2	ASL Accum 1 2		TSB ABS 3 6	ORA ABS 3 4	ASL ABS 3 6	BBR0 ZP 3 5**
1	BPL Relative 2 2**	ORA (IND), Y 2 5*	ORA (IND) 2 5		TRB ZP 2 5	ORA ZP, X 2 4	ASL ZP, X 2 6	RMB1 ZP 2 5	CLC Implied 1 2	ORA ABS, Y 3 4*	INC Accum 1 2		TRB ABS 3 6	ORA ABS, X 3 4*	ASL ABS, X 3 7	BBR1 ZP 3 5**
2	JSR ABS 3 6	AND (IND, X) 2 6			BIT ZP 2 3	AND ZP 2 3	ROL ZP 2 5	RMB2 ZP 2 5	PLP Implied 1 4	AND IMM 2 2	ROL Accum 1 2		BIT ABS 3 4	AND ABS 3 4	ROL ABS 3 6	BBR2 ZP 3 5**
3	BMI Relative 2 2**	AND (IND), Y 2 5*	AND (IND) 2 5		BIT ZP, X 2 4	AND ZP, X 2 4	ROL ZP, X 2 6	RMB3 ZP 2 5	SEC Implied 1 2	AND ABS, Y 3 4*	DEC Accum 1 2		BIT ABS, X 3 4*	AND ABS, X 3 4*	ROL ABS, X 3 7	BBR3 ZP 3 5**
4	RTI Implied 1 6	EOR (IND, X) 2 6				EOR ZP 2 3	LSR ZP 2 5	RMB4 ZP 2 5	PHA Implied 1 3	EOR IMM 2 2	LSR Accum 1 2		JMP ABS 3 3	EOR ABS 3 4	LSR ABS 3 6	BBR4 ZP 3 5**
5	BVC Relative 2 2**	EOR (IND), Y 2 5*	EOR (IND) 2 5			EOR ZP, X 2 4	LSR ZP, X 2 6	RMB5 ZP 2 5	CLI Implied 1 2	EOR ABS, Y 3 4*	PHY Implied 1 3			EOR ABS, X 3 4*	LSR ABS, X 3 7	BBR5 ZP 3 5**
6	RTS Implied 1 6	ADC (IND, X) 2 6†			STZ ZP 2 3	ADC ZP 2 3†	ROR ZP 2 5	RMB6 ZP 2 5	PLA Implied 1 4	ADC IMM 2 2†	ROR Accum 1 2		JMP (ABS) 3 6	ADC ABS 3 4†	ROR ABS 3 6	BBR6 ZP 3 5**
7	BVS Relative 2 2**	ADC (IND), Y 2 5*†	ADC (IND) 2 5†		STZ ZP, X 2 4	ADC ZP, X 2 4†	ROR ZP, X 2 6	RMB7 ZP 2 5	SEI Implied 1 2	ADC ABS, Y 3 4*†	PLY Implied 1 4		JMP (ABS, X) 3 6	ADC ABS, X 3 4*†	ROR ABS, X 3 7	BBR7 ZP 3 5**
8	BRA Relative 2 3*	STA (IND, X) 2 6			STY ZP 2 3	STA ZP 2 3	STX ZP 2 3	SMB0 ZP 2 5	DEY Implied 1 2	BIT IMM 2 2	TXA Implied 1 2		STY ABS 3 4	STA ABS 3 4	STX ABS 3 4	BB80 ZP 3 5**
9	BCC Relative 2 2**	STA (IND), Y 2 6	STA (IND) 2 5		STY ZP, X 2 4	STA ZP, X 2 4	STX ZP, Y 2 4	SMB1 ZP 2 5	TYA Implied 1 2	STA ABS, Y 3 5	TXS Implied 1 2		STZ ABS 3 4	STA ABS, X 3 5	STZ ABS, X 3 5	BB81 ZP 3 5**
A	LDY IMM 2 2	LDA (IND, X) 2 6	LDX IMM 2 2		LDY ZP 2 3	LDA ZP 2 3	LDX ZP 2 3	SMB2 ZP 2 5	TAY Implied 1 2	LDA IMM 2 2	TAX Implied 1 2		LDY ABS 3 4	LDA ABS 3 4	LDX ABS 3 4	BB82 ZP 3 5**
B	BCS Relative 2 2**	LDA (IND), Y 2 5*	LDA (IND) 2 5		LDY ZP, X 2 4	LDA ZP, X 2 4	LDX ZP, Y 2 4	SMB3 ZP 2 5	CLV Implied 1 2	LDA ABS, Y 3 4*	TSX Implied 1 2		LDY ABS, X 3 4*	LDA ABS, X 3 4*	LDX ABS, Y 3 4*	BB83 ZP 3 5**
C	CPY IMM 2 2	CMP (IND, X) 2 6			CPY ZP 2 3	CMP ZP 2 3	DEC ZP 2 5	SMB4 ZP 2 5	INY Implied 1 2	CMP IMM 2 2	DEX Implied 1 2		CPY ABS 3 4	CMP ABS 3 4	DEC ABS 3 6	BB84 ZP 3 5**
D	BNE Relative 2 2**	CMP (IND), Y 2 5*	CMP (IND) 2 5			CMP ZP, X 2 4	DEC ZP, X 2 6	SMB5 ZP 2 5	CLD Implied 1 2	CMP ABS, Y 3 4*	PHX Implied 1 3			CMP ABS, X 3 4*	DEC ABS, X 3 7	BB85 ZP 3 5**
E	CPX IMM 2 2	SBC (IND, X) 2 6†			CPX ZP 2 3	SBC ZP 2 3†	INC ZP 2 5	SMB6 ZP 2 5	INX Implied 1 2	SBC IMM 2 2†	NOP Implied 1 2		CPX ABS 3 4	SBC ABS 3 4†	INC ABS 3 6	BB86 ZP 3 5**
F	BEQ Relative 2 2**	SBC (IND), Y 2 5*†	SBC (IND) 2 5†			SBC ZP, X 2 4†	INC ZP, X 2 6	SMB7 ZP 2 5	SED Implied 1 2	SBC ABS, Y 3 4*†	PLX Implied 1 4			SBC ABS, X 3 4*†	INC ABS, X 3 7	BB87 ZP 3 5**



†Add 1 to N if in decimal mode.
 *Add 1 to N if page boundary is crossed.
 **Add 1 to N if branch occurs to same page;
 Add 2 to N if branch occurs to different page.

Incompatible compatibles

The proliferation of 6502 "clones" (cloning really began in 1975 when IMSAI "cloned" their version of the Altair 8800) can lead to confusion and incompatibility. For example, a program written using Rockwell's enhanced branching instructions is guaranteed not to work on an Apple IIc, which uses the NCR IC.

So programmers and systems developers are faced with a choice: Stick to the original 6502 instruction set and maintain compatibility at the expense of performance, or use the enhanced instructions, knowing that programs may not run on all machines.

The bottom line is that the only way to guarantee compatibility is to stick to the manufacturer's specified hardware. Anything else is a gamble.

In this article we have examined the 6502 family of microprocessors. The original 6502 was used in numerous machines from Apple, Commodore, Atari, and many others. In spite of many predictions of its early demise, it and its descendants are still being used in many personal computers and dedicated controllers. We hope this article has helped you understand the major differences between the various members of the 6502 family. ♦♦

COMPUTER-CONTROLLED ROBOT

An easy-to-build interface that lets you use your Commodore 64 computer to control a popular robot arm.

JIM BARBARELLO



For those of us interested in experimenting with robotics, the *Armatron* from Radio Shack was both agony and ecstasy. Still available, *Armatron* is a low-cost, fully functioning robot arm with six degrees of freedom (meaning there are six different portions of the arm whose movement can be controlled). For robotics experimentation, its serious shortcomings include the inability to lift anything of significant weight and its totally mechanical controls. While many different articles have described modifications that allow computer control of the *Armatron*, all required a substantial amount of mechanical skill.

Many of those shortcomings have been eliminated in a new version of that device called the *Mobile Armatron*; that new version easily lends itself to computer control. In this article, we'll describe a simple computer interface for the robot arm, as well as a comprehensive controller program for the Commodore 64.

The interface

The *Mobile Armatron's* movement is controlled using a series of switches. Those switches are used to direct the motion of the unit's base (forward, back, left, and right), and to control the positioning and motion of the arm (arm up, arm down, wrist up, wrist down, wrist turn, and fingers open/clamp). Four D cells are used to provide ± 3 volts for the unit's motors. By changing the polarity of the applied voltage, the motors can be reversed, therefore obtaining complimentary functions such as arm up and arm down. One motor each is used to control the left wheel, the right wheel, the movement of the arm, the movement of the wrist, and the wrist-turn/finger-position. Seven control wires run from the switches, which are located in a control module, to the motors; one wire each for positive or negative voltage, plus a return (ground) wire from each motor.

Because of its design, it is a relatively simple matter to control the *Mobile Armatron* using a personal computer. All that is required is to replace the control module switches with a simple interface. An appropriate circuit, designed for use with a Commodore 64, is shown in Fig. 1.

In that circuit, the switches are replaced by low-current relays. Those relays are activated by seven transistors, which are in turn controlled by seven of the eight available Commodore 64 user-port lines. Use of low-current relays ensures that the 100-mA maximum allowable current draw from the user port is not exceeded.

Construction

While the circuit is simple, we still recommend using a PC board. A suitable pattern for a double-sided board is shown in PC Service. The corresponding parts-placement diagram is shown in Fig. 2. Once the board is etched, inspect it carefully for shorted or open traces, etc.

The main reason for using a double-sided board is mechanical rigidity. Once assembled, the PC-board is mounted on a card-edge socket and soldered in place. With a double-sided board, solder connections can be made on both sides; with a single-sided board, connections can be made only on one side.

If you find the thought of etching a double-sided board intimidating, the component-side pattern can be eliminated. Then, you will need to add a jumper between pad A and edge-connector pad 2. Remember that you will lose the rigidity offered by the double-sided design, so extra care must be taken when handling the unit.

Mount the components on the PC board as shown in Fig. 2. If using a double-sided board, install a feedthrough at pad A; if using a single-sided board, install a jumper as previously discussed. Follow proper construction techniques.

Once the board is complete, insert it into SO1, a 12-position card-edge socket with 0.156-inch spacing. If you are only able to obtain a longer connector, for instance 22-position, it can be cut

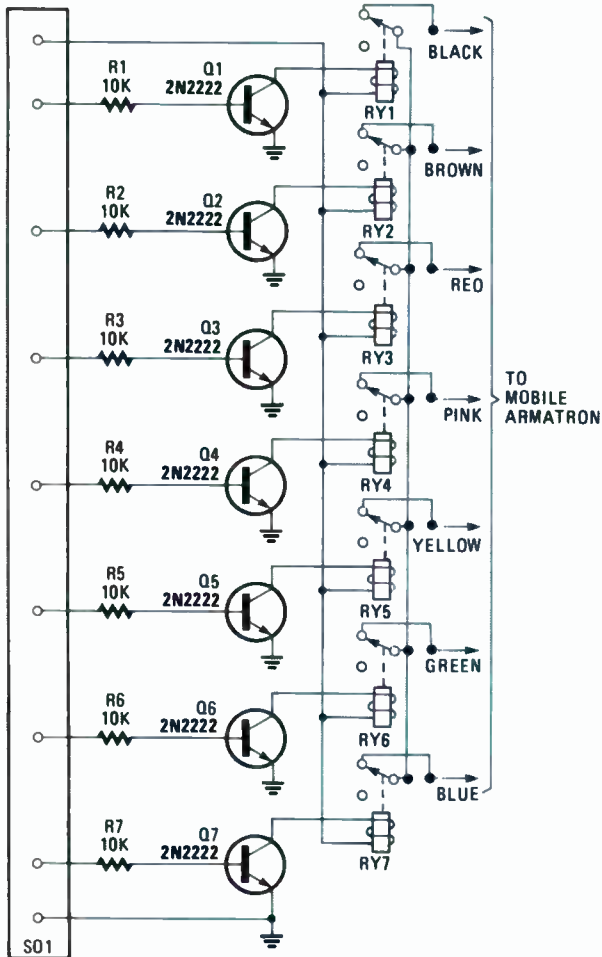

FIG. 1—YOU CAN ADD COMPUTER CONTROL to a Radio-Shack *Mobile Armatron* with this simple interface. It replaces the robot arm's control module.

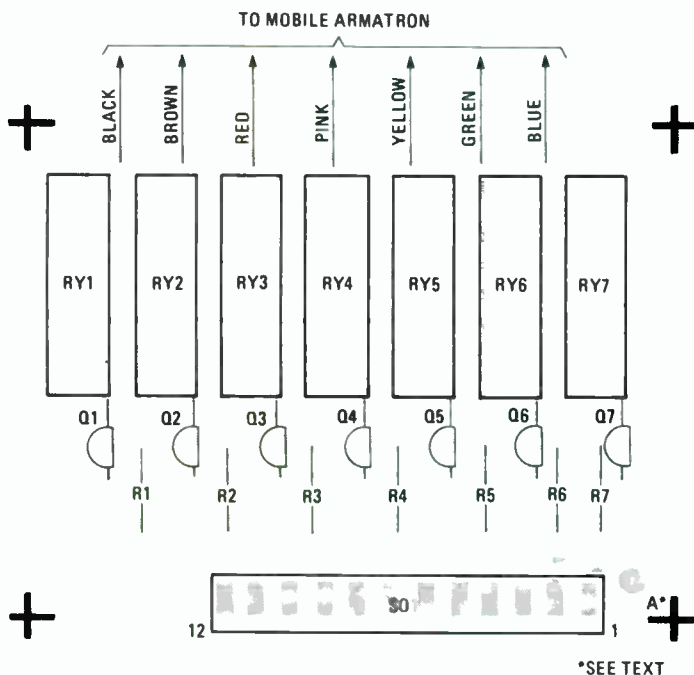

FIG. 2—ONCE ALL PARTS ARE MOUNTED, this double-sided PC board is inserted into a 12-position card-edge connector and the circuit is connected to the *Armatron*.

```

1 rem *****
2 rem ** mobile armatron software **
3 rem ** name: robot **
4 rem ** (c) 1986, jjb **
5 rem ** manalapan, nj 07726 **
6 rem ** v 860928 **
7 rem *****
10 dim a(12),b(250,1):gosub 3000:gosub 5000:poke
   56579,255:poke 56577,0
20 a(1)=38:a(2)=70:a(3)=36:a(4)=34:a(5)=33:a(6)=65
30 a(7)=40:a(8)=72:a(9)=48:a(10)=80:a(11)=66:a(12)=68
40 ss$="1234567890+-":rc$=chr$(5)+chr$(18)
50 gosub 3000:ro=6:co=10:gosub 5050:
   printrc$;" main menu "
60 print:prntab(12);"< f1 >:
   learn":print:prntab(12);"< f3 >: do"
70 print:prntab(12);"< f5 >: save":print:prntab(12);
   "< f7 >: retrieve"
80 print:prntab(10);"<ctrl>q: quit (end)
90 ro=19:co=10:gosub 5050:print"which... "
100 get sr$:if sr$="" then 100
110 sr=asc(sr$)-132:if sr=-115 then sr=5
120 if sr<1 or sr>5 then 90
130 on sr gosub 200,300,400,600,800
140 goto 50
200 gosub 1000:j=b(0,0):x=0:rem*** learn mode ***
210 get a$:if a$="" then 210
220 if asc(a$)=133 then return
230 gosub 2000:if i=# then poke 56577,0:goto 210
240 poke 56577,a(i)
250 get a$:if a$="" then x=x+1:goto 250
260 poke 56577,0
270 j=j+1:b(j,0)=i:b(j,1)=x:x=0:b(0,0)=j
280 ro=i+10:co=5:gosub 5050:print mid$(ss$,i,1):goto 210
300 rem** do procedure
310 printchr$(147):printbl$:
   print" do procedure":printbl$:print
320 if b(0,0)=3 then print"no procedure in memory.":
   goto 375
330 print"press any key to begin procedure."
340 get a$:if a$="" then 340
350 print"procedure execution in progress"
355 for i=1 to b(0,0):poke 56577,a(b(i,0))
360 for j=1 to b(i,1)
365 get a$:if a$="" then x=x+1:next j
370 poke 56577,0:for j=1 to 500:next j:
   next i:print"procedure done."
375 ro=18:co=0:gosub 5050:
   print"press any key to return to the menu."
380 get a$:if a$="" then 380
390 return
400 rem** save procedure
410 printchr$(147):printbl$:
   print" save procedure":printbl$:print
420 if b(0,0)=0 then print"no procedure in memory.":
   goto 480
430 input"enter file name to save";f$
440 open 1,8,15:open 2,8,2,"@:"+f$+",s,r":
   input#1,e,ed$,tn,bl:close 1:close 2
450 if e=62 then 500
460 print"file exists. continue (y/n)...":gosub 1500
470 if a$="y" then 500
480 print"abort. press any key..."
490 get a$:if a$="" then 490
495 return
500 open 2,8,2,"@:"+f$+",s,w":print:
   print"saving procedure. wait."
510 for i=0 to b(0,0):print#2,b(i,0):print#2,b(i,1):
   next i:close 2:close 15
520 print:print"procedure saved. press any key.":goto 490

```

down to the proper length. That's what was done in the author's prototype. (See Fig. 3) Solder each edge-connector pad to the corresponding terminal on the socket. For double-sided boards, remember to solder on both sides.

Connecting the interface

Place the *Mobile Armatron*'s controller module face down and remove the six screws that hold the unit together. When you remove the rear half of the case you will see a PC board that is held in place with just a single screw. Remove that screw and the board.

```

600 rem** retrieve procedure
610 printchr$(147):printbl$:
  print"      retrieve procedure":printbl$:print
620 if b(0,0)=0 then 650
630 print"procedure in memory. continue (y/n)?:":gosub 1500
640 if a$="n" then print"abort. ":goto 700
650 input"enter file name to retrieve":f$:
660 open 1,8,15:open 2,8,2,"@0:"+f$+",s,r":
  input#1,e,ed$,tn,bl:close 1:close 2
670 if e=0 then 720
680 if e=62 then print"file doesn't exist. ";
690 print"press any key."
700 get a$:if a$="" then 700
710 return
720 print"retrieving procedure. wait.":
  open 2,8,2,"@0:"+f$+",s,r"
730 input#2,b(0,0):input#2,b(0,1)
740 for i=1 to b(0,0):input#2,b(i,0):
  input#2,b(i,1):next:close 2
750 print"retrieval complete. ":goto 690
800 rem** end
810 ro=5:co=10:gosub 5050:for q=1 to 16:
  print tab(10);b$:next
820 ro=10:co=0:gosub 5050:close1:close2
830 print"program ended. to re-enter, type goto 50";
840 print:end
1000 rem** learn mode screen
1005 printchr$(147):printbl$:
1006 print" mobile armatron robot learn mode ":
  printbl$:print
1007 print"  press key to do function.  press any other
  key to stop.":
1008 print"  press <f1> to return to menu.":print
1009 print"  key function":
  print"  _ _ _ _ _"
1010 printtab(5);"1 = forward":printtab(5);"2 = backward"
1020 printtab(5);"3 = right forward turn":
  printtab(5);"4 = left forward turn"
1030 printtab(5);"5 = arm up":printtab(5);"6 = arm down"
1040 printtab(5);"7 = wrist up":
  printtab(5);"8 = wrist down"
1050 printtab(5);"9 = hand turn":
  printtab(5);"0 = fingers move in/out"
1060 printtab(5);"+ = right reverse turn"
1070 printtab(5);"- = left reverse turn"
1080 return
1500 get a$:if a$="" then 1500
1510 a$=chr$(asc(a$) and 223)
1520 if a$<"y" and a$<"n" then 1500
1530 print a$:return
2000 rem** position in string
2010 for i=1 to 12:if a$=mid$(ss$,i,1) then 2030
2020 next:i=0:return
2030 ro=i+10:co=5:gosub 5050:printrc$a$:return
3000 rem** format screen=
3010 poke 53280,6:poke 53281,6:printchr$(147):
  b$=chr$(5)+chr$(18)
3020 bl$=b$+" "
  print bl$
3030 print b$;"  mobile armatron robot controller "
3040 printbl$
3050 b$=" "
3060 return
5000 rem** cursor control using plot      kernel ($fff0)
5010 data 162,0,160,0,24,32,240,255,96,999
5020 a=49300:sc=a
5030 read b:if b<999 then poke a,b:a=a+1:goto 5030
5040 return
5050 poke sc+3,col:poke sc+1,row:sys sc
5060 return

```

Examining the circuit you will see that seven wires are terminated at one edge of the board. Orienting the board so that that edge is at the top, from left to right those wires are colored black, brown, red, pink, yellow, green, and blue. Unsolder the wires from the PC board and connect them to the interface as shown in Fig. 2.

Using the interface

Install four D cells in the *Mobile Armatron*. Plug SO1 and the interface board into the 64's user port (rear left of the computer) so that the interface board circuit faces upward. Power up the computer and enter the program shown in the listing; save the program under the name ROBOT.

PARTS LIST

R1-R7—10,000 ohms, 1/4 watt, 5%
 Q1-Q7—2N2222 NPN transistor
 RY1-RY7—reed relay, SPST, 5-volt, 250-ohm coil, Radio-Shack 272-232 or equivalent
 SO1—12-position card-edge socket, 0.156-inch spacing
Miscellaneous: *Mobile Armatron* robot arm (Radio-Shack), PC board, wire, solder, four D cells, etc.
The program shown in Listing 1 and a series of demonstration procedures is available on a Commodore 64 disk for \$6.00 (U.S. funds only) postpaid from B&BTC, RD 1, Box 241H, Tennent Road, Manalapan, NJ 07726. New Jersey residents, please add \$0.36 for sales tax.

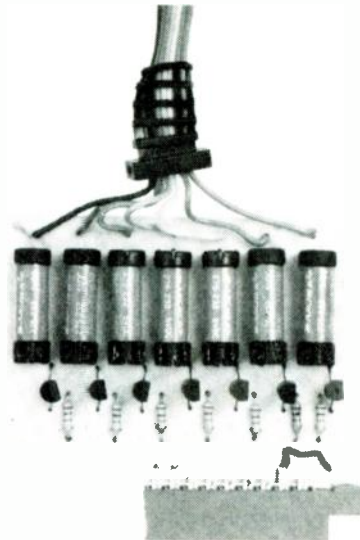

FIG. 3—THE AUTHOR'S PROTOTYPE. Note that it uses a single-sided board (as indicated by the jumper) and that SO1 has been cut down from a larger socket.

When you RUN the program, a menu with five options will appear on the screen. Those options are LEARN, DO, SAVE, RETRIEVE and QUIT (END). To better understand what each of those options do and how the program operates, let's discuss each option separately.

LEARN allows you to "teach" the robot to perform a series of functions in a specific manner. Together those functions form a procedure. Once created, the procedure can be saved, retrieved, added to, and executed at any time. Select LEARN by pressing key F1. The LEARN screen defines the keys to select the twelve possible movement functions. To perform one of the functions described, press the associated key. To end movement, press any key. The program remembers each function selected and the length of time the function is performed. To end the teaching session, press the F1 key to return to the main menu.

DO executes a procedure resident in memory. Select DO by pressing key F3. If a procedure is resident in memory, you will be advised to press any key to begin execution. Otherwise you will be informed that there is no procedure in memory and asked to press any key to return to the main menu.

SAVE allows you to transfer a procedure in memory to a disk file using a name that you specify. Select SAVE by pressing key F5. If there is no procedure in memory, you are so informed and asked to press any key to return to the main menu. If you specify the name of a file that already exists, you are asked if you want to continue. Continuing erases the old disk file and replaces it with the current contents of memory.

RETRIEVE copies the contents of a disk file into memory, erasing any

R-E Computer Admart

Rates: Ads are 2 1/4" x 2 7/8". One insert on \$825. Six insertions \$800 each. Twelve insertions \$775. each. Closing date same as regular rate card. Send order with remittance to Computer Admart, Radio Electronics Magazine, 500-B Bi-County Blvd., Farmingdale, NY 11735. Direct telephone inquiries to Arline Fishman, area code-516-293-3000. Only 100% Computer ads are accepted for this Admart.

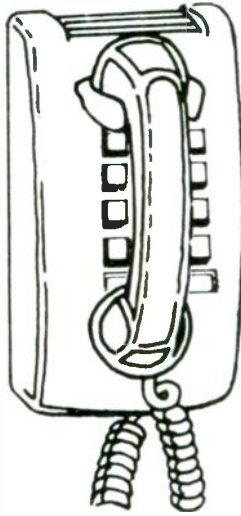

CALL NOW AND RESERVE YOUR SPACE

- 6 x rate \$800.00 per each insertion.
- Reaches 239,312 readers.
- Fast reader service cycle.
- Short lead time for the placement of ads.

Call 516-293-3000 to reserve space. Ask for Arline Fishman. Limited number of pages available. Mail materials to: Computer Admart, RADIO-ELECTRONICS, 500-B Bi-County Blvd., Farmingdale, NY 11735.

ICs PROMPT DELIVERY!!!

SAME DAY SHIPPING (US, ALY)
QUANTITY ONE PRICES SHOWN for FEB. 22, 1987

OUTSIDE OKLAHOMA NO SALES TAX

DYNAMIC RAM		
1Mbit	1000Kx1	100 ns \$32.00
51258	*256Kx1	100 ns 6.95
4464	64Kx4	150 ns 3.24
41256	256Kx1	100 ns 3.59
41256	256Kx1	120 ns 2.59
41256	256Kx1	150 ns 2.19
4154	64Kx1	150 ns 1.30
EPROM		
27512	64Kx8	200 ns \$12.10
27C256	32Kx8	250 ns 5.15
27256	32Kx8	250 ns 4.96
27128	16Kx8	250 ns 3.50
27C64	8Kx8	150 ns 4.85
2764	8Kx8	250 ns 3.25
STATIC RAM		
62256	32Kx8	120 ns \$14.95
6264LP-15	8Kx8	150 ns 2.85

OPEN 6 1/2 DAYS, 7 AM-10 PM SHIP VIA FED-EX ON SAT.

SUNDAYS & HOLIDAYS SHIPMENT OR DELIVERY, VIA U.S. EXPRESS MAIL

SAT DELIVERY INCLUDED ON FED-EX ORDERS RECEIVED BY TH. 5:00 AM \$6.4 lbs FR. P. ONE \$13.2 lbs

MasterCard VISA or UPS CASH COO

Factory New, Prime Parts JIPON

MICROPROCESSORS UNLIMITED, INC

24 000 S. Peoria Ave (918) 267-4961

BEGGS, OK 74421 No minimum order

*Please call for current prices because prices are subject to change. Shipping & insurance extra \$1.00 for factory materials. Orders received by 8 PM CST can usually be delivered the next morning, via Federal Express Standard Air = \$6.00 or Priority One = \$13.00

CIRCLE 61 ON FREE INFORMATION CARD

COMPUTER ASSEMBLY MANUALS



Eliminate Guesswork!
Build with Confidence!

BIG BLUE SEED for IBM™ BUILDERS
Parts list, placement diagrams & instructions for assembling over 75 IBM-compatible bare cards. Latest version includes guides for 640K, Turbo, & AT MthBds. \$17.95

APPLE SEED II for APPLE™ BUILDERS
Instructions for assembling over 85 Apple-compatible bare cards including II+ & IIe MthBds. For all Apple enthusiasts .. \$14.95

Both for \$30.00! Also bare cards in stock!
Check/money-order, VISA/MasterCard to:

NuScope Associates*, Dept RE
P.O. Box 790 • Lewiston, NY • 14092

*A Division of Cosmic MicroTech Inc

CIRCLE 200 ON FREE INFORMATION CARD

DISK SERVICE MANUAL \$15

Maintain, repair, adjust, align drives without special equipment/software - 5.25"/8"/microfloppies. IBM-PC/Compatible, Apple, Commodore, Kaypro, Tandy, Atari, TI, I-P, DEC, etc. 12 chap., 100+ photos, figures. Save \$!

DISK DRIVE TUTORIAL \$12

Theory and practical facts on drives, disks, FDCs, formatting, interfacing, software. Same drive types as listed above. 7 chap.; many photos, figures, and purchase/use tips.

COMPUTER PHREAKING \$15

Dozens of computer crime methods and countermeasures. How systems are penetrated. BBS advice; password defeats; EMI and audio eavesdropping (TEMPEST, Van Eck methods; crossstalk amps). 200 phreak-term Glossary.

CONSUMERTRONICS

2011 CRESCENT DR. P.O. DRAWER 537
ALAMOGORDO, NM 88310

CIRCLE 201 ON FREE INFORMATION CARD

GETTING THE MOST FROM YOUR PRINTER

Getting The Most From Your Printer



BP181—It is probable that 80% of dot-matrix printer users only ever use 20% of the features offered by their printers. This book will help you unlock the special features and capabilities that you probably don't even know exist. To order your copy send \$6.95 plus \$1.50 for shipping in the U.S. to Electronic Technology Today Inc., P.O. Box 240, Massapequa Park, NY 11762-0240.

procedure that is stored in memory at the time. Select RETRIEVE by pressing key F7. If you specify the name of a file that doesn't exist, you will be so informed and asked to press any key to return to the main menu. If memory already contains a procedure you will be so advised and asked if you want to continue. Continuing erases the current contents of memory and replaces it with the procedure saved on disk.

Quit is selected by pressing both the CTRL and Q keys. That ends the program, ensures all files are closed, and prints a message "To re-enter, type goto 50". If you end prematurely without saving a procedure in memory, executing a goto 50 allows you to re-enter the program with memory intact. You can then save memory contents to a disk file.

Tips for experimenters

Each movement you specify is called a step. After loading a procedure from disk, you can add steps to it in the LEARN mode. That allows you to build a procedure one part at a time, add to it, test it, and save the revised procedure if it proves acceptable. You

can also have standard procedures on file rather than having to build them manually each time.

You should always start a procedure with the robot in the same initial position. To do that, save the procedure in memory and enter the LEARN mode. Perform the functions necessary to get the robot to the initial position. Then retrieve the procedure you wish to perform.

Each procedure step is saved as a movement-function number and a time count. The movement function is specified by a number between one and twelve (corresponding to the twelve function-definition listings on the LEARN screen). The time count is a number that indicates how long the function should be performed. As the robot's batteries drain, the time count may produce slightly different results since the robot will move at a slower speed. Therefore, for precise procedures it is recommended that you always use a fresh set of batteries.

If your procedures will be longer than the currently allowable 250 steps, modify the DIMENSION statement in program line 10 to increase the size of the B array. ♦♦♦

MARKET CENTER

FOR SALE

RESTRICTED technical information: Electronic surveillance, schematics, locksmithing, covert sciences, hacking, etc. **Huge selection. Free brochure MENTOR-Z**, 135-53 No. Blvd., Flushing, NY 11354.

TV tunable notch filters, free brochure. **D.K. VIDEO**, Box 63/6025, Margate, FL 33063. (305) 752-9202.

FREE power supply with Assortment #103 (February '84 article, has PCB, TOKO coils(4), 2N3904(2), BFQ85, 7812, 74123, MC1330, 1N914, 1N5231B. **Only \$25.00. Five/\$112.50.** Shipping \$3.00. **1-800-821-5226 Ext. 426.** (orders), MC/VISA, COD, check or M.O. **JIM RHODES INC.**, P.O. Box 3421, Bristol, TN 37625.

TUBES, name brands, new, 80% off list. **KIRBY**, 298 West Carmel Drive, Carmel, IN 46032.

INDIVIDUAL Photofact-folders #1 to #1400. \$3.00 postpaid. **LOEB**, 414 Chestnut Lane, East Meadow, NY 11554.

WHOLESALE car-radio computer telephone audio video accessories antenna catalog (718) 897-0509 **D&WR**, 68-12 110th St., Flushing, NY 11375.

A SINGER'S DREAM!



REMOVES VOCALS FROM RECORDS!
Now You can sing with the world's best bands! The Thompson Vocal Eliminator can remove most or virtually all of a lead vocal from a standard stereo record and leave the background!
Write or call for a free brochure and demo record.
LT Sound, Dept. R-1, P.O. Box 338, Stone Mountain, GA 30086 (404) 493-1258

TUNABLE notch filters. Channels 2, 3, and 4 available. Send \$15 for sample. Specify channel. Money back guarantee. **DB ELECTRONICS**, P.O. Box 8644, Pembroke Pines, FL 33084.

NEW 12-channel microwave T.V. antenna! Complete \$104.95. Standard 2-channel system \$84.95. Lifetime warranty. Dealer pricing. COD-Mastercard-Visa. \$3.00 credit phone orders. **PHILLIPS-TECH ELECTRONICS**, P.O. Box 8533, Scottsdale, AZ 85252. (602) 947-7700.

INTEL, RCA, National, OKI, SGS, and more. Factory prime and surplus parts catalog. **LYNBAR INDUSTRIES**, 205 Main, Box 822, St. Joseph, MI. 49085-0822.

TEST equipment, reconditioned. For sale. \$1.25 for catalog. **WALTER'S**, 2697 Nickel, San Pablo, CA 94806. (415) 724-0587.

BRAND new Oak vari-sync descramblers \$45.00 each; Oak automatic on/off \$75.00; SB-3 \$89.00; Tri-mode \$125.00; Bi-state \$125.00; Scientific Atlanta \$125.00; Hamlin \$75.00; Zenith cable \$175.00; Starcom VI \$125.00; Oak Sigma \$175.00; also schematics, service manuals, descrambler information booklets; catalog \$3.00; call us, we ship units UPS COD. **PONDEROSA COMPANY**, (303) 634-6666.

VIDEO copier (\$69.95) connects between two VCR's (stereo) and makes copies as good as the original. For info/order write or call **VIDEO VIBES**, 657 Allerton Ave., Bronx, NY 10467. Tel. (212) 653-4644.

NOTICE! light controllers, rope lights, etc. Flyer \$1.00 **DESIGN SPECIALTY**, 2213 Chesley Dr., San Jose, CA 95130.

OLD radio TV schematics. Send \$1.00, make model. **RADIO MAPS**, P.O. Box 791, Union City, CA 94587.

CLASSIFIED AD ORDER FORM

To run your own classified ad, put one word on each of the lines below and send this form along with your check to:

Radio-Electronics Classified Ads, 500-B Bi-County Boulevard, Farmingdale, NY 11735

PLEASE INDICATE in which category of classified advertising you wish your ad to appear. For special headings, there is a surcharge of **\$23.00**.

() Plans/Kits () Business Opportunities () For Sale
() Education/Instruction () Wanted () Satellite Television
()

Special Category: \$23.00

PLEASE PRINT EACH WORD SEPARATELY, IN BLOCK LETTERS.

(No refunds or credits for typesetting errors can be made unless you clearly print or type your copy.) Rates indicated are for standard style classified ads only. See below for additional charges for special ads. **Minimum: 15 words.**

1	2	3	4	5
6	7	8	9	10
11	12	13	14	15 (\$42.75)
16 (\$45.60)	17 (\$48.45)	18 (\$51.30)	19 (\$54.15)	20 (\$57.00)
21 (\$59.85)	22 (\$62.70)	23 (\$65.55)	24 (\$68.40)	25 (\$71.25)
26 (\$74.10)	27 (\$76.95)	28 (\$79.80)	29 (\$82.65)	30 (\$85.50)
31 (\$88.35)	32 (\$91.10)	33 (\$94.05)	34 (\$96.90)	35 (\$99.75)

We accept MasterCard and Visa for payment of orders. If you wish to use your credit card to pay for your ad fill in the following additional information (Sorry, no telephone orders can be accepted.):

Card Number

Expiration Date

Please Print Name

Signature

IF YOU USE A BOX NUMBER YOU MUST INCLUDE YOUR PERMANENT ADDRESS AND PHONE NUMBER FOR OUR FILES. ADS SUBMITTED WITHOUT THIS INFORMATION WILL NOT BE ACCEPTED.

CLASSIFIED COMMERCIAL RATE: (for firms or individuals offering commercial products or services) \$2.85 per word prepaid (no charge for zip code)...**MINIMUM 15 WORDS.** 5% discount for same ad in 6 issues; 10% discount for same ad in 12 issues within one year; if prepaid. **NON-COMMERCIAL RATE:** (for individuals who want to buy or sell a personal item) \$2.30 per word, prepaid....no minimum. **ONLY FIRST WORD AND NAME** set in bold caps at no extra charge. Additional bold face (not available as all caps) **50¢ per word additional (20% premium).** Entire ad in boldface, add **20% premium** to total price. **TINT SCREEN BEHIND ENTIRE AD:** add 25% premium to total price. **TINT SCREEN BEHIND ENTIRE AD PLUS ALL BOLD FACE AD:** add 45% premium to total price. **EXPANDED TYPE AD:** \$4.30 per word prepaid. All other items same as for STANDARD COMMERCIAL RATE. **TINT SCREEN BEHIND ENTIRE EXPANDED TYPE AD:** add 25% premium to total price. **TINT SCREEN BEHIND ENTIRE EXPANDED TYPE AD PLUS ALL BOLD FACE AD:** add 45% premium to total price. **DISPLAY ADS:** 1" x 2 1/4" — \$320.00; 2" x 2 1/4" — \$640.00; 3" x 2 1/4" — \$960.00. **General Information:** Frequency rates and prepayment discounts are available. **ALL COPY SUBJECT TO PUBLISHERS APPROVAL. ADVERTISEMENTS USING P.O. BOX ADDRESS WILL NOT BE ACCEPTED UNTIL ADVERTISER SUPPLIES PUBLISHER WITH PERMANENT ADDRESS AND PHONE NUMBER.** Copy to be in our hands on the 12th of the third month preceding the date of the issue. (i.e., August issue copy must be received by May 12th). When normal closing date falls on Saturday, Sunday or Holiday, issue closes on preceding working day.

\$99.00 the TERMINAL

CABLES AND POWER SUPPLY NOT INCLUDED

VIDEO LOGIC BOARD

MONITOR AND CRT

KEYBOARD

BONUS

CPM ENGINE ONLY \$5.00

WHEN YOU BUY "THE TERMINAL" FOR \$99 AT THE SAME TIME, REGULAR PRICE \$45. SEE OUR FEB. RE. ADD FOR DETAILS

Call for a copy of 15 day trial agreement. Tax & freight extra. Send check or add 1.90 for COD. Price may change. Store Price may differ. While supplies last. No P.O.s, terms, or credit cards.

Silicon Valley Surplus
415-261-4506
4401 OAKPORT OAKLAND CA, 94601

OPEN 10am-6pm
CLOSED SUN & MON

CALL OUR BBS 415-261-4513

CIRCLE 192 ON FREE INFORMATION CARD

RS232 INPUT
300-19.2K BAUD WITH DB25

8 CHARACTER SETS
US, UK, FRENCH, GERMAN
SPANISH, ITALIAN, DANISH
NORWEGIAN, SWEDISH
FINNISH, & GRAPHICS

GRAPHICS
THICK AND THIN LINE
SEGMENTS, BAR GRAPHS
AND GRAPHIC SYMBOLS

21 FUNCTION KEYS
TELEVIEW OR MORROW

80 BY 24 LINE DISPLAY
9 BY 5 INCH AMBER TUBE

VISUAL ATTRIBUTES
REVERSE, UNDERLINE, 1/2
INTENSITY, COMBINATIONS

MONITOR MODE
CAUSES TERMINAL TO SHOW
ALL 32 CONTROL CODES

SCREEN SAVER
TURNS OFF WHEN NOT USED
FOR 15 MINUTES. DISPLAY
RETURNS WITHOUT LOSS OF
DATA WHEN ANY KEY IS HIT

PROGRAMMABLE KEYCLICK
AUTO SCROLL
PROGRAMMABLE TO SCROLL
OR WRAP AT 24TH LINE

93 KEY KEYBOARD
SEPARATE NUMERIC KEYPAD
KEYCLICK / BELL SPEAKER
LOW PROFILE FULL SIZE
QWERTY LAYOUT, 21 FUNCTION
KEYS, CAPS LOCK WITH
LED, ENTER KEY WITH LED,
KEYS AUTO REPEAT.

POWER REQUIRED
+12VDC -12VDC +5VDC

RECHARGEABLE "AA" nicads 500mAh 1.2volt
ten for \$11.00 plus shipping. **RAYMOND RICHARD**, 26557 Hass, Dearborn Heights, MI 48127.

ZENITH, SSAVI, ready to go \$100.00 plus shipping, order C.O.D. 1 (305) 752-9202.

ROBOT! kits. Books and Plans! Learn to build your own robots. Free catalogs contain hundreds of affordable robot systems. Explore the world of robotics today. Catalog: **CEARGS-ROBOTS!**, POB 458, Peterborough, NH 03458. (603) 924-3843.

AMPLIFIER breakthrough—The current amplifier drives loads push-pull without internal voltage gain. Fastest, quietest circuit in transistor electronics. Op amps now drive speakers. Plans for quieter, easier to construct audio amplifiers, all wattages, \$15. **AMPLIFIERS UNLIMITED**, Rt 2, Box 139, Highmore, SD 57345.

500 parts \$12.00. Mixed resistors, capacitors, diodes, inductors, etc. Good stuff. No junk. 5 free power transistors with each \$24.00 order. We pay shipping in U.S.A. add \$2.00 if C.O.D. **BARGAIN CITY**, P.O. Box 121, Glen, MS 38846.

PROTECT your delicate equipment with, non-toxic, non-corrosive, Halon Fire extinguisher. 22oz. \$29.95, 115 Gm. \$14.95 1 each \$39.95, plus \$3.00 P & H per order. **DAKOTA ENTERPRISES**, P.O. Box 3432-RE, Rapid City, SD 57709.

STEREO sound simulator. Connect your TV and stereo. Great for VCR's. Send \$15.00. **SHEPHERD**, 8125 Sunset Ave., Suite 183, Fair Oaks, CA. 95628.

CB Tune-up manual Volume II. Specific adjustments, modifications for peaking all popular CB's. Covers over 1300 radios. \$19.95, Visa, MasterCard to: **THOMAS PUBLISHING**, 127-R Westwood, Paris, IL 61944.

TRIPLE regulated, metered benchtop power supplies. Fixed $\pm 5VDC$, two variable $\pm 15VDC$, 1 amp. Maximum short and overload protected, current limited. Supplies stackable to $\pm 35VDC$. \$119.95 year warranty. **USI**, Box 332R, Weatogue, CT 06089. (203) 658-4318.

OSCILLOSCOPES and reconditioned test equipment, telontronix, H.P., etc. Free list. **CAL-SCOPES**, 983D Ponderosa Ave., Sunnyvale, CA 94086 (408) 730-4573.

WANTED: Western Electric, McIntosh, Marantz, RCA, Dynaco, Altec, Telefunken, JBL, tubes, speakers, amplifiers, (713) 728-4343. **MAURY**, 11122 Atwell, Houston, TX 77096.

ELECTRONIC equip., frequency counters, preamps, RF final amplifiers and more at below wholesale prices! Send \$2.00 for catalog refundable with purchase. Dealer inquiries invited. **DIGITREX DIST.**, 1948 Coventry, Thousand Oaks, CA 91362.

DESCRAMBLER catalog. Special combo Jerrold 400 and SB3 \$165. New cable descrambler kit \$49.00 (assemble in half hour). Much more. Send \$1.00. **MJ INDUSTRY**, Box 531, Bronx, NY 10461.

TUBES! 59¢. Year guarantee. Free catalog. Tube tester \$8.95. **CORNELL**, 4215 University, San Diego, CA 92105.

TI-99/4A software/hardware bargains. Hard-to-find items. Huge selection. Fast service. Free catalog **DYNA**, Box 690, Hicksville, NY 11801.

VIDEO scrambling techniques. The original "secret manual" covers sinewave, gated pulse, and SSAVI systems. 56 pages of solid, useful, legible information. Only \$14.95. **ELEPHANT ELECTRONICS, INC.**, Box 41865-J, Phoenix, AZ 85080. (602) 581-1973.

IS it true...Jeeps for \$44 through the government? Call for facts! 1 (312) 742-1142, ext. 4673.

OLDTIME radio programs on high quality tapes. Comedy! Adventure! Music! Free catalog. **CARL F. FROELICH**, Heritage Farm, New Freedom, PA 17349.

LINEAR PARTS—transistors: MRF454 \$15, MRF455 \$12, MRF477 \$11, MRF492 \$16.75, MRF421 \$22.50, SRF2072 \$13, SRF3662 \$25, 3800 \$18.75, 2SC2290 \$19.75, 2SC2879 \$25. Tubes: 6KD6 \$10.50, 6LQ6 \$9.75, 6LF6 \$9.75, 8950 \$16.75. Best prices on Palomar road noise mics, Ranger AR3300. New 16-page catalog listing radio/amplifier tricks—channel modification, PLL-sliders, peaking for range, hard-to-find linear parts—mail \$1.00 to: **RFPC**, Box 700, San Marcos, CA 92069. For same day parts shipment, call (619) 744-0728.

CHANNEL 3—60db notch filter, 63.5MHz. \$19.95. All other channels \$29.95. Cable converter and accessory catalog \$1. (514) 739-9328. **CROSLEY(A)**, Box 840, Champlain, NY 12919.

THE BEST PLACE to BUY, SELL or TRADE NEW and USED EQUIPMENT

NUTS & VOLTS MAGAZINE
BOX 1111-E • PLACENTIA, CA 92670
(714) 632-7721

Join Thousands of Readers Nationwide Every Month

ONE YEAR U.S. SUBSCRIPTIONS
\$10.00 - 3rd Class • \$15.00 - 1st Class

• \$35.00 - Lifetime - 3rd Class

NUTS & VOLTS
HAM GEAR
COMPUTERS
SOFTWARE
SCANNERS • OPTICS
TEST EQUIPMENT
MICROWAVE
SATELLITE
AUDIO VISUAL
NEW PRODUCTS
COMPONENTS • KITS
ANTIQUE ELECT
PUBLICATIONS
PLANS • SERVICES

ATTENTION looking for surplus test equipment signal generator voltmeter oscilloscope. **J.B. ELECTRONICS**, 9518 Grand, Franklin Park, IL 60131.

DECODE nearly any gated pulse signal with our new super simple circuit. Works on In-band, Out-band, AM or FM pilot tone—use with Hamlin, Jerrold, Sylvania. Complete plans and theory only \$13.50 plus \$1.50 P&H. **ELEPHANT ELECTRONICS INC.**, Box 41865-J, Phoenix, AZ 85080. (602) 581-1973.

BUILD from our quality diagrams; alarm, audio, automotive, power supply, environmental, etc., and related circuits. Write for free details list. Special requests invited. **CAN-PLAN**, 4690 Clark, Montreal, Quebec Canada H2T2T4.

FREE semiconductors catalog, gift with purchase. **C.M. ELECTRONIQUE**, Dept. RE, P.O. Box 243, Laprairie, Quebec, Canada J5R3Y3.

STRANGE stuff. Plans, kits, new items. Build satellite dish \$69.00. Descramblers, bugs, adult toys. Informational photo package \$3.00 refundable. **DARIJO CORPORATION**, Box 212, Lowell, NC 28098.

TUBES: "OLDEST", "LATEST". Parts and schematics. SASE for list. **Steinmetz**, 7519 Maplewood Ave., RE, Hammond, Ind., 46324

CB RADIO OWNERS!

We specialize in a wide variety of technical information, parts and services for CB radios. 10M-FM conversions, repairs, books, plans, kits, high-performance accessories. Our 11th year! Catalog \$2.

CBC INTERNATIONAL, P.O. BOX 31500RE, PHOENIX, AZ 85046

PROPAGANDA BROADCAST TAPES! Authentic, rare recordings of WW-II shortwave broadcast by "Tokyo Rose", "Axis Sally", others. Cassette \$9.95. **D-W Research**, 4548 Auburn Blvd., #231-C, Sacramento, CA 95841

LOW noise preamp. Great microphone booster, guitar direct box. Many other uses. \$29.95. Wired and tested. **C.M. Baker**, P.O. Box 186, Leola, PA 17540

Cable Television Converter, Descrambler and wireless Remote control video Equipment accessories catalog. **FREE. CABLE DISTRIBUTORS UNLIMITED**, 116-Main Road, Washington, AR 71862

CABLE-TV converters and descramblers. Low prices, quality merchandise, we ship C.O.D. Send \$2.00 for catalog. **CABLETRONICS UNLIMITED**, P.O. Box 266, South Weymouth, MA 02190. (617) 843-5191.

U.L. APPROVED VIDEO D/A's

THE VDA-601 Distribution Amplifier features six short circuit protection, D.C. coupled outputs. A user selectable looping or terminated input with adjustable level control. For details please send SASE to: **D & S ENGINEERING**, P.O. Box 4426, Orange, CA 92613-4426 **DEALERS WANTED!!!**

PLANS AND KITS

BUILD this five-digit panel meter and square wave generator including an ohms, capacitance and frequency meter. Detailed instructions \$2.50. **BAGNALL ELECTRONICS**, 179 May, Fairfield, CT 06430.

DESCRAMBLE the latest video cassette copy protection scheme. Our simple Line Zapper circuit takes the jitter out of your picture. Complete plans and theory only \$13.95 plus \$1.50 postage and handling. PC board and complete kits also available. **ELEPHANT ELECTRONICS, INC.**, Box 41865-J, Phoenix, AZ 85080. (602) 581-1973.

HI-FI speaker systems, kits and speaker components from the world's finest manufacturers. For beginners and audiophiles. Free literature. **A&S SPEAKERS**, Box 7462R, Denver, CO 80207. (303) 399-8609.

VOICE disguisers! FM bugs! SWL active antenna! Receivers! More! Catalog \$1.00 (refundable): **XAN-DI ELECTRONICS**, Box 25647, Dept. 60L, Tempe, AZ 85282.

JERROLD gated pulse theory. Twelve information-packed pages covering D1 & DIC converter operation. Includes introduction to trimode system. \$6.95 plus \$1.50 postage and handling. **ELEPHANT ELECTRONICS, INC.**, Box 41865-J, Phoenix, AZ 85080. (602) 581-1973.

WRITE FOR
McGEE'S
SPEAKER & ELECTRONICS CATALOG

1001 BARGAINS IN SPEAKERS
toll free 1-800-346-2433 for ordering only.

1901 MCGEE STREET KANSAS CITY, MO. 64108

DIGITAL audio recorder Commodore-64. Excellent Sound! Plans, P.C.B., & drum software: \$19.95. Kit \$49.95. Postpaid, order now!! **TAD PAINTER**, P.O. Box 166055, Irving, TX 75016.

CRT equipment rebuilds Sony/color tubes/other. **CRT SYSTEMS**, 633 North Semoran, Orlando, FL 32807. Call (305) 275-9543.

YOUR own radio station! AM, FM, cable. Licensed or unlicensed. **BROADCASTING**, Box 130-F5, Paradise, CA 95967.

BIG PROFITS **ELECTRONIC ASSEMBLY BUSINESS**

Start home spare time Investment knowledge or experience unnecessary. **BIG DEMAND** assembling electronic devices. Sales handled by professionals. Unusual business opportunity

FREE: Complete illustrated literature
BARTA RE-O Box 248
Walnut Creek Calif 94597

WANTED

INVENTORS! AIM wants—ideas, inventions, new products, improvements on existing products. We present ideas to manufacturers. Confidentiality guaranteed. Call toll free 1 (800) 225-5800 for information kit.

INVENTIONS, ideas, new products wanted! Industry presentation/national exposition. Call free 1 (800) 528-6050. Canada, 1 (800) 528-6060. X831.

WANTED surplus inventories of ICs, transistors etc. No quantity too small or large. Call **WESTERN TECHNOLOGY**, (303) 444-4403.

EDUCATION & INSTRUCTION

TRAINING in cable television technology. Prepare for the future. **CABLE CORRESPONDENCE COURSES INC.**, Post Office Box 1319, St. Charles, MO 63302.

FCC commercial general radiotelephone license correspondence course. 60 individual lessons for \$89.50. Payment plan. Results guaranteed! Details free. **AMERICAN TECHNICAL INSTITUTE**, Box 201, Cedar Mountain, NC 28718.

SUPERFAST morse code supereasy. Subliminal cassette. Moneyback guarantee. \$10. **BAHR**, 2549E Temple, Palmbay, FL 32905.

F.C.C. commercial general radiotelephone license. Electronics home study. Fast, inexpensive! "Free" details. **COMMAND**, D-176, Box 2223, San Francisco, CA 94126.

CASSETTE recorded home study for new general class FCC license examinations. Also broadcasting and cablevision courses. **BOB JOHNSON TELECOMMUNICATIONS**, 1201 Ninth, Manhattan Beach, CA 90266.

I have the idea; do you have the scientific knowledge in Audio/Video field? If you are interested in joining forces with me to convert this potentially very lucrative idea into reality and sharing the results, please contact: **ANTOINE RISTAKIAN**, 2 Overlea Ct., Massapequa Park, NY 11762.

Start Your Own TV/VCR Repair Business

Now you can train at home in your spare time for a money-making career as a TV/VCR Repair Specialist. No previous experience necessary. No need to quit your job or school. Everything is explained in easy-to-understand language with plenty of drawings, diagrams and photos. We show you how to troubleshoot and repair videocassette recorders and TV sets, how to handle house calls and shop repairs for almost any make of television or VCR. Tools are included with your course so you can get "hands-on" practice as you follow your lessons step by step. Send for free facts about the exciting opportunities in TV/VCR Repair and find out how you can start making money in your own business! **MAIL COUPON TODAY!**

ICS SCHOOL OF TV/VCR REPAIR, Dept. DE047
Scranton, Pennsylvania 18515

Please send me full information and color brochure on how I can learn TV/VCR Repair at home in my spare time. I understand there is no obligation and no salesman will visit me.

Name _____ Age _____
Address _____ Apt. # _____
City/State/Zip _____
Phone () _____

SATELLITE TV

CABLE TV Secrets—the outlaw publication the cable companies tried to ban. HBO, Movie Channel, Showtime, descramblers, converters, etc. Suppliers list included \$8.95. **CABLE FACTS**, Box 711-R, Pataskala, OH 43062.

SATELLITE systems \$349 up. VISA/MC available. Catalog \$3.00. **STARLINK, INC.**, 2603-16R Artie, Huntsville, AL 35805.

SATELLITE TV receiver kits! instructions, schematics! LNA's! Catalog \$1.00 (refundable): **XANDI ELECTRONICS**, Box 25647, Dept. 21N, Tempe, AZ 85282.

Multi-Channel Microwave T.V. Receivers

19-27 GHz Parabolic Dish 40+ dB Gain
LIFETIME WARRANTY
Complete System \$89.95 (Shipping Incl.)
Dealer Rates, Replacement Components & Expert Repairs Available

K & S ELECTRONICS Call now for same
P.O. BOX 34522 day shipping
PHOENIX, AZ 85067 (602) 230-0640

VISA/MC/COD \$2 credit on phone orders!

VIDEOCIPHER II, descrambling manual \$10.00; offset printed set of schematics \$10.00; free set of DeSug members "special" video and audio "working schematics" with \$20.00 order; **PONDEROSA COMPANY**, (303) 634-6666.

DESCRAMBLER build our low cost satellite TV video only descrambler for all major movies and sports. Uses all Radio Shack parts. Order P.C. board and instructions by sending cheque, money order, or Visa for \$35.00 U.S. funds to: **VALLEY MICROWAVE ELECTRONICS**, Bear River, Nova Scotia, Canada, BOS-180. (902) 467-3577.

ASSORTMENT #301 has Printed Circuit, all IC's, transistors, diodes for **RELEASE-MAST** project (October article) \$25.00. Shipping \$3.00. Call 1-800-821-5226 Ext. 426 (orders). **Jim Rhodes**, Inc. Box 3421, Bristol, TN 37625.

INVENTORS

INVENTORS! Can you patent and profit from your idea? Call **AMERICAN INVENTORS CORPORATION** for free information. Over a decade of service. 1 (800) 338-5656. In Massachusetts or Canada call (413) 568-3753.

PHONE RECORDER CONTROL

- Automatically records phone conversations when receiver is lifted.
- Interfaces your phone to any tape recorder.
- Meets all FCC requirements.
- Guaranteed to work.

Send 19.95 plus 3.00 shipping & handling to VISA, MASTER CHARGE, or COD to: **ELECTRONIC DEVICES**, 2429 Central Ave. St. Petersburg, FLA. 33173.
Dealer inquiries welcomed

SCIENTIFIC ATLANTA & TOCOM

SCIENTIFIC Atlanta cable converters (original units), models—8500 and 8550, remote control...\$250.00. **TOCOM** and Zenith descramblers \$225.00, Guaranteed. N.A.S., (213) 631-3552.

DESCRAMBLER MODULE

COMPLETE cable-TV decoder in a mini-module. Latest technology upgrade for Jerrold SB-3 or Radio Electronics Feb. 1984 project. Available at very low cost. For literature, **SOUTHTECH DISTRIBUTING**, 1(800) 821-5226 Ext. 130.

SB-3/TRI-BI/ZENITH

SB-3's...\$67.00. **Tri-Bi's**...\$79.00. **Zenith** (Tag-ones)...\$159.00. **N-12** (Varisync)...\$75.00. N.A.S., (213) 631-3552.

Pay TV and Satellite Descrambling All New 6th Edition!

100 pages. 13 cable, 7 satellite systems. Schematics, theory, countermeasures, detection. \$14.95 Experiments with **VideoCipher**. Bypasses, tuners 4 free updates \$12.95 **Cable TV**. Two-way systems, security \$12.95 **MDS/MMDS Handbook**. For microwave hackers \$9.95 **Build Satellite Systems Under \$600**. \$12.95 Any 3-\$26 New Spring catalog \$1

Shojiki Electronics Corp., 1327R Niagara St., Niagara Falls, NY 14303. COD's 716-284-2163

PRINTED CIRCUIT BOARDS

CIRTECH of Colorado delivers quality PC'B design/layout at affordable prices. Prototypes welcome. Single or double sided. Send specs for quote to 1330 Riverside Ave., Boulder, CO 80302 or call (303) 449-1307 (home).

DO IT YOURSELF TV REPAIRS

NEW...REPAIR ANY TV...EASY. Retired serviceman reveals secrets. Write **RESEARCH**, Rt. 3, Box 601B, Colville, WA 99114.

EPROM PROGRAMMING

FREE catalog. Your software/data installed in EPROM of your choice. Fast, low cost service. Write/call: **Romulus Microcontrol**, Dept. A, Box 8669, Rockville, Maryland 20856; (301) 540-8863

CABLE TV DESCRAMBLERS

Cable Television Converter, Descrambler and wireless Remote control video Equipment accessories catalog **FREE**. **CABLE DISTRIBUTORS UNLIMITED**, 116-C Main Road, Washington, AR 71862.

HOT BOOKS FOR HOBBYISTS



26177—**BUILD A REMOTE-CONTROLLED ROBOT FOR UNDER \$300**...\$9.95. Fool-proof instructions for putting together your own full-size robot



27357—**62 HOME REMOTE CONTROL AND AUTOMATION PROJECTS**...\$12.95. A fascinating collection of projects to make your life safer, more convenient and more fun

BUILD A REMOTE-CONTROLLED ROBOT...FOR UNDER \$300

26177—If you're fascinated by the home robots increasingly available on today's market ... but are stopped by their price tags ... here's your solution. Build your own home robot—and a full size unit at that—for less than \$300. No advanced electronics or computer skills are needed to put together "Questor", a robot butler especially designed to be both affordable and easy-to-build. — Order your copy for \$9.95 plus \$1.75 shipping.

62 HOME REMOTE CONTROL AND AUTOMATION PROJECTS

27357—A device that automatically dims the lights when you turn on your stereo ... an automatic guest greeter ... sensors that keep your air-conditioning at ideal levels automatically ... voice-operated transmitters, door and window controllers and more. Complete instructions, wiring diagrams, and show-how illustrations for each device. \$12.95 plus \$2.75 shipping.

Send 40-page catalog—FREE with order.
 I've included \$2.00 Send catalog and coupon good for \$2.00 on first order.

Electronic Technology Today
P.O. Box 240
Massapequa Park, NY 11762

Copies of articles from this publication are now available from the UMI Article Clearinghouse.

For more information about the Clearinghouse, please fill out and mail back the coupon below.

UMI Article Clearinghouse

Yes! I would like to know more about UMI Article Clearinghouse. I am interested in electronic ordering through the following system(s):

- DIALOG/Dialorder ITT Dialcom
 OnType OCLC ILL Subsystem
 Other (please specify) _____
 I am interested in sending my order by mail.
 Please send me your current catalog and user instructions for the system(s) I checked above.

Name _____
 Title _____
 Institution/Company _____
 Department _____
 Address _____
 City _____ State _____ Zip _____
 Phone (_____) _____

Mail to: University Microfilms International
 300 North Zeeb Road, Box 91 Ann Arbor, MI 48106

CALL FOR FREE CATALOG

TEXT TO SPEECH BOARD!

PC/XT COMPATIBLE. MAKE YOUR COMPUTER TALK!

A VERY POWERFUL AND AMAZING SPEECH CARD. USES THE NEW GENERAL INSTRUMENTS SPO256-AL2 SPEECH CHIP AND THE CTS256A-AL2 TEXT TO SPEECH CONVERTER.

THIS BOARD USES ONE SLOT ON THE MOTHERBOARD AND REQUIRES A COM SERIAL PORT. BOARD MAY ALSO BE USED IN A STAND ALONE ENVIRONMENT WITH ALMOST ANY COMPUTER THAT HAS A RS232 SERIAL PORT. FEATURES ON BOARD AUDIO AMP OR MAY BE USED WITH EXTERNAL AMPS.

DEMONSTRATION SOFTWARE AND A LIBRARY BUILDING PROGRAM ARE INCLUDED ON A 5 1/4 INCH PC/XT DISKETTE. FULL DOCUMENTATION AND SCHEMATICS ARE ALSO INCLUDED.



\$89.95
 ASSEMBLED & TESTED

NEW!

CANON 80 COLUMN PRINTER - \$39.95

ORIGINALLY MANUFACTURED FOR THE PC JR. BUT WITH OPTIONAL CONNECTOR WILL WORK WITH PC, XT, OR AT. REQUIRES SERIAL I/O. THIS THERMAL PRINTER IS QUIET AND USES EASY TO GET 8 1/2 IN. ROLLS OF PAPER. 50 C.P.S., JPPER AND LOWER CASE, PLUS GRAPHICS. ORIGINAL LIST PRICE \$199.00. ADD \$3.00 FOR PC/XT CONNECTOR. ADD \$5.00 UPS.

PC/XT EPROM PROGRAMMER

\$199

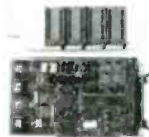

NEW!

• LATEST DESIGN • PROGRAMS UP TO 4 DEVICES AT ONE TIME • FEATURES EASY TO USE MENU DRIVEN SOFTWARE THAT RUNS UNDER PC OR MS-DOS. • USES AN INTELLIGENT PROGRAMMING ALGORITHM FOR SUPER FAST (8X) EPROM BURNING. • THIS PLUG-IN BOARD ATTACHES TO AN EXTERNAL MINI CHASSIS CONTAINING 4 TEXTOL Z.I.F. SOCKETS. • NO PERSONALITY MODULES REQUIRED • AUTOMATIC VPP SELECTION: 12.5V, 21V, OR 25V. • EPROM DATA CAN ALSO BE LOADED FROM OR SAVED TO A DISKETTE. • PROGRAMMING SOFTWARE SUPPORTS: 2716, 2732, 2732A, 2764, 2764A, 27128, 27128A, 27256, 27256A, 27512, AND 27512A. • ASSEMBLED AND TESTED. BURNED. IN WITH MANUAL. \$199 WITH SOFTWARE.

Digital Research Computers

(OF TEXAS)

P. O. BOX 381450B • DUNCANVILLE, TX 75138 • (214) 225-2309

TERMS: Add \$3.00 postage. We pay balance. Orders under \$15 add 75c handling. NO C.O.D. We accept Visa and MasterCard. Texas Res. add 6-1/4% Tax. Foreign orders (except Canada) add 20% P & H. Orders over \$50 add 85c for insurance.

Parts Express

HARDWARE AND ELECTRONICS

CHECK OUT OUR HARDWARE SELECTION!

We stock wood screws, machine screws, sheet metal screws, nuts, bolts, and fasteners. All are available in either convenient package sizes or bulk for large quantity users. And best of all, our prices are truly low!

COPPER CLAD PC BOARD



9" x 8" Double Sided #055-300 \$150
 18" x 12" Double Sided #055-320 \$395

RS-232 DATA SWITCH



• 2 position, rotary type • Fully shielded, FCC approved.
 #130-010 \$2795

REPLACEMENT POWER CORDS



• 18 gauge, 2 conductor • 6 foot, bulk.
 #110-010 (White) 29c
 #110-020 (Brown) (10-10)
 #110-030 (Black) (1-6) 40c



12" PIONEER WOOFER
 • Power 65W RMS • 11 oz. magnet
 • 25 to 2500 Hz response • 1 1/2" voice coil

#290-100 \$15.50 \$13.95
 (1-3) (6-10)

500 PIECE RESISTOR KIT



• 1/2 watt • Popular resistance values ranging from 2.7 ohms-33 Meg ohms

#010-010 \$1295

FREE CATALOG

Our new 56 page catalog contains thousands of items that you need every day for do-it-yourself projects, product engineering, electronics repair and more. Call us today for your free copy and start saving!



OUTLET STRIP



• Heavy duty four outlet box • All outlets switched w/circuit breaker. • UL approved.

#130-210 \$995

CALL TOLL FREE
 1-800-255-3525

In Ohio: 1-800-322-3525
 Local: (513) 222-0173

• 15 day money back guarantee • \$10.00 minimum order • COD orders accepted • 24 hour shipping • Shipping charge - UPS chart rate (\$2.50 minimum charge). Hours 8:30 a.m. - 6 p.m. EST M-F.

PARTS EXPRESS INT'L INC.
 340 East First St
 Dayton, Ohio 45402



CIRCLE 204 ON FREE INFORMATION CARD

ALL SALES SUBJECT TO THE TERMS OF OUR 90 DAY LIMITED WARRANTY. FREE COPY UPON REQUEST.

MAY 1987

153

1200B MODEM \$9995 FOR IBM W/ SOFTWARE 2400B MODEM \$11995

STATIC RAMS

2101	256x4	(450ns)	1.95
5101	256x4	(450ns)(CMOS)	3.95
2102L-4	1024x1	(450ns)(LP)	.99
2112	256x4	(450ns)	2.99
2114	1024x4	(450ns)(LP)	1.09
2114L-4	1024x4	(450ns)(LP)	1.49
2114L-2	1024x4	(200ns)(LP)	1.95
2114L-15	1024x4	(150ns)(LP)	1.95
TMS4044-4	4096x1	(450ns)	1.95
TMM2016-150	2048x8	(150ns)	1.49
TMM2016-100	2048x8	(100ns)	1.95
HM6116-4	2048x8	(200ns)(CMOS)	1.89
HM6116L-4	2048x8	(150ns)(CMOS)	1.95
HM6116L-3	2048x8	(150ns)(CMOS)(LP)	1.95
HM6116L-2	2048x8	(120ns)(CMOS)(LP)	2.95
HM6264P-15	8192x8	(150ns)(CMOS)	3.89
HM6264LP-15	8192x8	(150ns)(CMOS)(LP)	3.95
HM6264LP-12	8192x8	(120ns)(CMOS)(LP)	4.49

LP - Low power

DYNAMIC RAMS

4116-250	16384x1	(250ns)	.89
4116-200	16384x1	(200ns)	.49
4116-150	16384x1	(150ns)	.99
4116-120	16384x1	(120ns)	1.49
NK4332	32768x1	(150ns)	6.95
4164-200	65536x1	(200ns)(5v)	1.19
4164-150	65536x1	(150ns)(5v)	1.29
4164-120	65536x1	(120ns)(5v)	1.95
MCM6665	65536x1	(200ns)(5v)	1.95
TMS4164	65536x1	(150ns)(5v)	1.95
4164-REFRESH	65536x1	(150ns)(5v)(REFRESH)	2.95
TMS4416	16384x4	(150ns)(5v)	4.95
4112B-150	131072x1	(150ns)(5v)	5.95
TMS4464-15	65536x4	(150ns)(5v)	6.95
41256-200	262144x1	(200ns)(5v)	2.95
41256-150	262144x1	(150ns)(5v)	2.95

5v - Single 5 Volt Supply REFRESH - Pin 1 Refresh

★★★★ HIGH-TECH ★★★★★

NEC V20 UPD70108 \$1195

REPLACES 8088 TO SPEED UP IBM PC 10-40%

- HIGH-SPEED ADDRESS CALCULATION IN HARDWARE
- PIN COMPATIBLE WITH 8088
- SUPERSET OF 8088 INSTRUCTION SET
- LOW POWER CMOS

8MHZ V20 UPD70108-8 \$13.95
8MHZ V30 UPD70116-8 \$19.95

★★★★ SPOTLIGHT ★★★★★

EPROMS

2708	1024x8	(450ns)	4.95
2716	2048x8	(450ns)(5V)	3.49
2716-1	2048x8	(350ns)(5V)	3.95
TMS2532	4096x8	(450ns)(5V)	5.95
2732	4096x8	(450ns)(5V)	3.95
2732A	4096x8	(450ns)(5V)(21V PGM)	3.95
2732A-2	4096x8	(200ns)(5V)(21V PGM)	4.25
27C64	8192x8	(250ns)(5V)(CMOS)	5.95
2764	8192x8	(450ns)(5V)	3.49
2764-250	8192x8	(250ns)(5V)	3.95
2764-200	8192x8	(200ns)(5V)	4.25
MCM68766	8192x8	(350ns)(5V)(24 PIN)	17.95
27128	16384x8	(250ns)(5V)	4.25
27C256	32768x8	(250ns)(5V)(CMOS)	10.95
27256	32768x8	(250ns)(5V)	7.49

5V - Single 5 Volt Supply 21V PGM - Program at 21 Volts

ORDER TOLL FREE 800-538-5000



SPECTRONICS CORPORATION EPROM ERASERS



Model	Timer	Capacity Chip	Intensity (uW/cm²)	Unit Price
PE-14	NO	9	8,000	\$83.00
PE-14T	YES	9	8,000	\$119.00
PE-24T	YES	12	9,600	\$175.00

8000

8035	1.49
8039	1.95
8080	2.95
8085	2.49
8087-2	169.95
8087	129.00
8088	6.95
8088-2	9.95
8155	2.49
8155-2	3.95
8748	7.95
8755	14.95
80286	129.95
80287	199.95

6500 1.0 MHZ

6502	2.69
65C02 (CMOS)	12.95
6520	1.95
6522	4.95
6526	26.95
6532	6.95
6545	6.95
6551	5.95
6561	19.95
6581	34.95

CRT CONTROLLERS

6845	4.95
68845	8.95
6847	11.95
HD46505SP	6.95
MC1372	2.95
8275	26.95
7220	19.95
CRT5027	12.95
CRT5037	9.95
TMS9918A	19.95

CRYSTALS

32 768 KHz	.95
1.0 MHz	2.95
1.8432	2.95
2.0	1.95
2.097152	1.95
2.4576	1.95
3.2768	1.95
3.579545	1.95
4.0	1.95
4.032	1.95
5.0	1.95
5.0688	1.95
6.0	1.95
6.144	1.95
6.5536	1.95
8.0	1.95
10.0	1.95
10.738635	1.95
12.0	1.95
14.31818	1.95
15.0	1.95
16.0	1.95
17.430	1.95
18.0	1.95
18.432	1.95
20.0	1.95
22.1184	1.95
24.0	1.95
32.0	1.95

74LS00

74LS00	.16
74LS01	.18
74LS02	.17
74LS03	.18
74LS04	.16
74LS05	.18
74LS06	.18
74LS09	.18
74LS10	.16
74LS11	.22
74LS12	.22
74LS13	.26
74LS14	.39
74LS15	.26
74LS20	.17
74LS21	.22
74LS22	.22
74LS27	.23
74LS28	.26
74LS30	.17
74LS32	.18
74LS33	.28
74LS37	.26
74LS38	.26
74LS42	.39
74LS47	1.29
74LS48	.85
74LS51	.17
74LS73	.29
74LS74	.24
74LS75	.29
74LS76	.29
74LS83	.49
74LS85	.49
74LS86	.22
74LS90	.39
74LS92	.49
74LS93	.39
74LS95	.49
74LS107	.39
74LS109	.36
74LS112	.29
74LS122	.45
74LS123	.49
74LS124	2.75
74LS125	.39
74LS126	.39
74LS132	.49
74LS133	.49
74LS136	.39
74LS138	.39
74LS139	.39
74LS145	.99
74LS147	.99
74LS148	.99
74LS151	.39
74LS153	.39
74LS154	1.49
74LS155	.59
74LS156	.49
74LS157	.35
74LS159	.29
74LS160	.29
74LS161	.39
74LS162	.49
74LS163	.39
74LS164	.49

HIGH SPEED CMOS

A new family of high speed CMOS logic featuring the speed of low power Schottky™, 3ns typical gate propagation delay, combined with the advantages of CMOS: very low power consumption, superior noise immunity, and improved output drive.

74HC00

74HC: Operate at CMOS logic levels and are ideal for new, all-CMOS designs

74HC00	.59	74HC148	1.19
74HC02	.59	74HC151	.89
74HC04	.59	74HC154	2.49
74HC08	.59	74HC157	.89
74HC10	.59	74HC158	.95
74HC14	.79	74HC163	1.15
74HC20	.59	74HC175	.99
74HC27	.59	74HC240	1.89
74HC30	.59	74HC244	1.89
74HC32	.69	74HC245	1.89
74HC51	.69	74HC257	.85
74HC74	.75	74HC259	1.39
74HC85	1.35	74HC273	1.89
74HC86	.69	74HC299	4.99
74HC93	1.19	74HC368	.99
74HC107	.79	74HC373	2.29
74HC109	.79	74HC374	2.29
74HC112	.79	74HC390	1.39
74HC125	1.19	74HC393	1.39
74HC132	1.19	74HC4017	1.39
74HC133	.69	74HC4020	1.39
74HC138	.99	74HC4049	.89
74HC139	.99	74HC4050	.89

8200

8203	24.95
8205	3.29
8212	1.49
8216	1.49
8224	2.25
8237	4.95
8237-5	5.49
8250	6.95
8251	1.89
8251A	1.89
8253	1.89
8253-5	1.95
8255	1.69
8255-5	1.89
8259	2.29
8272	4.95
8279	2.49
8279-5	2.95
8282	3.95
8284	2.95
8286	3.95
8288	4.95

2.0 MHZ

6502A	2.95
6520A	2.95
6522A	5.95
6532A	11.95
6545A	7.95
6551A	6.95

DISK CONTROLLERS

1771	4.95
1791	9.95
1793	9.95
1795	12.95
1797	12.95
2791	19.95
2793	19.95
2797	29.95
6843	19.95
8272	4.95
UPD765	4.95
MB88776	12.95
MB8877	12.95
1691	6.95
2143	6.95

CRYSTAL OSCILLATORS

1.0MHz	5.95
1.8432	5.95
2.0	5.95
2.4576	5.95
2.5	4.95
4.0	4.95
5.0688	4.95
6.0	4.95
6.144	4.95
8.0	4.95
10.0	4.95
12.0	4.95
12.480	4.95
15.0	4.95
16.0	4.95
18.432	4.95
20.0	4.95
24.0	4.95

74LS00

74LS165	.65
74LS166	.95
74LS169	.95
74LS173	.49
74LS174	.39
74LS175	.39
74LS191	.49
74LS192	.69
74LS193	.69
74LS194	.69
74LS195	.69
74LS196	.69
74LS197	.59
74LS221	.59
74LS240	.69
74LS241	.69
74LS243	.69
74LS245	.69
74LS251	.49
74LS253	.49
74LS256	1.79
74LS257	.39
74LS258	.39
74LS260	1.29
74LS262	.39
74LS263	.79
74LS279	.39
74LS280	1.98
74LS283	.59
74LS290	.89
74LS299	1.49
74LS322	3.95
74LS323	2.49
74LS364	1.95
74LS365	.39
74LS367	.39
74LS373	.79
74LS374	.79
74LS375	.79
74LS377	.79
74LS378	1.18
74LS390	1.19
74LS393	.79
74LS41	1.49
74LS42	1.95
74LS44	.99
74LS45	.99
74LS46	.89
74LS48	3.20
74LS683	3.20
74LS684	3.20
74LS688	2.40
74LS783	22.95
81LS95	1.49
81LS96	1.49
81LS98	1.49
25LS2521	2.80
25LS2569	2.80
26LS31	1.95
26LS32	1.95

74HC00

74HC: Direct, drop-in replacements for LS TTL and can be intermixed with 74LS in the same circuit.

74HC00	.69	74HC166	3.05
74HC02	.69	74HC174	1.09
74HC04	.69	74HC193	1.39
74HC08	.69	74HC194	1.19
74HC10	.69	74HC240	2.19
74HC14	.69	74HC241	2.19
74HC27	.69	74HC244	2.49
74HC30	.69	74HC245	2.19
74HC32	.79	74HC257	.99
74HC74	.85	74HC259	1.59
74HC75	.95	74HC273	2.09
74HC138	1.15	74HC367	1.09
74HC139	1.15	74HC373	2.49
74HC154	2.99	74HC374	2.49
74HC157	.99	74HC393	1.59
74HC158	.99	74HC4017	2.19
74HC161	1.29	74HC4040	1.59
74HC164	1.39	74HC4060	1.49

Z-80

Z80-CPU 2.5 MHz	1.69
Z80A-CPU	1.79
Z80A-CTC	1.89
Z80A-DART	5.95
Z80A-DMA	5.95
Z80A-PIO	1.89
Z80A-SIO/0	5.95
Z80A-SIO/1	5.95
Z80A-SIO/2	5.95

2.0 MHZ

68800	4.95
68802	5.95
68809E	6.95
68809	6.95
68821	3.95
68845	6.95
68850	2.95
68854	7.95

UARTS

EGA CARD AND MONITOR NOW ONLY \$569!

DISK DRIVES FOR APPLE COMPUTERS

AP-150
\$99.95



- 1/2" HT. DIRECT DRIVE
- 100% APPLE COMPATIBLE
- SIX MONTH WARRANTY

AP-135
\$129.95

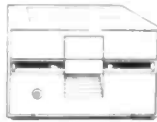

- FULL HT SHUGART MECHANISM
- DIRECT REPLACEMENT FOR APPLE DISK II
- SIX MONTH WARRANTY

DOUBLE SIDED!

MAC535
\$249.95



- 3.5" ADD-ON DISK DRIVE
- 100% MACINTOSH COMPATIBLE
- DOUBLE SIDED 800K BYTE STORAGE
- HIGH RELIABILITY DRIVE
- HAS AUTO-EJECT MECHANISM
- FULL ONE YEAR WARRANTY

AD-3C
\$139.95



- 100% APPLE IIc COMPATIBLE
- READY TO PLUG IN, W/ SHIELDED CABLE & MOLDED 19 PIN CONNECTOR
- FAST, RELIABLE SLIMLINE DIRECT DRIVE
- SIX MONTH WARRANTY

DISK DRIVE ACCESSORIES

- FDD CONTROLLER CARD \$49.95
 - IIc ADAPTOR CABLE \$19.95
- ADAPTS STANDARD APPLE DRIVES FOR USE WITH APPLE IIc

KB-1000 **\$79.95**

CASE WITH KEYBOARD FOR APPLE TYPE MOTHERBOARD

- USER DEFINED FUNCTION KEYS
- NUMERIC KEYPAD WITH CURSOR CONTROL
- CAPS LOCK
- AUTO-REPEAT

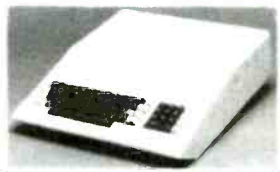

KEYBOARD-AP **\$49.95**

- REPLACEMENT FOR APPLE II KEYBOARD
- CAPS LOCK KEY, AUTO-REPEAT
- ONE KEY ENTRY OF BASIC OR CP/M COMMANDS

JOYSTICK CB-10 **\$19.95**

- SET X-Y AXIS FOR AUTO CENTER OR FREE MOVEMENT
- FIRE BUTTON FOR USE WITH GAME SOFTWARE
- ATTRACTIVE, SOLID, PLASTIC CASE
- INCLUDES ADAPTOR CABLE FOR IBM, APPLE II, IIc, IIc, ATARI AND VIC 20/64



POWER STRIP

- UL APPROVED
- 15A CIRCUIT BREAKER

\$12.95

CRT MONITORS FOR ALL APPLICATIONS



CASPER EGA MONITOR

- EGA & CGA COMPATIBLE
- SCANNING FREQUENCIES 15.75 21.85 KHz
- RES. 640 x 200 350
- 31mm DOT PITCH, 25 MHz
- 16 COLORS OUT OF 64
- 14" BLACK MATRIX SCREEN

\$399.95



CASPER RGB MONITOR

- COLOR GREEN AMBER SWITCH ON REAR
- DIGITAL RGB-IBM COMPATIBLE
- 14" NON-GLARE SCREEN
- RESOLUTION: 640H x 240V
- 39mm DOT PITCH
- CABLE FOR IBM PC INCLUDED

\$299.95



SAMSUNG MONOCHROME

- IBM COMPATIBLE TTL INPUT
- 12" NON-GLARE AMBER LOW DISTORTION SCREEN
- RESOLUTION: 720H x 350V
- ATTRACTIVE CASE WITH SWIVEL BASE
- ONE YEAR WARRANTY

\$119.95



FORTRONICS MONOCHROME

- IBM COMPATIBLE TTL INPUT
- 12" NON-GLARE SCREEN
- VERY HIGH RESOLUTION 1100 LINES (CENTER)
- 25 MHz BANDWIDTH
- CABLE FOR IBM PC INCLUDED

\$99.95

TILT & SWIVEL MONITOR STAND \$12⁹⁵

WITH POWER CENTER \$39⁹⁵

APPLE COMPATIBLE INTERFACE CARDS



EPROM PROGRAMMER

- DUPLICATE OR BURN ANY 27xx SERIES EPROM (2716 TO 27128)
- MENU-DRIVEN SOFTWARE
- HIGH SPEED WRITE ALGO RITHM

RP-525 **\$59⁹⁵**



16K RAMCARD

- FULL 2 YEAR WARRANTY
- EXPAND YOUR 48K MACHINE TO A FULL 64K OF MEMORY
- CAN BE USED IN PLACE OF THE APPLE LANGUAGE CARD

RAM-CARD **\$39⁹⁵**



IC TEST CARD

- QUICKLY TESTS MANY COMMON ICs
- OBTAINS PASS OR FAIL
- TEST 4000 & 74HC SERIES CMOS, 7400, 74LS, 741, 74H & 74S

IC-TESTER **\$129⁹⁵**

MOLDED INTERFACE CABLES

6 FOOT, 100% SHIELDED, MEETS FCC



- IBM PARALLEL PRINTER CABLE 9.95
- CENTRONICS (MALE TO FEMALE) 15.95
- CENTRONICS (MALE TO MALE) 14.95
- MODEM CABLE (FOR IBM) 7.95
- RS232 SERIAL (MALE TO FEMALE) 9.95
- RS232 SERIAL (MALE TO MALE) 9.95
- KEYBOARD EXTENDER (COILED) 7.95
- APPLE II JOYSTICK EXTENDER 4.95

SWITCH BOXES

ALL LINES SWITCHED, GOLD PLATED CONNECTORS, QUALITY SWITCHES

2 WAY **\$39.95**

- CONNECTS 2 PRINTERS TO COMPUTER OR VICE VERSA

AB-P (CENTRONICS PARALLEL)
AB-S (RS232 SERIAL)



3 WAY **\$99.95**

- CONNECTS 3 PRINTERS TO 1 COMPUTER OR VICE VERSA

SWITCH-3P (CENTRONICS PARALLEL)
SWITCH-3S (RS232 SERIAL)



300B MODEM **\$49.95**

- FOR APPLE OR IBM
 - INCLUDES ASCII PRO-EZ SOFTWARE
 - FCC APPROVED
 - BELL SYSTEMS 103 COMPATIBLE
 - INCLUDES AC ADAPTOR
 - AUTO-DIAL
 - DIRECT CONNECT
- CABLE FOR APPLE IIc \$14.95

C. ITOH RITEMAN II PRINTER



- 160 CPS DRAFT, 32 CPS NLQ
- 9 x 9 DOT MATRIX
- SUPPORTS EPSON/IBM GRAPHICS
- FRICTION AND PIN FEEDS
- VARIABLE LINE SPACING AND PITCH

\$219.95

- IBM PRINTER CABLE \$8.95
- REPLACEMENT RIBBON CARTRIDGE \$7.95

NASHUA DISKETTES

NASHUA DISKETTES WERE JUDGED TO HAVE THE HIGHEST POLISH AND RECORDED AMPLITUDE OF ANY DISKETTES TESTED (COMPARING FLOPPY DISKS, BYTE 9/84)

- N-MD2 DS/DD 5 1/4" SOFT \$9.90
- N-MD2F DS/QUAD 5 1/4" SOFT \$19.95
- N-MD2H DS/HD 5 1/4" FDR AT \$24.95
- N-FD1 SS/DD 8" SOFT \$27.95
- N-FD2 DS/DD 8" SOFT \$34.95

BULK DISKETTE SALE

5 1/4" SOFT SECTOR, DS/DD W/ TYVEC SLEEVES & HUB RINGS

\$9.90 **69c ea** **59c ea**

BOX OF 10 BULK QTY 50 BULK QTY 250

DISKETTE FILES

- 5 1/4" DISKFILE HOLDS 70 \$8.95
- 3 1/2" DISKFILE HOLDS 40 \$8.95



Seagate

5 1/4" HARD DISK DRIVES

- ST-225 HALF HT 20MB 65ms \$275
- ST-238 HALF HT 30MB 65ms (PLL) \$299
- ST-251 HALF HT 40MB 40ms \$599
- ST-277 HALF HT 60MB 40ms (PLL) CALL
- ST-4038 FULL HT 30MB 40ms \$559
- ST-4096 FULL HT 80MB 28ms \$1195

1/2" HEIGHT FLOPPY DISK DRIVES

- 5 1/4" TEAC FD-55B DS/DD \$109.95
- 5 1/4" TEAC FD-55F DS/QUAD \$124.95
- 5 1/4" TEAC FD-55GFV DS/HD \$154.95
- 5 1/4" MITSUBISHI DS/HD \$129.95
- 3 1/2" TOSHIBA KIT DS/DD \$149.95

KIT INCLUDES MOUNTING HARDWARE TO FIT 5 1/4" & FACEPLATES FOR AT & XT

DISK DRIVE ACCESSORIES

- TEAC SPECIFICATION MANUAL \$5.00
- TEAC MAINTENANCE MANUAL \$25.00
- 1/2" HT MNTG HARDWARE FOR IBM \$2.95
- MOUNTING RAILS FOR IBM AT \$4.95
- 1/2" POWER CABLE FOR 5 1/4" FDDs \$2.95
- 5 1/4" FDD POWER CONNECTORS \$1.19

DISK DRIVE ENCLOSURES WITH POWER SUPPLIES

- CAB-23V5 DUAL SLIMLINE 5 1/4" \$49⁹⁵
- CAB-1FH5 FULL HT 5 1/4" \$89⁹⁵
- CAB-23V8 DUAL SLIMLINE 8" \$208⁹⁵
- CAB-2FH8 DUAL FULL HT 8" \$218⁹⁵



BUILD STEVE CIARGIA'S INTELLIGENT EPROM PROGRAMMER

AS SEEN IN BYTE, OCT 86

- STAND-ALONE OR RS-232 SERIAL OPERATION
- MENU SELECTABLE EPROM TYPES - NO CONFIGURATION JUMPERS
- PROGRAMS ALL 5V 27XXX EPROMS FROM 2716 TO 27512
- READ, COPY OR VERIFY EPROM
- UPLOAD / DOWNLOAD INTEL HEX FILES
- PROGRAMMER DRIVER USER MODIFIABLE

ONLY \$199

KIT INCLUDES PCB AND ALL COMPONENTS EXCEPT CASE & POWER SUPPLY

CALL FOR VOLUME QUOTES COPYRIGHT 1987 JDR MICRODEVICES

CIRCLE 180 ON FREE INFORMATION CARD

EGA CARD AND MONITOR NOW ONLY \$569!

QUALITY IBM COMPATIBLE MOTHERBOARDS

FROM MODULAR CIRCUIT TECHNOLOGY

TURBO 4.77 / 8 MHZ \$129.95

JDR PART #: MCT-TURBO

- 4.77 OR 8 MHZ OPERATION WITH 8088-2 & OPTIONAL 8087-2 CO-PROCESSOR
- DYNAMICALLY ADJUSTS SPEED DURING DISKETTE OPERATION FOR MAXIMUM THROUGHPUT AND RELIABILITY
- CHOICE OF NORMAL TURBO MODE OR SOFTWARE SELECT PROCESSOR SPEED

STANDARD 4.77 MHZ \$109.95

JDR PART #: MCT-XTMB

- 8088 CPU, OPTIONAL 8087 CO-PROCESSOR
- 8 EXPANSION SLOTS
- EXPANDABLE TO 640K ON-BOARD MEMORY (0K RAM INSTALLED)
- ALLIC-SOCKETED-HIGHEST QUALITY PCB
- ACCEPTS 2764 OR 27128 ROMS

BOTH WITH FREE MCT BIOS!

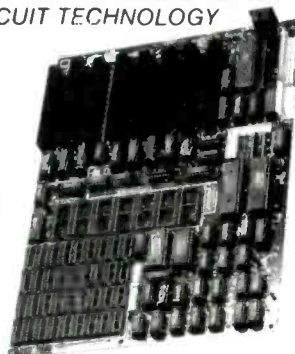

FARADAY FDD CONTROLLER

JDR PART #: FAR-FDD

- SUPPORTS UP TO 4 INTERNALLY MOUNTED FDD'S
- IBM COMPATIBLE, INTERFACES TO 360K OR 720K USING DOS 3.20
- INCLUDES CABLE FOR 2 DISK DRIVES

\$24.95

IBM COMPATIBLE FLOPPY DISK DRIVE

JDR PART #: FDD-360

- GOOD QUALITY DRIVES BY MAJOR MANUFACTURERS SUCH AS QUME, TANDON & CDC
- 5 1/4" HALF HEIGHT
- 360K STORAGE CAPACITY
- DS, DD
- 48 TPI

\$69.95

IBM STYLE COMPUTER CASE

AN ATTRACTIVE STEEL CASE WITH A HINGED LID. FITS THE POPULAR PC/XT COMPATIBLE MOTHERBOARDS



- SWITCH CUT-OUT ON SIDE FOR PC XT STYLE POWER SUPPLY
- CUT-OUT FOR 8 EXPANSION SLOTS
- ALL HARDWARE INCLUDED

\$34.95

SLIDE TYPE CASE \$39.95

BUILD YOUR OWN 256K XT COMPATIBLE SYSTEM

- **KT MOTHERBOARD \$109.95**
- **PRO-BIOS (A \$20 VALUE) FREE!**
- **256K RAM \$28.95**
- **130 WATT POWER SUPPLY \$89.95**
- **FLIP-TOP CASE \$34.95**
- **KEY TRONIC™ KEYBOARD \$49.95**
- **360K DRIVE \$89.95**
- **FARADAY CONTROLLER \$24.95**
- **MONOCHROME ADAPTOR \$49.95**
- **FORTRONICS MONITOR \$99.95**

TOTAL: \$536.15

IBM COMPATIBLE KEYBOARDS



MCT-5150 \$59.95

- '5150' STYLE KEYBOARD
- FULLY IBM COMPATIBLE
- LED STATUS INDICATORS FOR CAPS & NUMBER LOCK
- LARGE, EASY TO REACH SHIFT & RETURN KEYS
- 83 KEY TYPEWRITER LAYOUT



MCT-5151 \$79.95

- REPLACEMENT FOR KEY TRONIC™ KB 5151 KEYBOARD
- SEPARATE CURSOR & NUMERIC KEYPAD
- CAPS LOCK & NUMBER LOCK INDICATORS
- IMPROVED KEYBOARD LAYOUT



MCT-5060 \$59.95

- IBM AT STYLE LAYOUT
- SOFTWARE AUTONSENSE FOR XT OR AT COMPATIBLES
- EXTRA LARGE SHIFT & RETURN KEYS
- LED INDICATORS FOR SCROLL, CAPS & NUMBER LOCK
- AUTO REPEAT FEATURE



MCT-5339 \$89.95

- IBM ENHANCED STYLE LAYOUT
- SOFTWARE AUTONSENSE FOR XT OR AT COMPATIBLES
- 12 FUNCTION KEYS
- EXTRA LARGE SHIFT & RETURN KEYS
- LED INDICATORS FOR SCROLL, CAPS & NUMBER LOCK
- AUTO REPEAT FEATURE
- SEPARATE CURSOR PAD

MCT PRODUCTS CARRY A ONE YEAR WARRANTY

EASYDATA MODEMS

All models feature auto-dial/answer/redial on busy, Hayes compatible, power up self test, touchtone or pulse dialing, built-in speaker, PC Talk III Communications software, Bell Systems 103 & 212A full or half duplex and more.

INTERNAL

EASYDATA-12H \$99.95
1200 BUAD HALF CARD

EASYDATA-12B \$119.95
1200 BUAD 1C" CARD

EASYDATA-24B \$199.95
2400 BUAD FULL CARD

EXTERNAL

NO SOFTWARE INCLUDED

EASYDATA-12D \$119.95
1200 BUAD

EASYDATA-24D \$219.95
2400 BUAD



DISPLAY CARDS

FROM MODULAR CIRCUIT TECHNOLOGY

MCT-EGA

\$179.95

100% IBM COMPATIBLE, PASSES IBM EGA DIAGNOSTICS

- COMPATIBLE WITH IBM EGA, COLOR GRAPHICS AND MONOCHROME ADAPTORS
- TRIPLE SCANNING FREQUENCY FOR DISPLAY ON EGA, STANDARD RGE OR HIGH RESOLUTION MONOCHROME MONITOR
- FULL 256K OF VIDEO RAM ALLOWS 640 x 350 PIXELS IN 16 OF 64 COLORS
- LIGHT PEN INTERFACE



MCT-CGP

\$49.95

COMPATIBLE WITH IBM COLOR GRAPHICS STANDARD

- SHORT SLOT CARD USES /LSI CHIPS TO INSURE RELIABILITY
- PARALLEL PRINTER PORT CONFIGURABLE AS LPT1 OR LPT2
- SUPPORTS RGB, COMPOSITE MONOCHROME & COLOR AND AN RF MODULATOR OUTPUT
- 320 x 200 COLOR GRAPHICS MODE
- 640 x 200 MONOCHROMICS MODE



MCT-MGP

\$59.95

COMPATIBLE WITH IBM MONOCHROME AND HERCULES GRAPHICS STANDARDS

- SHORT SLOT CARD USES /LSI CHIPS TO INSURE RELIABILITY
- PARALLEL PRINTER PORT, CONFIGURABLE AS LPT1 OR LPT2
- 720 x 348 GRAPHICS MODE
- LOTUS COMPATIBLE
- CAN RUN WITH COLOR GRAPHICS CARD IN THE SAME SYSTEM



MCT-MG

\$79.95

COMPATIBLE WITH IBM MONOCHROME AND HERCULES GRAPHICS STANDARDS

- SERIAL PORT OPTION
- PARALLEL PRINTER PORT
- 720 x 348 GRAPHICS MODE
- 80 x 25 TEXT MODE
- LOTUS COMPATIBLE
- SELECTABLE TO RUN ALONG WITH COLOR GRAPHICS CARD IN THE SAME SYSTEM



MG-SERIAL OPTIONAL SERIAL PORT \$19.95

MCT-MONO

\$49.95

ANOTHER FANTASTIC VALUE FROM JDR!

- IBM COMPATIBLE TTL INPUT
 - 720 x 348 PIXEL DISPLAY
- PLEASE NOTE THIS CARD WILL NOT RUN LOTUS GRAPHICS AND DOES NOT INCLUDE A PARALLEL PORT

EPROM PROGRAMMERS

FROM MODULAR CIRCUIT TECHNOLOGY

MCT-EPROM

\$129.95

PROGRAMS 27xx AND 27xxx SERIES EPROMS UP TO 27512

- SUPPORTS VARIOUS MANUFACTURERS FORMATS WITH 12.5, 21 AND 25 VOLT PROGRAMMING
- MENU-DRIVEN SOFTWARE ALLOWS EASY MANIPULATION OF DATA FILES
- SPLIT OR COMBINE THE CONTENTS OF SEVERAL EPROMS OF DIFFERENT SIZES
- READ, WRITE, COPY, ERASE CHECK AND VERIFY WITH EASY ONE KEY SELECTION
- INCLUDES SOFTWARE FOR STANDARD HEX AND INTEL HEX FORMATS

4 GANG PROGRAMMER \$189.95

10 GANG PROGRAMMER \$299.95

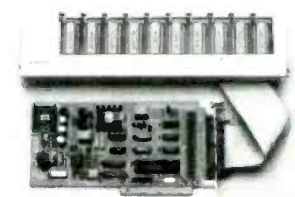

1200B MODEM \$99⁹⁵

**FOR IBM W/
SOFTWARE**

2400B MODEM \$119⁹⁵

MULTIFUNCTION CARDS

FROM MODULAR CIRCUIT TECHNOLOGY

MCT-MF \$84.95

ALL THE FEATURES OF AST'S SIX PACK PLUS AT HALF THE PRICE!

- 0-348K DYNAMIC RAM USING 4164s
- INCLUDES SERIAL PORT, PARALLEL PRINTER PORT, GAME CONTROLLER PORT AND CLOCK / CALENDAR
- SOFTWARE FOR A RAMDISK, PRINT SPOOLER AND CLOCK / CALENDAR



MCT-ATMF \$139.95

ADDS UP TO 3 MB OF 1 BIT RAM TO THE AT

- USER EXPANDABLE TO 1.5 MB OF ON-BOARD MEMORY (NO MEMORY INSTALLED)
- FLEXIBLE ADDRESS CONFIGURATION
- INCLUDES SERIAL PORT, PARALLEL PORT AND CLOCK / CALENDAR
- OPTIONAL PIGGYBACK BOARD PERMITS EXPANSION TO 3 MB



ATMF-SERIAL 2nd SERIAL PORT \$24⁹⁵
MCT-ATMF-MC \$29⁹⁵
PIGGYBACK BOARD (ZERO K INSTALLED)

MCT-MIO \$79.95

A PERFECT COMPANION FOR OUR MOTHERBOARD

- 2 DRIVE FLOPPY DISK CONTROLLER
- INCLUDES SERIAL PORT, PARALLEL PORT, GAME PORT AND CLOCK / CALENDAR WITH BATTERY BACK-UP
- SOFTWARE FOR A RAMDISK, PRINT SPOOLER AND CLOCK / CALENDAR



MIO-SERIAL 2nd SERIAL PORT \$15⁹⁵

MCT-IO \$59.95

USE WITH MCT-FH FOR A MINIMUM OF SLOTS USED

- SERIAL PORT ADDRESSABLE AS COM1, COM2, COM3 OR COM4
- PARALLEL PRINTER PORT ADDRESSABLE AS LPT1 OR LPT2 (x378 OR x278)
- GAME PORT AND CLOCK / CALENDAR WITH A BATTERY BACK-UP



IO-SERIAL 2nd SERIAL PORT \$15⁹⁵

MCT-ATIO \$59.95

USE WITH MCT-ATFH FOR A MINIMUM OF SLOTS USED

- SERIAL PORT ADDRESSABLE AS COM1, COM2, COM3 OR COM4
- PARALLEL PRINTER PORT ADDRESSABLE AS LPT1 OR LPT2 (x378 OR x278)
- GAME PORT
- USES 16450 SERIAL SUPPORT CHIPS FOR HIGH SPEED OPERATION IN AN AT



ATIO-SERIAL 2nd SERIAL PORT \$24⁹⁵

RAM CARDS

FROM MODULAR CIRCUIT TECHNOLOGY

MCT-RAM \$69.95

A CONTIGUOUS MEMORY SOLUTION FOR YOUR SHORT OR REGULAR SLOT

- SHORT SLOT, LOW POWER PC COMPATIBLE DESIGN
- CAN OFFER UP TO 576K OF ADDITIONAL MEMORY
- USER SELECTABLE CONFIGURATION AMOUNTS OF 192, 384, 512, 256 & 576K, USING COMBINATIONS OF 64 & 256K RAM



MCT-ATRAM \$149.95

A POWER USER'S DREAM, 4MB OF MEMORY FOR THE AT

- USER EXPANDABLE TO 2MB OF ON-BOARD MEMORY
- USES FULL 16 BIT PARITY CHECKED MEMORY, 64K OR 256K DYNAMIC RAM
- FLEXIBLE STARTING ADDRESS, ROUND OUT CONVENTIONAL MEMORY TO 640K & ADD EXTENDED MEMORY ABOVE 1MB



MCT-ATRAM-MC \$39⁹⁵
2MB PIGGYBACK BOARD (ZERO K INSTALLED)

MCT-EMS \$129.95

2MB OF LOTUS/INTELMICROSOFT COMPATIBLE MEMORY FOR THE AT

- CONFORMS TO LOTUS / INTEL EMS
- USER EXPANDABLE TO 2 MB
- USES 64K OR 256K DYNAMIC RAM (NO MEMORY INSTALLED)
- USE AS EXPANDED OR CONVENTIONAL MEMORY, RAMDISK OR SPOOLER
- SOFTWARE INCLUDES EMS DEVICE DRIVERS, PRINT SPOOLER AND RAMDISK



MCT-ATEMS AT VERSION OF THE MCT-EMS \$139⁹⁵

JDR Microdevices

THE JDR MICRODEVICES LOGO IS A REGISTERED TRADEMARK OF JDR MICRODEVICES. JDR INSTRUMENTS AND JDR MICRODEVICES ARE TRADEMARKS OF JDR MICRODEVICES. IBM'S A TRADEMARK OF INTERNATIONAL BUSINESS MACHINES.

COPYRIGHT 1987 JDR MICRODEVICES

Seagate

HARD DISK SYSTEMS

20 MB \$339 **30 MB \$399**

Systems include half height hard disk drive, hard disk drive controller, cables and instructions. Drives are pre-tested and warranted for one year.

Seagate 40 MB AT DRIVE
FAST 40ms ACCESS TIME



\$599

DISK CONTROLLER CARDS

FROM MODULAR CIRCUIT TECHNOLOGY

MCT-FDC \$34.95

QUALITY DESIGN OFFERS 4 FLOPPY CONTROL IN A SINGLE SLOT

- INTERFACES UP TO 4 FDDs TO AN IBM PC OR COMPATIBLE
- INCLUDES CABLING FOR 2 INTERNAL DRIVES
- USES STANDARD DB37 CONNECTOR FOR EXTERNAL DRIVES
- SUPPORTS BOTH DS-OD AND DS-OD WHEN USED WITH DOS 3.2 OR JFORMAT

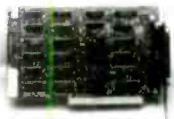

MCT-HDC \$89.95

HARD DISK CONTROL FOR WHEN OTHERS CHARGE FOR FLOPPY CONTROL

- IBM XT COMPATIBLE CONTROLLER SUPPORTS 16 DIFFERENT DRIVE SIZES INCLUDING 5, 10, 20, 30 & 40MB
- OPTIONS INCLUDE THE ABILITY TO DIVIDE 1 LARGE DRIVE INTO 2 SMALLER, LOGICAL DRIVES
- INCLUDES CABLING FOR 1 INTERNAL DRIVE

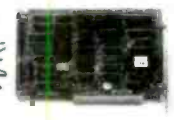

MCT-RLI \$119.95

GET UP TO 50% MORE STORAGE SPACE ON YOUR HARD DISK

- INCREASES THE CAPACITY OF PLATED MEDIA DRIVES BY 50%
- RLL 2.7 ENCODING FOR MORE RELIABLE STORAGE
- TRANSFER RATE IS ALSO 50% FASTER: 750K vs 500K bps
- USE WITH ST-238 DRIVE TO ACHIEVE 30+ MB IN A HALF HEIGHT SLOT



NEW!

MCT-FH \$139.95

STARVED FOR SLOTS? SATISFY IT WITH THIS TIMELY DESIGN

- INTERFACES UP TO 2 FDDs & 2 HDDs
- CABLING FOR 2 FDDs & 1 HDD
- FLOPPY INTERFACE SUPPORTS BOTH DS-OD & DS-OD WHEN USED WITH DOS 3.2 OR JFORMAT
- ALL POPULAR HDD SIZES ARE SUPPORTED, INCLUDING 5, 10, 20, 30 & 40MB
- CAN DIVIDE 1 LARGE DRIVE INTO 2 SMALLER, LOGICAL DRIVES



MCT-ATFH \$169.95

FLOPPY AND HARD DISK CONTROL IN A TRUE AT DESIGN

- AT COMPATIBLE, CONTROL UP TO 2: 60K 720K OR 1.2MB FDDs AS WELL AS 2 HDDs USING THE AT STANDARD CONTROL TABLES
- SUPPORTS AT STYLE FRONT PANEL LED TO INDICATE HD ACTIVITY
- 16 BIT BUS PROVIDES RAPID DATA TRANSFERS
- FULLY SUPPORTED BY AT BIOS



110 Knowles Drive, Los Gatos, CA 95030

Toll Free 800-538-5000 • (408) 866-6200 • FAX (408) 378-8927 • Telex 171-110

MAY 1987

1200B MODEM \$99⁹⁵

**FOR IBM W/
SOFTWARE**

2400B MODEM \$119⁹⁵

BARGAIN HUNTERS CORNER

KEY TRONIC™ \$49⁹⁵

- 5150 STYLE IBM KEYBOARD**
 * IMPROVED KEYBOARD LAYOUT
 * 83 KEYS, FULLY IBM COMPATIBLE
 * LED INDICATORS FOR CAPS & NUMBER LOCK

NEW! TOSHIBA 3 1/2" FDD KIT

- 360K, DOUBLE SIDED/DOUBLE DENSITY**
 * MOUNTING HARDWARE FOR 5 1/4" SLOT
 * FACEPLATE FOR BOTH AT & XT MACHINES

\$149⁹⁵

SPECIALS ENDS 6/30/87

PAGE WIRE WRAP WIRE PRECUT ASSORTMENT
 IN ASSORTED COLORS \$27.50

100ea: 5.5", 6.0", 6.5", 7.0"
 250ea: 2.5", 4.5", 5.0"
 500ea: 3.0", 3.5", 4.0"

SPOOLS

100 feet \$4.30 250 feet \$7.25
 500 feet \$13.25 1000 feet \$21.95

Please specify color:
 Blue, Black, Yellow or Red

EXTENDER CARDS

IBM-PC \$29.95
 IBM-AT \$39.95



WIRE WRAP PROTOTYPE CARDS
 FR-4 EPOXY GLASS LAMINATE
 WITH GOLD-PLATED EDGE-CARD FINGERS



IBM-PR2
IBM
 BOTH CARDS HAVE SILK SCREENED LEGENDS
 AND INCLUDES MOUNTING BRACKET
 IBM-PR1 WITH .5V AND GROUND PLANE \$27.95
 IBM-PR2 AS ABOVE WITH DECODING LAYOUT \$29.95

S-100

P100-1 BARE - NO FOIL PADS \$15.15
 P100-2 HORIZONTAL BUS \$21.80
 P100-3 VERTICAL BUS \$21.80
 P100-4 SINGLE FOIL PADS PER HOLE \$22.75

APPLE

P500-1 BARE - NO FOIL PADS \$15.15
 P500-3 HORIZONTAL BUS \$22.75
 P500-4 SINGLE FOIL PADS PER HOLE \$21.80
 7060-45 FOR APPLE IIe AUX SLOT \$30.00

SOCKET-WRAP I.D.™

- SLIPS OVER WIRE WRAP PINS
- IDENTIFIES PIN NUMBERS ON WRAP SIDE OF BOARD
- CAN WRITE ON PLASTIC, SUCH AS IC #

PINS	PART#	PCK. OF	PRICE
8	IDWRAP 08	10	1.95
14	IDWRAP 14	10	1.95
16	IDWRAP 16	10	1.95
18	IDWRAP 18	5	1.95
20	IDWRAP 20	5	1.95
22	IDWRAP 22	5	1.95
24	IDWRAP 24	5	1.95
28	IDWRAP 28	5	1.95
40	IDWRAP 40	5	1.95

PLEASE ORDER BY NUMBER OF PACKAGES (PCK. OF)

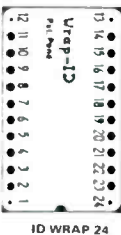

FRAME STYLE TRANSFORMERS

12.6V AC CT	2 AMP	5.95
12.6V AC CT	4 AMP	7.95
12.6V AC CT	8 AMP	10.95
25.2V AC CT	2 AMP	7.95

25 PIN D-SUB GENDER CHANGERS



\$7.95

SWITCHING POWER SUPPLIES

PS-IBM \$69.95

- FOR IBM PC-XT COMPATIBLE
- 135 WATTS
- .5V @ 15A, .12V @ 4.2A
- .5V @ 5A, .12V @ 5A
- ONE YEAR WARRANTY



PS-IBM-150 \$79.95

- FOR IBM PC-XT COMPATIBLE
- 150 WATTS
- .12V @ 5.2A, .5V @ 16A
- .12V @ 5A, .5V @ 5A
- ONE YEAR WARRANTY



PS-130 \$99.95

- 130 WATTS
- SWITCH ON REAR
- FOR USE IN OTHER IBM TYPE MACHINES
- 90 DAY WARRANTY



PS-A \$49.95

- USE TO POWER APPLE TYPE SYSTEMS, 73.5 WATTS
- .5V @ 7A, .12V @ 3A
- .5V @ 5A, .12V @ 5A
- APPLE POWER CONNECTOR



PS-1558 \$34.95

- 75 WATTS, UL APPROVED
- .5V @ 7A, .12V @ 3A
- .12V @ 250ma, .5V @ 300ma



BOOKS BY STEVE CIARCIA

- BUILD YOUR OWN Z80 COMPUTER \$19.95
- CIRCUIT CELLAR VOL 1 \$17.95
 CIRCUIT CELLAR VOL 2 \$18.95
 CIRCUIT CELLAR VOL 3 \$18.95
 CIRCUIT CELLAR VOL 4 \$18.95
 CIRCUIT CELLAR VOL 5 \$19.95

MUFFIN FANS

3.15" SQ 14.95 3.63" SQ 14.95
 3.18" SQUARE 16.95

6' LINE CORDS

2 conductor 39 3 conductor 89
 3 conductor w/ female socket 39

EMI FILTER \$4.95

WISH SOLDERLESS BREADBOARDS

PART NUMBER	DIMENSIONS	DISTRIBUTION STRIP(S)	TIE POINTS	TERMINAL STRIP(S)	TIE POINTS	BINDING POSTS	PRICE
WBU-D	.38 x 6.50"	1	100	---	---	---	2.95
WBU-T	1.38 x 6.50"	---	---	1	630	---	6.95
WBU-204-3	3.94 x 8.45"	1	100	2	1260	2	17.95
WBU 204	5.13 x 8.45"	4	400	2	1260	3	24.95
WBU 206	6.88 x 9.06"	5	500	3	1890	4	29.95
WBU 208	8.25 x 9.45"	7	700	4	2520	4	39.95



WBU-208

LITHIUM BATTERY
 AS USED IN CLOCK CIRCUITS

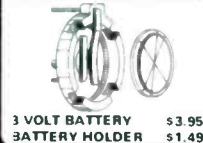

3 VOLT BATTERY \$3.95
 BATTERY HOLDER \$1.49

2 VOLUME SET

1986 IC MASTER
 THE INDUSTRY STANDARD
\$129.95

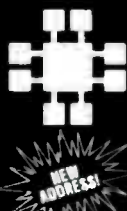

Visit our retail store located at 1256 S. Bascom Ave. in San Jose, (408) 947-8881

JDR Microdevices
 110 Knowles Drive, Los Gatos, CA 95030
 Toll Free 800-538-5000 • (408) 866-6200
 FAX (408) 378-8927 • Telex 171-110

PLEASE USE YOUR CUSTOMER NUMBER WHEN ORDERING
 TERMS: Minimum order \$10.00. For shipping and handling include \$2.50 for UPS Ground and \$3.50 for UPS Air. Orders over 1 lb. and foreign orders may require additional shipping charges. please contact our sales department for the amount. CA residents must include applicable sales tax. All merchandise is warranted for 90 days unless otherwise stated. Prices are subject to change without notice. We are not responsible for typographical errors. We reserve the right to limit quantities and to substitute manufacturer. All merchandise subject to prior sale.

COPYRIGHT 1987 JDR MICRODEVICES

THE JDR MICRODEVICES LOGO IS A REGISTERED TRADEMARK OF JDR MICRODEVICES. JDR INSTRUMENTS AND JDR MICRODEVICES ARE TRADEMARKS OF JDR MICRODEVICES. IBM IS A TRADEMARK OF INTERNATIONAL BUSINESS MACHINES. APPLE IS A TRADEMARK OF APPLE COMPUTER.

CIRCLE 183 ON FREE INFORMATION CARD

RADIO-ELECTRONICS

Radio Shack Parts Place™

PARTS FOR YOUR PROJECTS...NEIGHBORHOOD CLOSE

High-Tech ICs at Low Prices!

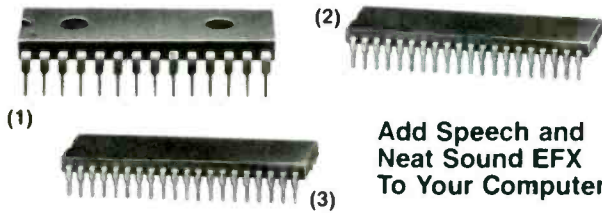

- (1) **SPO256-AL2 Speech Synthesizer.** This MOS/LSI device with a built-in program is very easy to interface with most computers. Includes detailed data and circuit examples. Requires 3.12 MHz crystal (special-order, see "Hotline" info, below). 28-pin DIP. #276-1784 12.95
- (2) **CTS256-AL2 Text-to-Speech IC.** Preprogrammed 8-bit processor translates ASCII characters into control data for Fig. 1. With detailed data, schematics. Requires 10 MHz crystal (special-order). 40-pin DIP. #276-1786, 16.95
- (3) **AY-3-8910A Sound Generator IC.** Only your imagination will limit the amazing variety of sound effects this chip can produce. Features three independently programmable audio outputs. Two 8-bit I/O ports and single 5 VDC supply operation make it easy to interface with most microprocessors. 40-pin DIP with detailed data. #276-1787 9.95

Add Speech and Neat Sound EFX To Your Computer

Unusual LEDs



- (4) **Wow! Super-Bright Red LED.** Outputs 300 mcd! #276-066 99¢
- (5) **Jumbo Red. Twin LEDs, one housing.** #276-065 1.19
- (6) **Blinking Red.** #276-036 1.19
- (7) **Blinking Green.** #276-030 1.19

Panel Switches



Fig	Description	Cat. No.	Only
8	SPST Rocker	275-690	1.89
—	DPDT Rocker	275-691	2.49
9	SPST Push Momentary	275-011	1.29
—	DPDT Push Momentary	275-609	2/1.69
10	SPST μ Toggle	275-624	1.59
—	SPDT μ Toggle	275-625	1.69
—	DPDT μ Toggle	275-626	1.99

Hobby Lamps



- 12-Volt Blinking Lamps.** 95 mA. 4" wire leads. #272-1097 Pkg. of 3/99¢
- Colored Mini Lamps** 3/69¢
- 6-Volt.** #272-1098 **12-Volt.** #272-1099

Bet on a FET



- (11) **IRF511 Power MOSFET.** Handles 60 VDC, 3 amps. #276-2072 1.99
- (12) **BS170 MOSFET.** Handles 60 VDC, 0.5 amps. #276-2074 1.19
- (13) **MPF102.** The "old workhorse". #276-2062 79¢

1/4-Watt, 5% Resistors

Pkg. of 5 **39¢**

Ohms	Cat. No.	Ohms	Cat. No.	Ohms	Cat. No.	Ohms	Cat. No.
10	271-1301	330	271-1315	4.7k	271-1330	47k	271-1342
100	271-1311	470	271-1317	10k	271-1335	100k	271-1347
150	271-1312	1k	271-1321	15k	271-1337	220k	271-1350
220	271-1313	2.2k	271-1325	22k	271-1339	470k	271-1354
270	271-1314	3.3k	271-1328	33k	271-1341	1 meg	271-1356
						10 meg	271-1365

Low-Cost Relays



Fig	Contacts	Coil	Cat. No.	Each
14	SPDT	5 VDC	275-243	1.79
15	4PDT	12 VDC	275-214	4.69
16	SPST Reed	5 VDC	275-232	1.49
—	SPST Reed	12 VDC	275-233	1.49
—	Socket for Fig. 15		275-221	1.49



- (17) **3" DC Fan.** 27 CFM. For humidity-sensitive circuits or portable devices. 7-13.8 VDC. #273-243 14.95
- (18) **3" 120 VAC Fan.** Just right for many computers. 32 CFM. UL recognized. #273-242 14.95

Hi-Q Ceramic Disc Capacitors



Low As **39¢** Pkg. of 2

pF	WVDC	Cat. No.	2-Pack	μ F	WVDC	Cat. No.	2-Pack
4.7	50	272-120	.39	0.01	500	272-126	.49
47	50	272-121	.39	0.047	500	272-130	.49
100	50	272-123	.39	.01	500	272-131	.49
220	50	272-124	.39	0.047	50	272-134	.49
470	50	272-125	.39	.1	50	272-135	.49

Knobs for 1/4" Shafts



- (19) **Communications.** 1 1/16" dia. #274-432 Pkg. of 2/1.49
- (20) **Red Insert.** 1" dia. by 5/8" #274-433 Pkg. of 2/99¢
- (21) **Blue Insert.** Matches our #270-220 series of boxes. #274-403 Pkg. of 2/79¢

Sound Off



- (22) **Tri-Sound Siren.** Wiring options create three distinctive 80 dB sounds. 3 VDC. #273-072 5.95
- (23) **Pulsing Piezo Buzzer.** 3-28 VDC. #273-066 3.59

Computer Interfacing Items



Solderless RS232 Connectors.

Fig	Type	Cat. No.	Each
24	D-Sub 25 Male	276-1559	3.99
25	D-Sub 25 Female	276-1565	3.99

(28) RS232 Ribbon Cable.

Length	Conductors	Cat. No.	Price
5 Feet	25	273-772	3.59
5 Feet	36	273-774	4.69

- (26) **36-Position Male Printer Connector.** #276-1533 5.99
- (27) **Female Connector.** #276-1523 5.99
- (29) **6-Pin DIN Plug.** #274-020 1.29
- 5-Pin DIN Plug.** #274-003 1.49
- 4-Pin DIN Plug.** #274-007 1.49

PC-Board Pots



59¢ Each
1/4 watt 260° rotation.

Ohms	Cat. No.	Ohms	Cat. No.
500	271-226	50k	271-219
1k	271-227	100k	271-220
5k	271-217	1 meg	271-229
10k	271-218	—	—

Project Box Bargains



Plastic housing, aluminum covers, hardware.

Size	Cat. No.	Each
3 1/4 x 2 1/8 x 1 1/8"	270-230	1.59
4 x 2 1/8 x 1 1/8"	270-231	1.69
5 1/16 x 2 5/8 x 1 1/8"	270-233	1.99
6 1/4 x 3 3/4 x 2"	270-627	2.39
7 3/4 x 4 3/8 x 2 3/8"	270-232	2.99

Fast "Hotline" Service

Radio Shack Can Replace Almost Any Popular IC or Semiconductor

If the device you need is not part of our regular stock, we'll special-order it from our warehouse. And there's NO postage charge or minimum order requirement! We also offer Hotline service on selected tubes, crystals, phono cartridges and more. Try us today!

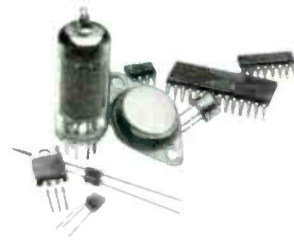

Dual-Tracking DC Supply—Super Value!

59⁹⁵ Independent Or "Slave" Operation

Quality and performance you wouldn't expect to find at this low price—check these features: 0 to 15 VDC output. Series mode for up to 30 VDC. Switched V/A meter, fuse protection, vented steel cabinet. Maximum output 1 amp per side. UL listed AC. #22-121



Over 1000 Items in stock: Binding posts, Books, Breadboards, Buzzers, Capacitors, Chokes, Clips, Coax, Connectors, Fuses, Hardware, ICs, Jacks, Knobs, Lamps, Multitesters, PC Boards, Plugs, Rectifiers, Relays, Resistors, Switches, Tools, Transformers, Transistors, Wire, Zeners, more!

Radio Shack®
A DIVISION OF TANDY CORPORATION
Prices apply at participating Radio Shack stores and dealers

Worldwide • Since 1974

• QUALITY COMPONENTS • COMPETITIVE PRICING
• PROMPT DELIVERY

Mail Order Electronics • Worldwide
Jameco
ELECTRONICS

COMMODORE® COMPATIBLE ACCESSORIES



HESWARE 300 Baud Modem

For VIC-20 and C-64

• Connects directly to User Port • Manual Answer/Dial • Function keys defined for convenience • Includes Midwest Micro Associates communication software.

CM-1 (For VIC-20 and C-64) ~~\$34.95~~ \$24.95

External Power Supply
CPS-10 (For C-64) \$39.95

Parallel Printer Interface
2K Buffer, Expandable to 10K!
MW-350 (For VIC-20, C-64 & C-128) \$54.95

TRS-80/TANDY® COMPATIBLE ACCESSORIES

E-X-P-A-N-D TRS-80 MEMORY

All kits come complete with documentation

TRS-80 MODEL 4, 4P, & 4D 64K/128K EXPANSION
TRS-64K-2 \$7.95
Expands Model 4 from 16K-64K or Model 4 (Gate Array Version) 4P and 4D from 64K-128K

TRS-64K-2PAL \$14.95
Expands Model 4 (Non-Gate Array Version) from 64K to 128K

TRS-80 MODEL 100 8K EXPANSION
M1008K \$19.95 ea. or 3 for \$54.95

ZUCKERBOARD



TANDY 1000 Expansion Memory Half Card

Expand the memory of your Tandy 1000 (128K Version) to as much as 640K. Also includes DMA controller chip.

TAN-EM256K Includes 256K RAM \$ 99.95
TAN-EM512K Includes 512K RAM \$119.95

Options for TAN-EM256K/512K
TAN-C Plug-in Clock option chip (only) \$39.95
TAN-D RAM Disk Printer Spooler Software (only) \$39.95

NEW! Expansion Memory NEW! Half Card for TANDY 1000SX

TSX256K Includes 256K RAM \$119.95



TANDY 1000 Multifunction Board with Clock Calendar

Expand the memory on your Tandy 1000 (128K Version) to as much as 640K. Complete with an RS232 port, clock/calendar, RAM Disk Printer Spooler and on-board DMA controller chip

MTAN-256K Includes 256K RAM \$179.95
MTAN-512K Includes 512K RAM \$199.95

NEW! Multifunction NEW! Board for TANDY 1000SX

M256K Includes 256K RAM \$189.95

UV-EPROM ERASER



Erases all EPROMs. Erases up to 8 chips within 21 minutes (1 chip in 15 minutes). Maintains constant exposure distance of 1" Special conductive foam liner eliminates static build-up Built-in safety lock to prevent UV exposure. Compact 9.00" x 3.70" W x 2.60" H. Complete with holding tray for 8 chips.

DE-4 UV-EPROM Eraser \$69.95

UVS-11EL Replacement Bulb \$19.95

NCF-2 Cond. Foam 12x24x1/4 Hard Bk. \$ 8.95

NOW YOU CAN BUILD AN IBM PC/XT COMPATIBLE!



IBM Compatible Kit

IBM-64K(2) 64K RAM Chips (18) . . \$ 19.90
KB83 83-Key Keyboard \$ 29.95
IBM-FCC Floppy Controller Card \$ 34.95
IBM-Case Case \$ 39.95
IBM-MCC Monochrome Card . . . \$ 59.95
IBM-PS Power Supply \$ 69.95
FD55B Disk Drive \$109.95
IBM-MON Monochrome Monitor \$ 99.95
IBM-MB Motherboard \$109.95

FREE! QUICKSOFT PC WRITE WORD PROCESSING SOFTWARE INCLUDED!

Regular List \$574.50

IBM-Special (Includes 9 items above) . . . \$499.95



IBM Special No. 2

Includes IBM AT style keyboard with tactile touch (KB5160, see below) and all the above items (except KB83) Regular List \$604.50

IBMSP2. \$529.95

ADDITIONAL ADD-ONS AVAILABLE!

IBM-KB 83-Key Keyboard \$ 59.95
IBM-ENH Enhanced Keyboard \$ 79.95
IBM-ICB Integrated Color Board w/Printer Port \$ 99.95
IBM-EGA Enhanced Graphics 256K RAM . . . \$249.95 \$229.95
IBM-20MBK 20MB Hard Disk Drive, Controller & Cable . . \$429.95
IMFC Multifunction 0-384K RAM (without RAM) . . \$109.95
EM-100 Expansion Memory Half Card (without RAM) . \$ 59.95
RS232HC RS232 Serial Half Card \$ 29.95
TTX-1410 14" RGB Color Monitor \$299.95 \$289.95
PM1200B-2 1200/300 Baud Half Card Modem without software . . \$129.95
PM1200B-2S 1200/300 Baud Half Card Modem with Mirco Software . . \$159.95

IBM is a registered trademark of IBM Computers

NEW PRODUCTS!

Turbo 4.77/8MHz Motherboard



IBM PC/XT Compatible

• 75% faster than the IBM PC while in the turbo mode • Turbo Mode selectable through either software or hardware • Expandable to 640K (comes with zero-K)

TURBO. NEW! \$129.95

IBM PC/XT/AT Compatible Keyboard

NEW! AT Style Layout



• Tactile touch keyswitches • AT style layout • Switch selectable between PC/XT or AT • Illuminated Caps Lock, Num Lock and Scroll Lock Indicators • Low profile design • 8 1/2 foot cord • Manual included

KB5160. \$59.95

ZUCKERBOARD Monochrome Graphics Half Card



with Printer Port for IBM PC/XT/AT and Compatible Computers

• Full Hercules™ compatibility • Printer port adapter • High resolution graphics 720 x 348 pixels • Diagnostics program included • Fast refresh rate • 2-yr. warranty • Manual included
MG201... NEW! ... \$89.95

APPLE COMPATIBLE ACCESSORIES



Parallel Printer Card for Apple II, II+ and IIe

• Intelligent interface to most dot matrix graphics printers
• Centronics standard
• Advanced text printing

JE880 Parallel Printer Card \$49.95

JE883 64K Buffer for JE880 ~~\$69.95~~ \$59.95

JE8803 JE880 and JE883 ~~\$109.90~~ \$99.95



Extended 80-Column Card for Apple IIe

• 80 Col 64K RAM • Doubles amount of data your Apple IIe can display as well as its memory capacity • Ideal for word processing • Complete with instructions

JE864 \$59.95

Apple II, II+ and IIe Compatible Products

APF-1 Cooling Fan \$ 29.95

KHP4007 Switching Power Supply . . . \$ 34.95

JE860 16K RAM Card (II & II+ only) \$ 39.95

JE875 Disk Controller Card \$ 49.95

JE877 Diagnostic Disk Controller Card ~~\$59.95~~ \$ 49.95

AMON Monochrome Monitor \$ 99.95

SMARTERM II 80-Col. Card \$139.95

Big Board-256K 256K RAM Card \$189.95

Big Board-512K 512K RAM Card \$219.95

Big Board-1M 1 Meg RAM Card \$289.95



JE450 Solderless Proto-Type Builder

• Provides user with quick and efficient system for breadboarding electronic circuits • Components & wire leads can be quickly inserted and removed without soldering or desoldering • 3 regulated power supplies: 5V @ 1A, +5V to +15V @ 5A, -5V to -15V @ 5A • Power: 120VAC, 60Hz fused

JE450 Solderless Proto-Type Builder . . . \$119.95



IBM Compatible! DISK DRIVES

Documentation Included

FD55B Tevic 5 1/4" DS 1/2-H (IBM PC/XT) . . \$109.95

JU-455 Panasonic 5 1/4" DS 1/2-H (IBM PC/XT) \$109.95

JU-475 Panasonic 5 1/4" DS 1/2-H (IBM AT) . . \$119.95

DATA BOOKS

30003 National Linear Data Book (82) \$14.95

30009 Intersil Data Book (86) \$ 9.95

30013 Zilog Data Book (85) \$14.95

30032 National Linear Supplement (34) . . . \$ 6.95

210830 Intel Memory Handbook (86) \$17.95

230843 Intel Microsystem Hndbk. Set (86) . . . \$24.95

MUFFIN/SPRITE-STYLE FANS



MUF60 \$9.95

Torn Industries (4.68" sq. 60 cfm)

SU2A1 \$8.95

EG&G Roltron (3.125" square, 20 cfm)

\$20 Minimum Order — U.S. Funds Only
Shipping: Add 5% plus \$1.50 Insurance

California Residents: Add 6%, 6 1/2% or 7% Sales Tax

Spec. Sheets — 50¢ each
Prices Subject to Change

Send stamped, self-addressed envelope to receive a Sales Flyer — FREE!

5/87



Send \$1.00 Postage for a FREE 1987 JAMECO CATALOG

© 1987 Jameco Electronics

1355 SHOREWAY ROAD, BELMONT, CA 94002 • PHONE ORDERS WELCOME 415-592-8097 Telex: 176043

SEND FOR
FREE
1987 CATALOG...
48 PAGES!

★QUALITY PARTS★DISCOUNT PRICES★FAST SHIPPING!

ALL ELECTRONICS CORP.

ALL ELECTRONICS CORP.

220 Vac COOLING FAN

ROTRON #
MX77A3
Muffin XL
220 Vac
4 1/8" square
metal frame fan.
CAT# CF-220 \$6.50 ea
10 for \$60.00 / 100 for \$500.00



LIGHT ACTIVATED MOTION SENSOR

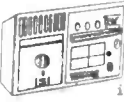

This device contains a photo cell which senses sudden changes in ambient light. When an object or person passes within it's field of view (about 5') it beeps for several seconds then resets. Could be used as a door annunciator or modified to trigger other devices. 5 1/2" x 4" x 1. Operates on 6 Vdc. Requires 4 AA batteries (not included). CAT# LSMD \$5.75 per unit

SOUND EFFECTS BOARD

PC board with 2 1/4" speaker, 2 LEDs, IC, battery snap, other components 2 3/8" x 3". When switch is pushed board beeps and leds light. Operates on 9v battery (not included). Experimenter's delight. CAT# ST-3 \$1.25 ea.



MICRO-CASSETTE MECHANISM

Micro-cassette tape transport for standard MC60 or MC45 micro-cassettes. 3 Vdc operation. Contains drive motor, belt, head, capstan, pinch wheel and other components. 3 1/2" x 2 1/4" x 5/8". CAT# MCMC \$3.00 each 10 for \$27.50



FUSES

3AG (AGC) SIZE
1, 1 1/2, 2, 2 1/2, 3, 4, 5, 6 AMP
GMA SIZE
1, 2, 3, 4, 5 AMP
5 of any ONE amperage 75¢



COMMODORE PRINTER PLOTTER

Commodore Model # 1520
4 inch paper
Four color X-Y plotter. Standard VIC serial interface allows easy connection to Commodore 64 computers. Up to 80 characters per line.
CAT # COM-1520 \$49.95 each
EXTRA pen sets \$1.50 per set.



EDGE CONNECTORS

ALL ARE .156" SPACING.



22 EDGE CONNECTOR \$1.25 ea
solder lug style 10 for \$11.00
22/44 EDGE CONNECTOR \$2.00 ea
PC style 10 for \$18.00
22/44 EDGE CONNECTOR solder lug style \$2.50 each
28/56 EDGE CONNECTOR PC style \$2.50 ea
36/72 EDGE CONNECTOR PC style \$3.00 each
43/86 EDGE CONNECTOR PC style \$4.50 each

2K 10 TURN MULTI-TURN POT

SPECTROL #MOD 534-7161 \$5.00 EACH

RELAYS

10 AMP SOLID STATE

CONTROL 3 32 vdc LOAD: 140 vac 10 amp SIZE: 2 1/2" x 3/4" x 1/2" \$9.50 EACH 10 FOR \$90.00

ULTRA-MINIATURE 5 VDC RELAY

Fujitsu # FBR211NED005M20 High sensitivity COIL: 120 ohms CONTACTS: 1 amp Mounts in 14 pin DIP socket \$1.25 each 10 for \$10.00

MINIATURE 6 VDC RELAY

Aromat # RSD-6V Super Small S.P.D.T. relay GOLD cobalt contacts rated 1 amp @ 30 vdc. Highly sensitive. TTL direct drive possible. 120 ohm coil. Operate from 4.3 - 6 vdc. COIL: 120 ohms \$1.50 each 10 for \$13.50

PHOTO-FLASH CAPACITORS

170 MFD 330 Volt CAT# PPC-170 75¢ each
400 MFD 330 Volt CAT# PPC-400 \$1.00 ea

COMPUTER GRADE CAPACITORS

1,400 mfd 200 Vdc 3" x 2" dia. \$2.00
6,400 mfd 60 Vdc 4 1/4" x 1 3/8" dia. \$2.50
7,500 mfd 200 Vdc 5 3/4" x 3" dia. \$4.00
12,000 mfd 40 Vdc 4 1/4" x 2" dia. \$2.50
22,000 mfd 25 Vdc 4 3/4" x 2" dia. \$2.50
48,000 mfd 10 Vdc 3" x 2 1/2" dia. \$2.50
66,000 mfd 15 Vdc 3 3/4" x 3" dia. \$3.50
72,000 mfd 15 Vdc 4" x 2" dia. \$3.50
100,000 mfd 10 Vdc 6" x 2 1/2" dia. \$1.00

MINIATURE TOGGLE SWITCHES

ALL ARE RATED 5 AMPS @ 125 VAC

S.P.D.T. (on-on) PC style non-threaded bushing. 75¢ each 10 for \$7.00
S.P.D.T. (on-on) Solder lug terminals \$1.00 each 10 for \$9.00 100 for \$80.00
S.P.D.T. (on-off-on) Solder lug terminals \$1.00 each 10 for \$9.00 100 for \$80.00
S.P.D.T. (on-off-on) PC lugs threaded bushing. 75¢ each 10 for \$7.00
D.P.D.T. (on-on) Solder lug terminals \$2.00 each 10 for \$19.00 100 for \$180.00

S.P.S.T. TOGGLE SWITCH

CARLING (on-off) RATED: 10 amp @ 125 Vac. All plastic body and toggle.
CAT# STS-1 \$1.00 ea.
10 for \$9.50 100 for \$7.50

XENON FLASH TUBE

3/4" long X 1/8" dia. Flash tube designed for use in compact camera flash units. Ideal for experimenters. CAT# FLT-1 2 for \$1.00

LED'S STANDARD JUMBO DIFFUSED T 1-3/4

RED 10 for \$1.50 100 for \$13.00
GREEN 10 for \$2.00 100 for \$17.00
YELLOW 10 for \$2.00 100 for \$17.00

FLASHER LED

5 volt operation red jumbo T 1 1/4 size CAT# LED-4 \$1.00
NEW GREEN FLASHER CAT# LED-4G \$1.00

BI-POLAR jumbo T 1 1/4 size

2 for \$1.70

LED HOLDERS

Two piece holder for jumbo LED 10 for 65¢ 100 for \$5.00

CLEAR CLIPLEAD LED HOLDER

Make LED a fancy indicator. Clear. 4 for \$1.00

TELEPHONE COUPLING TRANSFORMER

Slanor # TTPC-8 or Triad # TY-304 P
600 ohms c.t. to 600 ohms c.t. P.C. board mount 3/4" x 5/8" x 3/4" \$1.25 each

D.P.S.T. LIGHTED ROCKER SWITCH

115 vac lighted rocker. snap mounts in 1/2" x 1 1/2" hole. Orange lens. 16 amp contact \$1.50

MINI-PUSH BUTTON

S.P.S.T. momentary normally open 1/4" bushing. Red button. 35¢ each 10 for \$3.00

SNAP ACTION SWITCH

Cherry elect. #E-21 N.O. or N.C. 0.1A contacts. Suitable for alarms and other low energy circuits. 1 1/2" lever. 45¢ EACH 10 FOR \$4.20

WALL TRANSFORMERS

all plug directly into 120 vac outlet

4 VDC @ 70 ma. \$2.00
6 VDC @ 500 ma. \$3.50
6 VDC @ 750 ma. \$4.50
9 VDC @ 500 ma. \$5.00
12.5 VAC @ 265 ma. \$3.00
18 VAC @ 18 VA and 8.5 VAC @ 1.28 VA \$3.50
24 VAC @ 250 ma. \$3.00
MULTI-VOLTAGE @ 500 ma. 3, 4, 6, 7, 9 or 12 VDC \$7.50

MINI-BOX

Pomona #2104 \$1.00 EACH
Heavy-duty black phenolic project box with cover and screws. 2 1/2" X 1 1/2"

TRANSISTORS

2N706 4 for \$1.00
2N2222A 3 for \$1.00
PN2222A 4 for \$1.00
2N2904 3 for \$1.00
2N2905 3 for \$1.00
MJ2955 \$1.50
2N3055 \$1.00
PMD 10K 40 \$1.00
TIP 121 75¢
TIP 122 75¢

3rd TAIL LIGHT ?

Sleek high-tech lamp assembly. Could be used as a third auto tail light, emergency warning light, or special-effects lamp. Red reflective lens is 2 3/4" x 5 1/2" is mounted on a 4" high pedestal with up-down swivel adjustment. Includes 12v replaceable bulb. CAT# TLB \$3.95 each.

48 KEY ASSEMBLY FOR COMPUTER OR HOBBYIST

NEW T.I. KEYBOARDS. Originally used on computers, these keyboards contain 48 S.P.S.T. mechanical switches. Terminates to 15 pin connector. Frame 4" x 9" CAT# KP-48 \$3.50 each

SOUND AND VIDEO MODULATOR

T1#UM1381-1 Designed for use with T.I. computers. Can be used with video cameras, games or other audio/video sources. Built in A/B switch enables user to switch from T.V. antenna without disconnection. Channel 3 or 4 selection. Operates on 12 Vdc. Hook-up diagram included. CAT# AVMOD \$5.00 each.

RECHARGEABLE NI-CAD BATTERIES

AAA SIZE 1.25V 500MAH \$1.85
AA SIZE 1.25V 500MAH \$1.85
AA with solder tab \$2.00
C SIZE 1.2V 1200MAH \$3.50
SUB-C SIZE solder tab \$3.50
D SIZE 1.2V 1200MAH \$3.50

NI-CAD CHARGER TESTER

Will charge most every size Ni-cad battery available. Cat# UNCC-N \$12.50

8" 15 WATT SPEAKER

C.T.S Model BB3079 Full range speaker. 100-10,000Hz. Ideal for PA systems. Mounting holes for line-matching transformer. CAT# SK-815 \$3.50 ea. Case of 8 pcs. \$25.00 per case

STORES
LOS ANGELES, CA
905 S. Vermont Ave.
213 380-8000
VAN NUYS, CA
6228 Sepulveda Blvd.
818 997-1806

MAIL ORDERS TO:
ALL ELECTRONICS
P.O. BOX 20406
Los Angeles, CA 90006
TWX - 101010163
ALL ELECTRONIC

QUANTITIES LIMITED
MINIMUM ORDERS \$10.00
CALIF. ADD SALES TAX
USA: \$3.00 SHIPPING
NO C.O.D.I
FOREIGN ORDERS:
INCLUDE SUFFICIENT
SHIPPING

TOLL FREE ORDERS
800-826-5432
IN CA (800-258-6666)
INFO - (213) 389-8000
FAX - (213) 389-7073

POLARITY SWITCH

external coaxial relay on a satellite TV system. IDEAL FOR THE EXPERIMENTOR AS PARTS Heavy chassis box containing a 5 Vdc relay. CA 358 oh amp and other parts. Catalog # RDPS \$1.75 each 10 for \$15.00

SOLID STATE BUZZER

Star # SMB-06L 6 vdc TTL compatible. \$1.00 each 10 for \$9.00

Now! Choose between AT and XT compatibles!

AT Turbo Computer System

Superb engineering for reliability, performance, and full IBM AT compatibility at less than half the Big Blue price! Comes in easy to assemble kit form with complete instructions.

80286 AT Baby Motherboard-6/10MHz	(X-1050)	\$499 00
2x 256K Upgrade Kit	(X-1190)	69 90
Hard/Floppy Disk Controller Card	(X-1052)	199 00
1.2MB Floppy Disk Drive	(X-7502)	135 00
200W Power Supply	(X-1111)	99 00
84-key Keyboard	(X-1122)	59 95
Heavy-duty Steel Case	(X-1120)	39 95

Individual Components Total \$1101.80

\$975

X-1152

SAVE \$125

off individual component prices

XT Compatible Computer

IBM compatible. Easy to assemble (complete instructions included)

XT Motherboard	(X-1001)	\$129 00
BIOS for Motherboard	(X-1000)	29 95
64K RAM	(X-1187)	11 95
Monochrome Graphics Card	(X-1012)	89 95
Floppy Disk Controller	(X-1009)	34 95
130 Watt Power Supply	(X-1110)	69 95
IBM-style Case	(X-1120)	39 95
Half-height Disk Drive	(X-7506)	89 95
IBM-compatible Monochrome Monitor	(X-1132)	99 95
84-key Keyboard	(X-1122)	59 95

\$599

X-1150

SAVE \$56

off individual component prices

All DSE computer products carry a 1 year warranty!

80286 AT Baby Motherboard \$499

- Intel 80286 CPU; 24 bit addressing, 16 bit data path; 16 level interrupts; 7 channel DMA
- 80287 math coprocessor socket
- Socketted for up to 1MB memory
- Speed 6/10 MHz, software switchable
- Real clock time, built-in battery
- Standard speaker, keyboard & power connectors
- 7 expansion slots (4 x dual 62/36 pin for PC/XT adaptor cards)
- BIOS made in USA - legal and IBM AT compatible!

256K Upgrade Kit \$34.95

- IBM AT compatible ● 120 nsec
- contains 9 x 256K D/RAM (Z-9315)

Hard/Floppy Drive Controller Card \$199

- IBM AT compatible
- Supports two hard disk drives
- Supports two 1.2 MB floppy drives

360 KB/ 1.2 MB Floppy Drive Controller Card \$79

- IBM AT compatible

I/O Card \$79

- IBM AT compatible
- RS-232 & Parallel Game ports

1.2 MB Floppy Disk Drive \$135

- IBM AT compatible
- 15 sectors/track

2MB Memory Expansion Card \$139

- IBM AT compatible
- Fully socketted memory with parity check
- Select/split among Conventional, Extended or Expanded Memory
- Use up to 4 cards for up to 8MB expansion memory
- Includes software to enhance system performance

3MB Multifunction Card \$159.95

- IBM AT compatible
- Fully socketted memory with parity check
- True 16-bit architecture for memory
- RS-232 serial port, parallel printer port, game adapter port
- Includes serial & joystick interface cables

84-key Keyboard \$59.95

- IBM AT/XT compatible
- Keyboard angle adjusts from 7-15°
- Mechanical key switch with strike rate 20 million
- LED indicator shows lock key status
- Ergonomic design: adjustable height, tactile feel

100-key Keyboard \$79.95

- IBM AT/XT compatible
- Similar to 84-key model above (X-1122) with enhancements like Keytronic's 5151, includes numeric keypad

130W Power Supply \$69.95

- IBM XT compatible
- 115/230V AC dual input ● EMI filter
- Overload, short circuit & surge protection

200W Power Supply \$99

- IBM AT compatible
- Input: 117V AC, 50Hz
- Output: 200W DC

XT-style Case \$39.95

- IBM XT/AT Baby Board Compatible
- Easy internal access
- Includes hardware for expansion slots & power supply mounting
- Weight approx. mately 17 lbs.

AT-style Case \$79

- IBM AT compatible

PEPswitch FOR ELECTRONIC PRINTERS \$129

- This smart switch lets you select different printers from your keyboard (with a simple ASCII command sequence) or with a mechanical switch on the unit
- Centronics compatible
 - Select from as many as 5 printers on one PC (using multiple PEPswitches)

IBM Parallel Interface Cables \$9.95

- 6' length, fully RFI & EMI shielded (X-3590)
- 10' length, fully RFI & EMI shielded (X-3591)

IBM Serial Interface Cables \$9.95

- 25 pin Male/Male; 10' length (X-3592)
- 25 pin Male/Female; 10' length (X-3593)

XT Compatible Motherboard \$129

- 8088 microprocessor CPU; 16-bit; 4.77MHz
- 8087 socket for optional coprocessor
- Same power connector & physical dimensions as IBM PC/XT
- Only 54 watt power consumption
- Expandable to 640K

Monographics Card \$89.95

- IBM AT/XT/PC compatible
- 80 x 25 text mode; 720 x 348 graphic mode
- Parallel printer port

Floppy Disk Controller Card \$34.95

- Supports 2 internal 5 1/4" half-height, ds/dd drives
- Double density mem encoded
- Write precompensation with phase lock loop data separator
- Supports 2 external disk drives through a 37-pin D connector (optional)

360 KB Floppy Disk Drive \$89.95

- IBM PC/XT compatible ● Records 5876 BPI
- Supplied without covers

Green Monitor \$99.95

- IBM/AT/XT compatible

Amber Monitor \$119

- IBM AT/XT compatible

Power Command Monitor Stand \$39.95

- 360° swivel ● 12.5" tilt
- 3 pin AC sockets for computer, monitor, printer, AUX 1, AUX 2, push-button lighted control switches on front
- Surge & spike protection ● EMI filtering

Color Graphics Adaptor Card \$69.95

- IBM AT/XT compatible ● 40/80 col x 25 rows
- 320 x 200 med-res color, 640 x 200 hi-res b/w

3-pin AC Cord \$1.75

- 3-pin AC plug/3-pin in-line jack, 18 gauge

Multiport RS-232 Gender Changer \$14.95

- Great for radio-control & other applications. Molex conn (X-4003)

Hobbyists! DSE makes any project easier & better!

Photo-Etch™ PRINTED CIRCUIT KIT \$37.00

- All the chemicals necessary to make any circuit up to 5" x 6" - from original or magazine art. (For larger circuits, consult our catalog or call to inquire)
- Contents: 5 x 6 steel frame; Pos-Neg film, film processing pack, yellow filter, 4oz negative-acting etch resist; 16oz resist developer, blank copper circuit boards; dry concentrated etchant; 11 resist patterns & tapes, complete instructions
- This process requires exposure light - try DSE® S-3905 \$11.95

Economy Solder Station \$59.95

- For hobbyist or technician ● UL listed
- Temperature-controlled, fully adjustable to 900 F
- Readout in °F and °C ● Grounded tip
- Heat-sensing for instant compensation

Deluxe Solder/Desolder Station \$399

- Professional rack-mounting station with excellent desoldering facilities and 12 month warranty

- Soldering features:**
- Adjustable, temp-controlled iron with grounded tip
 - LED bargraph of tip temperature ● Fast pre-heat
 - LED "heating" indicator ● Lockable control knob
- Desoldering features:**

- Rapid, damage-free desoldering of any size joint
- Adjustable temperature with LED bargraph readout
- Grounded tip ● LED "heating" indicator
- Fingertip control vacuum gauge, filtered vacuum line
- Easy to clean

See our catalog for a wide range of tips to fit this deluxe station!

Variable Power Supply \$149.95

- Lab standards at a hobbyist's price! Variable voltage & current output with panel meters for each.
- Coarse & fine voltage controls; hi/low amp scales
- 0-30V DC supply ● 0-5A output ● 0.5mV rms ripple regulation ● 0.01% 2mV line ● 0.01% 3mV load

ScanRecord \$39.75

- This device interfaces between scanner and cassette recorder for automatic recording of scanner traffic
- Adjustable sensitivity ● Converts audio to proper recording level
 - 5K ohms input impd. ● 9-15V DC ● 2mA idle, 25 mA active
 - 4 1/2" L x 2 6/8" W x 1 8/8" H ● 7oz

Super Designer Board \$29.95

- Projects & prototypes are simple with these high quality plastic project boards. No soldering required - component leads push in!
- Holes are spaced to accept standard DIP packages and are alpha-numerically coded for easy identification. Each board also includes a pad of layout paper
- 4 Binding posts ● 27 x 14 pin IC capacitor
 - 2420 tie points ● B" x 9.75" x 0.8"

Heavy-duty Instrument Cases \$9.95

- High quality plastic project cases with PCB mounting slots
- 10" W x 7 1/2" D x 3 1/4" H (H-2507) \$9.95
 - 8" W x 6 1/4" D x 2 1/4" H (H-2505) \$7.95
 - 6" W x 6 1/4" D x 2 1/4" H (H-2506) \$6.95

Graphit 33 \$9.95

- Colloidal graphite spray creates conductive layers of any thickness on glass, plastic & other smooth surfaces. Gets rid of static charge

Sub-C size Fast-Charge NiCad (S-3324) \$3.95

- 7.2V NiCad Battery Pack (S-3326) \$24.95
- Great for radio-control & other applications. Molex conn

R-E Reader's Specials

AAA-size Rechargeable NiCads

- Ideal for Walkman-type radio/cassette players. Use one set while the other charges.
- Try our fantastic NiCad Charging Cabinet (M-9519) only \$9.95 \$14.32 value **SAVE 30%** \$10.95

Unbelievable AM/FM Amp/Tuner!

- Complete AM/FM stereo tuner with built-in amplifier & auxiliary stereo inputs (for turntable or cassette deck). Complete chassis (without cover - what do you expect for only \$14.95!), just hook up speakers, plug it in and you're ready for music!

CIRCLE 95 ON FREE INFORMATION CARD

Stores in BERKELEY (CA) 415/486-0755 REDWOOD CITY, CA 415/368-8844, SAN JOSE, CA 415/241-2266

14-Day Satisfaction Guarantee Order Toll Free 1-800-332-5373

Pre-paid & Credit Card Orders Only! Mon-Fri 7a.m. - 6p.m. Pacific Time

In California call 415-368-1066

We ship UPS Ground unless otherwise requested. Add 5% of order total (min \$1.50) for shipping. Outside USA add 20% (min \$4). There is an additional \$1.50 handling fee. California residents please add sales tax. VISA and MASTERCARD welcome. Minimum order value \$20.00.



EVERYTHING FOR THE ELECTRONICS ENTHUSIAST

To receive your copy of our colorful 148 page catalog, circle Reader Service

"The First Source" — for electromechanical & electronic equipment and components — AMERICAN DESIGN COMPONENTS!

Insides of the COMMODORE COMPUTER

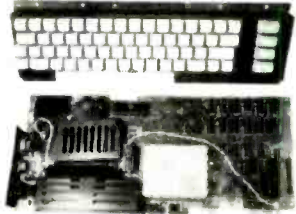

Commodore VIC 20 CPU board & mechanical keyboard. Guaranteed not to work. (For parts only.)
Item #12144 **\$14.95** RFE

190W DISK DRIVE POWER SUPPLY



Input: 115V
Output: +12V @ 4.13A } x 3
 +5.1V @ 3.04A }
Contains 3 sets of dual outputs, allowing for simultaneous operation of 3 disk drives. Originally designed for the AT & T computer.
Dim.: 11" W x 4 1/2" H x 7" deep
Item #10006 **\$59.95** New

HI-POWER SWITCHING POWER SUPPLY



Output: +5.15V @ 70A
 +12V @ 4A
 +12V @ 4A
 +5.2V @ 5A
Input: 115/230V nominal, .725KW cont. 47-63Hz. Enclosed in metal housing.
Dim.: 15" W x 2 1/2" H x 6" deep.
Mfr. — Todd Prod. #4XSB151A
Item #9749 **\$29.95** New

INTEGRATED CIRCUITS . . .

Linear . . .

LH0002CN	\$5.35	LM747CN	\$.53
LM10CLH	2.65	LM748CN	.53
LH0070-OH	3.55	DS8T28N	1.57
TL071CP	.53	LM1456V	1.75
TL072CP	.71	LM1458N	.44
LM301N	.32	LM1488N	.62
LM307N	.41	LM1496N	.90
LM310N	1.16	LM1899N	1.43
LM311N	.41	ULN2003A	.90
LM317K	2.65	DS26LS31CN	1.34
LM317LZ	.62	DS26LS32CN	1.34
LM317MP	.80	LM2901N	.53
LM317T	.90	LM2903N	.53
LM318N	1.07	LM2907N	1.75
LM319N	1.07	LM2917N	1.39
LM324N	.35	LM2917-14N	1.34
LM334Z	1.07	LM2931CT	1.07
LM336Z	.98	MC3346P	.90
LM337MP	1.03	MC3486	1.34
LM337T	1.34	MC3487	1.34
LM338K	3.55	SG3524	1.75
LM339N	.44	LM3900N	.53
LF347N	.90	LM3914N	1.75
LM348N	.62	RC4136N	.80
LM350K	3.55	RC4151NB	.90
LF353N	.53	RC4193NB(DE)	2.65
LF356N	.80	7805K	1.21
LM358N	.44	7812K	1.21
LM380N	.80	7815K	1.21
LM380N-8	.98	7818K	1.21
LM381N	1.16	7824K	1.21
LM383T	1.34	7805T	.44
LM385Z	1.70	7812T	.44
LM386N-4	.80	7815T	.44
LM389N	.90	7818T	.44
LM393N	.41	7824T	.44
LF398N	2.15	7840T	1.75
LF411CN	.71	7905K	1.21
TL494CN	1.75	7906K	1.21
TL496CP	1.34	7912K	1.21
TL497ACN	1.97	7915K	1.21
NE555V	.26	7918K	1.21
XR-1555	.62	7924K	1.21
LM556N	.53	7905T	.53
NE558N	1.07	7912T	.53
NE564N	1.75	7915T	.53
LM565N	.90	7918T	.53
LM566CN	1.25	7924K	1.21
LM567V	.80	7905T	.53
NE570N	2.24	7912T	.53
NE571N	1.75	7915T	.53
NE592N	.80	7918T	.53
LM709N	.44	7924K	1.21
LM709CH	.80	7905T	.53
LM710N	.62	7912T	.53
LM711N	.62	7915T	.53
LM723CN	.41	7918T	.53
LM725CN	2.24	7924K	1.21
LM733CN	.62	7905T	.53
LM739N	2.30	7912T	.53
LM741CN	.26	7915T	.53
LM741CH	.53	7918T	.53
LM741-14N	.53	7924K	1.21
Z8000 Series . . .		7905T	.53
Z80	\$1.57	7912T	.53
Z80-CTC	1.61	7915T	.53
Z80-DART	4.45	7918T	.53
Z80-DMA	4.45	7924K	1.21
Z80-PIO	1.61	7905T	.53
Z80-SIO/1	4.45	7912T	.53
Z80A	1.66	7915T	.53
Z80A-DART	4.72	7918T	.53
Z80A-DMA	5.35	7924K	1.21
Z80A-PIO	1.75	7905T	.53
Z80B	3.55	7912T	.53
Z80B-CTC	4.45	7915T	.53
Z80B-PIO	4.45	7918T	.53
		7924K	1.21
		7905T	.53
		7912T	.53
		7915T	.53
		7918T	.53
		7924K	1.21
		7905T	.53
		7912T	.53
		7915T	.53
		7918T	.53
		7924K	1.21
		7905T	.53
		7912T	.53
		7915T	.53
		7918T	.53
		7924K	1.21
		7905T	.53
		7912T	.53
		7915T	.53
		7918T	.53
		7924K	1.21
		7905T	.53
		7912T	.53
		7915T	.53
		7918T	.53
		7924K	1.21
		7905T	.53
		7912T	.53
		7915T	.53
		7918T	.53
		7924K	1.21
		7905T	.53
		7912T	.53
		7915T	.53
		7918T	.53
		7924K	1.21
		7905T	.53
		7912T	.53
		7915T	.53
		7918T	.53
		7924K	1.21
		7905T	.53
		7912T	.53
		7915T	.53
		7918T	.53
		7924K	1.21
		7905T	.53
		7912T	.53
		7915T	.53
		7918T	.53
		7924K	1.21
		7905T	.53
		7912T	.53
		7915T	.53
		7918T	.53
		7924K	1.21
		7905T	.53
		7912T	.53
		7915T	.53
		7918T	.53
		7924K	1.21
		7905T	.53
		7912T	.53
		7915T	.53
		7918T	.53
		7924K	1.21
		7905T	.53
		7912T	.53
		7915T	.53
		7918T	.53
		7924K	1.21
		7905T	.53
		7912T	.53
		7915T	.53
		7918T	.53
		7924K	1.21
		7905T	.53
		7912T	.53
		7915T	.53
		7918T	.53
		7924K	1.21
		7905T	.53
		7912T	.53
		7915T	.53
		7918T	.53
		7924K	1.21
		7905T	.53
		7912T	.53
		7915T	.53
		7918T	.53
		7924K	1.21
		7905T	.53
		7912T	.53
		7915T	.53
		7918T	.53
		7924K	1.21
		7905T	.53
		7912T	.53
		7915T	.53
		7918T	.53
		7924K	1.21
		7905T	.53
		7912T	.53
		7915T	.53
		7918T	.53
		7924K	1.21
		7905T	.53
		7912T	.53
		7915T	.53
		7918T	.53
		7924K	1.21
		7905T	.53
		7912T	.53
		7915T	.53
		7918T	.53
		7924K	1.21
		7905T	.53
		7912T	.53
		7915T	.53
		7918T	.53
		7924K	1.21
		7905T	.53
		7912T	.53
		7915T	.53
		7918T	.53
		7924K	1.21
		7905T	.53
		7912T	.53
		7915T	.53
		7918T	.53
		7924K	1.21
		7905T	.53
		7912T	.53
		7915T	.53
		7918T	.53
		7924K	1.21
		7905T	.53
		7912T	.53
		7915T	.53
		7918T	.53
		7924K	1.21
		7905T	.53
		7912T	.53
		7915T	.53
		7918T	.53
		7924K	1.21
		7905T	.53
		7912T	.53
		7915T	.53
		7918T	.53
		7924K	1.21
		7905T	.53
		7912T	.53
		7915T	.53
		7918T	.53
		7924K	1.21
		7905T	.53
		7912T	.53
		7915T	.53
		7918T	.53
		7924K	1.21
		7905T	.53
		7912T	.53
		7915T	.53
		7918T	.53
		7924K	1.21
		7905T	.53
		7912T	.53
		7915T	.53
		7918T	.53
		7924K	1.21
		7905T	.53
		7912T	.53
		7915T	.53
		7918T	.53
		7924K	1.21
		7905T	.53
		7912T	.53
		7915T	.53
		7918T	.53
		7924K	1.21
		7905T	.53
		7912T	.53
		7915T	.53
		7918T	.53
		7924K	1.21
		7905T	.53
		7912T	.53
		7915T	.53
		7918T	.53
		7924K	1.21
		7905T	.53
		7912T	.53
		7915T	.53
		7918T	.53
		7924K	1.21
		7905T	.53
		7912T	.53
		7915T	.53
		7918T	.53
		7924K	1.21
		7905T	.53
		7912T	.53
		7915T	.53
		7918T	.53
		7924K	1.21
		7905T	.53
		7912T	.53
		7915T	.53
		7918T	.53
		7924K	1.21
		7905T	.53
		7912T	.53
		7915T	.53
		7918T	.53
		7924K	1.21
		7905T	.53
		7912T	.53
		7915T	.53
		7918T	.53
		7924K	1.21
		7905T	.53
		7912T	.53
		7915T	.53
		7918T	.53
		7924K	1.21
		7905T	.53
		7912T	.53
		7915T	.53
		7918T	.53
		7924K	1.21
		7905T	.53
		7912T	.53
		7915T	.53
		7918T	.53
		7924K	1.21
		7905T	.53
		7912T	.53
		7915T	.53
		7918T	.53
		7924K	1.21
		7905T	.53
		7912T	.53
		7915T	.53
		7918T	.53
		7924K	1.21
		7905T	.53
		7912T	.53
		7915T	.53
		7918T	.53
		7924K	1.21
		7905T	.53
		7912T	.53
		7915T	.53
		7918T	.53
		7924K	1.21
		7905T	.53
		7912T	.53
		7915T	.53
		7918T	.53
		7924K	1.21
		7905T	.53
		7912T	.53
		7915T	.53
		7918T	.53
		7924K	1.21
		7905T	.53
		7912T	.53
		7915T	.53
		7918T	.53
		7924K	1.21
		7905T	.53
		7912T</	

What's New at AMERICAN DESIGN COMPONENTS . . . ?

We warehouse 60,000 items at American Design Components — expensive, often hard-to-find components for sale at a fraction of their original cost!

You'll find every part you need — either brand new, or removed from equipment (RFE) in excellent condition. But quantities are limited. Order from this ad, or visit our retail showroom and find exactly what you need from the thousands of items on display.

Open Mon. — Sat., 9-5

THERE'S NO RISK.

With our full 90-day warranty, any purchase can be returned for any reason for full credit or refund.

PC 8300 HOME COMPUTER

(Advanced version of the Timex 1000)



42-key mechanical keyboard (not membrane). Contains 2K of RAM. ** Reverse video, Z80A, 6.5 MHz processor, ROM 8K BASIC. Graphics capability/sound—music, TV or monitor. Joystick input operates on 115 VAC. Includes: AC adapter, TV cable, and pair of cassette cables. Will run all prerecorded tapes for Sinclair/Timex 1000-2X81. Mfr — Power 3000.

Item #10336 \$29.95 New (in orig. boxes)

Composite Video Monitors . . .



12" Monitor

(Controls front panel mounted)

12" green phosphor, high resolution (12 lines center) and bandwidth from 10Hz to 30 Hz ± 3dB. Op. volt.: 120/240VAC, 50/60Hz., 65VA max. Controls front panel mtd. Mfr — Motorola — Alpha Series

Item #10043 \$29.95 New

15" Monitor

15" screen. Same specs as above.
Item #10044 \$34.95 New

CORDLESS TELEPHONE

700 ft. Range
Wall or Base Mount

Full duplex: talk & listen simult. Auto redial: last number dialed recall. Comes with attachments for both types of mtg.; incl. AC power adaptor & battery Indicator light. Color: brown w/cream. Famous make mfr.

Item #9997 \$29.95 New

3 1/2", 10Mb HARD DISK DRIVE (IBM® Compatible)



Fits standard 5 1/4" spacing. Shock mounted. High speed, low power. Mfr — Rodime #R0252F
Item #10151 \$179.00 New
Controller Card for above
Item #9984 \$99.00

PC 8300 Accessories . . .

RAMPACK UPGRADES

*16K —
Item #10337 \$9.95 New
*32K —
Item #12148 \$19.95 New

COLOR PACK

Allows you to use your PC 8300 Computer with a color TV or monitor. Plugs directly into back of computer and has connections for additional Rampack.

Item #12147 \$19.95 New

115 CFM MUFFIN® FAN



SPECIAL!
115 VAC/60 Hz., 21W., 28A., 3100 RPM; 5-blade model, aluminum housing. Can be mounted for blowing or exhaust.
Dim.: 4 1/2" sq. x 1 1/2" deep.

Item #5345 \$5.95 RFE

5 1/4", 1.2 Mb. AT HALF HT. DISK DRIVE



48/96 TPI (IBM® Compatible)
Double sided, single double density; 80 track.
Mfr — Panasonic #JU-475
Item #10005 \$129.00 New

5 1/4" 1/2 HT. DISK DRIVE



DOS 3.2 Compatible 96 TPI, DS/QUAD DENSITY Tandem TM55D-4

Item #1904 \$79.00
2 for \$150.00

12/24 VDC MUFFIN-TYPE FANS



8 W. Can be mounted for blowing or exhaust. Aluminum housing, brushless, ball-bearing type.

1" Thin: 5 plastic blades w/ feathered edges
Mfr — Centaur #CUDC24K4-601
Item #8541 \$19.95 New

1 1/2" Standard: 5 plastic blades
Mfr — Centaur #CNDC24K4-601
Item #12109 \$14.95 RFE

5 1/4" FULL HT. DISK DRIVES



48 TPI (IBM® Compat.)
Double sided/double density, full height drive. 48 T.P.I., 80 tracks.
Mfr — MPI-52S
Item #7928 \$79.95
2 for \$150.00

96 TPI, DS/Quad Density
Mfr — CDC #9409T
Item #1893 \$99.00

JOYSTICK CONTROLLERS



Fits Atari, Apple, Commodore, and our #10335 PC8300 Computer. Has 4-ft. cord with plug.
Dim.: 3 1/2" sq. x 1 1/2" H

Item #12143 \$5.95 New

NS 87P50D-11 MICROCOMPUTER

8-bit single chip unit. Emulates 8048/49/50. Piggyback configuration. Allows you to plus in eproms: 2758, 2716, and 2732. Features: X.MOS, 5V, 8.16 Bit, 4K direct access memory, 256 bits on chip ROM, 11 MHz, max. freq.

Item #8899 \$24.95 New

MICROCOMPUTER with EPROM

MC68701 is an 8-bit single chip unit & significantly enhances the capabilities of the M6800 family. Includes an upgraded MC6800 microprocessor. Functions as a monolithic micro-computer or can be expanded to a 64K byte address space. TTL comp. Req.: 1 +5V power supply for nonprogramming operation. On chip resources: 2048 bytes of eprom, 128 bytes RAM, 'SCSI' parallel, I/O & 3-function programmable timer.

Item #9496 \$9.95 (house #)

ANALOG TO DIGITAL CONVERTER

Binary output: 12 bit; Conversion time: 8 ms. Linearity: 8 ms. ± 1/2 lbs. Parallel and series outputs; internal reference.

Mfr — Datal ADC-HZ-128GC

Item #7052 (RFE, tested good!)

Originally \$130.00
Special — \$39.95

115 VAC 27 CFM MINI FANS

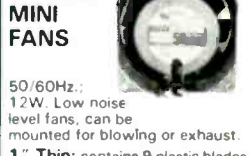

50/60Hz.; 12W. Low noise level fans, can be mounted for blowing or exhaust.

1" Thin: contains 9 plastic blades
Dim.: 3 1/2" sq. x 1" deep
Mfr — Toshiba #U9201B

Item #10960 \$7.95 New

1 1/2" Standard: contains 7 metal blades.

Mfr — Rotron #SU2A1

Item #5970 \$7.95 New

D-SUBMINIATURE SOLDERLESS CONNECTORS, CRIMP TERMINALS (Mfr — TRW)

Description	Fig.	9-Pin		15-Pin		25-Pin		37-Pin	
		Item #	Price	Item #	Price	Item #	Price	Item #	Price
Hood w/Metal Male	A	10998	\$1.29	11001	\$1.39	O/S	\$1.69	11002	\$2.09
Hood w/Metal Female	A	10999	1.49	11000	1.49	O/S	1.79	11003	2.19
Hood w/Plastic Male	A	11004	1.19	O/S	1.29	11007	1.59	11005	1.99
Hood w/Plastic Female	A	O/S	1.35	O/S	1.49	11008	1.79	11006	2.19
Chassis mount, Metal Male*	B	10747	.75	10745	.89	10735	1.19	10752	1.59
Chassis mount, Metal Female	B	10746	.89	10734	.99	10711	1.29	10888	1.69
Chassis mount, Plastic Male**	C	10890	.65	10910	.79	10732	1.09	10891	1.49
Chassis mount, Plastic Female	C	10728	.79	10731	.89	10724	1.19	10729	1.59
QC Hood w/Metal Male	D	11025	1.39	10029	1.49	11033	1.79	11037	2.19
QC Hood, Rt. Angle w/Metal Male	E	11026	1.39	11030	1.49	11034	1.79	11038	2.19
QC Hood w/Metal Female	D	11027	1.59	11031	1.69	11035	1.99	11039	2.39
QC Hood, Rt. Angle w/Metal Female	E	11028	1.59	11032	1.69	11036	1.99	11040	2.39
QC Hood w/Plastic Male	D	11009	1.29	11013	1.39	11017	1.69	11021	2.09
QC Hood, Rt. Angle w/Plastic Male	E	11011	1.29	11015	1.39	11018	1.69	11022	2.09
QC Hood w/Plastic Female	D	11010	1.49	11014	1.59	11019	1.89	11023	2.29
QC Hood, Rt. Angle w/Plastic Female	E	11012	1.49	11016	1.59	11020	1.89	11024	2.29

QC = Quick connect; * Without mounting device; ** Can be used with quick connect hoods

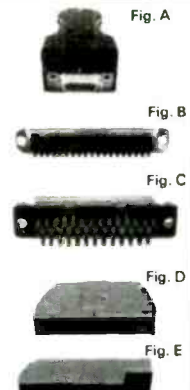

1-PIECE TELEPHONE



Features: last number redial & mute button. Comes w/15" cord & standard modular plug. Color: Ivory
Mfr — Spectra-phone, Model OP-1

Item #10748 \$10.95 New
2 for \$20.00

RECORDING TAPE

7 1/2" Reel, 2400 ft.



Bulk erased. Major mfrs.: Ampex, Scotch, etc.

Item #6711 — 1/4 Mil.
79¢ ea.; 3 for \$2.00

EMI FILTER

6 Amp., 120/240 Volt



Provides the most effective attenuation of 'line-to-ground' and 'line-to-line' noise across the frequency range.

Dim.: 2.62" L x 1.98" x .81" H
Mfr — SAE (equiv. to Corcom type 6EC1)
Item #10959 \$4.95
2 for \$9.00

MINI MICRO-COMPUTER REGULATOR



140 VA

Provides voltage regulation and ultra-isolation for microprocessor-based equipment. Contains less than 3% harmonic distortion, better than 60 dB traverse noise rejection. Contains dual outlet for CPU & monitor, and 6 ft. line cord.

Input: 95 — 130V, 60Hz.
Output: 120V @ 1.17A
Dimen.: 1 1/2" L x 4 3/4" H x 5 1/2" W
Mtd on metal base with rubber ft.
Mfr — Sola #63-13-114
Item #9999 \$99.00 New

Tenma 4½" Digit Multimeter

- True RMS AC voltage and current functions
- Built-in frequency counter, 20KHz and 200KHz range
- Data hold feature
- Carrying case included
- Measures AC and DC voltage/current, resistance and frequency
- For additional information see MCM Catalog #14

One Year
Limited Warranty

#72-430
\$15980
(ea.)

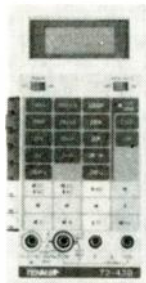

Tenma Regulated Power Supply

- Output: Regulated 13.8V
- Input: 120VAC
- Fuse protected
- With easily accessible fuse holder
- Neon light indicator
- Heavy duty binding posts
- Effective heat sinks for more power dissipation
- 90 day warranty
- For additional information see MCM Catalog #14

3.5 Amp
(5 Amp Surge)
#72-280 **\$2995**
(ea.)



Tenma LCR Meter

- Measures inductance from 1µH-200H in six ranges
- Measures capacitance from .1pF-200µF in seven ranges
- Measures resistance from .01ohm-20Mohm in seven ranges
- Carrying case included
- For additional information see MCM Catalog #14

One Year
Limited Warranty

#72-370
\$14995
(ea.)

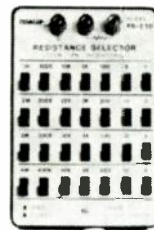

Tenma Resistance Selector Box

- This device allows the user to quickly substitute a resistor in a circuit with any value between 1ohm and 11Mohm
- Constructed entirely of ½ watt resistors with 1% tolerance ratings
- 90 day warranty

#72-405
\$2850
(ea.)

The Name You Can Trust In Electronic Test Equipment

Tenma Anti-Static Work Mat

- A must for the modern service shop
- Used in conjunction with our #21-660 wrist strap to help eliminate static related problems
- 18" x 26"

#21-655
~~\$37⁶⁰~~ **\$3345**
(1-4) (5-up)



Tenma Anti-Static Wrist Strap

- Silver-plated monofilament fibers are woven into a comfortable elastic wrist strap, that gently conforms to the user's wrist for reliable contact to ground

#21-660
~~\$10²⁵~~ **\$945**
(1-9) (10-up)

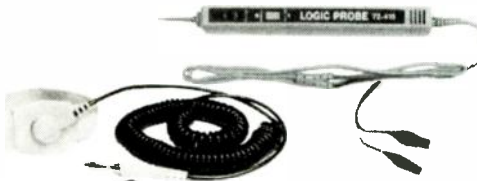

Tenma Soldering Station

- Adjustable temperature range of 150°-420° (300°-790°F)
- Grounded tip for soldering static sensitive devices
- LED power, heater and temperature indicators
- See MCM Catalog #14 for additional information

#21-147
~~\$49⁹⁵~~ **\$4480**
(1-3) (4-up)



TENMA

Tenma Logic Probe

- Working voltage: 4-16VDC
- Frequency response: Maximum 20MHz
- Detectable pulse width: Longer than 25nsec
- Input impedance: 1Mohm minimum
- Input overload protection: ±250V DC/AC
- 90 day warranty
- For additional information see MCM Catalog #14

#72-415
\$1495
(ea.)

Tenma RS-232 Break Out Box

- Monitors individual communication interface lines
- Detects the presence or absence of activity
- Rewire RS-232 interfaces
- Line powered
- Dual-state LEDs monitor both positive and negative signal levels
- 48 test points
- For additional information see MCM Catalog #14

#72-440
~~\$44⁸⁰~~ **\$3995**
(2-up)



Call Toll Free 1-800-543-4330 (In Ohio 1-800-762-4315 (In Alaska and Hawaii 1-800-858-1849))

In Ohio 1-800-762-4315

© 1987, MCM Electronics

Terms:



- \$10 minimum order \$1.00 charge for orders under \$10.
- \$20 minimum charge card order
- Orders shipped UPS C.O.D.
- Most orders shipped within 24 hours.
- Sales office open 8:30 am to 7:00 pm Saturdays 10:00 am to 3:00 pm EST.
- For prepaid orders add \$2.75 for shipping and handling.
- Should shipping and handling charges exceed \$2.75, the balance due will be sent C.O.D.



MCM ELECTRONICS
858 E. CONGRESS PARK DR.
CENTERVILLE, OH 45459
A PREMIER Company

Be Sure To Call For Your FREE Catalog! Over 7,000 Items!

SOURCE NO. RE-32

1-800-344-5399

AK, Puerto Rico - 218-881-8674 Telex - 82827914 FAX - 218-881-3380 TWX - 910350882 DIGI KEY CORP

**NATIONAL SEMICONDUCTOR • PANASONIC
OK MACHINE • EWC, INC. • INTERSIL • AD
EAC, INC. • J. W. MILLER • AAVDI ENGINEER
E. F. JOHNSON • ATLANTIC SEMICONDUCTOR**

256K (262,144 x 1) DRAM 150NS \$5.70/1; \$39.95/9

**DIODES • DIAMOND TOOL • UNGAR •
EGS • CW INDUSTRIES • AMDEK • G.E.
YAGEO • J. W. MILLER • LUXE
3C CHEMICALS • ARIES • PLESSEY**

INTEGRATED CIRCUITS

Part No.	Description	Price
7400 TTL	7400 TTL	1.00
7401	7401	1.00
7402	7402	1.00
7403	7403	1.00
7404	7404	1.00
7405	7405	1.00
7406	7406	1.00
7407	7407	1.00
7408	7408	1.00
7409	7409	1.00
7410	7410	1.00
7411	7411	1.00
7412	7412	1.00
7413	7413	1.00
7414	7414	1.00
7415	7415	1.00
7416	7416	1.00
7417	7417	1.00
7418	7418	1.00
7419	7419	1.00
7420	7420	1.00
7421	7421	1.00
7422	7422	1.00
7423	7423	1.00
7424	7424	1.00
7425	7425	1.00
7426	7426	1.00
7427	7427	1.00
7428	7428	1.00
7429	7429	1.00
7430	7430	1.00
7431	7431	1.00
7432	7432	1.00
7433	7433	1.00
7434	7434	1.00
7435	7435	1.00
7436	7436	1.00
7437	7437	1.00
7438	7438	1.00
7439	7439	1.00
7440	7440	1.00
7441	7441	1.00
7442	7442	1.00
7443	7443	1.00
7444	7444	1.00
7445	7445	1.00
7446	7446	1.00
7447	7447	1.00
7448	7448	1.00
7449	7449	1.00
7450	7450	1.00
7451	7451	1.00
7452	7452	1.00
7453	7453	1.00
7454	7454	1.00
7455	7455	1.00
7456	7456	1.00
7457	7457	1.00
7458	7458	1.00
7459	7459	1.00
7460	7460	1.00
7461	7461	1.00
7462	7462	1.00
7463	7463	1.00
7464	7464	1.00
7465	7465	1.00
7466	7466	1.00
7467	7467	1.00
7468	7468	1.00
7469	7469	1.00
7470	7470	1.00
7471	7471	1.00
7472	7472	1.00
7473	7473	1.00
7474	7474	1.00
7475	7475	1.00
7476	7476	1.00
7477	7477	1.00
7478	7478	1.00
7479	7479	1.00
7480	7480	1.00
7481	7481	1.00
7482	7482	1.00
7483	7483	1.00
7484	7484	1.00
7485	7485	1.00
7486	7486	1.00
7487	7487	1.00
7488	7488	1.00
7489	7489	1.00
7490	7490	1.00
7491	7491	1.00
7492	7492	1.00
7493	7493	1.00
7494	7494	1.00
7495	7495	1.00
7496	7496	1.00
7497	7497	1.00
7498	7498	1.00
7499	7499	1.00
7500	7500	1.00

T. I. C. SOCKETS

Part No.	Description	Price
100	100	1.00
101	101	1.00
102	102	1.00
103	103	1.00
104	104	1.00
105	105	1.00
106	106	1.00
107	107	1.00
108	108	1.00
109	109	1.00
110	110	1.00
111	111	1.00
112	112	1.00
113	113	1.00
114	114	1.00
115	115	1.00
116	116	1.00
117	117	1.00
118	118	1.00
119	119	1.00
120	120	1.00
121	121	1.00
122	122	1.00
123	123	1.00
124	124	1.00
125	125	1.00
126	126	1.00
127	127	1.00
128	128	1.00
129	129	1.00
130	130	1.00
131	131	1.00
132	132	1.00
133	133	1.00
134	134	1.00
135	135	1.00
136	136	1.00
137	137	1.00
138	138	1.00
139	139	1.00
140	140	1.00
141	141	1.00
142	142	1.00
143	143	1.00
144	144	1.00
145	145	1.00
146	146	1.00
147	147	1.00
148	148	1.00
149	149	1.00
150	150	1.00

5% Carbon Film Resistors

Part No.	Description	Price
100	100	1.00
101	101	1.00
102	102	1.00
103	103	1.00
104	104	1.00
105	105	1.00
106	106	1.00
107	107	1.00
108	108	1.00
109	109	1.00
110	110	1.00
111	111	1.00
112	112	1.00
113	113	1.00
114	114	1.00
115	115	1.00
116	116	1.00
117	117	1.00
118	118	1.00
119	119	1.00
120	120	1.00
121	121	1.00
122	122	1.00
123	123	1.00
124	124	1.00
125	125	1.00
126	126	1.00
127	127	1.00
128	128	1.00
129	129	1.00
130	130	1.00
131	131	1.00
132	132	1.00
133	133	1.00
134	134	1.00
135	135	1.00
136	136	1.00
137	137	1.00
138	138	1.00
139	139	1.00
140	140	1.00
141	141	1.00
142	142	1.00
143	143	1.00
144	144	1.00
145	145	1.00
146	146	1.00
147	147	1.00
148	148	1.00
149	149	1.00
150	150	1.00

DISC CAPACITORS

Part No.	Description	Price
100	100	1.00
101	101	1.00
102	102	1.00
103	103	1.00
104	104	1.00
105	105	1.00
106	106	1.00
107	107	1.00
108	108	1.00
109	109	1.00
110	110	1.00
111	111	1.00
112	112	1.00
113	113	1.00
114	114	1.00
115	115	1.00
116	116	1.00
117	117	1.00
118	118	1.00
119	119	1.00
120	120	1.00
121	121	1.00
122	122	1.00
123	123	1.00
124	124	1.00
125	125	1.00
126	126	1.00
127	127	1.00
128	128	1.00
129	129	1.00
130	130	1.00
131	131	1.00
132	132	1.00
133	133	1.00
134	134	1.00
135	135	1.00
136	136	1.00
137	137	1.00
138	138	1.00
139	139	1.00
140	140	1.00
141	141	1.00
142	142	1.00
143	143	1.00
144	144	1.00
145	145	1.00
146	146	1.00
147	147	1.00
148	148	1.00
149	149	1.00
150	150	1.00

TANTALUM CAPACITORS

Part No.	Description	Price
100	100	1.00
101	101	1.00
102	102	1.00
103	103	1.00
104	104	1.00
105	105	1.00
106	106	1.00
107	107	1.00
108	108	1.00
109	109	1.00
110	110	1.00
111	111	1.00
112	112	1.00
113	113	1.00
114	114	1.00
115	115	1.00
116	116	1.00
117	117	1.00
118	118	1.00
119	119	1.00
120	120	1.00
121	121	1.00
122	122	1.00
123	123	1.00
124	124	1.00
125	125	1.00
126	126	1.00
127	127	1.00
128	128	1.00
129	129	1.00
130	130	1.00
131	131	1.00
132	132	1.00
133	133	1.00
134	134	1.00
135	135	1.00
136	136	1.00
137	137	1.00
138	138	1.00
139	139	1.00
140	140	1.00
141	141	1.00
142	142	1.00
143	143	1.00
144	144	1.00
145	145	1.00
146	146	1.00
147	147	1.00
148	148	1.00
149	149	1.00
150	150	1.00

WIRE WRAP KITS

Part No.	Description	Price
100	100	1.00
101	101	1.00
102	102	1.00
103	103	1.00
104	104	1.00
105	105	1.00
106	106	1.00
107	107	1.00

ELECTRONIC WAREHOUSE CORP.

- Over 20,000 Electronic Items in stock
- TOLL—FREE "800" Phones
- 24 hour hot line automatic order taker
- Same day order processing & shipping
- VISA & MASTER CARD accepted



SANYO ORIGINAL FLYBACKS	
60108	\$8.95
48500	8.95
48600	8.95
F0241	11.75
F1123	11.50
F0192A	13.75
F0239	14.95
F0260	14.50



SANYO ORIGINAL FOCUS DIVIDERS	
Z0063	\$9.95
Z0064	10.95
Z0040	10.95



HORIZONTAL OUTPUT TRANSISTORS	
25C 1172B	\$1.49
25C 1308K	1.99
25D869	1.99

Fully Guaranteed

EARN BIG MONEY REPAIR GAMES & COMPUTERS
 EWC is the largest stocking distributor of ATARI, COLECO, INTELLIVISION & COMMODORE parts, service information & supplies. Call or write for complete details and a copy of our latest catalog.



TOLL FREE
(800) 221-0424

(718) 375-2700
 New York State
 dealers call collect

1910 CONEY ISLAND AVENUE
 BROOKLYN, NEW YORK 11230

CIRCLE 206 ON FREE INFORMATION CARD

AMAZING SCIENTIFIC & ELECTRONIC PRODUCTS

- PLANS—Build Yourself—All Parts Available In Stock**
- LC7—BURNING CUTTING CO₂ LASER \$ 20.00
 - RUB4—PORTABLE LASER RAY PISTOL 20.00
 - TCC1—3 SEPARATE TESLA COIL PLANS TO 1.5 MEV 20.00
 - IOG1—ION RAY GUN 10.00
 - GRA1—GRAVITY GENERATOR 10.00
 - EML1—ELECTRO MAGNET COIL GUN/LAUNCHER 5.00

- KITS**
- MFT1K—FM VOICE TRANSMITTER 3 MI RANGE 49.50
 - WYPM5K—TELEPHONE TRANSMITTER 3 MI RANGE 39.50
 - BTC3K—250.00 VOLT 10-14" SPARK TESLA COIL 199.50
 - LHC2K—SIMULATED MULTICOLOR LASER 39.50
 - BLS1K—100.000 WATT BLASTER DEFENSE DEVICE 69.50
 - ITM1K—100.000 VOLT 20" AFFECTIVE RANGE INTIMIDATOR 69.50
 - PSP4K—TIME VARIANT SHOCK WAVE PISTOL 59.50
 - PTG1K—SPECTACULAR PLASMA TORNADO GENERATOR 139.50
 - MNP1K—SEE IN DARK KIT 169.50

- ASSEMBLED**
- PG70H—MULTICOLOR VARIABLE MODE PLASMA GLOBE 7" 425.00
 - BTC10—50,000 VOLT—WORLD'S SMALLEST TESLA COIL 44.50
 - LGU40—1MW HeNe VISIBLE RED LASER GUN 299.50
 - TAT20 AUTO TELEPHONE RECORDING DEVICE 24.50
 - GPV10—SEE IN TOTAL DARKNESS IR VIEWER 299.50
 - LIST10—SNOOPER PHONE INFINITY TRANSMITTER 169.50
 - IPG70—INVISIBLE PAIN FIELD GENERATOR—MULTI MODE 69.50

• CATALOG CONTAINING DESCRIPTIONS OF ABOVE PLUS HUNDREDS MORE AVAILABLE FOR \$1.00 OR INCLUDED FREE WITH ALL ABOVE ORDERS.
 PLEASE INCLUDE \$3.00 PH ON ALL KITS AND PRODUCTS PLANS ARE POSTAGE PAID SEND CHECK, MO, VISA, MC IN US FUNDS

INFORMATION UNLIMITED
 P.O. BOX 715, DEPT. RE, AMHERST, NH 03031

ADVERTISING INDEX

RADIO-ELECTRONICS does not assume any responsibility for errors that may appear in the index below.

Free Information Number	Page		Page
81	A.L.S. Satellite	28	186
108	AMC Sales	75	71
76	AP Products Brand of 3M	13	200
203	Advanced Video	28	179
107	All Electronics	162	110
—	Amazing Devices	168	210
211	American Design Components	164, 165	—
84	Appliance Service	29	204
187	B N F Enterprises	130	208
53	BUYUS	28	78
214	Banner Technical Books	132	194
98	Beckman Industrial	3	185
85	Blue Star Industries	29	195,196
109	C & S Sales	22	197,198
—	C.O.M.B.	69	—
60	CIE	16	192
209	Cable Distributors	29	94
189	Cabletronics	28	178
189	Caig	33	190
—	Command Productions	75	92
79	Communications Electronics	9	191
201	Consumertronics	147	213
55	Contact East	29	199
188	Cook's Institute	132	207
—	Coop's Satellite Digest	78	66
212	Crystek	26	103
177	Daetron	124	—
127	Deco Industries	28,29	—
95	Dick Smith Electronics	163	—
82	Digi-Key	167	—
—	Digital Research Computers	153	—
202	Electronic Design Specialists	24	—
—	Electronic Technology Today	152	—
176	Electronics Book Club	15	—
206	Electronics Warehouse Corp.	168	—
120	Elephant Electronics	28	—
100	Firestik II	132	—
121	Fluke Manufacturing	32	—
—	Fordham Radio	126	—
—	Grantham College of Engineering	31	—
86,193	Heath	7,55	—
—	ICS Computer Training	11	—
—	ISCET	130	—
65	J & W	12	—
59	JDR Instruments	CV4	—
113,180	JDR Microdevices	154,155	—
181,182	JDR Microdevices	156,157	—
183	JDR Microdevices	158	—
114	Jameco	160,161	—
104	Jan Crystals	128	—
—	Joseph Electronics	14	—
87	MCM Electronics	166	—
205	MD Electronics	29	—
93	Mark V. Electronics	151	—
—	McGraw Hill Book Club	70	—
61	Microprocessors Unltd.	147	—
—	NRI	34,131	—
—	NTS	28	—
—	New-Tone Electronics	5	—
—	NuScope Associates	147	—
—	OCTE Electronics	29	—
—	Omnitron	30	—
—	Optima	33	—
—	Pacific Cable	149	—
—	Parts Express	153	—
—	Portasol	28	—
—	Radio Shack	159	—
—	Regency	38	—
—	Satellite TV Week Magazine	76	—
—	Sencore	21,23	—
—	Sencore	25,27	—
—	Shojiki Electronics	152	—
—	Silicon Valley Surplus	150	—
—	Star Circuits	29	—
—	T S M	CV3	—
—	Tapto	28	—
—	Tektronix	CV2	—
—	Trans-Am	128	—
—	Underwater Vehicle Training Center	126	—
—	United Electronic Supply	20	—
—	VIP Electronics	29	—
—	W.S. Jenks	128	—
—	Wm B Allen	122	—

Gernsback Publications, Inc.
 500-B Bi-County Blvd.
 Farmingdale, NY 11735
 (516) 293-3000
 President: Larry Steckler
 Vice President: Cathy Steckler

For Advertising ONLY 516-293-3000
 Larry Steckler
 publisher
 Arline Fishman
 advertising director
 Shelli Weinman
 advertising associate
 Lisa Strassman
 credit manager
 Christina Estrada
 advertising assistant

SALES OFFICES
EAST/SOUTHEAST
 Stanley Levitan
 Eastern Sales Manager
 Radio-Electronics
 259-23 57th Avenue
 Little Neck, NY 11362
 718-428-6037, 516-293-3000

MIDWEST/Texas/Arkansas/Okla.
 Ralph Bergen
 Midwest Sales Manager
 Radio-Electronics
 540 Frontage Road—Suite 339
 Northfield, IL 60093
 312-446-1444

PACIFIC COAST/ Mountain States
 Marvin Green
 Pacific Sales Manager
 Radio-Electronics
 15335 Morrison St.—Suite 227
 Sherman Oaks, CA 91403
 818-986-2001

FOR FREE INFORMATION USE THESE POST-PAID CARDS

- 1 Print your name, address and Zip Code on one of the attached postage-paid cards.
- 2 Circle the number (or numbers) on the card that matches the number at the bottom of each ad or editorial item that you want information on. Advertisers' free information numbers also appear in the ad index on the facing page.
- 3 Mail the card. It's Postage-Paid.

The bottom free-information card is a BUSINESS/PROFESSIONAL CARD. If you use this card you MUST complete the spaces for Company Name, Title, and Phone Number. If these are not filled in, the card will not be processed.

NOTE:
Use the postcard address for Free Product Information only. Address all editorial inquiries to Editor, Radio-Electronics, 500-B Bi-County Blvd., Farmingdale, NY 11735



Radio Electronics.
Your favorite electronics magazine and still getting better

BUSINESS/PROFESSIONAL FREE INFO CARD

Use this card if information requested is for business use. You must fill in company name and phone number.

4-587

Radio Electronics.

Name _____ Title _____

Company _____

Dept./MS _____

Daytime Business Phone _____

Company Address _____

City _____ State _____ Zip + 4 _____

- Unclear or incomplete mailing info will prevent our processing this request.
- 2 Please send me 12 issues of RADIO-ELECTRONICS for \$16.97 and bill me. (Canada \$22.97 - US Funds only)
- 4 Please send me 12 issues of HANDS-ON ELECTRONICS for \$28.00 and bill me. (Canada \$33.00 - US Funds only)

19	37	55	73	91	109	127	145	163	181	199	217	235	253	271	
20	38	56	74	92	110	128	146	164	182	200	218	236	254	272	
21	39	57	75	93	111	129	147	165	183	201	219	237	255	273	
22	40	58	76	94	112	130	148	166	184	202	220	238	256	274	
23	41	59	77	95	113	131	149	167	185	203	221	239	257	275	
24	42	60	78	96	114	132	150	168	186	204	222	240	258	276	
25	43	61	79	97	115	133	151	169	187	205	223	241	259	277	
26	44	62	80	98	116	134	152	170	188	206	224	242	260	278	
9	27	45	63	81	99	117	135	153	171	189	207	225	243	261	279
10	28	46	64	82	100	118	136	154	172	190	208	226	244	262	280
11	29	47	65	83	101	119	137	155	173	191	209	227	245	263	281
12	30	48	66	84	102	120	138	156	174	192	210	228	246	264	282
13	31	49	67	85	103	121	139	157	175	193	211	229	247	265	283
14	32	50	68	86	104	122	140	158	176	194	212	230	248	266	284
15	33	51	69	87	105	123	141	159	177	195	213	231	249	267	285
16	34	52	70	88	106	124	142	160	178	196	214	232	250	268	286
17	35	53	71	89	107	125	143	161	179	197	215	233	251	269	287
18	36	54	72	90	108	126	144	162	180	198	216	234	252	270	288

FREE INFORMATION CARD

VOID after JULY 31, 1987
Allow 6-8 weeks for delivery of first issue

POSTAGE-PAID FREE INFORMATION CARD



3-587

Name (please print) _____

Company Name (if applicable) _____

Address _____

City _____ State _____ Zip + 4 _____

- Unclear or incomplete mailing info will prevent our processing this request.
- 2 Please send me 12 issues of RADIO-ELECTRONICS for \$16.97 and bill me. (Canada \$22.97 - US Funds only)
- 4 Please send me 12 issues of HANDS-ON ELECTRONICS for \$28.00 and bill me. (Canada \$33.00 - US Funds only)
- Is this your personal copy of RADIO-ELECTRONICS?
6 Yes 8 No

19	37	55	73	91	109	127	145	163	181	199	217	235	253	271	
20	38	56	74	92	110	128	146	164	182	200	218	236	254	272	
21	39	57	75	93	111	129	147	165	183	201	219	237	255	273	
22	40	58	76	94	112	130	148	166	184	202	220	238	256	274	
23	41	59	77	95	113	131	149	167	185	203	221	239	257	275	
24	42	60	78	96	114	132	150	168	186	204	222	240	258	276	
25	43	61	79	97	115	133	151	169	187	205	223	241	259	277	
26	44	62	80	98	116	134	152	170	188	206	224	242	260	278	
9	27	45	63	81	99	117	135	153	171	189	207	225	243	261	279
10	28	46	64	82	100	118	136	154	172	190	208	226	244	262	280
11	29	47	65	83	101	119	137	155	173	191	209	227	245	263	281
12	30	48	66	84	102	120	138	156	174	192	210	228	246	264	282
13	31	49	67	85	103	121	139	157	175	193	211	229	247	265	283
14	32	50	68	86	104	122	140	158	176	194	212	230	248	266	284
15	33	51	69	87	105	123	141	159	177	195	213	231	249	267	285
16	34	52	70	88	106	124	142	160	178	196	214	232	250	268	286
17	35	53	71	89	107	125	143	161	179	197	215	233	251	269	287
18	36	54	72	90	108	126	144	162	180	198	216	234	252	270	288

FREE INFORMATION CARD

VOID after JULY 31, 1987
Allow 6-8 weeks for delivery of first issue

BUSINESS REPLY MAIL

FIRST CLASS PERMIT NO. 597 BOULDER, CO. ORADO

Radio Electronics.
SUBSCRIPTION SERVICE
P.O. Box 51866
BOULDER, COLORADO 80321-1866

NO POSTAGE NECESSARY IF MAILED IN THE UNITED STATES





NO POSTAGE
NECESSARY
IF MAILED
IN THE
UNITED STATES

BUSINESS REPLY MAIL

FIRST CLASS PERMIT NO. 132 DALTON, MA

POSTAGE WILL BE PAID BY ADDRESSEE

**Radio-
Electronics**

FREE PRODUCT INFORMATION
P.O. Box 388
DALTON, MA 01226-9990



**For New
Ideas
In Electronics
read Radio-
Electronics
every month.
During the next
12 months**

Radio-Electronics will carry up to the minute articles on:

- Computers • Video
- Solid-state technology
- Outstanding construction projects
- Satellite TV • Telephones
- Radio • Stereo • Equipment Reports
- Test equipment • VCR's
- Servicing
- Industrial electronics



**NEW IDEAS AND INNOVATIONS
IN ELECTRONICS APPEAR IN EVERY
ISSUE OF RADIO-ELECTRONICS**

**KEEP UP TO DATE! DON'T MISS
ANY ISSUES!**

SUBSCRIBE TODAY!

**USE THE ORDER CARD ON YOUR
LEFT!**

**Hands-on
Electronics**

Formerly Special Projects

Delivers construction article after construction article.....Exciting columns including Jensen on DXing, Freidman on computers, Test bench tips, Noll with Calling All Hams, New Products and more.



SUBSCRIBE TODAY!

**USE THE REPLY CARDS ON YOUR
LEFT!**

**Radio-
Electronics**

4SE72

Subscribe today to the magazine that keeps you up-to-date with the newest ideas and innovations in electronics. (If you already are a subscriber, do a friend a favor and pass this subscription card along to him.)

check offer preferred

- 1 Year—12 issues **ONLY \$16.97** 2 Years (**SAVE MORE**)—24 issues \$32.97
 (You save \$10.03 off single copy price) (You save \$21.03 off single copy price)
- Canada—12 issues \$22.97 Canada—24 issues \$44.97

ALL SUBSCRIPTIONS PAYABLE IN U.S. FUNDS ONLY

- Payment enclosed Bill Me Check here if you are extending or
renewing your subscription

Name (Please Print) _____

Company Name (If applicable) _____

Address _____

City _____ State _____ Zip _____

Allow 6-8 weeks for delivery of first issue



NO POSTAGE
NECESSARY
IF MAILED
IN THE
UNITED STATES

BUSINESS REPLY MAIL

FIRST CLASS PERMIT NO. 132 DALTON, MA

POSTAGE WILL BE PAID BY ADDRESSEE

**Radio-
Electronics**

FREE PRODUCT INFORMATION
P.O. Box 388
DALTON, MA 01226-9990



T S M

1 in EUROPE
SINCE 1966

2065 boston post road

larchmont n.y.10538

914-834-7190

Thank you for visiting us at the Summer C.E.S. in Chicago (Saturday, May 30 thru Tuesday, June 2, 1987).
See show directory for our booth number.
Welcome again!

TSM KITS - A LIBRARY OF KITS AND ELECTRONIC APPLICATIONS.

1 in Europe since 1966.

presented in a unique, appealing video-type packaging covering various subjects such as amplifiers, alarms, pre-amplifiers, color organs, power supplies, measurement, car appliances, home appliances, receivers, etc. More than 60 kits available and more to come.

MECANORMA: PCB TRANSFER SHEETS.

Photo-engraving method

Transfer symbols for direct etching.
SIEBER SCIENTIFIC

Double-sided bread board for easy assembly - no soldering required
professionnal heavy-duty models for teaching, design and quick evaluation.

LA TOLERIE PLASTIQUE

wide range of tooled plastic boxes

flexible custom-design

easy assembly

CIF LE CIRCUIT IMPRIME FRANCAIS

quick, professional etching machine

TSM ELECTRONIC COMPONENTS

import/export
large variety of brands
full range of components

TSM in America INC
2065 Boston Post Road
Larchmont NEW YORK
10538

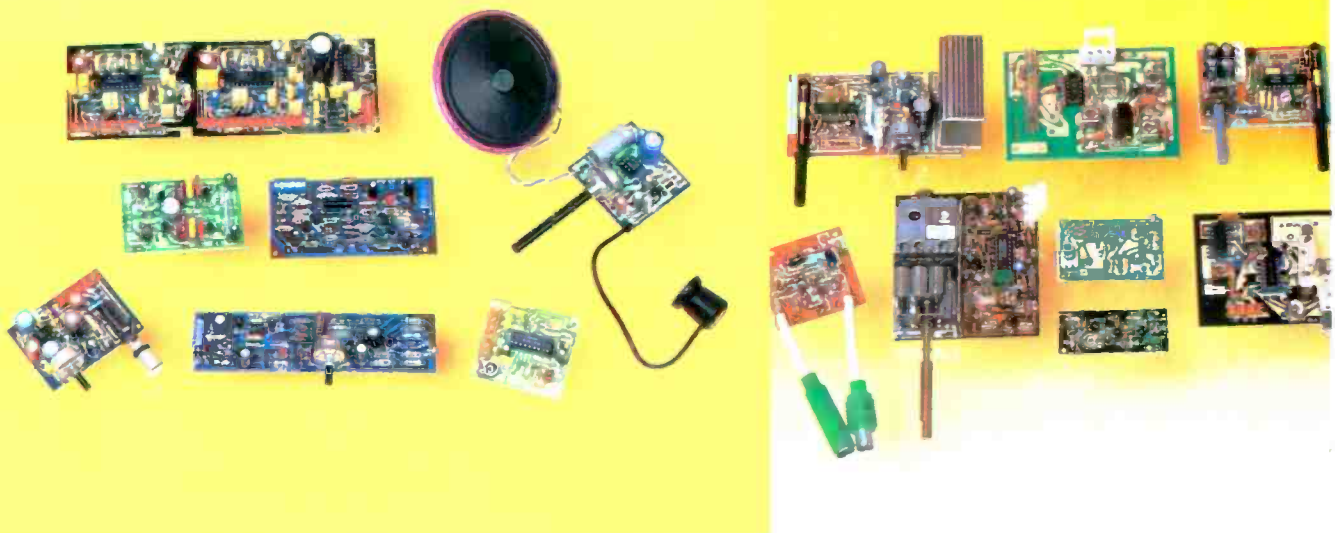
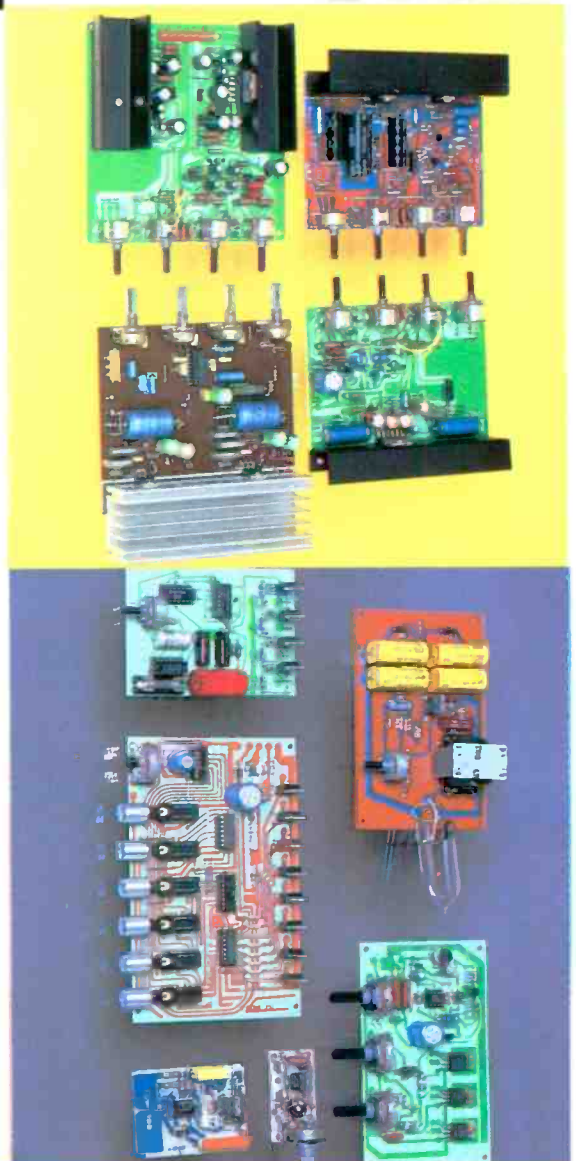

TEST EQUIPMENT THAT MEASURES UP TO YOUR SPECIFICATIONS



DMM-300 \$79.95
3.5 DIGIT DMM / MULTITESTER

Our best model. A highly accurate, full function DMM loaded with many extra features. Audible continuity, capacitance, transistor temperature and conductance fill in on a handheld meter. Temperature probe test leads and battery included.

- Basic DC accuracy: plus or minus 0.25%
- DC voltage: 200mv — 1000v, 5 ranges
- AC voltage: 200mv — 750v, 5 ranges
- Resistance: 200 ohms — 20M ohms, 3 ranges
- AC/DC current: 200uA — 10A, 6 ranges
- Capacitance: 2000pF — 20uF, 3 ranges
- Transistor tester, hFE test, hPN, PNP
- Temperature tester: C° — $200^{\circ}\text{F}^{\circ}$
- Conductance: 200ohms
- Fully over-load protected
- Input impedance: 10M ohms



DMM-200 \$49.95
3.5 DIGIT FULL FUNCTION DMM

High accuracy, 20 amp current capability and many range settings make this model ideal for serious bench or field work. Fit stand for hands-free operation, 2000 hour battery life with standard 9v cell. Probe and battery included.

- Basic DC accuracy: plus or minus 0.25%
- DC voltage: 200mv — 1000v, 5 ranges
- AC voltage: 200mv — 750v, 5 ranges
- Resistance: 200 ohms — 20M ohms, 6 ranges
- AC/DC current: 200uA — 20A, 6 ranges
- Fully over-load protected
- Input impedance: 10M ohm
- 180 x 86 x 37 mm, weighs 320 grams



DMM-700 \$49.95
3.5 DIGIT AUTORANGING DMM

Autorange convenience with manual operation. Selectable LO Ohm mode, plus bits accurate in-circuit resistance measurements involving semi-conductors. ME mode for measuring motor inductance, specific loading. Probes and battery included.

- Basic DC accuracy: plus or minus 0.5%
- DC voltage: 200mv — 1000v, autoranging or 5 manual ranges
- AC voltage: 2v — 750v, autoranging or 4 manual ranges
- Resistance: 200 ohms — 20M ohms, autoranging
- AC/DC current: 20mA — 10A, 2 ranges
- Fully over-load protected
- Audible continuity tester
- Input impedance: 10M ohm
- 150 x 75 x 34mm, weighs 230 grams



DMM-100 \$29.95
3.5 DIGIT POCKET SIZE DMM

Shirt-pocket portability with no compromise in features or accuracy. Large, easy to read 5" LCD display, 2000 hour battery life with standard 9v cell provides over two years of average use. Probe and battery included.

- Basic DC accuracy: plus or minus 0.5%
- DC voltage: 2v — 1000v, 4 ranges
- AC voltage: 200v — 750v, 2 ranges
- Resistance: 2k ohms — 2M ohms, 4 ranges
- DC current: 2mA — 2A, 4 ranges
- Fully over-load protected
- Input impedance: 10M ohm
- 130 x 75 x 28mm, weighs 195 grams

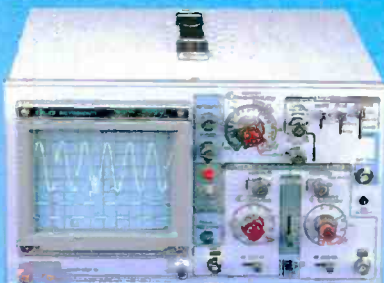

MODEL 2000 \$349.95
20 MHz DUAL TRACE OSCILLOSCOPE

Model 2000 combines useful features and exacting quality. Frequency calculation and phase measurement are quick and easy in the X-Y Mode. Service technicians will appreciate the TV Sync circuitry for viewing TV-V and TV-H as well as accurate synchronization of the Video Signal, Blanking Pedestals, VITS and Vertical/Horizontal sync pulses.

- Lab quality compensated 10X probes included
- Built-in component tester
- 110V/220 Volt operation
- X-Y operation • Bright 5" CRT • TV Sync filter

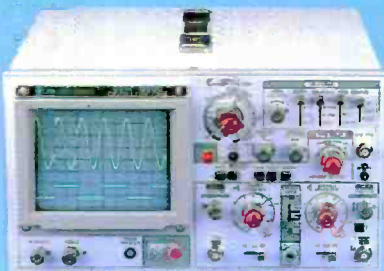

MODEL 3500 \$499.95
35 MHz DUAL TRACE OSCILLOSCOPE

Wide bandwidth and exceptional 1mV/DIV sensitivity make the Model 3500 a powerful diagnostic tool for engineers or technicians. Delayed triggering allows any portion of a waveform to be isolated and expanded for closer inspection. Variable Holdoff makes possible the stable viewing of complex waveforms.

- Lab quality compensated 10X probes included
- Delayed and single sweep modes
- Z Axis intensity modulation
- X-Y operation • Bright 5" CRT • TV Sync filter



DPM-1000 \$54.95
3.5 DIGIT PROBE TYPE DMM

Autoranging, pen style design for the ultimate in portability and ease of use. Custom 80 pin LSI chip increases reliability. Audible continuity tester and data hold feature for added convenience. Case, test leads and battery included.

- Basic DC accuracy: plus or minus 1%
- DC voltage: 2v — 500v, autoranging
- AC voltage: 2v — 500v, autoranging
- Resistance: 2k ohms — 2M ohms, autoranging
- Fully over-load protected
- Input impedance: 11M ohm
- 162 x 28 x 17mm, weighs 75 grams

2 YEAR WARRANTY ON ALL MODELS



JDR INSTRUMENTS

110 Knowles Drive, Los Gatos, CA 95030
(408) 866-6200 • FAX (408) 378-8927 • Telex 171-110

COPYRIGHT 1986 JDR MICRODEVICES
THE JDR INSTRUMENTS LOGO IS A REGISTERED TRADEMARK OF JDR MICRODEVICES.
JDR INSTRUMENTS IS A TRADEMARK OF JDR MICRODEVICES.

ORDER TOLL FREE 800-538-5000

OR VISIT OUR RETAIL STORE
1256 SOUTH BASCOM AVE.
SAN JOSE, CA. (408) 947-8881
CIRCLE 59 ON FREE INFORMATION CARD