

# Radio- Electronics

BUILD A TIMEX/SINCLAIR EXPANSION  
TO ENHANCE THE ZX81  
OPERATING SYSTEM

\$1.50 JULY 1983  
U.K. 85p

COMPUTERS - VIDEO - STEREO - TECHNOLOGY - SERVICE

What's coming in  
**NAVIGATION SYSTEMS**  
for your car

Build a  
**TALKING ALARM CLOCK**  
and listen to the time

How to use  
**LEAD-AC SIGNALS**  
for accuracy calibration

Build a  
**DRAWING BOARD DMM**

Test  
**CONDUCTANCE AMP IC's**  
and how to use them

48783

DGS

390736 DHM 09976093 6V 4 NOV83  
MR ROBERT DEHN  
997 GRAND AV  
AURORA IL 60505  
0746E



## PLUS:

- ★ Videogames ★ Hobby Corner
- ★ Drawing Board ★ Service Clinic
- ★ New Idea ★ State-Of-Solid-State



# affordable precision

## Excellence by Design

BBC has been building multimeters and other instrumentation for European engineers and technicians for over 7 decades. And now, twelve advanced technology BBC meters with a complete line of accessories are available in the U.S. Prices range from under \$50.00 to \$595.00. No other manufacturer offers you comparable price and performance values.

## Forms that Follow Function

To achieve a family of "hands free" instrumentation designed for heavy-duty use in a wide variety of environments, BBC relied on the industrial design skills of the Porsche Design Studios. You'll like the results.

The unique folding design lets you adjust the viewing angle. Extra large LCD displays make the meters easy to read. The exclusive function and range switch is logically laid out. And the folding meters even turn off automatically when you close the case.

## Accuracy Where it Counts

Precision is a tradition at BBC. The 3½ digit folding models feature 0.1% basic dc accuracy. For higher precision measurements, the model MA 5D delivers 0.05% basic dc accuracy and 30,000 counts.

## Precision Values

Some of the best news about BBC meters is that you can get them for less than you've been paying for old technology meters. They are built to the world's highest safety standards, VDE/DIN, and are backed by one of the strongest warranties in the industry.

## Local Availability

BBC has worked hard to make these meters available through leading U.S. distributors and representatives. There is an outlet close to you. And, if your instrumentation supplier doesn't carry BBC yet, we'll gladly tell you who does. Call toll free: 1-800-821-6327. (In CO, 303-469-5231)

## BBC-METRAWATT/GOERZ

6901 W. 117th Avenue  
Broomfield, CO 80020  
Telex 45-4540  
(303) 469-5231

- Send me information on BBC meters.  
 I'd like to be on your mail list.

Fast-Response Coupon

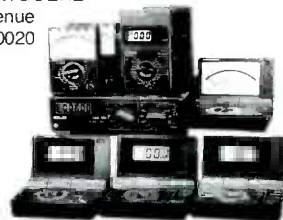

Name \_\_\_\_\_

Title \_\_\_\_\_

Company \_\_\_\_\_

Address \_\_\_\_\_

City \_\_\_\_\_ State \_\_\_\_\_ Zip \_\_\_\_\_

Telephone (\_\_\_\_\_) \_\_\_\_\_

Engineering Excellence in Test and Measurement



CIRCLE 60 ON FREE INFORMATION CARD

# Double Your Troubleshooting and Testing Productivity . . . Or Your Money Back!

**Six-digit readout:** Automatically tracks every CRT test. We call it digital autotracking. It's patent pending.

**Bright dual-trace CRT:** 60 MHz (-3 dB); 100 MHz (-12 dB).

**Delta PPV, Time, Freq:** Measure any part of a waveform for PPV, time or frequency using Delta measurements. Just dial in the waveform section you want to measure and push.

**Simplify Freq ratio tests:** Automatically compare input/output ratio of multiply/divide stages from 1:1 to 1:999,999 with the push of a button.

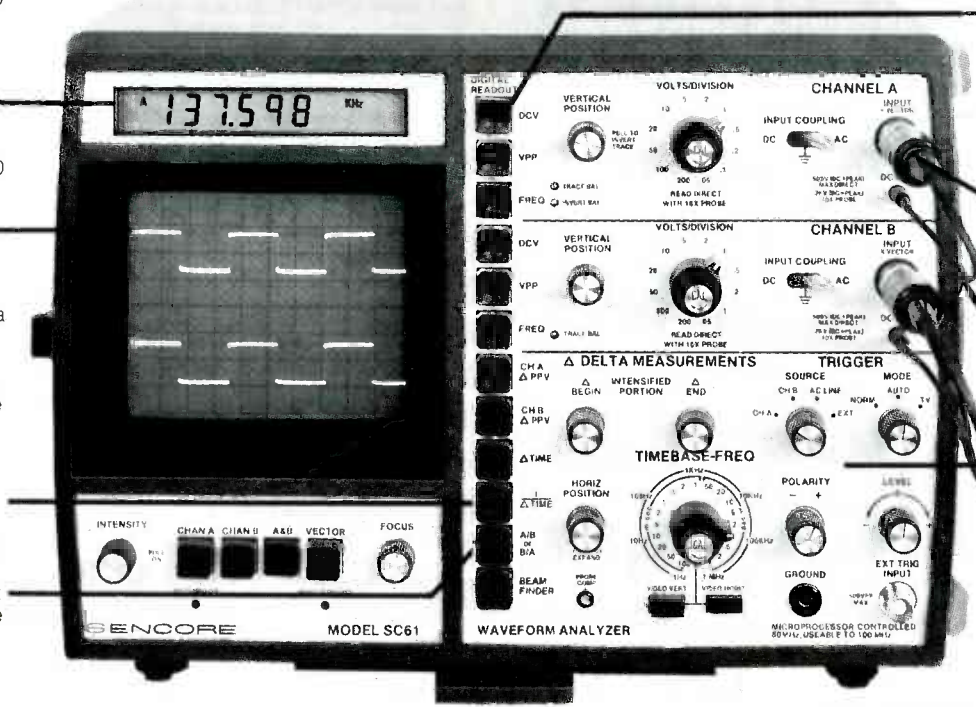

**Autotracking DCV, PPV, Freq:** Measure DCV to .5%; PPV to 2%; freq. to .001%. Just push a button for either Channel A or B.

**One probe input:** One probe input per channel for all measurements - digital and scope - with 5 mV to 2000 V measuring range. (2 lo-cap probes provided.)

**Super sync:** ECL provides rock-solid sync trigger circuits with only 4 controls; includes TV sync separators for video work.

U.S. Patent Pending  
Financing Available

**The first scope with push button digital readout.** If you use general purpose oscilloscopes for troubleshooting or testing, we can double your present productivity with the SC61 Waveform Analyzer, the first instrument to turn every conventional scope measurement into an automatic digital readout.

**No more graticule counting.** Connect only one probe to view any waveform to 100 MHz. Then, just push a button to read DCV, PPV, frequency and time — automatically!

There are no graticules to count or calculations to make, which speeds every measurement.

The digital readout is from 10 to 10,000 times more accurate as well.

Plus you have everything you want to know about a test point, at the push of a button, which speeds troubleshooting tremendously.

A special Delta function even lets you intensify parts of a waveform and digitally measure the PPV, time or frequency for just that waveform section.

And it's neat. No more tangled leads, piles of probes or dangling cords. The SC61 is an entire test station in one unit.

**The one and only.** There are other scopes with digital readout, but none of them completely automate every conventional scope measurement so you can automatically analyze any waveform without counting one single graticule. Totally automatic waveform analyzing at the push of a button. It will make all the difference in your productivity.

**Double your productivity.** When we say the SC61 will double your productivity, we're being conservative. We've seen cases of

three, four, even ten time increases in productivity with this first-of-its-kind, automated oscilloscope. Every situation is different, however, so try the SC61 and judge for yourself. Here's our offer.

**Money back guarantee.** If the SC61 does not at least double your productivity during the first thirty days, you may return it for a full refund, including freight both ways.

**Call today.** Get the entire SC61 Waveform Analyzer story. Call toll-free today, and ask for our eight page color brochure. It could be the most productive call you make this year!

**Phone Toll-Free  
1-800-843-3338**

Alaska, Hawaii, Canada and South Dakota call collect (605) 339-0100

**SENCORE**  
3200 Sencore Drive, Sioux Falls, SD 57107

CIRCLE 70 ON FREE INFORMATION CARD  
CIRCLE 71 FOR DEMONSTRATION

# ULTRA Diskettes

**Now...Diskettes you can swear by, not swear at.**

Lucky for you, the diskette buyer, there are many diskette brands to choose from. Some brands are good, some not as good, and some you wouldn't think of trusting with even one byte of your valuable data. Sadly, some manufacturers have put their profit motive ahead of creating quality products. This has resulted in an abundance of low quality but rather expensive diskettes in the marketplace.

## A NEW COMPANY WAS NEEDED AND STARTED

Fortunately, other people in the diskette industry recognized that making ultra-high quality diskettes required the best and newest manufacturing equipment as well as the best people to operate this equipment. Since most manufacturers seemed satisfied to give you only the everyday quality now available, an assemblage of quality conscious individuals decided to start a new company to give you a new and better diskette. They called this product the *Ultra* diskette, and you're going to love them. Now you have a product you can swear by, not swear at.

## HOW THEY MADE THE BEST DISKETTES EVEN BETTER

The management of *Ultra* Magnetics then hired all the top brains in the diskette industry to make the *Ultra* product. Then these top bananas (sometimes called floppy freaks) created a new standard of diskette quality and reliability. To learn the "manufacturing secrets" of the top diskette makers, they've also hired the remaining "magnetic media moguls" from competitors such as Verbatim, Memorex, Dysan and many more. Then all these top-dollar engineers, physicists, research scientists and production experts (if they've missed you, send in your resume to *Ultra*) were given one directive...to pool all their manufacturing know-how and create a new, better diskette.

## HOW ULTRA DISKETTES ARE MANUFACTURED

The *Ultra* Magnetics crew then assembled the newest, totally quality monitored, automated production line in the industry. We know that some of *Ultra's* competitors are still making magnetic media on equipment that is old enough to vote. Since all manufacturing equipment at *Ultra* is new, it's easy for *Ultra* to consistently make better diskettes. You can always be assured of ultra-tight tolerances and superb dependability when you use *Ultra*. If all this manufacturing mumbo-jumbo doesn't impress you, we're sure that at least one of these other benefits from using *Ultra* diskettes will:

- TOTAL SURFACE TESTING** - For maximum reliability, and to lessen the likelihood of disk errors, all diskettes must be totally surface tested. At *Ultra*, each diskette is 100% surface tested. *Ultra* is so picky in their testing, they even test the tracks that are in between the regular tracks.
- COMPLETE LINE OF PRODUCTS** - For a diskette to be useful to you and your computer, it must be compatible physically. *Ultra* Magnetics has an entire line of 5 1/4-inch and 8-inch diskettes.
- SPECIALLY LUBRICATED DISK** - *Ultra* uses a special oxide lubricant which is added to the base media in the production of their diskettes. This gives you a better disk drive head to media contact and longer head and disk life.
- HIGH TEMPERATURE/LOW-MARRING JACKET** - A unique high temperature and low-marring vinyl jacket allows use of their product where other diskettes won't work. This special jacket is more rigid than other diskettes and helps eliminate dust on the jacket.
- REINFORCED HUB RINGS** - Standard on all *Ultra* mini-disks, to strengthen the center hub hole. This increases the life of the disk to save you money and increase overall diskette reliability.
- DISK DURABILITY** - *Ultra* disks will beat all industry standards for reliability at well over millions and millions of revolutions. They are compatible with all industry specifications as established by ANSI, ECMA, ISO and JIS.
- CUSTOMER ORIENTED PACKAGING** - All *Ultra* disks are packaged 10 disks to a carton and 10 cartons to a case. The economy bulk pack is packaged 100 disks to a case without envelopes or labels.
- LIFETIME WARRANTY** - If all else fails, remember, all disks made by *Ultra* Magnetics, (except bulk pack) have a lifetime warranty. If your *Ultra* disks fail to meet factory specifications, *Ultra* Magnetics will replace them under the terms of their warranty.
- SUPERB VALUE** - With *Ultra's* automated production line, high-quality, error-free disks are yours without high cost.



## SAVE ON ULTRA DISKETTES

Product Description	Part #	CE quant. 100 price per disc (\$)
8" SSSD IBM Compatible (128 B/S, 26 Sectors)	81726	1.99
8" SSDD IBM Compatible (128 B/S, 26 Sectors)	81701	2.49
8" DSDD Soft Sector (Unformatted)	82701	3.19
8" DSDD Soft Sector (1024 B/S, 8 Sectors)	82708	3.19
5 1/4" SSSD Soft Sector w/Hub Ring	50001	1.79
5 1/4" Same as above, but bulk pack w/o envelope	00153	1.39
5 1/4" SSSD 10 Hard Sector w/Hub Ring	50010	1.79
5 1/4" SSSD 16 Hard Sector w/Hub Ring	50016	1.79
5 1/4" SSDD Soft Sector w/Hub Ring	51401	1.89
5 1/4" Same as above, but bulk pack w/o envelope	00096	1.49
5 1/4" SSDD 10 Hard Sector w/Hub Ring	51410	1.89
5 1/4" SSDD 16 Hard Sector w/Hub Ring	51416	1.89
5 1/4" DSDD Soft Sector w/Hub Ring	52401	2.79
5 1/4" Same as above, but bulk pack w/o envelope	00140	2.39
5 1/4" DSDD 10 Hard Sector w/Hub Ring	52410	2.79
5 1/4" DSDD 16 Hard Sector w/Hub Ring	52416	2.79
5 1/4" SSQD Soft Sector w/Hub Ring (96 TPI)	51801	2.49
5 1/4" DSQD Soft Sector w/Hub Ring (96 TPI)	52801	3.49

SSSD = Single Sided Single Density; SSDD = Single Sided Double Density; DSDD = Double Sided Double Density; SSQD = Single Sided Quad Density; DSQD = Double Sided Quad Density; TPI = Tracks per inch. For less than 100 diskettes, add 10% to our quantity 100 price. For additional compatibility info call Ultra Magnetics at 408-728-7777.

## The Small Print

To get the fastest delivery from CE of your *Ultra* computer products, send or phone your order directly to our Computer Products Division. Be sure to calculate your price using the CE prices in this ad. Michigan residents please add 4% sales tax or supply your tax I.D. number. Written purchase orders are accepted from approved government agencies and most well rated firms at a 30% surcharge for net 30 billing. All sales are subject to availability, acceptance and verification. All sales are final. Prices, terms and specifications are subject to change without notice. All prices are in U.S. dollars. Out of stock items will be placed on back order automatically unless CE is instructed differently. Minimum prepaid order \$50.00. Minimum purchase order \$200.00. International orders are invited with a \$20.00 surcharge for special handling in addition to shipping charges. All shipments are F.O.B. Ann Arbor, Michigan. No COD's please. Non-certified and foreign checks require bank clearance.

For shipping charges add \$8.00 per case or partial-case of 100 8-inch discs or \$6.00 per case or partial-case of 100 5 1/4-inch mini-discs for U.P.S. ground shipping and handling in the continental United States.

**Mail orders to:** Communications Electronics, Box 1002, Ann Arbor, Michigan 48106 U.S.A. If you have a Master Card or Visa card, you may call and place a credit card order. Order toll-free in the U.S. Dial 800-521-4414. In Canada, order toll-free by calling 800-265-4828. If you are outside the U.S. or in Michigan, dial 313-994-4444. Telex 810-223-2422. Order your *Ultra* diskettes from Communications Electronics today.

Copyright ©1983 Communications Electronics™

Ad #050583



**Order Toll-Free!**  
**800-521-4414**

In Michigan 313-994-4444

**ULTRA**  
**MAGNETICS**  
**diskettes**

**COMMUNICATIONS**  
**ELECTRONICS™**

**Computer Products Division**

854 Phoenix □ Box 1002 □ Ann Arbor, Michigan 48106 U.S.A.  
Call TOLL-FREE (800) 521-4414 or outside U.S.A. (313) 994-4444

CIRCLE 4 ON FREE INFORMATION CARD

**SPECIAL FEATURE**

- 43 **ALL ABOUT AUTOMOTIVE NAVIGATION SYSTEMS**  
Computer-aided navigation is expected to play a big part in the car of the future. But, as this report shows, that future is not all that far away. **Danny Goodman**

**BUILD THIS**

- 47 **EXPAND YOUR TIMEX/SINCLAIR OPERATING SYSTEM**  
Upgrade your computer with 8K of battery-backed-up CMOS RAM. **Paul W.W. Hunter**
- 51 **TALKING ALARM CLOCK**  
Part 2. With this fun project *you'll* never have to tell time again. **Lee Glinski**
- 59 **DIGITAL VOLTMETER FOR YOUR CAR'S DASHBOARD**  
This easy-to-build project helps keep an eye on your car's electrical system. **Fred L. Young Sr. and Fred L. Young Jr.**

**TECHNOLOGY**

- 4 **VIDEO ELECTRONICS**  
Tomorrow's news and technology in this quickly changing industry. **David Lachenbruch**
- 10 **SATELLITE/TELETEXT NEWS**  
The latest happenings in communications technology. **Gary H. Arlen**
- 12 **VIDEOGAMES**  
A new generation of videogames. **Danny Goodman**
- 63 **USING LORAN-C FOR TIME AND FREQUENCY CALIBRATION**  
All about the Loran-C navigational system and how it works. **R.W. Burhans**

**CIRCUITS AND COMPONENTS**

- 55 **TRANSCONDUCTANCE OPERATIONAL AMPLIFIERS**  
What they are, and some practical examples of how to use them. **Thomas Henry**
- 68 **HOW TO DESIGN ANALOG CIRCUITS**  
An in-depth look at positive- and negative-feedback circuits. **Manny Horowitz**
- 74 **NEW IDEAS**  
An award-winning project from one of our readers
- 76 **HOBBY CORNER**  
Some questions from the mailbag. **Earl "Doc" Savage, K4SDS**
- 78 **DRAWING BOARD**  
More on voltage regulators. **Robert Grossblatt**
- 80 **STATE OF SOLID STATE**  
Power MOSFET amplifiers. **Robert F. Scott**

**VIDEO**

- 82 **SERVICE CLINIC**  
A dish full of bugs. **Jack Darr**
- 82 **SERVICE QUESTIONS**  
R-E's Service Editor solves technicians' problems.

**RADIO**

- 90 **COMMUNICATIONS CORNER**  
Communications and the disabled. **Herb Friedman**

**COMPUTERS**

- 88 **COMPUTER CORNER**  
What's new in microcomputers. **Les Spindle**

**EQUIPMENT REPORTS**

- 24 **Philips Model PM 3215 50-MHz Dual-Trace Oscilloscope**
- 30 **Vector P184-7 Slit-N-Wrap Tool**
- 33 **Kensington Microware System Saver Protection Device for Apple II Computers**
- 38 **Soar Corporation 8050 Digital Multimeter**

**DEPARTMENTS**

- |     |                               |     |               |
|-----|-------------------------------|-----|---------------|
| 8   | Advertising and Sales Offices | 106 | Market Center |
| 136 | Advertising Index             | 95  | New Books     |
| 137 | Free Information Card         | 39  | New Products  |
| 20  | Letters                       | 6   | What's News   |

**ON THE COVER**

To most drivers, one of the most exasperating experiences is getting lost in completely unfamiliar territory. But an independent California inventor and a giant Japanese automobile manufacturer are hard at work trying to make that situation a thing of the past. If their efforts are successful, it won't be long until a common automotive accessory will be a navigational computer complete with a video display. This month, we'll preview the future and take a look at both systems. The story begins on page 43.



This upgrade for the Timex/Sinclair 1000 adds 8K of non-volatile RAM. The add-on can be used to increase the system/user memory, or more usefully, for the permanent storage of machine-language routines—thus, in effect, expanding the operating system. Find out more about it starting on page 47.

**COMING NEXT MONTH**

**On Sale July 19**

A special section devoted to electronics and photography. Among the things we'll look at are:

- The Sony Mavica system
  - Autofocus and autoexposure electronics
  - Electronics in the darkroom
- And lots more!

Radio-Electronics, (ISSN 0033-7862) Published monthly by Gernsback Publications, Inc., 200 Park Avenue South, New York, NY 10003. Second-Class Postage Paid at New York, N.Y. and additional mailing offices. One-year subscription rate: U.S.A. and U.S. possessions: \$14.97, Canada, \$17.97. Other countries, \$22.47 (cash orders only, payable in U.S.A. currency.) Single copies \$1.50. © 1983 by Gernsback Publications, Inc. All rights reserved. Printed in U.S.A.

**Subscription Service:** Mail all subscription orders, changes, correspondence and Postmaster Notices of undelivered copies (Form 3579) to Radio-Electronics Subscription Service, Box 2520, Boulder, CO 80322.

A stamped self-addressed envelope must accompany all submitted manuscripts and/or artwork or photographs if their return is desired should they be rejected. We disclaim any responsibility for the loss or damage of manuscripts and/or artwork or photographs while in our possession or otherwise.

As a service to readers, Radio-Electronics publishes available plans or information relating to newsworthy products, techniques and scientific and technological developments. Because of possible variances in the quality and condition of materials and workmanship used by readers, Radio-Electronics disclaims any responsibility for the safe and proper functioning of reader-built projects based upon or from plans or information published in this magazine.

# VIDEO ELECTRONICS

DAVID LACHENBRUCH  
CONTRIBUTING EDITOR

## New VCR Standard

A new VCR standard that eventually is expected to replace the three current half-inch home formats (Beta, VHS, and the European Video 2000) has been approved by a Standardization Conference of 122 Japanese, European, and American companies, whose representatives have been meeting in Tokyo for more than a year.

The new "8mm Video" standard was established to avoid the Beta-vs.-VHS problem that has plagued the home-VCR industry since its inception. In order to avoid disrupting the market, member companies, in the past, have insisted that the new standard was designed only for use in portable camera-VCR combinations; but with the issuance of the specifications, many conference members have dropped that pose. Although initially the system is designed to record for only 90 minutes on one cassette (in the NTSC color system), the standard is obviously flexible enough to accommodate much longer recording times.

The recording medium is an 8-mm-wide cassette tape. The cassette itself measures  $95 \times 62.5 \times 15$ -mm, slightly smaller in length and width than a standard audio cassette and just a touch thicker than the thickest part of such a cassette. The tape can be either the metal-powder or metal-evaporated type, and the system uses helical scan with a head drum 40mm in diameter.

Three separate audio systems are specified in the new 8mm specifications — a standard longitudinal track, an FM-stereo helical system multiplexed with the video signal of the type used in Beta Hi-Fi recorders, and a helical PCM (*Pulse Code Modulation*) track. The FM sound system is compulsory, the other two optional. A cue track is also reserved.

The cassette itself is designed for maximum simplicity and low cost, without tape guides and with a wide mouth to accommodate many different loading systems. It has two lids to keep out dust, and recognition holes for automatic detection of tape type and thickness, as well as grips for an auto-changer.

Sources in the Standardization Conference say that an increase in recording time to four hours by means of slower tape speed and thinner tape is easily possible now. Development in the future of new heads and new tape formulations (including the perpendicular or vertical-domain recording system, now in advanced stages of development) will make possible further increases in record/play time.

In Japan, there are widespread forecasts that 8mm VCR's will begin to appear before the year is over, but in any event the American market could see the first portables in 1984. Assuming that longer-playing versions are approved by the Standardization Conference, home decks could show up in about three years, and at that point the new format should begin to take over from Beta and VHS.

The 8mm standard was approved by the conference for both NTSC and PAL color systems, with different parameters — the PAL version has a record/play time of one hour. At the last minute, France's Thomson-CSF proposed that a baseband recording system, "timeplex," be used for any SECAM models. Therefore the conference approved no SECAM standard, but earmarked the French proposal for further study.

The agreement on a new standard format has great implications on the future of the entire video field, laying the groundwork for a new, far more flexible and potentially lower-cost system and eventually ending the standards war.

## DIGITAL TV

It can now be definitely reported that color-TV sets using all-digital signal processing will be available, at least in token quantities, in 1984. In the United States, they're expected to be available from General Electric and Zenith, with offerings also possible from Sharp and Sony. All are customers of ITT for its set of seven VLSI digital IC's. The first digital sets may well be in the form of component TV, because they will be designed for add-ons to make possible features not available with analog TV's. One of the first add-ons is expected to be a ghost eliminator. The new digital TV's also are expected to enhance the capabilities of home computers (since they are essentially computers themselves). With the development of low-cost frame-store accessories, the digital TV's will have the potential ability to simulate high-definition television by doubling the number of lines in the picture, inserting "derived" lines between the transmitted ones. Other features could be stop-motion and picture-in-picture (for viewing two channels simultaneously). While digital sets are imminent, those special effects probably won't be along for several years.

R-E

# "I built this 16-bit computer and saved money. Learned a lot, too."

Save now by building the Heathkit H-100 yourself. Save later because your computer investment won't become obsolete for many years to come.

Save by building it yourself. You can save hundreds of dollars over assembled prices when you choose the new H-100 16-Bit/8-Bit Computer Kit – money you can use to buy the peripherals and software of your choice.

## H-100 SERIES COMPUTER SPECIFICATIONS:

**USER MEMORY:**  
128K-768K bytes\*

**MICROPROCESSORS:**  
16-bit: 8088  
8-bit: 8085

**DISK STORAGE:**  
Built-in standard  
5.25" disk drive,  
320K bytes/disk

**KEYBOARD:**  
Typewriter-style,  
95 keys, 13  
function keys,  
18-key numeric pad

**GRAPHICS:**  
Always in graphics mode.  
640h/225v resolution;  
up to eight colors  
are available\*\*

**COMMUNICATIONS:**  
Two RS-232C Serial  
Interface Ports and  
one parallel port

\* 128K bytes standard.  
\*\* Optional.

**DIAGNOSTICS:**  
Memory self-test  
on power-up

**AVAILABLE SOFTWARE:**  
Z-DOS (MS-DOS)  
CP/M-85

Z-BASIC Language  
Microsoft BASIC  
Multiplan  
SuperCalc  
WordStar  
MailMerge  
Data Base  
Manager  
Most  
standard  
8-bit CP/M  
Software

The H-100 is easy to build – the step-by-step Heathkit manual shows you how. And every step of the way, you have our pledge – "We won't let you fail." Help is as close as your phone, or the nearest Heathkit Electronic Center.†

And what better way to learn state-of-the-art computing techniques than to build the world's only 16-bit/8-bit computer kit? To run today's higher-speed, higher-performance 16-bit software, you need an H-100. It makes a big difference by processing more data faster.

Dual microprocessors for power and compatibility. The H-100 handles both high-performance 16-bit software and most current Heath/Zenith 8-bit software.

Want room to grow? The H-100's standard 128K byte Random Access Memory complement can be expanded to 768K bytes – compared to a 64K standard for many desktop computers.

And the industry-standard S-100 card slots support memory expansion and additional peripheral devices, increasing future upgradability of the H-100.

High-capacity disk storage, too. The H-100's 5.25" floppy disk drive can store 320K bytes on a single disk. The computer also supports an optional second 5.25" and external 8" floppy disk drives. And an optional internal Winchester disk drive will be available soon.

For more information, circle the reader service number below. Better yet, visit your Heathkit Electronic Center for a demonstration!

*The H-100 gives me the most for my computer dollar!*



**Heathkit**  
Heath  
Company

Heathkit Electronic Centers are units of Veritechnology Electronics Corporation.  
Heath Company and Veritechnology Electronics Corporation are subsidiaries of Zenith Radio Corporation.

CIRCLE 16 ON FREE INFORMATION CARD

[www.americanradiohistory.com](http://www.americanradiohistory.com)

# WHAT'S NEWS

## Cellular radio system to begin in U.S.A.

The FCC has allocated 666 channels to a new "cellular" two-way radio service, which, with its greatly more efficient use of the radio spectrum than the current mobile telephony system, will make a car telephone available to anyone almost anywhere in the United States.

In a cellular system, an area such as a city is not covered with a single high-powered transmitter, as is done today. Instead, the area is divided up into sections, or "cells," each with a low-power transmitter whose range is pretty much limited to the area of the cell. Since adjacent cells are on non-interfering frequencies, the same frequency can be "re-used" for several widely separated cells in a large city or metropolitan area, increasing greatly the number of phone calls that may be handled in a given area.

The FCC opened applications for cellular system licenses, and as of March, 1983, had already granted permits to cellular mobile

telephone systems in nine U.S. metropolitan areas. Service is expected to start within two years.

A cellular system is made up of four elements (plus the regular telephone system). Those are the Mobile Telecommunications Switching Office (MTSO); a base station (transmitter/receiver), with its antennas, in each cell; wire or microwave connecting links between base stations and the MTSO, and the mobile radios, which may be vehicle-mounted or hand carried.

When a telephone user wishes to make a call, he simply dials the number of the mobile subscriber, as he would any other call. (He need know nothing of the whereabouts of the car he is calling.) The call then goes to the mobile unit's MTSO, which sends a paging signal over all the base stations in the area. The mobile unit, which monitors a nearby base station continuously, responds automatically to the paging signal and establishes contact with the base station. The MTSO then switches the call to one of the traffic channels of

that base station, and the subscriber's phone rings.

If the mobile subscriber travels out of the cell during a call, communications are automatically switched over to the base station of the cell into which he moves.

The subscriber in a mobile vehicle simply dials the number he wants, as he would on his home phone.

The service is expected to cost subscribers anywhere from \$75 to \$150 per month. That would include an access fee of between \$10 and \$50 per month, plus charges for actual use. Those might run from 12 cents per minute in off-peak hours to 40 cents per minute in peak periods.

## OK Industries forms electronics division

OK Industries, a New York-based manufacturer of production equipment for the electronics and telecommunications industries, has formed an Electronics Division. The new division is putting out a broad range of bench and

field test instruments, with the idea of offering "truly superior laboratory instruments at prices within the reach of even the 'smallest' user."

The first product from the new division is a 1-MHz function generator with both frequency and amplitude modulation; it will sell at \$250.

## 900-MHz personal radio may be on the way

The FCC has issued a Notice of Proposed Rulemaking to implement a new personal radio-communications service (PRCS), proposed by General Electric, in the 900-MHz frequency band. G.E. hopes that the FCC will issue a Final Report and Order within the next few months.

The FCC proposal is for a system that will consist of a base station connected to the telephone network, and one or more units that can be installed in cars. The user in a car will then be able to place calls to any telephone, or be reached in the car from any telephone, provided he is within the system's range.

The FCC notice proposes to set aside 8 MHz in the 900-MHz band for the new service. That reservation would permit 133 channels of 30 kHz each for two-way PRCS communications.

## New TV space camera

RCA has developed a new television camera tube that can detect objects the size of a soccer ball 22,000 miles away.

Serving as the "eye" of a special camera of the Ground-based Electro-Optical Deep Space Surveillance System (GEODSS), it can see objects 10,000 times dimmer than the faintest ones visible to the naked eye.

The new Silicon-Intensifier Target (SIT) tube, type C21146H, is the largest of its type that RCA has ever made. Its 32mm of usable area is twice that of the targets now used in the surveillance cameras that provide the resolving capability of the GEODSS equipment. The target has four times as many silicon diodes as older types.

The GEODSS system answers the need for advanced tracking

*continued on page 8*

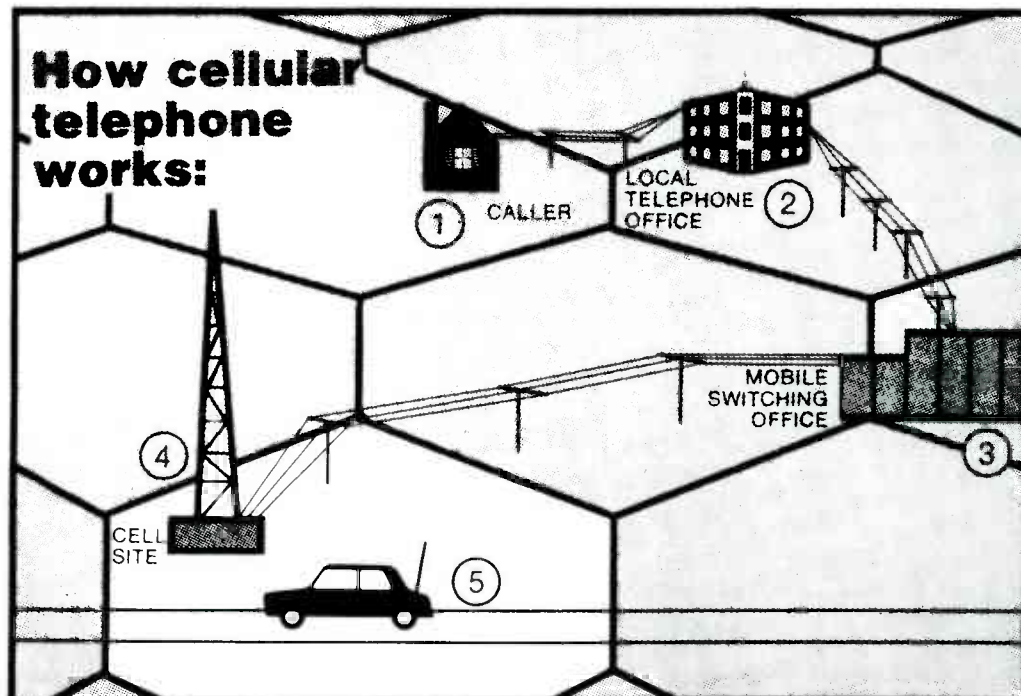

CELLULAR NETWORK OVER PART OF A CITY. The call is routed from the caller's home via the local telephone exchange to the Mobile Telecommunications Switching Office, a complex automatic device that locates the car, makes the connection, and then switches the call from cell to cell as the car moves through the area.



# Now. Tektronix 60 MHz Performance is just a free phone call away!

**Wide-range vertical sensitivity:** Scale factors from 100 V/div (10X probe) to 2 mV/div (1X probe). Accurate to  $\pm 3\%$ . Ac or dc coupling.

**Two high-sensitivity channels:** dc to 60 MHz bandwidth from 10 V/div to 20 mV/div; extended sensitivity of 2 mV/div at  $> 50$  MHz.

**Sweep speeds:** from 0.5 s to 50 ns. To 5 ns/div with X10 magnification.

**Delayed sweep measurements:** Accurate to  $\pm 3\%$  with single time-base 2213; to  $\pm 1.5\%$  with dual time-base 2215.

**Complete trigger system.** Includes TV field, normal, vertical mode, and automatic; internal, external and line sources; variable holdoff.

**Probes included.** High-performance, positive attachment 10-14 pF and 60 MHz at the probe tip.

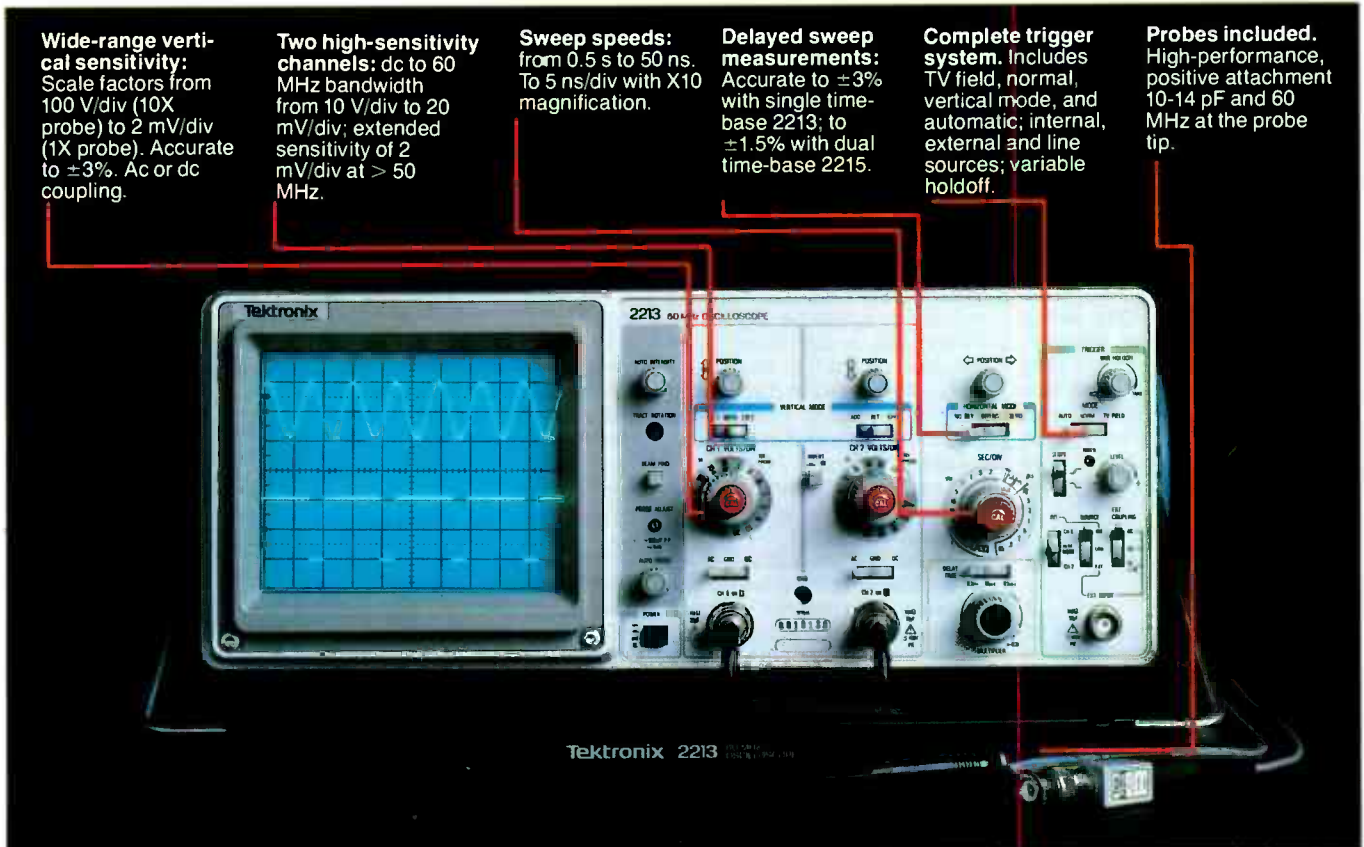

**These easy to order scopes are proof that it's not expensive to have advanced, 60 MHz performance from Tektronix on your bench. It's just practical!** Feature for feature, the Tek 2213 and 2215 set a price/performance standard unmatched among portable scopes. And are backed by the industry's first three-year warranty on all labor and parts, including the CRT.

**So advanced they cost you less: \$1200\* for the 2213! \$1450\* for the dual time base 2215!** These low costs are the result of a new design concept that utilizes

fewer mechanical parts than any other scope.

Yet there's no scrimping on performance and reliability. You have the bandwidth for digital and analog circuits. The sensitivity for low signal measurements. The sweep speeds for fast logic families. And delayed sweep for fast, accurate timing measurements.

**Scope. Probes. Three-year warranty and expert advice. One free call gets it all!** You can order, or obtain literature, through the Tektronix National Marketing Center. Technical personnel, expert in oscil-

loscope applications, will answer your questions and can expedite delivery. Direct orders include probes, operating manuals, 15-day return policy, full Tektronix warranty and worldwide service back-up.

**Order toll free:  
1-800-426-2200  
Extension 12**

In Oregon call collect:  
(503) 627-9000 Ext. 12

\*Price F.O.B. Beaverton, OR. Price subject to change.

# WHAT'S NEWS

continued from page 6

methods. That need is caused by the ever-increasing number of objects in space. (An estimated 15,000 pieces—satellites and debris—are now drifting in orbit.) It uses two 40-inch telescopes for deep space tracking and a 15-inch instrument for scanning lower altitudes. Each telescope is coupled to a camera containing one of the new low-light-level SIT camera tubes.

Pictures from the TV cameras are converted into digital pulses and fed into a computer, which examines the data to sort out stars from moving objects. The computer software also contains a catalog of known stars and orbiting satellites for identification and location purposes.

## Class A power amplifier for car stereo

Visonik of America, Inc., a manufacturer and distributor of automotive-sound products, has introduced the first Class-A power amplifier specifically intended for car-stereo applications. That amplifier, the model A265, boasts an output of 65 watts-per-channel with total harmonic distortion claimed to be less than 0.01% from 20 Hz to 20 kHz.

The chief advantage Class-A operation is that it eliminates the distortion introduced by the push-pull action of more conventional Class-B amplifiers. Among the unit's circuit features are full complementary symmetry, just 30 dB of negative feedback, and a wide open-loop bandwidth for a high slew-rate and low TIM distortion. The amplifier also includes an exclusive *Perma-Tect* circuit. That circuit monitors the output current and voltage across the output transistors; and, should those levels become excessive, the circuit limits the power without interfering with the signal. In addition, the amplifier has thermal breakers to prevent overheating. According to a company spokesman, that combination makes the amplifier "virtually unblowable."

The A265 offers a variable low-level (100-550mV) input for use with almost any program source. A Molex harness is included for easy installation.

## Sanyo LCD TV

Sanyo has developed 3 and 4-inch liquid crystal TV's, using a newly developed liquid-crystal display (LCD) and amorphous silicon thin-film transistors (aSiTFT) that

are designed for switching.

The display on the 4-inch model is 60 × 80 mm (about 2<sup>3</sup>/<sub>16</sub> × 5<sup>3</sup>/<sub>32</sub> inches) and exterior dimensions are 253 × 30 × 113 mm (approximately 10 × 1<sup>7</sup>/<sub>32</sub> × 4<sup>15</sup>/<sub>32</sub> inches)—truly pocket sized.

The new switching transistor is said to provide greater reliability than previous approaches, and the new TN (twisted nematic mode) crystal produces better contrast and a wider view angle. The display boasts are 220 × 240 pixels.

The liquid-crystal displays are being rapidly developed for use in TV sets, office machines, etc., but picture clarity and driving systems remain problems.

## "Telephone on a chip"

High reliability and reduced component count are among the features of the new telephone technology introduced by American Telecommunications Corporation, a subsidiary of Comdial. ATC is a supplier of telephones, answering machines, and automatic dialers to the Bell system, as well as to major independent telephone companies and retailers.

Evidence of that new technology can be seen in two ATC products. The *Allegro* is a compact residential phone that features a 10-number memory dialer, automatic redial, and a true hold button. The other new phone, the *Voice Express 41* is designed for business applications. It combines an improved speakerphone, a 41-number automatic dialer, clock, call timer, and security features. Both phones incorporate a new IC that is essentially a complete telephone. That IC is part of ATC's effort to reduce the cost and complexity of manufacturing telephones that meet Bell-system standards.

According to Robert E. Lee, ATC Vice President of Engineering, the company's goal is to totally automate telephone assembly. By using sophisticated robots to assemble the telephones, Comdial hopes to obtain the distinct technology and cost advantage it feels is needed to compete with imported low-cost, and often lower-quality, telephones.

R-E



THE ALPHASONIK A265 Class-A power amplifier delivers 65 watts-per-channel into a 4-ohm load. It features Visonik's exclusive Perma-Tect protection circuitry.

# Radio-Electronics

Hugo Gernsback (1884-1967) founder  
 M. Harvey Gernsback, editor-in-chief  
 Larry Steckler, CET, publisher  
 Arthur Kleiman, editor  
 Josef Bernard, K2HUF, technical editor  
 Carl Laron, WB2SLR, associate editor  
 Brian C. Fenton, assistant editor  
 Jack Darr, CET, service editor  
 Robert F. Scott, semiconductor editor  
 Herb Friedman, communications editor  
 Gary H. Arlen, contributing editor  
 David Lachenbruch, contributing editor  
 Earl "Doc" Savage, K4SDS, hobby editor  
 Danny Goodman, contributing editor  
 Dan Rosenbloom, production manager  
 Robert A. W. Lowndes, production associate  
 Joan Roman, circulation director

Arline R. Fishman, advertising coordinator  
 Cover photo by Robert Lewis  
 Radio-Electronics is indexed in *Applied Science & Technology Index* and *Readers Guide to Periodical Literature*.

Gernsback Publications, Inc.  
 200 Park Ave. South  
 New York, NY 10003  
 President: M. Harvey Gernsback  
 Vice President; Larry Steckler

ADVERTISING SALES 212-777-6400  
 Larry Steckler  
 Publisher

EAST/SOUTHEAST  
 Stanley Levitan  
 Radio-Electronics  
 200 Park Ave. South  
 New York, NY 10003  
 212-777-6400

MIDWEST/Texas/Arkansas/Okla.  
 Ralph Bergen  
 Radio-Electronics  
 540 Frontage Road—Suite 325  
 Northfield, Illinois 60093  
 312-446-1444

PACIFIC COAST  
 Mountain States  
 Marvin Green  
 Radio-Electronics  
 413 So. La Brea Ave.  
 Los Angeles, Ca 90036  
 213-938-0166-7



YOU SELECT FULL MANUAL  
OR FULL AUTORANGING

500 HOUR BATTERY LIFE

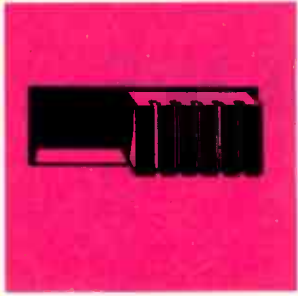

HIGH CONTRAST LCD  
SHOWS MEASUREMENT  
AND FUNCTION



0.25% dc volt  
accuracy  
Continuity beeper  
Diode test  
Transient and  
overload protected  
High energy fuse

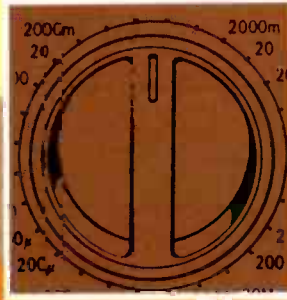

EASY TO USE... RELIABLE  
SINGLE-ROTARY SWITCH  
CONTROL

OTHER NEW  
DMM MODELS  
PRICED  
FROM  
\$75.00



# New! A digital multimeter that lets you choose autoranging convenience or manual control

MODEL 2816  
\$150.00

To learn more about the 2816  
and the complete line of new B&K-PRECISION  
DMMs, see your local distributor or call  
(1 312 889-9087).

**B&K PRECISION** DYNASCAN  
CORPORATION

6460 West Cortland Street • Chicago, Illinois 60635 • 312/889-9087

International Sales, 6460 W. Cort and St., Chicago, Illinois 60635

• Canadian Sales, Atlas Electronics, Ontario

South and Central American Sales, Empire Exporters, Plainview, NY 11803

CIRCLE 42 ON FREE INFORMATION CARD

# SATELLITE/TELETEXT NEWS

GARY ARLEN  
CONTRIBUTING EDITOR

## TELETEXT DECODERS

The CBS Television Network has started a teletext service called Extravision. The service will be broadcast by the almost 200 CBS affiliated stations (90 percent as this is being written), making it the first national broadcast teletext service. Extravision transmits 100 pages of national and local information and advertising as well as closed captioning of some programs. The service uses the North American Broadcast Teletext Standard (NABTS).

Time Inc. and Matsushita Electric Industrial Co. (Panasonic) have signed a "long-term technology agreement" under which the two companies will co-develop hardware for home-information systems. The first such product is a low-cost decoder for Time's teletext service—with the hoped-for \$150 device being offered under the Panasonic name. The first test models of the unit will be available late this year, with production runs set to begin in 1984 at Matsushita's automated color-TV factory in Japan.

The teletext decoder will use the "North American Broadcast Teletext Specification," the technical format that Time Inc., CBS, NBC and A.T.&T. have adopted. It will be able to pick up Time's full-channel teletext feed, now being tested, as well as vertical blanking-interval teletext, such as the feeds being planned by the television networks. The decoder will include an extension unit to permit add-ons such as a full alphanumeric keyboard, printer, and floppy disks for data storage. In addition, the terminal can accommodate joysticks for videogames, an audio cassette recorder, and a modem for two-way service.

The decoder will also be able to handle software for the customized information services that Time plans to transmit. The decoder's interactive capability makes faster access possible, and the unit will include provisions that allow it to be used for general-purpose computing. Time's teletext service will be offered to cable TV systems, starting with companies operated by its subsidiary American TV and Communications. In addition to news and other typical information services, Time's teletext project includes a variety of innovative recreational activities that take advantage of the high-quality graphics of the technology. For example, a youth-oriented section of the service includes an electronic version of "Mr. Potatohead," that allows children to compose a face by selecting features they would like to insert and placing them over the face outline on the TV screen.

## VCR'S AND TELETEXT

EECO (1601 E. Chestnut Ave., Santa Ana, CA 92701), a California company that produces tape-editing equipment and mini-computer systems, is testing *Pictureware*, a system that will permit home videocassette-records to record and transmit videotex or teletext signals. *Pictureware* is an interactive still-frame video technology that uses a VCR and a decoder box to compress images, text, and audio onto videotape; material can then be retransmitted in high-speed bursts. The equivalent of a 100-page teletext magazine with 75 color pages of near video-picture quality can be transmitted in about seven seconds—about the time it takes to cycle such a group of pages through a standard vertical blanking-interval sequence. The system becomes interactive through the use of phone lines or two-way cable. EECO sees the target price for the decoder needed to receive the videotex and teletext signals at about \$300. A modified VCR, needed to pick up the digital data, will cost about \$100 more than an unmodified one. EECO plans to begin marketing its *Pictureware* system in 1984.

## AROUND THE TELETEXT CIRCUIT

In an apparently unprecedented marketing maneuver, Zenith says its will build and sell teletext receivers in a local market if a TV-station owner in that community commits to offering British-format teletext for at least five years. The unusual offer would presumably encourage broadcasters to begin a service knowing that a supply of receivers will be available in their communities. Zenith, which has long favored the "sturdy" British technology, is presumably also willing to deal with broadcasters working in other teletext formats. The company has already been the primary supplier of teletext receivers for other field trials of teletext.

RCA Laboratories has received a patent for a system that will increase the legibility and color contrast of teletext material by modifying the video signal. The system, primarily for use in set-top teletext decoders, is said to improve color definition and clarity. R-E

# MAKE THE A P CONNECTION

NOW YOUR SINGLE SOURCE FOR ALL YOUR ELECTRONIC  
CIRCUIT BUILDING, TESTING AND INTERCONNECTION NEEDS.

**Introducing Our Complete Line of Interconnection Products and Accessories...Featuring Our New Insulation Displacement Connectors.**

No matter what your requirements in interconnection products, we have just what you are looking for. DIP, Socket, and Card-Edge IDC connectors, all styles and sizes of Headers and D-Submin in both IDC and solder versions. Also flat cable in both gray and rainbow in a wide range of widths.

**Brand New Low Cost IDC Assembly Tool**  
So sensationally low-priced it won't put a "crimp" in your budget.

**Famous A P Quality and Price**

Every A P product is built with time-proven quality and dependability. And best of all...each one is very competitively priced.

**Your Single Source**

A P makes hundreds of electronic circuit building and testing devices as well as a complete line of interconnection products and accessories. Everything from Breadboards, Super-Strips, Test Clips and Poweraces to Headers, Connectors and Cable.

**A P has it all for you!**



A P PRODUCTS INCORPORATED • 9450 Pineneedle Drive • P. O. Box 540 • Mentor, Ohio 44060 • (216) 354-2101 • TWX: 810-425-2250  
In Europe, contact A P PRODUCTS GmbH • Baumiesweg 21 • D-7031 Weil 1 • West Germany

**For the name of your nearest distributor call Toll Free 800-321-9668. (In Ohio call collect 216-354-2101.)**

CIRCLE 56 ON FREE INFORMATION CARD

# VIDEOGAMES

## Future games

DANNY GOODMAN, CONTRIBUTING EDITOR

THE ARRIVAL OF SO-CALLED THIRD-generation home-videogame systems like the Atari 5200 and Colecovision, plus Coleco's announcement of a "fourth generation" tape-loading peripheral, leads me to speculate about what kind of home videogames we're likely to be playing in the late 1980's. I'm not talking about science-fiction gadgetry—stuff like holographic projections coming from your R2-D2 robot. I'm talking about the application of technologies that we have today, buried behind locked laboratory doors—technology that needs only a little refinement to be both practical and affordable.

Interactivity between game play and player will be the area where we will see the greatest changes in the years ahead. This interactivity will take many forms.

Late last year, the world was treated to a glimpse of the interactive future when Sega/Gremlin (555 Millrose, Los Angeles, CA 90038) demonstrated an arcade game that superimposed a shoot-'em-up space chase on a videodisc-scene backdrop that looked like outtakes from a low-budget *Star Wars* imitation. If a player successfully hit an alien ship, the disc would jump to a scene of an explosion in space. The game play and background are not particularly well integrated in this early commercial attempt, but the concept is a valid one.

Videodiscs, by themselves, are just now offering interactive adventures such as *Murder, Anyone?* from Vidmax (36 East 4th St., Cincinnati, OH 45202). In that game, the viewer's response to clues causes the story to jump from one character's account of the crime to another's. As a viewer enters a response into a remote control keypad, the microprocessor-controlled videodisc player accesses the proper segment of the disc.

But that's nothing compared to the possibilities of integrating more traditional videogame play-screens with the high-resolution effects of a videodisc scene. With game-console-generated graphics linked to the videodisc frame counter (there are 54,000 individually addressable frames on a disc), we might have the effect of walking down a corridor in an adventure maze-game. Suddenly a game-generated object—how about a treasure chest—appears on the floor in the distance. As we walk toward it, the chest, in



FIG. 1

proper perspective, gets larger. When we're standing directly in front of the chest, we have arms (from the disc) reach down and pick it up. Together, the chest and arms recede out of sight below the screen as though we actually had picked it up. Other game-generated objects could be picked up by the same disc-generated arms later in the game.

Another interactive trend we'll see involves increased use of our other senses. Right now, only our senses of sight and hearing are stimulated by a videogame. For now, we'll have to live with the graphics-resolution limitations of the home color-TV. Better-quality speech synthesis is about all we can expect from the current selection of systems. But stereo sound-effects will be the next step in attempted realism. For example, we'll be able to hear enemy ships approaching from off-screen to the left or right.

Beyond that, the sense of touch opens the way for game development into the late 1980's. Small solenoids will be built into a hand controller to give your palm a little "kick" when you catch a fly ball in a baseball game, or vibration when you're at the control of a race car.

We can even see special environmental videogame-chairs that partially enclose us in a sensory barrage of surround sound and that have motorized or vibrating seats to stimulate the sensations of flying a B-17 through flack or piloting the Millennium Falcon through hyperwarp. Most joystick-type controls would be in the armrests; a steering controller and two foot-pedals would swing in front of us from one side for games requiring that kind of control. The enclosure could adequately contain vapors from scented air

and release them in synchronization with changing screens. For example, as you walked through dark, musty caverns of an adventure maze-game, only your keen sense of smell would help you distinguish between several look-alike scenes.

Are these ideas far fetched? Hardly. Coleco has already demonstrated the kicking hand controller, but decided to hold off for a while. And a new company in the add-on business, Amiga, has shown a foot-operated floor controller (the *Joyboard*, shown in Fig. 1) that lets you stand up and recreate the motions of skiing down a mountain in conjunction with a skier's-eye-view of a slalom course. There's even a prototype environmental chamber that spins you around and gives you a real sense of motion as you pilot your craft. Those are but the simple first steps toward future homebound simulations of real-life and imagined adventures.

### U.S. Games' Eggomania for Atari 2600



CIRCLE 101 ON FREE INFORMATION CARD

U.S. Games	Eggomania									
GRAPHICS	1	2	3	4	5	6	7	8	9	10
SOUND	1	2	3	4	5	6	7	8	9	10
EASE OF LEARNING	1	2	3	4	5	6	7	8	9	10
CHALLENGE	1	2	3	4	5	6	7	8	9	10
VALUE	1	2	3	4	5	6	7	8	9	10
	Poor	Fair	Good	Excellent						

U.S. Games (1515 Wyatt Drive, Santa Clara, CA 95054) is dedicated to produc-

continued on page 14

# Slashes Fordham Lowers Prices on **B&K PRECISION** Test Equipment

Now Fordham is passing on to customers the hugest savings possible on test instruments. To help celebrate the opening of our new 40,000 square foot facility on Long Island, we've purchased an extra large inventory of B&K Precision products.

We're offering the quality of name brand products and the benefits of our volume purchasing power. While supplies last we guarantee these unbelievably low prices.

## 3 1/2 Digit LCD Autoranging DMM

Model 2845  
Reg. \$175.00 **Now \$79.95 each**



**B&K PRECISION**

- Fully automatic, auto-ranges on all functions.
- Range lock holds any range.
- 0.1% accuracy.
- Fast reading.
- 0.5" LCD display.
- Autozeroing.
- Autopolarity on all ranges.
- Audible continuity indicator.
- Varistor and fuse overload protection.
- RF shielded.
- Meets UL 1244 safety standards.

## 8-Trace, 4 Channel 100 MHz Dual Time Base Scope

Model 1500  
Reg. \$2575.00 **Now \$1489.00 each**



**B&K**

Comes With Probes

- 100 MHz response, 3.5nS rise time • 2nS/div. sweep rate with 10X magnifier • Trigger views or four separate inputs • Dual time base • 1M ohm inputs or 50 ohm inputs • 1mV/div sensitivity to 100 mHz • CH 1 frequency counter output • Delayed sweep, 20 nS to 0.5 seconds • Alternate timebase
- Switching power supply • Selectable chop frequencies • Voltage and current probe calibrators.

## Low Distortion Function Generator

Model 3010  
Reg. \$220.00  
**Now \$187.50 each**



- Generates sine, square and triangle waveforms • Variable amplitude and fixed TTL squarewave outputs • 0.1 Hz to 1 MHz in six ranges • Typical sine wave distortion under 0.5% from 0.1 Hz to 100 kHz • Variable DC offset for engineering applications
- VCO external input for sweep-frequency tests.

## Dynapeak Transistor Tester

Model 520B  
Reg. \$239.00  
**Now \$199.75 each**



- Fast testing • Hi/Lo drive • Works in-circuit when others won't • Identifies leads of bipolars and FET's • Random lead connection • Audible test OK 'beep'
- Automatic NPN/PNP and Si/Ge identification.

## CRT Restorer/Analyzer

Model 467  
Reg. \$495.00  
**Now \$420.75 each**



- Restores color and b/w picture tubes like new! Uses the most powerful restoration method known with minimal danger to the CRT • Exclusive multiplex test technique tests all three guns of color CRT's simultaneously under actual operating conditions, even CRT's with common G1 and G2, with real dynamic tests • Instant, automatic tracking.

**FOR ORDERING OR PRICING ON OTHER TEST EQUIPMENT**

**Call Toll Free  
(800) 645-9518**  
N.Y.S. (800)832-1446

**FORDHAM**  
260 Motor Parkway, Hauppauge, N.Y. 11788



■ Master Charge ■ VISA ■ COD  
■ Money Order ■ Check  
\$50.00 minimum order  
COD's extra (required 25% deposit)

N.Y. State residents add appropriate sales tax.	ADD FOR SHIPPING AND INSURANCE
\$251.00 to \$250.00	\$4.50
\$251.00 to \$500.00	6.50
\$501.00 to \$750.00	8.50
\$751.00 to \$1000.00	12.50
over \$1000.00	15.00

# VIDEOGAMES

continued from page 12

ing videogame cartridges for the entire family to enjoy. As a result, they stay away from the heavy artillery shoot-'em-up games and favor those that are easy to grasp by inexperienced game players, young and old. *Eggomania*, for one to four players, is just such a game.

The scenario sets a turkey-like bird scurrying from side to side along the top of the screen. As he moves, he drops green eggs. Each player in turn uses a paddle controller to position a blue bear at the bottom of the screen under each egg and catch it in an upturned hat. Points are scored for each egg caught. If the bear should fail to catch an egg, the floor receives a layer of yellow egg yolk. At the end of each wave of eggs, the tables turn for about 15 seconds and you activate the bear to throw eggs back at the dancing bird. A successful hit is worth points. The game ends when enough eggs have been dropped for the yolk to cover up the bear and his hat.

By keeping most of the screen black, the game designer was able to make the Atari 2600 present a graphically well-detailed bird character. The bird is filled with a variety of colors and high resolution crispness that shows up well against the black background. When you hit the bird with an egg, the bird loses its feathers, revealing polka-dot underwear; his top feathers turn into a beanie-like propeller that help his scrawny wings lift him up and out of the screen.

As you can see, the graphics are meant to be entertaining. And the sound, too, is geared toward keeping kids amused. Three different musical tunes, intermixed with cheeps and other bird sounds, spark up the action in places.

One design feature of the game makes *Eggomania* difficult—perhaps frustrating—at the higher levels. You can't just sweep the bear and hat quickly across the screen to catch a horizontal string of eggs. There appears to be just a very small zone around the hat that allows you to catch an egg successfully. There will be many times when you'll think you should have caught an egg for sure, yet wind up knee-deep in yolk.

*Eggomania* begs comparison with a similar catching game called *Kaboom* from Activision. If you prefer cute music and cartoons, then *Eggomania* is the one to get. But if building game skill is your goal, *Kaboom* is a better choice.

## CBS Video Games' Wizard of Wor for Atari 2600

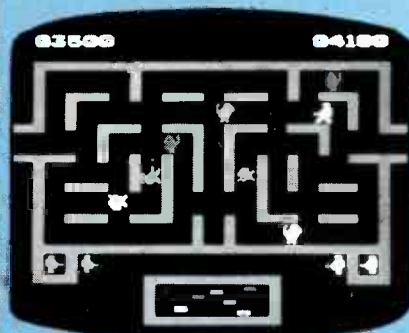

CIRCLE 102 ON FREE INFORMATION CARD

CBS Video Games Wizard of Wor									
GRAPHICS	■	■	■	■	■	■	■	■	■
SOUND	■	■	■	■	■	■	■	■	■
EASE OF LEARNING	■	■	■	■	■	■	■	■	■
CHALLENGE	■	■	■	■	■	■	■	■	■
VALUE	■	■	■	■	■	■	■	■	■
	1	2	3	4	5	6	7	8	9 10
	Poor	Fair	Good	Excellent					

As versatile as the Atari 2600 has proven to be over the years, the machine has limitations in graphics and sound. There is only so much that even the genius game designer will be able to accomplish with a standard cartridge game. *Wizard of Wor* from CBS Video Games (Long Meadow Road, Hagerstown, MD 21740), is one of those games whose ambitions fell prey to the 2600's stumbling blocks.

The original *Wizard of Wor* was a modestly successful Midway arcade game of the pre-*Pac-Man* era that put great demands on the player's peripheral vision and coordination. One or two players can each control a "warrior" armed with a laser blaster. Warriors search a dungeon maze for numerous enemies, some completely visible, others visible only at times. All enemies, whether visible or not, are tracked on a radar screen.

Beginning with wave two, after you've cleared the enemies from the dungeon, yet another super-swift enemy, the Worluk, tries to escape the dungeon, and will—unless your warrior can shoot him first. After that (on random waves) the

Wizard of Wor appears and hurls lightning bolts at your warrior. Shooting the elusive Wizard before he escapes nets players a dungeon-shaking graphics display—and a ton of points.

The difficulties in putting this game into a 2600 cartridge are many. One of the challenging features of the original was that in advanced waves, the maze walls were partially invisible, leading to a succession of "pits," or large sections of the maze with invisible walls. In CBS's version, there are only two maze-layouts that alternate between waves.

More disturbing during game play on the CBS version is excessive flicker caused by having so many moving objects on the screen at once. As you slowly eliminate enemies, the remaining images become more solid. But until that time, it is very difficult to keep your eye on the dimly lit enemies and the radar screen at the same time.

The only graphics salvation is the display when you hit the Wizard. Instead of a colorful fireworks display, the screen flashes in black and white for a surprisingly eerie effect.

There are many other elements of the original that were left out of the 2600 version, although they were well captured in Astrocade's *Incredible Wizard* version. But even on its own merit, CBS's *Wizard of Wor* does not contribute to the state of the art for the latest 2600 cartridges. R-E



"Yes, I built this computer from scratch—\$1,435 worth of scratch."



# VIDEO EQUIPMENT QUALITY • LOW PRICES OFF-THE-SHELF DELIVERY

from **FORDHAM** of course.

**BUY  
OF THE  
MONTH**



MODEL V-1880

## BP STABILIZER/IMAGE ENHANCER/RF CONVERTER/ VIDEO FADER/2-WAY DISTRIBUTION AMPLIFIER

OUR PRICE **\$135.00** each

Most versatile video processor. Contains five units in one: stabilizer (video guard remover); image enhancer; video to RF converter; video fader; and dual output distribution amplifier.

**Stabilizer** Will correct entire range of copy guard distortion such as jitter, vertical roll or black bar travelling through picture.

**Enhancer** Lets you attain best picture for your own preference.

**RF Converter** Allows your TV set to receive video and audio signals from your image enhancer, guard stabilizer, video camera, computer, VCR, etc. The direct video signal from any video component can be fed into the V-1880 and converted to a usable RF signal that can go to your TV antenna terminals.

**Video Fader** Used to produce professional fade ins and fade outs.

## BP VIDEO GUARD STABILIZER

MODEL V-1875



OUR PRICE **\$45.00** each

Has self contained A&B and bypass switch. Many movies, concerts and special programs for sale or rental are copy guarded. This removes copy guard and allows you to make copies. Many TV sets will not play prerecorded tapes because copy guard causes picture to roll and jitter, turn to snow or disappear. Video Guard Stabilizer removes copy guard from signal.

## BP VIDEO GUARD STABILIZER/ RF CONVERTER

MODEL V-1877



OUR PRICE **\$69.95** each

Same as above but with a built-in RF Converter that gives the model V-1877 an RF output which can be fed directly to the antenna terminals of a TV set. This enables you to remove the copy guard from a pre-recorded tape and view it on a TV using only a VCR.

**Use as an RF Converter only.** Used in conjunction with your TV, you can feed direct audio and video signals from any video device such as video camera, computer, portable VCR, etc.

## BP VIDEO COMMAND CENTER

MODEL V-4803

OUR PRICE **\$59.95** each

A switcher that can accept 6 inputs and direct them to 3 outputs. Utilizes switch similar to one used on home VCR's. You avoid signal loss incurred by using splitters.



## JERROLD 60 CHANNEL CORDLESS TV CONVERTER

MODEL DRX-3-105

CALL FOR PRICES



- Receive up to 60 TV channels
- Remote TV Control
- Attach to any age or model TV in minutes.
- No tools required.
- On/Off button.
- Channel selection.
- Channel Stepping.
- Fine Tuning.

## JERROLD JRX TV REMOTE CONVERTER

MODEL JRX-3C105 (SWITCH)

OUR PRICE **\$79.95** each

Consists of two units - a receiver and transmitter. 20 ft connecting cord is detachable at one end to help you position the unit. May be attached to any age or model TV in minutes. No tools required.

- Receive up to 36 channels.
- Remote TV control.



## BP VIDEO CONTROL CENTER

MODEL V-4802

OUR PRICE **\$19.95** each

Provides remote control access of all Video, TV or Cable, inputs to TV or Big Screen TV from one location by flipping switch.

- One output, your TV set or Big Screen TV
- Four inputs
- Completely passive, i.e. no AC power required to operate
- Auxiliary input and output provides added flexibility.



## BP UHF CONVERTER FOR TV AND VTR

MODEL V-5736

OUR PRICE **\$24.95** each  
5 FOR **\$100.00**

Use your VCR to its maximum capability. Record VHF, UHF, Cable or Pay TV while watching any other mode.

### FEATURES

- 36 channels
- Allows complete programming of VTR
- Super color quality
- Watch or record any combination of selectable channels.
- Receives midband, superband/Pay and all VHF channels on UHF.
- For Beta/VHS type recorders or TV set
- Record and use TV's remote control.



## BP IMAGE ENHANCER

MODEL V-1860

Dramatically improves performance of video cameras and VCR's (off-the-air or second generation recordings), by compensating for deterioration of detail and sharpness. Includes video distribution amplifier with two video outputs, allowing you to make two copies at once without loss in signal level.



OUR PRICE **\$59.95** each

## BP RF CONVERTER/MODULATOR

MODEL V-1885

OUR PRICE **\$39.95** each

Allows your TV to receive video and audio signals from image enhancer, guard stabilizer, video camera, computer, VCR, etc. The outputs of many video components cannot be directly hooked up to the VHF antenna terminals on your TV set. This problem is solved by using the Model V-1885 RF Converter. Converts video signal from any video component to adjustable RF signal at antenna terminals. Allows your VCR output to feed two TV sets at the same time, with virtually no signal loss.



**FORDHAM**  
260 Motor Parkway, Hauppauge, N.Y. 11788

Master Charge  
VISA  
COD  
Money Order  
Check  
N.Y. State residents add appropriate sales tax.  
COD's extra (required 25% deposit)

ADD FOR SHIPPING AND INSURANCE  
\$250.00 ..... \$4.50  
\$251.00 to 500.00 ..... 6.50  
501.00 to 750.00 ..... 8.50  
751.00 to 1000.00 ..... 12.50  
over 1000.00 ..... 15.00

**TOLL FREE (800) 645-9518**  
in N.Y. State call 800-832-1446

JULY 1983

# Only NRI Gives You This Kind of Training and Equipment.

## Only NRI Gives You So Much Professional Preparation For a TV/Audio/Video Servicing Career.

Build this 25" Heath/Zenith Color TV with 112 channel tuning system, infrared remote control, advanced sound system, and in-set space phone.

Get complete, thorough instruction in the theory, servicing, and repair of TV, VCR, video disc players, audio equipment, AM/FM receivers, antenna systems, home video cameras, projection TV, and more with 65 easy-to-digest, bite-size lessons.

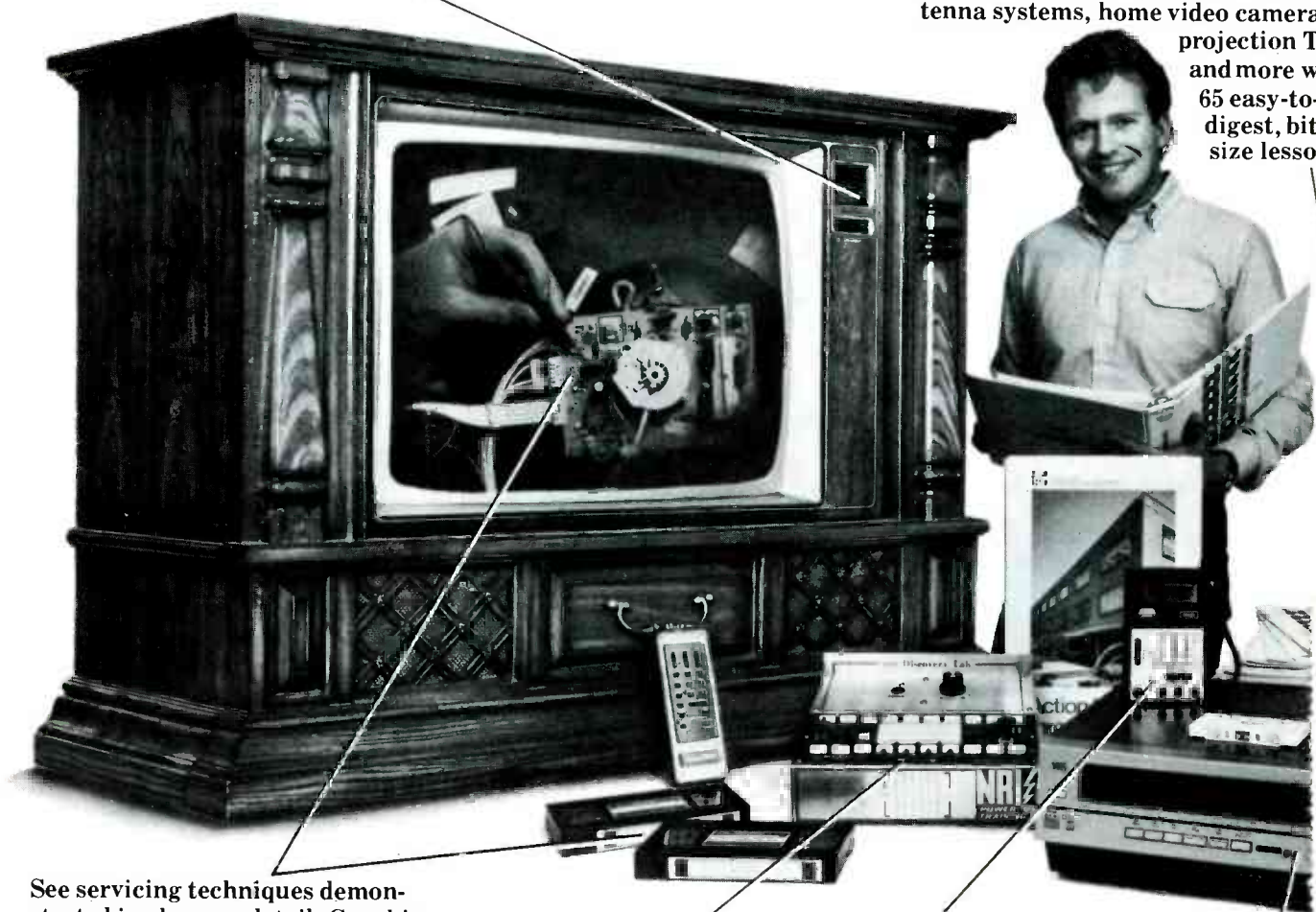

See servicing techniques demonstrated in close-up detail. Graphic presentations make theory and systems come alive on NRI Action Videotapes covering VCRs, disc players, and TVs.

Perform challenging state-of-the-art electronic experiments and demonstrations using your NRI Discovery Lab®.

Learn how to diagnose problems using a professional 3½-digit digital multimeter. Exclusive NRI Action Audio instructions talk you through its complete operation and use.

Learn servicing adjustment techniques with this 6-hour, remote control videocassette recorder you get part of your training.

Only NRI gives you so much practical training with equipment you learn on and keep. You learn by doing. That's the way to make it interesting, that's the way to make it enjoyable, that's the way to get the hands-on experience and know-how you need.

## Hands-On Training For Real Bench Experience and Priceless Confidence

You start with experiments and demonstrations on the unique NRI Discovery Lab. You learn basic circuit wiring and soldering techniques, and then quickly move on to more advanced concepts as you come to understand electronic theory, solid-state devices, digital systems, and microprocessors. You learn by actually building and observing the action of circuitry you'll be working with in real-life situations.

## Exclusive NRI Training On Videotape

In addition to profusely illustrated lessons, you get NRI's Action Audio cassette to "talk" you through the use and operation of the professional digital multimeter you receive as part of your equipment. Even more exciting are your NRI Action Videocassettes... videotaped lessons that show you graphic presentations of electronic systems, vivid closeups of servicing techniques and professional "shortcuts" to study and replay as often as you want.



## You Get TV, VCR, DMM and More Equipment To Keep

You also build your own 25" Heath/Zenith color TV, a state-of-the-art unit that includes infrared remote control, a Time Control Programmer, and the incredible Advanced Space Phone that lets you telephone from your chair. Using the videocassette recorder that's included as part of your training, you learn how to adjust, service and re-

pair these fast-selling units. Your front-loading VCR features up to 6-hour recording capacity, remote control, and programmable touch-button tuning.

The digital multimeter you receive is a truly professional instrument. You use it in the experiments throughout your course and as a key servicing tool on the job. Using the meter along with the NRI Discovery Lab, you'll learn how to measure voltage, current and resistance and how to diagnose all types of servicing problems.

## Advanced Systems Demand Advanced Technicians for Service and Maintenance

The art of TV/Audio/Video servicing has taken quantum leaps into the future. Now, successful technicians must understand advanced concepts like digital control, electronic tuning, laser video discs, microprocessors, and more. NRI gives you the training you need for success... state-of-the-art concepts and practical, hands-on experience working with the kind of equipment you'll encounter on the job.

## 7 Decades of Teaching Electronics Skills At Home

NRI is the oldest, largest, and most successful school of its kind in the world. It has pioneered and refined the teaching techniques that make learning at home the NRI way



## Send For Free Catalog Covering 12 Electronics Courses

Our 104-page catalog gives you all the details. In it, you'll find a summary description of every lesson, and photos and specifications for every item of equipment included in your course. You'll also learn about other fascinating career opportunities in the world of electronics... Microcomputers, Industrial Electronics including robotics, Communications, and more.

Mail the postage-paid card today for your free copy. See how completely and how thoroughly NRI gets you started on your tomorrow today.



**NRI SCHOOL OF ELECTRONICS**  
McGraw-Hill Continuing Education Center  
3939 Wisconsin Avenue  
Washington, DC 20016

# LETTERS

Address your comments to: Letters, **Radio-Electronics**,  
200 Park Avenue South, New York, NY 10003

## PRIVACY IN COMMUNICATIONS

Recently, I picked up a copy of **Radio-Electronics** quite by chance, and was so impressed that I subscribed the next day. Keep up the great work.

I would like to comment on the article, "Ensuring Privacy in Communications" in the "Communications Corner" department for January 1983. The writer seems to be conveying a false impression — a misunderstanding that even many amateur radio operators have: that by adding a sub-audible or dual tone signal to your transmission you can ensure privacy from the casual listener.

Tone-squelch systems do not prevent people with scanners from hearing what you say. The tone squelch simply keeps other radios (in a fleet, for example) that have a squelch-muting circuit from being bothered by any except properly encoded signals. A radio without that mute circuitry will pick up every-

thing transmitted over a given frequency, whether or not the transmission has a tone added to it. Since scanners, and the majority of monitoring radios, are not equipped with muting, the tone in no way protects the privacy of the communication. Even radios *with* such muting circuits are usually taken off mute when the microphone is picked up, enabling a listener to hear all the transmissions.  
DAN PETERSON  
Hemet, CA

## ANTIQUe RADIOS

I enjoyed reading Mr. Richard Fitch's recent article about restoring antique radios (**Radio-Electronics**, March 1983). Having repaired many pre-war radios, and some early TV sets, I know the feeling of accomplishment that results from getting one of those treasures playing again.

I'd like to offer a hint that might make

troubleshooting an old chassis a bit easier.

When smaller tube-radios became available (and later, when television appeared on the scene), many an old model was retired while still in good working order. But alas, 40 years later, when the old unit is dusted off and plugged in, all that issues from the speaker is a thin, garbled audio strongly overridden by a loud AC hum.

Here's the problem in almost every case that I've come across: The electrolytic capacitor in the power-supply circuit has dried out. Unlike the paper/foil and mica capacitors in the set, the electrolytics *do not* have an unlimited shelf life. The liquid electrolytic can evaporate away, leaving the caps virtually ineffective.

Two things result: First, the filtering of the pulsating DC from the vacuum-tube rectifier becomes very poor. All that's left to provide a modicum of filtering is the field coil on the

# GET THE SAME VIDEO TRAINING THE PEOPLE AT SONY GET.

Now you can be trained by Sony even if you aren't employed by Sony.

Because we're making our vast library of training videotapes available to you. The very tapes that teach our own engineering, service and sales personnel.

The tapes cover the products and concepts of video and its related technologies. You can learn the basics of video recording. Color systems. Digital video and electronics. Television production. And more.

Plus you can learn how to service cameras, VTR's, and other video products. As professionally as Sony does.

The tapes are produced entirely by Sony and contain up-to-the-minute information. They communicate clearly and simply. And some of them are even programmed for interactive learning.

And learning through video can be done at your own pace, in the convenience of your home, shop or school. Reviewing is quick and easy. And the tapes are always available for reference.

Send for your catalog, which lists more than 250 titles. In your choice of 3/4" or 1/2" formats.

Write Sony Video Products Company, Tape Production Services, 700 W. Artesia Boulevard, Compton, California 90220. Or call (213) 537-4300.

Of course, there's no obligation. Except the obligation you have to yourself: to find out about the best training available in one of the country's fastest-growing, most lucrative fields.

**SONY**  
Video Communications  
Sony is a reg. trademark of Sony Corp.

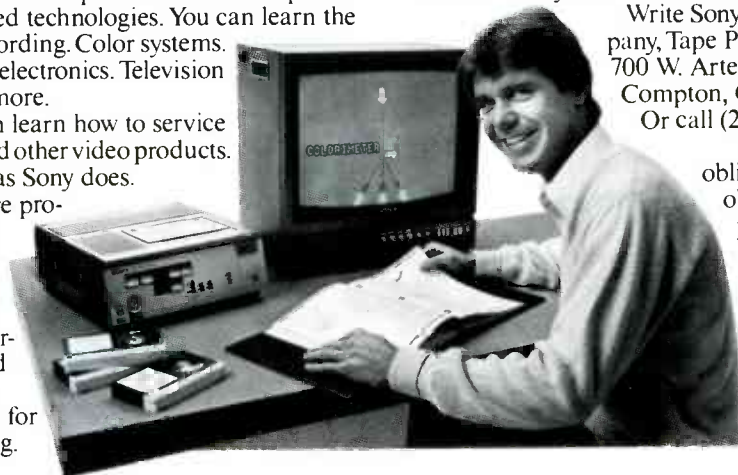

CIRCLE 28 ON FREE INFORMATION CARD

# wabash<sup>®</sup> diskettes for as low as **\$1.29 each!**

## Now get Wabash Quality at a CE Price

For over 17 years, Wabash has been making high quality and dependable computer products. Wabash diskettes are made to provide error-free performance on your computer system because every diskette has been totally and hypercritically tested. Since you can now buy Wabash computer products directly from CE, the world's largest distributor of magnetic media, you can now get maximum savings on every order. You can even order toll-free.

## New Wabash Six Year Warranty

The quality of Wabash diskettes is stressed throughout the entire manufacturing process. After coating, all Wabash diskettes go through a unique burnishing process that gives each diskette a mirror-smooth appearance. Wabash then carefully applies a lubricant that is specially formulated to increase diskette life. Then, to keep out foreign particles, a unique heat seal bonds the jacket and liner together to help prevent contamination. After 100% hypercritical testing and certification, Wabash then packages each diskette, (except bulk pack) in a super strong and tear resistant Tyvek<sup>®</sup> envelope. The final Wabash product is then shrink-wrapped to insure cleanliness and reduce contamination during shipment. Wabash diskettes are so very reliable that Wabash now offers a six year warranty in case of defects in materials or workmanship on all diskettes purchased directly from Communications Electronics.

## New...Wabash Diskette Duplication Services

Communications Electronics has teamed up with Wabash to provide a single-source solution for the diskette duplication requirements of software developers, OEM's and distributors. All service is in-house, to give you fast, dependable service. In most cases, delivery can be completed in five days. Whether you require 100, 1,000, or 10,000 copies per week, call CE first for a no obligation price quote. For additional information, please write us on your letterhead with your requirements.

### SAVE ON WABASH DISKETTES

Product Description	Part #	CE quant. 100 price per disk (\$)
8" SSSD IBM Compatible (128 B/S, 26 Sectors)	F111	1.89
8" SSSD Shugart Compatible, 32 Hard Sector	F31A	1.89
8" SSDD IBM Compatible (128 B/S, 26 Sectors)	F131	2.39
8" DSDD Soft Sector (Unformatted)	F14A	2.99
8" DSDD Soft Sector (256 B/S, 26 Sectors)	F144	2.99
8" DSDD Soft Sector (512 B/S, 15 Sectors)	F145	2.99
8" DSDD Soft Sector (1024 B/S, 8 Sectors)	F147	2.99
5 1/4" SSSD Soft Sector w/Hub Ring	M11A	1.49
5 1/4" Same as above, but bulk pack w/o envelope	M11AB	1.29
5 1/4" SSSD 10 Hard Sector w/Hub Ring	M41A	1.49
5 1/4" SSSD 16 Hard Sector w/Hub Ring	M51A	1.49
5 1/4" SSDD Soft Sector w/Hub Ring	M13A	1.79
5 1/4" Same as above, but bulk pack w/o envelope	M13AB	1.59
5 1/4" SSDD 10 Hard Sector w/Hub Ring	M43A	1.79
5 1/4" SSDD 16 Hard Sector w/Hub Ring	M53A	1.79
5 1/4" DSDD Soft Sector w/Hub Ring	M14A	2.69
5 1/4" Same as above, but bulk pack w/o envelope	M14AB	2.49
5 1/4" DSDD 10 Hard Sector w/Hub Ring	M44A	2.69
5 1/4" DSDD 16 Hard Sector w/Hub Ring	M54A	2.69
5 1/4" SSQD Soft Sector w/Hub Ring (96 TPI)	M15A	2.59
5 1/4" DSQD Soft Sector w/Hub Ring (96 TPI)	M16A	3.69
5 1/4" Tyvek Diskette Envelopes - Price per 100 Pack	TE5	12.00

SSSD = Single Sided Single Density; SSDD = Single Sided Double Density;  
DSDD = Double Sided Double Density; SSQD = Single Sided Quad Density;  
DSQD = Double Sided Quad Density; TPI = Tracks per inch.

**Quantity Discounts Available**  
Wabash diskettes are packed 10 disks to a carton and 10 cartons to a case. The economy bulk pack is packaged 100 disks to a case without envelopes or labels. Please order only in increments of 100 units for quantity 100 pricing. With the exception of bulk pack, we are also willing to accommodate your smaller orders. Quantities less than 100 units are available in increments of 10 units at a 20% surcharge above our 100 unit price. **Quantity discounts** are also available.



Order 500 or more disks at the same time and deduct 1%; 1,000 or more saves you 2%; 2,000 or more saves 3%; 5,000 or more saves 4%; 10,000 or more saves 5%; 25,000 or more saves 6%; 50,000 or more saves 7%; 100,000 or more saves 8%; 500,000 or more saves 9% and 1,000,000 or more disks earns you a 10% discount off our super low quantity 100 price. Almost all Wabash diskettes are immediately available from CE. Our efficient warehouse facilities are equipped to help us get you the quality product you need, when you need it. If you need further assistance to find the flexible disk that's right for you, call the Wabash compatibility hotline. Dial toll-free 800-323-9868 and ask for your compatibility representative. In Illinois or outside the U.S. dial 312-593-6363 between 9 AM to 4 PM Central time.

## Buy Wabash Diskettes with Confidence

To get the fastest delivery from CE of your Wabash computer products, we recommend you phone your order directly to our Computer Products Division and charge it to your credit card. Be sure to calculate your price using the CE prices in this ad. Written purchase orders are accepted from approved government agencies and most well rated firms at a 30% surcharge for net 30 billing. For maximum savings, your order should be prepaid. All sales are subject to availability, acceptance and verification. All sales are final. All prices are in U.S. dollars. Prices, terms and specifications are subject to change without notice. Out of stock items will be placed on backorder automatically unless CE is instructed differently. Minimum *prepaid* order is \$50.00. Minimum *purchase order* \$200.00. All shipments are F.O.B. Ann Arbor, Michigan U.S.A. No COD's please. Non-certified and foreign checks require bank clearance.

For **shipping charges** add \$8.00 per case or partial case of 100 8-inch flexible disks or \$6.00 per case or partial case of 100 5 1/4-inch mini-diskettes for U.P.S. ground shipping and handling in the continental U.S.A.

**Mail orders to:** Communications Electronics, Box 1002, Ann Arbor, Michigan 48106 U.S.A. If you have a Visa or Master Card, you may call and place a credit card order. Order toll-free in the U.S. Dial 800-521-4414. In Canada, order toll-free by calling 800-265-4828. If you are outside the U.S. or in Michigan dial 313-994-4444. Telex anytime 810-223-2422. Order your Wabash diskettes today.

Copyright ©1983 Communications Electronics™

Ad #U12483



**Order Toll-Free!**  
**800-521-4414**

In Michigan 313-994-4444

**wabash**  
**error-free**  
**diskettes**

**COMMUNICATIONS**  
**ELECTRONICS™**

**Computer Products Division**

818 Phoenix □ Box 1002 □ Ann Arbor, Michigan 48106 U.S.A.  
Order TOLL-FREE 800-521-4414 or outside U.S.A. 313-994-4444

# FORDHAM CUTS PRICES ON HITACHI SCOPES

CALL FOR PRICES

CALL FOR PRICES

## MINI-PORTABLE DUAL TRACE



Model V-209

3-way power supply, compact, light-weight package • High sensitivity 1 m V/div at 10m Hz and fast sweep times 50 ns/div • Built-in TV sync separation circuit/TV-V & TV-H modes • Auto-focus • Comes with probes.

## 20 MHz Dual Trace



Model V-202F

.55" square CRT • Vertical sensitivity 5m V/div to 5 V/div and 1 m V/div to 1V/div with 5X amplifier • Display modes Ch1, Ch2, Dual, Add, Diff. • Comes with probes.

Model V-203F - Same as above but with Delayed Sweep.

## 35 MHz DUAL TRACE

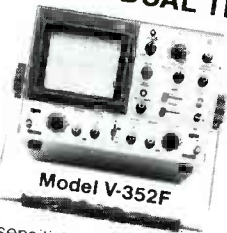

Model V-352F

Vertical sensitivity 5m V/div to 5V/div and 1 m V/div to 1V/div with 5X amplifier • Trigger modes Automatic, Normal, TV(+), TV(-) • Comes with probes.

Model V353F - Same as above but with Delayed Sweep.

## 60 MHz DUAL TRACE DELAYED SWEEP



Model V-650F

High sensitivity • 1 mV/div (10MHz) • 5 ns/div sweep rate • 3rd channel display (trigger view) • Variable trigger hold-off • Full TV triggering • Single sweep • Automatic focus correction • Comes with probes.

## 100 MHz QUAD TRACE DELAYED SWEEP



Model V-1050F

Large, bright 8x10 cm screen • Quad trace operation/Ch1, Ch2, A trigger and B trigger • High sensitivity 500  $\mu$  V/div (5 MHz) • Full TV triggering • Comes with probes.

# FREE DVM \$80 Value



BP Model DVM-532

Full autoranging 3-1/2 digit LCD • Built-in continuity buzzer • Easy to read, 1/2" digit LCD display • Overload protection • Low battery indication.

\*With purchase of an oscilloscope from this ad.

**CALL FOR SPECIAL INTRODUCTORY PRICES**  
**TOLL FREE (800) 645-9518** in N.Y. State 800-832-1446

# FORDHAM

260 Motor Parkway, Hauppauge, N.Y. 11788



- Master Charge
- VISA
- COD
- Money Order
- Check

electrodynamic speaker (which does double-duty as a choke in most of the old circuits). That isn't enough to prevent a loud hum in the speaker. Second, there's usually an electrolytic capacitor used to bypass the cathode resistor in the audio-output stage. When that goes, the AC gain of the stage is reduced to a fraction of its former level.

Solution? Replace *all* the old electrolytics. The values are almost always marked clearly, and modern equivalents are readily available. Some early electrolytics are rectangular in shape, like a matchbox covered with wax; others are enclosed in metal cans attached to the chassis, so keep that in mind when hunting for them in your old set. When replacing, just be sure to use capacitors of equal or higher voltage, and watch out for polarity. The exact capacitance value is usually not critical, and deviations of 25 or even 50 percent will often work satisfactorily.

So if you have an old set with those symptoms, try my suggestions first; they may save you a lot of time and trouble.

DAVID B. WARD

Madison, NJ

### ON NIKOLA TESLA

I would like to thank you for publishing my letter to the Editor in your November 1982 issue of *Radio-Electronics*. I believe that we owed that tribute to Nikola Tesla for his many accomplishments and few rewards. I am also sure that your readers have appreciated it. It is a great credit to your magazine to be so responsive to your readers.

May I now point to a slight discrepancy between my letter and the published version, which, I am afraid, may cause confusion among the experts. My letter said: "Of course, the General Electric Company, which originally followed Edison and the DC approach, abandoned it later and followed Tesla's AC direction to grow into the giant of today." The published version read: "That company had followed Edison and the DC approach, at first; later, it turned to follow Tesla's AC direction."

The substitution of "that company" for "the General Electric Company" unfortunately changes the meaning completely, since from the context, "that company" refers to Westinghouse Electric.

I would appreciate it very much if you will once again spare me some of your valuable space and publish my correction.

Once again, my thanks for publishing the tribute to Nikola Tesla, the inventor extraordinary.

SLOBODAN CUK, PH.D.

Assistant Professor of Engineering,  
 California Institute of Technology

*Our apologies for the transcription error through which the proper antecedent to the phrase "that company" was omitted. Editor*

### VIDEO TRANSMISSION

Just a note on the letter that appeared in the January 1983 *Radio-Electronics* by Mr. Peter K. Onnigan about video transmission via FM radio stations.

By his statements and incomplete reasoning, Mr. Onnigan would have us believe that high-resolution video can't be transmitted over 10-kHz telephone lines or via 3-kHz bandwidth radio-communications links. Well, maybe not *moving* pictures, but ...

RONALD S. MOODY

Bremen, GA

R-E

# Not Just Another Pretty Breadboard.



**S**o you thought Global Specialties was *just* the leading manufacturer of Solderless Breadboarding Systems? Look again. Over the past 10 years Global's developed more than 40 bench-crafted quality test and design instruments . . . Just for you.

Take your pick . . . We offer Capacitance Meters, benchtop and portable, and an array of complementary instruments to meet your specific needs. We've got 8 Frequency Counters to choose from, starting with our inexpensive MAX-50 and MAX-100 and capped with our recently-introduced 6002, 1 GHz model. Our Universal Counter-Timer family includes the new, widely-acclaimed, handheld 5000 Counter-Timer.

We also make logic probes and pulsers with frequency and pulse width ranges to suit any

application or budget. Global's popular Function and Pulse Generators are designed with the same quality as our NBS-certified Frequency Standard. And a broad range of accessories, hardware and cases round out the Global product line.

Of course, we still manufacture the largest selection of Breadboards and prototyping equipment anywhere . . . Simple Quick Test elements with our patented interlocking system . . . Experimentor Modules which combine sockets and bus strips in popular arrays . . . prototyping systems which provide uncomplicated translation from design to finished product . . . Mounted solderless assemblies, including Global's PB-105 Superboard, 50% larger than any other, and our powered proto-boards offering a wide

selection of power options.

You depend on us for the best in breadboards . . . Depend on us for the best in test and design instruments. Your pocket won't take a beating either. Global provides the specifications and features you require *now* . . . at prices you can afford *today*.

Remember . . . We're not just another pretty breadboard. If you need something for Test or Design, we've probably got it. So give us a call Toll-Free . . . TODAY.



## GLOBAL SPECIALTIES CORPORATION

70 Fulton Terr., New Haven, CT 06509  
(203) 624-3103 TWX 710-465-1227

OTHER OFFICES:  
San Francisco (415) 648-0611, TWX 910-372-7992,  
Europe: Phone Saffron-Walder 0799-21682,  
TLX 851-817477

Call toll free for details 1-800-243-6077 during business hours

CIRCLE 31 ON FREE INFORMATION CARD

# EQUIPMENT REPORTS

## Philips Model PM 3215 50-MHz Dual-Trace Oscilloscope

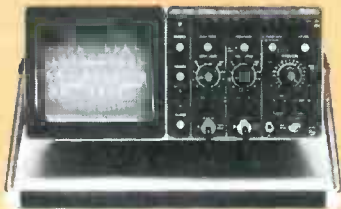

CIRCLE 103 ON FREE INFORMATION CARD

Philips		PM 3215									
OVERALL PRICE											
EASE OF USE											
INSTRUCTION MANUAL											
PRICE/VALUE											
		1	2	3	4	5	6	7	8	9	10
		Poor			Fair			Good			Excellent

YOU CANNOT BE INVOLVED WITH electronics—by profession or even as a hobbyist—without eventually needing an

oscilloscope. And today's advancing technology often demands an oscilloscope with a wide bandwidth. If you have

found that to be true in your experience, and if you are contemplating an oscilloscope purchase, one unit you should not overlook is the *PM 3215* from Philips Test and Measuring Instruments, Inc. (85 McKee Drive, Mahwah, NJ 07430).

### General overview

The *PM 3215* is a dual-channel scope with a 50-MHz bandwidth. It is relatively lightweight (less than 18 pounds) and measures 17.5 × 11.8 × 5.4 inches. (Those measurements do not include the front protective cover, the controls, or the handle.) The handle, with its nine locking positions, doubles as a stand for the scope.

The inclusion of a battery input (22–27 volts DC at 1.1 amp maximum) along

*continued on page 28*

## New Simpson Test Instruments for the 80's FAST PROFITABLE BENCH OR FIELD SERVICING

Three new DMMs offer high accuracy, beeper, diode test, transient protection and double fusing.

The **470<sup>TM</sup>** is our new low-cost full-function hand-held (calculator style) DMM with 25 ranges.

The **467E** hand portable DMM has peak hold, true RMS and 26 ranges.

The **360 Series 3** digital VOM (with world famous 260<sup>®</sup> styling) has 28 ranges, bright LED display, rechargeable batteries.

Our **Model 165** Handi-VOM is a pocket-size unit with 22 ranges including dB, large 3 1/4" meter, convenient one-knob selector switch.

The **Deluxe Test Lead Kit** (Catalog No. 00818) has everything you need for fast, convenient test setups, measurements and trouble-shooting.

Order Them from  
Your Local  
Electrical/  
Electronics  
Distributor



**SIMPSON ELECTRIC COMPANY**  
A Katy Industries, Inc. Subsidiary  
853 Dundee Avenue, Elgin, IL 60120  
(312) 697-2260 • Cable SIMELCO • Telex 72-2416



470<sup>TM</sup> \$139

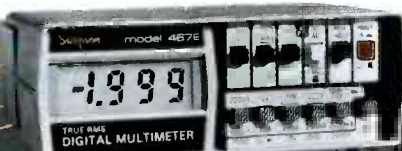

467E \$225

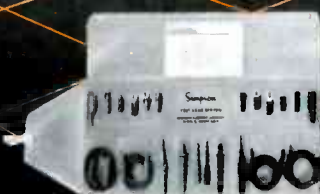

Deluxe Test Lead Kit \$57



165 Handi-VOM \$78



360 Series 3 \$275

CIRCLE 91 ON FREE INFORMATION CARD



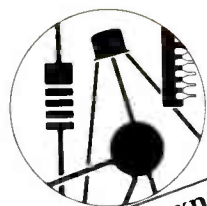

# The ELECTRONICS BOOK CLUB

18 years experience

Hundreds of time- and money-saving ideas for hobbyists, experimenters and technicians!



Select 6 fact-filled volumes for only \$295 (total value up to \$115.70)



1536  
List \$13.95



1406  
List \$17.95



1467  
List \$16.95



1000  
List \$13.95



1211  
List \$14.95



1468  
List \$18.95



1277  
List \$19.95

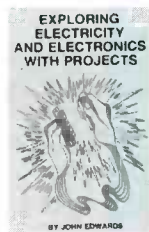

1497  
List \$15.95



1451  
List \$18.95



1199  
List \$18.95



1062  
List \$14.95



1474  
List \$15.95

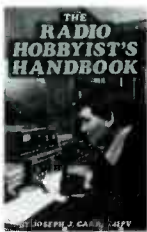

1346  
List \$19.95



1465  
List \$15.95



1332  
List \$16.95



1436  
List \$16.95



1473  
List \$18.95

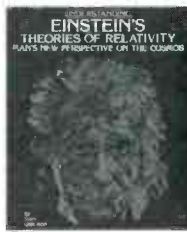

1505  
List \$18.95



1296  
List \$18.95

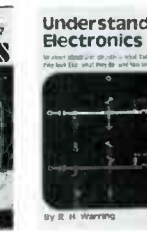

1113  
List \$11.95



1276  
List \$15.95



1486  
List \$17.95



1160  
List \$13.95



1435  
List \$15.95

## 7 very good reasons to try Electronics Book Club

Blue Ridge Summit, PA 17214

- **Reduced Member Prices.** Save 20% to 75% on books sure to increase your know-how
- **Satisfaction Guaranteed.** All books returnable within 10 days without obligation
- **Club News Bulletins.** All about current selections—mains, alternates, extras—plus bonus offers. Comes 13 times a year with dozens of up-to-the-minute titles you can pick from
- **"Automatic Order."** Do nothing, and the Main selection will be shipped automatically! But... if you want an Alternate Selection—or no books at all—we'll follow the instructions you give on the reply form provided with every News Bulletin
- **Continuing Benefits.** Get a Dividend Certificate with every book purchased after fulfilling membership obligation, and qualify for discounts on many other volumes
- **Bonus Specials.** Take advantage of sales, events, and added-value promotions
- **Exceptional Quality.** All books are first-rate publisher's editions, filled with useful, up-to-the-minute information



## ELECTRONICS BOOK CLUB

Blue Ridge Summit, PA 17214

Please accept my membership in Electronics Book Club and send the 6 volumes circled below, billing me \$2.95 plus shipping and handling charges. If not satisfied, I may return the books within ten days without obligation and have my membership cancelled. I agree to purchase 4 or more books at reduced Club prices (plus shipping/handling) during the next 12 months, and may resign any time thereafter.

1000 1062 1113 1160 1199 1211  
1276 1277 1296 1332 1346 1406  
1435 1436 1451 1465 1467 1468  
1473 1474 1486 1497 1505 1536

Name \_\_\_\_\_ Phone \_\_\_\_\_

Address \_\_\_\_\_

City \_\_\_\_\_

State \_\_\_\_\_ Zip \_\_\_\_\_

Valid for new members only. (Orders outside U.S. or Canada must be prepaid in International Money Orders in U.S. dollars. Canada must remit in U.S. dollars.) This order subject to acceptance by Electronics Book Club. RE-783





# QUALITY KITS

## ★ ★ ★ ★ ★ \$2.00 REBATE! ★ ★ ★ ★ ★

Buy one or more of Jim-Pak's electronic kits and receive a \$2.00 factory rebate for each kit you purchase from one of the authorized Jim-Pak distributors shown on the opposite page. Just remit the coupon below along with your ORIGINAL sales slip and receive a \$2.00 rebate direct from the Jim-Pak factory for each kit purchased.

**5VDC - 1 Amp REGULATED POWER SUPPLY KIT**



120VAC input. Includes components, hardware and instructions.

**JE200**

**±5 to ±15VDC ADJUSTABLE REGULATED POWER SUPPLY KIT**



120VAC input. Output per supply 5VDC @ 500mA, 10VDC @ 750mA, 12VDC @ 500mA, 15VDC @ 175mA. LED "On" indicator.

**JE215**

**DIGITAL THERMOMETER**



**JE300**

Dual sensors - switch controls for indoor/outdoor or dual monitoring. Extends to 500'. Range: -40°F to 199°F. Calibrate for Fahrenheit/Celsius. .8" ht. display. AC adapter included.

**6-DIGIT CLOCK KIT (.300" Ht.)**



**JE701**

115VAC - 12 to 24 hour operation. Includes components, case and wall transformer. Viewable to 20 feet. 6 1/2" x 3 3/8".

**SOLAR CELL PANEL KIT**

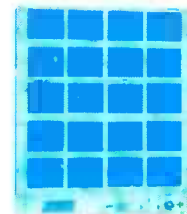

**JE305**

Output: 10VDC to 100mA in series. 5VDC to 200mA in parallel. Contains 20 solar cells. Power line taps select from 0.5VDC to 10VDC in 0.5VDC increments. Provides currents for small battery power applications.

**JUMBO 6-DIGIT CLOCK KIT (.800" Ht.)**



**JE747**

115VAC, 12 to 24 hour. Viewable to 30 feet. Includes components, case and wall transformer. 6 1/2" x 3 3/8".

**FUNCTION GENERATOR KIT**



**JE2206B**

Three waveforms: sine, triangle, square. Range from 1Hz to 100kHz. Output amplitude from 0 volts to over 6 volts. Uses a 12V or a ±6V split supply.

**ASCII ENCODED KEYBOARD KIT**



**JE610**

60 Keys generate the 128 characters, upper and lower case ASCII set. Fully buffered. Two user-definable keys provided for customer applications. Caps lock for upper case only alpha characters. Utilizes a 2376 (40-pin) encoder read only memory chip. Outputs directly compatible with TTL/DTL or MOS logic arrays. Parallel output. Easy interfacing with a 16-pin DIP or 18-pin edge connector. Interfaces into most computer systems. Requires +5V @ 150mA and -12V @ 10mA. Size: 1 1/2" H x 6 1/2" W x 1 3/4" L.

• REBATE COUPON • REBATE COUPON • REBATE COUPON • REBATE COUPON • REBATE COUPON • REBATE COUPON • R

**Please send my refund for \$ \_\_\_\_\_ for \_\_\_\_\_ kits. I have enclosed my ORIGINAL sales slip.**

**NOT VALID WITHOUT ORIGINAL SALES RECEIPT.**

**EXPIRES JULY 31, 1983**

ONE REBATE PER CUSTOMER

Send directly to JIM-PAK, 1355 Shoreway Road, Belmont, California 94002

NAME \_\_\_\_\_

ADDRESS \_\_\_\_\_

CITY \_\_\_\_\_ STATE \_\_\_\_\_ ZIP \_\_\_\_\_

PHONE ( ) \_\_\_\_\_

• REBATE COUPON • REBATE COUPON • REBATE COUPON • REBATE COUPON • REBATE COUPON • REBATE COUPON •

See your local JIM-PAK distributor listed on the opposite page.

## EQUIPMENT REPORTS

continued from page 24

with its light weight and compactness, protective panel cover, and handle, indicates that Philips wanted the *PM 3215* to be at home either on a laboratory bench or in the field.

The CRT display has an internal graticule (an 8- × 10-cm grid) with continuously variable illumination. Those features reduce parallax error and help to make reading the scope non-fatiguing, especially if you use the scope for long periods of time.

When the scope is first turned on, the blue trace appears within 10 seconds, and the unit is ready for immediate use, although a 30-minute warmup time is suggested in the manual. The trace comes on about 4/10 of a division below where it was when the unit was turned off. However, after the 30-minute warmup period, it has returned to its previous position and there is negligible drift in the trace thereafter.

The unit comes supplied with two passive probes with an attenuation factor of 10 (and a compensation range from 14 to 40 pF—full probe-compensation instructions are included in the manuals). A handy zero- or ground-check button is included on the probe shell. The probes

also come with a variety of accessories. They include a spring-loaded test clip, extra probe tips, and special caps for the probe tips that help to make measurements on dual in-line packages or in densely wired circuits easier. An adapter for making measurements of wire-wrapped circuits is also included with the probes.

### A look at the controls

The front panel is well organized and laid out in a neat, compact manner with the controls appearing where you would want—and expect—them to be. The controls can be grouped into three main sections. The first section includes the power and CRT controls. The second section contains the vertical-channel controls, and the third contains the triggering and horizontal-channel controls. We'll look at each section in more detail, starting with the first, which is located to the right of the CRT screen.

The ILLUM control acts as the power switch as well as the continuously variable graticule-illumination control. An LED immediately above that control indicates POWER ON. Other controls in this section include those for trace intensity and focus. A screwdriver-adjustable TRACE ROTATION control is included to allow you to align the trace with the horizontal graticule lines. Also included in this section is an output terminal, labeled CAL, which is the source of a 1.2-volt

squarewave having a frequency of about 2 kHz. That can be used for vertical-channel calibration or when compensating probes.

The second section includes two columns of controls for the "A" and "B" vertical channels. They include BNC input-jacks, above each of which are two pushbuttons—one grounds the input and the other selects AC or DC input-coupling. Above each set of pushbuttons is a AMPL/DIV which consists of two concentric knobs. The outer knob—with 12 click-stop positions from 2 mV/div to 10 V/div in a 1-2-5 sequence—selects the vertical-channel multiplier. The inner knob has a click-stop CAL position and can be used to continuously vary the vertical-channel scale multiplier. A POSITION control is located above each AMPL/DIV knob allows you to vary the vertical position of the display.

Centered above each of the two columns of controls for the "A" and "B" vertical channels is a 5-position pushbutton switch that is used to select the vertical-display mode. Your choices include looking at signals on channel "A" only or channel "B" only (positions A and B respectively), or looking at both (ALT or CHOP—chosen depending on the sweep rate that is in use). You can also look at the sum of the signals at the "A" and "B" inputs or, by pulling out the channel-B POSITION control, you can in-

## THIS CATALOG IS YOUR KEY TO INCREASED EFFICIENCY AND PRODUCTIVITY. AND BECAUSE IT'S FREE, YOU'VE ALREADY STARTED TO REDUCE COSTS!

This is our current catalog... The Wire Handlers. It's filled with wire handling tools designed and engineered to make your life easier. The tools are unique... unique in design, and unique in the way they perform.

You may know about our Wire Strippers...but we also offer the finest power electric desoldering tools, termination kits, wire and cable cutters, slitters, crimpers, and low cost voltage testers, available. Ask for your copy of The Wire Handlers today! Just send your business card.

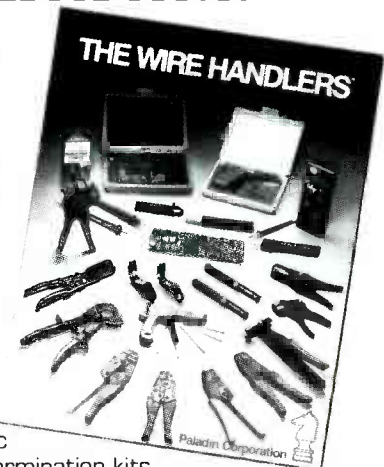

 **PALADIN CORPORATION**

Suite 106, 31332 Via Colinas, Westlake Village, CA 91362  
Call (213) 991-4970.

CIRCLE 93 ON FREE INFORMATION CARD



## HEADACHE SORTING HEX KEYS?

Cure it  
With Bondhex™  
Key Cases!

- Compact
- Self locking/quick release
- Easy to carry
- Oil resistant plastic
- Easy size identification
- Color coded yellow-inch red-metric



Cases available with:  
Balldriver™ or Chamfered L-Wrenches

WRITE OR PHONE FOR FREE INFORMATION



1400 East Broadway  
Monticello, MN 55362 U.S.A.  
Tels: 612/295-5500 800/328-8310  
TWX 910/578-1094

190 Highway 7 West Unit #8  
Brampton, Ontario L6V 1A1  
Tel: 416/453-7470  
Telex: 06-97856

CIRCLE 17 ON FREE INFORMATION CARD

# The Bearcat<sup>®</sup> 100. The first no crystal hand-held scanner.



Now you can have the one scanner you've always wanted—a no crystal, fully synthesized hand-held scanner. The incredible, Bearcat 100.

#### Push button programming.

The Bearcat 100 works just like the full size, no crystal Bearcat Scanners. Push button controls tune in all police calls, fire calls, weather warnings, and emergency information broadcasts, the split second they happen. Automatically.

#### All the features you want.

16 channels for storing frequencies. 8 band cover-

age—including high, low, UHF and "1" public service bands; both the 70 cm and 2 meter amateur bands; plus, for the first time ever, both the military and federal government land mobile bands. Both automatic and manual search, lockout, scan delay, direct channel access. Even a liquid crystal display. Flexible antenna, earphone, AC adapter/battery charger and carry case are included.

Your Bearcat Dealer wants to hand you an earful.

See your Bearcat Dealer now for a demonstration of the amazing Bearcat 100. Get complete information about the world's first hand-held, no crystal scanner.

SCAN's 30,000 members know what others miss! Insider news. Frequency info. Tech tips. Awards. SCAN Magazine ... and more! Send \$10 for 1-year membership to the Scanner Association of North America, 111 East Wacker Drive, Chicago, IL 60601.

# BEARCAT<sup>®</sup> SCANNERS

**Electra** Electra Company  
Division of Masco Corp. of Indiana  
300 East County Line Road  
Cumberland, Indiana 46229

© 1983 Masco Corp. of Indiana.

To find out more about where to buy the Bearcat 100 or other Bearcat Scanners, call 800-S-C-A-N-N-E-R toll free.

CIRCLE 5 ON FREE INFORMATION CARD

vert the signal on channel-B and can thus look at the difference of the two signals.

The third control-grouping contains a BNC input-jack for the trigger source or for the source of horizontal deflection. The source is selected by a 4-position pushbutton switch (A, B, EXT, or EXT + 10). Above the pushbuttons is the TIME/DIV control, which, like the AMPL/DIV control, consists of two knobs. The outer knob adjusts the sweep rate from 0.1 μs/div to 0.5 sec/div in a 1-2-5 sequence. As before, the center control allows you to continuously vary the sweep rate. The DEF. position of the TIME/DIV control allows you to use the scope in the horizontal-deflection mode. The horizontal deflection can be increased by a factor of ten by pulling out the horizontal channel's POSITION control.

Along the top of the third control-grouping is a 5-position pushbutton switch that selects the trigger mode and the polarity of the trigger. A LEVEL control lets you vary the level of the waveform on which the scope will trigger.

**Other features**

Located on the back panel is a BNC input for Z-axis (intensity) modulation. That allows you to feed a periodic signal to the control grid of the CRT, which will brighten or dim the trace and give a third, Z, dimension. Periodically brightened spots can be used as markers to time-

calibrate the main waveform. A signal that is applied to the external Z-axis input can also be used to cut off the CRT at selected parts of the trace (much like the retrace blanking signal that is fed to the Z amplifier).

The PM 3215 is very well documented. There are three manuals supplied—an operation manual, a service manual, and a manual for the attenuator probes. All of the manuals are very well written. The operating manual is 87 pages long and is written in three languages (about 25 pages for each). The operating manual includes a brief check-out procedure that is especially useful.

The service manual (written entirely in English) is over 100 pages long. It is comprehensive and includes full schematics, circuit descriptions, corrective-maintenance procedures, printed-circuit board layouts, parts lists, and more. In short, the manuals give you all the information that you need to operate and service the scope. However, if you do not wish to make your own repairs or adjustments, there is also a list of worldwide sales- and service-centers.

All in all, the PM 3215 is a high-quality 50-MHz dual-trace scope that would be a welcome addition to just about any benchtop. The suggested \$1195 list price is just about what you would expect to pay for such a professional piece of test equipment. R-E

**Vector P184-7 Slit-N-Wrap Tool**



CIRCLE 104 ON FREE INFORMATION CARD

Vector	P184-7										
OVERALL PRICE											
EASE OF USE											
INSTRUCTION MANUAL											
PRICE/VALUE											
	1	2	3	4	5	6	7	8	9	10	
	Poor			Fair				Good			Excellent

TWO MOTORIZED WIRE-WRAPPING TOOLS, the P184-7 (shown in photo above) and P180-7 Slit-N-Wrap tools from Vector (12460 Gladstone Avenue, P.O. Box 4336, Sylmar, CA 91342) represent a logical extension of their line of convenient and effective wire-wrapping tools. Of course, those two models make the same reliable connections as Vector's

**FIRST QUALITY COMPONENTS - NOT MAIL ORDER "SECONDS"**

Send for Free Catalog - over 1100 parts.

**ARIES ZERO INSERTION FORCE SOCKETS**



cam actuated, true zero insertion - tin plated solder plug pins - capable of being pulled into dip sockets, including wire wrap.

Stock No.	Pins	1-9	10-49	50
11055	24	4.98	\$4.35	\$3.90
11056	28	5.15	4.50	4.05
11057	40	6.81	5.95	5.35
11058	64	12.02	10.50	9.45

**IC-KOOLERS™ from UNITRACK™**

disipate over 2 watts of heat from IC's producing longer life and better performance. IC-Kooler on heat is collected from top and bottom of IC and dissipated. Won't shake loose!

Stock No.	No. Pins in IC	Price
22225	14	\$ .29
22226	16	.29
22227	18	.29
22228	20	.29

**WILD ROVER**

Touch switch capsule. Operating motion is 90° without the use of a levered arm. Extremely fast on and off with low noise. Normally operated 1.5 VAC, 1.8 amp-30 milliohm resistance. .515 radius by .160 thick.

Stock No.	1-9	10 & Up
12098	\$1.42	\$1.28

**DIGITAL MULTIMETER**

Single rotary switch operation. Large easy-to-read 5 1/2 digit display 800 hours operating life with single 9v battery. Seven functions—DC Volts, DC Amps, Ohms, AC Volts, AC Amps, Diode and Resistor Junction, Audible Continuity Check.

Stock No.	Carrying Case with belt loop	Price
62503	Yes	\$9.95

**TI WIRE WRAP SOCKETS**

Tin plated phosphor bronze contact - 3 wrap

Stock No.	No. Pins	1-99	100-499	500
11301	8	\$ .40	\$ .36	\$ .30
11302	14	.59	.54	.45
11303	16	.64	.58	.48
11304	18	.73	.66	.55
11305	20	.99	.90	.75
11306	22	1.12	1.02	.85
11307	24	1.25	1.14	.95
11308	28	1.52	1.38	1.15
11309	40	2.05	1.86	1.55

**TI LOW PROFILE SOCKETS**

Tin plated copper alloy 688 contact pins with gas tight seal.

Stock No.	No. Pins	1-24	25-99	100-999
11201	8	\$ .10	\$ .09	\$ .08
11202	14	.14	.13	.12
11203	16	.16	.15	.14
11204	18	.18	.17	.15
11205	20	.20	.18	.16
11206	22	.22	.20	.18
11207	24	.24	.22	.20
11208	28	.28	.26	.25
11209	40	.40	.37	.33

**60/40 ROSIN CORE SOLDER**

Stock No.	Dia. (mm)	Length (ft)	Weight (oz)	Price
50075	.062	9	1.5	\$1.16
50076	.062	25	4	2.39
50077	.062	50	8	4.25
50078	.032	33	1.5	1.31
50079	.032	88	4	2.47
50080	.032	175	8	4.57

**ELPAC POWER SUPPLIES - DC/DC CONVERTERS**

SINTEC Stock No.	ELPAC Part No.	Input Voltage (VDC)	Output Voltage (VDC)	Output Current (mA)	Dimensions (inches)	Price
13825	CB3801	3.0-7.0	12.0-6	0-25	48x51x3.05	5 7.95
13826	CB3811	3.0-7.0	-12.0-6	0-25	48x51x3.05	7 9.95
13827	CB3802	3.0-7.0	15.0-7	0-20	48x51x3.05	7 9.95
13828	CB3812	3.0-7.0	-15.0-7	0-20	48x51x3.05	7 9.95
13829	CB3804	3.0-7.0	28.0-7	0-10	48x51x3.05	7 9.95
13830	CB3814	3.0-7.0	-28.0-7	0-10	48x51x3.05	7 9.95
13831	CL3801	4.0-7.0	12.0-6	125	65x11.2x1.77	\$24.95
13832	CL3811	4.0-7.0	-12.0-6	125	65x11.2x1.77	24.95
13833	CL3802	4.0-7.0	15.0-7	100	65x11.2x1.77	24.95
13834	CL3812	4.0-7.0	-15.0-7	100	65x11.2x1.77	24.95
13835	CL3904	4.0-7.0	28.0-1.4	50	65x11.2x1.77	24.95
13836	CL3814	4.0-7.0	-28.0-1.4	50	65x11.2x1.77	24.95
13825-1	DATA SHEET FOR DC/DC CONVERTERS					

**ELPAC POWER SUPPLIES - SOLV SERIES FULLY REGULATED**

SINTEC Stock No.	ELPAC Part No.	Input Voltage	Output Voltage	Output Current	Dimensions (inches)	OVP	Price
13802	SOLV15-5	5	3.0A	4.7/18x4.2	Fixed included		\$39.95
13803	SOLV15-12	12	1.5A	4.7/18x4.2	Fixed included		39.95
13804	SOLV15-15	15	1.2A	4.7/18x4.2	Fixed included		39.95
13806	SOLV15-24	24	0.75A	4.7/18x4.2	Fixed included		39.95
13808	SOLV30-5	5	6.0A	5.0/8x4.7/8x3.1/8	OVP-A		59.95
13809	SOLV30-12	12	4.0A	5.0/8x4.7/8x3.1/8	OVP-A		59.95
13810	SOLV30-15	15	3.3A	5.0/8x4.7/8x3.1/8	OVP-A		59.95
13812	SOLV30-24	24	2.0A	5.0/8x4.7/8x3.1/8	OVP-A		59.95
13802-1	Data Sheet for SOLV Series						

**OK MACHINE AND TOOL**

**IC INSERTION/EXTRACTION KIT**  
Includes DIP IC extractors and inserters to accommodate all IC's from 14 to 40 pins. Tools that engage conductive surfaces are CMOS safe and include ground mg tips. Stock No. \$37.74 13309

**SOCKET WRAP ID**

DIP socket sized plastic panels with numbered holes in pin locations. Skip onto socket before wire wrapping to identify pins. Also write on them for location. IC part number, function, etc. Simplifies nut and wire wrapping. Trouble shooting and repair. \$1.82 per pack

**IC EXTRACTOR**

One-piece, spring steel construction. Will extract all LSI, MSI and SSL devices with 8 to 24 pins. Stock No. 13313 \$2.10

**Special of the Month!**

**HIGH PERFORMER II UHF-TV PREAMPLIFIER**  
Adds gain to UHF Reception  
59002 Kit \$37.50  
59003 Assembled Unit \$59.50  
For more detailed information call for catalog

**MODUTEC**

**Miniclamp AC Volt-Ammeter** allows singling one conductor out of many without disarrangement.  
Stock No. AC Amperes Price  
13730 0-25A \$39.50  
13731 0-50A 39.50  
13732 0-100A 39.50

**ACCESSORY LINE SPLITTER** allows fast readings of AC power consumption of plug in equipment without separation of leads.  
Stock No. 13727 \$9.95

**POCKET SIZED BATTERY TESTER** for all types of small batteries from 1.35v to 4.5v  
Stock No. 13733 \$13.95

**VOLT-ICATOR** automotive diagnostic meter plugs into lighter socket and indicates battery condition and charging rates.  
Stock No. 13736 \$15.95

**AC VOLTAGE TESTER** plugs into any 110v service receptacle to check line voltage over 50-150 VAC  
Stock No. 13735 \$14.95

**VOM-MULTITESTER** versatile Volt-Ohm-Milliammeter in small package  
Stock No. 13729 \$13.95

**SINTEC** Drawer Q Milford NJ 08848-9990 **TOLL 800-526-5960** **FREE** in NJ (201) 996-4093

CIRCLE 82 ON FREE INFORMATION CARD [www.americanradiohistory.com](http://www.americanradiohistory.com)

HITACHI

NLS Non-Linear Systems

HICKOK

WESTON

DATA PRECISION

KEITHLEY

AWS  
A.W. SPERRY  
INSTRUMENTS INC.

FLUKE

PHILIPS

BK PRECISION

VIZ RGA

TRIPLETT

Simpson

LEADER

# HITACHI A 30 MHz SCOPE AT A 15 MHz PRICE \$549<sup>95</sup>

## DUAL TRACE W/DELAY

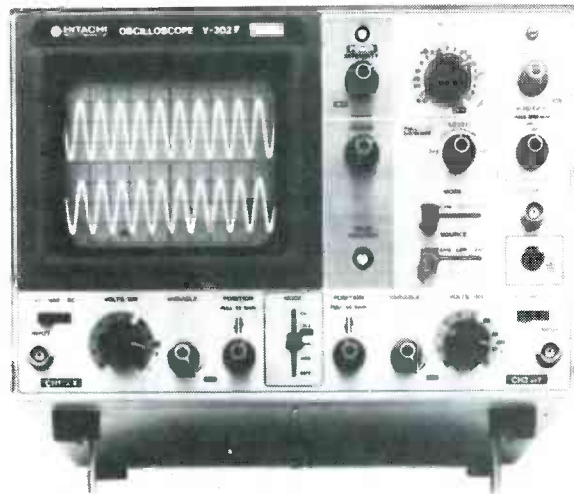

Price does not include probes.  
Probes \$50. a pair when purchased with  
scope. \$10. shipping within continental U.S.

**BK PRECISION** INDUSTRIAL TRANSISTOR TESTER

**\$199<sup>95</sup>**  
WAS \$249.

MODEL 520B

- Now with HI/LO Drive
- Works in-circuit when others won't
- Identifies all three transistor leads
- Random lead connection
- Audibly and visually indicates GOOD transistor

**BK PRECISION** POWER SUPPLIES

MODEL 1601

**\$299<sup>95</sup>**  
WAS \$359.

- Isolated 0-50VDC, continuously variable; 0-2A in four ranges
- Fully automatic shutdown, adjustable current limit
- Perfect for solid state servicing

MODEL 1650

**\$319<sup>95</sup>**  
WAS \$390.

- Functions as three separate supplies
- Exclusive tracking circuit
- Fixed output 5VDC, 5A
- Two 0 to 25VDC outputs at 0.5A
- Fully automatic, current-limited overload protection

All Hitachi Oscilloscopes feature 2 year parts and labor warranty.

## WE CARRY A FULL LINE OF HITACHI OSCILLOSCOPES

## CALL FOR OUR PRICES

### **BK PRECISION** FUNCTION GENERATORS

MODEL 3010 **\$179<sup>95</sup>**  
WAS \$229.

MODEL 3020 **\$319<sup>95</sup>**  
WAS \$394.

#### SWEEP FUNCTION MODEL 3020

- Four instruments in one package—sweep generator, function generator, pulse generator, tone-burst generator
- Covers 0.02Hz-2MHz
- 1000:1 tuning range
- Low-distortion high-accuracy outputs

MODEL 3010

- Sine, square and triangle output
- Variable and fixed TTL outputs
- 0-1 Hz to 1MHz in six ranges
- Push button range and function selection
- Typical sine wave distortion under 0.5% from 1 Hz to 100kHz

### **BK PRECISION** CAPACITANCE METERS

MODEL 830 **\$189<sup>95</sup>**  
WAS \$238.

- Automatically measures capacitance from 0.1pF to 200mF
- 0.1pF resolution
- 0.2% basic accuracy
- 3½ digit LCD display

MODEL 820 **\$159<sup>95</sup>**  
WAS \$192.

- Resolves to 0.1pF
- 4 digit easy-to-read LED display
- Fuse protected against charged capacitors
- Overrange indication

### **BECKMAN** DIGITAL MULTIMETERS

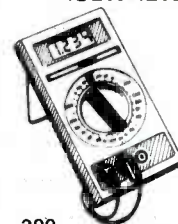

300 310 320  
330 350 360

ALL IN STOCK  
CALL FOR PRICES



TOLL FREE HOT LINE  
**800-223-0474**

## THE TEST EQUIPMENT SPECIALISTS

# ADVANCE ELECTRONICS

26 WEST 46th STREET, NEW YORK, N.Y. 10036 212-730-7030

other *Slit-N-Wrap* tools but they also have some desirable features that can be especially advantageous.

With the *P184-7* and *P180-7*, there will be no more over-wrapped or under-wrapped connections. You simply dial-in the desired number of wraps, and each time the trigger is squeezed, the tool delivers that pre-set number of turns and then stops! Anyone who does more than a minimum amount of wire-wrapping will really appreciate the value of an automatic turns-counter.

Before examining those tools farther, let's distinguish between them. The only difference between them is the type of wire that they use. The *P180-7* is set up for use

with 28-gauge copper wire coated with polyurethane and nylon insulation. That is the "standard" wrapping wire, which also may be soldered without stripping. The *P184-7* uses 28-gauge silver-plated copper wire with a Tefzel (Kynar and Teflon) insulation. The Tefzel is a bit thicker (.005 inches), but it takes the best features of its component parts, resulting in a tough insulation that helps to reduce crosstalk. Other than using different types of wire, both models are alike.

Certainly, *Slit-N-Wrap* is a well-known wire-wrapping technique. Using that method, it is unnecessary to strip the insulation from the wrapping wire before it is applied to the wire-wrap post. The

tool automatically slits the insulation as the wire is wrapped but the insulation remains intact between wraps. Thus, it is possible to wire from post-to-post (daisy-chain style) without cutting the wire and starting fresh at each one or having to worry about wires shorting to each other.

The amount of tension on the wrapping wire is very important. Too little tension will result in a poor electrical and mechanical connection. Too much tension can cause wire breakage and poor mechanical stability. Vector provides explicit and easily-followed instructions for properly setting the two adjustments which determine the tension on the wire as it is fed through the tool. Once those adjustments are made, the tension need be checked only occasionally. During our tests, the tension remained constant after the initial adjustment.

Setting the number of turns to be made is only a matter of setting a small dial on the top of the machine. For 28-gauge wire, 7 turns are recommended. Available settings range from 3 to 9 and  $\infty$ , which is a free-running mode that causes the tool to wrap continuously without counting or stopping—as long as the trigger is held. In addition, there is a small three-position toggle switch that engages or disengages the electronic counting-mechanism or disengages the trigger to prevent accidental turning when you are working on the tool.

Another convenient feature of the tools is that the free end of the first wrap need not be held—it is automatically secured. That provides a further advantage not only in convenience, but in speed as well.

So that you can keep track of the wiring in wire-wrapped circuits—it can get rather unwieldy at times—the insulated wire is available in different colors. At this time, four different wire colors are available with polyurethane-nylon insulation, while six colors are available with Tefzel insulation. The tools are designed to make changing the wire quite painless. Even changing the slitting-wrapping bit is easy, though with an anticipated life of 7,000 seven-turn wraps, the typical operator would not need to do that for some time.

During our testing of the *P184-7*, it was found to be fast and effective. Further, the pistol-like tool was balanced and shaped to reduce fatigue even when used for long periods of time.

The tools are packaged in complete kits. In addition to the wrapping tool, each contains an AC power supply, a large roll of wire, a cutting-format tool, and an adjustment tool. Also included are a weight for adjusting wire tension, a small supply of wrap posts, an Allen wrench and spare set-screws, and even a push pin that may come in handy when threading the wire. Of course, there is a thorough instruction booklet that covers not only the tool itself, but general wire-wrapping techniques.

## STUDIO SPEC™ MAGNIFIER LAMP

### AT \$59.95 YOU CAN'T AFFORD TO BE WITHOUT IT



ORDER NO. MX114

ORDER NO. LTS103

This quality all-metal construction UL recognized lamp uses a standard 22 W fluorescent circline bulb (the bulb is included!). Features of this great buy include a polished, distortion-free glass magnifier (X3); a 4-way, all metal clamp bracket; a full 45" reach. The lamp is available in two colors: Ivory or chocolate brown.

You must agree, it's a steal at only \$59.95 ea. (plus shipping). If you buy 5 or more, it's only \$54.95 (plus shipping). Order No. MX114.

Shipping is only \$5.00 ea. in the continental USA.

**SPECIAL BONUS!** If you buy one or more of the magnifier lamps, you can get our LTS103 bench lamp for only \$10.95 ea. (plus \$2.80 ea. shipping). The LTS103 is UL listed to 100 W, utilizes a porcelain socket, and includes mounting brackets.

**ORA**  
ELECTRONICS  
A DIVISION OF ALLIANCE RESEARCH CORPORATION

"OUR SERVICE MAKES THE DIFFERENCE"

18215 Parthenia Street, Northridge, CA 91325

To Order Call Toll Free  
**(800) 423-5336**

Calif. Toll Free  
**(800) 382-3663**

Local  
**(213) 701-5848**



QTY	ORDER NO.	COLOR	PRICE	SHIPPING	EXT
_____	85-MX114	_____	\$59.95*	\$5.00	_____
_____	85-LTS103	_____	10.95	2.80	_____
_____	85-MX115-FL	_____	5.95	2.00	_____
*Only \$54.95 for 5 or more				<b>TOTAL</b>	_____
Credit Card # _____				Exp. Date _____	
Name (Please print) _____					
Signature _____					

CIRCLE 37 ON FREE INFORMATION CARD



Altogether, the Vector P184-7 and P180-7, which sell for \$175 each, are well-designed, effective and well-package. Using either or both of these tools will provide increased efficiency and maximum assurance that the wraps are mechanically and electrically sound. The P180-7 and P184-7 are worthy additions to the *Slit-N-Wrap* line. R-E

### System Saver Protection Device for Apple II Computers



CIRCLE 105 ON FREE INFORMATION CARD

Kensington Microware System Saver														
OVERALL PRICE														
EASE OF USE														
INSTRUCTION MANUAL														
PRICE/VALUE														
		1	2	3	4	5	6	7	8	9	10			
		Poor		Fair			Good			Excellent				

A NUMBER OF TODAY'S SMALL COMPUTERS, such as the members of the *Apple II* family, do not use forced-air cooling. Because of their relatively low component count, and the fact that most of the IC's are the low-power Schottky type, they can get by with convection cooling through ventilation slots in the computer case.

The problem with the *Apples*, though, is that their seven or eight expansion slots encourage the addition of additional boards that contain additional heat-producing components. By the time you've added a disk-controller card, extra RAM, an 80-column display board, and I/O capabilities, it starts to get pretty warm inside the case.

Heat, as you are no doubt aware, is the enemy of electronics components. It shortens their lives and can frequently cause IC's to act erratically. (So *that's* why my disks got garbaged last night!)

Kensington Microware Ltd. (300 E. 54th St., New York, NY 10022) has come up with a solution to the "baked *Apple*" problem; it's called the *System Saver*.

#### The solution

The *System Saver* is really a very simple device. It attaches to the left side of the computer, over the ventilation slots there, and contains a fan that pulls 15-cubic-feet-per-minute of air through the

computer, across the area where the accessory boards are located. That flow of air carries away the heat generated by the boards and keeps the computer operating comfortably.

In operation, the fan is quiet enough to become completely unobtrusive after a little while, and the air exhausted is only mildly warm to the hand. What really matters is that the computer runs cool, and can be operated for extended periods without fear of overheating something inside and causing the system to crash.

The device offers several convenience features as well. At its rear are two three-prong electrical outlets rated at eight amps (total). They allow you to plug in your monitor and printer and, by throwing the rocker switch—which contains a pilot light, by the way—at the front of the unit, to turn those two pieces of equipment, and the computer, on all at the same time.

The *System Saver* provides another benefit in that it has a surge suppressor built in; voltage spikes that may appear on the power line are clipped off at a level of 130-volts RMS (175-volts DC). That will help keep glitches out of the system. You'll appreciate that, especially if you live in an area where spikes and surges are a way of life.

And, to put the icing on the cake, there is also a "pi"-type RF filter to prevent

*continued on page 38*

## SATELLITE TELEVISION SYSTEMS

VARIETY IS THE NORM, NOT THE EXCEPTION. Placed over the equator, by the U.S. and Canada, are 12 satellites carrying over 80 channels of TV programming. First run and classic movies, sports, specials, childrens shows and night club acts. Super stations from New York, Atlanta and Chicago. Adult films. Network broadcasts from ABC, CBS, NBC and PBS. Channels dedicated to health, medicine, science, religion, news, weather, financial information and live coverage of congress. Even video music in STEREO. There are channels dedicated to Pop/Rock and Country music. Yours with the push of a button and the twist of a knob on your TRITON satellite system.

ANTENNAS AS SMALL AS SIX FEET in diameter will deliver a picture that is quite watchable in most of the U.S. Some areas do require larger antennas to view all channels. TRITON carries complete systems to suit your individual need. Systems are available for ground or roof mounting with antennas constructed of aluminum, fiberglass or plastic. Optional equipment includes programmable antenna positioners, wireless remote control and stereo. Prices start as low as \$1395.00

INSTALLATION IS SIMPLE. Most people who purchase our systems do their own installations. You need no special tools or skills. Instructions, aiming coordinates and alignment instruments are provided with each system shipped. Just in case there is any part of the procedure not

perfectly clear, we have a technical staff standing by on our TOLL FREE line to answer any questions that you may have. What a great feeling !!! Watching satellite TV from a system YOU installed.

THE TIME TO ACT IS NOW. TRITON has all systems IN STOCK for immediate delivery. Shipping is done by motor freight and UPS, depending on size and weight. Our shipping staff is alert and efficient, assuring you quick, complete shipments at the lowest possible cost. Many systems can be shipped to you for less than \$100.00

DEALERSHIPS ARE WELCOME. We at TRITON would be pleased to discuss dealership opportunities with the established satellite dealer as well as those who are thinking about selling satellite equipment. National advertising, fast product delivery, lead generation and technical support are only a few reasons to choose TRITON as your satellite equipment distributor.

TO ORDER your TRITON satellite system, just phone. To make purchasing quick and simple we will accept MASTERCARD and VISA on all systems and accessories. Sorry, no charge cards on dealer sales. All systems and components carry a full one year warranty.

TRITON MARKETING Corp.  
679 REMSEN AVENUE  
BROOKLYN, N Y 11236

In NEW YORK  
212 345-8000  
Outside NY  
800 221-6535

CIRCLE 54 ON FREE INFORMATION CARD

# You gotta shop around.

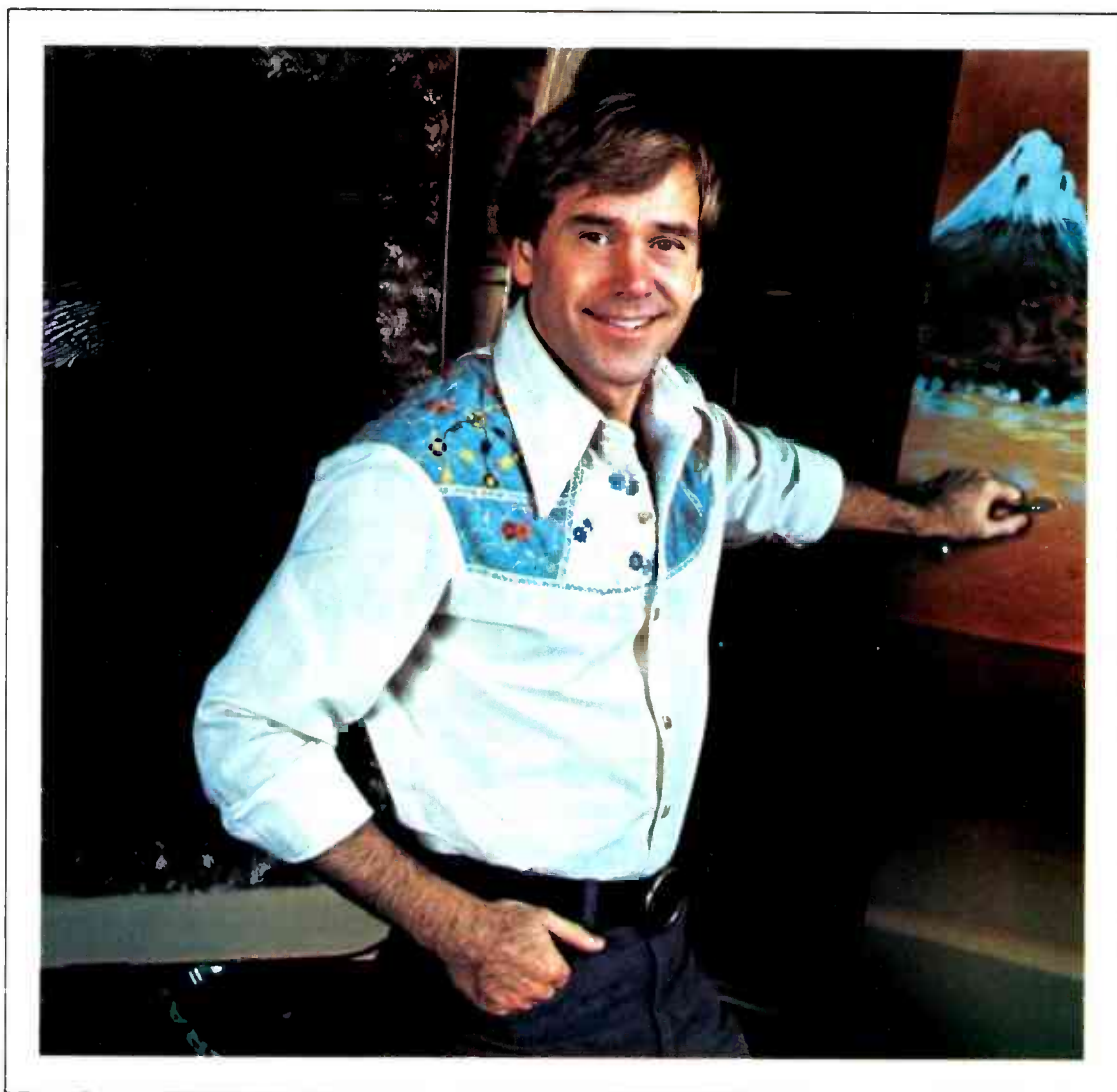

**When you do, you'll probably pick CIE.  
You can't afford to settle for  
less when it comes to something like  
electronics training that could  
affect your whole life.**

**W**hen you shop around for tires, you look for a bargain. After all, if it's the same brand, better price—why not save money?

Education's different. There's no such thing as "same brand." No two schools are alike. And, once you've made your choice, the training you get stays with you for the rest of your life.

So, shop around for your training. Not for the bargain. For the best. Thorough, professional training to help give you pride and confidence.

\* \* \*

If you talked to some of our graduates, chances are you'd find a lot of them shopped around for their training. They pretty much knew what was available. And they picked CIE as number one.

### Why you should shop around yourself.

We hope you'll shop around. Because, frankly, CIE isn't for everyone.

There are other options for the hobbyist. If you're the ambitious type—with serious career goals in electronics—take a close look at what we've planned for you at CIE.

### What you should look for first.

Part of what makes electronics so interesting is it's based on scientific discoveries—on ideas! So the first thing to look for is a program that starts with ideas and builds on them!

That's what happens with CIE's Auto-Programmed® Lessons. Each lesson takes one or two principles and helps you master them—before you start using them!

### How practical is the training?

This is the next big important question. After all, your career will be built on what you can do—and on how well you do it.

Here are ways some of CIE's troubleshooting programs help you get your "hands-on" training...

**With CIE's Personal Training Laboratory...**

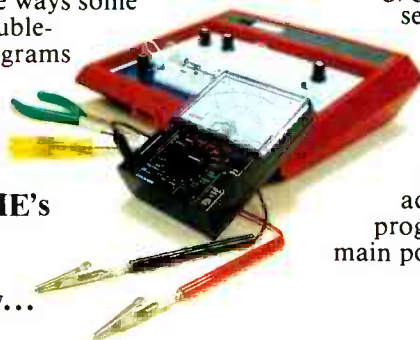

you learn and review the basics—perform dozens of experiments. Plus, you use a 3-in-1 precision Multimeter to learn testing, checking, analyzing!



**When you build your own 5 MHz Triggered-Sweep, Solid-State Oscilloscope** you take your first real professional step. You use it as a doctor uses an X-ray machine—to "read" waveform patterns... lock them in...study, understand and interpret them!

**When you get your Digital Learning Laboratory** you'll be into digital theory—essential training today for anyone



who wants to keep pace with the state of the art of electronics in the eighties. With CIE's Digital Lab, you'll be applying in dozens of fascinating ways the theory you've learned. For example, you'll compare analog and digital devices. You'll learn to make binary to decimal conversions and to work with semiconductor devices and circuits. You'll see how digital equipment is vital in today's exciting, growing fields such as security where digital theory provides the brains for space-age alarm and protective devices.

Of course, CIE offers even more advanced training programs, too. But the main point is simply this:

All this training takes effort. But you'll enjoy it. And it's a real plus for a troubleshooting career!

### Do you prepare for your FCC License?

Avoid regrets later. Check this out before you enroll in any program.

More than half of CIE's courses prepare you for the government-administered FCC License exam. In continuing surveys, nearly 4 out of 5 CIE graduates who take the exam get their Licenses!

### Associate Degree

Now, CIE offers an Associate in Applied Science Degree in Electronics Engineering Technology. In fact, all or most of every CIE Career Course is directly creditable towards the Associate Degree.

### Shop around...but send for CIE's free school catalog first!

Mail the card. If it's gone, cut out and mail the coupon. If you prefer to write, mention the name and date of this magazine. We'll send you a copy of CIE's FREE school catalog—plus a complete package of independent home study information! For your convenience, we'll try to have a representative contact you to answer your questions. Mail the card or coupon—or write:  
CIE, 1776 East 17th St.,  
Cleveland, OH 44114.

**CIE** Cleveland Institute of Electronics, Inc.

1776 East 17th Street, Cleveland, Ohio 44114

**YES...**I'm shopping around for the right kind of career training in electronics troubleshooting — and CIE sounds well worth looking into. Please send me my FREE CIE school catalog — including details about the Associate Degree program — plus my FREE package of home study information!

Print Name \_\_\_\_\_

Address \_\_\_\_\_ Apt. \_\_\_\_\_

City \_\_\_\_\_

State \_\_\_\_\_ Zip \_\_\_\_\_

Age \_\_\_\_\_ Phone \_\_\_\_\_ (area code)

Check box for G.I. Bill information:  
 Veteran  Active Duty

**Mail today!**

**RE-64**

## EQUIPMENT REPORTS

continued from page 33

electrical noise that may be present on the lines from getting into the computer. The filter is most effective from 600 kHz to 20 MHz, with an attenuation factor varying from 30 dB to 50 dB. Its effect is strongest at 2 MHz, which is close to the fundamental frequency of the computer's crystal clock.

### Installation and use

Setting up the *System Saver* is so simple that I'll quote the instructions here in full. My comments appear in parentheses.

1. Attach *System Saver* to your *Apple II* as shown. (A lip on the unit slips over the top of the side of the computer; the unit then just rests there.)
2. Disconnect your *Apple II* power cord. You won't need it any more. (But I'd hold onto it if I were you—you never know when it will come in handy.)
3. Plug the *System Saver's* short power cord into the back of your *Apple II*. Plug *System Saver's* long power cord into your wall outlet. IMPORTANT: Leave your *Apple* power switch permanently on. You'll never use it again.
4. Plug your monitor and printer in *System Saver's* rear outlets.
5. You're all set! *System Saver's*

front-mounted switch now controls your *System Saver*, *Apple II*, monitor, and printer.

That's all there is to it. The *System Saver* is in place and ready to protect your computer from heat, power surges, and line noise and, as far as I can tell, it does a good job of it. The *System Saver* is color matched to the *Apple II*, and can also be used with the *Apple Stand*, if you use one. \$89.95 buys a lot of protection. **R-E**

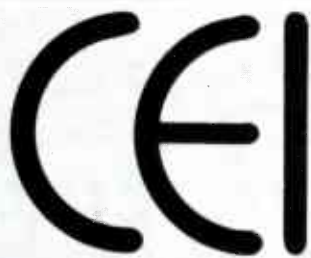

# The Technician's Choice

## YOUR COMPLETE ELECTRONIC PARTS SOURCE!

MOST ORDERS SHIPPED WITHIN 24 HOURS.  
CALL OR WRITE FOR YOUR FREE CATALOGUE.  
COMPARE OUR LOW PRICES AND SAVE!



## Consolidated Electronics, Incorporated

705 WATERVLLET AVE., DAYTON, OHIO 45420. TELEX NO. 288-229  
IN DAYTON, (513) 252-5662

CALL TOLL FREE TODAY! **1-800-543-3568** **1-800-762-3412**  
NATIONAL WATS OHIO WATS

CIRCLE 48 ON FREE INFORMATION CARD

## Soar Corporation 8050 Digital Multimeter



CIRCLE 106 ON FREE INFORMATION CARD

Soar	8050 DMM									
OVERALL PRICE										
EASE OF USE										
INSTRUCTION MANUAL										
PRICE/VALUE										
	1	2	3	4	5	6	7	8	9	10
	Poor		Fair		Good				Excellent	

THE NORTH AMERICAN SOAR CORPORATION (1126 Cornel Avenue, Cherry Hill, NJ 08002) is offering a digital multimeter, their model 8050, that has just about all the ranges and functions you'll ever need for almost any kind of electronic servicing.

Before we discuss its capabilities, let's look at its external features. The case is made of strong plastic that should be able to withstand some abuse. In the center of the front panel of the case is a single, recessed range-selector switch. The POWER switch is located at the upper left of the case—that's more convenient than having it included on the range selector. (I have more than once left my multimeter

continued on page 98

# NEW PRODUCTS

For more details use the free information card inside the back cover

**WAVEFORM ANALYZER**, model SC61, is the first instrument to automate completely every conventional scope measurement for the purpose of obtaining faster, more accurate waveform analysis than is possible with conventional scopes. The unit includes a digital readout on both channels for peak-to-peak



CIRCLE 131 ON FREE INFORMATION CARD

volts, DC volts, frequency, and time.

The automatic readout eliminates the time-consuming graticule counting and calculating for conventional scope measurements. That total automatic readout is an exclusive. All measurements are made through one probe, available on both channels, eliminating any extra time-consuming lead hookup. Peak-to-peak volts, TIME and 1/TIME are also featured for any waveform section using a variable bar called "DELTA MEASUREMENTS."

For a limited time, the model SC61 is priced at \$2995.00.—Sencore, Inc., 3200 Sencore Dr., Sioux Falls, SD 57107.

**MODEM ENHANCER**, the *turboMUX*, is designed for owners of 212A modems, and doubles the throughput of a 1200-baud modem. It provides two types of improvements: 2400-baud full-duplex throughput, and the operation of a 2-channel statistical multiplexor.

The *turboMUX* has 2 channels. It attaches via standard RS-232-C interfaces, to the



CIRCLE 132 ON FREE INFORMATION CARD

212A modem on one end, and to the data-terminal equipment on the other. When one channel is used, it accepts data at 2400 bits per second. As a multiplexor, each channel receives data at a minimum of 1200 baud and up to 2400 baud, for a total data throughput of 2400 bits per second. The *turboMUX* unit compacts the data for transmission over dial-up lines.

To double the 212A modem's throughput,

## CABLE TV Buy Direct & Save

### SUPER SPECIALS

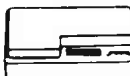

40 CHANNEL  
CONVERTER  
\$29<sup>95</sup>

Advanced Solid State design and circuitry allows you to receive mid & super band channels. Restores programming to Video Recorders.



36 CHANNEL  
REMOTE CONTROL  
CABLE CONVERTER  
\$69<sup>95</sup>

JERROLD 400  
THE ULTIMATE CABLE TV  
CONVERTER



60 CHANNEL  
INFRARED  
REMOTE  
CONTROL  
\$129<sup>95</sup>

Send \$5 for Complete Catalog

**DIRECT VIDEO SALES**  
P.O. BOX 1329  
JEFFERSONVILLE, INDIANA 47130  
CALL  
1-812-282-4766

CIRCLE 53 ON FREE INFORMATION CARD

## GET IBM-PC Capacity at a Fraction of IBM'S Price!

New NETRONICS 16 Bit EXPLORER 88-PC Kit  
Starts at Just \$399.95 - Accepts All IBM Peripherals.

It's true! Now you can enjoy the power of the Intel 8088—the same microprocessor which powers the IBM-PC—and run any program compiled for the IBM-PC...starting at only \$399.95!

Take this easy, low cost way to learn 16-bit technology! Two-board system features:

1. 8088 mother board with 5-slot expansion bus; accepts any hardware designed for IBM-PC; and
2. 64K memory board, expandable to 256K; with IBM compatible RS232 communications port.

Any disk-operating system which works on the IBM will work directly on the EXPLORER 88-PC, and all programs compiled for the IBM will run on it.

The system monitor ROM included in the Starter system features a user-friendly operating system that allows easy program generation and debugging. The commands include display/modify memory...display/modify registers...input/output data to I/O ports...block moves...single-step trace mode...go/run with optional breakpoint and register reports...cassette load/save with file labels...plus a complete system test program that tests and reports condition of ROM, RAM, cassette interface, timer, DMA controller, interrupt controller, and the communications port. These test programs not only allow easy debugging of software but they serve as hardware and software learning tools.

The EXPLORER 88-PC STARTER KIT includes a mother board, memory/I/O board, all components needed, sockets for IC's used, one 62-pin bus connector and complete assembly/test instructions. All you need is a soldering iron, solder, a power supply, and a standard RS232 terminal (Netronics has 2 low-cost ones to choose from). Explorer 88-PC Starter Kit...\$399.95

- + 10.00 p&i
- (wired & tested, add \$100.00)
- Extra 62-pin connectors at \$4.25 ea. + 1.00 p&i.

Use your own terminal with the EXPLORER 88-PC or, if you plan to expand it to be fully IBM compatible, we offer our IBM compatible keyboard and an IBM compatible color graphics board (only available wired and tested).

- IBM compatible keyboard...\$299.95 + 10.00 p&i.
- IBM compatible color board...\$299.95 + 10.00 p&i.
- Additional ROM required...\$35.00.

Set your own pace! Invest and learn, at the rate YOU want! Add to your EXPLORER 88-PC:

- Deluxe heavy-duty steel cabinet that houses either two 5 1/4" floppies or a 5 1/4" hard disk with one floppy. This cabinet features a brush-finish front panel and a wood-grained sleeve.
- EXPLORER 88-PC Cabinet...\$199.95 + 18.00 p&i.
- A heavy-duty open frame power supply with fan that can be used in your own cabinet or installed into the Netronics cabinet is available as follows:
  - 10 amp power supply for system + 2 floppies...\$149.95 + 8.00 p&i.
  - As above + extra power for 1 hard disk...\$169.95 + 8.00 p&i.
- IBM compatible disk controller board. Controls four 5 1/4" floppy drives (w/2 drive cable). Available wired and tested only...\$250.00 + 8.00 p&i.
- Monitors and BIOS source listings: available on either disk or hard copy at \$35.00.
- Please specify format and system required.
- INTEL 8086/8088 user manual...\$15.00 + 1.50 p&i.
- THE 8086 BODK by RECTOR & ALEX...\$16.00 + 1.50 p&i.

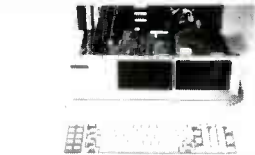

Special IBM compatible system: with keyboard, color graphics board, floppy disk controller, 64K RAM, cabinet, standard power supply and a single 5 1/4" floppy drive...\$1899.95 + 25.00 p&i.

IBM compatible hard disks, built-in modem board, eprom burner, print buffer system plus more will be available shortly.

Over 100 EXCLUSIVE Products and Kits—including the 'Speak Easy' universal voice synthesizer, a Diagnostic card with built-in logic probe for the IBM-PC, terminals, monitors, the ELF and EXPLORER 85 computers, and much more, are described in our upcoming catalog. It's yours FREE if you check here

For Canadian orders please double the amount of p&i shown. IBM-PC is a registered trademark of IBM Corporation.



"p&i" stands for "postage and insurance".

CALL TOLL FREE 1-800-243-7428 for Charge Card Orders.  
In Conn., call 203-354-9375. Conn. res. add sales tax.

TO ORDER BY MAIL, CHECK BOXES FOR PRODUCTS DESIRED AND MAIL ENTIRE AD 10:

**NETRONICS R&D LTD.**  
333 Litchfield Rd., New Milford, CT 06776

Amount enclosed      OR      Charge my  VISA       MASTERCARD  
Acct. No. \_\_\_\_\_ Exp. Date \_\_\_\_\_  
Signature \_\_\_\_\_  
PRINT NAME \_\_\_\_\_ City \_\_\_\_\_ State \_\_\_\_\_ Zip \_\_\_\_\_  
Address \_\_\_\_\_

# Digital Features.



# Analog Prices.

Now you can get all the measurement capability you've been looking for in a digital multimeter for the price of an analog.

Priced as low as \$59.95, the Circuitmate™ Series DMMs from Beckman offer a superior combination of standard features including:

- DC + AC Volts
- DC + AC Amps
- Resistance
- Diode Test
- 0.8% or 0.5% DC Accuracy (depending on model)
- Single Rotary Selection Switch

Depending on the model you choose—you can enjoy the added capability and convenience of 10 Amps AC + DC, audible continuity checking, hFE testing, capacitance and conductance capability.

Get your hands on a Circuitmate™ DMM today. For the dealer nearest you, write or call Beckman Instruments, Inc., Instrumentation Products, 2500 Harbor Blvd., Fullerton, CA 92634, (714) 993-8803.

## BECKMAN

the *turboMUX* unit uses a data-compaction algorithm. For phone-line inconsistencies, the *turboMUX* unit provides error detection and re-transmission facilities.

The *turboMUX* is priced at \$995.00. (At \$1,275.00, the *turboMUX* unit offers a 20-channel statistical multiplexor that can operate with the 212A modem.)—**Chung Telecommunications, Inc.**, 4046 Ben Lomond Dr., Palo Alto, CA 94306.

**TIME-INTERVAL OSCILLOSCOPE**, model 1726A, offers 50-picosecond accuracy and 10-picosecond resolution; it combines counter and oscilloscope technologies and has the viewing and measuring capabilities of a 275-MHz oscilloscope, and the ease of use of a time-interval counter.



CIRCLE 133 ON FREE INFORMATION CARD

The model 1726A uses a crystal-reference time base (i.e., the counter measurement technique) in conjunction with a CRT and stable triggering circuits (i.e., the oscilloscope measurement technique). The combination allows the model 1726A to display the signal being tested as well as measure the designated interval with up to 50-picosecond accuracy. The hybrid technology provides new measurement capabilities (e.g., first-pulse measurements) with a repeatability characteristic ( $\pm 30$  picoseconds) not offered by any other time-interval measurement instrument.

The model 1726A is priced at \$7675.00.—**Hewlett-Packard**, PO Box 2197, Colorado Springs, CO 80901.

**DC POWER SUPPLIES**, model 7400 (shown), model 7401, model 7402, and model 7403, all feature large, bright, 3-digit LED displays that indicate voltage or current. The output of each model is uniform. Ripple is held below 1 mA, line regulation is less than 5mV and 5mA, and load regulation is better than  $\pm 0.3\%$  on voltage and  $\pm 0.5\%$  on current. All models have constant voltage and constant current outputs. If the load current exceeds the established setting, the decimal point in the LED readout blinks and the unit stabilizes, i.e., the output current remains constant while the output voltage changes by whatever amount is necessary to accomplish that.

The model 7400 delivers 0 to 25V to 1.5A, and is priced at \$235.00. The model 7401 is 0 to 25V at 0 to 3A, while the model 7402 is 0 to 36V at 0 to 2A; both have the same price: \$275.00 each. The model 7403 is 0 to 36V at



CIRCLE 134 ON FREE INFORMATION CARD

0 to 3A, and is priced at \$325.00.—**North American Soar Corp.**, 1126 Cornell Ave., Cherry Hill, NJ 08002.

**BOARD**, the EPROM Programming Board, model EPB-MPF allows the user to program all single-supply (+5-volts) 1K/2K/4K EPROMS. Software stored in 2K bytes of on-board ROM gives the model EPB-MPF the capability to read, write, copy, test, and verify desired program code. The software also provides for restart, delete, and insert operations using 4K bytes of on-board static RAM as a buffer memory.

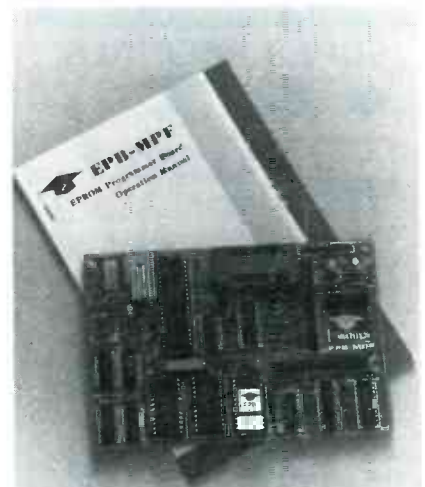

CIRCLE 135 ON FREE INFORMATION CARD

The model EPB-MPF's features include: 2K bytes of ROM, 4K bytes of RAM, 24 parallel I/O lines, 24 pin zero-insertion-force socket, 9-volt 400 MA power adaptor, complete accessories to hook up the model EPB-MPF, and a detailed operations manual.

The model EPB-MPF is priced at \$169.00.—**Etronix**, 14803 N.E. 40th Street, Redmond, WA 98052.

R-E

\*\*\*\*\*  
**2300 MHz VARIABLE DOWNCONVERTER**  
 \*\*\*\*\*

**ANTENNA KIT**

**\$1695**

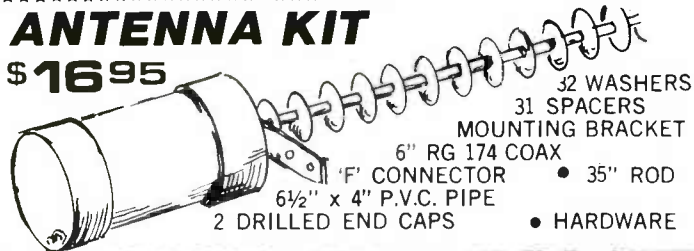

- 32 WASHERS
- 31 SPACERS
- MOUNTING BRACKET
- 6" RG 174 COAX
- 'F' CONNECTOR
- 6 1/2" x 4" P.V.C. PIPE
- 2 DRILLED END CAPS
- 35" ROD
- HARDWARE

**PARTS**

- Converter P.C. Board Plated through holes for stability.....\$4.95
- Power Supply
- P.C. Board .....2.95
- MRF 901 .....2.00
- NEO2135 .....4.95
- 2835 Diodes ..... .95
- .001 Chip Caps. .... 10/3.95
- Choke Set of 4.....1.95
- LM 317 Regulator 1.25
- 'F' Connectors
- Chassis ..... .50
- Wall Transformer
- 12 VAC 700 MA....4.95
- 'U' Bolt ..... .95
- BALUN
- 75 to 300 ohm.....1.95
- BALUN
- for rabbit ears...2.95
- \*RG 59/U COAX WITH CONNECTORS
- FACTORY MADE
- 100 Ft. ....\$17.50
- 50 Ft. .... 9.50
- 25 Ft. .... 5.75
- 3 Ft. .... 2.50

**CONVERTER KIT**

**\$1695**

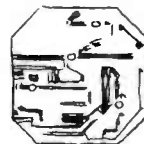

P.C. BOARD PRE-DRILLED SOLDER PLATED WITH PLATED THROUGH HOLES FOR A MORE STABLE PICTURE.

- NEW !!
- 2137 HOT TRANS.....
- 3 MRF 901 TRANSISTOR
- 2 HP 2835 Diodes
- 6 .001 Chip Caps.
- 9 Resistors
- 4 Prewound chokes
- 1 Electrolytic Cap.
- 1 Pre Made Probe



★ WIRED P.C. BOARD TESTED, READY TO CONNECT TO CAN WITH PROBE & CABLE CONNECTOR ATTACHED.  
**\$24.95**

**POWER SUPPLY KIT**

**\$1695**

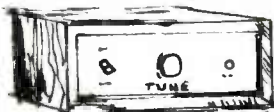

- POWER TRANSFORMER
- COURSE TUNE POT.
- FINE TUNE POT.
- 3 'F' CONNECTORS
- RESISTORS & CAPS
- LED WITH HOLDER
- TERMINAL STRIP
- P.C. BOARD
- RF CHOKE
- KNOB
- WIRE
- 2 SWITCHES
- 4 DIODES
- LM 317 REG.

WOOD GRAIN CABINET WITH SILK SCREENED front and back \$10.95 Extra  
 BUILT POWER SUPPLY.....\$34.95

Complete Down Converter System  
 INCLUDES ANTENNA KIT  
 POWER SUPPLY KIT  
 CONVERTER KIT  
**SPECIAL \$49.95**

**QUANTITY DISCOUNTS**  
 Any Price in Adv.

10 pcs.	12% off
25 pcs.	18% off
50 pcs.	25% off
100 pcs.	30% off
1000 pcs.	35% off

No Mixing for Quantity Discount

We will tune converter board for \$12.50  
 trouble shoot add .....7.50  
 trouble shoot power supply. \$12.50  
 plus any parts needed.

We will accept telephone orders for Visa & Mastercard  
 No C.O.D. Orders  
**To Order Call 800-428-3500 317-291-7262**  
 Complete Kit Weighs 70 pounds. Please add Sufficient Postage  
**6254 La Pas Trail**  
**Indianapolis, Indiana 46268**

**ELECTRONIC RAINBOW INC**

**SATELLITE TELEVISION RECEIVER**

**KITS**



*Rainbow makes a top-of-the-line Receiver affordable*

The Electronic Rainbow Receiver consists of a receiver with an external down-converter that mounts at the antenna, feeds the voltage to the LNA through the coax cable. The 4GHz signal is down converted to 70 MHz and is fed through the RG59/U coax to the receiver.

Rainbow Kits are supplied with simple step by step instructions. All the circuits that you need expensive test equipment to do are pre wired and tested. All printed circuit boards have the outline of each part printed on them.

**RECEIVER FEATURES**

Built in RF modulator • Detent Tuning-3.7 to 4.2 GHz • Variable Audio-5.5 to 7.5 MHz • Invert Video • Channel Scan • Voltage monitoring • Meter output • Remote Tuning  
**SPECIFICATIONS:**  
 Single Conversion Image Rejection Downconverter • Threshold 8 db CNR • IF Bandwidth 24MHz • Output IV Audio and Video • IF Frequency 70MHz • Video Bandwidth 4.5MHz • Size 3 1/2"Hx8 1/2"Dx11 1/4"W

**Complete Satellite TV Receiver**

**KIT #1 — Contains:**  
 • Mainboard • Tuning Board • Down-converter Board • Modulator Board  
 • All parts needed to complete receiver  
 • Down Converter built in case.  
 • Cabinet, attractive black brushed anodized metal with silk screened front and back for a professional look  
 • 70 MHz Filter is pre-wired and tested.  
 • Complete instruction Manual.  
**\$395.00**

**KIT #2 — Board Kit Contains:**

• Main Board • Tuning Board • Down-converter board • Modulator Board  
 • Parts List, assembly and alignment manual  
 • 4GHz local oscillator and 70MHz filter is pre-wired and tested. **\$129.00**

Instruction manual. Contains printed circuit board layouts, parts placement, and alignment instructions. **\$25.00**

*Ask about guaranteed to play*

We will accept telephone orders for Visa & Mastercard  
 No C.O.D. Orders  
**To Order Call 800-428-3500 317-291-7262**  
 Complete Kit Weighs 10 pounds. Please add Sufficient Postage  
**6254 La Pas Trail**  
**Indianapolis, Indiana 46268**

**ELECTRONIC RAINBOW INC**

JULY 1983

# A bench full of dragons and no relief?



Send in old reliable Keithley 179A. It could help you save the game. Get the high-performance accuracy you need today, and field-installable IEEE-488 compatibility you'll need soon. Our oversize LED is easier to read. And non-sinusoidal waveforms won't throw you a curve with our TRMS. Here's your workhorse Portable/Bench DMM at a price that won't strike out your budget. Keithley DMMs and Thermometers. **The Dragon Slayers.**

- 179A Features**
- Five full functions
  - 10 $\mu$ V sensitivity
  - 20A capability
  - 0.04% DCV accuracy
  - HI-LO  $\Omega$
  - Field-installable battery pack
  - Field-installable IEEE-488 Interface
  - \$379
  - Price U.S.A. only.

# KEITHLEY

Write Tom Hayden for your free, frameable 9 x 12" dragon poster. Keithley Instruments, Inc., 28775 Aurora Road, Cleveland, Ohio 44139. Phone 216-248-0400. Telex: 98-5469.

CIRCLE 36 ON FREE INFORMATION CARD



# ALL ABOUT

## AUTOMOTIVE

# NAVIGATION

IF YOU WATCH ANY "SCIENCE FICTION," EITHER ON TV or at the movies, you have a pretty good idea of what's Hollywood's concept of the car of the future—a sleek sports model with enough computer screens and controls to make even a Boeing 767 cockpit look like a child's toy.

But researchers are hard at work trying to separate the science from the fiction. A Sunnyvale, California inventor and a major Japanese automobile-manufacturer—in independent efforts—are bringing us closer to the day when you can equip your car with an automotive navigation-computer to guide you

## SYSTEMS

*Computers are finding more and more applications in the car, and soon one will even be able to tell you where you are and where you are going. Here's a look at the automobile navigation-systems of the not-too-distant future.*

DANNY GOODMAN



through unfamiliar territory. We are not talking about the Mercedes-Benz system that you might have read about; that system relies on communication between your car and central traffic computers and requires roadbed cables and sensors. The navigation systems we'll be looking at consist of self-contained computers and sophisticated optics systems that will, among other things, eliminate the folded mess of roadmaps in your glove compartment.

### Ready applications

If you frequently travel on business, you've probably arrived in a new or unfamiliar city armed with little knowledge about it other than the address of the company you're there to visit. Arriving at the car rental counter, you first ask for an area map that, to your dismay, features only a sketch of the main roads. Asking the agent behind the counter draws a blank as to the location of the company or the small industrial-park street on which it is located.

With a navigation system designed into every car in the agency's fleet, however, the agent could preprogram a small film pack that will display a map on the car's video screen; that map will show both your present location and the location of your appointment. When you're done with the business call, the computer could show you how to get to your next appointment, or perhaps a local restaurant or your hotel.

Preprogramming routes on a map could save time and money for trucking companies and local delivery services. The most efficient routes for each driver could be defined by the company's loading-dock computer based on the listing of deliveries to be made that day. Then each driver could plug his route module into the truck's computer and follow the directions. The same on-board computer could also be used to determine each driver's fuel efficiency and monitor how closely the driver follows the prescribed schedule. A long-haul trucking company could use the same computer-encoded film pack in an office version of the navigation computer to determine the best route for a potential customer, and then quote a price based on actual operating costs that will be incurred over the route.

The system should also prove quite helpful in your family car. Trouble with one-way streets or tricky expressway entrances would be a thing of the past as the computer could help you pinpoint those easily. And cross-country drives would be much more fun since the computer would be able to call up detailed maps of cities and towns for those impromptu side trips. Moreover, you'll never really be "lost" because the computer keeps constant track of where you are and what direction you're going: just check the screen map for your location in relation to some distant landmark.



FIG. 1—A TOUCH-SENSITIVE flat-panel screen displays a full-color area map that shows your location and destination

### The Navigator

Perhaps the most sophisticated system is being developed by Michael J. Alton and his company, Omni Devices, Inc. (845 Roble Dr., Sunnysvale, CA 94086). Although the system, called *The Navigator*, looks like something out of the 21st century, it is revolutionary only in the sense that it combines existing technologies—fiber optics and computers—in a new application. The result is a touch-sensitive flat-panel screen that displays a full-color area map indicating your location and destination (see Fig. 1). As you move toward the destination, your position on the map changes, and the screen zooms tighter on the map, producing increased detail over a smaller area.

Figure 2 shows how the *The Navigator* works. The light source consists of multiple bulbs, reflectors (to intensify the light in one direction), and color filters (explained later). Using many small bulbs instead of a single, high-intensity bulb helps disperse heat better. A single bulb would probably require space- and power-consuming forced-air cooling. The multiple light-sources are blended into a single projection beam using the coalescing fibers.

Next, the light passes through a condensing lens, followed by an LCD matrix that is under control of the computer. The matrix is where variable images—your location, destination, alphanumeric readouts, etc.—are added. Just as the electronically activated display-segments in an LCD watch block light from traveling to the reflective silver-gray back plate, images created and positioned by the computer in the LCD matrix of picture elements (pixels) will block light from passing any farther—thus making a shadow appear on the display screen. The prototype system uses a  $32 \times 32$  pixel matrix, but the projected resolution for the production version is  $128 \times 128$  pixels.

The film contained in the film cartridge plays a multiple role in the system. In addition to its obvious purpose of providing the map images that appear on the dashboard screen, the film is also contains the software that tells the computer

all about the area you're traveling through.

Map images are about the size of a 35-mm negative, and a single cartridge can hold as many as 400 separate map frames—enough to cover quite a large section of the U.S. for long-distance travel. But some frames contain solid "pages" of computer data (we'll see in a moment how the computer reads the data). The data frames hold not only "raw" data like street names and number ranges or hotel and restaurant locations, but also data the computer needs to follow a given street on the map: where the street starts, what color it is on the map, its direction of travel, length, etc. That data is important because in locating a precise address on a map, the computer essentially "walks up" the street. Text-like data (streets, hotels, etc.) would be converted to LCD matrix characters for display on the dashboard screen. Other coded data including data addresses (that is, where on the film other related data can be found) are implanted on the map's "black areas;" those areas include streets, boundaries, and frame edges. A film cartridge reportedly has space for six gigabytes of information.

To achieve the affect of zooming in on an increasingly smaller area as you approach your destination, the system uses motorized lenses in a sliding bellows-type arrangement. Each map will offer between four and eight different levels of magnification.

After it passes through the lenses, the map image passes through a beam splitter. A small portion of the light is passed straight through, via resolution-intensifying fibers, to film-reading sensors capable of handling a minimum resolution of one thousand lines per inch; those sensors are connected to the computer. The computer correlates what its sensors "see" with the previously obtained computer data to further reposition the zoom lens and variable objects on the LCD matrix. The computer "looks" for color images on the map to help it track exact locations. Instead of using expensive color sensors, the computer controls rapid sequencing of the multiple bulbs at the light source through their respective color filters. Thus, simple sensors in sync with the light-source bulbs can detect which color is being passed at any point on the map.

The majority of the map image light is reflected up through projection fibers in such a way that the screen image is divided into small pieces like a checkerboard. The fiber bundles are attached to a lens plate which in turn projects the segments onto a plastic display screen. The prototype 8-inch-square screen consists of 64 one-inch square segments. That flat-screen projection system is much more space efficient and safer in an accident than the traditional, long-necked cathode-ray tube (CRT) display.

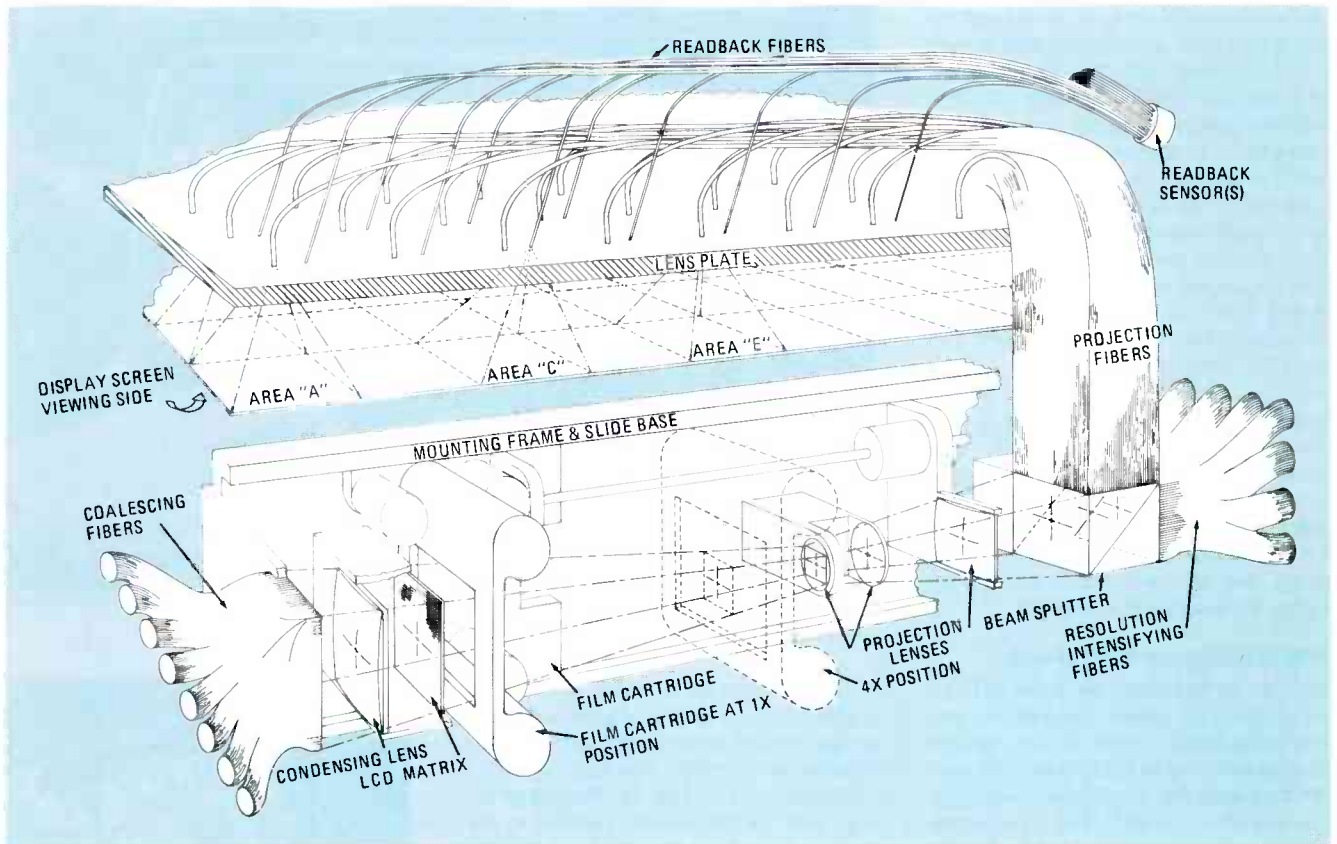

FIG. 2—INNER STRUCTURE of *The Navigator*. In the more recent version, the sliding film-cartridge has been replaced by a sliding bellows-type zoom-lens system.

Another feature of the display assembly is that readback sensors allow the screen to become touch-sensitive. When used in conjunction with screen menus (see Fig. 3), the sensors eliminate the need for a keyboard in an already crowded dashboard.

The prototype computer that controls all of that is currently designed around three Z80 8-bit microprocessors. It is anticipated that before production models become available, the computer will be based on 16-bit microprocessors such as the 8086 or 68000. In any case, multiple microprocessors will be the rule for the sake of redundancy: in case of one's failure, another can step in to keep the system operational.

### Intelligent software

Most of the inner workings we've discussed will be completely invisible to the operator. Intelligent software is the key to making *The Navigator* easy to use without any computer knowledge—and perhaps without any knowledge of what *The Navigator* is.

As already mentioned, operator input will be done using screen menus. When it comes to trying to fool the computer by asking for an intersection of two streets that don't meet or an address out of the range of the actual street, the computer will pre-check the commands and alert the operator that those entries are not legitimate and perhaps that a slip of the



FIG. 3—WITH *THE NAVIGATOR*, no additional controls need to be added to an already crowded dashboard. The touch-sensitive screen allows you to select functions, modes, and more by simply touching the display.

finger has occurred. Of course, while the computer can check map data for whether an address falls within a legitimate range, it won't be able to tell you if the location is a clothing store or an empty lot.

### A typical trip

To see how intelligent the software is, let's take a hypothetical trip in a rental car that is equipped with *The Navigator* of the future.

You've just picked up the keys and an area-map cartridge from the rental counter and are ready to leave the parking stall. You start the car, plug in the film pack, and the screen lights up and displays a

menu. By placing your finger on the screen, you select the menu item that asks for your destination's address. The screen changes to a scrolling alphabetical list of street names contained on the map. A command line at the bottom of the screen—also touch operated—offers fast, slow, and stop scrolling options. Finding the street name, you stop the scroll and touch the screen beside the street name. Next the screen fills with the numbers zero through nine, which you press to input the address digits. The numbers appear at the bottom command line along with the street name, and stays there throughout the trip.

Since your present location is already preprogrammed, the computer plots the destination on the map and adjusts the amount of lens zoom required to be able to display both the present location and destination. Then the map appears on the screen. Your location is designated by a black arrow pointed in the direction that the car is facing, and the destination appears as a square.

At this point, you'll have a choice of two routing methods. With the aid of the map on the screen, you can determine your route as you would with an ordinary paper map by spotting the major roads or highways to get you across town. Or, with the help of the computer, you can trace a route on the touch-sensitive screen map with your finger. Then, if you deviate from the prescribed route, by taking a wrong turn for example, the computer will alert you to it.

Your estimated time of arrival and the distance to your destination also appear on the command line. As you head out, the computer obtains readings from a magnetic compass and the speedometer; it uses those to update the display every couple of seconds. If you're not sure how to get out of the complex maze of roads that surrounds most major airports, with a touch, you can make the computer zoom in on the airport and show enough detail for you to see where you're going.

Traveling through area roadways, you won't be tempted to watch the display rather than the road because the screen blacks out. Display on/off time will be a function of speed. After all, you shouldn't be studying a video map while racing down a freeway at 60 mph (indeed most states outlaw installing a television in a car so that it can be viewed by the driver). But if you come to a stop, the display automatically reappears.

### Programming considerations

As can be imagined, the most difficult part of making a system like *The Navigator* commercially viable is the creation and programming of the film cartridges—it is expected that those will eventually cost consumers roughly \$30 for a metropolitan area. Naturally, sophisticated computers will play a large part in getting the job done.

Two techniques could be used to generate the maps. One would be to simply photograph high-detail conventional maps. The other is to generate the maps using computer graphics. The maps could then be drawn by a graphics plotter and photographed as before. New technology, however, may allow the cost-effective use of high-resolution computer-graphics-to-film conversion. Computers will also be needed to generate the data that is to be implanted in the black areas, as well as to bring together all of the map's detailed information for inclusion on the data-only frames.

Software for the on-board computer may be designed to be compatible with CP/M or other popular operating systems. The advantage to that is that a vehicle owner could preprogram a route into a cartridge on a home or portable computer the night before.

*The Navigator's* developer predicts that it could be offered as optional equipment on U.S. automobiles in about five years, at an estimated cost of about \$1000. It is likely that the most interest in such a device will be shown by the commercial transportation companies, which will benefit from routing and other economies offered by system.

### Honda's system

In Japan, the Honda Motor Company is already offering a simpler navigation device, called the *Electro Gyro-Cator*, on a limited basis.



FIG. 4—IN THE *ELECTRO GYRO-CATOR* from Honda, the maps are on overlays that slip over a display that sits on top of the dashboard.

In their system, a small control and display unit sits atop the dashboard. Maps in this system come in the form of color translucent overlays that slip in over a video display (see Fig. 4). At the start of a trip, you use the console controls to maneuver a screen cursor (a "+" symbol) to the place on the map that corresponds to your position and the direction you're facing.

Then, as your travel, a trip sensor (a magnetic detection system) measures the frequency of tire rotation. At the same time, a directional sensor (shown in Fig. 5) that contains a self-calibrating gyroscope detects any turns off the original course. A small navigational computer (see Fig. 6) processes the data and generates the video display. The computer traces a video line that highlights the path you've taken on the map overlay. Therefore, you'll have a display of where you are on the map and how you got there. If traffic is at a standstill, you can check the detailed map overlay for an alternate route. As with *The Navigator*, the *Electro Gyro-Cator's* 5- × 6-inch display stays off until the car comes to a stop. A passenger, however, can keep the display on at all times if so desired.

Overlays are produced in varying



FIG. 5—THE DIRECTIONAL SENSOR contains a self-calibrating gyroscope. Its purpose is to advise the computer of any changes in direction.

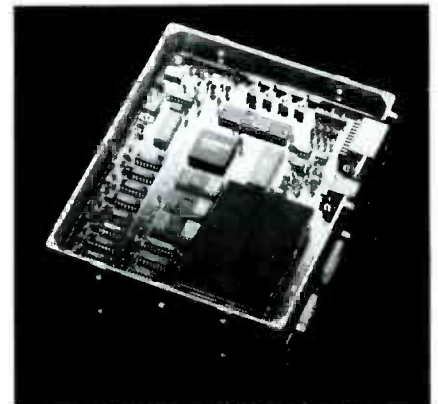

FIG. 6—THE NAVIGATIONAL COMPUTER processes data from the sensors and generates the video display.

scales and are coordinated with adjustable scales on the display screen. You can also map out paths on overlays with a grease pencil to assist in maneuvering through new territory. Cost for the *Electro Gyro-Cator*, including installation by Honda, is around \$1100, but the system is presently not available in the United States.

Compared to *The Navigator's* built-in map-generation technique, Honda's overlays seem cumbersome, especially when they may need to be changed in the middle of a trip. But both systems point toward increased use of computers in automobiles of the future, and even if their introduction here is five years or so away, it is an indication of how far and how fast consumer applications of computer technology have come. Concepts that were considered to be too complex for 20th-century development will likely be realized even before the end of the 1980's. Considering that, one must wonder what the next decade, and the next century will bring. It might even leave those in Hollywood breathless. R-E

# BUILD THIS

# EXPAND

## Your

# TIMEX/SINCLAIR Operating System



*Build this upgrade for your Timex/Sinclair 1000 and you'll be able to store your own system-software modifications in 8K of nonvolatile RAM.*

DESPITE ITS LIMITATIONS, THE TIMEX/Sinclair 1000 microcomputer (previously sold as the Sinclair ZX81) is a remarkable machine. It comes complete with an operating system and BASIC interpreter in 8K of ROM; 2K of RAM (the ZX81 came equipped with only 1K); an RF modulator for black-and-white video output to any TV, and a cassette interface for program and data storage. Perhaps the most remarkable thing about the machine, however, is its \$99.95 price, which is often discounted to as low as \$70, and may drop even lower in the coming months.

If you own a Timex/Sinclair 1000, you have probably wondered whether it can be improved. Well, it can. This article describes one upgrade that you can build for your machine—an 8K CMOS RAM board with battery backup. The board can be used simply to expand the computer's system/user memory, or—a more useful

application—the board can be used to store machine-language subroutines and, in effect, expand the operating system of the computer.

The 8K RAM board is designed to be used with the Timex/Sinclair 1000 computer and a 16K RAM pack to form a 32K system (8K of ROM, 16K of RAM, and 8K of battery-backed-up nonvolatile memory—see the memory map of Fig 1). In that 32K system, the memory board would occupy the 8K block from 8K to 16K. That area of memory is a very convenient location to store your own system-software modifications and machine-language subroutines because it is transparent to the computer's operating system. That means that the memory is not affected by NEW, LOAD, or other such commands that would normally clear the contents of memory. Even resetting the computer (turning it off and then on) will not affect the memory.

PAUL W.W. HUNTER

The CMOS RAM board that we will describe requires very little power, so it can use the computer's +5-volt regulated supply. Also, the board requires very little drive, so it is unnecessary to buffer the Z80's data, address, and control lines.

### Possible applications

What can you store in an 8K block of memory that is transparent to the computer's operating system? The list is almost endless, but we'll give you some examples.

The Timex/Sinclair BASIC, although

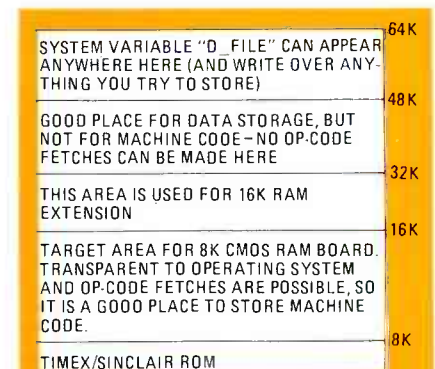

FIG. 1—MEMORY MAP OF the Timex/Sinclair 1000. The RAM board ignores address line A15, so additional decoding is necessary if you want the CMOS RAM to reside at a block of addresses above 32K.

powerful (especially for its 8K size), does not have READ or DATA commands. However, machine-code routines can be written to simulate those commands, and then those routines can be stored in the nonvolatile memory and called (by a user statement) when needed. That procedure thereby expands the operating system of the computer.

Other examples of user-defined system-routines that might be stored in the 8K-16K block are: line renumbering, resequencing, copying, and other editing routines; custom mathematical or statistical functions; routines to enter, examine, and edit machine-language programs; a machine-language disassembly program; a checksum routine; decimal/hex/octal conversion routines; other new BASIC commands; Sinclair code/ASCII conversion-tables, etc.

Once you have your software well established, the memory IC's can be replaced by pin-compatible 2716 or 2732 EPROM's. Thus you can even make up your own "game cartridges" that load almost instantly!

### The expansion port

Before we discuss the expansion board any farther, we will take a look at the port to which it will be connected. That port, which is located at the back of the computer, provides access to all of the lines from the computer's Z80 microprocessor. The lines that are available are listed in Table 1, and the port's pinout is shown in Fig. 2.

Peripheral modules like the Timex/Sinclair 16K RAM pack—as well as the

Description	Signal	Function
Address bus	A0 - A15	Outputs memory-and I/O-device addresses
Data bus	D0 - D7	Transmits bidirectional data into/out of CPU
System control	MREQ	Identifies any memory-access in progress
	IORQ	Identifies any I/O operation in progress
	RD	Indicates that the CPU wants to read data
	WR	Indicates that the CPU wants to output (write) data
	MI	Identifies the op-code fetch cycle of instruction Also used with IORQ to acknowledge interrupt
System clock	RFSH	Synchronizes dynamic-memory refresh
	$\phi$	3.25 MHz clock (output)
CPU control	RESET	Resets CPU when pulled low
	INT	Interrupt request input
	NMI	Interrupt request input; cannot be disabled
	WAIT	Indicates wait state in machine cycle
Bus control	HALT	Indicates CPU has executed a HALT instruction
	BUSRQ	Request to CPU for control
RAM/ROM select	BUSAK	Acknowledgement of release of control by CPU
	RAMCS	If pulled high will disable computer's on board RAM
Power	ROMCS	If pulled high will disable computer's ROM
	+9V	Unregulated
	+5V	Regulated
	GROUND	

wide variety of other plug-in units that are available from various manufacturers—plug in at the port, as does the CMOS RAM board. A "piggyback" connector is included, which allows you to plug the memory board into the computer, and then plug other peripherals into the computer via the board.

The signals that are available at the expansion port are predominantly the Z80 CPU signals. Two additional signals provided are RAMCS and ROMCS—the chip-select signals for the onboard RAM and the system ROM. Having those lines available allows the user to disable the internal memory by tying the appropriate chip-select signal to +5-volts.

Unfortunately, the connector that is required for connection to the port is a non-standard, 46-position (23 per side) card-edge connector with 0.1-inch spacing. However, that really isn't as bad as it sounds because the connector can be fabricated easily enough by cutting the ends off a standard 50-position card-edge connector with 0.1-inch spacing. (The connector for the computer must have open ends.) A key should be inserted in the third position to prevent anything from being inserted backwards.

### The CMOS RAM board

As we said earlier, the board is designed to occupy the 8K block of memory from 8K-16K. However, it can be easily "programmed" to occupy other 8K blocks, simply by changing jumper positions. (We'll get to the particulars of that in a little while.) Of course, you would probably not want the memory to occupy the first 8K block (where the computer's operating system is contained), but it could even do that if you wanted it to. The board could equally well, for example, replace half of the 16K RAM pack.

The schematic of the memory expansion is shown in Fig. 3. The Z80 MREQ control signal is used to enable the first half of the 74LS139 dual 1-of-4 decoder (IC5-a), which is used to divide the 32K of memory into four 8K blocks. The particular 8K block that the memory board will occupy is then selected by a jumper (JU1). (We will discuss how to position JU1 as well as all of the other jumpers in a following section.) The second half of that 74LS139 decoder (IC5-b) is used to provide chip-select signals for the 6116P 2K RAM's. The Z80 RD signal is used to enable the outputs of the memory IC's.

The Hitachi MH6116P (standard or 6116LP-3 low-power version) static CMOS RAM can be left in a standby mode when the computer is not in operation. That is done by backing-up the power supply with a lithium battery as shown in Fig 3. With such a back-up, the data stored in the RAM becomes non-volatile. (There is also a provision on the board for an external battery supply other than the lithium cell.) The 6116P data sheet specifies that for low-power standby, the chip-enable pin should be held at a voltage at least equal to  $V_{cc} - 0.2$  volt. Simple NPN-transistor switches (Q2-Q5) allow passage of the  $\overline{cs}$  signal when the power supply is connected, but pull the chip-enable pins to  $V_{cc}$  through resistors R2-R5 when the main power supply is not present. Transistor Q1 acts as a voltage-sensitive switch—it switches off when power from the main supply is not present which, in turn, switches off transistors Q2-Q5.

The RAM does not require a full +5-volt supply in standby mode, and a lithium cell (3 volts, 150 mAh) works well. The current drain for a fully populated board is less than one microamp. That means that a single lithium cell

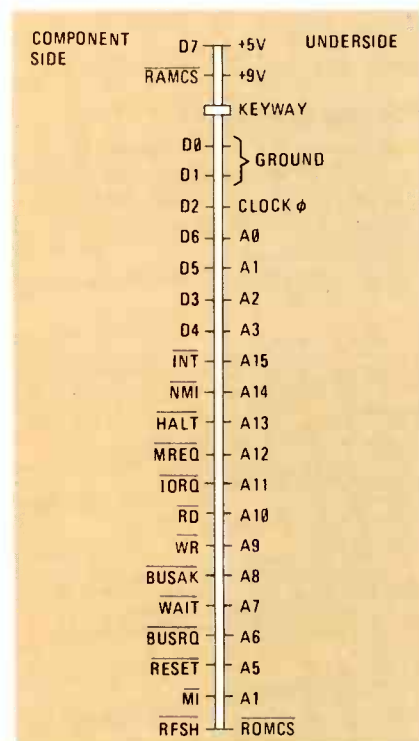

FIG. 2—THE PINOUT of the Timex/Sinclair 1000 card edge that is available at the port at the back of the computer.

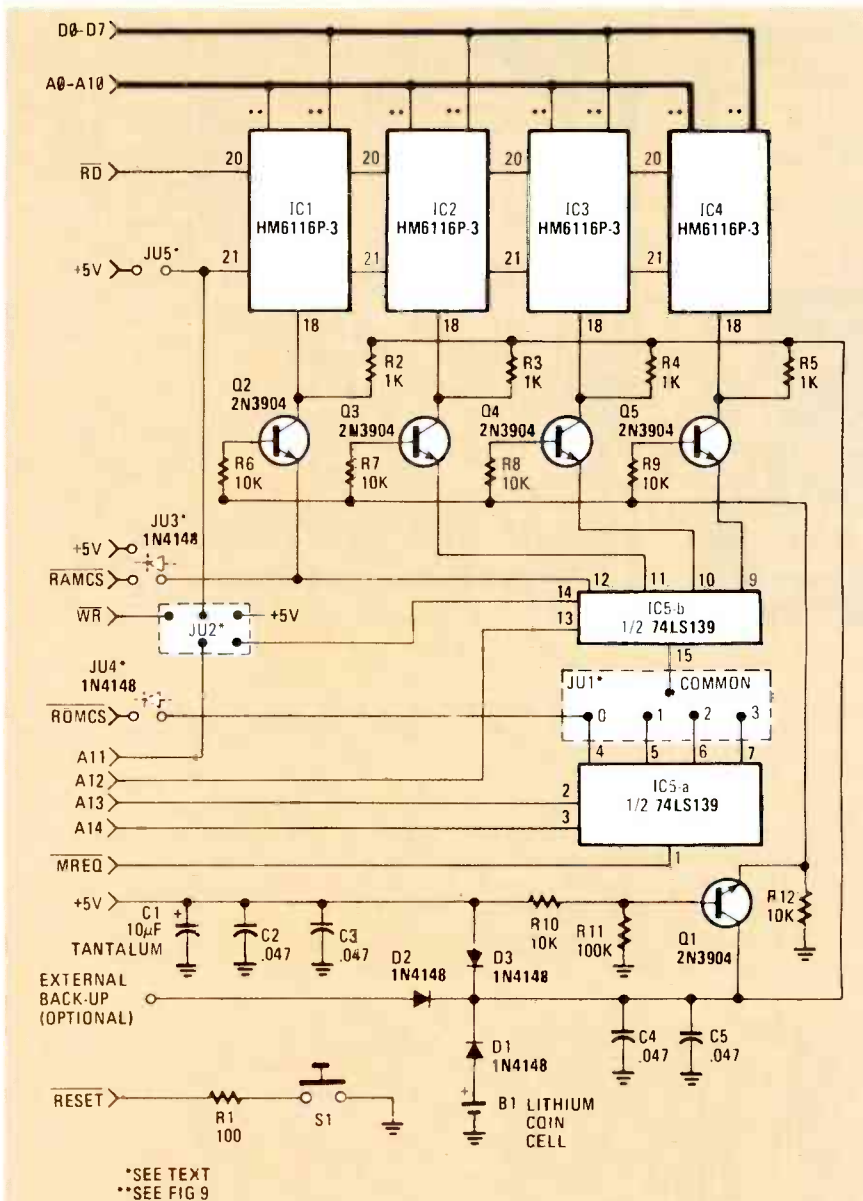

FIG. 3—SCHEMATIC of the 8K CMOS RAM board. Note that the exact pin connections for the data and address busses are not shown here—see Fig. 9.

should last for many years. Be sure to keep the CMOS RAM board plugged into the microcomputer even when you're not using it, and even when the computer is switched off. Doing that prevents the data and address lines from floating high—standby current consumption can increase two orders of magnitude if those lines go high.

A reset switch is located on the board to make it unnecessary to unplug the power supply every time you want to reset the system. It is recommended that you use the switch, because if you reset the computer by pulling the plug and then reinserting it, there is a chance that the filter capacitor in the power supply will not have time to discharge. If that happens, the CPU will not reset when the power is restored, and you may find that it will write over all of your nonvolatile memory.

### Construction

We recommend that you use a printed-circuit board for the CMOS 8K RAM extension. (The foil pattern for the piggyback extender board is shown in Fig. 4, and the foil patterns for the double-sided board are shown in Figs. 5 and 6. The parts-placement diagram is shown in Fig. 7). The author, however, did put together a prototype CMOS memory board using wire-wrap techniques, and the circuit worked well. The usual rules apply—

keep the connections as short as possible; lay out the circuit in an orderly way in the smallest possible area without unnecessary overcrowding; include decoupling capacitors at the power-supply pins of the IC's; avoid bundling wires together to prevent crosstalk, etc. With a wire-wrap board you will notice slight additional interference on your TV screen. Using prototype boards with a ground plane, and then shielding the boards in a grounded metal case helps a lot. However, interference is usually less of a problem with a printed-circuit board, and such a board will be more reliable in operation and construction.

If you do use a PC board, solder the sockets to the board first—use a fine-tipped low-power (about 27 watts) iron and take care not to cause solder bridges between the traces. Make sure the iron is hot and use a minimum amount of solder—too much solder may run through and form a solder bridge on the component side of the board.

### PARTS LIST

All resistors ¼ watt, 5%, unless otherwise specified

- R1—100 ohms
- R2–R5—1000 ohms
- R6–R10, R12—10,000 ohms
- R11—100,000 ohms

### Capacitors

- C1—10 µF, 16 volts, tantalum
- C2–C5—0.047 µF, ceramic disc

### Semiconductors

- IC1–IC4—HM6116LP-3 150-nS low-power 2K × 8 CMOS RAM
- IC5—74LS139 dual 1-of-4 decoder
- Q1–Q5—2N3904

- S1—SPST pushbutton switch (Panasonic EVQ-P1R04K or similar)

- B1—3-volt lithium coin-type battery (Panasonic BR-2325 or similar)

Miscellaneous: PC board or wire-wrap board, IC sockets, card-edge connector, battery holder, etc.

The following are available from Paul Hunter, 1630 Forest Hills Drive, Okemos, MI 48864: complete kit, including a drilled, plated, solder-masked, and silkscreened PC board; edge connector; piggyback connector; IC sockets; battery holder; battery; one HM6116LP-3, and all other components, \$29.95 plus \$1.95 shipping and handling. (Michigan residents add 4% sales tax.) The PC board alone is available for \$15.00 postpaid. An additional three HM6116LP-3 CMOS RAM'S may be purchased with the kit for an additional \$16.

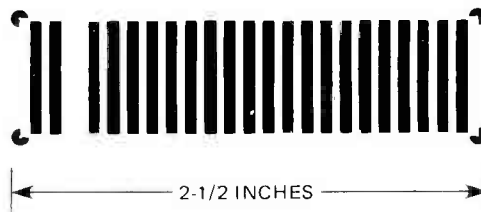

FIG. 4—FOIL PATTERN for the piggyback extender board that lets you use other peripherals with the CMOS RAM extension. Although it is a double-sided board, both sides are the same, so only one pattern is shown. The installation of this board is discussed in the text and is shown in Fig. 8.

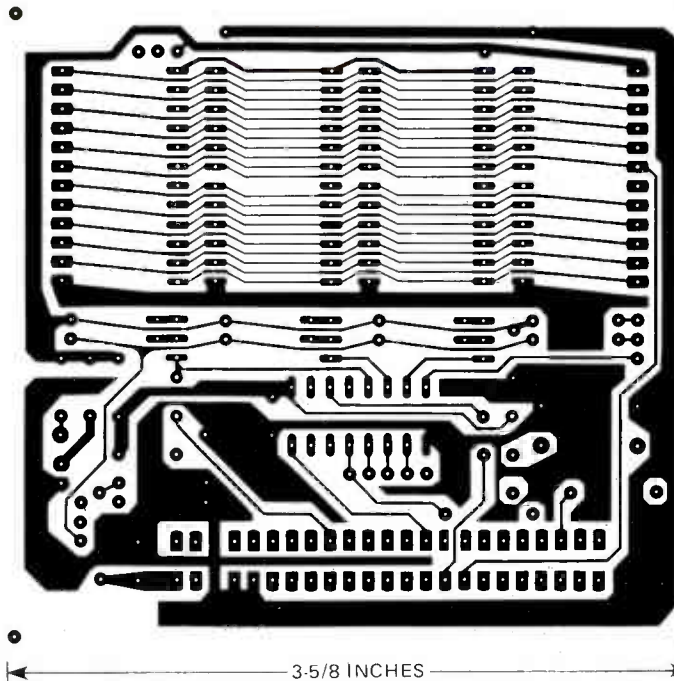

FIG. 5—FOIL PATTERN for the component side of the board. Be careful at the tight spots when you are soldering.

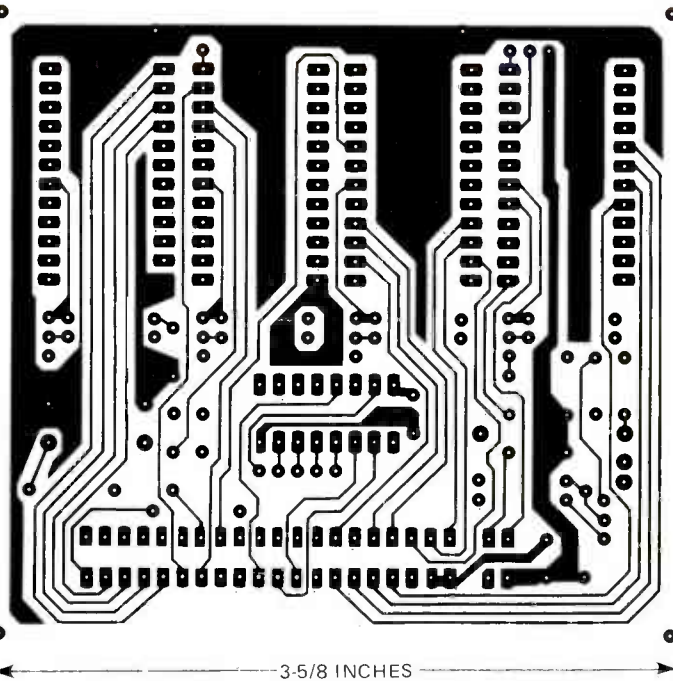

FIG. 6—FOIL PATTERN for the circuit side of the board. There are two components, S1 and the lithium battery B1, that mount on the circuit side.

Solder the card-edge connector in place as follows: Insert the connector in the appropriate holes and adjust the stand-off distance to at least 1/4 inch as shown in Fig. 8. Make sure the connector is the same distance off the board at both ends, and at right angles to it; then solder one

pin at each end. Check the alignment again, and if you're satisfied, solder the remaining pins. Bend the wrap posts in toward each other as shown. Secure the second extender board (for piggybacking other peripherals) between the pins, and solder the pins to its traces.

Next, solder the resistors, capacitors, diodes, and transistors in place—refer back to Fig. 7. Note especially the polarity of the tantalum capacitor, the diodes, and the transistors. The positive lead of the tantalum capacitor is nearer to the bottom of the board. The curved sides of

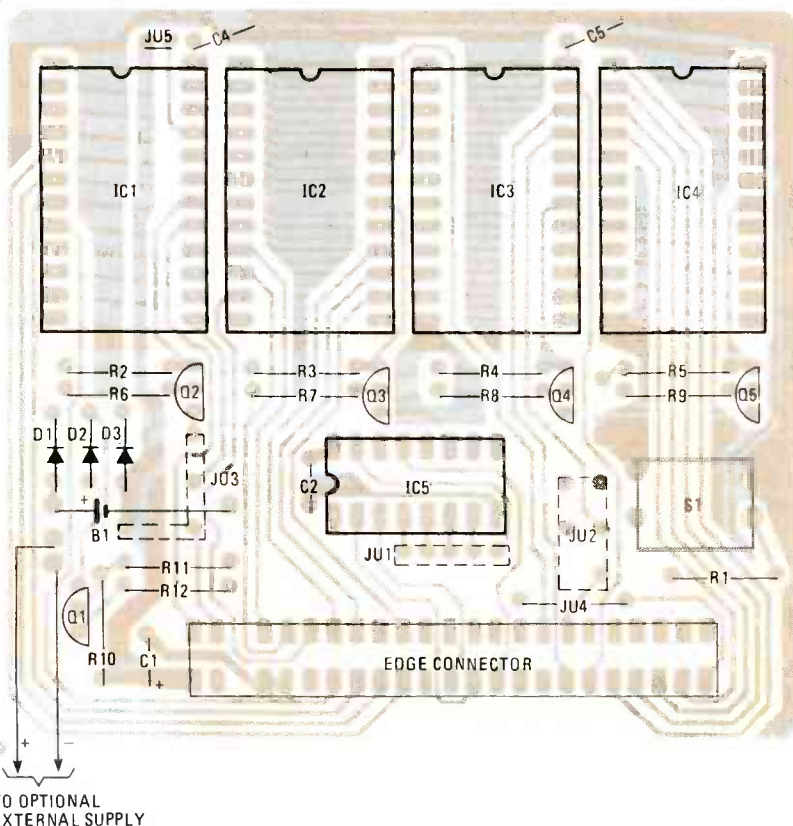

FIG. 7—COMPONENT-PLACEMENT DIAGRAM for the RAM board. Note the extra pads for connecting an external battery (other than the lithium battery) for backing up the RAM.

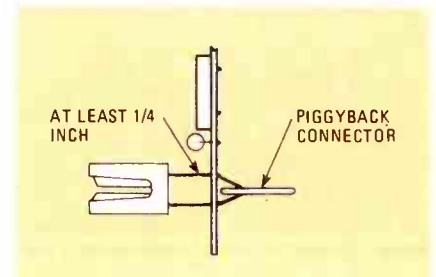

FIG. 8—SIDE VIEW OF THE CARD-EDGE CONNECTOR mounted on the PC board. Note also how the piggyback extender-board is attached.

all the transistors point to the left side of the board. Although we will not discuss the jumpers in great detail at this point, if you plan to vary your use of the board, insert wire-wrap pins at the jumper positions and use wire-wrap wire for the connections.

You should mount the RESET switch on the opposite side (circuit side) of the PC board where there's a little more room for your finger to get at it. Also solder the lithium-cell holder to the that side of the board. Hold the battery-holder firmly against the board when soldering it, and make sure it's oriented correctly.

When we continue we'll finish up the construction, discuss the available options, and look at some software you can store. **R-E**



# BUILD THIS

**Part 2** WE HAVE ALREADY DISCUSSED the theory behind how this clock talks. (See the May 1983 issue of **Radio-Electronics**.) Now we'll discuss how to build the clock, and how to operate it.

## Hardware description

Please refer to the block diagram (Fig. 2), and the schematic diagram (Fig. 3) of the talking clock as we discuss its internal operation.

The entire clock is controlled by a Z80 microprocessor, IC1. It keeps track of the time, reads all the switches, and controls the speech synthesizer. The control software for the processor is stored in a 2516 or 2716 EPROM, IC4, with a capacity of 2K bytes. The microprocessor also uses two 1K × 4 2114 RAM's (IC2 and IC3).

The six mode and set switches, S1-S6, are connected to the microprocessor through a Tri-State buffer IC10.

A 74LS139 address decoder, IC9, connected to the microprocessor's address and control lines, generates the various strobe pulses that control reading and writing from and to the memory, speech synthesizer, and the switch buffer.

The voice-synthesis processor is the TMS5220, IC6, which is connected to the microprocessor bus through a 74LS245 bidirectional octal buffer, IC5. The buffer is needed to isolate the TMS5220 from the microprocessor data bus.

In operation, the TMS5220 and the microprocessor operate at different speeds—the TMS5220 is a very slow device. Therefore, the microprocessor has to be slowed down whenever it does a

# TALKING

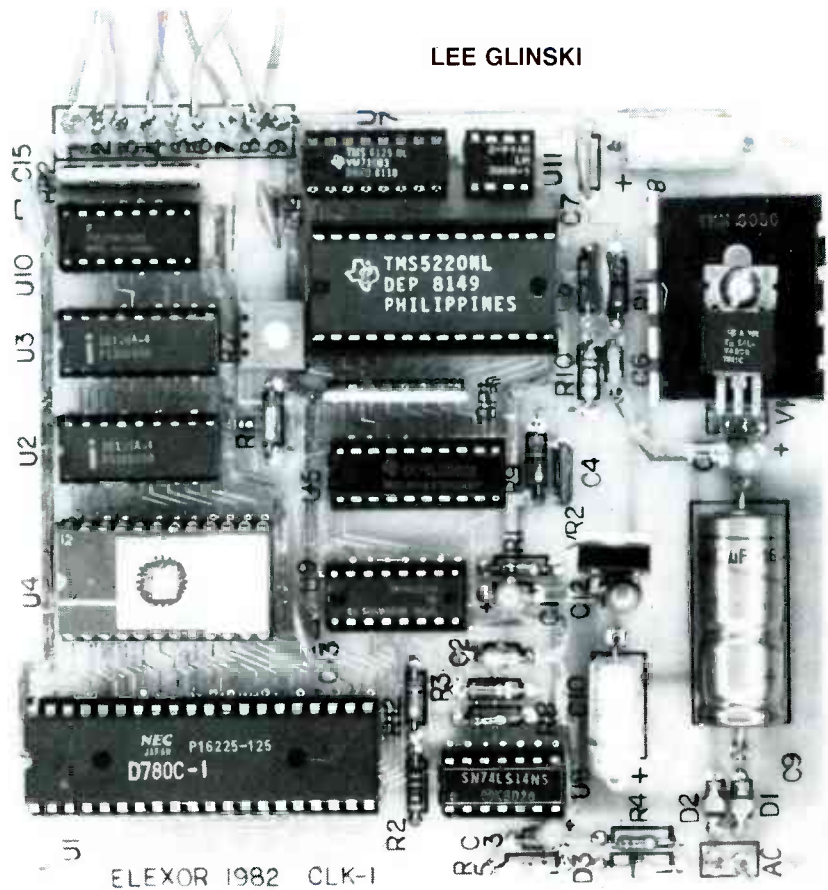

# ALARM CLOCK

*When you need to know what time it is, this clock tells you—literally.*

read or write from or to the VSP. That is accomplished by using a special line coming out of the voice synthesizer—the **READY** line. That line is connected to the microprocessor's **WAIT** line. When the microprocessor reads or writes from or to the VSP, the **READY** line indicates when the TMS5220 has finished its data transfer. The VSP will take the microprocessor's **WAIT** line low to signal the microprocessor to temporarily stop and wait until it (the VSP) has completed its data transfers. As soon as the data transfer is complete, the VSP releases the Z80, and program execution continues.

Speech data for time announcements is contained in ROM IC7, a Texas Instruments VM71003 that is pre-

programmed with a clock vocabulary. It is connected to the TMS5220 by means of a dedicated interface bus.

The audio output of the voice processor IC is fed to a simple, passive, low-pass filter consisting of R9-R11, C5, and C6. The filter is needed because the speech waveform coming from the D/A converter contains some digitizing noise and must be smoothed out to produce a clean analog waveform. The filtered waveform is fed to audio amplifier IC11, an LM386 audio amplifier capable of delivering over 100 mW—more than enough for most purposes.

The power supply uses a wall-plug-type transformer, T1. The nine-volts AC from the transformer is rectified by diodes

D1 and D2. The rectified voltage is filtered by capacitors C9 and C10 and then goes to two 3-terminal regulators, IC12 and IC13, which regulate it to +5 and -5 volts, respectively. The clock draws under 500 mA from the +5-volt supply, and under 50 mA from the -5-volt supply.

The transformer also supplies the 60-Hz reference frequency used for the timekeeping function. A 60-Hz sine wave is taken from the transformer and rectified by diode D3. The signal is then dropped to TTL levels by a voltage divider made up from R4 and R5. That TTL-level signal is buffered by a Schmitt trigger (IC8-c) and applied to the non-maskable-interrupt (NMI) line of the microproces-

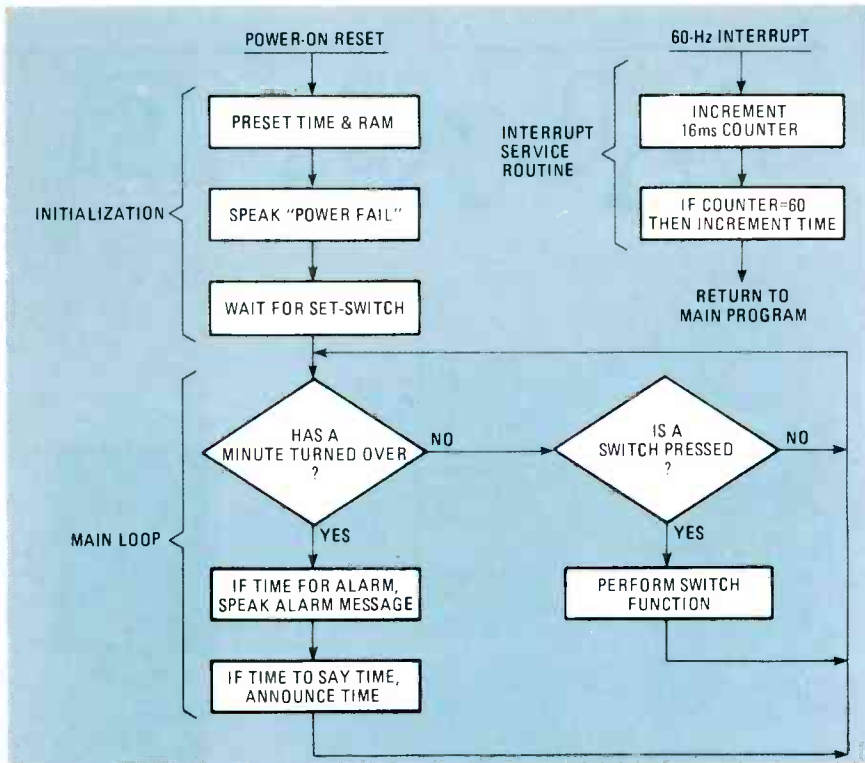

FIG. 4—MAIN LOOP IN LOGIC DIAGRAM handles coordination of timekeeping and speech functions.

(1/60-second), a count of 60 will indicate precisely one second. So, every time the counter reaches 60, the time of day is incremented by one second. The only action performed at the time the interrupt takes place is the incrementing of the time counters; resetting of the clock functions is done in the main loop of the software.

As shown in the flowchart, the primary function of the main loop is to decide when to perform certain operations.

Whenever the minute-point is reached, the software checks to see whether the alarm is on, and whether the time of day matches the alarm time. If the alarm is on and the two times match, then an alarm message is spoken.

The software also checks to see whether it's time to speak the time in the auto-speak mode. Once it decides that the time is to be spoken, it composes a phrase containing the appropriate "hour" and "minute" words. That phrase is then spoken by the voice processor.

Another function of the program's main loop is to continuously check on whether one of the pushbutton switches is pressed. If it finds one of the SET switches pressed, it increments the time, thus allowing the user to set the time of day. If

sor. Capacitor C3 across the input of the buffer filters out high-frequency noise that might give false interrupts.

### Software

As mentioned earlier, the entire clock is software-driven. There are routines to keep track of time, check whether switches are pressed, compose phrases for speaking, and control the voice synthesizer to generate speech.

As indicated in the flowchart, Fig. 4, the microprocessor takes care of all timekeeping functions, as well as causing the speech synthesizer to speak words and phrases.

When power is applied to the clock, the microprocessor RESET line is activated, and the microprocessor performs a power-on initialization routine. That routine presets the time and the alarm to 12:00 AM, as well as initializing some internal registers. It then alerts you to set the time by first beeping and then announcing, "Power fail. Set the time." twice. During initialization the normal time-speaking function is inhibited. That's done to prevent false time-indications. When the TALK button is pressed, instead of announcing the time, the clock will tell you to "set the time." The normal speaking-function is enabled only after the time has been set.

The 60-Hz line frequency provides the time reference for the clock. The 60-Hz power-line signal is applied to the non-maskable-interrupt line of the microprocessor. Every time the interrupt occurs, the microprocessor increments a counter. Since the interrupts come every 16.67 ms

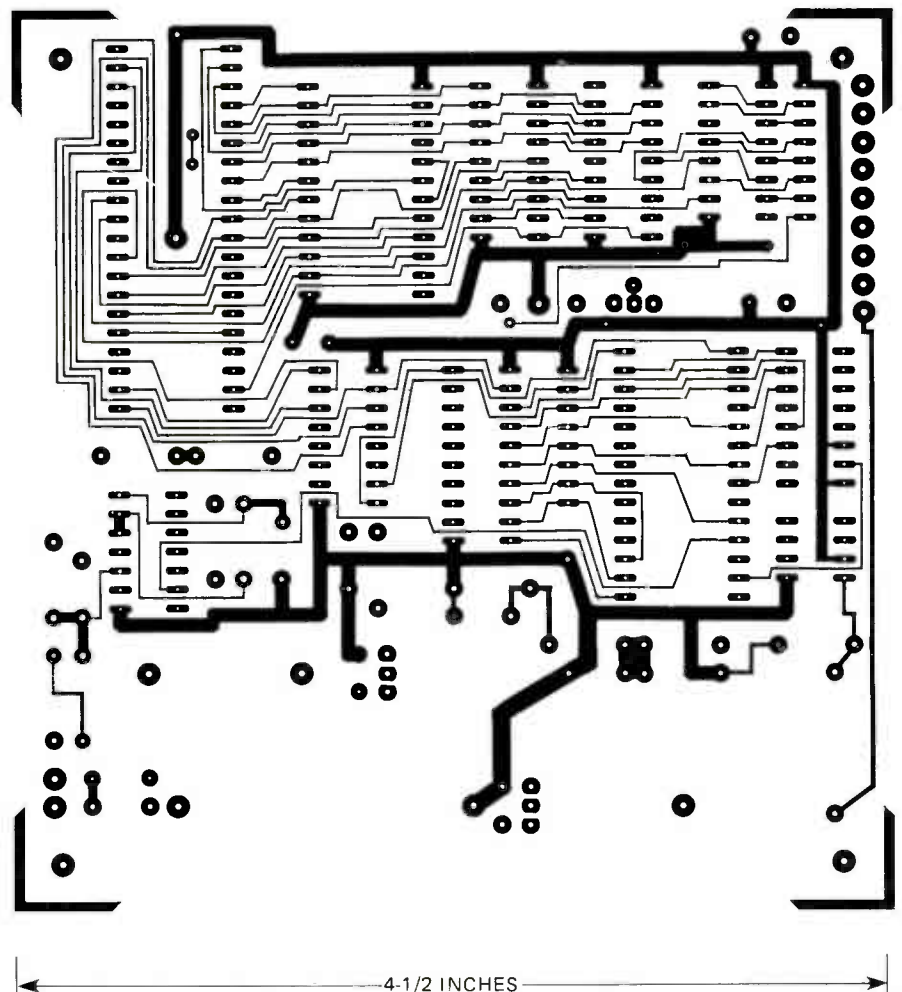

FIG. 5—COMPONENT SIDE of clock board. Large pads at right are for connections to switches and speakers.

the SPEAK TIME switch is found pressed, the software composes a phrase containing the current-time information, and announces it.

### Construction

The talking clock should be built using a double-sided printed-circuit board with plated-through holes. A foil pattern for the component side of the board is shown in Fig. 5, and one for the "foil" side in Fig. 6. A professionally made silk-screened board can be obtained from the source shown in the Parts List.

### PARTS LIST

All resistors ¼ watt, 5% unless otherwise noted

- R1, R11—10,000 ohms
- R2—330 ohms
- R3—620 ohms
- R4, R8, R9, R12—1000 ohms
- R5—470 ohms
- R5—180,000 ohms
- R7—100,000 ohms, PC-mount trimmer potentiometer
- R10—100,000 ohms
- R13, R14—8 × 1K SIP (Single In-line Package) resistor pack

### Capacitors

- C1—330 μF, 10 volts, electrolytic or tantalum
- C2—0.001 μF, ceramic disc
- C3, C11, C12—2.2 μF, 10 volts, electrolytic or tantalum
- C4—0.05 μF, ceramic disc
- C5, C7, C13—C15—0.1 μF, ceramic disc
- C6—0.01 μF, ceramic disc
- C8, C10—100 μF, 16 volts, electrolytic
- C9—680 μF, 16 volts, electrolytic

### Semiconductors

- IC1—Z80 microprocessor
- IC2, IC3—2114 1K × 4 RAM
- IC4—2516 or 2716 2K × 8 EPROM, pre-programmed
- IC5—74LS245 octal bus transceiver
- IC6—TMS5220 voice-synthesis processor
- IC7—VM71003 clock-vocabulary ROM
- IC8—74LS14 hex inverting Schmitt trigger
- IC9—74LS139 dual 2/4 decoder
- IC10—74LS367 hex Tri-State bus driver
- IC11—LM386 audio amplifier
- IC12—7805 5-volt positive regulator
- IC13—7905 5-volt negative regulator
- D1—D3—1N4001
- T1—9 VAC, 600 mA, wall-plug transformer
- S1—S3—SPST slide or toggle switch
- S4—S6—SPST N.O. pushbutton switch

**Miscellaneous:** PC board, speaker, IC sockets, heat sink for +5-volt regulator, enclosure, wire, solder, etc.

The following are available from ELEX-OR, PO Box 246, Morris Plains, NJ 07950: double-sided plated-through PC board, \$12.50; IC4, \$7.50; IC6 and IC7, \$25.00; kit of all parts (less enclosure) \$69.50. Please add \$2.50 for postage and handling as well as applicable state and local sales tax(es).

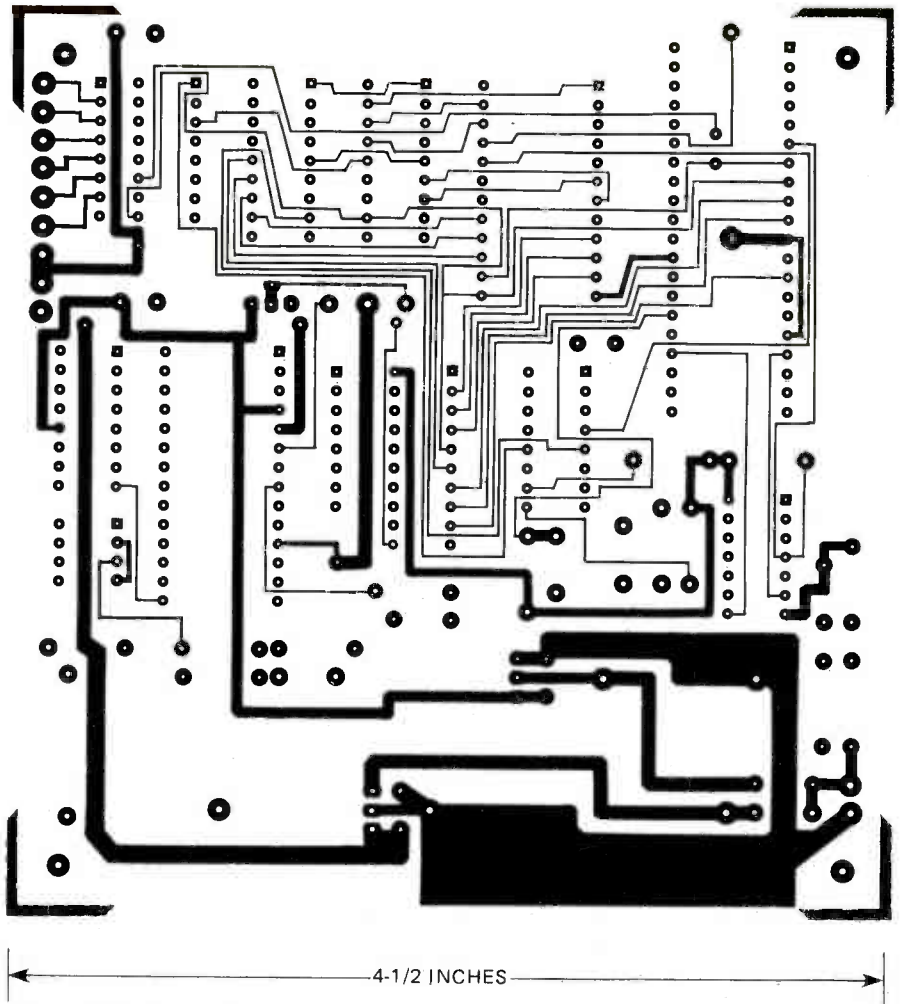

FIG. 6—"FOIL SIDE" of clock board. Double-sided board uses plated-through holes and can be ordered from supplier indicated in Parts List.

Hand-wired breadboard construction can also be used if a great deal of care is taken. The layout should follow the PC-board design. Use heavy wire for the

ground and power lines, and make sure the audio section is away from the other IC's to eliminate noise-pickup by the amplifier.

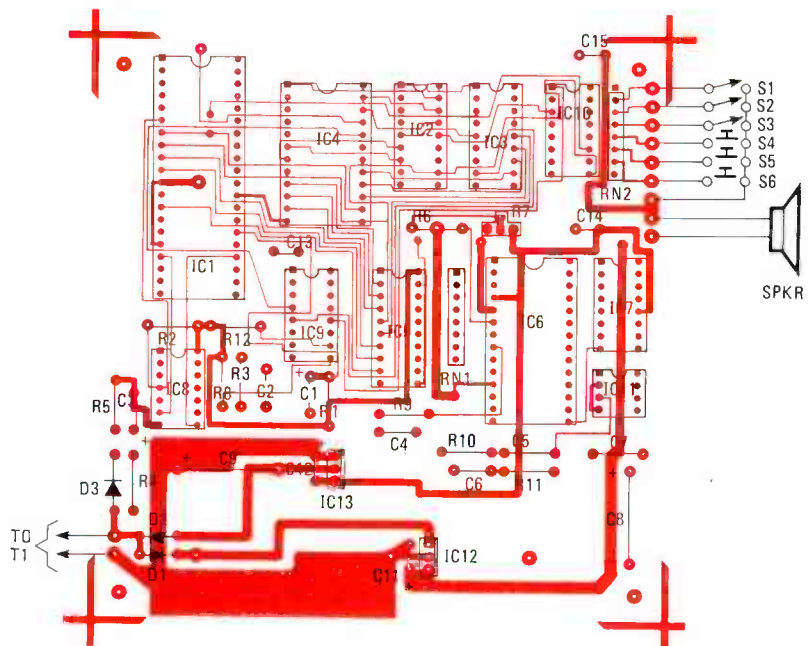

FIG. 7—OFF-THE-BOARD COMPONENTS (with the exception of T1) are mounted on clock case. See Fig. 3 for switch functions.

When assembling the board refer to the parts-placement diagram (Fig. 7). Sockets should be used for all IC's. Install the sockets, but do not insert the IC's (except for the two regulators) until after the initial checkout. When mounting the diodes and capacitors, be sure to observe their polarities. The two SIP (Single In-line Package) resistor-networks, R13 and R14, must have their pin-1 ends oriented toward the top of the board as shown. When soldering, use a low-power (about 25 watts) soldering iron and contact the pads on the board for only a few seconds at a time to avoid excessive heat buildup. Excessive heat will lift the pads and thus ruin the board.

When you've finished, check the board to make sure there are no solder bridges between IC pins or adjacent traces. The completed board is shown in Fig. 8.

### Final assembly

The assembled circuit board should be housed in some type of an enclosure. The enclosure should be large enough to hold the switches and speaker, as well. The prototype was housed in a toy-clock case (with the insides removed). The "alarm bells" could be mounted on top of such a case and could contain two pushbutton switches (S6) connected in parallel to activate time speaking.

The SPEAK TIME pushbutton switch should be mounted in a visible and easily accessible place like the top or front of the case, since the switch will be used often. If the alarm is also to be used frequently, then the alarm ON-OFF switch should be mounted in an easily accessible place. The MODE and SET switches should be mounted on the rear of the box to keep curious fingers from disturbing the time setting.

The speaker can be any type with an impedance between four and eight ohms. The quality of the speech output is highly dependent on the speaker and its enclosure. Some experimentation can be performed to get the most natural sounding voice. Best performance will be obtained when using a speaker with good low-frequency response. The speaker used in

the prototype was 2¾ inches in diameter and, in its plastic enclosure, produced excellent sound.

After the PC board, speaker, and switches are mounted in the enclosure, connect the switches, speaker, and transformer to the board. Double check all the connections to make sure they go to the right places.

### Checkout

For this step, the entire clock should be assembled except for the IC's.

Before turning on the power double-check to make sure all the components are oriented correctly, and check the solder pads again for cold joints and shorts. Also make sure that the off-the-board wiring is correct.

Next, turn on the power and check the power supplies. Measure the +5- and -5-volt supplies to make sure they are operating correctly.

Now turn off the power and (finally!) insert the IC's into their sockets. Make sure they are oriented correctly. Pin 1 of all the IC's should face the top of the board.

With all the IC's in place, turn on the power and listen for sounds coming from the speaker. If everything is working, you should hear a beep followed by the words, "Power fail. Set the time." That is the power-fail message and is spoken whenever power is first applied to the clock. If you don't hear anything, something is wrong. The first thing to do is turn off power and re-check the board for cold solder joints and shorts. Make sure that all the IC's are inserted correctly, all the parts are the correct values, and that the power supply is working.

### Calibration

Calibration of the clock consists of adjusting the clock frequency of the TMS5220 (it has a built-in oscillator) with R7. It should be 640 kHz (measured at pin 3 of the IC) for the speech to sound natural. The adjustment is not very critical, and can easily be made by listening to the clock's speech output.

### Using the clock

Setting the time is performed by using the two SET TIME pushbutton switches. One advances the hours, and the other the minutes. When the SET HOURS switch is depressed, the current hour is announced. (For the SET MINUTES switch it's the current minute.) As the switch is held down, the time will count up, with each increment being announced by the clock. When the desired hour or minute is reached simply release the switch and the time will be set.

If the MINUTE/HOUR SET switch is depressed momentarily, the current MINUTE/HOUR is announced, but is not incremented. At the same time, a counter inside the microprocessor is cleared to

TABLE 1

S1 Mode 0	S2 Mode 1	Function
OFF	OFF	Speak time every minute
OFF	ON	Speak time on the hour
ON	OFF	Speak time on the quarter hour
ON	ON	Auto-speak disabled

zero. That counter is used to count time in seconds, and every time it reaches 60 the time-count will increment by a minute. Thus, momentarily depressing the SET switch will synchronize time to the second.

If the clock is just plugged in without the time being set, every time the SPEAK TIME pushbutton is pressed, the clock will say, "Set the time" as a reminder that the time has not yet been set.

The position of the ALARM switch determines whether the time or the alarm is to be set. If the switch is off, the time of day will be set. If it's on, the time the alarm goes off will be set. The alarm is set just like the time, except that the ALARM switch must be in the ON position. Remember that whenever the switch is on, the SET switches will set the alarm time and not the time of day. The current alarm setting can be heard by throwing the ALARM ON/OFF switch from the OFF to the ON position. Every time that's done, the clock will announce the alarm setting.

To use the alarm, first set the time you want it to go off, as described above. Then set the ALARM ON-OFF switch to the ON position; that will enable the alarm circuitry. When the alarm time-setting time matches the time of day, you'll hear the following: "Good morning. The time is seven twenty-six AM. Time to get up." The time announced is the actual time of day, and the "good morning" changes to "good afternoon" or "good evening," depending on the time of day.

After using the alarm several times I found it much more effective and pleasant than the conventional buzzer. If you are a heavy sleeper and don't wake up to turn off the alarm, it will repeat the alarm message every minute until it is turned off. Once the alarm is tripped, it can be shut off either by pressing the SPEAK switch, or by setting the alarm switch to the OFF position.

Switches S1 and S2 are used to select the auto-speak mode of the clock. In that mode the time will be announced automatically at predetermined intervals. The settings are shown in Table 1.

If you choose not to use the auto-speak mode, you can make the clock tell you the time simply by pressing the TALK button. If the button is held down, the time will be announced continuously.

R-E

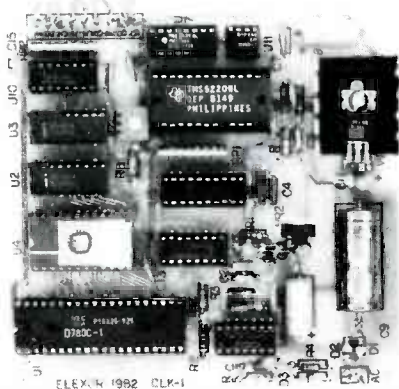

FIG. 8—THE COMPLETED CLOCK BOARD. Note that IC12 requires a heat sink.

# CIRCUITS AND COMPONENTS

IT SEEMS HARD TO BELIEVE THAT THE first integrated-circuit operational amplifiers (op-amps) were introduced less than twenty years ago. The extremely low price of IC op-amps, and the almost unlimited number of applications for them, have served to make them one of the mainstays of modern electronic-circuit design. Indeed, it is difficult to flip through the pages of any electronics publication without seeing some reference to those useful IC's.

Actually, the term "op-amp" doesn't describe one integrated-circuit, but rather is a generic term for a whole family of linear circuits. There are compensated and uncompensated types, single-supply types, current-differencing types, BiFET types, and so on. But one breed of op-amp, known as the operational transconductance amplifier (OTA) hasn't received the amount of attention that it deserves. This article details both the theoretical and practical aspects of the OTA. By the time you are done reading it, you should feel confident enough to attempt your own design with this interesting type of IC.

One of the earliest OTA's was the 3080. There are now several others available and, while they offer several additional features, they essentially obey the same rules and operate just like their predecessor. Hence, designing with the 3080 is emphasized in this article, but keep in mind that switching over to other OTA's is easy.

Before considering the internal makeup of the 3080, we should consider in general terms just what it is, and what it can do. In many respects, the 3080 is much like a common op-amp. It has differential inputs. The difference between the voltages at those two inputs is multiplied by a certain gain, and the result is available at an output pin. Also, the gain

*Often ignored by beginners, operational transconductance amplifiers are useful and easy to work with. This article will give you a good start toward designing and building your own projects using these versatile devices.*

THOMAS HENRY

## How to Use Transconductance Operational Amplifiers



can be altered simply by changing the values of certain resistors. And, finally, the 3080 needs a bipolar power-supply.

What sets it apart from the common op-amp, however, is the inclusion of another pin that allows the user to change the gain (or more properly, the transconductance) of the amplifier. That control pin, pin 5, is a current-type input. The more current,  $I_{ABC}$  that flows into the pin, the greater the IC's gain. In other words, that input current varies the transconductance of the device.

In the January, 1983 issue of **Radio-Electronics**, in the series on analog-circuit design, the op-amp was modeled as a voltage source in series with an output resistance. (See Fig. 3 of that article.) The transconductance amplifier, on the other hand, is modeled as a current source in parallel with an output resistance. So, yet another difference between an OTA and other op-amps is that an OTA features a current output. Speaking very generally, then, the 3080 is a current-controlled amplifier. If you consider the input for  $I_{ABC}$  (the control current) to be a programming input, then the 3080 is a programmable OTA.

What can such a device be used for? There are countless applications, but some of the more interesting ones are voltage-controlled amplifiers, voltage-controlled oscillators, sample and hold circuits, analog switches, a trianglewave-to-sine-wave converter, and so on. Several of those circuits will be discussed later in this article.

### Internal structure

Now that we know basically what a 3080 is and what it can do, we can start to consider its internal makeup. Unlike some other integrated circuits,

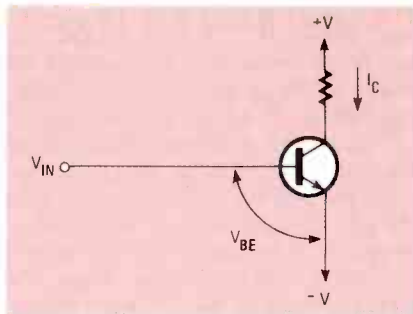

FIG. 1—THE OPERATION of the transistor differential-pair amplifier is based on the relationship of the input voltage to the collector current

where no specific knowledge of the internal circuitry is needed to use them, the unusual nature of the 3080 makes such knowledge very important.

The usual model used to demonstrate the internal structure of the 3080 is the differential-pair amplifier, although there are a few differences between them. Let's take a closer look at such an amplifier.

To understand the operation of the transistor differential-pair amplifier let's first look at the relationship of input voltage to collector current in a single transistor (see Fig. 1). That relationship is exponential and is given by the equation:

$$I_C = I'(e^{qV_{BE}/kT} - 1)$$

Several physical constants appear in that equation. The so-called emitter saturation-current,  $I'$ , depends on the particular transistor used. Its value will generally be between 1 and 0.01 picoamperes. Other constants that appear include  $K_B$ , the Boltzmann constant, and  $q$ , the charge of a single electron. The equation can be considerably simplified by letting  $V_T = K_B T/q$ , where  $T$  is the temperature of the transistor in degrees Kelvin. The value of  $V_T$  is then about 26 mV at room temperature. Finally, the  $-1$  term can be ignored if the transistor is forward biased. The revised equation is then:

$$I_C = I' e^{V_{BE}/V_T}$$

That revised equation is considerably easier to work with.

Figure 2 shows a transistor differential-pair amplifier. The input of the amplifier is at the base of Q1, while the base of Q2 is grounded. A control current is drawn from the two tied emitters, and it is that control current that is used to alter the gain of the circuit. The output is taken from the two collectors.

In examining the operation of this amplifier, it is convenient to assume that the beta of the transistors is large. In that case, the emitter currents are approximately equal to the collector current. Hence,  $I_O = I_1 + I_2$ . Using the transistor equation we previously discussed, and Ohm's law, the equations for  $I_1$  and  $I_2$  can be derived. They are:

$$I_1 = \frac{I_O}{(1 + e^{V_{IN}/V_T})}$$

$$I_2 = \frac{I_O}{(1 + e^{-V_{IN}/V_T})}$$

Note the symmetry of those equations; They must always sum to  $I_O$ . That relationship is shown clearly in Fig. 3. The asymptotes of that curve are quite

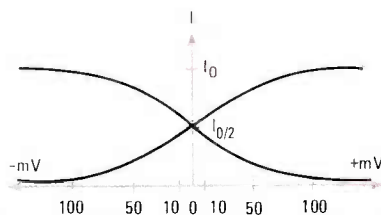

FIG. 3—THIS PLOT of emitter currents  $I_1$  and  $I_2$  shows that their sum is never greater than  $I_O$ . In fact, the sum of  $I_1$  and  $I_2$  is a constant and is equal to  $I_O$ .

important; neither  $I_1$  or  $I_2$  can be less than zero or greater than  $I_O$ . At  $V_{IN} = 0$ , the currents both equal  $I_O/2$ .

The curves are, of course, exponential, but for input voltages of less than 10 mV or so, the relationship between  $I_1$  and  $I_2$ , and  $V_{IN}$ , is more or less linear. Therefore, to keep distortion to an acceptable level in linear applications,  $V_{IN}$  should be held to 10 mV or less. Also, once the input voltage exceeds 100 mV, raising  $V_{IN}$  farther has no additional affect. One of the transistors will be cut-off, while the other will be saturated.

A simplified schematic of the 3080 is shown in Fig. 4. The transistor differential-pair is quite apparent, as is the absence of resistors. In their place, current mirrors are used. In a current mirror, the output current "mirrors" the input current, hence the name. Current mirrors CM1 and CM4 are current-sinking types, while CM2 and CM3 are current-sourcing types.

Current mirrors CM3 and CM4 mimic the collector currents of the two transistors of the differential pair. The sum of those currents is thus presented to the output. If the two currents are equal, indicating equal potentials at the inverting and noninverting inputs, the currents balance and there is no current at the output. If, however, CM3 sources more than CM4 can sink, the surplus is made available at the output. Similarly, if CM4 is sinking more than CM3 can provide, the difference must be provided through the output pin.

Figure 4 also shows a pinout of the 3080. The inverting and non-inverting inputs are at pins 2 and 3 respectively; those are voltage inputs. Pin 6 is the current output and may source or sink current depending on the conditions described above. Pin 5 is the input for the amplifier control-current,  $I_{ABC}$ . Finally, pin 7 is the positive supply pin and pin 4 is the negative supply pin.

### Some practical design-equations

Having described the internal structure

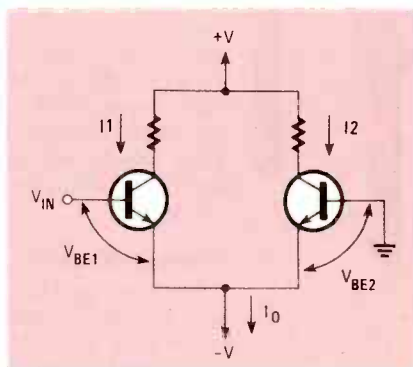

FIG. 2—A SIMPLE transistor differential-pair amplifier. In analyzing it, it is convenient to assume that the beta of the transistors is very large.

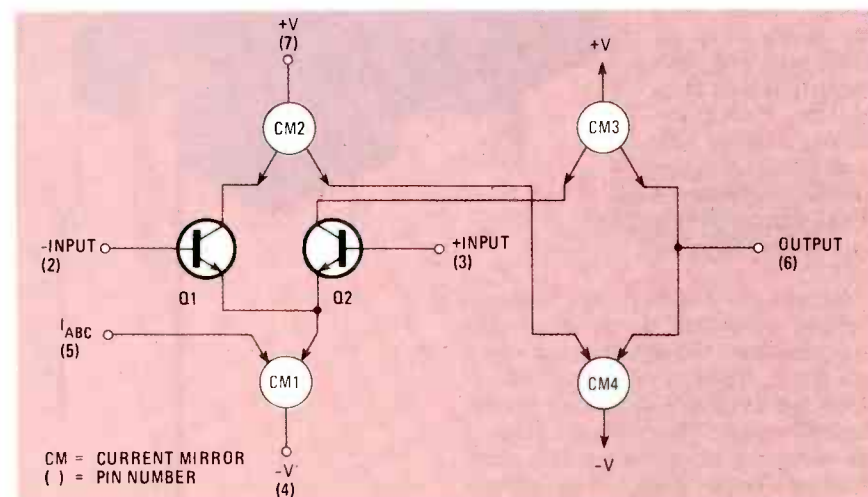

FIG. 4—SIMPLIFIED SCHEMATIC DIAGRAM of the 3080. The pin-out of the device is also shown here.

of the 3080 we can derive some practical design-equations. The most important is the so-called general transconductance equation that relates the output current to the input voltage and control current. It is:  $I_{OUT} = 19.2 I_{ABC} V_{IN}$ , where  $I_{OUT}$  and  $I_{ABC}$  are measured in milliamps and  $V_{IN}$  is measured in volts.

Eventually, we will want to convert  $I_{OUT}$  to a voltage, so that the unit will operate as a voltage amplifier, but for the moment, note that if  $V_{IN}$  is some fixed input-signal, we can vary the output amplitude simply by modulating the control current  $I_{ABC}$ .

Before the foregoing equation can be put to good use, some practical limits must be specified. In general  $I_{ABC}$  should always lie between  $0.5 \mu A$  and  $0.5 mA$  for best results. While it is possible to increase that upper limit somewhat, it is best not to do so since the 3080 can go into thermal runaway.

The inputs at pins 2 and 3 also have certain limitations that must be respected for good results. As we previously saw, the relationship between the input voltage and the output current is exponential and once the input reaches 100 mV any further increase will have no effect on the output current. Obviously, then, the input must be limited to less than 100 mV (or 200-mV peak-to-peak) for any sort of normal amplifier-response. But for true linear-response, the input voltage must be limited even more—a maximum value of 10 mV (20-mV peak-to-peak) is usually best. There is a trade-off here too, however, as the lower the input voltage, the lower the signal-to-noise ratio. Thus, keeping the inputs at the high end of the linear range—as close to 10 mV as possible—is desirable.

Let's now consider the supply voltage. The 3080 will work well with any power supply between  $\pm 2$  volts and  $\pm 18$  volts. Those high and low limits are extremes; best results are obtained with voltages that are somewhat between those. In many modern designs, a bipolar 15-volt supply is used, and that seems about right.

Before we move on, let's consider two other points. First of all, pin 5, the control-current input, is usually at a potential that is about one diode drop above the negative supply-voltage. Thus, if a bipolar 15-volt supply is used, the potential at pin 5 is  $-14.4$  volts. When calculating resistor values for that input, be sure to take the negative potential into account.

Secondly, even though the 3080 is an uncompensated-type op-amp, compensation is not usually needed since most applications use an open-loop design. Compensation is only needed when negative feedback is introduced. And simplifying things still farther, the two most common negative-feedback applications for the 3080, the voltage-controlled lowpass filter and the sample-and-hold, already use

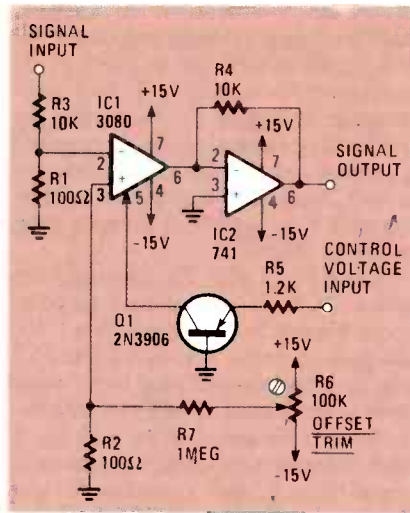

FIG. 5—THIS VOLTAGE-CONTROLLED AMPLIFIER uses just two IC's and a transistor. Though simple, this circuit works surprisingly well.

capacitors in their designs. Thus no additional compensation is needed.

Of course, there is much more to working with the 3080, but that can be picked up with experience. For now, the rules we've presented are all that you need to begin designing. Let's see how to use them in practice.

### Some practical circuits

Figure 5 shows a common 3080 application, a voltage-controlled amplifier, (VCA). That circuit is common nowadays, and shows up in everything from noise-reduction units and computerized recording-studio mixing consoles to electronic music-synthesizers. (See the May, 1983 *Radio-Electronics* for a discussion of how VCA's are used in such synthesizers.) We'll examine that circuit first because it involves a very straightforward application of the design formulas and constraints we've discussed.

Suppose that our VCA is going to process a signal with a peak amplitude of  $\pm 1$  volt. As we've said, however, the 3080 works best when the input-level is limited to 10 mV. Hence, resistors R1 and R3 are used to drop the voltage to that level. Since R1 is 100 ohms, a similar resistor, R2 is placed at the other input of the 3080. In theory the 3080 should now be properly balanced, and there should be no DC feedthrough. In practice, however, offsets can still occur and when those are modulated by the amplifier severe "thumps" will result. Therefore, trimmer potentiometer R6 is added to the circuit so that any offsets can be nulled out. To adjust that trimmer, modulate the control voltage input rapidly while watching the output on an oscilloscope. Adjust R6 for minimum DC-feedthrough.

It was seen above that  $I_{ABC}$ , fed to pin 5, should be no greater than  $0.5 mA$  under most circumstances. Resistor R5 and transistor Q1 provide a linear current that

meets that requirement. At the maximum control-voltage of  $+15$  volts, Ohm's law shows that R5 will conduct a current of about  $0.5 mA$ . (Remember, pin 5 is at  $-14.4$  volts).

A 741 op-amp, IC2 is configured as a current-to-voltage converter and will provide a low-impedance output as well. To calculate the value for R4, we apply the general transconductance equation. We know that  $I_{ABC}$  is a maximum of  $0.5 mA$ , and we know that the input voltage is 10 mV (thanks to the attenuator—R1 and R3). Substituting those numbers into the transconductance equation yields an output current of  $96 \mu A$ . Now using Ohm's law, a value for R4 can be calculated. For unity gain, divide 1 volt (the original peak input-voltage) by  $96 \mu A$  and the result is  $10.4K$ . Pick  $10K$  as the nearest standard value.

That VCA, while very simple, works quite well. Perhaps its main fault is the non-linear response of the control input when the control voltage is small. A better circuit can easily be realized with the addition of a few parts. Such a circuit is shown in Fig. 6.

That circuit is actually a linear voltage-to-current converter. It will produce a current that is linearly dependent on the input voltage. In addition, since the transistor is within the feedback loop, a very precise response is guaranteed whether the control voltage is small or large. The design equation is:

$$I_{ABC} = \frac{V_{IN} (R1/R2)}{R2 \parallel R3}$$

where  $R2 \parallel R3$  is the parallel combination of R2 and R3.

In designing this circuit, you determine

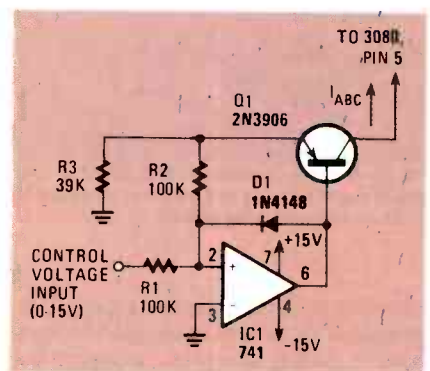

FIG. 6—FOR BEST RESULTS, this high-precision current source can be used with the circuit shown in Fig. 5. Its output is fed to pin 5 of the 3080.

the desired output-current and then select appropriate values for R1 and R2. Those three values are then used in the equation to determine the value of R3. The circuit, using the values shown, is set up to output a maximum current of  $0.5 mA$  for a 15-volt input. That current is fed to pin 5 of the 3080. Diode D1 is included to protect the circuit from large negative input-

voltages.

The VCA just described is actually a two-quadrant multiplier. It is a multiplier in the sense that the input signal is multiplied by a certain gain; that gain is determined by the control-voltage input. And it has two-quadrant operation because the signal is allowed to be bipolar; the control voltage, though, can only be positive. For that reason, the graph of the product of the two inputs, which is the output of the circuit, can lie only in one or the other of two quadrants of the four-quadrant Cartesian plane so familiar to most of us from elementary algebra. A four-quadrant multiplier, on the other hand, allows both the control voltage and the signal to be bipolar. Thus the output of that circuit can fall in any of the four quadrants.

#### Four-quadrant multiplier

Perhaps one of the most interesting circuits to come along in quite a while is a four-quadrant multiplier that uses a single 3080 and a 741 op-amp. Figure 7 shows such a circuit; its simplicity is quite striking. Before describing the circuit in detail, a few things should be said about four-quadrant multiplier applications. As mentioned above, either input of the

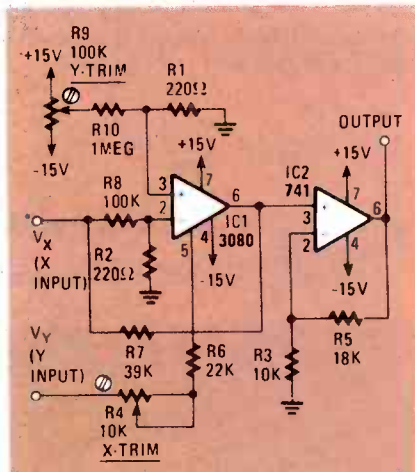

FIG. 7—A FOUR-QUADRANT MULTIPLIER. This circuit could be used in a music synthesizer to create chime and gong effects.

amplifier will accept bipolar signals. The product of those two signals (divided by a suitable scaling factor) is available at the output. But, most important, the polarity of the output will be correct. For example, if two negative signals are multiplied, the output will be positive. That, of course, makes such a circuit quite interesting for, among other things, analog-computer applications. (Actually the circuit given here is inverting; that means that the output will be the opposite of the true product. That can easily be corrected, if needed, by adding an additional inverting-stage).

Another place that the circuit is es-

pecially useful is in audio applications. That's because it produces sounds that are quite similar to those produced by a ring modulator. For example, if two sine-waves are multiplied by the device, the output will be a complex signal composed of the sum and difference frequencies of the two. Such a signal can be used in electronic music-synthesis to create gong and chime effects.

Refer to Fig. 7 now. The two inputs are labeled "X" and "Y" and are set up to accept bipolar 5-volt signals (i.e., 10-volts peak-to-peak). Resistors R8 and R2 form an attenuator and drop the X-input signal to the desired 10-mV level. Resistors R4 and R6 are in series with the Y input. To balance the multiplier you apply a signal to the X input, ground the Y input (0 volts), and then adjust R9 for minimum feedthrough. Then, reverse the procedure—apply a signal to the Y input, ground the X input, and adjust R4 for minimum feedthrough.

The output is converted to a voltage by IC2, a 741 op-amp. For more demanding applications, that IC should be changed to a BiFET-type op-amp, such as the LF351. Note that this stage not only buffers, but also scales the output suitably—since the circuit is set up to accept bipolar 5V signals the output is scaled so that it equals  $-V_x V_y / 5$ . That puts the output in the same range as the inputs.

One drawback of this circuit is that

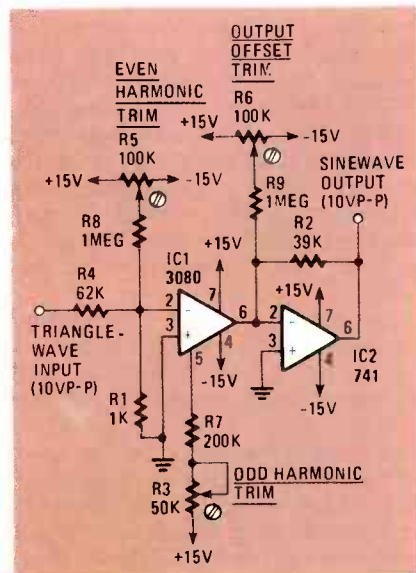

FIG. 8—IF A TRIANGLEWAVE is fed to the input of this circuit, the output will be a sinewave of the same amplitude. The total harmonic distortion will range from 2% to 4%.

only very-low-impedance input sources can be used. That is easy enough to correct, though, by buffering the two inputs. Additionally, the driving sources must be DC coupled. If those limitations are respected, however, the circuit performs very well and is far cheaper to build than any equivalent.

#### Trianglewave-to-sinewave converter

When we looked at the differential pair, we said that the input signal must always be at or below 10 mV for lowest distortion. A circuit that deliberately violates that rule is shown in Fig. 8.

In that circuit, which is a trianglewave-to-sinewave converter, a triangular wave with a value of 10-volts peak-to-peak is applied to the input at R4. Resistors R4 and R1 drop the voltage to about 160-mV peak-to-peak, which is applied to the 3080. Resistor R5 is used to trim the symmetry, which reduces the even-order harmonics. Resistors R7 and R3 form the current source for the 3080, and adjusting R3 has the effect of rounding or flattening the output; the result is that the odd harmonics are reduced. By adjusting R5 and R3, a very close approximation of a sine-wave can be obtained. The total harmonic distortion of the circuit will typically range from 2% to 4%. Resistor R6 is used to adjust the output offset.

The output of this circuit will be a sine-wave with the same amplitude as the input triangular wave. An important thing to note about the circuit is that it is non-reactive—it uses no capacitors or inductors. Thus it will work over a wide range of frequencies.

As this article has shown, the 3080 operational transconductance amplifier is not only versatile, but quite easy to work with. The equations we've presented, and Ohm's law, are really all it takes to get circuits using that device up and running. Obviously there are many refinements that can be made—correcting for temperature effects, for instance—but they can be tackled later on when you've had more experience with the device. R-E





# BUILD THIS

# DIGITAL VOLTMETER



## For Your Car's Dashboard

FRED L. YOUNG, SR. and FRED. L. YOUNG, JR.

*Keep an eye on the condition of your car's electrical system with this 3-digit digital voltmeter. Even if you're just a beginner in electronics, you can easily assemble it.*

MOST CARS THESE DAYS DON'T HAVE gauges or meters on their dashboards—they have "idiot lights" instead. They're great for telling you when something has gone wrong, but they do very little to warn you when something is *about to* go wrong. What's more, even if you are one of the lucky ones and your car does have gauges, their accuracy is not the best. A device with a digital readout would be much more satisfactory in many cases and easier to read as well.

The digital voltmeter described here can be installed in your car (or boat, or truck) to give you constant and accurate (to a tenth of a volt) information about the state of your battery. It is equally useful in electrically powered vehicles like golf carts and electric service-trucks (forklifts, baggage carts, etc.). While most of the latter do have meters, this voltmeter will prove to be more accurate.

The meter is very simple to build—it has only three IC's, three capacitors, five resistors, three transistors (and, of course, three LED's)—and for that reason makes an excellent project for the electronics novice who wants to "get his feet wet." Because it may be your first project, we'll go into the details of construction a little more deeply than we usually do in **Radio-Electronics**.

### How it works

Figure 1 is a schematic of the entire voltmeter. The LM340T-5 regulator, IC1, has an output of five volts, which is ideal for the other two IC's in the circuit and for the LED displays. The input to the regulator is protected by diodes D1 and D2, and by a 47  $\mu$ F capacitor, C1. Those components minimize positive- or negative-going voltage spikes that may be caused by switching inductive devices like the windshield wipers, air conditioning, electric windows, etc., on or off. A 10  $\mu$ F capacitor, C2, at IC1's output damps any noise or transients that may appear on the five-volt output line and makes the regulator a very stable voltage source, which is critical for accurate readings.

The heart of the voltmeter circuit is IC2, a CA3162E dual-slope, dual-speed, A/D (Analog-to-Digital) converter that reads the battery voltage and converts it into a BCD (Binary-Coded Decimal) digital number. That number appears at pins 2, 1, 15, and 16 of the IC and is fed to pins 7, 1, 2, and 6, respectively, of IC3, a CA3161E BCD 7-segment decoder/driver that drives the three FND507 seven-segment LED numeric displays (DISP1-DISP3).

The CA3161E deserves a little further

attention. It performs several functions that, in the past, would have required the circuit to contain a number of additional components. For one thing, it limits the current that is drawn by the displays. Without current-limiting, the LED's would tend to overheat and burn out and, in the past, current-limiting resistors would have been required to prevent that from happening; the CA3161E eliminates the need for them. That IC also allows the displays to be multiplexed; that means that only one LED is on at a time—although they're switched on and off so rapidly through driver transistors Q1-Q3 that they all seem to be on simultaneously. Multiplexing the displays saves a lot of power, and the total current needed to operate the voltmeter is 160 mA or less.

The maximum voltage differential allowed between the input pins on IC2—pins 10 and 11—is 999 mV. Therefore, resistors R1 and R2, whose values have the ratio 100:1, are used to form an attenuation network with a factor of 100. If 13.8 volts are applied to the attenuator network, the voltage difference between the pin 10 (which is grounded) and that at pin 11 (the input pin) will be, according to Ohm's law, 136.6 mV. What we want it to be, though, is 138.0 mV. That differ-

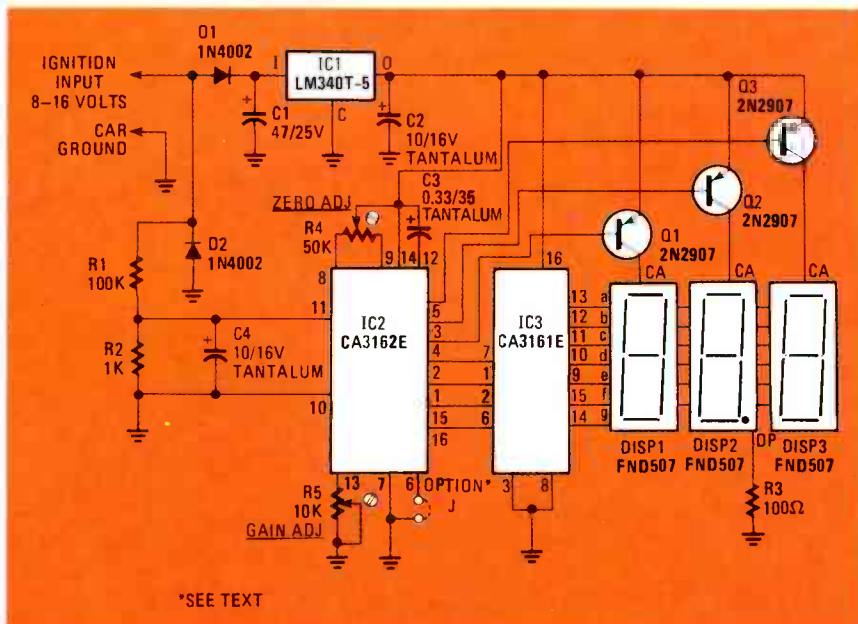

FIG. 1—NOTE THE POINTS MARKED "OPTION" at pins 6 and 7 of IC2; they allow the sampling rate of the converter A/D to be changed. See the text for details.

ence is compensated for by the GAIN ADJUST potentiometer, R5.

The ZERO ADJUST potentiometer, R4, is used—together with a 0.33  $\mu$ F capacitor, C3—to generate the correct internal ramp-voltage (needed for the dual-slope A/D conversion process) for IC2. We'll discuss the adjustment of both potentiometers later.

Finally, there are two different conversion rates (the rate at which the A/D converter samples the analog input and changes it to digital form) available from IC2. Tying its pin 6 to five volts will produce a conversion rate of 96 (samples) per second. That speed, though, will cause the last digit of the display to become a blur, so we use the other conversion rate—four samples-per-second—by tying pin 6 to ground. The point at which the choice of conversion rates is made is marked "OPTION" in the schematic.

### Construction tips

The voltmeter is so easy to build that the process really needs little description. Instead, we'll assume that this is the first circuit you've ever put together, and give you lots of helpful information. Even if you're an experienced constructor, you may find something of interest here, so don't skip this section!

While an etched and drilled circuit board is available from the source indicated in the Parts List, you may decide to go all the way and make your own (the foil pattern is reproduced in Fig. 2). Techniques for making your own PC boards were discussed in detail in the December 1982–February 1983 issues of **Radio-Electronics**. If the board's foil traces are naked copper, there is the possibility that some oxidation may have taken place if the board was not used immediately, and the copper may be difficult to solder to. If

that's the case (or even as a preventative measure) use a clean *dry* scouring pad to wipe the copper side of the board gently and bring it to a relatively high polish. *Do not* try to clean it up using a buffing wheel! Then wipe it off with a soft cloth. It should then be as solderable as a board that's just been produced.

The choice of a soldering iron is very important. It should be low power—about 27 watts—and should be used sparingly. Keep it in contact with the points to be soldered only long enough to do the job; if you apply too much heat to a PC board the foil is apt to separate from the board. Use as fine a tip as you can get—that not only keeps heat-buildup down, but lessens the possibility of your creating solder blobs and bridges between adjacent foil points that were meant to be isolated. A fine (thin) rosin-core solder will also help keep your work neat. Use only as much solder as is needed to "wet" the connection; don't make big

blobs.

A final word about soldering: keep the tip of the iron clean. A clean tip is a requirement for precision soldering. As your work progresses, solder will usually accumulate on the tip of the iron and it is important that you start soldering with a clean tip, and that you stop the buildup of solder on the tip before it gets started. A damp (not sopping wet) sponge makes a good tip cleaner. Place it out of the way on a plate where you can lightly wipe the tip against it frequently. Wipe the tip whenever you are about to put the iron down after using the it, or at intervals if you are soldering something like a series of IC pins. And, of course, wipe the tip well at the end of your work session.

Many components—like IC's, LED's, diodes, transistors, and tantalum or aluminum electrolytic capacitors—are polarized. That means that they will work properly only if they are installed in the circuit so that the correct pins or leads go to the appropriate points.

The polarities of diodes and capacitors are clearly indicated in schematics and parts-placement diagrams. On diodes, the cathode end is indicated a band; on capacitors, the positive lead may be marked with a dot on the body of the capacitor, or in another fashion. The September 1982 and November 1982 issues of **Radio-Electronics** contained a lot of valuable information on the various types of electronic components; you might want to take a look at them.

Integrated circuits like the ones used in the voltmeter come in DIP (*Dual In-line Pin*) packages. The pin-1 end of the IC may be marked with a notch, a dot (usually placed next to pin 1), or both. Many IC sockets—which you should use, by the way, in case you have to remove an IC for some reason—also have their pin-1 ends marked, even though the sockets themselves are not polarized. Those markings help you to remember which way the IC is to be installed.

Finally, a word of caution about IC's. Many of them—including the CA3161E

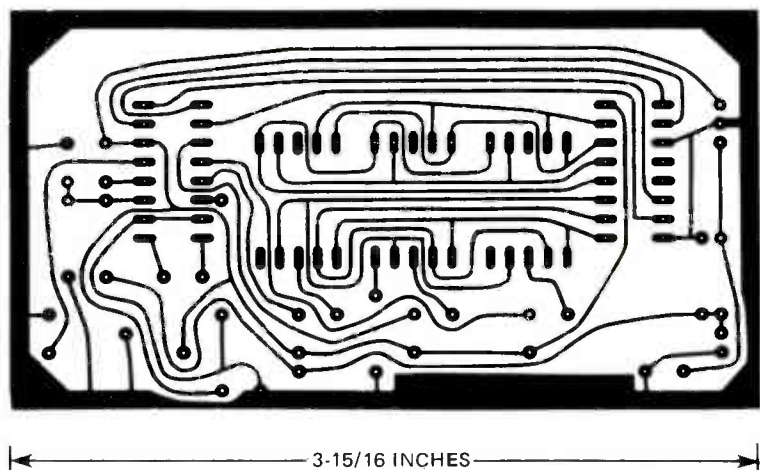

FIG. 2—FOIL PATTERN FOR ETCHING the voltmeter PC-board. A ready-to-use board is available from the supplier indicated in the Parts List.

and CA3162E—can be damaged by static electricity. Do not wear clothing made of synthetic fibers when working with such devices (although, once they've been installed on the PC board, they're relatively safe from harm and you can pretty much wear what you like). If static electricity is a problem for you, handle the IC's under humid conditions. A good solution to the problem is to steam up your bathroom by running the hot water in the shower for a few minutes and then installing the IC's in their sockets in that room while the air is still damp. That trick is especially useful in winter.

### Construction

A red plastic filter will make the displays of the voltmeter easier to read under difficult lighting conditions. Use a piece of plastic  $\frac{1}{8}$ -inch thick and a little larger than the PC board. Drill a hole in each corner of the PC board, and drill matching holes in the plastic. To avoid cracking the fragile material, drill small pilot-holes first, and then carefully enlarge them. Be careful not to scratch the plastic. Then set the plastic aside temporarily and, with the advice just given in mind, proceed to "stuff" the PC board.

Use Fig. 3, the parts-placement diagram, to guide you. Install the IC sockets first, and then the resistors, diodes, and capacitors. Don't forget the "OPTION" jumper, which can be a piece of leftover resistor lead. Save the larger parts, like the potentiometers, for last. The  $47\ \mu\text{F}$  capacitor, C1, can be mounted on the foil side of the board if you wish to conserve height between the plastic filter and the voltmeter board.

When you install the LED's, which can be soldered directly to the board, be certain that you mount them with the side with the ridges at the top (if you look closely, you'll be able to see the decimal point of the display at the lower right). Solder only two pins, at opposite corners

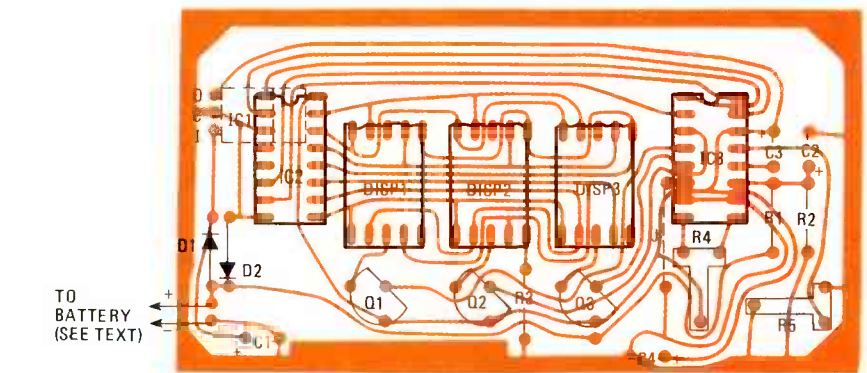

FIG. 3—NOTE THE RIDGES AT THE TOPS of the display LED's. The devices must be installed with the ridges in that position.

of each device, first. That will allow you to reposition the displays easily if you find that they're in at an angle.

The five-volt regulator, IC1, should be mounted on the foil side of the board as shown in Fig. 4. Bend the leads carefully as shown so they arch backwards. The reason for installing the regulator on the back of the board is, again, to conserve height.

Connect about three feet each of red and black 22-gauge wire to the "IGNITION" and "GROUND" pads of the board, respectively. That will prevent confusion later on in connecting the voltmeter to the vehicle.

Finally, *do not* install IC1 and IC2 in their sockets until you have carefully inspected the board for poor solder-connections, solder bridges, proper component-orientation, and anything else that you might conceivably have done wrong (*anyone*—even you—can make a mistake). Then verify that the supply voltages to the IC sockets are correct. If you temporarily connect the red and black wires to a 12-volt-DC source, you should measure five volts at pin 14 of the socket for IC2 and at pin 16 of the socket for IC3. Pins 7 and 8, respectively,

### PARTS LIST

**All resistors 5%,  $\frac{1}{4}$  watt unless otherwise indicated**

R1—100,000 ohms

R2—1000 ohms

R3—100 ohms

R4—50,000 ohms, trimmer potentiometer

R5—10,000 ohms, trimmer potentiometer

#### Capacitors

C1— $47\ \mu\text{F}$ , 25 volts, electrolytic (axial leads)

C2, C4— $10\ \mu\text{F}$ , 16 volts, tantalum or electrolytic (axial leads)

C3— $0.33\ \mu\text{F}$ , 35 volts, tantalum

#### Semiconductors

IC1—LM340T-5 (7805) five-volt regulator, tab type

IC2—CA3162E dual-speed, dual-slope A/D converter

IC3—CA3161E BCD 7-segment LED decoder/driver

Q1—Q3—2N2907 or similar PNP transistor

DISP1—DISP3—FND507 or FND510 7-segment LED

D1, D2—1N4002

**Miscellaneous:** PC board, IC sockets, wire, red plastic filter, mounting hardware, etc.

The following are available from Digital World, PO Box 5508, Augusta, GA 30906: PC board only, \$7.50; PC board with schematic, \$8.50; CA3161E and CA3162E, \$12.00; PC board with all three IC's and with IC sockets, \$20.00; kit of all parts (no filter, chassis or solder) \$30.00. The prices of the *first two items only* include postage and handling costs within the continental U.S. and Canada. For all other items add \$2.00 within the continental U.S.; \$3.00 all other U.S., APO, and FPO. Canadians please use U.S. postal money order. Other countries write for prices and shipping costs. Please allow 4-6 weeks for delivery.

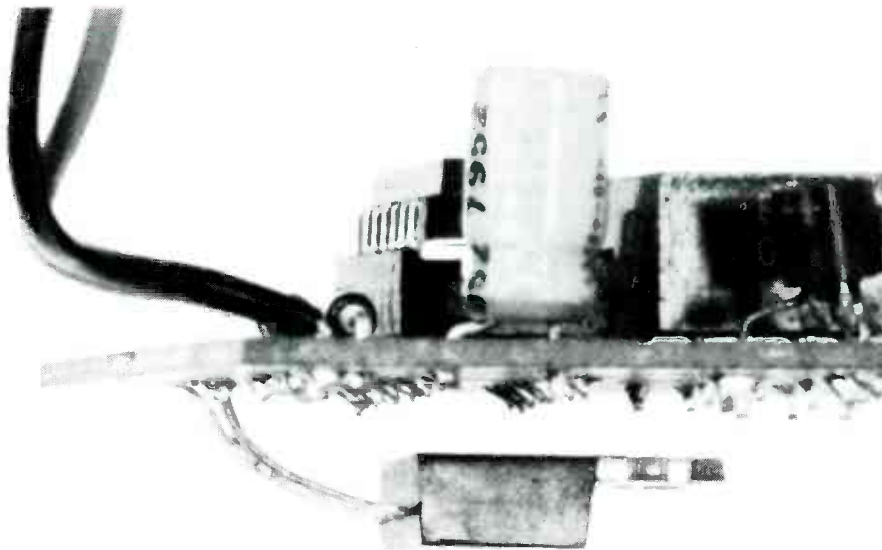

FIG. 4—THE FIVE-VOLT regulator is mounted on the bottom of the PC board, exactly as shown.

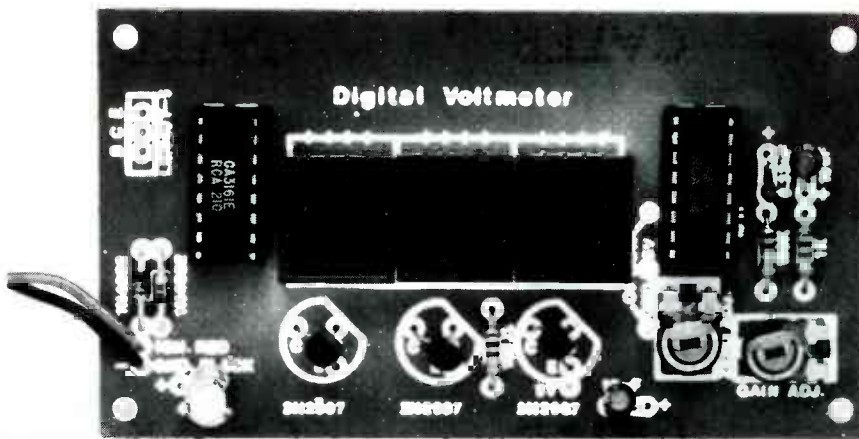

FIG. 5—THIS IS WHAT the completed voltmeter should look like prior to installation.

of those sockets should be at ground potential; you should measure no voltage there.

If your voltage readings are correct, you can disconnect the board from its temporary power supply and install the two remaining IC's. If your measurements differed from those indicated, recheck the board carefully for errors. The completed board should look similar to the one shown in Fig. 5, assuming, of course, that you used the same types of capacitors and other parts.

### Calibration

Connect a known, accurate, voltage source to the red and black input wires of the voltmeter. If you already have an accurate meter, connect it in parallel with the one you're calibrating to act as a double check. The calibration voltage should be between 10 and 16 volts; 13.8 volts is recommended. Do not attempt to use a source of less than 10 volts, for it may result in inaccuracies.

To set the ZERO ADJUST trimmer potentiometer, R4, temporarily ground pins 10 and 11 of IC2 to the ground foil of the PC board. Then, very carefully adjust the pot until the display reads "00.0." (You'll need a very fine screwdriver—and some patience—for this.) You can then unground the two IC pins.

Adjust the GAIN ADJUST trimmer potentiometer, R5, until the display indicates the exact value of the calibration voltage being applied. That's all there is to it.

### Troubleshooting

If the voltmeter did not light up for the calibration procedure, first make sure that potentiometer R4 is centered. If there is still no response, double check your work once again for solder bridges, unsoldered connections, components installed incorrectly, etc. Carefully remove the IC's from their sockets and make sure that none of their pins were bent under.

If the displays are dim, check the emitter and collector leads of transistors Q1-Q3; you might have mistakenly inserted the transistors backwards.

If a digit seems to be trying to display two numbers at the same time, its driver transistor may be defective.

If, after you've installed the meter, it doesn't work, make certain that the red and black wires are properly connected to the "tie in" point and to ground, respectively.

### Installation

The first step in installing the meter is to mount the plastic filter in front of it. That can be done using 3/4-inch spacers, or by making spacers using 1 1/2-inch bolts and nuts. If you use the latter method, insert a bolt through the plastic and put a nut on the reverse side. Then put a second nut on the bolt, allowing 3/4-inch of space between it and the first nut. Do that at all four corners of the plastic. Next, insert the bolts through the holes drilled in the PC board, and secure them with four more nuts. Securing the plastic at all four corners gives the assembly greater strength and minimizes the potential for the plastic's cracking from vibration.

The voltmeter does not require a special cabinet or chassis. It can be mounted in a recess in the dashboard of the vehicle and the edges of the mounting hole covered with a frame, or bezel. For a touch of class, the displays can be mounted on a separate board (a duplicate of the voltmeter board will do quite nicely) and "remoted" from the meter itself. In that case you'll need a 14-conductor ribbon cable to connect the two boards.

The black wire should be securely connected to the vehicle's chassis ground. The red wire should go to a point in the vehicle's electrical system that is active only when the ignition switch is turned on; a good place for that connection is at the same fuse terminal to which the radio is connected.

Now that your voltmeter is installed and working, what voltages should you expect to read? You're probably thinking that the answer is 12 volts. Wrong! Actually, it should be about 12.6 volts. When you're driving, and the battery is being charged, expect to read about 13.8 volts. Any readings above 17 volts or

below 11 volts (such as when cranking the starter) indicate trouble!

### A possible problem

It is possible that the display-multiplexing circuit will interfere with the operation of an AM radio (especially if the meter and the radio are connected to the same point) by generating some radio-frequency interference that will cause the radio to "whine."

Some radios are more sensitive to that problem than others. There are several solutions to that problem, should it occur.

First, try using a "tie in" point other than the one used by the radio. Just remember that it should be active only when the ignition switch is on.

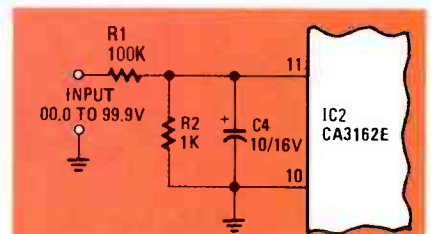

FIG. 6—USING RESISTOR R1 as the input allows you to measure up to 99.9 volts. See the text for precautions.

You can also try moving the meter away from the radio (or vice versa).

Finally, you can try shielding the voltmeter circuit in a metal box. That is usually very effective.

If you decided to "remote" the display from the rest of the meter circuit, wrap the connecting ribbon cable in aluminum foil, and connect the foil to ground. That is almost a "must" in applications where the two units will be separate.

### Use with higher voltages

The voltmeter can be used to measure voltages up to 99.9 volts *provided that two conditions are met.*

First, the supply voltage to the board must be between 8 and 16 volts. Any lower, and the regulator will not function properly; any higher and it will quickly self-destruct.

Second, the end of the 100K resistor (R1) connected to D2 should be disconnected from that diode, and the voltage being measured applied to the circuit through that resistor. This is shown in Fig. 6.

A last word of advice: Even though your new meter will almost certainly be more accurate than the old indicator you were using, don't get rid of the old one! Keep it in place to monitor the functioning of the meter you built, and to act as a backup just in case something should go wrong.

If you follow the instructions given here, you will not only have learned something about electronics construction-techniques, but you will also have built yourself a very useful measurement instrument. **R-E**

## Using LORAN-C for Time and

THE LORAN NAVIGATION SYSTEM OPERATES on two different frequencies, each with a different set of characteristics. Each frequency has its own Loran designation—Loran-A and Loran-C. Although Loran-C's primary purpose is for long-distance navigation, it has another important use. Because Loran stations have to maintain a high level of precision they can—if used properly—serve as extremely accurate frequency standards. In this article we'll be discussing how we can use Loran-C signals for such applications as calibrating a frequency standard or a frequency-counter timebase.

Before we get into the details of the Loran-C system, let's take a brief look at how Loran-C signals can be used for calibration purposes. The Loran-C signals are observed on an oscilloscope that is externally triggered by a special pulse generator. (The pulse generator is quite simple, and we will provide construction details for it shortly.) The pulse generator is driven by the frequency standard you wish to calibrate. (Details for calibrating a 1-MHz frequency standard will be given, but other frequency-standards can also be calibrated using this technique.) The stability of the frequency standard can be obtained by determining the time it takes the display of the Loran-C signal to drift a given distance across the screen. Using this technique you can calibrate a 1-MHz oscillator to better than 0.001 Hz.

### The Loran-C navigation system

Loran-C signals are broadcast on a frequency of 100 kHz with a 20-kHz bandwidth (from 90 to 110 kHz). Because of their low frequency, Loran-C signals tend to be ground waves—they follow the earth's curvature. The signals are usually very stable because they are not affected by the ionosphere. But how are they used for navigation?

Loran signals are sent from a *chain* (usually three to five) of stations. One station in each chain is the *master* and the others are *slaves*. The master station transmits groups of pulses that are received by the slave stations. Each slave station transmits similar groups of pulses, and adds a fixed time-delay between the groups of pulses transmitted by the master and its own pulse groups. A Loran-C receiver receives both pulse groups and

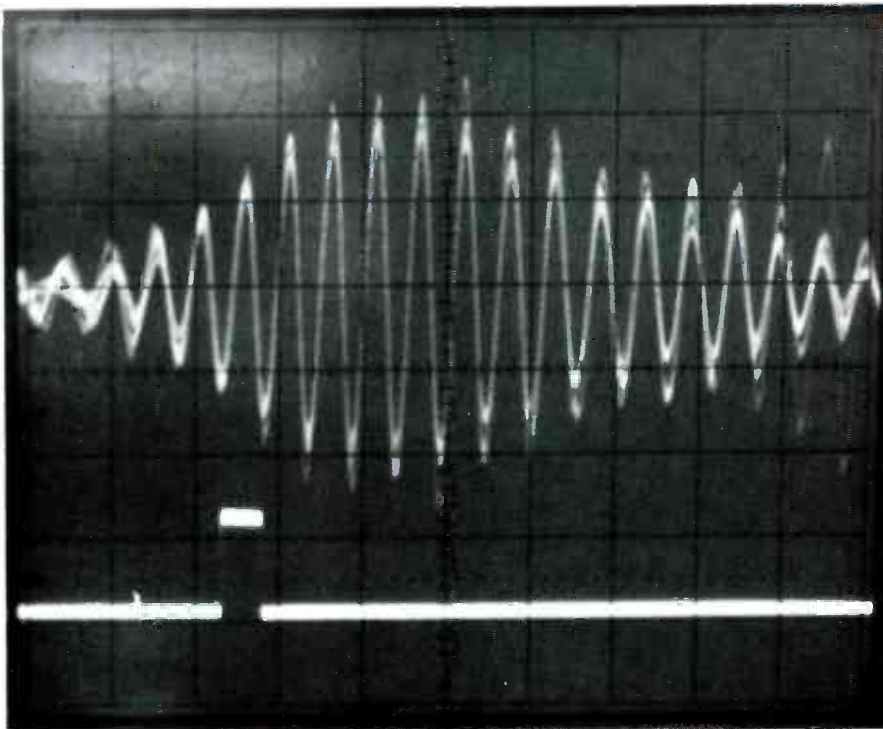

## Frequency Calibration

*Here's a look at the Loran-C navigation system—what it is and how it works. We will also discover how Loran-C signals can be used as frequency standards for calibrating oscillators.*

R.W. BURHANS

calculates the time difference between them. It is that time difference that is used to establish a line of position that is used for navigation.

If (at the receiving end) the time difference between the received signals were to equal the original delay added by the slave station, the receiver would be somewhere along a straight line equidistant from both the slave and the master transmitters. If the time difference were to deviate from that fixed time-delay, the

receiver would be somewhere along a particular hyperbola. (A hyperbola is a curve where the *difference* of the distances from any point on the curve to two fixed points is a constant.)

As shown in Fig. 1., a second pair of transmitters (the same master but a different slave) can be used to construct a second hyperbola. The intersection of the two hyperbolas is the receiving point. To be useful for navigation, at least three Loran stations in a chain must be re-

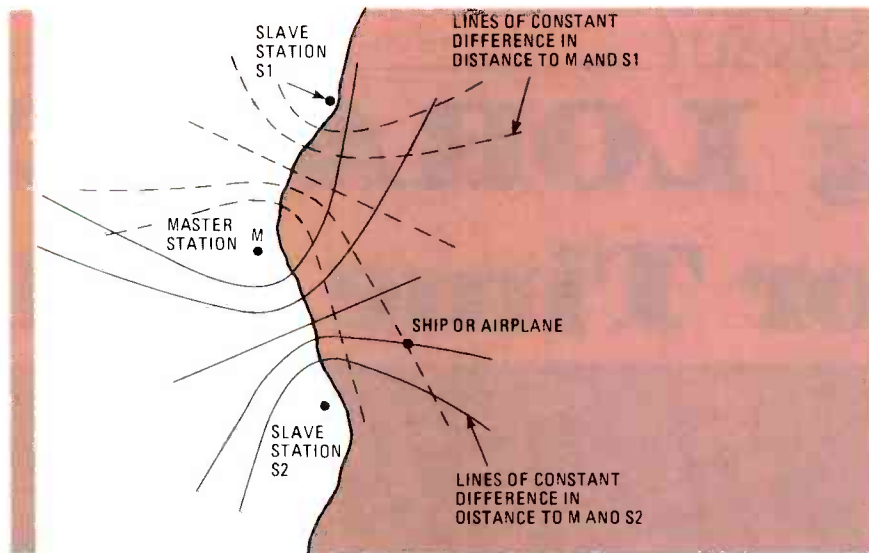

FIG. 1—AT LEAST THREE Loran stations must be received to be useful for navigation. Each master-slave pair is used to establish a particular hyperbola of constant time-differences. The intersection of the hyperbolas gives the receiver location.

ceived. However, for time- and frequency-calibration applications—which is what we are interested in—only one Loran station needs to be received.

One source of more detailed information on the Loran-C navigation system, is the *Loran-C Handbook*. For information on its price and availability, write the Superintendent of Documents, U.S. Government Printing Office, Washington D.C. 20402. The book's stock number is 050-012-00171-5.

### Loran-C receivers

The sophistication of modern Loran-C receivers is now very high—some will directly compute your latitude, longitude, range, and bearing. The cost of those receivers is also high, typically \$5000 for marine systems and \$10,000 for airborne receivers. The navigational precision that can be obtained varies with the chain's geometry and distance, but it can be as good as  $\pm 50$  feet when differential and propagation corrections are taken into account.

A complete Loran-C navigation receiver usually consists of the main components shown in Fig. 2: an active-antenna coupler, an RF sensor, a sensor processor, a navigation processor, and finally a data-display device. The last three are microprocessor controlled.

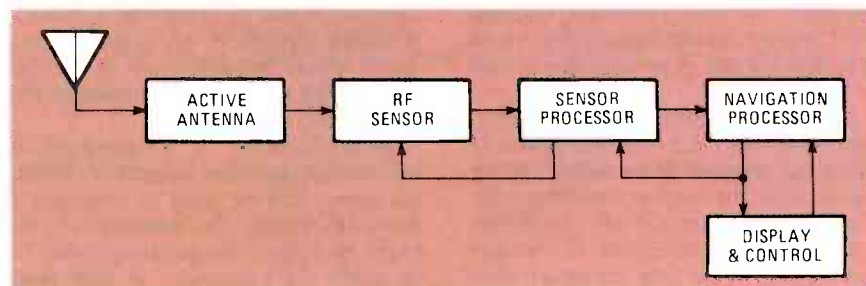

FIG. 2—BLOCK DIAGRAM of a Loran-C navigation receiver.

search mode, and to reject multi-hop sky waves.

### Sky waves

One problem encountered when using Loran-C is that the ground waves are often contaminated by sky waves. (Remember—one of the reasons that Loran can be used for great accuracy is due to the stability of ground waves.) So that the signal at the receiver will not be contaminated by the arrival of sky waves, a signal with a fast risetime is used. That allows the pulse to build up to its maximum value at the receiver before the sky waves arrive. Also, the tail of one pulse should be low in amplitude when compared to the beginning of the next one so that the trailing sky waves will not contaminate the beginning of the next pulse. The limiting constraint on a signal's risetime is its bandwidth. (For example, a squarewave has a very fast risetime, but its bandwidth would be too large to be used by the Loran system.)

The pulse shape shown in Fig. 3 is used to reduce the problem of one pulse affecting the beginning of the next—the tails of the pulses are greatly attenuated (and the 20-kHz bandwidth constraint is still met.) The third cycle of the pulse (that's the one which is tracked by the receiver) will not be contaminated by sky-wave (or reflected) signals.

Because the transmitted signals have a relatively wide (20-kHz) bandwidth, ordinary communications receivers cannot do a good job of detecting Loran-C pulses, although some receivers with a 12-kHz bandwidth can do a reasonable job for long-term frequency calibration (where the local clock is kept running 24 hours a day).

As we mentioned previously, a Loran-C receiver is designed to detect a point on the signal (the third cycle) before the stronger sky waves have a chance to contaminate the envelope. That task is not easy to perform and there is still argument over the best way to detect the earlier, weak ground wave at long range when it has been contaminated with sky waves (which often have a peak level 20 dB greater than the ground wave). Because

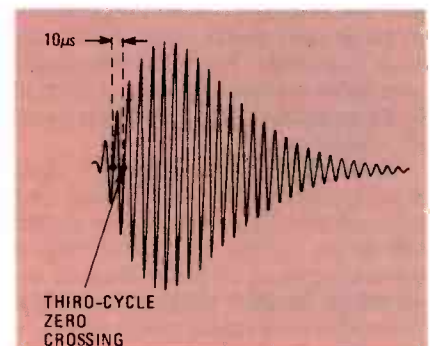

FIG. 3—IDEAL SHAPE of a 100-kHz Loran-C transmitted pulse. Note how the trailing edge is attenuated so that the trailing sky waves will not interfere with the next pulse.

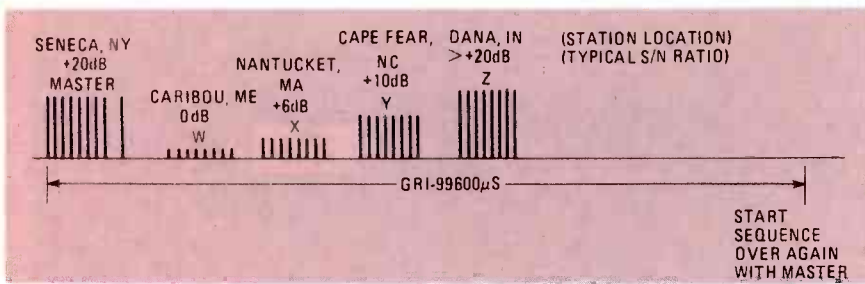

FIG. 4—RELATIVE ENVELOPE AMPLITUDES of a Loran-C chain as received in the midwestern US. Note the "extra" pulse that identifies the master.

the sky-wave signals are not stable—they vary considerably in amplitude and risetime—large errors will be produced if the receiver tracks them.

Another problem with Loran receivers is that any filtering will delay the risetime of the signal so that, with many receivers, a point later than the ideal third cycle is tracked. However, as long as that point is the same for all signals, strong or weak, and is chosen to precede the sky wave's reaching an appreciable amplitude, then the receiver can still operate satisfactorily. Let's look at how the third cycle of the Loran-C pulse is detected.

### Third-cycle detection

A theoretical way of detecting a point on the pulse shown in Fig. 3 is to generate the second derivative of the pulse's envelope shape. The resultant envelope has a zero crossing at about 35 µs. The problem in this case is that the envelope generator (with the differentiators) ends up with an extremely wide bandwidth—that adds a lot of noise to the system.

Another way to detect the third cycle is to produce a delay-and-add circuit. Such a circuit delays the signal 5 µs (180°) and then algebraically adds the delayed signal to the original (with a multiplying constant) to produce a phase reversal at about

the 30-µs point. A simple implementation of a delay-and-add network—and the effect it has on the Loran-C signal—is shown in Fig. 5.

If the output *pinched-balloon* shape of the delay-and-add network is fed to a *hard limiter*, then the result, as shown in Fig. 5, is a rectangular waveform where the phase-reversal point (the third-cycle point) has a gap. All the receiver designer then has to do is to devise some machine-language software to track that gap for the stations of a given chain. That is, of course, no easy task. But that's what is done in the sensor processor of many Loran-C receivers.

Another problem with Loran reception and third-cycle detection is that the conductivities of the earth and of seawater are different. That can cause the group velocity and the phase velocity of the signal to differ, producing an envelope-to-cycle difference (ECD) error up to several microseconds (depending on the terrain and the distance). (Some very precise Loran-C receivers can use that to an advantage. Precision measurements of the amplitude and phase of Loran-C signals made while flying at low altitudes can yield information on the ground's contours.)

Still another problem associated with Loran-C receivers is the fact that strong interference on frequencies like 88 kHz or 116 kHz can produce errors in the navigation data. Fixed, tuned traps—that are designed for particular coverage areas where there are interfering signals—are often found in Loran-C receivers.

### RF filtering

A signal takes a finite time to pass through a filter. That time, called a delay, is a function of the signal's velocity. The signal's velocity is a function of its frequency. (For instance, the signal's velocity is lowest at the lower band-edge.) Thus, a filter can cause EDD (*Envelope Delay Distortion*).

The effect that a filter with narrow skirts has on the received signal is shown in Fig. 6. Here we have assumed a worst-case sky wave rising at about 30 µs after the start of the ground wave, and we have assumed that the peak amplitude of the sky wave is 20 dB greater than that of the ground wave.

The filter delays the Loran ground-wave signal (the envelope's zero crossing

occurs at a later time), but coincidentally, the strong sky-wave signal is also delayed. Unfortunately, however, the ground wave's third cycle (which we want to detect) is at -60 dB. Fortunately, though, even at the 50-µs point the desired pulse is some 30 dB greater than the sky-wave contamination.

A -30-dB contamination of the tracking point at 50 µs would result in a small error in the data. The data will contain additional error because the results are not as precise when the fifth cycle (50-µs point) is tracked instead of the third cycle. However, as long as the sky-wave contamination is low enough, and the same point is tracked for all signals, then the error can be kept down to perhaps 0.1 µs, even for a weak signal.

The effect of filtering and AGC in conventional communications receivers destroys most of the information in the Loran-C signal. However with a receiver such as the Yaesu FRG7700 in the WIDE-BAND AM (12-kHz) mode, it is just possible to track the fifth cycle (which will be about the start of the pulse envelope as observed at the receiver's line-level output terminal). Noise blankers in communications receivers also destroy the pulse information because they are inherently timed to blank a pulse of the Loran-C shape and duration.

The envelope detector and simple GRI generator that we will discuss next are useful for experimental observations but are not well suited to precision navigation-receiver applications. The minimal equipment required for Loran-C observation is: a triggered-sweep oscilloscope, a frequency standard, a GRI generator (we'll discuss one), and a reasonably wideband AM receiver. If you do not have a suitable receiver available, you can use the Loran-C front end (or envelope detector) that we'll discuss next.

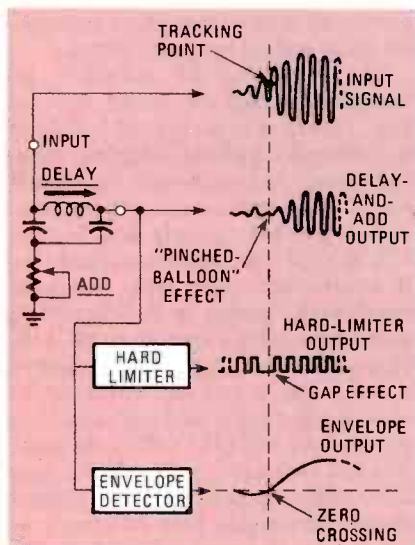

FIG. 5—A DELAY-AND-ADD network can be used to produce a pinched-balloon effect output, which is then used to produce an envelope with a zero crossing at the third cycle.

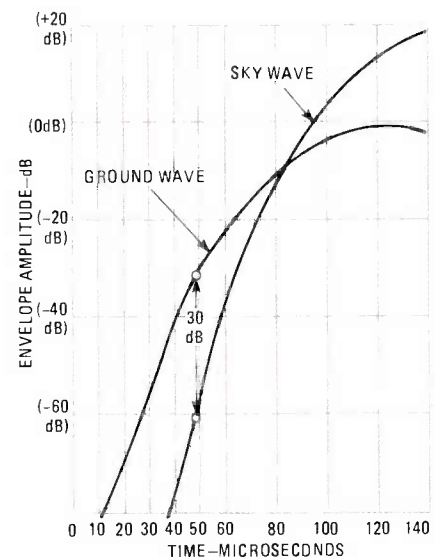

FIG. 6—A FILTER DELAYS both the Loran-C sky-wave and ground-wave signals, resulting in an zero crossing at about the fifth cycle.

## RF envelope detector

For the experimenter who wishes only to study Loran-C or to use the signals as a frequency-calibration source, the envelope method (which detects the envelope zero-crossing as shown in Fig. 5) is simple and effective. A schematic of an envelope detector is shown in Fig. 7. The active-antenna preamplifier has been described previously (see the February, March, and April 1983 issues of **RADIO-ELECTRONICS**). It uses a 1-meter whip with a 150-kHz lowpass filter at the antenna input. The "receiver" coupler is built as part of the Loran-C front end (Fig. 7) and consists of an 80-kHz highpass filter (instead of the 10-kHz filter used with the previous active-antenna circuits). The output of that coupler is fed to a network consisting of a 100-kHz impedance-matching transformer; to series T-notch traps tuned to 88 kHz and 115.3 kHz; and finally to an MC1350 RF amplifier. The sequence of matching and filtering at the input is an impedance step-up to the MC1350 RF stage such that there is a net voltage gain of 10 dB or more between the active antenna and the RF stage, which provides an added 60 dB of gain. The RF stage is operated with a manual control-voltage for the RF gain (or an external AGC system could be devised). The amplifier drives a transformer and a delay-and-add network. The delayed output and the undelayed (RF-amplifier) output are fed to an MC1357 FM detector. There, the hard-limited RF carrier is mixed or multiplied with the delay signal. That results in an envelope with the same amplitude and phase as that from the delay-and-add network. The zero crossing is adjusted for 40 to 50  $\mu$ s, and the ADD trimmer potentiometer is adjusted for a good null at the zero-crossing point. The actual pinched-balloon effect can be observed on a scope at pin 11 of the MC1357.

To align the RF transformers and traps with the active antenna preamplifier you can use a signal generator along with a 10-pF coupling capacitor to inject a signal at the antenna input. (By doing that you are simulating the response that will be obtained from the active antenna in the presence of an electromagnetic field.) The response at the input (pin 4) of the MC1350 should look something like that shown in Fig. 8, with a peak at about 103 kHz, nulls at 88 kHz and 115.3 kHz, and fairly wide skirts. The MC1350 output transformer is peaked at about 100 kHz and the delay network is adjusted using an on-the-air Loran-C signal.

With this front end, the zero crossing will actually be at about the fourth or fifth cycle of a strong Loran-C signal. But that is quite satisfactory. If a Loran-C signal simulator is available, the network should be adjusted for a pinched-balloon effect (or zero crossing) at about 40  $\mu$ s.

The output from the limiter/detector drives a 3-pole 33-kHz lowpass filter (IC3

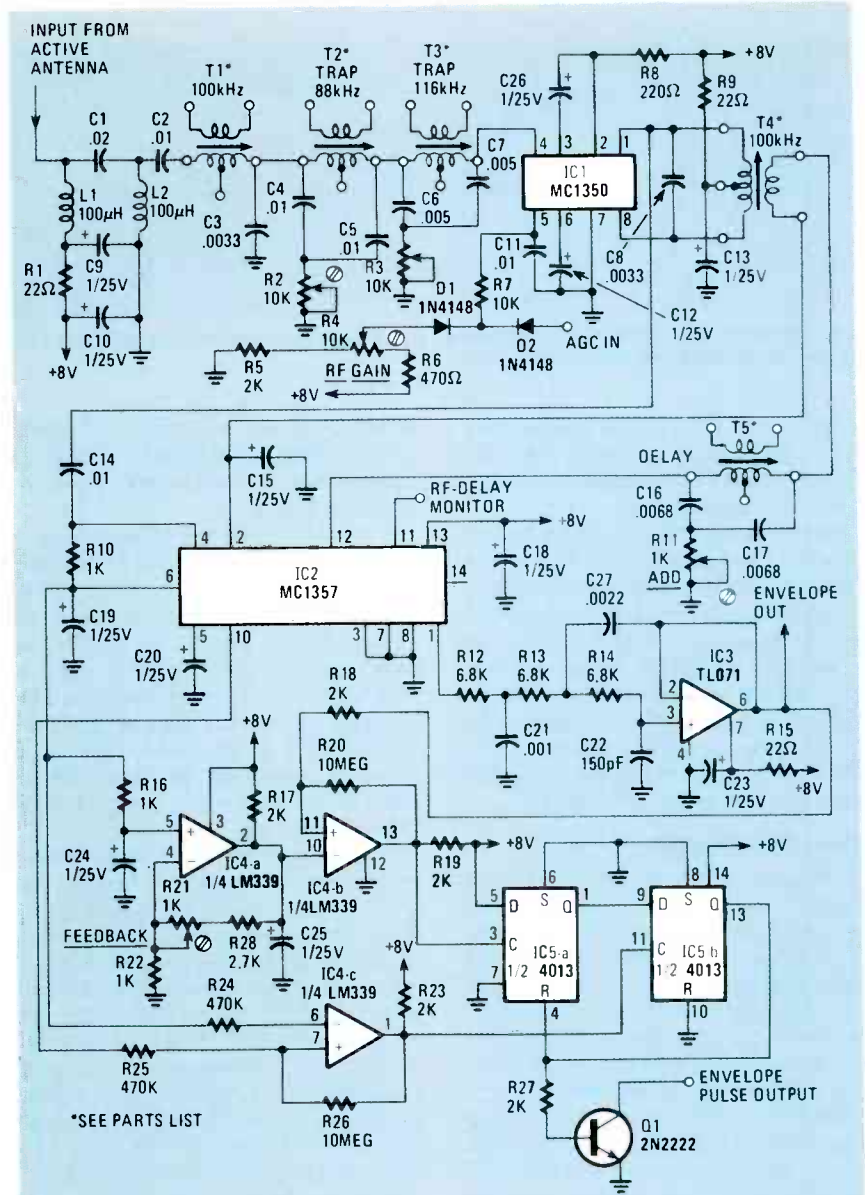

FIG. 7—THE LORAN-C FRONT END can be used to study Loran signals if a receiver with sufficient bandwidth is not available.

and its associated components) to generate a DC envelope that can be observed on an oscilloscope. The comparators and flip-flop provide a synchronized 10- $\mu$ s pulse at the envelope's zero-crossing point, but it is fairly noisy compared to observing the envelope at the analog lowpass-filter output. However, this output pulse for each Loran-C envelope is useful for further experimenting with microcomputer tracking-loops (where the bandwidth of the noise can be narrowed with memory-aided numerical techniques in software).

West-coast and foreign experimenters may wish to align the interference traps at some other frequencies. It is a good idea to keep the traps outside the 90 to 110 kHz region because they are not high enough in Q and could attenuate too much of the desired Loran-C signal. A lot of detuning—going back and forth over the adjustments of all of the tuned circuits—pays off in arriving at a reasonably wide

bandwidth with a sharp phase-reversal at the delay-and-add network output.

The adjustable RF inductors and transformers used in the circuit shown in Fig. 7 are normally 455-kHz IF transformers padded with additional capacitance to tune them to the 100-kHz region. The particular transformers in this experimental circuit are Mouser 42IF303's, a type sometimes called a 3rd-IF transformer. Other types will sometimes work, except in the case of the transformer at the output of the MC1350. That's because the tap on the transformer is not a true center tap. However, the loading effect of the 0.01-mF capacitor at pin 4 of the MC1357 makes the output look like a balanced load for the RF stage. Some older transformers, from different manufacturers, may have different winding phases, so you may have to reverse the secondary connections to get everything operating properly. The phase of the smaller output-winding has to be such



## PARTS LIST— ENVELOPE DETECTOR

All resistors 1/4 watt, 5% unless otherwise specified

R1, R9, R15—22 ohms  
 R2, R3, R4—10,000 ohms, trimmer potentiometer  
 R5, R17, R18, R19, R23, R27—2000 ohms  
 R6—470 ohms  
 R7—10,000 ohms  
 R8—220 ohms  
 R10, R16, R22—1000 ohms  
 R11, R21—1000 ohms, trimmer potentiometer  
 R12, R13, R14—6800 ohms  
 R20, R26—10 megohms  
 R24, R25—470,000 ohms  
 R28—2700 ohms

### Capacitors

C1—0.02  $\mu$ F, polystyrene  
 C2—0.01  $\mu$ F, polystyrene  
 C3, C8—0.0033  $\mu$ F, ceramic disc  
 C4, C5—0.01  $\mu$ F polystyrene  
 C6, C7—0.005  $\mu$ F, polystyrene  
 C9, C10, C12, C13, C15, C18, C19, C20, C23—C26—1  $\mu$ F, 25 volts, tantalum  
 C11, C14—0.01  $\mu$ F, ceramic disc  
 C16, C17—0.0068  $\mu$ F, polystyrene  
 C21—0.001  $\mu$ F, ceramic disc  
 C22—150 pF, ceramic disc  
 C27—0.0022  $\mu$ F

### Semiconductors

IC1—MC1350 video-IF amplifier  
 IC2—MC1357 sound-IF amplifier and quadrature detector  
 IC3—TL071 JFET-input op-amp  
 IC4—LM339 quad comparator  
 IC5—4013 dual D-type flip-flop  
 D1, D2—1N4148  
 Q1—2N2222 or similar NPN-type  
 T1—T5—455-kHz IF transformer, Mouser 42IF303 or equivalent  
 L1, L2—100- $\mu$ H RF choke

that a positive-going envelope is created at pin 1 of the MC1357 detector IC. The transformers come with a small 150-pF built-in capacitor across the main primary winding, but it can be ignored since it is very small compared to the 3300-pF capacitor required for resonance at 100 kHz.

The LM339 comparator (for the envelope pulse signal) generates a reference voltage from pin 6 of the MC1357. The small FEEDBACK trimmer potentiometer across the LM339 reference source is used to adjust the DC level of the pulse edge that is fed to the flip-flop. The reason for doing that is that the DC level is controlled by the MC1357, so that drift in the lowpass filter DC-level or in the comparator reference DC-level is self-compensating. The envelope 10- $\mu$ s-pulse output is intended to drive external logic, usually at a five-volt level. The power source for the whole RF front-end should be from an eight-volt regulated source (using a regulator such as an LM7808).

### GRI pulse source

Practically every Loran-C experimenter needs a GRI generator that is capable of producing pulse-repetition intervals of

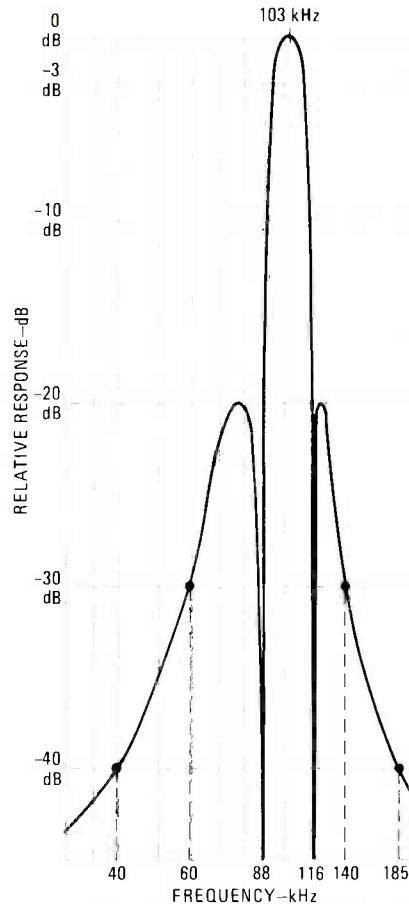

FIG. 8—THE RESPONSE AT THE INPUT to the RF stage (due to the filters) should look like this.

50,000 to 100,000  $\mu$ s. We'll discuss a simple generator that consists of a 4040 programmable ripple-counter and a dual decade-divider that is driven from a 1-

## PARTS LIST— GRI PULSE SOURCE

All resistors 1/4-watt, 5% unless otherwise specified

R1—47,000 ohms  
 R2, R3—10,000 ohms

### Capacitors

C1, C2—0.001  $\mu$ F

### Semiconductors

IC1—4518 dual decade divider  
 IC2—12-stage binary ripple counter  
 IC3—quad 2-input nor gate  
 D1—D12—1N4148  
 S1—S3—Hexadecimal thumbwheel switch, 16 position BCD, Unimax SF-54 or equiv.

MHz crystal-controlled frequency standard. There are other methods for producing GRI pulses, but the three-IC circuit of Fig. 10 is about as simple as they come. (You could, for example, use only programmable decade-dividers. And you could use something other than a 1-MHz standard to drive the GRI generator and obtain the same results.) The circuit is programmed in hexadecimal notation for the GRI intervals as indicated in Table 1. That table lists the common designation for the GRI in 4-digit numbers ( $\mu$ s/10), as is done on Loran charts and in United States Coast Guard data. The pulse generator that's shown in Fig. 9 produces a 10- $\mu$ s pulse that is used to synchronize your oscilloscope for observing Loran-C signals.

The programmable GRI-source allows the experimenter to stop the Loran-C signals on the scope trace and examine them in minute detail. That is also the basic

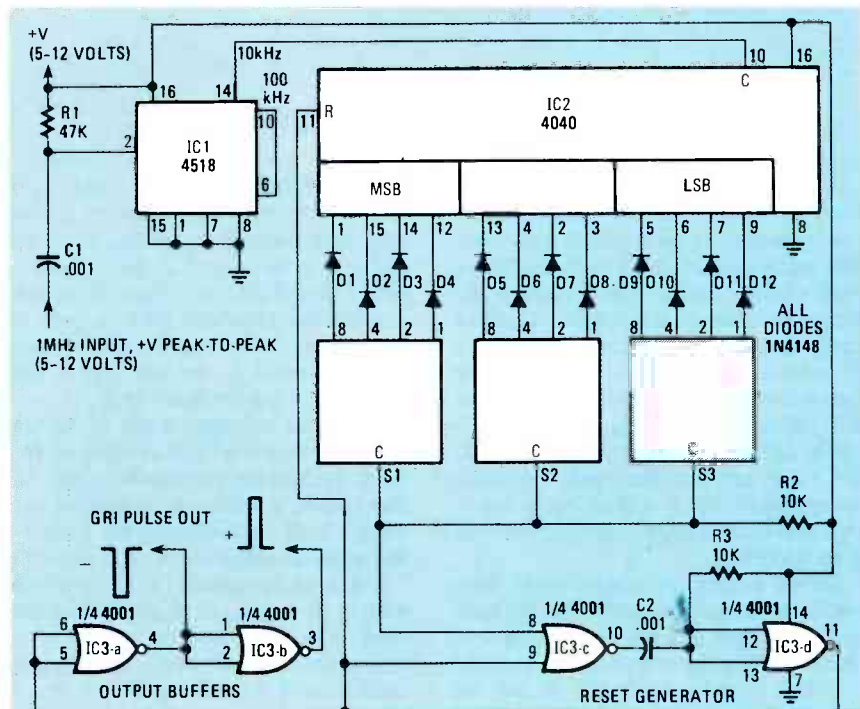
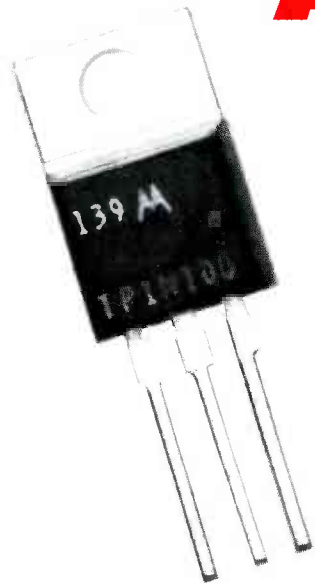

FIG. 9—THE GRI PULSE GENERATOR is used to stop the Loran signals on the scope trace so that they can be examined, and their drift measured. The drift indicates the stability of your frequency standard.

continued on page 92

# How to Design Analog Circuits

## How to Use Feedback



MANNY HOROWITZ

*This month we turn our attention to an in-depth look at both positive and negative feedback. We will discuss both the advantages and disadvantages of feedback and how to properly design circuits that use feedback.*

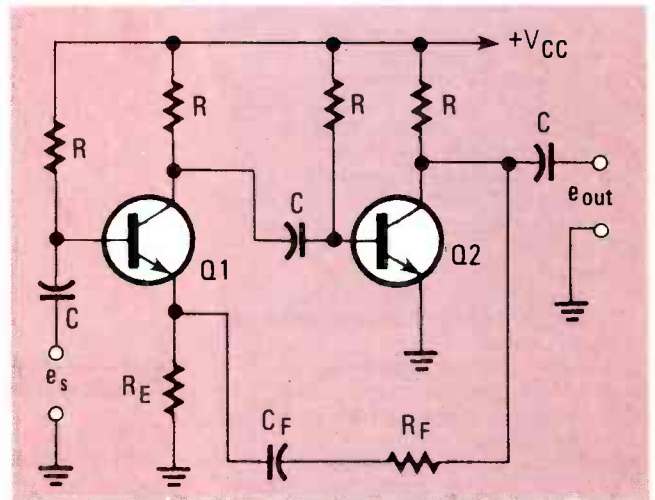

WE'VE TOUCHED UPON FEEDBACK IN some of our earlier discussions, particularly when we looked at op-amps. In those discussions we saw that feedback was important in establishing many circuit characteristics; this month we'll look more closely at that topic. Among the things we'll see are the different types of feedback, how feedback is established in an audio-amplifier circuit, and how the presence of feedback affects various circuit parameters including gain, bandwidth, and input and output impedances. We'll also see how feedback can cause circuit instability, a characteristic that is undesirable in an audio amplifier but vital in an oscillator.

Before we get too much farther, let's clarify two terms. A signal that is fed back from the output of a circuit to its input in such a way that the overall gain is reduced is called *negative* feedback. If, on the other hand, the signal is fed back in such a way that the overall gain is increased, or so that it causes the circuit to go into oscillation, it is called *positive* feedback.

### Feedback characteristics

In any circuit that uses feedback, a portion of the signal at the output is fed back to the input. The ratio  $e_f/e_{out}$ , where  $e_f$  is the amount of signal that is fed back and  $e_{out}$  is the signal at the output, has been called  $\beta$  for many years. So as not to confuse that term with the  $I_C/I_B$  ratio of a bipolar transistor, which is also identified by the symbol  $\beta$ , we will use  $B$  when referring to the feedback ratio.

With that convention out of the way, let's now look at a basic circuit with feedback, such as the one shown in Fig. 1. In that circuit, a voltage  $e_s$  is applied to the input. With no feedback, the voltage at the input to amplifier  $A$ ,  $e_{in}$ , equals  $e_s$ . The gain of the overall circuit would then simply be  $e_{out}/e_{in} = e_{out}/e_s$ . When feedback is added, however, some of  $e_{out}$  appears at the input as  $e_f$ . Assuming that the feedback is positive, that is, that the signals are in phase and thus add, the input to the amplifier becomes  $e_s + e_f$ . When feedback is negative, the signals are  $180^\circ$  out-of-phase and the input to the

amplifier equals  $e_s - e_f$ . Since  $e_f$  depends upon  $e_{out}$  and  $B$ , the gain of the circuit with feedback is:

$$A_F = \frac{A_V}{1 - BA_V} \quad (1)$$

where  $A_V$  is the voltage gain of the amplifier without feedback, or  $e_{out}/e_{in}$ , and  $A_F$  is the gain of the overall circuit with feedback. The denominator of the equation,  $1 - BA_V$ , is known as the feedback factor. When negative feedback is used, the expression  $BA_V$  is negative; when positive feedback is used, that term is positive.

Assuming that the feedback is negative, and  $BA_V$  is much larger than 1, the gain of the amplifier is just about equal to  $1/B$ . Negative feedback makes the gain of an amplifier less sensitive to variations in the circuit's parameters, such as the supply voltage. Positive feedback makes the gain more sensitive to such variations. We will see why that's important when we discuss oscillators.

Because the feedback in this circuit is

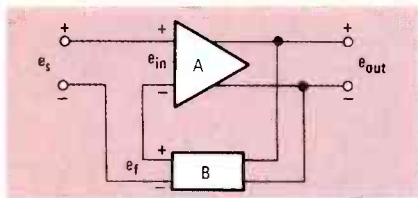

FIG. 1—AN AMPLIFIER with negative voltage feedback is shown in this block diagram.

applied in series with the input signal, the input impedance increases over what it would have been without any feedback; the amount it increases is directly proportional to the feedback factor. The output impedance, on the other hand, is reduced because the feedback signal is taken from across the load; the amount it decreases is indirectly proportional to the feedback factor. We'll see more about how input and output impedances are related to feedback later in this article.

Another effect of negative feedback is that distortion is reduced and the frequency response of an audio amplifier is improved. Distortion with feedback is equal to the distortion without feedback divided by the feedback factor. High-frequency response is extended from  $f_{OH}$ , the high-frequency limit without feedback to  $f_{OH}(1 - BA_V)$ , while the low-frequency response is extended from  $f_{OL}$ , the low-frequency limit without feedback, to  $f_{OL}/(1 - BA_V)$ . Remember here that since the feedback is negative the  $BA_V$  terms are negative and  $1 - (-BA_V) = 1 + BA_V$ .

### Designing a circuit

When designing an amplifier with feedback, the first step is to determine the amount of overall gain that will be required. Let us say you need a circuit with a voltage gain of 40 dB, or 100. Assume that in this application about 20 dB of negative feedback is necessary around the circuit to reduce the distortion to about 10% of what it would have been without feedback. Then the gain of the overall circuit must be  $100 \times 10 = 1000$  if it is to be adequate after feedback has been applied. The circuit shown in Fig. 2 should

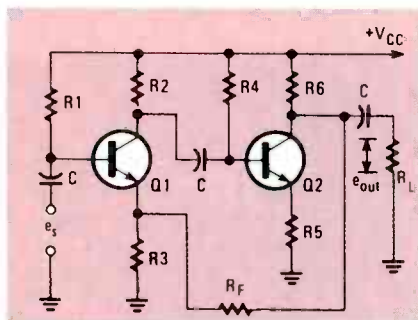

FIG. 2—IF THE FORWARD GAIN of this circuit is to be 100 after 20 dB of negative feedback is applied, the forward gain before the feedback is applied must be 1000. The circuit shown here uses series feedback.

fulfill all the requirements. (That circuit, minus the feedback loop, was first covered in the December 1982 issue of **Radio-Electronics**; please see that issue for a more complete discussion of the circuit). Assume the load,  $R_L$ , is 10,000 ohms,  $V_{CC} = 9$  volts, and the  $\beta$  of  $Q1$  and  $Q2$  are 100.

Let's start by determining the values needed to get an overall gain of 1000 (before feedback is applied). The signal across the output load should be capable of an output voltage-swing of close to 9 volts, the voltage of the power supply. To accomplish that, the value of  $R6$  should be less than one-fifth of  $R_L$ . Resistor  $R6$  is chosen to be 1800 ohms.

The load in the collector circuit is equal to the resistance of  $R6$  in parallel with  $R_L$ , or about 1500 ohms. It is actually somewhat less because  $R_F$  is in parallel with the 1500 ohms. In this first step of the design, however,  $R_F$  can be ignored. For one thing, we have not yet determined what the value of  $R_F$  is. Also, it usually has only a minor effect on the load resistance as that of  $R_F$  is very small compared to that of  $R_L$  in parallel with  $R6$ . So we'll ignore  $R_F$  until after the feedback circuit has been designed.

The gain of the overall circuit should be divided between  $Q1$  and  $Q2$ . If the overall gain without feedback is 1000, we can let the gain of each stage be about 35 so that the total gain will be  $35 \times 35$ , or 1225, which, of course, is somewhat more than 1000. As the gain around  $Q2$  is just about equal to the ratio of the load in the collector circuit to the load in the emitter circuit (assuming that the load in the emitter circuit is much greater than the AC resistance of the emitter junction itself), by rearranging terms we can see that the value of  $R5$  should equal  $1500/35$ , or about 43 ohms.

The  $Q2$  circuit presents an impedance of  $\beta \times 43$  ohms =  $100 \times 43 = 4300$  ohms to the collector of  $Q1$ . If a 4300-ohm resistor is used for  $R2$ , the impedance in the collector circuit of  $Q1$  is equal to 4300 ohms in parallel with 4300 ohms, or about 2150 ohms. If  $Q1$  is to provide a gain of 35, the value of  $R3$  should equal  $2150/35$ , or about 61.5 ohms; the closest standard value to that is 56 ohms.

Now, let's add feedback to the circuit. Resistor  $R_F$  and the 56-ohm emitter resistor,  $R3$ , are the components that determine the B term in the feedback factor. If gain is to be reduced by 20 dB and be equal to 10% of the gain without feedback, the gain with feedback,  $A_F$ , must be equal to:

$$A_F = 100 = \frac{A_V}{1 - BA_V}$$

$$A_F = \frac{1000}{1 + \left(\frac{56}{56 + R_F}\right) 1000}$$

so that  $R_F$  must be about 6200 ohms. Note that since we are again applying negative feedback, the  $BA_V$  term here is also negative and  $1 - (-BA_V) = 1 + BA_V$ .

When  $R_F$  is 6200 ohms, it reduces the load in the collector of  $Q2$  to a substantial degree. It was originally calculated to be at about 1500 ohms. With the additional 6200 ohms across it, the collector load becomes about 1200 ohms. With the 43 ohms in the emitter of  $Q2$ , its forward gain is now reduced to about 29. To re-establish a gain of 35 for that circuit,  $R5$  must be changed from 43 ohms to  $1200/35 = 34$  ohms. Use a standard 33-ohm resistor.

In the preceding analysis and example, the circuit discussed used series feedback. The next circuit we'll discuss uses parallel feedback; in it, the feedback signal is applied in parallel with the input. That circuit is shown in Fig. 3.

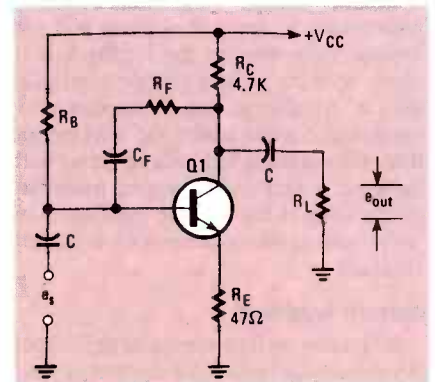

FIG. 3—PARALLEL FEEDBACK is used in this circuit.

Let's assume that we want to use that circuit in an application where the gain must be 10. If the  $\beta$  of the transistor is 100, the impedance at the base of the transistor due to  $R_E$ , the 47-ohm emitter resistor, is 4700 ohms. Now assume that all other impedances at the input of the transistor are high when compared to the 4700-ohm input impedance. As for the output impedance, if  $R_L$  were 47,000 ohms, the output impedance would be 47,000 ohms in parallel with  $R_C$ , the 4700 ohm collector resistor, or about 4200 ohms.

Ignoring feedback resistor  $R_F$ , the voltage gain of the circuit is the output impedance divided by the value of  $R_E$ ; that is  $4200/47$ , or about 90. In order to get a gain of 10, the feedback factor,  $1 + BA_V$ , must equal 9. If  $A_V = 90$ , B is just about equal to  $8/90$ . Because B is equal to the input resistance divided by  $R_F$ ,  $8/90 = 4700/R_F$ . So  $R_F$  must be about 49,000 ohms. Make the impedance of capacitor  $C_F$  very small with respect to  $R_F$  at the lowest frequency to be reproduced by the circuit so that the capacitor does not affect the feedback.

While the input impedance of a circuit with series feedback is its impedance without feedback multiplied by the feed-

back factor, in parallel-feedback circuits the input impedance without feedback must be divided by the feedback factor to determine the input impedance. The output impedance is likewise reduced by that same feedback factor, just as it was in the series-feedback circuit. That is because the feedback signal in both instances is taken from across the load at the output.

In all of our discussion thus far, the feedback has been a function of the voltage at the output and hence is called voltage feedback. The feedback could, however, be a function of the current at the output instead. In that case, the signal is not fed back from across the load but from across a resistor or other device connected in series with it. That is referred to as current feedback because the the voltage generated across that device depends upon the current flowing through it as well as the load. When that configuration is used, the output impedance increases with feedback. Input impedance will still depend upon whether the feedback is in series with the input signal or in parallel with it. As always, input impedance increases in circuits where the information from the output is fed back in series with the input signal and decreases when that information is fed back in parallel. Now we'll want to take a closer look at current feedback.

### Current feedback

When the current sensed at the output of a circuit determines the amount of voltage fed back to its input, the circuit is called a current-feedback amplifier. Such a circuit is shown in Fig. 4. As was the case with the circuit in Fig. 1, the feedback voltage is applied in series with the input signal.

In Fig. 4, voltage  $e_s$  is amplified and appears at the + and - output terminals of amplifier A. The total output is applied across the two series-connected resistors,  $R_L$  and  $R_S$ . The output voltage across  $R_L$ , as well as the voltage developed across  $R_S$ , varies with the current flowing through the two resistors. Because the signal voltage developed across  $R_S$  depends upon the amount of current flowing through it, all or a portion of that voltage can be used to supply the required feedback information. Voltage gain of the

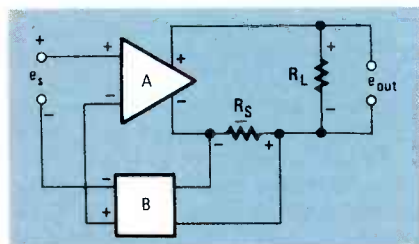

FIG. 4—SINCE FEEDBACK IS GENERATED across a resistor,  $R_F$ , that is in series with the load, this amplifier is said to use current feedback. That's because the same current that flows through the load must flow through that resistor

overall circuit, with feedback, is:

$$A_F = \frac{A_v}{1 - BA_v \left( \frac{R_S}{R_L} \right)} \quad (2)$$

The values of resistors  $R_L$  and  $R_S$  can usually be adjusted so that there will be no need to further reduce the signal fed back through use of additional B networks. If that is done, equation 2 can then be simplified by setting B equal to 1.

Although the circuit in Fig. 3 was treated as if it used voltage feedback, it can also be thought of as an amplifier with current feedback (affecting current rather than voltage gain). To see that more clearly, remove  $R_B$  and C1 from the circuit and connect  $R_F$  directly from the collector of Q1 to the base. The value of  $R_F$  must be larger than was found in our original analysis of that circuit so that it can do the dual job of establishing the feedback and setting the DC bias of the amplifier. As collector current divides between  $R_F$  and  $R_C$ , the portion of the current fed back to the input is  $4700/R_F$ . If the current gain of the amplifier without feedback is  $A_I$ , the current gain with feedback,  $A_{IF}$ , becomes:

$$A_{IF} = \frac{A_I}{1 + \left( \frac{4700}{R_F} \right) A_I}$$

Note that while one requirement in establishing a substantial amount of voltage feedback was to make  $R_F$  small, its magnitude here has been greatly increased. If  $R_F$  is large, voltage gain with feedback is affected slightly by its presence while current gain is reduced considerably.

In practical circuits, current feedback can radically affect voltage gain. Consider the circuit shown in Fig. 5. Here, current in the base circuit due to the input signal voltage is amplified by the transistor. The amplified current flows through both  $R_C$  and  $R_E$  in the transistor's output circuit. Voltage  $e_f$  developed across  $R_E$  due to the signal current in the emitter circuit is subtracted from  $e_s$  (because the voltages are  $180^\circ$  out-of-phase with each other  $e_f$  bucks  $e_s$ ) and applied to the base-emitter circuit of the transistor. Because  $e_s - e_f$  is less than  $e_s$ , the gain of the overall circuit is less with feedback than without feedback.

Gain may be reduced further by increasing the size of  $R_E$ . Now a larger voltage will be developed across that resistor. That larger voltage is subtracted from  $e_s$  so that less voltage is applied to the base-emitter circuit, reducing the gain further. Hence the gain of the overall circuit is inversely related to the value of  $R_E$ . That was noted earlier when we indicated that voltage gain of a circuit similar to the one in Fig. 5, is equal to about  $R_C/R_E$ . That is true because of the presence of current feedback.

It was pointed out that for this circuit,

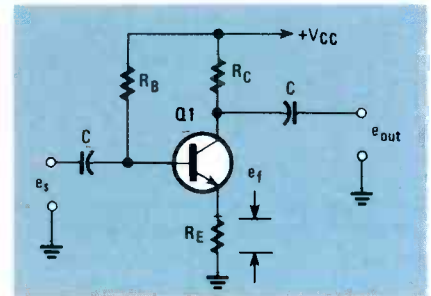

FIG. 5—IN PRACTICAL CIRCUITS such as this one, current feedback can greatly affect the circuit's voltage gain.

the fed-back voltage is in series with the input signal voltage. From our discussion of feedback characteristics, we can conclude that the input impedance of that circuit should increase with the amount of voltage fed back. That amount depends upon the value of  $R_E$ . When basic amplifiers were discussed, we noted that the input impedance of that type of circuit is  $\beta R_E$  in parallel with  $R_B$ . That effect of  $R_E$  on the input impedance also holds in circuits where feedback is used.

In order to minimize the affect of  $R_B$  on the input impedance, a bootstrapping circuit may be used. An example of that type of circuit is shown in Fig. 6. Capacitor C1 has a large value and it acts as a short circuit to input signal voltage  $e_s$ . Without C1, the input impedance seen by  $e_s$  is  $\beta R_E + R_{IN}$  in parallel with  $R_B$ ; the combination is in parallel with  $R_X$ . (As far as the signal is concerned,  $V_{CC}$  and ground are at the same potential.) By adding C1 to the circuit,  $R_X$  and  $R_B$  are, signal-wise, across  $R_E$  while  $R_{IN}$  is connected from the base to the emitter of Q1. Now the input impedance of the circuit is equal to the parallel combination of  $R_B$ ,  $R_X$ , and  $R_E$ , multiplied by beta. Resistor  $R_{IN}$  does not come into the picture for it is directly across the low impedance base-emitter junction; it is negligible when compared to that impedance. Because  $R_B$  and  $R_X$  have been shifted to be across  $R_E$ , the input impedance of the circuit is increased many times over what it would have been if C1 were not present.

### Feedback in audio circuits

It was pointed out in a previous article

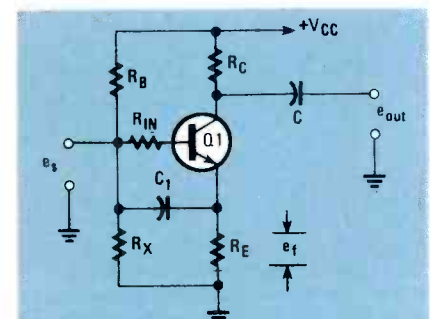

FIG. 6—TO MINIMIZE THE EFFECT of  $R_B$  on input impedance, a bootstrap circuit such as this one can be used.

that negative feedback is used around power amplifiers, small-signal audio amplifiers, op-amps, and so on. Its primary function is to reduce distortion, broaden the bandwidth of the amplifier, and reduce the output impedance. If a resistor-capacitor network is included in a feedback loop, the feedback network can also be designed to alter the frequency-response characteristics of the circuit.

Let's take a look at an audio amplifier. An example of an amplifier that can be used to reproduce the output from a tape player is shown in Fig. 7; an approximate curve that shows the desirable frequency characteristics of such an amplifier is shown in Fig. 8. The curve shows that the amplifier's output should remain at a maximum at frequencies below 50 Hz, should drop at the rate of 6-dB-per-octave from 50 Hz to 3000 Hz, and then become level once again at all frequencies above 3000 Hz. To establish that frequency characteristic, only a series resistor-capacitor circuit is required in the feedback loop. That is shown as  $C_F$  and  $R_F$  in the circuit.

The circuit to accomplish that goal can be designed through use of an R-C impedance equation and equation 1. The impedance of the series circuit consisting of  $C_F$  and  $R_F$  is  $Z_F = (R_F + j/6.28fC_F) = (j + 6.28fC_FR_F)/6.28fC_F$ . (For those unfamiliar with the topic, the impedance of a resistor and a capacitor in series is equal to the resistance of the resistor plus the reactance of the capacitor, where the capacitive reactance,  $X_C$ , equals  $1/2\pi fC$ . However, those two quantities can not simply be summed, as the voltages across the components are out of phase. Hence the introduction of the  $j$  operator, where  $j = \sqrt{-1}$ . That of course is an imaginary number and the reactive portion of the impedance is the imaginary component; the resistive part of the impedance is called the real component.) Plugging the impedance equation into equation 1, the voltage gain with feedback is:

$$A_{VF} = \frac{A_v}{1 + BA_v}$$

$$A_{VF} = \frac{A_v}{1 + A_v \left( \frac{R_E}{R_E + Z_F} \right)}$$

The portion of the output voltage that appears across resistor  $R_E$  is  $R_E/(R_E + Z_F) = B$ . That is the  $B$  that should be used in the equation. Should  $R_F$  be much larger than  $R_E$ ,  $B$  simplifies to being equal to  $R_E/Z_F$ . The entire equation may be simplified farther if the voltage gain is very large. When  $A_v(R_E/Z_F)$  is much greater than 1, the equation simplifies to:

$$A_{VF} = \frac{Z_F}{R_E} = \frac{j + 2\pi f C_F R_F}{2\pi f C_F R_F}$$

The above equation is the equation of the curve shown in Fig. 8. From the curve, we see that there are two break

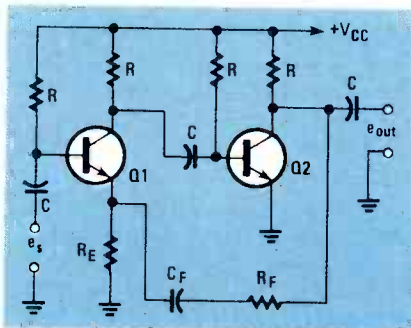

FIG. 7—A TAPE PLAYBACK PREAMPLIFIER is shown here; its simplified frequency-characteristic curve is shown in Fig. 8.

points, or corner frequencies, where roll-off begins and ends. The lower break-point occurs at a frequency such that the denominator of equation 2 is equal to zero. The upper break-point occurs at a frequency such that the numerator of equation 2 is equal to  $j + 1$ .

Let's first find the frequency where the denominator is equal to zero. That is, of

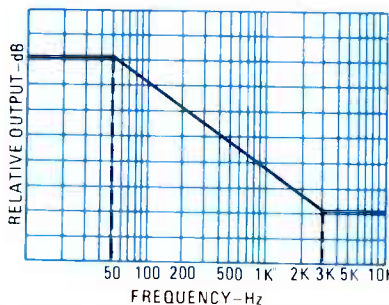

FIG. 8—THE SLOPE between the 50- and 3000-Hz points is 6-dB-per-octave.

course, at  $f = 0$ . Thus, at  $f = 0$  rolloff begins. It will keep rolling off indefinitely unless there is some frequency where gain due to feedback begins to rise to compensate for that initial rolloff. That happens when the numerator in equation 2 is equal to  $j + 1$ , or when  $f = 1/6.28C_FR_F$ . Since the curve calls for a corner frequency of 3000 Hz, choose values of  $R_F$  and  $C_F$  that satisfy that condition.

Getting back to the frequency where rolloff starts, it was determined from our calculations that for this circuit it begins at 0 Hz. Actually, the curve calls for it to start at 50 Hz. That is taken care of by coupling capacitor  $C1$ . In an actual circuit, the value of the capacitor would be selected so that the corner frequency would fall as close to 50 Hz as possible. In a more accurate circuit, a resistor would be placed across  $C1$  so that the corner frequency could be made precisely 50 Hz.

The curve in Fig. 8 is shown with sharp points at the corner frequencies. In the "real world" that never happens—the changes in the curve are never sharp at the corner frequencies and the flat-response sections do not follow the

exact contours shown in the drawing. The curve in Fig. 8 is only an approximation of the actual curve required to satisfy the requirements of the circuit, and is used as shown here to simplify the design problem. When designing an actual circuit, most designers follow that procedure.

## Stability

Even when only resistors are used in a feedback circuit, the feedback is not uniform over the entire band. It varies with the overall gain of the circuit as well as with the capacitance, inductance, and resistance inherent in the different sections of the circuit.

To check for stability, plot the frequency response of the circuit before feedback is applied. Note the response at the extreme high and low ends of the band. If a circuit is to be stable, the rolloff, when feedback is applied, should be less than 12-dB-per-octave. That can be shown with the help of Fig. 9.

That figure shows the frequency response of a circuit. Two feedback lines have also been plotted—one at -10 dB and one at -20 dB. At the points where the -10-dB feedback line crosses the frequency-response curve, the rolloff is 6-dB-per-octave. At the points where the -20-dB feedback line crosses the frequency-response curve, the rolloff is 12-dB-per-octave. Thus if 10 dB of feedback is added to the amplifier, the circuit is stable, but if 20 dB of feedback is added, the amplifier will be only marginally stable—it may have a tendency to oscillate because the line indicating the -20-dB feedback level crosses the frequency-response curve at a point where the rolloff is 12-dB-per-octave. At that point, feedback has a tendency to turn positive.

If the rolloff should exceed 12-dB-per-octave at the extreme high or low ends of the band, anything more than 20 dB of negative feedback at mid-frequency will turn the circuit into an oscillator.

## Oscillators

Getting back to equation 1, if feedback is positive, the  $BA_v$  factor is positive. If  $BA_v$  is made equal to +1, the denominator of equation 1 becomes zero and the gain with feedback becomes infinite. A circuit with in-phase positive

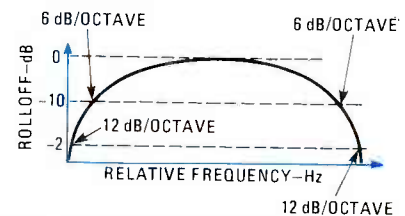

FIG. 9—TO CHECK AN AMPLIFIER FOR STABILITY, first plot its frequency response and then the feedback. At the points where the curves intersect, the rolloff should be less than 12-dB-per-octave to insure stable operation.

feedback and a gain of 1 or more after feedback has been applied will oscillate—there is an output even though no input signal is applied.

A conventional feedback arrangement is shown in Fig. 10. A resonant circuit is formed by L1 and C1. All feedback oscillators are resonant at a frequency of about  $1/2\pi\sqrt{LC}$  Hz. Oscillation occurs because of the following sequence of events: When the supply voltage is applied to the oscillator circuit, a pulse reaches the L-C circuit. The L-C circuit turns the pulse into a waveform at its resonant frequency. It is coupled from L1 to L<sub>F</sub> and from there to the base-emitter circuit of the transistor. That signal is amplified by the transistor and applied to the resonant circuit. If the signal across L1 and L<sub>F</sub> is in the proper relative phase, it keeps on being fed back and amplified until the overall circuit remains in oscillation.

Oscillators have many shapes and forms—three are shown in Fig. 11. The oscillator shown in Fig. 11-a is known as a Colpitts oscillator. When calculating its resonant frequency, use  $C1C2/(C1 + C2)$  for the total capacitance of the L-C circuit. Another popular oscillator is the Hartley, shown in Fig. 11-b; its resonant frequency is simply  $1/2\pi\sqrt{L1C1}$ . A feedback oscillator circuit using only resistors and capacitors is shown in Fig. 11-c. It oscillates because the transistor shifts the phase of the signal 180° from the base to the collector. Each of the R-C networks in the circuit is designed to shift the phase 60° at the frequency of oscillation, for a total of 180°. The appropriate values of R and C for each network is found from  $f = 1/(2\sqrt{3}\pi RC)$ ; that equation allows for the 60° phase shift required by the design.

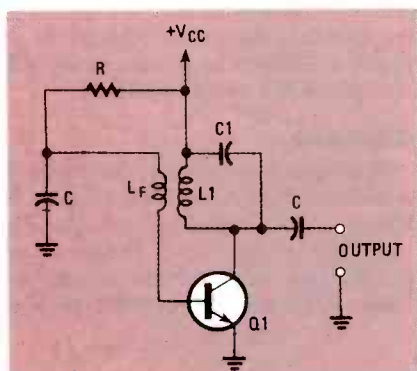

FIG. 10—A CONVENTIONAL FEEDBACK OSCILLATOR. The values of L1 and C1 determines the frequency of oscillation.

Adding the phase shift due to the transistor and the phase shift due to the R-C circuits, the overall phase shift from the input to the output is 360°. Signal from the output is fed back to the base in a positive feedback arrangement (due to the 360° phase shift), to reinforce the signal present at the base. That signal at the base

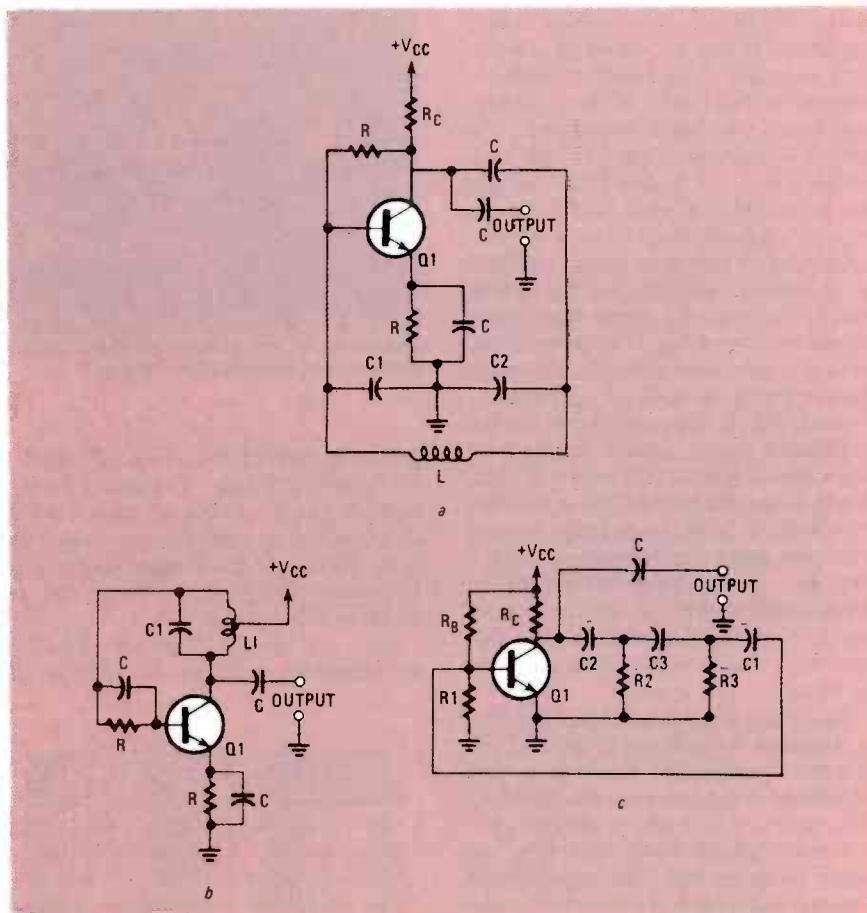

FIG. 11—THERE ARE MANY different kinds of oscillators. A Colpitts oscillator (a), a Hartley oscillator (b), and a phase-shift oscillator (c) are shown here.

was initiated by a random pulse when power was applied to the circuit, it was amplified, the phase shifted 360°, and fed back. The oscillator frequency will be about:

$$f = \frac{1}{2\pi(C1)} \sqrt{4(R1)R_C + 6(R1)^2}$$

if R<sub>B</sub> is considerably larger than R<sub>1</sub>. Should R<sub>1</sub> be omitted from the base circuit, the input resistance of the base circuit, when combined in parallel with R<sub>B</sub>, must be chosen so that the combination is equal to R<sub>2</sub> or R<sub>3</sub> (note that R<sub>1</sub>, R<sub>2</sub>, and R<sub>3</sub> are all equal).

Oscillators can be built around op-amps. The output of the circuit shown in Fig. 12 is a squarewave; let's see why. Negative feedback is established through R<sub>F1</sub>, while there is positive feedback through R<sub>F2</sub>. For that circuit, as well as for circuits described below, assume that the positive saturation voltage at the output of the op-amp is +V<sub>CC</sub> and that the negative saturation voltage at the output is -V<sub>CC</sub>. The voltage at the non-inverting input depends upon the voltage at the output. It is positive when the saturation voltage is at +V<sub>CC</sub>, and negative when it is at -V<sub>CC</sub>.

Assume the oscillation starts when the output is at +V<sub>CC</sub>. At that time, C<sub>1</sub> gets charged to a positive level through R<sub>F1</sub>.

When that voltage exceeds the positive voltage at the non-inverting input, voltage at the output drops to -V<sub>CC</sub>. When that happens, the voltage across C<sub>1</sub> begins to drop and become negative because its charging voltage is now being supplied by the negative voltage at the output of the op-amp. Once it drops to below the voltage at the non-inverting input, the voltage at the output returns to +V<sub>CC</sub>. The process keeps repeating itself. Consequently, the output is a squarewave. The frequency of oscillation is  $1/2R_{F1}C$ , provided that B = 0.462. Since  $B = R1/(R1 + R_{F2})$ , that condition will hold true if R<sub>F2</sub> is made equal to 1.16R<sub>1</sub>.

A sawtooth generator is composed of

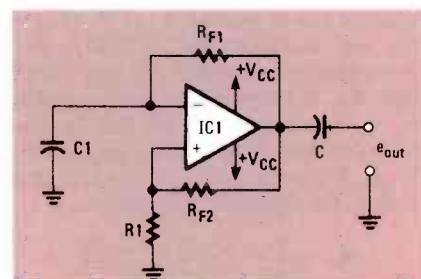
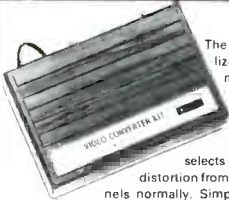

FIG. 12—OP-AMPS are commonly found in oscillator circuits. The output of this circuit is a squarewave.

continued on page 94

## SWD-1 VIDEO CONVERTER

FOR CABLE TV



The SWD-1 Video Converter is utilized on cable TV systems to remove the KHz's signal from a distorted video (channel 3 in/out) and also pass thru the normal undistorted/detected audio signal. Rocker switch selects operating mode to remove KHz's distortion from the video or pass all other channels normally. Simple to assemble—less than 30 minutes. Pre-tuned. Input/output Channel 3. Impedance 75 ohms. 117VAC.

SWD-1 Video Converter Kit ..... \$69.95

## 0-35dB VARIABLE GAIN

# RF AMPLIFIER

USES TWO REVOLUTIONARY NEW HYBRID BROADBAND AMPLIFIER ICs

Works on all RF Signals from 40-900MHz

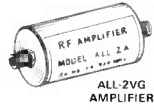

EXCELLENT FOR USE WITH:

- All Antenna Systems
- Voice Communications
- MATV Systems
- CCTV Systems
- Video RF Line Amplifiers
- Frequency Counters
- Oscilloscopes
- FM Broadcasts



COAX FEED POWER SUPPLY

Now you can use one TV/FM Antenna to cover all close and distant stations without experiencing overloading problems. Ideal for outdoor and indoor use. I/O impedance is 75 ohms. Power Supply is separate coax feed system which allows amplifier to be located anywhere in cable run. Power Supply has knob to control variable gain, LED power on indicator and on/off switch.

ALL-2VG Wired and Tested ..... \$49.95

## Our New STVA 14.5dB GAIN, 14 ELEMENT CORNER REFLECTOR YAGI ANTENNA

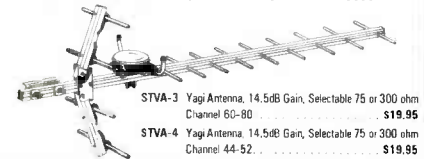

STVA-3 Yagi Antenna, 14.5dB Gain, Selectable 75 or 300 ohm Channel 60-80 ..... \$19.95  
STVA-4 Yagi Antenna, 14.5dB Gain, Selectable 75 or 300 ohm Channel 44-52 ..... \$19.95

RG-59/U 75 ohm Low Loss Coax Cable ..... \$12p/ft. F-59 Coax Connector ..... \$ .39 ea.  
MT-1 Special UHF 75-300 ohm Matching Transformer ..... \$1.45 ea.

## AMATEUR — ETV 32 ELEMENT YAGI ANTENNA

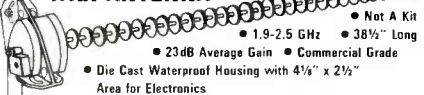

MAE-2 32 Element YAGI Antenna ..... \$23.95

## Kato Sons' Regulated Variable DC Power Supply

For use with KSDC-KIT 1.9 - 2.5GHz Down Converter. Completely assembled with Attractive Cabinet, TV/Converter Mode Switch, Frequency Control and LED Indicator.

Model KSPS-1A Assembled Power Supply ..... \$23.95

SPECIAL PACKAGE OFFER

ORDER ALL THREE ITEMS  
MAE-2, KSDC-KIT and KSPS-1A for Only. **\$74.95**  
Regular price if ordered separately \$82.95  
— CO-AX CABLES ARE NOT INCLUDED —

# Switch to Bambi™!

## Electronically

**Bambi Electronic Video Switch ... makes switching of your VCR/VTR, Pay TV Decoders, Cable TV, Video Discs, Video Games, Closed Circuit TV, Antennae and Microcomputer as easy as pushing buttons.**

The Bambi Electronic Video Switch is an electronic computerized switching network with memory which can accept up to six different sources of video signals and provide the flexibility of directing the inputs to any or all of the three outputs.

Now you can eliminate ... the drudgery of disconnecting and reconnecting your video equipment each time you use it ... the tangled mess of cables which are impossible to trace out ... not being able to use more than one function at a time.

Bambi lets you enjoy using your video equipment the way it should be ... electronically and on line at the push of a button.

Model BEVS-1 Completely Wired and Assembled. Includes comprehensive instruction/Operation Manual and Decal Set for customizing your Video Switch installation.

**\$129.95**



Bambi's front panel was designed with the user in mind. Computer styled construction, with soft-touch keyboard (rated for over 10 million operations), arranged in matrix form allows easy input/output selection without referring to charts. Functions selected through the keyboard are immediately displayed on the 18 LED status indicators.

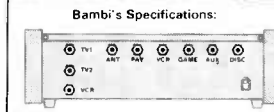

Bambi's Specifications:

- Input/Output Impedance 75 ohm
- Signal Loss 3dB ±1dB
- Noise 4dB ±1dB
- Input Return Loss 12dB min.
- Isolation 65dB min.
- Power Req. 117VAC 60 Hz, 2W
- Dimensions 10 1/2" W x 6" D x 3 1/4" H
- Weight 4 1/2 lbs

Check the quality of Bambi against that of much higher priced competition. All solid state electronic switching provides low attenuation (3dB), wide frequency response (40-890 MHz), and excellent isolation between signal sources (each I/O section individually shielded for 65dB min. isolation).

## NEW VCR Quality



Assembly Time Approximately 5 Minutes.

## MODULATOR

Not a Game Type Modulator

The MPS-1 Kit converts Video/Audio signals to a crystal controlled RF output for TV Channels 3 and 4. The MPS-1 Modulator's adjustable inputs are designed to match all TV Cameras and VCRs and features a voltage regulated power supply, power switch and LED indicator. No Tuning Required. Operates on 117VAC. Ideal for use with our new Debbie CCTV-1 and revised Bambi BEVS-1S.

MPS-1 Modulator Kit ..... \$39.95

## SEE PACKAGE OFFER BELOW FOR ANTENNA, DOWN CONVERTER, POWER SUPPLY, & RF AMP.

### Kato Sons' Down Converter Kit ★1.9 - 2.5GHz★

Designed for Simple Simon by former Japanese CQ Amateur Magazine's UHF Editor/Engineer. Unit utilizes new ingenious Printed Circuit Probe for maximum gain. Circuit board fits inside MAE-2 antenna housing. Requires mechanical assembly only. All electronics are pre-soldered and pre-tested. Usable up to approximately 15 miles.

Model KSDC-KIT 1.9 - 2.5GHz Down Converter Kit ..... \$34.95

### Kato Sons' RF Amplifier ★22dB Gain★

High quality 2 stage low noise RF Amplifier for 1.9 to 2.5GHz. Unit requires approximately 10 minutes assembly. Fits in same housing with down converter. Covers distances of up to 30 miles.

Model KSRF-2 RF Amplifier ..... \$23.95

SPECIAL PACKAGE OFFER

ORDER ALL FOUR ITEMS  
MAE-2, KSDC-KIT, KSPS-1A and KSRF-2 for Only. **\$94.95**  
Regular price if ordered separately \$108.80  
— CO-AX CABLES ARE NOT INCLUDED —

## BE SECURE WITH BAMBI!

Bambi Now Provides Home/Industrial Security With The New ... Automatic Sequential Scanning BEVS-1S

That's right! In addition to Bambi's regular features listed above, we have added Autoscanning with a controlled 1-10 second Variable Delay for up to six input security cameras.

The BEVS-1S allows simultaneous recording on a VCR while observing activity on the monitor. Manual lock-on of any one of six inputs can be accomplished at any time. The BEVS-1S coupled with our new Debbie CCTV-1 listed below makes an excellent security system for your Home or Business.

BEVS-1S Sequential Scanning Electronic Video Switch ... \$199.95

## You Should Have Debbie's™ Quality!

Debbie CCTV-1 CLOSED CIRCUIT TELEVISION CAMERA



Excellent For Use In Home or Business Security Systems, Monitoring Production Lines, Childrens Play Areas, Etc.

Features:

- 2/3" Electrostatic Focusing Vidicon Tube
- EIA 525 Line, 60 Fields Per Sec. Scanning System
- 800 Line at Center Horizontal Resolution
- 1 Footcandle Minimum Illumination
- 10,000 to 1 Automatic Light Control Range
- 1 0Vpp Composite, Negative Sync, 75 Ohm Video Output
- 40dB Signal to Noise Ratio
- Standard "C" Lens Mount
- 110V ±10%, 50-60Hz, 9 Watts

Debbie CCTV-1 Requires C-Mount Lens ..... \$159.95

16mm, F1.6 Hi-Resolution Lens w/Cap ..... 19.95

Mounting Bracket Flexible, Locking, 360° Gooseneck for use in ceiling or wall mounting ..... 12.95

NOTE: When using the Debbie CCTV-1 with Bambi BEVS-1S, an RF Modulator such as our Model MPS-1 is required.

## MODEL IC-1 INFRARED CONVERTER

Adapts to any video camera. Reduces energy costs for night viewing by 60%. Video tape in the dark without being detected. Excellent for • Factory Grounds Security • Home Surveillance. Write for Details.

★ PWD FOR DETAILS SEE OUR PAST ADS

★ SPECIAL \$109.95

WRITE FOR OUR CATALOG OF ADDITIONAL CCTV ACCESSORIES

**SIMPLE SIMON ELECTRONIC KITS,™ Inc.**  
3871 S. Valley View, Suite 12, Dept. R, Las Vegas, NV 89103

NEED 6 OR MORE OF AN ITEM? WRITE FOR QUANTITY DISCOUNTS

In Nevada Call: **702-871-2892**

**1-800-782-3716**

Outside Nevada Call:

Available by Mail Order Only Send Check\* or Money Order. Minimum Order: \$16.95. Add 10% Shipping and Handling on orders under \$40.00. For orders over \$40.00, add 5%. Minimum Shipping and Handling \$2.00. Cat. \$1.00 — VISA and Mastercard Acceptable — \*Check orders will be held 30 days before shipping.

# NEW IDEAS

## Low-distortion audio limiter

SHORTWAVE LISTENING AND DXING IS, without a doubt, an enjoyable hobby. However, it does pose a hazard to your ears—or to your peace of mind—because of the annoying loud-volume pops and blasts you're sure to hear from your communications receiver. Although the AGC (Automatic Gain-Control) circuits in communications receivers are supposed to take care of those sudden changes in volume, they never seem to do the job well enough. Those of you who wear headphones are especially vulnerable to the annoyance. What's especially annoying then is that you're probably wearing the headphones not for your own benefit, but for the benefit of those around you.

I tried several ways to reduce the problem (for example, using FET's as attenuators) but I was unhappy because I was always trading one problem off for another: distortion. But I finally came up with a design that does what I want—it attenuates the blasts from my communications receiver while causing no noticeable distortion.

The circuit of the audio limiter is shown in Fig. 1. The level at which it comes into action can be set with the LIMIT LEVEL trimmer potentiometer. When that level is exceeded, the output from the LIMITER-DETECTOR half of the op-amp (which is used as a comparator) causes the LED to light. The light from the LED causes the resistance of the photoresistor to decrease rapidly. That in turn causes the gain of the LIMITER half of the op-amp to decrease. When the signal drops below the desired limiting level the LED turns off, the resistance of the photoresistor increases, and the gain of the LIMITER op-amp returns to its normal level—that set by the combination of resistors R1 and R2. A dual-polarity power supply ( $\pm 12$  volts is desirable) is, of course, needed for the op-amp.

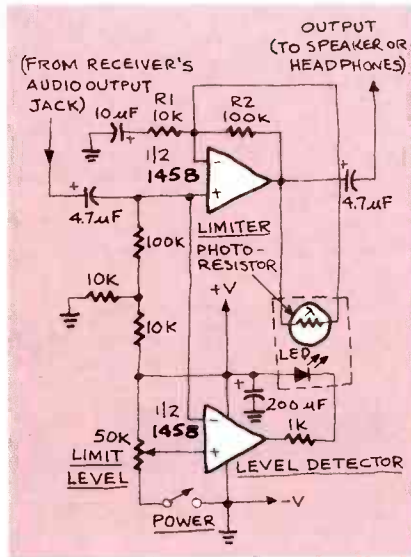

FIG. 1

The circuit is very easy to build, and since the construction method is not critical, use the one you prefer. You might even want to mount the circuit inside your receiver. One important construction note, however, is that the photoresistor and LED should be encased facing each other in a light-tight enclosure.

The parts that you use are not critical either. One note here however is that the (cadmium sulfide, or CdS) photoresistive cell is most sensitive to light with a wavelength of about 5000 angstroms (or, approximately, green light). Therefore, you may want to use a green LED for best response.

Perhaps the best feature of the audio-limiter circuit is that it can be used with any receiver, whether it's a tube-type shortwave receiver or a new solid-state scanner. Your ears will thank you.—  
*Daniel Ulmer*

## NEW IDEAS

This column is devoted to new ideas, circuits, device applications, construction techniques, helpful hints, etc.

All published entries, upon publication, will earn \$25. In addition, Panavise will donate their model 333—The Rapid Assembly Circuit Board Holder, having a retail price of \$39.95. It features an eight-position rotating adjustment, indexing at 45-degree increments, and six positive lock positions in the vertical plane, giving you a full ten-inch height adjustment for comfortable working.



I agree to the above terms, and grant **Radio-Electronics** Magazine the right to publish my idea and to subsequently republish my idea in collections or compilations of reprints of similar articles. I declare that the attached idea is my own original material and that its publication does not violate any other copyright. I also declare that this material has not been previously published.

Title of Idea

Signature

Print Name

Date

Street

City

State

Zip

Mail your idea along with this coupon to: **New Ideas Radio-Electronics**,  
200 Park Ave. South,  
New York, NY 10003

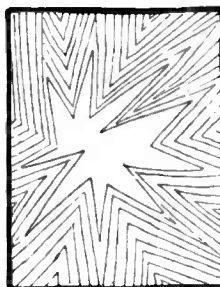

4..... 3..... 2..... 1..... 0..... L.P.T OFF 4



No wonder they call it the SUPERFONE!

# At Last—a Cordless Phone with TWICE the Range, Sound Fidelity to Rival Phones with Cords, and a Privacy Code System—All This in a Phone Less Than an Inch Thick!



The Super Fone is less than 1" thick. The base unit has a built-in speaker phone, a fully independent intercom and is 110 volt-220 volt switchable.

Until now, cordless phones have given you wonderful convenience. But they've had two problems:

1. The range is limited to 600 to 700 feet.
2. Some of them sound as though you're talking inside a barrel.

As cordless phones have become enormously popular, another problem has arisen: two people, living near each other, can have the same channel. Not only is there line confusion, but someone else can literally make a long distance call on your phone.

No more. Never again.

## Range: 1500 Feet OR MORE!

The SuperFone 650 uses state-of-the-art electronics to bring you the ultimate cordless phone. Sound quality is superb — and it stays superb, 1500 feet or more from the base station. That's more than twice the distance of standard cordless phones.

Only SuperFone 650 has a secret code system to prevent interference and false operation of the phone. You choose from 512 possible "code" combinations. Both the base unit and the phone are locked onto that code, which you can change when you want to.

No other phone can interfere. No other unit can share the signal. No one else can hear or speak on your carrier-wave.

## Enormous Range

We say the SuperFone 650 has a range of 1500 feet.

Notice we didn't say "up to" or "as far as" 1500 feet. There's no hedging, because this seems to be the minimum, not the maximum range.

Users report 1800 and 2000 feet. That's nearly half a mile. SuperFone 650 is a radiophone, not a toy, and that's why its signal doesn't break up or start hissing or crackling when you get half a block away.

You can tell when you heft it. It's a Little Giant. You can feel the power inside. What a marvel of electronic engineering it is! And it's tough, too. It fits into your shirt pocket, and you can bounce it around all day without damaging it.

## Speakerphone, Intercom — Everything!

SuperFone 650 is The Everything Phone. Anything any phone can do, it can do.

First, the base station is a speaker phone. Touch a button and you can have a hands-free conference conversation in the room in which the base station sits.

Next, it's an intercom. You can page the handset from the base unit and have a private conversation. You have a true wireless intercom, not just a signal.

Third, you have a privacy button. Push that button and you'll still be able to hear anything the other party says, but he or she won't be able to hear you until you take the button off "hold."

Fourth, you have an automatic redial. Touch the key and the SuperFone will redial the last complete number.

What else? A security switch which makes it impossible for anyone to call out on the remote phone, without changing the ability to receive calls. A volume control for the speaker on the base unit. A call button to page the base from the cordless phone. THIS PHONE HAS EVERYTHING!

## 30-Second Installation

Plug your SuperFone 650 into any wall AC outlet. Push its standard modular terminal into the telephone plug. You're in business.

Every component is heavy-duty, from the built-in condenser microphone (with automatic gain control) to the LED indicator lights. This phone is designed for hard use.

The SuperFone 650 is yours for \$249.95. If you want the SuperAntenna with it, giving you a range of a mile — or even more — you can have both for \$319.95. (Or you can get the SuperAntenna alone for \$79.95.)

## We Absolutely Guarantee!

Use the SuperFone 650 (or any electronic instrument you acquire from us) for up to 30 days. If for any reason you decide not to keep it, return it for a 100% refund.

The SuperFone 650 — \$249.95

The SuperAntenna — \$79.95

BOTH Phone and Antenna — \$319.95

Adapter for Multi-Line phone — \$39.95

Add \$4.50 per total order for shipping.

## New! MULTILINE ADAPTER FOR BUSINESS PHONES

If you have several lines, you can plug them into your SuperFone with this single adapter.

The adapter costs \$39.95. Nothing else is required to attach multi-line phones to one SuperFone 650.

## TRIPLE THE RANGE OF ANY CORDLESS PHONE!

The SuperAntenna will give your cordless phone, regardless of make or model, three times the range it has now.

If the range is 700 feet, it'll leap to over 2,000. If it's 1500 feet, it could be as far as one mile!

Easy to install. Only \$79.95 complete. Add \$4.50 for shipping.

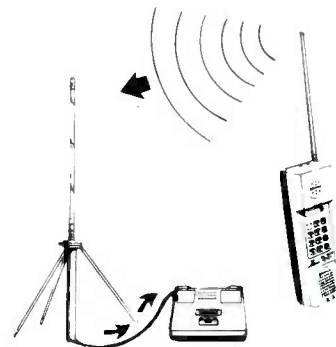

For instant service, if you have a VISA or MasterCard, call toll-free 24 hours a day, seven days a week:

**1-800-824-7888**

Ask for Operator 551.  
(in California: 1-800-852-7777)

The SuperFone 650, SuperAntenna, and Multi-Line Adapter are more electronic marvels from

**NEW HORIZONS**

Dept. RE-7, 1 Penn Plaza, Suite 100  
New York, NY 10119

# HOBBY CORNER

## Reducing battery drain

EARL "DOC" SAVAGE, K4SDS, HOBBY EDITOR

THE FIRST LETTER THAT WE'LL LOOK AT this month is from Ken Alexander in Tennessee. He built and installed a security alarm system in his car. The alarm doesn't draw any current until it is activated. The problem, though, is that the LED indicator light *does* draw current—typically about 40 mA. When the car is not moved for a long period of time, the battery can be affected, particularly in cold weather. Ken wants a way to run the LED with less current drain.

Suppose there were a way to keep the LED turned off most of the time, and on for only short periods. Then, the "heavy" battery drain would occur only in short bursts as the LED was turned on briefly. That would not only solve the main problem but, in my opinion, provide a better indicator—a flashing light usually attracts more attention than a steady one.

Of course, there are many ways to make an LED flash, but one of the simplest is to use a 3909 LED flasher/oscillator IC. The best thing about it (from Ken's viewpoint) is that the operating current is 1 mA—and usually less, depending on the applied voltage (6.4 volts maximum).

The circuit, in spite of the current peaks on flashes, draws only about 1/50 the power used by an LED alone. Add to that the reduced average-current as the flash rate is lowered and you are have an in-

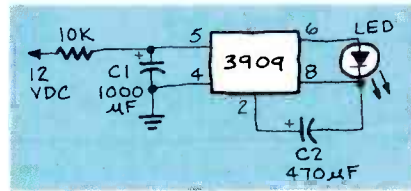

FIG. 1

significant load for a car battery.

Figure 1 shows a schematic of a simple 3909 flasher circuit operated from a 12-volt source. The 10K resistor drops the voltage to the four volts needed to operate the IC. It also restricts the current that flows when the LED does flash. Capacitor C1 is needed to provide that burst of current.

The flashing rate is determined by the value of capacitor C2. I suggest that the rate be made fast enough for the LED to attract attention, but not too fast—the faster it flashes, the more current you'll need. If C2 is 220 µF the rate is about one Hz. For a rate around four Hz, use a 1000 µF capacitor.

If there is a voltage source between 1.5 and 6 volts available, just omit C1 and the 10K resistor. I hope this little circuit meets your needs, Ken.

### Battery voltages

Peter Poulos in our nation's capital wonders why all batteries of the same size don't have the same output voltage. (I guess he also is wondering why many batteries of different sizes *do* have the same output voltage.) Well, Pete, it all depends upon the materials of which the batteries are made. Different metals separated by different chemicals (called electrolytes) will produce different voltage potentials.

Let's make a few simple batteries to see how it works. Get a couple of paper cups

and put salt water in one and lemon juice in the other. Now find a piece of copper wire, a piece of aluminum wire, and a shiny nail. Clip different pairs of the three metals to the leads of your voltmeter (set on the one- or two-volt scale) and dip them into the two solutions.

You will find that your "batteries" will produce potentials of from 0.15-volt to over a half of a volt. Try some other solutions and other metals (especially an old silver coin if you can find one). What combination can you find to give the highest voltage?

Yes, those really are batteries (actually, wet cells). I wouldn't care to hook them together and carry them around in my flashlight, but they will do real work. Folk who lived out in the country often used similar power sources for early radios. But let's stick with the "dry cells" that we're familiar with. In those batteries, the electrolyte material, which is usually damp, is considered to be "dry."

There you have the basic principles that you need to answer your question, Pete. Of course, sometimes the manufacturers will fool you. They may stack several low-voltage cells together. For example, the common nine-volt "transistor-radio" battery is actually a package of six small 1.5-volt cells. In any event, now you know why all batteries of the same size are not the same voltage. And why some batteries that *are* the same size produce different voltages.

### Young entrepreneur

I have a letter from a 12-year-old by the name of Steve Knelly. (I don't know where he lives because I misplaced the envelope.) The rest of us had better watch out because this young man is going somewhere. Steve has a videogame ma-

### AN INVITATION

To better meet your needs, "Hobby Corner" will undergo a change in direction. It will be changed to a question-and-answer form in the near future. You are invited to send us questions about general electronics and its applications. We'll do what we can to come up with an answer or, at least, suggest where you might find one.

If you need a basic circuit for some purpose, or want to know how or why one works, let us know. We'll print those of greatest interest here in "Hobby Corner." Please keep in mind that we cannot become a circuit-design service for esoteric applications; circuits must be as general and as simple as possible. Please address your correspondence to:

Hobby Corner  
Radio-Electronics  
200 Park Ave. South  
New York, NY 10003

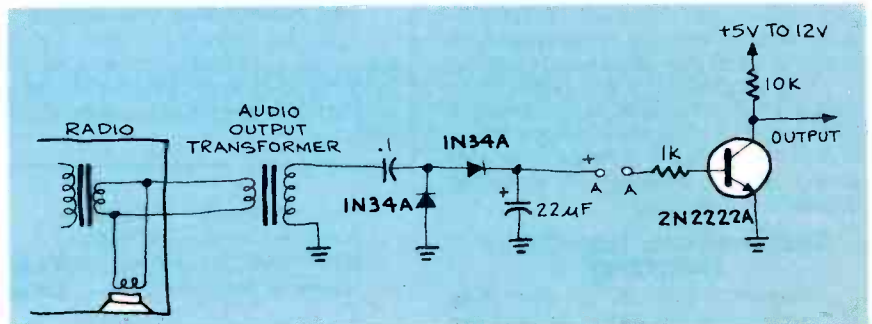

FIG. 2

chine and he is looking for the plans for a coin box similar to the ones used in the arcades. He wants the box to accept dimes, so he must realize he has to beat the competition when he starts out. That boy has a head on his shoulders.

Sorry, Steve, but I can't seem to find plans for a coin box. Perhaps you could figure out a way to use a key-operated switch to turn on a timer that would supply AC to the machine for a preset time-period. Hobby Corner has discussed timer circuits on several occasions in the past. Good luck!

### Sound activation

Don Dawson of Ontario, Canada needs help on a circuit to activate some device when sound comes out of his radio. (I'm sure that many of you could use such a circuit to activate something that will wake you up when the clock radio doesn't.) Well, Don, the circuit you wrote me about is on the right track, but I would do it as shown in Fig. 2.

An audio-output transformer is connected "backwards" across the audio output of the radio. This transformer outputs still-higher-level audio, and it goes to the following rectifier. Note that germanium diodes are used instead of silicon ones—the voltage drop across them is lower.

The output at point A is just straight old direct-current created from the audio signal fed into the rectifier. Whenever sound comes from the radio, a positive voltage appears. If that voltage is not great enough for your purposes, an audio amplifier can be added between the transformer and the rectifier.

The DC output (at A) can be used for a variety of purposes. It can turn on a signal light, sound a tone, or do almost anything else. Not knowing what use Don intends for the device, I have shown a 2N2222A transistor switch connected to the output, but almost any NPN transistor can be used. As shown, the switch output varies between ground and the applied voltage. The circuit could as easily activate a relay or other low-voltage device. Of course, if your relay is sensitive enough, it can be operated right from point A without the need for the transistor switch.

### Experiment!

Before closing this month's column, I would like to preach a small sermon. Surprisingly often, the mailbag contains a letter that refers to a circuit published here, in another article in **Radio-Electronics**, or even in another magazine. The question usually goes something like this: "Wouldn't it work better if you connected A to C instead of to B?" or "What would happen if you connected a wire from X to Z?"

Well, friends, let me suggest that you get down and dig into the matter for yourselves. Study the circuit as best you can and then try it out. If there are costly

OF ALL THE MICROWAVE DEVICES AVAILABLE ONLY THE ET-1000 . . .

## PORTABLE "POCKET" "MICROWAVE"

HAS SO MANY USES

**\$169<sup>00</sup>**



**SETS ON TV!**

**VIDEO ENG Supply Co.**  
9794 Forest Ln., Suite 106 • Dallas, Texas 75243

**CIRCLE 15 ON FREE INFORMATION CARD**

Versatility — Works indoors, Channels 2 & 3, (or you specify) color or B&W TV. Great for apartments, hotels, office buildings, condominiums, anywhere an outdoor antenna cannot be used. Works best above ground level. (upstairs apts., etc.)  
Description — All metal construction, high concentration parabolic reflector with dual element Yagi for center element at focal point for maximum gain. One year in testing and development. One year warranty, parts & labor.  
Personal check, M.O. - Return address, plus \$4.00 handling. Tex. res. add 5% sales tax. (214) 341-3397

components involved, take whatever measures you can to protect them and *experiment*. Even a failed experiment is of value—you'll learn what not to do the next time!

It's easy to try out different things when you use a solderless breadboard. Just build a circuit on it and then start changing component values or connections until you find the combination that makes the circuit perform best. I learn quite a bit by experimenting—you can do the same. **R-E**



"They demand a franchise fee or they'll knock out our satellites."

## The world of electronics gee-wizardry

Test Equipment □ Burglar/Fire Alarms □ Hobbyist & Automotive Electronics



### EICO CATALOG

The Newest and Best Voltage-Dependent and Factory Assembled Electronic Instruments

## -YOURS FREE.

32-pages of test instruments—from the latest digital multimeters to the famous EICO scopes. Security systems. Automotive and hobbyist products. Kits and assembled. EICO quality. EICO value. For FREE catalog, check reader service card or send 50¢ for first class mail.

**EICO** 108 New South Road  
Hicksville, N.Y. 11801

**CIRCLE 59 ON FREE INFORMATION CARD**

## ELECTRONIC PROJECTS FOR MUSICIANS

27 ALL NEW PROJECTS \$14.95

Even if you don't know an ohm from a volt, Craig Anderton's newly revised and expanded book shows you how to build 27 accessories that enhance your sound and broaden your musical horizons.

If you're an old hand at musical electronics, you'll really appreciate that all of these processors, from Tube Sound Fuzz to Phase Shifter are compatible and work together without creating noise, signal loss, bandwidth compression or any of the other problems common to interconnecting effects from different manufacturers. There's even a complete chapter on how to modify and combine effects to produce your own custom pedal board.

Low cost project kits available from PAIA help make even your first exposure to electronics a pleasant, hassle-free experience and thanks to the sound sheet demo record bound into the book you know just how the completed device will sound before you even start.

**CHARGE TO VISA OR MC TOLL-FREE**  
1-800-654-8657 9AM to 5PM CST MON-FRI

DIRECT INQUIRIES TO:  
**PAIA Electronics, Inc.**  
1020 W. Wilshire Blvd., Oklahoma City, OK 73116 (405)843-9626

I RUSH MY COPY OF "ELECTRONIC PROJECTS FOR MUSICIANS", \$14.95 plus \$1 postage enclosed.

I SEND FREE CATALOG OF OTHER PAIA PRODUCTS.

name \_\_\_\_\_  
address \_\_\_\_\_  
city \_\_\_\_\_ state \_\_\_\_\_ zip \_\_\_\_\_

**PAIA Electronics, Inc.**  
Dept. 5R, 1020 W. Wilshire Blvd., Oklahoma City, OK 73116  
**CIRCLE 52 ON FREE INFORMATION CARD**

# THE DRAWING BOARD

## Increasing current-handling capability of regulators

ROBERT GROSSBLATT

THE TREND IN MODERN LOGIC FAMILIES IS to make them operate with smaller and smaller amounts of power. (I suppose the ultimate goal is the family that can run on potential energy!) Lower power-requirements get rid of the necessity for wrist-thick cables and glass insulators, but there's an even more important benefit. Lower power means smaller, and less complicated, regulator circuits. Some IC's even have the regulator circuitry built onto the chip's substrate. Less current-draw means that the layout of the +V run on printed-circuit boards is much simpler. Remember that when heavy amounts of current are running through a trace on a board, a potentially troublesome voltage drop will be generated because of the resistance (however small) of the copper trace. That can lead to inductive oscillation and other nightmares.

That "low power" side benefit, however, can tend to make you a bit forgetful when you're developing a power supply. LED's, relays, and other things can still gobble up current at an alarming rate. A power supply that can deliver half an amp may seem perfectly adequate for, say, a CMOS circuit—and it is. Unfortunately, when we start asking the circuit to turn something on or light something up, the current draw is going to increase dramatically and our half-amp supply is rapidly going to drop dead.

The voltage-regulator circuit that we've been developing over the past few months can so far safely supply about a half amp over its full range, but it's a smart move to design it so that it can provide a lot more. Since the internal circuitry of the 7805 is limited to less than one amp, it's obvious that we're going to need some other device to provide the additional current.

### Adding a pass transistor

In Fig. 1, we've added a transistor and a resistor to take care of the additional current. For simplicity's sake I haven't drawn in the rest of the circuit we've developed so far. All the current that goes into the regulator has to pass through  $R_B$  since it's in series with the regulator input. Ohm's law tells us that as the current flow through a resistor increases, so does the voltage developed across it. The base-emitter junction of Q1, a PNP transistor, is in parallel with  $R_B$ . As long as the current flowing through the resistor is be-

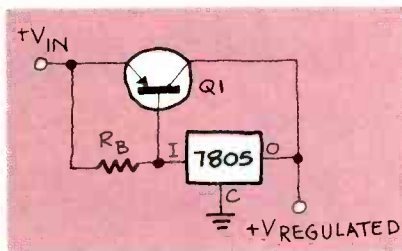

FIG. 1

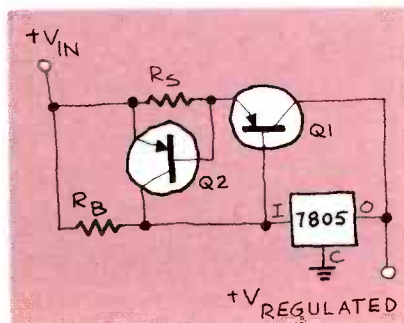

FIG. 2

low a certain level, just about all that's going to happen is that the resistor will get a little warm. At some point, however, the voltage drop across  $R_B$  is going to get high enough to turn on the transistor, which will start to pass current through its collector. That current is added to the current supplied by the regulator and allows the draw on our power supply to be increased by the amount that the Q1 can handle without blowing up.

Transistor Q1, then, is used as a switch that senses when the regulator output is near some limit and turns on to provide the extra current that the regulator can't handle. The turn-on point of Q1 is determined by the value of  $R_B$  and the base-emitter voltage of Q1. One other thing to be aware of is that the difference between the input and output voltages is going to change. Since Q1 and  $R_B$  are in series with the regulator input, the voltage drop across them has to be added to the inherent 2-volt drop of the regulator. That is important to remember when we're figuring out how much voltage we need at the output of the rectifier.

### Short-circuit protection

Before we start doing any arithmetic to calculate the value of  $R_B$  we have to add some short-circuit protection to the circuit. I know you're thinking that we took care of that earlier, but we've now added

active components to the input. If the output is shorted now, all our earlier protection springs into action—but it only takes care of the regulator. The collector of Q1 is going to be shorted out and the transistor is going to start passing current through the short. It will rapidly exceed its maximum collector-current rating, and all you'll be able to do is administer the last rites.

That is, to say the least, an undesirable state of affairs. In Fig. 2 we've added a safety net for Q1 in the form of Q2 and  $R_S$ . Those of you with sharp eyes will recognize that those two new components form a switch in exactly the same manner as  $R_B$  and Q1. The same sort of analysis also applies.

All the current that flows through Q1 has to pass through  $R_S$ . When a certain point is reached, the emitter-base junction of Q2 is going to conduct and the transistor will turn on. When it does, it will lower the voltage across  $R_B$  and turn Q1 off. Since Q2 isn't going to turn on until the power supply is providing really large amounts of current, we need a hefty transistor there. It has to handle pretty close to the sum of the short-circuit currents of both the 7805 and Q1.

Since there are more components connected in the circuit between the base and emitter of Q1, the math needed to calculate the values of the two resistors is going to be more complicated. Rather than going through it however, let's make a few intelligent assumptions and see if we can make life easier.

If we use silicon transistors for Q1 and Q2, we know that the base-emitter voltage is going to be about .65 volts when the transistor is turned on. As long as the voltage is below that, the transistor will be turned off.

Now let's look at Fig. 1 again and assume that Q1 isn't there. The 7805 needs about 8 mA to operate—the rest of the current it passes is available to whatever circuit it's powering. The regulator can handle half an amp without any problem, but let's be on the safe side and arrange for Q1 to turn on when the regulator draw exceeds 250 mA. Since the turn-on voltage for the transistor is 0.65 volts, calculating the value of  $R_B$  is a snap:  $R_B = E/I = .65/.250 = 2.6$  ohms

Now, it's true that the emitter-base junction of Q1 is in parallel with  $R_B$  so that bunch of arithmetic isn't strictly cor-

rect. Remember, though, that the apparent resistance of the junction when the transistor is in cutoff is pretty high. It's not really accurate to talk about the resistance of a transistor (or any semiconductor, for that matter), because they're dynamic devices and we should more properly refer to their "impedance." That's the DC resistance coupled with an AC component. For our "real world" circuit, however, the difference doesn't amount to much and we can ignore it.

If you look at Fig. 2, you'll see that we have to go a little farther in figuring the value of  $R_B$ . Since both  $R_B$  and  $R_S$  are across the emitter-base junction of Q1, both their values have to be taken into account when we figure the trip point of Q1. Once again, the "resistance" of Q2 in cutoff is high enough for us to ignore it and just work with the resistor values.

Since  $R_S$  has to pass all the current that flows through Q1, we have to decide what we're going to let the maximum current be. Five amps is a good value for our regulator circuit—more than that will cause design problems we don't want to get involved with. Just as was the case with Q1, Q2 will start conducting when its emitter-base voltage reaches 0.65 volts. If we want that to happen when Q1 is passing 5 amps,  $R_S$  has to be on the order of 0.13 ohms. The total resistance we need to turn on Q1 is 2.6 ohms. Since  $R_S$  must be .13 ohms, the new value of  $R_B$  will be 2.47 ohms.

Now, I'm the first to admit that those are pretty oddball values for resistors. You can't exactly amble down to your local resistor store and buy a 2.47 ohm resistor. There are ways around that, though.

Next month we'll take care of all the unfinished business and complete our regulator. We'll consider choices for Q1, Q2, and the proper wattage for the resistor. Not only all that, but, since we've all been working so hard we'll find ourselves treated to a surprise in the circuit that's not only useful, but that's one we get for free.

R-E

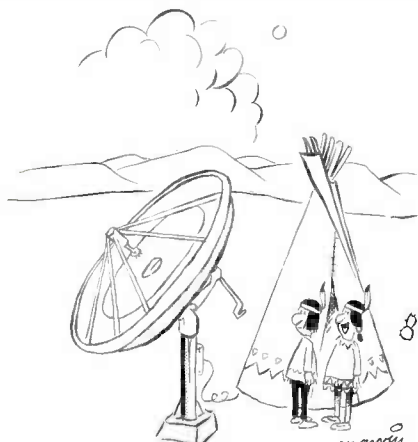

"I'm not too thrilled with its aesthetic value, but I sure dig the variety of channels I can get."

## HOBBY MICROWAVE ANTENNAS

### "COMPLETE SYSTEMS"



OUR DAISY  
ONLY  
\$89.50

OUR  
SOLID  
20"  
ONLY  
\$94.50



OUR  
LOW PROFILE

ONLY \$92.50



A B \$18.00  
TUNER  
A B C \$22.00  
TUNER

65" COAX 3' COAX TUNER W/SYSTEM "NOT FOR S.T.S."  
WE REPAIR ALL MICROWAVE \$17.00



REDIAL  
PHONE  
ONLY  
\$19.50



CORD-FREE  
UP TO 1 MILE RANGE  
"PACER"  
MULTIPLY  
\$297.50  
TRUE TOUCH TONE

DEALER PROGRAMS AVAILABLE



COMPLETE BOMAN PRODLIN  
SATELLITE SYSTEM \$2250.00



**SPACE AGE**

14824 CAMDEN AVE. SAN JOSE, CA. 95124  
(408) 266-1511



CIRCLE 57 ON FREE INFORMATION CARD

## TIMEX/SINCLAIR COMPUTER USERS

We Have The Books You Need



- ART OF PROGRAMMING THE 1K ZX81.**  
How to use the features of the ZX81 in programs that fit into the 1K machine. 96pp. \$5.75 postpaid.
- ART OF PROGRAMMING THE 16K ZX81.**  
How to use your 16K RAM pack and ZX printer to the full. 144 pp. \$6.95 postpaid.
- ART OF PROGRAMMING THE ZX SPECTRUM.**  
Everything you need to know to put the ZX Spectrum to work for you. 144 pp. \$8 postpaid.

ELECTRONIC TECHNOLOGY TODAY, INC.  
P.O. BOX 83  
MASSAPEQUA PARK, NY 11762

Name: \_\_\_\_\_  
Address: \_\_\_\_\_  
City: \_\_\_\_\_ State: \_\_\_\_\_ Zip: \_\_\_\_\_  
 Number of books ordered

## POWER LINE PROBLEMS?



### SPIKE-SPIKERS™...The Solution!

Minimize equipment damaging spikes and conducted RF noise to or from sensitive equipment. Transient surge protection plus low pass RFI hash filtering. All units 120V 15A.

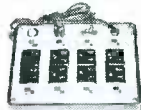

**MINI II \$44.95**

Wall Mount  
3-stage filter  
2 sockets

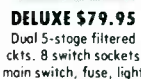

**QUAD II \$59.95**

Wall mount. Dual 3-stage filter  
4 sockets & light

**DELUXE \$79.95**  
Dual 5-stage filtered  
ccts. 8 switch sockets  
main switch, fuse, light



**Kalglo Electronics Co., Inc.**  
65 84 Ruch Rd., Dept. FE  
Bethlehem, PA 18017

Order Factory Direct  
**215-865-0006**

Out of State  
**800-523-9685**

DEALERS INVITED

PA Res. Add 6% • COD odd \$3.00 + Shipping

CIRCLE 46 ON FREE INFORMATION CARD

# BIG PERFORMANCE small PACKAGE

## Model 240



## Video Generator

- Video output for all VCR, CCTV and Monitor Applications † 1 volt into 75  $\Omega$  load
- RF output: CH 2, 3, 4
- Scope trigger output for V or H sync
- 10 step gray-scale staircase signal for video circuit analysis
- 10 bar and 3 bar gated rainbow pattern
- 8 other dot, bar and line patterns
- Operates from 2 std. 9V batteries or 115VAC
- Single slide switch control
- Complete with test leads, protective cover, AC adapter, comprehensive instruction manual

**PRICED UNDER \$200.**  
**THE 240 DOES SO MUCH  
FOR SO LITTLE!!**

**HICKOK**  
the value innovator

THE HICKOK ELECTRICAL INSTRUMENT CO.  
10514 Dupont Avenue • Cleveland, Ohio 44108  
(216) 541-8060 • TWX: 810-421-8286

CIRCLE 85 ON FREE INFORMATION CARD

# STATE OF SOLID STATE

## Power MOSFET amplifiers

ROBERT F. SCOTT, CONTRIBUTING EDITOR

SOME OF THE NEWER HI-FI AMPLIFIERS are designed around power FET's in the output stage. That's because they offer low harmonic distortion, extended SOA (Safe Operation Area), and infinite current gain. The design, construction, and performance of such an amplifier is covered in a recent Intersil applications note. Its schematic diagram is shown in Fig. 1. The amplifier delivers 50 watts into an 8-ohm load. Its frequency response is  $\pm 3$ -dB from 20 Hz to 100 kHz while distortion is less than 0.25% from 20 Hz to 20 kHz.

The amplifier's design is unconventional in several respects: First, there are no rolloff or compensation capacitors. Instead, rolloff is provided by the input capacitance of the power MOSFET's (Q8 and Q9) that are arranged in a quasi-complementary output stage. The driver stage uses bipolar transistors and provides the usual voltage amplification and phase-splitting functions. Finally,

the positive power-supply line is bootstrapped to insure that the positive and negative half-cycles of the output signal are equal and maximized.

The input stage is designed around Q3, a U402 dual N-channel JFET in a differential configuration. A pair of J113 JFET's (Q1 and Q2) provide a constant current for the U402. That current controls the bias current of the output stage and is set by R18, a 10-turn 1K trimmer potentiometer. Bipolar transistor pairs Q4-Q6 and Q5-Q7 turn on in proportion to the input signal and provide drive current for output transistors Q9 and Q8, respectively. The drive current flows through R10 and R11 and develops the necessary gate-source voltage for the output transistors. The power gain of the output stage is quite high because of the comparatively high value of the resistors connected between gate and source.

The boot-strapped positive power-supply line, mentioned earlier, is needed

because if Q8 is to clip at the level of the positive power-supply line, its gate voltage must be driven beyond that point. Thus, a voltage higher than  $\frac{1}{2}$  must be supplied to the input and driver stages. Instead of using an external power-supply with an output of more than 35 volts, the designers elected to bootstrap the  $\frac{1}{2}$ -volt supply; that bootstrap circuit consists of D7, C4, D6, C9, and R15.

The closed-loop gain is determined by resistors R16 and R17. Capacitor C3 compensates for any offset in the output. In this design, the open-loop gain is set at 20 kHz by the gate capacitance of the power MOSFET's and the values of the gate resistors, R10 and R11. This frequency can be pushed higher by reducing the value of the gate resistor. However, this will increase the power dissipated in the driver stage—particularly in Q6 and Q7.

Data for this section of the column was taken from a pre-published copy of Application Note A0-40 (A Low-Cost Audio Amplifier Using Power MOSFET's by Bruce Rosenthal and Jim Meador) from Intersil, Inc., 10710 N. Tantau Ave., Cupertino, CA 95014.

### High-voltage trigger

A series of new semiconductor devices for high-voltage bilateral trigger applications has been introduced by Motorola. Known as SIDAC's, the devices combine the high-voltage bilateral trigger functions of triacs with the simplicity and low cost of two-terminal diac triggers. The devices replace less reliable components such as neon bulbs for applications such as: high-voltage regulators, strobes and flashers, ignitors, line-transient clippers, pulse generators, fluorescent lighting, and high-pressure sodium-vapor lighting.

The devices are designed for direct interface with the AC power line. Upon reaching the breakdown voltage in each direction (104 to 135 volts) the SIDAC switches from a blocking state to a low-voltage "on" state. Conduction continues—as in an SCR—until the main terminal current falls below the holding current, typically 100 mA.

The new MKIV series of SIDAC's includes three devices, the MKIV-115, MKIV-125, and MKIV-135; with the last three numbers indicating the maximum repetitive break-over voltage. Fig-

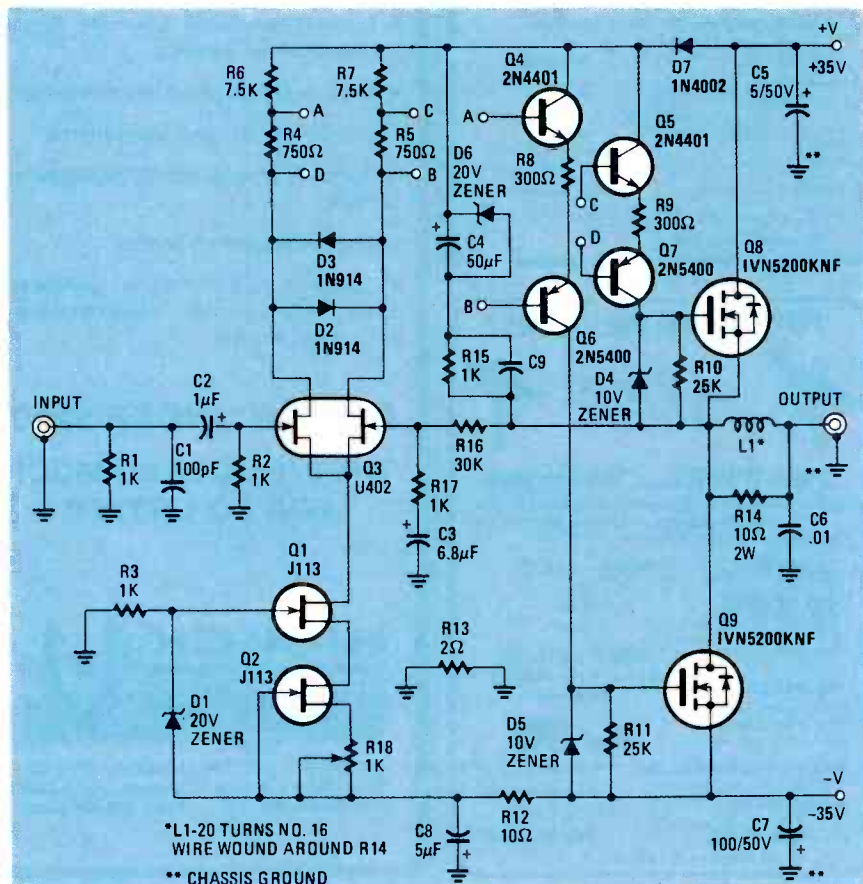

FIG. 1

Figure 2 shows two SIDAC circuits; Fig. 2-a shows how electronic equipment can be protected against line-voltage transients and Fig. 2-b shows a SIDAC as a two-terminal trigger for a strobe or flasher application.

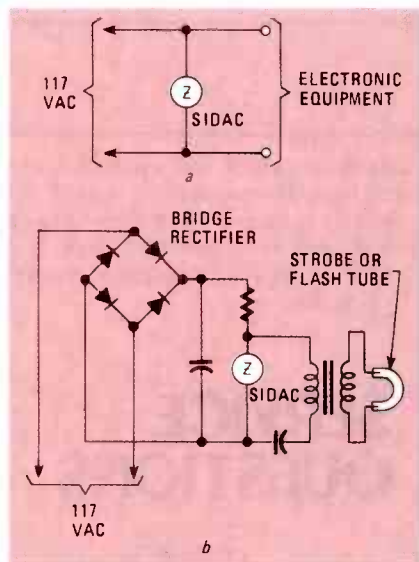

FIG. 2

The minimum breakover (breakdown) voltages are 104, 110, and 120, respectively for the three devices. Off-state repetitive voltage is  $\pm 90$  volts and repetitive peak off-state current is  $10 \mu\text{A}$ . Instantaneous on current is 1.0 amp RMS for each device. Maximum breakdown current (60-Hz sine wave) is  $200 \mu\text{A}$ . Forward "on" voltage is typically 1.1 while dynamic holding current is 100 mA.

#### Transistor data book

*Field-Effect Transistors—Selector Guide and Cross Reference* is a 32-page booklet chock full of valuable information on FET's. It opens with a brief description of all types of field-effect transistors and then comparing FET's to bipolar devices and then JFET's versus MOSFET's. This is followed by many listings of pertinent characteristics of JFET's, single- and dual-gate MOSFET's, dual-gate DMOS as well as power MOSFET's.

A numerical index lists approximately 70 devices whose characteristics are listed in tables depending on their classification as Switches and Choppers, Power MOS, Low-Frequency Low-Noise Amplifiers, or High-Frequency Amplifiers. A Cross-Reference and Interchangeability Guide matches industry type numbers of approximately 1900 FET's with equivalent types from Motorola. The book concludes with illustrated FET applications that include an ionization-chamber smoke detector and a 500-MHz dual-gate MOSFET amplifier that is suitable for service in the front-end of a communications receiver.—**Motorola Semiconductor Products**, PO Box 20912, Phoenix, AZ 35036.

continued on page 89

**Quick charge cordless soldering iron. Up to 125 electronics joints per charge. Total recharge in less than 4 hours. Isolated tip design. One of more than 2 dozen ISC-TIP and ORYX irons available. Write for free catalog and name of nearest distributor.**

## A Hot Tip on Cordless Soldering

No. 7700  
QUICK CHARGE  
Cordless  
Soldering Iron

ISO-TIP®  
ORYX®

WAHL CLIPPER CORPORATION  
Sterling, Illinois 61081 • (815) 625-6525

CIRCLE 19 ON FREE INFORMATION CARD

## Radio-Electronics REPRINT BOOKSTORE

- |   |  |
|---|--|
| <input type="checkbox"/> Build Your Own Satellite TV Receiver ..... \$7.00    | <input type="checkbox"/> Radio-Electronics back issues (1981) ..... \$3.50 |
| <input type="checkbox"/> 8-Ball Satellite TV Antenna ..... \$5.00             | (March, December 1981 not available)                                       |
| <input type="checkbox"/> Build Your Own Robot ..... \$12.00                   | Write in issues desired  |
| <input type="checkbox"/> TV Descrambler (January, February 1981) ..... \$3.00 |  |
| <input type="checkbox"/> Video Entertainment (January 1982) ..... \$2.00      | <input type="checkbox"/> Special Projects (Winter 1980) ..... \$4.00       |
| <input type="checkbox"/> Your Own Computer (October 1981) ..... \$3.00        | <input type="checkbox"/> Special Projects (Spring 1981) ..... \$4.00       |
| <input type="checkbox"/> Radio-Electronics back issues (1983) ..... \$3.00    | <input type="checkbox"/> Special Projects #4 (Summer 1982) ..... \$4.00    |
| (January, February 1983 not available)  | <input type="checkbox"/> Special Projects #5 (Winter 1983) ..... \$3.00    |
| Write in issues desired   | <input type="checkbox"/> Special Projects #6 (Spring 1983) ..... \$3.00    |
| <input type="checkbox"/> Radio-Electronics back issues (1982) ..... \$3.00    | <input type="checkbox"/> Radio-Electronics Annual 1983 ..... \$2.50        |
| (January 1982 not available)  | <input type="checkbox"/> How to Make PC Boards ..... \$2.00                |
| Write in issues desired   | <input type="checkbox"/> All About Kits ..... \$2.00                       |
|   | <input type="checkbox"/> Modern Electrics (Vol. 1, #1 ..... \$2.25         |
|   | April 1908)  |
|   | <input type="checkbox"/> Electro Importing Co. Catalog ..... \$4.95        |
|   | (1918) (176 pp)  |

To order any of the items indicated above, check off the ones you want. Complete the order form below, include your payment, check or money order (DO NOT SEND CASH), and mail to Radio-Electronics, Reprint Department, 200 Park Ave. South, New York, NY 10003. Please allow 4-6 weeks for delivery.

If you need a copy of an article that is in an issue we indicate is unavailable you can order it directly from us. We charge 50¢ per page. Indicate the issue (month & year), pages and article desired. Include payment in full, plus shipping and handling charge.

ARTICLE \_\_\_\_\_

MONTH \_\_\_\_\_ YEAR \_\_\_\_\_

PAGES \_\_\_\_\_

TOTAL PAGES @ 50¢ each TOTAL PRICE \_\_\_\_\_

MAIL TO: **Radio-Electronics** 7 83  
Reprint Department, 200 Park Ave. South, New York, NY 10003 **All payments must be in U.S. funds**

Total price of order	\$ _____
Sales Tax (New York State Residents only)	\$ _____
Shipping & Handling (U.S. & Canada only) (Includes FIRST CLASS POSTAGE) \$1.00 per item	\$ _____
All other (\$2.00 per item, sea mail)	\$ _____
(\$4.00 per item, air mail)	\$ _____
Total Enclosed	\$ _____
Name _____	
Address _____	
City _____ State _____ Zip _____	

# SERVICE CLINIC

## A dish full of bugs JACK DARR SERVICE EDITOR

SATELLITE-RECEIVING SYSTEMS HAVE BECOME very popular of late, especially in rural areas where cable TV is pretty certain to remain merely a dream. Such systems, and the large outdoor antennas that they use, have their own peculiar problems, some of which can really "bug" you if you don't recognize the cause. Here are some cases that you may find interesting.

In the first case, the system had been working well, until suddenly the reception started getting worse and worse, and finally went out completely. Checks of the system showed nothing out of order in the electronics—LNA, downconverter, etc. That left only the dish antenna. Nothing was immediately apparent, but close examination finally showed the cause.

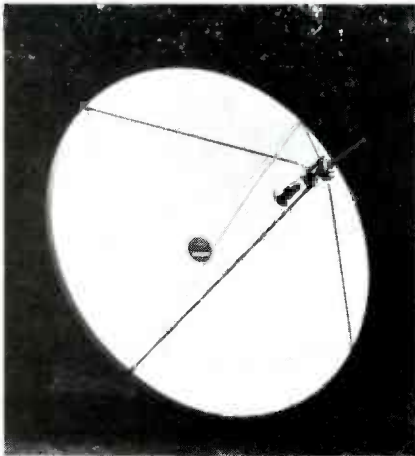

FIG. 1

A parabolic dish reflects the 3-4-GHz satellite signals on to a structure called a feed horn at the focal point of the dish (see Fig. 1). The feed horn directs the signal on to a small pickup device. There are various ways of picking up the signal; some antennas use very tiny dipoles, others use a waveguide, and so on. But one thing is common to all designs—there is a small hole at the end of the feed horn that the signal must pass through. In this case, the hole had been chosen by a female mud-dauber wasp to make her nest in. That busy little bug finds a deposit of wet clay, and carries vast quantities of it, considering her size, to your garage eaves, or anyplace else she can find to build nests, which are long tubes of clay. She loves to use holes in anything she can find—garden hose stored for the winter, a set of

socket wrenches in an open toolbox, a paint spray-gun left on the bench; etc. In this case, she had adopted the end of the feed horn—and it's hard to get a signal through a couple of inches of wet clay. Cleaning the aperture out, and guarding against further problems by tying a small piece of plastic wrap over the end, cleared up the problem.

In the second case the system worked nicely during the day, but at dusk the reception gradually got worse until it quit altogether. Once again a wasp eventually proved to be the source of the problem. That one is called the paper-making wasp; their nests, found under eaves, etc., look like a cone made of paper. Those wasps also like to adopt any kind of hole as their own. They were settling in the horn, and getting ready to build their nest there. During the day, they were all out foraging; at dusk, they came back and crawled into the horn. This is a big wasp, and it didn't take many to fill the feed horn completely.

Here's a word of caution. Those red-bodied wasps have a nasty disposition and when they sting you you'll know it. The best way to deal with them is to spray the feed horn with a strong wasp killer while it's "occupied," and come back later to clean it out. Once again, cover the opening with plastic wrap to prevent any future problems.

### A different kind of animal

The last case we'll talk about deals with another kind of animal, one that can do far more damage. The animal I am talking about is man, and in particular the type of man that doesn't think.

One such critter was working as an assistant to a dish installer. The installer wrote me asking for help (incidentally, this is the only case of satellite trouble we've ever fixed—by mail, of course). One of his customers had complained that the system got very noisy in rainy weather. I told him to tighten all the coax fittings and then spray them with a clear acrylic coating to weatherproof them. The installer then sent his assistant out to spray the plugs. Spray them he did—with a penetrating oil (the fellow simply did not read the label before doing the job). Of course, the oil not only penetrated the plugs, but went right down to the coax's center conductor, dissolving the insulation as it went. All the coax had to be

replaced—which was expensive, to say the least. The moral of the story is: When you give someone instructions to do a job, make sure everyone understands exactly what's to be done. Otherwise, you're inviting disaster. **R-E**

## SERVICE QUESTIONS

### TWO HINTS

Here are a couple you might be interested in. I had a Wollesak 3M tape recorder that would not run in one direction. It had an odd clutch setup; when the direction was reversed, the idler ran up a spiral groove to engage the other drive. After cleaning the grooves, the idler worked, but the clutch facings were so badly worn that they slipped. The fix turned out to be fairly simple. We got some fairly thin gasket material from an auto supply store, and cut two new clutch facings out of it. Those were cemented to the idler and the whole thing works better than new.

The second hint is for those into restoring old radios. A good place to find information about parts and services is *Hemmings Motor News*, Box 380, Bennington, VT 05201. Their classified section includes ads for various components, as well as for such services as re-coning speakers and restoring wood veneer.

*Thanks to Rodney K. Schrock of Somers, PA for these.*

### BURNING RESISTOR

*I repaired a Satchell-Carlson 3C66, including installing a new CRT and so on. I noticed that the 22K resistor between the cathode of the 3A3 and the plate of the 6BK4 had burnt up and replaced it with one of equal value, but rated at 2 watts. The set worked and the customer took it home. A while later I got a call—the set had gone out again. When I got it back into the shop, I found that the same 22K resistor was once more charred beyond recognition. I'm puzzled; is it possible that a common carbon resistor won't work there?—L.P., Osceola, IA*



I think your guess is right. I've had some embarrassing experiences trying to use common carbon-types in high-voltage circuits. The best bet here would be to use a glass-film or flameproof type. Carbon resistors, when used in high-voltage circuits, have to handle a lot more power than you might suspect at first glance. As a result, they get hot and burn up.

To tell you the truth, I'm not sure what that resistor is doing there anyhow. The only other time I've seen something like that was in an old Zenith. Incidentally, that resistor, which was a 1K unit, also burned up regularly. We eventually replaced it with a short piece of heavy hook-up wire.

### WHICH CAPACITORS?

In the February, 1983 issue of Radio-Electronics you had a question about "flag waving" (instability) in older sets when using a VCR. We have a CTC-68 (1973) with that problem. You said to reduce the value of the AFC capacitors; are those the ones that are called out as C2 and C3 in the MAH001A module in that set?—L.K., Newark, CA

I took a look at the Sams Photofact (number 1378-2), and I'm pretty sure that they are; try smaller ones there. You might also try reducing the value of the 100K resistors, although I've never heard of anyone having to do that.

### POSSIBLE CURE

A recent letter in your column described a problem with a Zenith 16Z7C19Z that was destroying 6HV5's; I may have a solution. In several of those I have found that the tube's screen resistor, a 1K unit, has either increased in value or opened. If that happens, it may produce the symptoms observed. If the 6HV5 has to be replaced, it is a good practice to check that resistor, especially if the tube's glass is cracked; the resistor can be checked from the top of the chassis. Hope that helps—Robert Cortner Jr., Davison TV, Buffalo, MO

### VERTICAL PROBLEM

I have a Sears 528.41670314 with nothing but a bright horizontal line on the screen. The sound is OK. I checked the vertical circuit and found one problem: There was -50 volts on V6A where there should have been +300. I scoped the boost that fed that plate and found a very high ripple-voltage. Replacing C113C in the +300-volt line cleared up that problem. The moral is that you should always scope the B+ lines.

That bad capacitor was evidently allowing feedback that was upsetting everything. Incidentally, when you see mysterious vertical lines on one side of the picture, and the set uses flyback-derived low-voltage sources, always scope those. You may find, as we did in several sets, that the small filter-capacitor on the low-

## YOUR EXCITING NEW HOBBY!

- » Enjoy fantastic savings by assembling your own organ or piano.
- » It's easy. No technical knowledge required.
- » Just follow our clear, pictured instructions.
- » Choose from many models from portables to consoles.
- » Ask about our interest-free installment plan.

## WERSI ORGAN & PIANO KITS



For Free Information Pack M40

Call Toll Free

800-233-3865

In PA 717-299-4327

or send

coupon

below

WERSI Dept M40 P.O. Box 5318  
Lancaster, PA 17601

Free Info. Pack.  Organ  Piano  
 Catalog & Demo Record (enclose \$6)

Name \_\_\_\_\_

Address \_\_\_\_\_

City \_\_\_\_\_ State \_\_\_\_\_ Zip \_\_\_\_\_

Phone (\_\_\_\_\_) \_\_\_\_\_

Rep inquiries invited

CIRCLE 95 ON FREE INFORMATION CARD

*voltage supply is open and you're getting a ripple voltage at the horizontal frequency!*

*Thanks to Lesley F. Dahm for this.*

### REPLACEMENT IC

*I need a replacement or substitute for IC-200 in a K-Mart SKC-1940-AM; the part number is 56A49-2 or 56C49-2. I've looked everywhere I can think of.—C.H., Liberty Lake, WN*

That set was made by Admiral for the Kresge Co. To my surprise I found a listing for the IC in the Sylvania ECG guide; it's an ECG-854. Incidentally, the letter in most Admiral part numbers doesn't mean much, hence both part numbers you listed are the same. If you need other Admiral parts, and can't get them locally, try their WATS-line number: 1-800-447-8361. Be sure to have the correct Admiral part number handy or they can't do much for you.

### CLOCK IC

An Imperial clock radio, model CR-102, made for Superscope, was stuck in the calendar mode. The data sheet for the clock IC, an Electronic Arrays 7317, showed that an internal pull-down resistor at pin 24 enables the clock mode unless V<sub>SS</sub> (20 volts in this case) is applied to the pin. When I measured, I found the

*continued on page 99*



## GET MICROCONTROL WITH SAMs.

This fascinating book shows how you can turn a low-cost computer into a dedicated microcontroller for a robot, your home's environment, games, instruments, and more! You can even design your own microcontroller from scratch!

No previous design experience is needed. Just your brain, a microchip and Sams MICROCOMPUTER DESIGN AND TROUBLESHOOTING.

Starting with the basic controller functions, it covers sequencing, counting, timing, computation and management. It also answers such questions as, "What is a development system?" and "Can you use a Motorola chip with an Intel processor?" It even discusses how to put together a simple test instrument for locating board faults and other useful troubleshooting techniques.

Also included are detailed chapters on read/write timing, interfacing ROM and RAM, bus schemes, address decoding and other important design and system considerations. MICROCOMPUTER DESIGN AND TROUBLESHOOTING is like having a computer consultant in your pocket, yet it costs only \$17.95!

**Get your hands on a copy and get computer control! To order MICROCOMPUTER DESIGN AND TROUBLESHOOTING (No. 21819), call 800-428-3696 or 317-298-5566 and ask for Operator 393.**



**SAMS BOOKS AND SOFTWARE**  
HOWARD W. SAMS & CO., INC.  
4300 West 62nd Street  
P.O. Box 7092  
Indianapolis, IN 46206

Offer good in USA only and expires 10/31/83. Prices subject to change without notice. In Canada, contact Lenbrook Electronics, Markham, Ontario L3R 1H2. AD393

CIRCLE 32 ON FREE INFORMATION CARD

# EQUIPMENT AND TRAINING NO OTHER SCHOOL CAN MATCH.

**NTS HOME TRAINING INVITES YOU TO EXPLORE MICROCOMPUTERS,  
DIGITAL SYSTEMS AND MORE, WITH STATE-OF-THE-ART EQUIPMENT  
YOU ASSEMBLE AND KEEP.**

Without question, microcomputers are the state of the art in electronics. And NTS is the only home study school that offers you training for this booming field with a choice of 3 production-model micro computers.

We'll explain the principles of troubleshooting and testing your microcomputer and, best of all, we'll show you how to program it to do what you want.

You'll use a digital multimeter, a digital logic probe and other sophisticated testing gear to learn how to localize problems and solve them.

Send for the full color catalog in the electronics area of your choice—discover *all* the advantages of home study with NTS!

NTS also offers courses in Auto Mechanics, Air Conditioning and Home Appliances. Check card for more information.

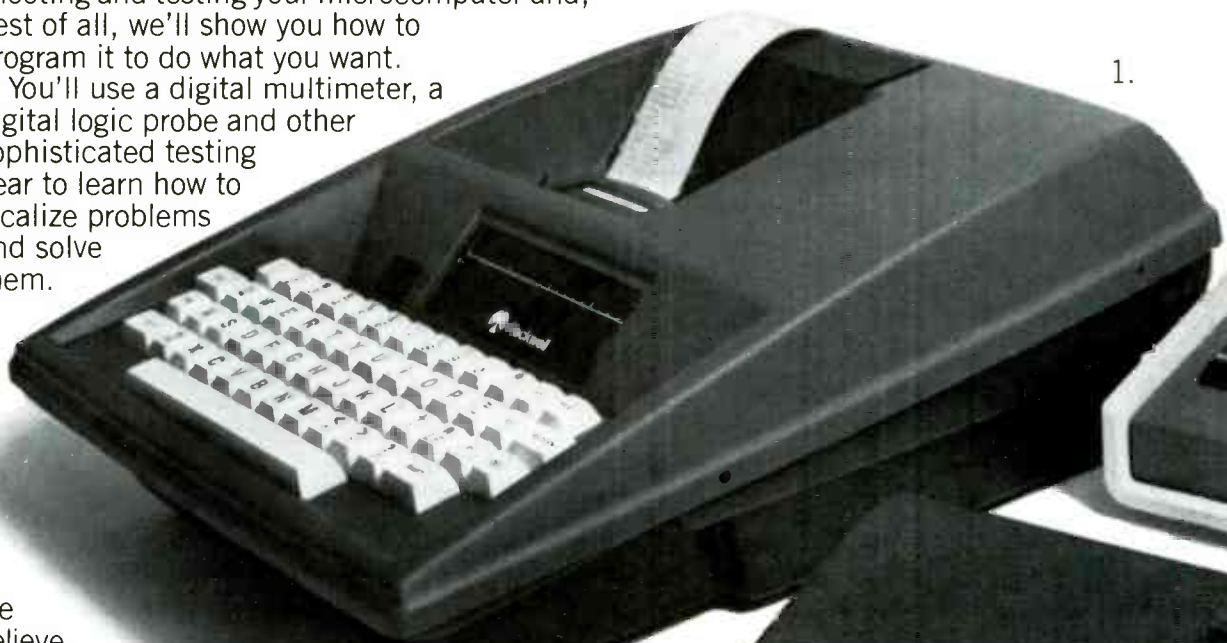

We believe that training on production-model equipment, rather than home-made learning devices, makes home study more exciting and relevant. That's why you'll find such gear in most of NTS's electronic programs.

For instance, to learn Color TV Servicing you'll build and keep the 25" (diagonal) NTS/HEATH digital color TV.

In Communications Electronics you'll be able to assemble and keep your own NTS/HEATH 2-meter FM transceiver, plus test equipment.

But no matter which program you choose, NTS's Project Method of instruction helps you quickly acquire practical know-how.





Simulated TV Reception

4.



3. The NTS/Heath HN-E9A Microcomputer features floppy disk storage, "smart" video terminal, two Z80 microprocessors, with 32K RAM Memory, expandable to 64K on board. 4. The NTS/Heath GR 2001 Digital Color TV (25" diagonal) features specialized AGC-SYNC muting, filtered color and new solid-state high voltage tripler rectifier.

## NTS NATIONAL TECHNICAL SCHOOLS

TECHNICAL-TRADE TRAINING SINCE 1965  
Resident and Home-Study Schools  
4000 SO. FIGUEROA ST., LOS ANGELES, CA 90037



1. The NTS/Rockwell AIM 65 Dedicated Microcomputer A Single board unit featuring on board printer and display—4K RAM (expandable). Application Functions: Central processor—Controller/Monitor—Development System. 2. "The NTS/SYM-1 Microcomputer" 6502 Based CPU—4K bytes ROM (expandable)—1K RAM (expandable). 51 active I/O lines for versatile interfacing: disk drives, ASCII key boards, cassette tape, etc.

**NATIONAL TECHNICAL SCHOOLS**  
4000 South Figueroa Street Dept. 206-073  
Los Angeles, California 90037

Please rush FREE color catalog on course checked below

- |   |   |
|---|---|
| <input type="checkbox"/> MicroComputers/MicroProcessors | <input type="checkbox"/> Auto Mechanics     |
| <input type="checkbox"/> Communications Electronics     | <input type="checkbox"/> Air Conditioning   |
| <input type="checkbox"/> Digital Electronics            | <input type="checkbox"/> Home Appliances    |
| <input type="checkbox"/> Industrial Technology          | <input type="checkbox"/> Color TV Servicing |

Name \_\_\_\_\_ Age \_\_\_\_\_

Address \_\_\_\_\_

Apt. \_\_\_\_\_ City \_\_\_\_\_

State \_\_\_\_\_ Zip \_\_\_\_\_

- Check if interested in G.I. information.  
 Check if interested ONLY in classroom training in Los Angeles.

# COMPUTER CORNER

## Recently-introduced microcomputers

LES SPINDLE\*

NOT WILLING TO BE LEFT BEHIND WHILE well-established computer companies like IBM and DEC moved aggressively into the personal-computer marketplace, veteran personal-microcomputer manufacturers like Tandy/Radio Shack and Apple Computer recently came back with a vengeance.

After months of media speculation about its not-too-well-kept secret, Apple unveiled its new 32/16-bit *Lisa* computer. Both the *Apple IIe* and the simultaneously-announced Radio Shack *Model 12* were upstaged by the attention-grabbing *Lisa*.

If *Lisa* actually lives up to its pre-release promises, it may well give all competitors a run for their money. Priced just below \$10,000, *Lisa* barely fits into the "personal" or "small business" computer categories. Yet, its comprehensive list of features and integrated software may well compensate for its price. And there's plenty of room for expansion as the applications needs grow. But its biggest feature is its user-friendliness. It's aimed at those not well-versed in "computerese." Apple claims that a first-time user can put the *Lisa* to work in less than a half-hour.

The hallmark feature of *Lisa* (*Local Integrated Software Architecture*) is the extreme ease of use promised by its "mouse" device. The mouse is a palm-sized box connected to the terminal that allows the user to manipulate a cursor just by moving the mouse across the desk top. Pictorial symbols, such as a file folder, a wastebasket, and stationery, provide the user with an immediately-identifiable range of functions—such as filing a document, discarding old data, or writing a letter. By simply moving the cursor to the desired function, the user can perform functions that ordinarily require a good deal of key-punching, several commands—and occasional swearing by newcomers or those not familiar with the particular system—to accomplish.

Meanwhile, a menu at the top of the screen continuously lists the various functions within each application. By simply moving the mouse to point at one item, another detailed menu is displayed on the screen to guide the user step-by-step through that particular function. The



FIG. 1

interactive process continues, allowing even a complete computer novice to move quickly from one transaction to another with a minimum of time and effort.

The range of software that comes standard with the computer is also impressive, and—another important feature of the machine—data from each package is easily integrated with data from the other packages through the use of the versatile mouse. *LisiCalc* is an spreadsheet program for financial planning. The *LisaWrite* word-processing program integrates several text-editing functions for correspondence, reports, short memos, etc. *LisaGraph* integrates spreadsheet data with various graphs—bar, line, bar/line, scatter graph, or pie charts. That program can work in conjunction with the *LisaDraw* program for creating graphic designs. The *LisaList* program performs comprehensive data-base and filing functions, while *LisaProject* handles various critical-path and project-management functions. And that, too, can be integrated with the other programs.

To make the machine even more versatile, it is compatible with either BASIC, Cobol, or Pascal. Two operating systems—CP/M and Xenix—are supported.

The microprocessor for the *Lisa* is the MC68000, which combines a 32-bit internal architecture with a 16-bit external data path. The computer comes with one

megabyte of RAM. Two 5¼-inch floppy-disk drives are standard and a *Profile* hard disk supplies 5 megabytes of storage.

The CRT screen is a 12 inch, black-and-white display. The resolution is 364 × 720 pixels. A typewriter-style keyboard and numeric keypad are standard.

Two serial ports and one parallel port are included and allow for a multitude of additional functions. The *AppleNet* software package (not available as this was written) will enable local-area network communications. Data-base access to The Source, CompuServe, and other such services is possible with the *LisaTerminal* software accessory.

### Another new Apple

Somewhat buried under all the hoopla surrounding *Lisa*, the *Apple IIe* (*e* is for "enhanced") is a successor to Apple's most popular computer—the *Apple II*. The system is priced below the similarly-configured *Apple II +*. The 64K unit offers easy expansion to 128K with a plug-in card. A low-cost 80-column card is also available.

The system is fully compatible with all *Apple II* software on the market. Meanwhile, enhancements to existing programs are rapidly being developed by various companies to add new features that are possible on the *Apple IIe*. Among new programs are the *Apple Writer II* word processor and *Quick File II*.

\*Managing Editor, *Interface Age* magazine

The price for a complete system (with 64K memory, floppy-disk drive with controller card, 12-inch monitor with stand, and the 80-column card) is \$1,995.

### Not to be outdone

Last, but not least, Tandy/Radio Shack craftily unveiled its latest offering almost the same day as Apple. The TRS-80 *Model 12* (priced at \$3,199 with one disk drive, \$3,999 with two) is Tandy's low-cost alternative to its popular *Model II*. While running all software designed for the *Model II*, the system looks very much like the 16-bit *Model 16* introduced last year.

The system includes a Z80A 8-bit processor, direct memory access, and vectored interrupts. Standard memory capacity is 80K, with either one or two 1.25-megabyte disk drives.

TRSDOS 4.2 is the unit's resident operating system—an enhancement of the TRSDOS 2.0. Double-density disks are supported, as well as double- or single-sided 8-inch floppy disks.

The display is a 12-inch green-phosphor monitor capable of 80 × 24 or 40 × 24 lines. Upper and lower case characters are supported, as well as 32 graphics characters. A detachable keyboard includes 82 keys, with a numeric keypad and eight special-function keys.

An optional card cage provides six slots for expansion. An upgrade card will convert the system to *Model 16* capability. High-resolution graphics and a 64K VisiCalc are other possible expansions.

Meanwhile, further expansion is available with the newly introduced 12-megabyte hard-disk drive, adaptable to the TRS-80 *Model II, 16, or 12* systems. The price is \$3,495 for the primary drive and \$2,495 for a secondary drive.

While the *Model 12* unveiling may not have been as exciting as Apple's double announcement, Radio Shack reportedly has more tricks up its sleeve, including a portable computer to rival the *Osborne I* and all of its imitators. In any event, it's clear that the pioneer microcomputer companies are determined not to be undone by the flood of competitors entering the market. As the competition heats up, the coming months should offer a number of surprises. R-E

## STATE OF SOLID STATE

*continued from page 81*

### High-power 900-MHz transistors

Motorola has introduced three new 24-volt DC, 900-MHz power transistors. The line includes the MRF890, a 2-watt, 9.0-dB minimum-gain predriver; the MRF892 14-watt, 8.5-dB driver; and the MRF894 30-watt, 7.0-dB final amplifier. A chain of those three devices is capable of boosting a 100-mW UHF input signal (804 to 960 MHz) to 30 watts output. The

new transistors are intended for large-signal, common-base amplifier applications in industrial and commercial cellular-FM radiotelephone equipment. All three devices have guaranteed gain performance at 900 MHz, collector efficiencies of 55% minimum, and will withstand a 30:1 VSWR load mismatch at their rated voltages and power outputs. The MRF390 is packaged in a 305-1 case; the other two devices in the family in 319-04 packages. Prices in quantities of 100-499 are \$10.00, \$19.55, and \$30.60 for the MRF890, -892 and -894, respectively.—**Motorola Semiconductor Products**, Attention: Tom Bishop, PO Box 20912, Phoenix, AZ 20912.

### Voltage regulator design data

*Linear Voltage Regulators*, (Application Note APN-27) is a 16-page booklet that provides detailed design information on a wide variety of voltage-reference circuits and voltage regulators. The material includes schematics, performance data, and descriptions of 18 circuits. Those circuits include band-gap voltage references, Zener-diode references, series and shunt regulators, and positive and negative voltage regulators. The designs include information on such parameters as temperature stability, noise voltages, and line and load regulation.—**Interdesign, Inc.**, 1255 Reamwood Ave., Sunnyvale, CA 94086. R-E

# DON'T FORGET

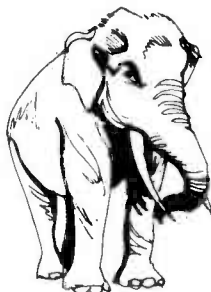

USE  
YOUR  
READER  
SERVICE  
CARD

## 64K Applesoft Compatible Micro-Professor II™ \$399.95

Dear Computer Enthusiast:  
You can now have a 64K Applesoft-compatible computer for only a fraction of what you might expect. The Micro-Professor II™ is a full 64K computer with expansion capabilities. This great little computer has entry level pricing with professional grade quality. See for yourself. Try out the Micro II today.

Sincerely,  
*Chris Johnson*  
Chris Johnson  
Customer Service  
P.S. Act now and get a full size keyboard (a \$39.95 VALUE) ABSOLUTELY FREE.

\*Optional

\*Optional

**Compatible:** \*Micro II is 98% compatible to Applesoft and 90% compatible to Machine Language. Most programs written for the Apple can be run directly or with slight modification.

**Expandable!** Add a printer, game paddles, floppy disk drives, speech and sound synthesizer, and Firmware ROM cartridges to expand the Micro II to cover many applications.

- |   |  |   |  |
|---|--|---|--|
| <b>Features:</b> <ul style="list-style-type: none"> <li>• 6502 CPU</li> <li>• 16K BYTES of ROM (12K BASIC)</li> <li>• 64 BYTES of RAM</li> <li>• 46 one-key Basic Commands</li> <li>• Joystick Interface</li> <li>• Video Monitor &amp; TV Interface</li> <li>• Printer Interface (Parallel)</li> </ul> | <ul style="list-style-type: none"> <li>• Tape Cassette Interface</li> <li>• Video Display Memory Mapped Into System RAM</li> <li>• Systems Diagnostic Tape</li> <li>• Instant Color Graphics</li> <li>• Installation/Diagnostic/Basic Programming Manuals</li> </ul> | <b>Options:</b> <ul style="list-style-type: none"> <li>• Floppy Disk with Controller (\$395.00)</li> <li>• Joystick Game Controller (\$24.95)</li> <li>• Printer interface cable and software (\$34.95)</li> <li>• MPE-II Printer (\$199.95)</li> <li>• Green Screen Monitor (\$99.95)</li> </ul> | <ul style="list-style-type: none"> <li>• Demo Cartridge (\$34.95)</li> <li>• Software, cassette (\$8.95) disk (\$34.95), prices vary according to application</li> <li>• Full size keyboard (\$39.95)</li> </ul> |
|---|--|---|--|

### MONEY BACK GUARANTEE

Order today and receive a FREE Full Size Keyboard for the Micro-Professor II™ — a \$39.95 value.

For Fast Service Call  
Toll Free  
1-800-426-1044

**ETRONIX** Dept. RE073  
14803 NE 40th  
Redmond, WA 98052

CIRCLE 10 ON FREE INFORMATION CARD

**A 10 HOUR TAPE RECORDER** WAS \$125.00  
**NOW only \$95.00\*** LONG PLAY

Modified Panasonic Slimline high quality AC-DC Recorder provides 5 continuous hrs. of recording & play back of top quality sound on each side of cassette for a total of 10 hrs. Built-in features include:

- Voice level control
- Digital counter, etc.

TDK DC-180 Cassette included.

**PHONE RECORDING ADAPTER**

Records calls automatically. All Solid state connects to your telephone jack and tape recorder. Starts recording when phone is lifted. Stops when you hang up. **\$24.50\*** FCC APPROV.

**VOX VOICE ACTIVATED CONTROL SWITCH**

Solid state. Self contained. Adjustable sensitivity. Voices or other sounds automatically activate and control recorder. Uses either recorder or remote mike. **\$24.95\***

\*Add for ship. & hdlg. Phone Call Adapter & VOX Recorder \$4.00. Cal. Res. add tax. Mail order. VISA, M/C, cod's ok. Qty. disc. avail. Money back guar. Free data. Dir. inv. AMC SALES, Dept. A, 9335 Lubec St., Box 928, Downey, CA 91821 (213) 902-4111 Phone 869-8519

CIRCLE 51 ON FREE INFORMATION CARD

# COMMUNICATIONS CORNER

## Communications for the disabled

HERB FRIEDMAN, COMMUNICATIONS EDITOR

FOR ALMOST ALL MY WORKING LIFE I WAS associated with New York City's High School of the Air for Home Instruction. Using FM radio and sophisticated (for their day) telephone couplers and switching systems, the High School of the Air created real-time classrooms for disabled children who could leave home only infrequently, if at all.

The dial-up telephone system connected the homebound students to the studio console where they were mixed (electronically) with a teacher and his class. We could do straight classroom simulations, or even dramatic programs with music, sound effects, in-studio performers, and dial-up telephone performers. The studio mix was then fed to the transmitter and also out to up to 25 telephone users. (The budget-cutters eliminated the five teachers who serviced 1000 students, and thereby—after 35 successful years—destroyed the program.)

While it was easy for most disabled children to use the service, the blind and deaf had severe communications handicaps, which carried through to adulthood. There is little in the way of low-cost communications equipment for the disabled, and little information on what there is, even from the manufacturers and distributors. (Most of them simply appear concerned with charging as much as the traffic will bear.) Personal computers appeared to be an ideal solution for providing low- or moderate-cost communications for the deaf and blind, but

again, there is no centralized information source.

When several of our readers with disabled children inquired about using personal computers for communications, I ran up against the same problem they did—too little information. By chance, I got to talking with some people at The Source about the problem, and it turned out that they were working toward a similar goal of providing a bulletin board and information database for the disabled. In less than two weeks the system was in place.

Users of The Source can go directly from the command mode to a bulletin board and message center for the disabled by typing "POST R DISABILITY" on the terminal. Manufacturers and users can leave general information or specific details concerning special personal-computer equipment specifically intended for the disabled. Also, through the Texas Instruments *Texnet* tie-in with The Source, the UPI news service is prepared for voice output through a personal computer with a speech synthesizer. (Got the idea of what we're looking for? We want everything in communications for the disabled!)

If you have any specific knowledge about personal-computer or communications equipment that would benefit the disabled—such as a moderately priced Braille printer for the Apple computer, or a store-and-forward with voice output for any personal computer—put it

up on The Source or pass it along to me here.

### Saving money by telephone

The way I heard it a few years ago, the telephone was dead. Microprocessors, satellites, and systems that we hadn't even yet conceived were going to make the telephone system as obsolete as the singing telegram. Well, here it is a few years into the computer age and the telephone is livelier than ever thanks to new developments. We're getting more low-cost telephone systems than we could imagine, all thanks to the computer, microwave communications, satellites, and whatever new inventions our engineers will conjure up in the coming years.

Just as soon as I finish typing this column I am going to telephone the editor and explain why it's late. It's a call in the same part of the state, but it will cost a lot less than usual. I will press two keys on the keypad built into the mouthpiece of my phone, and a computer also built into the mouthpiece will dial Sprint. Sprint is one of several communications services that provide short- and long-distance telephone service that is less expensive than the equivalent service from the telephone company (which we'll call Telco). When I hear the Sprint answer-tone, I will press two more keys, and the mouthpiece computer will transmit my identification, travel code (which I can use from coast to coast), and the number that I'm calling. A Sprint computer will recognize who I am and route my call through its facilities to New York City, put it back into the Telco system, and connect my call. I will be billed by Sprint, and pay about 40% less than I would for a telephone call made in the standard way. My only extra charge will be the local one for the connection to Sprint.

As you might guess, the secret to all that is a computer that does the Telco-system interconnects and the monthly billing. There are several ways that such a communications system can be put together, so we'll construct a "basic" model that will help you understand this new wrinkle that's shown up in telephone communications.

First, it's possible to purchase "bulk" telephone service from Ma Bell at lower rates than regular subscribers pay. Then, there are private and public microwave systems through the main business corri-

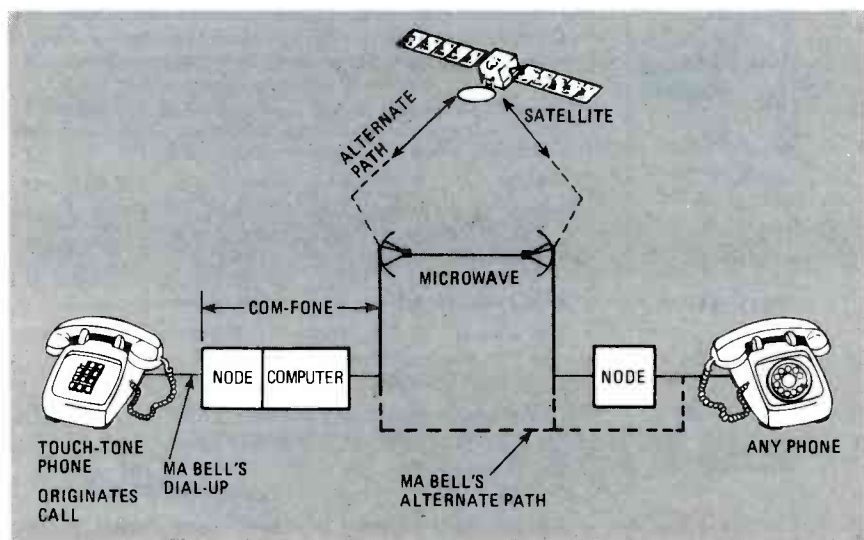

FIG. 1

# SAVE!

MONEY • TIME • FREIGHT

- ♫ QUALITY STEREO EQUIPMENT AT LOWEST PRICES.
- ♫ YOUR REQUEST FOR QUOTATION RETURNED SAME DAY.
- ♫ FACTORY SEALED CARTONS—GUARANTEED AND INSURED.
- ♫ SAVE ON NAME BRANDS LIKE:

PIONEER	JVC
KENWOOD	TEAC
MARANTZ	SANSUI
TECHNICS	SONY

AND MORE THAN 50 OTHERS  
BUY THE MODERN WAY  
BY MAIL—FROM

## illinois audio

BANK CARDS ACCEPTED

12 East Delaware

Chicago, Illinois 60611

312-664-0020

800-621-8042

CIRCLE 94 ON FREE INFORMATION CARD

For Home or Business  
WHAT...WHEN...HOW...

## BE A COMPUTER PROGRAMMER

Train at home in spare time! No previous experience needed! Now you can learn it all! Computer programming...computer applications...computer games...everything you ever wanted to know about computer operations! Write your own computer programs or use hundreds of programs already available...budgeting, real estate, bookkeeping, expenses, investments, interest, taxes, shopping lists, vacation planning, addresses, phone numbers, routing...even foreign languages and graphics.

You'll know what really happens when you have a computer problem with a bank, store, loan company, oil company, utility or anyone else. You'll be able to talk their language...understand why and how things happen...to be able to take the offensive when you're the victim of a computer error. Experts explain everything in easy-to-understand language with step-by-step directions.

- TIMEX COMPUTER INCLUDED WITH YOUR TRAINING • Plugs into any TV
- SEND FOR FREE FACTS!

ICS  
SINCE 1951

COMPUTER TRAINING, Dept. DE063  
Scranton, Pennsylvania 18515

Please rush me free facts and color brochure that tells how I can learn computer applications, programming and operation at home in spare time. No cost. No obligation.

Name \_\_\_\_\_ Age \_\_\_\_\_

Address \_\_\_\_\_

City/State/Zip \_\_\_\_\_

dors, such as New York to Atlanta, or Los Angeles to Chicago, or Houston to everywhere. Since communications circuits are often kicked upstairs to a satellite (because it's easier to get over a mountain that way), it's a safe bet that part of our budget communications will involve satellite transmission (as is often the case with "regular" telephone service).

Figure 1 shows how a hypothetical system we'll call "Com-Fone" might be used to provide you with low-cost telephone communications. Starting at point "A," you use your standard phone with rotary or Touch-Tone dialing to get into the nearest Com-Fone node (switching center). Com-Fone's computer answers, and on hearing the answer tone, you transmit your identification code using Touch-Tone frequencies. You cannot use the standard telephone dial pulses because the Com-Fone computer "understands" only the DTMF (Dual-Tone Multi-Frequency) tones used by the Touch-Tone system. Still using tones, you dial the area code and number you want. The computer checks your I.D. If it's not valid, the computer does an intercept and a computerized voice informs you that that's the case. If your account is clear, the computer seizes an open communications path that may be part microwave link, part satellite, and part Ma Bell's wiring. At the receiving end, the computer connects back into Ma Bell's system and dials the local telephone number that you are trying to reach.

You pay the telephone charge (to your local telephone company) from your phone to the Com-Fone node. Com-Fone's computer calculates and bills you for the charges for service from the node right up to the party you called. Com-Fone's costs (what Com-Fone must pay Ma Bell) at the receiving end—where your call re-enters Ma Bell's wiring—are calculated and built into your Com-Fone charges. But because Com-Fone purchases bulk telephone-service, your total bill is reduced.

Oh yes! That computer inside the telephone mouthpiece! That's not hypothetical, it's a Soft-Touch dialer from Buscom Systems, Inc. (4700 Patrick Henry Drive, Santa Clara, CA 95050) that provides Touch-Tone dialing on rotary dial telephones. It substitutes a microphone and miniature keypad for the existing carbon microphone. It has 80 programmable memories that are accessed by pushing two buttons. The memories are maintained by subminiature batteries that last several years. The memories stack automatically, so you can program any series of access numbers and codes; all of them are transmitted by pressing the two buttons representing the initial memory address.

Next month, when we continue, we will look more closely at that Touch-Tone autodialer. We'll also be looking at other applications for Touch-Tones. R-E

SEE YOUR DEALER TODAY

FROM

**Firestik**  
ANTENNAS  
ACCESSORIES

HERE'S A TIP  
THAT'S PERFECT!

AM/FM AUTO RADIO  
AND CB

**'Firestik' II**  
GOLDEN SERIES

BARE-HANDS TUNABLE  
"NO TOOLS NEEDED"  
HIGH PERFORMANCE ANTENNAS

ALSO ANTENNAS FOR  
CORDLESS TELEPHONES  
MONITOR SCANNERS

Dealer & Distributor Inquiries Invited  
SEND FOR FREE CATALOG

'Firestik' Antenna Company  
2614 East Adams Phoenix, AZ 85034

Name \_\_\_\_\_

Street \_\_\_\_\_

City \_\_\_\_\_

State \_\_\_\_\_ Zip \_\_\_\_\_

Serving the CB and  
Communications Market Since 1962.

**5-YEAR REPLACEMENT WARRANTY**

CIRCLE 40 ON FREE INFORMATION CARD

NEW  
1983 Products

**TINKER TRON**  
MINI POWER SUPPLIES



• 5 Models • 100mA to 3.0A • 1.5 to 20 Volts

MODEL	VOLTAGE	DIGITAL	DISPLAY	AMP	CURRENT	PRICE
1530A	1.2-15V	Yes	Yes	Yes	3 Amp	\$216.00
2020A	1.2-20V	Yes	Yes	No	2 Amp	179.95
0530A	5V	Yes	No	No	3 Amp	149.95
1230B	12V	Yes	No	No	3 Amp	149.95
1295B	5, 9, 12V	No	No	No	100mA	69.95

### The Phaser II (Model P-2280)

Infrared Transmitter and Receiver Switch

\* Turn Appliances On/Off

\* Range Up to 30'

\* Switch Handles 500 Watts

\* Directional (Just Point)

\$29.95



### Magic Touch Ceiling Fan/Light Control

\* Works on any Fan/Light

\* No Additional Wiring

\* Controls Fan Speed/Light Brightness

\* Eliminates Motor Hum (Not Triac)

\$39.95



This new concept totally simplifies ceiling fan installation. Just remove light fixture and switch, and replace with your fan and the Magic Touch control system. With no addition to your existing wiring, you can control fan speed and light brightness.

### Encapsulated Modules for PCB Mount

(Application notes included)

**Z500 AUDIO AMPLIFIER**—4-12V operation, 4mA quiescent current, output 500mW with 9V supply and 8 ohm speaker. Requires only a speaker and 10K pot. \$6.95 3/\$18.00

**Z100 PREAMP**—(for additional amplification) \$5.95

### DC to DC Polarity Converters

Generate negative output from positive input voltage

MODEL	INPUT VOLTAGE	OUTPUT VOLTAGE	I (max)	PRICE	3 or More
PC100	2.0-6.0	-(2.0-6.0)	15mA	\$7.25	\$6.35
PC200	6.1-10	-(5.0-9.0)	15mA	\$7.25	\$6.35

### Solid State Relays

Optically coupled, TTL, CMOS compatible, zero crossing

(Resistive or Inductive loads)

MODEL	INPUT DCV	mA	OUTPUT V (max)	I (max)	PRICE	3 or more
SS120AC	4-15	25-1.0	120VAC	5A	\$10.95	\$9.60
SS050DC	4-15	25-1.0	50VDC	1A	9.95	8.85

Send 25¢ for our 1983 Summer Catalog of electronic parts (free with order) including resistors, capacitors, semiconductors, plastic boxes, motors, etc.

**LOWEST PRICES — SAVE UP TO 50% OR MORE!**

Add \$2.00 shipping to each order. In Texas add 4% tax. \$10.00 minimum order.

VISA

**TINKER TRON**  
P. O. BOX 53128  
LUBBOCK, TEXAS 79453  
806/745-2228

MasterCard

All TinkerTron Products Have A Ten Day Money Back Trial Period.

CIRCLE 30 ON FREE INFORMATION CARD

## USING LORAN-C ETC.

continued from page 67

idea of using Loran-C for frequency-standard checking/calibration. The GRI source, driven from a local frequency standard, is used to trigger the scope externally. The Loran-C signal, either from a suitable receiver or from the RF front end (the circuit shown in Fig. 7) is displayed, and the sweep time is adjusted to observe some part of a particular signal. The Loran-C signal at a given GRI can be momentarily speeded up or slowed down by "bumping" the thumbwheel switches of the GRI generator to place the Loran-C trace at some point on the scope so that a very small part of the leading edge of a pulse can be observed. Then, by determining the length of time it takes the Loran-C signal to move a given distance across the screen of the scope, the fractional frequency-stability of the local 1-MHz standard can be determined.

How is that time measurement used to obtain a measurement of the relative frequency stability? The two measurements can be related by calculus; we will only give the result:  $\Delta f/f = -\Delta t/T$ .

Here,  $\Delta t$  is the change in time (the drift) read over a measurement time,  $T$ .

If, for example, the result was  $1.5 \times 10^{-6}$ , it would indicate that the oscillator's actual frequency was its nominal frequency (in this case 1 MHz) multiplied by  $1.5 \times 10^{-6}$ . In this case, the actual frequency of the standard would be 1.0000015 MHz. Typically, with a good (proportional oven controlled) standard, the Loran-C signal will only move to the right or left about 10  $\mu\text{s}/\text{hour}$ . That implies an offset of the order of  $3 \times 10^{-9}$ .

The expanded scope-trace (about 10  $\mu\text{s}/\text{division}$ ) is useful for examining the actual RF-carrier output from the pin-11 test point of the MC1357 detector in Fig.

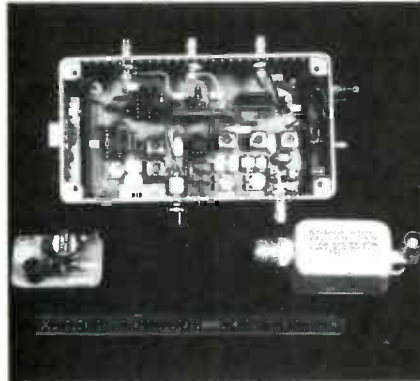

FIG. 10—EXPERIMENTAL MODEL of the Loran-C envelope detector with active antenna preamp and housing.

TABLE 1—GRI RATES

GRI ( $\mu\text{s}/10$ )	CHAIN	COUNTER CODE
4990	Suez Canal	1F3
4990	Central Pacific	1F3
5930	Canada East	251
5990	Canada West	257
7930	North Atlantic	319
7960	Gulf of Alaska	31C
7970	Norwegian Sea	31D
7980	US Southeast	31E
7990	Mediterranean Sea	31F
8970	US Great Lakes	381
9940	US Westcoast	3E2
9960	US Northeast	3E4
9970	NW Pacific	3E5
9990	North Pacific	3E7
10000	(HF Radar 0.1s)	3E8
8000	(USSR West)	320
5000	(USSR East)	1F4
1000	(0.01s)	064
100	(0.001s)	00A
10	(0.0001s)	001

7. The envelope of that signal at the output of the op-amp-filter can also be observed, and the movement of the inflection point or zero crossing can be recorded at hourly intervals to check the clock-stability.

When using receivers like the FRG7700 for Loran-C, the envelope rise-time is smeared out over 150  $\mu\text{s}$  or so. But by observing the change of that signal at daily time intervals, with the clock and GRI source operating continuously, the frequency stability of the clock can be determined without any special Loran-C front-end hardware.

For Loran-C DX hunting on late winter evenings when the noise level is low and DX is coming in from other stations such as Allouis in France on 164 kHz, the GRI rate can be set to try to find some chain not normally observed in the USA. That is done by examining the whole GRI frame in detail (with the oscilloscope in the expanded-sweep mode) and slowly bumping the GRI rate a few tens of milliseconds at a time to find weaker sky-wave pulses standing still. Loran-C signals from the USSR using GRI rates of 8000 and 5000 can sometimes (although rarely) be observed that way. The main problem in looking for weak signals is the cross-rate interference from other chains drifting by the desired small-amplitude signal on the scope trace.

A photograph of an experimental model of a Loran-C RF-envelope detector is shown in Fig. 10. Circuit-board layouts have been prepared for the Loran-C RF detector and the GRI generator. Contact: R. W. Burhans, 161 Grosvenor St., Athens, Ohio 45701. Include a SASE for information on the availability of these boards for experimental use. **R-E**

## NOW AVAILABLE: FREE ZX81/TS1000 CATALOG

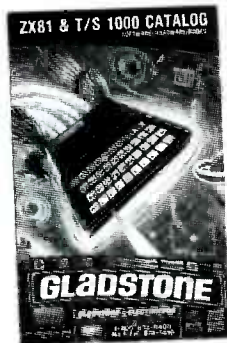

New from Gladstone Electronics! Our ZX81/TS1000 catalog will take you where no one has dared go before! You will view the widest selection of up-to-date software, books and hardware add-ons available to get the most from your personal computer. This exciting new 34 page color catalog lists arcade, fantasy and family games, business and educational programs; books for beginners as well as experienced users; hardware add-ons and other peripherals for use with ZX81/TS1000 Home Computer!

Use the convenient coupon below and send for your FREE catalog TODAY!

Call toll free 1-800-833-8400  
N.Y. (716) 874-5510  
In Canada call toll free 1-800-268-3640

**GLADSTONE** Electronics

Please rush me this exciting new ZX81/TS1000 catalog.

Name \_\_\_\_\_

Address \_\_\_\_\_

City \_\_\_\_\_ State \_\_\_\_\_ Zip \_\_\_\_\_

Mail to: 1585 Kenmore Ave., Buffalo, N.Y. 14217  
In Canada: 1736 Avenue Rd., Toronto, Ont. M5M 3Y7

## Put Professional Knowledge and a COLLEGE DEGREE in your Electronics Career through HOME STUDY



### Earn Your DEGREE

No commuting to class. Study at your own pace, while continuing your present job. Learn from easy-to-understand lessons, with help from your home-study instructors whenever you need it.

In the Grantham electronics program, you first earn your A.S.E.T. degree, and then your B.S.E.T. These degrees are accredited by the Accrediting Commission of the National Home Study Council.

Our free bulletin gives full details of the home-study program, the degrees awarded, and the requirements for each degree. Write for *Bulletin R-83*.

**Grantham College of Engineering**  
2500 So. LaCienega Blvd.  
Los Angeles, California 90034





**ON SALE  
AT YOUR  
LOCAL  
NEWSSTAND**

**JUNE 2**

**Reserve your  
copy now!**

**Get every issue  
SUBSCRIBE  
TODAY!**

**Use the order  
form below**

## Special Projects #7

■ IF YOU'RE THE KIND OF READER that doesn't want to wait, you can get your copy of **Special Projects #7** now. This 100-page magazine is crammed full of electronic projects that you won't be able to wait to build for yourself. There's a Digital Prototyping System, a Soundbox to add sound to TRS-80 games, a Code-Practice Oscillator, Electronic Flasher for your car, plus all the other articles listed on the cover above. You get a total of 21 fun-filled build-it stories.

■ TO HELP YOU TO BE SURE that you don't miss any future issues—SUBSCRIPTIONS ARE NOW AVAILABLE!

■ YOU CAN HAVE THE NEXT FOUR ISSUES of **Special Projects** delivered directly to your home for only \$9.00. We pay the postage. If you want the next eight issues, you can even save a dollar off the newsstand price. Get eight issues for \$17.00.

■ EVERY ISSUE OF SPECIAL PROJECTS will continue to contain a variety of construction articles to suit every taste. In addition, feature articles on electronics fundamentals, test equipment and tools will round out each issue. Of course, we will continue to provide new product and literature listings to keep you up to date on the latest developments in electronic technology.

■ GET IN ON THE ACTION! Order your next issue of **Special Projects** today. Use the convenient order coupon below.

### Special Projects #7

DETACH AND MAIL TODAY TO:  
SPECIAL PROJECTS  
SUBSCRIPTION DEPT.  
200 PARK AVE. SOUTH  
NEW YORK, N.Y. 10003

CASH WITH ORDER ONLY RE-7  
Allow 6-8 weeks for the first issue to arrive.

Send me \_\_\_\_\_ copies of **Special Projects #7** at \$2.25 plus \$1.00 postage and handling for U.S. Canada and Mexico. U.S. funds only. All others add \$2.00.

I want to be sure I don't miss any issues. Send me the next four issues of **Special Projects** for \$9.00; starting with #7. Postage is free in U.S. For Canada add \$3.00. Foreign add \$7.00.

I want to be sure I don't miss any issues and want to save \$1.00 too. Send me the next eight issues of **Special Projects** for \$17.00; Starting with #7. Postage is free in U.S. For Canada add \$6.00. Foreign add \$14.00.

Please print

(Name)

(Street Address)

(City)

(State)

(Zip)

DRE

## ANALOG CIRCUITS

continued from page 72

complex passive- and active-circuits around an op-amp. A triangular wave can be formed by adding the op-amp integrator shown in Fig. 13 to the output terminals of a squarewave generator like the one shown in Fig. 12.

Among the most popular oscillator circuits is the Wien bridge. A basic transistor circuit using the Wien bridge is shown in Fig. 14. Here, the Wien bridge circuit is placed around a single-ended differential amplifier; it consists of the series and parallel-connected R-C networks. Current is fed back through that filter network from the output to the input. Oscillation

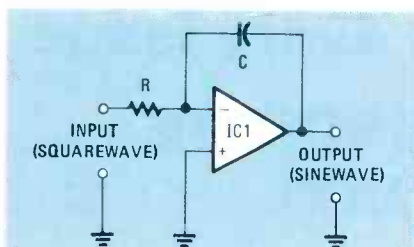

FIG. 13—AN INTEGRATOR, such as the one shown here, can be used to change a square-wave into a triangular wave.

occurs if the forward gain of the amplifier is greater than 3 because the output at the junction of the series and parallel R-C circuits is  $\frac{1}{3}$  of that at the collector of Q2. The frequency of oscillation is  $1/2\pi R_1 C_1$ , assuming that  $R_1 = R_2$  and  $C_1 = C_2$ .

A similar circuit can be built around an op-amp, as shown in Fig. 15. Positive feedback is applied through the R-C Wien bridge to the non-inverting input of the op-amp. Negative feedback is applied through a resistor divider to the inverting input. The frequency of oscillation is found exactly as it was in the previous example. Two Zener diodes are included

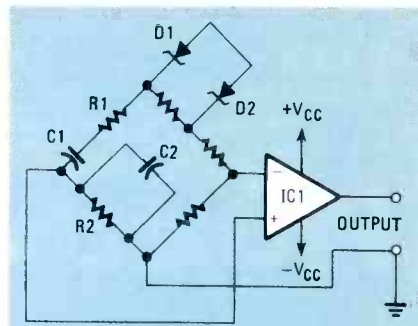

FIG. 15—ANOTHER EXAMPLE of the Wien bridge, this one is built around an op-amp.

in the circuit to keep the output voltage, when at a peak, from putting the op-amp circuit into saturation. If it did go into saturation, the circuit would remain in that state and oscillation would no longer take place.

### High frequency

Unwanted feedback is quite likely to occur in high-frequency circuits. It has many causes: To give just one example, signal at an output can be coupled back to the input through adjacent wiring or through stray capacitances in a circuit. In the next article in this series, we will explore and determine just what its effects are and how to handle them in transistor circuits. **R-E**

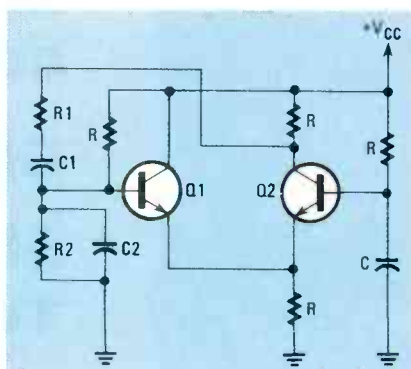

FIG. 14—ONE OF THE MOST POPULAR sine-wave generators, the Wien-bridge circuit has been around since the days of vacuum tubes.

# TAFT

## ELECTRONIC SALES

# HAS IT ALL FOR LESS

NORTH AMERICAN SOAR CORPORATION



- MS-3015-15MHZ DUAL TRACE PORTABLE
- MS-6020-20MHZ DUAL TRACE
- MS-6035-35MHZ DUAL TRACE
- MS-6050-50MHZ DUAL TRACE
- MS-6100-100MHZ QUAD TRACE

CALL FOR LOW, LOW PRICES

DIGITAL MULTIMETERS

**FLUKE**

- 8060A \$345
- 8062A \$275
- 8022B \$143
- 8020B \$193
- 8024B \$247

**BECKMAN**

- 300 \$109
- 310 \$129
- 330 \$199

**Xcelite**



- TC-100ST XCELITE'S BEST CONTAINS 53 TOOLS \$329
- TC-150ST SMALLER UNIT CONTAINS 23 TOOLS \$279

**EK PRECISION**



- 1476P-10MHZ DUAL TRACE \$439
- 1477P-15MHZ DUAL TRACE \$495
- 1479BP-30MHZ DUAL TRACE \$609
- 1570P-70MHZ QUAD TRACE \$1079

PRICES INCLUDE PROBES

6.5MHZ OSCILLOSCOPE AT ONLY \$188.00



- 6.5MHZ
- 75MM ROUND SCREEN
- 10mV/DIV. SENSITIVITY
- INTERNAL OR EXTERNAL SYNC
- XY VECTORSCOPE CAPABILITIES
- 8½ LBS. LIGHT & COMPACT
- OUTPERFORMS UNITS COSTING MUCH MORE

ONE-YEAR WARRANTY

20,000 OHM/VDC V-0-M



- DC/AC VOLT TO 1 KV
- FUSE & DIODE PROTECTION
- 17 RANGES ON MIRROR SCALE
- LEVER SELECTOR RANGE SWITCH

\$19.88 ONE-YEAR WARRANTY

VIDEO CONTROL CENTER



\$16.88

REMOTE CONTROL ACCESS OF ALL VIDEO, TV OR CABLE INPUTS TO TV SET. 4 INPUTS TO ONE OUTPUT

46 CHANNEL VCR CONVERTER WITH FINE TUNING \$27.88



WATCH ONE CHANNEL AND RECORD ANOTHER

STABILIZER/VIDEO FADER/ ENHANCER/RF CONVERTER



\$99.88

ONE UNIT DOES IT ALL

**TAFT ELECTRONIC SALES**

68 W. 45th Street  
N.Y.C., N.Y. 10036

CALL  
212-575-8632

- MASTER CHARGE
- VISA
- MONEY ORDER
- CHECK
- 25% DEPOSIT ON C.O.D.'s

ADD FOR SHIPPING

UP TO \$300.00 - \$5.50  
OVER \$300.00 - \$8.00  
N.Y.S. ADD SALES TAX

# NEW BOOKS

For more details use the free information card inside the back cover

**MY INVENTIONS, The Autobiography of Nikola Tesla (Introduction by Ben Johnston); Hart Brothers, Publishing, PO Box 205, Williston, VT 05495; 112 pp., illustrated; 5½ × 8½ inches; softcover; \$7.95; hardcover \$12.95.**

This material by the great Yugoslav-American inventor (1856-1943) has been virtually unavailable since 1919 when it was published serially in Hugo Gernsback's *Electrical Experimenter*. The editor's note tells us that Tesla's "idiosyncratic phonetic spellings" have not been changed in this edition, but some of the picture captions have been revised. All the original illustrations are here, and six new ones have been added. There are two excellent wash illustrations by Frank R. Paul, who later became world-famous as the principal illustrator for the Gernsback science fiction magazines.

Tesla was 63 when these articles were published; they reveal his youthful struggle to harness his runaway imagination; after the chapters "My Early Life," and "My First Efforts in Invention", we proceed to the discovery of the rotating magnetic field, the Tesla coil and transformer, the magnifying transmitter, and the art of teleautomatics. Much of what the reader may have seen in various biographics is a mixture of fact and fiction; here the inventor himself sets the record straight.

Although he lived and worked in the United States for nearly 60 years, by the time he died he was virtually forgotten. The present volume is needed to bring Nikola Tesla into proper perspective.

**CIRCLE 121 ON FREE INFORMATION CARD**

**MICROCOMPUTER EXPERIMENTATION WITH THE MOS TECHNOLOGY KIM-1, by Lance A. Leventhal; Prentice-Hall, Inc, Englewood Cliffs, NJ 07632; 467 pp., including appendices and index; 6¼ × 9¼ inches; softcover; \$16.95.**

This practical easy-to-follow and self-contained guide to MOS Technology KIM-1 experiments represents diverse disciplines and a wide variety of applications. The emphasis throughout is on approaches that are fundamental to the design of controllers for external systems; at the same time, it illustrates its points through examples that use nothing more complex than switches, single displays, and the on-board peripherals.

The inexpensive and widely available KIM-1 microcomputer and 6502 microprocessor were selected to provide realistic experience with popular devices for those involved in a wide range of control-operation applications: instrumentation, communications equipment, test equipment, computer peripherals, industrial processes, signal processing, business equipment, consumer products, and many more.

There are two major groupings of experiments. Those in the first group focus on writing and running simple programs, simple input and output, processing of inputs and outputs, forming and processing data arrays, designing and debugging programs, and arithmetical operations. Those in the second group deal with subroutines and the stack, input/output using handshakes, interrupts, timing methods, serial input/output, and microcomputer timing and control.

**CIRCLE 122 ON FREE INFORMATION CARD**

**70 YEARS OF RADIO TUBES AND VALVES, by John W. Stokes; The Vestal Press, Ltd., PO Box 97, Vestal, New York 13850. 256 pp., including glossary and index; 8½ × 11 inches; hardcover; \$21.95 through bookstores—add \$2.00 shipping when ordering from publisher, and New York residents add 7% sales tax.**

Here is the history of the radio tube from its invention in 1904 to its gradual eclipse, beginning in the 1960's when it was replaced by solid-state devices. The emphasis, however, is on developments occurring between 1927 and 1937—the period when the "all electric" receiver evolved to become a familiar part of our daily lives.

All the giants of the industry—Westinghouse, General Electric, Sylvania, RCA, Raytheon, and others their size, as well as many smaller firms now forgotten—are covered in this story of how our technical know-how progressed in the period. It ranges from Edison's discovery that electrons would flow in a vacuum (the "Edison effect") to Lee deForest's invention of the "grid", to RCA's "Nuvistor" that closed the era.

**CIRCLE 123 ON FREE INFORMATION CARD**

**A MANAGER'S GUIDE TO INDUSTRIAL ROBOTS, by Ken Susnjara; Corinthian Press, publishing division of EDR Corporation, Shaker Heights, OH; 181 pp., including appendices, but no index; 6½ × 8¼ inches; hardcover; \$24.95.**

The robot industry is one of the fastest-growing industries. The capability of those machines, the number of units available, the number of manufacturers, and the number of installations, are all growing at an astounding pace.

This book discusses the new technology in a simple, straightforward manner. It is designed for the non-technical manager who must deal with robots, and assumes no previous knowledge or experience in the area on the reader's part. The author addresses such questions as: "What is an industrial robot?"; "How do industrial robots work?"; "What can they do and what can they not do?"; "How much do they cost?"; "How do I find applications in my plant?"; and "How do I handle labor and community relations?"

This illustrated, comprehensive guide includes a reference manual covering the details of installing and using an industrial robot. It also provides a glossary of robotic and technical terms explained in simple, non-technical language.

**CIRCLE 124 ON FREE INFORMATION CARD**

**THE ILLUSTRATED DICTIONARY OF ELECTRONICS (2nd Edition), by Rufus P. Turner; TAB Books, Inc., Blue Ridge Summit, PA 17214; 893 pp.; 5½ × 8¼ inches; softcover; \$16.95.**

Anyone in any way associated with the electronics field, whether beginning hobbyist, experienced, amateur, or professional will find this book valuable. From "A" to "zymurgy", the more than 25,000 definitions provide needed information to anyone who wants to look up an electronics term in a hurry. The new 2nd edition has not only been completely updated, but contains over 600 new entries, covering electronics, radio, audio, computers, and related studies.

In addition to the alphabetically-arranged definitions, there is a "Tables and Data" appendix that includes the resistor color code, electronics symbols, wire gauge, abbreviations, and a variety of conversion tables.

**CIRCLE 125 ON FREE INFORMATION CARD**

**THE BASIC HANDBOOK (2nd edition), Encyclopedia of the BASIC Computer Language, by David A. Lien; CompuSoft Publishing, San Diego, CA 92119; 480 pp, 7 × 9 inches; softcover; \$19.95.**

The BASIC language has changed in many ways since 1978, when the first edition of this book appeared. With each new computer came new words, and with each new word the need to update. Drawing upon his extensive BASIC language library, and with the assistance of many manufacturers, the author has attempted to document and explain virtually every BASIC feature of every type of computer in the world.

Special attention has been given to documenting the diverse BASICs implemented on the many new computers introduced (and about to be introduced) from Europe and Asia. In addition to filling gaps in the 1st edition, a strong effort has been made to continue documenting "disk BASIC", which many users find frustrating. Although there are as yet no standards for "disk BASIC's," only common concepts, the documentation follows those trends that can be identified.

This new second edition introduces 238 additional words, bringing the total of BASIC words to almost 500. Nearly every significant BASIC word, used by virtually every BASIC-speaking computer in the world is explained.

**CIRCLE 126 ON FREE INFORMATION CARD**

# \$1590



Full size smart terminal with detachable keyboard

4Mhz Z80A CPU  
64K RAM Main Memory  
200Kbyte 5 1/4" floppy disk  
(Osborn, Xerox, IBM, CP/M-86 formats)  
Two serial ports

Complete software package includes:  
WordStar word processing  
Correct-It spelling checker  
LogiCalc electronic spreadsheet  
Microsoft BASIC  
NorthStar compatible BAZIC  
CP/M 2.2 Operating System

# At \$1790, this computer was selling like hotcakes. So we dropped the price.

Crazy? No, not really. You see in order to meet the demand for the Micro Decision™ we increased our production. When we did that, our costs dropped. We're passing our savings on to you, because that's our philosophy.

More for less.

So now it only takes \$1590 to buy a Micro Decision with 64K of memory, a 200K double-density floppy drive and a full-size Morrow smart terminal with detachable keyboard. Not bad. But there's more.

The Micro Decision also includes a package of business and professional software worth well over \$2000. The WordStar® word processor. A 36,000 word spelling checker. The LogiCalc™ electronic spreadsheet. And both Microsoft BASIC-80® and NorthStar-compatible BAZIC® Plus, the CP/M® 2.2 Operating System that gives you access to thousands of other software programs. And, we take the mystery out of CP/M with plain English commands and single-key operation.

If you have your own terminal, you can buy the complete computer and software package for \$995. That's the Micro Decision MD1™. The MD2™ includes another double-density disk drive, plus Personal PEARL™, the relational data base manager. Price? Only \$1395.

More memory? No problem. The Micro Decision MD3™ gives you two double-sided, double-density disk drives with 768K of storage and Personal PEARL for only \$2490. Without the terminal, \$1895.

Come in for a complete demonstration at your nearest Morrow dealer. If you don't know who that is, call us toll-free at (800) 521-3493. In California, call (415) 430-1970. At \$1790, the Micro Decision sold like hotcakes. At \$1590, we've just sweetened the deal.

## MORROW

MORROW, 600 McCormick Street, San Leandro, CA 94577  
(800) 521-3493, (415) 430-1970 In California

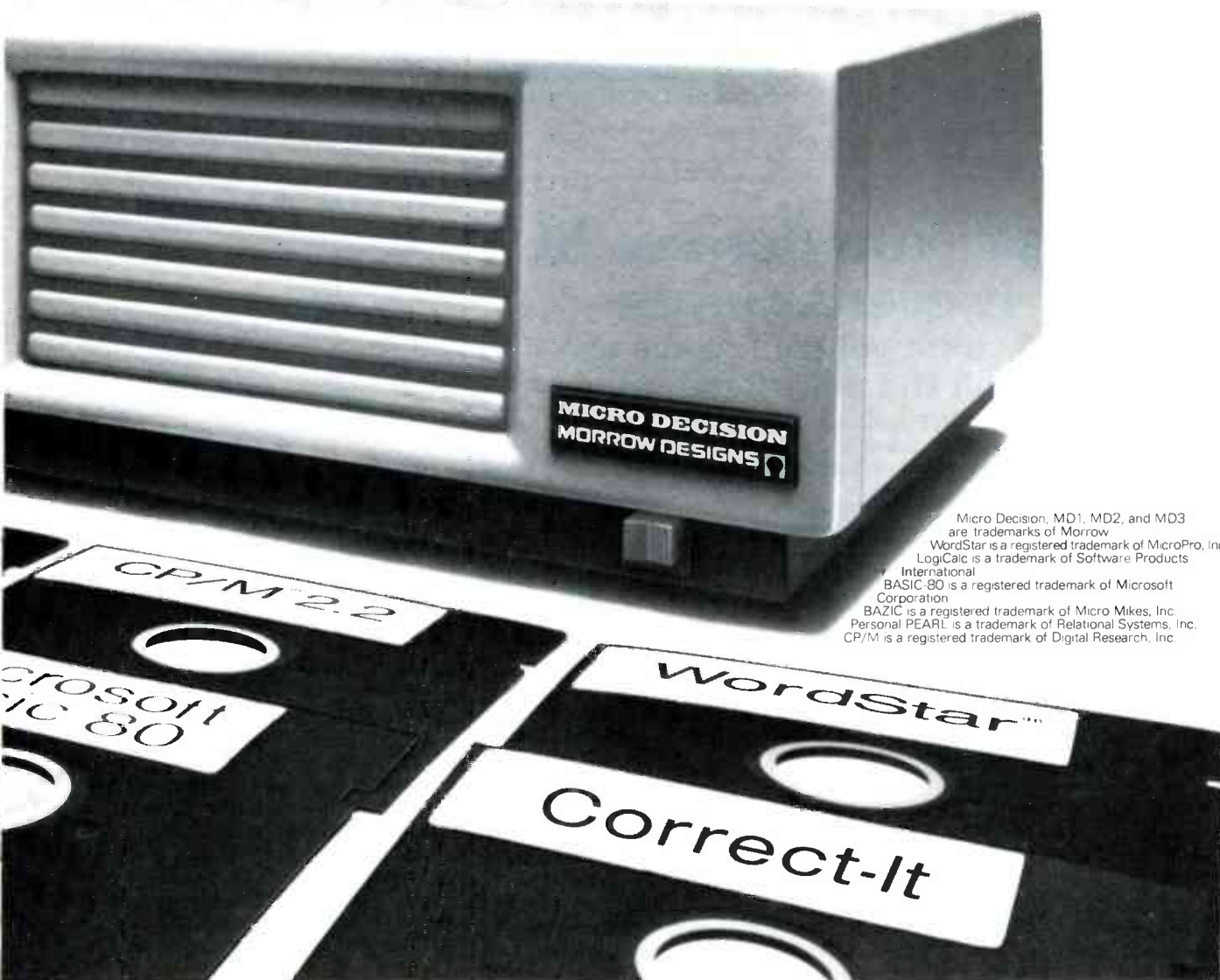

Micro Decision, MD1, MD2, and MD3 are trademarks of Morrow.  
WordStar is a registered trademark of MicroPro, Inc.  
LogiCalc is a trademark of Software Products International.  
BASIC-80 is a registered trademark of Microsoft Corporation.  
BAZIC is a registered trademark of Micro Mikes, Inc.  
Personal PEARL is a trademark of Relational Systems, Inc.  
CP/M is a registered trademark of Digital Research, Inc.

CIRCLE 77 ON FREE INFORMATION CARD

## MASTERING MICROPROCESSORS BEGIN WITH LS6802



LS6802 is a complete learning system to master microprocessor hardware and software. It is based on the 6802 CPU, an improved version of the renowned 6800 and is a good starting point to master the varieties of 6800 family microprocessors so widely used in industry.

Its features include: 2K monitor program with 20 editing, debugging functions; 2K RAM; spare socket for 2K RAM or 4K EPROM; built-in breadboarding system for hardware experiments; speaker; cassette tape interface; 16 programmable I/O lines (6821 PIA); 3 user keys; the full capabilities of 6802 CPU and an AC/DC adaptor to power the LS. An ideal tool for learning, teaching, experimenting and prototyping at only \$159.00. 90 days warranty.

Binary System, Maxwell Road, P.O. Box 1583, Singapore 9031, Republic of Singapore.

Send me \_\_\_\_\_ unit(s) of LS6802 at \$159.00 each, a total amount of \_\_\_\_\_ I am paying by \_\_\_\_\_ Money order, Visa, Mastercard American Express.

Name \_\_\_\_\_

Signature \_\_\_\_\_

Address \_\_\_\_\_

Card No. \_\_\_\_\_ Expires \_\_\_\_\_

# CANCER. NOT KNOWING THE RISKS IS YOUR GREATEST RISK.

A lot of people think cancer is unbeatable.

That simply isn't true. In fact, over two million people have had cancer and survived to lead happy, normal lives.

And not only can cancer be beaten, it can also be prevented.

There are definite precautions that have been proven to decrease your risk of getting certain cancers.

Ask your local American Cancer Society to send you a free booklet about cancer risks.

Learn the facts about cancer.

And make not knowing the risks, one less risk.

**AMERICAN CANCER SOCIETY®**  
How you live may save your life.

This space contributed as a public service.

## EQUIPMENT REPORTS

continued from page 38

in the OHMS range and have come back to it only to find a dead battery. Of course my multimeter didn't have a separate power switch.) Across from the POWER switch is a transistor test socket. Four input-jacks (V-Ω, COM, mA, and 10A) are in a row across the bottom, below the range selector. The readout is a "bright," easy-to-read, 3½-digit LCD display that includes a low-battery indicator.

The 8050 has thirty ranges that cover eight functions. It can measure DC voltages to 1000 volts over five ranges (200 mV, 2 volts, 20 volts, 200 volts, and 1000 volts), and AC voltages to 750 volts over similar ranges (except for the upper limit). The input impedance is 10 megohms on all voltage ranges. AC and DC current can be measured to 10 amperes over five ranges: 200 μA, 2 mA, 20 mA, 200 mA, and 10 amperes. (The 10-amp range requires that a separate input jack be used.) Polarity indication is automatic, with a minus sign appearing at the left of the display. And if the battery is low, an arrow appears on the left of the readout.

Resistance measurements (with automatic zeroing) can be made to 20 megohms over six ranges: 200 ohms, 2K, 20K, 200K, 2 megohms, and 20 megohms. Those resistance measurements are accurate to within 1% of the reading on all but the 20-megohm range, where the accuracy 2%.

### Other features

A separate position on the range-selector switch, marked with a diode symbol, lets you quickly check diodes. There is also an audible continuity-test position. It sounds rather shrill, but it's very handy for making quick continuity checks.

One unusual feature that is included on the 8050 is a test socket at the upper right of the panel that lets you find a transistor's hFE (Beta) on a 0 to 1000 scale. The NPN-PNP positions on the range switch select the type under test—or they can be used to identify an unknown transistor type. Maximum collector-to-emitter voltage is 2.8 volts under test.

This little instrument is very convenient easy to use. All controls are easy to get at, the readout is visible under all practical conditions, and it is compact enough to fit into the average work-shirt pocket. It's also magnetically shielded; the manufacturer claims that even strong magnetic fields will not affect its accuracy. The test leads that come with it have nice sharply pointed tips that can make some measurements much easier. All in all, the 8050 is a lot of meter for its \$89.95 price.

R-E

## Radio-Electronics® You deserve it!

### Get it every month

Come on, treat yourself...save up to \$10.03 off the newsstand price.

Subscribe to RADIO-ELECTRONICS and have the best electronics magazine delivered to your home—check off the money-saving offer you prefer on the handy coupon, and start enjoying RADIO-ELECTRONICS every month. Enclose your payment and get ONE EXTRA ISSUE per year.

Get the Best—Every Month! Mail Today!

YES! please send me

7HG33

Payment enclosed, 13 issues \$14.97

(You save \$4.53 off newsstand price.)  
Canada \$17.97 - U.S. funds only

Bill me - 12 issues \$14.97

(You save \$3.03 off newsstand price.)  
Canada \$17.97 - U.S. funds only

Payment enclosed, 26 issues \$28.97

(Save More! \$10.03 off newsstand price.)  
Canada \$34.97 - U.S. funds only

Bill me - 24 issues \$28.97

(Save More! \$7.03 off newsstand price.)  
Canada \$34.97 - U.S. funds only

Name \_\_\_\_\_ (please print)

Address \_\_\_\_\_

City \_\_\_\_\_ State \_\_\_\_\_ Zip Code \_\_\_\_\_

Mail to: RADIO-ELECTRONICS  
P.O. Box 2520  
Boulder, Colorado 80322

Offer valid in U.S. and Canada only  
Allow 6-8 weeks for delivery of first issue.

## SERVICE QUESTIONS

*continued from page 83*

voltage at the pin to be 18 volts. Installing a 14.2K resistor between pin 24 and pin 29 (ground) pulled that voltage down to 14.5, and restored proper clock operation in all modes. The value of the resistor was found experimentally. Incidentally, if you need a new clock IC, they can be bought from SSI Components Ltd., Suite 201, Austin Centre, 21 Austin Ave., Kowloon, Hong Kong. They cost \$11.00 each (in U.S. funds) when bought in quantities of 1 to 24.—*V.M., Bronx, NY*

### BURNING CAPACITOR

*After fixing some other problems in this Zenith 23EC15, I noticed a burning smell, but no smoke, coming from the set during testing. When I investigated I found that fuse F204 had blown, and that capacitor C267 had burned to a crisp. Replacing the fuse and capacitor got the set working, but after an hour the capacitor began getting hot again. What's going on here?—B.M., S. Portsmouth, KY*

What you're describing is fairly common in solid-state sets, although this is the first time I've ever heard about it in a tube set. In any event, the cure should be the same. Capacitor C267 is in a circuit with horizontal-frequency pulses; an ordinary capacitor won't work there. You need one of the special "RF" types, one with dielectrics rated to handle the high frequency. Either get an exact Zenith replacement, or one rated for high-frequency service.

### UNUSUAL VERTICAL PROBLEM

I had a vertical problem in a Zenith 13A16Z. You made several suggestions including checking the resistance of the vertical-output transformer's primary. After following all of your other hints, and replacing several bad components that I had found, the problem was still there. When I did get around to checking that transformer, the primary's resistance was indeed lower than it should have been. Replacing the transformer solved the problem.—*A.S., Middletown, NJ*

*Glad to hear that you found it. Failure in those transformers is really quite rare, but, as you discovered, it can happen.*

### PEGGING METER

*The meter needle on this tube-type VTVM pegs to the right side. I've heard about pegging to the left, but never this. What's going on?—A.M., Darlington, MD*

If the meter pegs in either direction, it means that there is a bad unbalance in the circuit. Most often, the cause is a defective VTVM bridge tube, usually a 12AT7 or similar twin triode. Note that you may need to try several tubes, especially in the older models, before you'll

find one that will balance the circuit.

*Feedback—That was the problem; only needed to try one tube before the trouble cleared up.*

### COLLAPSING RASTER

I've run into a problem that seems to be common in the Zenith System-3 sets that use the 9-153 high-voltage module. The symptom is an intermittent collapse of the raster and horizontal foldover. The cause is poor solder-connections on two components: the horizontal-output transformer and T3301. It helps to take those components out, scrape the connections clean, and then reinstall them. I've seen that problem in six sets over the past few months, including my own.—*George Yarbrough, West Yellowstone, MT*

### CREEPING HIGH VOLTAGE

*The high voltage in this Sears 528.41681941 can be varied between 22 and 27 kilovolts when the set is first turned on. After it has been on for a while, however, the high voltage creeps up until it can be varied only between 28 and 30 kilovolts. The B+ voltages are all close to what they should be and stable, but the boost voltage rises from +800 volts at turn-on to +870 volts. Any ideas on this?—J.O., Winthrop, ME*

I ran into this some time ago in an RCA that used a 31JS6 output tube. Here's what to do: Check the grid waveform on your 40KD6 tube with an oscilloscope. If it is normal at turn on, but the peaks flatten as the tube warms up, you've got it. The problem is grid emission in the 40KD6. If the peaks flatten enough, it will make a normal waveform look almost like a squarewave. The flattened peaks keep the tube turned on too long, raising the boost, high voltage, etc. The only cure is to replace the tube, and check to make sure the replacement is good; I've gone through 4 or 5 new tubes at times before I've found a good one.

### MORE HINTS

Here are a couple more hints from Mike Danish of Aberdeen Proving Ground, MD:

The first involves bad colors and low brightness in an RCA CTC59XD. Resistor RT201 was burnt up. Replacing it, however, did not help. Looking farther, I found that I had no control over the CRT screens. The only thing common to all of the screens was that they got 600 volts from the flyback through a 1K resistor and the boost rectifier. When I looked at the 1K resistor, I found that it, too, had burned up. I tried replacing the resistor, but the replacement also burned out in short order. The problem turned out to be in the boost rectifier. Once it was replaced, and a new 1K resistor was installed, everything returned to normal.

The second one involves a Packard-

Bell 1C620WL; that set is actually a GE C2 chassis. The set had no raster but the audio was fine. The trouble was traced to R189 and R191 in the video-output circuit. Those two resistors had burned up. When they were replaced, the set ran fine.

### HORIZONTAL FOLDOVER

This Zenith HT2382P came in with intermittent horizontal-foldover in the center of the screen: the left side of the screen was perfect but the raster pulled away from the right side and folded in the center with a vertical white line about 1/2 inch wide. Replacing the horizontal module had no effect. When I checked the driver transformer I found that the resistance was off—it was 40-45 ohms instead of 96 ohms. A new transformer fixed the problem, for about three weeks. When I got it back in the shop I finally found the true culprit; C227, a 50μF electrolytic was intermittently opening. Replacing that capacitor fixed things permanently.—*Danny Joe Davis, Moundsville, AL*

### BAD TRACKING

I asked you about an old RCA AM-FM portable that wouldn't track at the low end of the dial. You suggested spraying contact cleaner on the tuning capacitor, and running the dial back and forth several times. I did that, and it worked. It also cleared up a bad drift problem on FM at the same time. Thanks—*Bill Suhy, Stratford, CT*

*Old-radio restorers take note! The cause of that problem is a very poor or corroded contact between the rotor of the capacitor and the frame. As the rotor turns, the resistance varies, which of course changes the capacitance. That used to be quite common in the old sets, but I haven't seen it lately, till now.*

### OSCILLOSCOPE HINT

We had some Dumont 208 oscilloscopes in our lab with problems in the vertical positioning of the trace. Your column in **Radio-Electronics** about bad contacts rang a bell. We simply pulled the 6V6 vertical amplifier tubes and then put them back in. That fixed everything up. Dumont used the DC plate current of those tubes to provide the positioning voltage for the trace, and the humid summers here had caused some corrosion in the wafer sockets.—*J.R., Ocala, FL*

### ION BURN

I saw a question in **Radio-Electronics** some time ago about what seemed to be ion burn in a modern CRT. I ran into a similar problem a while back with a Zenith 14B36Z. After checking several things, I read the high voltage and, lo and behold, it was only 5 kilovolts. The cause of the problem was a bad flyback. Replacing it cleared everything up.—*Bert Balt, Rochester, NY*

R-E

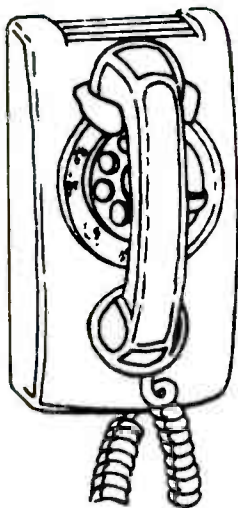

## CALL NOW AND RESERVE YOUR SPACE

- 6 x rate \$550 per each insertion.
- Reaches 220,500 readers.
- Fast reader service cycle.
- Short lead time for the placement of ads.
- We typeset and layout the ad at no additional charge.

Call 212-777-6400 to reserve space. Ask for Arline Fishman. Limited number of pages available. Mail materials to: mini-ADS, RADIO-ELECTRONICS, 200 Park Ave. South, New York, NY 10003

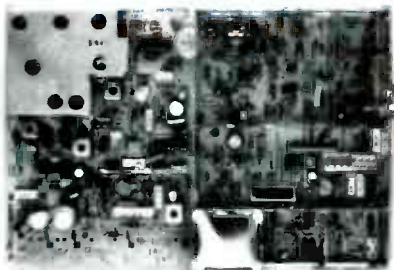

**TELEVISION MODULE** includes VHF, UHF, and CABLE-TV TUNERS, IF AMPLIFIER, VIDEO DETECTOR, SOUND DETECTOR and AMPLIFIER, and SYNC PROCESSOR: **\$85.00**. TELEVISION SIGNAL PROCESSING MANUAL explores standard and non-standard television: **\$15.95**. Add 5% handling and shipping. Catalog \$2.00. Visa and MC accepted. ORDER DESK (415) 439-7470. **ABEX, P.O. BOX 26601-RZ, SAN FRANCISCO, CA 94126.**

CIRCLE 62 ON FREE INFORMATION CARD

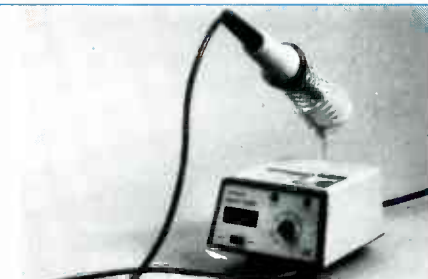

**SOLDERING STATION FOR LESS** Front display of tip temperature, adjustable temperature 200°F to 900°F. UL listed, low current leakage, high insulation. Complete as shown. 7 tips available, also takes standard tips. **ORDER MODEL 81-XY 168, \$79.95** plus shipping. To order call toll free: (800) 423-5336. In California (800) 382-3663. Or send **\$79.95** (California residents add sales tax) plus **\$5.00**, shipping to **ORA ELECTRONICS DEPT. RE, 18215 Parthenia St., Northridge, CA 91325 (213) 701-5848.**

CIRCLE 92 ON FREE INFORMATION CARD



**CONVERTERS**  
**DESCRAMBLERS-MICROWAVE**-Not C and D grade. Only grade A new, genuine Oak, Jerrold, Zenith, Hamlin, Pico, Bogner, Pioneer! Name it! Sine-wave, gated-sync, vari-sync, in-band, out-band. We sell 'em all! No order too big or small. Dealers-we can beat any price. Send \$3.00 for catalog to: **TV PRODUCTS CO., 635 Park Avenue, Suite 222, Idaho Falls, ID 83402.**

CIRCLE 61 ON FREE INFORMATION CARD

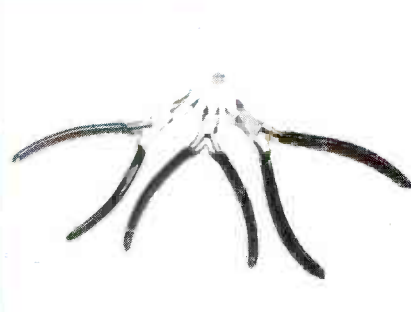

**QUALITY TOOLS AT HALF PRICE!** Sunnex manufactures a wide range of high precision, box joint cutters and pliers for the electronics industry. Sunnex only sells direct and can offer you quality tools at the most competitive prices. **A HALF PRICE INTRODUCTORY OFFER** will be enclosed with the catalog **SUNNEX INC., 87 Crescent Rd., Needham, MA 02194. Phone 1-800-225-8480 (in MA 617-444-4730).**

CIRCLE 98 ON FREE INFORMATION CARD

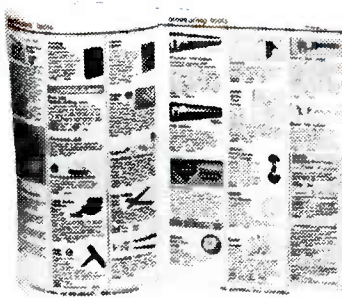

**FREE CATALOG OF HARD-TO-FIND TOOLS** is packed with more than 2000 quality items. Your single source for precision tools used by electronic technicians, engineers, instrument mechanics, schools, laboratories and government agencies. Also contains Jensen's line of more than 40 tool kits. Send for your free copy today! **JENSEN TOOLS INC., 7815 46th St., Phoenix, AZ 85040. (602) 968-6231.**

CIRCLE 97 ON FREE INFORMATION CARD

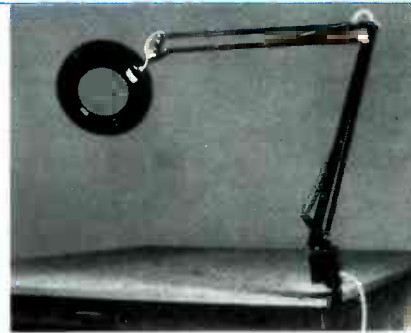

**MAGNIFIER LAMP FOR LESS** All metal construction, UL approved 5", 3x magnifier, 22 watt fluorescent circline lamp. 45" arm reach, heavy duty clamp mount. **Only \$59.95** plus shipping. (California residents add sales tax.) To order call (800) 423-5336. In California, (800) 382-3663 or send **\$59.95** plus **\$5.00** shipping to **ORA ELECTRONICS, 18215 Parthenia St., Northridge, CA 91325 (213) 701-5848.**

CIRCLE 96 ON FREE INFORMATION CARD



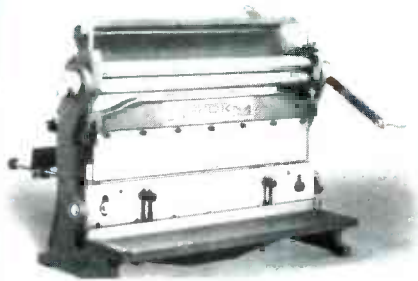

**SHEET METAL WORKER** - The 24" TRIOK is a Press Brake, Shear and Slip-roll machine-perfect for research and development or maintenance shops. Over a thousand machines world wide in little to the largest companies. For free literature on this and our other sheet metal working machines contact: **PACIFIC ONE CORPORATION, 513 Superior Ave. Suite K201, Newport Beach, CA 92663, (714) 645-5962.**

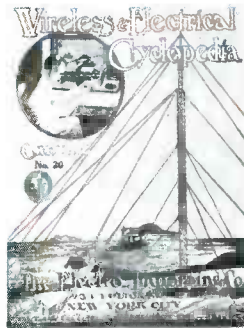

**ELECTRO IMPORTING CO. CATALOG.** This reprint of the historic 176-page catalog No. 20 gives you an accurate look at the state of electronics in 1918. Contains everything from a Zinc Spark Gap to a 1000-Mile Receiving Outfit. You can get your own copy of this modern antique, profusely illustrated, for only \$4.95 plus \$1.00 P&H. Order yours from **R-E BOOKSTORE, Radio-Electronics, 200 Park Avenue South, New York, NY 10003.**



**CLOSE OUT - BLOW OUT - LIQUIDATION SALE - AMATEUR MICROWAVE RECEIVER - REGULARLY \$99.50. NOW LIQUIDATING AT ONLY \$59.95 EACH!** (Dealer "eight-pack" for just \$399.00) Complete system includes dish, probe/downconverter, co-ax cables, power supply, hardware and instructions. Top quality units with genuine #2137 transistors for hi-gain, lo-noise. **ORDER TODAY!** Supply limited. Money order, VISA or Mastercard only. (No C.O.D. at this price.) **T.V. PRODUCTS CO., 635 Park Ave., Dept. 222, Idaho Falls, Idaho 83402. DESCRABLERS??** We stock all types. Send \$3.00 for catalog!

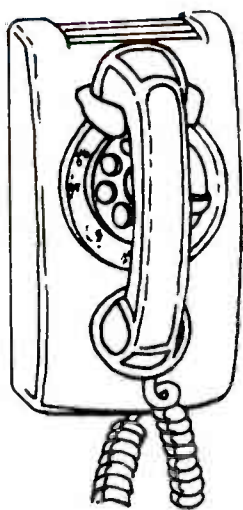

**CALL NOW  
AND  
RESERVE  
YOUR SPACE**

- 6 - rate \$550 per each insertion.
- Reaches 220,500 readers
- Fast reader service cycle
- Short lead time for the placement of ads
- We typeset and layout the ad at no additional charge

Call **212-777-6400** to reserve space. Ask for Arline Fishman. Limited number of pages available. Mail materials to: mini-ADS, RADIO-ELECTRONICS, 200 Park Ave. South, New York, NY 10003



**3S-WICK STARTS AT 450°F.....3S-Wick** is the best and most economical wick. Give it a try. The special 80c a spool price for a minimum order of 30 spools can be lowered to as little as 59c a spool when purchased in 1000 + piece lots. **Call our toll free number 1-800-628-8862** for free sample, and to place an order (Distributor inquiries welcomed.) **CIRCLE 100 ON FREE INFORMATION CARD**

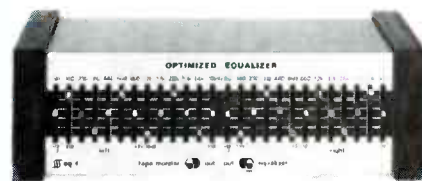

**OPTIMIZED Graphic Equalizer—NEW** Our latest EQ has been optimized for room equalization, emphasizing the critical mid-range. Construction article: **Computers & Electronics 12/82.** Near 20-band capability, but...Kit only **\$100** ppd; M/C, Visa add shgp. Kit instructions \$3.50 (refundable). **SYMMETRIC SOUND SYSTEMS, 856K Lynn Rose Ct., Santa Rosa, CA 95404, (707) 546-3895.** **CIRCLE 72 ON FREE INFORMATION CARD**

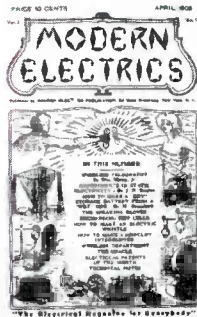

**MODERN ELECTRICS.** Miniature souvenir of the first publication ever produced by Gernsback Publications. This issue appeared in April 1908—just 75 years ago. You can own your own reprint of this unique first edition for just **\$2.50** plus 75c P&H. It's available from **R-E BOOKSTORE, Radio-Electronics, 200 Park Avenue South, New York, NY 10003**



**APPLIANCE REPAIR HANDBOOKS—13** volumes by service experts; easy-to-understand diagrams, illustrations. For major appliances (air conditioners, refrigerators, washers, dryers, microwaves, etc.), elec. housewares, personal-care appliances. Basics of solid state, setting up shop, test instruments. **\$2.65 to \$5.90** each. Free brochure. **APPLIANCE SERVICE, PO Box 789, Lombard, IL 60148. 1-(312) 932-9550.** **CIRCLE 64 ON FREE INFORMATION CARD**

# Go with McGraw-Hill's EXPERIENCE!

## TAKE ANY 3 BOOKS FOR ONLY \$100 EACH when you join McGraw-Hill's Electronics and Control Engineers' Book Club (Values up to \$87.00)\*

**INTUITIVE IC ELECTRONICS: A Sophisticated Primer for Engineers and Technicians.** By T. M. Frederiksen. 208 pp., illus. Covering both the simplest and the most complicated IC designs, this lively, easy-to-read volume provides a sophisticated, nonmathematical explanation of the basic internal mechanisms common to all semiconductor devices. 219/230 \$19.95

**RADIO HANDBOOK, 22/e.** By W. Orr. 1,136 pp., more than 1,300 illus. Here's the latest edition of what is universally regarded as the most useful reference in the industry. It's a "course" in communications, a fact-packed reference, and a how-to guide—all in a single book! 582442-6B \$39.95 (Counts as 2 of your 3 books)

**VLSI TECHNOLOGY** By S. M. Sze. 672 pp., 400 illus., 50 tables. An anthology from more than 3,000 technical papers, by 14 leading experts, covering everything from crystal growth to special packaging considerations. 626/863B \$32.50 (Counts as 2 of your 3 books)

**ANTENNA THEORY: Analysis and Design.** By C. A. Balanis. 816 pp., illus. Packed with equations, design procedures, and plenty of nuts-and-bolts know-how, this is the first place to turn for answers to all your antenna design questions. 582493-0B \$39.50 (Counts as 2 of your 3 books)

**MICROPROCESSOR DATA BOOK.** By S. A. Money. 350 pp., 220 illus. Easily the most comprehensive collection of data on microprocessors and their support chips available anywhere! Provides important facts on a wide range of popular devices from American, European, and Japanese manufacturers. 427/062B \$35.00 (Counts as 2 of your 3 books)

**HANDBOOK OF SEMICONDUCTOR AND BUBBLE MEMORIES.** By W. A. Triebel and A. D. Chu. 416 pp., illus., over 50 worked-out problems. This detailed, comprehensive guide brings you right up to the minute on such newly developed devices as the PLA, FIFO, CAM, CCD, and magnetic bubble memory—as well as all the standard storage devices from ROMs and RAMs to shift registers. 582376-4 \$24.95

**INTRODUCTION TO RADAR SYSTEMS, 2/e.** By M. I. Skolnik. 698 pp., 244 illus. This new edition of a widely used text on radar from the systems engineer's point of view brings you full discussions of the many major changes that have occurred in the field recently. 579/091B \$39.95 (Counts as 2 of your 3 books)

**McGraw-Hill's long-established club that saves you BIG money on the important new books of all publishers!**

\*If you join now for a trial period and agree to purchase three more books—at handsome discounts—over the next year. (Publishers' prices shown)



**ELECTRONICS ENGINEERS' HANDBOOK, 2/e.** Edited by D. G. Fink & D. Christiansen. 2,272 pp., 2,189 illus. This updated and enlarged edition covers the latest knowledge in the field, including new advances in integrated circuits, pulsed and logic circuits, laser technology, telecommunications, and much more. 209/812A \$75.00 (Counts as 3 of your 3 books)

**ELECTRONIC COMMUNICATION, 4/e.** By R. L. Shrader. 801 pp., 870 illus. This thoroughly updated edition offers all the theory and fundamentals you need to prepare yourself for the FCC commercial and amateur grade license examinations—and pass them the first time! 571/503 \$26.95

**DIGITAL HARDWARE DESIGN.** By J. B. Peatman. 428 pp., over 400 illus. Taking you beyond the microcomputer, this guide reexamines traditional techniques and focuses on the design of circuitry too fast for the microcomputer alone. 491/321B \$35.50 (Counts as 2 of your 3 books)

**MICROPROCESSOR APPLICATIONS HANDBOOK.** Editor-in-Chief, D. F. Stout. 472 pp., 284 illus. At last—a reference guide to microprocessor applications to help you make your systems timely, versatile, and cost-effective. 617/988B \$35.00 (Counts as 2 of your 3 books)

**SIGNALS AND SYSTEMS.** By A. Oppenheim, A. Willsky, and I. Young. 869 pp., more than 350 illus. This unique volume presents a comprehensive discussion of methods for analyzing discrete-time systems. Includes a look at feedback, convolution, and other concepts not treated in depth elsewhere. 582674-7B \$32.50 (Counts as 2 of your 3 books)

**MODERN ELECTRONIC CIRCUITS REFERENCE MANUAL.** By J. Markus. 1,264 pp., 3,666 circuit diagrams. Complete with values of components and suggestions for revisions, plus the original source of each circuit in case you want additional performance or construction details. 404/461A \$67.95 (Counts as 3 of your 3 books)

**OPTICAL FIBER COMMUNICATIONS.** By G. Keiser. 416 pp., illus. For those with little or no prior experience with optical fibers, the perfect book to walk you through a typical system. 334/676B \$35.95 (Counts as 2 of your 3 books)

**PCM AND DIGITAL TRANSMISSION SYSTEMS.** By R. Owen. 320 pp., 186 illus. This useful volume allows newcomers to the field to familiarize themselves with its problems and equipment in two weeks, instead of the three months it would ordinarily take. 479/542B \$30.00 (Counts as 2 of your 3 books)

**MANUAL OF ACTIVE FILTER DESIGN, 2/e.** By J. L. Hilburn and D. E. Johnson. 225 pp., 157 easy-to-use design graphs. This ingenious manual enables you to design filter circuits for virtually any application in minutes—without making a single computation! Covers all the latest designs. 287/694B \$37.50 (Counts as 2 of your 3 books)

**DIGITAL CIRCUITS AND MICRO-PROCESSORS.** By H. Taub. 608 pp., heavily illus. This fast-paced, carefully written guide gives you thorough explanations of all the basic principles of digital systems and logic design—plus a solid introduction to microprocessors and microprocessor-based designs.

629/455B \$32.95  
(Counts as 2 of your 3 books)

**DIGITAL COMMUNICATIONS.** By J. G. Proakis. 624 pp., illus. A wealth of new material, information about spread spectrum signals, requiring a minimum of math to get through it.

509/271B \$37.50  
(Counts as 2 of your 3 books)

**ELECTRONICS ENGINEERING FOR PROFESSIONAL ENGINEERS' EXAMINATIONS.** By C. R. Hafer. 336 pp., more than 200 illus. Actually two books in one—a quick preparation manual to help you pass your P.E. exams on the first try and a rich source of practical electronics engineering information and know-how.

254/303 \$27.50

**MICROPROCESSOR SUPPORT CHIPS Theory, Design and Application.** By J. J. Byers. 228 pp., 170 illus. Everything from pinouts to operating characteristics is spelled out for telecommunications, power supplies, interfaces, control, video and A/D and D/A converters.

095/183B \$38.00  
(Counts as 2 of your 3 books)

**INTEGRATED CIRCUIT FABRICATION TECHNOLOGY.** By D. J. Elliott. 480 pp., 220 illus. Covering every step in the transformation of a silicon chip to an integrated circuit, this is the first book to combine, in a single volume, a cohesive examination of the equipment, materials, and techniques of IC fabrication.

192/383 \$29.75

**STANDARD HANDBOOK FOR ELECTRICAL ENGINEERS, 11/e.** By D. G. Fink and H. Beaty. 2,448 pp., 1,414 illus. Today's most widely used source of electrical engineering information and data serves you as no other single work when you need detailed, timely, and reliable facts

209/74XA \$65.95  
(Counts as 3 of your 3 books)

**McGraw-Hill's NATIONAL ELECTRICAL CODE® HANDBOOK, 17/e.** By J. F. McPartland. 1,162 pp., 1,096 illus. Bigger and better than ever! This mammoth reference explains and clarifies the many complex provisions of the current (1981) Code® to help you meet rules exactly and pass inspections the very first time.

456/933 \$26.50

**HANDBOOK OF ELECTRONIC PACKAGING DESIGN AND ENGINEERING.** By B. Matisoff. 480 pp., 312 illus. This handy volume examines the broad array of packaging techniques available today, providing the data you need to select the best one for a given application. Stresses the interplay between design criteria.

582515-5B \$32.50  
(Counts as 2 of your 3 books)

**ANALYSIS AND DESIGN OF DIGITAL INTEGRATED CIRCUITS.** By D. A. Hodges & H. G. Jackson. 448 pp., illus. The only book available written from a quantitative point of view for those who design as well as use ICs.

291/535 \$27.50

**Be sure to consider these important titles as well!**

**RADAR TRANSMITTERS.** By G. W. Ewell. 198/438 \$26.95

**16-BIT MICROPROCESSOR SYSTEMS.** By Texas Instruments, Inc. 637/601B \$45.00  
(Counts as 2 of your 3 books)

**ELECTRONIC CIRCUITS NOTEBOOK: Proven Designs for Systems Applications.** Edited by S. Weber. 192/448B \$35.50  
(Counts as 2 of your 3 books)

**OPTICAL FIBER SYSTEMS: Technology, Design, and Applications.** By C. K. Kao. 332/770 \$26.00

**INTRODUCTION TO THE THEORY AND DESIGN OF ACTIVE FILTERS.** By L. P. Huelsman & P. E. Allen. 308/543B \$34.50  
(Counts as 2 of your 3 books)

**MICROELECTRONICS.** By J. Millman. 423/27XB \$35.95  
(Counts as 2 of your 3 books)

**HANDBOOK OF OPERATIONAL AMPLIFIER CIRCUIT DESIGN.** By D. E. Stout & M. Kaufman. 617/97XB \$38.00  
(Counts as 2 of your 3 books)

**MICROCOMPUTER-BASED DESIGN.** By J. Peatman. 491/380B \$35.95  
(Counts as 2 of your 3 books)

**BIT-SLICE MICROPROCESSOR DESIGN.** By J. Mick & J. Brick. 417/814 \$29.50

**NETWORK SYSTEMS.** By R. Sharma & P. DeSousa. 582557-0 \$29.95

**ENGINEERING MATHEMATICS HANDBOOK, 2/e.** By J. J. Tuma. 654/298B \$31.25  
(Counts as 2 of your 3 books)

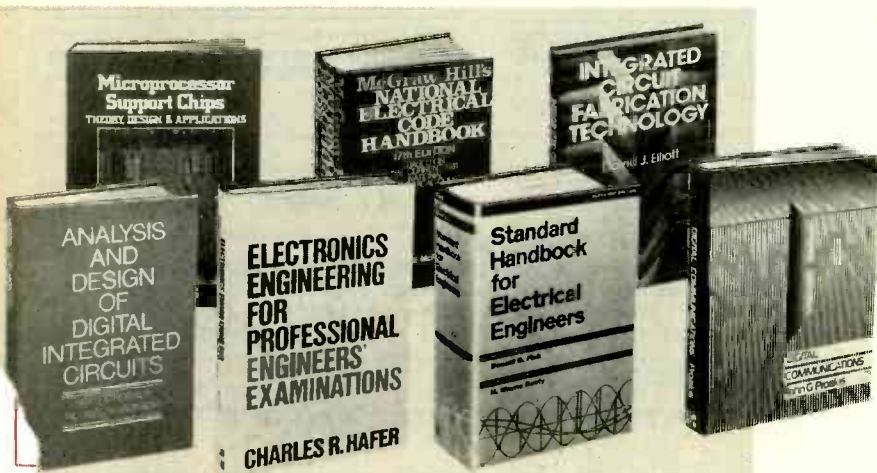

Plc I ha and 10 d, purch first y descri to all SAVINGS! Build your library and save money too! Savings ranging up to 30% off publishers' list prices—usually 20% to 25%.

**Why YOU should join now!**

**AND NEWEST BOOKS IN YOUR FIELD!** Books are selected from a wide range of publishers by expert editors and consultants to give you continuing access to the best and latest books in your field.

**US BOOKS!** You will immediately begin to participate in our Bonus Plan that allows you savings up to 80% off the publisher's prices on professional and general interest books!

**VIENCE!** 12-14 times a year [about once every 3-4 weeks] you receive the Main Selection FREE. It fully describes the Main Selection and alternate selections. Reply Card is included. If you want the Main Selection, you simply do it will be shipped automatically. If you want an alternate selection—or all—you simply indicate it on the Reply Card and return it by the date you will have at least 10 days to decide. If, because of late delivery of the Main Selection you do not want you may return it for credit expense.

**Name** \_\_\_\_\_ member you agree only to the purchase of three additional books during the first year of membership. Membership may be discontinued by either you or McGraw-Hill at any time after you have purchased the three additional books.

**Address/Apt** \_\_\_\_\_

**City/State/Zip** \_\_\_\_\_

**Signature** \_\_\_\_\_

**McGraw-Hill Book Clubs:** Architects' Book Club • Byte Book Club • Chemical Engineers' Book Club • Civil Engineers' Book Club • Mechanical Engineers' Book Club

This order is subject to McGraw-Hill's terms and conditions. Write to: McGraw-Hill Book Clubs • P.O. Box 582, Hightstown, NJ 08520

**MAIL THIS COUPON TODAY**

**McGraw-Hill Book Clubs  
Electronics and Control Engineers'  
Book Club**  
P.O. Box 582, Hightstown, New Jersey 08520

Please enroll me as a member and send me the three choices I have listed below. Bill me only \$3.00 plus local tax, postage, and handling. If not satisfied, I may return the books within 10 days and my membership will be canceled. I agree to purchase a minimum of three additional books during my first year of membership as outlined under the Club plan described in this ad. A shipping and handling charge is added to all shipments. Indicate below by number the books you want. A few expensive books (noted in the descriptions) count as more than one choice.

Name \_\_\_\_\_

Address/Apt. \_\_\_\_\_

City/State/Zip \_\_\_\_\_

This order subject to acceptance by McGraw-Hill. All prices subject to change without notice. Offer good only to new members. Orders from outside the U.S. cannot be accepted.

E33606

JULY 1983

# MARKET CENTER

## SATELLITE TELEVISION

SATELLITE antennas build 10' wood under \$160 metal \$93 plans \$40. **PROTOTYPE ENGINEERS**, Box 1812 Deming, NM 88030.

SATELLITE TV receiver breakthrough! Build your own commercial quality receiver now! Instruction manuals, schematics, circuit boards! Send stamped envelope: **XANDI**, Box 25647, Dept. 21L, Tempe, AZ 85282.

SATELLITE Television. Free wholesale price list! Save big! **COMMUNICATIONS CONSULTANTS**, PO Box 5099, Fort Smith, AR 72913.

INTERESTED in home satellite television? Don't buy anything until you've read **Homesat Handbook & Buyers Guide**. Our book tells everything about home satellite TV and may save you hundreds, even thousands of dollars in your selection and installation of a system! \$10.00: **H & G HOMESAT SERVICES**, Box 422, Seaford, N.Y. 11783.

## SATELLITE TV WEEK

The most complete weekly listings.  
Send \$1 for sample copy.

**Satellite TV Week**

P.O. Box 308, Fortuna, California 95540  
Call (800) 338-9997 • California (707) 723-2476

## CB EQUIPMENT

CB radio books, kits, modifications, free catalog. **APS**, POB 263RE, Newport, RI 02840.

## VIC-20

**CAPACITOR** tester/meter. Connects to userport. Displays values 10-PFD through 650-MFD. Indicates shorts and opens. Needs no extra memory. Guaranteed. Wired tester and cassette program. \$39.95. **SANDI ELECTRONICS**, 203 Cambridge Belton, MO 64012.

## WIRELESS MICROPHONES

**BIG** savings on Cony transmitters — up to 30% off! Send two stamps for catalog. **S.E. CORP.**, Box 1132-RC, Yorba Linda, CA 92686.

## SECURITY-MONITORING DEVICES

**ULTRA**-miniature, super-range wireless FM transmitters as small as 7/8" long! Micro wireless telephone transmitter, voice activators, telephone voice changers, six-channel crystal communication systems, and more! Professional, high-tech microelectronics now available to you. Free brochures. **EXTENDO-TAPE SYSTEMS**, Dept. R-E, Box LC, Temple Terrace, FL 33687 (813) 985-3014.

## XENON FLASH LAMPS

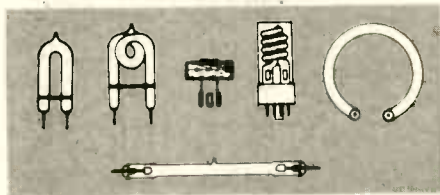

ASK FOR OUR NEW CATALOG.  
CALL OR WRITE FOR INFORMATION.

**TEC/WEST (USA) INC.**

10889 WILSHIRE BLVD., SUITE 740  
LOS ANGELES, CA 90024-4299

CA: 213/208-5529 • OUTSIDE CA: 1-800-421-7215

## BUSINESS OPPORTUNITIES

**PROJECTION TV...** Make \$\$\$ assembling projectors... Easy... Results comparable to \$2500.00 projectors... Your total cost less than \$17.00... Plans, lens & dealers information \$15.50... Illustrated information free ... **MACROCOMGKX**, Washington Crossing, PA 18977. Credit card orders 24 hours. (215) 736-2880.

HIGHLY PROFITABLE

## ONE-MAN ELECTRONIC FACTORY

Investment unnecessary, knowledge not required, sales handled by professionals. Ideal home business. Write today for facts!

Postcard will do, **Barta-RE-X**, Box 248, Walnut Creek, CA 94597.

**WIND** power an investment in the future. The right decision is essential. Information \$2.00 **WINDESIGN**, Box 138, Boston, NY 14025.

**HOME** burglar alarms. Career opportunities. High income. Information \$2.00. **SECURITY ELECTRONICS INTERNATIONAL**, PO Box 1456-XE, Grand Rapids, MI 49501.

**MECHANICALLY** inclined individuals desiring ownership of small electronics manufacturing business — without investment. Write: **BUSINESSES**, 92-R, Brighton lth, Brooklyn, NY 11235.

**WHOLESALE** MATV/CATV/VCR equipment, antennas, audio cables, adapters, original/replacement cartridges & styli, telephone accessories, radios, cassette recorders, speakers, etc. Send letterhead for free catalog (212) 897-0509. **D&WR**, 69-19 Booth, Flushing, NY 11374.

## COMPUTERS

\$44,000 first year in computers. Get in now! Free details. **DIGATEK CORPORATION**, Suite T2, 2723 West Butler Drive, Phoenix, AZ 85021.

**FREE** high technology semiconductors catalog 32bit microprocessor, 64KDRAM, speech synthesizer kits, 128KEPROM, no minimum or piece order, toll free number, etc., etc., **H.T.S.**, Box 213 Tustin, CA 92684 (714) 731-8859.

## AT LAST!!

**CABLE** devices for 'beeping' or 'buzzing' channels. Details \$4.00. **Money back guarantee.** **CATV INFORMATION CENTER**, PO Box 17621, Ft. Laud., FL 33318.

To run your own classified ad, put one word on each of the lines below and send this form along with your check for \$1.90 per word (minimum 15 words) to:  
**Radio-Electronics, 200 Park Avenue South, N.Y., N.Y. 10003**

### ORDER FORM

PLEASE INDICATE in which category of classified advertising you wish your ad to appear. For special headings, there is a surcharge of \$15.00.

( ) Plans/Kits ( ) Business Opportunities ( ) For Sale  
( ) Education/Instruction ( ) Wanted ( ) Satellite Television

Special Category: \$15.00

PLEASE PRINT EACH WORD SEPARATELY, IN BLOCK LETTERS.)

1	2	3	4	5
6	7	8	9	10
11	12	13	14	15
16	17	18	19	20
21	22	23	24	25
26	27	28	29	30
31	32	33	34	35

PLEASE INCLUDE FOR OUR FILES YOUR PERMANENT ADDRESS AND PHONE NUMBER.

**CLASSIFIED COMMERCIAL RATE** for firms or individuals offering commercial products or services). \$1.90 per word prepaid (no charge for zip code)...MINIMUM 15 WORDS. 5% discount for 6 issues, 10% for 12 issues within one year, if prepaid.

**NON-COMMERCIAL RATE** (for individuals who want to buy or sell a personal item) \$1.25 per word prepaid...no minimum.

**ONLY FIRST WORD AND NAME** set in bold caps. Additional bold face (not available as all caps) at 15¢ per word. All copy subject to publisher's approval. **ADVERTISEMENTS USING P.O. BOX ADDRESS WILL NOT BE ACCEPTED UNTIL ADVERTISER SUPPLIES PUBLISHER WITH PERMANENT ADDRESS AND PHONE NUMBER.** Copy to be in our hands on the 20th of the third month preceding the date of the issue (i.e., August issue closes May 20th). When normal closing date falls on Saturday Sunday, or a holiday, issue closes on preceding working day.

## EDUCATION & INSTRUCTION

EARN your university degree through evaluation assessment, of existing education, experience, achievements. Call, (614) 863-1791, or write, **ASSESSMENT**, Box 13130 R, Columbus, OH 43213.

**YOUR own radio station!** AM, FM, cable, licensed, unlicensed. Low cost transmitter kits, free info. **BROADCASTING**, Box 130-F7, CA 95969.

**ELECTRONICS** computer books. International publishers. Lowest rates. Ask list. **BUSINESS PROMOTION**, Lajpat Rai Market, Delhi, India.

## REEL TO REEL TAPES

**TRUCKLOAD** sale Ampex high quality open reel tape, 1800- or 2400-foot on 7-inch reels, used once. Case of 40, \$45.00. Cassettes available. **VALTECH ELECTRONICS**, Box 6-RE, Richboro, PA 18954.

## CABLE TV

**CHANNEL 3**—60dB notch filter. 63.5MHz. \$32. **CROSLEY**, Dept 606, Box 840, Champlain, NY 12919.

## CB RADIO

**GET more CB channels and range!** Frequency expanders, boosters, speech processors, FM converters, PLL/slider tricks, how-to books, plans, modifications. Catalog \$2.00. **CB CITY**, Box 31500 RE, Phoenix, AZ 85046.

## CONVERTERS

**GATED** pulse wave UHF (speaker box type), has true AGC, parts \$125.00. The following have sound out of the TV like normal with only an antenna connection to the TV or VCR. Deluxe IIB sine wave UHF, has true AGC, parts \$150.00. Digital sync suppression/active video inversion VHF/UHF FV-4, has true AGC, parts \$225. Mitsumi tuner module with AGC, AFT, 504KHz, etc., \$60.00. Quantity discounts. Plans: large SASE (54 cents postage). Free shipping/handling. 1-312/267-3455. **LSR ENGINEERING**, Dept. RE, PO Box 6075, Chicago, IL 60680.

## LONG-PLAY RECORDER

**FOUR** unique models, allowing up to 20 recording hours on a single ordinary cassette! Models as small as 1½ pounds! Fidelity, features, and quality unavailable elsewhere. Free brochures. **EXTENDOTAPE SYSTEMS**, Dept. R-E, Box LC, Temple Terrace, FL 33687 (813) 985-3014.

## SAVE CABLE TV \$\$

**CABLE TV Consumer Buyers Guide**. Guaranteed lowest prices on cable TV devices and converters. We are an independent consumer service. Manual includes info on which equipment works on your cable system. \$8.00. **CATV INFORMATION CENTER**, PO Box 17621, Ft. Laud., FL 33318.

## TI-99/4A SOFTWARE

**TI-99/4A** owners. Games and application software on cassettes as low as \$5.95. Write: **TI-99/4A CASSETTE SOFTWARE**, 4129 Abercorn Rd., Knoxville, TN 37921.

## TIMEX/SINCLAIR SOFTWARE

**T/S 1000** programs finance aid (barcharts, interest, record keeping), math quiz (20 levels), electrosolve (solves most electronics circuit problems), \$6.95 each. **BILL KEMP**, Box 26086, Bluff Park, AL 35226.

## UPGRADE YOUR TELEPHONES

ADD THESE EASY-TO-INSTALL SPECIAL FEATURES  
**Hold/Busy/Silencer Circuit**  
 Allows you to put calls on hold. Also lets you silence bell or put phone on "busy". Plans: \$4.00; Kit: \$4.00 - \$2.00 phone.  
**Intercom Circuit**  
 Lets you use phones as an intercom. No extra wiring required. Less costly than wireless models. Plans: \$7.00; Kit: \$15.00 - \$5.00 phone.  
 Kits include plans, parts and board. When ordering kits, add \$2.00 for postage. Send SASE for more information.  
 dB Enterprises, Box 8, Oradell, NJ 07649

## TRS-80 COLOR COMPUTER

**COLOR COMPUTER OWNERS**—12 different programs on cassette for only \$15.00! Games, quizzes, etc. Send check or money order to: **QJN ENTERPRISES**, PO Box 983, Sarasota, FL 33578. Fla. residents add 5% sales tax.

**A SINGER'S DREAM!**  
 TVE  
**REMOVES VOCAL FROM MOST STEREO DISCS**  
 The Thompson Vocal Eliminator can actually remove most or virtually all of a solo vocalist from a standard stereo record and yet leave most of the background music untouched! Not an equalizer! We can prove it works over the phone. Write or call for a 24 page brochure and demo record.  
 Write to: **LT Sound**, Dept. R, P.O. Box 338, Stone Mountain, GA 30086. Phone: (404) 493-1258. COST: \$295.00

## REVERBERATION FOR ORGANS

Solid state with controls for reverberation and room size.  
**EVERY ORGAN SHOULD OWN ONE.** Send for free flyer—  
**DEVTRONIX ORGANS, INC.**  
 6101 WAREHOUSE WAY  
 SACRAMENTO, CALIFORNIA 95826 Dept. B

## PLANS & KITS

**SUBSCRIPTION TV** manual, covers both sine wave and gated sync system, only \$12.95. Includes theory, circuits, waveforms, and trouble-shooting hints. Video game cartridges are easy and inexpensive to duplicate. Plans \$9.95. Information \$2.00, refundable. **RANDOM ACCESS** (Formerly D & S Enterprises), Box 41770R, Phoenix, AZ 85080.

**CATALOG!** 40 pages of neat electronics parts and kits. Send 50 cents, refundable first order. **BEC ELECTRONICS**, Box 401244R, Garland, TX 75046.

**UHF** over the air all types, cable systems. Coming soon 2 new complicated UHF units (compatible with satellite owners). Now brand new Deluxe III gated pulse unit, sound through TV. Call for information 301-862-9362, or send \$2.00 (refundable) for catalog. **SATELLITE ELECTRONICS**, PO Box 9534, Baltimore, MD 21237.

**FREE KIT Catalog**  
 FUNCTION GENERATOR KIT \$59.95  
 Auto-Ranging Cap-meter kit \$79.95  
 contains TEST & EXPERIMENTER'S EQUIP.  
 Phone 209-772-2076  
 Write or Phone for FREE CATALOG  
**DAGE SCIENTIFIC INSTRUMENTS**  
 BOX 144 VALLEY SPRINGS CA 95252

**INCREDIBLE** price and quality for amplifier, power supply, and many many new electronics kits. Write now for your absolutely free catalog. **INTERNATIONAL POLYTECHNIQUES**, PO Box 862R, New York, NY 10002.

**BREADBOARD** using spirafit lead kit. Pretinnged, spiral leads stretch to desired lengths. No cutting, stripping, wrapping required. Send 50 cents for sample, details, prices free. **CALDER TRADING**, 720 Smithtown Ave., Bohemia, NY 11716.

**FUN kits — low cost.** Easy to build educational electronics projects. Handbook/catalog \$1.00. **TRIANGLE ELECTRONICS**, 89 Arkay Drive, Hauppauge, NY 11788.

**MINI FM MIC**  
  
 Compact size, only 2" x 1" x 3/4". Transmit to FM radio 88-108 MHz. Exceptional audio quality. Transmits stable signal up to 900 ft. Complete kit incl. case, battery & instructions. Only \$15.95. Assembled \$20.95. Add \$1.55 S&H ea. CA. RES. ADD TAX. Send 20c stamp for brochure.  
 S.E. Corp., Box 1132-RE  
 Yorba Linda, CA. 92686

**TIMEX/SINCLAIR 1000/ZX81** How-To hardware upgrade book. Covering: buffered expansion interface, serial interface, standard printer interface, and more. \$6.95 ppd 10-day money back guaranteed. **INNER KNOWLEDGE COMPUTERS & PERIPHERALS**, 5944 N.E. Sandy Blvd., Portland, OR 97213.

## SUBSCRIPTION TV KITS

**UHF Gated Pulse Kit.....\$39.00**  
**UHF Sinewave Kit.....\$37.00**  
**Special Both Kits.....\$59.00**  
**Informative Catalog.....\$ 2.00**

Kits include all parts, manual and an etched & drilled PC board. Send for our "Informative Catalog" and find out what type you need.

**J & W ELECTRONICS, INC.**  
 P. O. BOX 61-B  
 CUMBERLAND, RI. 02864

**OWN** a tone remote retrieve telephone answering device? Throw your tone device away. Retrieve messages with any standard Touch-Tone® telephone. Plans \$10.95 — kit including PC board \$39.95 — check or M.O. — **APP-COM**, PO Box 1031, New Castle, IN 47362.

**CATALOG**—transmitters, linears, MDS downconverters, scramblers, broadcasting, CB, hobby plans & kits. \$1.00. **PANAXIS**, Box 130-F7, Paradise, CA 95969.

**NEW FM** transmitter kit. Great for experimenters. Instructions and parts only \$19.95. Buy now. **TUCKER ENTERPRISES**, PO Box 10120, Alexandria, VA 22310-0120.

**CONTROL** and read up to 256 devices. Plugs into Radio Shack model III. Simple construction, software included. Plans \$15.00. **SPECIALTY ENGINEERING & MFG., Inc.** PO Box 120, Gonzales, TX 78629.

**ELECTRONIC combination lock**, patented. Plans available for \$3.00 and SASE from **JINN**, Box 764, Herndon, VA 22070.

**TIMEX/Sinclair** kits: 2parallel and 2RS232C/I/O ports \$69.95. **Color graphics** and sound w/16K RAM \$179.95. 32K RAM \$88.95. All kits furnished with high quality PC boards, and plug into the ST-50, fully buffered, 8slot motherboard \$149.95. **CW/TTY** interface available soon. Brochure \$1.00 (refundable). **SIGMA-TECHNOLOGY**, Dept. K, Box 971, Va. Beach, VA 23451.

**CUSTOM PC boards** and photo masks from sketches, schematics, or artwork. Free brochure on services, products, and kits: TTL logic probe, \$13.35. **AIE**, Box 2287, Arcadia, FL 33821.

**PRINTED** circuit boards. Quick prototypes, production, design, reflow solder. Send print or description for quote to **KIT CIRCUITS**, Box 235 Clawson, MI 48017.

**LIGHT** display sequencer kits. Send stamp for flyer. **DESIGN SPECIALTY**, P.O. Box 1995, Huntington Beach, CA 92647.

**PROJECTION TV** ... Convert your TV to project 7 foot picture. Results comparable to \$2,500 projector... Total cost less than \$20.00 ... Plans and lens \$17.50... Illustrated information free... Credit card orders 24 hours. (215) 736-3979. **MACROCOMAGK**, Washington Crossing, PA 18977

**ELECTRONIC** touch light control pad five modes dim, medium, bright, delay, and off. Two kits available. Write for free brochure. **EXOTIC ELECTRONIC IDEAS**, PO Box 446, Lake Bluff, IL 60044.

**SINE** wave decoder problems? Manual includes trouble shooting, alignment, antenna hookup, improvements, theory. \$15.00. **SIGNAL**, Box 2512-R, Culver City, CA 90230.

**PROFESSIONAL** electronics devices plans, kits, P.C. circuitry, famous drop-in microphone cartridge, debugging equipment, more items available. For information send \$3.00. **MOUNTAIN ELECTRONICS**, R.2, Box 30, Charlotte, TN 37036.

**FREE** phone calls made by users. Electronics device report, plans sold for information, education only. \$7.50. **DISTRIBUTORS MART**, Dept. RE73, Box 333, Modena, NY 12548.

**SAVE** energy! Build a computerized thermostat. Schematic and software \$5.00. **GLOVATRON**, PO Box 559, East Detroit, MI 48021.

**MICROWAVE** television "downconverters." Exclusive new five stage design. Easily assembled. Catalog: \$2.00 (refundable). **NDS**, Box 12652R, Dallas, 75225.

## FOR SALE

**NEW Repair any TV ... Easy.** Anyone can do it. Write **RESEARCH**, Box 517C, Brea, CA 92621.

**CABLE TV products:** Wireless, corded, & settop converters. Send \$3.00 for catalog. **ADDITIONAL OUTLET CORP.**, 231 E. Commercial Blvd., Ft. Lauderdale, FL 33334.

**CABLE TV SECRETS**—the outlaw publication the cable companies tried to ban. HBO, Movie Channel, Showtime, descramblers, converters, etc. Suppliers list included. Send \$7.95 to **CABLE FACTS**, Box 711-R Pataskala, OH 43062.

**PCB** 15 cents sq-in. Free drilling. Quantity discount. **INTERNATIONAL ENTERPRISE**, 6452 Hazel Circle, Simi Valley, CA 93063.

**RESISTORS** 1/4W & 1/2W 5% C.F. 3 cents. 1% M.F. All values. No minimums Volume discounts. Write **JR INDUSTRIES**, 5834-B Swancreek, Toledo, OH 43614.

### RELIABLE MICROWAVE TV ANTENNAS

**2.1 to 2.6 GHz  
Frequency Range**

**34db System Gain [or Greater]**

Complete System (pictured) \$119.95  
Down Converter Probe Style  
(Assembled & Tested) \$ 49.95  
Power Supply (12V to 16V DC) (Assembled & Tested) \$ 39.95

**PETERSON ELECTRONICS**  
4558 Auburn Blvd.  
Sacramento, CA 95841  
(916) 486-9071

SPECIAL QUANTITY PRICING  
Dealers Wanted - COO'S

1 YEAR WARRANTY  
PARTS & LABOR

**COLOR** computer VIC-20 programs hardware Rty code EPROM Programmer RS-232. **FRANK LYMAN**, Box 3091, Nashua, NH 03061.

**THE Intelligence Library.** Restricted technical secrets—books on electronic surveillance, lock-picking, demolitions, investigation, etc. Free brochures: **MENTOR**, Dept. Z, 135-53 No. Blvd., Flushing, NY 11354.

**SURVEILLANCE** device schematics, books on electronic surveillance methods & equipment, locksmithing, covert technologies, etc. Catalog, \$1.00. **MENTOR**, Dept. Z, 135-53 N. Blvd., Flushing, NY 11354.

.125 aluminum—make your own chassis! Cut to size, squares, rectangles only. 6 cents sq. in., \$10.00 minimum, \$2.00 handling. Shipped UPS collect. Send dimension(s) of piece(s) to: **O'DAY**, PO Box 248, Lansing, IL 60438.

\*\*\*\*\*  
QUALITY MICROWAVE TV SYSTEMS  
\*\*\*\*\*  
Complete Systems From \$69<sup>95</sup>  
\*\*\*\*\*  
1.9 to 2.5  
GHz  
Antennas  
\*\*\*\*\*  
**Galaxy Electronics**  
6007 N. 61st Ave.  
Glendale, Az.  
85301  
1-602-247-1151  
1-800-247-1151  
\*\*\*\*\*  
COD's / Dealers Wanted  
\*\*\*\*\*

GOLD STAR      SILVER STAR      TELE STAR

STAR II

## WIRELESS THERMOSTAT

**TELESTAT** - a portable, wireless thermostat that moves with you. From room to room. To the TV room after dinner. To the bedroom at night. To the kitchen early in the morning. Your furnace works to keep the room where you and Telestat are, at a comfortable level. Telestat saves you money because your furnace works only when needed, instead of running continuously. Use with forced air furnaces and air conditioners. That's double the savings. Year in and year out. **\$94.95\***

\*SPECIAL THROUGH AUG. 31, 1983

CALL 1-800-426-8075 or write

**COMMUNICATIONS RESEARCH CORPORATION**  
1720 - 130th Ave. N.E. Bellevue, WA 98005

**UNUSUAL UHF** subscription TV kits. Also microwave downconverters. Catalog 50 cents. **TROJAN**, 2920 Shelby, Indianapolis, IN 46203.

**TELEPHONES**—extensive selection—parts, accessories, systems. Free catalog. **NDS**, Box 35444, Los Angeles, CA 90035-0444 (213) 935-9900.

**PRINTED** circuit boards: quotes free. **SASE** to **JAHMAAL ELECTRONIC SUPPORT**, PO Box 397, Troy, NY 12181.

**ELECTRONICS** catalog: Scanners, CB, video. All kinds of electronics goodies. Send \$1.00 refundable. **CLEM ELECTRONICS**, 1520 N. Pacific, Fresno, CA 93728.

## Full Size Keyboard Conversion

10 3/4 x 7 1/4 x 2 1/8

For Your  
**ZX81/  
TS1000**  
SUN KD-81  
**\$69<sup>95</sup>**

Easy To Install  
No Soldering - No Modifications

**41 Keys with Full Size Space Bar - Allows Touch Typing Same Key Layouts as Sinclair - Two Color Keypops Keyboard Case Holds Both Keyboard and Computer Commands and Graphics Spelled Out on Keypops Rear Cutout for Any RAM or Expansion Modules**

**16K Piggyback RAM Module ... P/N MX-16 \$49.95**

**SUNTRONICS CO., INC.**

In Calif Call **213-644-1149**  
Outside Calif Call **1-800-421-5775**  
Or send Check or M.O. to:  
**P.O. Box 1957 Hawthorne CA 90250**  
California residents add 6 1/2% sales tax.  
Includes: Detailed Instructions  
Parts Lists-Schematics-Design Tips

Add \$4.00 ship/handling. VISA/MasterCard include expiration date

**TUBES** — all types, discount prices. Many oldies and hard-to-find types. **SASE** for list. **ANTIQUÉ RADIO & TUBE CO.**, Dept. 701, 1725 W. University, Tempe, AZ 85281.

**XFORTH** — Forth-79 standard sub-set plus extra utilities. 10K+ available for user code. Or cassette for 16K ZX-81. \$25.00 + \$1.00 P&H. Arkansas residents add \$1.00. **HAWG WILD SOFTWARE** Box 7668-R, Little Rock, AR 72207.

**TRANSPOSERS** digital rhythm displays super cymbal, many more inexpensive accessories, all organs. Send for free brochure. **SACHA INTERNATIONAL**, 943 Archer Street, San Diego, CA 92109.

### "Bare Power Supply Boards"

(FOR ALL TO-220 3 TERMINAL REGULATORS)

**"Four Styles In Stock"**

- 7800 Positive Fixed
- 7900 Negative Fixed
- 317T Positive Adjustable
- 337T Negative Adjustable

All Boards 2"x3" - G10  
Silk Screened - Soldermasked  
Make Projects A Snap!  
Includes: Detailed Instructions  
Parts Lists-Schematics-Design Tips

\$2.50 ea. - 4 for \$9.00 add \$1.00 postage & handling

**MIDWEST TECHNICAL**  
P.O. BOX 272, AURORA, IL 60507

**HI-REL** mil-spec metal film resistors. RN55's, RNC60's, etc. at super low prices. Contact us for free inventory listing and price list. **IN-TERMOUNTAIN ELECTRONICS**, Box 531, Boise, ID 83701 (208) 384-9755.

**PRINTED-circuit boards:** single side, prototype, and quantity, quick delivery. Send positive, free quotes. **FABTRON**, Box 925, Dept. C, Columbia, TN 38401 (615) 381-1143.

**SUPER** summertime surplus savings! Free flyer. **ELECTRONIX LTD.**, Dept. R-7, 3214 S. Norton, Sioux Falls, SD 57105.

**RADIO West** — still the best for SW/MW DX receivers and receiver modifications! Catalog 50 cents. **RADIO WEST**, 3417 Purer Road, Dept RE, Escondido, CA 92025 (619) 741-2891.

**SPECIAL** sale —40-channel TV converter, built-in fine tuning. Only \$28.95, add \$2.50 postage and handling. Free bargain catalog. **IN-X-SALES**, Box 222, Medford, MA 02155.

WRITE FOR  
**McGEE'S**  
SPEAKER & ELECTRONICS CATALOG

1001 BARGAINS IN SPEAKERS

Tel.: 1 (816) 842 5092

1901 MCGEE STREET KANSAS CITY, MO. 64108

**SCANNER** accessories and crystals. Free catalog —best prices anywhere. **SCANNER PLUS**, Box 45, Tilton, NH 03276 (603) 286-3082.

**SCANNER/monitor** accessories—kits and factory assembled. Free catalog. **CAPRI ELECTRONICS**, Route 1R, Canon, GA 30520.

**ZX81/TS1000: 25 Family Fun Programs** for 16K! You type and save! Send \$7.50 to **H. DAILY**, Box 553, Valley Center, CA 92082.

**MICROWAVE** antenna 38 dB gain, slotted dish, probe, power supply, 60' cable, warranty. **AMA SYSTEMS**, PO Box 1354, Sandy, UT 84091. Only \$79.95.

THE BEST PLACE to BUY, SELL or TRADE NEW and USED EQUIPMENT

NUTS & VOLTS MAGAZINE

BOX 1111-E • PLACENTIA, CA 92670  
(714) 632-7721

Join Thousands of Readers Nationwide  
Every Month

ONE YEAR U.S. SUBSCRIPTIONS

\$7.00 - 3rd Class • \$12.50 - 1st Class

\$25.00 - Lifetime - 3rd Class

NUTS & VOLTS

HAM GEAR  
COMPUTERS  
SOFTWARE  
SCANNERS • OPTICS  
TEST EQUIPMENT  
MICROWAVE  
SATELLITE  
AUDIO VISUAL  
NEW PRODUCTS  
COMPONENTS • KITS  
ANTIQUE SELECT  
PUBLICATIONS  
PLANS • SERVICES

# Many Happy Returns

Take stock  
in America.

UNITED STATES  
SAVINGS BONDS

# NEW ITEMS, SUPER VALUES AT THE PARTS PLACE™

**No Minimum Order! Friendly Service! See Before You Buy!**

## Telephone Ringer IC



**NEW! 3.99**

- Phone Line Powered
- Ideal for Remote Ringers

8-Pin DIP

TCM1512A. Detects ring and drives an external piezo element (not incl.). 800 to 2 kHz output with 10 Hz warble, determined by external resistor. On-chip static protection and anti-tap circuitry. 276-1302 ..... 3.99

## Enclose Your Project!



**NEW!**  
Low As **4.99**

Aluminum. Eggshell white with black top. Complete with hardware and rubber feet.

Size	Cat. No	Price
1 1/16 x 4 1/4 x 4 1/8"	270-271	4.99
1 1/16 x 8 1/4 x 6 1/8"	270-272	5.99
3 1/16 x 4 1/4 x 4 1/8"	270-273	6.99
3 1/16 x 8 1/4 x 6 1/8"	270-274	7.99

## Sale! 25-Range Multitester

**Save \$12**

Reg. 27.95

**15.95**

- 20,000 Ohms Per Volt DC Sensitivity
- With Leads And Manual



Buy now and get this accurate Micronta® multitester at 43% off! Features a big 4" mirrored scale, "output" jack to measure AC signals present in DC circuits. Measures 0 to 1200 volts DC in seven ranges, 0 to 1200 volts AC in five ranges, 0 to 300 milliamps DC current in four ranges, resistance in four ranges, and -20 to +63 dB in five ranges. 5 1/2 x 3 7/8 x 1 1/2". Requires "AA" battery. 22-202 ..... Sale 15.95

## IF, FM & Video ICs

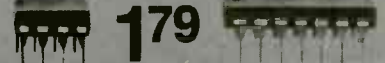

**1.79**

MC1330 Video Detector. 3rd IF, detector, video and AFC buffers. High linearity. 10-24VDC. 8-pin w/specs. 276-1757 ... 2.29  
MC1350 Universal IF Amp With AGC. For radio and TV circuits. Usable to beyond 60 MHz. 8-pin w/specs. 276-1758 ..... 1.99  
MC1358/CA3065 FM Detector. IF amp, limiter, FM detector, electronic volume attenuator and audio driver. For 100 kHz-5.5 MHz IFs. 14-pin w/specs. 276-1759 ..... 1.79

## Ceramic TV-Sound Filters

**NEW!**

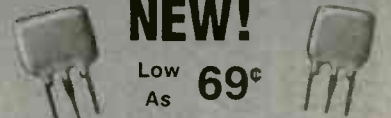

Low As **69¢**

- Replace Costly Transformers
  - Pretuned—No Peaking or Tweaking!
- SFE4.5MB. Use in place of 4.5 MHz sound take-off transformer. 3 db bandwidth: 105 kHz, typ. 272-1304 ..... 69¢  
CDA4.5MD3 Discriminator. This differential peak detector works great with our FM detector IC #276-1759, above. 274-1305 ..... 79¢

## 10% IRD Capacitors



**NEW!**  
Low As **59¢**

IC pin spacing. 63WVDC

- .01 µF. 272-110 ..... 59¢
- .1 µF. 272-111 ..... 69¢
- .47 µF. 272-112 ..... 89¢

## Horizontal Output



**7.95**  
TO-3 Case

2SC1308. Rugged NPN transistor is exact replacement in many 19" color TVs. Servicemen—keep several on hand! 276-2055 ..... 7.95

## 3PDT Toggle Switch



**3.49** Mini Size

Contacts rated 6 amps at 125VAC. 1/4" mounting hole. With hardware. 275-661 ..... 3.49

## Tri-Color LED



**1.39** Ideal Status Indicator

XC-5491. Glows red on DC, green on reverse DC, yellow on AC! 2.2V at 25 milliamperes, typical. 276-035 ..... 1.39

## Micro 5VDC Relay



**2.49** ACTUAL SIZE

Ideal for crowded PC boards. SPDT contacts: 1 amp at 125VAC. 55-ohm coil, .100" pin spacing. 275-240 ..... 2.49

## Sale! Program Books for Your TRS-80



**39% Off!**  
Your Choice Only

Reg. 7.95

**4.88**

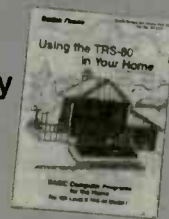

Computer Games. Contains listings for over 25 fun-filled game programs for TRS-80 Level II BASIC. Selections include Blackjack, Poker, Tennis, Tic-Tac-Toe, Escape, Golf, Basketball, Psycho, Star Trek, Biorhythm, Poem and more. 151 pages. 62-2068 ..... Sale 4.88  
Using the TRS-80 in Your Home. Listings for over 75 practical programs in Level II BASIC including finance, analysis, games, scheduling, lists and much more. 330 pages. 62-2069 ..... Sale 4.88

## Electret Element



**99¢**  
Hi-Fi Response

Omnidirectional, PC mountable. 20 to 15 kHz ± 4 dB. 2-10VDC, only 1 millamp current drain. 270-090 ..... New Low Price 99¢

## Portable Solar Panel



**24.95**

Radio Shack Exclusive!

Switchable 6 or 12VDC output. 32 full-spec cells produce approximately 1/2 watt of "free" power. 277-1250 ..... 24.95

## Resistor Networks



**NEW!**  
**89¢** Each  
IC Lead Spacing

Five 1/4-watt resistors in one package. Ideal for digital pull up, LED current limiting. 470-Ohm, 271-095. 1000-Ohm, 271-096. 10k-Ohm, 271-097.

## Fun Sounds Made Easy!



Only **2.49**

16-Pin DIP With Data  
SN94281. Just add a speaker and a few parts to make amazing sounds. Heart of a rewarding project—try it! 276-1767 ..... 2.49

## D-Sub 25 Connectors

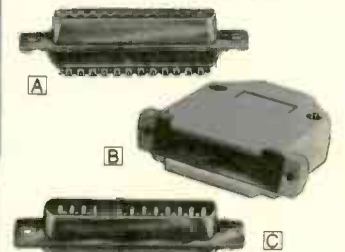

Solder type. Perfect for computer interfacing and making your own RS-232 cables and extension cords.  
A Male. 276-1547 ..... 2.99  
B Optional Hood. 276-1549 ..... 1.99  
C Female. 276-1548 ..... 3.99

Table with columns: CPU's & SUPPORT CHIPS, Part numbers, and Prices. Includes items like 8251, 8253, 8238, etc.

Table with columns: SCR's, TRIAC's, and Prices. Includes columns for 1.5A, 6A, 35A, 110A and 1A, 10A, 25A.

Table for EPOXY GLASS VECTOR BOARD with specifications like 1/16" thick with 1/10" spacing and prices for 14 PIN HEADERS, etc.

Table with columns: INTER FACE & DRIVERS, SHIF REGISTER, and DISC. Includes part numbers like 8275, 8903L, etc.

Table for C/MOS with columns for part numbers and prices. Includes items like 4001, 4002, 4008, etc.

Table for TRANSISTOR SPECIALS with columns for part numbers and prices. Includes items like 2N1307 PNP GE TO-18, etc.

Table with columns: ROM's, RAM's, NO. 30 WIRE, and CRYSTALS. Includes part numbers like 2708, 2716 + 5V, etc.

Table for 74S SERIES with columns for part numbers and prices. Includes items like 74S00, 74S10, 74S11, etc.

Table for TTL IC SERIES with columns for part numbers and prices. Includes items like 7400, 7401, 7402, etc.

Table for 50 PIN RIBBON CONNECTORS, 40 PIN RIBBON CABLE CONN, etc. with prices.

Table for LINEAR CIRCUITS with columns for part numbers and prices. Includes items like DA008EQ, TL062 CP, etc.

Table for 74LS SERIES with columns for part numbers and prices. Includes items like 74LS00, 74LS10, 74LS11, etc.

Table for DISC CAPACITORS with columns for part numbers and prices. Includes items like 1U1F 16V, etc.

Table for FULL WAVE BRIDGE with columns for part numbers and prices. Includes items like 100V, 200V, 400V, etc.

Table for SILICON POWER RECTIFIERS with columns for part numbers and prices. Includes items like 1N4001, 1N4002, etc.

Table for PRINTED CIRCUIT BOARD, TOGGLE SWITCHES, and IN4148 (IN914) with prices.

Table for REGULATORS with columns for part numbers and prices. Includes items like LM338K, LM317T, etc.

Table for TANTALUM CAPACITORS with columns for part numbers and prices. Includes items like 22UF 35V, 47UF 35V, etc.

Table for FLAT RIBBON CABLE, DIP SWITCHES, and DIP SOCKETS with prices.

Table for MULTI TURN TRIM POTS with columns for part numbers and prices. Includes items like 50 OHM 5K, 100 OHM 10K, etc.

Table for RESISTOR BUYOUT with columns for part numbers and prices. Includes items like 1/4 WATT 5% RESISTORS, etc.

Table for WIRE WRAP SOCKETS, DB CONNECTORS, and POSTAGE RATES.

Table for TERMS FOR CAMBRIDGE, MASS. SEND CHECK OR MONEY ORDER, MINIMUM TELEPHONE, etc.

Table for UHF/VHF Conversion Kit with price \$119.95.

ACTIVE RECEIVING ANTENNA. Gives excellent reception, 50 KHz to 30 MHz. New MFJ-1024 Active Recieving Antenna mounts outdoors away from electrical noise for maximum signal. Gives excellent reception of 50 KHz to 30 MHz signals. Equivalent to wire hundreds of feet long. Use any SWL, MW, BCB, VLF or Ham receiver. High dynamic range RF amplifier. 54 in. whlp. 50 foot coax. 20 dB attenuator prevents receiver overload. Switch between two receivers. Select auxiliary or active antenna. Gain control. "ON" LED. Remote unit, 3x2x4 in. Control, 6x2x5 in. 12 VDC or 110 VAC with optional adapter, MFJ-1312, \$9.95. \$129.95 (MSRP shipping).

Order from MFJ and try it. If not delighted, return within 30 days for refund (less shipping). One year unconditional guarantee. Order today. Call TOLL FREE 800-647-1800. Charge VISA, MC, or mail check, money order. Write for free catalog. Over 100 products.

CALL TOLL FREE 800-647-1800

Call 601-323-5869 in Miss., outside continental USA, tech/order/repair info. TELEX 53-4590.

MFJ ENTERPRISES, INCORPORATED. Box 494, Mississippi State, MS 39762

CIRCLE 66 ON FREE INFORMATION CARD

SCR. Free Buyers Guide. pages of the latest in components, tools and instruments - a must for DESIGNERS, instructors and maintenance engineers.

NEW ZENITH ZXM 121. High legibility 12" green phosphor monitor. 15 Mhz bandwidth, 40 or 80 character selectable full compatibility. \$99.95

Table with columns: IC'S, CAPACITORS, PARTS, PRICES, ITEM, PRICES. Includes items like 7808, 7815, 1330, 1350, 388-3, 4558, 1458.

RESISTOR BUYOUT. MOST STANDARD VALUES. 1/4 WATT 5% RESISTORS 1 OHM TO 10 MEG. OHM 2 K MIN. BUY 1 K MIN. PER VALUE \$6.50 Per 1,000

UHF/VHF Conversion Kit - with Genuine Mitsumi Tuner. \$119.95

CALL OUR HOT LINES. IN CALIF. (714) 527-2554. OUTSIDE CAL. (800) 854-8660. SCR ELECTRONICS CENTER. 5303 Lincoln Ave., Cypress, CA 90630

SOLID STATE SALES. P.O. BOX 74D. SOMERVILLE, MASS. 02143. TEL. (617) 547-7053. WE SHIP OVER OVER 95% OF OUR ORDERS WITHIN 24 HOURS OF RECEIPT. TOLL FREE 1-800-343-5230 FOR ORDERS ONLY.



# WE HAVE QUALITY PARTS, DISCOUNT PRICES AND FAST SHIPPING!

### TRANSFORMERS

120 volt primaries

5.6 VOLTS at 750 MA	\$3.00
6 VOLTS at 150 MA	\$1.25
16.5 V. at 3 AMPS	\$6.50
18 V at 650 MA	\$3.50
18 VOLTS at 1 AMP	\$4.50
18 V.C.T. at 2 AMP	\$5.50
24 VOLTS at 250 MA	\$2.50
24 VCT at 1 AMP	\$4.50
42 V.C.T. at 1.2 AMP	\$4.50

### BLACK PLASTIC CASE

PAC-TEC SERIES C



BLACK PLASTIC ENCLOSURE ADJUSTABLE HEIGHT FROM 1.63" TO 2.93". WIDTH 6.85", DEPTH 8". BUILT-IN STAND OFFS FOR P.C. BOARDS. FRONT AND BACK PANELS NOT INCLUDED.

\$5.25 PER CASE

### T.V. GAME SWITCH

RCA PLUG or 300 OHM IN



300 ohms OUT

\$2.75 EACH

### LIGHTS

#### GRAIN OF WHEAT

##### T1 SIZE

.125" DIA. (3.15mm)

3 to 6 VOLTS 3 for \$1.00  
Rated: 55ma @ 5 VOLTS

6 to 12 VOLTS 3 for \$1.00  
Rated: 55ma @ 8 VOLTS

12 to 24 VOLTS 3 for \$1.00  
Rated: 45ma @ 14 VOLTS

### 12 VOLT A.C. POWER UNIT



THIS UNIT CONSISTS OF A 12 VOLT 2 AMP TRANSFORMER, 1 AMP CIRCUIT BREAKER, 4 PRONG CINCH JONES SOCKET AND A 3 WIRE A.C. CORD ALL MOUNTED IN AN ATTRACTIVE 4 1/2" x 5 1/2" x 3" CHASSIS BOX. GOOD FOR PARTS OR A NICE START FOR D.C. POWER SUPPLY.

\$8.50 PER UNIT

### DC WALL TRANSFORMER

ALL ARE 115 VAC PLUG IN



4 VDC at 70 MA	\$2.50
9 VDC at 225 MA	\$3.00
16.5 VAC at 10 VA	\$3.50
17 VAC at 500 MA	\$4.00
22 VDC at 60 MA	\$2.50

### 2K 10 TURN MULTI-TURN POT

SPECTROL #MOD 534-7161



\$5.00 EACH

### S.C.R.

0.8 AMPS 30 VOLTS 5 for \$1.00

4 AMPS 200 VOLTS 65¢ EACH

4 AMPS 500 VOLTS 85¢ EACH

### T1 SIZE WITH WIRE LEADS

3 to 6 VOLTS 2 for \$1.00  
Rated: 55ma @ 5 VOLTS

6 to 12 VOLTS 2 for \$1.00  
Rated: 55ma @ 8 VOLTS

12 to 24 VOLTS 2 for \$1.00  
Rated: 45ma @ 14 VOLTS

### CO-AX SWITCH (A/B SWITCH)

75 ohms IN TWO



75 ohms OUT

\$3.50 EACH

### LINE CORDS

#### TWO WIRE

6' 18ga TWO WIRE 3 FOR \$1.00

#### THREE WIRE

18 INCH 18ga THREE WIRE 2 for \$1.00

8 FOOT 18ga THREE WIRE \$2.00 EACH

### VARACTOR DIODE

MV2205 3 for \$1.00  
16 PF 100 FOR \$30.00



BB-103 3 for \$1.00  
33 PF 100 FOR \$30.00

### MIKE CONNECTOR



5 CONDUCTOR IN-LINE PLUG AND CHASSIS MOUNT JACK. TWIST LOCK STYLE. SAME AS SWITCHCRAFT 12CL5M.

\$2.50 PER SET

### TRANSISTORS

2N706	5 for \$1.00
2N2222A	4 for \$1.00
PN2222	8 for \$1.00
2N2904	4 for \$1.00
2N2905	4 for \$1.00
2N2907	4 for \$1.00
MJ3030	\$2.50
2N3055	\$1.00
2N3585	\$1.00
2N3904	5 for \$1.00
2N3906	5 for \$1.00
2N4401	5 for \$1.00
2N4403	5 for \$1.00
2N4898	\$1.50
D43C8	2 for \$1.00
D44C2	.75
TIP 31	.75
TIP 32	.75
TIP 121	.75
TIP 126	.75

### T1- 3/4 SIZE WITH WIRE LEADS

163" DIA. (4.14mm)

3 to 6 VOLTS 2 for \$1.00  
Rated: 45ma @ 6 VOLTS

6 to 12 VOLTS 2 for \$1.00  
Rated: 55ma @ 8 VOLTS

12 to 24 VOLTS 2 for \$1.00  
Rated: 45ma @ 14 VOLTS

### METERS

#### 0 - 20 V.D.C.

0-20 VDC FULL SCALE FACEPLATE BATTERY TEST SET-UP AS INDICATOR



\$5.50 EACH

### SWITCHES

#### MINI-PUSH BUTTON

S.P.S.T. MOMENTARY NORMALLY OPEN 1/4" BUSHING



35¢ EACH

10 FOR \$3.25  
100 FOR \$30.00

SPECIFY COLOR: RED, BLACK, WHITE, GREEN, YELLOW.

### 2 CHANNEL LIGHT ORGAN

EASILY-HOOKS INTO STEREO SPEAKERS AND ALLOWS 110 VAC LIGHTS TO DANCE WITH MUSIC. TWO SEPARATE 110 VAC OUTPUTS FOR HIGH AND LOW FREQUENCY AUDIO SIGNALS. USE TWO ORGANS FOR STEREO.



\$8.50 PER UNIT

COLOR LIGHT STRING AVAILABLE \$1.75 EA

### MICROWAVE TRANSISTOR

MRF 901 REDUCED TO N.P.N. SILICON \$2.00 EACH



### NEON W/ RESISTOR

DIRECT OPERATION FROM 120 VOLT

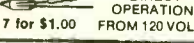

7 for \$1.00

### 1 MA 2 5/16" SQUARE PANEL METER MOUNTS IN 2 1/8" HOLE



\$5.50 EACH

### KEY SWITCH

S.P.S.T. 4 AMPS @ 125 VAC KEY REMOVES BOTH POSITIONS \$3.50 EA



### 120V INDICATOR

NEON INDICATOR. RATED 120 V 1/3 W. MOUNTS IN 5/16" HOLE. ... RED LENS.



75¢ EACH  
10 FOR \$7.00  
100 FOR \$65.00

### 0 - 15 V.D.C. THIS 2-1/4" SQUARE METER MEASURES 0-15 VDC.



\$4.50 EACH

### LIGHTED PUSH BUTTON

RED LIGHTED 120 VAC 10 AMP. S.P.S.T. "POWER" PRINTED ON FACE MOUNTS IN 7/8" SQUARE HOLE.



\$1.50 EA 10 FOR \$13.50

FREE! FREE! free! SEND FOR OUR NEW 40 PAGE CATALOG free! FREE! FREE!

### 2-WAY CAR STEREO SPEAKER SYSTEM



THESE SPEAKERS COME IN HEAT RESISTANT ABS PLASTIC CABINETS. IDEAL FOR CAR INTERIORS WHERE HEAT CHANGE OCCURS. POWER RATING: 15 WATT NOM. 45 WATT MAX.

EACH SYSTEM CONTAINS A 4 INCH 10 OZ. WOOFER AND 2 INCH TWEETER

SPECIAL PRICE \$36.00 PER PAIR

### RELAYS

#### 6 VDC RELAY

MINIATURE D.P.D.T. 3 AMP CONTACTS FUJITSU # FBR321D006 \$1.75 EA 10/ 16.00



#### MINIATURE 6 VDC RELAY

SUPER SMALL SPDT RELAY. GOLD COBALT CONTACTS. RATED 1 AMP AT 30 VDC. HIGHLY SENSITIVE. TTL DIRECT DRIVE POSSIBLE. OPERATES FROM 4.3 TO 6 V. COIL RES. 220 OHM.



1 3/16" x 13/32" x 7/16" AROMAT # RSD-6V \$1.50 EACH 10 FOR \$13.50

### COMPUTER GRADE CAPACITORS

1700 mfd. 150 VDC \$2.00  
2 1/2" DIA. x 4 3/4" HIGH

3,600 mfd. 40VDC \$1.00  
1 3/8" DIA. x 3" HIGH

6,400 mfd. 60 VDC \$2.50  
1 3/8" DIA. x 4 1/4" HIGH

18,000 mfd. 75 VDC \$4.00  
2 1/2" DIA. x 4 1/2" HIGH

22,000 mfd. 15 VDC 2" DIA. x 2 1/2" HIGH \$2.00

22,000 mfd. 40 VDC 2" DIA. x 6" HIGH \$3.00

24,000 mfd. 30 VDC 1 3/4" DIA. x 4" HIGH \$3.50

31,000 mfd. 15 VDC 1 3/4" DIA. x 4" HIGH \$2.50

72,000 mfd. 15 VDC 2" DIA. x 4" HIGH \$3.50

180,000 mfd. at 6V 2 1/2" DIA. x 4 1/2" HIGH \$1.50

CLAMPS TO FIT CAPACITORS 50¢ ea.

### EDGE CONNECTORS

ALL ARE .156" SPACING

15 PIN GOLD SOLDER EYELET \$1.75 EACH

15/30 GOLD SOLDER EYELET \$2.00 EACH

18/36 GOLD SOLDER EYELET \$2.00 EACH

22/44 GOLD SOLDER TAIL (P.C. STYLE) \$2.50 EA 10 FOR \$22.50

### SOLID STATE RELAY

CONTROL: 3-32VDC

LOAD: 10 AMP 140 VAC



\$9.50 EACH

### L.E.D.'S STANDARD JUMBO DIFFUSED

RED 10 FOR \$1.50  
GREEN 10 FOR \$2.00  
YELLOW 10 FOR \$2.00



### FLASHER LED 5 VOLT OPERATION RED JUMBO SIZE \$1.00 EACH



### BI POLAR LED 2 FOR \$1.70



### SUB-MINI LED

.079" x .098" 20 MA AT 1.75V

RED 10 FOR \$1.00  
200 FOR \$18.00  
GREEN 10 FOR \$1.50



### LED HOLDERS

TWO PIECE HOLDER FOR JUMBO LED 10 FOR 65¢ 200 FOR \$10.00



### KEY ASSEMBLY 5 KEY



\$1.00 EACH

CONTAINS 5 SINGLE-POLE NORMALLY OPEN SWITCHES. MEASURES 3 3/4" LONG

### 6 KEY



\$1.25 EACH

CONTAINS 6 SINGLE-POLE NORMALLY OPEN SWITCHES. MEASURES 4 1/4" LONG.

### SLIDE POTS



#### 100K linear tape

2" LONG 1 5/8" TRAVEL 75¢ EACH

#### 500K linear taper

2 7/8" LONG 1 3/4" TRAVEL 75¢ EACH

#### DUAL 100K audio taper

3 1/2" LONG 2 1/2" TRAVEL. \$1.50 EACH

### 13 VDC RELAY

CONTACT: S.P.N.C. 10 AMP @ 120 VAC ENERGIZE COIL TO OPEN CONTACT... COIL: 13 VDC 650 OHMS



PRICE \$1.00 EACH

### 4 PDT RELAY

- 14 pin style
- 3 amp contacts
- 24 volt d.c. or 120 volt a.c. coil
- Used but fully tested \$1.70 EACH

specify coil voltage LARGE QUANTITIES AVAILABLE SOCKETS FOR RELAY 50¢ each



### MINIATURE TOGGLE SWITCHES ALL ARE RATED 5 AMPS @ 125 VAC

#### S.P.D.T. (on-on)

P.C. STYLE. NON-THREADED BUSHING. 75¢ EACH 10 FOR \$7.00



#### S.P.D.T. (on-off-on)

P.C. LUGS. THREADED BUSHING. \$1.00 EACH 10 FOR \$9.00 100 FOR \$80.00



#### S.P.D.T. (on-on)

P.C. LUGS. THREADED BUSHING. \$1.00 EACH 10 FOR \$9.00 100 FOR \$80.00



#### S.P.D.T. (on-off-on)

SOLDER LUG TERMINALS. \$2.00 EACH 10 FOR \$19.00 100 FOR \$180.00



### PHOTO-FLASH CAPACITORS

#### 35 MFD 330 VOLT

1" x 5/8" DIA. 45¢ EACH... 10 FOR \$4.00



#### 170 MFD 330 VOLT

1 1/8" x 7/8" 2 FOR \$1.50 10 FOR \$7.00



#### 750 MFD 330 VOLT

2" HIGH x 1 1/4" DIA. \$1.25 EACH 10 FOR \$11.00





TOLL FREE ORDERS ONLY 1-800-826-5432 (ORDER ONLY)

ALASKA, HAWAII, CALIF OR INFORMATION (213) 380-8000

# ALL ELECTRONICS CORP.

905 S. Vermont Ave. P.O. BOX 20406 Los Angeles, Calif. 90006

QUANTITIES LIMITED MINIMUM ORDER \$10.00 USA: \$2.50 SHIPPING FOREIGN ORDERS: INCLUDE SUFFICIENT SHIPPING CALIF. RES. ADD 6 1/2% NO C.O.D!



### Wall Transformers AC and DC Types

Part No.	Input	Output	Price
AC 250 (Picture)	117V/60Hz	12VAC 250mA	\$3.95
AC 500	117V/60Hz	12VAC 500mA	\$4.95
AC 1000	117V/60Hz	12VAC 1 amp	\$5.95
AC3004	117V/60Hz	9.2VAC 2.5 amp	\$3.95
DC 80	120V/60Hz	8VDC 400mA	\$1.95
DC912	120V/60Hz	6.8, 12VDC 300mA	\$8.95
DC5480	120V/60Hz	9.5VDC 275mA	\$2.95
DC900	120V/60Hz	9VDC 500mA	\$3.95
DC1200	120V/60Hz	9.5VDC 300mA	\$2.95
DV9200	117V/60Hz	9VDC 200mA	\$3.25

### PCB-3 Makes Circuit Assembly A Breeze!

Let's you work with both hands. Sturdy aluminum construction.

Clamp "3rd Hand" on edge of bench table or workbench. Insert circuit board, position components. No need for soldering and clipping. Reverse flip circuit board to flat position for soldering and clipping. Reverse procedure for double-sided boards.

PCB-3 ..... \$13.95  
Extension to hold PCB 3" 2" from bench and 6" from front edge. PCB-X ..... \$6.95

### Mostek DC/DC Converter +5 VOLTS TO -9 VOLTS

Input: +5V. Output: -9V (regulated) @ 30mA. Printed circuit mounting. Specifications incl.

DC10 ..... \$2.95 ea. or \$14.95

### Jameco Digital Thermometer Kit

Dual sensors - switch controls for indoor/outdoor or dual monitoring - can be extended to 500 feet. Continuous LED .8" ht. display. Range: 40°F to 199°F. Accuracy: ±1°C to 100°C. Accuracy: ±1°F nominal. Calibrates for Fahrenheit/Celsius. Simulated walnut case. AC wall adapter included. Size: 6 1/2" x 3 1/2" x 1 1/2".

JE300 ..... \$39.95

### RADIO CONTROL CIRCUITS

Ideal to use for:

- Toys, hobby crafts, robots, trains
- Burglar alarms - IR data link
- Remote slide projector control
- Consumer remote data links
- Energy-saving, remotely switched lighting systems

A complete 2-channel digital encoder and RF transmitter; low power, at frequency of 27MHz or 49MHz; a field strength of 10,000V/meter at 3 meters. 9V operation on chip RF oscillator/transmitter, on chip 4.5 regulator. Up to 80MHz carrier frequency operation.

LM1871N RC Encoder/Transmitter Chip ..... \$1.95

A complete RF receiver/decoder, with either 27MHz, 49MHz or 72MHz. It provides 4 independent channels when used with LM1871N. 2 analog, 2 dig. operates from four 1.5V cells. Crystal controlled.

LM1872N RC Receiver/Decoder Chip ..... \$2.49

SRX1504 49.435MHz Crystal (LM1872N) ..... \$3.95

SRX1505 49.890MHz Crystal (LM1871N) ..... \$3.95

### ATARI

#### ATARI PADDLES

JSP (2) ..... \$4.95 pair

#### ATARI DRIVER

JSD (1) ..... \$2.95 ea.

#### TV GAME SWITCH

Used on Atari. Cosmetically blemished. 100% functional.

TGS-1 ..... \$2.95 ea.

### BOOKS

NATIONAL SEMICONDUCTOR - INTERSIL - INTEL

30003 National Linear Data Book (1982) (1376 pages) LM, LF, ADC, DAC, LH Series	\$11.95
30008 National Memory Data Book (1980) (484 pages) RAMs, ROMs, PROMs, EPROMs Series	\$8.05
30009 Intersil Data Book (1983) (1356 pages) Complete line	\$9.95
30010 National Audio/Radio Handbook (1980) (240 pages) Pre-Amps, AM, FM & FM Stereo, Power Amps	\$5.95
30011 National Linear Application Handbook (1980) (736 pages) Application Notes, Linear Briefs, etc.	\$16.95
30012 National PAL Data Book (1982) (178 pages) Application Notes, Linear Briefs, etc.	\$8.95
30013 Zilog Data Book (1983) (641 pages) Microprocessors and Support Chips	\$7.95
210830 Intel Memory Components Handbook (1983) (798 pages) Contains all Application Notes, Article Reprints, Data Sheets, and other design information on Intel's RAMs, EPROMs, EPROMs & Bubble Memories.	\$14.95
210844 Intel Microprocessors & Peripheral Handbook (1983) (1027 pages) Contains Data Sheets on all of Intel's Microprocessors and Peripherals.	\$14.95

### Universal Computer Keyboard Enclosures

"DTE" Blank Desk-Top Enclosures are designed for easy modification. High strength epoxy molded and pieces in moka brown finish. Sliding rear/bottom panel for service/component access. Top/bottom panels are 1/8" thick alum. anodized type 1200 finish (gold tint color) for best paint adhesion after modification. Vented top & bottom panels for cooling efficiency. Rapid construction provides unlimited applications. Assembly instructions included.

DTE-8 Panel Width 7.5" ..... \$24.95  
DTE-11 Panel Width 10.13" ..... \$27.95  
DTE-14 Panel Width 13.5" ..... \$29.95  
DTE-20 Panel Width 19.25" ..... \$34.95

### TIMEX Sinclair 1000

Powerful - fully programmable 2K memory • Portable - 6 1/2" x 6 1/2" x 1 1/2" - 12 oz. • Expandable - Optional 16K RAM module • Single-key entry commands • Educational • Unique syntax-check report codes for error identity • Accurate to 9/10 decimal places for full range math and scientific functions • Graph drawing and animated display • Advanced 4-chip design combining power, portability and affordable price.

TS1000 ..... \$69.95

### ACCESSORIES FOR TIMEX Sinclair 1000 and ZX81

TIMEX Sinclair 1016 Expansion from 2K to 16K, size: 3" x 3 1/2" x 1.5" (5oz) ..... TS1016 \$49.95  
TIMEX Sinclair 2040 32 column thermal printer (4 lbs) ..... TS2040 \$99.95

### Keyboard Mask for Your ZX81/1000\* Computer

Jameco JE681 KEYBOARD MASK \$9.95 each

JE681 KEYBOARD MASK \$9.95 each

JE682-AK Keyboard Conversion Kit (WITH DTE AK CASE - AS PICTURED) ..... \$99.95 ea.  
JE682 Keyboard Conversion Kit (WITHOUT DTE AK CASE) ..... \$59.95 ea.

### CONTROL DATA KEYBOARDS

- ★ Parallel ASCII
- ★ SPST Switching
- ★ FTZ Shielded Base
- ★ N-Key Rollover
- ★ 128 Character ASCII
- ★ Non-Slip, Non-Glare Keypads
- ★ CDC752 Terminal Keyboards
- ★ Attractive Case

CA150C ..... \$69.95  
84-Key Keyboard  
CA153A ..... \$69.95  
95-Key Keyboard  
CA154A ..... \$79.95

These Control Data Keyboards consist of a base, cover, the keyboard assembly, and an interface cable. Color (case): Harvest gold and black. Color (keypads): Black, blue, and red. Electrical requirements: +5V @ 600mA, -12V @ 50mA. Weight: 6 lbs. All units brand new in original boxes, specifications included.

### Keytronic 90-Key Soft-Programmable Keyboard WITH SECURITY KEYLOCK SWITCH

Part No. KB270 ..... \$109.95 each

MICRO SWITCH 85-KEY KEYBOARD Word Processing Keyboard, 38 Pin Edge Card Connection. Supply Voltage +5VDC. Main Keyboard is CONVERTIBLE. Additional Key Pack for cursor and word processing functions. Part No. 85SD18-1 ..... \$29.95 each

HI-TEK 14-KEY NUMERIC KEYPAD SPST switching, Charcoal gray keycaps. Mounted on printed circuit board. Part No. K-14 ..... \$9.95 each

ALPS 28-KEY CALCULATOR KEYBOARD Features one 8-position decimal select switch, one 3-position switch, and two 2-position switches, mechanical SPST switching, 22-pin edge card connection, In-line. Part No. K829704D (Fits DTE-11 Enclosure) ..... \$4.95 each

POWER SUPPLY +5VDC @ 1 AMP REGULATED Transaction Tech Output: +5VDC @ 1A (also +30VDC) req. Input 118VAC 60Hz, 2-ton (black/white) self-enclosed case, 8 in. x 3.5 in. x 2.5 in. (black power cord, 8 1/2" W x 7" D x 2 1/2" H. Wt. 3 lbs. Data sheet incl.) Part No. PS5119AS ..... \$14.95 each

POWER SUPPLY +5VDC @ 3 AMP REGULATED Detron Input: 118VAC, 47-440Hz. Output: 5VDC Adjustable @ 3 amp, 6VDC @ 2.5 amp. Adjustable current limit. Ripple & Noise: 1mV rms, 8mV p-p @ 2 mounting surfaces. UL recognized. Size: 4 1/2" W x 2 1/2" H x 1 1/2" D. Data sheet included. Part No. DRS ..... \$29.95 each

POWER SUPPLY +5VDC @ 7.5 AMP, 12VDC @ 1.5 AMP SWITCHING Input: 118VAC, 80-80Hz @ 3 amp/230VAC, 60Hz @ 1.8 amp. Fan vent./amp supply rated switches (115/230VAC). Output: 5VDC @ 7.5 amp, 12VDC @ 1.5 amp, 8 pin. blk. pow. cord. 11 1/2" W x 13 1/2" H x 2 1/2" D. Wt. 6 lbs. Part No. PS94VDS ..... \$39.95 each

POWER SUPPLY 4-Channel Switching - Apple Compatible Microprocessor, micro-computer, terminal, medical equipment and process control applications. Input: 90-130VAC 47-440Hz. Output: +5VDC @ 5A, +5VDC @ 1A; +12VDC @ 1A, -12VDC @ 1A. Line reg. ±0.2%, Ripple: 30mV p-p. Load reg. ±1%. Overcurrent protection. Adj. 5V main output: 10%, 5.9/11.5/17.5V W x 4-1/8" H x 1 1/2" D. Wt. 1 1/2 lbs. Part No. FCS-604A ..... \$69.95 each

Made for Visual Technology, this keyboard features: a security keylock (includes two keys) to guard against unauthorized use, an 11-key numeric keypad, cursor controls, and 10 user-programmable keys. Electrical requirements: +5VDC. Color (case): White. Color (keypads): Black. Complete with case, keyboard assembly, 40-inch interface cable, and schematics. Weight: 7 lbs.

Part No. KB270 ..... \$109.95 each

\$10.00 Minimum Order - U.S. Funds Only  
California Residents Add 6 1/2% Sales Tax  
Shipping - Add 5% plus \$1.50 Insurance  
Send S.A.S.E. for Monthly Sales Flyer!

Spec Sheets - 30c each  
Send \$1.00 Postage for your FREE 1983 JAMECO CATALOG  
Prices Subject to Change

MasterCard JAMECO ELECTRONICS VISA

1355 SHOREWAY ROAD, BELMONT, CA 94002  
713 PHONE ORDERS WELCOME - (415) 592-8097 Telex: 176043

### 2708, 2716, 2732 & 2764 EPROM Programmer

#### JE664 EPROM PROGRAMMER

8K TO 64K EPROMS - 24 AND 28 PIN PACKAGES - PROGRAMS 2716'S IN 16 SECONDS

- Programs, validates, and checks for properly erased EPROMs
- Emulates PROMs or EPROMs
- RS232C Computer Interface for setting program loading
- Loads data into RAM by keyboard
- Changes data in RAM by keyboard
- Loads RAM from an EPROM
- Compares EPROMs for content differences
- Copies EPROMs
- Power for light card cable, w/insulated moka brown end pieces
- Size: 15.5" H x 3 1/2" W x 3 1/2" D

JE664-A EPROM Programmer ..... \$995.00  
Assembled & Tested (Includes JM16A Module)

JE665 - RS232C INTERFACE OPTION - The JE665 RS232C Interface Option implements computer access to the JE664 RAM. Sample software written in BASIC provided for TRS-80\* Model I, Level II Computer. Baud rate: 3000. Word Lght. 8 bits, odd parity. Stop bits: 2. Option may be adapted to other computers.

JE664-ARS EPROM Prog. w/JE665 Option ..... \$1195.00  
Assembled & Tested (Includes JM16A Module)

### EPROM JUMPER MODULES

The JE664's JUMPER MODULE (Personally Modified) is a plug-in Module that pre-sets JE664 for proper programming guides to the EPROM & configures EPROM socket connections for that particular EPROM.

Part No.	EPROM	EPROM MANUFACTURER	PRICE
JM05A	2708	AMD, Motorola, National, Intel, TI	\$14.95
JM16A	2716, TMS2516	Intel, Motorola, National, NEC, TI	\$14.95
JM18B	TMS2716	Motorola, TI (4-5, 12-12)	\$14.95
JM32A	TMS2532	Motorola TI	\$14.95
JM32B	2732	AMD, Fujitsu, NEC, Hitachi, Intel	\$14.95
JM32C	2732A(21V)	Fujitsu, Intel	\$14.95
JM64A	MCM68764	Motorola	\$14.95
JM64B	2764	Intel	\$14.95
JM64C	TMS2564	TI	\$14.95
JM64D	NN482764-4	Hitachi (21V)	\$14.95

### EXPAND YOUR MEMORY

TRS-80 to 16K, 32K, or 48K

\*\*Model 1 - From 4K to 16K Requires (1) One Kit  
Model 3 - From 4K to 48K Requires (3) Three Kits  
Color - From 4K to 16K Requires (1) One Kit

\*\*Model I equipped with Expansion Base up to 48K Two Kits Required - One Kit Required for each 16K of Expansion -

TRS-16K3 \*200ns for Color & Model III ..... \$12.95  
TRS-16K4 \*250ns for Model I ..... \$10.95

TRS-80 Color 32K or 64K Conversion Kit

Kit comes complete with 8 each 4164-2 (200ns) 64K dynamic RAMs and conversion documentation. Converts TRS-80 color computers with D and E circuit boards, and all new color computers to 32K. Minor modifications of 32K memory will allow the use of all 64K of the dynamic RAM providing you have a FLEX-DOS operating system.

TRS-64K2 ..... \$54.95

### IBM MEMORY EXPANSION KIT

SAVE HUNDREDS OF \$\$\$ BY UPGRADING MEMORY BOARDS YOURSELF!

Most of the popular memory boards allow you to add an additional 64K, 128K, 192K, or 256K. The IBM64K Kit will populate these boards in 64K bit increments. The kit is simple to install - just insert the nine 64K RAM chips in the provided sockets and set the two groups of switches. Directions are included.

IBM64K (Nine 200ns 64K RAMs) ..... \$59.95

### 5 1/4" Mini-Floppy Disk Drive

FOR TRS-80 MODEL I (Industry Standard)  
Features single or double density. Recording Mode: FM single, MFM double density. Power: +12VDC (±0.5V) 1.8A max., +5VDC (±0.25V) 0.8A max. Unit as pic. at right (does not incl. case, power supply, cables). 30 pp. data book incl. Wt. 3 1/2 lbs. Size: 5 1/4" W x 8 1/4" D x 3 1/4" H

Part No. Limited Quantity! Price

FD200 ..... \$179.95  
Single-sided, 40 tracks, 260K byte capacity

FD250 ..... \$199.95  
Double-sided, 35 tracks, 438K byte capacity

### 8" FLOPPY DISK DRIVE

Shugart 801R compatible  
Single-Sided  
77 Tracks  
400/800K Bytes Capacity  
Industry Standard

The FDD100-8 8" Floppy Disk Drive (Industry Standard) features single or double density. Recording mode: FM single, MFM double density. Transfer rate: 250K bits/sec, single density; 500K bits/sec, double density. The FDD100-8 is designed to work with the single-sided soft sectored IBM Diskette I, or, disc, disk cartridge. Power: 118VAC @ 50-60Hz, ±24VDC @ 1.7 amps max., +8VDC @ 1.2 amps max. Unit as pictured above (Does not include case, power supply, or cables). Size: 8.55" W x 14" L x 4.5" H. Weighs 12 lbs. Incl. 98 pp. manual.

Part No. Price

FDD100-8 ..... \$169.95 ea.

### UV-EPROM Eraser

8 Chips - 51 Minutes  
1 Chip - 37 Minutes

Erase 2708, 2716, 2732, 2764, 2516, 2532, 2564. Erase up to 8 chips within 51 minutes (1 chip in 37 minutes). Maintain constant exposure distance of one inch. Special conductive foam liner eliminates static build-up. Built-in safety lock to prevent UV exposure. Compact - only 9.00" x 3.70" x 2.60". Complete with holding tray for 8 chips.

DE-4 UV-EPROM Eraser ..... \$79.95  
UVS-11EL Replacement Bulb ..... \$16.95



# FORMULA INTERNATIONAL INC.

12603 Crenshaw Blvd., Dept. B, Hawthorne, CA 90250

For information (213) 973-1921 • Orders Only (outside Calif.) (800) 672-8758



## pinecom™

### The Alternative! The Compatible! The Affordable! 64K Color Computer Kit!

Copyright Problem Free!



## \$645<sup>00</sup> EACH

(please add 5% shipping and handling)  
DEALERS INQUIRIES INVITED!

#### FEATURES:

- ★ Fully compatible with Apple® II+
- ★ Singleboard for easy assembly
- ★ Popular 6502 MPU for large amount of software
- ★ Game paddle connector on both sides of case
- ★ Upper/lower case
- ★ Built in 2-watt amplifier for realistic sound effect with volume control
- ★ 8 on board peripheral connectors for expansion
- ★ 14 key numeric key pad
- ★ 5-amp switching power supply
- ★ Auto repeat

Easy to assemble! All components are clearly silk-screened on the high quality double-sided mother board. All integrated circuits, IC sockets, peripheral connectors, keyboard, switching power supply and the professional high impact plastic case are included.

\*Pinecom is a trade mark of Pineapple Computer Products (HK) Ltd.

### 5 1/4" DISC DRIVE FROM

100% Made In USA 100% Apple and Pincom Compatible  
50% Faster Seeking Time Than Apple Disk II Drive!

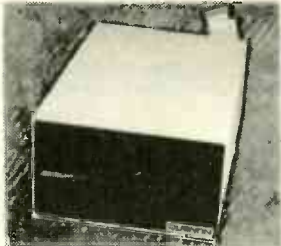

- 1 Year Full Warranty
- 40 Tracks
- One of the Most Quiet Drives
- Color and Shape same as the Disk II Drive

Disk Drive **\$285.00**  
Controller Card **\$ 75.00**

Controller Card with 13 Sector, 16 Sector Auto Select **\$ 85.00**

### The APPLE II LOOKALIKE COMPUTER CASE

Made with high impact plastic.  
Color and shape are compatible with the APPLE II

**Special \$99.95**

Keyboard not included with this price!



Model: APII

### 6502 CPU MOTHER BOARD

- 48K on board RAM (4116)
- 12K on board ROM (2716)
- Upper/lower case
- Composite-video output
- Apple II alternative
- Size: 14 1/4" x 8 1/2"

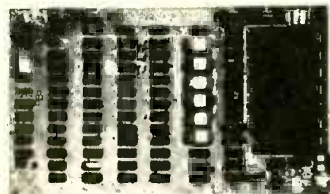

P.C. Board Only **\$99.00 ea.**

Complete Component Pack (No ROMs) **\$175.00**

**GUARANTEED TO WORK! BUILD IT IN 2 HOURS!**

### Big Savings On Peripheral Cards

Buy them in kit form.  
All cards APPLE II and PINEAPPLE compatible.

80 column card kit .....	<b>\$120.00</b>	EPROM writer card assembled (For 2708,2716,2732,2764,2532) .....	<b>\$89.50</b>
Z80 CP/M card kit .....	<b>\$110.00</b>	Printer interface card kit (For Epson or Oki)	<b>\$69.50</b>
16K RAM card kit .....	<b>\$49.50</b>	New disk controller card kit (3.2, 3.3 auto select) .....	<b>\$69.50</b>
RS232 Interface card kit .....	<b>\$95.00</b>		
16K RAM card (cable-less) kit	<b>\$59.50</b>		

### HEAVY DUTY SWITCHING POWER SUPPLY for Apple II, AP-II™ and Pinecom Computers

- +5V at 5.0 Amp
- +12V at 2.5 Amp
- 5V at 0.5 Amp
- 12V at 0.5 Amp



Model: THB-43H

Size and mounting holes are same as the ones used in the Apple II

**\$145.00 ea.**

### APPLE II+ COMPATIBLE KEYBOARD

- LSI keyboard decoder
- Full ASCII code output
- Upper/lower case function
- N-key rollover function
- LED ON/OFF indicator

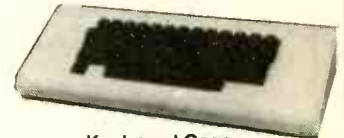

LKB-3600-N

Keyboard Case

Keyboard Only **\$99.00 EA.** Plastic Case **\$35.00 EA.**

**NEW**

### MICRO-II CASE

Made with ABS Plastic  
Same size as the Apple II, with Numeric Key-Pad and Upper/Lower Case.



**\$250.00 ea.**

Keyboard Included

SEND ONE DOLLAR FOR OUR DETAIL CATALOG

Shipping & Handling Charges	Under \$50.00	Under \$50.00
	Purchase 10%	Purchase 5%
	15%	10%
	25%	20%

Minimum Order \$10.00/Calif. Residents add 6.5% Sales Tax. Phone Orders Accepted on VISA or MC ONLY. NO C.O.D.'s. Prices subject to change without notice.



**STORE HOURS**  
MON-FRI—10-7  
SAT—10-6

Inside California  
Outside Calif. (incl. Mexico & Canada)  
Overseas

\*Apple and Apple II are the trademark of APPLE COMPUTERS, INC.

CIRCLE 76 ON FREE INFORMATION CARD

**QUALITY  
SERVICE  
AVAILABILITY**



**ACTIVE, YOUR  
NUMBER ONE  
CHOICE**

# Active Electronics

**WE ARE THE LARGEST BECAUSE WE ARE THE BEST.**  
Over \$40 million in stock. The world's most complete hobbyist inventory.

Active Electronics is your one stop source for the widest variety of top quality semiconductors, microprocessors, memories, microcomputer systems, peripherals and electronic components.

## NEW — 1983 IC MASTER

The FIRST and ONLY complete guide to IC's, Microcomputer Boards and Development Systems.  
Deluxe 2-volume set  
3300 pages  
Regular Price: \$95.00



Call or write for our FREE comprehensive catalogue. If you work with electronics you shouldn't be without it!

**ACTIVE'S PRICE  
ONLY \$79.95**

Circle No. 3 on free information card or write:  
P.O. Box 8000, Westboro, Mass. 01581  
**CALL TOLL FREE: 1-800-343-0874**  
MASS. customers call (617) 366-0500

CIRCLE 3 ON FREE INFORMATION CARD

<b>POPULAR CHIPS</b> LM 301 .39 LM 380 1.25 LM 386 .79 NE 564 2.50 LM 565 .89 MC 1330 1.10 MC 1350 1.00 MC 1358 1.10 MC 1458 .49 MC 1496 1.50 LM 1889 1.95 7808 .75 7812 .75 7815 .75 7818 .75 MV 2109 .69 2N2222A .30 MC1349 1.39		<b>MITSUMI UES A55F VARACTOR TUNER</b> CHAN. 14-83 300 ohm INPUT \$17.95	
<b>DELUXE PARTS ASSORTMENTS</b> <b>#1 Resistors &amp; Trimpots</b> 68 1/4 watt, 5% resistors & 5 PT-15 10K trimpots. 1 each - 51, 75, 100, 470, 1.5K, 3.6K, 51K, 470K, 13-1.2K, 2-220, 3-100K, 6-330, 6-12K, 7-910, 9-3.3K, & 14-4.7K. <b>\$5.25 each</b> <b>#2 Capacitor "A"</b> Monolythics - 1-560pf, 7-.1 mfd, & 1-.22 mfd. Silver Micas - 2-10pf, & 1 each of 43pf, 110pf, 560pf, 1200pf, 3000 or 3300pf. <b>\$5.05 each</b> <b>#3 Capacitor "B"</b> Mylars 4-.001, 2-.047, 29-.01. Radial lytics 3-10 mfd 16V, 1-1000 mfd 50V, 1-2200 mfd 35V. Disc Caps 1 each of 5, 12, 27, 36, 110, 330pf, 2-120pf, 3-39pf, 3-220pf, and 1 Vari Cap 5-35pf. <b>\$7.50 each</b>		<b>#4 Coil &amp; Chokes</b> 1 each of 15, 33, and 100 (uh) micro henries chokes. 1-variable RF coil (same as #49A537MPC) <b>\$3.25 each</b> <b>#5 IC's, Sockets, &amp; Semi's</b> 1 each of: NE564, LM565, MC1330, MC1350, MC1496, LM1889, 7812, 7818, 2N2222A, MV2109, heat sink 2-MC1458, 4-1N4002, 4-8 pin, 2-14 pin, 1-16, & 1-18 pin socket. <b>\$13.25 each</b> <b>#6 Misc. Hardware</b> LED & holder, fuse & holder, line cord, grommet, SPST switch, DPDT switch, 2-F61 conn. & lugs, knob, 4-spacers, 6-screws & nuts, 2-RG-174, matching transformer w/nut. <b>\$5.95 each</b>	
<b>CHOKES</b> 33 uh 33 uh .47 uh 100 uh 15 uh 10 mh 18 uh 69c each		<b>UHF AMP KIT</b> 25 db gain stripline PC board using (2) BFR-90's <b>\$9.95</b> power supply for above \$3.49	
<b>VARI CAPS</b> 10 - 60 pf 69c each 30 - 90 pf 69c each		<b>METAL BOX— PRE-DRILLED</b> DIM: 10"W x 4"D x 3" High HOLES: (4) 1/8" in back, (1) 1/8" in front (2) 1/4" in front, 6 #6 on bottom <b>PAINTED \$10.95 ea. /10/ \$99.50 25/\$223.75</b>	

**NETWORK SALES, INC.**  
2343 W. BELMONT AVE.  
CHICAGO, IL. 60618  
312-248-3202

TERMS: Visa, M.C., Check, Money Order or COD (add 3.00). Min. Order \$10.00. Add \$2.50 S&H for USA Ill. add 7% Tax. MAIL ORDER ONLY. Phone Orders Welcome. WRITE FOR OUR MONTHLY UN-ADVERTISED SPECIALS

CIRCLE 90 ON FREE INFORMATION CARD

# CIRCUIT SPECIALISTS YOUR SEMICONDUCTOR SUPERMARKET

<b>74LS00 SALE</b> 74LS00 .20 74LS123 .50 74LS249 1.25 74LS01 .24 74LS125A .50 74LS251 .60 74LS02 .24 74LS126A .50 74LS253 .60 74LS03 .24 74LS132 .80 74LS256 1.50 74LS05 .24 74LS133 .80 74LS257A .60 74LS08 .24 74LS136 .40 74LS258A .60 74LS09 .24 74LS137 1.00 74LS259 1.25 74LS10 .24 74LS138 .80 74LS260 .55 74LS11 .24 74LS139 .80 74LS266 .55 74LS12 .24 74LS145 1.30 74LS273 1.25 74LS13 .45 74LS147 1.65 74LS279 .55 74LS14 .60 74LS151 .55 74LS283 .90 74LS15 .32 74LS153 .55 74LS290 .80 74LS20 .29 74LS155 .85 74LS293 .90 74LS21 .32 74LS156 .80 74LS295A .95 74LS22 .32 74LS157 .80 74LS298 .90 74LS26 .32 74LS158 .80 74LS299 2.60 74LS27 .32 74LS160A .85 74LS322A 4.60 74LS28 .32 74LS161 .85 74LS323 4.60 74LS30 .32 74LS162 .80 74LS348 1.75 74LS32 .32 74LS163A .85 74LS352 1.25 74LS33 .32 74LS164 .80 74LS353 1.25 74LS37 .40 74LS165 1.25 74LS365A .55 74LS40 .35 74LS166 1.25 74LS366A .55 74LS42 .60 74LS168 1.25 74LS367A .55 74LS47 .89 74LS169 1.25 74LS368A .55 74LS48 1.00 74LS170 1.75 74LS373 1.35 74LS49 1.00 74LS173 .80 74LS374 1.25 74LS51 .29 74LS174 .55 74LS375 .55 74LS54 .29 74LS175 .60 74LS377 1.25 74LS55 .29 74LS181 2.25 74LS378 1.25 74LS73A .42 74LS182 1.25 74LS379 1.25 74LS74A .42 74LS183 2.75 74LS385 3.50 74LS75 .45 74LS190 .85 74LS386 .55 74LS76A .45 74LS191 .85 74LS390 1.25 74LS77 .70 74LS192 .85 74LS393 1.25 74LS78A .49 74LS193 .85 74LS395 1.25 74LS83A .75 74LS194A .80 74LS398 1.25 74LS85 .90 74LS195A .80 74LS399 1.25 74LS86 .45 74LS196 1.00 74LS490 2.10 74LS90 .45 74LS197 1.00 74LS540 2.10 74LS91 1.10 74LS221 1.25 74LS541 2.10 74LS92 .55 74LS240 1.25 74LS568 3.99 74LS93 .55 74LS241 1.25 74LS569 3.99 74LS95B .65 74LS242 1.25 74LS620 2.00 74LS107A .45 74LS243 1.25 74LS621 2.00 74LS109A .45 74LS244 1.25 74LS622 2.00 74LS112A .45 74LS245 1.75 74LS623 2.00 74LS113A .45 74LS247 1.25 74LS640 2.00 74LS114A .60 74LS248 1.25 74LS122 .80			<b>7400</b> 7400 .20 7475 .50 7401 .29 7476 .38 7402 .29 7485 1.10 7403 .29 7486 .35 7404 .31 7489 2.40 7405 .32 7490 .52 7406 .36 7492 .52 7408 .31 7493 .52 7410 .30 7495 .67 7411 .31 7496 .73 7413 .46 74107 .35 7414 .56 74121 .40 7417 .32 74123 .58 7420 .29 74125 .52 7425 .31 74145 .75 7427 .32 74147 1.67 7430 .30 74151 .75 7432 .31 74153 .75 7437 .31 74154 1.17 7438 .31 74157 .75 7440 .29 74164 1.05 7441 1.00 74165 1.05 7442 .60 74174 1.00 7446 .83 74175 .83 7447 .83 74176 .80 7448 .83 74177 .80 7450 .29 74190 1.08 7472 .35 74192 .99 7473 .35 74193 .99 7474 .35 74196 .80			<b>LINEAR IC'S</b> LM301AN .48 LM3900 .75 MC1489P 1.10 LM307N .56 LM3909 1.00 MC1496P 1.48 LM308N .71 LM3911 1.50 MC1723P .62 LM310N 2.40 LF347 2.35 MC1741CP1 .56 LM311N .69 LF351 .60 MC3301 .90 LM318N 2.50 LF353 .99 MC3302 .80 LM319N 2.40 LF357 1.10 MC3401 .90 LM324N .71 NE555 .42 MC3403P 1.30 LM325N 3.30 MC1306P 1.10 MC1648P 3.80 LM326N 3.30 MC1310 4.29 MC1658P 4.50 LM556N .93 MC1330A1P 1.17 MC4024P 4.49 LM339N .69 MC1349P 1.17 MC4044P 4.49 LM383T 2.30 MC1350P .98 ICM7208 15.95 LM377N 2.40 MC1351P 1.70 ICM7207A 6.00 LM378N 3.15 MC1357P 1.49 ICM7205 12.95 LM379N 4.60 MC1358P 1.30 ICM7045 15.50 LM380N .90 MC1372P 4.42 ICL8036 3.40 LM381N 2.25 MC1373P 3.54 ICM7555 1.20 LM381AN 3.60 MC1403U 2.71 ICM7555 7.45 LM384N 2.00 MC1405L 9.70 MWA110 7.80 LM386N .99 MC1413P 1.20 MWA120 7.80 LM565N 1.35 MC1374P 2.61 MWA130 8.25 LM566N 2.30 MC1376P 2.08 MWA310 8.25 LM567N 1.35 MC1458CP1 .77 MWA320 8.65 LM1889 3.20 MC1488P 1.10 ZN414 2.00		
<b>VOLT-REGS</b> 7805 .80 LM317T 1.00 7806 .80 LM317K 3.75 7808 .80 LM323K 6.95 7812 .80 LM350T 3.25 7815 .80 LM350K 5.50 7818 .80 LM338K 7.60 7824 .80 LM337T 1.90 7905 1.30 78L05 .40 7906 1.30 78L12 .40 7908 1.30 78L15 .40 7912 1.30 79L05 .80 7915 1.30 79L12 .80 7918 1.30 79L15 .80 7924 1.30 78H05KC 9.25 78H12KC 9.25			<b>CMOS</b> CD4001 .30 CD4046 1.50 MC14000 .40 MC14023 1.22 CD4007 .32 CD4047 1.40 MC14001 .40 MC14024 1.06 CD4010 .55 CD4049 .45 MC14002 .40 MC14024 .40 CD4011 .32 CD4050 .45 MC14006 1.42 MC14027 72 CD4013 .45 CD4051 1.00 MC14007 .40 MC14028 1.02 CD4016 .50 CD4066 .65 MC14008 1.25 MC14032 1.93 CD4017 1.00 CD4069 .32 MC14012 .40 MC14034 3.50 CD4020 1.17 CD4070 .45 MC14013 .72 MC14035 1.86 CD4023 .32 CD4071 .32 MC14014 1.25 MC14038 2.19 CD4024 .83 CD4081 .32 MC14015 1.47 MC14040 1.47 CD4025 .32 CD4093 .60 MC14016 .72 MC14042 1.06 CD4027 .55 CD4510 1.17 MC14017 1.25 MC14043 .99 CD4029 1.42 CD4511 1.20 MC14018 1.15 MC14044 .99 CD4040 1.17 CD4515 2.80 MC14020 1.47 MC14046 1.57 CD4044 .80 CD4518 1.17 MC14021 1.25 MC14049 .72					

MOST MOTOROLA CMOS IN STOCK

**CIRCUIT SPECIALISTS INC.**  
BOX 3047, SCOTTSDALE, AZ 85257  
(602) 966-0764  
INCLUDE \$1.25 SHIPPING

CIRCLE 44 ON FREE INFORMATION CARD

# “The Deluxe II”

Is The Ultimate In UHF Sine Wave Converter Technology

**PC BOARD & PLANS \$20.00**

With purchase of COMPLETE SET OF PARTS & ENCLOSURE

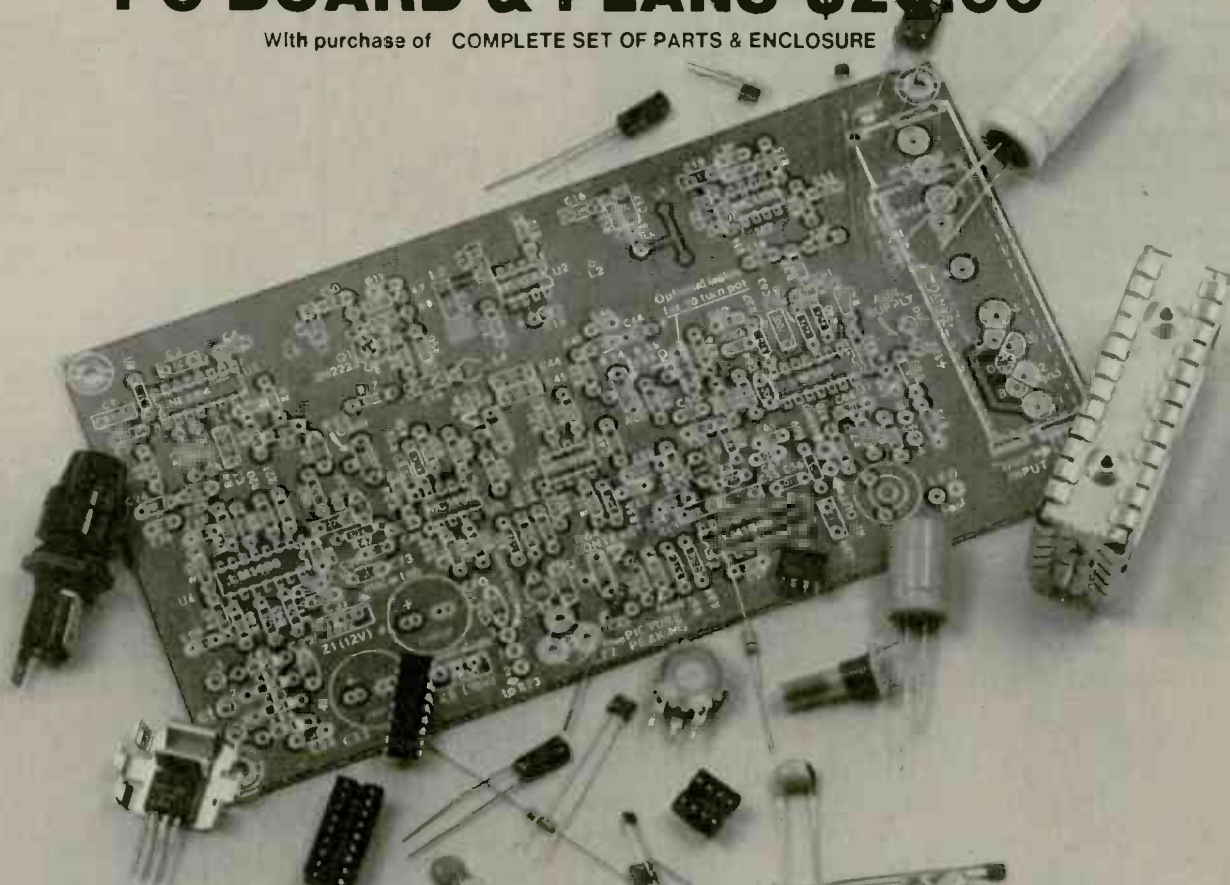

The latest state of the art electronics combined with the excellence in printed circuit manufacturing creates this high performance UHF Sine Wave Converter kit that outperforms the imitations by a long shot. Engineered for reliable stability and outstanding reception clarity, uninterrupted modulated audio and fully illustrated instructions with the amateur in mind.

TOLL FREE

BETA ELECTRONICS, 1700 E. DESERT INN ROAD, SUITE 222, LAS VEGAS, NEVADA, 89109 **1-800-782-2701**

QTY	DESCRIPTION OF ITEM	COST EACH	SHIPPING EACH	TOTAL
	PC BOARD, PLANS, PARTS & ENCLOSURE	\$152.99	\$4.95	
	PARTS & ENCLOSURE ONLY	\$132.99	\$4.95	
	PC BOARD & PLANS ONLY	\$30.00	\$1.50	
GRAND TOTAL				\$

PLEASE PRINT CLEARLY

SEND THIS ORDER FORM

NAME \_\_\_\_\_

ADDRESS \_\_\_\_\_

CITY/STATE/ZIP \_\_\_\_\_

VISA  MST. CARD CARD NO. \_\_\_\_\_

GRAND TOTAL

QUANTITY DISCOUNTS AVAILABLE

ORDER DATE \_\_\_\_\_

MO. DAY YR.

EXP. DATE \_\_\_\_\_

FOR IMMEDIATE DELIVERY MONEY ORDERS OR CERTIFIED CHECKS PREFERRED PERSONAL CHECKS ALLOW 4 WEEKS FOR DELIVERY

CIRCLE 67 ON FREE INFORMATION CARD

# DoKau Computer Products, Inc.

VISIT OUR RETAIL STORE

3250 KELLER STREET, #9 • SANTA CLARA, CA 95050

8000		
8035	4.95	8251 4.39
8039	5.95	8253 6.89
8080A	3.89	8253-5 7.89
8085A	5.89	8255 4.39
8086	24.95	8255-5 5.19
8088	34.95	8257 7.89
8155	7.75	8259 6.85
8156	8.75	8272 39.00
8185	29.00	8275 29.00
8202	27.95	8279 8.89
8205	3.45	8279-5 9.89
8212	1.79	8282 6.49
8214	3.75	8283 6.49
8216	1.69	8284 5.49
8224	2.19	8286 6.49
8226	1.79	8287 6.49
8228	3.34	8288 24.95
8237	19.00	8289 39.00
8238	4.39	8741 34.95
8243	4.39	8748 14.95
8250	10.49	8755 29.95

### 16K APPLE RAM CARD

Upgrade your 48K Apple II to full 64K

**BARE BOARD 14.00**  
**ASSEMBLED & TESTED 42.50**

### EPROM ERASERS

HOLDS 15 EPROMS  
ERASES IN 20 MINUTES

**59.95**

### CONNECTORS

RS232 Male	3.00
RS232 Female	3.50
RS232 Female RA	4.95
RS232 Hood	1.20

### 6500 1 MHz

6502	5.25
6504	6.85
6505	7.60
6507	9.85
6520	3.95
6522	4.95
6532	5.95
6545	16.95
6551	10.95

### UPGRADE YOUR APPLE or TRS-80

**4116 200ns 8/10.00**

EPROMS		STATIC RAMS			
1702	1ns	2.95	2101	450ns	1.80
2708	450ns	2.98	2102L-2	250nsLP	1.44
2716	450ns	3.25	2111	450ns	2.48
2716-1	350ns	4.69	2114	450ns	1.74
2532	450ns	4.69	2114L-4	450nsLP	1.84
2732	450ns	4.15	2114L-3	300nsLP	1.84
2764	450ns	CALL	2114L-2	200nsLP	1.94
<b>DYNAMIC RAMS</b>			TMS4044-4	450ns	3.15
TMS 4027	250ns	.79	TMS4044-3	300ns	3.45
UPD 411	300ns	2.89	TMS4044-2	200ns	3.89
MM 5280	300ns	2.89	MK4118	250ns	9.69
MK4108	200ns	1.74	TMM2016	200ns	4.15
MM 5298	250ns	1.74	TMM2016	150ns	4.89
4027	250ns	2.00	HM6116-4	200ns	CALL
4116	200ns	CALL	HM6116-3	150ns	CALL
4116	150ns	CALL	HM6116-2	120ns	CALL
4164	200ns	CALL	Z6132	300ns	32.95
4164	150ns	CALL			

LP = LOW POWER

**WE WILL BEAT ANY COMPETITOR'S PRICES!**  
Call before you buy

### CRYSTALS

32.768 KHz	1.90	6.144	2.69
1.00 Hz	4.50	6.5536	2.69
1.8432	4.50	8.0	2.69
2.0	3.90	10.0	2.69
2.097152	3.90	12.0	2.69
2.4576	2.69	14.31818	2.69
3.2768	2.69	15.0	2.69
3.579545	2.69	16.0	2.69
4.0	2.69	17.430	2.69
5.0	2.69	18.0	2.69
5.0688	2.69	18.432	2.69
5.185	2.69	20.0	2.69
5.7143	2.69	22.1184	2.69
6.0	2.69		

### 74LS00 SERIES

74LS00	.23	74LS123	.49	74LS253	.58
74LS01	.23	74LS124	1.24	74LS257	.58
74LS02	.23	74LS125	.44	74LS258	.58
74LS03	.23	74LS126	.44	74LS259	1.19
74LS04	.23	74LS132	.54	74LS260	.58
74LS05	.23	74LS136	.54	74LS266	.58
74LS08	.23	74LS137	.89	74LS273	1.48
74LS10	.23	74LS138	.49	74LS275	3.20
74LS11	.25	74LS139	.49	74LS279	.48
74LS12	.25	74LS145	1.19	74LS280	1.79
74LS13	.39	74LS147	2.39	74LS283	.68
74LS14	.39	74LS148	1.29	74LS290	.74
74LS15	.29	74LS151	.39	74LS293	.78
74LS20	.23	74LS153	.39	74LS295	.98
74LS21	.23	74LS154	1.89	74LS298	.88
74LS22	.23	74LS155	.59	74LS324	1.74
74LS26	.29	74LS156	.69	74LS352	1.28
74LS27	.23	74LS157	.44	74LS353	1.28
74LS28	.29	74LS158	.49	74LS363	1.34
74LS30	.23	74LS160	.68	74LS364	1.89
74LS32	.25	74LS161	.64	74LS365	.48
74LS33	.49	74LS162	.68	74LS366	.48
74LS37	.29	74LS163	.64	74LS367	.44
74LS38	.29	74LS164	.68	74LS368	.44
74LS40	.23	74LS165	.79	74LS373	.98
74LS42	.43	74LS166	1.69	74LS374	.98
74LS47	.49	74LS168	1.69	74LS377	1.24
74LS48	.74	74LS169	1.74	74LS378	1.15
74LS49	.74	74LS170	1.45	74LS379	1.34
74LS51	.23	74LS173	.68	74LS385	1.89
74LS54	.23	74LS174	.44	74LS386	.44
74LS55	.28	74LS175	.39	74LS390	1.15
74LS63	1.19	74LS181	1.89	74LS393	1.15
74LS73	.34	74LS189	8.79	74LS395	1.15
74LS74	.34	74LS190	.79	74LS399	1.48
74LS75	.34	74LS191	.79	74LS424	.37
74LS76	.34	74LS192	.64	74LS447	.37
74LS78	.45	74LS193	.64	74LS490	1.94
74LS83	.59	74LS194	.68	74LS668	1.69
74LS85	.65	74LS195	.68	74LS669	1.89
74LS86	.35	74LS196	.78	74LS670	1.48
74LS90	.35	74LS197	.78	74LS674	9.45
74LS91	.79	74LS221	.74	74LS682	2.99
74LS92	.54	74LS240	.89	74LS683	2.99
74LS93	.54	74LS251	.89	74LS684	2.99
74LS95	.74	74LS242	.98	74LS685	2.99
74LS96	.69	74LS243	.98	74LS688	2.39
74LS107	.35	74LS244	.79	74LS689	2.99
74LS109	.35	74LS245	1.48		
74LS112	.35	74LS247	.74	81LS95	1.48
74LS113	.35	74LS248	.89	81LS96	1.48
74LS114	.35	74LS249	.89	81LS97	1.48
74LS122	.39	74LS251	.58	81LS98	1.48

### DISC CONTROLLERS

1771	15.95
1791	27.95
1793	29.95
1795	49.95
1797	49.95
6843	32.95
8272	39.00
UPD765	34.95
1691	17.95

### INTERFACE

8T28	1.65
8T28	1.95
8T95	.95
8T96	.95
8T97	.95
8T98	.95
DM8131	2.90
DP8304	2.25
DS8835	1.69
DS8836	.99

### IC SOCKETS

	ST	W/W
8 PIN	.10	.49
14 PIN	.12	.50
16 PIN	.15	.57
18 PIN	.20	.85
20 PIN	.25	.99
22 PIN	.25	1.30
24 PIN	.25	1.40
28 PIN	.35	1.50
40 PIN	.40	1.80

ST = Soldertail  
W/W = Wirewrap

## ORDER TOLL FREE

# (800) 538-8800

# (800) 848-8008

(CALIFORNIA RESIDENTS)  
ALL MERCHANDISE IS 100% GUARANTEED

### APPLE SUPER COOLING FANS

**49.95**  
**WITH SURG PROTECH 69.95**

### APPLE PADDLES

**9.95**

### LINEAR

LM301	.32	LM741	.29
LM308	.75	LM747	.75
LM309K	1.25	LM748	.49
LM311	.64	LM1310	2.45
M317T	1.65	MC1330	1.69
LM317K	1.70	MC1350	1.25
LM318	1.49	MC1358	1.69
LM323	3.75	LM1414	1.49
LM324	.59	LM1458	.55
LM337K	3.90	LM1488	.65
LM339	.79	LM1489	.65
LM377	2.25	LM1800	2.45
LM380	1.25	LM1889	2.45
LM386	1.00	LM3900	.59
LM555	.38	LM3909	.95
LM556	.65	LM3914	3.70
LM565	.95	LM3915	3.70
LM566	1.45	LM3916	3.70
LM567	.99	75451	.35
LM723	.49	75452	.35
LM733	.95	75453	.35

### APPLE\* II COMPATIBLE DISK DRIVE CONTROLLER CARD

**225.95**  
**79.95**

**DoKau Computer Products, Inc.**  
3250 Keller Street, #9  
Santa Clara, CA 95050  
(800) 538-8800  
Calif. Residents (800) 848-8008



**STORE HOURS:**  
MON-FRI 8:30 A.M.-5:30 P.M.  
SAT 10:00 A.M.-3:00 P.M.

**TERMS:** For shipping include \$2.00 for UPS Ground, \$3.00 for UPS Blue Label Air. \$10.00 minimum order. Bay Area residents add 6 1/2% Sales Tax. California residents add 6% Sales Tax. We reserve the right to limit quantities and substitute manufacturer. Prices subject to change without notice. Send SASE for complete list.

**CHANEY**  
electronics inc.

- Minimum Order \$9.00
- Please include \$1.50 for shipping (UPS)
- We accept VISA and MASTERCARD
- EXTRA FAST SERVICE

P.O. BOX 27038, DENVER, COLO. 80227  
PHONE ORDERS: 303-781-5750

**120VAC VARIABLE STROBE LIGHT KIT**  
Complete variable rate strobe light kit produces brilliant flashes of light. Operates from standard 120VAC. Reliable design—thousands of these are in use throughout the world. Overall size of completed board: 3"L x 2"W x 3"H.  
C3071 \$9.99

**3VDC ELECTRONIC WARNING FLASHER KIT**  
This portable battery operated device continuously emits bursts of intense light at a fixed repetition rate. Can be seen for great distances making it a great safety device. Features xenon flashtube. Operates on 3VDC (two 1.5V Batteries). Size of board: 2½"L x 2"W.  
C3207 \$7.95

**FASCINATION STAR KIT**  
Produces an "exploding star" visual effect using 25 LEDs and IC circuitry. The center LED lights first then the next group of LEDs light and then another set of lights until the outer edge of the star lights up. The process then reverses itself. Operates from 9V battery.  
C4432 \$10.95

**SEQUENTIAL LED FLASHER KIT**  
This kit combines IC circuitry and 10 jumbo red LEDs to produce a unique visual display. LEDs continuously light sequentially from right to left. Easy to build kit. Operates from 9V battery. Size of board: 5.25" x 1.5".  
C4431 \$6.75

**MICRO-MINIATURE SPEAKER**  
Only ¾" dia. mounted on a 1" square PC board.  
C4832 \$1.49 ea.

**SOLID CARBIDE PC DRILL BIT**  
#65 .035 Standard size for PC boards.  
C4800 \$1.49 ea.  
10 for \$12.00

**KESTER PC TYPE SOLDER**  
6 foot coil of ultra thin diameter low melting temperature 60/40 rosin core.  
C4456 \$1.00

**Kits!!!** We offer over 70 complete electronic kits. Send for our free catalog  
CIRCLE 34 ON FREE INFORMATION CARD

**FINEST QUALITY**  
Government Approved QQ-S-571e  
**SOLDER**

**SPECIAL FOR THE MONTH**  
Good until June 30, 1983

**SN 60/40 Rosin Core (RA)**

One lb. Reels	
16 swg. (.064)	\$8.50
18 swg. (.048)	\$8.95
19 swg. (.040)	\$9.50
21 swg. (.032)	\$10.50
½ lb. Reels	
22 swg. (.028)	\$6.95
24 swg. (.022)	\$8.95

**Plus FREE Desoldering Wick** with each pound of solder  
**FREE Freight On All Orders Over \$25**  
Under \$25 add \$2.50 per order. Minimum order \$10  
■ Check ■ Money Order ■ Master Charge ■ Visa

N.Y. State residents add appropriate sales tax.  
**To place your order call:**  
**TOLL FREE 800-645-4808**  
In NYS (516) 334-2660 No COD's accepted  
**SolderCraft™**  
P.O. Box 668 Jericho, N.Y. 11753

CIRCLE 69 ON FREE INFORMATION CARD

**FUJITECH AUDIO KITS**  
LATEST AUDIO TECHNOLOGY FROM JAPAN

**Model A501 Power Amp**

- Pure Class A 25W + 25W
- Switchable to Class AB 100W + 100W
- Switchable to Bridge Class A 100W mono
- Switchable to Bridge Class AB 300W mono
- Frequency Response 5-200KHz (-1dB)
- Signal-to-Noise Ratio 120dB
- Non-magnetic Chassis
- "Out-board" comprehensive protection circuitry
- DC circuitry with limited use of NFB
- High Efficiency Fluid Convection Cooling
- THD under 0.007%



**Model A502 DC Stereo Control Center**

- Direct DC coupling from Input to Output
- DC servo circuitry
- Cascade FET Input in all stages
- Separate Moving Coil RIAA amplifier
- Distortion below 0.005% (3V)
- Max Output 15V
- Frequency Response 20Hz-20KHz ±0.2 dB
- Maximum Phono Input  
MC = 16mv RMS (1KHz)  
MM = 270mv RMS (1KHz)
- Built-in Headphone amplifier
- Relay Output Muting

**KIT ONLY \$349.00**



**Model A1033 Integrated Tube Amplifier**

- Latest Japanese Design
- Distortionless Output Transformer using special winding techniques
- Most circuitry on PCB for easy assembly and humfree performance
- Output 30W x 2 Ultra Linear (Switchable to Triode)  
15W x 2 Triode Output (near class A performance)
- THD under 0.4%
- Frequency Response 30~30,000 Hz (-1dB)
- Separate Pre-Out and Main-In

**KIT ONLY \$499.00**

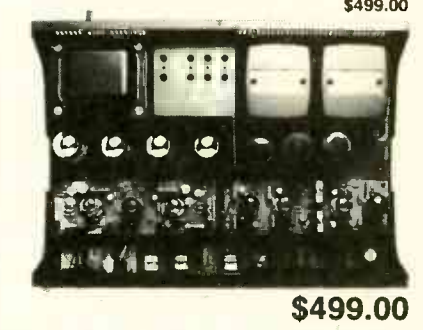

Send \$5.00 for each assembly manual, refundable with order.  
**Monarchy Engineering, Inc.**  
380 Swift Avenue, Unit 21  
South San Francisco, CA 94080  
Visa or Mastercharge acceptable.

**Graymark Electronic Kits**  
Quality Products for 18 Years

**Digital Dice**  
Roll-'em electronically. Handy, portable set of electronic dice for your favorite games. 14 LEDs for realistic dice count, Battery operated. PCB, instructions, and all parts included.  
Order Model 146F **Only \$15.90 each**

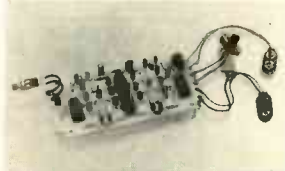

**Variable Strobe Light**  
Great for parties and photography. Variable flash rate of long life xenon tube assures hours of fun. AC operated. Comes complete with parts, PCB, and instructions.  
Order Model 104F **Only \$14.70 each**

**5 Volt Power Supply**  
Perfect for digital circuits. Provides 1.5 amps at 5V under full load. IC voltage regulator. Ripple less than 0.5%. AC operated. Includes all necessary parts, PCB, and instructions.  
Order Model 135F **Only \$18.20 each**

**Warbling Siren**  
Two-tone oscillating siren for automobile or other 12V system. Loud, penetrating sound driven by 2 ICs. Parts, PCB, and instructions are all included.  
Order Model 124F **Only \$8.60 each**

**1-IC Radio**  
Private earphone listening to your favorite stations. AM broadcast band with high selectivity. No alignment necessary. Battery operated. Comes complete with parts, PCB, and instructions.  
Order Model 141F **Only \$12.00 each**

MC & VISA orders only call Toll Free **800-854-7393**  
(In CA 714-540-5480)

CA residents add sales tax • We pay shipping on orders over \$25.00, otherwise add \$2.50. *Sorry no COD.*  
Send \$1.00 for Catalog [over 60 Kits] (Refundable with 1st Order)

**Graymark** Box 17359 • Irvine, CA 92713  
SATISFACTION GUARANTEED

RADIO-ELECTRONICS



(602) 971-0990 (602) 971 0996

# ARIZONA ELECTRONIC

**SURPLUS**  
Wholesale - Retail - Surplus  
Electronic Parts

12627 N. Cave Creek Rd. • Phoenix, AZ 85022

The Most Unbelievable Electrolytic Sale In The USA!

AXIAL		RADIAL	
33/6.3	12/1.00	1000/10	12/1.00
220/6.3	20/1.00*	10/16	30/1.00*
470/6.3	10/1.00	47/16	30/1.00*
220/10	15/1.00	220/16	25/1.00*
47/35	12/1.00	470/16	20/1.00*
220/35	10/1.00	47/25	20/1.00*
15/50	20/1.00*	47/100	5/1.00
22/50	20/1.00*	100/100	4/1.00
47/50	20/1.00*	4.7/160	10/1.00
150/50	8/1.00	10/160	10/1.00
220/50	8/1.00	22/250	5/1.00
10/75	12/1.00		
47/100	5/1.00*	4/50	10/1.00
1500/100	2/1.00*	10/50	10/1.00
2.2/150	12/1.00	47/75	4/1.00
3.3/150	12/1.00	10/75	4/1.00
47/200	5/1.00	Carbide Drill Bits *1.00 ea.	

**BI-POLAR**

4/50	10/1.00
10/50	10/1.00
47/75	4/1.00
10/75	4/1.00

Carbide Drill Bits \*1.00 ea. (various sizes to 3/8")

\* Yes All Prices Are Correct! • \$10.00 Minimum Order on All Above Capacitors • Some Quantity Pricing Available •

## MORE \$1.00 SPECIALS

1N4001	15/*1.00	Horz P.C. Trimpots, 250Ω
2N3905	5/*1.00	500Ω, 5kΩ, 10Ω
2SC828	5/*1.00	MC3420P
2SC644	5/*1.00	SN75150
MINI D.P.D.T. Slide	4/*1	Transformer
D.P.D.T. Rocker Sw		12 V.C.T. 250 MA
4A. 120 VAC	3/*1.00	7805
1N4152	25/*1.00	7812
Similar to 1N914		1N5239
4 Pos DIP switch	3/*1.00	9 V. ZENER
LED's	8/*1.00	

12V 6 A.H. Re-chargeable  
GEL CELL BATTERY  
\$9.95



NOT A KIT

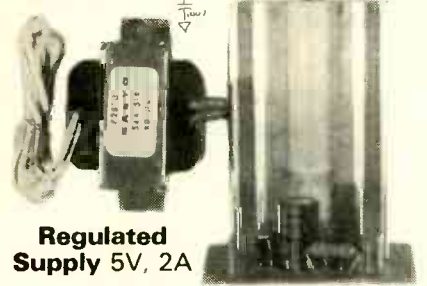

Regulated  
Supply 5V, 2A

w/Transformer & 4" x 2.3" Heat Sink  
\$5.50 ea. or 2/\$10.00

1½ WATT  
AMPLIFIER  
w/DC Bridge

\$27<sup>5</sup>ea. or 2/\$5

Contains: Volume Control, (1) LM 386N, (1) NPN Pre-amp, (4) 4001 Diodes, (2) Coupling Caps  
100% Functional! NOT A KIT

## LIMITED QUANTITY!

\$32<sup>9</sup>ea. or 2/\$6

4 Scales

- (1) R.F. Power 0-6
- (2) SWR 1-10
- (3) Modulation 0-100%
- (4) Signal Strength 1-40  
Ext. Shunt 2.3" x 2.3"

ITEMS MC, VISA, COD VIA UPS  
(Plus Shipping/Handling)

## MICROWAVE TRANSISTORS

42¢ ea.

M 2369

- f<sub>r</sub> 4.5 GHz
- NF 1.5 dB @ 1GHz
- MAG 14 dB @ 1GHz
- V<sub>CB0</sub> 25V
- Replaces NE021-37, MFR-901

42¢ ea. in lots of 1,000 (larger quantity pricing is available)

1SS98 MIXER DIODE

- Glass Package (type DO-35)
- V<sub>F</sub> = 0.34 V Max @ 1mA
- Replaces MBD-101

15¢ ea. in lots of 1,000 (larger quantity pricing is available)

Just call Jeff or Linda TOLL FREE at 1-800-543-4330 or 1-800-762-4315 (in Ohio).



CIRCLE 35 ON FREE INFORMATION CARD

## CABLE TV

## CONVERTERS DESCRAMBLERS

Largest Selection  
of Equipment Available  
\$ Buy Warehouse Direct & Save \$



36 channel  
converter  
\$45<sup>95</sup>

36 channel  
wired remote  
converter  
only  
\$88<sup>95</sup>



Send \$2 for complete catalog  
of converters and unscramblers

Quantity Discounts • Visa • Master Charge  
Add 5% shipping - Mich. residents add 4% sales tax

C&D Electronics, Inc.  
P.O. Box 21, Jenison, MI 49428  
(616) 669-2440

**TUSA**

A WHOLE NEW WORLD OF TV VIEWING WITH TUSA'S NEW MODEL CVU-40, 40 CHANNEL CABLE TV CONVERTER. Receive all the EXTRA CABLE TV "MIDBAND" & SUPERBAND CHANNELS on your UHF DIAL.

Eliminates the need for renting or leasing. This system takes the "midband" and "superband" channels your TV, VCR or projector can't receive and converts them to standard UHF channels that any set can tune in.

**A MUST FOR VIDEO-TAPING FROM CABLE TV!**

The system allows you to program both pay per TV decoder required and standard cable channels for taping on any VCR while you are watching a different channel on your TV.

Simple to install and operate on any make of TV with UHF.

Now \$28.95 ea. PLUS POSTAGE.

NEW AVAILABLE  
NEW TUNABLE DELUXE MODEL CVU-1000 \$34.95 ea.

**UHF TUNERS**

Continuous Tune Model  
45MHz Output

While They Last

\$3.50 ea.  
5 or more \$2.25 ea.

**POPULAR IC'S**

TYPE	DESCRIPTION	1-9	10-UP
LM-380N	2 watt Audio Power Amp	\$1.49	\$1.12
LM-386N-3	Low Voltage Audio Amp	1.59	1.19
50WV9V		3.50	2.69
NE564N	Digital Phase Locked Loop	1.49	1.12
LM 565N	Phase Locked Loop	1.59	1.27
LM-733N	Video Amp	2.49	1.67
MG-130	Video Detector	2.06	1.55
MG-1349	Video If Amp	1.75	1.31
MG-1350	Video If Amp	1.69	1.27
MC-1352	Video If Amp AGC	2.69	2.06
MC-1358	Audio If Amp	1.95	1.46
MC-1374P	R.F. Modulator	3.19	2.39
MC-1458	Dual Comp. Dp Amp	.88	.66
MC-1498N	Balanced Mod/Demodulator	1.79	1.34
LM-1800	PLL Stereo Decoder	2.29	1.99
LM-1889	Video Modulator	2.79	2.19
LM-7805	5 Volt Positive Volt. Reg.	1.19	.89
LM-7808	8 Volt Positive Volt. Reg.	1.19	.89
LM-7812	12 Volt Positive Volt. Reg.	1.19	.89
LM-7815	15 Volt Positive Volt. Reg.	1.19	.89
LM-7818	18 Volt Positive Volt. Reg.	1.19	.89
LM-7824	24 Volt Positive Volt. Reg.	1.19	.89

**AC LINE CORDS**

18 gauge wire  
8 ft. long cable  
Prestriped and tinned ends  
for easy installation.

49¢ ea.  
AC-6G 12-Up 39¢ ea.

**WINEGARD**

75 OHM UHF YAGI ANTENNAS

12 db GAIN  
\$8.95 ea.  
8 OR MORE \$6.95 ea.

OPTIONAL Winegard UHF Antenna Preamp 18db Gain \$39.95 ea.

**BRAND NEW UHF VARACTOR TUNERS**

Sanyo 45 MHz Output \$24.95 ea.  
Mitsumi 45 MHz Output \$24.95 ea.

Call for Quantity Prices

**SPECIAL PURCHASE**

MV-2109  
33pt Tuning Dial

1-9 ..... \$69 ea.  
10-Up ..... \$39 ea.

5% MICA CAPS 5%  
10pf .42 ea. 560pf .66 ea.  
43pf .36 ea. 1000pf .89 ea.  
110pf .36 ea. 3000pf 1.39 ea.

Call for Quantity Discount

**Radial Lead Caps**

1000 mfd 35V	1-11 \$25 ea.	1000 mfd 50V	1-11 \$36 ea.
12 or more	16 ea.	12 or more	25 ea.
1 mfd 35V	1-11 25 ea.	2200 mfd 35V	1-11 1.39 ea.
12 or more	16 ea.	12 or more	1.19 ea.
470 mfd 35V	1-11 59 ea.	3300 mfd 35V	1-11 1.96 ea.
12 or more	49 ea.	12 or more	1.79 ea.
1000 mfd 35V	1-11 89 ea.	100V ± 10% Polyester Film (Mylar)	
12 or more	69 ea.	1-12	10-99 100-999
2200 mfd 35V	1-11 1.29 ea.	.001mf	20 15 08
12 or more	1.09 ea.	.01mf	20 15 08
2200 mfd 50V	1-11 1.69 ea.	.047mf	20 15 08
12 or more	1.39 ea.	.1mf	20 15 08
		.22mf	30 27 22

**AXIAL LEAD CAPS**

1-12	10-99	100-999
1-12	10-99	100-999
1-12	10-99	100-999
1-12	10-99	100-999

**WINEGARD UHF - VHF - FM SPLITTER**

40-900 MHz  
Model PM1030

Low Loss 3.5-4 db, Low VSWR  
Waterproof 1-9 \$24.99 ea.  
Housing 10-Up \$1.89 ea.

**POPULAR MICROWAVE PARTS**

MRF-901	..... \$2.75
9-Up	..... 2.19
MRF-911	..... 3.46
9-Up	..... 3.12
MBD-101	..... 98
CHIP CAPS - .001 mfd	..... 50
26-Up	..... 30
2N5653 (Demerly MRF-902)	..... 11.95

**PROJECT BOXES**

Woodgrain

This box is 11 1/4" W - 4 1/4" H - 8 1/2" D with a removable aluminum U-shaped chassis 11" W - 3 1/4" H - 6" D inside.

\$12.50 ea.  
10 or more \$10.95 ea.

For Larger Quantities - CALL

**DELUXE A-B SWITCHES**

Specify Pushbutton or lever type

For CATV - MATV - VCR  
75 ohm - 90 db Isolation

While They Last \$6.95 ea.

**5" DELUXE SPEAKER**

Handles up to 15 watts. 4 Ohms.  
3 oz. Ceramic Magnet

\$1.89 ea.  
10 up \$1.49 ea.

**75 OHM CHASSIS MOUNT CONNECTOR**

F-41 Female connector. Rear chassis mount with nut. Mates with male "F" connectors.

While they last! 4 for \$1.00

**SURPLUS UHF-VHF VARACTOR TUNERS**

These tuners receive all channels 2-83, plus midband cable channels and are perfect for home-brew TV circuits etc. Output Freq. 45 MHz. Hookup data included. Name Brand.

Actual unit may differ from that shown.

While They Last \$13.95 ea.

**QUALITY POWER TRANSFORMERS**

24V CT, 400 mA

\$3.69 ea. 10-49 \$2.75 ea.  
50 or more \$2.25 ea.

**DELUXE A-B SWITCHES**

Specify Pushbutton or lever type

For CATV - MATV - VCR  
75 ohm - 90 db Isolation

While They Last \$6.95 ea.

**POPULAR MISCELLANEOUS PARTS**

1N4001 Diodes	..... \$1.00
15 for	..... 5.00
100 for	..... 5.00
1/4 W 10K Thumbwheel pots	.....
1-12	..... 39
13-Up	..... 39
Toroids - T30 12	..... 46
20-Up	..... 25
Toroids - T37 2	..... 38
20-Up	..... 25

**ORDER NOW**

TOLL FREE  
800-854-4655  
OUTSIDE CALIFORNIA  
714-635-5090  
INSIDE CALIFORNIA

**R.F. ELECTRONICS**  
1056 N. STATE COLLEGE BLVD., DEPT. R  
ANAHEIM, CALIFORNIA 92806

PERSONAL CHECKS HELD FOR CLEARANCE - NO MINIMUM ORDER  
ALL PREPAID ORDERS 2 LBS OR LESS MUST INCLUDE \$2.50 SHIPPING & HANDLING - SHIPPED SAME DAY RECEIVED

OPEN TUES - FRI  
10 - 6  
SAT 10 - 5  
CLOSED SUN & MON

Call or Write  
FREE Mail Order Catalog

CIRCLE 89 ON FREE INFORMATION CARD

CIRCLE 27 ON FREE INFORMATION CARD

JULY 1983

www.americanradiohistory.com

# "THE NEW DELUXE II"

The new leader in sinewave technology is now available at industry shattering prices. We also have the new and improved plusewave kit.

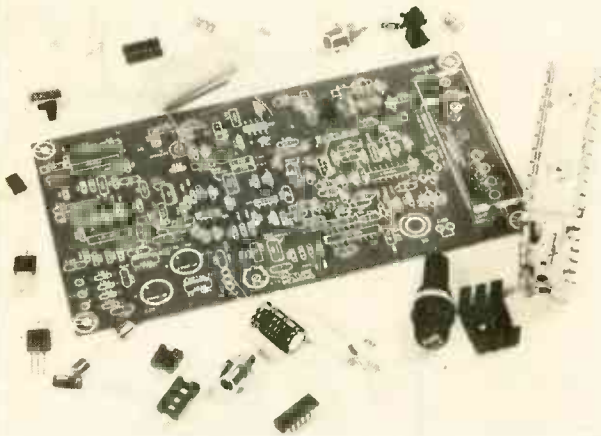

New Deluxe II Board with free-complete assembly plans ..... 20.00  
 New Deluxe II complete kit and enclosure ..... 119.95  
 Pulse Wave AD-1 board with free complete assembly plans ..... 20.00  
 Pulse Wave AD-1 complete kit and enclosure ..... 119.95  
 Add 5% shipping and handling for Continental U.S. Add 10% shipping and handling for outside Continental U.S.

## GAMMA ELECTRONICS

455 Massachusetts Avenue  
 Arlington, Mass. 02174

To Order Call:  
 1-617-641-0778



DEALERS WANTED

CIRCLE 21 ON FREE INFORMATION CARD

# Special Take 2 Sale!

**Take 2**  
**12" CRT MONITOR**  
 2 for 1 Special  
 Untested 12" CRT  
 Monitors, no broken tubes,  
 all are whole, but untested.  
 12" P-31 phosphor, transformer  
 AC, 120 220 VAC Includes schematic

THIS MONTH ONLY

Buy 1 Get 1 FREE \$39<sup>00</sup> each  
 Add \$5 Packaging Plus Shipping

**Take 2**  
**MPI/CDC 9404**  
 • Single sided single density  
 • Removed from equipment to install DSSD drives  
 • Includes data & schematics  
 • Untested, complete

Plus Shipping 2/\$199<sup>00</sup>

**Take 2**  
**2 BAND PRINTER TERMINALS**  
 FOR THE PRICE OF 1

Features:

- RS32 ASCII Input • Fully Formed Type • Up to 1200 Baud (120 cps) for almost 60 lpm • 120 Columns at 10 pitch • Changeable Print Band • Ultra Reliable • 94 Characters (Upper & Lower Case) • 115 VAC 60 Hz • MFG'R'S PRICE OVER \$5K

One unit is fully tested and operational, cleaned and ready to use. The other is clean and whole but UNTESTED (use as a spare or as parts machine). Line Cord & Forms Tractor NOT included (available from GE direct!) Tractor GE Part No. 44C414730-G02.

2 FOR 1 SALE PRICE Only \$295<sup>00</sup> Pair

(Add \$30 for Pkg.-Pay Shpg. on Delivery)

## "SELECTRIC" 745 I/O Printers



- No time to test 'em
- Complete w/TTL driver inputs
- IBM model 745 I/O printer
- Use as a typewriter or printer

JUST \$279<sup>00</sup>

Cleaned & Adjusted Fully Operational ..... \$399<sup>00</sup>  
 Plus Shipping (\$20.00 Ea. Pkg.)

We Stock New "Selectric" Parts For The Above

Write or Call Now For Our NEW BARGAIN-PACKED FLYER

Computer Products & Peripherals Unlimited

WAREHOUSE: 18 Granite St., Haverhill, Mass. 01830  
 MAIL ORDERS: Box 204, Newton, New Hampshire 03858

617/372-8637

Sorry No Collect Calls  
 MasterCard & VISA Accepted

CIRCLE 68 ON FREE INFORMATION CARD

# Components is Our First Name call Us with Your Requirements



**NEW 12" Green Monitor**

Easy on the Eyes. Connects to most popular computers w/o interface or modifications

\$85<sup>00</sup>

## 5 1/4" Floppy DISKETTES

All Certified-100% Guaranteed

BOX of 100... \$149<sup>00</sup>  
 Above with Hub Rings..... \$169.00

## APPLE IIe 64K RAM CARD

80 x 24, 64K RAM  
 Compatible with Apple IIe Software

\$149<sup>00</sup>

## FLOPPY DISK DRIVE

Apple IIe Compatible  
 with • Track Zero Micro Switch  
 • DOS 3.2.1 & DOS 3.3  
 • CP/M and PASCAL

DESIGNED FOR YOUR APPLE™ ..... \$235<sup>00</sup>  
 Controller Card for above..... \$75.00

## COEX 80-FT DOT MATRIX PRINTER

- 9x7 Dot Matrix, 80 CPS, Bi-Directional Printing
- 2K Buffered Memory
- 80, 96, 132 Columns, Graphics and Block Printing
- Selectable Char Pitch, Line Spacing and Feed



COEX Interface Card to Apple... \$49.95  
 Commodore Interface Card to VIC, 64, PET..... \$79.95

\$275<sup>00</sup>

## for APPLE 16K RAM CARD

Language Transparent  
 COEX FACTORY WARRANTY

\$69<sup>95</sup>

## VISION-80® \$229<sup>00</sup>

80x24 Video Display Card  
 Vista Computer Company's new Vision-80 board is a sophisticated yet easy to use video display card for the Apple™ computer.

## EXTENDER CARDS

for APPLE... \$16.95  
 for I.B.M.... \$19.95

## DO YOU HAVE A COMMODORE?

NEW ROM for COEX 80 & DP8480  
 Allows Full Graphics Compatibility with All Commodore Computers ..... \$29<sup>95</sup>

## PARALLEL INTERFACE EPSON TO APPLE

New From COEX \$49<sup>95</sup> CABLE INCLUDED

"Have You Kissed Your Computer Lately?"

# Components Express, Inc.

1380 E. Edinger • Santa Ana, Calif. 92705 • 714/558-3972

TWX 910-595-1565 • ADVACON SNA • International Orders Welcome  
 Terms of Sale: Cash, Checks, Credit Cards, M.O., C.O.D. FOB Santa Ana. Calif. residents add 6% sales tax.



CIRCLE 88 ON FREE INFORMATION CARD

www.americanradiohistory.com

**ramsey**

# the first name in Counters!



## 9 DIGITS 600 MHz \$129<sup>95</sup> WIRED

**PRICES:**

CT-90 wired, 1 year warranty	\$129.95
CT-90 Kit, 90 day parts warranty	
AC-1 AC adapter	109.95
BP-1 Nicad pack + AC Adapter/Charger	3.95
OV-1, Micro-power Oven time base	12.95
External time base input	49.95
	14.95

The CT-90 is the most versatile, feature packed counter available for less than \$300.00! Advanced design features include; three selectable gate times, nine digits, gate indicator and a unique display hold function which holds the displayed count after the input signal is removed! Also, a 10MHz TCXO time base is used which enables easy zero beat calibration checks against WWV. Optionally, an internal nicad battery pack, external time base input and Micro-power high stability crystal oven time base are available. The CT-90, performance you can count on!

**SPECIFICATIONS:**

Range: 20 Hz to 600 MHz  
 Sensitivity: Less than 10 MV to 150 MHz  
 Less than 50 MV to 500 MHz  
 Resolution: 0.1 Hz (10 MHz range)  
 1.0 Hz (60 MHz range)  
 10.0 Hz (600 MHz range)  
 Display: 9 digits 0.4" LED  
 Time base: Standard-10,000 mHz, 1.0 ppm 20-40°C.  
 Optional Micro-power oven-0.1 ppm 20-40°C  
 Power: 8-15 VAC @ 250 ma

## 7 DIGITS 525 MHz \$99<sup>95</sup> WIRED



**SPECIFICATIONS:**

Range: 20 Hz to 525 MHz  
 Sensitivity: Less than 50 MV to 150 MHz  
 Less than 150 MV to 500 MHz  
 Resolution: 1.0 Hz (5 MHz range)  
 10.0 Hz (50 MHz range)  
 100.0 Hz (500 MHz range)  
 Display: 7 digits 0.4" LED  
 Time base: 1.0 ppm TCXO 20-40°C  
 Power: 12 VAC @ 250 ma

The CT-70 breaks the price barrier on lab quality frequency counters. Deluxe features such as: three frequency ranges - each with pre-amplification, dual selectable gate times, and gate activity indication make measurements a snap. The wide frequency range enables you to accurately measure signals from audio thru UHF with 1.0 ppm accuracy - that's .0001%! The CT-70 is the answer to all your measurement needs, in the field, lab or ham shack.

**PRICES:**

CT-70 wired, 1 year warranty	\$99.95
CT-70 Kit, 90 day parts warranty	
AC-1 AC adapter	84.95
BP-1 Nicad pack + AC adapter/charger	3.95
	12.95

## 7 DIGITS 500 MHz \$79<sup>95</sup> WIRED



**PRICES:**

MINI-100 wired, 1 year warranty	\$79.95
AC-Z Ac adapter for MINI-100	3.95
BP-Z Nicad pack and AC adapter/charger	12.95

Here's a handy, general purpose counter that provides most counter functions at an unbelievable price. The MINI-100 doesn't have the full frequency range or input impedance qualities found in higher price units, but for basic RF signal measurements, it can't be beat! Accurate measurements can be made from 1 MHz all the way up to 500 MHz with excellent sensitivity throughout the range, and the two gate times let you select the resolution desired. Add the nicad pack option and the MINI-100 makes an ideal addition to your tool box for "in-the-field" frequency checks and repairs.

**SPECIFICATIONS:**

Range: 1 MHz to 500 MHz  
 Sensitivity: Less than 25 MV  
 Resolution: 100 Hz (slow gate)  
 1.0 KHz (fast gate)  
 Display: 7 digits, 0.4" LED  
 Time base: 2.0 ppm 20-40°C  
 Power: 5 VDC @ 200 ma

## 8 DIGITS 600 MHz \$159<sup>95</sup> WIRED



**SPECIFICATIONS:**

Range: 20 Hz to 600 MHz  
 Sensitivity: Less than 25 mv to 150 MHz  
 Less than 150 mv to 600 MHz  
 Resolution: 1.0 Hz (60 MHz range)  
 10.0 Hz (600 MHz range)  
 Display: 8 digits 0.4" LED  
 Time base: 2.0 ppm 20-40°C  
 Power: 110 VAC or 12 VDC

The CT-50 is a versatile lab bench counter that will measure up to 600 MHz with 8 digit precision. And, one of its best features is the Receive Frequency Adapter, which turns the CT-50 into a digital readout for any receiver. The adapter is easily programmed for any receiver and a simple connection to the receiver's VFO is all that is required for use. Adding the receiver adapter in no way limits the operation of the CT-50, the adapter can be conveniently switched on or off. The CT-50, a counter that can work double-duty!

**PRICES:**

CT-50 wired, 1 year warranty	\$159.95
CT-50 Kit, 90 day parts warranty	
RA-1, receiver adapter kit	119.95
RA-1 wired and pre-programmed (send copy of receiver schematic)	14.95
	29.95

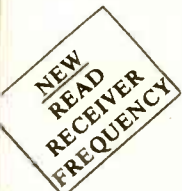

## DIGITAL MULTIMETER \$99<sup>95</sup> WIRED



**PRICES:**

DM-700 wired, 1 year warranty	\$99.95
DM-700 Kit, 90 day parts warranty	
AC-1, AC adaptor	79.95
BP-3, Nicad pack + AC adapter/charger	3.95
MP-1, Probe kit	19.95
	2.95

The DM-700 offers professional quality performance at a hobbyist price. Features include; 26 different ranges and 5 functions, all arranged in a convenient, easy to use format. Measurements are displayed on a large 3 1/2 digit, 1/2 inch LED readout with automatic decimal placement, automatic polarity, overrange indication and overload protection up to 1250 volts on all ranges, making it virtually goof-proof! The DM-700 looks great, a handsome, jet black, rugged ABS case with convenient retractable tilt bail makes it an ideal addition to any shop.

**SPECIFICATIONS:**

DC/AC volts: 100uV to 1 KV, 5 ranges  
 DC/AC current: 0.1 uA to 2.0 Amps, 5 ranges  
 Resistance: 0.1 ohms to 20 Megohms, 6 ranges  
 Input impedance: 10 Megohms, DC/AC volts  
 Accuracy: 0.1% basic DC volts  
 Power: 4 'C' cells

### AUDIO SCALER

For high resolution audio measurements, multiplies UP in frequency.

- Great for PL tones
- Multiplies by 10 or 100
- 0.01 Hz resolution!

\$29.95 Kit \$39.95 Wired

### ACCESSORIES

Telescopic whip antenna - BNC plug	\$ 7.95
High impedance probe, light loading	15.95
Low pass probe, for audio measurements	15.95
Direct probe, general purpose usage	12.95
Tilt bail, for CT 70, 90, MINI-100	3.95
Color burst calibration unit, calibrates counter against color TV signal.	14.95

### COUNTER PREAMP

For measuring extremely weak signals from 10 to 1,000 MHz. Small size, powered by plug transformer-included.

- Flat 25 db gain
- BNC Connectors
- Great for sniffing RF with pick-up loop

\$34.95 Kit \$44.95 Wired

**ramsey electronics, inc.**  
 2575 BAIRD RD. • PENFIELD, NY 14526

**PHONE ORDERS**  
 CALL 716-586-3950

**TERMS**

Satisfaction guaranteed - examine for 10 days, if not pleased, return in original form for refund. Add 5% for shipping insurance to a maximum of \$10. Overseas add 15%. COD, add \$2. Orders under \$10, add \$1.50. NY residents add 7% tax.

CIRCLE 79 ON FREE INFORMATION CARD



# DIGI-KEY CORPORATION

In Mn., Ak., HI, Call 218-681-6674

NATIONAL SEMICONDUCTOR • PANASONIC • QUALITY - Name brand products from nationally recognized manufacturers. CHEMICALS • ARIES • PLESSEY • MOLEX • E. I. du Pont • DELOID • DIAMOND TOOL • LANGAR • GC CO. AS INSTRUMENTS • ITC • PRO • G. C. CHEMICALS • ARIES • PLESSEY • MOLEX • E. I. du Pont • DELOID • DIAMOND TOOL • LANGAR • GC CO. MASTER CHARGE

### 3 APP SILICON RECTIFIER

3 APP SILICON RECTIFIER  
3.00 27.50 250.00

IT RECTIFIERS

Part No.	Rating	Price
1N4001	1A 50V	1.00
1N4002	1A 100V	1.00
1N4003	1A 200V	1.00
1N4004	1A 400V	1.00
1N4005	1A 600V	1.00
1N4006	1A 800V	1.00
1N4007	1A 1000V	1.00

### MA1025 Time-Time Clock Module

MA1025 Time-Time Clock Module  
1" x 1" x 1" 100% Duty Cycle  
P and/or C and virtually any number of displays  
• 10-50Hz line frequency operation  
• 12 or 24 Hour Display

Typical Applications include:  
Clock Radio, Alarm Clock, Desk Clock, TV and Stereo Time Instrument, Pacer Clock, Digital Thermostat and much more.

Part No.	Description	Price
MA1025P	Digi-Key switch panel kit (PC)	\$27.99
MA1025B	Board, 12 switches, two 1/2" LCD	\$19.99
MA1025C	Temp. sensor, two K0402, 100K	3.10
MA1025D	Alarm buzzer for MA1025M	3.36
MA1025E	MA1025M P.T.B.	42.99

### alpha wire cable tubing

Hookup, Wire, Strain, PVC Insulated  
4 Color Mil (1870) Type B 500 Yds 55" x 100"

Color	Part No.	Price
White	W1000	3.32
Black	B1000	3.32
Red	R1000	3.32
Blue	B1000	3.32

### MA1025 0.7" or 0.84" Red 4-Digit LED Display

MA1025 0.7" or 0.84" Red 4-Digit LED Display  
Universal alarm clock module  
• 12 or 24 hour display  
• 50/60 Hz line frequency  
• Fixed or flashing dot location display  
• Display, hours and minutes, minute and seconds, alarm time, and sleep time  
• Battery back up (1/2" coin power)  
• Typical applications include: clock radio, alarm clock, desk clock, instrument panel clock, and many others.

Part No.	Description	Price
MA1025P	Digi-Key switch panel kit (PC)	\$27.99
MA1025B	Board, 12 switches, two 1/2" LCD	\$19.99
MA1025C	Temp. sensor, two K0402, 100K	3.10
MA1025D	Alarm buzzer for MA1025M	3.36
MA1025E	MA1025M P.T.B.	42.99

### TERMINATION JUMPERS

TERMINATION JUMPERS  
S - SECRET CONNECTION TERMINATION  
P - PCB CONNECTOR TERMINATION  
C - CARO EDGE CONNECTOR TERMINATION

Part No.	Value	Price
2N3636	1.44	12.00
2N3637	1.80	15.00
2N3638	2.25	18.00
2N3639	2.70	21.00
2N3640	3.15	24.00
2N3641	3.60	27.00
2N3642	4.05	30.00
2N3643	4.50	33.00
2N3644	5.00	36.00
2N3645	5.40	39.00
2N3646	5.85	42.00
2N3647	6.30	45.00
2N3648	6.75	48.00
2N3649	7.20	51.00
2N3650	7.65	54.00
2N3651	8.10	57.00
2N3652	8.55	60.00
2N3653	9.00	63.00
2N3654	9.45	66.00
2N3655	9.90	69.00
2N3656	10.35	72.00
2N3657	10.80	75.00
2N3658	11.25	78.00
2N3659	11.70	81.00
2N3660	12.15	84.00
2N3661	12.60	87.00
2N3662	13.05	90.00
2N3663	13.50	93.00
2N3664	13.95	96.00
2N3665	14.40	99.00
2N3666	14.85	102.00
2N3667	15.30	105.00
2N3668	15.75	108.00
2N3669	16.20	111.00
2N3670	16.65	114.00
2N3671	17.10	117.00
2N3672	17.55	120.00
2N3673	18.00	123.00
2N3674	18.45	126.00
2N3675	18.90	129.00
2N3676	19.35	132.00
2N3677	19.80	135.00
2N3678	20.25	138.00
2N3679	20.70	141.00
2N3680	21.15	144.00
2N3681	21.60	147.00
2N3682	22.05	150.00
2N3683	22.50	153.00
2N3684	22.95	156.00
2N3685	23.40	159.00
2N3686	23.85	162.00
2N3687	24.30	165.00
2N3688	24.75	168.00
2N3689	25.20	171.00
2N3690	25.65	174.00
2N3691	26.10	177.00
2N3692	26.55	180.00
2N3693	27.00	183.00
2N3694	27.45	186.00
2N3695	27.90	189.00
2N3696	28.35	192.00
2N3697	28.80	195.00
2N3698	29.25	198.00
2N3699	29.70	201.00
2N3700	30.15	204.00

### Standard Assembly Styles

Standard Assembly Styles  
Step 1  
Step 2  
Step 3  
Step 4  
Step 5  
Step 6  
Step 7  
Step 8  
Step 9  
Step 10

Part No.	Value	Price
2N3636	1.44	12.00
2N3637	1.80	15.00
2N3638	2.25	18.00
2N3639	2.70	21.00
2N3640	3.15	24.00
2N3641	3.60	27.00
2N3642	4.05	30.00
2N3643	4.50	33.00
2N3644	5.00	36.00
2N3645	5.40	39.00
2N3646	5.85	42.00
2N3647	6.30	45.00
2N3648	6.75	48.00
2N3649	7.20	51.00
2N3650	7.65	54.00
2N3651	8.10	57.00
2N3652	8.55	60.00
2N3653	9.00	63.00
2N3654	9.45	66.00
2N3655	9.90	69.00
2N3656	10.35	72.00
2N3657	10.80	75.00
2N3658	11.25	78.00
2N3659	11.70	81.00
2N3660	12.15	84.00
2N3661	12.60	87.00
2N3662	13.05	90.00
2N3663	13.50	93.00
2N3664	13.95	96.00
2N3665	14.40	99.00
2N3666	14.85	102.00
2N3667	15.30	105.00
2N3668	15.75	108.00
2N3669	16.20	111.00
2N3670	16.65	114.00
2N3671	17.10	117.00
2N3672	17.55	120.00
2N3673	18.00	123.00
2N3674	18.45	126.00
2N3675	18.90	129.00
2N3676	19.35	132.00
2N3677	19.80	135.00
2N3678	20.25	138.00
2N3679	20.70	141.00
2N3680	21.15	144.00
2N3681	21.60	147.00
2N3682	22.05	150.00
2N3683	22.50	153.00
2N3684	22.95	156.00
2N3685	23.40	159.00
2N3686	23.85	162.00
2N3687	24.30	165.00
2N3688	24.75	168.00
2N3689	25.20	171.00
2N3690	25.65	174.00
2N3691	26.10	177.00
2N3692	26.55	180.00
2N3693	27.00	183.00
2N3694	27.45	186.00
2N3695	27.90	189.00
2N3696	28.35	192.00
2N3697	28.80	195.00
2N3698	29.25	198.00
2N3699	29.70	201.00
2N3700	30.15	204.00

### MA1025 0.7" or 0.84" Red 4-Digit LED Display

MA1025 0.7" or 0.84" Red 4-Digit LED Display  
Universal alarm clock module  
• 12 or 24 hour display  
• 50/60 Hz line frequency  
• Fixed or flashing dot location display  
• Display, hours and minutes, minute and seconds, alarm time, and sleep time  
• Battery back up (1/2" coin power)  
• Typical applications include: clock radio, alarm clock, desk clock, instrument panel clock, and many others.

Part No.	Description	Price
MA1025P	Digi-Key switch panel kit (PC)	\$27.99
MA1025B	Board, 12 switches, two 1/2" LCD	\$19.99
MA1025C	Temp. sensor, two K0402, 100K	3.10
MA1025D	Alarm buzzer for MA1025M	3.36
MA1025E	MA1025M P.T.B.	42.99

### STANDARD RESISTOR VALUE TABLE

STANDARD RESISTOR VALUE TABLE  
Nominal Values in Ohms  
100 110 120 130 150 160 180 200 220 240 270 300 330 360 390 430 470 510 560 620 680 750 820 910 1000

Value	Price
100	0.10
110	0.11
120	0.12
130	0.13
150	0.15
160	0.16
180	0.18
200	0.20
220	0.22
240	0.24
270	0.27
300	0.30
330	0.33
360	0.36
390	0.39
430	0.43
470	0.47
510	0.51
560	0.56
620	0.62
680	0.68
750	0.75
820	0.82
910	0.91
1000	1.00

### TERMINATION JUMPERS

TERMINATION JUMPERS  
S - SECRET CONNECTION TERMINATION  
P - PCB CONNECTOR TERMINATION  
C - CARO EDGE CONNECTOR TERMINATION

Part No.	Value	Price
2N3636	1.44	12.00
2N3637	1.80	15.00
2N3638	2.25	18.00
2N3639	2.70	21.00
2N3640	3.15	24.00
2N3641	3.60	27.00
2N3642	4.05	30.00
2N3643	4.50	33.00
2N3644	5.00	36.00
2N3645	5.40	39.00
2N3646	5.85	42.00
2N3647	6.30	45.00
2N3648	6.75	48.00
2N3649	7.20	51.00
2N3650	7.65	54.00
2N3651	8.10	57.00
2N3652	8.55	60.00
2N3653	9.00	63.00
2N3654	9.45	66.00
2N3655	9.90	69.00
2N3656	10.35	72.00
2N3657	10.80	75.00
2N3658	11.25	78.00
2N3659	11.70	81.00
2N3660	12.15	84.00
2N3661	12.60	87.00
2N3662	13.05	90.00
2N3663	13.50	93.00
2N3664	13.95	96.00
2N3665	14.40	99.00
2N3666	14.85	102.00
2N3667	15.30	105.00
2N3668	15.75	108.00
2N3669	16.20	111.00
2N3670	16.65	114.00
2N3671	17.10	117.00
2N3672	17.55	120.00
2N3673	18.00	123.00
2N3674	18.45	126.00
2N3675	18.90	129.00
2N3676	19.35	132.00
2N3677	19.80	135.00
2N3678	20.25	138.00
2N3679	20.70	141.00
2N3680	21.15	144.00
2N3681	21.60	147.00
2N3682	22.05	150.00
2N3683	22.50	153.00
2N3684	22.95	156.00
2N3685	23.40	159.00
2N3686	23.85	162.00
2N3687	24.30	165.00
2N3688	24.75	168.00
2N3689	25.20	171.00
2N3690	25.65	174.00
2N3691	26.10	177.00
2N3692	26.55	180.00
2N3693	27.00	183.00
2N3694	27.45	186.00
2N3695	27.90	189.00
2N3696	28.35	192.00
2N3697	28.80	195.00
2N3698	29.25	198.00
2N3699	29.70	201.00
2N3700	30.15	204.00

### JAG NORMAL-BLO-FUSES

JAG NORMAL-BLO-FUSES  
1/2" x 1/4" x 1/8" 100% Duty Cycle  
• 12 or 24 hour display  
• 50/60 Hz line frequency  
• Fixed or flashing dot location display  
• Display, hours and minutes, minute and seconds, alarm time, and sleep time  
• Battery back up (1/2" coin power)  
• Typical applications include: clock radio, alarm clock, desk clock, instrument panel clock, and many others.

Part No.	Rating	Price
F100	0.10	0.10
F110	0.11	0.11
F120	0.12	0.12
F130	0.13	0.13
F150	0.15	0.15
F160	0.16	0.16
F180	0.18	0.18
F200	0.20	0.20
F220	0.22	0.22
F240	0.24	0.24
F270	0.27	0.27
F300	0.30	0.30
F330	0.33	0.33
F360	0.36	0.36
F390	0.39	0.39
F430	0.43	0.43
F470	0.47	0.47
F510	0.51	0.51
F560	0.56	0.56
F620	0.62	0.62
F680	0.68	0.68
F750	0.75	0.75
F820	0.82	0.82
F910	0.91	0.91
F1000	1.00	1.00

### MA1025 0.7" or 0.84" Red 4-Digit LED Display

MA1025 0.7" or 0.84" Red 4-Digit LED Display  
Universal alarm clock module  
• 12 or 24 hour display  
• 50/60 Hz line frequency  
• Fixed or flashing dot location display  
• Display, hours and minutes, minute and seconds, alarm time, and sleep time  
• Battery back up (1/2" coin power)  
• Typical applications include: clock radio, alarm clock, desk clock, instrument panel clock, and many others.

Part No.	Description	Price
MA1025P	Digi-Key switch panel kit (PC)	\$27.99
MA1025B	Board, 12 switches, two 1/2" LCD	\$19.99
MA1025C	Temp. sensor, two K0402, 100K	3.10
MA1025D	Alarm buzzer for MA1025M	3.36
MA1025E	MA1025M P.T.B.	42.99

### TERMINATION JUMPERS

TERMINATION JUMPERS  
S - SECRET CONNECTION TERMINATION  
P - PCB CONNECTOR TERMINATION  
C - CARO EDGE CONNECTOR TERMINATION

Part No.	Value	Price
2N3636	1.44	12.00
2N3637	1.80	15.00
2N3638	2.25	18.00
2N3639	2.70	21.00
2N3640	3.15	24.00
2N3641	3.60	27.00
2N3642	4.05	30.00
2N3643	4.50	33.00
2N3644	5.00	36.00
2N3645	5.40	39.00
2N3646	5.85	42.00
2N3647	6.30	45.00
2N3648	6.75	48.00
2N3649	7.20	51.00
2N3650	7.65	54.00
2N3651	8.10	57.00
2N3652	8.55	60.00
2N3653	9.00	63.00
2N3654	9.45	66.00
2N3655	9.90	69.00
2N3656	10.35	72.00
2N3657	10.80	75.00
2N3658	11.25	78.00
2N3659		



# ADVANCED COMPUTER PRODUCTS

SEND \$2.00 for 1983 CATALOG

## MICROPROCESSORS

Z8001	\$99.00	8006-1	\$14.95	8802P	14.95
Z8002	89.00	2901	9.90	8035	14.95
Z8003	9.95	2902A	14.95	8036	12.95
Z8004	11.95	9900JL	49.95	8073N	34.95
F-8 (38051)	16.95	6502	9.95	8755	49.85
2650	16.95	6502A	16.95	8748	49.85
1802	9.75	IM610	29.95	6809	30.00
8080A	4.75	6800	11.75	8086	49.95
8085	14.95	8800B	19.95	8090	129.95

## 16K Apple™ Ramcard

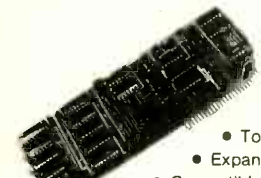

LIST 195 ACP

\$59.95

- Full 1 year warranty
- Top quality — gold fingers
- Expand Apple II 48K to 64K
- Compatible with Z-80 Softcard™

NOW AVAILABLE

Apple IIe 64K Add-in Memory with 80 Columns

\$149.95

## 32K STATIC RAM

2 or 4 MHz Expandable Uses 2114L's

16K 4 MHz Kit	\$159.95
16K 4 MHz A&T	\$217.95
32K 4 MHz Kit	\$129.95
32K 4 MHz A&T	\$339.00
BARE BOARD	\$99.95
Bare Bd w/all parts less mem.	99.95

## REPEAT OF SELL-OUT

58 Key Unencoded Keyboard

\$19.95 ea.

This is a new 58 key terminal keyboard manufactured by a major manufacturer. It is unencoded with SPST keys unattached to any PC board. Solid molded plastic 11" x 4" base.

## Unencoded Key Pad

15 key Keypad with 1-10 keys and tab, return, (-), (.) and (,).

Only \$9.95 ea.

## UV "EPROM" ERASER

Model DE-4

\$89.95

Holds 4 EPROM's at a time. Model S-52T \$325.00

## 16K Memory Expansion Kits

For Apple/TRS-80

8 pcs 4116 16K 200/250NS Specify computer \$12.95

CALL FOR VOLUME PRICING

## CORCOM FILTER

Popular CORCOM Filter

\$4.95

Compatible Line Cord Add... \$3.80

## Astec RF Modulator

for COLOR & B/W

P/N 1082 Channel 3 or 4 \$8.95

## AMD MODEM IC

P/N AM7910 1200Baud 5 Volts

Special ACP Price \$99.00

## PARALLEL ALPHA NUMERIC PRINTER

18 Column Printer prints 18 numerical columns plus 3 columns which have math, alpha and other notations.

Each wheel has 12 positions with position 12 blank. Position 11 on numerical columns have decimal point or #. Utilizes 2.75" wide adding machine tape and a dual color ink ribbon. Input data parallel with four bit BCD comparator circuit (schematic provided). Print rate, 3 lines per second. Operating voltage 22-28VDC with typical cycle time of 340mS. Size 6 1/2" W x 3 1/2" H x 5 1/2" Dp. New. \$8.95 ea. 3/\$25

## 64K CMOS RAMCARD

Compatible Uses Low Power 6116 IC's

\$299.00

Single Supply Assm and Tested

## INTEL 4K STATIC RAMS

Super Fast! Super Low Power!

Part No. 2147... \$1.95 ea.

## STEPPER MOTOR

Operates by applying 12VDC in one direction and then reversing polarity (or square wave). Uses 12VDC, Clock Wise Rotation, Rated 3 RPM at 4 P.P.S. with a 5 degree stepping angle.

ACP PRICE \$3.95 ea. 10 for \$34.95

## RS232 SIGNAL TESTER

COEX RS232 Line Tester (7) LED Indicators

only \$24.95

## INTEL CODEC IC

P/N 2910A For Digital Voice

\$9.95 ea.

## CONNECTORS

DB28P (RS232) DB28S Female Hood Set with Hood, Sale 22/44 S/T, KIM 43/86 S/T, MOT 60/100 9-100 Connector W/W 60/100 9-100 Connector S/T

\$3.26 3.76 1.26 2.96 8.50 4.95 3.95

## RAMS

CALL FOR QTY PRICING

6116/2016 \$7.95 2147 \$5.99 5290 \$1.99

8264-64\* 5.95 411 5.99 5290 1.49

4116-2 1.99 414 4.69 6508 4.50

4116-2 3/12.95 1101 99 6518 6.79

2101 3.99 1103 99 6581 3.79

2102 7.9 4027 4.69 8604 3.99

L1208-2 1.49 4044 3.99 6605 7.99

L1202-4 1.29 4050 4.69 9130 8.99

2111 3.49 4060 6.69 9140 8.99

2112 3.49 4096 3.99 93415 6.99

13114 1.29 4115 1.49 93425 6.99

2114-2 3.25 4200 1.95

2114-4 2.29 4402 1.99

2125 6.99 6280 4.60

## SUPPORT

8155 89.95 8259 58.95 68047 \$22.95

8156 9.95 8275 19.95 68488 19.95

8202 29.95 8279 9.50 46505 22.95

8205 2.69 8810 4.75 6520 6.95

8212 2.75 6820 6.50 6522 9.95

8214 4.95 6921 6.50 6530-X 24.95

8216 2.75 6922 10.50 6532 17.95

8224 2.95 6834 16.95 6551 19.95

8226 2.95 6845 22.95 280-PIO 6.50

8228 3.95 6847 27.95 280A-PIO 9.50

8243 8.50 6850 5.25 280-CTC 6.50

8252 4.95 6852 5.25 280A-CTC 5.50

8251 6.50 6860 10.95 280-DMA 19.95

8253 11.95 6862 10.95 280-DMA 27.95

8255 4.50 6862 5.95 280-SIO 24.95

8257 9.50 6880 2.49 280-SIO 29.95

## MOS PROMS

2764 (8Kx8) TS \$69.95 2708 (4Kx8)S \$5.75

2732 (4Kx8) TS 12.95 2708 (8650S) 5.25

2716/2516 5V 1702A 5.75

(2Kx8) TS 7.95 MMS20A30A 14.50

TMS2718, 5V, 12V 17.95 MMS20A0 9.95

2756, 5V, (4Kx8)S 3.50

## HI-TECH

2913-001 (5V) Upper \$9.50 DAC08 \$9.95

2913-005 (5V) Lower 10.95 DAC08 \$9.95

2913-0043 (5V) Lower 14.95 8038 Function Generator 4.50

MCM68710 ASCII Shifted 12.95 MCM6824 VCO 2.95

MCM66740 Math Symbol 13.95 LMS66 VCO 1.95

MCM66750 Alpha Control 13.45 XR202C Function Generator 5.25

1771-01 8" x 1/4" floppy 24.95 TR1802B (5V, 12V) 3.95

1781 Dual Floppy 29.95 AYS1013 (5V, 12V) 9.95

1791-01 Dual Floppy 39.95 AYS1014 (5V, 12V) 9.95

## LINEAR

78H05K \$5.95 LM1414N \$1.90

78M06 1.49 LM1458CN 49

78L05 1.49 MC1488N 99

LM1084H 2.95 LM1489N 39

LM300H .99 LM1496N 89

LM301CN .35 LM1556N 1.50

LM304H 1.98 LM1820N .95

LM305H 1.69 LM1850N 95

LM305H 3.25 LM1898N 3.10

LM307CN .29 LM2111N 1.75

LM309CN .98 LM2900N 99

LM309K 1.49 LM2917N 2.50

LM310CN 1.25 LM2917N 2.95

LM311D/CN .99 CA3013T 2.19

LM312H 1.59 CA3018T 1.99

LM317 1.70 CA3021T 3.48

LM318CN 1.49 CA3023T 2.99

LM319H/V 1.25 CA3035T 2.95

LM320K-XX 1.35 CA3039T 1.29

LM320T-XX 1.39 CA3048T 1.29

LM320H-XX 1.49 CA3053N 1.49

LM323K 4.95 CA3059N 3.19

LM324N .95 CA3060N 4.95

LM337K 5.95 CA3062N 1.49

LM338K 6.95 LM3065N 4.95

LM339K 7.95 CA3080T 1.29

LM340K-XX\* 1.75 CA3081N 1.69

LM340H-XX\* 1.25 CA3082N 1.29

LM343H 1.55 7438 29

LM344H 1.95 7439 29

LM348N 1.20 7440 19

LM348N 5.90 7441 29

LM358CN .98 CA3097N 2.99

LM360N 1.49 CA3130T 1.30

LM372N 1.95 CA3140T 1.19

LM376N 3.75 CA3148N 2.49

LM377N 2.75 CA3180T 1.19

LM3800CN 5.90 CA3098N 3.49

LM381N 1.79 CA3410N .59

LM383T 1.95 LM3423N 1.49

LM386N 1.25 MC3460N 3.95

LM387N 1.40 SG3524N 3.95

## 7400

7400 \$ .19 7475 \$ .38 74161 \$ .88

7401 22 7476 .34 74162 .89

7402 22 7479 4.60 74163 .87

7403 22 7480 .39 74164 .87

7404 22 7482 .95 74165 .87

7405 23 7483 .55 74166 1.20

7406 35 7485 .65 74167 1.95

7407 35 7486 .35 74170 1.69

7408 26 7489 1.75 74172 4.75

7409 33 7490 .39 74173 4.87

7410 22 7491 .57 74174 .89

7411 29 7492 .45 74175 .85

7412 29 7493 .45 74176 .75

7413 39 7494 .69 74177 .75

7414 39 7495 .69 74178 1.34

7415 22 74100 2.90 74181 1.75

7416 22 74100 2.90 74182 1.75

7417 35 74107 3.2 74184 2.25

7418 29 74109 3.7 74185 2.25

7419 29 74121 2.9 74186 3.90

7420 29 74122 2.9 74189 1.15

7421 25 74123 5.9 74190 1.15

7422 29 74125 4.41 74192 8.6

7423 29 74126 4.41 74193 8.6

7424 29 74127 5.9 74194 8.6

7425 25 74132 6.9 74195 8.6

7426 29 74136 7.5 74196 8.6

7427 29 74137 7.5 74197 8.6

7428 29 74138 8.5 74198 8.6

7429 29 74139 8.5 74199 8.6

7430 29 74145 1.25 74200 1.25

7431 19 74154 1.19 74206 5.9

7432 19 74155 1.19 74208 9.95

7433 19 74156 7.8 74209 1.25

7434 19 74157 1.19 74210 1.10

7435 19 74158 7.5 74211 1.10

7436 19 74159 1.48 74212 1.75

7437 19 74160 1.05 74213 1.75

7438 26 74161 1.15 74214 1.40

7439 26 74162 2.48 74215 3.69

7440 26 74163 1.15 74216 3.69

# 4164 64K DYNAMIC \$595

200 NS

# TMM2016 2KX8 STATIC \$415

200 NS

## STATIC RAMS

2101	256 x 4 (450ns)	1.95
5101	256 x 4 (450ns) (cmos)	3.95
2102-1	1024 x 1 (450ns)	.89
2102L-4	1024 x 1 (450ns) (LP)	.99
2102L-2	1024 x 1 (250ns) (LP)	1.49
2111	256 x 4 (450ns)	2.49
2112	256 x 4 (450ns)	2.99
2114	1024 x 4 (450ns)	8/9.95
2114L-4	1024 x 4 (450ns) (LP)	8/12.95
2114L-3	1024 x 4 (300ns) (LP)	8/13.45
2114L-2	1024 x 4 (200ns) (LP)	8/13.95
2147	4096 x 1 (55ns)	4.95
TMS4044-4	4096 x 1 (450ns)	3.49
TMS4044-3	4096 x 1 (300ns)	3.99
TMS4044-2	4096 x 1 (200ns)	4.49
MK4118	1024 x 8 (250ns)	9.95
TMM2016-200	2048 x 8 (200ns)	4.15
TMM2016-150	2048 x 8 (150ns)	4.95
TMM2016-100	2048 x 8 (100ns)	6.15
HM6116-4	2048 x 8 (200ns) (cmos)	4.75
HM6116-3	2048 x 8 (150ns) (cmos)	4.95
HM6116-2	2048 x 8 (120ns) (cmos)	8.95
HM6116LP-4	2048 x 8 (200ns) (cmos)(LP)	5.95
HM6116LP-3	2048 x 8 (150ns) (cmos)(LP)	6.95
HM6116LP-2	2048 x 8 (120ns) (cmos)(LP)	10.95
Z-6132	4096 x 8 (300ns) (Qstat)	34.95

LP = Low Power Qstat = Quasi-Static

## DYNAMIC RAMS

TMS4027	4096 x 1 (250ns)	1.99
UPD411	4096 x 1 (300ns)	3.00
MMS280	4096 x 1 (300ns)	3.00
MK4108	8192 x 1 (200ns)	1.95
MMS298	8192 x 1 (250ns)	1.85
4116-300	16384 x 1 (300ns)	8/11.75
4116-250	16384 x 1 (250ns)	8/11.95
4116-200	16384 x 1 (200ns)	8/12.95
4116-150	16384 x 1 (150ns)	8/14.95
4116-120	16384 x 1 (120ns)	8/29.95
2118	16384 x 1 (150ns) (5v)	4.95
4164-200	65536 x 1 (200ns) (5v)	5.95
4164-150	65536 x 1 (150ns) (5v)	6.95

5V = single 5 volt supply

## EPROMS

1702	256 x 8 (1us)	4.50
2708	1024 x 8 (450ns)	3.95
2758	1024 x 8 (450ns) (5v)	5.95
2716	2048 x 8 (450ns) (5v)	3.95
2716-1	2048 x 8 (350ns) (5v)	5.95
TMS2516	2048 x 8 (450ns) (5v)	5.50
TMS2716	2048 x 8 (450ns) (5v)	7.95
TMS2532	4096 x 8 (450ns) (5v)	5.95
2732	4096 x 8 (450ns) (5v)	4.95
2732-250	4096 x 8 (250ns) (5v)	8.95
2732-200	4096 x 8 (200ns) (5v)	11.95
2764	8192 x 8 (450ns) (5v)	9.95
2764-250	8192 x 8 (250ns) (5v)	14.95
2764-200	8192 x 8 (200ns) (5v)	24.95
TMS2564	8192 x 8 (450ns) (5v)	17.95
MC68764	8192 x 8 (450ns) (5v)(24 pin)	39.95

5v Single 5 Volt Supply

## EPROM ERASERS

	Timer	Capacity Chip	Intensity (uW/Cm <sup>2</sup> )	
PE-14		6	5,200	83.00
PE-14T	X	6	5,200	119.00
PE-24T	X	9	6,700	175.00
PL-265T	X	20	6,700	255.00
PR-125T	X	16	15,000	349.00
PR-320	X	32	15,000	595.00

## Z-80 2.5 Mhz

Z80-CPU	3.95
Z80-CTC	4.49
Z80-DART	10.95
Z80-DMA	14.95
Z80-PIO	4.49
Z80-SIO/0	16.95
Z80-SIO/1	16.95
Z80-SIO/2	16.95
Z80-SIO/9	16.95

## 4.0 Mhz

Z80A-CPU	4.95
Z80A-CTC	4.95
Z80A-DART	11.95
Z80A-DMA	16.95
Z80A-PIO	4.95
Z80A-SIO/0	16.95
Z80A-SIO/1	16.95
Z80A-SIO/2	16.95
Z80A-SIO/9	16.95

## 6.0 Mhz

Z80B-CPU	11.95
Z80B-CTC	13.95
Z80B-PIO	13.95
Z80B-DART	19.95

## ZILOG

Z6132	34.95
Z8671	39.95

## CRYSTALS

32.768 khz	1.95
1.0 mhz	4.95
1.8432	4.95
2.0	3.95
2.097152	3.95
2.4576	3.95
3.2768	3.95
3.579535	3.95
4.0	3.95
5.0	3.95
5.0688	3.95
5.185	3.95
5.7143	3.95
6.0	3.95
6.144	3.95
6.5536	3.95
8.0	3.95
10.0	3.95
10.738635	3.95
14.31818	3.95
15.0	3.95
16.0	3.95
17.430	3.95
18.0	3.95
18.432	3.95
20.0	3.95
22.1184	3.95
32.0	3.95

## CRT CONTROLLERS

6845	14.95
68B45	19.95
HD46505SP	15.95
6847	11.95
MC1372	6.95
68047	24.95
8275	29.95
7220	99.95
CRT5027	39.95
CRT5037	49.95
TMS9918A	39.95
DP8350	49.95

## KEYBOARD CHIPS

AY5-2376	11.95
AY5-3600	11.95

## 8000

8035	5.95
8039	5.95
INS-8060	17.95
INS-8073	24.95
8080	3.95
8085	5.95
8085A-2	11.95
8086	29.95
8087	CALL
8088	39.95
8089	89.95
8155	6.95
8155-2	7.95
8156	6.95
8185	29.95
8185-2	39.95
8741	39.95
8748	24.95
8755	24.95

## 8200

8202	24.95
8203	39.95
8212	3.50
8214	3.85
8216	1.75
8224	2.25
8226	1.80
8228	3.49
8231	call
8237	19.95
8237-5	21.95
8238	4.49
8243	4.45
8250	10.95
8251	4.49
8253	6.95
8253-5	7.95
8255	4.49
8255-5	5.25
8257	7.95
8257-5	8.95
8259	6.90
8259-5	7.50
8271	39.95
8272	39.95
8275	29.95
8279	8.95
8279-5	10.00
8282	6.50
8283	6.50
8284	5.50
8286	6.50
8287	6.50
8288	25.00
8289	49.95

## DISC CONTROLLERS

1771	16.95
1791	24.95
1793	26.95
1795	49.95
1797	49.95
2791	54.95
2793	54.95
2795	59.95
2797	59.95
6843	34.95
8272	39.95
UPD765	39.95
1691	17.95
2143	18.95

## CONNECTORS

RS232 MALE	2.50
RS232 FEMALE	3.25
RS232 HOOD	1.25
S-100 ST	3.95

## 6800

68000	59.95
6800	3.95
6802	7.95
6808	13.90
6809E	19.95
6809	11.95
6810	2.95
6820	4.35
6821	3.25
6828	14.95
6840	12.95
6843	34.95
6844	25.95
6845	14.95
6847	11.95
6850	3.25
6852	5.75
6860	9.95
6862	11.95
6875	6.95
6880	2.25
6883	22.95
68047	24.95
68488	19.95

## 6500 1 MHz

6502	4.95
6504	6.95
6505	8.95
6507	9.95
6520	4.35
6522	7.95
6532	9.95
6545	22.50
6551	11.85

## 2 MHz

6502A	6.95
6522A	9.95
6532A	11.95
6545A	27.95
6551A	11.95

## 3 MHz

6502B	14.95
-------	-------

## UARTS

AY3-1014	6.95
AY5-1013	3.95
AY3-1015	6.95
PT1472	9.95
TR1602	3.95
2350	9.95
2651	8.95
TMS6011	5.95
IM6402	7.95
IM6403	8.95
INS8250	10.95

## GENERATORS BIT-RATE

MC14411	11.95
BR1941	11.95
4702	12.95
COM5016	16.95
COM8116	10.95
MM5307	10.95

## FUNCTION

MC4024	3.95
LM566	1.49
XR2206	3.75
8038	3.95

## 74LS00

74LS00	.24	74LS173	.69
74LS01	.25	74LS174	.55
74LS02	.25	74LS175	.55
74LS03	.25	74LS181	2.15
74LS04	.24	74LS189	8.95
74LS05	.25	74LS190	.89
74LS08	.28	74LS191	.89
74LS09	.29	74LS192	.79
74LS10	.25	74LS193	.79
74LS11	.35	74LS194	.69
74LS12	.35	74LS195	.69
74LS13	.45	74LS196	.79
74LS14	.59	74LS197	.79
74LS15	.35	74LS221	.89
74LS20	.25	74LS240	.95
74LS21	.29	74LS241	.99
74LS22	.25	74LS242	.99
74LS26	.29	74LS243	.99
74LS27	.29	74LS244	.99
74LS28	.35	74LS245	1.49
74LS30	.25	74LS247	.75
74LS32	.29	74LS248	.99
74LS33	.55	74LS249	.99
74LS37	.35	74LS251	.59
74LS38	.35	74LS253	.59
74LS40	.25	74LS257	.59
74LS42	.49	74LS258	.59
74LS47	.75	74LS259	2.75
74LS48	.75	74LS260	.59
74LS49	.75	74LS266	.55
74LS51	.25	74LS273	1.49
74LS54	.29	74LS275	3.35
74LS55	.29	74LS279	.49
74LS63	1.25	74LS280	1.98
74LS73	.39	74LS283	.69
74LS74	.35	74LS290	.89
74LS75	.39	74LS293	.89
74LS76	.39	74LS295	.99
74LS78	.49	74LS298	.89
74LS83	.60	74LS299	1.75
74LS85	.69	74LS323	3.50
74LS86	.39	74LS324	1.75
74LS90	.55	74LS352	1.29
74LS91	.89	74LS353	1.29
74LS92	.55	74LS363	1.35
74LS93	.55	74LS364	1.95
74LS95	.75	74LS365	.49
74LS96	.89	74LS366	.49
74LS107	.39	74LS367	.45
74LS109	.39	74LS368	.45
74LS112	.39	74LS373	.99
74LS113	.39	74LS374	.99
74LS114	.39	74LS377	1.39
74LS122	.45	74LS378	1.18
74LS123	.79	74LS379	1.35
74LS124	2.90	74LS385	1.90
74LS125	.49	74LS386	.45
74LS126	.49	74LS390	1.19
74LS132	.59	74LS393	1.19
74LS133	.59	74LS395	1.19
74LS136	.39	74LS399	1.49
74LS137	.99	74LS424	2.95



2114 450 NS 8/\$995

2114 250 NS 8/\$1095

7400

Table of 7400 series components with part numbers and prices.

LINEAR

Table of Linear components including LM301, LM301H, LM307, etc.

RCA

Table of RCA components including CA 3023, CA 3039, etc.

CMOS

Table of CMOS components including 4000, 4001, 4002, etc.

TI

Table of TI components including TL494, TL496, etc.

BI FET

Table of BI FET components including TL071, TL072, etc.

H = TO-5 CAN T = TO-220 K = TO-3

74S00

Table of 74S00 series components including 74S00, 74S02, etc.

IC SOCKETS

Table of IC sockets including 8 pin ST, 14 pin ST, etc.

VOLTAGE REGULATORS

Table of Voltage Regulators including 7805T, 7808T, etc.

DIP SWITCHES

Table of DIP Switches including 4 POSITION, 5 POSITION, etc.

INTERFACE

Table of Interface components including 8T26, 8T28, etc.

MISC.

Table of Miscellaneous components including ULN2003, 3242, etc.

LED LAMPS

Table of LED Lamps including Red, Green, Yellow.

LED DISPLAYS

Table of LED Displays including HP 5082-7760, MAN 72, etc.

CLOCK CIRCUITS

Table of Clock Circuits including MM5314, MM5369, etc.

INTERSIL

Table of Intersil components including ICL7103, ICL7106, etc.

9000

Table of 9000 series components including 9316, 9334, etc.

EXAR

Table of EXAR components including XR 2206, XR 2207, etc.

DATA ACQUISITION

Table of Data Acquisition components including ADC0800, ADC0804, etc.

SOUND CHIPS

Table of Sound Chips including 76477, 76489, etc.

ORDER TOLL FREE 800-538-5000 800-662-6279 (CALIFORNIA RESIDENTS) ALL MERCHANDISE 100% GUARANTEED CALL US FOR VOLUME QUOTES

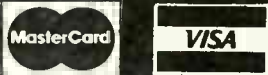

© 1983 JDR MICRODEVICES, INC.

CIRCLE 49 ON FREE INFORMATION CARD

### CABINETS FOR 5 1/4" DISK DRIVES

#### CABINET #1 \$29.95

- \* DIMENSIONS 8 3/8 x 5 1/8 x 3 1/8"
- \* COLOR MATCHES APPLE
- \* FITS STANDARD 5 1/4" DRIVES, INCL. SHUGART
- \* INCLUDES MOUNTING HARDWARE AND FEET

#### CABINET #2 \$79.00

- \* COMPLETE WITH POWER SUPPLY, SWITCH, LINE CORD, FUSE & STANDARD POWER CONNECTOR
  - \* DIMENSIONS: 11 1/2 x 5 1/4 x 3 1/8"
  - \* +5V @ 1 AMP, +12V @ 1.5 AMP
  - \* FITS STANDARD 5 1/4" DRIVES
  - \* PLEASE SPECIFY GRAY OR TAN
- NOTE: Please include sufficient amount for shipping on above items.

### CONNECTORS

RS232 MALE	2.50
RS232 FEMALE	3.25
RS232 FEMALE RIGHT ANGLE	5.25
RS232 HOOD	1.25
S-100 ST	3.95
S-100 WW	4.95
44 pin ST	2.95
44 pin WW	4.95
72 pin ST	6.95
72 pin WW	7.95

### SWITCHES

SPDT mini-toggle	1.25
DPDT mini-toggle	1.50
SPDT push-button	1.49

### OPTO-ISOLATORS

MCA-7	1.50
MCA-255	1.75
IL-1	1.25
ILA-30	1.25
ILQ-74	2.75
H11C5	1.25
TIL-111	1.00
TIL-113	1.75
4N26	1.00
4N27	1.10
4N28	.69
4N33	1.75
4N35	1.25
4N37	1.25
MCT-2	1.00
MCT-6	1.50

### TRANSISTORS

2N918	.50	2N3772	1.85
MPS918	.25	2N3903	.25
2N2102	.50	2N3904	.10
2N2218	.50	2N3906	.10
2N2218A	.50	2N4122	.25
2N2219	.50	2N4123	.25
2N2219A	.50	2N4249	.25
2N2222	.25	2N4304	.75
PN2222	.10	2N4401	.25
MPS2369	.25	2N4402	.25
2N2484	.25	2N4403	.25
2N2905	.50	2N4857	1.00
2N2907	.25	PN4916	.25
PN2907	.125	2N5086	.25
2N3055	.79	PN5129	.25
3055T	.69	PN5139	.25
2N3393	.30	2N5209	.25
2N3414	.25	2N6028	.35
2N3563	.40	2N6043	1.75
2N3565	.40	2N6045	1.75
PN3565	.25	MPS-A05	.25
MPS3638	.25	MPS-A06	.25
MPS3640	.25	MPS-A55	.25
PN3643	.25	TIP29	.65
PN3644	.25	TIP31	.75
MPS3704	.15	TIP32	.79
MPS3706	.15		

### MICROCOMPUTER HARDWARE HANDBOOK FROM ELCOMP — \$14.95

Over 800 pages of manufacturers data sheets on most commonly used IC's.

- Includes:
- \* TTL — 74/74LS and 74F
  - \* CMOS
  - \* Voltage Regulators
  - \* Memory — RAM, ROM, EPROM
  - \* CPU's — 6800, 6500, Z80, 8080, 8085, 8086/8
  - \* MPU support & interface — 6800, 6500, Z80, 8200, etc.

### HEAT SINKS

TO-3 style	.95
TO-220 style	.35

### DISK DRIVES

TM100-1 5 1/4" (FOR IBM) SS/DD	229.00
TM100-2 5 1/4" (FOR IBM) DS/DD	295.00

### SHUGART

SA 400L 5 1/4" (40 TRACK) SS/DD	199.95
SA 400 5 1/4" (35 TRACK) SS/DD	189.95

### SIEMENS

FD100-8 8" SS/DD (801 REPLACEMENT)	259.00
------------------------------------	--------

### PERTEC

FD-200 5 1/4" SS/DD	179.95
FD-250 5 1/4" DS/DD	199.95

### MPI

MP-52 5 1/4" (FOR IBM) DS/DD	295.00
------------------------------	--------

### RESISTORS

1/4 WATT 5% CARBON FILM ALL STANDARD VALUES FROM 1 OHM TO 10 MEG OHM

50 PCS. SAME VALUE	.025
100 PCS. SAME VALUE	.02
1000 PCS. SAME VALUE	.015

### BYPASS CAPS

.01 UF DISC	100/6.00
.1 UF DISC	100/8.00
.1 UF MONOLITHIC	100/15.00

### POWER SUPPLY MODEL 2 \$39.95

MOUNTED ON PC BOARD MANUFACTURED BY CONVERTER +5 VOLT 4 AMP ±12 VOLT 1 AMP

NOTE: Please include sufficient amount for shipping on above items.

### DIODES

1N751	5.1 volt zener	.25
1N759	12.0 volt zener	.25
1N4148	(1N914) switching	25/1.00
1N4004	400PIV rectifier	10/1.00
KBP02	200PIV 1.5amp bridge	.45
KBP04	400PIV 1.5amp bridge	.55

**WE HAVE THE COMPLETE LINE OF DISC, TANTALUM AND ELECTROLYTIC CAPACITORS IN STOCK!**

### D-SUBMINIATURE

DESCRIPTION	SOLDER		RIGHT ANGLE SOLDER		RIBBON CABLE		HOODS	
	MALE	FEMALE	MALE	FEMALE	MALE	FEMALE	BLACK HOOD-B	GREY HOOD
ORDER BY	DBxxP	DBxxS	DBxxPR	DBxxSR	IDBxxP	IDBxxS		
CONTACTS 9	2.08	2.66	1.65	2.18	3.37	3.69	---	1.60
15	2.69	3.63	2.20	3.03	4.70	5.13	---	1.60
25	2.50	3.25	3.00	4.42	6.23	6.84	1.25	1.25
37	4.80	7.11	4.83	6.19	9.22	10.08	---	2.95
50	6.06	9.24	---	---	---	---	---	3.50

For order instructions see "IDC Connectors" below.

### RIBBON CABLE

CONTACTS	SINGLE COLOR		COLOR CODED	
	1'	10'	1'	10'
10	.50	4.40	.83	7.30
20	.65	5.70	1.25	11.00
26	.75	6.60	1.32	11.60
34	.98	8.60	1.65	14.50
40	1.32	11.60	1.92	16.80
50	1.38	12.10	2.50	22.00

### IDC CONNECTORS

DESCRIPTION	SOLDER HEADER	RIGHT ANGLE SOLDER HEADER	WW HEADER	RIGHT ANGLE WW HEADER	RIBBON HEADER SOCKET	RIBBON HEADER	RIBBON EDGE CARD
ORDER BY	IDHxxS	IDHxxSR	IDHxxW	IDHxxWR	IDSxx	IDMxx	IDExx
CONTACTS 10	.82	.85	1.86	2.05	1.15	---	2.25
20	1.29	1.35	2.98	3.28	1.86	5.50	2.36
26	1.68	1.76	3.84	4.22	2.43	6.25	2.65
34	2.20	2.31	4.50	4.45	3.15	7.00	3.25
40	2.58	2.72	5.28	4.80	3.73	7.50	3.80
50	3.24	3.39	6.63	7.30	4.65	8.50	4.74

ORDERING INSTRUCTIONS: Insert the number of contacts in the position marked "xx" of the "order by" part number listed. Example: A 10 pin right angle solder style header would be IDH10SR.

### VISIT OUR RETAIL STORE

HOURS: M-W-F, 9-5 T-Th., 9-9 Sat. 11-3

PLEASE USE YOUR CUSTOMER NUMBER WHEN ORDERING  
TERMS: For shipping include \$2 for UPS Ground or \$3 for UPS Blue Label Air. Items over 5 pounds require additional shipping charges. Foreign orders, include sufficient amount for shipping. There is a \$10 minimum order. Bay Area and Los Angeles Counties add 6% Sales Tax. Other California residents add 6% Sales Tax. We reserve the right to substitute manufacturer. Not responsible for typographical errors. Prices are subject to change without notice. We will match or beat any competitor's price provided it is not below our cost.

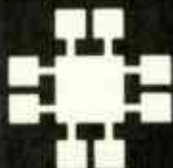

# JDR Microdevices

1224 S. Bascom Ave. • San Jose, CA 95128  
(408) 995-5430 • Telex 171-110

© 1983 JDR MICRODEVICES, INC.

CIRCLE 49 ON FREE INFORMATION CARD

# SPRING APPLE SALE!

## FD-35 DISK DRIVE

By MA Systems

- ★ Direct Replacement for Apple Disk II
- ★ Compatible with Apple Controller or other Apple compatible controllers
- ★ Specially designed electronics with **low power consumption**
- ★ DOS 3.3 and 3.2 compatible
- ★ Owner's Manual and Warranty Card included
- ★ 90-day Warranty

**NEW INTRODUCTORY OFFER**  
**\$229.95**  
 CONTROLLER CARD \$89.95

## APPLE II KEYBOARD \$99.95

From the Keyboard Co.

- ★ Brand New Rev. 7 keyboard — NOT an imitation
- ★ Special Purchase — Supply very limited
- ★ Includes Encoder Board and Cable

## APPLE COMPATIBLE POWER SUPPLY \$99.95

- ★ Compact Switching Design
- ★ All Outputs regulated
- ★ Short Circuit and Overload Protection
- ★ Complete with Apple-type plug-in power cord
- ★ Apple Compatible — Yet higher output allows more disk drives and cards without overheating
- ★ +5V @ 5A, +12V @ 3A, -5V @ .5A, -12V @ .5A
- ★ Shielded enclosure: 10 3/4" x 3 1/2" x 2 3/8"

## VIEWMAX 80

A Full Function 80 column card for Apple II\*

2 YEAR WARRANTY

**\$199.95**

## NEW IMPROVED

## JDR COOLING FAN FOR YOUR APPLE II

- ★ Easy modification — no modification of Apple required
- ★ Eliminates overheating problems
- ★ Switch on front controls fan, Apple, and extra outlet
- ★ Rotron whisper fan is the quietest, most reliable on the market

**NOW WITH SURGE SUPPRESSION**  
**\$69.95**

WITHOUT SURGE SUPPRESSION \$59.95

## INTERFACE CARDS

By Perisoft

### PRINTERLINK \$79.00

- ★ Centronics Standard Parallel Interface for Apple II
  - ★ Simple to use — Yet supports custom driver applications from ROM or Disk
  - ★ Includes card, cable and user's manual
  - ★ 1 Year Warranty
- MESSENGER \$119.00**
- ★ Serial I/O for Apple II
  - ★ Connects virtually any RS-232 serial device
  - ★ 6 switch selectable drivers:
    - 4 printer drivers
    - Terminal Driver — 40 or 80 driver
  - ★ Includes card, cable and user's manual
  - ★ 1 Year Warranty

## OKIDATA PRINTERS

- ★ 120 cps, 9x9 Dot Matrix
- ★ 50% faster than EPSON
- ★ Parallel and Serial interfaces are standard

ML-82A . . . . . \$479.50

ML-83A . . . . . \$699.95

ML-84 PARALLEL . . . \$1059.00

CALL FOR PRICES ON 82A TRACTOR OPTION AND 82A, 83A GRAPHICS OPTION. CABLES AND INTERFACE CARDS AVAILABLE

## JDR 16K RAMCARD

For Apple II\*

- ★ Expand your 48K Apple to 64K
- ★ Fully compatible with Apple Language System — Use in place of Apple Language card
- ★ Provides extra memory for Visicalc™
- ★ Run PASCAL, FORTRAN, Integer Basic with appropriate software
- ★ Highest quality card features: gold edge connector, sockets for all IC's

NOW WITH 2 YEAR WARRANTY

ASSEMBLED & TESTED WITH WARRANTY . . . . . \$44.95

KIT — INCLUDES ALL PARTS & INSTRUCTIONS . . . \$40.95

BARE PC CARD WITH INSTRUCTIONS . . . . . \$14.95

## MONITORS

GREEN PHOSPHOR

NEC JB1201M \$169.00

ZENITH ZVM-121 \$119.00

COLOR

AMDEK COLOR 1 \$335.00

**IF YOU CAN FIND A PRICE LOWER ELSEWHERE, LET US KNOW AND WE WILL MEET OR BEAT THEIR PRICE! (SEE TERMS BELOW)**

## 5 1/4" DISKETTES

ATHANA SS SD SOFT . . . 24.95  
 MEMOREX SS SD SOFT . . . 26.95  
 VERBATIM SS DD SOFT . . . 29.95  
 VERBATIM 10 SECT. HARD 29.95

## NASHUA

TOP QUALITY — LOW PRICE!

Single Sided, Single Density Soft Sected with Hub Ring

**\$19.95 BOX OF 10**

**ORDER TOLL FREE**  
**ALL MERCHANDISE**  
**100% GUARANTEED**

**800-538-5000**

**800-662-6279**  
 (CALIFORNIA RESIDENTS)

**CALL US FOR VOLUME QUOTES**



© 1983 JDR MICRODEVICES, INC.

\* APPLE IS A TRADEMARK OF APPLE COMPUTER CO.

CIRCLE 49 ON FREE INFORMATION CARD

# WHY SPEND A FORTUNE ON A DIGITAL CAPACITANCE METER?

As a matter of fact you don't have to pay \$180 to \$500 and up anymore for a Digital Capacitance Meter that is both dependable and rugged with good accuracy. The MC100A comes completely assembled and calibrated and at \$79.95 is an outstanding value. The extensive range of 30 pF to 9,999 uF (no external meters required) and true hand held portable size (only 4 3/4" x 2 1/2" x 1 1/2") make the MC100A an extremely practical and easy to use instrument for the hobbyist technician or engineer.

## CHECK THESE OTHER FEATURES

\*Basic accuracy 2% (± one count) on pF, nF ranges, 5% (± one count) on uF range.

\*Uses single 9V battery (not included).

\*Decimal points light up when battery is low or when capacitor is overrange.

\*Full 4 digit high efficiency LED display uses special circuitry to save on batteries.

\*Maximum conversion time for 9,999 uF is less than 6 seconds.

\*Constructed with a tough impact resistant plastic case.

\*90 day parts and labour warranty.



**\$79.95**



**DAETRON**  
935 THE QUEENSWAY, BOX 641  
TORONTO, ONTARIO M8Z 5Y9  
(416) 499-7221  
DEALER ENQUIRIES INVITED

### PLEASE SEND ME

(Quantity) MC100A(s) @ \$79.95 U.S. (Canadian residents send \$89.95 CDN.) \$ \_\_\_\_\_

Ontario residents add 7% PST \$ \_\_\_\_\_

Postage — \$2.25 for U.S. \$1.85 for Canada (per instrument) \$ \_\_\_\_\_

I ENCLOSE CHECK  MONEY ORDER  BILL MY VISA TOTAL \$ \_\_\_\_\_

VISA CARD NO. \_\_\_\_\_ EXPIRY DATE \_\_\_\_\_ SIGNATURE \_\_\_\_\_

Immediate shipping on orders with money orders or VISA.

Personal checks please allow 2 to 3 weeks for clearance.

NAME \_\_\_\_\_

ADDRESS \_\_\_\_\_

CITY \_\_\_\_\_ STATE \_\_\_\_\_ ZIP CODE \_\_\_\_\_

MAIL TO DAETRON 935 THE QUEENSWAY BOX 641  
TORONTO ONTARIO M8Z 5Y9

# MICRO MART

508 Central Ave.  
Westfield, N.J. 07090  
(201) 654-6008

## UHF-TV PREAMP

(As featured in Radio Electronics March/May articles, 1982)

This inexpensive antenna mounted preamp can add more than 26 dB of gain to your system. Lots of satisfied customers and repeat orders for this high quality kit, which includes all component parts, PC BD, Case, Power Supply and Belin \$34.50 Assembled Version.....\$67.50

**APPLE Heart Rate Monitor KIT-\$39.95**

**Have Some Fun...Fun...Fun!**  
PROGRAMMABLE MESSAGES  
IN SPACE, with SPACE WRITER  
KIT \$39.50

## Signalman Mark I Modem-\$99

Direct connect modem/RS-232C; Built In interface cable and connector; Light, compact, Bell 103 compatible Data/Voice switch

**BMC-12A, 12" Green Phosphor Monitor \$99**

2N3055 (PRIME).....	2/81
2N3791 (PRIME).....	3/81
555'S (TELEPHONE 355).....	3/81
2714 EPROM (4096).....	83, 85
NPN 4571 (NPN SILICON TRANS).....	10/81
"GODT" SOLDERING IRON (20w).....	89
"GODT" SOLDER BUCKER (works great).....	912
LM1310.....	3/82
CD4047.....	2/83
RF CHOKE 100H 1/2W FIXED.....	3/82
LM1889.....	2/84
BNC "T" CONNECTOR.....	81
20V 1W EXPOXY ZENERS.....	20/81
78L08 (5V REGULATOR).....	5/81
MOTION DETECTOR BOARDS-82 EACH.....	7/81
MOTION DETECTOR IC DUAL.....	20/81
CONDENSER MICROPHONE.....	3/82
9V BATTERIES.....	2/81
1000 PIECE RESISTOR ASSY T 1/2W.....	85
CRYSTALS-1MHz, .02-3.5MHz, .01/6MHz.....	82
2560.0 KC.....	91
.22uF 50V SUB MINI EPOXY DISC.....	20/81
.33uF 100V DIP NYLAR.....	8/81
47uF 25V MINI RADIAL.....	5/81
4.7uF 40V MINI RADIAL.....	10/81
6.8uF 35V BOLD TANTALUM.....	2/81
10uF 50V DIP TANTALUM.....	3/82
3200uF 50V TWIST LOCK.....	3/82
11000uF 50V (CMP GRADE MALLORY).....	82
1000uF 16V TWIST LOCK.....	2/81
VINYL COATED (FIBERGLASS REINFORCED) SLEEVEING-1" LENGTHS, 10 DIAMETERS.....	83
LED HIGH INTENS. RED EMITTER WATER CLEAR LENS) 10/81, 100/87.50, 1000/869	
BATTERY SNAPS.....	5/81
HEAVY DUTY ALLIGATOR CLIPS.....	10/83
LIGHTER WEIGHT CLIPS.....	10/82
74LS174 (PRIME TEXAS INST).....	2/81
VERY LOUD BUZZER.....	2/81
6N75324 IC.....	3/81

LM1391 (PRIME, HOUSE #D).....	3/81
ULN 2001 (UNTESTED).....	10/81
RB333 CONNECTOR (DB-25P-A123).....	83
100K TRIMPOT.....	4/81
10V TRIMPOT.....	4/81
BN7447.....	2/81
BN7492.....	3/81
8N938 2-P IDTL.....	5/81
8P0 85 UHF HIGH GAIN AMP.....	2/83
WINGARD KU20 UHF ANT, 48AY BOWTIE25 CONNECTOR FOR RIBBON CABLE 34 PIN.....	82
8243 16 LINE I/O EXTENDER CHIP.....	85
7805, 7812, 7905, 7912 MIX/HATCH.....	4/85
AM/FM RADIO IC (UNTESTED) W/SPECS 10/83	
MULTI-IN TAP/BAND-10K, 100K, 1M.....	3/82
IC BOX (STORES & LABELS IC'S).....	82
DIP SWITCHES-4, 6, 8 MIO POS.....	2/83
TV KN088.....	10/81
8888888888 COLOR MONITOR.....	8305888888
Voltage-Rate (switching regulator kit with adjustable DC/DC voltage conversion. Output voltages-24 to +30VDC, 3 op. modes) step-up, down/inversion -819	
CHIP CAPS (SET OF 4, 2EACH 2.7x3.3pf) 83	
FPA104 INFRARED EMITTER/SENSOR.....	89
MINIATURE SPEAKER (1 1/2").....	2/81
DKIDATA EPSON CENTRONICS PRINTERS/TEL CONVENIENCE PAPER PAKS, CDNT. ROLL	
TEAR AWAY RAZOR EDGE, 1K SHEETS.....	816
LOWEST PRICES EVER IN DISKETTES/CALL TEK TOOL ZERO INSERTION IC TEST SOCK-ET-18 14 PIN-89.....	16 PIN-810
475uF 470uF 1KV DISC (NICE 812E) 20/81	
LM380 (ULN2281).....	3/81
UDN7180 GAS DISCHARGE DIRF/DRVR.....	3/83

**MICRO-CONTROLLER BOARD (KIT \$99.50)**

Terms: MICRO-MART accepts Visa, MC and telephone COO's. Minimum order \$10.00. Shipping—U.S. orders, \$2.00. Canada and other countries \$3.50 (includes ins.). Shipping rate adjusted where applicable. NJ residents add 5% sales tax.

**MICRO-MART • 508 CENTRAL AVE., WESTFIELD, NJ 07090 • (201) 654-6008**

CIRCLE 12 ON FREE INFORMATION CARD

## MICROWAVE TV ANTENNA SYSTEMS

Freq. 2.1 to 2.6 GHz • 34 db Gain +

### COMPLETE SYSTEMS

(as Pictured)  
Commercial 40"

Rod Style \$109.95

Parabolic 20"

Dish Style \$ 99.95

### COMPONENTS

Down Converters  
(both types) \$ 34.95

Power Supplies  
(12V to 16V) \$ 24.95

Data Info (Plans) \$ 9.95

CALL OR WRITE FOR  
KITS, PARTS, INDIVIDUAL  
COMPONENTS

We Repair All Types Down  
Converters & Power Supplies

**Phillips-Tech  
Electronics**

P.O. Box 34772  
Phoenix, AZ 85067  
(602) 265-8255

Special Quantity Pricing  
Dealers Wanted



# KCS

## ELECTRONICS CORPORATION

### SEMICONDUCTOR PARTS & PRODUCTS

#### FACTORY PRIME DEVICES INCLUDE:

- Capacitors
- all types & styles
- Chokes & Coils
- Connectors
- Digital & Linear IC's
- Hardware & Accessories
- IC Sockets
- Memory
- Microwave Semiconductors
- Resistors
- fixed & variable
- Transformers
- Transistors & MORE!

MANUFACTURERS SUCH AS: Motorola, National, NEC, J.W. Miller, Texas Instruments and more!

WE STOCK & SUPPLY DEVICES FOR: OEM's, Distributors, Hobbyists, Magazine Projects, Engineers, Schools, Technicians & You!

Call or Write for Quantity Pricing  
and FREE Catalog.

P.O. Box 33205  
Phoenix, AZ 85067 **(602) 274-2885**

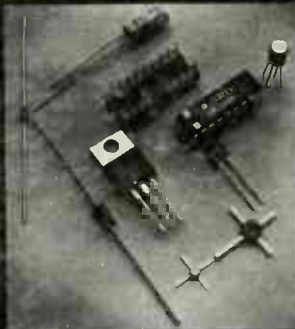



# POPULAR TELEVISION CIRCUITS

## SINE WAVE SUPER BOARD

- ★ NO Internal Connection to T.V.
- ★ Continuous Audio/Video Modulation
- ★ AGC FOR STABILITY
- ★ Quality Circuit Board
- ★ Silk Screened Parts Layout
- ★ Fully Illustrated Instructions
- ★ Quantity Discounts Available



- P.C. Board and Plans \$30.00 + Ship. & Hand. \$3.00
- All Parts, and Wood Grained Cabinet \$129.00 + Ship. & Hand. \$5.95
- P.C. Board, Plans, All Parts and Wood Grained Cabinet \$149.00 + Ship. & Hand. \$5.95

## ZENITH M1

09-151-03

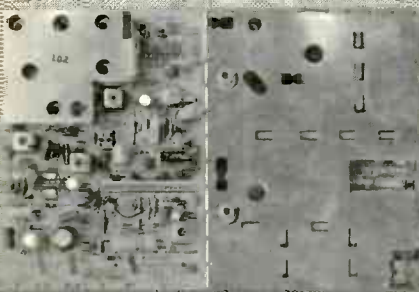

- ★ No Internal Connection to T.V.
- ★ Continuous Audio/Video Modulation
- ★ AGC FOR STABILITY
- ★ Quality Circuit Board
- ★ Fully Illustrated Instructions
- ★ Quantity Discounts Available

- FV-5 Board and Plans \$30.00 + Shipping & Handling \$3.00
- All Parts, Wood Grain Cabinet \$149.95 + Shipping & Handling \$5.95
- P.C. Board, Plans, All Parts, Wood Grain Cabinet \$169.95 + Shipping & Handling \$5.95

## FV-5

Phase Video/Sync. Suppression

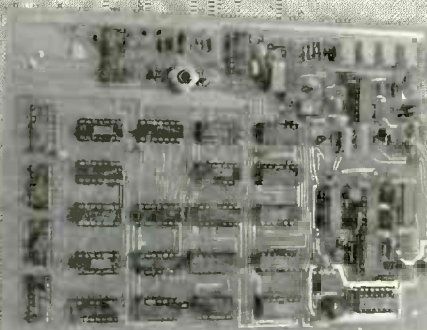

## MICROWAVE PROBE KIT

P.C. Board, Microwave Transistors, All Parts and Plastic Housing

Complete \$24.95 + Shipping & Handling \$3.00

Power Supply Complete Kit \$19.95 + Shipping & Handling \$3.00



- ★ COMPLETE REPAIR SERVICE ON ALL ITEMS
- ★ AVAILABLE BY MAIL ORDER ONLY
- ★ SEND FOR INFORMATION ON OTHER KITS
- ★ HOBBY USE ONLY, NOT FOR UNAUTHORIZED RECEPTION OF T.V. SIGNALS



CERTIFIED FUNDS AND MONEY ORDERS SHIPPED IMMEDIATELY. PERSONAL CHECKS HELD FOR 2 WEEKS FOR CLEARANCE. MASTERCARD, VISA/UPS/C.O.D.



INFO PHONE: (602) 829-6700

ORDERS ONLY: (800) 243-6700

**FREE** THE WORLD FAMOUS **ETCO** CATALOG OF ELECTRONICS

• VIDEO  
• TELEPHONE  
• CABLE TV  
• PARTS  
• AUDIO  
• ELECTRONICS  
• and much, much more!

1000's OF FASCINATING FACTORY CLEAROUTS, SURPLUS SPECIALS AND BARGAIN OFFERS NOT FOUND IN STORES OR CATALOGS ANYWHERE!

**LOW PRICES**

**ETCO ELECTRONICS**  
DEPT. 591  
Mailing List Control Center  
Box 840  
Champlain, N.Y. 12919

**NOW 112 PAGES**

I Enclose \_\_\_\_\_ (cash OK);  
Please rush postpaid

\$1 for 1 year subscription to the world famous ETCO catalog.  
 \$3 Canadian & Foreign 1 year subscription to the ETCO catalog.  
 304 page handbook "BUILD YOUR OWN EARTH STATION". (TA025) \$10.00  
 360 pages MASTER HANDBOOK OF TELEPHONES. (TA001) \$11.00  
 FREE - sample copy of the bargain packed ETCO catalog. (USA only)

Name \_\_\_\_\_  
Address \_\_\_\_\_  
City \_\_\_\_\_  
State \_\_\_\_\_ Zip \_\_\_\_\_

**CIRCLE 50 ON FREE INFORMATION CARD**

**HIGH QUALITY 55 dB GAIN**

# MICROWAVE TV SYSTEM

Variable from 1.9 to 2.5 GHz



The latest advance in microwave technology with a **SNOW-FREE PICTURE.**

Introductory **SPECIAL**

## \$124.95

Includes Tax and Shipping

**THIS UNIT COMES COMPLETE WITH:**

- 20" Fiberglass Parabolic Dish
- Pre-Assembled Probe with Down Converter
- Power Supply and Coax Switch
- 60' of RG-59/U Coax with Connector
- Transformer for 75 to 300 Ohms
- All Mounting Hardware for Fast and Easy Installation

Send Cashiers Check or Money Order to:  
(Personal Checks, allow 2-5 weeks to clear)

**PROFESSIONAL VIDEO, Inc.**  
4670 Hollywood Blvd., Hollywood, Calif. 90027  
219-0227  
352-9681

For C.O.D. Orders Call (213)

**CIRCLE 43 ON FREE INFORMATION CARD**

# AMAZING DEVICES

**PHASORS**

**PHASOR PAIN FIELD** — Patented and recently developed in our labs is being tested by Gov't for riot control. Soon to come under weapons restrictions as an internal machine. Easily hand-held. Hazardous IF NOT USED WITH DISCRETION.  
PPF-1 PLANS (sold for animal control) \$15.00

**INVISIBLE PAIN FIELD GENERATOR** — Produces a directional field of moderately intense pain to back of head up to 50'. Cigarette pack size enclosure is easily hidden.  
IPG-3 PLANS \$7.00 IPG-3K KIT & PLANS \$44.50  
IPG-30 (assembled for animal control) \$59.50

**PHASOR STUN/BURNING WAND** — Produces sufficient electrical energy capable of burning flesh. Intended as a personal defense device.  
PSW-3 PLANS \$8.00 PSW-3K KIT & PLANS \$59.50

**LASERS**

**RUBY LASER RAY PISTOL** — Intense visible red, burns, hazardous, with parts sources.  
RUBY PLANS (includes all part sources) \$15.00

**CARBON DIOXIDE LASER** — Generates 20-40 watts of continuous power capable of burning, cutting, hazardous. (with all part sources) \$15.00

**LASER RIFLE** — Produces 200-3000 pulses of 30 watt optical energy. Portable and easily hand-held.  
LRG-3 PLANS \$10.00  
LRG-3K KIT PLANS (minus diode) \$129.50

**POCKET LASER** — For the beginner, visible red "optical version", non-hazardous.  
LHC-2 \$5.00 LHC-2K KIT & PLANS \$24.50

**HIGH POWERED PORTABLE ENERGY SOURCE FOR LASERS AND MAGNETIC WEAPONS** — Exploding wires, shockwave, etc. Miniature size.  
HPS-1 PLANS \$8.00 HPS-1K KIT & PLANS \$49.50

**PARTICLE BEAM WEAPON** — PLANS \$15.00

**SECURITY**

**INFINITY XMTR** — Uses telephone lines for selective home or office listening while away on business or vacation.  
INF-1 PLANS \$15.00

**SEE IN DARK** — Long range, total darkness.  
SD-4 PLANS \$10.00

**LONG RANGE WIRELESS MIKE** — Crystal clear quality — miniature.  
FBT-7 PLANS \$7.00 FBT-7K PLANS & KIT \$34.50

**WIRELESS TELEPHONE TRANSMITTER** — Long range, automatic.  
VWPM-5 PLANS \$10.00 VWPM-5K PLANS & KIT \$34.50

Send for **FREE** catalog description of above plus hundreds more plans, kits and completed items. We accept MC or Visa or when ordering, send check or money order. We pay shipping charges on orders over \$50.00, otherwise include 10% with remittance.

SEND TO: **SCIENTIFIC SYSTEMS**  
DEPT. R8, BOX 716, AMHERST, N.H. 03031

**OVER 70,000 ITEMS IN STOCK**

**VISA** **DISCOUNT PRICES** **MasterCard**

**ON ALL MAJOR INDUSTRIAL AND PERSONAL ELECTRONICS**

**PANASONIC**

**KX-T3820 CORDLESS**  
700' Cordless Range • Auto Redial • Auto Dial Lock Switch • 2-Band Frequency And Tone/Pulse Selector • Built-in Recharger • 2-Way Paging • Standby/Talk • Pause • Base And Handset LED Indicators

**\$141.25**

**GTE**

**LINEAR TELEPHONE UNIVERSAL DIALING KEYSET**  
Unique Linear Keypad Arrangement • UDK Provides Pushbutton Operation On Most Private Lines • Auto Redial • Call Hold • 3 Position Electronic Tone Ringer • Fully Modular

**\$48.00**

**LINEAR TELEPHONE TOUCH GALL KEYSET**  
**\$53.00**

**KEITHLEY**

**132C**  
Temp. Gauge  
-20°C To 1370°C • 1°C Resolution • DCV • TRMS AC Volts • DC Amps • Resistance And Diode Test • Drop Proof •  
**\$177**

**132F**  
Temp Gauge  
0°F To 2000°F • 1°F Resolution • All Features Of 132C  
**\$185.70**

**8024B**  
3 1/2 Digit • 11 Functions • 0.1% DC Accuracy • Safety Designed Test Leads  
**\$217**

**8062A**  
4 1/2 Digit • Full Functions And Ranges • True RMS to 30 kHz • 0.05% DC Accuracy  
**\$244**

**FLUKE**

**LX-306**  
3 1/2 Digit • New VARI-PITCH Full Function, Variable Audible Tone • 0.25% Accuracy • AC/DC Volts • AC/DC Current • Resistance And Diode Test • Low Battery Indicator • Sustains 4' Drop  
**\$139**

**WELLER SOLDERING TOOLS**

**WTCPN Soldering Station**  
Closed Loop • Auto Temp • Lightweight • Pencil Iron • \$72.95

**7200 Soldering Iron**  
Lightweight • Fingerprint Trigger • Self Support Back • \$10.99

**7200 Standard Soldering Gun**

**XCELITE TOOL CASES**

TC Series With Wide Range Of Tools • Sturdy-Spacious • Professional • Solid Wood Frame • Classico Cover

TC-100 \$346.95  
TC-150 279.99  
TC-200 178.75

**REVERSE RTR-1 VHF TRANSMITTER/RECEIVER**  
2 Required • 2-Way Hands Free Radio Communication • Rugged • Lightweight • 400-800 Meters Range  
**\$39.95**

**PANAVISE ELECTRONIC WORK CENTER 324**  
Keeps Everything At Hand • Holds Up To 10" Board • 6 Compartment Tray Base • Solder Iron Holder • Stable  
**\$38.00**

**TOTAL ELECTRONICS CENTER • LOWER PRICES • IMMEDIATE DELIVERY**

# WM. B. ALLEN SUPPLY COMPANY, INC.

**800 535-9593** 1601 BASIN STREET, NEW ORLEANS, LA 70116 LOUISIANA TOLL FREE 800 462-9520 **800 535-9593**

**CIRCLE 26 ON FREE INFORMATION CARD**

RADIO-ELECTRONICS 132

# SJB DISTRIBUTORS. THE MOST COMPETITIVE PRICES ON COMMODORE.

## **commodore**

### NEW COMMODORE PRODUCTS

CBM 128-40	\$ 695
CBM C128-80	795
CBM B700	2990
CBM 1520 Plotter	169
CBM 1701 Color Monitor	269
B Series Software	Call
CBM 4023 Printer	399

### SOFTWARE FOR CBM 64

Word Processing (WordPro 3*)	\$ 69
M File Database (merge with Word Pro)	89
Quick Brown Fox	56
Writer's Assistant (easy and flexible)	99
File Assistant (database with merge)	99
Spreadsheet Assistant	99
Pers. Finance Assist. (great reports)	45
Basicalc (Spreadsheet)	55
Coco II (build your own games easily)	45
Calc Result	125
General Ledger, A/R, A/P (with check writing)	ea. 139
CBM EasyFinance	50
CBM EasyScript	80
CBM EasyFile	80
Data Manager	70
Stock (investment analysis)	80
Pet Emulator (emulates 4.0 basic)	30
Sprite-Master	29
Assembler Package (cassette or disk, compiled, includes editor, loader, disassembler)	39
Spacebeff	20
Retroball	34
ZWARK	25

### INTERFACES & ACCESSORIES

80 Column Expander	\$159
VIC 1600 Modem	95
VIC 1650 (auto answer, auto dial)	150
VIC 1525 Graphic Printer	329
VIC 1530 Datasette Recorder	65
VIC 1541 Disk Drive	329
VIC Switch (connect 8 64's or Vics to printer, dd)	149
PET-IEEE cable	33
IEEE-IEEE cable (2m)	43
Parallel Interface (Epson, Okidata, IDS, NEC)	80
RS-232 Printer Interface (Okidata, Diablo, etc.)	60
Programmers Reference Guide	18
Verbatim Diskettes (10 per box)	26
Victree (Programmers Utility)	75

### VIC PRODUCTS & ACCESSORIES

8K RAM Memory Expansion Cartridge	\$ 40
16K RAM	70
24K RAM	105

VIC 3 Slot Expander	27
VIC 6 Slot Expander	70
RS-232 Printer Interface	65
Cassette Interface	30
Golf (64 also)	30
Omega Race	30
Arcade Joystick - Heavy duty w/2 firing buttons! Great for the VIC or 64	25

### MONITORS - GREAT RESOLUTION (64 OR VIC)

Amdek Color I	\$ 299
Amdek II or III	call
Panasonic CT160	279
Comrex 6500 - 13" Color	299
Transtar 20 (High Resolution Green Phosphor)	129
Video/Audio Cable	15

### PRINTERS - LETTER QUALITY

CBM 8300, 40 cps	\$1450
Diablo 620, 25 cps	949
ComRiter, 17 cps	819
Transtar 130, 16 cps (auto load, wp features!)	769
NEC 7700 series	2350
NEC 3500 series	1600

### PRINTERS - DOT MATRIX

CBM 8023, 150 cps/graphics	589
Epson FX Printer, 160 cps	549
Epson MX-80FT	459
Epson MX-80 w/Graftrax	349
CBM Graphics for Epson	65
Okidata 82A, 120 cps (serial and parallel)	429
NEC 8023A (parallel)	429
Okidata 92	559
Star Gemini, 10	329
Star Gemini, 15	499

### COMMODORE BUSINESS SERIES

SuperPet (5 languages, 2 processors)	\$1409
CBM 8032 Computer, 80 Column	1029
CBM Memory Expansion, 64K	359
CBM 8050, 1 mg. Dual Drive	1259
CBM 8250, 2 mg. Dual Drive	1395
CBM D9060, 5 mg. Hard Disk	1995
CBM D9090, 7.5 mg. Hard Disk	2295
CBM 2031, 170K Single Drive (New)	489
DC Hayes Smart Modem	220

### BUSINESS SOFTWARE

WordPro 4+ or 5+	\$ 309
Administrator	489
VisiCalc (expanded)	199
The Manager (database)	199
BPI A/R, G/L, Job Cost, Inventory, Payroll	ea. 325

### MasterCard, Visa, Money Order, Bank Check

COD (add \$5) accepted.  
Add 3% surcharge for credit cards.  
In stock items shipped within 48 hours,  
F.O.B. Dallas, Texas  
All products shipped with manufacturer's  
warranty.

Prices are subject to change without notice.

**TO ORDER  
CALL TOLL FREE  
800-527-4893  
800-442-1048  
(Within Texas)**

Business Hours  
Mon.- Fri. 8 to 6, Sat. 10-2

Write for free catalog.

### GAME OF THE MONTH

Adventu-Writer (make your  
own adventure game) ..... 39

### PRODUCT OF THE MONTH

INTERPOD (intelligent IEEE  
RS232, serial interface  
for VIC or C64) ..... \$ 179



### SJB DISTRIBUTORS INC.

10520 Plano Road, Suite 206  
Dallas, Texas 75238  
**(214) 343-1328**

# Electronics Paperback Books

## Quality Paperbacks at Affordable Prices



- 30 SOLDERLESS BREADBOARD PROJECTS BOOK-1.** \$5.75. Whenever possible the same parts are used in several projects. Even a first-time builder can complete these circuits.
- HOW TO GET YOUR ELECTRONIC PROJECTS WORKING.** \$5.00. Helps you troubleshoot and repair home-built projects of every description.
- MINI-MATRIX BOARD PROJECTS.** \$5.00. A variety of projects that can all be built upon a mini-matrix board that has 10 strips and is 24 holes long.
- MODERN OP-AMP PROJECTS.** \$6.00. Wide range of specialized op-amp circuits including ultra-noise, low-distortion, ultra-high input impedance, etc.
- MULTI-CIRCUIT BOARD PROJECTS.** \$5.00. 21 fairly simple projects that can all be built on a single printed-circuit board. All are powered by a 9V battery.
- IC PROJECTS FOR BEGINNERS.** \$5.00. Inexpensive digital and linear IC's are used to assemble this selection of circuits intended for the beginner.



- ART OF PROGRAMMING THE 1K ZX81.** \$6.25. Topics include full screen, scrolling, PEEK & POKE, plus actual working programs.
- THE 6809 COMPANION.** \$5.00. Written for the average assembly language programmer. A discussion of 6809 features & reference work for the 6809 programmer.
- PRACTICAL COMPUTER EXPERIMENTS.** \$4.50. Fills in background to microprocessor by constructing typical computer circuits using discrete logic components.
- ART OF PROGRAMMING THE 1K ZX81.** \$5.00. How to use the features of the ZX81 in programs that fit the 1K machine and are still fun to use.
- INTRODUCTION TO BASIC PROGRAMMING TECHNIQUES.** \$5.00. Based on author's own experience in learning BASIC and helping others to learn to program.
- A MICROPROCESSOR PRIMER.** \$4.50. Painless approach to computing for the beginner. Step-by-step explains computer operations and assembly.

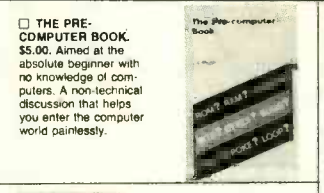

- THE PRE-COMPUTER BOOK.** \$5.00. Aimed at the absolute beginner with no knowledge of computers. A non-technical discussion that helps you enter the computer world painlessly.
- AN INTRODUCTION TO VIDEO.** \$5.00. Perfect for the person just about to buy a VCR. Discusses pros & cons of the various formats; video discs; videotext, tape copying and more.
- PRACTICAL ELECTRONIC BUILDING BLOCKS—Book 1.** \$5.00. All electronics circuits consist of simple building blocks. When you know how to make the blocks you can easily create your own projects.
- FIRST BOOK OF TRANSISTOR EQUIVALENTS & SUBSTITUTES.** \$3.75.
- PRACTICAL COMPUTER EXPERIMENTS.** \$4.50.
- ELECTRONICS SIMPLIFIED CRYSTAL SET CONSTRUCTION.** \$4.50.
- ELECTRONIC HOUSEHOLD PROJECTS.** \$4.50.

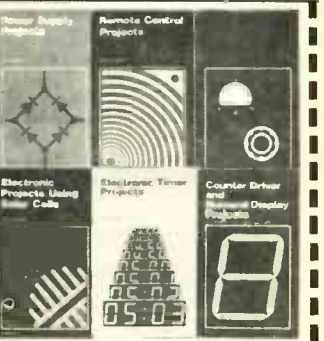

- POWER SUPPLY PROJECTS.** \$4.50. Contains designs and construction details for almost any power supply the experimenter is likely to need.
- REMOTE CONTROL PROJECTS.** \$5.00. Radio-control infra-red, visible light, & ultrasonic systems are all included, along with methods of applying them.
- ELECTRONIC TEST EQUIPMENT CONSTRUCTION.** \$4.50. Construction details of a wide range of test equipment the experimenter can build at home.
- ELECTRONIC PROJECTS USING GAME COINS.**
- ELECTRONIC TIMER PROJECTS.** \$5.00. Timing circuits for almost any application the experimenter might need. A most valuable reference.
- COUNTER DRIVER & NUMERICAL-DISPLAY PROJECTS.** \$4.50. Features applications & projects using various types of numerical-display devices.



- PRACTICAL ELECTRONICS CALCULATIONS AND FORMULAE.** \$7.50. A basic reference work that bridges the gap between complicated technical theory & cut and tried methods.
- INTERNATIONAL DIODE EQUIVALENTS GUIDE.** \$5.75. Helps you find substitutes for the many different types of semiconductor diodes in use today.
- INTERNATIONAL TRANSISTOR EQUIVALENTS GUIDE.** \$7.50. Products of more than 100 manufacturers are listed & cross-referenced with possible replacements.
- HOW TO MAKE WALKIE TALKIES.** \$5.00. Describes equipment for low-power handheld operation with 112 pages of must reading for the dedicated experimenter.
- ELECTRONIC CALCULATOR USERS HANDBOOK.** \$3.95. Presents formulae data, methods of calculation, conversion factors & more from the view of the calculator user.
- LINEAR IC EQUIVALENTS AND PIN CONNECTIONS.** \$8.25. Shows equivalents & pin connections of a popular user-oriented selection of linear IC's.

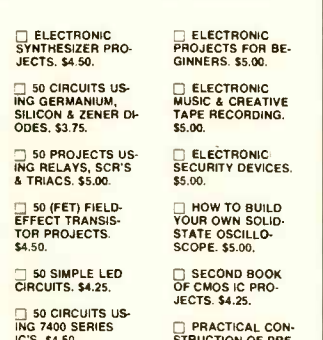

- ELECTRONIC SYNTHESIZER PROJECTS.** \$4.50.
- 50 CIRCUITS USING GERMANIUM, SILICON & ZENER DIODES.** \$3.75.
- 50 PROJECTS USING RELAYS, SCR'S & TRIACS.** \$5.00.
- 50 (FET) FIELD-EFFECT TRANSISTOR PROJECTS.** \$4.50.
- 50 SIMPLE LED CIRCUITS.** \$4.25.
- 50 CIRCUITS USING 7400 SERIES IC'S.** \$4.50.
- 50 SIMPLE LED CIRCUITS BOOK 2.** \$3.95.
- PROJECTS USING 555 IC'S.** \$5.00.
- PROJECTS USING LM3900 IC'S.** \$4.75.
- RADIO CONTROL FOR BEGINNERS.** \$4.50.
- ELECTRONIC GAMES.** \$4.50.
- SINGLE IC PROJECTS.** \$4.25.
- RADIO CIRCUITS USING IC'S.** \$4.50.
- ELECTRONIC PROJECTS FOR BEGINNERS.** \$5.00.
- ELECTRONIC MUSIC & CREATIVE TAPE RECORDING.** \$5.00.
- ELECTRONIC SECURITY DEVICES.** \$5.00.
- HOW TO BUILD YOUR OWN SOLID-STATE OSCILLOSCOPE.** \$5.00.
- SECOND BOOK OF CMOS IC PROJECTS.** \$4.25.
- PRACTICAL CONSTRUCTION OF PRE-AMPS, TONE CONTROLS, FILTERS AND ATTENUATORS.** \$3.75.
- BEGINNERS GUIDE TO DIGITAL TECHNIQUES.** \$3.75.
- ELECTRONIC HOUSEHOLD PROJECTS.** \$4.50.
- ELECTRONIC MUSIC PROJECTS.** \$4.50.
- POPULAR ELECTRONIC PROJECTS.** \$3.75.
- PROJECTS IN OPTO-ELECTRONICS.** \$5.00.



- ANTENNA PROJECTS.** \$5.00. Covers practical antenna designs including active, loop & ferrite types that are easy & inexpensive to build.
- RADIO STATIONS GUIDE.** \$4.75. Comprehensive listing of transmitters around the world. Presents location, frequency, power.
- LONG DISTANCE TELEVISION RECEPTION (TVDX) FOR THE ENTHUSIAST.** \$5.00. Practical & authoritative introduction to this unusual aspect of electronics.
- CB PROJECTS.** \$5.00. A number of useful and interesting designs for CB accessories. Speech processor, interference filter & more.
- CRYSTAL SET CONSTRUCTION.** \$4.50. Packed full of easy to duplicate designs for crystal radio receivers.
- AN INTRODUCTION TO RADIO DXING.** \$5.00. Listen, in your home, to broadcasts originating thousands of miles away. Tells how you can do it.

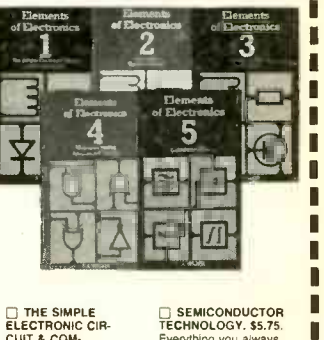

- THE SIMPLE ELECTRONIC CIRCUIT & COMPONENTS.** \$5.75. All the fundamental theory needed to lead to a full understanding of the simple electronic circuit and its components.
- ALTERNATING CURRENT THEORY.** \$5.75. Alternating current theory without which there can be no comprehension of speech, music, radio, or Television.
- MICROPROCESSING SYSTEM & CIRCUITS.** \$7.50. A truly comprehensive guide to all of the elements of a microprocessing system.
- SEMICONDUCTOR TECHNOLOGY.** \$5.75. Everything you always needed to know about solid-state devices in one volume.
- COMMUNICATIONS.** \$7.50. Covers most modern communication systems. Line, microwave, submarine, satellite, digital multiplex, radio & telegraphy.
- FIRST BOOK OF HI-FI SPEAKER ENCLOSURES.** \$4.50.
- SOLID STATE NOVELTY CIRCUITS.** \$3.50.
- 28 TESTED TRANSISTOR PROJECTS.** \$4.25.

**ELECTRONIC TECHNOLOGY TODAY INC.**  
P.O. Box 83, Massapequa Park, NY 11762

Number of books ordered

Total Price of Books .....\$.....

Sales Tax (NY State Residents) .....

Shipping (75¢ 1st two books, 30¢ ea additional) .....

TOTAL ENCLOSED .....\$.....

Name.....

Address.....

City..... State..... ZIP.....

**Prices good until August 30, 1983**

RADIO-ELECTRONICS JULY 1983



## AMATEUR MICROWAVE TV ANTENNA'S

1.9 to 2.5 GHz Frequency Range  
50 db System Gain

Complete System (Rod Style as pictured, 25 db Gain)

PS-3 assembled, tested ..... \$79.95  
PS-3 kit form ..... \$64.95

Complete System (Dish Style as pictured, 50 db Gain)

PS-5 assembled, tested ..... \$109.95  
PS-5 kit form ..... \$79.95

All systems come complete with Accessory package of

- Control Box
- 60' Coax Cable
- Mounting Hardware
- Matching Transformer
- Instructions
- 90 Day Warranty

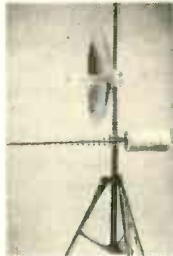

### S.E.I., Inc.

912 West Touhy Ave. • Park Ridge, IL 60068  
To Order Call: 1-800-323-1327 Out of State  
1-312-564-0104 In Illinois  
For Information Call: 1-312-564-0104  
C.O.D.'s Accepted • Special Quantity Pricing  
Dealers Wanted

5% shipping and handling, 10% for out of Continental U.S.



## OUR ISOLATORS FOR YOUR PROTECTION

Prevents:

disk drive woes,  
printer interaction,  
memory loss and damage due to lightning  
or AC power line disturbances.



Commercial Grade Isolator  
ISO-1 3 Isolated Sockets... \$76.95

Industrial Grade Isolator  
ISO-3 3 Double Isolated Sockets... 115.95

Laboratory Grade Isolator  
ISO-17 4 Quad Isolated Sockets... 200.95

Circuit Breaker  
any model (Add-CB)... Add 10.00  
Remote Switch  
any model (Add-RS)... Add 18.00

ESP. Electronic Specialists, Inc.

171 S. Main St., Box 389, Natick, MA 01760

Toll Free Order Desk 1-800-225-4876  
MasterCard, VISA, American Express

## ELECTRONIC KITS FROM HAL-TRONIX

2304 MHZ DOWN CONVERTERS. TUNES IN ON CHANNELS 2 TO 7 ON YOUR OWN HOME T.V. HAS FREQUENCY RANGE FROM 2000 MHZ TO 2500 MHZ. EASY TO CONSTRUCT AND COMES COMPLETE WITH ALL PARTS INCLUDING A DIE-CAST ALUM CASE AND COAX FITTINGS. REQUIRE A VARIABLE POWER SUPPLY AND ANTENNA (Antenna can be a dish type or coffee can type depending on the signal strength in your area.)

2304 MOD 1 (Basic Kit) \$19.95  
(Less case & fittings)

2304 MOD 2 (Basic/Pre-amp) \$29.95  
(less case & fittings)

2304 MOD 3 (Hi-Gain Pre-amp) \$39.95  
(Includes case & fittings)

POWER SUPPLY FOR EITHER MODEL ABOVE IS AVAILABLE. COMES COMPLETE WITH ALL PARTS, CASE, TRANSFORMER, ANTENNA SWITCH AND CONNECTORS (Kit) \$24.95  
Assembled..... \$34.95  
Slotted Microwave Antenna For Above Downverters..... \$39.95

### PREAMPLIFIERS

HAL PA-19—1.5 mhz to 150 mhz. 19db gain operates on 8 to 18 volts at 10ma. Complete unit \$8.95.

HAL PA-14—3 mhz to 1.4 ghz. 10 to 12 db gain operates on 8 to 18 volts at 10 ma. Complete unit \$12.95.

(The above units are ideal for receivers, counters, etc.)

16 LINE TOUCH TONE DECODE KIT WITH P.C. BOARD AND PARTS..... \$69.95

12 LINE TOUCH TONE DECODER KIT WITH P.C. BOARD AND PARTS..... \$39.95

16 LINE ENCODER KIT, COMPLETE WITH CASE, PAD AND COMPONENTS..... \$39.95

12 LINE ENCODER KIT, COMPLETE WITH CASE, PAD AND COMPONENTS..... \$29.95

Complete Sets of P.C. Boards Available For: Unicorn Robot Project and Heart-A-Matic Project.  
MANY, MANY OTHER KITS AVAILABLE

Send 20 cents stamp or S.A.S.E. for information and flyer on other HAL-TRONIX products. To order by phone: 1-313-285-1782.



HAL-TRONIX

P.O. Box 4101

Southgate, MI 48195

SHIPPING INFORMATION. ORDERS OVER \$25.00 WILL BE SHIPPED POSTPAID EXCEPT ON ITEMS WHERE ADDITIONAL CHARGES ARE REQUIRED. ON ORDERS LESS THAN \$25.00 PLEASE INCLUDE ADDITIONAL \$4.00 FOR HANDLING CHARGES.

CIRCLE 75 ON FREE INFORMATION CARD

CIRCLE 55 ON FREE INFORMATION CARD

CIRCLE 6 ON FREE INFORMATION CARD

Order Line  
800-435-0907  
(outside Calif.)  
Please use for  
orders only

RANA Systems  
Apple Drives

\$395.00 w/controller  
\$295.00 w/o controller

SUPER 3.5amp POWER SUPPLY  
for APPLE → \$82.00 ☆

Diskette Storage BOX

5 1/4 in. > 5/8" : 8 in. > 5/8"  
\$2.50 ea. \$10.00 : \$3.50 : \$15.00

Bare Bones APPLE II  
EURO

w/o Keyboard = 48K RAM =

w/o Pwr. Supply \$399.

Microswitch: Power Supply: APPLE  
Keyboard : w/ Purchase : Reference Manl.  
\$ 75.00 : \$ 79.00 : \$ 18.00

## CONCORD COMPUTER PRODUCTS

2910 B E LA PALMA  
ANAHEIM CA 92806  
(714) 632-6790 CHECK-M-O

10 MIN. ORD. IN CALIF. RES. ADD. 5% ALLOW. 10% DISC. 10% PERSONAL CHECK. S. SERV. freight \$10-49 → \$200-1250-499 → \$900 send \$100 50-99 → 490 500-999 → 1100 for 100-740-890 1000-UP → Call catalog

MONITORS ☆ ☆  
ZENITH # ZVM-121

12in. 15MHz./GREEN Phos.  
→ \$94.00 ☆

BMC # BM-12EUN  
12in 20 MHz./GREEN Phos.  
Non-Glare Screen  
→ \$134.00 ☆

BMC # BM1401RGB  
13in. "RGB" COLOR  
with Apple interface!!  
→ \$425.00 ☆

EPROMS  
1702 3.95 2716 3.25 2732 4.95 2532 8.25 2764 12.50 4558 1.75  
2708 3.95

Diskette SALE!!  
"Wabash"

5 1/4 8inch  
SS/SD \$17.50 \$20.00

soft SS/DD 27.40 30.40

DS/SD 0 34.90

DS/DD 32.40 37.40

74LS		74LS55		74LS139		74LS194		74LS299		LM500H	
74LS90	21	74LS73	36	74LS145	1.15	74LS195	85	74LS233	4.55	LM501H	35
74LS92	24	74LS74	35	74LS147	1.75	74LS196	75	74LS232	1.05	LM507H	45
74LS93	24	74LS75	38	74LS148	1.35	74LS197	75	74LS231	1.05	LM508AN	2.25
74LS94	20	74LS76	38	74LS151	55	74LS201	95	74LS235	45	LM510H	1.45
74LS95	20	74LS77	42	74LS153	50	74LS240	95	74LS236	45	LM511	50
74LS96	24	74LS78	42	74LS154	1.75	74LS241	95	74LS237	75	LM511A	3.85
74LS97	24	74LS79	48	74LS154	1.75	74LS241	95	74LS238	75	LM516H	1.45
74LS98	20	74LS80	50	74LS154	1.75	74LS241	95	74LS239	75	LM517K	3.85
74LS99	24	74LS81	50	74LS154	1.75	74LS241	95	74LS240	95	LM518H	1.45
74LS100	24	74LS82	50	74LS154	1.75	74LS241	95	74LS241	95	LM522	1.55
74LS101	24	74LS83	48	74LS154	1.75	74LS241	95	74LS241	95	LM523K	4.95
74LS102	24	74LS84	50	74LS154	1.75	74LS241	95	74LS241	95	LM524	55
74LS103	24	74LS85	80	74LS154	1.75	74LS241	95	74LS241	95	LM529	99
74LS104	24	74LS86	30	74LS154	1.75	74LS241	95	74LS241	95	LM534H	1.25
74LS105	24	74LS87	50	74LS154	1.75	74LS241	95	74LS241	95	LM535	85
74LS106	24	74LS88	50	74LS154	1.75	74LS241	95	74LS241	95	LM538	1.10
74LS107	24	74LS89	85	74LS154	1.75	74LS241	95	74LS241	95	LM538A	1.85
74LS108	24	74LS90	89	74LS154	1.75	74LS241	95	74LS241	95	LM538B	1.40
74LS109	24	74LS91	85	74LS154	1.75	74LS241	95	74LS241	95	LM531	1.95
74LS110	24	74LS92	50	74LS154	1.75	74LS241	95	74LS241	95	LM555	27
74LS111	24	74LS93	50	74LS154	1.75	74LS241	95	74LS241	95	LM556	1.10
74LS112	24	74LS94	50	74LS154	1.75	74LS241	95	74LS241	95	LM558	2.45
74LS113	24	74LS95	65	74LS154	1.75	74LS241	95	74LS241	95	LM565	95
74LS114	24	74LS96	89	74LS154	1.75	74LS241	95	74LS241	95	LM568	1.45
74LS115	24	74LS97	89	74LS154	1.75	74LS241	95	74LS241	95	LM703	75
74LS116	24	74LS98	38	74LS154	1.75	74LS241	95	74LS241	95	LM709	40
74LS117	24	74LS99	38	74LS154	1.75	74LS241	95	74LS241	95	LM710	75
74LS118	24	74LS100	38	74LS154	1.75	74LS241	95	74LS241	95	LM711	45
74LS119	24	74LS101	38	74LS154	1.75	74LS241	95	74LS241	95	LM720	1.75
74LS120	24	74LS102	38	74LS154	1.75	74LS241	95	74LS241	95	LM723	35
74LS121	24	74LS103	38	74LS154	1.75	74LS241	95	74LS241	95	LM741-8	95
74LS122	24	74LS104	38	74LS154	1.75	74LS241	95	74LS241	95	LM741N-14	35
74LS123	24	74LS105	38	74LS154	1.75	74LS241	95	74LS241	95	LM747	65
74LS124	24	74LS106	38	74LS154	1.75	74LS241	95	74LS241	95	LM775	25
74LS125	24	74LS107	38	74LS154	1.75	74LS241	95	74LS241	95	LM780	1.60
74LS126	24	74LS108	38	74LS154	1.75	74LS241	95	74LS241	95	LM789	1.75
74LS127	24	74LS109	38	74LS154	1.75	74LS241	95	74LS241	95	LM789A	1.75
74LS128	24	74LS110	38	74LS154	1.75	74LS241	95	74LS241	95	LM789B	1.75
74LS129	24	74LS111	38	74LS154	1.75	74LS241	95	74LS241	95	LM789C	1.75
74LS130	24	74LS112	38	74LS154	1.75	74LS241	95	74LS241	95	LM789D	1.75
74LS131	24	74LS113	38	74LS154	1.75	74LS241	95	74LS241	95	LM789E	1.75
74LS132	24	74LS114	38	74LS154	1.75	74LS241	95	74LS241	95	LM789F	1.75
74LS133	24	74LS115	38	74LS154	1.75	74LS241	95	74LS241	95	LM789G	1.75
74LS134	24	74LS116	38	74LS154	1.75	74LS241	95	74LS241	95	LM789H	1.75
74LS135	24	74LS117	38	74LS154	1.75	74LS241	95	74LS241	95	LM789I	1.75
74LS136	24	74LS118	38	74LS154	1.75	74LS241	95	74LS241	95	LM789J	1.75
74LS137	24	74LS119	38	74LS154	1.75	74LS241	95	74LS241	95	LM789K	1.75
74LS138	24	74LS120	38	74LS154	1.75	74LS241	95	74LS241	95	LM789L	1.75
74LS139	24	74LS121	38	74LS154	1.75	74LS241	95	74LS241	95	LM789M	1.75
74LS140	24	74LS122	38	74LS154	1.75	74LS241	95	74LS241	95	LM789N	1.75
74LS141	24	74LS123	38	74LS154	1.75	74LS241	95	74LS241	95	LM789O	1.75
74LS142	24	74LS124	38	74LS154	1.75	74LS241	95	74LS241	95	LM789P	1.75
74LS143	24	74LS125	38	74LS154	1.75	74LS241	95	74LS241	95	LM789Q	1.75
74LS144	24	74LS126	38	74LS154	1.75	74LS241	95	74LS241	95	LM789R	1.75
74LS145	24	74LS127	38	74LS154	1.75	74LS241	95	74LS241	95	LM789S	1.75
74LS146	24	74LS128	38	74LS154	1.75	74LS241	95	74LS241	95	LM789T	1.75
74LS147	24	74LS129	38	74LS154	1.75	74LS241	95	74LS241	95	LM789U	1.75
74LS148	24	74LS130	38	74LS154	1.75	74LS241	95	74LS241	95	LM789V	1.75
74LS149	24	74LS131	38	74LS154	1.75	74LS241	95	74LS241	95	LM789W	1.75
74LS150	24	74LS132	38	74LS154	1.75	74LS241	95	74LS241	95	LM789X	1.75
74LS151	24	74LS133	38	74LS154	1.75	74LS241	95	74LS241	95	LM789Y	1.75
74LS152	24	74LS134	38	74LS154	1.75	74LS241	95	74LS241	95	LM789Z	1.75
74LS153	24	74LS135	38	74LS154	1.75	74LS241	95	74LS241	95	LM789AA	1.75
74LS154	24	74LS136	38	74LS154	1.75	74LS241	95	74LS241	95	LM789AB	1.75
74LS155	24	74LS137	38	74LS154	1.75	74LS241	95	74LS241	95	LM789AC	1.75
74LS156	24	74LS138	38	74LS154	1.75	74LS241	95	74LS241	95	LM789AD	1.75
74LS157	24	74LS139	38	74LS154	1.75	74LS241	95	74LS241	95	LM789AE	1.75
74LS158	24	74LS									

# SPARTAN Electronics Inc.



CALL MAIL  
(516) 499-9500  
6094 Jericho Tpke.  
Commack, N.Y. 11725

CTC9R

## Philips Remote Cable Converter

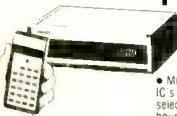

\$139.95

• Micro computer technology • Quartz controlled IC's lock in picture & prevent drift • 60 channel selections • Programmable time on & off • 24 hour LED digital clock • Favorite channel memory & recall plus scan • Wireless hand held "infra-red" transmitter system • Automatic line tune • Adaptable to any brand television • One year warranty service

## CABLE TV ACCESSORIES

2 set coupler	2.95
3 set coupler	3.95
4 set coupler	4.50
F Connectors	.25
Matching transformer	.99
TV Game Switch	3.95
VHF-UHF AMP-28DB	29.95

## 2-WAY SWITCH for



printers, modems,  
& computers  
(RS232)

\$119.95

## SGL WABER

\$35.95

Protect your computer and electronic equipment from voltage spikes

DG115P

DG115S  
(6 Outlet)  
\$45.95



## SCOTCH DISKETTES



5 1/4 SSDD Soft Box 10 \$29.95  
5 1/4 DSDD Soft Box 10 \$39.95

## REFURBISHED MONITORS

9", 12", Commercial Grade  
as low as \$49.95



## 1500 Feet Cordless Phone \$229.95



10 KM (6 miles) Cordless  
Phone for Export Use Only  
\$325.00

## BECKMAN CIRCUITMATE 20

8 functions and 30 ranges - Diode/transistor test function - auto-polarity, auto-zero, and auto-decimal - 10 Amps AC and DC Current Capability - Transistor Gain Test (hFE) - Conductance



\$64.95

## Jerrold 36 Channel Remote CATV Converter

w/on/off Fine Tuning \$94.95  
58 Channel Wireless \$109.95

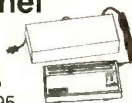

## 40 Channel VHF to UHF Block Converter



28.95 Ea.  
24.95 4 & up

Deluxe Version - Features fine tuning knob, matching X former & 2 cables \$38.95

## Volume Discounts

Dealers Welcome

Min. Order \$25.00		
International shipping Add'l.	to 75.00	\$2.50
Prices subject to change without notice	76.00 to 250.00	\$4.50
COD 2.00 Extra	251.00 to 500.00	\$6.00
Add'l. shipping for monitors	501.00 to 750.00	\$8.50
	751.00 to 1000.00	\$12.00
	Over 1000.00	\$12.50

(516) Mon Th Tu W F Sa  
499-9500 9-8 9-6 9:30-5

CIRCLE 47 ON FREE INFORMATION CARD

# ADVERTISING INDEX

RADIO-ELECTRONICS does not assume any responsibility for errors that may appear in the index below.

Free Information Number	Page		Page	
62	Abex	100	52 PAIA Electronics Inc	77
3	Active Electronic Sales Corp	115	93 Paladin	28
—	Advance Electronics	31	9 Phillips-Tech Electronics	130
80	Advanced Computer Products	125	Radio-Electronics Bookstore	81
73	All Electronics Corp	111	86 Radio Shack	109
51	AMC Sales	102	79 Ramsey Electronics Inc	121
56	AP Products	111	27 R. F. Electronics	119
14	Appliance Service News	101	32 Sams Books	83
89	Arizona Electronic Surplus	119	25 SCR Electronics Center	110
60	BBC Metrawatt	Cover II	55 SEI	135
41, 78	Beckman Instruments	Cover III, 40	70, 71 Sencore	1
67	Beta Electronics	116	— Simple Simon Electronic Kits Inc	73
—	Binary System	98	91 Simpson Electric Company	24
42	BK Precision Dynascan Corp	9	82 Sintec Company	30
17	Bondhus Corp	28	24 SJB Distributors Inc	133
—	CD Electronics Inc	119	— Solder Absorbing Technology Inc	100
34	Chaney Electronics Inc	118	69 Solder Craft	118
—	CIE, Cleveland Institute of Electronics Inc	34-37	23 Solid State Sales	110
44	Circuit Specialists Inc	115	28 Sony	20
2, 21	Communications Electronics	2, 21	57 Space Age Video Dist Inc	79
88	Components Express Inc	120	47 Spartan Electronics Inc	136
68	Computer Products	120	72 Symmetric Sound Systems	101
—	Peripherals Unitd	120	98 Sunnex Inc	100
7	Concord Computer Products	135	38 Taft Electronics	94
48	Consolidated Electronics Inc	38	8 Technical Electronics	136
—	Daetron	130	74 Tektronix	7
39	Digi-Key Corp	122, 123	30 Tinker Tron	91
—	Digitron Electronic	124	43 Triton Mkt Corp	33
53	Direct Video Sales	39	18 Ungar	Cover IV
99	Dokay Computer Products Inc	117	15 Video Engineering Supply Co	77
59	EICO	77	19 Wahl Clipper	81
5	Electra Company	29	13 Westech	131
45	Electronic Rainbow	41	95 Wersi	83
6	Electronic Specialists Inc	135	26 Wm B Allen Supply	132
—	Electronic Technology Today Inc	79, 134		
33	Electronics Book Club	25		
10	Etronix	89		
40	Firestick Antenna Company	91		
—	Fordham Radio	13, 15, 22		
76	Formula International Inc	114		
21	Gamma Electronics	120		
84	Gilco International Inc	124		
—	Gladstone	92		
31	Global Specialties Corp	23		
—	Grantham College of Engineering	92		
—	Graymark Inc	118		
75	Hal-tronix	135		
16	Heath Company	5		
85	Hickok	79		
—	ICS Computer Training	91		
94	Illinois Audio	91		
20	Jameco Electronics	112, 113		
29	Javanco	124		
49	JDR Microdevices Inc	126-129		
97	Jensen Tools Inc	100		
11	Jim-Pac Electronic Components	26, 27		
46	Kalglo Electronics Company Inc	79		
83	KCS Electronics Corp	130		
36	Keithly Instruments Inc	42		
—	McGraw-Hill Book Clubs	102-105		
35	MCM	119		
66	MFJ Enterprises Inc	110		
12	Micro-Mart	130		
—	Monarchy Engineering Inc	118		
77	Morrow	96, 97		
—	Netronics R D Ltd	39		
90	Network Sales Inc	115		
—	New Horizons	75		
—	NRI Schools	16-19		
—	NTS Schools	84-87		
61	OEM Distributing Company	100, 101		
37, 100	Ora Electronics	32, 100, 101		
58	Pacific I	100		

# TEK-EL

TECHNICAL ELECTRONICS,  
YOUR SUPPLY SOURCE  
WITH BARGAINS LIKE THESE:

## RECHARGEABLE AA CELL



Standard AA nickel cadmium rechargeable battery.  
Stock No. 16-2379 \$ .95 ea.

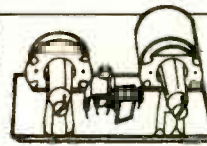

## AUDIO AMP

Complete audio amp includes volume/on-off and tone controls.

Requires 6-9 VDC. Just the thing for PA systems, record players, or intercoms!

Stock No. 36-3023 \$4.95 ea.

## 4" SOLAR CELL

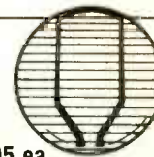

1 amp at .5 volts at an unbelievably low price!

Stock No. 47-3029 \$5.95 ea.

ORDER TODAY! VISA, MASTERCARD & COD accepted for phone orders. Please add \$3.00 for UPS ground. Satisfaction guaranteed. Call or write for your FREE CATALOG!

## TECHNICAL ELECTRONICS

Dept. J P.O. Box 2361  
Woburn, MA 01888 (617) 935-1717

CIRCLE 8 ON FREE INFORMATION CARD



# The Workaholics.

Beckman DMMs stay on the job when others call it quits. They're a hard-nosed breed of 3½ digit hand-held multimeters you can always count on for outstanding performance.

## Staying power

Beckman DMMs work up to 2000 hours on a common 9V battery. That's ten times longer than other DMMs. And to prevent burnout on the job, Beckman DMMs can withstand 1500 Vdc loads and 6kV transients. Current ranges are protected with a 2A/250V fuse, and resistance ranges are protected up to 500 Vdc.

## Easy to work with

No matter how hard they work, they're never hard to work with. Their single rotary switch makes function and range selection simple and sure. For your added convenience, most Beckman DMMs have built-in 10-Amp capability and Insta-ohms® continuity indication. That means you never have to carry an accessory shunt or wait for a continuity check.

SELECTION CHART

MODEL	SPECIAL FEATURES	BASIC DC ACCURACY	INSTA-OHMS®	10 AMPS	SUGGESTED RETAIL PRICE (U.S.)
Tech 300	Basic six functions	0.5%			\$120
Tech 310	Added features	0.25%	✓	✓	145
Tech 310UL	UL-listed	0.25%	✓	✓	155
Tech 320B	Audible continuity beeper	0.1%	✓	✓	189
Tech 330	High accuracy & true RMS (AC & DC)	0.1%	✓	✓	219
HD-100	Heavy duty (drop-proof, contamination-proof)	0.25%	✓		169
HD-110	Heavy duty, plus 10 Amps	0.25%	✓	✓	189

And to make sure that the job is done right the first time, Beckman DMMs have superior RF shielding, and an impressive 22 Meg-ohm input impedance that reduces circuit loading to ensure accurate readings.

No matter how much the job demands, you can count on Beckman DMMs to see you through.

There's a Beckman DMM just right for every application. Use the selection chart to find the model best for you.

For a closer look at the workaholics, see your local Beckman distributor today. To locate the one nearest you, call or write Beckman Instruments, Inc., Instrumentation Operations, 210 S. Ranger Street, Brea, CA 92621. (714) 993-8803.

# BECKMAN

CIRCLE 41 ON FREE INFORMATION CARD

UNGAR®

# The Professionals' Choice.

Introducing Ungar's New Lightweight Heat Gun For Heavyweight Jobs.

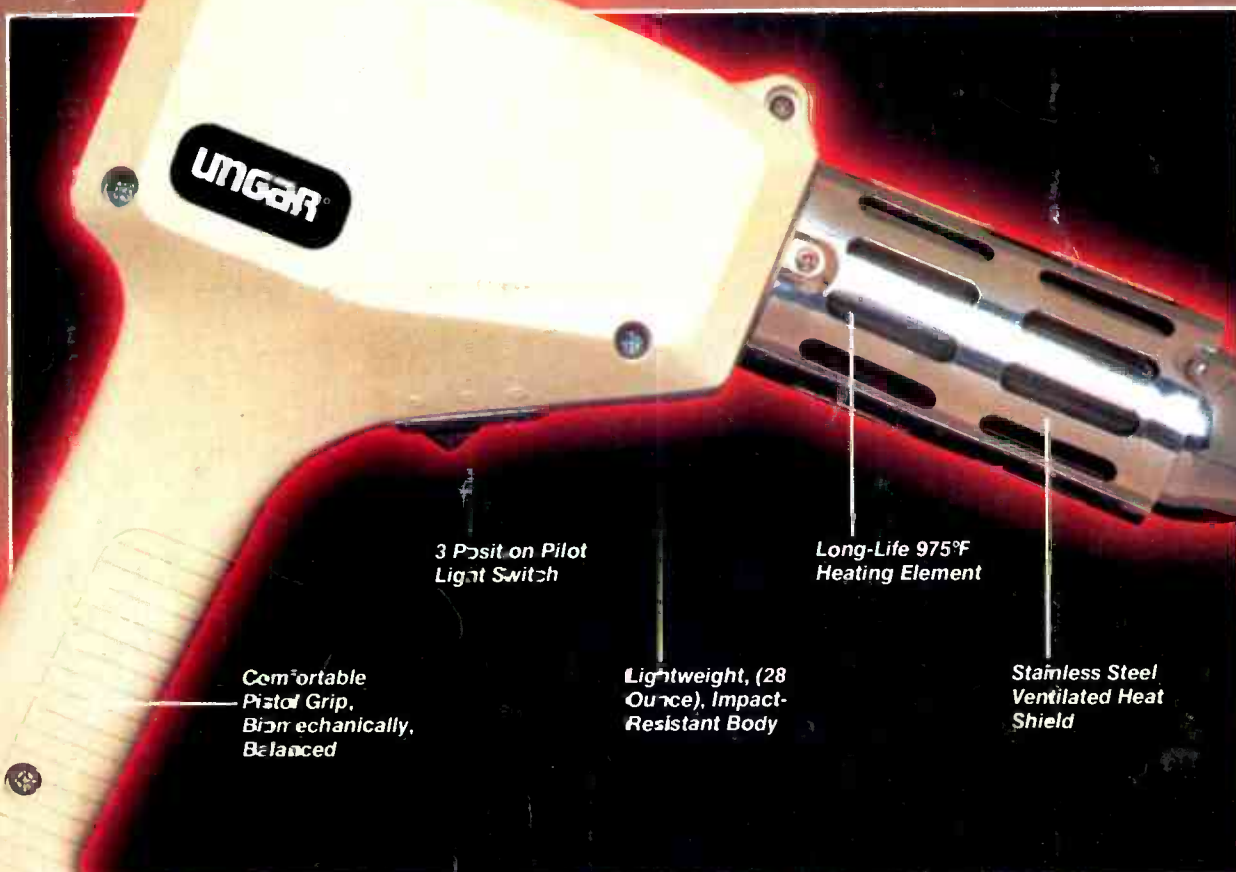

Comfortable Pistol Grip, Built Mechanically, Balanced

3 Position Pilot Light Switch

Lightweight, (28 Ounces), Impact-Resistant Body

Long-Life 975°F Heating Element

Stainless Steel Ventilated Heat Shield



Cure Thermoset Adhesives



Shrink Tubing



Heat Liquids



Form Plastics



Peel Paint

At Ungar, we've designed the ultimate heat gun for the hard-working pro. Feature for feature, no other heat gun can make your job quicker, easier or safer.

To begin with, our new 6977 is the lightest heat gun of its kind (28 ounces). You can use it for hours on end with maximum control and minimum fatigue. The contoured handle provides a firm grip and remains cool at all times.

The 6977 is a high-temp, high air volume heat gun with power

for the heaviest jobs. It delivers 975°F to the nozzle in seconds and is perfect for curing adhesives, forming plastics, shrinking tubing, peeling paint and just about any other tough job you'll ever run across.

And the 6977 can take it in the real world. The body is made of rugged, impact-resistant Valox® 855. It features a proven, reliable high-rpm motor for low noise operation, long-life heating element and a 6-foot, 3-conductor ground cord.

A wide range of optional attachments can provide additional versatility. The new Ungar 6977 heat gun... light years ahead of the competition, is Underwriter's Laboratory, Inc. listed. For more information, contact your local Ungar distributor or call Ungar in California 1-213-774-5950.

**UNGAR®**

Division of Eldon Industries, Inc.  
Compton, California 90220

CIRCLE 18 ON FREE INFORMATION CARD